

2012 Civic Sedan

Online Reference Owner's Manual

This owner's manual should be considered a permanent part of the vehicle and should remain with the vehicle when it is sold.

This owner's manual covers all models of the Civic 4-Door. You may find descriptions of equipment and features that are not on your particular model.

Images throughout this owner's manual (including the front cover) represent features and equipment that are available on some, but not all, models. Your particular model may not have some of these features.

This owner's manual is for vehicles sold in the United States and Canada.

The information and specifications included in this publication were in effect at the time of approval for printing. Honda Motor Co., Ltd. reserves the right, however, to discontinue or change specifications or design at any time without notice and without incurring any obligation.

Navigation Key

QRG	Quick Reference Guide
TOC	Chapter Table of Contents
Index	Index
Home	Book Table of Contents

➤ Safe Driving P. 23

For Safe Driving P. 24 Seat Belts P. 28 Airbags P. 35

➤ Instrument Panel P. 65

Indicators P. 66 Gauges and Displays P. 78

➤ Controls P. 97

Setting the Clock P. 98 Locking and Unlocking the Doors P. 99
Opening and Closing the Moonroof* P. 116
Adjusting the Seats P. 126

➤ Features P. 143

Audio System* P. 144 Audio System Basic Operation* P. 147
Bluetooth® HandsFreeLink®* P. 177

➤ Driving P. 201

Before Driving P. 202 Towing a Trailer P. 207
Refueling P. 234 Fuel Economy P. 237

➤ Maintenance P. 239

Before Performing Maintenance P. 240 Maintenance Minder™ P. 243
Checking and Maintaining Wiper Blades P. 278
Heating and Cooling* System Maintenance P. 291

➤ Handling the Unexpected P. 297

Tools P. 298 If a Tire Goes Flat P. 299
Overheating P. 311 Indicator, Coming On/Blinking P. 313

➤ Information P. 323

Specifications P. 324 Identification Numbers P. 328
Emissions Testing P. 331 Warranty Coverages P. 333

Contents

2012 Civic Sedan

Child Safety P. 50

Exhaust Gas Hazard P. 62

Safety Labels P. 63

Opening and Closing the Trunk P. 109

Security System P. 112

Opening and Closing the Windows P. 114

Operating the Switches Around the Steering Wheel P. 117

Adjusting the Mirrors P. 125

Interior Lights/Interior Convenience Items P. 134

Heating and Cooling* P. 140

Audio Error Messages* P. 172

General Information on the Audio System* P. 174

When Driving P. 211

Braking P. 229

Parking Your Vehicle P. 233

Accessories and Modifications P. 238

Maintenance Under the Hood P. 251

Replacing Light Bulbs P. 268

Checking and Maintaining Tires P. 280

Battery P. 289

Remote Transmitter Care* P. 290

Cleaning P. 292

Engine Does Not Start P. 306

Jump Starting P. 307

Shift Lever Does Not Move P. 310

Fuses P. 318

Emergency Towing P. 321

Devices that Emit Radio Waves P. 329

Reporting Safety Defects P. 330

Authorized Manuals P. 335

Customer Service Information P. 336

Quick Reference Guide P. 2

Safe Driving P. 23

Instrument Panel P. 65

Controls P. 97

Features P. 143

Driving P. 201

Maintenance P. 239

Handling the Unexpected P. 297

Information P. 323

Index P. 337

* Not available on all models

Visual Index

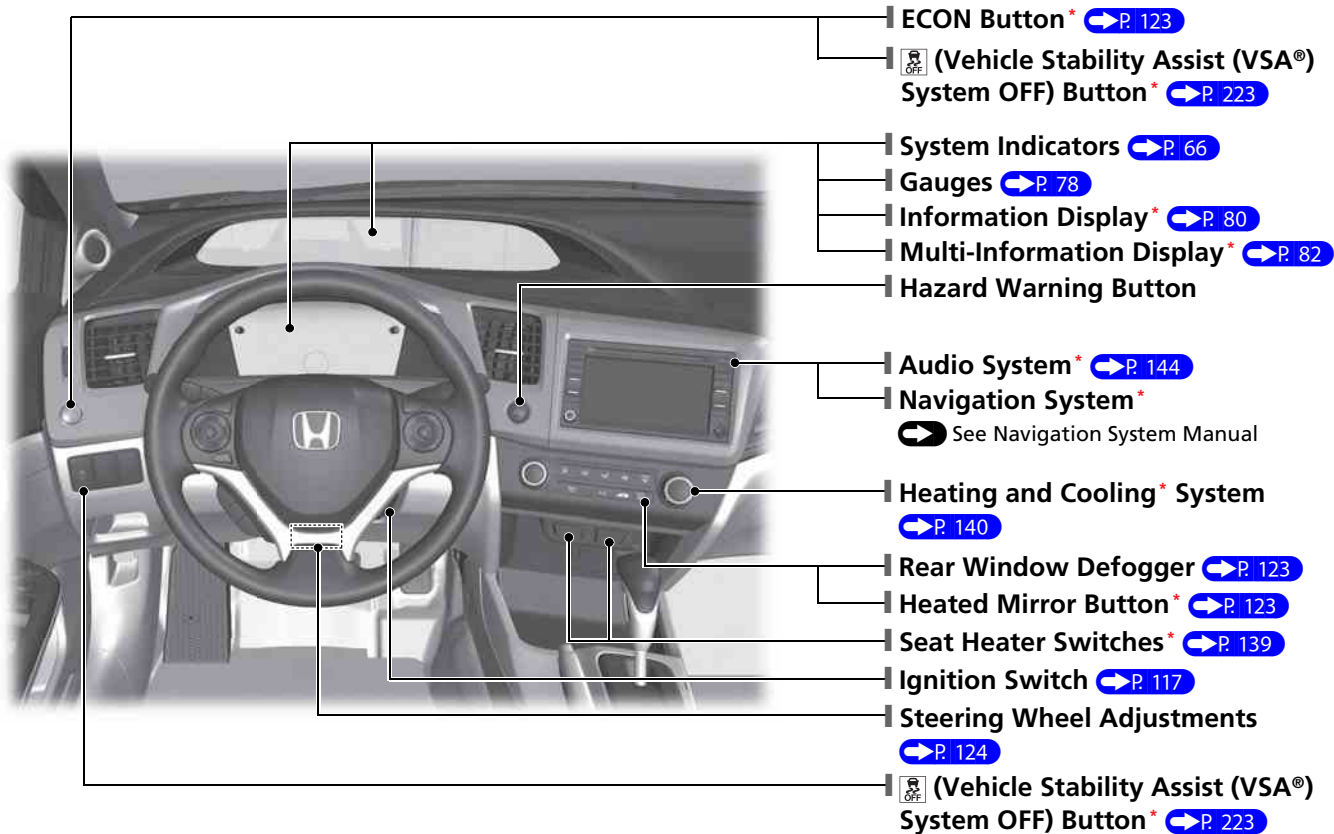

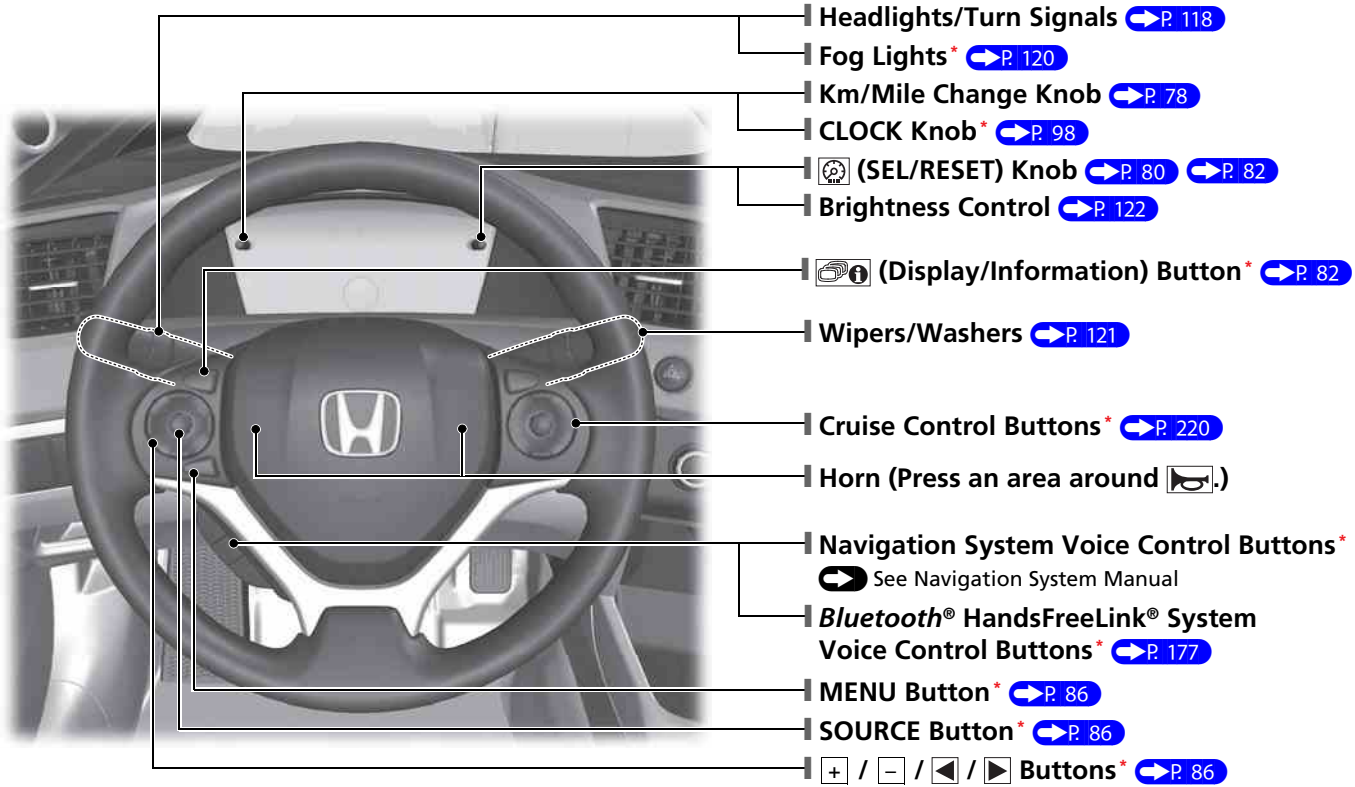

Headlights/Turn Signals ➔ P. 118

Fog Lights* ➔ P. 120

Km/Mile Change Knob ➔ P. 78

CLOCK Knob* ➔ P. 98

(SEL/RESET) Knob ➔ P. 80 ➔ P. 82

Brightness Control ➔ P. 122

(Display/Information) Button* ➔ P. 82

Wipers/Washers ➔ P. 121

Cruise Control Buttons* ➔ P. 220

Horn (Press an area around [Horn icon])

Navigation System Voice Control Buttons*
 See Navigation System Manual

Bluetooth® HandsFreeLink® System
 Voice Control Buttons* ➔ P. 177

MENU Button* ➔ P. 86

SOURCE Button* ➔ P. 86

+ / - / ◀ / ▶ Buttons* ➔ P. 86

Visual Index

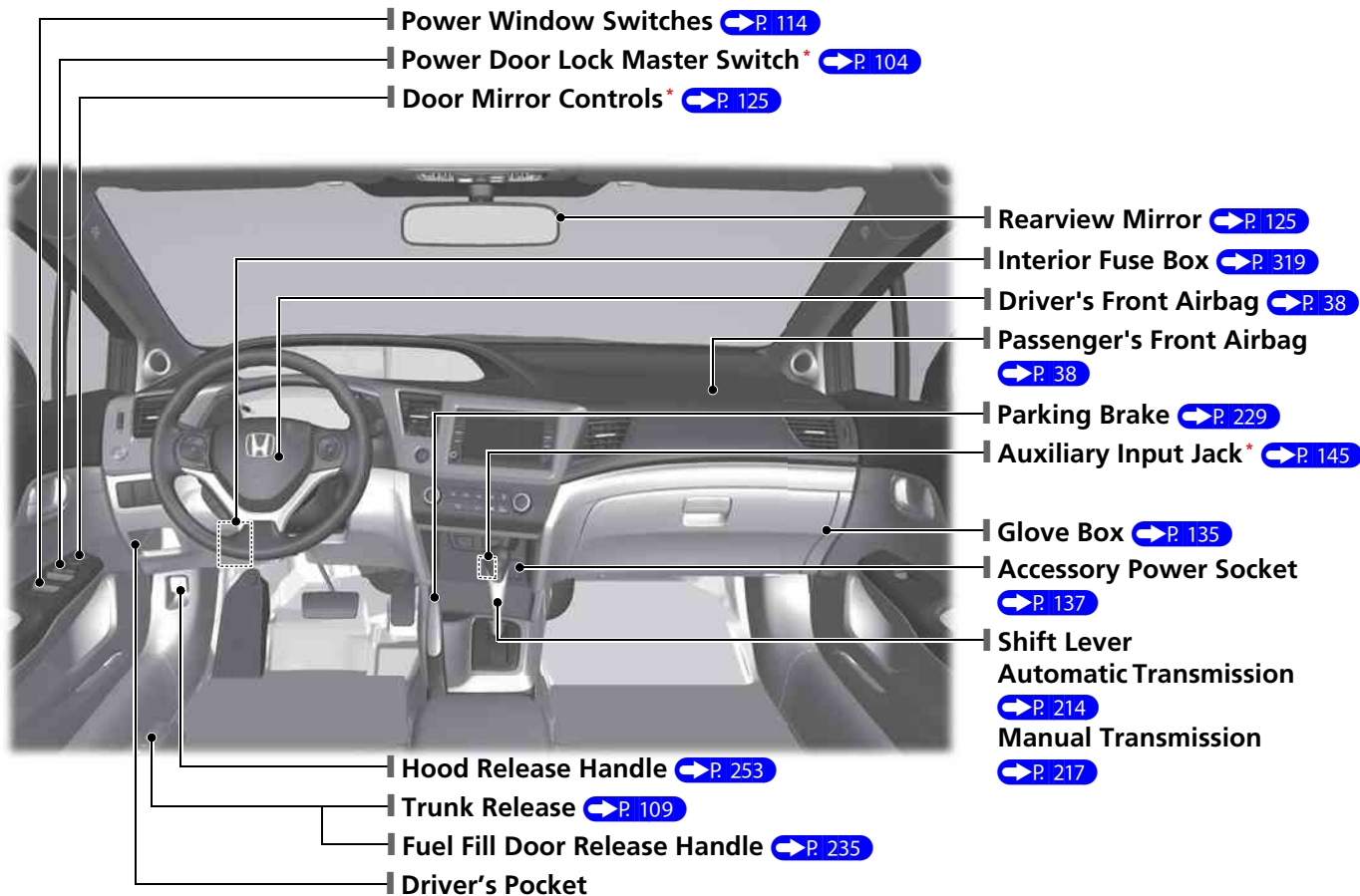

* Not available on all models

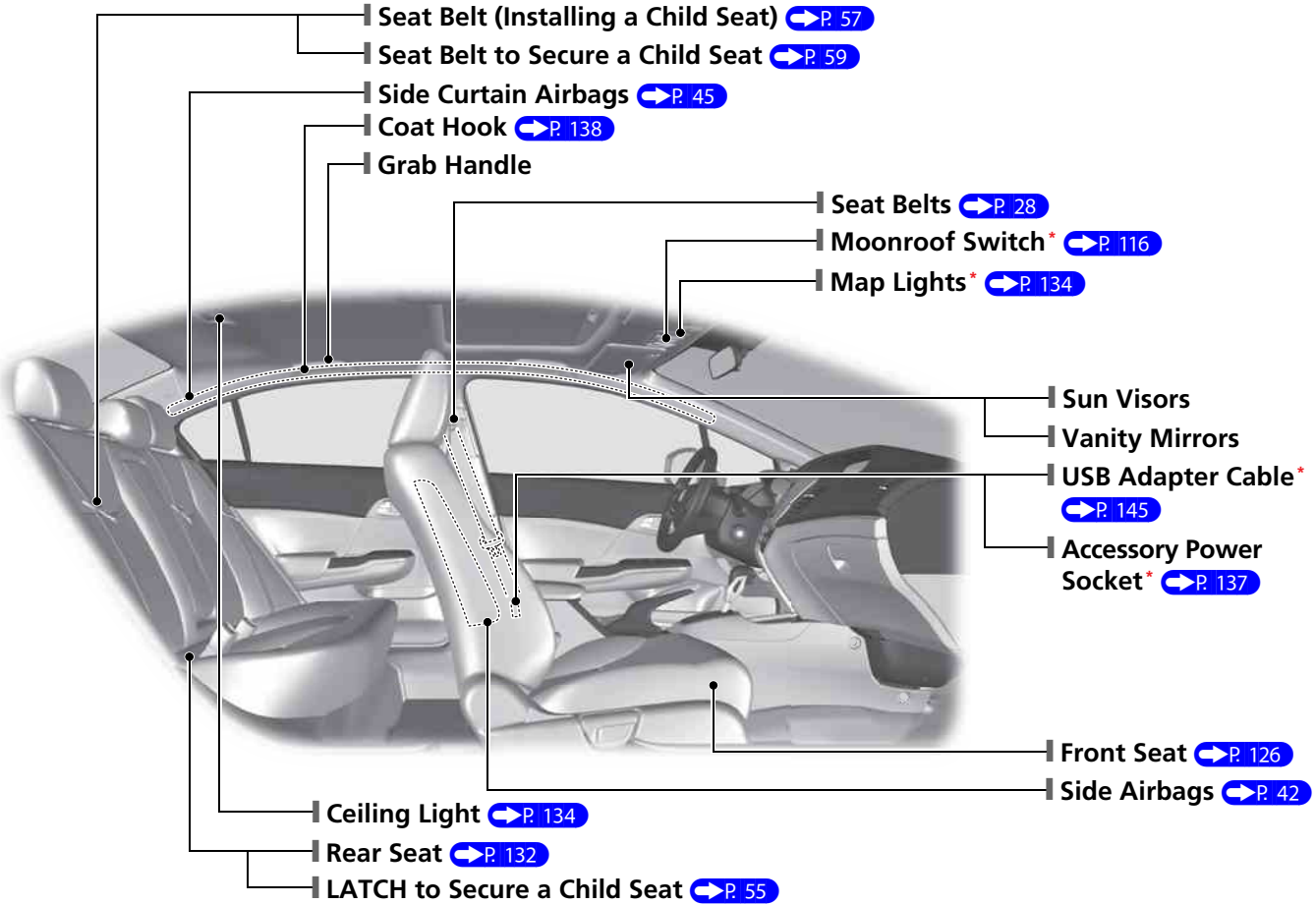

Visual Index

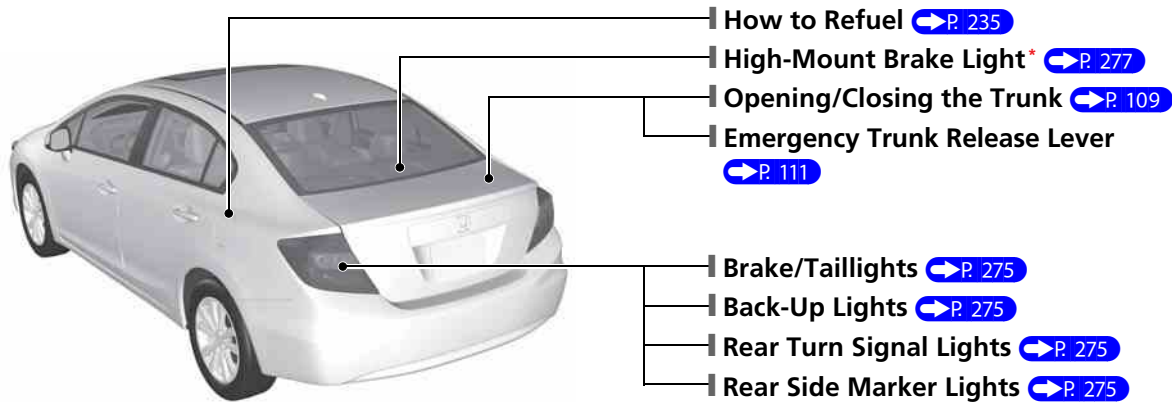
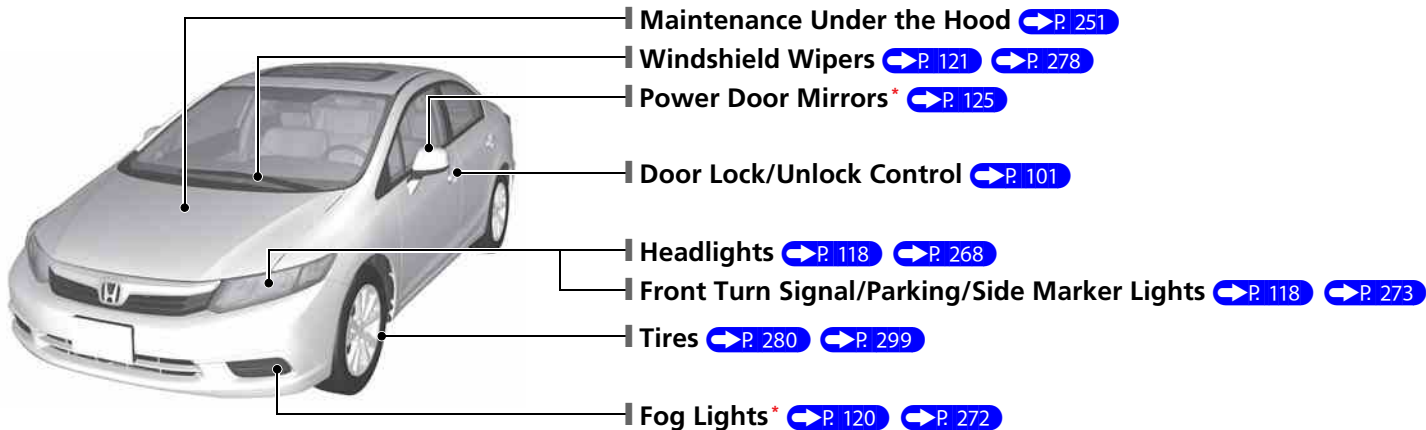

Eco Assist System* P. 123

Ambient Meter

- Changes color to reflect your driving style.
Green: Fuel efficient driving
Blue green: Moderate acceleration/ deceleration
Blue: Aggressive acceleration/ deceleration
- The ambient meter color changes in accordance with your brake or accelerator pedal operation.

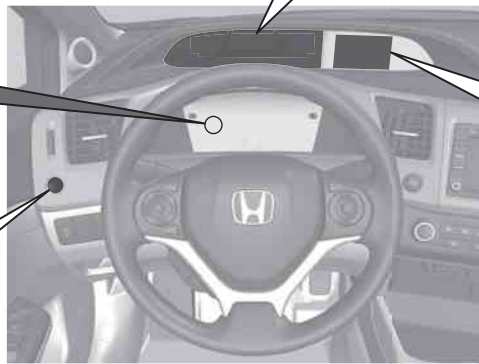

ECON Button P. 123

Helps maximize fuel economy.

ECON Mode Indicator P. 75

Comes on when the ECON button is pressed.



Models with multi-information display

This message is displayed for a few seconds when the ECON button is pressed.

Safe Driving [➔ P. 23](#)

Airbags [➔ P. 35](#)

- Your vehicle is fitted with airbags to help protect you and your passengers during a moderate-to-severe collision.

Child Safety [➔ P. 50](#)

- All children 12 and younger should be seated in the rear seat.
- Smaller children should be properly restrained in a forward-facing child seat.
- Infants must be properly restrained in a rear-facing child seat.

Exhaust Gas Hazard [➔ P. 62](#)

- Your vehicle emits dangerous exhaust gases that contain carbon monoxide. Do not run the engine in confined spaces where carbon monoxide gas can accumulate.

Seat Belts [➔ P. 28](#)

- Fasten your seat belt and sit upright well back in the seat.
- Check that your passengers are wearing their seat belts correctly.

Before Driving Checklist [➔ P. 27](#)

- Before driving, check that the front seats, head restraints, steering wheel, and mirrors have been properly adjusted.

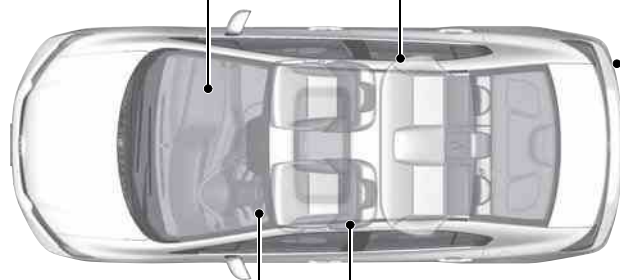











Fasten your lap belt as low as possible.

Instrument Panel ➔ P. 65



Gauges ➔ P. 78 / Information Display* ➔ P. 80 /
Multi-Information Display* ➔ P. 82 / System Indicators ➔ P. 66

System Indicators

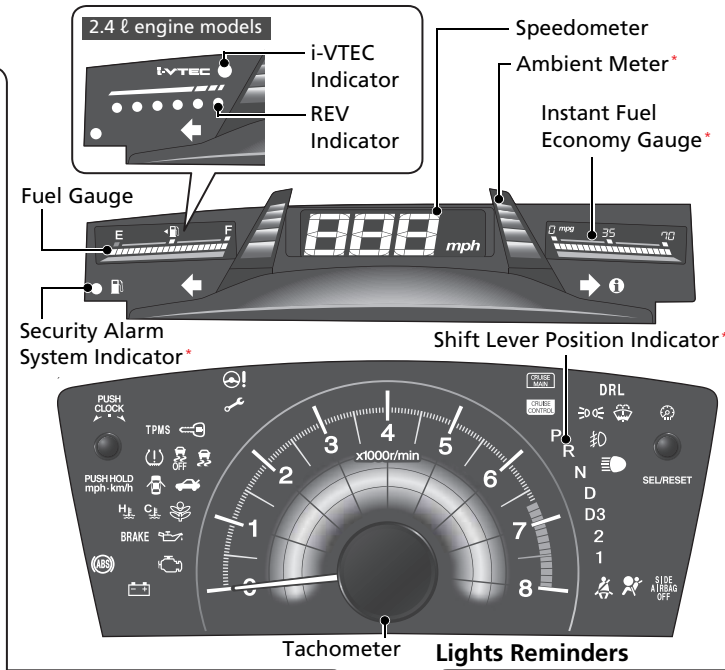













-  Malfunction Indicator Lamp
 -  Low Oil Pressure Indicator
 -  Charging System Indicator
 -  Anti-lock Brake System (ABS) Indicator
 -  Vehicle Stability Assist (VSA®) System Indicator
 -  VSA® OFF Indicator
 -  Door Open Indicator
 -  Trunk Open Indicator
 -  ECON Mode Indicator*
 -  Immobilizer System Indicator
 -  Parking Brake and Brake System Indicator
- Canada



- TPMS** TPMS Indicator*
Low Tire Pressure Indicator* /
Low Tire Pressure/TPMS Indicator*

-  Lights On Indicator
-  High Beam Indicator
-  Fog Light Indicator*

System Indicators

-  Turn Signal and Hazard Warning Indicators
-  Electric Power Steering (EPS) Indicator
-  High Temperature Indicator
-  Low Temperature Indicator
-  Low Fuel Indicator
-  Seat Belt Reminder Indicator
-  Supplemental Restraint System Indicator
-  Side Airbag Off Indicator
-  Cruise Main Indicator*
-  Cruise Control Indicator*
-  System Message Indicator*
-  Maintenance Minder Indicator*
-  Daytime Running Lights Indicator*
-  Washer Level Indicator*

* Not available on all models

Controls ➔ P. 97

Turn Signals ➔ P. 118

Turn Signal Control Lever

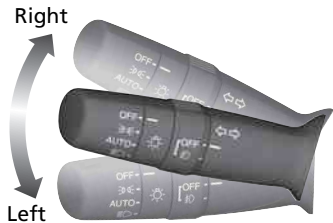

Lights ➔ P. 118

Light Control Switches

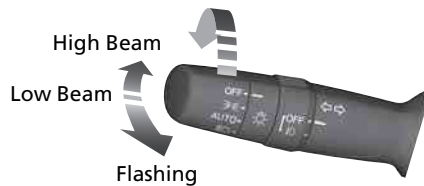

Wipers and Washers ➔ P. 121

Wiper/Washer Control Lever

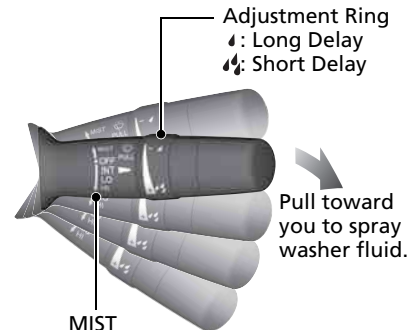

- MIST
- OFF
- INT: Low speed with intermittent
- LO: Low speed wipe
- HI: High speed wipe

Steering Wheel P. 124

- To adjust, pull the adjustment lever towards you, adjust to the desired position, then lock the lever back in place.

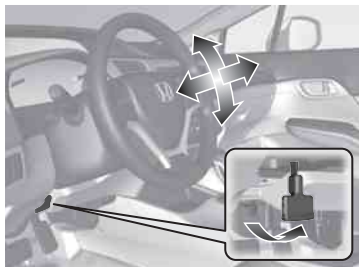

Unlocking the Front Doors from the Inside

 P. 103

- Pull either front door inner handle to unlock and open it at the same time.



Trunk P. 109

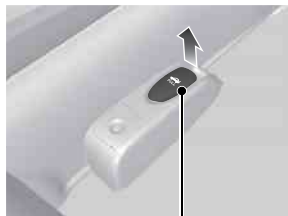

Trunk Release

- To unlock and open the trunk:
 - Pull the trunk release.
 - Press the trunk release button*.
 - Turn the key in the cylinder on the trunk*.

Power Door Mirrors*

 P. 125

- With the ignition switch in ON , move the selector switch to L or R.
- Push the appropriate edge of the adjustment switch to adjust the mirror.

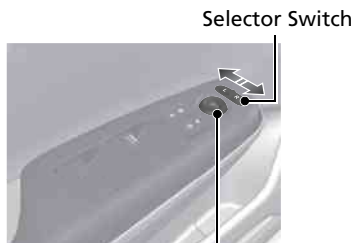

Adjustment Switch

Power Windows P. 114

- With the ignition switch in ON , open and close the power windows.
- If the power window lock button is in the OFF position, each passenger's window can be opened and closed with its own switch.
- If the power window lock button is in the ON position (indicator is on), each passenger's window switch is disabled.

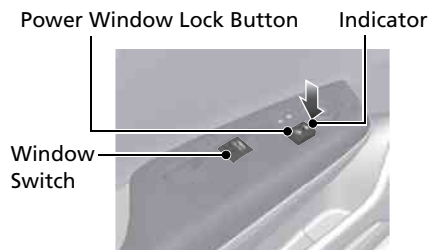

Heating and Cooling* System P. 140

- Rotate the fan control dial to adjust the fan speed and airflow.
- Press the Mode buttons (/ / /) to select the vents air flows from.
- Rotate the temperature control dial to adjust the temperature.
- Use the MAX
A/C button for maximum cool setting.
- Rotate the fan control dial to OFF to turn the system off.
- Press the FRONT
W button to defrost the windshield.

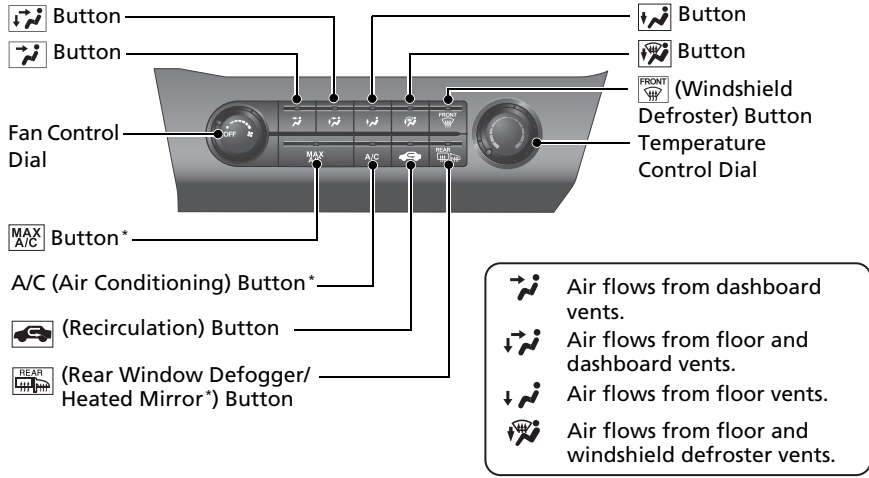

Clock P. 98

Models without navigation system

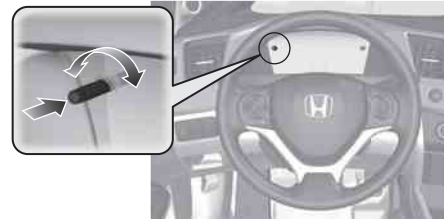

- 1 Press the CLOCK knob to access the clock adjustment mode screen.
- 2 Turn the CLOCK knob to adjust the hours.
- 3 Press the CLOCK knob. The display switches to minute adjustment.
- 4 Turn the CLOCK knob to adjust the minutes.
- 5 Press the CLOCK knob to complete clock adjustment.

Models with navigation system

The navigation system receives signals from GPS satellites, updating the clock automatically.

* Not available on all models

Features [➔ P. 143](#)

Audio system* [➔ P. 144](#) For navigation system operation  See Navigation System Manual

On models with information display [➔ P. 147](#)

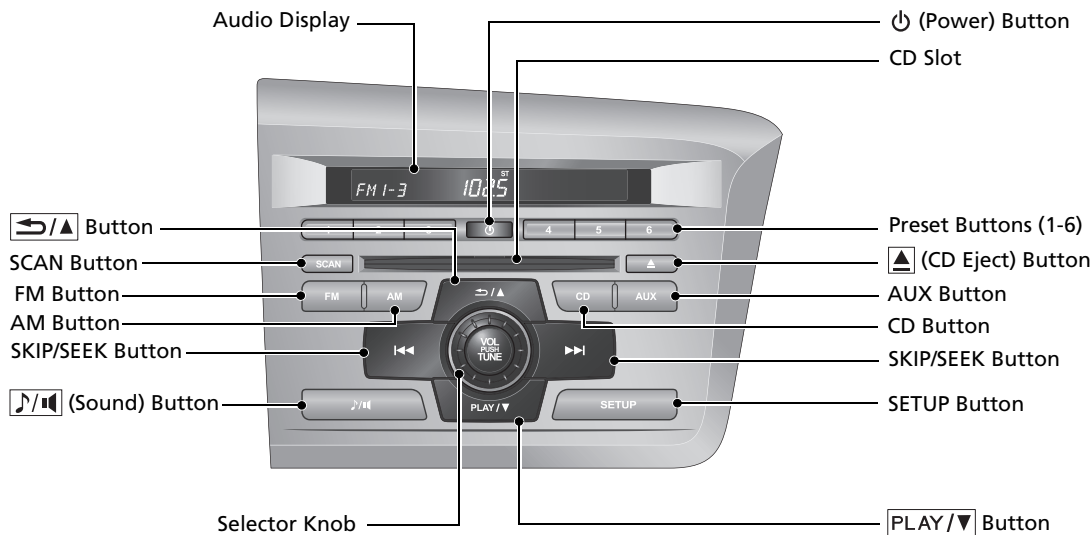

On models with multi-information display [➔ P. 155](#)

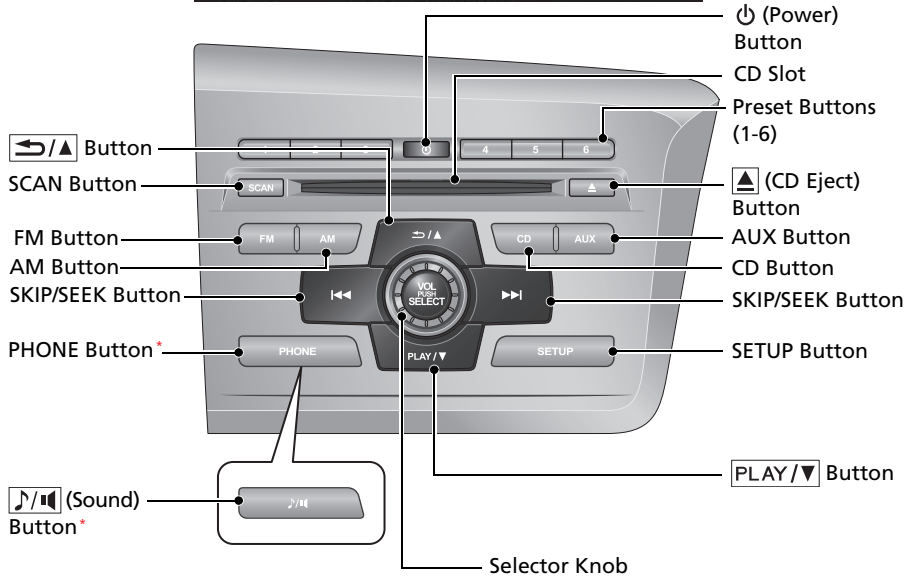

● **Audio Remote Controls*** [➔ P. 156](#)

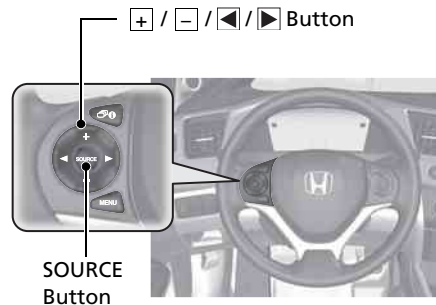

- **+ / - Button**
Press and release to adjust the volume up/down.
- **SOURCE Button**
Press and release to change the audio mode: FM1/FM2/AM/CD/AUX.
- **◀ / ▶ Button**
Radio: Press and release to change the preset station.
Press and hold to select the next or previous strong station.
CD/USB device:
Press and release to skip to the beginning of the next song or return to the beginning of the current song.
Press and hold to change a folder.

Driving ➔ P. 201

Manual Transmission ➔ P. 217

Automatic Transmission ➔ P. 215

- Shift to **P** and depress the brake pedal when starting the engine.

● Shifting

P **Park**
Turn off or start the engine.
Transmission is locked.

R **Reverse**

N **Neutral**
Transmission is not locked.

D **Drive**
Normal driving.

D3 **Drive (D3)**
Used when:
• Going up or down hills
• Towing a trailer in hilly terrain

2 **Second**
Used to increase engine braking
(the transmission is locked in 2nd gear)

1 **First**
Used to further increase engine braking
(the transmission is locked in 1st gear)

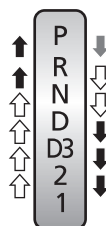
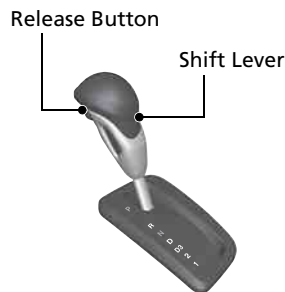

Depress the brake pedal and press the release button to move out of **P**.

Press the release button to move the shift lever.

Move the shift lever without pressing the release button.

VSA® OFF Button P. 224

- The vehicle stability assist (VSA®) system helps stabilize the vehicle during cornering, and helps maintain traction while accelerating on loose or slippery road surfaces.
- VSA® comes on automatically every time you start the engine.
- To turn VSA® on or off, press and hold the button until you hear a beep.

Cruise Control* P. 220

- Cruise control allows you to maintain a set speed without keeping your foot on the accelerator pedal.
- To use cruise control, press the CRUISE button, then press  once you have received the desired speed (above 25 mph or 40 km/h).

Tire Pressure Monitoring System (TPMS) P. 225

U.S. models only

- TPMS monitors tire pressure.
- TPMS is turned on automatically every time you start the engine.

Refueling P. 234

Fuel recommendation: **1.8 L engine models**

Unleaded gasoline with a pump octane number 87 or higher required

2.4 L engine models

Premium unleaded gasoline with a pump octane number 91 or higher recommended

Fuel tank capacity: 13.2 US gal (50 L)

- 1** Push the fuel fill door release handle.
- 2** Turn the fuel fill cap slowly to remove the cap.
- 3** Place the cap in the holder on the fuel fill door.
- 4** After refueling, screw the cap back on until it clicks at least once.

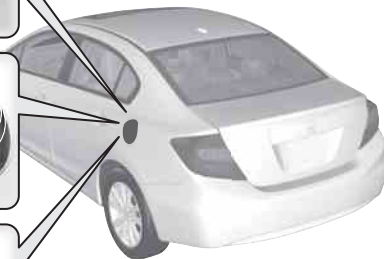
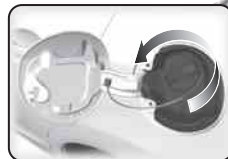
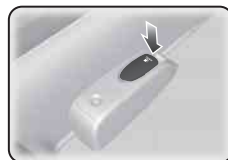

Maintenance [➔ P. 239](#)

Under the Hood [➔ P. 251](#)

- Check engine oil, engine coolant, and windshield washer fluid. Add when necessary.
- Check brake fluid and clutch fluid.
- Check the battery regularly.

- 1** Pull the hood release handle under the corner of the dashboard.



- 2** Locate the hood latch lever, pull the lever up, and lift up the hood.



- 3** When finished, close the hood and make sure it is firmly locked in place.

Wiper Blades [➔ P. 278](#)

- Replace blades if they leave streaks across the windshield.



Tires [➔ P. 280](#)

- Inspect tires and wheels regularly.
- Check tire pressures regularly.
- Install snow tires for winter driving.

Lights [➔ P. 268](#)

- Inspect all lights regularly.

Handling the Unexpected

→ P. 297

Flat Tire → P. 299

- Park in a safe location and replace the flat tire with the compact spare tire in the trunk.



Engine Won't Start

→ P. 306

- If the battery is dead, jump start using a booster battery.

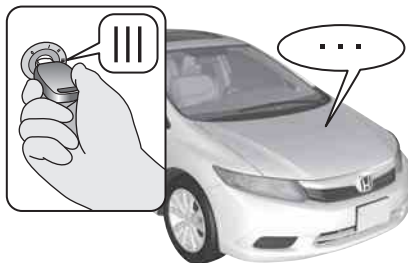

Overheating → P. 311

- Park in a safe location. If you do not see steam under the hood, open the hood, and let the engine cool down.



Indicators Come On

→ P. 313

- Identify the indicator and consult the owner's manual.



Blown Fuse → P. 318

- Check for a blown fuse if an electrical device does not operate.

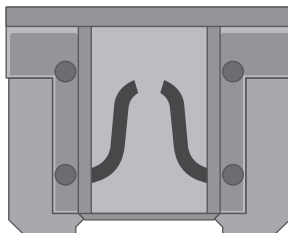

Emergency Towing

→ P. 321

- Call a professional towing service if you need to tow your vehicle.



What to Do If

Q The ignition switch does not turn from **0** to **I**. Why?

A

- The steering wheel may be locked.
- Try to turn the steering wheel left and right while turning the ignition key.



Q The ignition switch does not turn from **I** to **0** and I cannot remove the key. Why?

A The shift lever should be moved to **P**.



Q Why does the brake pedal pulsate slightly when applying the brakes?

A This can occur when the ABS activates, and does not indicate a problem. Apply firm, steady pressure on the brake pedal. Never pump the brake pedal.

Q The rear door cannot be opened from inside the vehicle. Why?

A Check if the childproof lock is in the LOCK position. If so, open the rear door with the outside door handle. To cancel this function, push the lever to the UNLOCK position.



Q **Models with remote transmitter**
Why do the doors lock after I unlocked the doors using a remote transmitter?

A If you do not open the doors within 30 seconds, the doors are relocked automatically for security.

Q **Why does the beeper sound when I open the driver's door?**

A The beeper sounds when:

- The key is left in the ignition switch.
- The exterior lights are left on.

Q **Why does the beeper sound when I start driving?**

A The beeper sounds when:

- Driver and/or front passenger are not wearing their seat belts.
- The parking brake lever is not fully released.

Q **Why do I hear a screeching sound when I apply the brake pedal?**

A The brake pads may need to be replaced. Have your vehicle inspected by a dealer.

Q **2.4 ℓ engine models**
Is it possible to use unleaded gasoline with a Pump Octane Number (PON) of 87 or higher on this vehicle?

A Unleaded gasoline with a PON of 91 or higher is recommended. If premium unleaded gasoline with a PON of 91 or higher is not available, you can temporarily use the gasoline with a PON of 87 or higher. This will result in decreased engine performance, and can cause occasional metallic knocking noise in the engine.

California Proposition 65 Warning

WARNING: This product contains or emits chemicals known to the state of California to cause cancer and birth defects or other reproductive harm.

Event Data Recorders

This vehicle is equipped with an event data recorder (EDR).

The main purpose of an EDR is to record, in certain crash or near crash-like situations, such as an air bag deployment or hitting a road obstacle, data that will assist in understanding how a vehicle's systems performed. **The EDR is designed to record data related to vehicle dynamics and safety systems for a short period of time, typically 30 seconds or less. The EDR in this vehicle is designed to record such data as:**

- **How various systems in your vehicle were operating;**
- **Whether or not the driver and passenger safety belts were buckled/fastened;**
- **How far (if at all) the driver was depressing the accelerator and/or brake pedal; and,**
- **How fast the vehicle was traveling.**

These data can help provide a better understanding of the circumstances in which crashes and injuries occur. NOTE: EDR data are recorded by your vehicle only if a non-trivial crash situation occurs; no data are recorded by the EDR under normal driving conditions and no personal data (e.g., name, gender, age, and crash location) are recorded. However, other parties, such as law enforcement, could combine the EDR data with the type of personally identifying data routinely acquired during a crash investigation.

To read data recorded by an EDR, special equipment is required, and access to the vehicle or the EDR is needed. In addition to the vehicle manufacturer, other parties, such as law enforcement, that have the special equipment, can read the information if they have access to the vehicle or the EDR.

The data belongs to the vehicle owner and may not be accessed by anyone else except as legally required or with the permission of the vehicle owner.

Service Diagnostic Recorders

This vehicle is equipped with service-related devices that record information about powertrain performance. The data can be used to verify emissions law requirements and/or help technicians diagnose and solve service problems. It may also be combined with data from other sources for research purposes, but it remains confidential.

California Perchlorate Contamination Prevention Act

The airbags, seat belt tensioners, and CR type batteries in this vehicle may contain perchlorate materials - special handling may apply. See www.dtsc.ca.gov/hazardouswaste/perchlorate/

As you read this manual, you will find information that is preceded by a **NOTICE** symbol. This information is intended to help you avoid damage to your vehicle, other property, or the environment.

A Few Words About Safety

Your safety, and the safety of others, is very important. And operating this vehicle safely is an important responsibility.

To help you make informed decisions about safety, we have provided operating procedures and other information on labels and in this manual. This information alerts you to potential hazards that could hurt you or others.

Of course, it is not practical or possible to warn you about all the hazards associated with operating or maintaining your vehicle. You must use your own good judgement.

You will find this important safety information in a variety of forms, including:

- **Safety Labels** - on the vehicle.
- **Safety Messages** - preceded by a safety alert symbol  and one of three signal words: **DANGER**, **WARNING**, or **CAUTION**. These signal words mean:

 **DANGER**

You **WILL** be **KILLED** or **SERIOUSLY HURT** if you don't follow instructions.

 **WARNING**

You **CAN** be **KILLED** or **SERIOUSLY HURT** if you don't follow instructions.

 **CAUTION**

You **CAN** be **HURT** if you don't follow instructions.

- **Safety Headings** - such as Important Safety Precautions.
- **Safety Section** - such as Safe Driving.
- **Instructions** - how to use this vehicle correctly and safely.

This entire book is filled with important safety information - please read it carefully.

Safe Driving

You can find many safety recommendations throughout this chapter, and throughout this manual.

For Safe Driving			
Important Safety Precautions	24		
Your Vehicle's Safety Features.....	26		
Seat Belts			
About Your Seat Belts.....	28		
Fastening a Seat Belt.....	31		
Seat Belt Inspection.....	34		
Airbags			
Airbag System Components.....	35		
Types of Airbags	38		
Front Airbags (SRS)	38		
Side Airbags.....	42		
		Side Curtain Airbags..... 45	
		Airbag System Indicators..... 46	
		Airbag Care	49
		Child Safety	
		Protecting Child Passengers	50
		Safety of Infants and Small Children	52
		Safety of Larger Children	60
		Exhaust Gas Hazard	
		Carbon Monoxide Gas.....	62
		Safety Labels	
		Label Locations	63

The following pages explain your vehicle's safety features and how to use them properly. The safety precautions below are ones that we consider to be among the most important.

Important Safety Precautions

■ Always wear your seat belt

A seat belt is your best protection in all types of collisions. Airbags are designed to supplement seat belts, not replace them. So even though your vehicle is equipped with airbags, make sure you and your passengers always wear your seat belts, and wear them properly.

■ Restrain all children

Children age 12 and under should ride properly restrained in a back seat, not the front seat. Infants and small children should be restrained in a child seat. Larger children should use a booster seat and a lap/shoulder seat belt until they can use the belt properly without a booster seat.

■ Be aware of airbag hazards

While airbags can save lives, they can cause serious or fatal injuries to occupants who sit too close to them, or are not properly restrained. Infants, young children, and short adults are at the greatest risk. Be sure to follow all instructions and warnings in this manual.

■ Don't drink and drive

Alcohol and driving don't mix. Even one drink can reduce your ability to respond to changing conditions, and your reaction time gets worse with every additional drink. So don't drink and drive, and don't let your friends drink and drive, either.

▣ Important Safety Precautions

Some states, provinces and territories prohibit the use of cell phones other than hands-free devices by the driver while driving.

■ Pay appropriate attention to the task of driving safely

Engaging in cell phone conversation or other activities that keep you from paying close attention to the road, other vehicles, and pedestrians could lead to a crash. Remember, situations can change quickly, and only you can decide when it is safe to divert some attention away from driving.

■ Control your speed

Excessive speed is a major factor in crash injuries and deaths. Generally, the higher the speed, the greater the risk, but serious injuries can also occur at lower speeds. Never drive faster than is safe for current conditions, regardless of the maximum speed posted.

■ Keep your vehicle in safe condition

Having a tire blowout or a mechanical failure can be extremely hazardous. To reduce the possibility of such problems, check your tire pressures and condition frequently, and perform all regularly scheduled maintenance.

Your Vehicle's Safety Features

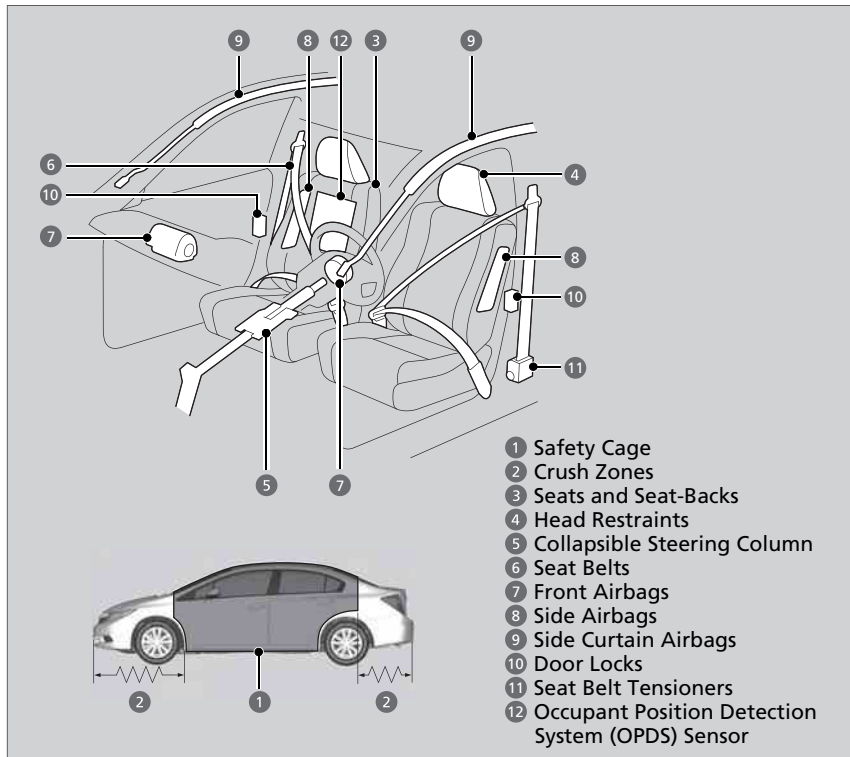

- 1 Safety Cage
- 2 Crush Zones
- 3 Seats and Seat-Backs
- 4 Head Restraints
- 5 Collapsible Steering Column
- 6 Seat Belts
- 7 Front Airbags
- 8 Side Airbags
- 9 Side Curtain Airbags
- 10 Door Locks
- 11 Seat Belt Tensioners
- 12 Occupant Position Detection System (OPDS) Sensor

► Your Vehicle's Safety Features

Your vehicle is equipped with many features that work together to help protect you and your passengers during a crash.

Some features do not require any action on your part. These include a strong steel framework that forms a safety cage around the passenger compartment, front and rear crush zones, a collapsible steering column, and tensioners that tighten the front seat belts in a sufficient crash.

However, you and your passengers cannot take full advantage of these features unless you remain seated in the correct position and always wear your seat belts. In fact, some safety features can contribute to injuries if they are not used properly.

The following checklist will help you take an active role in protecting yourself and your passengers.

Safety Checklist

For the safety of you and your passengers, make a habit of checking these items each time before you drive.

- After everyone has entered the vehicle, be sure all doors are closed and locked. Locking the doors helps prevent an occupant from being ejected and an outsider from unexpectedly opening a door.

➤ [Locking/Unlocking the Doors from the Inside P. 103](#)

- Adjust your seat to a position suitable for driving. Be sure the front seats are adjusted as far to the rear as possible while allowing the driver to control the vehicle. Sitting too close to a front airbag can result in serious or fatal injury in a crash.

➤ [Adjusting the Seats P. 126](#)

- Adjust head restraints to the proper position. Head restraints are most effective when the center of the head restraint aligns with the center of your head. Taller persons should adjust their head restraint to the highest position.

➤ [Adjusting the Head Restraints P. 129](#)

- Always wear your seat belt, and make sure you wear it properly. Confirm that any passengers are properly belted as well.

➤ [Fastening a Seat Belt P. 31](#)

- Protect children by using seat belts or child seats according to a child's age, height and weight.

➤ [Child Safety P. 50](#)

☒ Safety Checklist

If the door open indicator is on, a door is not completely closed. Close all doors tightly until the indicator goes off.

➤ [Door Open Indicator P. 70](#)



About Your Seat Belts

Seat belts are the single most effective safety device because they keep you connected to the vehicle so that you can take advantage of many built-in safety features. They also help keep you from being thrown against the inside of the vehicle, against other passengers, or out of the vehicle. When worn properly, seat belts also keep your body properly positioned in a crash so that you can take full advantage of the additional protection provided by the airbags.

In addition, seat belts help protect you in almost every type of crash, including:

- frontal impacts
- side impacts
- rear impacts
- rollovers

■ Lap/shoulder seat belts

All five seating positions are equipped with lap/shoulder seat belts with emergency locking retractors. In normal driving the retractor lets you move freely while keeping some tension on the belt. During a collision or sudden stop the retractor locks to restrain your body. The rear seat belts also have a lockable retractor for use with child seats.

➔ [Installing a Child Seat with a Lap/Shoulder Seat Belt](#) P. 57

» About Your Seat Belts

WARNING

Not wearing a seat belt properly increases the chance of serious injury or death in a crash, even though your vehicle has airbags.

Be sure you and your passengers always wear seat belts and wear them properly.

Seat belts cannot completely protect you in every crash. But in most cases, seat belts can reduce your risk of serious injury.

Most states and all Canadian provinces and territories require you to wear seat belts.

■ Proper use of seat belts

Follow these guidelines for proper use:

- All occupants should sit upright, well back in the seat, and remain in that position for the duration of the trip. Slouching and leaning reduces the effectiveness of the belt and can increase the chance of serious injury in a crash.
- Never place the shoulder part of a lap/shoulder seat belt under your arm or behind your back. This could cause very serious injuries in a crash.
- Two people should never use the same seat belt. If they do, they could be very seriously injured in a crash.
- Do not put any accessories on the seat belts. Devices intended to improve comfort or reposition the shoulder part of a seat belt can reduce the protective capability and increase the chance of serious injury in a crash.

■ Seat Belt Reminder



Your vehicle monitors front seat belt use. If the ignition switch is turned to ON **[II]** before the driver's seat belt is fastened, a beeper will sound and the indicator will blink. If the driver does not fasten the belt before the beeper stops, the indicator will remain on.

The beeper will also periodically sound and the indicator will blink while driving until the driver's and front passenger's seat belts are fastened.

* Not available on all models

Continued

▣ About Your Seat Belts

If a rear seat passenger moves around and extends the seat belt, the lockable retractor may activate. If this happens, release the retractor by unfastening the seat belt and allow the belt to retract completely. Then refasten the belt.

▣ Seat Belt Reminder

The indicator will also come on if a front passenger does not fasten their seat belt within 6 seconds after the ignition switch is turned to ON **[II]**. When no one is sitting in the front passenger's seat, or a child or small adult is riding there, the indicator will not come on. This is because the weight sensors in the seat cannot detect their presence.

Automatic Seat Belt Tensioners

The front seats are equipped with automatic seat belt tensioners to enhance safety.

The tensioners automatically tighten the front seat belts during a moderate-to-severe frontal collision, sometimes even if the collision is not severe enough to inflate the front airbags.

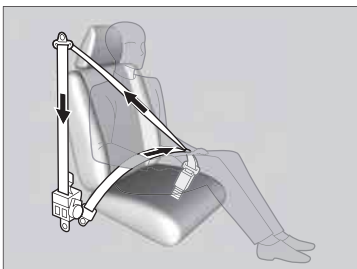

Automatic Seat Belt Tensioners

The seat belt tensioners can only operate once. If a tensioner is activated, the SRS indicator will come on. Have a dealer replace the tensioner and thoroughly inspect the seat belt system as it may not offer protection in a subsequent crash.

During a moderate-to-severe side impact, the tensioner on that side of the vehicle also activates.

Fastening a Seat Belt

After adjusting a front seat to the proper position, and while sitting upright and well back in the seat:

▶ [Adjusting the Seats](#) P. 126

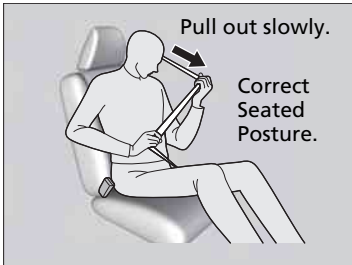

1. Pull the seat belt out slowly.

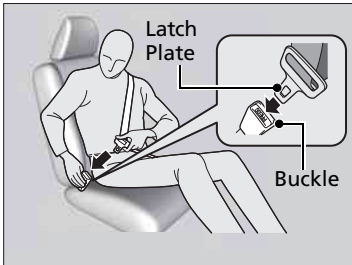

2. Insert the latch plate into the buckle, then tug on the belt to make sure the buckle is secure.

▶ Make sure that the belt is not twisted or caught on anything.

Fastening a Seat Belt

No one should sit in a seat with an inoperative seat belt or one that does not appear to be working correctly. Using a seat belt that is not working properly may not protect the occupant in a crash. Have a dealer check the belt as soon as possible.

Never insert any foreign objects into the buckle or retractor mechanism.



3. Position the lap part of the belt as low as possible across your hips, then pull up on the shoulder part of the belt so the lap part fits snugly. This lets your strong pelvic bones take the force of a crash and reduces the chance of internal injuries.
4. If necessary, pull up on the belt again to remove any slack, then check that the belt rests across the center of your chest and over your shoulder. This spreads the forces of a crash over the strongest bones in your upper body.

Adjusting the Shoulder Anchor

The front seats have adjustable shoulder anchors to accommodate taller and shorter occupants.

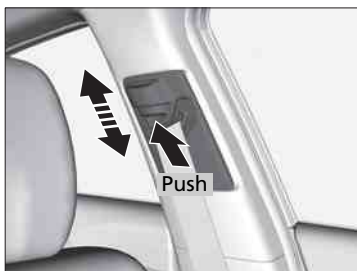

1. Move the anchor up and down while holding the release button.
2. Position the anchor so that the belt rests across the center of your chest and over your shoulder.

Fastening a Seat Belt

WARNING

Improperly positioning the seat belts can cause serious injury or death in a crash.

Make sure all seat belts are properly positioned before driving.

To release the belt, push the red PRESS button then guide the belt by hand until it has retracted completely.

When exiting the vehicle, be sure the belt is out of the way and will not get caught by closing the door.

Adjusting the Shoulder Anchor

The shoulder anchor height can be adjusted to four levels. If the belt contacts your neck, lower the height one level at a time.

After an adjustment, make sure that the shoulder anchor position is secure.

Advice for Pregnant Women

If you are pregnant, the best way to protect yourself and your unborn child when driving or riding in a vehicle is to always wear a seat belt and keep the lap part of the belt as low as possible across the hips.

Wear the shoulder belt across the chest avoiding the abdomen.



Wear the lap part of the belt as low as possible across the hips.

Advice for Pregnant Women

Each time you have a checkup, ask your doctor if it is okay for you to drive.

To reduce the risk of injuries to both you and your unborn child that can be caused by an inflating front airbag:

- When driving, sit upright and adjust the seat as far back as possible while allowing full control of the vehicle.
- When sitting in the front passenger's seat, adjust the seat as far back as possible.

Seat Belt Inspection

Regularly check the condition of your seat belts as follows:

- Pull each belt out fully, and look for frays, cuts, burns, and wear.
- Check that the latches work smoothly and the belts retract easily.
 - If a belt does not retract easily, cleaning the belt may correct the problem. Only use a mild soap and warm water. Do not use bleach or cleaning solvents. Make sure the belt is completely dry before allowing it to retract.

Any belt that is not in good condition or working properly will not provide proper protection and should be replaced as soon as possible.

A belt that has been worn during a crash may not provide the same level of protection in a subsequent crash. Have your seat belts inspected by a dealer after any collision.

►► Seat Belt Inspection

WARNING

Not checking or maintaining seat belts can result in serious injury or death if the seat belts do not work properly when needed.

Check your seat belts regularly and have any problem corrected as soon as possible.

Airbag System Components

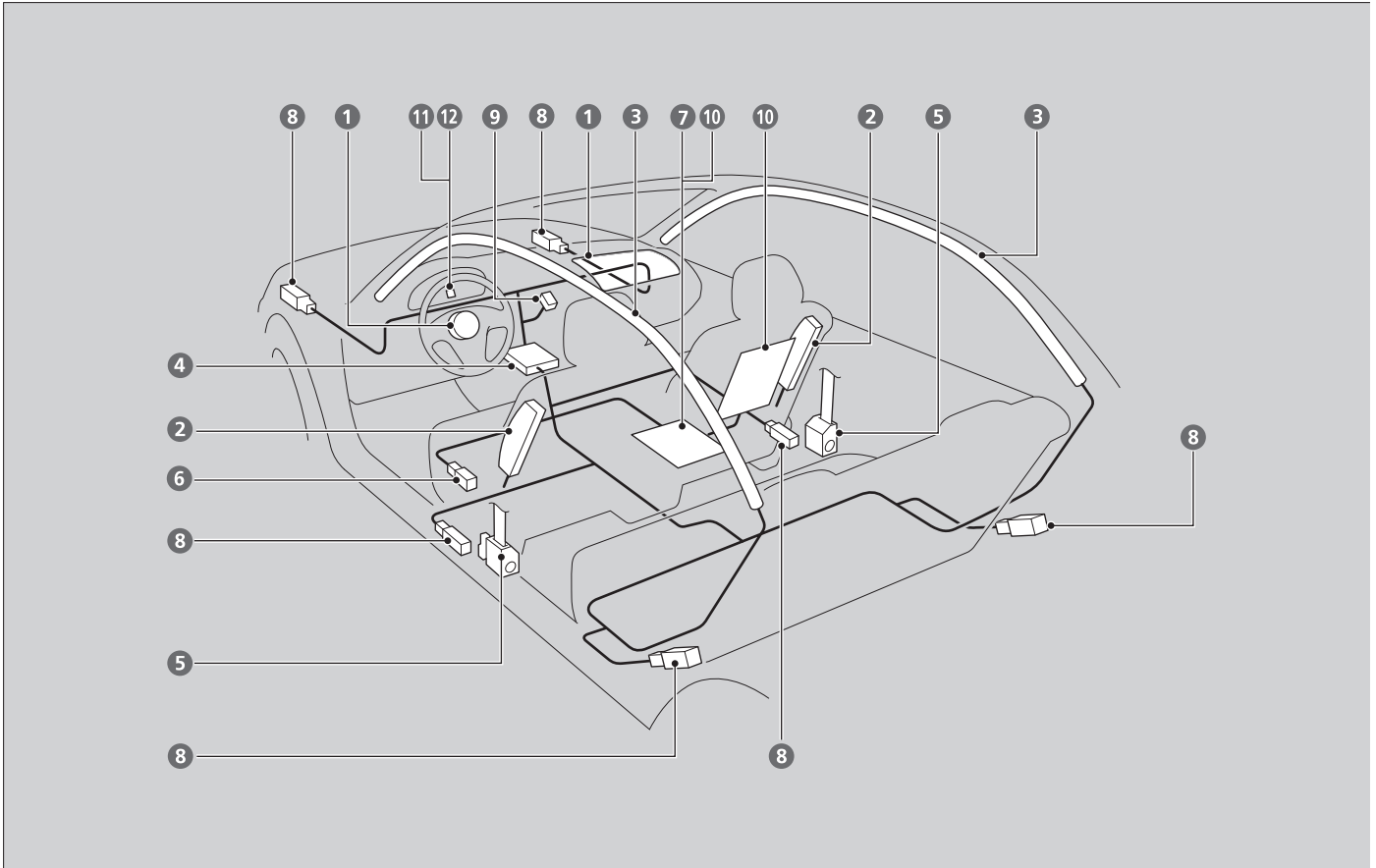

The front, front side, and side curtain airbags are deployed according to the direction and severity of impact. The airbag system includes:

- 1 Two SRS (Supplemental Restraint System) front airbags. The driver's airbag is stored in the center of the steering wheel; the front passenger's airbag is stored in the dashboard. Both are marked "SRS AIRBAG."
- 2 Two side airbags, one for the driver and one for a front passenger. The airbags are stored in the outer edges of the seat-backs. Both are marked "SIDE AIRBAG."
- 3 Two side curtain airbags, one for each side of the vehicle. The airbags are stored in the ceiling, above the side windows. The front and rear pillars are marked "SIDE CURTAIN AIRBAG."
- 4 An electronic control unit that continually monitors and records information about the sensors, the airbag activators, the seat belt tensioners, and driver and front passenger seat belt use when the ignition switch is in ON **II**.
- 5 Automatic front seat belt tensioners. The driver's and front passenger's seat belts incorporate sensors that detect whether or not they are fastened.
- 6 A driver's seat position sensor. If the seat is too far forward, the airbag will inflate with less force.
- 7 Weight sensors in the front passenger's seat. The front passenger's airbag will be turned off if the weight on the seat is 65 lbs (29 kg) or less (the weight of an infant or small child).
- 8 Impact sensors that can detect a moderate to severe front or side collision.
- 9 An indicator on the dashboard that alerts you that the front passenger's front airbag has been turned off.
- 10 Sensors that can detect if a child or small statured adult is in the deployment path of the front passenger's side airbag.
- 11 An indicator on the instrument panel that alerts you to a possible problem with your airbag system or seat belt tensioners.
- 12 An indicator on the instrument panel that alerts you that the front passenger's side airbag has been turned off.

Important facts about your airbags

Airbags can pose serious hazards. To do their job, airbags must inflate with tremendous force. So, while airbags help save lives, they can cause minor injuries, sometimes even fatal ones if occupants are not wearing their seat belts properly and sitting correctly.

What you should do: Always wear your seat belt properly, and sit upright and as far back from the steering wheel as possible while allowing full control of the vehicle. A front passenger should move their seat as far back from the dashboard as possible.

Remember, however, that no safety system can prevent all injuries or deaths that can occur in a severe crash, even when seat belts are properly worn and the airbags deploy.

Do not place hard or sharp objects between yourself and a front airbag.

Carrying hard or sharp objects on your lap, or driving with a pipe or other sharp object in your mouth, can result in injuries if your front airbag inflates.

Do not attach or place objects on the front airbag covers. Objects on the covers marked "SRS AIRBAG" could interfere with the proper operation of the airbags or be propelled inside the vehicle and hurt someone if the airbags inflate.

Important facts about your airbags

Do not attempt to deactivate your airbags. Together, airbags and seat belts provide the best protection.

When driving, keep hands and arms out of the deployment path of the front airbag by holding each side of the steering wheel. Do not cross an arm over the airbag cover.

Types of Airbags

Your vehicle is equipped with three types of airbags:

- **Front airbags:** Airbags in front of the driver's and front passenger's seats.
- **Side airbags:** Airbags in the driver's and front passenger's seat-backs.
- **Side curtain airbags:** Airbags above the side windows.

Each is discussed in the following pages.

Front Airbags (SRS)

The front SRS airbags inflate in a moderate to severe frontal collision to help protect the head and chest of the driver and/or front passenger.

SRS (Supplemental Restraint System) indicates that the airbags are designed to supplement seat belts, not replace them. Seat belts are the occupant's primary restraint system.

Housing Locations

The front airbags are housed in the center of the steering wheel for the driver, and in the dashboard for the front passenger. Both airbags are marked SRS AIRBAG.

Types of Airbags

The airbags can inflate whenever the ignition switch is in ON **III**.

Front Airbags (SRS)

Dual-Stage, Multiple-Threshold Front Airbags (SRS)

Your vehicle is equipped with dual-stage, multiple-threshold front airbags (SRS).

During a frontal crash severe enough to cause one or both front airbags to deploy, the airbags can inflate at different rates, depending on the severity of the crash, whether or not the seat belts are latched, and/or other factors. Frontal airbags are designed to supplement the seat belts to help reduce the likelihood of head and chest injuries in frontal crashes.

Operation

Front airbags are designed to inflate during moderate-to-severe frontal collisions. When the vehicle decelerates suddenly, the sensors send information to the control unit which signals one or both front airbags to inflate.

A frontal collision can be either head-on or angled between two vehicles, or when a vehicle crashes into a stationary object, such as a concrete wall.

How the Front Airbags Work

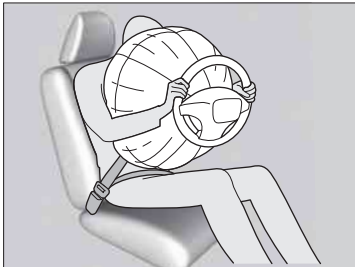

While your seat belt restrains your torso, the front airbag provides supplemental protection for your head and chest.

The front airbags deflate immediately so that they won't interfere with the driver's visibility or the ability to steer or operate other controls.

The total time for inflation and deflation is so fast that most occupants are not aware that the airbags deployed until they see them lying in front of them.

How the Front Airbags Work

After a front airbag inflates in a crash, you may see what looks like smoke. This is actually powder from the airbag's surface. Although the powder is not harmful, people with respiratory problems may experience some temporary discomfort. If this occurs, get out of the vehicle as soon as it is safe to do so.

Although the driver's and front passenger's airbags normally inflate within a split second of each other, it is possible for only one airbag to deploy. This can happen if the severity of a collision is at the margin, or threshold, that determines whether or not the airbags will deploy. In such cases, the seat belt will provide sufficient protection, and the supplemental protection offered by the airbag would be minimal.

■ When front airbags should not deploy

Minor frontal crashes: Front airbags were designed to supplement seat belts and help save lives, not to prevent minor scrapes, or even broken bones that might occur during a less than moderate-to-severe frontal crash.

Side impacts: Front airbags can provide protection when a sudden deceleration causes a driver or front passenger to move towards the front of the vehicle. Side airbags and side curtain airbags have been specifically designed to help reduce the severity of injuries that can occur during a moderate-to-severe side impact which can cause the driver or passenger to move towards the side of the vehicle.

Rear impacts: Head restraints and seat belts are your best protection during a rear impact. Front airbags cannot provide any significant protection and are not designed to deploy in such collisions.

Rollovers: Seat belts and, in vehicles equipped with a rollover sensor, side airbags and side curtain airbags offer the best protection in a rollover. Because front airbags could provide little if any protection, they are not designed to deploy during a rollover.

■ When front airbags deploy with little or no visible damage

Because the airbag system senses sudden deceleration, a strong impact to the vehicle framework or suspension might cause one or more of the airbags to deploy. Examples include running into a curb, the edge of a hole, or other low fixed object that causes a sudden deceleration in the vehicle chassis. Since the impact is underneath the vehicle, damage may not be readily apparent.

■ When front airbags may not deploy, even though exterior damage appears severe

Since crushable body parts absorb crash energy during an impact, the amount of visible damage does not always indicate proper airbag operation. In fact, some collisions can result in severe damage but no airbag deployment because the airbags would not have been needed or would not have provided protection even if they had deployed.

Advanced Airbags

Your front airbags have advanced features to reduce the likelihood of airbag related injuries to smaller occupants.

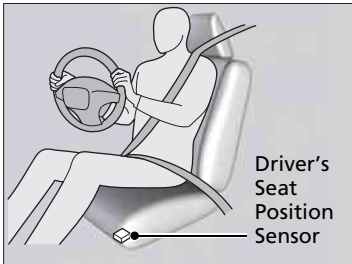

The driver's advanced front airbag system includes a seat position sensor.

If the seat is too far forward, the airbag inflates with less force, regardless of the severity of the impact.

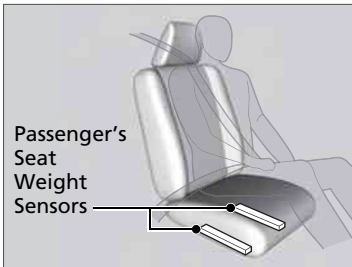

The passenger's advanced front airbag system has weight sensors.

Although Honda recommends against carrying an infant or small child in front, if the sensors detect the weight of a child (up to about 65 lbs or 29 kg), the system will automatically turn off the passenger's front airbag.

Advanced Airbags

If there is a problem with the driver's seat position sensor, the SRS indicator will come on and the airbag will inflate with full (normal) force, regardless of the driver's seating position.

For both advanced front airbags to work properly:

- Do not spill any liquid on or under the seats.
- Do not put any object under the passenger's seat.
- Make sure any objects are positioned properly on the floor. Improperly positioned objects can interfere with the advanced airbag sensors.
- All occupants should sit upright and wear their seat belts properly.

Side Airbags

The side airbags help protect the upper torso of the driver or a front passenger during a moderate to severe side impact.

Housing Locations

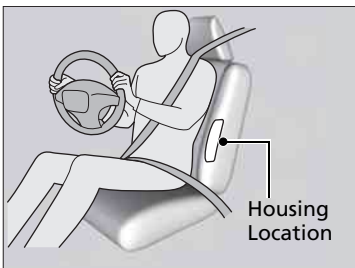

The side airbags are housed in the outside edge of the driver's and passenger's seat-backs.

Both are marked SIDE AIRBAG.

Operation

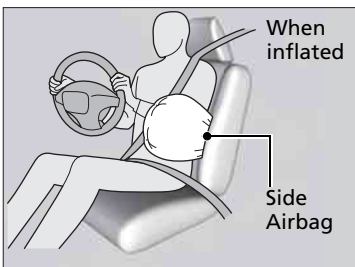

When the sensors detect a moderate-to-severe side impact, the control unit signals the side airbag on the impact side to immediately inflate.

Side Airbags

Do not attach accessories on or near the side airbags. They can interfere with the proper operation of the airbags, or hurt someone if an airbag inflates.

If the impact is on the passenger side, the airbag deploys even if there is no passenger's in the passenger seat.

Do not cover or replace the front seat-back covers without consulting a dealer.

Improperly replacing or covering front seat-back covers can prevent your side airbags from properly deploying during a side impact.

■ When a side airbag deploys with little or no visible damage

Because the airbag systems senses sudden acceleration, a strong impact to the side of the vehicle's framework can cause a side airbag to deploy. In such cases, there may be little or no damage, but the side impact sensors detected a severe enough impact to deploy the airbag.

■ When a side airbag may not deploy, even though visible damage appears severe

It is possible for a side airbag to not deploy during an impact that results in apparently severe damage. This can occur when the point of impact was towards the far front or rear of the vehicle, or when the vehicle's crushable body parts absorbed most of the crash energy. In either case, the side airbag would not have been needed nor provided protection even if it had deployed.

Side Airbag Cutoff System

To reduce the likelihood that a front passenger may be injured by an inflating side airbag, the passenger side airbag is automatically turned off when:

- The height sensors detect a child or short-statured adult is seated in the front passenger seat.
- The position sensor detects that the front passenger is leaning into the deployment path of the side airbag.

When the side airbag cutoff system is activated, the side airbag off indicator comes on.

➤ [Side Airbag Off Indicator P. 48](#)

Side Airbag Off Indicator

If the side airbag off indicator comes on, have the passenger sit upright. A few seconds after the passenger is sitting properly, the side airbag will automatically be turned on, and the indicator will go off.

If the front passenger is a child, stop when it is safe to do so, and have the child sit properly restrained in a rear seat.

Side Airbag Cutoff System

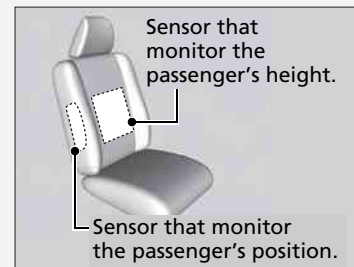

The sensors that monitor the front passenger's height and body position may not work if:

- The seat-back is wet
- The passenger is touching a metal or other electrical conductive object
- A seat cushion is on the seat
- The passenger is wearing excessively thick clothing

Side Curtain Airbags

The side curtain airbags help protect the heads of the driver and passengers in outer seating positions during a moderate-to-severe side impact.

Housing Locations

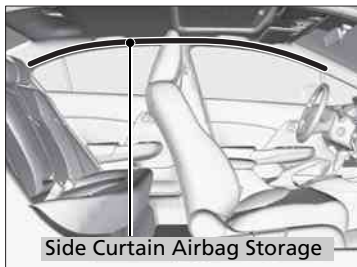

Side Curtain Airbag Storage

The side curtain airbags are located in the ceiling above the side windows on both sides of the vehicle.

Operation

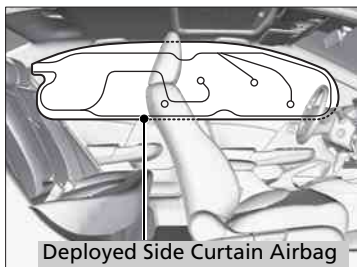

Deployed Side Curtain Airbag

The side curtain airbag is designed to deploy in a moderate-to-severe side impact.

■ When side curtain airbags deploy in a frontal collision

One or both side curtain airbags may inflate in a moderate to severe angled frontal collision.

In this case, the side curtain airbags will deploy slightly after the front airbags.

⊗ Side Curtain Airbags

The side curtain airbags are most effective when an occupant is wearing their seat belt properly and sitting upright, well back in their seat.

Do not attach any objects to the side windows or roof pillars as they can interfere with the proper operation of the side curtain airbags.

Airbag System Indicators

If a problem occurs in the airbag system, the SRS indicator will come on and a message appears on the multi-information display*.

▶▶ SRS (Supplemental Restraint System) Indicator

■ SRS (Supplemental Restraint System) Indicator



■ When the ignition switch is turned to ON

The indicator comes on for a few seconds, then goes off. This tells you the system is working properly.

If the indicator comes on at any other time, or does not come on at all, have the system checked by a dealer as soon as possible. If you don't, your airbags and seat belt tensioners may not work properly when they are needed.

WARNING

Ignoring the SRS indicator can result in serious injury or death if the airbag systems or tensioners do not work properly.

Have your vehicle checked by a dealer as soon as possible if the SRS indicator alerts you to a possible problem.

Passenger Airbag Off Indicator



■ When the passenger airbag off indicator comes on

The indicator comes on to alert you that the passenger's front airbag has been turned off. This occurs when the weight sensors detect 65 lbs (29 kg) or less, the weight of an infant or small child, on the seat.

Infants and small children should always ride properly restrained in a back seat.

[Child Safety P. 50](#)

Objects placed on the seat can also cause the indicator to come on.

If the front passenger seat is empty, the passenger's front airbag will not deploy and the indicator will not come on.

⊠ Passenger Airbag Off Indicator

If the indicator comes on with no front passenger and no objects on the passenger's seat, or with an adult riding there, something may be interfering with the weight sensors. Such as:

- An object hanging on the seat or in the seat-back pocket.
- A child seat or other object pressing against the rear of the seat-back.
- A rear passenger pushing or pulling on the back of the front passenger's seat.
- The front seat or seat-back is forced back against an object on the seat or floor behind it.
- An object placed under the front passenger's seat.

If none of these conditions exist, have your vehicle checked by a dealer as soon as possible.

The passenger airbag off indicator may come on and goes off repeatedly if the total weight on the seat is near the airbag cutoff threshold.

■ Side Airbag Off Indicator

■ When the side airbag off indicator comes on

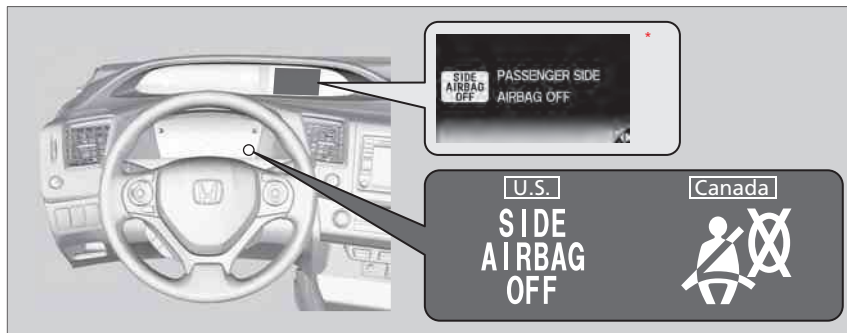

This indicator comes on if the passenger's side airbag has been turned off because the passenger is too small to be sitting in the front seat, is slouching or not sitting upright, or has leaned into the airbag's deployment path.

Unless the passenger is a smaller statured adult or a child, the indicator should go off when the passenger returns to a proper upright sitting position.

▶▶ Side Airbag Off Indicator

When you turn the ignition switch to ON (II), the indicator should come on for a few seconds and then go out. If it doesn't come on, stays on, or comes on while driving without a passenger in the front seat, have the system checked by a dealer as soon as possible.

Airbag Care

You do not need to, and should not, perform any maintenance on or replace any airbag system components yourself. However, you should have your vehicle inspected by a dealer in the following situations:

■ When the airbags have deployed

If an airbag has inflated, the control unit and other related parts must be replaced. Similarly, once an automatic seat belt tensioner has been activated, it must be replaced.

■ When the vehicle has been in a moderate-to-severe collision

Even if the airbags did not inflate, have your dealer inspect the following: the driver's seat position sensor, weight sensors in the passenger's seat, front seat belt tensioners, and each seat belt that was worn during the crash.

■ Do not remove or modify a front seat without consulting a dealer

This would likely disable the driver's seat position sensor or the weight sensors in the passenger's seat. If it is necessary to remove or modify a front seat to accommodate a person with disabilities, contact a Honda dealer, or for U.S. vehicles, American Honda Automobile Customer Service at 800-999-1009 and for Canadian vehicles, Honda Canada Customer Relations at 888-9-HONDA-9.

✘ Airbag Care

We recommend against the use of salvaged airbag system components, including the airbag, tensioners, sensors, and control unit.

Protecting Child Passengers

Each year, many children are injured or killed in vehicle crashes because they are either unrestrained or not properly restrained. In fact, vehicle accidents are the number one cause of death of children age 12 and under.

To reduce the number of child deaths and injuries, every state, Canadian province and territory requires that infants and children be properly restrained when they ride in a vehicle.

Children should sit properly restrained in a rear seat. This is because:



- An inflating front or side airbag can injure or kill a child sitting in the front seat.
- A child in the front seat is more likely to interfere with the driver's ability to safely control the vehicle.
- Statistics show that children of all sizes and ages are safer when they are properly restrained in a rear seat.

Protecting Child Passengers

⚠️ WARNING

Children who are unrestrained or improperly restrained can be seriously injured or killed in a crash.

Any child too small for a seat belt should be properly restrained in a child seat. A larger child should be properly restrained with a seat belt, using a booster seat if necessary.

The National Highway Traffic Safety Administration and Transport Canada recommend that all children age 12 and under be properly restrained in a rear seat. Some states or provinces/territories have laws restricting where children may ride.

- Any child who is too small to wear a seat belt correctly must be restrained in an approved child seat that is properly secured to the vehicle using either the lap belt portion of the lap/shoulder belt or the lower anchors of the LATCH system.
- Never hold a child on your lap because it is impossible to protect them in the event of a collision.
- Never put a seat belt over yourself and a child. During a crash, the belt would likely press deep into the child and cause serious or fatal injuries.
- Never let two children use the same seat belt. Both children could be very seriously injured in a crash.
- Do not allow children to operate the doors, windows or seat adjustments.
- Do not leave children in the vehicle unattended, especially in hot weather when the inside of the vehicle can get hot enough to kill them. They could also activate vehicle controls causing it to move unexpectedly.

 Protecting Child Passengers

 **WARNING**

Allowing a child to play with a seat belt or wrap one around their neck can result in serious injury or death.

Instruct children not to play with any seat belt and make sure any unused seat belt a child can reach is buckled, fully retracted, and locked.

To deactivate a lockable retractor, release the buckle and allow the seat belt to wind up all the way.

To remind you of the passenger's front airbag hazards and child safety, your vehicle has warning labels on the dashboard (U.S. models) and on the front visors. Please read and follow the instructions on these labels.

 [Safety Labels P. 63](#)

Safety of Infants and Small Children

■ Protecting Infants

An infant must be properly restrained in a rear-facing, reclining child seat until the infant reaches the seat maker's weight or height limit for the seat, and the infant is at least one year old.



■ Positioning a rear-facing child seat

Child seats must be placed and secured in a rear seating position.

When properly installed, a rear-facing child seat may prevent the driver or a front passenger from moving their seat all the way back, or from locking their seat-back in the desired position.

It can also interfere with proper operation of the passenger's advanced front airbag system.

➤ [Airbags P. 35](#)

If this occurs, we recommend that you install the child seat directly behind the front passenger's seat, move the seat as far forward as needed, and leave it unoccupied. Or, you may wish to get a smaller rear-facing child seat.

▶▶ Protecting Infants

⚠ WARNING

Placing a rear-facing child seat in the front seat can result in serious injury or death during a crash.

Always place a rear-facing child seat in the rear seat, not the front.

Rear-facing child seats should never be installed in a forward facing position.

Always refer to the child seat manufacturer's instructions before installation.

Protecting Smaller Children

If a child is at least one year old and within the weight range indicated by the child seat manufacturer, the child should be properly restrained in a firmly secured forward-facing child seat.



■ Forward-facing child seat placement
We strongly recommend placing a forward-facing child seat in a rear seating position.

Placing a forward-facing child seat in the front seat can be hazardous, even with advanced front airbags that automatically turn the passenger's front airbag off. A rear seat is the safest place for a child.

Protecting Smaller Children

⚠ WARNING

Placing a forward-facing child seat in the front seat can result in serious injury or death if the front airbag inflates.

If you must place a forward-facing child seat in front, move the vehicle seat as far back as possible, and properly restrain the child.

Educate yourself about the laws and regulations regarding child seat use where you are driving, and follow the child seat manufacturer's instructions.

Many experts recommend use of a rear-facing seat up to age two, if the child's height and weight are appropriate for a rear-facing seat.

■ Selecting a Child Seat

Most child seats are LATCH-compatible (Lower Anchors and Tethers for CHildren). Some have a rigid-type connector, while others have a flexible-type connector. Both are equally easy to use. Some existing and previously owned child seats can only be installed using the seat belt. Whichever type you choose, follow the child seat manufacturer's use and care instructions as well as the instructions in this manual. Proper installation is key to maximizing your child's safety.

In seating positions and vehicles not equipped with LATCH, a LATCH compatible child seat can be installed using the seat belt and a top tether for added security. This is because all child seats are required to be designed so that they can be secured with a lap belt or the lap part of a lap/shoulder belt. In addition, the child seat manufacturer may advise that a seat belt be used to attach a LATCH-compatible seat once a child reaches a specified weight. Please read the child seat owner's manual for proper installation instructions.

■ Important consideration when selecting a child seat

Make sure the child seat meets the following three requirements:

- The child seat is the correct type and size for the child.
- The child seat is the correct type for the seating position.
- The child seat is compliant with Federal Motor Vehicle Safety Standard 213 or Canadian Motor Vehicle Safety Standard 213.

▶▶ Selecting a Child Seat

Installation of a LATCH-compatible child seat is simple.

LATCH-compatible child seats have been developed to simplify the installation process and reduce the likelihood of injuries caused by incorrect installation.

Installing a LATCH-Compatible Child Seat

A LATCH-compatible child seat can be installed in either of the two outer rear seats. A child seat is attached to the lower anchors with either the rigid or flexible type of connectors.



1. Locate the lower anchors under the marks.

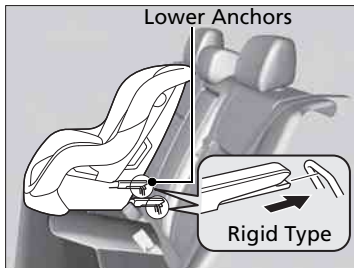

2. Place the child seat on the vehicle seat then attach the child seat to the lower anchors according to the instructions that came with the child seat.

- ▶ When installing the child seat, make sure that the lower anchors are not obstructed by the seat belt or any other object.

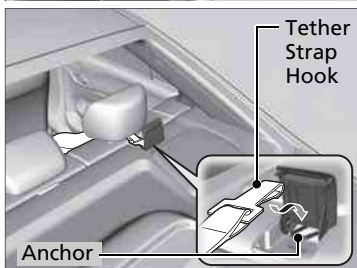
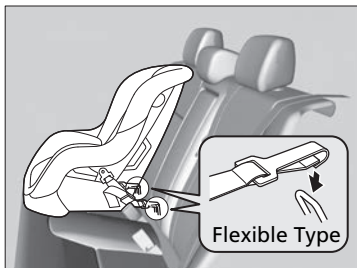

3. Open the tether anchor cover behind the head restraint.
4. Raise the head restraint to its highest position, then route the tether strap between the head restraint legs, and secure the tether strap hook onto the anchor.
5. Tighten the tether strap as instructed by the child seat maker.
6. Make sure the child seat is firmly secured by rocking it forward and back and side to side; little movement should be felt.
7. Make sure any unused seat belt that a child can reach is buckled, the lockable retractor is activated, and the belt is fully retracted and locked.

▶▶ Installing a LATCH-compatible Child Seat

For your child's safety, when using a child seat installed using the LATCH system, make sure that the seat is properly secured to the vehicle. A child seat that is not properly secured will not adequately protect a child in a crash and may cause injury to the child or other vehicle occupants.

Installing a Child Seat with a Lap/Shoulder Seat Belt



1. Place the child seat on the vehicle seat.
2. Route the seat belt through the child seat according to the seat maker's instructions, and insert the latch plate into the buckle.
 - ▶ Insert the latch plate fully until it clicks.

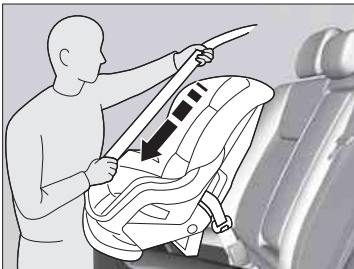

3. Slowly pull the shoulder part of the belt all the way out until it stops. This activates the lockable retractor.
4. Let the seat belt completely wind up into the retractor, then try to pull it out to make sure the retractor is locked.
 - ▶ If you are able to pull the shoulder belt out, the lockable retractor is not activated. Pull the seat belt all the way out, and repeat steps 2 – 4.



5. Grab the shoulder part of the seat belt near the buckle, and pull up to remove any slack from the lap part of the belt.
 - ▶ When doing this, place your weight on the child seat and push it into the vehicle seat.

⊠ Installing a Child Seat with a Lap/Shoulder Seat Belt

A child seat that is not properly secured will not adequately protect a child in a crash and may cause injury to the child or other vehicle occupants.

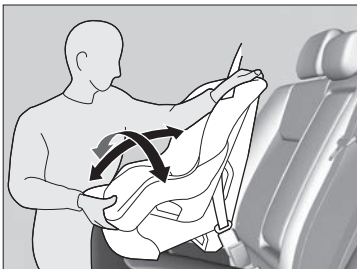

6. Make sure the child seat is firmly secured by rocking it forward and back and side to side; little movement should be felt.
7. Make sure any unused seat belt that a child can reach is buckled, the lockable retractor is activated, and the belt is fully retracted and locked.

▶▶ Installing a Child Seat with a Seat Belt

To deactivate a lockable retractor, release the buckle and allow the seat belt to wind up all the way.

Adding Security with a Tether

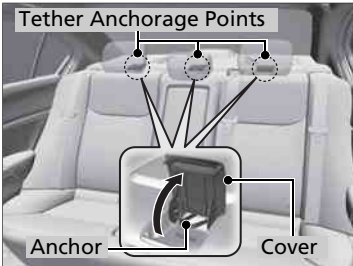

A tether anchorage point is provided behind each rear seating position. A child seat that is installed with a seat belt and comes with a tether can use the tether for additional security.

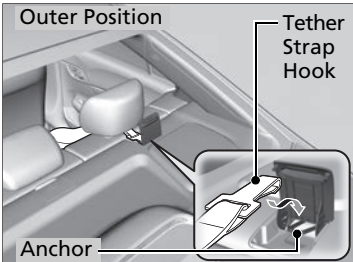

1. Locate the appropriate tether anchorage point and lift the cover.
2. Raise the head restraint to its highest position, then route the tether strap through the head restraint legs. Make sure the strap is not twisted.

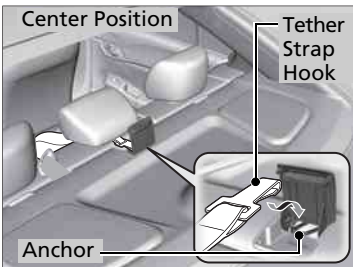

3. Secure the tether strap hook onto the anchor.
4. Tighten the tether strap as instructed by the child seat manufacturer.

Adding Security with a Tether

Since a tether can provide additional security to the lap/shoulder seat belt installation, we recommend using a tether whenever one is available.

Safety of Larger Children

■ Protecting Larger Children

The following pages give instructions on how to check proper seat belt fit, what kind of booster seat to use if one is needed, and important precautions for a child who must sit in front.

■ Checking Seat Belt Fit

When a child is too big for a child seat, secure the child in a rear seat using the lap/shoulder seat belt. Have the child sit upright and all the way back, then answer the following questions.

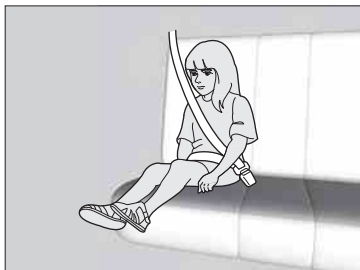

■ Checklist

- Do the child's knees bend comfortably over the edge of the seat?
- Does the shoulder belt cross between the child's neck and arm?
- Is the lap part of the seat belt as low as possible, touching the child's thighs?
- Will the child be able to stay seated like this for the whole trip?

If you answer yes to all these questions, the child is ready to wear the lap/shoulder seat belt correctly. If you answer no to any question, the child needs to ride on a booster seat until the seat belt fits properly without a booster seat.

» Safety of Larger Children

⚠ WARNING

Allowing a child age 12 or under to sit in front can result in injury or death if the passenger's front airbag inflates.

If a larger child must ride in front, move the vehicle seat as far to the rear as possible, have the child sit up properly and wear the seat belt properly, using a booster seat if needed.

Booster Seats



If a lap/shoulder seat belt cannot be used properly, position the child in a booster seat in a rear seating position. For the child's safety, check that the child meets the booster seat manufacturer's recommendations.

Protecting Larger Children-Final Checks

Your vehicle has a rear seat where children can be properly restrained. If you ever have to carry a group of children, and a child must ride in front:

- Make sure you read and fully understand the instructions and safety information in this manual.
- Move the front passenger seat as far back as possible.
- Have the child sit upright and well back in the seat.
- Check that the seat belt is properly positioned so that the child is secure in the seat.

Monitoring child passengers

We strongly recommend that you keep an eye on child passengers. Even older, more mature children sometimes need to be reminded to fasten their seat belts and sit up properly.

Booster Seats

When installing a booster seat, make sure to read the instructions that came with it, and install the seat accordingly.

There are high- and low-type booster seats. Choose a booster seat that allows the child to wear the seat belt correctly.

Some U.S. states and Canadian provinces and territories require children to use a booster seat until they reach a given age or weight (e.g. 6 years or 60 lbs). Be sure to check current laws in the state or province, or territory where you intend to drive.

Carbon Monoxide Gas

The engine exhaust from this vehicle contains carbon monoxide, a colorless, odorless, and highly toxic gas. As long as you properly maintain your vehicle, carbon monoxide gas will not get into the interior.

■ Have the exhaust system inspected for leaks whenever

- The exhaust system is making an unusual noise.
- The exhaust system may have been damaged.
- The vehicle is raised for an oil change.

When you operate a vehicle with the trunk open, airflow can pull exhaust gas into the interior and create a hazardous condition. If you must drive with the trunk open, open all the windows and set the heating and cooling* system as shown below.

1. Select the fresh air mode.
2. Select the  mode.
3. Set the fan speed to high.
4. Set the temperature control to a comfortable setting.

Adjust the heating and cooling* system in the same manner if you sit in your parked vehicle with the engine running.

Carbon Monoxide Gas

⚠ WARNING

Carbon monoxide gas is toxic. Breathing it can cause unconsciousness and even kill you.

Avoid any enclosed areas or activities that expose you to carbon monoxide.

An enclosed area such as a garage can quickly fill up with carbon monoxide gas.

Do not run the engine with the garage door closed. Even when the garage door is open, drive out of the garage immediately after starting the engine.

Instrument Panel



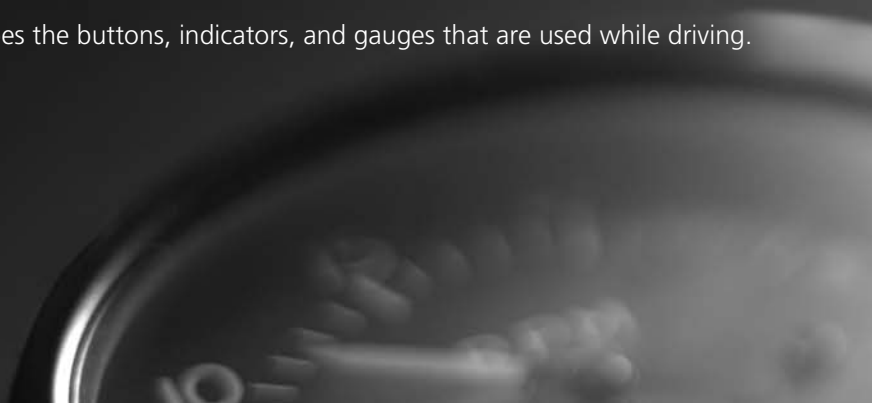



This chapter describes the buttons, indicators, and gauges that are used while driving.







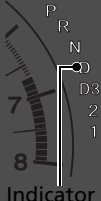

- Indicators** 66
 - Multi-Information Display Warning and Information Messages* 76
- Gauges and Displays**
 - Gauges 78
 - Information Display* 80
 - Multi-Information Display* 82







* Not available on all models

Indicator	Name	On/Blinking	Explanation	Message*
	Parking Brake and Brake System Indicator	<ul style="list-style-type: none"> Comes on for a few seconds when you turn the ignition switch to ON (II), then goes off. Comes on when the parking brake is applied, and goes off when it is released. Comes on when the brake fluid level is low. Comes on if there is a problem with the brake system. The beeper sounds and the indicator comes on if you drive with the parking brake not fully released. 	<ul style="list-style-type: none"> Comes on while driving - Make sure the parking brake is released. Check the brake fluid level. <ul style="list-style-type: none"> ➤ What to do when the indicator comes on P. 315 Comes on along with the ABS indicator - Have the vehicle checked by a dealer. <ul style="list-style-type: none"> ➤ If the Brake System Indicator Comes On P. 315 	
	Low Oil Pressure Indicator	<ul style="list-style-type: none"> Comes on when you turn the ignition switch to ON (II), and goes off when the engine starts. Comes on when the engine oil pressure is low. 	<ul style="list-style-type: none"> Comes on while driving - Immediately stop in a safe place. <ul style="list-style-type: none"> ➤ If the Low Oil Pressure Indicator Comes On P. 313 	





Indicator	Name	On/Blinking	Explanation	Message*
	Malfunction Indicator Lamp	<ul style="list-style-type: none"> • Comes on when you turn the ignition switch to ON II, and goes off either when the engine starts or after several seconds if the engine is not started. If "readiness codes" have not been set, it blinks five times before it goes off. • Comes on if there is a problem with the emissions control system. • Blinks when a misfire in the engine's cylinders is detected. 	<ul style="list-style-type: none"> • Readiness codes are part of the on board diagnostics for the emissions control systems. <ul style="list-style-type: none"> ► Testing of Readiness Codes P. 331 • Comes on while driving - Have the vehicle checked by a dealer. • Blinks while driving - Stop in a safe place where there are no flammable objects. Stop the engine for 10 minutes or more, and wait for it to cool down. Then, take the vehicle to a dealer. <ul style="list-style-type: none"> ► If the Malfunction Indicator Lamp Comes On or Blinks P. 314 	
	Charging System Indicator	<ul style="list-style-type: none"> • Comes on when you turn the ignition switch to ON II, and goes off when the engine starts. • Comes on when the battery is not charging. 	<ul style="list-style-type: none"> • Comes on while driving - Turn off the heating and cooling* system and rear defogger in order to reduce electricity consumption. <ul style="list-style-type: none"> ► If the Charging System Indicator Comes On P. 313 	
	Shift Position Indicator*	<ul style="list-style-type: none"> • Indicates in which position your shift lever is. 	<ul style="list-style-type: none"> ► Shifting P. 215 	





* Not available on all models

Indicator	Name	On/Blinking	Explanation	Message*
	Transmission Indicator*	<ul style="list-style-type: none"> Comes on for a few seconds when you turn the ignition switch to ON II, then goes off. Blinks if the transmission system has a problem. 	<ul style="list-style-type: none"> Blinks while driving - Avoid sudden starts and acceleration and have the vehicle checked by a dealer immediately. 	
	Seat Belt Reminder Indicator	<ul style="list-style-type: none"> Comes on and the beeper sounds if you are not wearing a seat belt when you turn the ignition switch to ON II. If the front passenger is not wearing a seat belt, the indicator comes on about six seconds later. Blinks while driving if either you or the front passenger has not fastened a seat belt. The beeper sounds and the indicator blinks at regular intervals. 	<ul style="list-style-type: none"> The beeper stops and the indicator goes off when you and the front passenger fasten their seat belts. Stays on after you or the front passenger has fastened the seat belt - A detection error may have occurred in the sensor. Have the vehicle checked by a dealer. ▶ Seat Belt Reminder P. 29 	 
	Low Fuel Indicator	<ul style="list-style-type: none"> Comes on when the fuel reserve is running low (approximately 1.9 U.S. gal./7.5 Liter left). Blinks if there is a problem with the fuel gauge. 	<ul style="list-style-type: none"> Comes on - Refuel your vehicle as soon as possible. Blinks - Have the vehicle checked by a dealer. 	



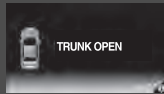





Indicator	Name	On/Blinking	Explanation	Message*
	ABS (Anti-lock Brake System) Indicator	<ul style="list-style-type: none"> Comes on for a few seconds when you turn the ignition switch to ON II, then goes off. If it comes on at any other time, there is a problem with the ABS. 	<ul style="list-style-type: none"> Stays on constantly - Have the vehicle checked by a dealer. With this indicator on, your vehicle still has normal braking ability but no anti-lock function. ► ABS (Anti-lock Brake System) P. 231 	
	Supplemental Restraint System Indicator	<ul style="list-style-type: none"> Comes on for a few seconds when you turn the ignition switch to ON II, then goes off. Comes on if a problem with any of the following is detected: <ul style="list-style-type: none"> - Supplemental restraint system - Side airbag system - Side curtain airbag system - Seat belt tensioner 	<ul style="list-style-type: none"> Stays on constantly or does not come on at all - Have the vehicle checked by a dealer. 	
	High Temperature Indicator	<ul style="list-style-type: none"> Comes on for a few seconds when you turn the ignition switch to ON II, then goes off. Blinks when the engine coolant temperature goes up, and stays on if the temperature continues to rise. 	<ul style="list-style-type: none"> Blinks while driving - Drive slowly to prevent overheating. Stays on while driving - Immediately stop in a safe place and allow the engine to cool. ► Overheating P. 311 	

* Not available on all models





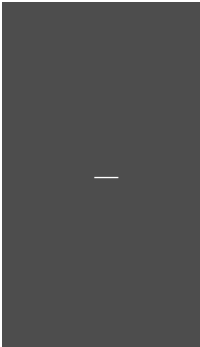

Indicator	Name	On/Blinking	Explanation	Message*
	VSA® (Vehicle Stability Assist) System Indicator	<ul style="list-style-type: none"> Comes on for a few seconds when you turn the ignition switch to ON II, then goes off. Blinks when VSA® is active. Comes on if there is a problem with the VSA® system. 	<ul style="list-style-type: none"> Stays on constantly - Have the vehicle checked by a dealer. VSA® (Vehicle Stability Assist) System P. 223 	
	VSA® (Vehicle Stability Assist) OFF Indicator	<ul style="list-style-type: none"> Comes on for a few seconds when you turn the ignition switch to ON II, then goes off. Comes on when you deactivate VSA®. 	<ul style="list-style-type: none"> VSA® (Vehicle Stability Assist) System P. 224 	—
	Door Open Indicator	<ul style="list-style-type: none"> Comes on for a few seconds if you turn the ignition switch to ON II, then goes off. Comes on if any door is not completely closed. The beeper sounds and the indicator comes on if any door is opened while driving. 	<ul style="list-style-type: none"> Goes off when all doors are closed. 	

Indicator	Name	On/Blinking	Explanation	Message*
	Trunk Open Indicator	<ul style="list-style-type: none"> Comes on for a few seconds if you turn the ignition switch to ON II, then goes off. Comes on if the trunk is not completely closed. 	<ul style="list-style-type: none"> Goes off when the trunk is closed. 	
	EPS (Electric Power Steering System) Indicator	<ul style="list-style-type: none"> Comes on when you turn the ignition switch to ON II, and goes off when the engine starts. Comes on if there is a problem with the EPS (Electric Power Steering System). 	<ul style="list-style-type: none"> Stays on constantly or does not come on at all - Have the vehicle checked by a dealer. ▶ If the EPS Indicator Comes On P. 315 	
DRL	Daytime Running Lights Indicator*	<ul style="list-style-type: none"> Comes on for a few seconds when you turn the ignition switch to ON II, then goes off. Comes on if there is a problem with the DRL system. 	<ul style="list-style-type: none"> Have your vehicle checked by a dealer. ▶ Daytime Running Lights P. 120 	—
	<div style="background-color: #333; color: white; padding: 2px; font-size: 0.8em;">Models with information display</div> TPMS Indicator	<ul style="list-style-type: none"> Comes on for a few seconds when you turn the ignition switch to ON II. Comes on if there is a problem with the TPMS, or when a compact spare tire is temporarily installed. 	<ul style="list-style-type: none"> Stays on constantly or does not come on at all - Have the vehicle checked by a dealer. If the vehicle is fitted with a compact spare, get your regular tire repaired or replaced and put back on your vehicle as soon as you can. 	—





* Not available on all models









Indicator	Name	On/Blinking	Explanation	Message*
	<p>Models with information display</p> <p>Low Tire Pressure Indicator</p> <p>U.S. models only</p> <p>Models with multi-information display</p> <p>Low Tire Pressure/TPMS Indicator</p>	<ul style="list-style-type: none"> Comes on for a few seconds when you turn the ignition switch to ON . Comes on if the tire pressure of any of the tires becomes significantly low. <p>Models with information display</p> <ul style="list-style-type: none"> Comes on for a while and then goes off when a compact spare tire is temporarily installed. <p>Models with multi-information display</p> <ul style="list-style-type: none"> Blinks for about one minute, and then stays on if there is a problem with the TPMS, or when a compact spare tire is temporarily installed. 	<ul style="list-style-type: none"> Comes on while driving - Stop in a safe place, check tire pressures, and inflate the tire(s) if necessary. <p>Models with multi-information display</p> <ul style="list-style-type: none"> Blinks and remains on - Have the vehicle checked by a dealer. If the vehicle is fitted with a compact spare, get your regular tire repaired or replaced and put back on your vehicle as soon as you can. 	 
	<p>System Message Indicator*</p>	<ul style="list-style-type: none"> Comes on for a few seconds when you turn the ignition switch to ON , then goes off. Comes on along with a beep when a problem is detected. A system message on the multi-information display appears at the same time. 	<ul style="list-style-type: none"> While the indicator is on, press the  (display/information) button to see the message again. Refer to the Indicators information in this chapter when a system message appears on the multi-information display. Take the appropriate action for the message. The multi-information display does not return to the normal screen unless the warning is canceled, or the  button is pressed. 	

* Not available on all models

Indicator	Name	On/Blinking	Explanation	Message*
	Turn Signal Indicators	<ul style="list-style-type: none"> The turn signal indicators blink when you operate the turn signal lever. If you press the hazard warning button, both indicators and all turn signals blink at the same time. 	<ul style="list-style-type: none"> Does not blink or blinks rapidly - A turn signal light bulb has blown. Change the bulb immediately. <ul style="list-style-type: none"> ➔ Replacing Light Bulbs ➔ P. 273 ➔ P. 275 	—
	High-Beam Indicator	<ul style="list-style-type: none"> Comes on when the high beam headlights are on. 	—	—
	Lights On Indicator	<ul style="list-style-type: none"> Comes on whenever the light switch is on, or in AUTO* when the exterior lights are on. 	<ul style="list-style-type: none"> If you remove the key from the ignition switch while the exterior lights are on, a chime sounds when the driver's door is opened. 	—
	Fog Light Indicator*	<ul style="list-style-type: none"> Comes on when the fog lights are on. 	—	—
	Side Airbag Off Indicator	<ul style="list-style-type: none"> Comes on for a few seconds when you turn the ignition switch to ON II, then goes off. Comes on when the passenger side airbag system is automatically shut off. 	<ul style="list-style-type: none"> It does not mean there is a problem with your side airbags. Comes on when nobody is sitting in the passenger seat - Have the vehicle checked by a dealer. Comes on when someone is sitting in the seat - Have the passenger sit properly. 	

* Not available on all models



Indicator	Name	On/Blinking	Explanation	Message*
	Immobilizer System Indicator	<ul style="list-style-type: none"> Comes on briefly when you turn the ignition switch to ON [II], then goes off. Comes on if the immobilizer system cannot recognize the key information. 	<ul style="list-style-type: none"> Blinks - You cannot start the engine. Turn the ignition switch to LOCK [O], pull the key out, and then insert the key and turn it to ON [II] again. Repeatedly blinks - The system may be malfunctioning. Have the vehicle checked by a dealer. Do not attempt to alter this system or add other devices to it. Electrical problems can occur. 	—
	Security System Alarm Indicator*	<ul style="list-style-type: none"> Blinks when the Security System Alarm has been set. 	<p> Security System Alarm P. 112</p>	—
	Low Temperature Indicator	<ul style="list-style-type: none"> Comes on for a few seconds when you turn the ignition switch to ON [II]. Comes on when the engine coolant temperature is low. 	<ul style="list-style-type: none"> If the indicator stays on after the engine has reached normal operating temperature, there may be problem with the temperature sensors. Have the vehicle inspected by a dealer. 	—



Indicator	Name	On/Blinking	Explanation	Message*
	ECON Mode Indicator*	<ul style="list-style-type: none"> Comes on when you turn the ignition switch to ON (II), and goes off when the engine starts. Comes on when you press the ECON button. 	<ul style="list-style-type: none"> ➤ ECON Button P. 123 	
	CRUISE MAIN Indicator*	<ul style="list-style-type: none"> Comes on when you press the CRUISE button. 	<ul style="list-style-type: none"> ➤ Cruise Control P. 220 	—
	CRUISE CONTROL Indicator*	<ul style="list-style-type: none"> Comes on if you have set a speed for cruise control. 	<ul style="list-style-type: none"> ➤ Cruise Control P. 220 	—
	Washer Level Indicator*	<ul style="list-style-type: none"> Comes on when washer fluid gets low. 	<ul style="list-style-type: none"> Refill washer fluid. ➤ Refilling Window Washer Fluid P. 267 	—
	Maintenance Minder Indicator*	<ul style="list-style-type: none"> Comes on when the scheduled maintenance is due soon. 	<ul style="list-style-type: none"> ➤ Maintenance Minder™ P. 243 	—
	i-VTEC Indicator*	<ul style="list-style-type: none"> Comes on when the i-VTEC system switches the low RPM cams to the high RPM cams. 	<ul style="list-style-type: none"> When the i-VTEC indicator comes on, the REV indicator begins to come on simultaneously. ➤ i-VTEC indicator P. 79 	—
	REV Indicators*	<ul style="list-style-type: none"> Come on when the tachometer reading approaches the red zone. 	<ul style="list-style-type: none"> ➤ REV indicators P. 79 	—

* Not available on all models

Multi-Information Display Warning and Information Messages*

The following messages appear only on the multi-information display. Press the  (display/information) button to see the message again with the system message indicator on.

Message	Condition	Explanation
	<ul style="list-style-type: none"> Appears when the fuel fill cap is loose or is not installed. 	<ul style="list-style-type: none"> ➤ Check/Tighten Fuel Cap Message P. 314
	<ul style="list-style-type: none"> Appears if there is a problem with the DRL system. 	<ul style="list-style-type: none"> Have your vehicle checked by a dealer. <ul style="list-style-type: none"> ➤ Daytime Running Lights P. 120
Canadian models 	<ul style="list-style-type: none"> Appears when washer fluid gets low. 	<ul style="list-style-type: none"> Refill washer fluid. <ul style="list-style-type: none"> ➤ Refilling Window Washer Fluid P. 267

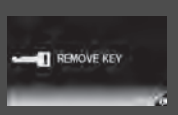
Message	Condition	Explanation
	<ul style="list-style-type: none"> • Appears when the scheduled maintenance is due soon. • Consequently, "SERVICE DUE NOW" and "SERVICE PAST DUE" follow. 	<p>► Maintenance Minder Messages on the Multi-Information Display P. 248</p>
	<ul style="list-style-type: none"> • Appears when you open the driver's door while the ignition key is in ACCESSORY I. 	<ul style="list-style-type: none"> • Turn the ignition switch to LOCK 0, then remove the key.
	<ul style="list-style-type: none"> • Appears when you open the driver's door while the ignition key is in LOCK 0. 	<ul style="list-style-type: none"> • Remove the key from the ignition switch.

* Not available on all models

Gauges

Gauges include the speedometer, tachometer, fuel gauge, and related indicators. They are displayed when the ignition switch is in ON .

Speedometer

Displays your driving speed in mph or km/h.

Tachometer

Shows the number of engine revolutions per minute.

Fuel Gauge

Displays the amount of fuel left in the fuel tank.

Instant Fuel Economy Gauge*

Shows the instant fuel economy as a bar graph in mpg or l/100km.

⌘ Gauges

Press and hold the km/mile change knob until you hear a beep. The speedometer reading and the displayed measurements switch between mph and km/h.

⌘ Fuel Gauge

NOTICE

You should refuel when the reading approaches . Running out of fuel can cause the engine to misfire, damaging the catalytic converter.

The actual amount of remaining fuel may differ from the fuel gauge reading.

⌘ Instant Fuel Economy Gauge

Press and hold the km/mile change knob to switch the measurement.

i-VTEC and REV Indicators*

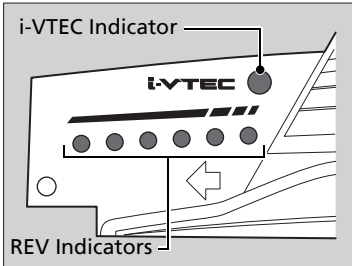

■ i-VTEC indicator

Comes on when the i-VTEC system switches the low RPM cams to the high RPM cams.

■ REV indicators

Come on when the tachometer reading approaches the red zone on a scale of one to six.

☒ REV Indicators

When the fifth indicator (red) comes on, the engine has reached its maximum output.

When all the indicators are on, the tachometer reading is on the verge of entering into the red zone.

* Not available on all models

Information Display *

The information display shows the odometer, trip meter, engine oil life and maintenance service item codes, and other gauges.

Switching the Display

Press the  (SEL/RESET) knob to change the display.

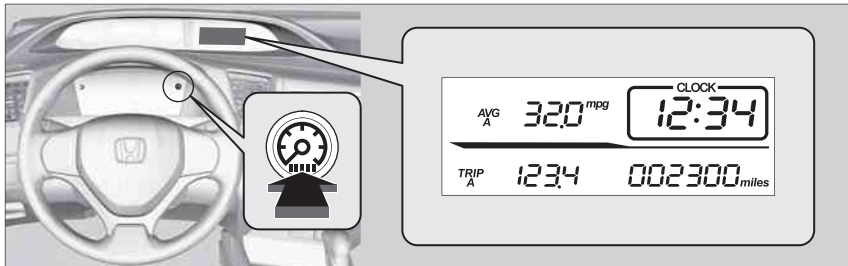

Odometer

Shows the total number of miles or kilometers that your vehicle has accumulated.

Trip Meter

Shows the total number of miles or kilometers driven since the last reset. Meters A and B can be used to measure 2 separate trips.

Resetting a trip meter

To reset a trip meter, display it, then press and hold the  knob. The trip meter is reset to "0.0".

Switching the display

Each time you press the  knob, the information display changes as follows:

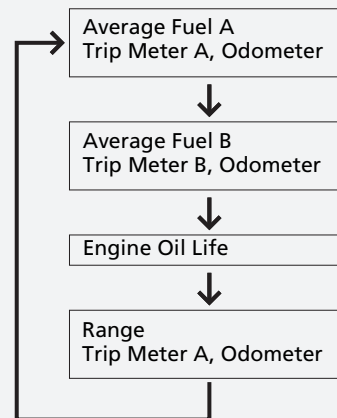

Trip Meter

Switch between trip meter A and trip meter B by pressing the  knob.

Average Fuel Economy

Shows the estimated average fuel economy of each trip meter in mpg or l/100 km. The display is updated at set intervals. When a trip meter is reset, the average fuel economy is also reset.

Engine Oil Life

Shows the remaining oil life and Maintenance Minder™.

[Maintenance Minder™](#) P. 243

Range

Shows the estimated distance you can travel on the remaining fuel. This distance is estimated from the fuel economy of your trips in the past.

Check Fuel Cap

Appears when the fuel fill cap is loose or is not installed.



[Check/Tighten Fuel Cap Message](#) P. 314

Multi-Information Display*

The multi-information display shows the odometer, trip meter, outside temperature indicator*, and other gauges. It also displays important messages such as warnings and other helpful information.

It also displays important messages such as warnings and other helpful information.

Switching the Display

Press the  (display/information) button or the  (SEL/RESET) knob to change the display.

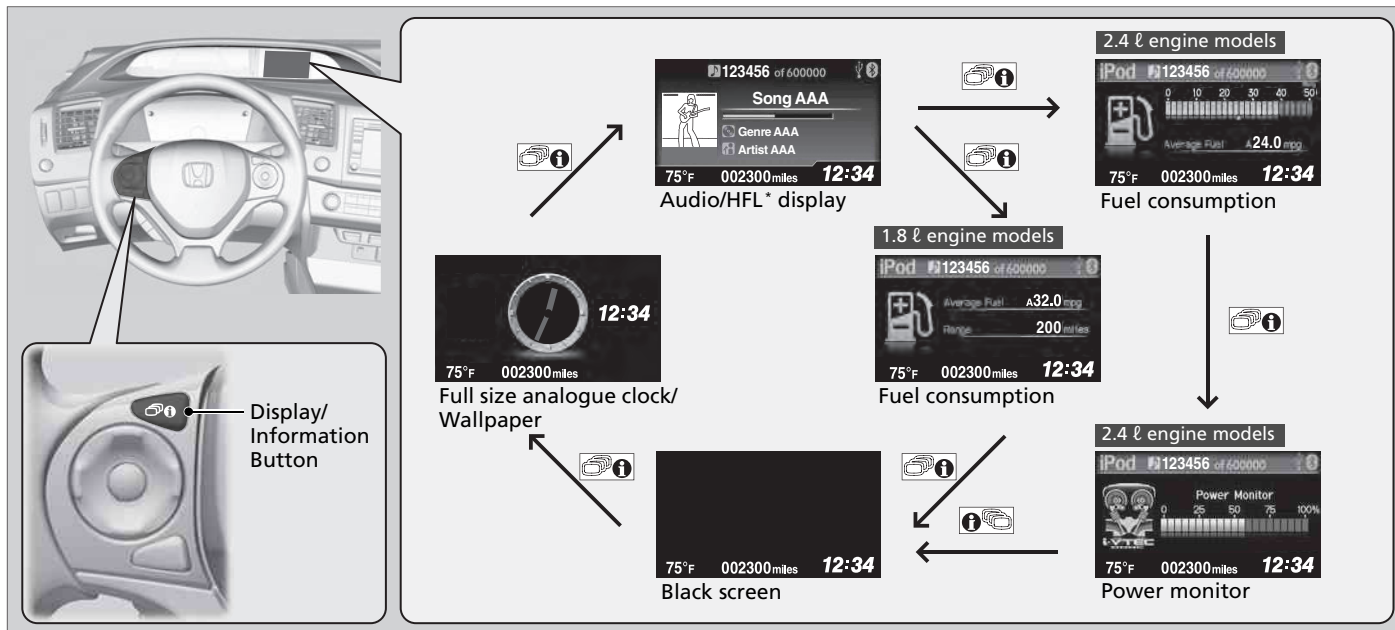

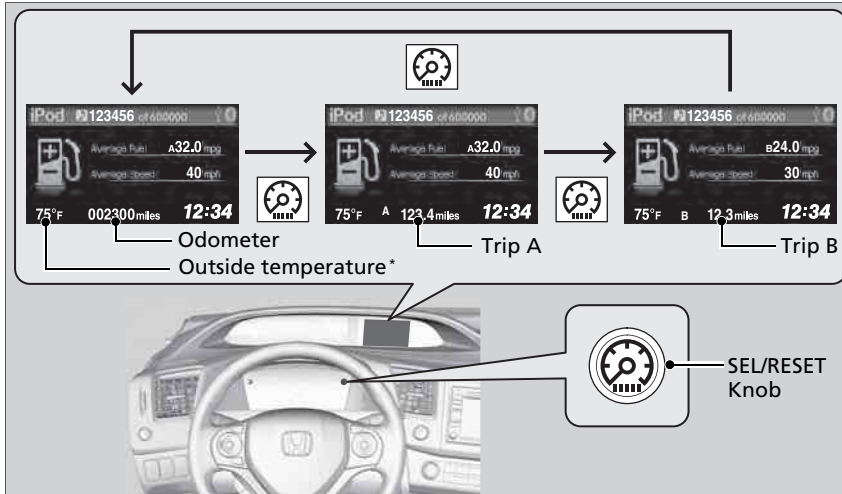

■ Odometer

Shows the total number of miles or kilometers that your vehicle has accumulated.

■ Trip Meter

Shows the total number of miles or kilometers driven since the last reset. Meters A and B can be used to measure 2 separate trips.

■ Resetting a trip meter

To reset a trip meter, display it, then press and hold the  knob. The trip meter is reset to "0.0".

* Not available on all models

Continued

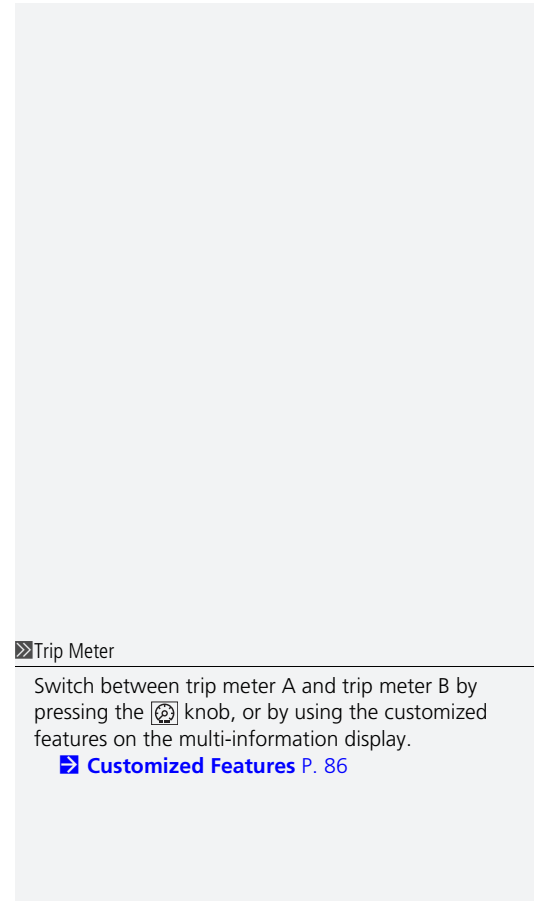

▶▶ Trip Meter

Switch between trip meter A and trip meter B by pressing the  knob, or by using the customized features on the multi-information display.

[▶ Customized Features P. 86](#)

Average Fuel Economy

Shows the estimated average fuel economy of each trip meter in mpg or l/100 km. The display is updated at set intervals. When a trip meter is reset, the average fuel economy is also reset.

Range

Shows the estimated distance you can travel on the remaining fuel. This distance is estimated from the fuel economy of your trips in the past.

Elapsed Time

Shows the time elapsed since the last time Trip A or Trip B was reset.

Average Speed

Shows the average speed in mph or km/h since the last time Trip A or Trip B was reset.

Engine Oil Life

Shows the remaining oil life and Maintenance Minder™.

▶ [Maintenance Minder™ P. 243](#)

▶▶ Average Fuel Economy

You can choose to reset either Trip A or average fuel economy A when you refuel.

▶ [Customized Features P. 86](#)

2.4 l engine models

You can choose an item to be displayed in the fuel consumption screen. Average fuel economy, range, elapsed time, or average speed can be selected.

▶ [Customized Features P. 86](#)

▶▶ Range

1.8 l engine models

You can choose an item to be displayed in the fuel consumption screen. Range, elapsed time, or average speed can be selected.

▶ [Customized Features P. 86](#)

■ Outside Temperature*

Shows the outside temperature in Fahrenheit (U.S.) or Celsius (Canada).

■ Adjusting the outside temperature display

Adjust the temperature reading up to $\pm 5^{\circ}\text{F}$ or $\pm 3^{\circ}\text{C}$ if the temperature reading seems incorrect.

Use the multi-information display's customized features to correct the temperature.

➤ [Customized Features P. 86](#)

■ Instant Fuel Economy*

Shows the instant fuel economy as a bar graph in mpg or l/100 km.

■ Power Monitor*

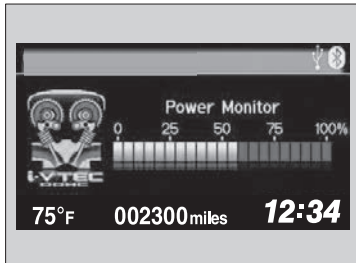

Engine horsepower usage while driving is displayed in the power monitor.

"100%" indicates that horsepower is at its maximum.

■ Turn-by-Turn Directions*

Shows you turn-by-turn driving directions to your destination linked with the navigation system.

➤ [Refer to the navigation system manual](#)

* Not available on all models

☒ Outside Temperature

The temperature sensor is in the front bumper. Road heat and exhaust from another vehicle can affect the temperature reading when your vehicle speed is less than 19 mph (30 km/h).

It may take several minutes for the display to be updated after the temperature reading has stabilized.

☒ Power Monitor

Engine horsepower is affected by external conditions such as driving conditions, or vehicle condition. The power monitor can compensate for some of these variables, but different readings may be displayed.

☒ Turn-by-Turn Directions

You can select whether the turn-by-turn display comes on or not during the route guidance.

➤ [Customized Features P. 86](#)

Continued

■ Customized Features



Use the multi-information display to customize certain features.

■ How to customize

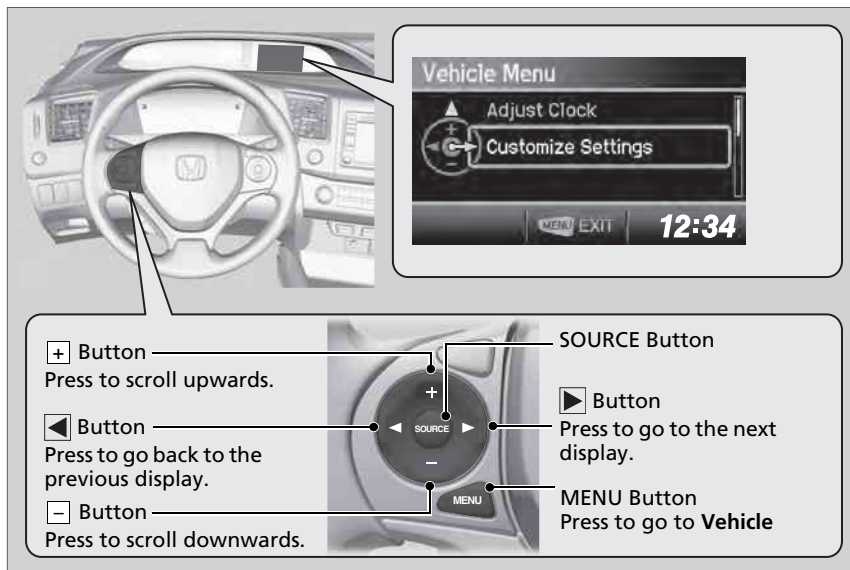
Select the **Vehicle Menu** screen by pressing the MENU button while the ignition switch is in ON , and the vehicle is at a complete stop. Select **Customize Settings**, then press the SOURCE button.



▶ Customized Features

To customize other features, press the  /  button.

- ▶ [List of customizable options P. 89](#)
- ▶ [Example for customizing wallpapers P. 93](#)

■ Customization flow

Press the MENU button.

☒ Customized Features

You can exit the customizing screen at any time by pressing the MENU button.

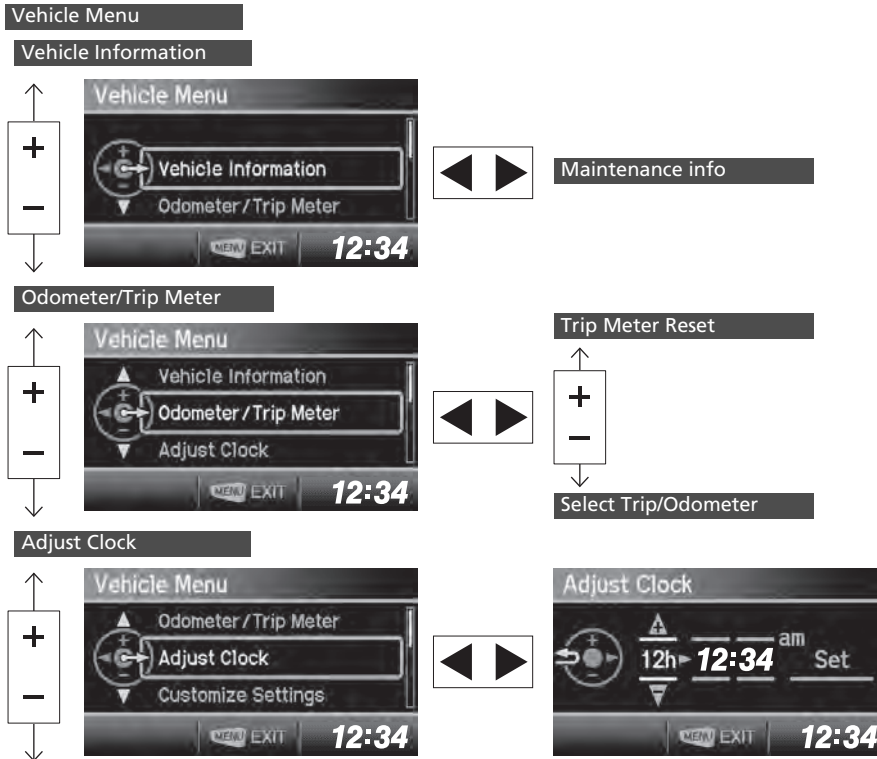

* Not available on all models

Continued

Customize Settings

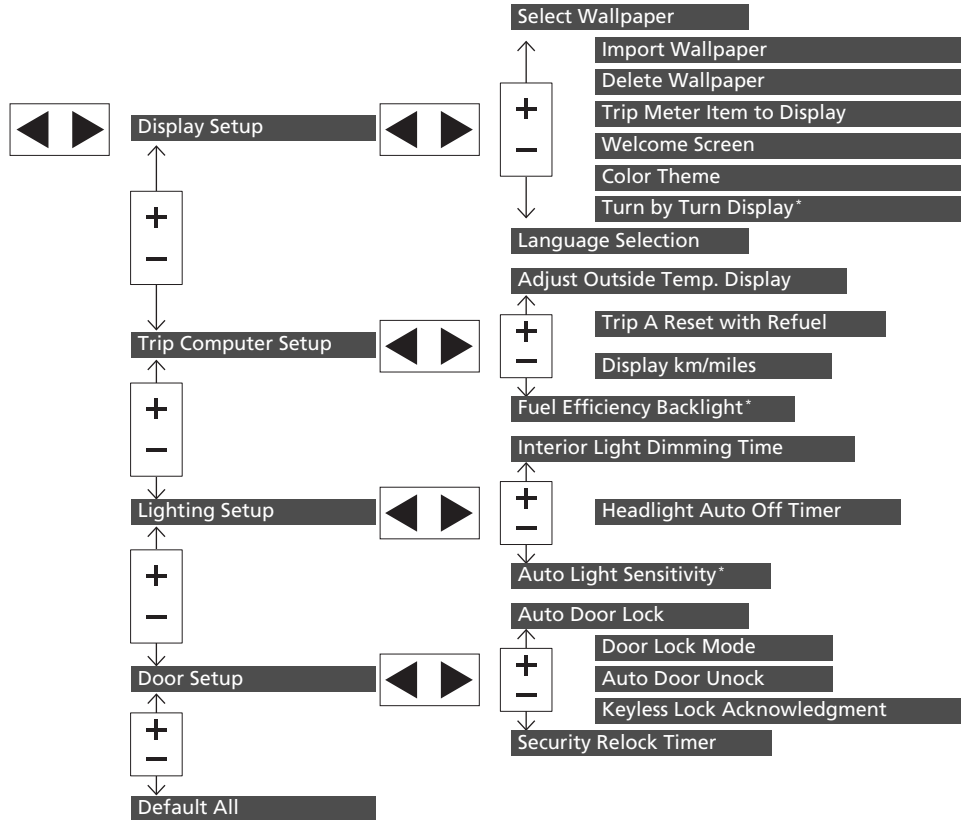

■ List of customizable options

Setup Group	Customizable Features	Description	Selectable settings
Vehicle Information	Maintenance info	Reset the Maintenance Minder™.	No/Yes
Odometer/ Trip Meter	Trip Meter Reset	Reset the trip meter.	Trip A/Trip B
	Select Trip/Odometer	Switch between odometer, trip meter A, and trip meter B.	ODO* ¹ /Trip A/Trip B
Adjust Clock		Sets time display 12 hour or 24 hour and adjust the time.	12 h* ¹ /24 h

*¹: Default Setting

Setup Group	Customizable Features	Description	Selectable settings
	Select Wallpaper	Select the full-size analogue clock or the wallpaper.	Clock* ² /Image 1/Image 2/Image 3
	Import Wallpaper	Import an image file for a new wallpaper.	Three images can be stored. ▶ Importing Wallpapers from USB P. 93
	Delete Wallpaper	Delete an image file for a wallpaper.	Image 1/Image 2/Image 3
Customize Settings	Display Setup	1.8 ℓ engine models Select an item to be displayed along with average fuel economy.	Range* ² /Elapsed time/Average speed
		2.4 ℓ engine models Select an item to be displayed along with the instant fuel economy.	Average Fuel* ² /Range/Elapsed time/Average speed
	Welcome Screen	Select whether the welcome screen comes on or not when you turn the ignition switch to ON [II] .	On* ² /Off
	Color Theme	Changes the color of the screen.	Blue* ³ /Red* ⁴ /Amber/Gray
	Turn by Turn Display * ¹ , * ⁵	Select whether the turn-by-turn display comes on or not during the route guidance.	On* ² /Off
	Language Selection	Changes the displayed language.	English* ² /French/Spanish

*1: Not available on all models

*2: Default Setting

*3: Default Setting for 1.8 ℓ engine models

*4: Default Setting for 2.4 ℓ engine models

*5: Refer to the navigation system manual for complete details.

* Not available on all models

Setup Group	Customizable Features	Description	Selectable settings	
Customize Settings	Adjust Outside Temp. Display ^{*1}	Adjusts the temperature reading by a few degrees.	-5°F ~ ±0°F ^{*2} ~ +5°F (U.S.) -3°C ~ ±0°C ^{*2} ~ +3°C (Canada)	
	Trip Computer Setup	Trip A Reset with Refuel	Set Trip A and the average fuel economy to reset when you refuel.	On/Off ^{*2}
		Display km/miles	Changes the displayed measurement on the multi-information display.	Auto ^{*2} /km/miles
	Lighting Setup	Fuel Efficiency Backlight	Turns the ambient meter feature on and off.	On ^{*2} /Off
		Interior Light Dimming Time	Changes the length of time the interior lights stay on after you close the doors.	60sec/30sec ^{*2} /15sec
		Headlight Auto Off Timer	Changes the length of time the exterior lights stay on after you close the driver's door.	60sec/30sec/15sec ^{*2} /0sec
	Auto Light Sensitivity ^{*1}	Changes the timing for the headlights to come on.	Max/High/Mid ^{*2} /Low/Min	

*1: Not available on all models

*2: Default Setting

Setup Group	Customizable Features	Description	Selectable settings	
Customize Settings	Auto Door Lock	Changes the setting for the automatic locking feature.	Off/With Vehicle Speed ^{*1} / Shift from P	
	Door Lock Mode	Sets up either the driver's door or all doors to unlock on the first operation of the remote or ignition key.	Driver Door ^{*1} /All Doors	
	Door Setup	Auto Door Unlock	Changes the setting for when the doors unlock automatically.	Off/ Driver Door with Shift to P ^{*2} / All Doors with Shift to P / Driver Door with IGN Off ^{*3} / All Doors with IGN Off
	Keyless Lock Acknowledgment	LOCK/UNLOCK- The exterior lights flash. LOCK (2nd push)- The beeper sounds.	On ^{*1} /Off	
	Security Relock Timer	Changes the time it takes for the doors to relock and the security system to set after you unlock the vehicle without opening any door.	90sec/60sec/30sec ^{*1}	
	Default All	Cancels/Resets all the customized settings as default.	Cancel Reset All Defaults	

*1: Default Setting

*2: Default Setting for automatic transmission

*3: Default Setting for manual transmission

■ Example for customizing wallpapers

You can customize the display from clock to wallpaper.

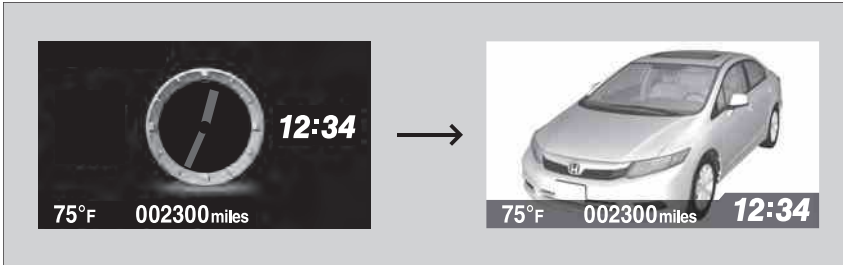

Importing Wallpapers from USB

You can import up to three images, one at a time for wallpaper from a USB flash drive.

Select **Import Wallpaper** from **Customize Settings** and properly connect a USB flash drive to store an image.

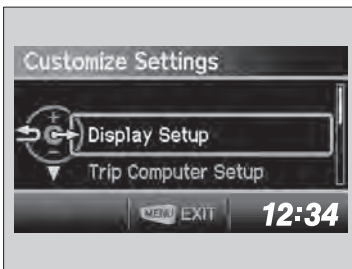

1. Connect the USB flash drive to the adapter cable.
▶ USB Adapter Cable P. 145
2. Press the Menu button.
3. Select **Customize Settings** with the / button, then press the SOURCE button.
4. Select **Display Setup** with the / button, then press the SOURCE button.

⌘ Customize Features

- When importing wallpaper files, the image must be in the USB flash drive's root directory. Images in a folder cannot be imported.
- The file format of the image that can be imported is BMP (bmp) or JPEG (jpg).
- The individual file size limit is 2 MB.
- The maximum image size is 1,920 x 936 pixels. If the image size was less than 480 x 234 pixels, the image is displayed in the middle of the screen with the extra area appearing in black.
- The number of files that can be selected is up to 255.
- Up to 64 characters can be displayed in the file name.

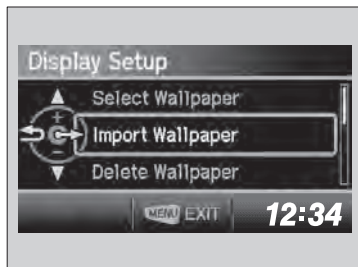

5. Select **Import Wallpaper** with the $\boxed{+}$ / $\boxed{-}$ button, then press the SOURCE button.
 - ▶ The file names are displayed on the screen.

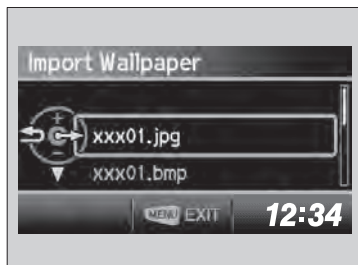

6. Press the $\boxed{-}$ button until the file name you want to store appears on the center of the display, then press the SOURCE button.



7. The preview of the imported data is displayed. Press the SOURCE button if it is OK.
8. Press the SOURCE button to save the image file.



9. Select the location you want to store the image file in with the / button, then press the SOURCE button.
10. Press the MENU button to exit the customize screen.

Selecting a Wallpaper

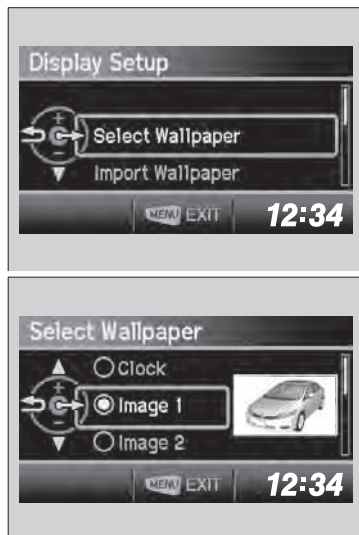

1. Press the MENU button.
2. Select **Customize Settings** with the $\boxed{+}$ / $\boxed{-}$ button, then press the SOURCE button.
3. Select **Display Setup** with the $\boxed{+}$ / $\boxed{-}$ button, then press the SOURCE button.
4. Select **Select Wallpaper** with the $\boxed{+}$ / $\boxed{-}$ button, then press the SOURCE button.
5. Select the image file you want with the $\boxed{+}$ / $\boxed{-}$ button, then press the SOURCE button.
 - ▶ When the scroll is stopped, the thumbnail is displayed.
6. Press the MENU button to exit the customize screen.

Controls

This chapter explains how to operate the various controls necessary for driving.



- Setting the Clock** 98
- Locking and Unlocking the Doors**
 - Key Types and Functions 99
 - Locking/Unlocking the Doors from the Outside 101
 - Locking/Unlocking the Doors from the Inside 103
 - Childproof Door Locks 104
 - Auto Door Locking/Unlocking* 105
- Opening and Closing the Trunk**..... 109
- Security System** 112
 - Immobilizer System 112
 - Security System Alarm* 112
- Opening and Closing the Windows**..... 114

- Opening and Closing the Moonroof*** 116
- Operating the Switches Around the Steering Wheel**
 - Ignition Switch..... 117
 - Turn Signals 118
 - Light Switches..... 118
 - Fog Lights* 120
 - Daytime Running Lights 120
 - Wipers and Washers 121
 - Brightness Control 122
 - Rear Defogger/Heated Door Mirror*
 - Button 123
 - ECON Button* 123
 - Adjusting the Steering Wheel..... 124

- Adjusting the Mirrors**..... 125
 - Interior Rearview Mirror 125
 - Power Door Mirrors* 125
- Adjusting the Seats** 126
 - Adjusting the Seat Positions..... 126
- Interior Lights/Interior Convenience Items** 134
 - Interior Lights 134
 - Interior Convenience Items 135
- Heating and Cooling*** 140
 - Using Vents, Heating and A/C* 140

* Not available on all models

Clock

Models without navigation system

You can adjust the time in the clock display, using the CLOCK knob with the ignition switch in ON .

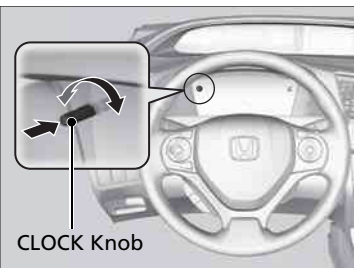

On multi-information display



On information display



1. Press the CLOCK knob to access the clock adjustment mode screen.
2. Turn the CLOCK knob to adjust the hours.
3. Press the CLOCK knob. The display switches to minute adjustment.
4. Turn the CLOCK knob to adjust the minutes.
5. Press the CLOCK knob to complete clock adjustment.

»Clock

Models with navigation system

The clock is automatically updated through the navigation system, so the time does not need to be adjusted.

Models with multi-information display

You can customize the clock display to show the 12 hour clock or 24 hour clock.

[▶ Customized Features P. 86](#)

Models with information display

You cannot adjust the time while the vehicle is moving.

Key Types and Functions

This vehicle comes with the following keys:

Master Keys



Use the keys to start and stop the engine, to lock and unlock the doors and to open the trunk. You can also use the remote transmitter* to lock and unlock the doors and to open the trunk.

There is a panic button in the remote transmitter.

Key Types and Functions

All of the keys have an immobilizer system. The immobilizer system helps to protect against vehicle theft.

[Immobilizer System P. 112](#)

The keys contain precision electronics. Adhere to the following advice to prevent damage to the electronics:

- Do not leave the keys in direct sunlight, or in locations with high temperature or high humidity.
- Do not drop the keys or set heavy objects on them.
- Keep the keys away from liquids.
- Do not take the keys apart except for replacing the battery.

If the circuits in the keys are damaged, the engine may not start, and the remote transmitter may not work.

If the keys do not work properly, have them inspected by a dealer.

* Not available on all models

■ Valet Key



Can be used to start and stop the engine, and lock and unlock driver's door.

■ Key Number Tag

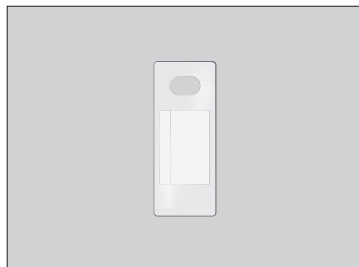

Contains a number that you will need if you purchase a replacement key.

▣ Valet Key

When you need to leave a key with a third party, leave the valet key.

▣ Key Number Tag

Keep the key number tag separate from the key in a safe place outside of your vehicle. If you wish to purchase an additional key, contact a dealer.

If you lose your key and you cannot start the engine, contact a dealer.

Locking/Unlocking the Doors from the Outside

Using the Remote Transmitter*

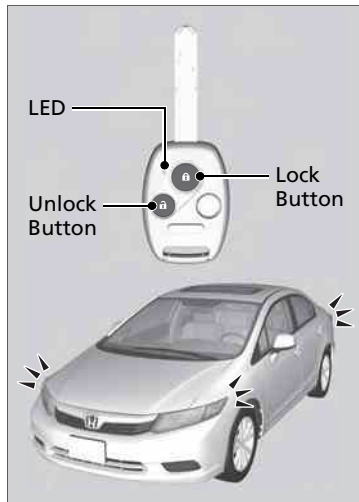

■ Locking the doors

Press the LOCK button.

Once:

- ▶ Some exterior lights will flash, all the doors will lock, and the security system sets.

Twice (within five seconds after the first push):

- ▶ A beeper sounds and verifies the security system is set.

■ Unlocking the doors

Press the UNLOCK button.

Once:

- ▶ Some exterior lights will flash twice, and the driver's door unlocks.

Twice:

- ▶ The remaining doors unlock.

Using the Remote Transmitter

If you do not open a door within 30 seconds of unlocking the vehicle with the remote transmitter, the doors will automatically relock.

You can change the relock timer setting.

▶ [Customized Features P. 86](#)

If the interior light switch is in the door activated position, the interior lights come on when you press the UNLOCK button.

No doors opened: The lights fade out after 30 seconds.

Doors relocked with the remote: The lights go off immediately.

▶ [Interior Lights P. 134](#)

The remote transmitter uses low-power signals, so the operating range may vary depending on the surroundings.

The remote will not lock the vehicle when a door is open.

If the distance at which it works varies, the battery is probably low.

If the LED does not come on when you press a button, the battery is dead.

▶ [Replacing the Battery P. 290](#)

Models with multi-information display

You can customize the door unlock mode setting.

▶ [Customized Features P. 86](#)

* Not available on all models

■ Locking/Unlocking the Doors Using a Key

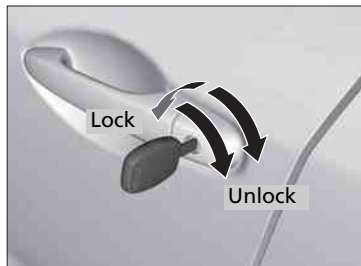

Fully insert the key and turn it.

■ Locking a Door Without Using a Key

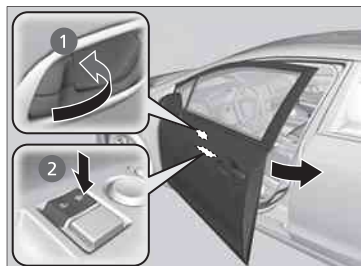

■ Locking the driver's door

Models with remote transmitter

Push the lock tab forward **1** or push the master door lock switch in the lock direction **2**, and close the door.

Models without remote transmitter

Pull and hold the outside door handle, then push the lock tab forward **1**. Release the handle, then close the door.

■ Locking the passenger's doors

Push the lock tab forward and close the door.

Models with remote transmitter

■ Lockout prevention system

The doors cannot be locked when the key is in the ignition switch, and any door is open.

▶▶ Locking/Unlocking the Doors Using a Key

Models with remote transmitter

When you lock the driver's door with a key, all of the other doors lock at the same time. When unlocking, the driver's door unlocks first. Turn the key a second time within a few seconds to unlock the remaining doors.

Models with multi-information display

You can customize the door unlock mode setting.

[▶ Customized Features P. 86](#)

▶▶ Locking a Door Without Using a Key

Models with remote transmitter

When you lock the driver's door, all the other doors lock at the same time.

Make sure you have the key in your hand before locking the door to prevent it from being locked in the vehicle.

Locking/Unlocking the Doors from the Inside

Using the Lock Tab

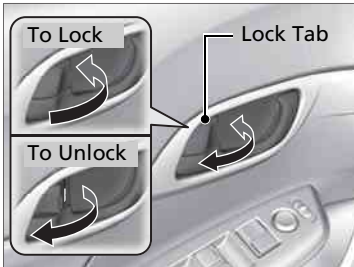

■ **Locking a door**
Push the lock tab forward.

■ **Unlocking a door**
Pull the lock tab rearward.

Unlocking Using the Inner Handle of Front Doors

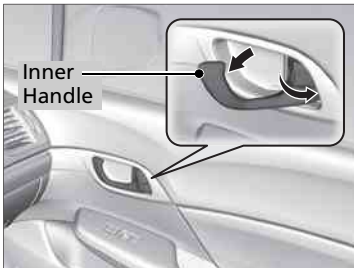

Pull the front door inner handle.
▶ The door unlocks and opens in one motion.

Using the Lock Tab

Models with remote transmitter

When you lock the door using the lock tab on the driver's door, all of the other doors lock at the same time.

When you unlock the door using the lock tab on the driver's door, only the driver's door will unlock.

Unlocking Using the Inner Handle of Front Doors

The inner front door handles are designed to allow front seat occupants to open the door in one motion. However this feature requires that front seat occupants never pull a front door inner handle while the vehicle is in motion.

Children should always ride in a rear seat where childproof door locks are provided.

➤ [Childproof Door Locks P. 104](#)

■ Using the Master Door Lock Switch*

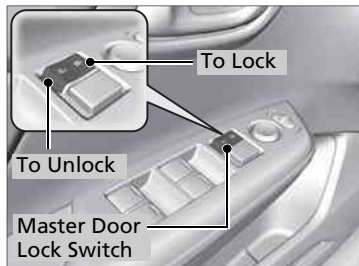

Press the master door lock switch in as shown to lock or unlock all doors.

▶▶ Using the Master Door Lock Switch

When you lock/unlock the driver's door using the master lock switch, all the other doors lock/unlock at the same time.

Childproof Door Locks

The childproof door locks prevent the rear doors from being opened from the inside regardless of the position of the lock tab.

▶▶ Childproof Door Locks

To open the door from the inside when the childproof door lock is on, put the lock tab in the unlock position, lower the rear window, put your hand out of the window, and pull the outside door handle.

■ Setting the Childproof Door Locks

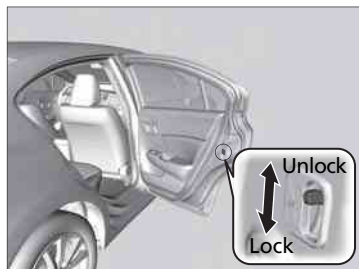

Slide the lever in the rear door to the lock position, and close the door.

■ When opening the door

Open the door using the outside door handle.

Auto Door Locking/Unlocking*

Your vehicle locks all doors and unlocks the driver's door automatically when a certain condition is met.

Auto Door Locking

■ Drive lock mode

All doors lock when the vehicle's speed reaches about 10 mph (15 km/h).

Auto Door Unlocking

Models with automatic transmission

■ Park unlock mode

The driver's door unlocks when the shift lever is moved into **P** with the brake pedal depressed.

Models with manual transmission

■ Ignition switch unlock mode

The driver's door unlocks when the ignition switch is moved out of ON **II**.

The settings can be changed to unlock all doors.

Auto Door Locking/Unlocking

Models without multi-information display

You can turn off or change to another auto door locking/unlocking setting using the master door lock switch.

➤ [Customizing the Auto Door Locking/Unlocking Setting](#) P. 106

Models with multi-information display

You can turn off or change to another auto door locking/unlocking setting using the multi-information display.

➤ [Customized Features](#) P. 86

* Not available on all models

Customizing the Auto Door Locking/Unlocking Setting*

You can customize the auto door locking/unlocking setting to your liking using the master door lock switch.

List of the Auto Door Locking/Unlocking Customizable Options

■ Auto door locking

Mode	Description
Drive Lock Mode ^{*1}	All doors lock when the vehicle's speed reaches about 10 mph (15 km/h).
Models with automatic transmission Park Lock Mode	All doors lock when the shift lever is moved out of P .
Off	The auto door locking is deactivated all the time.

■ Auto door unlocking

Mode	Description
Models with automatic transmission Park Unlock Mode	Driver's door unlocks ^{*2} All doors unlock
Ignition Switch Unlock Mode	When the shift lever is moved into P with the brake pedal depressed.
Off	Driver's door unlocks ^{*3} All doors unlock
	When the ignition switch is moved out of ON II .
Off	The auto door unlocking is deactivated all the time.

*1: Default setting

*2: Default setting for automatic transmission models

*3: Default setting for manual transmission models

Customizing Flow for Auto Door Locking Options

Steps	Drive Lock Mode* ¹	Models with automatic transmission Park Lock Mode	Off
1	Apply the parking brake. Models with automatic transmission Move the shift lever out of P .	Apply the parking brake. Move the shift lever to P .	Apply the parking brake. Models with automatic transmission Move the shift lever to P .
2	Close the driver's door.		Open the driver's door.
3	Turn the ignition switch to ON II .		Turn the ignition switch to ON II .
4	Press and hold the front of the master door lock switch on the driver's door for more than five seconds. Release the switch after you hear a click twice.		Press and hold the front of the master door lock switch on the driver's door for more than five seconds. Release the switch after you hear one click.
5	Turn the ignition switch to ACCESSORY I within 20 seconds. ▶ Customization is completed.		

*1: Default setting

Customizing Flow for Auto Door Unlocking Options

Steps	Ignition Switch Unlock Mode		Models with automatic transmission Park Unlock Mode		Off
	To unlock driver's door ^{*1}	To unlock all doors	To unlock driver's door ^{*2}	To unlock all doors	
1	Apply the parking brake. Models with automatic transmission Move the shift lever out of P .		Apply the parking brake. Move the shift lever to P .		Apply the parking brake. Models with automatic transmission Move the shift lever to P .
2	Close the driver's door.				Open the driver's door.
3	Turn the ignition switch to ON II .				Turn the ignition switch to ON II .
4	Press and hold the rear of the master door lock switch on the driver's door for more than five seconds. You will hear a click twice.				
					
5	Release the switch.	Keep pressing the switch for another five seconds to hear one more click.	Release the switch.	Keep pressing the switch for another five seconds to hear one more click.	Release the switch.
6	Turn the ignition switch to ACCESSORY I within 20 seconds. ▶ Customization is completed.				

*1: Default setting for manual transmission models

*2: Default setting for automatic transmission models

* Not available on all models

Precautions for Opening/Closing the Trunk

■ Opening the trunk

Open the trunk all the way.

- ▶ If it is not fully opened, the trunk lid may begin to close under its own weight.

■ Closing the trunk

Keep the trunk lid closed while driving to:

- ▶ Avoid possible damage.
- ▶ Prevent exhaust gas from leaking into the vehicle.

[Exhaust Gas Hazard P. 62](#)

Using the Trunk Opener

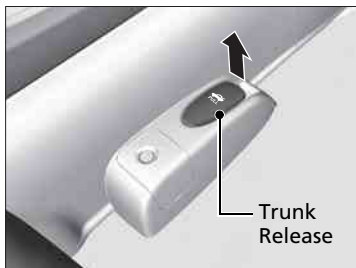

Pulling the trunk release to the lower left of the driver's seat unlocks and opens the trunk.

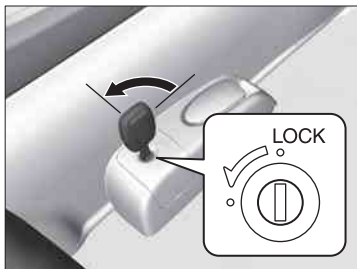

■ **Locking the trunk opener**

You can lock the trunk release with the master key.

Using the Master Key*

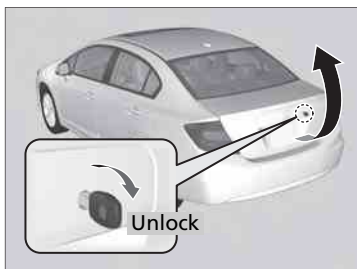

Insert the key in the cylinder to unlock and open the trunk.

▶▶ Locking the trunk opener

If you need to give the key to someone else, give them the valet key.

▶▶ Using the Master Key

The valet key does not unlock the trunk.

Using the Remote Transmitter*



Press the trunk release button* for approximately one second to unlock and open the trunk.

Emergency Trunk Opener

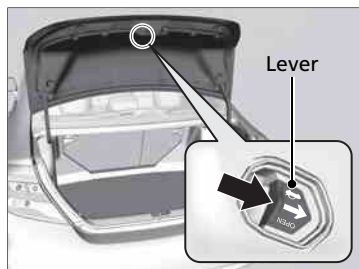

The trunk release lever allows you to open the trunk from inside for your safety.

Slide the release lever in the direction of the arrow.

☒ Emergency Trunk Opener

Parents should decide if their children should be shown how to use this feature.

* Not available on all models

Immobilizer System

The immobilizer system prevents a key that has not been pre-registered from starting the engine. Each key contains electronic transmitters that use electronic signals to verify the key.

Pay attention to the following when inserting the key into the ignition switch:

- Do not allow objects that emit strong radio waves near the ignition switch.
- Make sure the key is not covered by or touching a metal object.
- Do not bring a key from another vehicle's immobilizer system near the ignition switch.

Security System Alarm *

The security system alarm activates when the doors, trunk, or hood are opened without the key, or remote transmitter.

■ When the security system alarm activates

The horn sounds intermittently and all of the exterior lights flash.

■ To deactivate the security system alarm

Unlock the vehicle using the key, or remote transmitter. The system, along with the horn and flashing lights, is deactivated.

» Immobilizer System

NOTICE

Leaving the ignition key in the vehicle can result in theft or accidental movement of the vehicle. Always take the ignition key with you whenever you leave the vehicle unattended.

Do not alter the system or add other devices to it. Doing so may damage the system and make your vehicle inoperable.

» Security System Alarm

The security alarm continues for a maximum of two minutes until the security system deactivates.

■ Setting the security system alarm

The security system alarm automatically sets when the following conditions have been met:

- The ignition switch is in LOCK [0], and the key has been removed from the ignition switch.
- The hood and trunk are closed.
- All doors are locked with the key or the remote transmitter.

■ When the security system alarm sets

The security system indicator in the instrument panel blinks. When the blinking interval changes after about 15 seconds, the security system is set.

■ To cancel the security system alarm

The security system is canceled when the vehicle is unlocked using the key or remote transmitter, or the ignition switch is turned to ON [II]. The security system indicator goes off at the same time.

☒ Security System Alarm

Do not set the security system alarm when someone is in the vehicle or a window is open. The system can accidentally activate when:

- Unlocking the door with the lock tab or the master door lock switch.
- Opening the trunk with the trunk release or the emergency trunk opener.

If the battery goes dead after you have set the security system alarm, the security alarm may go off once the battery is recharged or replaced. If this occurs, deactivate the security system alarm by unlocking a door using the key or remote transmitter.

Do not attempt to alter this system or add another device to it.

■ Panic Mode



■ The panic button on the remote transmitter

If you press the panic button for approximately one second, the following will occur for about 30 seconds:

- The horn sounds.
- Some exterior lights flash.

■ Canceling panic mode

Press any button on the remote transmitter, or turn the ignition switch to ON [II].

* Not available on all models

Opening/Closing the Power Windows

The power windows can be opened and closed when the ignition switch is in ON **II**, using the switches on the doors. The driver's side switches can be used to open and close all of the windows.

The power window lock button on the driver's side must be switched off (not pushed in, indicator off) to open and close the windows from anywhere other than the driver's seat.

When the power window lock button is pushed in, the indicator comes on and you can only operate the driver's window. Turn the power window lock button on when children are in the vehicle.

Opening/Closing Windows with Auto-Open/Close Function *

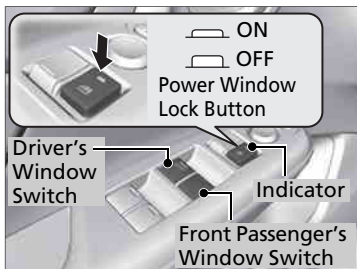

Automatic operation

To open: Push the switch down firmly.

To close: Pull the switch up firmly.

The window opens or closes completely. To stop the window at any time, push or pull the switch briefly.

Manual operation

To open: Push the switch down lightly.

To close: Pull the switch up lightly.

Release the switch when the window reaches the desired position.

Opening/Closing the Power Windows

WARNING

Closing a power window on someone's hands or fingers can cause serious injury.

Make sure your passengers are away from the windows before closing them.

The power windows can be operated for up to 10 minutes after you turn the ignition switch off. Opening either front door cancels this function.

Auto Reverse

If a power window senses resistance when closing automatically, it will stop closing and reverse direction.

The driver's window auto reverse function is disabled when you continuously pull up the switch.

The auto reverse function stops sensing when the window is almost closed to ensure that it fully closes.

■ Opening/Closing Windows without Auto-Open/Close Function

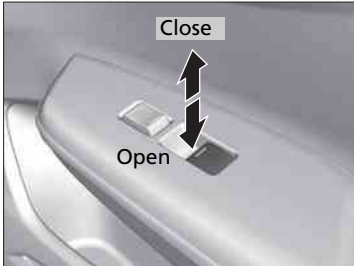

To open: Push the switch down.

To close: Pull the switch up.

Release the switch when the window reaches the desired position.

Opening/Closing the Moonroof

You can only operate the moonroof when the ignition switch is in ON (II). Use the switch in the front of the ceiling to open and close the moonroof.

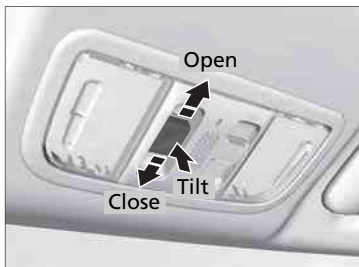

Automatic operation

To open: Pull the switch back firmly, then release.

To close: Push the switch forward firmly, then release.

The moonroof will automatically open or close all the way. To stop the moonroof midway, touch the switch briefly.

Manual operation

To open: Pull the switch back, and hold it until the desired position is reached.

To close: Push the switch forward, and hold it until the desired position is reached.

Tilting the moonroof up

To tilt: Push on the center of the moonroof switch.

To close: Push the switch forward firmly, then release.

Opening/Closing the Moonroof

WARNING

Opening or closing the moonroof on someone's hands or fingers can cause serious injury.

Make sure all hands and fingers are clear of the moonroof before opening or closing it.

NOTICE

Opening the moonroof in below freezing temperature or when it is covered with snow or ice can damage the moonroof panel or motor.

The power moonroof can be operated for up to 10 minutes after you turn the ignition switch off. Opening either front door cancels this function.

When resistance is detected, the auto reverse function causes the moonroof to change directions, then stop. Auto reverse stops sensing when the moonroof is almost closed to ensure that it fully closes. Make sure that all objects, including fingers, are clear of the moonroof.

Ignition Switch



- 0** LOCK: Insert and remove the key in this position.
- I** ACCESSORY: Operate the audio system and other accessories in this position.
- II** ON: This is the position when driving.
- III** START: This position is for starting the engine. The switch returns to ON **II** when you let go of the key.

Ignition Switch

Manual transmission models

⚠ WARNING

Removing the key from the ignition switch while driving locks the steering. This can cause you to lose control of the vehicle.

Remove the key from the ignition switch only when parked.

Automatic transmission models

You cannot take the key out unless the shift lever is in **P**.

All models

If you open the driver's door when the key is in LOCK **0** or ACCESSORY **I**, a warning buzzer will sound to remind you to take the key out.

When this happens, the following messages appear on the multi-information display*:

- In LOCK **0**: "REMOVE KEY."
- In ACCESSORY **I**: "RETURN IGNITION SWITCH TO LOCK (0) POSITION" The buzzer will stop when you take the key out.

If the key won't turn from LOCK **0** to ACCESSORY **I**, turn the key while moving the steering wheel left and right. The steering wheel will unlock, allowing the key to turn.

* Not available on all models

Turn Signals

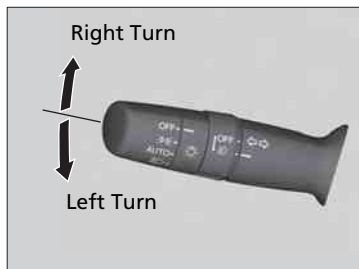

The turn signals can be used when the ignition switch is in ON **II**.

Light Switches

Manual Operation

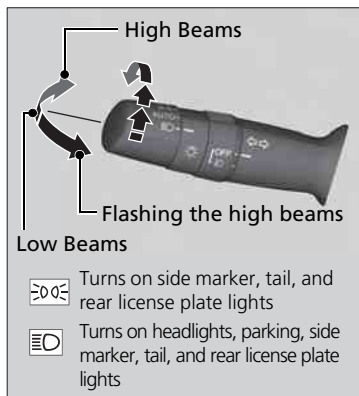

Rotating the light switch turns the lights on and off, regardless of the position of the ignition switch.

■ High beams

Push the lever forward until you hear a click.

■ Low beams

When in high beams, pull the lever back to return to low beams.

■ Flashing the high beams

Pull the lever back, and release it.

Light Switches

If you remove the key from the ignition switch while the lights are on, a chime sounds when the driver's door is opened.

When the lights are on, the lights on indicator in the instrument panel will be on.

[▶ Lights On Indicator P. 73](#)

Do not leave the lights on when the engine is off because it will cause the battery to discharge.

Automatic Lighting Control*

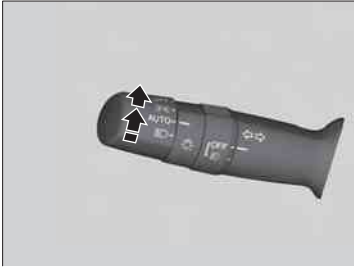

Automatic lighting control can be used when the ignition switch is in ON **(II)**.

When you turn the light switch to **AUTO**, the headlights and other exterior lights will switch on and off automatically depending on the ambient brightness.

Automatic Lighting Off Feature

The headlights, all other exterior lights, and the instrument panel lights turn off within 15 seconds after you remove the key and close the driver's door.

If you turn the ignition switch to LOCK **(0)** with the headlight switch on, but do not open the door, the lights turn off after 10 minutes (3 minutes, if the switch is in the **AUTO** position).

The lights turn on again when you unlock or open the driver's door. If you unlock the door, but do not open it within 15 seconds, the lights go off. If you open the driver's door, you will hear a lights on reminder chime.

Automatic Lighting Control

We recommend that you turn on the lights manually when driving at night, in a dense fog, or in dark areas such as long tunnels or parking facilities.

The light sensor is in the location shown below. Do not cover this light sensor with anything; otherwise, the automatic lighting system may not work properly.

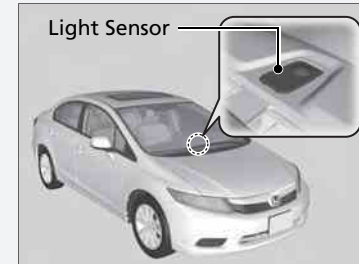

You can change the AUTO light sensitivity and automatic lighting off timer setting using the multi-information display.

▶ [Customized Features P. 86](#)

* Not available on all models

Fog Lights*

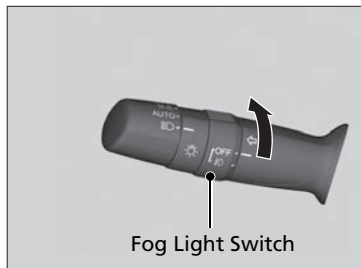

When the low beam headlights are on, turn the fog light switch on to use the fog lights.



» Fog Lights

When the fog lights are on, the indicator in the instrument panel will be on. They go off when the headlights turn off, or when the daytime running lights are on.

[▶ Fog Light Indicator* P. 73](#)

Daytime Running Lights

The high beam headlights come on slightly dimmer than normal when the following conditions have been met:

- The ignition switch is in ON .
- The headlight switch is off, or in .
- The parking brake is released.

The lights remain on even if you set the parking brake. Turning off the ignition switch will turn off the daytime running lights.

The high beam headlights return to the original brightness once the headlight switch is turned on.

Wipers and Washers

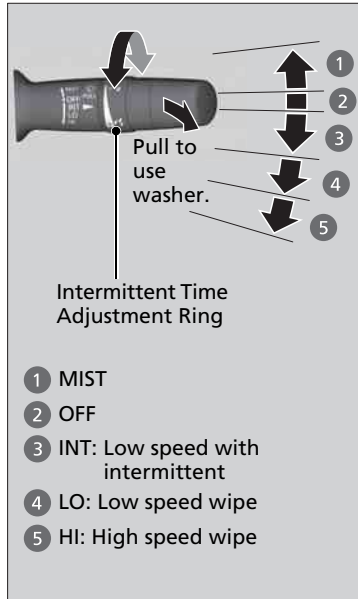

The windshield wipers and washers can be used when the ignition switch is in ON .

■ MIST

The wipers run at high speed until you release the lever.

■ Wiper switch (OFF, INT, LO, HI)

Change the wiper switch setting according to the amount of rain.

■ Adjusting the delay

Turn the adjustment ring to adjust the wiper delay.



■ Washer

Sprays while you pull the lever toward you. When you release the lever, the wipers make two or three more sweeps before stopping.

Wipers and Washers

NOTICE

Do not use the wipers when the windshield is dry. The windshield will get scratched, or the rubber blades will get damaged.

NOTICE

In cold weather, the blades may freeze to the windshield, becoming stuck. Operating the wipers in this condition may damage the wipers. Use the defroster to warm the windshield, then turn the wipers on.

If the vehicle speeds up while the wipers are operating intermittently, the length of the wipe interval shortens. When the vehicle starts moving, the wipers make a single sweep. When the vehicle speeds up, the wiper operation's shortest delay setting  and the LO setting become the same.

Turn the washers off if no washer fluid comes out. The pump may get damaged.

Brightness Control



When the parking lights are turned on and the ignition switch is in ON (II), you can use the brightness control knob to adjust instrument panel brightness.

Brighten: Turn the knob to the right.

Dim: Turn the knob to the left.



You will hear the beeper when the brightness reaches minimum or maximum. The information display*/multi-information display* will return to its original state several seconds after you adjust the brightness.

■ Brightness level indicator

The brightness level is shown on the information display*/multi-information display* while you are adjusting it.

▶▶ Brightness Control

Instrument panel brightness varies, depending on whether the exterior lights are on or off. The instrument panel dims to reduce glare when they are on.

Pressing the  (SEL/RESET) knob or the  (display/information) button* switches the display.

If you turn the knob to the right until the brightness display is up to max, the beeper sounds. This cancels the reduced instrument panel brightness when the parking lights are on.

The brightness can be set differently for when the exterior lights are on, and when they are off.

On multi-information display

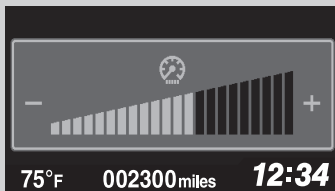

On information display



Rear Defogger/Heated Door Mirror* Button

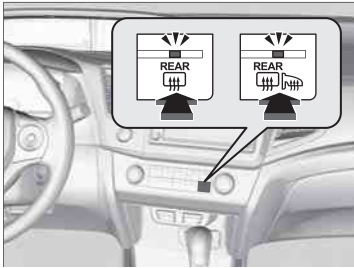

Press the rear defogger and heated door mirror button to defog the rear window and mirrors when the ignition switch is in ON .

The rear defogger and heated door mirrors automatically switch off after 20 minutes.

⌘ Rear Defogger/Heated Door Mirror Button

NOTICE

When cleaning the inside of the rear window, be careful not to damage the heating wires. It is critical to wipe the window from side to side along the defogger heating wires.

This system consumes a lot of power, so turn it off when the window has been defogged. Also, do not use the system for a long period when the engine is idling. This may weaken the battery, making it difficult to start the engine.

ECON Button*



The ECON button turns the ECON mode on and off.

The ECON mode helps you improve your fuel economy by adjusting the performance of the engine, transmission, heating and cooling system, and cruise control.

* Not available on all models

Adjusting the Steering Wheel

The steering wheel height and distance from your body can be adjusted so that you can comfortably grip the steering wheel in an appropriate driving posture.

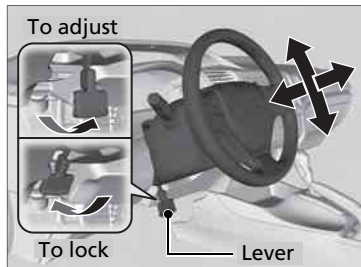

1. Pull the steering wheel adjustment lever up.
 - ▶ The steering wheel adjustment lever is under the steering column.
2. Move the steering wheel up or down, and in or out.
 - ▶ Make sure you can see the instrument panel gauges and indicators.
3. Push the steering wheel adjustment lever down to lock the steering wheel in position.
 - ▶ After adjusting the position, make sure you have securely locked the steering wheel in place by trying to move it up, down, in, and out.

▶▶ Adjusting the Steering Wheel

⚠ WARNING

Adjusting the steering wheel position while driving may cause you to lose control of the vehicle and be seriously injured in a crash.

Adjust the steering wheel only when the vehicle is stopped.

Make any steering wheel adjustments before you start driving.

Interior Rearview Mirror

Adjust the angle of the rearview mirror when you are sitting in the correct driving position.

Adjusting the Mirrors

Keep the inside and outside mirrors clean and adjusted for best visibility.

Adjust the mirrors before you start driving.

[Adjusting the Seat Positions P. 126](#)

Rearview Mirror with Day and Night Positions

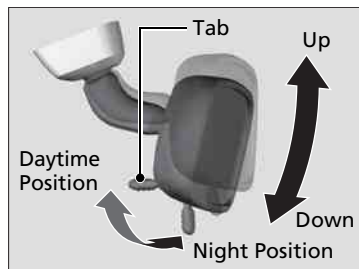

Flip the tab to switch the position. The night position will help to reduce the glare from headlights behind you when driving after dark.

Power Door Mirrors*

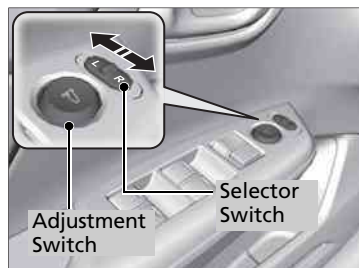

You can adjust the door mirrors when the ignition switch is in ON .

Mirror position adjustment

L/R selector switch: Select the left or right mirror. After adjusting the mirror, return the switch to the center position.

Mirror position adjustment switch: Press the switch left, right, up, or down to move the mirror.

* Not available on all models

Adjusting the Seat Positions

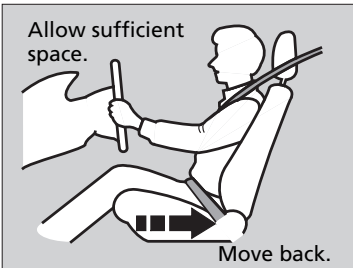

Adjust the driver's seat as far back as possible while allowing you to maintain full control of the vehicle. You should be able to sit upright, well back in the seat and be able to adequately press the pedals without leaning forward, and grip the steering wheel comfortably. The passenger's seat should be adjusted in a similar manner, so that it is as far back from the front airbag in the dashboard as possible.

Adjusting the Seats

⚠ WARNING

Sitting too close to a front airbag can result in serious injury or death if the front airbags inflate.

Always sit as far back from the front airbags as possible while maintaining control of the vehicle.

The National Highway Traffic Safety Administration and Transport Canada recommend that drivers allow at least 10 inches (25 cm) between the center of the steering wheel and the chest.

Always make seat adjustments before driving.

■ Adjusting the front power seat*



■ Adjusting the front manual seat(s)



⊠ Adjusting the front manual seat(s)

Once a seat is adjusted correctly, rock it back and forth to make sure it is locked in position.

■ Adjusting the Seat-Backs

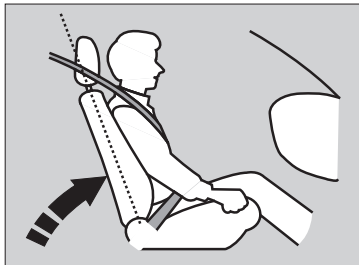

Adjust the driver's seat-back to a comfortable, upright position, leaving ample space between your chest and the airbag cover in the center of the steering wheel.

The front seat passenger should also adjust their seat-back to a comfortable, upright position.

Reclining a seat-back so that the shoulder part of the belt no longer rests against the occupant's chest reduces the protective capability of the belt. It also increases the chance of sliding under the belt in a crash and being seriously injured. The farther a seat-back is reclined, the greater the risk of injury.

►► Adjusting the Seat-Backs

⚠ WARNING

Reclining the seat-back too far can result in serious injury or death in a crash.

Adjust the seat-back to an upright position, and sit well back in the seat.

Do not put a cushion, or other object, between the seat-back and your back.

Doing so may interfere with proper seat belt or airbag operation.

If you cannot get far enough away from the steering wheel and still reach the controls, we recommend that you investigate whether some type of adaptive equipment may help.

■ Adjusting the Head Restraints

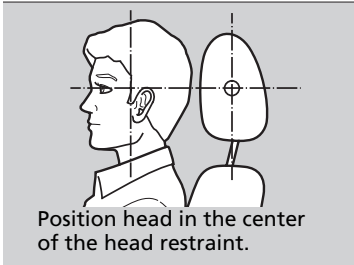

Your vehicle is equipped with head restraints in all seating positions.

Head restraints are most effective for protection against whiplash and other rear-impact crash injuries when the center of the back of the occupant's head rests against the center of the restraint. The tops of the occupant's ears should be level with the center height of the restraint.

■ Adjusting the front head restraint positions

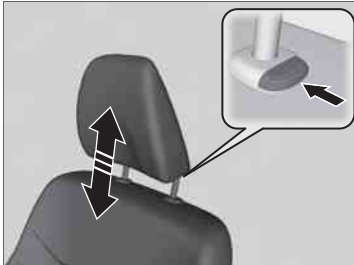

To raise the head restraint: Pull it upward.

To lower the head restraint: Push it down while pressing the release button.

ⓘ Adjusting the Head Restraints

⚠ WARNING

Improperly positioning head restraints reduces their effectiveness and increases the likelihood of serious injury in a crash.

Make sure head restraints are in place and positioned properly before driving.

For a head restraint system to work properly:

- Do not hang any items on the head restraints, or from the restraint legs.
- Do not place any object between an occupant and the seat-back.
- Install each restraint in its proper location.

■ Changing the Rear Seat Head Restraint Positions

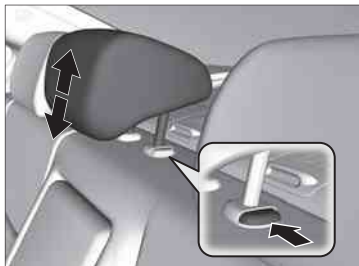

A passenger sitting in a back seating position should adjust the height of their head restraint to an appropriate position before the vehicle begins moving.

To raise the head restraint:

Pull it upward.

To lower the head restraint:

Push it down while pressing the release button.

■ Removing and Reinstalling the Head Restraints

Head restraints can be removed for cleaning or repair.

To remove a head restraint:

Pull the restraint up as far as it will go. Then push the release button, and pull the restraint up and out.

To reinstall a head restraint:

Insert the legs back in place, then adjust the head restraint to an appropriate height while pressing the release button. Pull up on the restraint to make sure it is locked in position.

✎ Removing and Reinstalling the Head Restraints

⚠ WARNING

Failure to reinstall, or correctly reinstall, the head restraints can result in severe injury during a crash.

Always replace the head restraints before driving.

Maintain a Proper Sitting Position

After all occupants have adjusted their seats and head restraints, and put on their seat belts, it is very important that they continue to sit upright, well back in their seats, with their feet on the floor, until the vehicle is safely parked and the engine is off.

Sitting improperly can increase the chance of injury during a crash. For example, if an occupant slouches, lies down, turns sideways, sits forward, leans forward or sideways, or puts one or both feet up, the chance of injury during a crash is greatly increased.

In addition, an occupant who is out of position in the front seat can be seriously or fatally injured in a crash by striking interior parts of the vehicle or being struck by an inflating front airbag.

ⓘ Maintain a Proper Sitting Position

⚠ WARNING

Sitting improperly or out of position can result in serious injury or death in a crash.

Always sit upright, well back in the seat, with your feet on the floor.

Rear Seats

Folding Down the Rear Seats

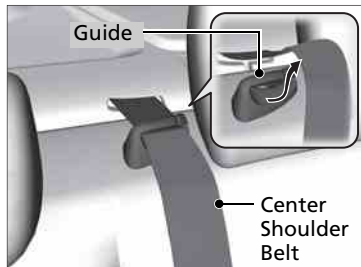

1. Remove the center shoulder belt from the guide.

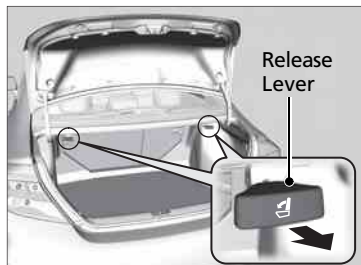

2. Pull the release lever in the trunk to release the lock.



3. Fold the seat-back down.

If the rear head restraints get caught on the front seat-backs, remove the head restraints.

➤ [Removing and Reinstalling the Head Restraints P. 130](#)

Folding Down the Rear Seats

The rear seat-back(s*) can be folded down to accommodate bulkier items in the trunk.

Never drive with the seat-back folded down and the trunk lid open.

➤ [Exhaust Gas Hazard P. 62](#)

To lock the seat-back upright, push it backwards until it locks.

When returning a seat-back to its original position, push it firmly back. Also, make sure all rear shoulder belts are positioned in front of the seat-back, and the center shoulder belt is re-positioned in the guide.

Make sure that the folded seat-back does not press against the front passenger seat, as this can cause the weight sensors in the front passenger seat to work improperly.

➤ [Passenger Airbag Off Indicator P. 47](#)

Also make sure all items in the trunk or items extending through the opening into the rear seats are properly secured. Loose items can fly forward if you have to brake hard.

Armrest

■ Using the Rear Seat Armrest*



Pull down the armrest in the center seat-back.

* Not available on all models

Interior Lights

Interior Light Switches



■ ON

The interior lights come on regardless of whether the doors are open or closed.

■ Door activated

The interior lights come on in the following situations:

- When any of the doors are opened.
- You unlock the driver's door.
- You remove the key from the ignition switch.

■ OFF

The interior lights remain off regardless of whether the doors are open or closed.

Map Lights*

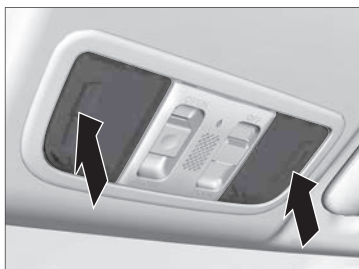

The map lights can be turned on and off by pressing the lenses.

» Interior Light Switches

In the door activated position, the interior lights fade out and go off about 30 seconds after the doors are closed.

The lights go off after 30 seconds in the following situations:

- When you unlock the driver's door but do not open it.
- When you remove the key from the ignition switch but do not open a door.

Models with multi-information display

You can change the interior lights dimming time.

[Customized Features P. 86](#)

All models

The interior lights go off immediately in the following situations:

- When you lock the driver's door.
- When you close the driver's door with the key in the ignition switch.
- When you turn the ignition switch to ON **[II]**.

If you leave any of the doors open without the key in the ignition switch, the interior lights go off after about 15 minutes.

» Map Lights

When the ceiling light switch is in the door activated position and any door is open, the map light will not go off when you press the lens.

Interior Convenience Items

Glove Box



Pull the handle to open the glove box.

Glove Box

⚠ WARNING

An open glove box can cause serious injury to your passenger in a crash, even if the passenger is wearing the seat belt.

Always keep the glove box closed while driving.

Console Compartment

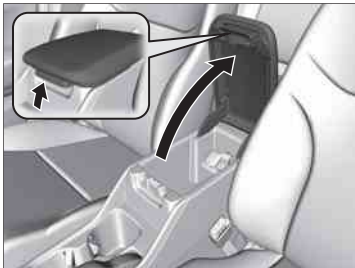

Pull the handle to open the console compartment.

Beverage Holders



■ Front seat beverage holders

Are located in the console between the front seats.



■ Rear seat beverage holders*

Fold the armrest down to use the rear seat beverage holders.

» Beverage Holders

NOTICE

Spilled liquids damage the upholstery, carpeting, and electrical components in the interior.

Be careful when you are using the beverage holders. Hot liquid can scald you.

Accessory Power Sockets

The accessory power sockets can be used when the ignition switch is in ACCESSORY **I** or ON **II**.



Accessory power socket (console panel)

Open the cover to use it.



Accessory power socket (console compartment)*

Open the console lid and the cover to use it.

Accessory Power Sockets

NOTICE

Do not insert an automotive type cigarette lighter element.

This can overheat the power socket.

The accessory power socket is designed to supply power for 12 volt DC accessories that are rated 120 watts or less (10 amps).

To prevent battery drain, only use the power socket with the engine running.

Models with rear accessory power socket

When both sockets are being used, the combined power rating of the accessories should not exceed 120 watts (10 amps).

* Not available on all models

Coat Hook



There is a coat hook on the rear left grab handle. Pull it down to use it.

Coat Hook

The coat hook is not designed for large or heavy items.

Seat Heaters*



The ignition switch must be in ON **II** to use the seat heaters. The HI setting heats the seats faster than the LO setting.

There is no heater in the passenger's seat-back due to the side airbag cutoff system.



While in HI, the heater cycles on and off.

- The appropriate indicator will be on while the seat heater is on. Briefly press the switch on the opposite side to turn the heater off. The indicator will be off. When a comfortable temperature is reached, select LO to keep the seat warm.

Seat Heaters

⚠ WARNING

Heat induced burns are possible when using seat heaters.

Persons with a diminished ability to sense temperature (e.g., persons with diabetes, lower-limb nerve damage, or paralysis) or with sensitive skin should not use seat heaters.

Do not use the seat heaters even in LO when the engine is off. Under such conditions, the battery may be weakened, making the engine difficult to start.

In the LO setting, the heater runs continuously and does not automatically turn off.

* Not available on all models

Using Vents, Heating and A/C*

Mode Buttons

Change airflow.

Floor and defroster vents

Floor vents

Dashboard and floor vents

Dashboard vents

Fan Control Dial

Adjusts the fan speed. Rotate the dial all the way to OFF to turn everything off.

MAX A/C Button*

Turns on the A/C, selects airflow from the dashboard vents, and switches the mode to recirculation.

A/C Button*

Press to cool the interior or dehumidify while heating.

Windshield Defroster Button

Turns on the A/C, selects airflow from the defroster vents at the base of the windshield, and switches the mode to fresh air.

Temperature Control Dial

Adjusts the interior temperature.

(Recirculation) Button

Press the  button and switch the mode depending on environmental conditions.

Recirculation Mode (indicator on):
Recirculates air from the vehicle's interior through the system.

Fresh Air Mode (indicator off):
Maintains outside ventilation. Keep the system in fresh air mode in normal situations.

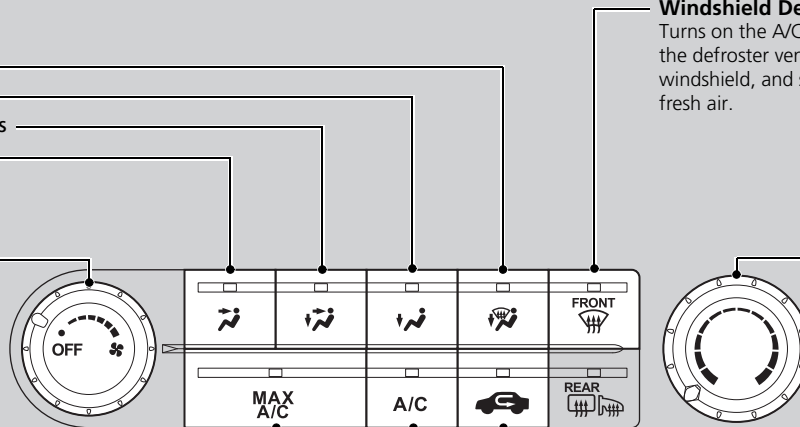

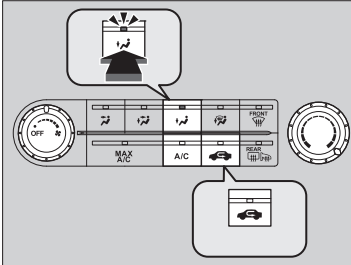

Heating



The heater uses engine coolant to warm the air.

1. Adjust the fan speed using the fan control dial.
2. Select .
3. Adjust the temperature using the temperature control dial.

■ To rapidly warm up the interior

1. Set the fan to the maximum speed.
2. Select .
3. Set the temperature to maximum warm.
4. Press the  button (the indicator on).

■ To dehumidify the interior*

When used in combination with the heater, the air conditioning system makes the interior warm and dry and can prevent the windows from fogging up.

1. Turn the fan on.
2. Press the A/C button to turn on the air conditioning.

* Not available on all models

Continued

Heating

When you select , the mode automatically switches to fresh air.

To rapidly warm up the interior

Change to fresh air mode as soon as the interior gets warm enough. The windows may fog up if kept in recirculation mode.

■ Cooling*

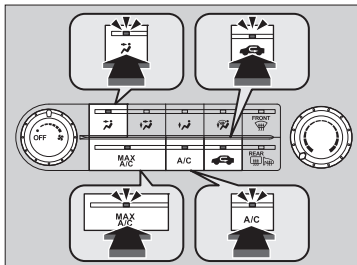



1. Adjust the fan speed using the fan control dial.
2. Select .
3. Adjust the temperature using the temperature control dial.
4. Press the A/C button (the indicator on).

■ To rapidly cool down the interior

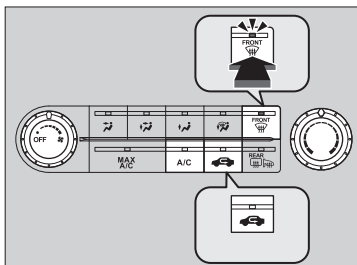

1. Set the fan to the maximum speed.
2. Set the temperature to maximum cool.
3. Press the  button (the indicator on).

■ Defrosting the Windshield and Windows*



Pressing the  button turns the air conditioning system on and automatically switches the system to fresh air mode.

■ To rapidly defrost the windows

1. Set the fan to the maximum speed.
2. Press the  button.
3. Press the  button.
4. Set the temperature to maximum warm.

▶▶ To rapidly cool down the interior

If the interior is very warm, you can cool it down more rapidly by partially opening the windows.

While in the ECON mode, the system has greater temperature fluctuations.

Pressing the  button bypasses the ECON mode control, and cools down the interior more rapidly.

▶▶ Defrosting the Windshield and Windows

For your safety, make sure you have a clear view through all the windows before driving.

Do not set the temperature near the upper or lower limit.

When cold air hits the windshield, the outside of the windshield may fog up.

If the side windows fog up, adjust the vents so that the air hits the side windows.

▶▶ To rapidly defrost the windows

After defrosting or defogging the windows, switch over to fresh air mode.

If you keep the system in recirculation mode, the windows may fog up from humidity. This impedes visibility.

Features

This chapter describes how to operate technology features on models without the navigation system.



Audio System*

- About Your Audio System 144
- USB Adapter Cable* 145
- Auxiliary Input Jack 145
- Audio System Theft Protection* 146

Models with information display

- Audio System Basic Operation*** 147
 - Adjusting the Sound 148
 - Playing the AM/FM Radio 149
 - Playing a CD 151

Models with multi-information display

- Audio System Basic Operation*** 155
 - Audio Remote Controls* 156
 - Adjusting the Sound 157
 - Playing the AM/FM Radio 158
 - Playing a CD 161
 - Playing an iPod® 164
 - Playing a USB Flash Drive 167
 - Playing *Bluetooth*® Audio 170

Audio Error Messages*

- CD Player 172
- iPod®/USB Flash Drive 173

General Information on the Audio System*

- Recommended CDs 174
- Compatible iPod® and USB Flash Drives 176
- Bluetooth*® HandsFreeLink®***
 - Using HFL 177
 - HFL Menus 179

* Not available on all models

About Your Audio System

On models with navigation system, see the Navigation System Manual for operation of the audio system, *Bluetooth*® HandsFreeLink®, and voice commands for these features.

Models with information display

The audio system features AM/FM radio. It can also play CDs and WMA/MP3 files. You can operate the audio system from the buttons and switches on the panel.

Models with multi-information display

The audio system features AM/FM radio. It can also play audio CDs, WMA/MP3/AAC files, iPods®, USB flash drives, and *Bluetooth*® devices*.

You can operate the audio system from the buttons and switches on the panel, or the remote controls on the steering wheel.

About Your Audio System

Video CDs, DVDs, and 3-inch (8-cm) mini CDs are not supported.

iPod® is a registered trademark owned by Apple Inc.

MP3 and AAC are standard audio compression formats. WMA is an audio compression format developed by Microsoft Corporation.



USB Adapter Cable*

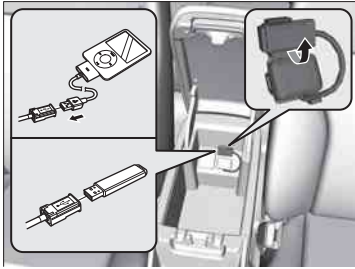

1. Unclip the USB connector and loosen the adapter cable.
2. Install the iPod® dock connector or the USB flash drive to the USB connector.

Auxiliary Input Jack

Use the jack to connect standard audio devices.



1. Open the AUX cover.
2. Connect a standard audio device to the input jack using a 1/8 inch (3.5 mm) stereo miniplug.
 - ▶ The audio system automatically switches to the AUX mode.

USB Adapter Cable

- Do not leave the iPod® or USB flash drive in the vehicle. Direct sunlight and high temperatures may damage it.
- Do not use an extension cable with the USB adapter cable.
- Do not connect the iPod® or USB flash drive using a hub.
- Do not use a device such as a card reader or hard disk drive, as the device or your files may be damaged.
- We recommend backing up your data before using the device in your vehicle.
- Displayed messages may vary depending on the device model and software version.

If the audio system does not recognize the iPod®, try reconnecting it a few times or reboot the device. To reboot, follow the manufacturer's instructions provided with the iPod® or visit www.apple.com/ipod.

Auxiliary Input Jack

To switch the mode, press any of the audio mode buttons. You can return to the AUX mode by pressing the AUX button.

You cannot use the auxiliary input jack if you replace the audio system.

State or local laws may limit the circumstances in which you can launch or control your attached audio device.

Audio System Theft Protection*

The audio system is disabled when it is disconnected from the power source, such as when the battery is disconnected or goes dead.

■ Reactivating the audio system

1. Turn the ignition switch to ON **II**, and turn on the audio system.
 - ▶ If you turn the ignition switch to ACCESSORY **I**, you will be requested to enter the audio security code. See step 3.
2. Press and hold the power button again for more than two seconds.
 - ▶ The audio system is reactivated when the system's control unit recognizes that the system is in your vehicle.
If the control unit fails to recognize, "ENTER CODE" appears on the multi-information display.
3. Enter the audio security code using the preset buttons. If you enter an incorrect digit, continue to the last digit, then try again. If you do not enter code correctly after 10 tries, leave the system for one hour before trying again, or visit a dealer to have the system reset.

▶▶ Audio System Theft Protection

Find the audio system's security code and serial number label in your owner's manual kit.

We recommend that you write down the serial number in this owner's manual.

Do not store the label in your vehicle. If you lose the label, you must first retrieve the serial number, and then obtain the code.

You can find out about your serial number and security code from a dealer.

U.S. models

You can register the security code at Owner Link (owners.honda.com), and find information on how to retrieve the serial number and obtain the code at radio-navicode.honda.com.

Models with information display

To use the audio system function, the ignition switch must be in ACCESSORY **I** or ON **II**.

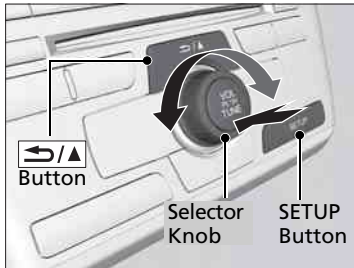

Use the selector knob or SETUP button to access some audio functions.

Press  to switch between the normal and extended display for some functions.

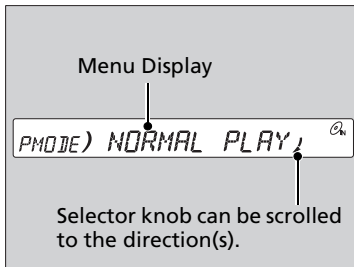

Selector knob: Rotate left or right to scroll through the available choices. Press  to set your selection.

SETUP button: Press to select any mode such as the Auto Select (A.SEL), Radio Data System (RDS), Play Mode, or the Title Display.

 **button:** Press to go back to the previous display.

Audio System Basic Operation

These indications are used to show how to operate the selector knob.

Rotate  to select.

Press  to ENTER.

Press the SETUP button while listening to the radio:

 **Auto Select (A.SEL)** P. 150

 **Radio Data System (RDS)** P. 150

Press the SETUP button while listening to a CD:

 **How to Select a Play Mode** P. 153

 **How to Select a Title Display** P. 154

Adjusting the Sound

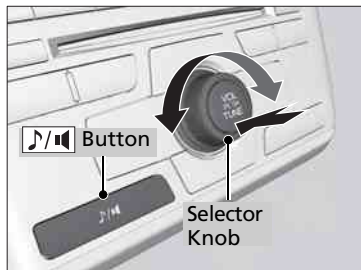

Press the button, and rotate to adjust the setting.

Each time you press the button, a sound mode switches as follows.

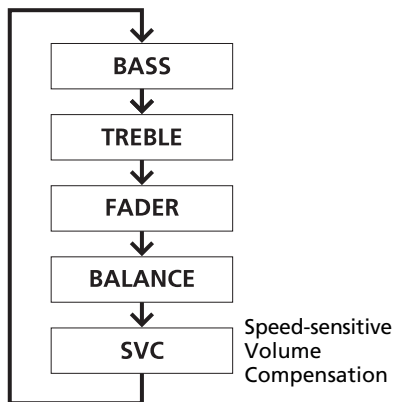

▶▶ Adjusting the Sound

When the adjustment level reaches the center, you will see "C" in the display.

The SVC has four modes: OFF, LOW, MID, and HIGH. SVC adjusts the volume level based on the vehicle speed. As you go faster, audio volume increases. As you slow down, audio volume decreases.

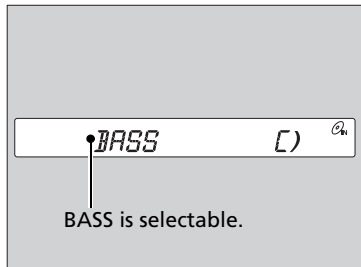

Playing the AM/FM Radio

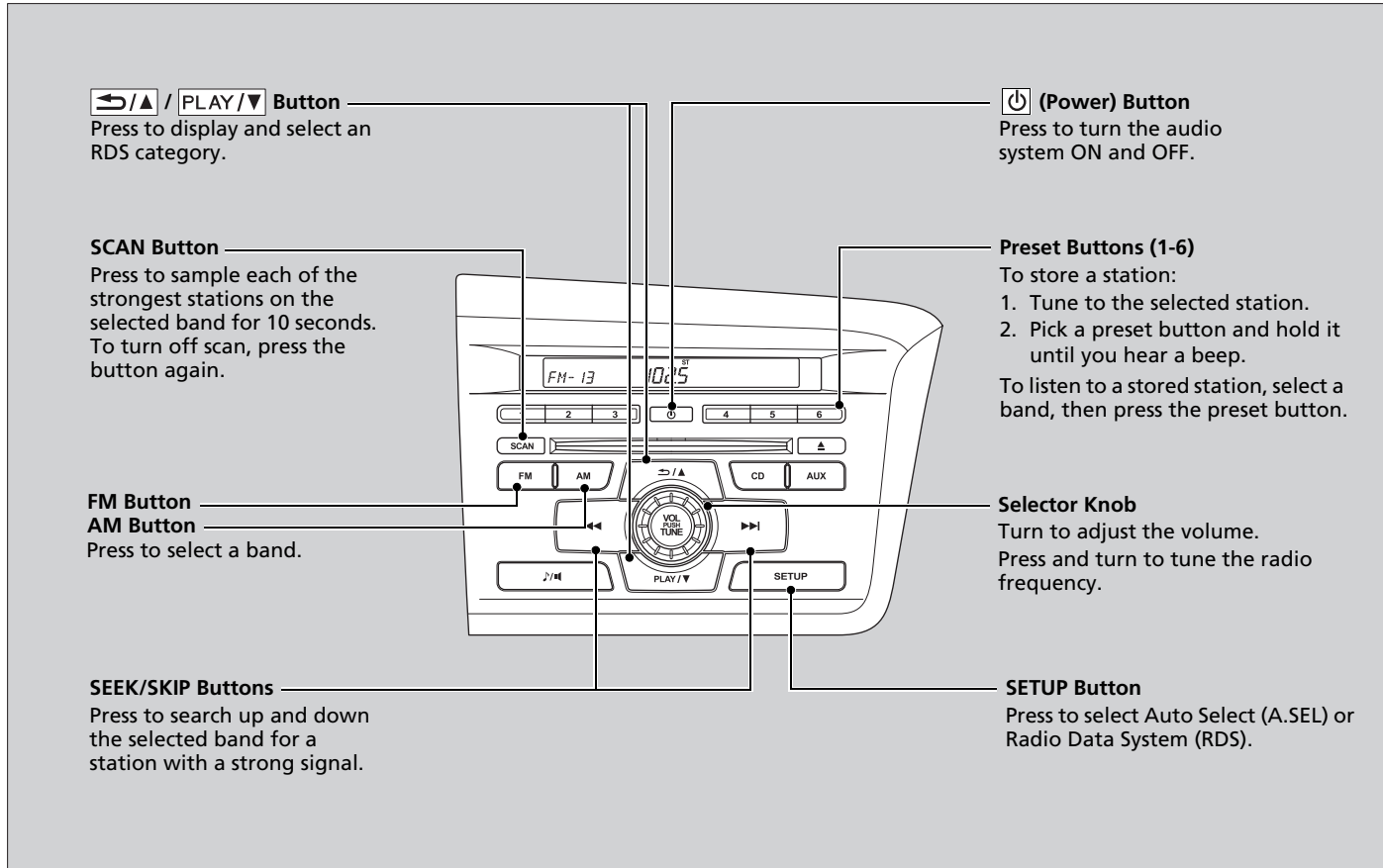

Auto Select (A.SEL)

Use the auto select feature to scan both bands and store the strongest station in each preset.



1. Press the SETUP button.
2. Press  to enter the auto select mode.
 - ▶ The system goes into scan mode for several seconds.

To turn off auto select, press  again. This restores the presets you originally set.

Radio Data System (RDS)



Provides text data information related to your selected RDS capable FM station.

RDS INFO ON

Press the SETUP button twice then press  while listening to an RDS capable station. The station name is displayed. To turn off the RDS information, press  again.

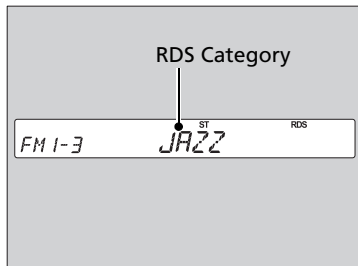
To find an RDS station from your selected program category



1. Press the  /  / [PLAY/▼] button to display and select an RDS category.
2. Use SEEK/SKIP or SCAN to select an RDS station.

▶▶ Playing the AM/FM Radio

The ST indicator appears on the display indicating stereo FM broadcasts. Stereo reproduction in AM is not available.

You can store six AM stations and twelve FM stations into the preset button memory. FM1 and FM2 let you store six stations each.

A.SEL function scans and stores up to six AM stations and twelve FM stations with a strong signal into the preset button memory.

If you do not like the stations auto select has stored, you can manually store your preferred frequencies.

▶▶ Radio Data System (RDS)

The display shows up to 12 characters of text data.

Playing a CD

Your audio system supports audio CDs, CD-Rs, and CD-RWs in either MP3 or WMA format. With the CD loaded, press the CD button.

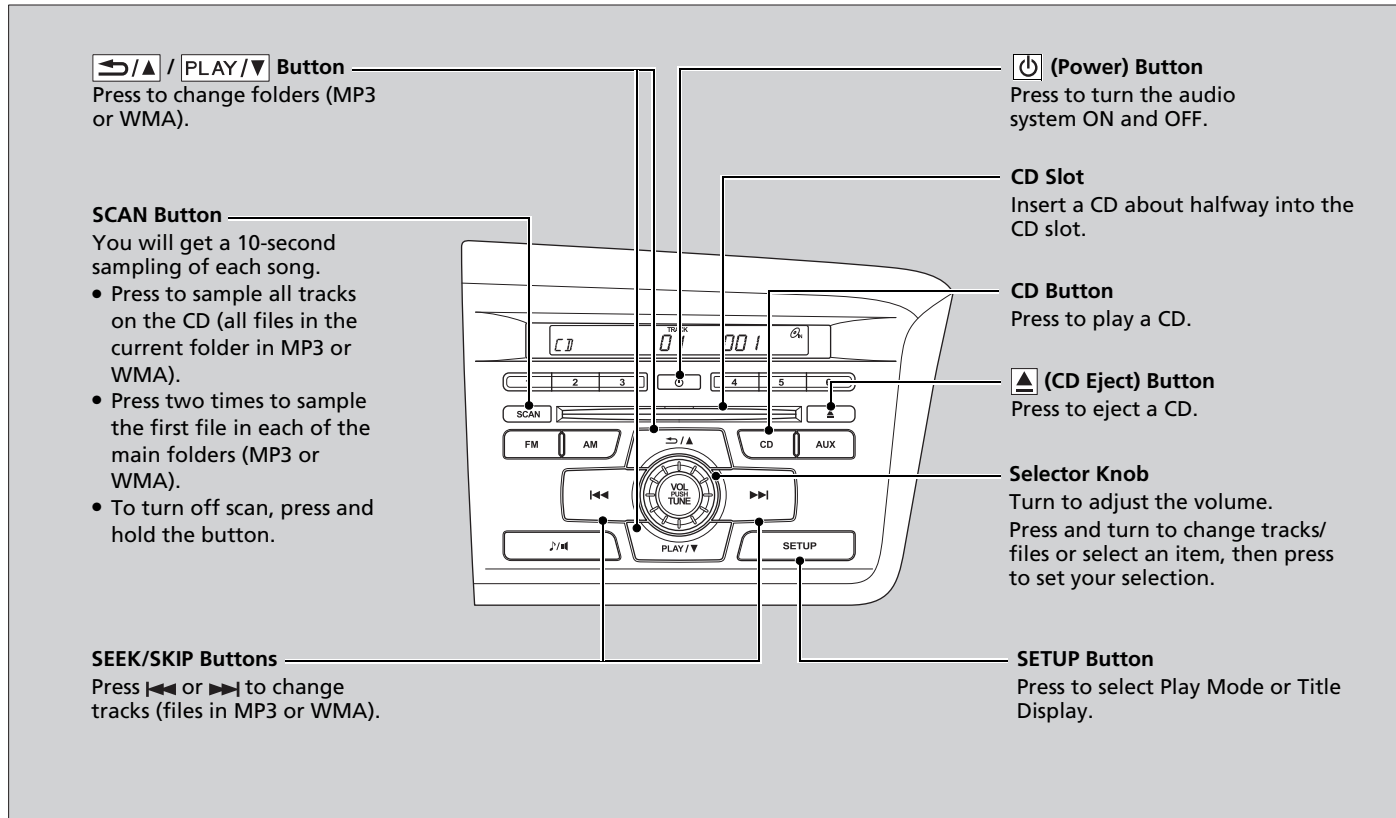

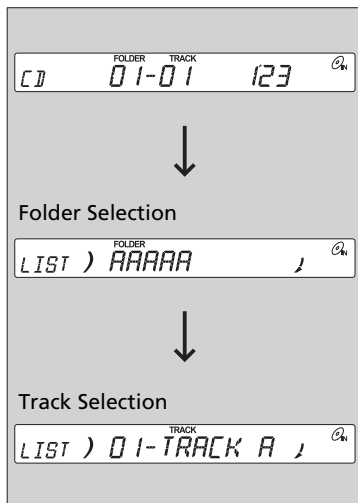

How to Select a File from a Folder with the Selector Knob (MP3/WMA)



1. Press  to switch the display to a folder list.

2. Rotate  to select a folder.

3. Press  to change the display to a list of files in that folder.

4. Rotate  to select a file, then press .

▶▶▶ Playing a CD

NOTICE

Do not use CDs with adhesive labels. The label can cause the CD to jam in the unit.

WMA files protected by digital rights management (DRM) cannot be played. The audio system displays UNPLAYABLE, then skips to the next file.

Text data appears on the display under the following circumstances:

- When you select a new folder, file, or track.
- When you change the audio mode to CD.
- When you insert a CD.

The display shows up to 12 characters of text data.



If you eject the CD but do not remove it from the slot, the system reloads the CD automatically after several seconds.

How to Select a Play Mode

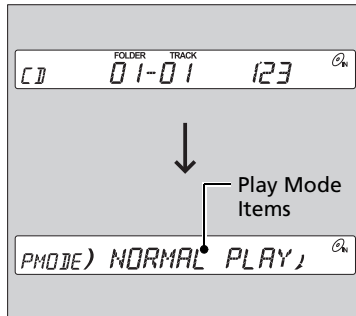
You can select repeat, random, and scan modes when playing a track or file.



1. Press the SETUP button.

2. Rotate  to select a mode, then press .

To turn off a play mode

1. Press the SETUP button.

2. Rotate  to select **NORMAL PLAY**, then press .

How to Select a Play Mode

Press the  button to go back to the previous display, and press the SETUP button twice to cancel this setting mode.

Play Mode Menu Items

NORMAL PLAY

RPT ONE TRK: Repeats the current track/file(s).

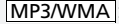
RPT ONE FLD : Repeats all files in the current folder.



RDM IN DISC: Plays all tracks/files in random order.

RDM IN FLD : Plays all files in the current folder in random order.

How to Select a Title Display

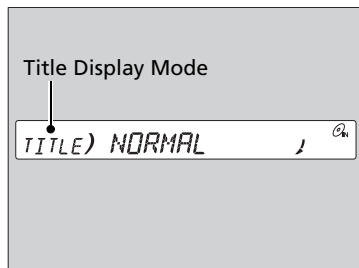
You can select an item to be shown on the display if the CD was recorded with text data.



1. Press the SETUP button twice.
2. Rotate  to select a title display mode, then press .

How to Select a Title Display

Press the  button to go back to the previous display, and press the SETUP button to cancel this setting mode.

Title Display Mode Menu Items

NORMAL: Track number

MP3/WMA: File number and folder number

FOLDER **MP3/WMA**: Folder name

FILE **MP3/WMA**: File name

ALBUM: Album name

TRACK: Track name

ARTIST: Artist name

Models with multi-information display

To use the audio system function, the ignition switch must be in ACCESSORY **I** or ON **II**.

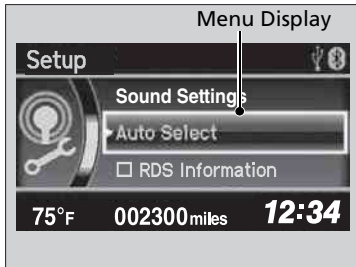
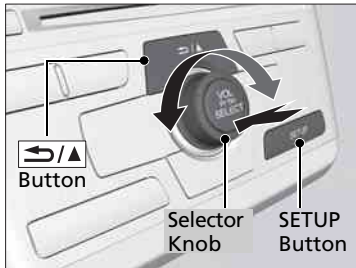

Use the selector knob or SETUP button to access some audio functions.

Press to switch between the normal and extended display for some functions.

Selector knob: Rotate left or right to scroll through the available choices. Press to set your selection.

SETUP button: Press to select any mode such as the Auto Select, RDS Information, Sound Settings*, Play Mode, Resume/Pause*.

button*: Press to select the Sound Setting mode.

button: Press to go back to the previous display.

Audio System Basic Operation

These indications are used to show how to operate the selector knob.

Rotate to select.

Press to ENTER.

Press the SOURCE, , , , or button on the steering wheel to change any audio setting.

[▶ Audio Remote Controls P. 156](#)

SETUP Menu Items

[▶ Auto Select P. 159](#)

[▶ RDS Information P. 160](#)

[▶ Sound Settings P. 157](#)

[▶ Play Mode P. 163](#)

[▶ Resume/Pause P. 171](#)

* Not available on all models

Audio Remote Controls*

Allows you to operate the audio system while driving.

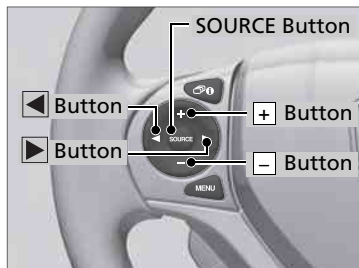

SOURCE Button

Cycles through the audio modes as follows:

FM1→FM2→AM→CD→AUX

+ - (Volume) Buttons

Press **+**: Increases the volume.

Press **-**: Decreases the volume.

◀ ▶ Buttons

- When listening to the radio

Press **▶**: Selects the next preset radio station.

Press **◀**: Selects the previous preset radio station.

- When listening to a CD, iPod®, USB flash drive, or *Bluetooth*® Audio*

Press **▶**: Skips to the next song.

Press **◀**: Goes back to the beginning of the current or previous song.

▶▶ Audio Remote Controls

The CD mode appears only when a CD is loaded.

When in the AUX mode, the following are operable from the remote controls:

- iPod®/USB flash drive connected to the USB adapter cable
- Bluetooth*® Audio (with some phones only)

Adjusting the Sound

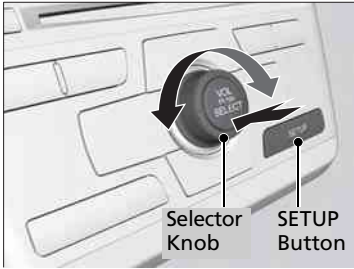

Press the **SETUP** button, and rotate to select **Sound Settings**, then press . Rotate to scroll through the following choices:

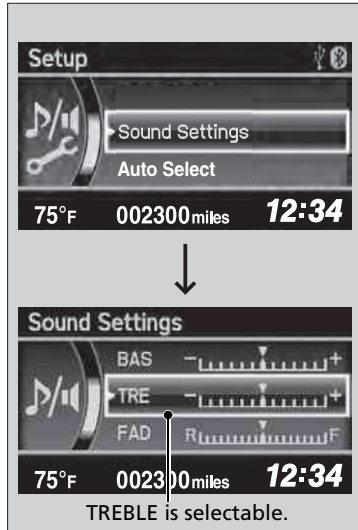
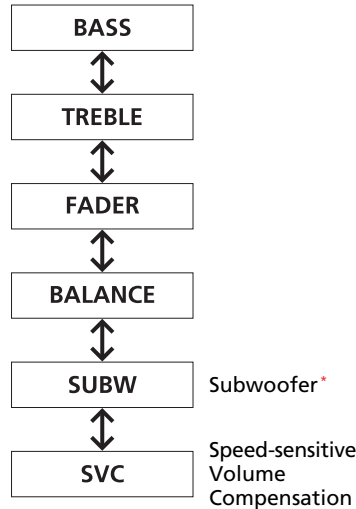

Adjusting the Sound

The SVC has four modes: OFF, LOW, MID, and HIGH. SVC adjusts the volume level based on the vehicle speed. As you go faster, audio volume increases. As you slow down, audio volume decreases.

Models with the button

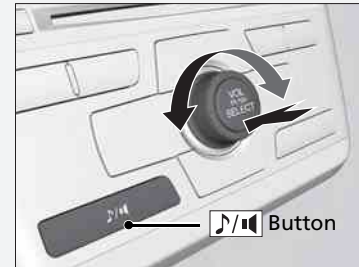

Press the button, and rotate to scroll through the choices.

* Not available on all models

Playing the AM/FM Radio

QRG

TOC

Features

Index

Home

↔ / ▲ / PLAY / ▼ Button

Press to display and select an RDS category.

SCAN Button

Press to sample each of the strongest stations on the selected band for 10 seconds. To turn off scan, press the button again.

FM Button

AM Button

Press to select a band.

SEEK/SKIP Buttons

Press to search up and down the selected band for a station with a strong signal.

⏻ (Power) Button

Press to turn the audio system ON and OFF.

Preset Buttons (1-6)

To store a station:
 1. Tune to the selected station.
 2. Pick a preset button and hold it until you hear a beep.
 To listen to a stored station, select a band, then press the preset button.

Selector Knob

Turn to adjust the volume. Press and turn to tune the radio frequency.

SETUP Button

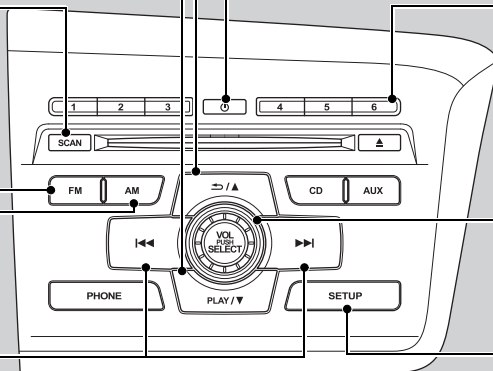
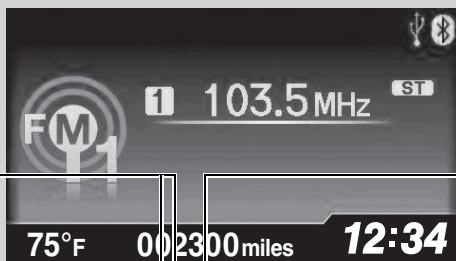

Press to display menu items.

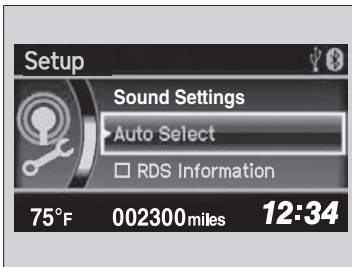

Auto Select

Use the auto select feature to scan both bands and store the strongest station in each preset.



1. Press the SETUP button.
2. Rotate  to select **Auto Select**, then press .

To turn off auto select, press  again. This restores the presets you originally set.

▶▶ Playing the AM/FM Radio

The ST indicator appears on the display indicating stereo FM broadcasts. Stereo reproduction in AM is not available.

Switching the Audio Mode
Press the SOURCE button on the steering wheel.

[▶ Audio Remote Controls P. 156](#)

You can store six AM stations and twelve FM stations into the preset button memory. FM1 and FM2 let you store six stations each.

Auto Select function scans and stores up to six AM stations and twelve FM stations with a strong signal into the preset button memory.



If you do not like the stations auto select has stored, you can manually store your preferred frequencies.

Radio Data System (RDS)

Provides text data information related to your selected RDS capable FM station.

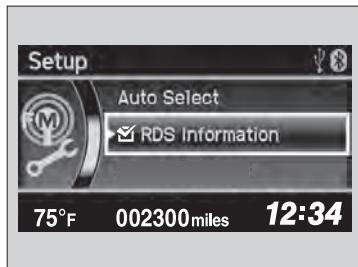

■ RDS Information

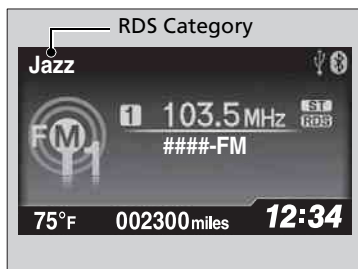

1. Press the SETUP button and rotate  to select **RDS Information**.
2. Each time you press , the RDS Information switches between on and off.

■ To find an RDS station from your selected program category



1. Press the  /  /  button to display and select an RDS category.
2. Use SEEK/SKIP or SCAN to select an RDS station.

Playing a CD

Your audio system supports audio CDs, CD-Rs and CD-RWs in either MP3 or WMA format. With the CD loaded, press the CD button.

SCAN Button
You will get a 10-second sampling of each song.

- Press to sample all tracks on the CD (all files in the current folder in MP3 or WMA).
- Press two times to sample the first file in each of the main folders (MP3 or WMA).
- To turn off scan, press and hold the button.

Power Button
Press to turn the audio system ON and OFF.

CD Slot
Insert a CD about halfway into the CD slot.

CD Button
Press to play a CD.

(CD Eject) Button
Press to eject a CD.

Selector Knob
Turn to adjust the volume. Press and turn to select an item, then press to set your selection.

SETUP Button
Press to display menu items.

SEEK/SKIP Buttons
Press **⏮** or **⏭** to change tracks (files in MP3 or WMA).

PLAY Button
Press **⏪** to skip to the next folder, and **⏩** to skip to the beginning of the previous folder in MP3 or WMA.

The diagram shows a central display screen with the following information: "256 999", "Track AAA", a progress bar at "1'23\"", "Genre AAA", "Artist AAA", "75°F", "002300 miles", and "12:34". Below the screen is a row of buttons labeled 1 through 6. The main control panel includes a "SCAN" button, "FM" and "AM" radio buttons, a "CD" button, an "AUX" button, a "PHONE" button, a "SETUP" button, and a central "VOL SELECT" knob. A "CD EJECT" button is located above the "CD" button. A "POWER" button is located to the right of the display screen.

How to Select a File from a Folder with the Selector Knob (MP3/WMA)

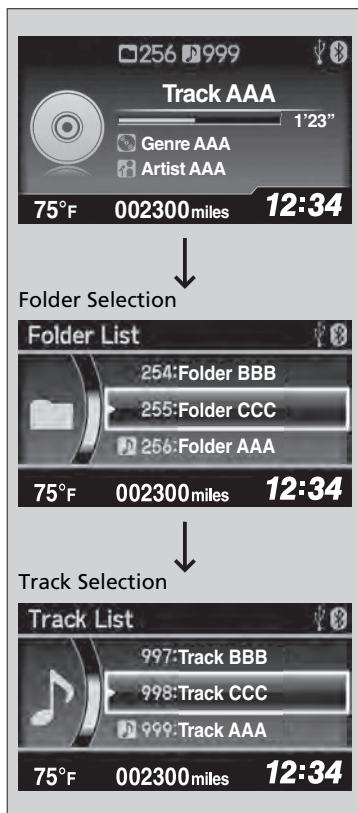

1. Press to switch the display to a folder list.

2. Rotate to select a folder.

3. Press to change the display to a list of files in that folder.

4. Rotate to select a file, then press .

▶▶ Playing a CD

NOTICE

Do not use CDs with adhesive labels. The label can cause the CD to jam in the unit.

WMA files protected by digital rights management (DRM) cannot be played.

The audio system displays "Unsupported," then skips to the next file.

Text data appears on the display under the following circumstances:

- When you select a new folder, file, or track.
- When you change the audio mode to CD.
- When you insert a CD.





If you eject the CD but do not remove it from the slot, the system reloads the CD automatically after several seconds.

How to Select a Play Mode





You can select repeat, random, and scan modes when playing a track or file.



1. Press the SETUP button.

2. Rotate  to select **Play Mode**, then press .
3. Rotate  to select a mode, then press .

■ To turn off a play mode

1. Press the SETUP button.
2. Rotate  to select **Play Mode**, then press .
3. Rotate  to select **Normal Play**, then press .

⌘ How to Select a Play Mode

Press the  button to go back to the previous display, and press the SETUP button to cancel this setting mode.

Play Mode Menu Items

Normal Play

Repeat One Track: Repeats the current track/file(s).

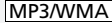
Repeat One Folder : Repeats all files in the current folder.

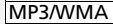
Random in Folder : Plays all files in the current folder in random order.

Random in Disc: Plays all tracks/files in random order.

Playing an iPod®

Connect the iPod® using your dock connector to the USB adapter cable, then press the AUX button.

➤ [USB Adapter Cable](#) P. 145

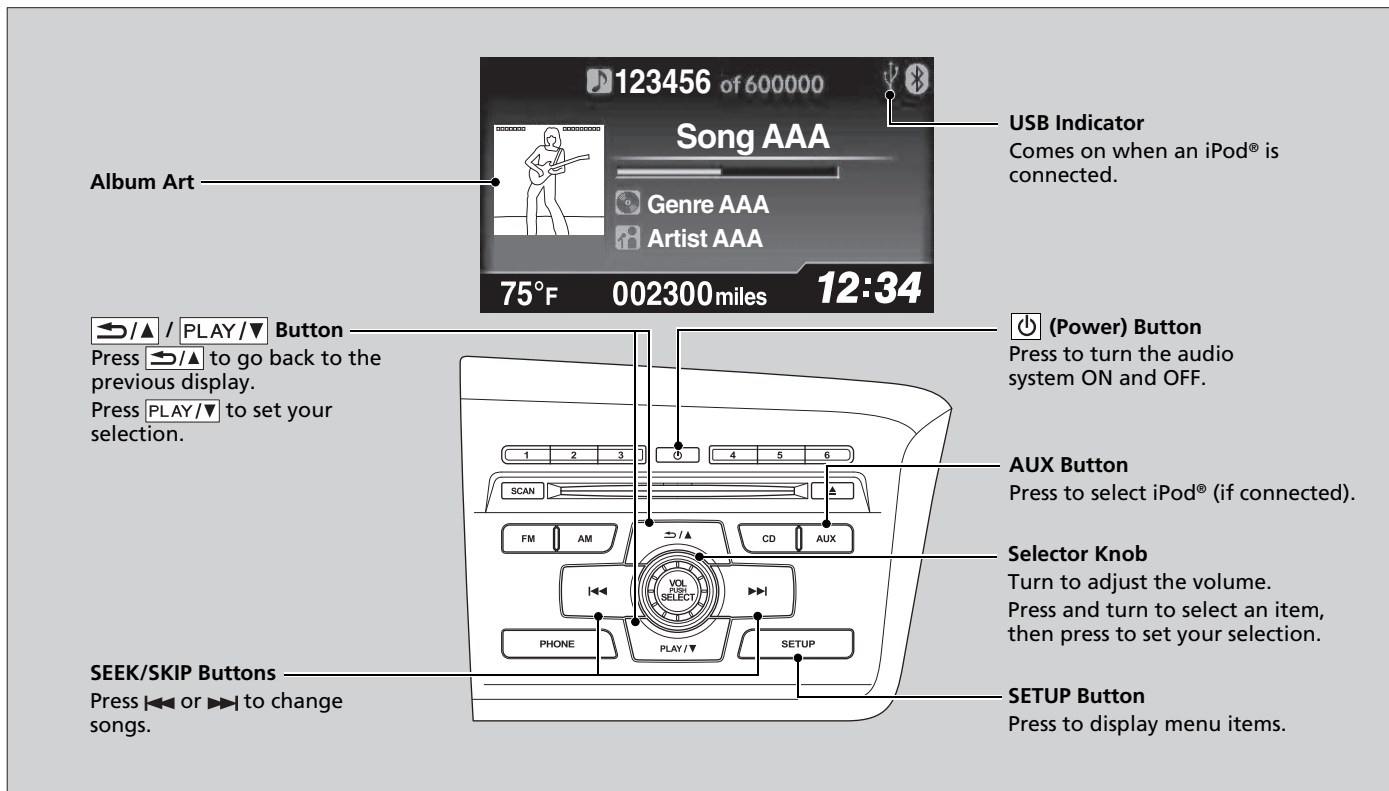

How to Select a File from the iPod® Menu

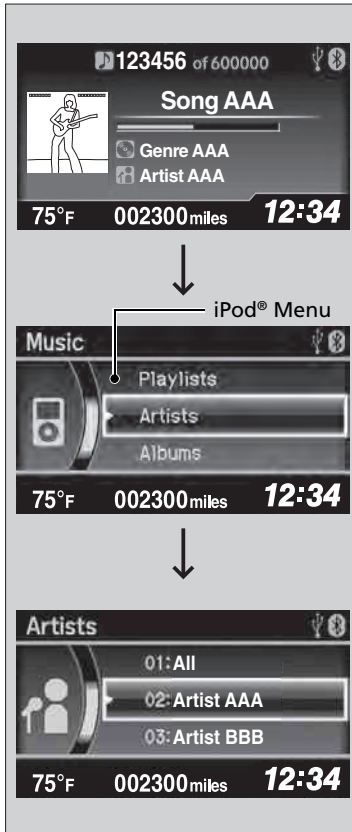

1. Press to display the iPod® menu.

2. Rotate to select a menu.

3. Press to display the items on that menu.

4. Rotate to select an item, then press .

▶▶▶ Playing an iPod®

Available operating functions vary on models or versions. Some functions may not be available on the vehicle's audio system.

If there is a problem, you may see an error message on the multi-information display.

[▶▶ iPod®/USB Flash Drive P. 173](#)

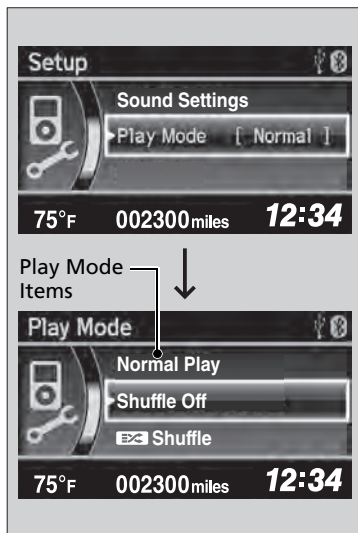

How to Select a Play Mode

You can select repeat and shuffle modes when playing a file.



1. Press the SETUP button.

2. Rotate  to select **Play Mode**, then press .

3. Rotate  to select a mode, then press .

To turn off a play mode

1. Press the SETUP button.

2. Rotate  to select **Play Mode**, then press .

3. Rotate  to select **Normal Play**, then press .

How to Select a Play Mode

Play Mode Menu Items

Normal Play

Shuffle Off: Turns off the shuffle mode.

Shuffle: Plays all available files in a selected list (playlists, artists, albums, songs, genres, or composers) in random order.

Shuffle Albums: Plays all available albums in a selected list (playlists, artists, albums, songs, genres, or composers) in random order.

Repeat Off: Turns off the repeat mode.

Repeat One Track: Repeats the current track.

Playing a USB Flash Drive

Your audio system reads and plays sound files on a USB flash drive in either MP3, WMA or AAC*¹ format.

Connect your USB flash drive to the USB adapter cable, then press the AUX button.

➤ [USB Adapter Cable](#) P. 145

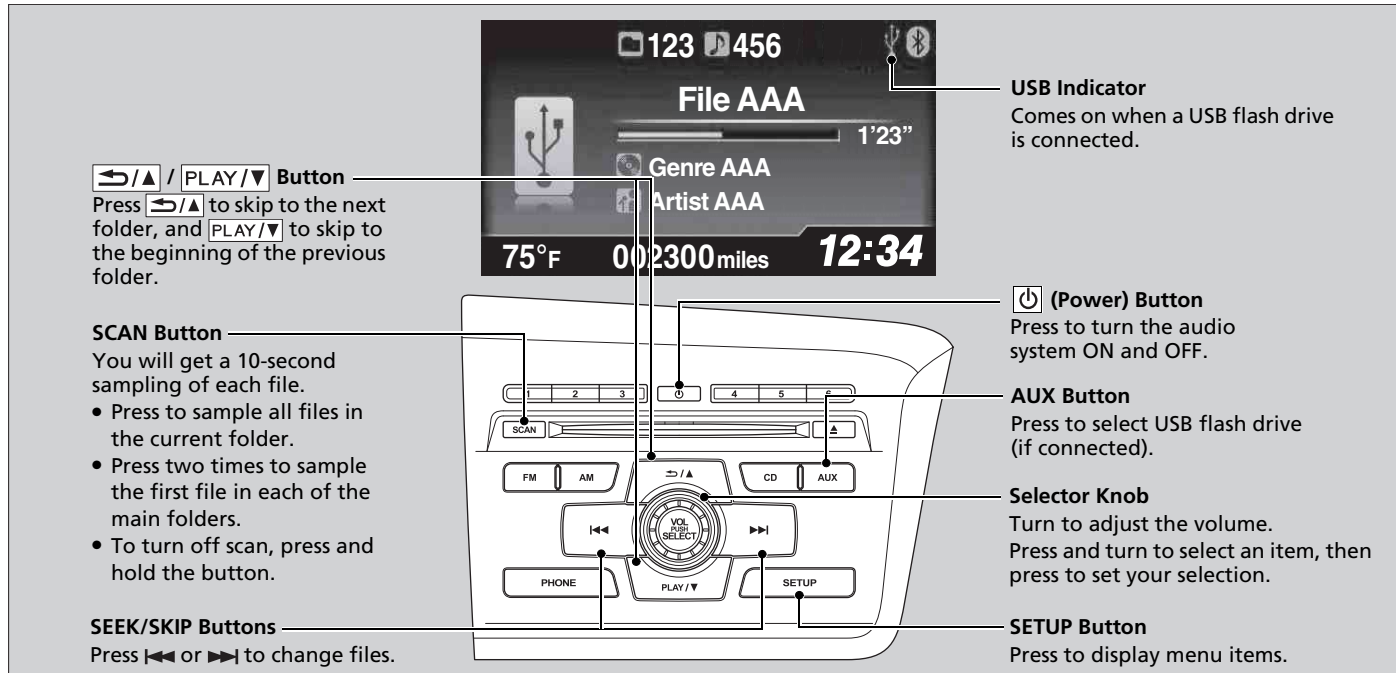

*¹: Only AAC format files recorded with iTunes® are playable on this unit.

* Not available on all models

How to Select a File from a Folder with the Selector Knob

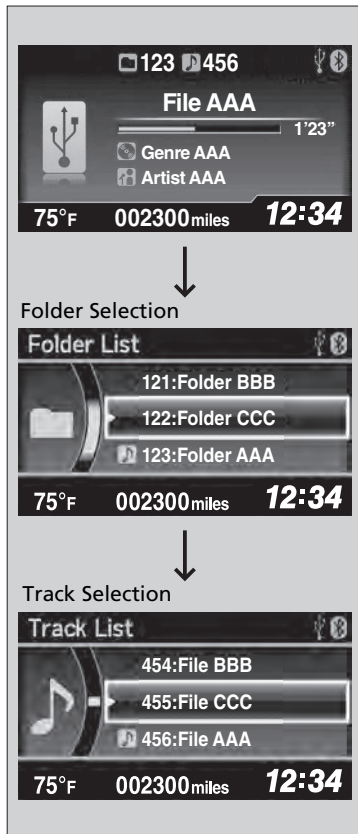

1. Press  to switch the display to a folder list.

2. Rotate  to select a folder.

3. Press  to change the display to a list of files in that folder.

4. Rotate  to select a file, then press .

▶▶ Playing a USB Flash Drive

Use the recommended USB flash drives.

 [General Information on the Audio System P. 174](#)

Files in WMA format protected by digital rights management (DRM) are not played.

The audio system displays “Unplayable File,” and then skips to the next file.

If there is a problem, you may see an error message on the multi-information display.

 [iPod®/USB Flash Drive P. 173](#)

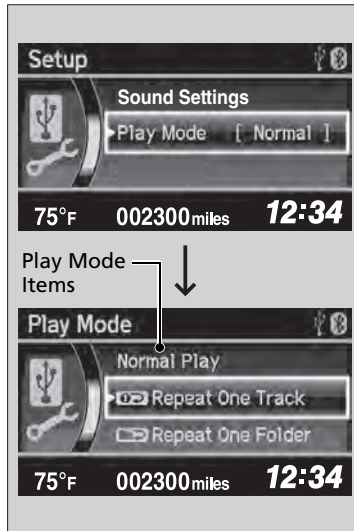

How to Select a Play Mode

You can select repeat, random, and scan modes when playing a file(s).



1. Press the SETUP button.

2. Rotate  to select **Play Mode**, then press .

3. Rotate  to select a mode, then press .

■ To turn off a play mode

1. Press the SETUP button.

2. Rotate  to select **Play Mode**, then press .

3. Rotate  to select **Normal Play**, then press .

How to Select a Play Mode

Play Mode Menu Items

Normal Play

Repeat One Track: Repeats the current file.

Repeat One Folder: Repeats all files in the current folder.

Random in Folder: Plays all files in the current folder in random order.

Random All: Plays all files in random order.

Models with *Bluetooth*® HandsFreeLink®

Playing *Bluetooth*® Audio

Your audio system allows you to listen to music from your *Bluetooth*®-compatible phone.

This function is available when the phone is paired and linked to the vehicle's *Bluetooth*® HandsFreeLink® (HFL) system.

➤ **Phone Setup** P. 183

▶▶ Playing *Bluetooth*® Audio

Not all *Bluetooth*-enabled phones with streaming audio capabilities are compatible with the system. You can find an approved phone by visiting www.handsfreelink.honda.com, or by calling the HandsFreeLink® consumer support at (888) 528 -7876.

In Canada, visit www.handsfreelink.ca, or call (888) 528 -7876.

In some states, it may be illegal to perform some data device functions while driving.

If more than one phone is paired to the HFL system, there will be a delay before the system begins to play.

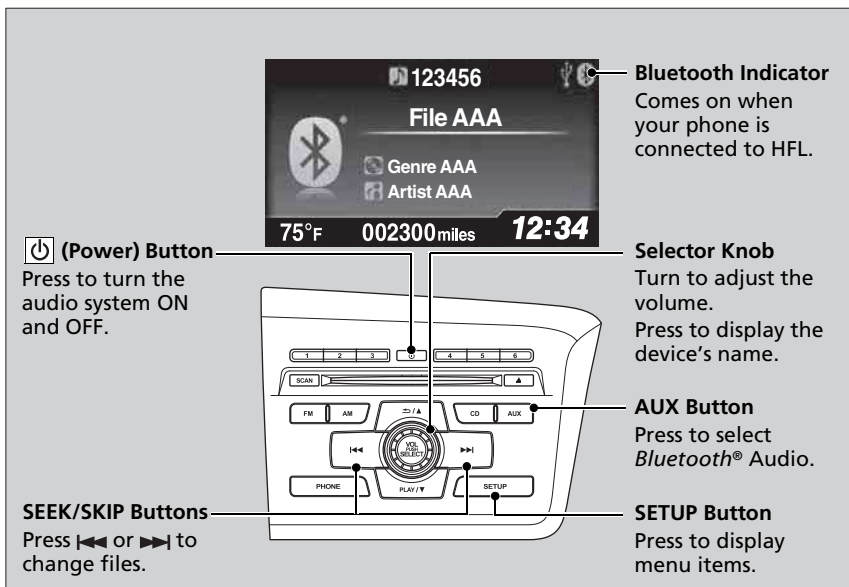

To Play *Bluetooth*® Audio Files

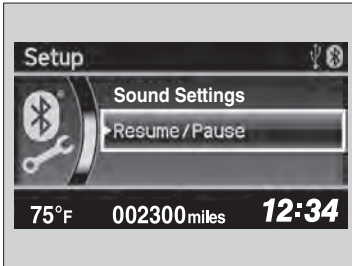

1. Make sure that your phone is paired and linked to HFL.
2. Press the AUX button.

If the phone is not recognized, another HFL-compatible phone, which is not compatible for *Bluetooth*® Audio, **may be** already linked.

■ To pause or resume a file

1. Press the SETUP button.
2. Rotate to select **Resume/Pause**, then press .

Each time you press , the setting switches between Pause and Resume.

Switching to HFL

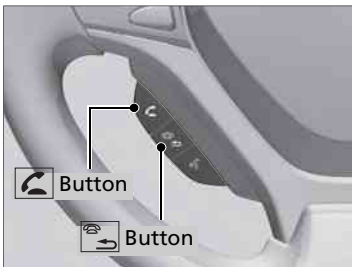

Press the (pick-up) button on the steering wheel to receive a call when *Bluetooth*® Audio is playing.

[▶ *Bluetooth*® HandsFreeLink® P. 177](#)

Press the (hang-up/back) button to end the call and return to *Bluetooth*® Audio.

▶▶ To Play *Bluetooth*® Audio Files

To play the audio files, you may need to operate your phone. If so, follow the phone maker's operating instructions.

The pause function may not be available on some phones.

If any audio device is connected to the auxiliary input jack, you may need to press the AUX button repeatedly to select the *Bluetooth*® Audio system.



Switching to another mode pauses the music playing from your phone.

▶▶ Switching to HFL

If you receive a call while *Bluetooth*® Audio is in the pause mode, it will resume play after ending the call.

CD Player

If a disc error occurs, you may see the following error messages.

Error Message	Cause	Solution
HEAT ERROR	High temperature	<ul style="list-style-type: none"> • Turn the audio system off and allow the player to cool down until the error message is cleared.
UNPLAYABLE/ Unsupported	Track/file format not supported	<ul style="list-style-type: none"> • Current track/file will be skipped. The next supported track/file plays automatically.
BAD DISC PLEASE CHECK OWNERS MANUAL PUSH EJECT	Mechanical error	<ul style="list-style-type: none"> • Press the  (eject) button and remove the disc, and check that the error message is cleared. • Check that the disc is not damaged or deformed, and insert the disc again. <p>➤ Protecting CDs P. 175</p>
MECH ERROR		
BAD DISC PLEASE CHECK OWNERS MANUAL	Servo error	<ul style="list-style-type: none"> • If the error message reappears, press the  button, and pull out the disc. • Insert a different disc. If the new disc plays, there is a problem with the first disc. • If the error message repeats, or the disc cannot be removed, contact a dealer. Do not try to force the disc out of the player.
CHECK DISC	Disc error	<ul style="list-style-type: none"> • Check that the disc is not damaged or deformed. <p>➤ Protecting CDs P. 175</p>

Models with multi-information display

iPod®/USB Flash Drive

If an error occurs while playing an iPod® or USB flash drive, you may see the following error messages. If you cannot clear the error message, contact a dealer.

Error Message	Solution
USB Error	Appears when there is a problem with the USB adapter unit. Check if the device is compatible with the USB adapter unit.
Bad USB Device Please Check Owners Manual.	Appears when an incompatible device is connected. Disconnect the device. Then turn the audio system off, and turn it on again. Do not reconnect the device that caused the error.
No Song	Appears when the iPod® is empty. Check that compatible files are stored on the device.
Unsupported Ver	Appears when an unsupported iPod® is connected. If it appears when a supported iPod® is connected, update the iPod® software to the newer version.
Retry Connection	Appears when the system does not acknowledge the iPod®. Reconnect the iPod®.
Unplayable File	Appears when the files in the USB flash drive are DRM or an unsupported format. This error message appears for about 3 seconds, then plays the next song.
No Data	Appears when the USB flash drive is empty or there are no MP3, WMA, or AAC files in the USB flash drive. Check that compatible files are stored on the device.
Unsupported	Appears when an unsupported device is connected. If it appears when a supported device is connected, reconnect the device.

Recommended CDs

- Use only high-quality CD-R or CD-RW discs labeled for audio use.
- Use only CD-R or CD-RW discs on which the recordings are closed.
- Play only standard round-shaped CDs.

The CD packages or jackets should have one of these marks.



CDs with MP3 or WMA files

- Some software files may not allow for audio play or text data display.
- Some versions of MP3 or WMA formats may be unsupported.

Recommended CDs

A Dual-disc cannot play on this audio unit. If recorded under certain conditions, a CD-R or CD-RW may not play either.

■ Protecting CDs

Follow these precautions when handling or storing CDs:

- Store a CD in its case when it is not being played.
- When wiping a CD, use a soft clean cloth from the center to the outside edge.
- Handle a CD by its edge. Never touch either surface.
- Never insert foreign objects into the CD player.
- Keep CDs out of direct sunlight and extreme heat.
- Do not place stabilizer rings or labels on the CD.
- Avoid fingerprints, liquids, and felt-tip pens on the CD.

☒ Protecting CDs

NOTICE

Do not insert a damaged CD. It may be stuck inside and damage the audio unit.

Examples:

- Bubbled, wrinkled, labeled, and excessively thick CDs



Bubbled/
Wrinkled



With Label/
Sticker



Using
Printer Label
Kit



Sealed

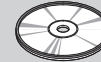

With Plastic Ring

- Damaged CDs



Chipped/
Cracked

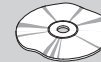

Warped

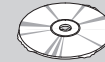

Burrs

- Poor quality CDs

- Small CDs



3-inch
(8-cm)
CD

Models with multi-information display

Compatible iPod® and USB Flash Drives

iPod® Model Compatibility

Model
iPod classic® (80/160G)
iPod classic® (120G)
iPod® with video (iPod® 5th generation)
iPod nano®
iPod nano® 2nd generation
iPod nano® 3rd generation
iPod nano® 4th generation
iPod nano® 5th generation
iPod touch®
iPod touch® 2nd generation

USB Flash Drives

- Use a recommended USB flash drive of 256 MB or higher.
- Some digital audio players may not be compatible.
- Some USB flash drives (e.g., a device with security lockout) may not work.
- Some software files may not allow for audio play or text data display.
- Some versions of MP3, WMA, or AAC formats may be unsupported.

▶▶ iPod® Model Compatibility

This system may not work with all software versions of these devices.

▶▶ USB Flash Drives

Files on the USB flash drive are played in their stored order. This order may be different from the order displayed on your PC or device.

Models with navigation system

For models with the navigation system, see Navigation System Manual for how to operate the *Bluetooth*® HandsFreeLink®.

Models without navigation system

Bluetooth® HandsFreeLink® (HFL) allows you to place and receive phone calls using your vehicle's audio system, without handling your cell phone.

Using HFL

HFL Buttons

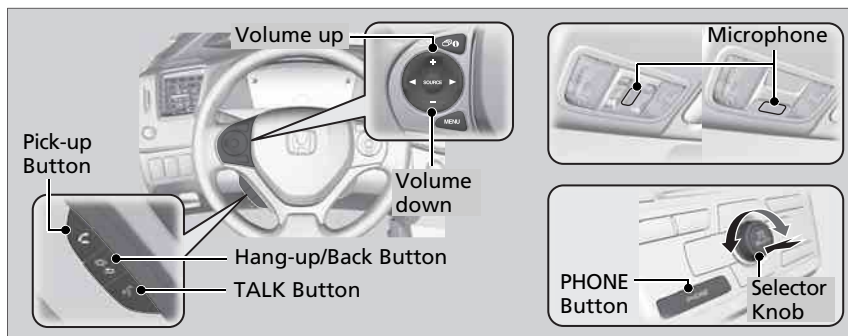

(Pick-up) button: Press to go directly to the **Phone** screen or to answer an incoming call.

(Hang-up/back) button: Press to end a call or to cancel a command.

(TALK) button: Press to call a number with a stored voice tag.

PHONE button: Press to go directly to the **Phone** screen.

Selector knob: Rotate to select an item on the screen, then press .

* Not available on all models

Continued

Bluetooth® HandsFreeLink®

To use HFL, you need a *Bluetooth*-compatible cell phone. For a list of compatible phones, pairing procedures, and special feature capabilities:

- U.S.: Visit www.handsfreelink.honda.com, or call (888) 528-7876.
- Canada: Visit www.handsfreelink.ca, or call (888) 528-7876.

Voice control tips

- Aim the vents away from the ceiling and close the windows, as noise coming from them may interfere with the microphone.
- Press and release the button when you want to call a number using a stored voice tag. Speak clearly and naturally after a beep.
- If the microphone picks up voices other than yours, the command may be misinterpreted.
- To change the volume level, use the audio system's volume knob or the remote audio controls on the steering wheel.

HFL Status Display



The multi-information display notifies you when there is an incoming call.

Bluetooth® HandsFreeLink®

Bluetooth® Wireless Technology
Bluetooth® name and logos are registered trademarks owned by *Bluetooth* SIG, Inc., and any use of such marks by Honda Motors Co., Ltd., is under license. Other trademarks and trade names are those of their respective owners.

HFL Limitations

An incoming call on HFL will interrupt the audio system when it is playing. It will resume when the call is ended.

HFL Status Display

The information that appears on the multi-information display varies between phone models.

You can change the system language to English, French, or Spanish.

[▶ Customized Features P. 86](#)

HFL Menu

The ignition switch must be in ACCESSORY **I** or ON **II** to use HFL.

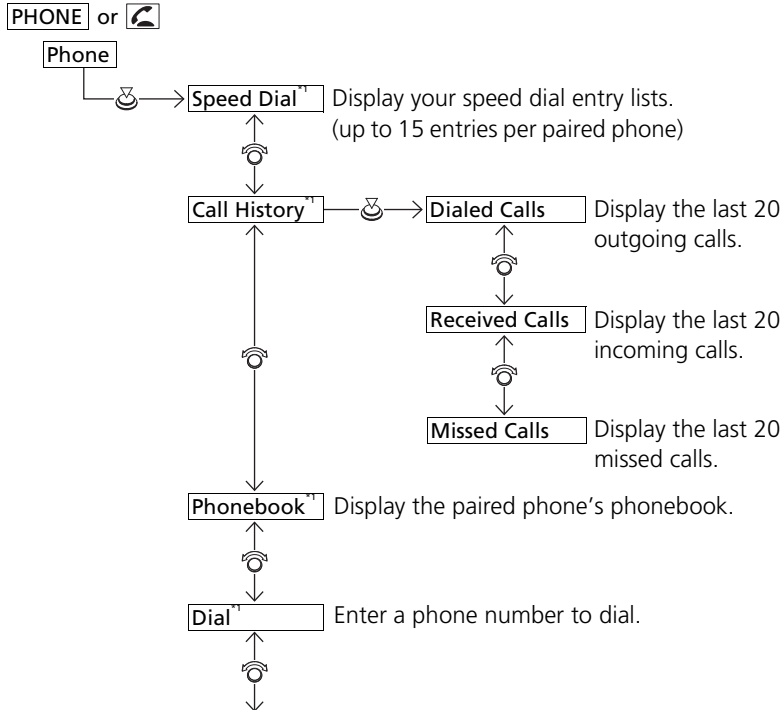

☒ HFL Menu

To use HFL, you must first pair your *Bluetooth*-compatible cell phone to the system while the vehicle is parked.

Some functions are limited while driving. A message appears on the screen when the vehicle is moving and the operation is canceled.

*1: Appears only when a phone is connected to HFL.

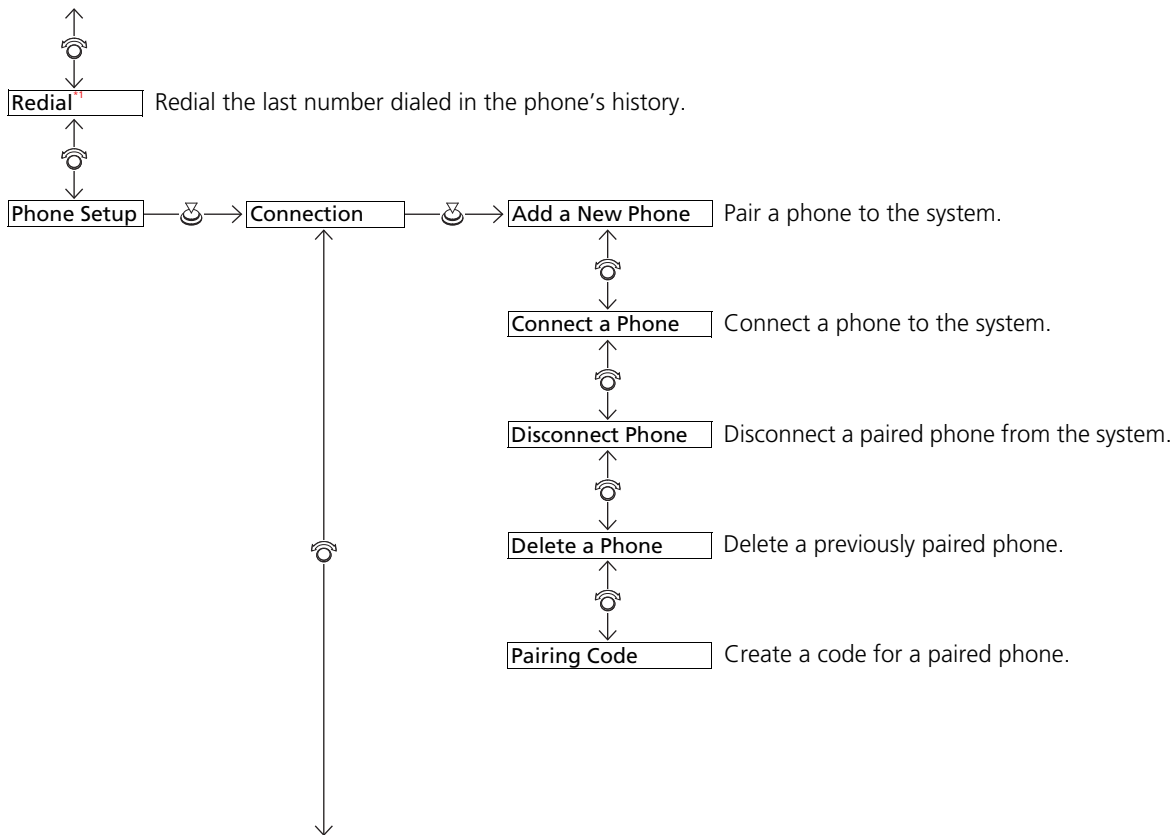

*1: Appears only when a phone is connected to HFL.

* Not available on all models

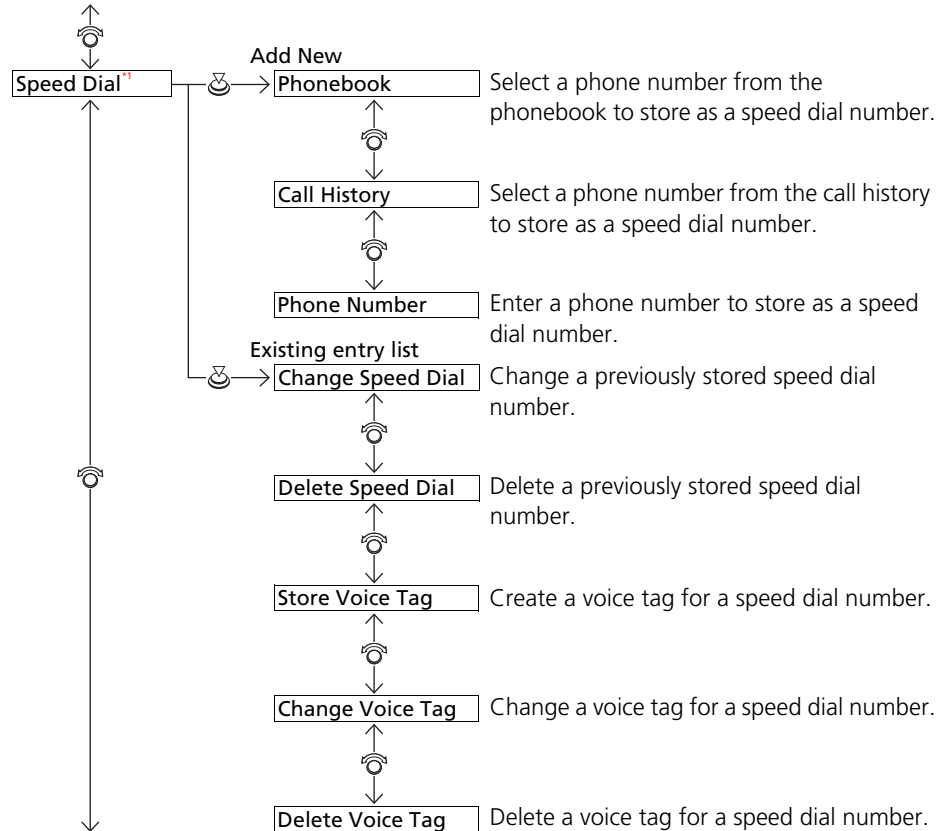

*1: Appears only when a phone is connected to HFL.

* Not available on all models

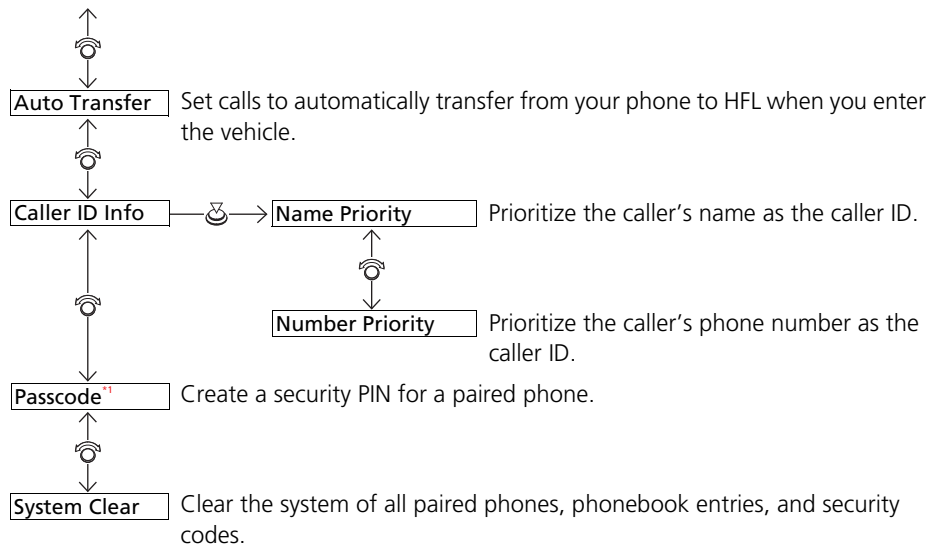



*1: Appears only when a phone is connected to HFL.

* Not available on all models

Phone Setup

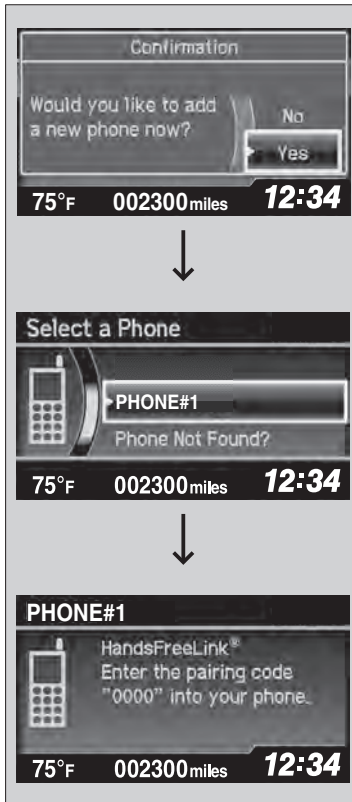
■ To pair a cell phone (when there is no phone paired to the system)



1. Press the PHONE button or the  button.

2. Rotate  to select **Yes**, then press .

▶ HFL automatically searches for a Bluetooth device.

3. When your phone appears on the list, select it by pressing .

▶ If your phone doesn't appear, select **Phone Not Found?** and search for Bluetooth devices using your phone. From your phone, select **HandsFreeLink**.

4. HFL gives you a four-digit pairing code to input on your phone. When your phone prompts you, input the four-digit pairing code.

5. You will receive a notification on the screen if pairing is successful.

☒ Phone Setup

Your Bluetooth-compatible phone must be paired to HFL before you can make and receive hands-free calls.

Phone Pairing Tips:

- You cannot pair your phone while the vehicle is moving.
- Your phone must be in the discoverable or search mode when pairing the phone. Refer to your phone's manual.
- Up to six phones can be paired.
- Your phone's battery may drain faster when it is paired to HFL.
- If your phone is not ready for pairing or not found by the system within three minutes, the system will time out and returns to idle.

Once you have paired a phone, you can see it displayed on the screen with one or two icons on the right side.







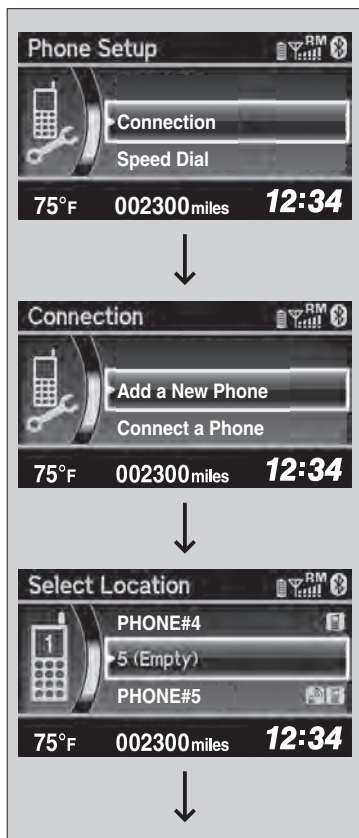

These icons indicate the following:

: The phone can be used with HFL.

: The phone is compatible with Bluetooth® Audio.

■ To pair a cell phone (when a phone has already been paired to the system)



1. Press the PHONE button or the  button.
2. Rotate  to select **Phone Setup**, then press .
3. Rotate  to select **Connection**, then press .
4. Rotate  to select **Add a New Phone**, then press .
 - ▶ The screen changes to **Select Location**.
5. Rotate  to select **Empty**, then press .

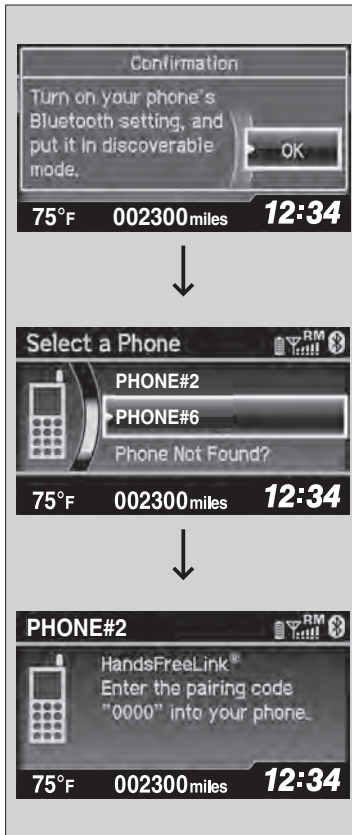

6. Make sure your phone is in search or discoverable mode, then press .
 - HFL automatically searches for a Bluetooth device.



7. When your phone appears on the list, select it by pressing .
 - If your phone doesn't appear, select **Phone Not Found?** and search for Bluetooth devices using your phone. From your phone, select **HandsFreeLink**.



8. HFL gives you a four-digit pairing code to input on your phone. When your phone prompts you, input the four-digit pairing code.

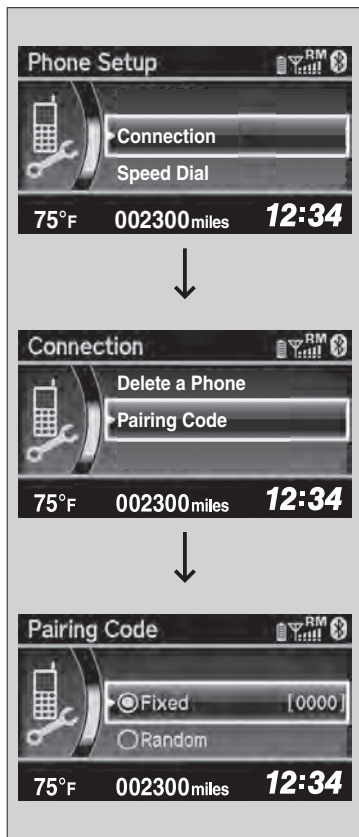

9. You will receive a notification on the screen if pairing is successful.



■ To change the pairing code setting



1. Press the PHONE button or the  button.
 - ▶ Rotate  to select **Phone Setup**, then press .

2. Rotate  to select **Connection**, then press .

3. Rotate  to select **Pairing Code**, then press .

4. Rotate  to select **Fixed** or **Random**, then press .

▶▶ To change the pairing code setting





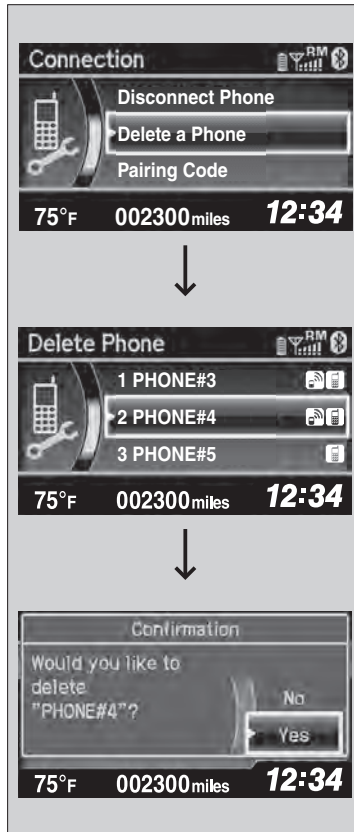

The default pairing code is “0000” until you change the setting.

To create your own, select **Fixed**, and delete the current code, then enter a new one.

For a randomly generated pairing code each time you pair a phone, select **Random**.

■ To delete a paired phone



1. Press the PHONE button or the  button.
2. Rotate  to select **Phone Setup**, then press .
▶ Repeat the procedure to select **Connection**, then **Delete a Phone**.
3. Rotate  to select a phone you want to delete, then press .
4. You will receive a confirmation message on the screen. Rotate  to select **Yes**, then press .
▶ You will receive a notification on the screen if it is successful.

To Create a Security PIN

You can protect each of the six cell phones with a security PIN.

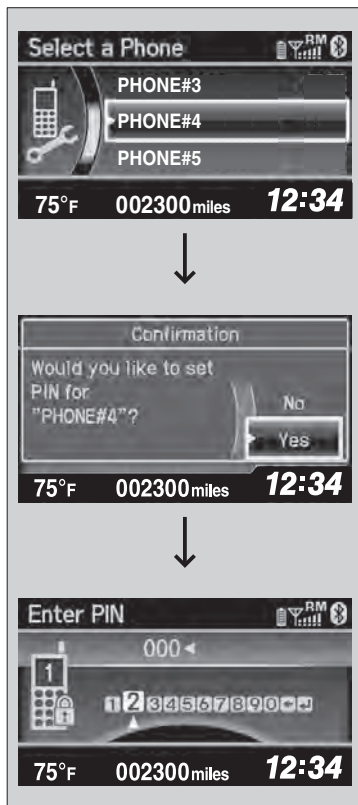

1. Press the PHONE button or the button.

2. Rotate to select **Phone Setup**, then press .

▶ Repeat the procedure to select **Passcode**.

3. Select a phone you want to add a security PIN to.

▶ Rotate to select a phone you want to add a security PIN to, then press .

4. You will receive a confirmation message on the screen.

▶ Rotate to select **Yes**, then press .

5. Enter a new four-digit number.

▶ Rotate to select, then press . Press to delete. Press to enter the security PIN.

6. Re-enter the four-digit number.

▶ The screen returns to the screen in step 2.

▶▶ To Create a Security PIN

In the phone is already security PIN protected, you need to enter the current security PIN before clearing the PIN or creating a new one.

Automatic Transferring

If you get into the vehicle while you are on the phone, the call can be automatically transferred to HFL.

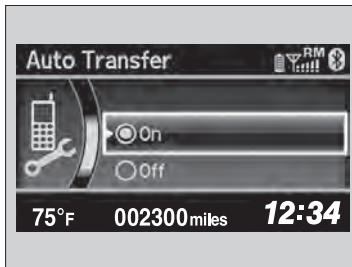

1. Press the PHONE button or the button.
2. Rotate to select **Phone Setup**, then press .
 - ▶ Repeat the procedure to select **Auto Transfer**.
3. Rotate to select **On**, then press .
4. You will receive a notification on the screen if the change is successful.

Caller's ID Information

You can select a caller's information to be displayed when you have an incoming call.

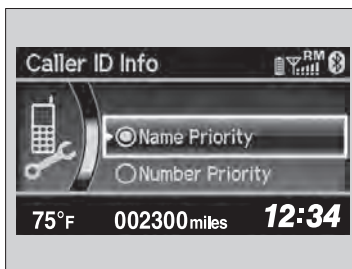

1. Press the PHONE button or the button.
2. Rotate to select **Phone Setup**, then press .
 - ▶ Repeat the procedure to select **Caller ID Info**.
3. Rotate to select a mode you want, then press .
4. You will receive a notification on the screen if the change is successful.

☒ Caller's ID Information







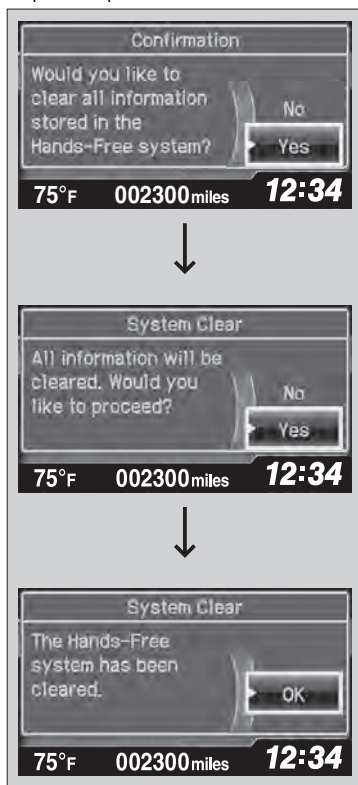

Name Priority mode: A caller's name is displayed if it is stored in the phonebook.

Number Priority mode: A caller's phone number is displayed.

■ To Clear the System

Security codes, paired phones, all stored voice tag, all speed dial entries, and all imported phonebook data are erased.



1. Press the PHONE button or the  button.
2. Rotate  to select **Phone Setup**, then press .
 - ▶ Repeat the procedure to select **System Clear**.
3. Rotate  to select **Yes**, then press .
4. You will receive a notification message on the screen. Rotate  to select **Yes**, then press .
5. You will receive a confirmation message on the screen. Press  to finish.

Automatic Import of Cellular Phonebook and Call History

When your phone is paired, the contents of its phonebook and call history are automatically imported to HFL.



Automatic Import of Cellular Phonebook and Call History

When you select a person from the list in the cellular phonebook, you can see up to three category icons. The icons indicate what types of numbers are stored for that name.



If a name has four or more numbers, "...” appears instead of category icons.

On some phones, it may not be possible to import the category icons to HFL.

The phonebook is updated after every connection. Call history is updated after every connection or call.

Speed Dial

Up to 15 speed dial numbers can be stored per phone.



To store a speed dial number:

1. Press the PHONE button or the button.
2. Rotate to select **Phone Setup**, then press .
 - ▶ Repeat the procedure to select **Speed Dial**, then **Add New**.
3. Rotate to select a place to choose a number from, then press .
 - By Phonebook:
 - ▶ Select a number from the linked cell phone's imported phonebook.
 - By Call History:
 - ▶ Select a number from the call history.
 - By Phone Number:
 - ▶ Input the number manually.
4. When the speed dial is successfully stored, you are asked to create a voice tag for the number. Rotate to select **Yes** or **No**, then press .
5. Using the button, follow the prompts to say the name for the speed dial entry.

Speed Dial

You can use the audio preset buttons during a call to store a speed dial number:

1. Press and hold the desired audio preset button during a call.
2. The contact information for the active call will be stored for the corresponding speed dial.

■ To add a voice tag to a stored speed dial number



1. Press the PHONE button or the button.
2. Rotate to select **Phone Setup**, then press .
 - ▶ Repeat the procedure to select **Speed Dial**.
3. Select an existing speed dial entry.
4. Rotate to select **Store Voice Tag**, then press .
5. Using the button, follow the prompts to complete the voice tag.

☒ Speed Dial





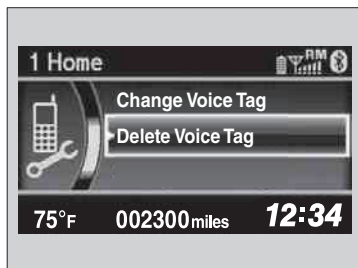

Avoid using duplicate voice tag.

Avoid using “home” as a voice tag.

It is easier for HFL to recognize a longer name. For example, use “John Smith” instead of “John.”







■ To delete a voice tag

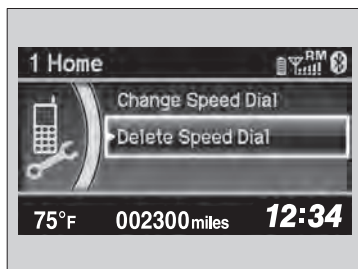

1. Press the PHONE button or the  button.
2. Rotate  to select **Phone Setup**, then press .
 - ▶ Repeat the procedure to select **Speed Dial**.
3. Select an existing speed dial entry.
4. Rotate  to select **Delete Voice Tag**, then press .
 - ▶ You will receive a confirmation message on the screen. Rotate  to select **Yes**, then press .

■ To delete a speed dial number



1. Press the PHONE button or the  button.
2. Rotate  to select **Phone Setup**, then press .
 - ▶ Repeat the procedure to select **Speed Dial**.
3. Select an existing speed dial entry.
4. Rotate  to select **Delete Speed Dial**, then press .
 - ▶ You will receive a confirmation message on the screen. Rotate  to select **Yes**, then press .

Making a Call

You can make calls by inputting any phone number, or by using the imported phonebook, call history, speed dial entries, or redial.



☒ Making a Call

Any voice-tagged speed dial entry can be dialed by voice from any screen.

Press the  button and wait for a beep before giving a command.







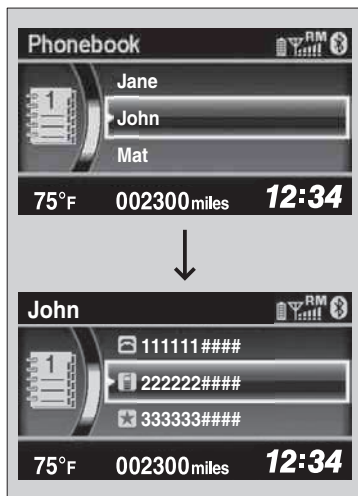

The maximum range between your phone and vehicles is 30 feet (10 meters).

Once a call is connected, you can hear the voice of the person you are calling through the audio speakers.

■ To make a call using the imported phonebook







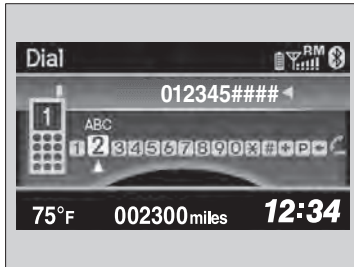

When your phone is paired, the contents of its phonebook are automatically imported to HFL.



1. Press the PHONE button or the  button.
2. Rotate  to select **Phonebook**, then press .
3. The phonebook is stored alphabetically. Rotate  to select the initial, then press .
4. Rotate  to select a name, then press .
5. Rotate  to select a number, then press .
 - ▶ Dialing starts automatically.



■ To make a call using a phone number

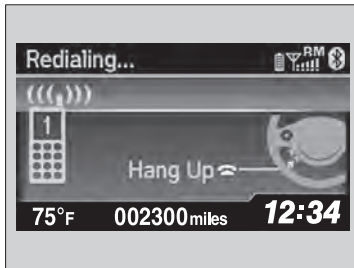

1. Press the PHONE button or the  button.
2. Rotate  to select **Dial**, then press .
3. Rotate  to select a number, then press .
4. Rotate  to select , then press .
 - ▶ Dialing starts automatically.

■ To make a call using redial



1. Press the PHONE button or the  button.
2. Rotate  to select **Redial**, then press .
 - ▶ Dialing starts automatically.

■ To make a call using the call history

Call history is stored by **Dialed Calls**, **Received Calls**, and **Missed Calls**.



1. Press the PHONE button or the button.
2. Rotate to select **Call History**, then press .
3. Rotate to select **Dialed Calls**, **Received Calls**, or **Missed Calls**, then press .
4. Rotate to select a number, then press .
 - ▶ Dialing starts automatically.

■ To make a call using a speed dial entry

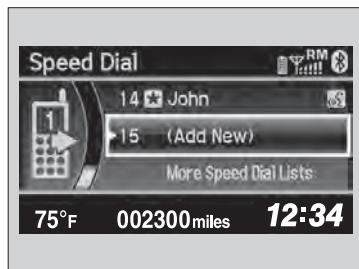

1. Press the PHONE button or the button.
2. Rotate to select **Speed Dial**, then press .
3. Rotate to select a number, then press .
 - ▶ Dialing starts automatically.

▶▶ To make a call using the call history

The call history displays the last 20 dialed, received, or missed calls.
(Appears only when a phone is connected to HFL.)

▶▶ To make a call using a speed dial entry

On the **Phone** screen, the first six speed dials on the list can be directly selected by pressing the corresponding audio preset buttons (1-6).

Select **More Speed Dial Lists** to view another paired phone's speed dial list.

Receiving a Call

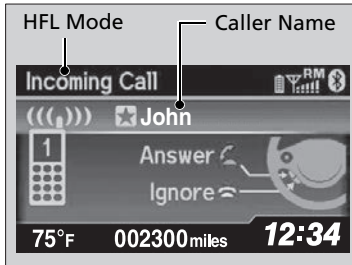

When there is an incoming call, an audible notification sounds (if activated) and the Incoming Call screen appears.

Press the  button to answer the call.

Press the  button to decline or end the call.

Receiving a Call

Call Waiting

Press the  button to put the current call on hold to answer the incoming call.

Press the  button again to return to the current call.

Ignore the incoming call if you do not want to answer it.

Press the  button if you want to hang up the current call.

Options During a Call

The following options are available during a call.



Mute: Mute your voice.

Transfer: Transfer a call from HFL to your phone.

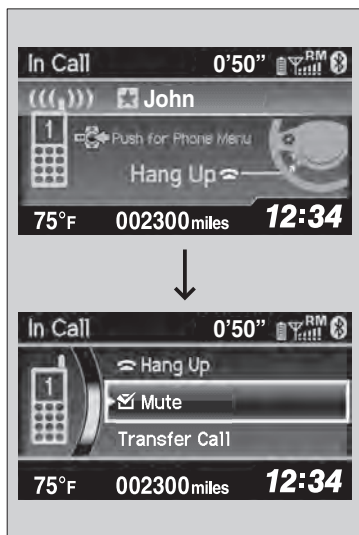
Touch Tones: Send numbers during a call. This is useful when you call a menu-driven phone system.



1. To view the available options, press the PHONE button.

2. Rotate  to select the option, then press .
 - ▶ The check box is checked when **Mute** is selected. Select **Mute** again to turn it off.

Options During a Call

Touch Tones: Available on some phones.

Driving



This chapter discusses driving, refueling, and information on items such as accessories.

Before Driving

- Driving Preparation 202
- Maximum Load Limit..... 205

Towing a Trailer

- Towing Preparation..... 207
- Driving Safely with a Trailer..... 209
- Towing Your Vehicle..... 210

When Driving

- Starting the Engine 211
- Precautions While Driving..... 213
- Automatic Transmission 214

Automatic transmission models

- Shifting 215

Manual transmission models

- Shifting..... 217
- Cruise Control* 220
- VSA® (Vehicle Stability Assist), aka ESC (Electronic Stability Control), System 223
- TPMS (Tire Pressure Monitoring System)... 225
- Tire Pressure Monitoring System (TPMS) - Required Federal Explanation 226

Braking

- Brake System 229
- ABS (Anti-lock Brake System) 231

- Brake Assist System 232

Parking Your Vehicle

- When Stopped 233
- Parking 233

Refueling

- Fuel Information 234
- How to Refuel 235

Fuel Economy..... 237

- Improving Fuel Economy..... 237

Accessories and Modifications

- Accessories..... 238
- Modifications..... 238

* Not available on all models

Driving Preparation

Check the following items before you start driving.

Exterior Checks

- Make sure there are no obstructions on the windows, door mirrors, exterior lights, or other parts of the vehicle.
 - ▶ Remove any frost, snow, or ice.
 - ▶ Remove any snow on the roof, as this can slip down and obstruct your field of vision while driving. If frozen solid, remove ice once it has softened.
 - ▶ When removing ice from around the wheels, be sure not to damage the wheel or wheel components.
- Make sure the hood is securely closed.
 - ▶ If the hood opens while driving, your front view will be blocked.
- Make sure the tires are in good condition.
 - ▶ Check air pressure, check for damage and excessive wear.
 - ▶ [Checking and Maintaining Tires P. 280](#)
- Make sure there are no people or objects behind or around the vehicle.
 - ▶ There are blind spots from the inside.

Exterior Checks

NOTICE

When doors are frozen shut, use warm water around the door edges to melt any ice. Do not try to force them open, as this can damage the rubber trim around the doors. When done, wipe dry to avoid further freezing.

Do not pour warm water into the key cylinder. You will be unable to insert key if the water freezes in the hole.

Interior Checks

- Store or secure all items on board properly.
 - ▶ Carrying too much cargo, or improperly storing it, can affect your vehicle's handling, stability, stopping distance, and tires, and make it unsafe.
 - [Maximum Load Limit P. 205](#)
- Do not pile items higher than the seat height.
 - ▶ They can block your view and may be thrown forward in the event of sudden braking.
- Do not place anything in the front seat footwells. Make sure to secure the floor mat*.
 - ▶ An object or unsecured floor mat can interfere with your brake and accelerator pedal operation while driving.
- If you have any animals on board, do not let them move around in the vehicle.
 - ▶ They may interfere with driving and a crash could occur.
- Securely close and lock all doors and the trunk.
 - [Locking/Unlocking the Doors from the Inside P. 103](#)
- Adjust your seating position properly.
 - ▶ Adjust the head restraint, too.
 - [Adjusting the Seats P. 126](#)
 - [Adjusting the Head Restraints P. 129](#)
- Adjust the mirrors and steering wheel properly for your driving.
 - ▶ Adjust them while sitting in the proper driving position.
 - [Adjusting the Mirrors P. 125](#)
 - [Adjusting the Steering Wheel P. 124](#)

* Not available on all models

Continued

Interior Checks

The headlight aim is set by the factory, and does not need to be adjusted. However, if you regularly carry heavy items in the trunk or tow a trailer, have the aiming readjusted at a dealer or by a qualified technician.

- Be sure items placed on the floor behind the front seats cannot roll under the seats.
 - ▶ They can interfere with the driver's ability to operate the pedals, the operation of the seats, or the operation of the sensors under the seats.
- Everyone in the vehicle must fasten their seat belt.
 - ▶ [Fastening a Seat Belt P. 31](#)
- Make sure that the indicators in the instrument panel come on when you start the vehicle, and go off soon after.
 - ▶ Always have a dealer check the vehicle if a problem is indicated.
 - ▶ [Indicators P. 66](#)

Maximum Load Limit

The maximum load for your vehicle is 850 lbs (385 kg).

See Tire and Loading Information label attached to the driver's doorjamb.

Label Example

TIRE AND LOADING INFORMATION

SEATING CAPACITY : TOTAL 5 ; FRONT 2 ; REAR 3

The combined weight of occupants and cargo should never exceed 385kg or 850lbs.

TIRE	SIZE	COLD TIRE PRESSURE	SEE OWNER'S MANUAL FOR ADDITIONAL INFORMATION
FRONT	XXXX/XXXXX XXX	XXXKPA, XXPSI	
REAR	XXXX/XXXXX XXX	XXXKPA, XXPSI	
SPARE	XXXX/XXXXX XXX	XXXKPA, XXPSI	

This figure includes the total weight of all occupants, cargo, and accessories, and the tongue load if you are towing a trailer.

Steps for Determining Correct Load Limit -

- (1) Locate the statement "The combined weight of occupants and cargo should never exceed XXX kg or XXX lbs." on your vehicle's placard.
- (2) Determine the combined weight of the driver and passengers that will be riding in your vehicle.
- (3) Subtract the combined weight of the driver and passengers from XXX kg or XXX lbs.
- (4) The resulting figure equals the available amount of cargo and luggage load capacity. For example, if the "XXX" amount equals 1,400 lbs. and there will be five 150 lb. passengers in in your vehicle, the amount of available cargo and luggage load capacity is 650 lbs.
(1,400 - 750 (5 x 150) = 650 lbs.)

Continued

Maximum Load Limit

⚠ WARNING

Overloading or improper loading can affect handling and stability and cause a crash in which you can be hurt or killed.

Follow all load limits and other loading guidelines in this manual.

Gross Vehicle Weight Rating (GVWR):

The maximum allowable weight of the vehicle, all occupants, all accessories, all cargo, and the tongue load.

➤ Specifications

➤ P. 324 ➤ P. 326

Gross Axle Weight Rating (GAWR):

The maximum allowable weight of the vehicle axle.

➤ Specifications

➤ P. 324 ➤ P. 326

- (5) Determine the combined weight of luggage and cargo being loaded on the vehicle. That weight may not safely exceed the available cargo and luggage load capacity calculated in step 4.
- (6) If your vehicle will be towing a trailer, load from your trailer will be transferred to your vehicle. Consult this manual to determine how this reduces the available cargo and luggage load capacity of your vehicle.

In addition, the total weight of the vehicle, all occupants, accessories, cargo, and trailer tongue load must not exceed the Gross Vehicle Weight Rating (GVWR) or the Gross Axle Weight Rating (GAWR). Both are on a label on the driver's doorjamb.

Load Limits Example

Example1



Max Load
850 lbs
(385 kg)



Passenger Weight
150 lbs x 2 = 300 lbs
(68 kg x 2 = 136 kg)



Cargo Weight
550 lbs
(249 kg)

Example2



Max Load
850 lbs
(385 kg)



Passenger Weight
150 lbs x 5 = 750 lbs
(68 kg x 5 = 340 kg)



Cargo Weight
100 lbs
(45 kg)

HF model

Your vehicle is not designed to tow a trailer. Attempting to do so can void your warranties.

Except HF model

Towing Preparation

Towing Load Limits

Your vehicle can tow a trailer if you carefully observe the load limits, use the proper equipment, and follow the towing guidelines. Check the load limits before driving.

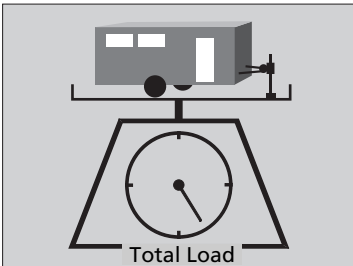

■ Total trailer weight

Maximum allowable weight of the trailer, cargo, and everything in or on it must not exceed 1,000 lbs (450 kg). Towing loads in excess of this can seriously affect vehicle handling and performance and can damage the engine and drivetrain.

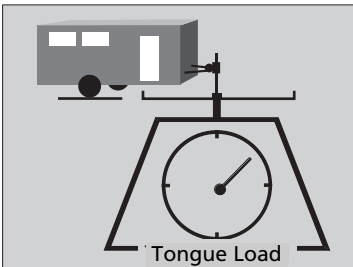

■ Tongue load

The weight of the tongue with a fully loaded trailer on the hitch should be approximately 10% of the total trailer weight.

- Excessive tongue load reduces front tire traction and steering control. Too little tongue load can make the trailer unstable and cause it to sway.
- To achieve a proper tongue load, start by loading 60% of the load toward the front of the trailer and 40% toward the rear. Readjust the load as needed.

▣ Towing Load Limits

⚠ WARNING

Exceeding any load limit or improperly loading your vehicle and trailer can cause a crash in which you can be seriously hurt or killed.

Check the loading of your vehicle and trailer carefully before starting to drive.

Check if all loads are within limits at a public scale. If a public scale is not available, add the estimated weight of your cargo load to the weight of your trailer (as quoted by the manufacturer), and the tongue load.

Break-in Period

Avoid towing a trailer during your vehicle's first 600 miles (1,000 km).

Continued

■ Towing Equipment and Accessories

Towing equipment varies by the size of your trailer, how much load you are towing, and where you are towing.

■ Hitches

The hitch must be of an approved type and properly bolted to the underbody.

■ Safety chains

Always use safety chains when you tow a trailer. Leave enough slack to allow the trailer to turn corners easily, but do not allow the chains to drag on the ground.

■ Trailer brakes

There are two common types of trailer brakes: surge and electric. Surge brakes are common for boat trailers, since the brakes will get wet. If you choose electric brakes, be sure they are electronically actuated. Do not attempt to attach trailer brakes to your vehicle's hydraulic system, as it will lower braking effectiveness and create a potential hazard.

■ Additional towing equipment

Many states and provinces/territories require special outside mirrors when towing a trailer. Even if mirrors are not required in your locale, you should install special mirrors if visibility is restricted in any way.

■ Trailer light

Trailer lights and equipment must comply with federal, state, province/territory, and local regulations. Check with your local trailer sales or rental agency for the requirements in the area where you plan to tow.

▶▶ Towing Equipment and Accessories

Make sure that all equipment is properly installed and maintained, and that it meets federal, state, province/territory, and local regulations.

Consult your trailer sales or rental agency if any other items are recommended or required for your towing situation.

The lighting and wiring of trailers can vary by type and brand. If a connector is required, it should only be installed by a qualified technician.

Driving Safely with a Trailer

Things You Need To Know Before Towing a Trailer

- Have the trailer properly serviced and keep it in good condition.
- Make sure that all the weights and load in the vehicle and trailer are within limits.
➤ [Towing Load Limits](#) P. 207
- Securely attach the hitch, safety chains, and other necessary parts to the trailer.
- Securely store all the items in and on the trailer so that they do not shift while driving.
- Check if the lights and brakes on the trailer are working properly.
- Check the pressures of the trailer tires, including the spare.

Towing Speeds and Gears

- Drive slower than normal.
- Obey posted speed limits for vehicles with trailers.

Automatic transmission models

- Use the **[D]** position when towing a trailer on level roads.

Turning and Braking

- Turn more slowly and with a wider turning arc than normal.
- Allow more time and distance for braking.
- Do not brake or turn suddenly.

☒ Driving Safely with a Trailer

Parking

In addition to the normal precautions, place wheel chocks at each of the trailer's tires.

Driving in Hilly Terrain

- Closely watch your high temperature indicator. If the indicator remains on, turn off the heating and cooling* system and reduce speed. Pull to the side of the road safely to cool down the engine if necessary.

Automatic transmission models

- Shift to the **D3** position if the transmission shifts frequently.

Towing Your Vehicle

Your vehicle is not designed to be towed behind a motor home. If your vehicle needs to be towed in an emergency, refer to the emergency towing information.

➤ [Emergency Towing](#) P. 321

Starting the Engine



1. Make sure the parking brake is applied.

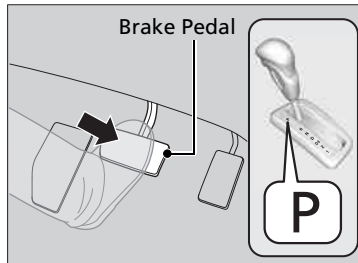

Automatic transmission models

2. Check that the shift lever is in **P**, then depress the brake pedal.
 - ▶ Although it is possible to start the vehicle in **N**, it is safer to start it in **P**.

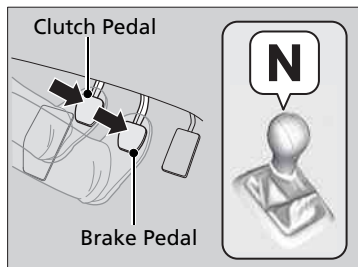

Manual transmission models

2. Check that the shift lever is in **N**. Then depress the brake pedal with your right foot, and the clutch pedal with your left foot.
 - ▶ The clutch pedal must be fully depressed to start the engine.

Starting the Engine

Keep your foot firmly on the brake pedal when starting the engine.

The engine is harder to start in cold weather and in thinner air found at altitudes above 8,000 feet (2,400 meters).

When starting the engine in cold weather, turn off all electrical accessories such as the lights, heating and cooling* system, and rear defogger in order to reduce battery drain.

If the exhaust system sounds abnormal or you can smell exhaust gas inside the vehicle, have your vehicle checked by a dealer. There may be a problem with the engine or exhaust system.

* Not available on all models

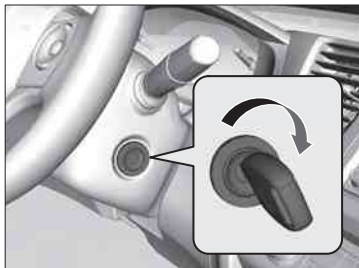

3. Turn the ignition switch to START **[III]** without depressing the accelerator pedal.

Starting to Drive

Automatic transmission models

1. Keeping your right foot on the brake pedal, release the parking brake. Check that the brake system indicator has gone off.
 - ▶ [Parking Brake P. 229](#)
2. Put the shift lever in **[D]**. Select **[R]** when reversing.
3. Gradually release the brake pedal and gently depress the accelerator pedal to pull away.

Starting the Engine

Do not hold the key in START **[III]** for more than 15 seconds.

- If the engine does not start right away, wait for at least 10 seconds before trying again.
- If the engine starts, but then immediately stops, wait at least 10 seconds before repeating step 3 while gently depressing the accelerator pedal. Release the accelerator pedal once the engine starts.

The immobilizer system protects your vehicle from theft. If an improperly coded key (or other device) is used, the engine's fuel system is disabled.

▶ [Immobilizer System P. 112](#)

Precautions While Driving

In Rain

Avoid driving in deep water and on flooded roads. This can damage the engine or cause electrical component failure.

Other Precautions

If there is a strong impact with something under the vehicle, stop in a safe location. Check the underside of the vehicle for damage or any fluid leaks.

Precautions While Driving

NOTICE

Do not operate the shift lever while pressing the accelerator pedal. You could damage the transmission.

If the ignition switch is turned to ACCESSORY [1] or LOCK [0] while driving, the engine will shut down and all steering and brake power assist functions will stop, making it difficult to control the vehicle.

Do not put the shift lever in [N], as you will lose engine braking (and acceleration) performance.

During the first 600 miles (1,000 km) of operation, avoid sudden acceleration or full throttle operation so as to not damage the engine or powertrain.

Avoid hard braking for the first 200 miles (300 km). You should also follow this when the brake pads are replaced.

2.4 l engine models

NOTICE

The following can damage the under spoiler:

- Parking the vehicle by a parking block
- Parallel parking along the road shoulder
- Driving towards the bottom of a hill
- Driving up or down to a different surface level (such as a road shoulder)
- Driving on a rutted or bumpy road
- Driving on a road with potholes.

Automatic Transmission

■ Creeping

The following conditions cause the engine to run at high revolutions, and increase creeping:

- Immediately after the engine starts.
- When the heating and cooling* system is in use.

Keep the brake pedal firmly depressed when stopped.

■ Kickdown

Quickly depressing the accelerator pedal while driving uphill may cause the transmission to drop to a lower gear, unexpectedly increasing vehicle speed. Depress the accelerator pedal carefully, especially on slippery roads and curves.

Automatic transmission models

Shifting

Change the shift position in accordance with your driving needs.

■ Shift lever positions

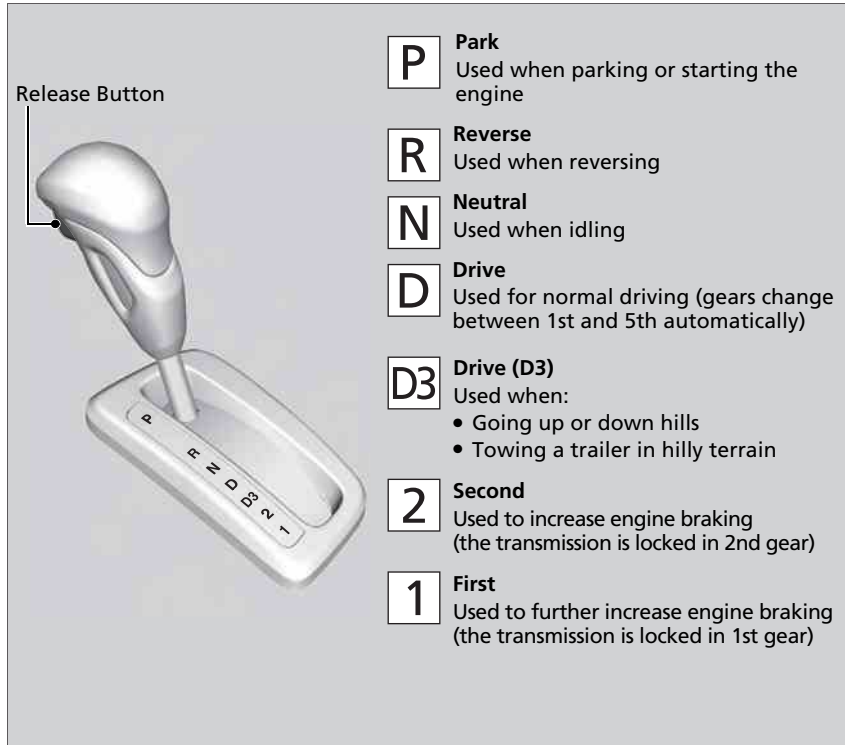

⌘ Shifting

You cannot turn the ignition switch to LOCK **[O]** and remove the key unless the shift lever is in **[P]**.

The vehicle may move forward very slightly even in **[N]** while the engine is cold. Depress the brake pedal firmly and, when necessary, apply the parking brake.

Shift Lever Operation

Shift Lever Operation

NOTICE

When you change the shift lever from **D** to **R** and vice versa, come to a complete stop and keep the brake pedal depressed.

Operating the shift lever before the vehicle has come to a complete standstill can damage the transmission.

Use the shift lever position indicator to check the lever position before pulling away.

Whichever position the shift lever is in when driving, a blinking **D** indicator indicates a transmission problem.

Avoid sudden acceleration and have the transmission checked by a dealer as soon as possible.

The fuel supply may be cut off if you drive at engine speeds in or over the tachometer red zone (engine speed limit). If this happens, you may experience a slight jolt.

It may not be possible to operate the shift lever if the brake pedal is applied while the shift lever release button is held down.

Depress the brake pedal first.

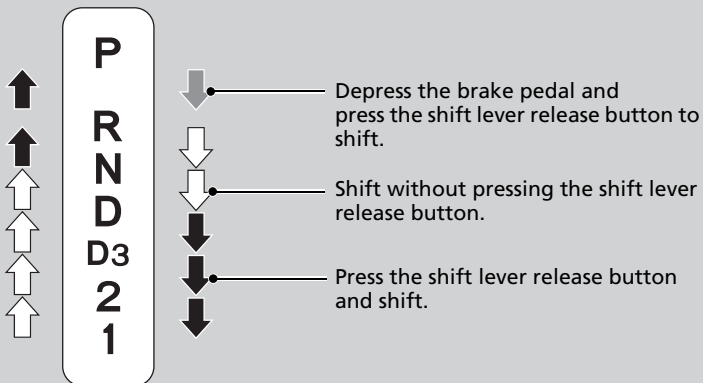
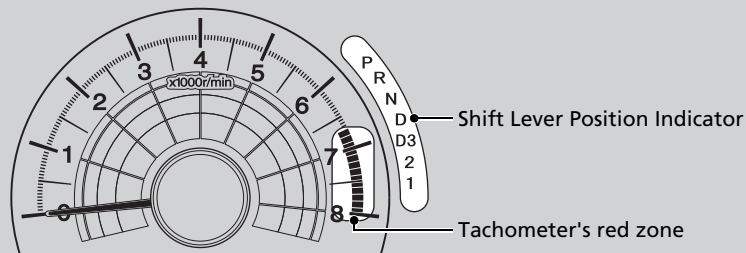

Manual transmission models

Shifting

Shift Lever Operation

Fully depress the clutch pedal to operate the shift lever and change gears, then slowly release the pedal.

Depress the clutch pedal, and pause for a few seconds before shifting into **R**, or shift into one of the forward gears for a moment. This stops the gears so they do not “grind.”

Shifting

NOTICE

Do not shift to **R** before the vehicle comes to a complete stop.

Shifting to **R** before stopping can damage the transmission.

NOTICE

Before downshifting, make sure the engine will not go into the tachometer's red zone. Should this occur, it can severely damage your engine.

There is a metallic part on the shift lever. If you leave the vehicle parked outside for a long time on a hot day, be careful before moving the shift lever. Because of heat, the shift lever may be extremely hot. If the outside temperature is low, the shift lever may feel cold.

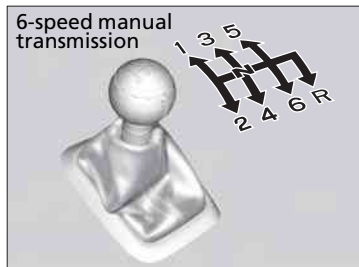
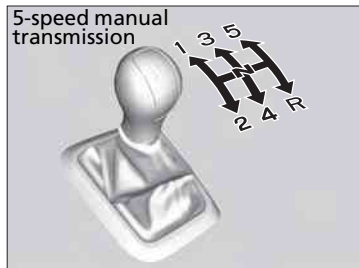

When you are not shifting, do not rest your foot on the clutch pedal. This can cause your clutch to wear out faster.

▶▶ Shifting

Recommended Shift Points

Driving in the highest gear that allows the engine to run and accelerate smoothly helps to optimize fuel economy and effective emissions control. The following shift points are recommended:

5-speed manual transmission models

Shift Up	Normal Acceleration
1st to 2nd	15 mph (24 km/h)
2nd to 3rd	27 mph (43 km/h)
3rd to 4th	39 mph (63 km/h)
4th to 5th	53 mph (85 km/h)

6-speed manual transmission models

Shift Up	Normal Acceleration
1st to 2nd	17 mph (27 km/h)
2nd to 3rd	29 mph (46 km/h)
3rd to 4th	37 mph (59 km/h)
4th to 5th	43 mph (69 km/h)
5th to 6th	49 mph (79 km/h)

If you exceed the maximum speed for the gear you are in, the engine speed will enter into the tachometer's red zone. When this happens, you may experience a slight jolt.

Reverse Lockout

6-speed manual transmission models

The manual transmission has a lockout mechanism that stops you from accidentally shifting into **R** from a forward gear while the vehicle is moving above a certain speed.

If you cannot shift to **R** when the vehicle is stopped, do the following:

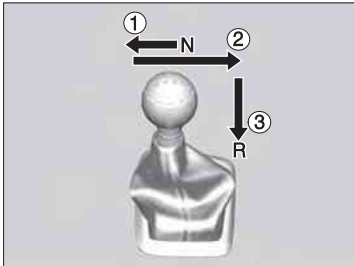

1. Depress the clutch pedal, move the shift lever all the way to the left, and shift to **R**.
2. If you still cannot shift into **R**, apply the parking brake, and turn the ignition switch to ACCESSORY **I** or LOCK **O**.
3. Depress the clutch pedal and shift into **R**.
4. Keep depressing the clutch pedal and start the engine.

Have the vehicle checked by a dealer if you have to go through this procedure repeatedly.

Cruise Control *

Maintains a constant vehicle speed without having to keep your foot on the accelerator. Use cruise control on freeways or open roads where you can travel at a constant speed with little acceleration or deceleration.

»» Cruise Control

⚠ WARNING

Improper use of the cruise control can lead to a crash.
Use the cruise control only when traveling on open highways in good weather.

When to use

- Vehicle speed for cruise control: Desired speed in a range above roughly 25 mph (40 km/h) ~

Always keep sufficient distance between you and the vehicle in front of you.

Automatic transmission models



- Shift positions for cruise control: In **D** or **D3**



How to use

- Press the **CRUISE** button on the steering wheel.

CRUISE MAIN is on in the instrument panel. Cruise control is ready to use.

It may not be possible to maintain a constant speed when driving uphill or downhill.
When not using cruise control: Turn off cruise control by pressing the CRUISE button.
1.8 l engine models
While in the ECON mode, it may take relatively more time to accelerate to maintain the set speed.

■ To Set the Vehicle Speed

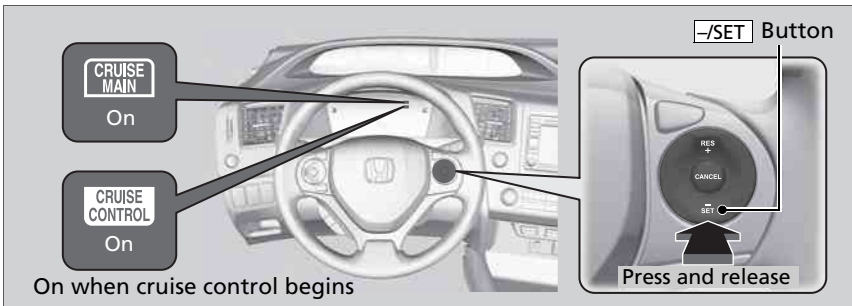

Take your foot off the pedal and press the **[-/SET]** button when you reach the desired speed.

The moment you release the **[-/SET]** button, the set speed is fixed, and cruise control begins. The **CRUISE CONTROL** indicator comes on.

* Not available on all models

■ To Adjust the Vehicle Speed

Increase or decrease the vehicle speed using the **[RES/+]** or **[-/SET]** buttons on the steering wheel.

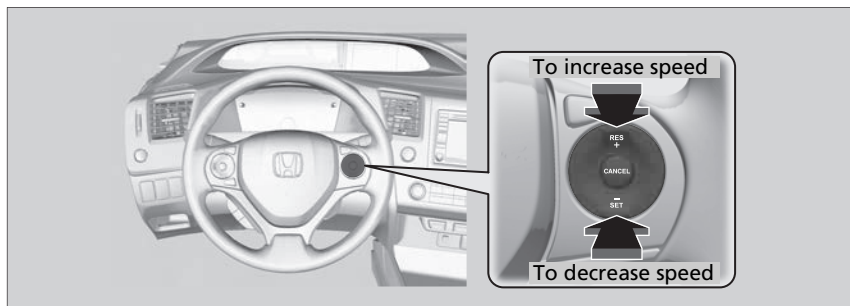

- Each time you press the button, the vehicle speed is increased or decreased by about 1 mph (1.6 km/h).
- If you keep the button pressed, the vehicle speed increases or decreases until you release it. This speed is then set.

■ To Cancel

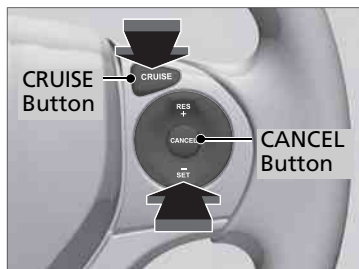

To cancel cruise control, do any of the following:

- Press the CANCEL button.
- Press the CRUISE button.
- Depress the brake pedal.
- Depress the clutch pedal for five seconds or more.

The **CRUISE CONTROL** indicator goes off.

▶▶ To Adjust the Vehicle Speed

You can set the vehicle speed using the **[-/SET]** button on the steering wheel when adjusting the speed with the accelerator and brake pedals.

▶▶ To Cancel

Resuming the prior set speed:
After cruise control has been canceled, you can still resume the prior set speed by pressing the **[RES/+]** button while driving at a speed of at least 25 mph (40 km/h) or more.

You cannot set or resume in the following situations:

- When vehicle speed is less than 25 mph (40 km/h)
- When the CRUISE button is turned off

At vehicle speeds of 22 mph (35 km/h) or less, cruise control is canceled automatically.

VSA® (Vehicle Stability Assist), aka ESC (Electronic Stability Control), System

VSA® helps to stabilize the vehicle during cornering if the vehicle turns more or less than what was intended. It also assists in maintaining traction on slippery surfaces. It does so by regulating engine output and selectively applying the brakes.

⊞ VSA® (Vehicle Stability Assist), aka ESC (Electronic Stability Control), System

The VSA® may not function properly if tire type and size are mixed. Make sure to use the same size and type of tire, and the air pressures as specified.

When the VSA® indicator comes on and stays on while driving, there may be a problem with the system. While this may not interfere with normal driving, have your vehicle checked by a dealer immediately.

VSA® cannot enhance stability in all driving situations and does not control the entire braking system. You still need to drive and corner at speeds appropriate for the conditions and always leave a sufficient margin of safety.

The main function of the VSA® system is generally known as Electronic Stability Control (ESC). The system also includes a traction control function.

■ VSA® Operation

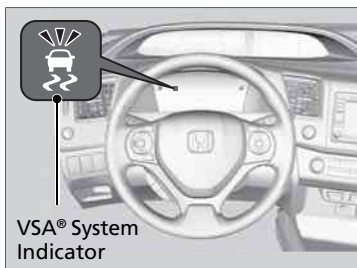

When VSA® activates, you may notice that the engine does not respond to the accelerator. You may also notice some noise from the hydraulic system. You will also see the indicator blink.

■ VSA® On and Off

▶▶ VSA® (Vehicle Stability Assist), aka ESC (Electronic Stability Control), System

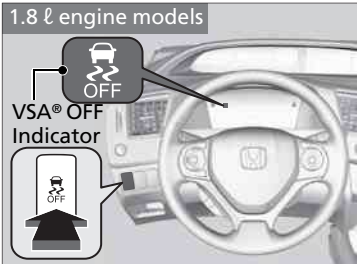

This button is on the driver side control panel. To turn the VSA® system on and off, press and hold it until you hear a beep.

VSA® will stop and the indicator will come on.

To turn it on again, press the  (VSA® OFF) button until you hear a beep.

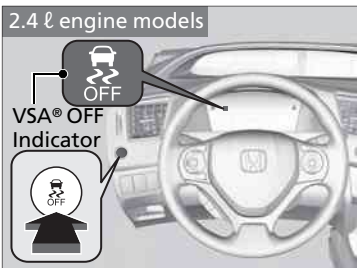

VSA® is turned on every time you start the engine, even if you turned it off the last time you drove the vehicle.

Without VSA®, your vehicle will have normal braking and cornering ability, but it will not have VSA® traction and stability enhancement.

In certain unusual conditions when your vehicle gets stuck in shallow mud or fresh snow, it may be easier to free it with the VSA® temporarily switched off.

When the VSA® system is off, the traction control system is also off. You should only attempt to free your vehicle with the VSA® off if you are not able to free it when the VSA® is on.

Immediately after freeing your vehicle, be sure to switch VSA® on again. We do not recommend driving your vehicle with the VSA® and traction control systems switched off.

If the low tire pressure/TPMS*, low tire pressure*, or TPMS indicator* comes on or blinks, the VSA® system comes on automatically. In this case, you cannot turn the system off by pressing the  button.

You may hear a motor sound coming from the engine compartment while system checks are being performed immediately after starting the engine or while driving. This is normal.

U.S. models only

TPMS (Tire Pressure Monitoring System)



Models with information display

Monitors the tire pressure while you are driving. If your vehicle's tire pressure becomes significantly low, the low tire pressure indicator comes on.

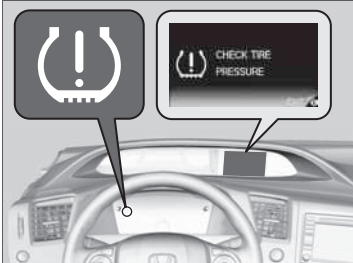

Models with multi-information display

Monitors the tire pressure while you are driving. If your vehicle's tire pressure becomes significantly low, the low tire pressure/TPMS indicator comes on and a message appears on the multi-information display.

"CHECK TIRE PRESSURE" is displayed when a tire has significantly low pressure.

TPMS (Tire Pressure Monitoring System)

Models with information display

Conditions such as low ambient temperature and altitude change directly affect tire pressure and can trigger the low tire pressure indicator to come on.

➤ **If the Low Tire Pressure Indicator Comes On** P. 316

Tire pressure checked and inflated in:

- Warm weather can become under-inflated in colder weather.
- Cold weather can become over-inflated in warmer weather.

The low tire pressure indicator will not come on as a result of over inflation.

Models with multi-information display

Conditions such as low ambient temperature and altitude change directly affect tire pressure and can trigger the low tire pressure/TPMS indicator to come on.

➤ **If the Low Tire Pressure/TPMS Indicator Comes On or Blinks** P. 317

Tire pressure checked and inflated in:

- Warm weather can become under-inflated in colder weather.
- Cold weather can become over-inflated in warmer weather.

The low tire pressure/TPMS indicator will not come on as a result of over inflation.

U.S. models

Tire Pressure Monitoring System (TPMS) - Required Federal Explanation

Each tire, including the spare (if provided), should be checked monthly when cold and inflated to the inflation pressure recommended by the vehicle manufacturer on the vehicle placard or tire inflation pressure label.

(If your vehicle has tires of a different size than the size indicated on the vehicle placard or tire inflation pressure label, you should determine the proper tire inflation pressure for those tires.)

As an added safety feature, your vehicle has been equipped with a tire pressure monitoring system (TPMS) that illuminates a low tire pressure telltale when one or more of your tires is significantly under-inflated.



Accordingly, when the low tire pressure telltale illuminates, you should stop and check your tires as soon as possible, and inflate them to the proper pressure.

Driving on a significantly under-inflated tire causes the tire to overheat and can lead to tire failure. Under-inflation also reduces fuel efficiency and tire tread life, and may affect the vehicle's handling and stopping ability.

Please note that the TPMS is not a substitute for proper tire maintenance, and it is the driver's responsibility to maintain correct tire pressure, even if under-inflation has not reached the level to trigger illumination of the TPMS low tire pressure telltale.

Models with information display

Your vehicle has also been equipped with a TPMS malfunction indicator to indicate when the system is not operating properly. The TPMS malfunction indicator is provided by a separate telltale, which displays the symbol "TPMS" when illuminated.

When the malfunction indicator is illuminated, the system may not be able to detect or signal low tire pressure as intended.



TPMS malfunctions may occur for a variety of reasons, including the installation of replacement or alternate tires or wheels on the vehicle that prevent the TPMS from functioning properly.

Always check the TPMS malfunction telltale after replacing one or more tires or wheels on your vehicle to ensure that the replacement or alternate tires and wheels allow the TPMS to continue to function properly.

Models with multi-information display

Your vehicle has also been equipped with a TPMS malfunction indicator to indicate when the system is not operating properly. The TPMS malfunction indicator is combined with the low tire pressure telltale. When the system detects a malfunction, the telltale will flash for approximately one minute and then remain continuously illuminated. This sequence will continue upon subsequent vehicle start-ups as long as the malfunction exists.

When the malfunction indicator is illuminated, the system may not be able to detect or signal low tire pressure as intended.

TPMS malfunctions may occur for a variety of reasons, including the installation of replacement or alternate tires or wheels on the vehicle that prevent the TPMS from functioning properly.

Always check the TPMS malfunction telltale after replacing one or more tires or wheels on your vehicle to ensure that the replacement or alternate tires and wheels allow the TPMS to continue to function properly.

Brake System

Parking Brake

Use the parking brake to keep the vehicle stationary when parking.

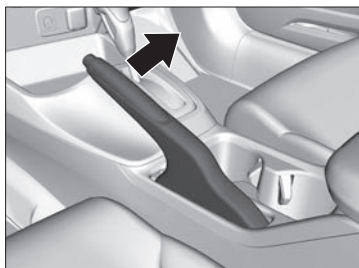

To apply:

Pull the lever fully up without pressing the release button.

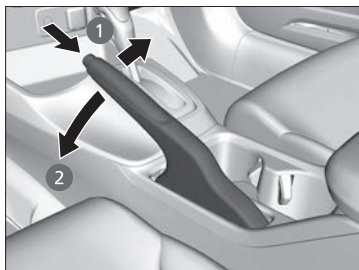

To release:

1. Pull the lever slightly, and press and hold the release button.
2. Lower the lever down all the way, then release the button.

⊠ Parking Brake

NOTICE

Release the parking brake fully before driving. The rear brakes and axle can be damaged if you drive with the parking brake applied.

If you start driving without fully releasing the parking brake, a buzzer sounds as a warning, and "RELEASE PARKING BRAKE" appears on the multi-information display*.

Always apply the parking brake when parking.

To prevent the parking brake from freezing when the outside temperature is extremely cold, do not apply it, but do the following:

Automatic transmission models

Put the shift lever in **P**, then use a block or other wheel chock to stop the wheels from turning.

Manual transmission models

Put the shift lever in **R** or **1**, then use a block or other wheel chock to stop the wheels from turning.

* Not available on all models

Foot Brake

Your vehicle is equipped with front disc brakes. The brakes on the rear wheels may be disc or drum, depending on the model. A power assist helps reduce the effort needed on the brake pedal. The brake assist system increases the stopping force when you depress the brake pedal hard in an emergency situation. The anti-lock brake system (ABS) helps you retain steering control when braking very hard.

➤ [Brake Assist System](#) P. 232

➤ [ABS \(Anti-lock Brake System\)](#) P. 231

Foot Brake

Check the brakes after driving through deep water, or if there is a buildup of road surface water. If necessary, dry the brakes by lightly depressing the pedal several times.

If you hear a continuous metallic friction sound when applying the brakes, the brake pads need to be replaced. Have the vehicle checked by a dealer.

Constantly using the brake pedal while going down a long hill builds up heat, which reduces the brake effectiveness. Apply engine braking by taking your foot off the accelerator pedal and downshifting to a lower gear. With manual transmission use a lower gear for greater engine braking.

Do not rest your foot on the brake pedal while driving, as it will lightly apply the brakes and cause them to lose effectiveness over time and reduce pad life. It will also confuse drivers behind you.

ABS (Anti-lock Brake System)

ABS

Helps prevent the wheels from locking up, and helps you retain steering control by pumping the brakes rapidly, much faster than you.

The electronic brake distribution (EBD) system, which is part of the ABS, also balances the front-to-rear braking distribution according to vehicle loading.

You should never pump the brake pedal. Let the ABS work for you by always keeping firm, steady pressure on the brake pedal. This is sometimes referred to as "stomp and steer."

■ ABS operation

The brake pedal may pulsate slightly when the ABS is working. Keep holding the pedal firmly down. On dry pavement, you will need to press on the brake pedal very hard before the ABS activates. However, you may feel the ABS activate immediately if you are trying to stop on snow or ice.

When the vehicle speed goes under 6 mph (10 km/h), the ABS stops.

ABS (Anti-lock Brake System)

NOTICE

The ABS may not function correctly if you use an incorrect tire type and size.

When the ABS indicator comes on while driving, there may be a problem with the system. While normal braking is not affected, there is a possibility of the ABS not operating. Have the vehicle checked by a dealer immediately.

The ABS does not reduce the time or distance it takes to stop the vehicle. It only helps with steering control during hard braking.

In the following cases, your vehicle may need more stopping distance than a vehicle without the ABS:

- When driving on rough road surfaces, including when driving on uneven surfaces, such as gravel or snow.
- When tire chains are installed.

You may hear a motor sound coming from the engine compartment while system checks are being performed immediately after starting the engine or while driving. This is normal.

Brake Assist System

■ Brake Assist System

Designed to assist the driver by generating greater braking force when you depress the brake pedal hard during emergency braking.

■ Brake assist system operation

Press the brake pedal firmly for more powerful braking.

When brake assist operates, the pedal may wiggle slightly and an operating noise may be heard. This is normal. Keep holding the brake pedal firmly down.

When Stopped

1. Always use the parking brake when you park your vehicle.
2. Make sure the parking brake is set firmly, or your vehicle may roll if parked on an incline.

Parking

Automatic transmission models

1. Depress the brake pedal firmly with the shift lever in **[D]**.
2. Apply the parking brake while holding the brake pedal down.
3. Move the shift lever to **[P]**.
4. Turn off the engine.

▣ Parking Your Vehicle

Do not park your vehicle near flammable objects, such as dry grass, oil, or timber. Heat from the exhaust can cause a fire.

▣ When Stopped

Automatic transmission models

NOTICE

The following can damage the transmission:

- Depressing the accelerator and brake pedals simultaneously.
- Holding the vehicle in place when facing uphill by depressing the accelerator pedal.
- Moving the shift lever into **[P]** before the vehicle stops completely.

▣ Parking

Raise the wiper arms when snow is expected.

Fuel Information

■ Fuel recommendation

1.8 ℓ engine models

Unleaded gasoline, pump octane number 87 or higher

Use of a lower octane gasoline can cause a persistent, heavy metallic knocking noise that can lead to engine damage.

2.4 ℓ engine models

Unleaded premium gasoline, pump octane number 91 or higher

Use of a lower octane gasoline can cause occasional metallic knocking noise in the engine and will result in decreased engine performance.

Use of a gasoline with a pump octane less than 87 can lead to engine damage.

■ Top tier detergent gasoline

Because the level of detergency and additives in gasoline vary in the market, Honda endorses the use of “TOP TIER Detergent Gasoline” where available to help maintain the performance and reliability of your vehicle. TOP TIER Detergent Gasoline meets a new gasoline standard jointly established by leading automotive manufacturers to meet the needs of today’s advanced engines.

» Fuel Information

NOTICE

We recommend quality gasoline containing detergent additives that help prevent fuel system and engine deposits. In addition, in order to maintain good performance, fuel economy, and emissions control, we strongly recommend the use of gasoline that does NOT contain harmful manganese-based fuel additives such as MMT, if such gasoline is available.

Use of gasoline with these additives may adversely affect performance, and cause the malfunction indicator lamp on your instrument panel to come on. If this happens, contact a dealer for service. Some gasoline today is blended with oxygenates such as ethanol. Your vehicle is designed to operate on oxygenated gasoline containing up to 10% ethanol by volume. Do not use gasoline containing methanol. If you notice any undesirable operating symptoms, try another service station or switch to another brand of gasoline.

Qualifying gasoline retailers will, in most cases, identify their gasoline as having met "TOP TIER Detergent Gasoline" standards at the retail location. This fuel is guaranteed to contain the proper level of detergent additives and be free of metallic additives. The proper level of detergent additives, and absence of harmful metallic additives in gasoline, help avoid build-up of deposits in your engine and emission control system.

For further important fuel-related information for your vehicle, or on information on gasoline that does not contain MMT, visit www.hondacars.com. In Canada, visit www.honda.ca for additional information on gasoline. For more information on top tier gasoline, visit www.toptiergas.com.

■ Fuel tank capacity: 13.2 US gal (50 liters)

How to Refuel

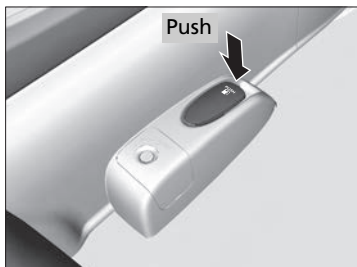

1. Stop your vehicle with the service station pump on the left side of the vehicle in the rear.
2. Turn off the engine.
3. Push on the fuel fill door release handle at the foot of the driver's seat.
 - ▶ The fuel fill door opens.

How to Refuel

⚠ WARNING

Gasoline is highly flammable and explosive. You can be burned or seriously injured when handling fuel.

- Stop the engine, and keep heat, sparks, and flame away.
- Handle fuel only outdoors.
- Wipe up spills immediately.

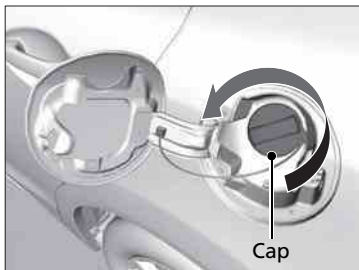

4. Remove the fuel fill cap slowly. If you hear a release of air, wait until this stops, then turn the knob slowly to open the fuel fill cap.

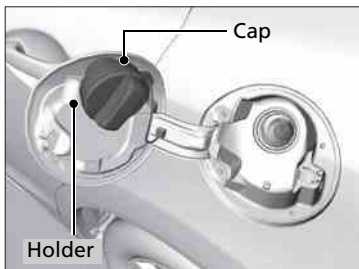

5. Place the fuel fill cap in the holder.
6. Insert the filler nozzle fully.
 - ▶ When the tank is full, the fuel nozzle will click off automatically. This leaves space in the fuel tank in case the fuel expands with a change in the temperature.
7. After filling, replace the fuel fill cap, tightening it until you hear it click at least once.
 - ▶ Shut the fuel fill door by hand.

▶▶ How to Refuel

The filler nozzle automatically stops to leave space in the fuel tank so that fuel does not overflow as a result of changes in air temperature.

If the fuel nozzle keeps turning off when the tank is not full, there may be a problem with the pump's fuel vapor recovery system. Try filling at another pump. If this does not fix the problem, consult a dealer.

Do not continue to add fuel after the nozzle has automatically stopped. Additional fuel can exceed the full tank capacity.

Improving Fuel Economy

Fuel economy depends on several conditions, including driving conditions, your driving habits, the condition of your vehicle, and loading. Depending on these and other conditions, you may or may not achieve the rated fuel economy of this vehicle.

Maintenance and Fuel Economy

You can optimize your fuel economy with proper maintenance of your vehicle. Always maintain your vehicle in accordance with the messages displayed on the information display*/multi-information display*.

- Use the recommended viscosity engine oil, displaying the API Certification Seal.
- Maintain the specified tire pressure.
- Do not load the vehicle with excess cargo.
- Keep your vehicle clean. A buildup of snow or mud on your vehicle's underside adds weight and increases wind resistance.

* Not available on all models

Improving Fuel Economy

Direct calculation is the recommended method to determine actual fuel consumed while driving.

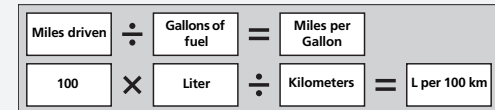

In Canada, posted fuel economy numbers are established following a simulated test. For more information on how this test is performed, please visit <http://oee.nrcan.gc.ca/>

Accessories

When installing accessories, check the following:

- Do not install accessories on the windshield. They can obstruct your view and delay your reaction to driving conditions.
- Do not install accessories on the side pillars or across the side windows. Accessories installed in these areas may interfere with proper operation of the side curtain airbags.
- Be sure electronic accessories do not overload electrical circuits or interfere with proper operation of your vehicle.
[Fuses P. 318](#)
- Before installing any electronic accessory, have the installer contact a dealer for assistance. If possible, have a dealer inspect the final installation.

Modifications

Do not modify your vehicle or use non-Honda components that can affect its handling, stability, and reliability.

Overall vehicle performance can be affected. Always make sure all equipment is properly installed and maintained, and that it meets federal, state, province, territory, and local regulations.

» Accessories and Modifications

⚠ WARNING

Improper accessories or modifications can affect your vehicle's handling, stability, and performance, and cause a crash in which you can be seriously hurt or killed.

Follow all instructions in this owner's manual regarding accessories and modifications.

Honda Genuine accessories are recommended to ensure proper operation on your vehicle.

Maintenance

This chapter discusses basic maintenance.



- Before Performing Maintenance**
- Inspection and Maintenance 240
- Safety When Performing Maintenance..... 241
- Parts and Fluids Used in Maintenance Service 242
- Maintenance Minder™** 243
- Maintenance Under the Hood**
- Maintenance Items Under the Hood..... 251
- Opening the Hood 253
- Recommended Engine Oil 254
- Oil Check 255
- Adding Engine Oil 257
- Changing the Engine Oil and Oil Filter 258

- Engine Coolant..... 261
- Transmission Fluid..... 263
- Brake/Clutch Fluid..... 266
- Refilling Window Washer Fluid..... 267
- Replacing Light Bulbs** 268
- Checking and Maintaining Wiper Blades** 278
- Checking and Maintaining Tires**
- Checking Tires 280
- Tire and Loading Information Label..... 281
- Tire Labeling 281
- DOT Tire Quality Grading (U.S. Vehicles)..... 283
- Wear Indicators..... 285

- Tire Service Life..... 285
- Tire and Wheel Replacement 286
- Tire Rotation 287
- Winter Tires 288
- Battery**..... 289
- Remote Transmitter Care***
- Replacing the Battery..... 290
- Heating and Cooling* System Maintenance** 291
- Cleaning**
- Interior Care 292
- Exterior Care..... 294

* Not available on all models

Inspection and Maintenance

For your safety, perform all listed inspections and maintenance to keep your vehicle in good condition. If you become aware of any abnormality (noise, smell, insufficient brake fluid, oil residue on the ground, etc.), have your vehicle inspected by a dealer. (Note, however, that service at a dealer is not mandatory to keep your warranties in effect.) Refer to the separate maintenance booklet for detailed maintenance and inspection information.

Types of Inspection and Maintenance

Daily inspections

Perform inspections before long distance trips, when washing the vehicle, or when refueling.

Periodic inspections

- Check the automatic transmission fluid level monthly.
➤ [Automatic Transmission Fluid](#) P. 263
- Check the brake fluid level monthly.
➤ [Brake/Clutch Fluid](#) P. 266
- Check the tire pressure monthly. Examine the tread for wear and foreign objects.
➤ [Checking and Maintaining Tires](#) P. 280
- Check the operation of the exterior lights monthly.
➤ [Replacing Light Bulbs](#) P. 268
- Check the condition of the wiper blades at least every six months.
➤ [Checking and Maintaining Wiper Blades](#) P. 278

Inspection and Maintenance

U.S. models

Maintenance, replacement, or repair of emissions control devices and systems may be done by any automotive repair establishment or individuals using parts that are "certified" to EPA standards.

According to state and federal regulations, failure to perform maintenance on the maintenance main items marked with # will not void your emissions warranties. However, all maintenance services should be performed in accordance with the intervals indicated by the information display*/multi-information display*.

➤ [Maintenance Service Items](#)
➤ P. 245 ➤ P. 249

If you want to perform complex maintenance tasks that require more skills and tools, you can purchase a subscription to the Service Express website at www.techinfo.honda.com.

➤ [Authorized Manuals](#) P. 335

If you want to perform maintenance yourself, make sure that you have the necessary tools and skills first. After performing maintenance, update the records in the separate maintenance booklet.

Safety When Performing Maintenance

Some of the most important safety precautions are given here. However, we cannot warn you of every conceivable hazard that can arise in performing maintenance. Only you can decide whether or not you should perform a given task.

Maintenance Safety

- To reduce the possibility of fire or explosion, keep cigarettes, sparks, and flames away from the battery and all fuel related parts.
- To clean parts, use a commercially available degreaser or parts cleaner, not gasoline.
- Wear eye protection and protective clothing when working with the battery or compressed air.
- Engine exhaust contains carbon monoxide, which is poisonous and can kill you.
 - ▶ Only operate the engine if there is sufficient ventilation.

Vehicle Safety

- The vehicle must be in a stationary condition.
 - ▶ Make sure your vehicle is parked on level ground, the parking brake is set, and the engine is off.
- Be aware that hot parts can burn you.
 - ▶ Make sure to let the engine and exhaust system cool thoroughly before touching vehicle parts.
- Be aware that moving parts can injure you.
 - ▶ Do not start the engine unless instructed, and keep your hands and limbs away from moving parts.

⊗ Safety When Performing Maintenance

⚠ WARNING

Improperly maintaining this vehicle or failing to correct a problem before driving can cause a crash in which you can be seriously hurt or killed.

Always follow the inspection and maintenance recommendations according to the schedules in this owner's manual.

⚠ WARNING

Failure to properly follow maintenance instructions and precautions can cause you to be seriously hurt or killed.

Always follow the procedures and precautions in this owner's manual.

Parts and Fluids Used in Maintenance Service

The use of Honda genuine parts and fluids is recommended when maintaining and servicing your vehicle. Honda genuine parts are manufactured according to the same high quality standards used in Honda vehicles.

If the engine oil life is less than 15%, you will see the Maintenance Minder messages appear on the information display* or the multi-information display* every time you turn the ignition switch to ON **II**. The messages notify you when to change the engine oil, or when to bring your vehicle to a dealer for indicated maintenance services.

Models with information display

To Use Maintenance Minder™

Displaying the Engine Oil Life

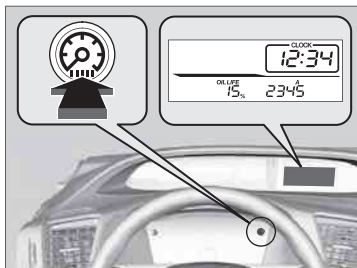

1. Turn the ignition switch to ON **II**.
2. Press the **(SEL/RESET)** knob repeatedly until the engine oil life appears on the information display.

The Maintenance Minder indicator () stays on in the instrument panel after the engine oil life becomes 0%. Have the indicated maintenance done by a dealer immediately.

Displaying the Engine Oil Life





Based on the engine operating conditions, the remaining engine oil life is calculated and displayed as a percentage.

Displayed Engine Oil Life (%)	Calculated Engine Oil Life (%)
100	100 to 91
90	90 to 81
80	80 to 71
70	70 to 61
60	60 to 51
50	50 to 41
40	40 to 31
30	30 to 21
20	20 to 16
15	15 to 11
10	10 to 6
5	5 to 1
0	0

* Not available on all models

Maintenance Minder Messages on the Information Display

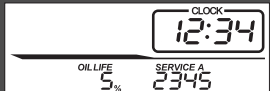
To switch the display, press the  (SEL/RESET) knob.

Oil Life Display	Explanation	Information	Maintenance Minder Indicator
	The engine oil life indicator starts to appear along with other due soon maintenance item codes when the remaining oil life becomes 15 percent.	The engine oil is approaching the end of its service life.	 Starts to come on when the remaining engine oil life becomes 15 percent.
	The "SERVICE" message also starts to appear along with the engine oil life indicator and the maintenance item codes.	The engine oil has almost reached the end of its service life, and the maintenance items should be inspected and serviced as soon as possible.	It goes off when the display is switched.
	The remaining engine oil life has passed its service life, and a negative distance appears after driving over 10 miles (U.S. models) or 10 km (Canadian models). The negative distance on the display blinks.	The engine oil life has passed. The maintenance items must be inspected and serviced immediately.	 Stays on as a reminder even when the display is switched.

Maintenance Service Items

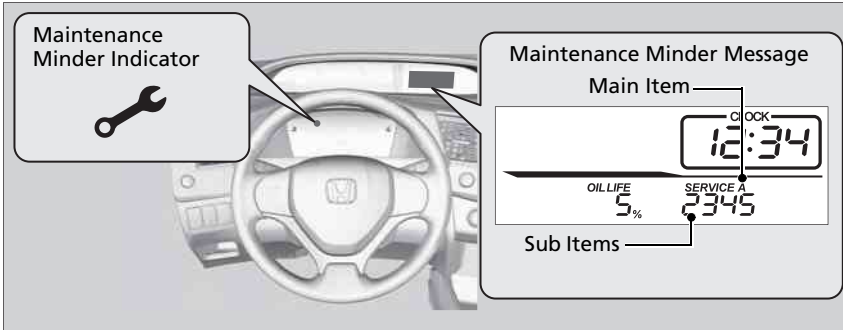

▣ Maintenance Service Items

- Independent of the Maintenance Minder information, replace the brake fluid every 3 years.
- Inspect idle speed every 160,000 miles (256,000 km).
- Adjust the valves during services A, B, 1, 2, or 3 if they are noisy.

CODE	Maintenance Main Items
A	<ul style="list-style-type: none"> • Replace engine oil^{*1}
B	<ul style="list-style-type: none"> • Replace engine oil^{*1} and oil filter • Inspect front and rear brakes/service as necessary • Check parking brake adjustment • Inspect tie rod ends, steering gearbox, and boots • Inspect suspension components • Inspect driveshaft boots • Inspect brake hoses and lines (Including ABS/VSA) • Inspect all fluid levels and condition of fluids • Inspect exhaust system[#] • Inspect fuel lines and connections[#]

CODE	Maintenance Sub Items
1	<ul style="list-style-type: none"> • Rotate tires
2	<ul style="list-style-type: none"> • Replace air cleaner element^{*2} • Replace dust and pollen filter^{*,*3} • Inspect drive belt
3	<ul style="list-style-type: none"> • Replace transmission fluid
4	<ul style="list-style-type: none"> • Replace spark plugs • Inspect valve clearance
5	<ul style="list-style-type: none"> • Replace engine coolant

^{*2}: If you drive in dusty conditions, replace the air cleaner element every 15,000 miles (24,000 km).

^{*3}: If you drive primarily in urban areas that have high concentrations of soot in the air from industry and from diesel-powered vehicles, replace the dust and pollen filter every 15,000 miles (24,000 km).

^{*1}: If a message "SERVICE" does not appear more than 12 months after the display is reset, change the engine oil every year.

[#]: See information on maintenance and emissions warranty.



* Not available on all models

Continued

Resetting the Display

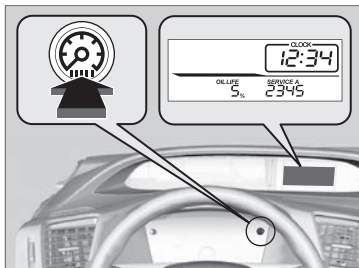
Reset the engine oil life display if you have performed the maintenance service.



1. Turn the ignition switch to ON **II**.
2. Display the engine oil life by repeatedly pressing the  (SEL/RESET) knob.
3. Press and hold the  knob for ten seconds or more.
 - ▶ The engine oil life indicator and the maintenance item codes blink.
4. Press the  knob for five seconds or more.
 - ▶ The displayed maintenance items disappear, and the engine oil life display returns to 100%.

Resetting the Display

NOTICE

Failure to reset the engine oil life after a maintenance service results in the system showing incorrect maintenance intervals, which can lead to serious mechanical problems.

The dealer will reset the engine oil life display after completing the required maintenance service. If someone other than a dealer performs maintenance service, reset the engine oil life display yourself.



Models with multi-information display

To Use Maintenance Minder™

Displaying the Engine Oil Life and Maintenance Items

Maintenance items, which should be serviced at the same time that you replace the engine oil, appear on the multi-information display.

You can view them on the **Maintenance info** screen at any time.

1. Turn the ignition switch to ON .
2. Press the MENU button to go to the **Vehicle Menu** screen.
3. Select **Vehicle Information** with the  button, then press the SOURCE button.
4. Press the SOURCE button again to go to the **Maintenance info** screen. The engine oil life appears on the multi-information display.

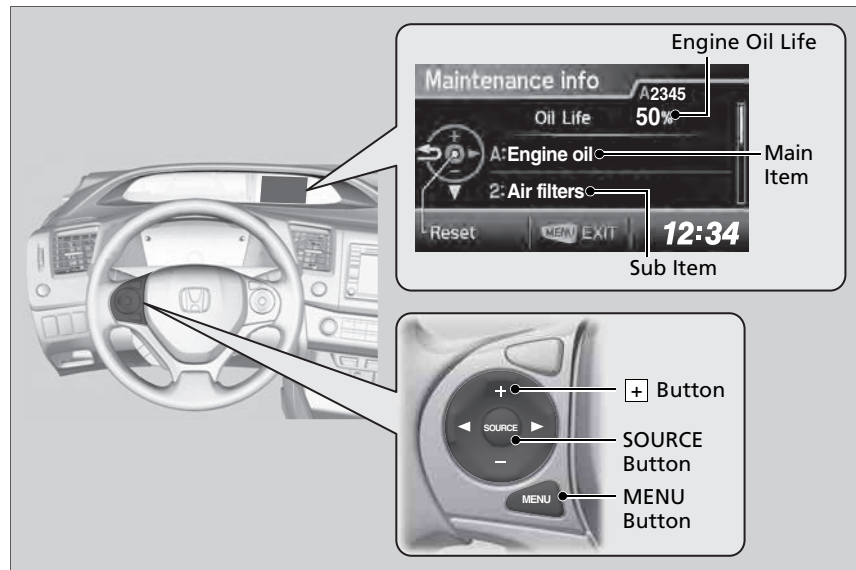

Displaying the Engine Oil Life and Maintenance Items







Based on the engine operating conditions, the remaining engine oil life is calculated and displayed as a percentage.

Displayed Engine Oil Life (%)	Calculated Engine Oil Life (%)
100	100 to 91
90	90 to 81
80	80 to 71
70	70 to 61
60	60 to 51
50	50 to 41
40	40 to 31
30	30 to 21
20	20 to 16
15	15 to 11
10	10 to 6
5	5 to 1
0	0

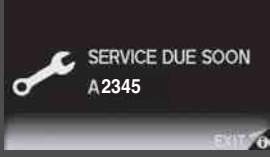
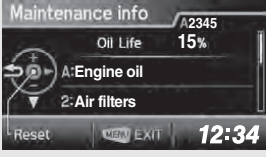
There is a list of maintenance main and sub items you can view on the multi-information display.

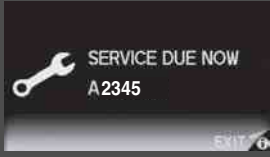
[Maintenance Service Items P. 249](#)

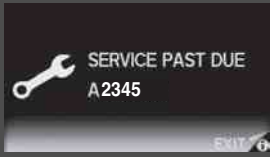
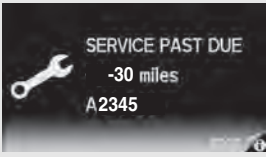
Maintenance Minder Messages on the Multi-Information Display

Maintenance Message	Oil Life Display	Explanation	Information
<p>SERVICE DUE SOON</p> 	<p>15 %</p> 	<p>The remaining engine oil life is 15 to 6 percent. Once you switch the display by pressing the  (display/information) button, this message will go off.</p>	<p>The engine oil is approaching the end of its service life, and the maintenance items should be inspected and serviced soon.</p>
<p>SERVICE DUE NOW</p> 	<p>5 %</p> 	<p>The remaining engine oil life is 5 to 1 percent. Press the  button to switch to another display.</p>	<p>The engine oil has almost reached the end of its service life, and the maintenance items should be inspected and serviced as soon as possible.</p>
<p>SERVICE PAST DUE</p> 	<p>Negative Distance</p> 	<p>The remaining engine oil life has passed its service life, and a negative distance appears after driving over 10 miles (U.S. models) or 10 km (Canadian models). Press the  button to switch to another display.</p>	<p>The engine oil life has passed. The maintenance items must be inspected and serviced immediately.</p>

The system message indicator  comes on along with the Maintenance Minder message.

Maintenance Service Items

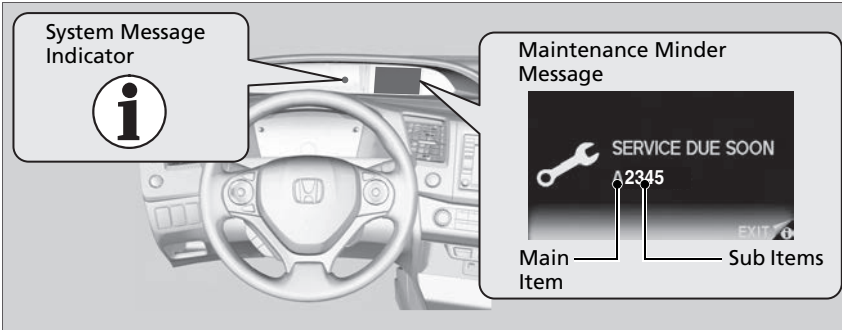

⌘ Maintenance Service Items

- Independent of the Maintenance Minder information, replace the brake fluid every 3 years.
- Inspect idle speed every 160,000 miles (256,000 km).
- Adjust the valves during services A, B, 1, 2, or 3 if they are noisy.

CODE	Maintenance Main Items
------	------------------------

A	<ul style="list-style-type: none"> • Replace engine oil*1
B	<ul style="list-style-type: none"> • Replace engine oil*1 and oil filter • Inspect front and rear brakes/service as necessary • Check parking brake adjustment • Inspect tie rod ends, steering gearbox, and boots • Inspect suspension components • Inspect driveshaft boots • Inspect brake hoses and lines (Including ABS/VA) • Inspect all fluid levels and condition of fluids • Inspect exhaust system# • Inspect fuel lines and connections#

*1: If a message "SERVICE" does not appear more than 12 months after the display is reset, change the engine oil every year.

: See information on maintenance and emissions warranty.

CODE	Maintenance Sub Items
------	-----------------------

1	<ul style="list-style-type: none"> • Rotate tires
2	<ul style="list-style-type: none"> • Replace air cleaner element*2 • Replace dust and pollen filter*3 • Inspect drive belt
3	<ul style="list-style-type: none"> • Replace transmission fluid
4	<ul style="list-style-type: none"> • Replace spark plugs • Inspect valve clearance
5	<ul style="list-style-type: none"> • Replace engine coolant



*2: If you drive in dusty conditions, replace the air cleaner element every 15,000 miles (24,000 km).

*3: If you drive primarily in urban areas that have high concentrations of soot in the air from industry and from diesel-powered vehicles, replace the dust and pollen filter every 15,000 miles (24,000 km).

■ Resetting the Display

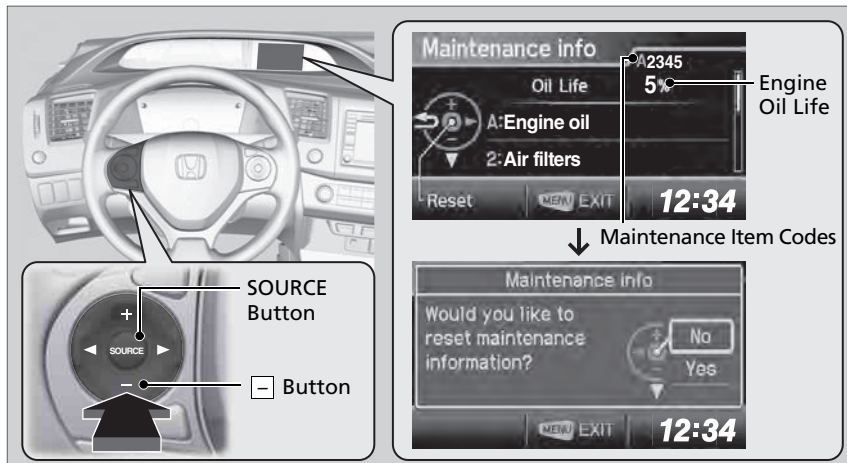
Reset the engine oil life display if you have performed the maintenance service.



1. Turn the ignition switch to ON .
 2. Go to the **Maintenance info** screen.
▶ [Displaying the Engine Oil Life and Maintenance Items](#) P. 247
 3. Press the SOURCE button.
▶ The oil life reset mode is displayed on the multi-information display.
 4. Select Yes with the  button, then press the SOURCE button.
▶ The displayed maintenance items disappear, and the engine oil life display returns to 100%.
▶ Any maintenance items that are necessary for your vehicle at the next maintenance service will appear.
- To cancel the oil life reset mode, select **No**, then press the SOURCE button.

▶▶ Resetting the Display

NOTICE

Failure to reset the engine oil life after a maintenance service results in the system showing incorrect maintenance intervals, which can lead to serious mechanical problems.

The dealer will reset the engine oil life display after completing the required maintenance service. If someone other than a dealer performs maintenance service, reset the engine oil life display yourself.

Maintenance Items Under the Hood

1.8 l engine models

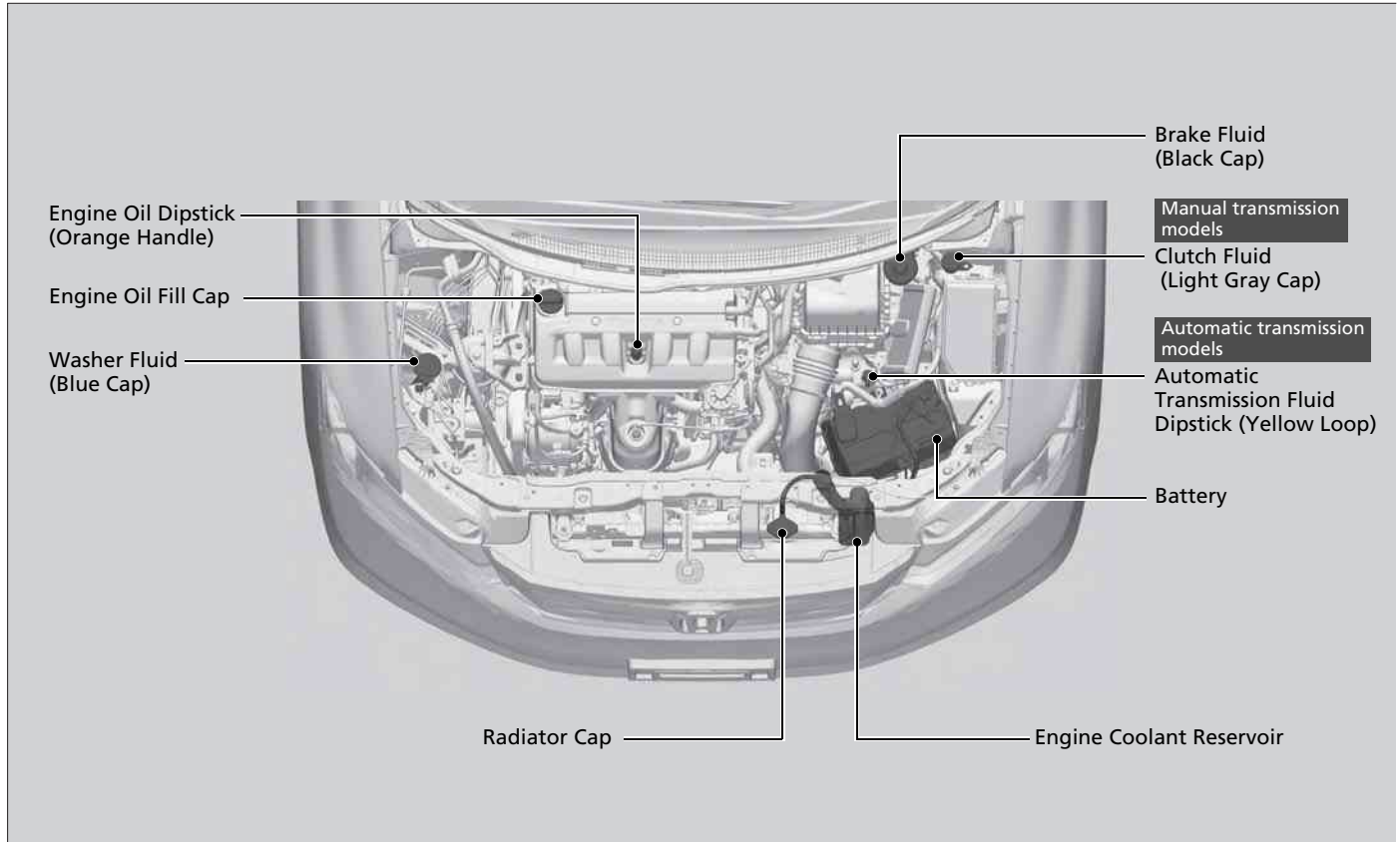

2.4 l engine models

Engine Oil Fill Cap

Engine Oil Dipstick
(Orange Handle)

Washer Fluid
(Blue Cap)

Brake Fluid
(Black Cap)

Clutch Fluid
(Light Gray Cap)

Battery

Radiator Cap

Engine Coolant Reservoir

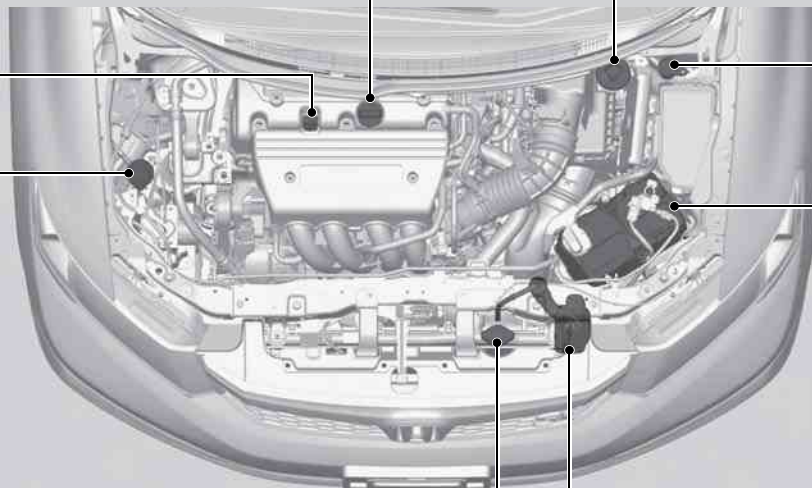

Opening the Hood



1. Park the vehicle on a level surface, and set the parking brake.
2. Pull the hood release handle under the lower left corner of the dashboard.
 - The hood will pop up slightly.



3. Push up the hood latch lever in the center of the hood to release the lock mechanism, and open the hood.

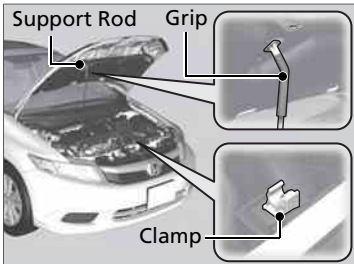

4. Remove the support rod from the clamp using the grip. Mount the support rod in the hood.

When closing, remove the support rod, and stow it in the clamp, then gently lower the hood. Remove your hand at a height of approximately 12 inches (30 cm) and let the hood close.

Opening the Hood

NOTICE

Do not open the hood when the wiper arms are raised.

The hood will strike the wipers, and may damage either the hood or the wipers.

When closing the hood, check that the hood is securely latched.

If the hood latch lever moves stiffly, or if you can open the hood without lifting the lever, the latch mechanism should be cleaned and lubricated.

Recommended Engine Oil

- **Genuine Honda Motor Oil**
- **Premium-grade 0W-20 detergent oil with an API Certification Seal on the container.**



Oil is a major contributor to your engine's performance and longevity. If you drive the vehicle with insufficient or deteriorated oil, the engine may fail or be damaged.

This seal indicates the oil is energy conserving and that it meets the American Petroleum Institute's latest requirements.

Use a Genuine Honda Motor Oil or another commercial engine oil of suitable viscosity for the ambient temperature as shown.

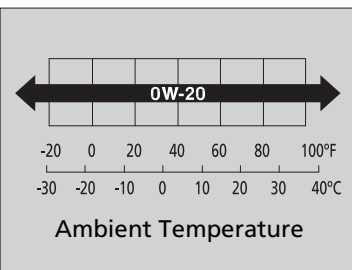

■ Synthetic oil

You may also use synthetic motor oil if it is labeled with the API Certification Seal and is the specified viscosity grade.

►► Recommended Engine Oil

Engine Oil Additives

Your vehicle does not require oil additives. In fact, they may adversely affect the engine performance and durability.

Oil Check

We recommend that you check the engine oil level every time you refuel. Park the vehicle on level ground. Wait approximately three minutes after turning the engine off before you check the oil.

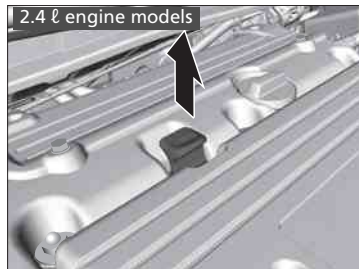
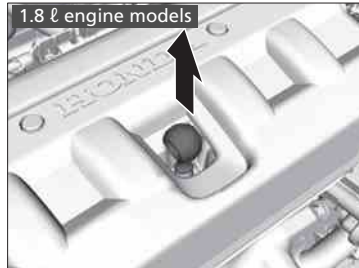

1. Remove the dipstick (orange handle).
2. Wipe the dipstick with a clean cloth or paper towel.
3. Insert the dipstick back all the way into its hole.

Oil Check

If the oil level is near or below the lower mark, slowly add oil being careful not to overfill.

Continued

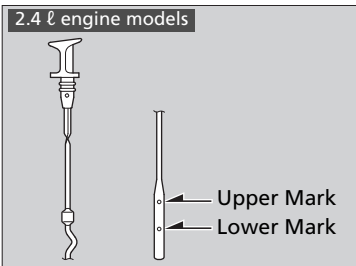
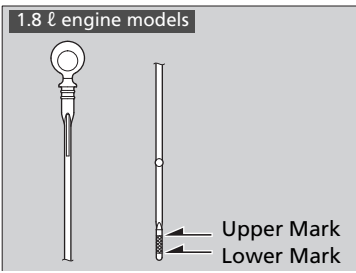

4. Remove the dipstick again, and check the level. It should be between the upper and lower marks. Add oil if necessary.

Adding Engine Oil

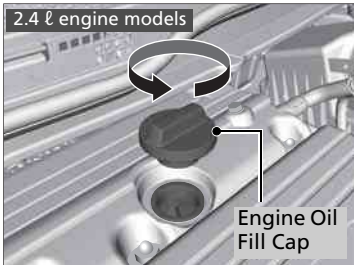
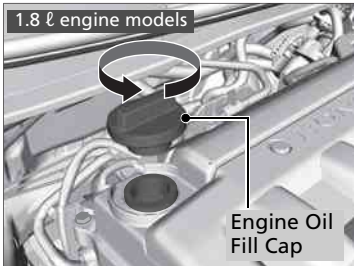

1. Unscrew and remove the engine oil fill cap.
2. Add oil slowly.
3. Reinstall the engine oil fill cap, and tighten it securely.
4. Wait for three minutes and recheck the engine oil dipstick.

Adding Engine Oil

If any oil spills, wipe it up immediately. Spilled oil may damage the engine compartment components.

NOTICE

Do not fill the engine oil above the upper mark. Overfilling the engine oil can result in leaks and engine damage.

Changing the Engine Oil and Oil Filter

You must change the engine oil and oil filter regularly in order to maintain the engine's lubrication. The engine may be damaged if they are not changed regularly.

Change the oil and filter in accordance with the maintenance message on the information display*/multi-information display*.

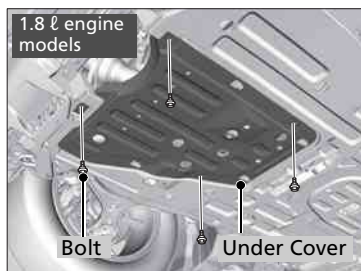

1. Run the engine until it reaches normal operating temperature, and then turn the engine off.
2. Open the hood and remove the engine oil fill cap.

1.8 l engine models

3. Remove the bolts on the undercarriage and remove the under cover.

►► Changing the Engine Oil and Oil Filter

NOTICE

You may damage the environment if you do not dispose of the oil in a suitable way. If you are changing the oil by yourself, appropriately dispose of the used oil. Put the oil in a sealed container and take it to a recycling center. Do not throw the oil away into a garbage can or onto the ground.

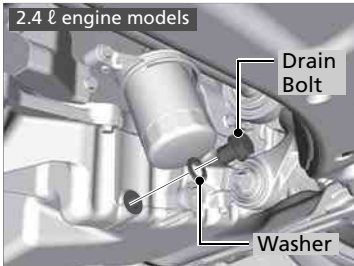
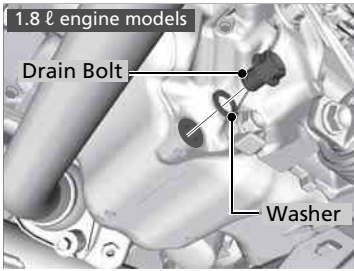

All models

4. Remove the drain bolt and washer from the bottom of the engine, and drain the oil into a suitable container.

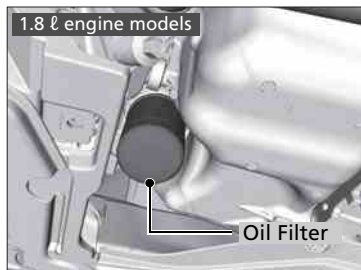

1.8 L engine models

Oil Filter

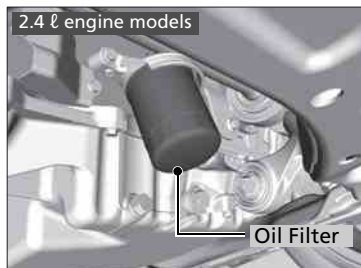

2.4 L engine models

Oil Filter

5. Remove the oil filter and dispose of the remaining oil.
6. Check that the filter gasket is not stuck to the engine contact surface.
 - If it is stuck, you must detach it.
7. Wipe away dirt and dust adhering to the contact surface of the engine block, and install a new oil filter.
 - Apply a light coat of new engine oil to the oil filter rubber seal.
8. Put a new washer on the drain bolt, then reinstall the drain bolt.
 - Tightening torque:
 - 1.8 L engine models**
29 lbf·ft (39 N·m, 4.0 kgf·m)
 - 2.4 L engine models**
30 lbf·ft (40 N·m, 4.0 kgf·m)
9. Pour the recommended engine oil into the engine.
 - Engine oil change capacity (including filter):
 - 1.8 L engine models**
3.9 US qt (3.7 L)
 - 2.4 L engine models**
4.4 US qt (4.2 L)
10. Reinstall the engine oil fill cap securely and start the engine.
11. Run the engine for a few minutes, and then check that there is no leak from the drain bolt or oil filter.
12. Stop the engine, wait for three minutes, and then check the oil level on the dipstick.
 - If necessary, add more engine oil.

►► Changing the Engine Oil and Oil Filter

You will need a special wrench to replace the oil filter. You can buy this wrench from a dealer.

When installing the new oil filter, follow the instructions supplied with the oil filter.

Reinstall the engine oil fill cap. Start the engine. The low oil pressure indicator should go off within five seconds. If it does not, turn off the engine, and check your work.

Engine Coolant

Specified coolant: Honda Long Life Antifreeze/Coolant Type 2

This coolant is premixed with 50% antifreeze and 50% water. Do not add any straight antifreeze or water.

We recommend you check the engine coolant level every time you refuel. Check the reserve tank first. If it is completely empty, also check the coolant level in the radiator. Add the engine coolant accordingly.

Reserve Tank

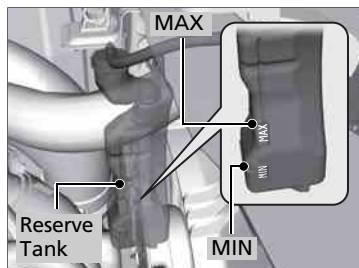

1. Check the amount of coolant in the reserve tank.
2. If the coolant level is below the MIN mark, add the specified coolant until it reaches the MAX mark.
3. Inspect the cooling system for leaks.

Engine Coolant

NOTICE

2.4 L engine models

You will need a more concentrated coolant if you are driving in extremely cold temperature below -31°F (-35°C). Consult your Honda dealer for details about a suitable coolant mixture.

All models

If Honda antifreeze/coolant is not available, you may use another major brand non-silicate coolant as a temporary replacement. Check that it is a high quality coolant recommended for aluminum engines. Continued use of any non-Honda coolant can result in corrosion, causing the cooling system to malfunction or fail. Have the cooling system flushed and refilled with Honda antifreeze/coolant as soon as possible.

Do not add rust inhibitors or other additives to your vehicle's coolant system. They may not be compatible with the coolant or with the engine components.

Radiator

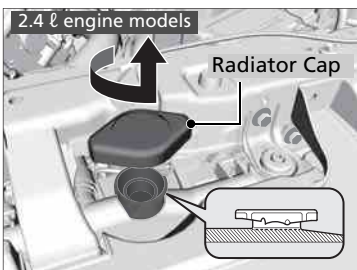
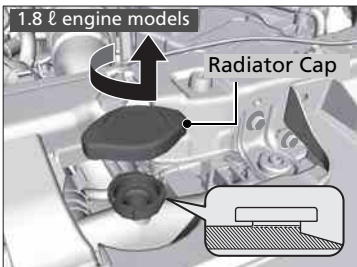

1. Make sure the engine and radiator are cool.
2. Turn the radiator cap counterclockwise and relieve any pressure in the coolant system. Do not push the cap down when turning.
3. Push down and turn the radiator cap counterclockwise to remove it.
4. The coolant level should be up to the base of the filler neck. Add coolant if it is low.
5. Put the radiator cap back on, and tighten it fully.
6. Pour coolant into the reserve tank until it reaches the MAX mark. Put the cap back on the reserve tank.

» Radiator

⚠ WARNING

Removing the radiator cap while the engine is hot can cause the coolant to spray out, seriously scalding you.

Always let the engine and radiator cool down before removing the radiator cap.

NOTICE

Pour the fluid slowly and carefully so you do not spill any. Clean up any spills immediately; they can damage components in the engine compartment.

Transmission Fluid

Automatic Transmission Fluid

Specified fluid: Honda ATF DW-1 (automatic transmission fluid)

Check the fluid level when the engine is at normal operating temperature.

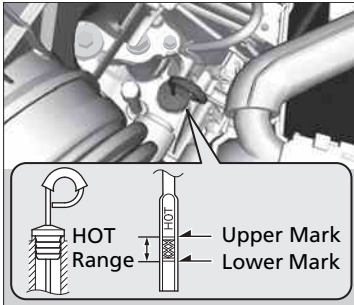

1. Park on level ground, and start the engine.
2. Wait until the radiator fan starts and then turn off the engine.
 - ▶ Perform step 3 after waiting for about 60 seconds (less than 90 seconds).
3. Remove the dipstick (yellow loop) from the transmission and wipe it with a clean cloth.
4. Insert the dipstick all the way back into the transmission securely, as shown in the image.
5. Remove the dipstick and check the fluid level.
 - ▶ It should be between the upper and lower marks in the HOT range.
6. If the level is below the lower mark, add fluid into the dipstick hole to bring it to the level between the upper and lower marks, and have your vehicle checked by a dealer immediately.

Automatic Transmission Fluid

NOTICE

Do not mix Honda ATF DW-1 with other transmission fluids.

Using a transmission fluid other than Honda ATF DW-1 may adversely affect the operation and durability of your vehicle's transmission, and damage the transmission.

Any damage caused by using a transmission fluid that is not equivalent to Honda ATF DW-1 is not covered by Honda's new vehicle warranty.

NOTICE

Pour the fluid slowly and carefully so you do not spill any. Clean up any spills immediately; they can damage components in the engine compartment.

Manual Transmission Fluid

Specified fluid: Honda Manual Transmission Fluid (MTF)

Check the fluid level when the engine is at normal operating temperature.

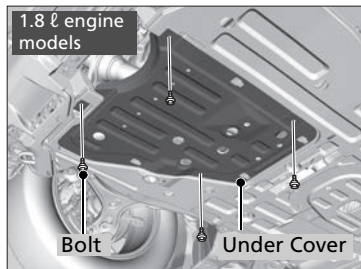

1. Park the vehicle on level ground.
- 1.8 l engine models
2. Remove the bolts with a wrench, then carefully remove the under cover.

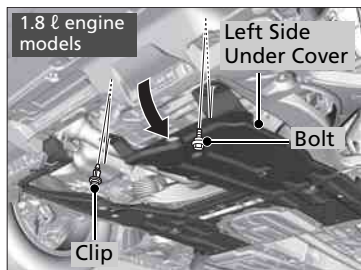

3. Remove the holding clip and the bolt, then bend down the front edge of the left side under cover as shown in the image.

Manual Transmission Fluid

If Honda MTF is not available, you may use the API certificated SAE 0 W-20 or 5 W-20 viscosity motor oil as a temporary measure.

Replace with MTF as soon as possible. Motor oil does not contain the proper additives for the transmission and continued use can cause decreased shifting performance and lead to transmission damage.

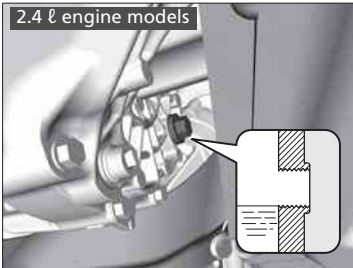
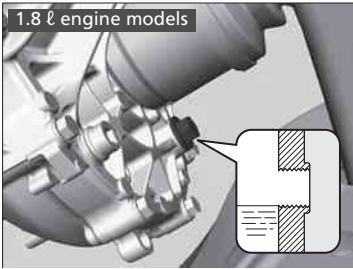

All models

4. Remove the transmission filler bolt and washer. Carefully feel inside the bolt hole with your fingers.
 - Check if the fluid level is up to the edge of the bolt hole.
5. If the fluid level is not up to the edge of the bolt hole, add Honda Manual Transmission Fluid (MTF) until it runs out of the hole.
6. Put a new washer on the filler bolt, then reinstall the filler bolt.
 - Tightening torque:
33 lbf·ft (44 N·m, 4.5 kgf·m)

1.8 L engine models

7. Reinstall the left side under cover with the holding clip and the bolt.
8. Reinstall the under cover with the bolts.

Brake/Clutch Fluid

Specified fluid: Honda Heavy Duty Brake Fluid DOT 3

Use the same fluid for both the brakes and clutch.

Checking the Brake Fluid

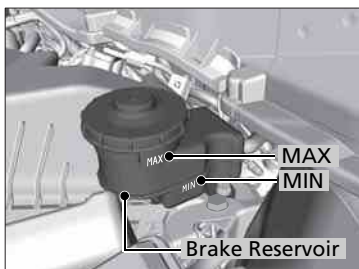

The fluid level should be between the MIN and MAX marks on the side of the reservoir.

Brake/Clutch Fluid

NOTICE

Brake fluid marked DOT 5 is not compatible with your vehicle's braking system and can cause extensive damage.

If the specified brake fluid is not available, you should use only DOT 3 or DOT 4 fluid from a sealed container as a temporary replacement.

Using any non-Honda brake fluid can cause corrosion and decrease the longevity of the system. Have the brake system flushed and refilled with Honda Heavy Duty Brake Fluid DOT 3 as soon as possible.

If the brake fluid level is at or below the MIN mark, have a dealer inspect for leaks or worn brake pads as soon as possible.

Checking the Clutch Fluid

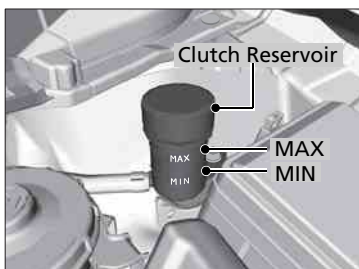

The fluid level should be between the MIN and MAX marks on the side of the reservoir.

Checking the Clutch Fluid

If the clutch fluid level is at or below the MIN mark, have a dealer inspect for leaks or an excessively worn clutch plate as soon as possible.

Refilling Window Washer Fluid

Check the amount of window washer fluid using the washer fluid level gauge on the cap.

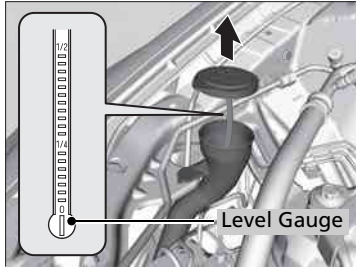

If the level is low, fill the washer reservoir.

Refilling Window Washer Fluid

NOTICE

Do not use engine antifreeze or a vinegar/water solution in the windshield washer reservoir. Antifreeze can damage your vehicle's paint. A vinegar/water solution can damage the windshield washer pump.

Headlight Bulbs

When replacing, use the following bulbs.

High beam headlight: 60 W (HB3)

Low beam headlight: 51 W (HB4)

High Beam Headlight

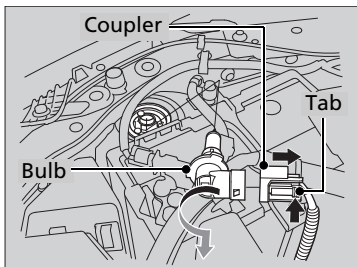

1. Remove the coupler.
 - ▶ It can be removed by pushing the tab.
2. Rotate the old bulb to the left to remove.
3. Insert a new bulb into the headlight assembly and turn it to the right.
4. Insert the coupler into the connector of the bulb.

Headlight Bulbs

NOTICE

Halogen bulbs get very hot when lit.

Oil, perspiration, or a scratch on the glass can cause the bulb to overheat and shatter.

The headlight aim is set by the factory, and does not need to be adjusted. However, if you regularly carry heavy items in the trunk or tow a trailer, have the aiming readjusted at a dealer or by a qualified technician.

The HB3 and HB4 types are halogen bulbs. When replacing a bulb, handle it by its base, and protect the glass from contact with your skin or hard objects. If you touch the glass, clean it with denatured alcohol and a clean cloth.

The exterior lights' inside lenses (headlights, brake lamps, etc.) may fog temporarily after a vehicle wash or while driving in the rain. This does not impact the exterior light function.

However, if you see a large amount of water or ice accumulated inside the lenses, have your vehicle inspected by a dealer.

Low Beam Headlights

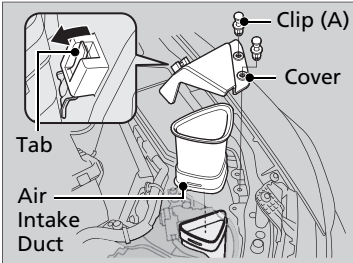

Driver side

1.8 L engine models

1. Remove the holding clips (A). Push up the tab, and remove the cover of the air intake duct and its upper part.

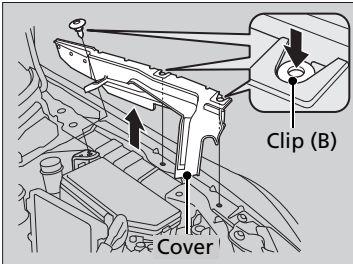

2.4 L engine models

1. Unlock the holding clips (B), then remove the cover of the air intake duct.

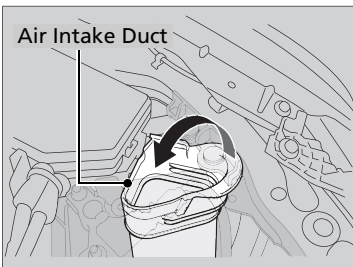

Fold in the upper part of the air intake duct to get enough working space.

Low Beam Headlights

Holding clip (A-type)

Pull the clip straight up to remove it.

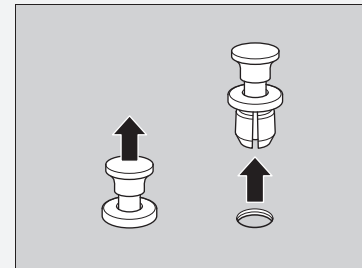

Keep the head of the clip raised when you insert it, push until it clicks.

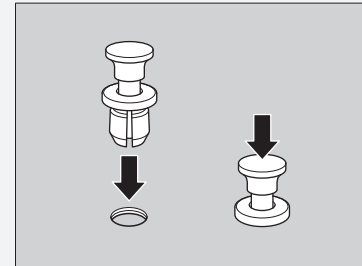

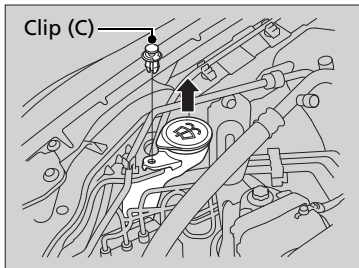

Passenger side

All models

2. Remove the holding clip (C) using a flat-tip screwdriver, then remove the upper part of the windshield washer reservoir.

▶▶ Low Beam Headlights

Holding clip (B-type)

Press down the central pin until it clicks to unlock it.

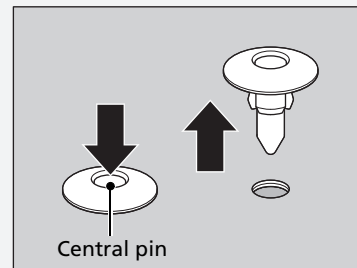

Push the central pin back to lock the clip. Then, insert the clip into the hole and press on the central pin until it is flat.

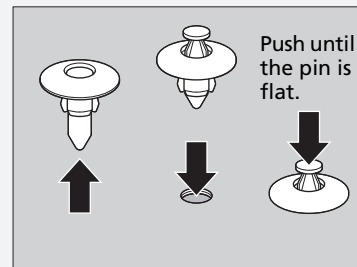

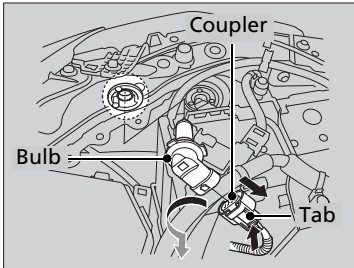

All models

3. Remove the coupler.
 - ▶ It can be removed by pushing the tab.
4. Rotate the old bulb to the left to remove.
5. Insert a new bulb into the headlight assembly and turn it to the right.
6. Insert the coupler into the connector of the bulb.

Low Beam Headlights

Holding clip (C-type)

Insert a flat-tip screwdriver, lift and remove the central pin to remove the clip.

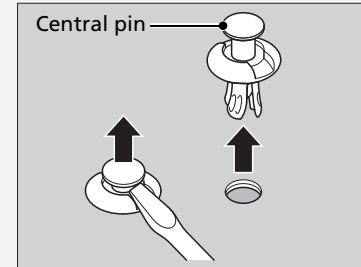

Insert the clip with the central pin raised, and push until it is flat.

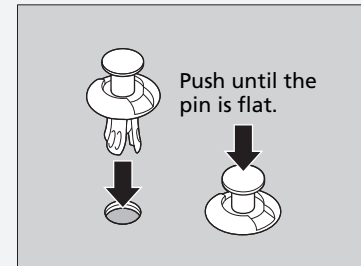

Fog Light Bulbs*

When replacing, use the following bulbs.

Fog Light: 55 W (H11)

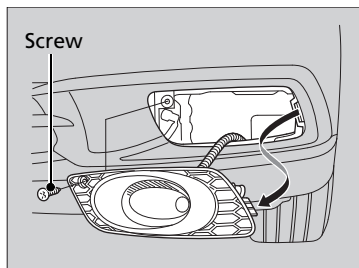

1. Remove the screw using a Phillips-head screwdriver and carefully pull the fog light assembly out of the bumper.

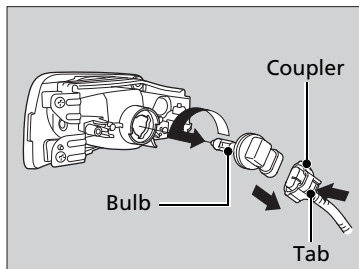

2. Remove the coupler.
 - It can be removed by pushing the tab.
3. Rotate the old bulb to the left to remove.
4. Insert a new bulb into the fog light assembly and turn it to the right.
5. Insert the coupler into the connector of the bulb.

► Fog Light Bulbs

NOTICE

Halogen bulbs get very hot when lit. Oil, perspiration, or a scratch on the glass can cause the bulb to overheat and shatter.

The fog lights are halogen bulbs.

When replacing a bulb, handle it by its plastic case, and protect the glass from contact with your skin or hard objects. If you touch the glass, clean it with denatured alcohol and a clean cloth.

Front Turn Signal/Parking/Side Marker Light Bulbs

When replacing, use the following bulbs.

Front Turn Signal/Parking/Side Marker Light: 28/8 W

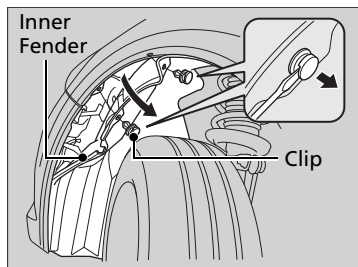

1. Turn the steering wheel all the way to the opposite side from the light being replaced.

Passenger side: Turn the steering wheel to the left.

Driver side: Turn the steering wheel to the right.

2. Remove the holding clips, and pull the inner fender back.

➤ [Low Beam Headlights P. 271](#)

2.4 l engine models

3. Detach the air intake duct tube and swing it out of the inner fender.

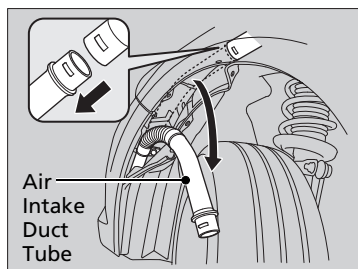

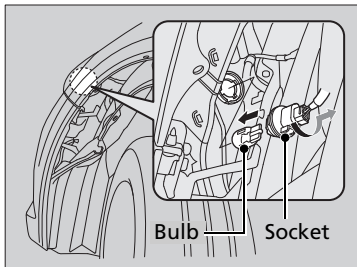

All models

4. Turn the socket to the left and remove it, then remove the old bulb.
5. Insert a new bulb.

Brake Light, Taillight, Back-Up Light, Rear Turn Signal Light and Rear Side Marker Light Bulbs

When replacing, use the following bulbs.

Brake/Taillight: 21/5 W
Back-Up Light: 21 W
Rear Turn Signal Light: 21 W (Amber)
Rear Side Marker Light: 3 CP

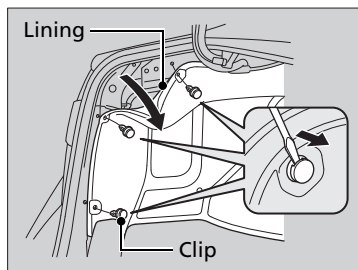

1. Remove the holding clips using a flat-tip screwdriver, then pull the lining back.

➤ [Low Beam Headlights P. 271](#)

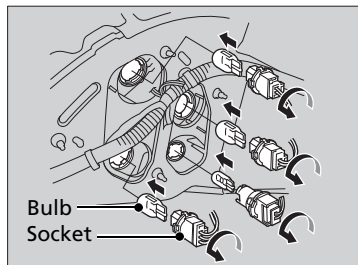

2. Turn the socket to the left and remove it. Remove the old bulb.
3. Insert a new bulb.

Rear License Plate Light Bulb

When replacing, use the following bulb.

Rear License Plate Light: 5 W

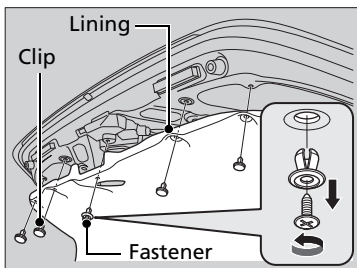

Models with trunk lid lining

1. Remove the screw from the center of the fastener using a Phillips-head screwdriver.
2. Remove the holding clips using a flat-tip screwdriver, then pull the lining back.
 - ▶ [Low Beam Headlights P. 271](#)

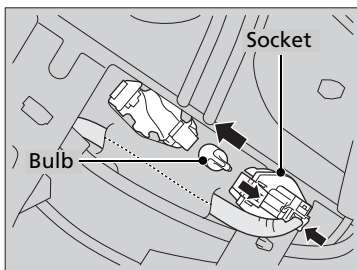

All models

3. Remove the license plate light assembly by squeezing the tabs on both sides of the socket.
4. Remove the old bulb and insert a new bulb.

High-Mount Brake Light Bulb

1.8 l engine models

When replacing, use the following bulb.

High-Mount Brake Light: 21 W

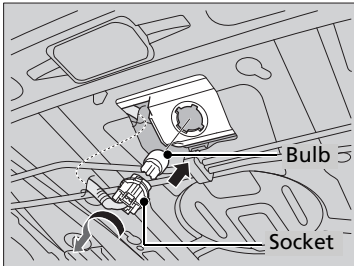

1. Open the trunk.
2. Turn the socket to the left and remove it.
3. Remove the old bulb and insert a new bulb.

2.4 l engine models

High-mount brake light bulbs are LED type. Have an authorized Honda dealer inspect and replace the light bulbs.

Checking Wiper Blades

If the wiper blade rubber has deteriorated, it will leave streaks and the metal wiper arm may scratch the window glass.

Changing the Wiper Blade Rubber

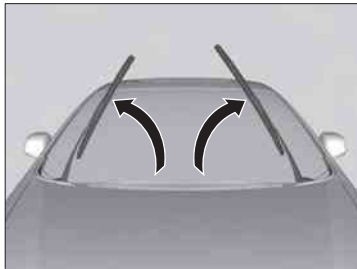

1. Lift the driver side wiper arm first, then the passenger side.

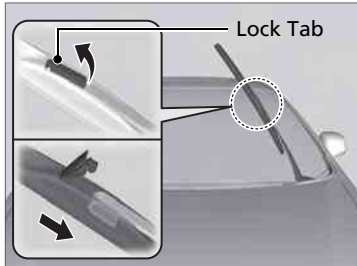

2. Place a cloth on the edge of the lock tab. Push the lock tab up with a flat-tip screw driver.
3. Slide the blade from the wiper arm.

Changing the Wiper Blade Rubber

NOTICE

Avoid dropping the wiper arm; it may damage the windshield.

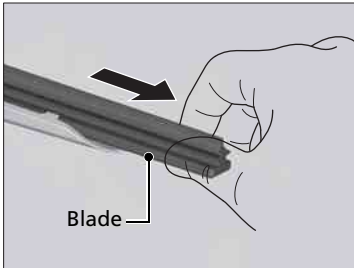

4. Slide the wiper blade out from its holder by pulling the tabbed end out.

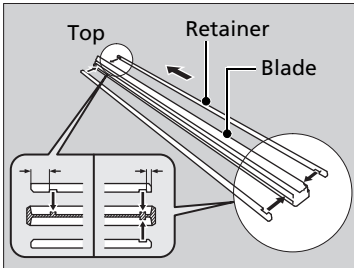

5. Remove the retainers from the rubber blade that has been removed, and mount to a new rubber blade.
▶ Correctly align the rubber protrusion and the retainer grooves.

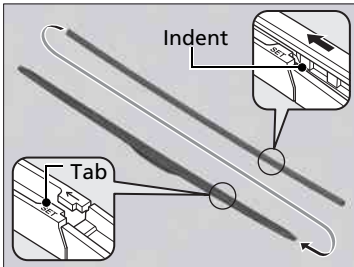

6. Slide the new wiper blade onto the holder from the bottom end.
▶ The tab on the blade should fit in the indent of the wiper blade.
7. Slide the wiper blade onto the wiper arm, then push down the lock tab.
8. Lower the passenger side wiper arm first, then the driver side.

Checking Tires

To safely operate your vehicle, your tires must be of the proper type and size, in good condition with adequate tread, and properly inflated.

■ Inflation guidelines

Properly inflated tires provide the best combination of handling, tread life, and comfort. Refer to the driver's doorjamb label or specification's page for the specified pressure.

Underinflated tires wear unevenly, adversely affect handling and fuel economy, and are more likely to fail from overheating.

Overinflated tires make your vehicle ride harshly, are more prone to road hazards, and wear unevenly.

Every day before you drive, look at each of the tires. If one looks lower than the others, check the pressure with a tire gauge.

At least once a month or before long trips, use a gauge to measure the pressure in all tires, including the spare. Even tires in good condition can lose 1 to 2 psi (10 to 20 kPa, 0.1 to 0.2 kgf/cm²) per month.

■ Inspection guidelines

Every time you check inflation, also examine the tires and valve stems. Look for:

- Bumps or bulges on the side or in the tread. Replace the tire if you find any cuts, splits, or cracks in the side of the tire. Replace it if you see fabric or cord.
- Remove any foreign objects and inspect for air leaks.
- Uneven tread wear. Have a dealer check the wheel alignment.
- Excessive tread wear.
[▶ Wear Indicators P. 285](#)
- Cracks or other damage around valve stem.

▶▶ Checking Tires

⚠ WARNING

Using tires that are excessively worn or improperly inflated can cause a crash in which you can be seriously hurt or killed.

Follow all instructions in this owner's manual regarding tire inflation and maintenance.

Measure the air pressure when tires are cold. This means the vehicle has been parked for at least three hours, or driven less than 1 mile (1.6 km). If necessary, add or release air until the specified pressure is reached.

If checked when hot, tire pressure can be as much as 4–6 psi (30–40 kPa, 0.3–0.4 kgf/cm²) higher than if checked when cold.

Have a dealer check the tires if you feel a consistent vibration while driving. New tires and any that have been removed and reinstalled should be properly balanced.

Tire and Loading Information Label

The label attached to the driver's doorjamb provides necessary tire and loading information.

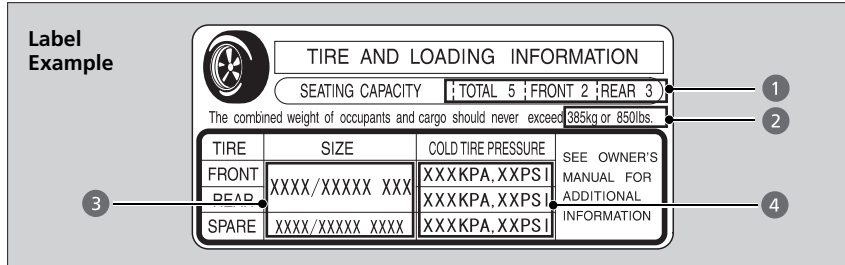

▣ Tire and Loading Information Label

The tire and loading information label attached to the driver's doorjamb contains:

- 1 The number of people your vehicle can carry.
- 2 The total weight your vehicle can carry. Do not exceed this weight.
- 3 The original tire sizes for front, rear, and spare.
- 4 The proper cold tire pressure for front, rear, and spare.

Tire Labeling

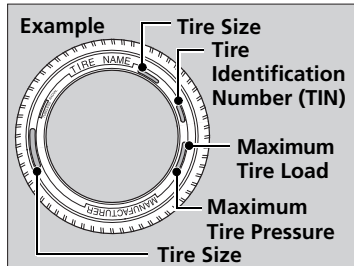

The tires that came on your vehicle have a number of markings. Those you should be aware of are described below.

▣ Tire Size

Following is an example of tire size with an explanation of what each component means.

P205/55 R16 89H

P: Vehicle type (P indicates passenger vehicle).

205: Tire width in millimeters

55: Aspect ratio (the tire's section height as a percentage of its width).

R: Tire construction code (R indicates radial).

16: Rim diameter in inches

89: Load index (a numerical code associated with the maximum load the tire can carry).

H: Speed symbol (an alphabetical code indicating the maximum speed rating).

Tire Sizes

Whenever tires are replaced, they should be replaced with tires of the same size.

Continued

■ Tire Identification Number (TIN)

The tire identification number (TIN) is a group of numbers and letters that look like the example in the side column. TIN is located on the sidewall of the tire.

■ Glossary of Tire Terminology

Cold Tire Pressure – The tire air pressure when the vehicle has been parked for at least three hours or driven less than 1 mile (1.6 km).

Load Rating – Means the maximum load that a tire is rated to carry for a given inflation pressure.

Maximum Inflation Pressure – The maximum tire air pressure that the tire can hold.

Maximum Load Rating – Means the load rating for a tire at the maximum permissible inflation pressure for that tire.

Recommended Inflation Pressure – The cold tire inflation pressure recommended by the manufacturer.

Treadwear Indicators (TWI) – Means the projections within the principal grooves designed to give a visual indication of the degrees of wear of the tread.

▶▶ Tire Identification Number (TIN)

DOT B97R FW6X 2209

DOT: This indicates that the tire meets all requirements of the U.S. Department of Transportation.

B97R: Manufacturer's identification mark.

FW6X: Tire type code.

22 09: Date of manufacture.

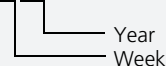

DOT Tire Quality Grading (U.S. Vehicles)

The tires on your vehicle meet all U.S. Federal Safety Requirements. All tires are also graded for treadwear, traction, and temperature performance according to Department of Transportation (DOT) standards. The following explains these gradings.

Uniform Tire Quality Grading

Quality grades can be found where applicable on the tire sidewall between tread shoulder and maximum section width.

Treadwear

The treadwear grade is a comparative rating based on the wear rate of the tire when tested under controlled conditions on a specified government test course. For example, a tire graded 150 would wear one and one-half (1 1/2) times as well on the government course as a tire graded 100. The relative performance of tires depends upon the actual conditions of their use, however, and may depart significantly from the norm due to variations in driving habits, service practices and differences in road characteristics and climate.

Uniform Tire Quality Grading

For example:

Treadwear 200

Traction AA

Temperature A

All passenger car tires must conform to Federal Safety Requirements in addition to these grades.

Traction

The traction grades, from highest to lowest, are AA, A, B, and C. Those grades represent the tire's ability to stop on wet pavement as measured under controlled conditions on specified government test surfaces of asphalt and concrete. A tire marked C may have poor traction performance.

Temperature

The temperature grades are A (the highest), B, and C, representing the tire's resistance to the generation of heat and its ability to dissipate heat when tested under controlled conditions on a specified indoor laboratory test wheel. Sustained high temperature can cause the material of the tire to degenerate and reduce tire life, and excessive temperature can lead to sudden tire failure. The grade C corresponds to a level of performance which all passenger care tires must meet under the Federal Motor Vehicle Safety Standard No. 109. Grades B and A represent higher levels of performance on the laboratory test wheel than the minimum required by law.

▶▶ Traction

Warning: The traction grade assigned to this tire is based on straight-ahead braking traction tests, and does not include acceleration, cornering, hydroplaning, or peak traction characteristics.

▶▶ Temperature

Warning: The temperature grade for this tire is established for a tire that is properly inflated and not overloaded. Excessive speed, underinflation, or excessive loading, either separately or in combination, can cause heat buildup and possible tire failure.

Wear Indicators

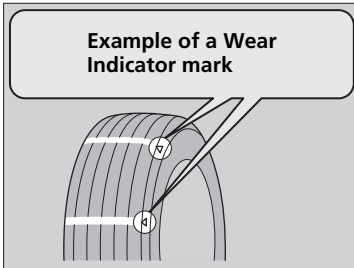

The groove where the wear indicator is located is 1/16 inch (1.6 mm) shallower than elsewhere on the tire. If the tread has worn so that the indicator is exposed, replace the tire.

Worn out tires have poor traction on wet roads.

Tire Service Life

The life of your tires is dependent on many factors, including driving habits, road conditions, vehicle loading, inflation pressure, maintenance history, speed, and environmental conditions (even when the tires are not in use).

In addition to regular inspections and inflation pressure maintenance, it is recommended that you have annual inspections performed once the tires reach five years old. All tires, including the spare, should be removed from service after 10 years from the date of manufacture, regardless of their condition or state of wear.

Checking Tires

2.4 l engine models

High speed driving

We recommend that you do not drive faster than the posted speed limits and conditions allow. If you drive at sustained high speeds (over 118 mph or 190 km/h), adjust the cold tire pressures as shown below to avoid excessive heat build up and sudden tire failure.

Tire Size	P215/45R17 87V 215/45ZR17 91W**1
Pressure	35 psi (240 kPa, 2.4 kgf/cm ²)

*1: Optional for U.S. models (summer tires)

Tire and Wheel Replacement

Replace your tires with radials of the same size, load range, speed rating, and maximum cold tire pressure rating (as shown on the tire's sidewall). Using tires of a different size or construction can cause the ABS and VSA® (vehicle stability assist) system to work incorrectly.

It is best to replace all four tires at the same time. If that isn't possible, replace the front or rear tires in pairs.

Make sure that the wheel's specifications match those of the original wheels.

U.S. models only

If you replace a wheel, only use TPMS specified wheels approved for your vehicle.

🔧 Tire and Wheel Replacement

WARNING

Installing improper tires on your vehicle can affect handling and stability. This can cause a crash in which you can be seriously hurt or killed.

Always use the size and type of tires recommended in this owner's manual.

Tire Rotation

Rotating tires according to the maintenance messages on the information display* / multi-information display* helps to distribute wear more evenly and increase tire life.

■ Tires without rotation marks

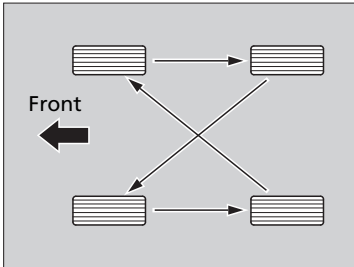

Rotate the tires as shown here.

■ Tires with rotation marks

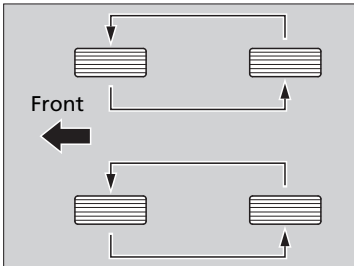

Rotate the tires as shown here.

☒ Tire Rotation

Tires with directional tread patterns should only be rotated front to back (not from one side to the other). Directional tires should be mounted with the rotation indication mark facing forward, as shown below.

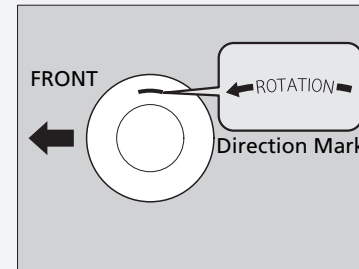

* Not available on all models

Winter Tires

If driving on snowy or frozen roads, mount all season marked "M+S" tires, snow tires, or tire chains; reduce speed; and maintain sufficient distance between vehicles when driving.

Be particularly careful when operating the steering wheel or brakes to prevent skidding.

Use tire chains, snow tires, or all season tires when necessary or according to the law.

When mounting, refer to the following points.

For winter tires:

- Select the size and load ranges that are the same as the original tires.
- Mount the tires to all four wheels.

For tire chains:

- Install them on the front tires only.
- Because your vehicle has limited tire clearance, we strongly recommend using the chains listed below:

Models with P195/65R15 tires
Cable-type: SCC Radial Chain SC1030
Models with P205/55R16 tires
Models with P215/45R17 tires
Models with 215/45ZR17 tires
Cable-type: SCC Radial Chain SC1032

- Follow the chain manufacturer's instruction when installing. Mount them as tightly as you can.
- Check that the chains do not touch the brake lines or suspension.
- Drive slowly.

Winter Tires

⚠ WARNING

Using the wrong chains, or not properly installing chains, can damage the brake lines and cause a crash in which you can be seriously injured or killed.

Follow all instructions in this owner's manual regarding the selection and use of tire chains.

NOTICE

Traction devices that are the wrong size or improperly installed can damage your vehicle's brake lines, suspension, body, and wheels. Stop driving if they are hitting any part of the vehicle.

When tire chains are mounted, follow the chain manufacturer's instructions regarding vehicle operational limits.

If your vehicle is equipped with summer tires, be aware that these tires are not designed for winter driving conditions. For more information, contact a dealer.

Checking the Battery

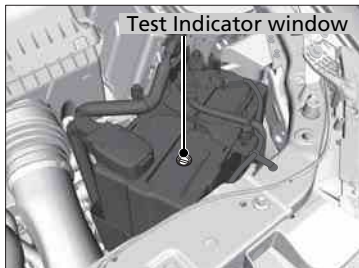

Check the battery condition monthly. Look at the test indicator window and check the terminals for corrosion.

If your vehicle's battery is disconnected or goes dead:

- The audio system* is disabled.
➤ [Reactivating the audio system P. 146](#)
- The clock resets.
➤ [Setting the Clock P. 98](#)
- The navigation system* is disabled.
➤ [Refer to the navigation system manual](#)

Charging the Battery

Disconnect both battery cables to prevent damaging your vehicle's electrical system. Always disconnect the negative (–) cable first, and reconnect it last.

Battery

⚠ WARNING

The battery gives off explosive hydrogen gas during normal operation.

A spark or flame can cause the battery to explode with enough force to kill or seriously hurt you.

When conducting any battery maintenance, wear protective clothing and a face shield, or have a skilled technician do it.

WARNING: Battery post, terminals, and related accessories contain lead and lead compounds.
Wash your hands after handling.

The test indicator's color information is on the battery.

When you find corrosion, clean the battery terminals by applying a baking powder and water solution. Rinse the terminals with water. Cloth/towel dry the battery. Coat the terminals with grease to help prevent future corrosion.

* Not available on all models

Replacing the Battery

If the indicator does not come on when the button is pressed, replace the battery.

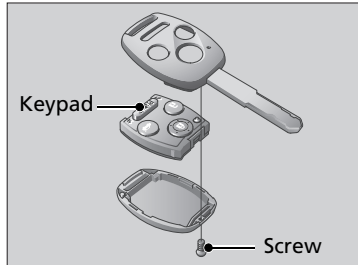

Battery type: CR1616

1. Unscrew the cover with a small Phillips-head screwdriver. Press a button to pry open the transmitter.
2. Open the keypad.
 - ▶ Separate the inner cover from the keypad by releasing the two tabs on the cover.
3. Make sure to replace the battery with the correct polarity.

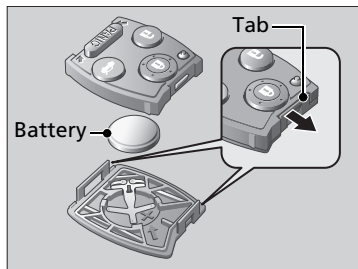

Replacing the Battery

NOTICE

An improperly disposed of battery can damage the environment. Always confirm local regulations for battery disposal.

Replacement batteries are commercially available or at a dealer.

Dust and Pollen Filter*

The heating and cooling system is equipped with a dust and pollen filter that collects pollen, dust, and other debris in the air. The Maintenance Minder™ messages will let you know when to replace the filter.

We recommend that you replace the dust and pollen filter sooner when using your vehicle in areas with high concentrations of dust.

☒ Dust and Pollen Filter

If the airflow from the heating and cooling system deteriorates noticeably, and the windows fog up easily, the filter may need to be replaced. Please contact a dealer for replacement.

* Not available on all models

Interior Care

Use a damp cloth with a mixture of mild detergent and warm water to remove dirt. Use a clean cloth to remove detergent residue.

Cleaning Seat Belts

Use a soft brush with a mixture of mild soap and warm water to clean the seat belts. Let the belts air dry. Wipe the openings of the seat belt anchors using a clean cloth.

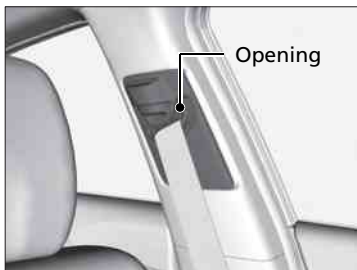

Interior Care

Do not spill liquids inside the vehicle. Electrical devices and systems may malfunction if liquids are splashed on them.

Do not use silicone based sprays on electrical devices such as audio devices and switches. Doing so may cause the items to malfunction or a fire inside the vehicle.

If a silicone based spray is inadvertently used on electrical devices, consult a dealer.

Depending on their composition, chemicals and liquid aromatics may cause discoloration, wrinkles, and cracking to resin-based parts and textiles. Do not use alkali solvents or organic solvents such as benzene or gasoline.

After using chemicals, make sure to gently wipe them off using a dry cloth.

Do not place used cloths on top of resin based parts or textiles for long periods of time without washing.

■ Floor Mats*

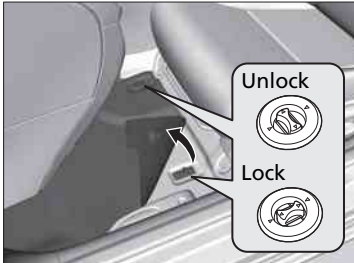

The driver's floor mat hooks over the floor anchors, which keep the mat from sliding forward. To remove a mat for cleaning, turn the anchor knobs to the unlock position. When reinstalling the mat after cleaning, turn the knobs to the lock position.

Do not put additional floor mats on top of the anchored mat.

■ Maintaining Genuine Leather*

Vacuum dirt and dust from the leather frequently. Pay close attention to the pleats and seams. Clean the leather with a soft cloth dampened with a 90% water and 10% neutral soap solution. Then buff it with a clean, dry cloth. Remove any dust or dirt on leather surfaces immediately.

▣ Floor Mats

If you use any floor mats that were not originally provided with your vehicle, make sure they are designed for your specific vehicle, fit correctly, and are securely anchored by the floor anchors. Position the rear seat floor mats properly. If they are not properly positioned, the floor mats can interfere with the front seat functions.

* Not available on all models

Exterior Care

Dust off the vehicle body after you drive.

Regularly inspect your vehicle for scratches on painted surfaces. A scratch on a painted surface can result in body rust. If you find a scratch, promptly repair it.

■ Washing the Vehicle

Wash the vehicle regularly. Wash more frequently when driving in the following conditions:

- If driving on roads with road salt.
- If driving in coastal areas.
- If tar, soot, bird droppings, insects, or tree sap are stuck to painted surfaces.

■ Using an Automated Vehicle Wash

Fold in the door mirrors. Make sure to follow the instructions indicated on the automated vehicle wash.

■ Using High Pressure Cleaners

- Keep sufficient distance between the cleaning nozzle and the vehicle body.
- Take particular care around the windows. Standing too close may cause water to enter the vehicle interior. Do not spray water into the engine compartment.

▶▶ Washing the Vehicle

Do not spray water into the air intake vents or engine compartment. It can cause a malfunction.



Air Intake Vents

■ Applying Wax

A good coat of automotive body wax helps protect your vehicle's paint from the elements. Wax will wear off over time and expose your vehicle's paint to the elements, so reapply as necessary.

■ Maintaining the Bumpers and Other Resin Coated Parts

If you get gasoline, oil, engine coolant, or battery fluid on resin coated parts, they may be stained or the coating may peel. Promptly wipe it away using a soft cloth and clean water.

■ Cleaning the Window

Wipe using a glass cleaner.

■ Maintaining Aluminum Wheels*

Aluminum is susceptible to deterioration caused by salt and other road contaminants. Use a sponge and mild detergent to wipe away promptly. Be careful not to use harsh chemicals (including some commercial wheel cleaners) or a stiff brush. They can damage the clear coat of the aluminum alloy wheels that helps keep the aluminum from corroding and tarnishing.

☒ Applying Wax

NOTICE

Chemical solvents and strong cleaners can damage the paint, metal, and plastic on your vehicle. Wipe up spills immediately.

☒ Maintaining the Bumpers and Other Resin Coated Parts

Ask a dealer about the correct coating material when you want to repair the painted surface of the parts made of resin.

☒ Cleaning the Window

Wires are mounted to the inside of the rear window. Wipe along the same direction as the wires with a soft cloth so as not to damage them.

* Not available on all models

QRG

TOC

Maintenance

Index

Home

Handling the Unexpected

This chapter explains how to handle unexpected troubles.

- Tools**
- Types of Tools 298
- If a Tire Goes Flat**
- Changing a Flat Tire 299
- Engine Does Not Start**
- Checking the Engine 306
- Jump Starting** 307
- Shift Lever Does Not Move** 310
- Overheating**
- How to Handle Overheating 311

- Indicator, Coming On/Blinking**
- If the Low Oil Pressure Indicator Comes On 313
- If the Charging System Indicator Comes On 313
- If the Malfunction Indicator Lamp Comes On or Blinks 314
- If the Brake System Indicator Comes On 315
- If the EPS Indicator Comes On 315
- If the Low Tire Pressure Indicator Come On 316
- If the TPMS Indicator Comes On 316

- If the Low Tire Pressure/TPMS Indicator Comes On or Blinks 317
- Fuses**
- Fuse Locations 318
- Inspecting and Changing Fuses 320
- Emergency Towing** 321

Types of Tools

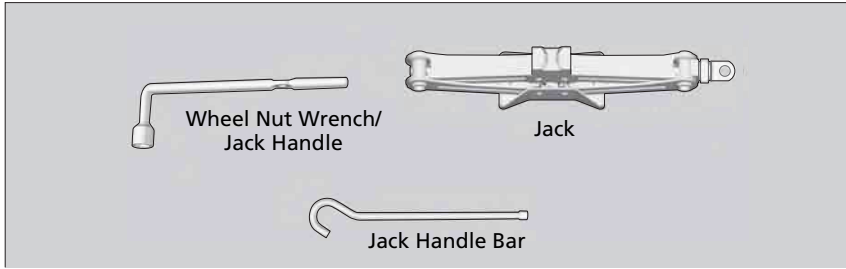

Types of Tools

[▶ How to Set Up the Jack P. 302](#)

Changing a Flat Tire

If a tire goes flat while driving, grasp the steering wheel firmly, and brake gradually to reduce speed. Then, stop in a safe place. Replace the flat tire with a compact spare tire. Go to a dealer as soon as possible to have the full size tire repaired or replaced.

1. Park the vehicle on firm, level, and non-slippery ground.

Automatic transmission models

2. Put the shift lever in **P**.

Manual transmission models

2. Put the shift lever in **R**.

All models

3. Set the parking brake.
4. Turn on the hazard warning lights and turn the ignition switch to LOCK **0**.

Changing a Flat Tire

Periodically check the tire pressure of the compact spare. It should be set to the specified pressure. Specified Pressure: 60 psi (420 kPa, 4.2 kgf/cm²)

When driving with the compact spare tire, keep the vehicle speed under 50 mph (80 km/h). Replace with a full size tire as soon as possible.

The compact spare tire and wheel in your vehicle are specifically for this model.

Do not use them with another vehicle.

Do not use another type of compact spare tire or wheel with your vehicle.

Do not mount tire chains on a compact spare tire. If a chain-mounted front tire goes flat, remove one of the full-size rear tires and replace it with the compact spare tire. Remove the flat front tire and replace it with the full size tire that was removed from the rear. Mount the tire chains on the front tire.

U.S. models only

Do not use a puncture-repairing agent on a flat tire, as it can damage the tire pressure sensor.

Getting Ready to Replace the Flat Tire



1. Open the trunk floor lid.



2. Take the tool case out of the trunk. Take the jack and wheel nut wrench out of the tool case.
3. Unscrew the wing bolt, and remove the spacer cone. Then, remove the spare tire.

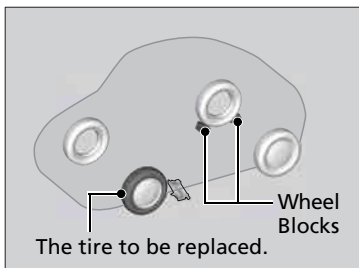

4. Place a wheel block or rock in front and rear of the wheel diagonal to the flat tire.

Getting Ready to Replace the Flat Tire

2.4 l engine models

NOTICE

Do not mount the compact spare on the front. If mounted on the front, the compact spare, smaller in size than the normal tire, may damage the differential.

If either front tire goes flat, remove the rear tire on the same side, and mount the compact spare on the rear and the rear tire on the front.

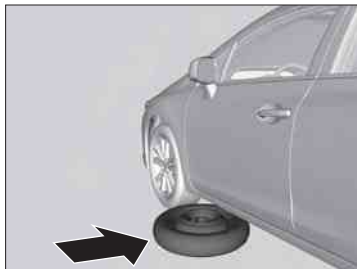

5. Place the compact spare tire (wheel side up) under the vehicle body, near the tire that needs to be replaced.

Models with 15 x 6J aluminum wheels

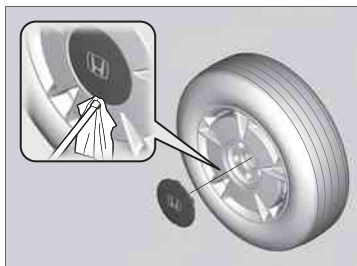

6. Remove the center cap from the wheel with the jack handle bar.

All models



7. Loosen each wheel nut about one turn using the wheel nut wrench.

How to Set Up the Jack

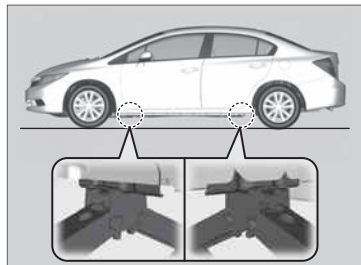

1. Place the jack under the jacking point closest to the tire to be changed.



2. Turn the end bracket (as shown in the image) clockwise until the top of the jack contacts the jacking point.
 ▶ Make sure that the jacking point tab is resting in the jack notch.

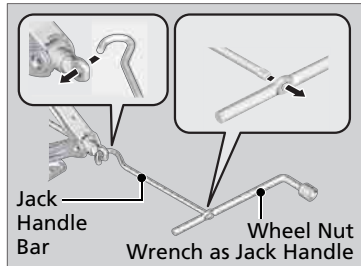

3. Raise the vehicle, using the jack handle bar and the jack handle, until the tire is off the ground.

How to Set Up the Jack

⚠ WARNING

The vehicle can easily roll off the jack, seriously injuring anyone underneath.

Follow the directions for changing a tire exactly, and never get under the vehicle when it is supported only by the jack.

Do not use the jack with people or luggage in the vehicle.

Use the jack provided in your vehicle. Other jacks may not support the weight ("load") or their shape may not match.

The following instructions must be followed to use the jack safely.

- Do not use while the engine is running.
- Use only where the ground is firm and level.
- Use only at the jacking points.
- Do not get in the vehicle while using the jack.
- Do not put anything on top of or underneath the jack.

Replacing the Flat Tire

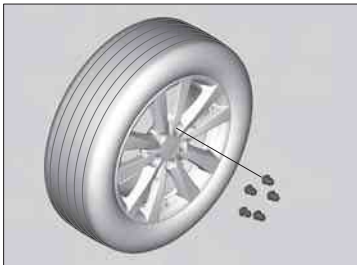

Models with aluminum wheels

1. Remove the wheel nuts and flat tire.

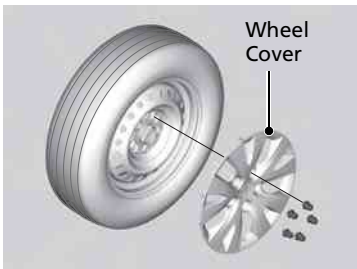

Models with wheel cover

1. Remove the wheel nuts, wheel cover, and flat tire.

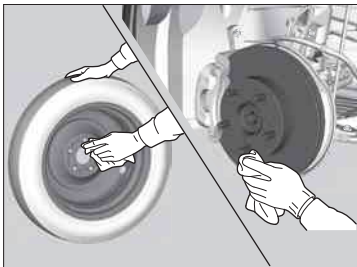

All models

2. Wipe the mounting surfaces of the wheel with a clean cloth.
3. Mount the compact spare tire.
4. Screw the wheel nuts until they touch the lips around the mounting holes, and stop rotating.

Replacing the Flat Tire

Do not over tighten the wheel nuts by applying extra torque using your foot or a pipe.

Models with wheel cover

Do not attempt to forcibly pry the wheel cover off with a screwdriver or other tool. The wheel cover cannot be removed without first removing the wheel nuts.

Continued

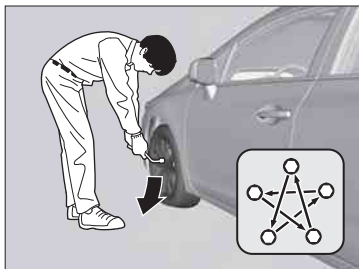

- Lower the vehicle and remove the jack. Tighten the wheel nuts in the order indicated in the image. Go around, tightening the nuts, two to three times in this order.

Wheel nut torque:

80 lbf-ft (108 N-m, 11 kgf-m)

Storing the Flat Tire

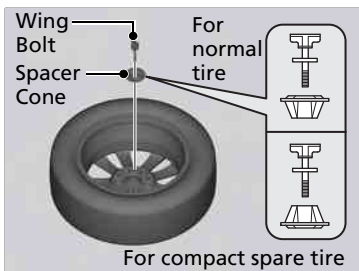

Models with aluminum wheels

- Remove the center cap.
- Place the flat tire face down in the spare tire well.
- Remove the spacer cone from the wing bolt, flip it over, and insert it back on the bolt. Secure the flat tire with the wing bolt.
- Securely put the jack and wheel nut wrench back in the tool case. Store the case in the trunk.

All models

▶▶ Storing the Flat Tire

WARNING

Loose items can fly around the interior in a crash and can seriously injure the occupants. Store the wheel, jack, and tools securely before driving.

TPMS and the Spare Tire

U.S. models with information display

If you replace a flat tire with the spare tire, the low tire pressure indicator comes on while you are driving. After driving for a few miles (kilometers), the indicator will go off and the TPMS indicator comes on, but this is normal.

If you replace the tire with a specified regular tire, the low tire pressure or TPMS indicator will go off after a few miles (kilometers).

U.S. models with multi-information display

If you replace a flat tire with the spare tire, the low tire pressure/TPMS indicator comes on while you are driving. After driving for a few miles (kilometers), the indicator will start blinking for a short time and then stay on. "CHECK TPMS SYSTEM" appears on the multi-information display, but this is normal.

If you replace the tire with a specified regular tire, the warning message on the multi-information display and the TPMS indicator will go off after a few miles (kilometers).

TPMS and the Spare Tire

The system cannot monitor the pressure of the spare tire. Manually check the spare tire pressure to be sure that it is correct.

Use TPMS specific wheels. Each is equipped with a tire pressure sensor mounted inside the tire behind the valve stem.

Checking the Engine

If the engine does not start, turn the ignition switch to START  and check the starter.

Checking the Engine

If you must start the vehicle immediately, use an assisting vehicle to jump start it.

[Jump Starting P. 307](#)

Starter condition

Checklist

Starter doesn't turn or turns over slowly.

The battery may be dead. Check each of the items on the right and respond accordingly.

The starter turns over normally but the engine doesn't start.

There may be a problem with the fuse. Check each of the items on the right and respond accordingly.

Check brightness of the interior light.

Turn on interior lights and check brightness.

- If the interior lights are dim or do not come on at all
[Battery P. 289](#)
- If the interior lights come on normally [Fuses P. 318](#)

Review the engine start procedure.

Follow its instructions, and try to start the engine again. [Starting the Engine P. 211](#)

Check the immobilizer system indicator.

When the immobilizer system indicator is blinking, the engine cannot be started.

[Immobilizer System P. 112](#)

Check the fuel level.

There should be enough fuel in the tank. [Fuel Gauge P. 78](#)

Check the fuse.

Check all fuses, or have the vehicle checked by a dealer.

[Inspecting and Changing Fuses P. 320](#)

If the problem continues:

[Emergency Towing P. 321](#)

Jump Starting Procedure

Turn off the power to electric devices, such as audio and lights. Turn off the engine, then open the hood.

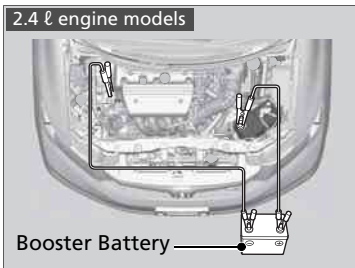
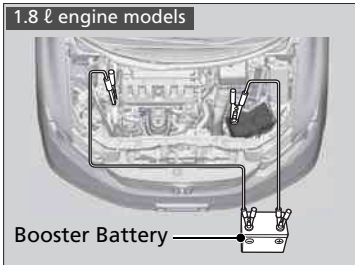

1. Connect the first jumper cable to your vehicle's battery ⊕ terminal.
2. Connect the other end of the first jumper cable to the assisting vehicle's ⊕ terminal.
▶ Use a 12-volt booster battery only.
3. Connect the second jumper cable to the assisting vehicle's ⊖ terminal.

Jump Starting

⚠ WARNING

A battery can explode if you do not follow the correct procedure, seriously injuring anyone nearby.

Keep all sparks, open flames, and smoking materials away from the battery.

Securely attach the jumper cables clips so that they do not come off when the engine vibrates. Also be careful not to tangle the jumper cables or allow the cable ends to touch each other while attaching or detaching the jumper cables.

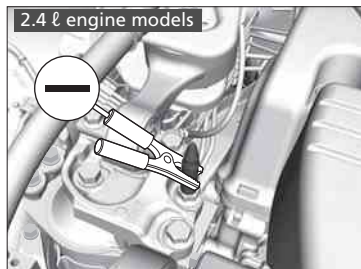
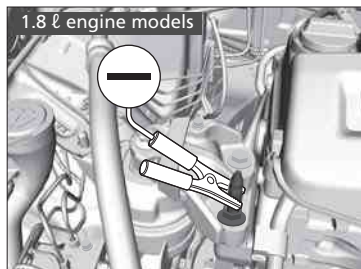

4. Connect the other end of the second jumper cable to the engine mounting bolt as shown. Do not connect this jumper cable to any other part.
5. If your vehicle is connected to another vehicle, start the assisting vehicle's engine and increase its rpm slightly.
6. Attempt to start your vehicle's engine. If it turns over slowly, check that the jumper cables have good metal-to-metal contact.

▶▶ Jump Starting

Battery performance degrades in cold conditions and may prevent the engine from starting.

What to Do After the Engine Starts

Once your vehicle's engine has started, remove the jumper cables in the following order.

1. Disconnect the jumper cable from your vehicle's ground.
2. Disconnect the other end of the jumper cable from the assisting vehicle's battery \ominus terminal.
3. Disconnect the jumper cable from your vehicle's battery \oplus terminal.
4. Disconnect the other end of the jumper cable from the assisting vehicle's battery \oplus terminal.

Have your vehicle inspected by a nearby service station or a dealer.

Automatic transmission models

Follow the procedure below if you cannot move the shift lever out of the **P** position.

Releasing the Lock

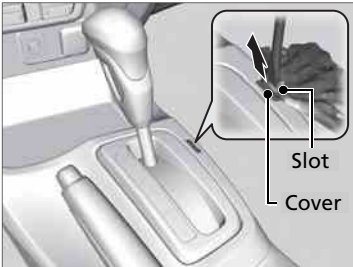

1. Set the parking brake.
2. Remove the key from the ignition switch.
3. Wrap a cloth around the tip of a small flat-tip screwdriver and remove the cover of the shift lock release slot.
 - ▶ Put the tip of the flat-tip screwdriver into the slot and remove it as shown in the image.

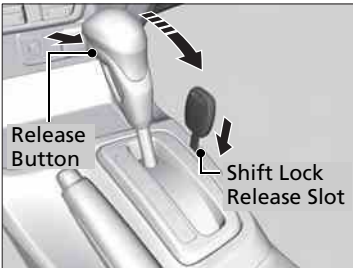

4. Insert the key into the shift lock release slot.
5. While pushing on the key, press the shift lever release button and place the shift lever into **N**.
 - ▶ The lock is now released. Have the shift lever checked by a dealer as soon as possible.

How to Handle Overheating

Overheating symptoms are as follows:

- The high temperature indicator comes on or the engine suddenly loses power.
- Steam is coming out of the engine compartment.

■ First thing to do

1. Immediately park the vehicle in a safe place.

Automatic transmission models

- ▶ Move the shift lever to **P** and set the parking brake. Turn off all accessories and turn on the hazard warning lights.

Manual transmission models

- ▶ Move the shift lever to **N** and set the parking brake. Turn off all accessories and turn on the hazard warning lights.

2. **No steam coming out:** Keep the engine running and open the hood.

Steam coming out: Turn off the engine and wait until steam goes away. Then, open the hood.

How to Handle Overheating

⚠ WARNING

Steam and spray from an overheated engine can seriously scald you.

Do not open the hood if steam is coming out.

NOTICE

Continuing to drive with the high temperature indicator on may damage the engine.

■ Next thing to do

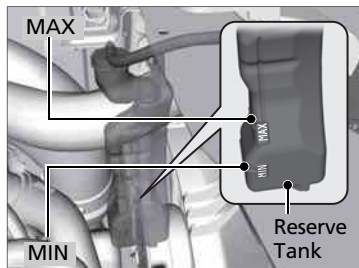

1. Check that the cooling fan is operating and stop the engine once the high temperature indicator goes off.
 - If the cooling fan is not operating, immediately stop the engine.
2. Once the engine has cooled down, inspect the coolant level and check the cooling system components for leaks.
 - If the coolant level in the reserve tank is low, add coolant until it reaches the MAX mark.
 - If there is no coolant in the reserve tank, check that the radiator is cool. Cover the radiator cap with a heavy cloth and open the cap. If necessary, add coolant up to the base of the filler neck, and put the cap back on.

■ Last thing to do

Once the engine has cooled sufficiently, restart it and check the high temperature indicator.

If the high temperature indicator is off, resume driving. If it stays on, contact a dealer for repairs.

►► How to Handle Overheating

⚠ WARNING

Removing the radiator cap while the engine is hot can cause the coolant to spray out, seriously scalding you.

Always let the engine and radiator cool down before removing the radiator cap.

If the coolant is leaking, contact a dealer for repairs.

Use water as an emergency/temporary measure only. Have a dealer flush the system with proper antifreeze as soon as possible.

If the Low Oil Pressure Indicator Comes On



■ Reasons for the indicator to come on

Comes on when the engine oil pressure is low.

■ What to do as soon as the indicator comes on

1. Immediately park the vehicle in a safe place.
2. If necessary, turn the hazard warning lights on.

■ What to do after parking the vehicle

1. Stop the engine and let it sit for about one minute.
2. Open the hood and check the oil level.
 - ▶ Add oil as necessary.
3. Start the engine and check the low oil pressure indicator.
 - ▶ The light goes out: Start driving again.
 - ▶ The light does not go out within 10 seconds: Stop the engine and contact a dealer for repairs immediately.

If the Charging System Indicator Comes On



■ Reasons for the indicator to come on

Comes on when the battery is not being charged.

■ What to do when the indicator comes on

Turn off the heating and cooling* system, rear defogger, and other electrical systems, and immediately contact a dealer for repairs.

☒ If the Low Oil Pressure Indicator Comes On

NOTICE

Running the engine with low oil pressure can cause serious mechanical damage almost immediately.

☒ If the Charging System Indicator Comes On

If you need to stop temporarily, do not turn off the engine. Restarting the engine may rapidly discharge the battery.

* Not available on all models

If the Malfunction Indicator Lamp Comes On or Blinks



■ Reasons for indicator lamp to come on or blink

- Comes on when there is a problem with the engine emissions control system, or the fuel fill cap is missing, or loose.
- Blinks when engine misfiring is detected.

■ What to do when the indicator lamp comes on

Avoid high speeds and immediately get your vehicle inspected at a dealer.

■ What to do when the indicator lamp blinks

Park the vehicle in a safe place with no flammable items and wait at least ten minutes or more with the engine stopped until it cools.

■ Check/Tighten Fuel Cap Message

■ The message appears on when:

An evaporative system leak is detected. This may be caused by the fuel fill cap being loose or not being installed.

■ What to do when the message appears:

1. Stop the engine.
2. Check that the fuel fill cap is fully installed.
 - ▶ If not, loosen the cap, and then retighten it until it clicks at least once.
3. Drive for several days of normal driving.
 - ▶ The message should go off.

■ When the malfunction indicator lamp comes on

Malfunction indicator lamp comes on if the system continues to detect a leak of gasoline vapor. If this happens, check the fuel fill cap using the procedures described above.

▶▶ If the Malfunction Indicator Lamp Comes On or Blinks

NOTICE

If you drive with the malfunction indicator lamp on, the emissions control system and the engine could be damaged.

If the malfunction indicator lamp blinks again when restarting the engine, drive to the nearest dealer at 31 mph (50 km/h) or less. Have your vehicle inspected.

If the Brake System Indicator Comes On



■ Reasons for the indicator to come on

- The brake fluid is low.
- There is a malfunction in the brake system.



■ What to do when the indicator comes on while driving

Press the brake pedal lightly to check pedal pressure.

- If normal, check the brake fluid level the next time you stop.
- If abnormal, take immediate action. If necessary, downshift the transmission to slow the vehicle using engine braking.

If the EPS Indicator Comes On



■ Reasons for the indicator to come on

- Comes on when there is a problem with EPS.
- If you depress the accelerator pedal repeatedly to increase the engine speed while the engine is idling, the indicator comes on, and sometimes the steering wheel becomes harder to operate.

■ What to do when the indicator comes on

Stop the vehicle in a safe place and restart the engine.

If the indicator comes on and stays on, immediately have your vehicle inspected by a dealer.

▶▶ If the Brake System Indicator Comes On

Have your vehicle repaired immediately.

It is dangerous to drive with low brake fluid. If there is no resistance from the brake pedal, stop immediately in a safe place. If necessary downshift the gears.

If the brake system indicator and ABS indicator come on simultaneously, the electronic brake distribution system is not working. This can result in vehicle instability under sudden braking. Have your vehicle inspected by a dealer immediately.

▶▶ If the EPS Indicator Comes On

NOTICE

If you repeatedly turn the steering wheel at an extremely low speed, or hold the steering wheel on the full left or right position for a while, the system heats up. The system goes into a protective mode, and limits its performance. The steering wheel becomes harder and harder to operate. Once the system cools down, EPS is restored. Repeated operation under these conditions can eventually damage the system.

U.S. models with information display

If the Low Tire Pressure Indicator Comes On



■ Reasons for the indicator to come on

A tire pressure is significantly low. If the compact spare tire is installed, the indicator stays on for a while, and then goes off.

■ What to do when the indicator comes on

Stop your vehicle in a safe place. Check the tire pressure and adjust the pressure to the specified level. The specified tire pressure is on a label on the driver side doorjamb.

U.S. models with information display

If the TPMS Indicator Comes On



■ Reasons for the indicator to come on

- Comes on when there is a problem with the TPMS.
- If the compact spare is installed, the indicator comes on after driving for a few miles (kilometers).

■ What to do when the indicator comes on

Have the tire inspected by a dealer as soon as possible. If the compact spare tire has triggered the indicator to come on, change the tire to a full size tire. The indicator goes off after a while.

▶▶ If the Low Tire Pressure Indicator Comes On

NOTICE

Driving on an extremely underinflated tire can cause it to overheat. An overheated tire can fail. Always inflate your tires to the prescribed level.

U.S. models with multi-information display

If the Low Tire Pressure/TPMS Indicator Comes On or Blinks



■ Reasons for the indicator to come on or blink

A tire pressure is significantly low. If there is a problem with the TPMS or the compact spare tire is installed, the indicator blinks for about one minute, and then stays on.

■ What to do when the indicator comes on

Stop your vehicle in a safe place. Check the tire pressure and adjust the pressure to the specified level. The specified tire pressure is on a label on the driver side doorjamb.

■ What to do when the indicator blinks

Have the tire inspected by a dealer as soon as possible. If the compact spare tire has triggered the indicator to blink, change the tire to a full size tire. The indicator goes off after a while.

▶ If the Low Tire Pressure/TPMS Indicator Comes On or Blinks

NOTICE

Driving on an extremely underinflated tire can cause it to overheat. An overheated tire can fail. Always inflate your tires to the prescribed level.

Fuse Locations

If any electrical devices are not working, turn the ignition switch to LOCK **0** and check to see if any applicable fuse is blown.

Fuse locations are shown on the fuse box cover. Locate the fuse in question by the fuse number and box cover number.

Engine Compartment Fuse Box

Located near the brake fluid reservoir. Push the tabs to open the box.

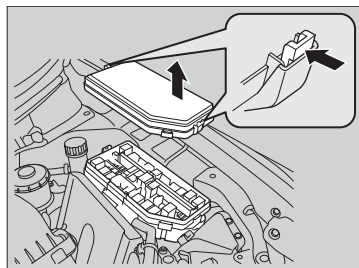

■ Circuit protected and fuse rating

	Circuit Protected	Amps
1	EPS	70 A
	–	–
	ABS/VSA Motor	30 A
	ABS/VSA FSR	30 A
	–	–
	Main Fuse	100 A
	IG Main	50 A
2	Fuse Box Main	60 A
	Fuse Box Main 2	60 A
	Headlight Main	30 A
	–	–
	Rear Defogger	30 A
	–	–
	Blower	40 A
3	–	–
	Sub Fan Motor	20 A
	Main Fan Motor	20 A
	–	–
4	Left Headlight Low Beam	10 A
5	Starter DIAG, ST MG	7.5 A
6	Right Headlight Low Beam	10 A
7	–	–
8	–	–
9	–	–
10	–	–

	Circuit Protected	Amps
11	Oil Level	7.5 A
12	Fog Lights*	(20 A)
13	Driver's Power Seat Sliding*	(20 A)
14	Hazard	10 A
15	FI Sub	15 A
16	IG Coil	15 A
17	Stop	15 A
18	Horn	10 A
19	Premium Amp*	(20 A)
20	INJ	(15 A)
21	IGP	15 A
22	DBW	15 A
23	H/L LO	20 A
24	Driver's Power Seat Reclining*	(20 A)
25	MG Clutch	7.5 A
26	–	–
27	SMALL	20 A
28	Interior Lights	7.5 A
29	Backup	10 A

Interior Fuse Box

Located under the dashboard.

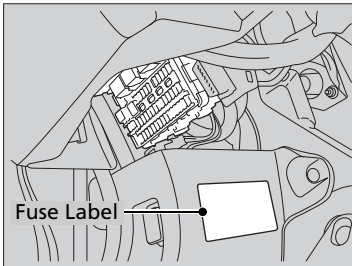

Fuse locations are shown on the label on the side panel.

Locate the fuse in question by the fuse number and label number.

■ Circuit protected and fuse rating

	Circuit Protected	Amps
1	–	–
2	ACG	15 A
3	SRS	10 A
4	Fuel Pump	15 A
5	Meter	7.5 A
6	Power Window	7.5 A
7	VB SOL*	(15 A)
8	Door Lock Motor 2 (Unlock)	15 A
9	Door Lock Motor 1 (Unlock)	15 A

	Circuit Protected	Amps
10	–	–
11	Moonroof*	(20 A)
12	Accessory Power Socket (Center Console)*	(15 A)
13	–	–
14	Seat Heaters*	(15 A)
15	Driver's Door Lock Motor (Unlock)*	(10 A)
16	–	–
17	–	–
18	–	–
19	ACC	7.5 A
20	ACC Key Lock	7.5 A
21	Daytime Running Lights	7.5 A
22	HAC	7.5 A
23	–	–
24	ABS/VSA	7.5 A
25	–	–
26	–	–
27	Accessory Power Socket (Front)	15 A
28	Washer	15 A
29	ODS	7.5 A
30	Driver's Door Lock Motor (Lock)*	(10 A)
31	–	–
32	Door Lock Motor 2 (Lock)	15 A

	Circuit Protected	Amps
33	Door Lock Motor 1 (Lock)	15 A
34	Small Lights	7.5 A
35	Illumination	7.5 A
36	–	–
37	–	–
38	Left Headlight High Beam	10 A
39	Right Headlight High Beam	10 A
40	TPMS*	(7.5 A)
41	Door Lock	20 A
42	Driver's Power Window	20 A
43	Rear Passenger's Side Power Window	(20 A)
44	Front Passenger's Side Power Window	20 A
45	Rear Driver's Side Power Window	(20 A)
46	Wiper	30 A

* Not available on all models

Inspecting and Changing Fuses

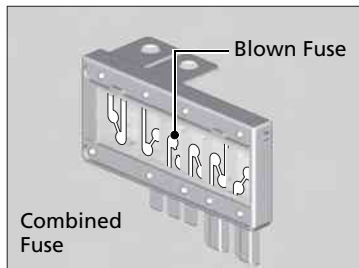

1. Turn the ignition switch to LOCK [0]. Turn headlights and all accessories off.
2. Remove the fuse box cover.
3. Check the large fuse in the engine compartment.
 - If the fuse is blown, use a Phillips-head screwdriver to remove the screw and replace it with a new one.
4. Inspect the small fuses in the engine compartment and the vehicle interior.
 - If there is a burned out fuse, remove it with the fuse puller and replace it with a new one.

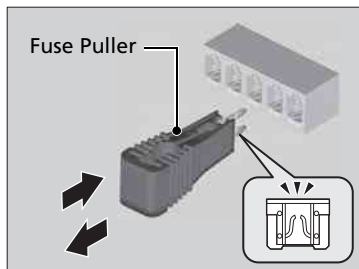

Inspecting and Changing Fuses

NOTICE

Replacing a fuse with one that has a higher rating greatly increases the chances of damaging the electrical system.

Replace fuse with a spare fuse of the same specified amperage.

Confirm the specified amperage using the charts on P. 318 to 319.

There is a fuse puller on the back of the engine compartment fuse box cover.

Call a professional towing service if you need to tow your vehicle.

■ Flat bed equipment

The operator loads your vehicle on the back of a truck.

This is the best way to transport your vehicle.

■ Wheel lift equipment

The tow truck uses two pivoting arms that go under the front tires and lift them off the ground. The rear tires remain on the ground. **This is an acceptable way to**

tow your vehicle.

☒ Emergency Towing

NOTICE

Trying to lift or tow your vehicle by the bumpers will cause serious damage. The bumpers are not designed to support the vehicle's weight.

NOTICE

Improper towing such as towing behind a motorhome or other motor vehicle can damage the transmission.

Never tow your vehicle with just a rope or chain. It is very dangerous, since ropes or chains may shift from side to side or break.

QRG

Handling the Unexpected

TOC

Index

Home

Information

This chapter includes your vehicle's specifications, locations of identification numbers, and other information required by regulation.



Specifications	324	Emissions Testing	
Identification Numbers		Testing of Readiness Codes.....	331
Vehicle Identification Number (VIN).....	328	Warranty Coverages	333
Engine Number and Transmission		Authorized Manuals	335
Number.....	328	Customer Service Information	336
Devices that Emit Radio Waves	329		
Reporting Safety Defects	330		

1.8 ℓ engine models

Vehicle Specifications

Model	Honda Civic 4-Door
No. of Passengers:	
Front	2
Rear	3
Total	5
Weights:	
Gross Vehicle Weight Rating	U.S.: 3,660 lbs (1,660 kg) ^{*1} Canada: 1,660 kg ^{*1} U.S.: 3,792 lbs (1,720 kg) ^{*2} Canada: 1,720 kg ^{*2}
Gross Axle Weight Rating (Front)	U.S.: 1,985 lbs (900 kg) ^{*1} Canada: 900 kg ^{*1} U.S.: 2,029 lbs (920 kg) ^{*2} Canada: 920 kg ^{*2}
Gross Axle Weight Rating (Rear)	U.S.: 1,742 lbs (790 kg) ^{*1} Canada: 790 kg ^{*1} U.S.: 1,786 lbs (810 kg) ^{*2} Canada: 810 kg ^{*2}
Air Conditioning:	
Refrigerant Type	HFC-134a (R-134a)
Charge Quantity	13.2 – 15.0 oz (375 – 425 g)
Lubricant Type	SP-10

^{*1}: DX, LX and HF models

^{*2}: EX and EX-L models

Engine Specifications

Displacement	110 cu-in (1,798 cm ³)	
Spark Plugs	NGK	DILZKR7B11GS
	DENSO	DXU22HCR-D11S

Fuel

Fuel:	Unleaded gasoline, Pump octane number of 87 or higher
Fuel Tank Capacity	13.2 US gal (50 ℓ)

Battery

Capacity/Type	36AH(5)/45AH(20)
	36AH(5)/47AH(20)
	38AH(5)/47AH(20)

Washer Fluid

Tank Capacity	U.S.: 2.6 US qt (2.5 ℓ)
	Canada: 4.8 US qt (4.5 ℓ)

Light Bulbs

Headlights (Low Beam)	51W (HB4)
Headlights (High Beam)	60W (HB3)
Front Turn Signal/Parking/Side Marker Lights	28/8W
Brake/Taillights	21/5W
Back-Up Lights	21W
Rear Turn Signal Lights	21W (Amber)
Rear Side Marker Lights	3CP
High-Mount Brake Light	21W
Rear License Plate Light	5W
Trunk Light	5W
Interior Lights	
Map Lights ^{*3}	8W
Ceiling Light	8W

^{*3}: Not available on all models

■ Brake/Clutch Fluid

Specified	Honda Heavy Duty Brake Fluid DOT 3
-----------	------------------------------------

■ Automatic Transmission Fluid

Specified	Honda ATF DW-1 (automatic transmission fluid)
Capacity	Change 2.5 US qt (2.4 ℓ)

■ Manual Transmission Fluid

Specified	Honda Manual Transmission Fluid
Capacity	Change 1.5 US qt (1.4 ℓ)

■ Engine Oil

Recommended	·Genuine Honda Motor Oil 0W-20	
	·API Premium-grade 0W-20 detergent oil	
Capacity	Change	3.7 US qt (3.5 ℓ)
	Change including filter	3.9 US qt (3.7 ℓ)

■ Engine Coolant

Specified	Honda Long-Life Antifreeze/Coolant Type2
Ratio	50/50 with distilled water
Capacity	1.48 US gal (5.59 ℓ)
	(change including the remaining 0.125 US gal (0.475 ℓ) in the reserve tank)

■ Tire

Regular	Size	P195/65R15 89H ^{*1} P195/65R15 89S ^{*2} P205/55R16 89H ^{*3}
	Pressure psi(kPa[kgf/cm ²])	30 (210 [2.1]) ^{*1} 32 (220 [2.2]) ^{*2, *3}
	Size	T135/80D15 99M
Compact Spare	Pressure psi(kPa[kgf/cm ²])	60 (420 [4.2])
	Wheel Size	Regular
Compact Spare		15 x 4T

*1: DX and LX models
*2: HF model
*3: EX and EX-L models

2.4 ℓ engine models

■ Vehicle Specifications

Model	Honda Civic 4-Door
No. of Passengers:	
Front	2
Rear	3
Total	5
Weights:	
Gross Vehicle	U.S.: 3,924 lbs (1,780 kg)
Weight Rating	Canada: 1,780 kg
Gross Axle Weight	
Rating (Front)	U.S.: 2,116 lbs (960 kg) Canada: 960 kg
Gross Axle Weight	
Rating (Rear)	U.S.: 1,830 lbs (830 kg) Canada: 830 kg
Air Conditioning:	
Refrigerant Type	HFC-134a (R-134a)
Charge Quantity	13.2 – 15.0 oz (375 – 425 g)
Lubricant Type	SP-10

■ Engine Specifications

Displacement	144 cu-in (2,354 cm ³)	
Spark Plugs	NGK	JLZKR7B-11S
	DENSO	SXU22HCR11S

■ Fuel

Fuel:	Unleaded gasoline, Pump octane number of 91 or higher
Type	
Fuel Tank Capacity	13.2 US gal (50 ℓ)

■ Battery

Capacity/Type	38AH(5)/47AH(20)
---------------	------------------

■ Washer Fluid

Tank Capacity	U.S.: 2.6 US qt (2.5 ℓ)
	Canada: 4.8 US qt (4.5 ℓ)

■ Light Bulbs

Headlights (Low Beam)	51W (HB4)
Headlights (High Beam)	60W (HB3)
Fog Lights	55W (H11)
Front Turn Signal/Parking/Side Marker Lights	28/8W
Brake/Taillights	21/5W
Back-Up Lights	21W
Rear Turn Signal Lights	21W (Amber)
Rear Side Marker Lights	3CP
High-Mount Brake Light	LED
Rear License Plate Light	5W
Trunk Light	5W
Interior Lights	
Map Lights	8W
Ceiling Light	8W

■ Brake/Clutch Fluid

Specified	Honda Heavy Duty Brake Fluid DOT 3
-----------	------------------------------------

■ Manual Transmission Fluid

Specified	Honda Manual Transmission Fluid	
Capacity	Change	2.0 US qt (1.9 ℓ)

■ Engine Oil

Recommended	·Genuine Honda Motor Oil 0W-20	
	·API Premium-grade 0W-20 detergent oil	
Capacity	Change	4.2 US qt (4.0 ℓ)
	Change	4.4 US qt (4.2 ℓ)
	including filter	

■ Engine Coolant

Specified	Honda Long-Life Antifreeze/Coolant Type2	
Ratio	50/50 with distilled water	
Capacity	1.45 US gal (5.5 ℓ)	
	(change including the remaining 0.125 US gal (0.475 ℓ) in the reserve tank)	

■ Tire

Regular	Size	P215/45R17 87V 215/45ZR17 91W**
	Pressure psi(kPa[kgf/cm ²])	32 (220 [2.2])
Compact Spare	Size	T135/80D16 101M
	Pressure psi(kPa[kgf/cm ²])	60 (420 [4.2])
Wheel Size	Regular	17 x 7J
	Compact Spare	16 x 4T

**1: Optional for U.S. models (summer tires)

Vehicle Identification Number (VIN)

Your vehicle has a 17-digit vehicle identification number (VIN) used to register your vehicle for warranty purposes, and for licensing and insuring your vehicle. See the image below for the VIN locations.

Engine Number and Transmission Number

See the image below for the locations of your vehicle's engine number and transmission number.

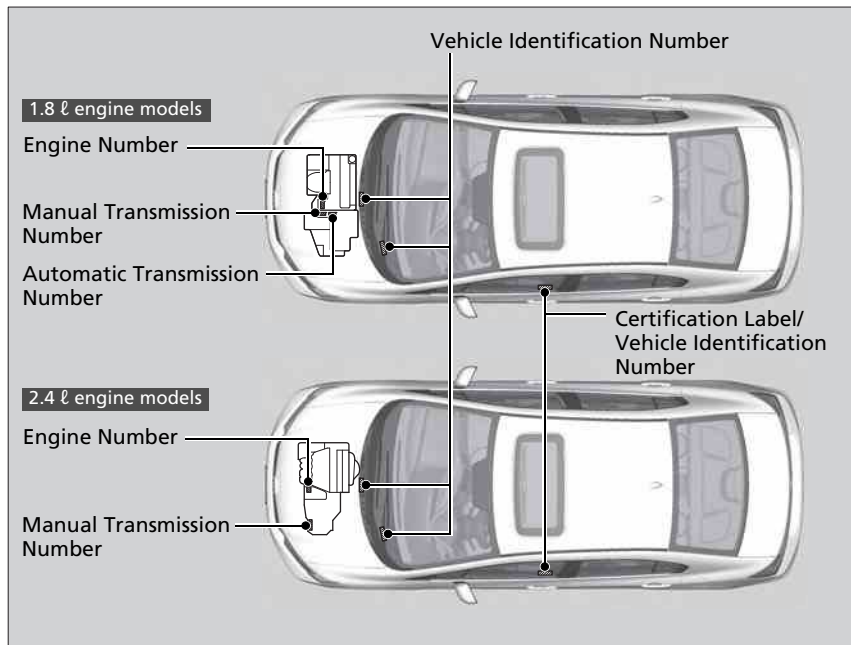

The following products and systems on your vehicle emit radio waves when in operation.

Audio System

Bluetooth[®] Audio

Bluetooth[®] HandsFreeLink[®]

Immobilizer System

Remote Transmitter

Tire Pressure Monitoring System (TPMS) (U.S. models only)

Each of the above complies with the appropriate requirements or the required standards of FCC (Federal Communications Commission) and Industry Canada Standard, described below:

As required by the FCC:

This device complies with Part 15 of the FCC rules. Operation is subject to the following two conditions: (1) This device may not cause harmful interference, and (2) this device must accept any interference received, including interference that may cause undesired operation.

Changes or modifications not expressly approved by the party responsible for compliance could void the user's authority to operate the equipment.

This device complies with Industry Canada Standard RSS-210. Operation is subject to the following two conditions: (1) this device may not cause interference, and (2) this device must accept any interference that may cause undesired operation of the device.

In the U.S.

If you believe that your vehicle has a defect which could cause a crash or could cause injury or death, you should immediately inform the National Highway Traffic Safety Administration (NHTSA) in addition to notifying American Honda Motor Co., Inc.

If NHTSA receives similar complaints, it may open an investigation, and if it finds that a safety defect exists in a group of vehicles, it may order a recall and remedy campaign. However, NHTSA cannot become involved in individual problems between you, your dealer, or American Honda Motor Co., Inc.

To contact NHTSA:

You may call the Vehicle Safety Hotline toll-free at 1-888-327-4236 (TTY: 1-800-424-9153);

go to <http://www.safercar.gov>;

or write to: Administrator, NHTSA,
1200 New Jersey Avenue, SE.,
Washington, DC 20590

You can also obtain other information about motor vehicle safety from <http://www.safercar.gov>.

In Canada

If you believe that your vehicle has a defect which could cause a crash or could cause injury or death, you should immediately inform Honda Canada Inc. and you may also inform Transport Canada.

If Transport Canada receives similar complaints, it may open an investigation, and if it finds that a safety defect exists in a group of vehicles, it may lead to a recall and remedy campaign. However, Transport Canada cannot become involved in individual problems between you, your dealer, or Honda Canada Inc.

To contact Transport Canada's Defect Investigations and Recalls Division, you may call 1-800-333-0510.

For more information on reporting safety defects or about motor vehicle safety, go to <http://www.tc.gc.ca/roadsafety>

Testing of Readiness Codes

Your vehicle uses "readiness codes," as part of its onboard self diagnostic system. Some states refer to these codes during testing to see if your vehicle's emissions components are working properly.

The codes may not be read if you go through the testing just after the battery has gone dead or been disconnected.

To check if they are set, turn the ignition switch to ON **II**, without starting the engine. The malfunction indicator lamp will come on for several seconds. If it then goes off, the readiness codes are set. If it blinks five times, the readiness codes are not set.

If you are required to have your vehicle tested before the readiness codes are ready, prepare the vehicle for retesting by doing the following:

1. Fill the gas tank to approximately 3/4 full.
2. Park the vehicle and leave the engine off for 6 hours or more.
3. Make sure the ambient temperature is between 40°F and 95°F (4°C and 35°C).
4. Start the engine without touching the accelerator pedal, and let it idle for 20 seconds.
5. Keep the vehicle in **P** (automatic transmission) or **N** (manual transmission). Increase the engine speed to 2,000 rpm, and hold it there for about 3 minutes.
6. Let the engine idle with your foot off the accelerator for 20 seconds.

Testing of Readiness Codes

The readiness codes are erased when the battery is disconnected, and set again only after several days of driving under a variety of conditions.

If a testing facility determines that the readiness codes are not set, you may be requested to return at a later date to complete the test.

If the testing facility determines the readiness codes are still not set, see a dealer.

7. Select a nearby, lightly traveled major highway where you can maintain a speed of 50 to 60 mph (80 to 97 km/h) for at least 20 minutes. Drive on the highway in **D** (automatic) or 5th (manual). Do not use cruise control. When traffic allows, drive for 90 seconds without moving the accelerator pedal. (Vehicle speed may vary slightly; this is okay.) If you cannot do this for a continuous 90 seconds because of traffic conditions, drive for at least 30 seconds, then repeat it two more times (for a total of 90 seconds).
8. Drive in city/suburban traffic for at least 10 minutes. When traffic conditions allow, let the vehicle coast for several seconds without using the accelerator pedal or the brake pedal.
9. Park the vehicle and leave the engine off for 30 minutes.

■ U.S. Owners

Your new vehicle is covered by these warranties:

New Vehicle Limited Warranty – covers your new vehicle, except for the emissions control systems and accessories, against defects in materials and workmanship.

Emissions Control Systems Defects Warranty and Emissions Performance Warranty – these two warranties cover your vehicle's emissions control systems. Time, mileage, and coverage are conditional. Please read your warranty booklet for exact information.

Seat Belt Limited Warranty – a seat belt that fails to function properly is covered by a limited warranty. Please read your warranty booklet for details.

Rust Perforation Limited Warranty – all exterior body panels are covered for rust-through from the inside for the specified time period with no mileage limit.

Accessory Limited Warranty – Honda accessories are covered under this warranty. Time and mileage limits depend on the type of accessory and other factors. Please read your warranty booklet for details.

Replacement Parts Limited Warranty – covers all Honda replacement parts against defects in materials and workmanship.

Replacement Battery Limited Warranty – provides prorated coverage for a replacement battery purchased from a dealer.

Replacement Muffler Lifetime Limited Warranty – provides coverage for as long as the purchaser of the muffler owns the vehicle.

Restrictions and exclusions apply to all these warranties. Please read the 2012 Honda warranty information booklet that came with your vehicle for precise information on warranty coverages. Your vehicle's original tires are covered by their manufacturer. Tire warranty information is in a separate booklet.

■ **Canadian Owners**

Please refer to the 2012 warranty manual that came with your vehicle.

■ Service Express

For electronic copies of service publications, you can purchase a subscription to Service Express. Visit www.techinfo.honda.com for pricing and options.

■ For U.S. Owners:

The publications listed below can be purchased from Helm Incorporated. You can order a manual by phone at (800) 782-4356 (credit card orders only), or online at www.helminc.com.

Make an inquiry to Helm Inc. at (800) 782-4356 if you are interested in ordering other models' or other years' manuals.

Publication Form Number	Form Description
31TR3600	2012 Honda Civic 4-Door Owner's Manual
31TR3800	2012 Honda Civic Navigation System Owner's Manual
31TR3M00	2012 Honda Civic Service History
31TR3A00	2012 Honda Civic 4-Door Technology Reference Guide (DX)
31TR3B00	2012 Honda Civic 4-Door Technology Reference Guide (LX/HF)
31TR3C00	2012 Honda Civic 4-Door Technology Reference Guide (EX/EX-L/Si)
31TR3D00	2012 Honda Civic 4-Door Technology Reference Guide (EX/EX-L/Si with Navigation)
HON-R	Order Form for Previous Years-Indicate Year and Model Desired

Authorized Manuals

For Canadian Owners:

Si vous avez besoin d'un Manuel du Conducteur en français, veuillez demander à votre concessionnaire de commander le numéro de pièce 33TR3C00

Honda dealership personnel are trained professionals.

They should be able to answer all your questions. If you encounter a problem that your dealership does not solve to your satisfaction, please discuss it with the dealership's service manager or general manager. If you are dissatisfied with the decision made by the dealership's management, contact Honda Customer Services.

U.S. Owners:

American Honda Motor Co., Inc.
Honda Automobile Customer Services
Mail Stop 500-2N-7A
1919 Torrance Blvd.
Torrance, CA 90501-2746
Tel: (800) 999-1009

Canadian Owners:

Honda Canada Inc.
Customer Relations
180 Honda Boulevard
Markham, ON
L6C 0H9
Tel: 1-888-9-HONDA-9
Fax: 1-877-939-0909
E-mail: Honda_cr@ch.honda.com

In Puerto Rico and the U.S. Virgin Islands:

Bella International
P.O. Box 190816
San Juan, PR 00919-0816
Tel: (787) 620-7546

Customer Service Information

When you call or write, please give us the following information:

- Vehicle Identification Number
 ▶ [Vehicle Identification Number P. 328](#)
- Date of purchase
- Odometer reading of your vehicle
- Your name, address, and telephone number
- A detailed description of the problem
- Name of the dealer who sold the vehicle to you

A

ABS (Anti-lock Brake System) 231

Accessories and Modifications 238

Accessory Power Sockets 137

Additives

 Coolant 261

 Engine Oil 254

 Washer 267

Additives, Engine Oil 254

Adjusting

 Armrest 133

 Front Seats 126

 Head Restraints 129

 Mirrors 125

 Rear Seats 132

 Steering Wheel 124

 Temperature 85

Air Conditioning System (Heating and Cooling System) 140

 Cooling 142

 Defrosting the Windshield and Windows 142

 Dust and Pollen Filter 291

 Heating 141

Air Pressure 281, 325, 327

Airbags 35

 Advanced Airbags 41

 After a Collision 39

 Airbag Care 49

 Event Data Recorder 21

 Front Airbags (SRS) 38

 Indicator 46, 69, 73

 Passenger Airbag Off Indicator 47

 Sensors 35

 Side Airbag Cutoff System 44

 Side Airbag Off Indicator 48

 Side Airbags 42

 Side Curtain Airbags 45

AM/FM Radio 149, 158

Anti-lock Brake System (ABS) 231

 Indicator 69

Armrest 133

Audio Remote Controls 156

Audio System 144

 Adjusting the Sound 148, 157

 Auxiliary Input Jack 145

 Error Messages 172

 General Information 174

 MP3/WMA/AAC 167

 Reactivating 146

 Recommended CDs 174

 Recommended Devices 176

 Remote Controls 156

 Security Code 146

 Theft Protection 146

 USB Adapter Cable 145

 USB Flash Drives 176

Authorized Manuals 335

Auto Door Locking/Unlocking 105

 Customize 88, 92, 106

Automatic Lighting 119

Automatic Transmission 214

 Creeping 214

 Fluid 263

 Kickdown 214

 Operating the Shift Lever 15, 216

 Shift Lever Does Not Move 310

 Shifting 215

Auxiliary Input Jack 145

Average Fuel Economy 81, 84

Average Speed 84

B

Battery 289

 Charging System Indicator 67, 313

 Jump Starting 307

 Maintenance (Checking the Battery) 289

 Maintenance (Replacing) 290

Belts (Seat) 28

Beverage Holders 136

Bluetooth® Audio 170

Bluetooth® HandsFreeLink® 177

Booster Seats (For Children) 61

Brake System 229

 Anti-lock Brake System (ABS) 231

 Brake Assist System 232

 Fluid 266

 Foot Brake 230

 Indicator 66, 315

 Parking Brake 229

Brightness Control (Instrument Panel) 122

Bulb Replacement..... 268
 Brake Light, Taillight, Back-Up Light,
 Rear Turn Signal Light and Rear Side Marker
 Lights..... 275
 Fog Lights..... 272
 Front Turn Signal/Parking/Side Marker
 Lights..... 273
 Headlights..... 268
 High-Mount Brake Light..... 277
 Rear License Plate Light..... 276
Bulb Specifications..... 324, 326

C

Carbon Monoxide Gas..... 62
Carrying Cargo..... 203, 205
CD Player..... 151, 161
Certification Label..... 328
Changing Bulbs..... 268
Charging System Indicator..... 67, 313
Child Safety..... 50
 Childproof Door Locks..... 104
 Emergency Trunk Opener..... 111
Child Seat..... 50
 Booster Seats..... 61
 Child Seat for Infants..... 52
 Child Seat for Small Children..... 53
 Installing a Child Seat with a Lap/
 Shoulder Seat Belt..... 57
 Larger Children..... 60
 Rear-facing Child Seat..... 52

Selecting a Child Seat..... 54
 Using a Tether..... 59
Childproof Door Locks..... 104
Cleaning the Exterior..... 294
Cleaning the Interior..... 292
Clock..... 98
Clutch Fluid..... 266
Coat Hook..... 138
Compact Spare Tire..... 299, 325, 327
Console Compartment..... 135
Controls..... 97
Coolant (Engine)..... 261
 Adding to the Radiator..... 262
 Adding to the Reserve Tank..... 261
 High Temperature Indicator..... 69
 Low Temperature Indicator..... 74
 Overheating..... 311
Creeping (Automatic Transmission)..... 214
Cruise Control..... 220
 Indicator..... 75
Cup Holders..... 136
Customer Service Information..... 336
Customized Features..... 86

D

Daytime Running Lights..... 120
Dead Battery..... 307
**Defrosting the Windshield and
 Windows**..... 142
Devices that Emit Radio Waves..... 329

Dimming

Headlights..... 118
 Rearview Mirror..... 125
Dipstick (Engine Oil)..... 255
Directional Signals (Turn Signal)..... 118
Display/Information Button..... 82
Door Mirrors..... 125
Doors..... 99
 Auto Door Locking..... 105
 Auto Door Unlocking..... 105
 Door Open Indicator..... 27, 70
 Keys..... 99
 Locking/Unlocking the Doors
 from the Inside..... 103
 Locking/Unlocking the Doors
 from the Outside..... 101
 Lockout Prevention System..... 102
DOT Tire Quality Grading..... 283
Driving..... 201
 Automatic Transmission..... 214
 Braking..... 229
 Cruise Control..... 220
 Shifting Gear..... 215, 217
 Starting the Engine..... 211
Dust and Pollen Filter..... 291

E

Eco Assist System..... 7
ECON Button..... 123
Elapsed Time..... 84

Electric Power Steering System (EPS)
 Indicator 71, 315

Electronic Stability Control (ESC) 223

Emergency 321

Emergency Trunk Opener 111

Emissions Testing (Readiness Codes) 331

Engine 328

 Coolant 261

 Jump Starting 307

 Oil 254

 Starting 211

 Switch Buzzer 117

Engine Coolant 261

 Adding to the Radiator 262

 Adding to the Reserve Tank 261

 High Temperature Indicator 69

 Low Temperature Indicator 74

 Overheating 311

Engine Oil 254

 Adding 257

 Checking 255

 Displaying Oil Life 243, 247

 Low Oil Pressure Indicator 66, 313

 Recommended Engine Oil 254

EPS (Electric Power Steering System) 71, 315

Exhaust Gas Hazard (Carbon Monoxide) 62

Exterior Care (Cleaning) 294

Exterior Mirrors 125

F

Features 143

Filters

 Dust and Pollen 291

 Oil 258

Flat Tire 299

Floor Mats 293

Fluids

 Automatic Transmission 263

 Brake/Clutch 266

 Engine Coolant 261

 Manual Transmission 264

 Windshield Washer 267

Fog Light Indicator 73

Folding Down the Rear Seats 132

Foot Brake 230

Front Airbags (SRS) 38

Front Seats 126

 Adjusting 126

Fuel 16, 234

 Economy 237

 Gauge 78

 Instant Fuel Economy 78, 85

 Low Fuel Indicator 68

 Range 81, 84

 Recommendation 234

 Refueling 234

Fuel Economy 237

Fuel Fill Cap 16, 236

 Message 314

Fuel Fill Door 16, 235

Fuses 318

 Inspecting and Changing 320

 Locations 318, 319

G

Gasoline (Fuel)

 Economy 237

 Gauge 78

 Information 234

 Instant Fuel Economy 78, 85

 Low Fuel Indicator 68

 Refueling 234

Gauges 78

Gear Shift Lever Positions

 Automatic Transmission 215

 Manual Transmission 218

Glass (care) 295

Glove Box 135

H

Halogen Bulbs 268, 272

Handling the Unexpected 297

HandsFreeLink® (HFL) 177

 Automatic Import of Cellular Phonebook and Call History 191

 Automatic Transferring 189

 Caller's ID Information 189

 HFL Buttons 177

 HFL Menus 179

Keys..... 99
 Lockout Prevention 102
 Master Keys 99
 Number Tag..... 100
 Rear Door Won't Open 104
 Remote Transmitter 101
 Types and Functions..... 99
 Valet Key 100
 Won't Turn 19
Kickdown (Automatic Transmission) 214

L

Language (HFL) 178
LATCH (Child Seats) 55
Lights 118, 268
 Automatic..... 119
 Bulb Replacement..... 268
 Daytime Running Lights 120
 Fog Lights 120
 High-Beam Indicator 73
 Interior..... 134
 Light Switches..... 118
 Lights On Indicator..... 73
 Turn Signals..... 118
Load Limits 205
Locking/Unlocking 99
 Auto Door Locking/Unlocking 105
 Childproof Door Locks 104
 From Inside 103
 From Outside 101

Keys 99
 Using a Key 102
Lockout Prevention System..... 102
Low Battery Charge..... 313
Low Fuel Indicator 68
Low Oil Pressure Indicator 66, 313
Lower Anchors..... 55
Lubricant Specifications Chart 324, 326
Luggage (Maximum Load Limit) 205

M

Maintenance..... 239
 Battery 289
 Brake/Clutch Fluid 266
 Cleaning..... 292
 Coolant..... 261
 Heating and Cooling System..... 291
 Maintenance Minder™..... 243
 Oil 255
 Precautions..... 240
 Radiator 262
 Remote Transmitter 290
 Replacing Light Bulbs..... 268
 Safety..... 241
 Service Items 245, 249
 Tires 280
 Transmission Fluid 263
 Under the Hood 251
Malfunction Indicator Lamp 67, 314
Manual Transmission..... 217

Map Lights 134
Maximum Load Limit 205
Meters, Gauges..... 78
Mirrors 125
 Adjusting 125
 Door 125
 Exterior 125
 Interior Rearview 125
Modifications (and Accessories) 238
Moonroof 116
MP3 151, 161, 167
Multi-Information Display 82

N

Numbers (Identification)..... 328

O

Odometer 80, 83
Oil (Engine)..... 254
 Adding..... 257
 Checking..... 255
 Displaying Oil Life..... 243, 247
 Low Oil Pressure Indicator 66, 313
 Recommended Engine Oil 254
 Viscosity..... 254
Opening/Closing
 Hood..... 253
 Moonroof 116
 Power Windows..... 114

Trunk..... 109
 Outside Temperature Display 85
 Overheating 311

P

Panic Mode 113
 Parking 233
 Parking Brake..... 229
 Parking Brake and Brake System
 Indicator 66, 315
 Passenger Airbag Off Indicator 47
 Passing Indicators 118
 Power Windows..... 114
 Precautions While Driving..... 213
 Rain..... 213
 Pregnant Women 33
 Puncture (Tire) 299

R

Radiator..... 262
 Radio (AM/FM)..... 149, 158
 Radio Data System (RDS)..... 150, 160
 Range 81, 84
 RDS (Radio Data System)..... 150, 160
 Readiness Codes (Emissions Testing) 331
 Rear Defogger/Heated Door Mirror
 Button..... 123
 Rear Seats (Folding Down)..... 132
 Rearview Mirror..... 125

Refueling 234
 Fuel Gauge..... 78
 Gasoline..... 234, 324, 326
 Low Fuel Indicator 68
 Regulations..... 226, 283, 329
 Remote Transmitter 101
 Replacement
 Battery 290
 Bulbs..... 268
 Fuses..... 318, 319
 Tires..... 286
 Wiper Blade Rubber 278
 Reporting Safety Defects 330
 Resetting a Trip Meter 80, 83

S

Safe Driving 23
 Safety Check 27
 Safety Labels..... 63
 Safety Message..... 22
 Seat Belts 28
 Adjusting the Shoulder Anchor..... 32
 Automatic Seat Belt Tensioners 30
 Checking..... 34
 Fastening 31
 Installing a Child Seat with a Lap/
 Shoulder Seat Belt 57
 Pregnant Women 33
 Reminder 29
 Warning Indicator 29, 68

Seat Heaters 139
 Seats..... 126
 Adjusting 126
 Front Seats..... 126
 Rear Seats..... 132
 Seat Heaters 139
 Security System 112
 Immobilizer System Indicator..... 74
 Security System Alarm Indicator 74
 SEL/RESET Knob..... 80, 82
 Select Lever 15, 215, 217
 Operation 15, 216, 217
 Releasing 310
 Won't Move 310
 Selecting a Child Seat 54
 Selector Knob (Audio) 147, 155
 Setting the Clock..... 98
 Shift Lever 15, 215, 217
 Shift Position Indicator 67, 216
 Shifting (Transmission) 215, 217
 Shoulder Anchor 32
 Side Airbags 42
 Cutoff System..... 44
 Off Indicator 44
 Side Curtain Airbags 45
 Snow Tires 288
 Spare Tire 299, 325, 327
 Spark Plugs..... 324, 326
 Specifications 324
 Specified Fuel 234, 324, 326
 Speedometer..... 78

SRS Airbags (Airbags)	38	Puncture (Flat Tire).....	299	Overheating	311
Starting the Engine.....	211	Regulations	283	Premium Gasoline	234, 326
Does Not Start	306	Rotation	287	Puncture/Flat Tire	299
Engine Switch Buzzer	117	Spare Tire	299, 325, 327	Rear Door Won't Open.....	19, 104
Jump Starting	307	Summer	288	Select Lever Won't Move.....	310
Steering Wheel	124	Tire Chains	288	Warning Indicators.....	66
Adjusting	124	Wear Indicators	285	Trunk	109
Stopping	233	Winter	288	Lid.....	109
Summer Tires.....	288	Tools	298	Light Bulb.....	324, 326
Supplemental Restraint System (SRS)	38	Towing a Trailer	207	Turn Signals	118
Switches (Around the		Equipment and Accessories	208	Indicators (Instrument Panel)	73
Steering Wheel)	2, 3, 117	Load Limits	207		
System Message Indicator	72	Towing Your Vehicle	210		
T		Emergency	321	U	
Tachometer	78	TPMS (Tire Pressure Monitoring		Unlocking the Doors	101
Temperature		System)	225	Unlocking the Front Doors	
High Temperature Indicator	69	Indicator	71, 72, 316, 317	from the Inside	11
Low Temperature Indicator	74	Transmission	215, 217	USB Adapter Cable.....	144, 145
Outside Temperature Display	85	Automatic	215	USB Flash Drives	176
Temperature Sensor	85	Fluid	263, 264		
Time (Setting).....	98	Manual.....	217	V	
Tire Pressure Monitoring System		Number.....	328	Valet Key.....	100
(TPMS).....	225	Shift Position Indicator.....	67, 216	Vanity Mirrors.....	5
Indicator	71, 72, 316, 317	Trip Meter	80, 83	Vehicle Identification Number	328
Tires	280	Troubleshooting	297	Vehicle Stability Assist (VSA®).....	223
Air Pressure.....	281, 325, 327	Blown Fuse.....	318, 319	Off Button.....	224
Checking and Maintaining	280	Brake Pedal Vibrates	19	Off Indicator.....	70
Inspection	280	Buzzer Sounds When Opening Door.....	20	System Indicator.....	70
Labeling.....	281	Emergency Towing	321	Viscosity (Oil)	254, 325, 327
		Engine Won't Start	306	VSA® (Vehicle Stability Assist).....	223
		Noise When Braking	20		

W

Wallpaper.....	93
Warning and Information Messages.....	76
Warning Indicator On/Blinking.....	313
Warning Labels.....	63
Warranties (Warranty Manual provided separately).....	333
Watts.....	324, 326
Wear Indicators (Tire).....	285
Wheel Cover.....	303
Wheel Nut Wrench (Jack Handle).....	302
Window Washers.....	121
Adding/Refilling Fluid.....	267
Switch.....	121
Windows (Opening and Closing).....	114
Windshield.....	121
Cleaning.....	295
Defrosting/Defogging.....	142
Washer Fluid.....	267
Wiper Blades.....	278
Wipers and Washers.....	121
Winter Tires.....	288
Snow Tires.....	288
Tire Chains.....	288
Wipers and Washers.....	121
Checking and Replacing Wiper Blades.....	278
WMA.....	151, 161, 167
Worn Tires.....	280