

# 2005 Odyssey Online Reference Owner's Manual

Use these links (and links throughout this manual) to navigate through this reference.  
For a printed owner's manual, click on authorized manuals or go to [www.helminc.com](http://www.helminc.com).

## Contents

### Owner's Identification Form

<b>Introduction</b> .....	<b>i</b>
<b>A Few Words About Safety</b> .....	<b>ii</b>
<b>Your Vehicle at a Glance</b> .....	<b>4</b>
<b>Driver and Passenger Safety</b> .....	<b>7</b>
Proper use and care of your vehicle's seat belts, and Supplemental Restraint System.	
<b>Instruments and Controls</b> .....	<b>59</b>
Instrument panel indicator and gauge, and how to use dashboard and steering column controls.	
<b>Features</b> .....	<b>187</b>
How to operate the climate control system, the audio system, and other convenience features.	
<b>Before Driving</b> .....	<b>277</b>
What gasoline to use, how to break-in your new vehicle, and how to load luggage and other cargo.	
<b>Driving</b> .....	<b>291</b>
The proper way to start the engine, shift the transmission, and park, plus towing a trailer.	
<b>Maintenance</b> .....	<b>313</b>
The Maintenance Schedule shows you when you need to take your vehicle to the dealer.	
<b>Taking Care of the Unexpected</b> .....	<b>355</b>
This section covers several problems motorists sometimes experience, and how to handle them.	
<b>Technical Information</b> .....	<b>383</b>
ID numbers, dimensions, capacities, and technical information.	
<b>Warranty and Customer Relations (U.S. and Canada)</b> .....	<b>397</b>
A summary of the warranties covering your new Honda, and how to contact us.	
<b>Authorized Manuals (U.S. only)</b> .....	<b>401</b>
How to order manuals and other technical literature.	
<b>Index</b> .....	<b>I</b>

### Service Information Summary

A summary of information you need when you pull up to the fuel pump.



## Owner's Identification

---

OWNER \_\_\_\_\_  
\_\_\_\_\_

ADDRESS \_\_\_\_\_  
\_\_\_\_\_

STREET

\_\_\_\_\_ CITY

\_\_\_\_\_ STATE/PROVINCE

\_\_\_\_\_ ZIP CODE/  
POSTAL CODE

V. I. N. \_\_\_\_\_

DELIVERY DATE \_\_\_\_\_

(Date sold to original retail purchaser)

DEALER NAME \_\_\_\_\_ DEALER NO. \_\_\_\_\_

ADDRESS \_\_\_\_\_  
\_\_\_\_\_

STREET

\_\_\_\_\_ CITY

\_\_\_\_\_ STATE/PROVINCE

\_\_\_\_\_ ZIP CODE/  
POSTAL CODE

OWNER'S SIGNATURE \_\_\_\_\_

DEALER'S SIGNATURE \_\_\_\_\_

This Owner's Manual should be considered a permanent part of the vehicle and should remain with the vehicle when it is sold.

This Owner's Manual covers all models of the Odyssey. You may find descriptions of equipment and features that are not on your particular model.

The information and specifications included in this publication were in effect at the time of approval for printing. Honda Motor Co., Ltd. reserves the right, however, to discontinue or change specifications or design at any time without notice and without incurring any obligation whatsoever.

**POUR CLIENTS CANADIEN  
AVIS IMPORTANT: Si vous avez  
besoin d'un Manuel du Conducteur  
en français, veuillez demander à  
votre concessionnaire de  
commander le numéro de pièce  
33SHJC00**

Congratulations! Your selection of a 2005 Honda Odyssey was a wise investment. It will give you years of driving pleasure.

One of the best ways to enhance the enjoyment of your new Honda is to read this manual. In it, you will learn how to operate its driving controls and convenience items. Afterwards, keep this owner's manual in your vehicle so you can refer to it at any time.

Several warranties protect your new Honda. Read the warranty booklet thoroughly so you understand the coverages and are aware of your rights and responsibilities.

Maintaining your vehicle according to the schedules given in this manual helps to keep your driving trouble-free while it preserves your investment. When your vehicle needs maintenance, keep in mind that your Honda dealer's staff is specially trained in servicing the many systems unique to your Honda. Your Honda dealer is dedicated to your satisfaction and will be pleased to answer any questions and concerns.

## California Proposition 65 Warning

**WARNING:** This product contains or emits chemicals known to the State of California to cause cancer and birth defects or other reproductive harm.

As you read this manual, you will find information that is preceded by a **NOTICE** symbol. This information is intended to help you avoid damage to your Honda, other property, or the environment.

## Event Data Recorders

This vehicle is equipped with one or more recording devices commonly referred to as "event data recorders" or "sensing and diagnostic modules."

## A Few Words About Safety

---

Your safety, and the safety of others, is very important. And operating this vehicle safely is an important responsibility.

To help you make informed decisions about safety, we have provided operating procedures and other information on labels and in this manual. This information alerts you to potential hazards that could hurt you or others.

Of course, it is not practical or possible to warn you about all the hazards associated with operating or maintaining your vehicle. You must use your own good judgement.

You will find this important safety information in a variety of forms, including:

- **Safety Labels** — on the vehicle.
- **Safety Messages** — preceded by a safety alert symbol  and one of three signal words: **DANGER**, **WARNING**, or **CAUTION**.

These signal words mean:

 **DANGER**

You **WILL** be **KILLED** or **SERIOUSLY HURT** if you don't follow instructions.

 **WARNING**

You **CAN** be **KILLED** or **SERIOUSLY HURT** if you don't follow instructions.

 **CAUTION**

You **CAN** be **HURT** if you don't follow instructions.

- **Safety Headings** — such as Important Safety Reminders or Important Safety Precautions.
- **Safety Section** — such as Driver and Passenger Safety.
- **Instructions** — how to use this vehicle correctly and safely.

This entire book is filled with important safety information — please read it carefully.

# Your Vehicle at a Glance

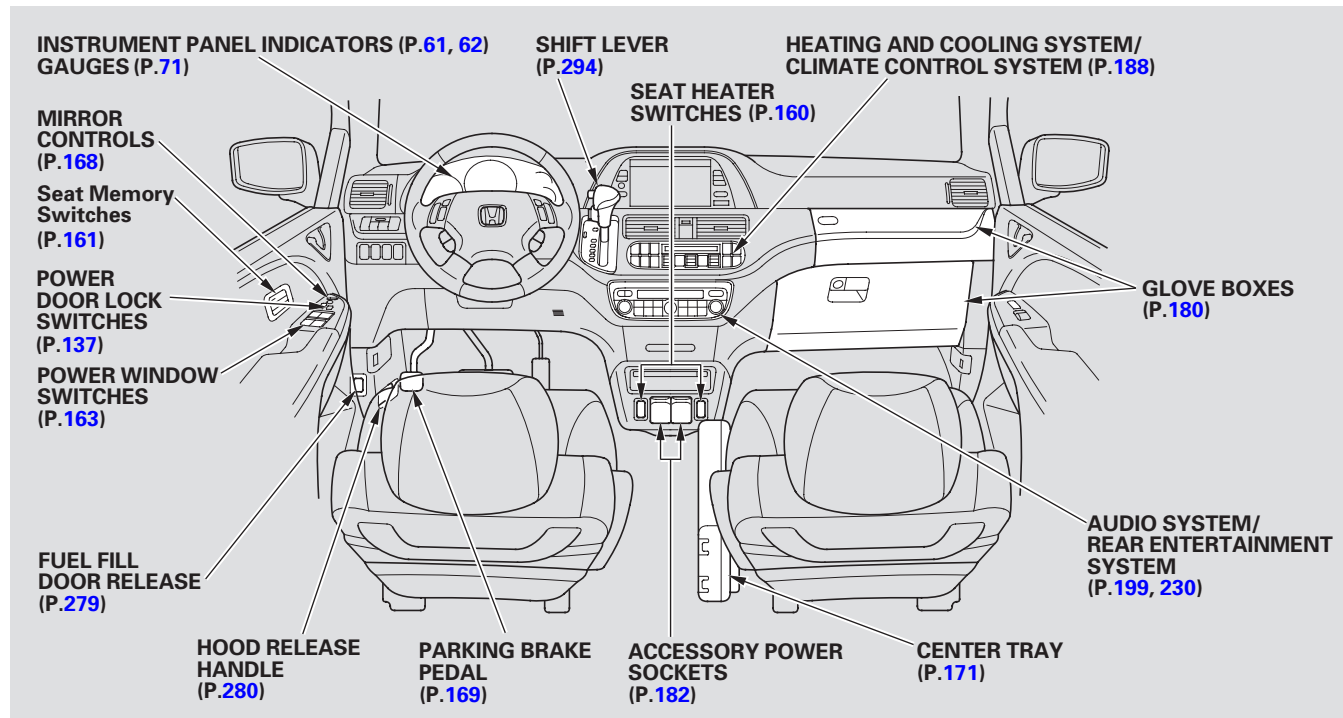

# Your Vehicle at a Glance

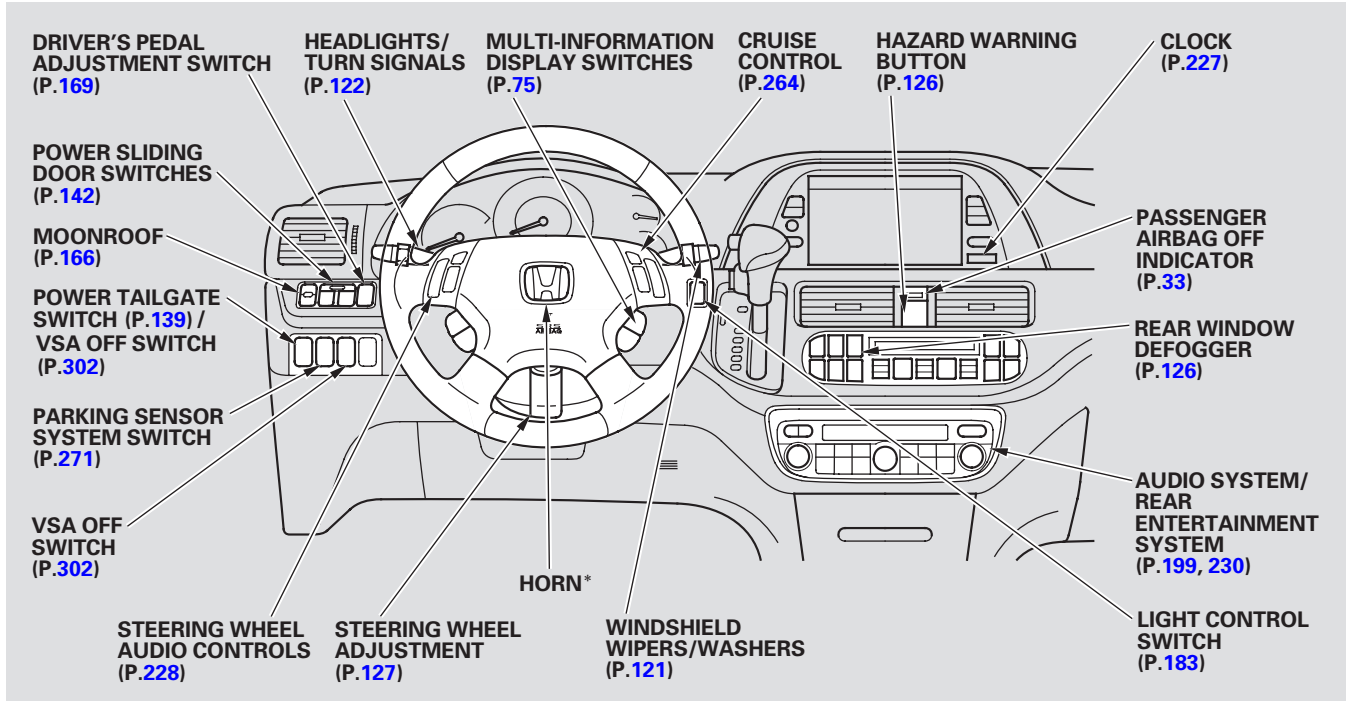

Your Vehicle at a Glance

\*: To use the horn, press the pad around the “H” logo.





This section gives you important information about how to protect yourself and your passengers. It shows you how to use seat belts. It explains how your airbags work. And it tells you how to properly restrain infants and children in your vehicle.

Important Safety Precautions .....	8
Your Vehicle's Safety Features.....	9
Protecting Adults and Teens.....	13
1. Close and Lock the Doors .....	13
2. Adjust the Front Seats .....	13
3. Adjust the Seat-Backs .....	14
4. Adjust the Head Restraints ....	15
5. Fasten and Position the Seat Belts .....	16
6. Maintain a Proper Sitting Position .....	19
Advice for Pregnant Women.....	20
Additional Safety Precautions....	20
Additional Information About Your Seat Belts.....	22
Seat Belt System Components...	22

Lap/Shoulder Belt.....	22
Automatic Seat Belt Tensioners.....	23
Seat Belt Maintenance .....	23
Additional Information About Your Airbags.....	25
Airbag System Components.....	25
How Your Front Airbags Work.....	27
Advanced Airbag .....	29
How Your Side Airbags Work.....	30
How Your Side Curtain Airbags Work.....	32
How the SRS Indicator Works... ..	32
How the Side Airbag Off Indicator Works.....	33
How the Passenger Airbag Off Indicator Works .....	33
Airbag Service.....	34
Additional Safety Precautions....	35
Protecting Children – General Guidelines.....	36
All Children Must Be Restrained .....	36

All Children Should Sit in a Back Seat .....	37
The Passenger's Front Airbag Can Pose Serious Risks .....	37
If You Must Drive with Several Children .....	39
If a Child Requires Close Attention .....	39
Additional Safety Precautions....	40
Protecting Infants and Small Children .....	41
Protecting Infants.....	41
Protecting Small Children .....	42
Selecting a Child Seat.....	43
Installing a Child Seat .....	44
With LATCH.....	45
With a Lap/Shoulder Belt .....	48
With a Tether .....	50
Protecting Larger Children .....	51
Checking Seat Belt Fit.....	52
Using a Booster Seat .....	53
When Can a Child Sit in Front ...	53
Additional Safety Precautions....	55
Carbon Monoxide Hazard .....	56
Safety Labels .....	57



## Important Safety Precautions

---

You'll find many safety recommendations throughout this section, and throughout this manual. The recommendations on this page are the ones we consider to be the most important.

### **Always Wear Your Seat Belt**

A seat belt is your best protection in all types of collisions. Airbags are designed to supplement seat belts, not replace them. So even though your vehicle is equipped with airbags, make sure you and your passengers always wear your seat belts, and wear them properly (see page 16).

### **Restrain All Children**

Children age 12 and under should ride properly restrained in a back seat, not in the front seat. Infants and small children should be restrained in a child seat. Larger children should use a booster and a lap/shoulder belt until they can use the belt properly without a booster (see page 36).

### **Be Aware of Airbag Hazards**

While airbags can save lives, they can cause serious or fatal injuries to occupants who sit too close to them, or are not properly restrained. Infants, young children, and short adults are at the greatest risk. Be sure to follow all instructions and warnings in this manual.

### **Don't Drink and Drive**

Alcohol and driving don't mix. Even one drink can reduce your ability to respond to changing conditions, and your reaction time gets worse with

every additional drink. So don't drink and drive, and don't let your friends drink and drive, either.

### **Control Your Speed**

Excessive speed is a major factor in crash injuries and deaths. Generally, the higher the speed, the greater the risk, but serious injuries can also occur at lower speeds. Never drive faster than is safe for current conditions, regardless of the maximum speed posted.

### **Keep Your Vehicle in Safe Condition**

Having a tire blowout or a mechanical failure can be extremely hazardous. To reduce the possibility of such problems, check your tire pressures and condition frequently, and perform all regularly scheduled maintenance (see page 315).

# Your Vehicle's Safety Features

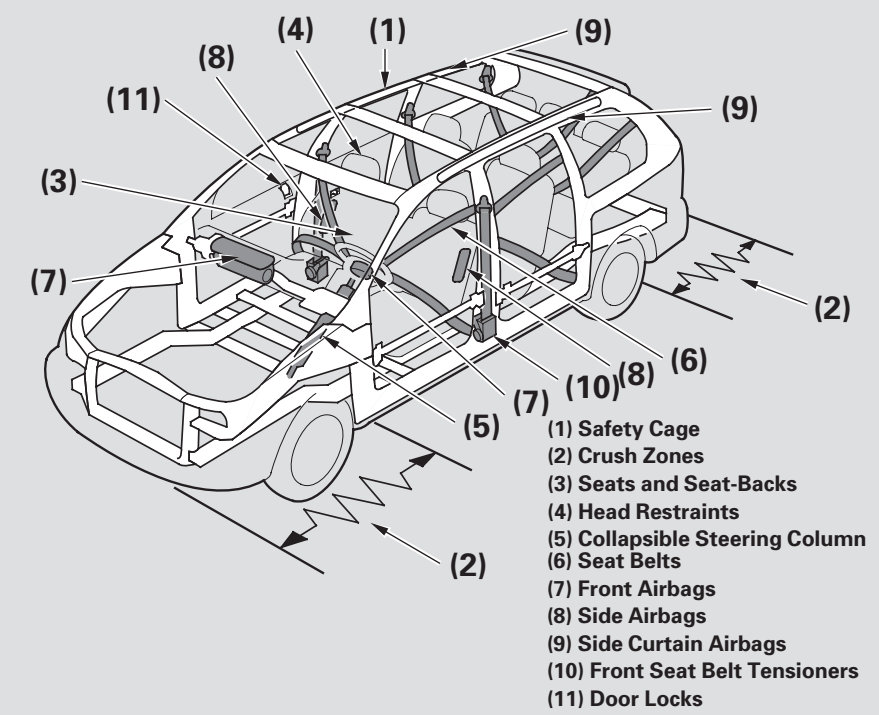

Your vehicle is equipped with many features that work together to protect you and your passengers during a crash.

Some features do not require any action on your part. These include a strong steel framework that forms a safety cage around the passenger compartment; front and rear crush zones; a collapsible steering column; and tensioners that tighten the front seat belts in a crash.

Driver and Passenger Safety

*CONTINUED*

## Your Vehicle's Safety Features

---

However, you and your passengers can't take full advantage of these features unless you remain sitting in a proper position and ***always wear your seat belts***. In fact, some safety features can contribute to injuries if they are not used properly.

The following pages explain how you can take an active role in protecting yourself and your passengers.

### Seat Belts

Your vehicle is equipped with seat belts in all seating positions.

Your seat belt system also includes an indicator on the instrument panel to remind you and your passengers to fasten your seat belts.

### *Why Wear Seat Belts*

Seat belts are the single most effective safety device for adults and larger children. (Infants and smaller children must be properly restrained in child seats.)

Not wearing a seat belt properly increases the chance of serious injury or death in a crash, even though your vehicle has airbags.

In addition, most states and all Canadian provinces require you to wear seat belts.

### **⚠ WARNING**

Not wearing a seat belt properly increases the chance of serious injury or death in a crash, even though your vehicle has airbags.

Be sure you and your passengers always wear seat belts and wear them properly.

When properly worn, seat belts:

- Keep you connected to the vehicle so you can take advantage of the vehicle's built-in safety features.
- Help protect you in almost every type of crash, including frontal, side, and rear impacts and rollovers.

- Help keep you from being thrown against the inside of the vehicle and against other occupants.
- Keep you from being thrown out of the vehicle.
- Help keep you in a good position should the airbags ever deploy. A good position reduces the risk of injury from an inflating airbag and allows you to get the best advantage from the airbag.

Of course, seat belts cannot completely protect you in every crash. But in most cases, seat belts can reduce your risk of serious injury.

**What you should do:** Always wear your seat belt, and make sure you wear it properly.

## Airbags

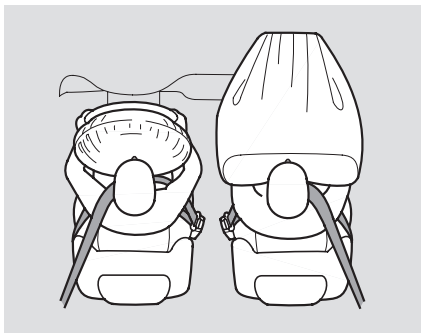

Your vehicle has a Supplemental Restraint System (SRS) with front airbags to help protect the heads and chests of the driver and a front seat passenger during a moderate to severe frontal collision (see page [27](#) for more information on how your front airbags work).

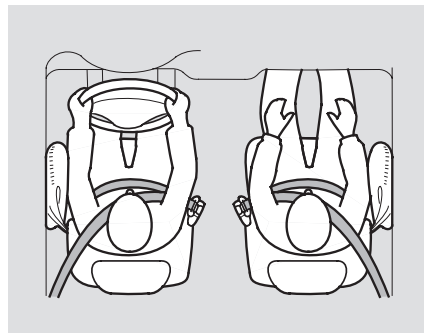

Your vehicle also has side airbags to help protect the upper torso of the driver or a front seat passenger during a moderate to severe side impact (see page [30](#) for more information on how your side airbags work).

CONTINUED

## Your Vehicle's Safety Features

---

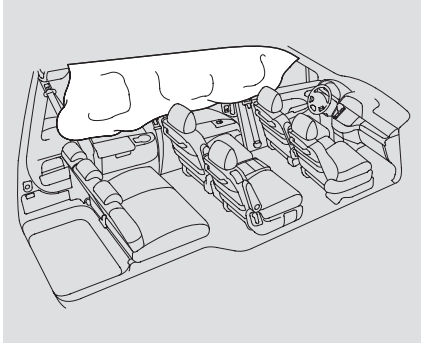

Your vehicle also has side curtain airbags to help protect the heads of the driver, front passenger, and passengers in the outer rear seating positions during a moderate to severe side impact (see page 32 for more information on how your side curtain airbags work).

The most important things you need to know about your airbags are:

- ***Airbags do not replace seat belts.*** They are designed to supplement the seat belts.
- ***Airbags offer no protection in rear impacts, or minor frontal or side collisions.***
- ***Airbags can pose hazards.*** To do their job, airbags must inflate with tremendous force. So while airbags help save lives, they can cause minor injuries or more serious or even fatal injuries if occupants are not properly restrained or sitting properly.

***What you should do:*** Always wear your seat belt properly, and sit upright and as far back from the steering wheel as possible while allowing full control of the vehicle. A front passenger should move their seat as far back from the dashboard as possible.

The rest of this section gives more detailed information about how you can maximize your safety.

Remember, however, that no safety system can prevent all injuries or deaths that can occur in a severe crash, even when seat belts are properly worn and the airbags deploy.

## Introduction

The following pages provide instructions on how to properly protect the driver, adult passengers, and teenage children who are large enough and mature enough to drive or ride in the front.

See pages [36](#) – [40](#) for important guidelines on how to properly protect infants, small children, and larger children who ride in your vehicle.

## 1. Close and Lock the Doors

After everyone has entered the vehicle, be sure the doors and tailgate are closed and locked.



Your vehicle has a door and tailgate monitor indicator on the instrument panel to indicate when a specific door or the tailgate is not tightly closed.

Locking the doors reduces the chance of someone being thrown out of the vehicle during a crash, and it helps prevent passengers from accidentally opening a door and falling out.

Locking the doors also helps prevent an outsider from unexpectedly opening a door when you come to a stop.

See page [137](#) for how to lock the doors, and page [67](#) for how the door and tailgate monitor indicator works.

## 2. Adjust the Front Seats

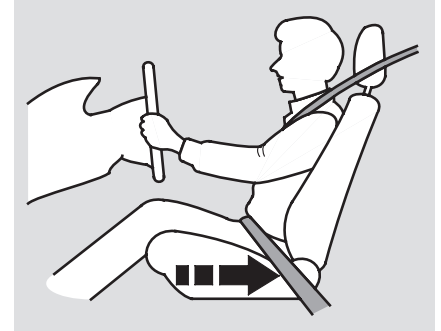

Adjust the driver's seat as far to the rear as possible while allowing you to maintain full control of the vehicle. Have a front passenger adjust their seat as far to the rear as possible.

*CONTINUED*

## Protecting Adults and Teens

If you sit too close to the steering wheel or dashboard, you can be seriously injured by an inflating front airbag, or by striking the steering wheel or dashboard.

The National Highway Traffic Safety Administration and Transport Canada recommend that drivers allow at least 10 inches (25 cm) between the center of the steering wheel and the chest.

If you cannot get far enough away from the steering wheel and still reach the controls, we recommend that you extend the adjustable driver's foot pedals (Touring model only, see page 169), or investigate whether some type of adaptive equipment may help.

### **⚠ WARNING**

Sitting too close to a front airbag can result in serious injury or death if the front airbags inflate.

Always sit as far back from the front airbags as possible.

Once your seat is adjusted correctly, rock it back and forth to make sure the seat is locked in position.

See page 149 for how to adjust the front seats.

### 3. Adjust the Seat-Backs

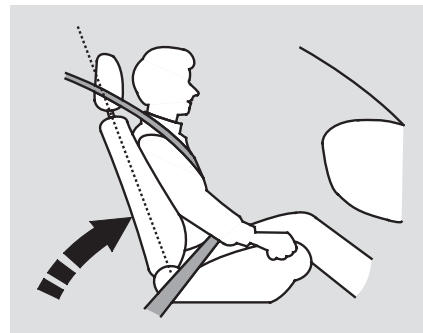

Adjust the driver's seat-back to a comfortable, upright position, leaving ample space between your chest and the airbag cover in the center of the steering wheel.

Passengers with adjustable seat-backs should also adjust their seat-back to a comfortable, upright position.

## **⚠ WARNING**

Reclining the seat-back too far can result in serious injury or death in a crash.

Adjust the seat-back to an upright position, and sit well back in the seat.

Reclining a seat-back so that the shoulder part of the belt no longer rests against the occupant's chest reduces the protective capability of the belt. It also increases the chance of sliding under the belt in a crash and being seriously injured. The farther a seat-back is reclined, the greater the risk of injury.

See page [150](#) for how to adjust the seat-backs.

## 4. Adjust the Head Restraints

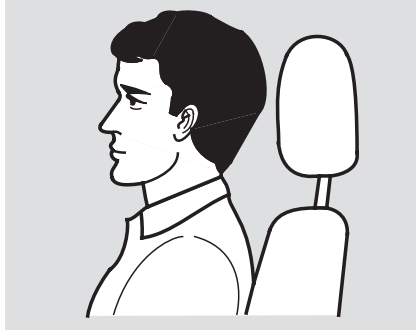

Adjust the driver's head restraint so the back of your head rests against the center of the restraint.

Have passengers with adjustable head restraints adjust their restraints properly as well. Taller persons should adjust their restraint as high as possible.

## **⚠ WARNING**

Improperly positioning head restraints reduces their effectiveness and you can be seriously injured in a crash.

Make sure head restraints are in place and positioned properly before driving.

Properly adjusted head restraints will help protect occupants from whiplash and other crash injuries.

See page [152](#) for how to adjust the head restraints.



## Protecting Adults and Teens

### 5. Fasten and Position the Seat Belts

Insert the latch plate into the buckle, then tug on the belt to make sure the belt is securely latched. Check that the belt is not twisted, because a twisted belt can cause serious injuries in a crash.

The center seating position of the third row has a detachable seat belt anchor that can be unlatched and released, to allow the seat to be folded down. See page 17 for how to unlatch and relatch the seat belt anchor.

The plus-one seat on EX models that can be installed in the center seating position of the second row also has a detachable seat belt anchor.



Position the lap part of the belt as low as possible across your hips, then pull up on the shoulder part of the belt so the lap part fits snugly. This lets your strong pelvic bones take the force of a crash and reduces the chance of internal injuries.

If necessary, pull up on the belt again to remove any slack, then check that the belt rests across the center of your chest and over your shoulder. This spreads the forces of a crash over the strongest bones in your upper body.

#### **⚠ WARNING**

Improperly positioning the seat belts can cause serious injury or death in a crash.

Make sure all seat belts are properly positioned before driving.

If the seat belt touches or crosses your neck, or if it crosses your arm instead of your shoulder, you need to adjust the seat belt anchor height.

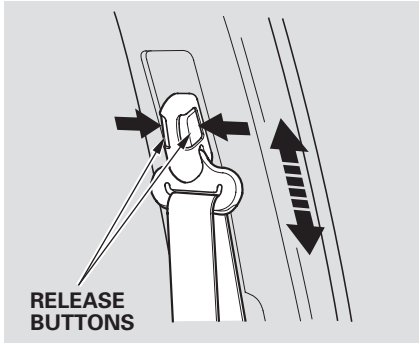

The front seats and second row seats have adjustable seat belt anchors. To adjust the height of an anchor, squeeze the two release buttons, and slide the anchor up or down as needed (the anchor has four positions).

## Using the Lap/Shoulder Belt in the Center Position of the Third Row

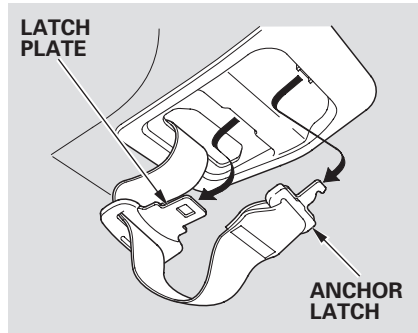

*The plus-one seat on EX model also has this type of seat belt.*

Pull out the anchor latch and the latch plate from each holding slot in the ceiling, and pull out the seat belt to extend it.

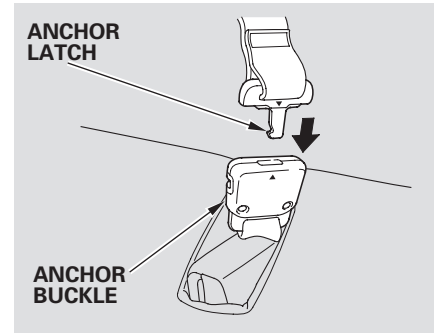

Insert the hook at the end of the anchor latch into the anchor buckle by lining up the triangle marks on the anchor latch and buckle. Make sure the belt is not twisted. Push the anchor latch until it locks. Then follow the procedure for fastening an ordinary seat belt (see page 16).

CONTINUED

## Protecting Adults and Teens

### **⚠ WARNING**

Using a seat belt with the detachable seat belt anchor unlatched increases the chance of serious injury or death in a crash.

Before using the seat belt, make sure the detachable seat belt anchor is correctly latched.

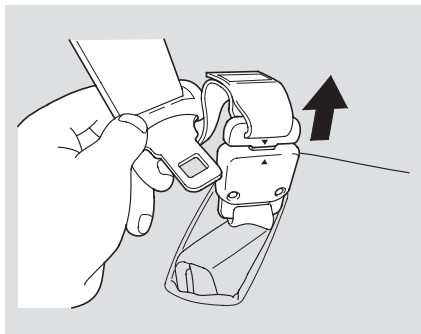

To unlatch the detachable seat belt anchor before folding down the seat-back, insert the latch plate into the slot on the side of the anchor buckle and allow the seat belt to retract. Place the latch plate and anchor latch into their holding slots in the ceiling. When the seat-back is returned to its upright position, be sure to latch the detachable seat belt anchor.

***Never place the shoulder portion of a lap/shoulder belt under your arm or behind your back.*** This could cause very serious injuries in a crash.

If a seat belt does not seem to work as it should, it may not protect the occupant in a crash.

***No one should sit in a seat with an inoperative seat belt.*** Using a seat belt that is not working properly can result in serious injury or death. Have your dealer check the belt as soon as possible.

See page [20](#) for additional information about your seat belts and how to take care of them.

## 6. Maintain a Proper Sitting Position

After all occupants have adjusted their seats and put on seat belts, it is very important that they continue to sit upright, well back in their seats, with their feet on the floor, until the vehicle is parked and the engine is off.

Sitting improperly can increase the chance of injury during a crash. For example, if an occupant slouches, lies down, turns sideways, sits forward, leans forward or sideways, or puts one or both feet up, the chance of injury during a crash is greatly increased.

In addition, an occupant who is out of position in the front seat can be seriously or fatally injured in a crash by striking interior parts of the vehicle or being struck by an inflating front airbag.

### **WARNING**

Sitting improperly or out of position can result in serious injury or death in a crash.

Always sit upright, well back in the seat, with your feet on the floor.

## Protecting Adults and Teens

---

### Advice for Pregnant Women



If you are pregnant, the best way to protect yourself and your unborn child when driving or riding in a vehicle is to always wear a seat belt, and keep the lap part of the belt as low as possible across the hips.

When driving, remember to sit upright and adjust the seat as far back as possible while allowing full control of the vehicle. When riding as a front passenger, adjust the seat as far back as possible.

This will reduce the risk of injuries to both you and your unborn child that can be caused by a crash or an inflating front airbag.

Each time you have a checkup, ask your doctor if it's okay for you to drive.

### Additional Safety Precautions

- ***Never let passengers ride in the cargo area or on top of a folded-down back seat.*** If they do, they could be very seriously injured in a crash.
- ***Passengers should not stand up or change seats while the vehicle is moving.*** A passenger who is not wearing a seat belt during a crash or emergency stop can be thrown against the inside of the vehicle, against other occupants, or out of the vehicle.
- ***Two people should never use the same seat belt.*** If they do, they could be very seriously injured in a crash.

- **Do not put any accessories on seat belts.** Devices intended to improve occupant comfort or reposition the shoulder part of a seat belt can reduce the protective capability of the seat belt and increase the chance of serious injury in a crash.
  - **Do not place hard or sharp objects between yourself and a front airbag.** Carrying hard or sharp objects on your lap, or driving with a pipe or other sharp object in your mouth, can result in injuries if your front airbag inflates.
  - **Keep your hands and arms away from the airbag covers.** If your hands or arms are close to an airbag cover, they could be injured if the airbag inflates.
- **Do not attach or place objects on the front airbag covers.** Objects on the covers marked “SRS AIRBAG” could interfere with the proper operation of the airbags or be propelled inside the vehicle and hurt someone if the airbags inflate.
  - **Do not attach hard objects on or near a front door.** If a side airbag or a side curtain airbag inflates, a cup holder or other hard object attached on or near the door could be propelled inside the vehicle and hurt someone.

## Additional Information About Your Seat Belts

---

### Seat Belt System Components

Your seat belt system includes lap/shoulder belts in all seating positions. The front seat belts are also equipped with automatic seat belt tensioners.



The seat belt system includes an indicator on the instrument panel and a beeper to remind you to fasten your seat belt.

If you turn the ignition switch to ON (II) without fastening your belt, a beeper will sound and the indicator will flash. If you do not fasten your seat belt before the beeper stops, the indicator will stop flashing but remain on.

If you continue driving without fastening your seat belt, the beeper will sound and the indicator will flash again at regular intervals.

### Lap/Shoulder Belt

The lap/shoulder belt goes over your shoulder, across your chest, and across your hips.

To fasten the belt, insert the latch plate into the buckle, then tug on the belt to make sure the buckle is latched (see page 16 for how to properly position the belt).

To unlock the belt, push the red PRESS button on the buckle. Guide the belt across your body so that it retracts completely. After exiting the vehicle, be sure the belt is out of the way and will not get closed in the door.

All seat belts have an emergency locking retractor. In normal driving, the retractor lets you move freely in your seat while it keeps some tension on the belt. During a collision or sudden stop, the retractor automatically locks the belt to help

restrain your body.

The seat belts in all positions except the driver's have an additional locking mechanism that must be activated to secure a child seat (see page 48).

If the shoulder part of the belt is pulled all the way out, the locking mechanism will activate. The belt will retract, but it will not allow the passenger to move freely.

To deactivate the locking mechanism, unlatch the buckle and let the seat belt fully retract. To refasten the seat belt, pull it out only as far as needed.

## Additional Information About Your Seat Belts

### Automatic Seat Belt Tensioners

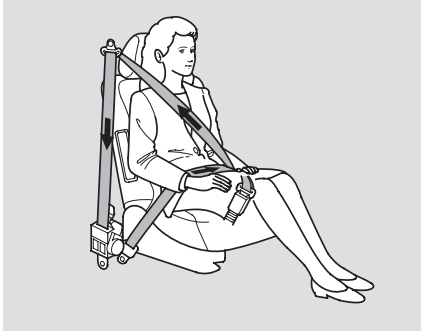

For added protection, the front seat belts are equipped with automatic seat belt tensioners. When activated, the tensioners immediately tighten the belts to help hold the driver and a front passenger in place.

The tensioners are designed to activate primarily in frontal collisions, and they should activate in any collision severe enough to cause front-airbag inflation.

The tensioners are also designed to activate when sensors detect side impact and when your vehicle is about to roll over (see page 32).

The tensioners can also be activated during a collision in which the front airbags do not deploy. In this case, the airbags would not be needed, but the additional restraint could be helpful.

When the tensioners are activated, the seat belts will remain tight until they are unbuckled in the normal manner.

### Seat Belt Maintenance

For safety, you should check the condition of your seat belts regularly.

Pull each belt out fully and look for frays, cuts, burns, and wear. Check that the latches work smoothly and the belts retract easily. Any belt that is not in good condition or working properly will not provide good protection and should be replaced as soon as possible.

Honda provides a lifetime warranty on seat belts for U.S. models. See your *Honda Warranty Information* booklet for details.

CONTINUED



## Additional Information About Your Seat Belts

---

If a seat belt is worn during a crash, it must be replaced by the dealer. A belt that has been worn during a crash may not provide the same level of protection in a subsequent crash.

The dealer should also inspect the anchors for damage and replace them if needed. If the automatic seat belt tensioners activate during a crash, they must be replaced.

For information on how to clean the seat belts, see page [343](#).

### **WARNING**

Not checking or maintaining seat belts can result in serious injury or death if the seat belts do not work properly when needed.

Check your seat belts regularly and have any problem corrected as soon as possible.

## Additional Information About Your Airbags

### Airbag System Components

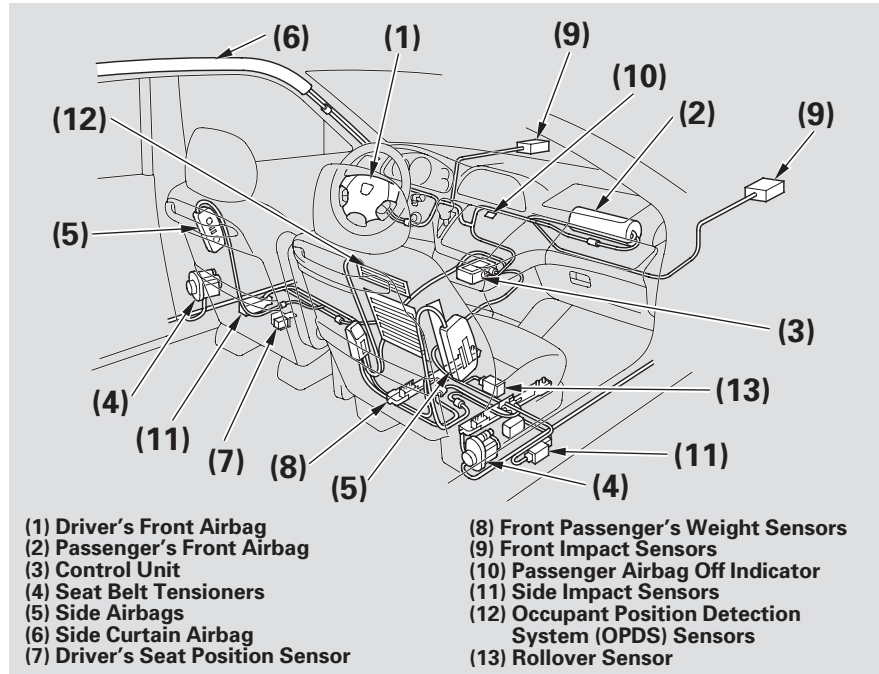

Your Airbag System includes:

- Two SRS (Supplemental Restraint System) front airbags. The driver's airbag is stored in the center of the steering wheel; the front passenger's airbag is stored in the dashboard. Both are marked "SRS AIRBAG" (see page 27).
- Two side airbags, one for the driver and one for a front passenger. The airbags are stored in the outer edges of the seat-backs. Both are marked "SIDE AIRBAG" (see page 30).
- Two side curtain airbags, one for each side of the vehicle. The airbags are stored in the ceiling above the side windows. All pillars are marked "SIDE CURTAIN AIRBAG" (see page 32).

CONTINUED

## Additional Information About Your Airbags

---

- Automatic seat belt tensioners (see page 23 ).
- Sensors that can detect a moderate to severe front impact or side impact.
- Sensors that can detect whether a child is in the passenger's side airbag path and automatically turn the airbag off (see page 33 ).
- A sophisticated electronic system that continually monitors and records information about the sensors, the control unit, the airbag activators, the seat belt tensioners, and driver and front passenger seat belt use when the ignition is in the ON (II) position.
- A driver's seat position sensor that monitors the distance of the seat from the front airbag. If the seat is too far forward, the airbag will inflate with less force (see page 29 ).
- Weight sensors that monitor the weight on the front passenger's seat. These automatically turn off the passenger's front airbag if they detect an infant or small child may be in the seat (see page 29 ).
- An indicator on the instrument panel that alerts you to a possible problem with your airbags (see page 32 ).
- A rollover sensor that monitors the degree and rate your vehicle may roll over and automatically deploy the side curtain airbags and activate the front seat belt tensioners if needed (see page 32 ).
- An indicator on the dashboard that alerts you that the passenger's side airbag has been turned off (see page 33 ).
- An indicator on the dashboard that alerts you that the passenger's front airbag has been turned off (see page 33 ).
- Emergency backup power in case your vehicle's electrical system is disconnected in a crash.

## Additional Information About Your Airbags

### How Your Front Airbags Work

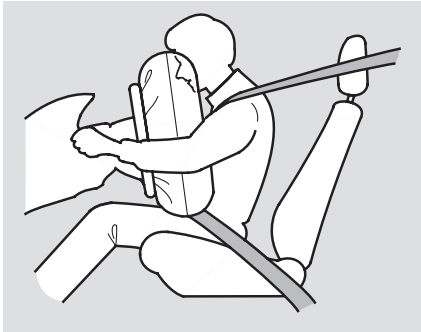

If you ever have a moderate to severe frontal collision, sensors will detect the vehicle's rapid deceleration.

If the rate of deceleration is high enough, the control unit will instantly inflate the driver's and front passenger's airbags, at the time and with the force needed.

During a frontal crash, your seat belt restrains your lower body and torso, and the airbag helps protect your head and chest.

Although both airbags normally inflate within a split second of each other, it is possible for only one airbag to deploy.

This can happen if the severity of a collision is at the margin, or threshold, that determines whether or not the airbags will deploy. In such cases, the seat belt will provide sufficient protection, and the supplemental protection offered by the airbag would be minimal.

Only the driver's airbag can deploy if there is no passenger in the front seat, or if the advanced airbag system has turned the passenger's airbag off (see [33](#)).

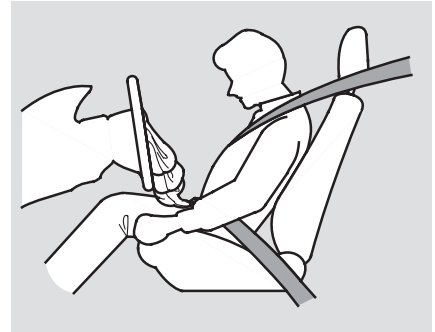

After inflating, the front airbags will immediately deflate, so they won't interfere with the driver's visibility, or the ability to steer or operate other controls.

*CONTINUED*

## Additional Information About Your Airbags

---

The total time for inflation and deflation is one-tenth of a second, so fast that most occupants are not aware that the airbags deployed until they see them lying in their laps.

After a crash, you may see what looks like smoke. This is actually powder from the airbag's surface. Although the powder is not harmful, people with respiratory problems may experience some temporary discomfort. If this occurs, get out of the vehicle as soon as it is safe to do so.

### *Dual-Stage Airbags*

Your front airbags are dual-stage airbags. This means they have two inflation stages that can be ignited sequentially or simultaneously, depending on crash severity.

In a **more severe** crash, both stages will ignite simultaneously to provide the quickest and greatest protection.

In a **less severe** crash, one stage will ignite first, then the second stage will ignite a split second later. This provides longer airbag inflation time with a little less force.

### *Dual-Threshold Airbags*

Your front airbags are also dual-threshold airbags. Airbags with this feature have two deployment thresholds that depend on whether or not the occupant is wearing a seat belt.

If the occupant's belt is **not latched**, the airbag will deploy at a slightly lower threshold, because the occupant would need extra protection.

If the occupant's belt is **latched**, the airbag will inflate at a slightly higher threshold, when the airbag would be needed to supplement the protection provided by the seat belt.

## Additional Information About Your Airbags

### Advanced Airbags

Your front airbags are also advanced airbags. The main purpose of this feature is to help prevent airbag-caused injuries to short drivers and children who ride in front.

For both advanced airbags to work properly:

- Occupants must sit upright and wear their seat belts properly.
- Do not spill any liquids on or under the seats, cover the sensors, or put any cargo or metal objects under the front seats.
- Back-seat passengers should not put their feet under the front seats.

Failure to follow these instructions could damage the sensors or prevent them from working properly.

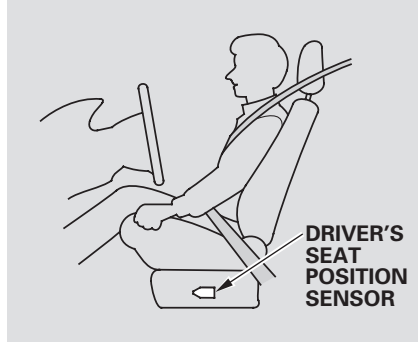

The driver's advanced front airbag system includes a seat position sensor under the seat. If the seat is too far forward, the airbag will inflate with less force, regardless of the severity of the impact.

If there is a problem with the sensor, the SRS indicator will come on, and the airbag will inflate in the normal manner regardless of the driver's seating position.

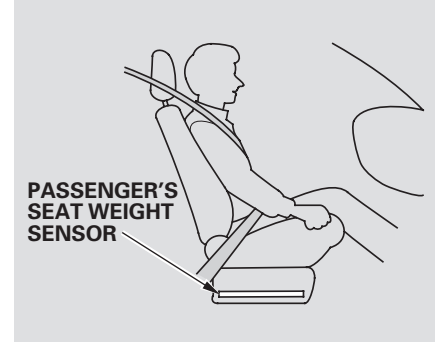

The passenger's advanced front airbag system has weight sensors under the seat. If the sensors detect an infant or small child may be in the seat, the system will automatically turn the passenger's front airbag off.

CONTINUED

## Additional Information About Your Airbags

---

When the airbag is turned off, an indicator in the center of the dashboard will come on indicating passenger airbag “OFF” (see page 33).

If there is no passenger in the front seat, the airbag will be off. However, the Passenger Airbag Off indicator will not come on.

To ensure that the passenger’s advanced front airbag system will work properly, ***do not do anything that would increase or decrease the weight on the front passenger’s seat.*** This includes:

- A rear passenger pushing or pulling on the back of the passenger’s seat.

- Moving the front seat forcibly back against cargo on the seat or floor behind it.
- Hanging heavy items on the front passenger seat, or placing heavy items in the seat-back pocket.

### How Your Side Airbags Work

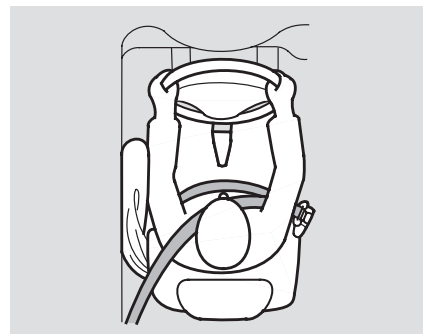

If you ever have a moderate to severe side impact, sensors will detect rapid acceleration and signal the control unit to instantly inflate either the driver’s or the passenger’s side airbag and activate the seat belt tensioner.

## Additional Information About Your Airbags

Only one airbag will deploy during a side impact. If the impact is on the passenger's side, the passenger's side airbag will deploy even if there is no passenger.

To get the best protection from the side airbags, front seat occupants should wear their seat belts and sit upright and well back in their seats.

### ***Side Airbag Cutoff System***

To reduce the risk of injury from an inflating side airbag, your vehicle has an automatic cutoff system for the passenger's side airbag.

Although Honda does not encourage children to ride in front, this system is designed to shut off the side airbag if a child leans into the side airbag's deployment path.

The side airbag may also shut off if a short adult leans sideways, or a larger adult slouches and leans sideways into the airbag's deployment path.

Objects placed on the front passenger seat can also cause the side airbag to be shut off.

If the Side Airbag Off Indicator comes on (see page 33), have the passenger sit upright. Once the passenger is out of the airbag's deployment path, the system will turn the airbag back on, and the indicator will go out.

There will be some delay between the moment the passenger moves into or out of the airbag deployment path and when the indicator comes on or goes off.

A front seat passenger should not use a cushion or other object as a backrest. It may prevent the cutoff system from working properly.



## Additional Information About Your Airbags

### How Your Side Curtain Airbags Work

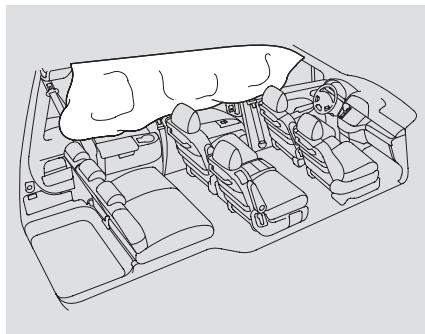

#### *In a Side Impact*

In a moderate to severe side impact, sensors will detect rapid acceleration and signal the control unit to instantly inflate the side curtain airbag and activate the seat belt tensioner on the driver's or the passenger's side of the vehicle.

If the impact is on the passenger's side, the passenger's side curtain airbag will inflate even if there are no occupants on that side of the vehicle.

#### *In a Rollover*

A rollover sensor monitors the degree and rate your vehicle may roll over and automatically deploy the side curtain airbags and activate the front seat belt tensioners (see page 23).

In a rollover toward the front passenger's side of the vehicle, both side curtain airbags will inflate and the front seat belt tensioners will activate even if there are no occupants on that side of the vehicle.

To get the best protection from the side curtain airbags, occupants should wear their seat belts and sit upright and well back in their seats.

### How the SRS Indicator Works



The SRS indicator alerts you to a potential problem with your airbags or seat belt tensioners.

When you turn the ignition switch to ON (II), this indicator will come on briefly then go out. This tells you the system is working properly.

If the indicator comes on at any other time, or does not come on at all, you should have the system checked by your dealer. For example:

- If the SRS indicator does not come on after you turn the ignition switch to ON (II).
- If the indicator stays on after the engine starts.
- If the indicator comes on or flashes on and off while you drive.

## Additional Information About Your Airbags

If you see any of these indications, the airbags and seat belt tensioners may not work properly when you need them.

### **⚠ WARNING**

Ignoring the SRS indicator can result in serious injury or death if the airbag systems or tensioners do not work properly.

Have your vehicle checked by a dealer as soon as possible if the SRS indicator alerts you to a possible problem.

### How the Side Airbag Off Indicator Works

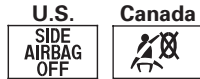

This indicator alerts you that the passenger's side airbag has been automatically shut off. It does **not** mean there is a problem with your side airbags.

When you turn the ignition switch to ON (II), the indicator should come on briefly and then go off (see page 64). If it doesn't come on, stays on, or comes on while driving without a passenger in the front seat, have the system checked.

### How the Passenger Airbag Off Indicator Works

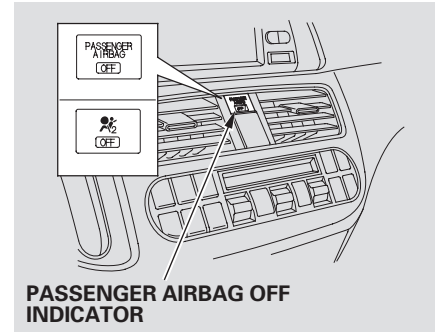

This indicator alerts you that the passenger's front airbag is shut off because weight sensors detect an infant or small child may be in the front passenger's seat. It does not mean there is a problem with the airbag.

CONTINUED

## Additional Information About Your Airbags

---

If no one is riding in the front seat, the airbag will be automatically shut off. However, the indicator will not come on.

If the indicator comes on with no passenger in the front, or with an adult in the seat, there may be a problem with the advanced airbag system. Have the vehicle checked by the dealer as soon as possible.

The Passenger Airbag Off indicator may also come on and off repeatedly if total weight on the seat is near the airbag cutoff threshold.

If this happens, have the passenger ride properly restrained in a back seat. If the passenger must ride in front, move the seat as far to the rear as possible, and have the passenger sit upright and wear the seat belt properly.

### Airbag Service

Your airbag systems are virtually maintenance free, and there are no parts you can safely service.

However, you must have your vehicle serviced if:

- **An airbag ever inflates.** Any airbag that has deployed must be replaced along with the control unit and other related parts. If a front airbag inflates, the seat belt tensioners must also be replaced.

Do not try to remove or replace any airbag by yourself. This must be done by your dealer or a knowledgeable body shop.

- **The SRS indicator alerts you to a problem.** Take your vehicle to an authorized dealer as soon as possible. If you ignore this indication, your airbags may not operate properly.

- **If your vehicle has a moderate to severe impact.** Even if your airbags do not inflate, your dealer should inspect the driver's seat position sensor and the front passenger's weight sensors to make sure they are operating properly.

## Additional Information About Your Airbags

### Additional Safety Precautions

- **Do not attempt to deactivate your airbags.** Together, airbags and seat belts provide the best protection.
- **Do not tamper with airbag components or wiring for any reason.** Tampering could cause the airbags to deploy, possibly causing very serious injury.
- **Do not remove or modify a front seat without consulting your dealer.** This could make the driver's seat position sensor or the front passenger's weight sensors ineffective. If it is necessary to remove or modify a front seat to accommodate a person with disabilities, first contact American Honda at 800-999-1009.
- **Do not cover or replace front seat-back covers without consulting your dealer.** Improperly replacing or covering front seat-back covers can prevent your side airbags from inflating during a side impact.

## Protecting Children – General Guidelines



Children depend on adults to protect them. However, despite their best intentions, many adults do not know how to properly protect child passengers.

If you have children, or ever need to drive with a child in your vehicle, be sure to read this section. It begins with important general guidelines, then presents special information for infants, small children, and larger children.

**All Children Must Be Restrained**  
Each year, many children are injured or killed in vehicle crashes because they are either unrestrained or not properly restrained. In fact, vehicle accidents are the number one cause of the death of children ages 12 and under.

To reduce the number of child deaths and injuries, every state and Canadian province requires that infants and children be properly restrained when they ride in a vehicle.

***Infants and small children must be restrained in an approved child seat that is properly secured to the vehicle*** (see pages [41](#) – [51](#)).

### **⚠ WARNING**

Children who are unrestrained or improperly restrained can be seriously injured or killed in a crash.

Any child too small for a seat belt should be properly restrained in a child seat. A larger child should be properly restrained with a seat belt and use a booster seat if necessary.

***Larger children must be restrained with a lap/shoulder belt and ride on a booster seat until the seat belt fits them properly*** (see pages [51](#) – [55](#)).

### All Children Should Sit in a Back Seat

According to accident statistics, children of all ages and sizes are safer when they are restrained in a back seat. The National Highway Traffic Safety Administration and Transport Canada recommend that all children age 12 and under be properly restrained in a back seat.

Children who ride in back are less likely to be injured by striking interior vehicle parts during a collision or hard braking. Also, children cannot be injured by an inflating front airbag when they ride in the back.

### The Passenger's Front Airbag Can Pose Serious Risks

Front airbags have been designed to help protect adults in a moderate to severe frontal collision. To do this the passenger's front airbag is quite large, and it can inflate with enough force to cause very serious injuries.

Even though your vehicle has an advanced front airbag system, which can automatically turn the passenger's front airbag off (see page 29), please follow the guidelines below.

#### **Infants**

***Never put a rear-facing child seat in the front seat of a vehicle equipped with a passenger's front airbag.*** If the airbag inflates, it can hit the back of the child seat with enough force to kill or very seriously injure an infant.

#### **Small Children**

***Placing a forward-facing child seat in the front seat of a vehicle equipped with a passenger's front airbag can be hazardous.*** If the vehicle seat is too far forward, or the child's head is thrown forward during a collision, an inflating front airbag can strike the child with enough force to kill or very seriously injure a small child.

#### **Larger Children**

***Children who have outgrown child seats are also at risk of being injured or killed by an inflating passenger's front airbag.*** Whenever possible, larger children should sit in the back seat, on a booster seat if needed, and be properly restrained with a seat belt. (See page 51 for important information about protecting larger children.)

# Protecting Children – General Guidelines

To remind you of the passenger's front airbag hazards, and that children must be properly restrained in a back seat, your vehicle has warning labels on the dashboard (U.S. models) and on the driver's and front passenger's visors. Please read and follow the instructions on these labels.

## U.S. Models



This Vehicle is Equipped with  
Advanced Air Bags

### Even with Advanced Air Bags

Children can be killed or seriously injured by the air bag.

The back seat is the safest place for children.

Never put a rear-facing child seat in the front.

Always use seat belts and child restraints.

See owner's manual for more information about air bags.

To be removed by owner only.

## Canadian Models

### CAUTION

TO AVOID SERIOUS INJURY:

- FOR MAXIMUM SAFETY PROTECTION IN ALL TYPES OF CRASHES, YOU MUST ALWAYS WEAR YOUR SAFETY BELT.
- DO NOT INSTALL REARWARD-FACING CHILD SEATS IN ANY FRONT PASSENGER SEAT POSITION.
- DO NOT SIT OR LEAN UNNECESSARILY CLOSE TO THE AIR BAG.
- DO NOT PLACE ANY OBJECTS OVER THE AIR BAG OR BETWEEN THE AIR BAG AND YOURSELF.
- SEE THE OWNER'S MANUAL FOR FURTHER INFORMATION AND EXPLANATIONS.

### PRECAUTIONS:

POUR EVITER DES BLESSURES GRAVES:

- POUR PROFITER D'UNE PROTECTION MAXIMALE LORS D'UNE COLLISION BOUCLEZ TOUJOURS VOTRE CEINTURE DE SECURITE.
- N'INSTALLEZ JAMAIS UN SIEGE POUR ENFANTS FAISANT FACE A L'ARRIERE SUR LE SIEGE DU PASSAGER AVANT.
- NE VOUS APPUYEZ PAS ET NE VOUS ASSOYEZ PAS PRES DU COUSSIN GONFLABLE.
- NE DEPOSEZ AUCUN OBJET SUR LE COUSSIN GONFLABLE OU ENTRE LE COUSSIN GONFLABLE ET VOUS.
- LISEZ LE GUIDE UTILISATEUR POUR DE PLUS AMPLES RENSEIGNEMENTS.

### If You Must Drive with Several Children

Your vehicle has two rows of back seats where children can be properly restrained. If you ever have to carry a group of children, and a child must ride in front:

- Place the largest child in the front seat, provided the child is large enough to wear the lap/shoulder belt properly (see page 52).
- Move the vehicle seat as far to the rear as possible (see page 13).
- Have the child sit upright and well back in the seat (see page 19).
- Make sure the seat belt is properly positioned and secured (see page 16).

### If a Child Requires Close Attention

Many parents say they prefer to put an infant or small child in the front passenger seat so they can watch the child, or because the child requires attention.

Placing a child in the front seat exposes the child to hazards in a frontal collision, and paying close attention to a child distracts the driver from the important tasks of driving, placing both of you at risk.

If a child requires close physical attention or frequent visual contact, we strongly recommend that another adult ride with the child in a back seat. The back seat is far safer for a child than the front.



## Protecting Children – General Guidelines

---

### Additional Safety Precautions

- **Never hold an infant or child on your lap.** If you are not wearing a seat belt in crash, you could be thrown forward and crush the child against the dashboard or a seat-back. If you are wearing a seat belt, the child can be torn from your arms and be seriously hurt or killed.
- **Never put a seat belt over yourself and a child.** During a crash, the belt could press deep into the child and cause serious or fatal injuries.
- **Never let two children use the same seat belt.** If they do, they could be very seriously injured in a crash.

- **Use childproof door locks to prevent children from opening the doors.** This can prevent children from accidentally falling out (see page 138).
- **Use the power sliding door main switch to prevent children from operating the sliding doors.** This will prevent unintended use of the doors.
- **Do not leave children alone in a vehicle.** Leaving children without adult supervision is illegal in most states and Canadian provinces, and can be very hazardous.

For example, infants and small children left in a vehicle on a hot day can die from heatstroke. A child left alone with the key in the ignition can accidentally set the vehicle in motion, possibly injuring themselves or others.

- **Lock all doors and tailgate when your vehicle is not in use.** Children who play in vehicles can accidentally get trapped inside. Teach your children not to play in or around vehicles.
- **Keep vehicle keys/remote transmitters out of the reach of children.** Even very young children learn how to unlock vehicle doors, turn on the ignition switch, and open the tailgate, which can lead to accidental injury or death.

## Protecting Infants

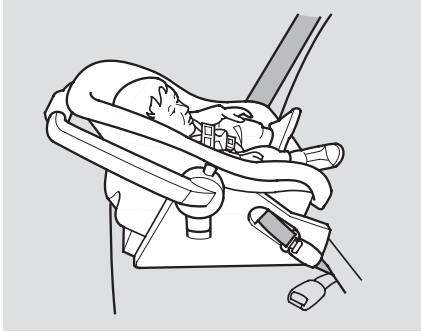

### ***Child Seat Type***

An infant must be properly restrained in a rear-facing, reclining child seat until the child reaches the seat maker's weight or height limit for the seat and the child is at least one year old.

Only a rear-facing child seat provides proper support for a baby's head, neck, and back.

Two types of seats may be used: a seat designed exclusively for infants, or a convertible seat used in the rear-facing, reclining mode.

***Do not put a rear-facing child seat in a forward-facing position.*** If placed facing forward, an infant could be very seriously injured during a frontal collision.

### ***Child Seat Placement***

A rear-facing child seat can be placed in any seating position in the back seat, but not in the front. Never put a rear-facing child seat in the front seat.

If the passenger's front airbag inflates, it can hit the back of the child seat with enough force to kill or seriously injure an infant.

When properly installed, a rear-facing child seat may prevent the driver or a front passenger from moving the seat as far back as recommended, or from locking the seat-back in the desired position.

Or, it can interfere with proper operation of the passenger's advanced front airbag system.

*CONTINUED*

## Protecting Infants and Small Children

In any situation, we strongly recommend that you install the child seat directly behind the front passenger's seat, move the seat as far forward as needed, and leave it unoccupied. Or, you may wish to get a smaller rear-facing child seat.

### **⚠ WARNING**

Placing a rear-facing child seat in the front seat can result in serious injury or death during a collision.

Always place a rear-facing child seat in the back seat, not the front.

### Protecting Small Children



#### *Child Seat Type*

A child who is at least one year old, and who fits within the child seat maker's weight and height limits, should be restrained in a forward-facing, upright child seat.

Of the different seats available, we recommend those that have a five-point harness system as shown.

#### *Child Seat Placement*

We strongly recommend placing a forward-facing child seat in a back seat, not the front.

Even with advanced front airbags, which can automatically turn the passenger's front airbag off (see page 29), a back seat is the safest place for a small child.

# Protecting Infants and Small Children, Selecting a Child Seat

If it is necessary to put a forward-facing child seat in the front, move the vehicle seat as far to the rear as possible, be sure the child seat is firmly secured to the vehicle, and the child is properly strapped in the seat.

## **WARNING**

Placing a forward-facing child seat in the front seat can result in serious injury or death if the front airbag inflates.

If you must place a forward-facing child seat in front, move the vehicle seat as far back as possible, and properly restrain the child.

## **Selecting a Child Seat**

When buying a child seat, you need to choose either a conventional child seat, or one designed for use with the Lower Anchors and Tethers for Children (LATCH) system.

Conventional child seats must be secured to a vehicle with a seat belt, whereas LATCH-compatible seats are secured by attaching the seat to hardware built into the two second-row seat and the center seating position of the third row.

Since LATCH-compatible child seats are easier to install and reduce the possibility of improper installation, we recommend selecting this style.

We also recommend selecting a LATCH-compatible seat with a rigid, rather than a flexible, anchor (see page 45 ).

In seating positions and vehicles not equipped with LATCH, a LATCH-compatible child seat can be installed using a seat belt.

*CONTINUED*

## Selecting a Child Seat, Installing a Child Seat

---

Whatever type of seat you choose, to provide proper protection, a child seat should meet three requirements:

- 1. The child seat should meet U.S. or Canadian Motor Vehicle Safety Standard 213.** Look for FMVSS 213 or CMVSS 213 on the box.
- 2. The child seat should be of the proper type and size to fit the child.** Rear-facing for infants, forward-facing for small children.
- 3. The child seat should fit the vehicle seating position (or positions) where it will be used.**

Before purchasing a conventional child seat, or using a previously purchased one, we recommend that you test the seat in the specific vehicle seating position, or positions, where the seat will be used.

### Installing a Child Seat

After selecting a proper child seat, and a good place to install the seat, there are three main steps in installing the seat:

- 1. Properly secure the child seat to the vehicle.** All child seats must be secured to the vehicle with the lap part of a lap/shoulder belt or with the LATCH (Lower Anchors and Tethers for Children) system. A child whose seat is not properly secured to the vehicle can be endangered in a crash.
- 2. Make sure the child seat is firmly secured.** After installing a child seat, push and pull the seat forward and from side to side to verify that it is secure.

A child seat secured with a seat belt should be installed as firmly as possible. However, it does not need to be “rock solid.” Some side-to-side

movement can be expected and should not reduce the child seat’s effectiveness.

If the child seat is not secure, try installing it in a different seating position, or use a different style of child seat that can be firmly secured.

- 3. Secure the child in the child seat.** Make sure the child is properly strapped in the child seat according to the child seat maker’s instructions. A child who is not properly secured in a child seat can be seriously injured in a crash.

The following pages provide guidelines on how to properly install a child seat. A forward-facing child seat is used in all examples, but the instructions are the same for rear-facing child seats.

## Installing a Child Seat with LATCH

Your vehicle is equipped with LATCH (Lower Anchors and Tethers for Children) in the two second row seats and the center seating position of the third row.

The lower anchors are located between the seat-back and seat bottom, and are to be used only with a child seat designed for use with LATCH.

The location of each lower anchor is indicated by a small button above the anchor point.

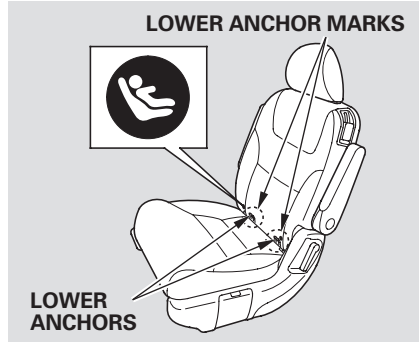

To install a LATCH-compatible child seat in a second row seat:

1. Move the seat belt buckle or tongue away from the lower anchors.
2. Make sure there are no objects near the anchors that could prevent a secure connection between the child seat and the anchors.

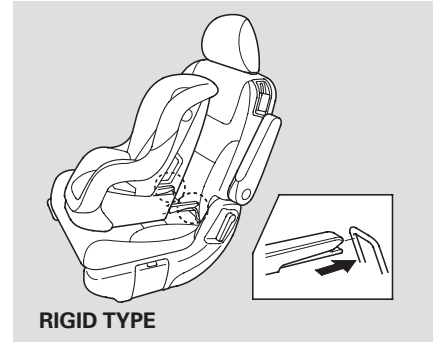

3. Place the child seat on the vehicle seat, then attach the seat to the lower anchors according to the child seat maker's instructions.

Some LATCH-compatible seats have a rigid-type connector as shown above.

CONTINUED

## Installing a Child Seat

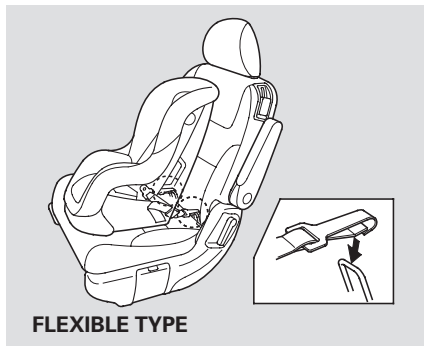

Other LATCH-compatible seats have a flexible-type connector as shown above.

4. Whatever type you have, follow the child seat maker's instructions for adjusting or tightening the fit.

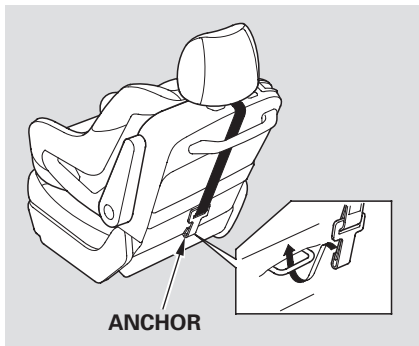

5. Lift the head restraint (see page [153](#)), then route the tether strap through the legs of the head restraint, over the seat-back, making sure the strap is not twisted.

6. Attach the tether strap hook to the tether anchor, then tighten the strap as instructed by the child seat maker.

7. Push and pull the child seat forward and from side to side to verify that it is secure.

To install a LATCH-compatible child seat in the center seating position of the third row:

1. Unlatch the detachable seat belt anchor and retract the seat belt all the way into the ceiling. Place the latch plate and anchor latch in their holding slots (see page 18).

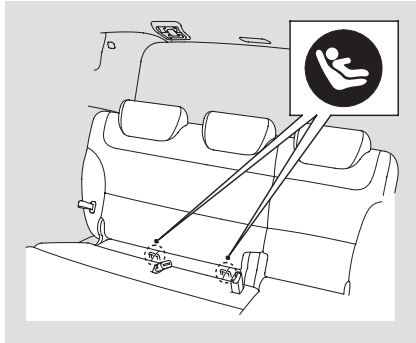

2. Follow steps 1 through 4 of the second row installation (see pages 45 and 46).

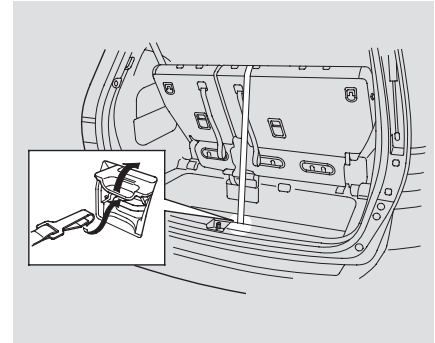

3. Remove the head restraint, then route the tether strap over the seat-back, making sure the strap is not twisted.
4. Slide the anchor cover to open it, then follow steps 6 and 7 of the second row installation (see page 46).



## Installing a Child Seat

### Installing a Child Seat with a Lap/Shoulder Belt

When not using the LATCH system, all child seats must be secured to the vehicle with the lap part of a lap/shoulder belt.

In addition, the lap/shoulder belts in all seating positions except the driver's have a locking mechanism that must be activated to secure a child seat.

If you intend to install a child seat in the center seating position of the third row, make sure the detachable seat belt anchor is securely latched.

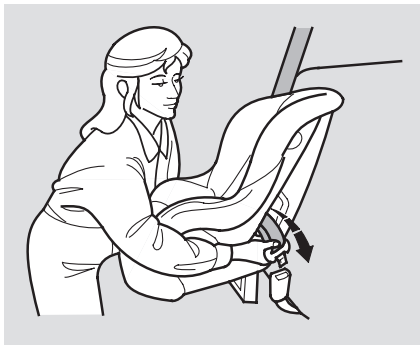

1. With the child seat in the desired seating position, route the belt through the child seat according to the seat maker's instructions, then insert the latch plate into the buckle.

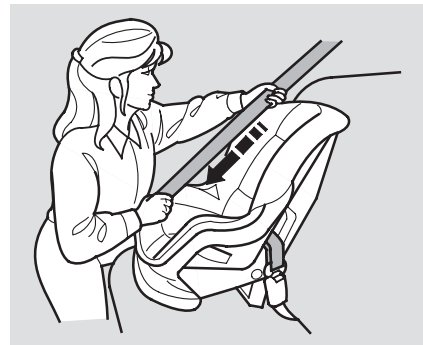

2. To activate the lockable retractor, slowly pull the shoulder part of the belt all the way out until it stops, then let the belt feed back into the retractor.
3. After the belt has retracted, tug on it. If the belt is locked, you will not be able to pull it out. If you can pull the belt out, it is not locked, and you will need to repeat these steps.



4. After confirming that the belt is locked, grab the shoulder part of the belt near the buckle, and pull up to remove any slack from the lap part of the belt. Remember, if the lap part of the belt is not tight, the child seat will not be secure.

To remove slack, it may help to put weight on the child seat, or push on the back of the seat while pulling up on the belt.

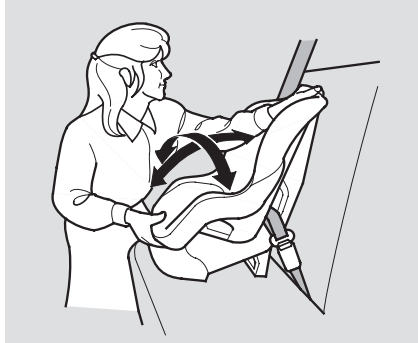

5. Push and pull the child seat forward and from side-to-side to verify that it is firmly secured. If the child seat is not secure, unlatch the belt, allow it to retract fully, then repeat these steps.

To deactivate the locking mechanism and remove a child seat, unlatch the buckle, unroute the seat belt, and let the belt fully retract.

## Installing a Child Seat

### Installing a Child Seat with a Tether

A child seat with a tether can be installed in any seating position in the second or the center seating position of the third row.

Since a tether can provide additional security, we recommend using a tether whenever one is required or available.

### *Second Row Installation*

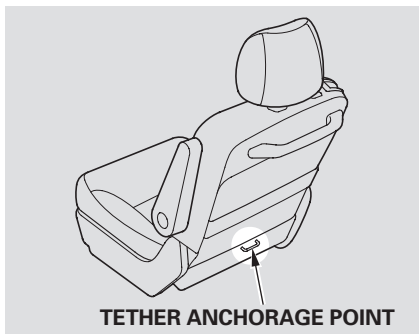

Each second row bucket seat has a tether anchorage point at the bottom of the seat-back.

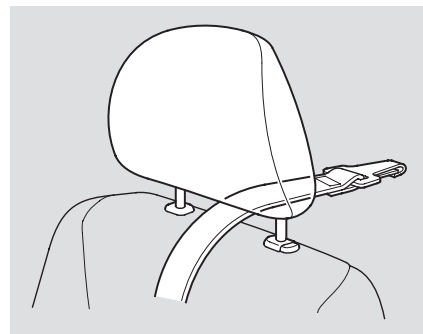

1. After properly securing the child seat (see page 48 ), lift the head restraint, then route the tether strap over the seat-back and through the head restraint legs.

# Installing a Child Seat, Protecting Larger Children

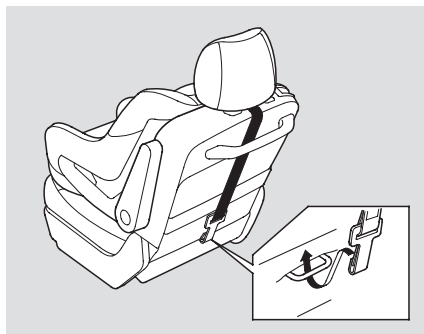

2. Attach the tether strap hook to the anchor, making sure the strap is not twisted.
3. Tighten the strap according to the seat maker's instructions.

## Third Row Installation

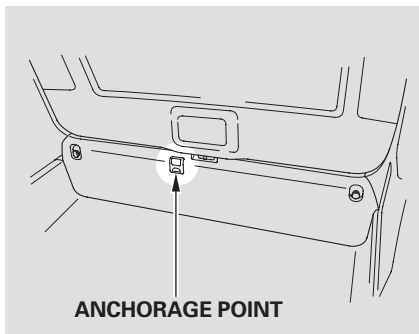

The center seating position of the third row has an anchorage point on the tailgate sill.

1. Remove the bead restraint, then route the tether strap over the seat-back.
2. Slide the anchor cover to open it.
3. Follow step 2 and 3 of the second row installation.

## Protecting Larger Children

When a child reaches the recommended weight or height limit for a forward-facing child seat, the child should sit in a back seat on a booster seat and wear a lap/shoulder belt.

The following pages give instructions on how to check proper seat belt fit, what kind of booster seat to use if one is needed, and important precautions for a child who must sit in front.

CONTINUED

## Protecting Larger Children

### **⚠ WARNING**

Allowing a child age 12 or under to sit in front can result in injury or death if the passenger's front airbag inflates.

If a child must ride in front, move the vehicle seat as far back as possible, use a booster seat if needed, have the child sit up properly and wear the seat belt properly.

### Checking Seat Belt Fit



To determine if a lap/shoulder belt properly fits a child, have the child put on the seat belt, then ask yourself:

1. Does the child sit all the way back against the seat?
2. Do the child's knees bend comfortably over the edge of the seat?

3. Does the shoulder belt cross between the child's neck and arm?
4. Is the lap part of the belt as low as possible, touching the child's thighs?
5. Will the child be able to stay seated like this for the whole trip?

If you answer yes to all these questions, the child is ready to wear the lap/shoulder belt correctly. If you answer no to any question, the child needs to ride on a booster seat.

### Using a Booster Seat



A child who has outgrown a forward-facing child seat should ride in a back seat and use a booster seat until the lap/shoulder belt fits them properly without the booster.

Some states also require children to use a booster seat until they reach a given age or weight (e.g., 6 years or 60 lbs). Be sure to check current laws in the state or states where you intend to drive.

Booster seats can be high-back or low-back. Whichever style you select, make sure the booster meets federal safety standards (see page 37) and that you follow the booster seat maker's instructions.

If a child who uses a booster seat must ride in front, move the vehicle seat as far to the rear as possible, and be sure the child is wearing the seat belt properly.

A child may continue using a booster seat until the tops of their ears are even with the top of the vehicle's or booster's seat-back. A child of this height should be tall enough to use the lap/shoulder belt without a booster seat.

### When Can a Larger Child Sit in Front

The National Highway Traffic Safety Administration and Transport Canada recommend that all children age 12 and under be properly restrained in a back seat.

If the passenger's airbag inflates in a moderate to severe frontal collision, the airbag can cause serious injuries to a child who is unrestrained, improperly restrained, sitting too close to the airbag, or out of position.

A side airbag also poses risks. If any part of a larger child's body is in the path of a deploying side airbag, the child could receive possibly serious injuries.

## Protecting Larger Children

---

Of course, children vary widely. And while age may be one indicator of when a child can safely ride in the front, there are other important factors you should consider.

### ***Physical Size***

Physically, a child must be large enough for the lap/shoulder belt to properly fit (see page 52 ). If the seat belt does not fit properly, with or without the child sitting on a booster seat, the child should not sit in front.

### ***Maturity***

To safely ride in front, a child must be able to follow the rules, including sitting properly, and wearing the seat belt properly throughout a ride.

If you decide that a child can safely ride up front, be sure to:

- Carefully read the owner's manual, and make sure you understand all seat belt instructions and all safety information.
- Move the vehicle seat to the rear-most position.
- Have the child sit up straight, back against the seat, and feet on or near the floor.
- Check that the child's seat belt is properly and securely positioned.
- Supervise the child. Even mature children sometimes need to be reminded to fasten the seat belts or sit properly.

### **Additional Safety Precautions**

***Do not let a child wear a seat belt across the neck.*** This could result in serious neck injuries during a crash.

***Do not let a child put the shoulder part of a seat belt behind the back or under the arm.*** This could cause very serious injuries during a crash. It also increases the chance that the child will slide under the belt in a crash and be injured.

***Do not put any accessories on a seat belt.*** Devices intended to improve a child's comfort or reposition the shoulder part of a seat belt can make the belt less effective and increase the chance of serious injury in a crash.



## Carbon Monoxide Hazard

---

Your vehicle's exhaust contains carbon monoxide gas. You should have no problem with carbon monoxide entering the vehicle in normal driving if you maintain your vehicle properly.

Have the exhaust system inspected for leaks whenever:

- The vehicle is raised for an oil change.
- You notice a change in the sound of the exhaust.
- The vehicle was in an accident that may have damaged the underside.

### **WARNING**

Carbon monoxide gas is toxic. Breathing it can cause unconsciousness and even kill you.

Avoid any enclosed areas or activities that expose you to carbon monoxide.

High levels of carbon monoxide can collect rapidly in enclosed areas, such as a garage. Do not run the engine with the garage door closed. Even with the door open, run the engine only long enough to move the vehicle out of the garage.

With the tailgate open, air flow can pull exhaust gas into your vehicle's interior and create a hazardous condition. If you must drive with the tailgate open, open all the windows and set the heating and cooling system/climate control system as shown below.

If you must sit in your parked vehicle, even in an unconfined area, adjust the heating and cooling system/climate control system as follows:

1. Select the fresh air mode.
2. Select the  mode.
3. Turn the fan on high speed.
4. Set the temperature control to a comfortable setting.

These labels are in the locations shown. They warn you of potential hazards that could cause serious injury. Read these labels carefully.

If a label comes off or becomes hard to read (except for the U.S. dashboard label which is removed by the owner), contact your dealer for a replacement.

## HOOD

**▲ WARNING**  
 Accidental deployment can seriously hurt or kill you.  
 Follow Service Manual instructions carefully.

**▲ ATTENTION**  
 Un déploiement accidentel risque de causer de graves blessures, voire la mort.  
 Suivre attentivement les instructions du manuel de réparation.

## DASHBOARD

*U.S. models only*

**This Vehicle is Equipped with Advanced Air Bags**

---

**Even with Advanced Air Bags**  
 Children can be killed or seriously injured by the air bag.  
 The back seat is the safest place for children.  
 Never put a rear-facing child seat in the front.  
 Always use seat belts and child restraints.  
 See owner's manual for more information about air bags.

To be removed by owner only.

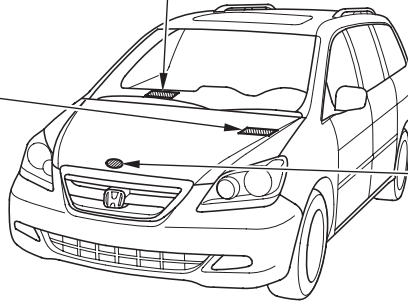

## RADIATOR CAP

**▲ DANGER**  
**▲ WARNING**  
 危険

▶ NEVER OPEN WHEN HOT.  
 Hot coolant will scald you.  
 ▶ N'OUVREZ PAS QUAND CHAUD.  
 ▶ NICHT BEI HEISSEM MOTOR ÖFFNEN.  
 ▶ 熱い時あけないで下さい。  
 ▶ 高温時、請勿打开。

**1.1**

CONTINUED

## SUN VISOR

### U.S. models

**▲ WARNING**  
**EVEN WITH ADVANCED AIR BAGS**



- Children can be killed or seriously injured by the air bag
- The back seat is the safest place for children
- Never put a rear-facing child seat in the front
- Always use seat belts and child restraints
- See owner's manual for more information about air bags

### Canadian models

**CAUTION**  
 TO AVOID SERIOUS INJURY:

- FOR MAXIMUM SAFETY PROTECTION IN ALL TYPES OF CRASHES, YOU MUST ALWAYS WEAR YOUR SAFETY BELT
- DO NOT INSTALL REARWARD-FACING CHILD SEATS IN ANY FRONT PASSENGER SEAT POSITION.
- DO NOT SIT OR LEAN UNNECESSARILY CLOSE TO THE AIR BAG.
- DO NOT PLACE ANY OBJECTS OVER THE AIR BAG OR BETWEEN THE AIR BAG AND YOURSELF.
- SEE THE OWNER'S MANUAL FOR FURTHER INFORMATION AND EXPLANATIONS.

**PRECAUTIONS:**  
 POUR ÉVITER DES BLESSURES GRAVES:

- POUR PROFITER D'UNE PROTECTION MAXIMALE EN CAS D'UNE COLLISION, PORTÉZ TOUJOURS VOTRE CEINTURE DE SÉCURITÉ.
- N'INSTALLÉZ JAMAIS UN SIÈGE POUR ENFANTS FAISANT FACE À L'ARRIÈRE SUR LE SIÈGE DU PASSAGER AVANT.
- NÉ VOUS APPUYEZ PAS ET NE VOUS ASSOYEZ PAS PRÈS DU COUSSIN GONFLABLE.
- NÉ VOUS ADRESSER AUCUN OBJET SUR LE COUSSIN GONFLABLE ET VOUS.
- LISEZ LE GUIDE UTILISATEUR POUR DE PLUS AMPLES RENSEIGNEMENTS.

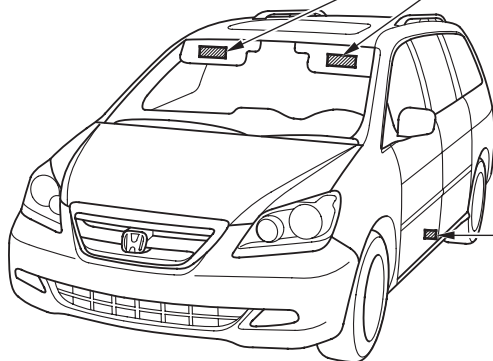

## DOORJAMB

### U.S. models

**SIDE AIRBAG**

- This car is equipped with side airbags in the front seats and side curtain airbags.
- Do not lean against the door.
- See owner's manual for more information.

### Canadian models

**SIDE AIRBAG**

- This car is equipped with side airbags in the front seats and side curtain airbags.
- Do not lean against the door.
- See owner's manual for more information.

**COUSSIN GONFLABLE LATÉRAL**

- Cette automobile est équipée de coussins gonflables latéraux dans les sièges avant ainsi que de coussins gonflables latéraux de type rideau.
- Né vous appuyez pas sur la porte.
- Consultez le Manuel du propriétaire pour en savoir plus.

This section gives information about the controls and displays that contribute to the daily operation of your vehicle. All the essential controls are within easy reach.

Control Locations .....	60		
Instrument Panel .....	61	Seat Heaters .....	160
Instrument Panel Indicators.....	63	Driver's Seat Position Memory System.....	161
Gauges .....	71	Power Windows .....	163
Multi-Information Display .....	74	Moonroof .....	166
Controls Near the Steering Wheel .....	120	Mirrors .....	167
Windshield Wipers and Washers .....	121	Parking Brake .....	169
Rear Window Wiper and Washer.....	122	Adjustable Driver's Foot Pedals ..	169
Turn Signal and Headlights.....	122	Interior Convenience Items.....	170
Instrument Panel Brightness .....	125	Retractable Center Tray .....	171
Hazard Warning Button.....	126	Beverage Holders.....	171
Rear Window Defogger .....	126	Integrated Sunshade .....	173
Steering Wheel Adjustment .....	127	Sunglasses Holder .....	174
Keys and Locks.....	128	Conversation Mirror .....	174
Immobilizer System.....	129	Sun Visor .....	175
Ignition Switch .....	130	Vanity Mirror .....	175
Remote Transmitter .....	131	Rear Compartment.....	175
Door Locks .....	137	Removable Second Row Console .....	176
Power Door Locks.....	137	In-Floor Storage Area.....	177
Childproof Door Locks .....	138	Lower Glove Box .....	180
Tailgate .....	138	Upper Glove Box .....	180
Power Tailgate .....	139	Center Pocket .....	181
Sliding Doors.....	142	Accessory Power Sockets.....	182
Seats .....	148	AC Power Outlet.....	182
		Interior Lights.....	183

# Control Locations

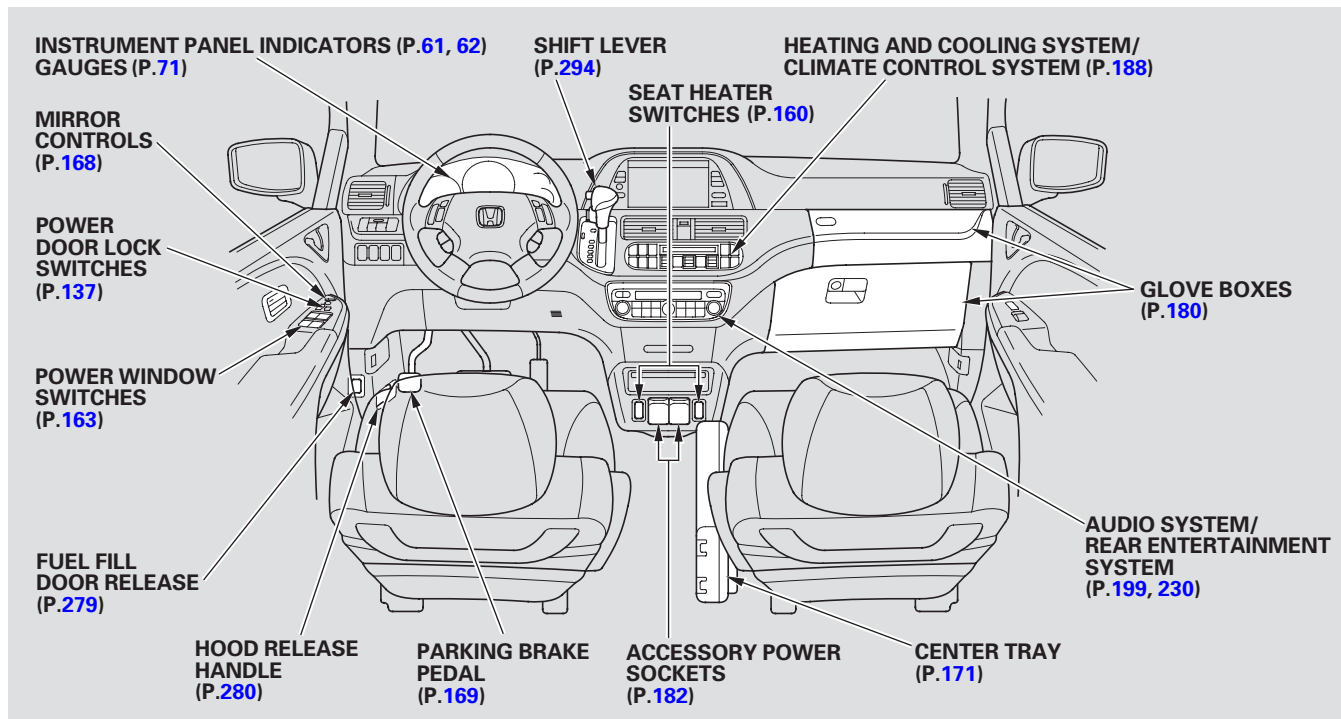

# Instrument Panel

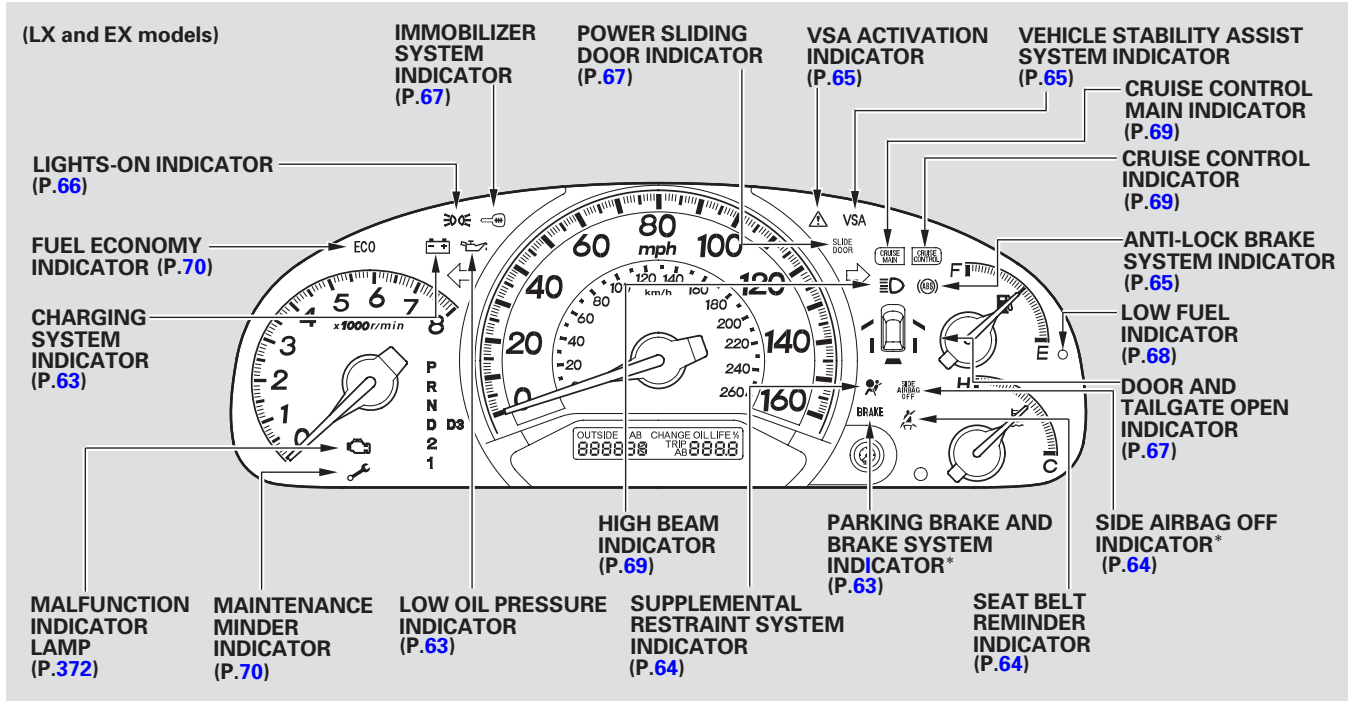

Instruments and Controls

\* The U.S. instrument panel is shown. Differences for the Canadian models are noted in the text.

# Instrument Panel

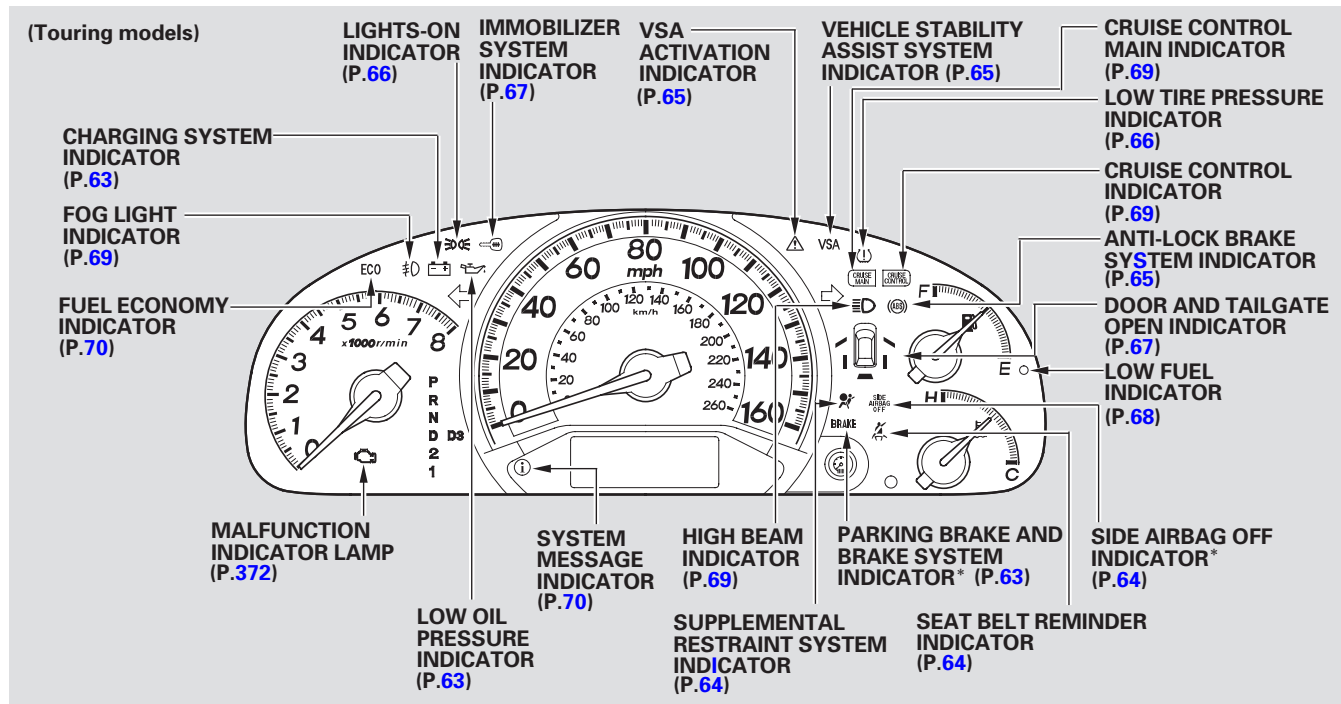

\* The U.S. instrument panel is shown. Differences for the Canadian models are noted in the text.

The instrument panel has many indicators to give you important information about your vehicle.



## Malfunction Indicator Lamp

See page [372](#).



## Low Oil Pressure Indicator

The engine can be severely damaged if this indicator flashes or stays on when the engine is running. For more information, see page [371](#). On the Touring model, you will also see a “CHECK ENGINE OIL LEVEL” message in the multi-information display.



## Charging System Indicator

If this indicator comes on when the engine is running, the battery is not being charged. For more information, see page [371](#).

On the Touring model, you will also see a “CHECK CHARGING SYSTEM” message in the multi-information display.

U.S.



Canada



## Parking Brake and Brake System Indicator

This indicator has two functions:

1. It comes on when you turn the ignition switch to ON (II). It is a reminder to check the parking brake. Driving with the parking brake not fully released can damage the brakes and tires.

2. If it stays on after you fully release the parking brake while the engine is running, or if it comes on while driving, there could be a problem with the brake system. For more information, see page [373](#).

If you drive without releasing the parking brake, a chime will sound. On the Touring model, you will also see a “RELEASE PARKING BRAKE” message in the multi-information display.



## Instrument Panel Indicators



### Seat Belt Reminder Indicator

This indicator comes on when you turn the ignition switch to ON (II). It reminds you and your passengers to fasten your seat belts. A beeper also sounds if you have not fastened your seat belt.

If you turn the ignition switch to ON (II) before fastening your belt, the beeper sounds and the indicator flashes. If you do not fasten your seat belt before the beeper stops, the indicator stops flashing but remains on.

If you continue driving without fastening your seat belt, the beeper sounds and the indicator flashes again at regular intervals. On the Touring model, you will also see a “FASTEN SEAT BELT” message in the multi-information display.



### Supplemental Restraint System Indicator

This indicator comes on briefly when you turn the ignition switch to ON (II). If it comes on at any other time, it indicates a potential problem with your front airbags. This indicator will also alert you to a potential problem with your side airbags, passenger’s side airbag automatic cutoff system, side curtain airbags, automatic seat belt tensioners, driver’s seat position sensor, or the front passenger’s weight sensors. For more information, see page 32 .

On the Touring model, you will also see a “CHECK AIRBAG SYSTEM” message in the multi-information display.



U.S.

SIDE  
AIRBAG  
OFF



Canada

SIDE AIRBAG OFF

### Side Airbag Off Indicator

This indicator comes on when you turn the ignition switch to ON (II). If it comes on at any other time, it indicates that the passenger’s side airbag has automatically shut off. For more information, see page 33 .

On the Touring model, you will also see a “PASSENGER SIDE AIRBAG OFF” message in the multi-information display.



## Anti-lock Brake System (ABS) Indicator

This indicator normally comes on for a few seconds when you turn the ignition switch to ON (II), and when the ignition switch is turned to START (III). If it comes on at any other time, there is a problem in the ABS; have your vehicle checked at a dealer. With the ABS indicator on, your vehicle still has normal braking ability but no anti-lock braking. For more information, see page [300](#).

On the Touring model, you will also see a “CHECK ABS SYSTEM” message in the multi-information display.



## Vehicle Stability Assist (VSA) System Indicator

This indicator normally comes on for a few seconds when you turn the ignition switch to ON (II).

If it comes on and stays on at any other time or it does not come on when you turn the ignition switch to ON (II), there is a problem with the VSA system. Take your vehicle to a dealer to have it checked. Without VSA, your vehicle still has normal driving ability, but will not have VSA traction and stability enhancement. On the Touring model, you will also see a “CHECK VSA SYSTEM” message in the multi-information display.

For more information, see page [301](#).



## VSA Activation Indicator

This indicator has three functions:

1. It comes on as a reminder that you have turned off the vehicle stability assist (VSA) system.
2. It flashes when VSA is active (see page [301](#)).
3. It comes on along with the VSA system indicator if there is a problem with the VSA system. On the Touring model, you will also see a “CHECK VSA SYSTEM” message in the multi-information display.

This indicator normally comes on for a few seconds when you turn the ignition switch to ON (II). See page [301](#) for more information.

*CONTINUED*

## Instrument Panel Indicators



### Low Tire Pressure Indicator

*On U.S. Touring model only*

This indicator normally comes on for a few seconds when you turn the ignition switch to ON (II).

If it comes on while driving, it means that one or more of your vehicle's tires are extremely low on pressure. You will also see a "LOW TIRE PRESSURE" message on the multi-information display. The multi-information display will show you which tire has lost the pressure and how much pressure it has lost (see page [303](#)).

If this happens, pull to the side of the road when it is safe, check which tire has lost pressure on the multi-information display, and determine the cause. If it is because of a flat tire, have the flat tire repaired as soon as possible. If two or more tires are underinflated, call a professional towing service (see page [381](#)). For



more information, see page [303](#).

Your vehicle has Michelin PAX tires. Repair or replacement of PAX tires must be done by a Honda dealer or an authorized Michelin PAX system dealer. For more information, see page [356](#).



### Lights On Indicator

*On EX and Touring models*

This indicator reminds you that the exterior lights are on. It comes on when the light switch is in either the  or  position. If you turn the ignition switch to ACCESSORY (I) or LOCK (0) without turning off the light switch, this indicator will remain on. A reminder chime will also sound when you open the driver's door.

On the Touring model, this indicator also comes on when the light switch is in AUTO and the lights turn on automatically.



## Immobilizer System Indicator

This indicator comes on for a few seconds when you turn the ignition switch to ON (II). It will go off if you have inserted a properly-coded ignition key. If it is not a properly-coded key, the indicator will blink and the engine will not start (see page [129](#)).

This indicator also blinks several times when you turn the ignition switch from ON (II) to ACCESSORY (I) or LOCK (0).



## Power Sliding Door Indicator

*On EX model only*

This indicator comes on for a few seconds when you turn the ignition switch to ON (II). If it comes on at any other time, there is a problem in the power sliding door system. With this indicator on, move the main switch on the dashboard to the OFF position, and have the system checked by your dealer as soon as possible. You can still open or close each sliding door manually. For more information on the power sliding doors, see page [142](#).

On the Touring model, you will also see a “CHECK LEFT SLIDING DOOR” or “CHECK RIGHT SLIDING DOOR” message in the multi-information display.

## Door and Tailgate Open Monitor

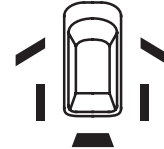

The appropriate light comes on in this display if the tailgate or any door is not closed tightly.

All the lights in the monitor come on for a few seconds when you turn the ignition switch to ON (II).

## Instrument Panel Indicators



### Turn Signal and Hazard Warning Indicators

The left or right turn signal indicator blinks when you signal a lane change or turn. If the indicators do not blink or blink rapidly, it usually means one of the turn signal bulbs is burned out (see page 338). Replace the bulb as soon as possible, since other drivers cannot see that you are signaling.

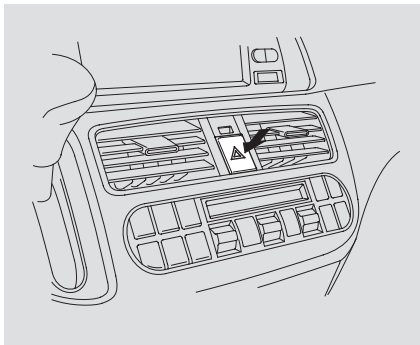

When you press the hazard warning button, both turn signal indicators and all turn signals on the outside of the vehicle flash.

### Low Fuel Indicator

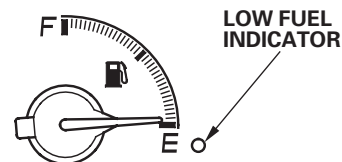

This indicator comes on as a reminder that you must refuel soon.

On the Touring model, you will also see a “FUEL LOW” message in the multi-information display.



## High Beam Indicator

This indicator comes on with the high beam headlights. For more information, see page [123](#).

On Canadian models, this indicator comes on with reduced brightness when the daytime running lights (DRL) are on (see page [125](#)).



## Fog Light Indicator

*Touring model only*

This indicator comes on when you turn on the fog lights. See page [123](#) for information on fog light operation.



## “Daytime Running Lights” Indicator

*Canadian models only*

This indicator comes on when you turn the ignition switch to ON (II) with the headlight switch off and the parking brake set. It should go off if you turn on the headlights or release the parking brake. If it comes on at any other time, it means there is a problem with the DRL. There may also be a problem with the high beam headlights.

On the Touring model, you will also see a “CHECK DRL SYSTEM” in the multi-information display.



## Cruise Main Indicator

This indicator comes on when you turn on the cruise control system by pressing the master button (see page [264](#)).



## Cruise Control Indicator

This indicator comes on when you set the cruise control. See page [264](#) for information on operating the cruise control.



## Washer Level Indicator

*Canadian models only*

This indicator comes on when the washer fluid level is low. Add washer fluid when you see this indicator comes on (see page [333](#)).

On the Touring model, you will also see a “WASHER FLUID LOW” message in the multi-information display.

## Instrument Panel Indicators

---

**ECO**

### Fuel Economy Indicator

*On EX with leather and Touring models*

While the engine is operating in its most economical range, this indicator comes on and stays on. It goes off when your vehicle uses extra fuel.



### Maintenance MINDER Indicator

*On LX and EX models*

This indicator reminds you that the maintenance main items and sub items will be displayed in the odometer/trip meter display. See page 315 for more information on the maintenance minder.

This indicator goes off when your dealer resets it after completing the required maintenance service.



### System Message Indicator

*On Touring model*

This indicator comes on when there is a system message in the multi-information display. Press the INFO button on the steering wheel to see the message (see page 79).

Most of the time, this indicator comes on along with other indicators in the instrument panel such as the seat belt reminder indicator, SRS indicator, VSA system indicator, etc.

## LX and EX models

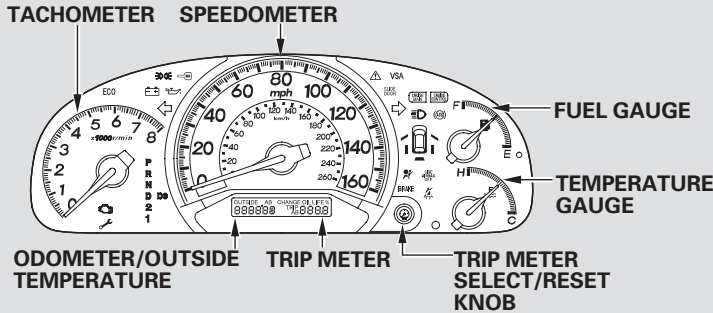

## Touring model

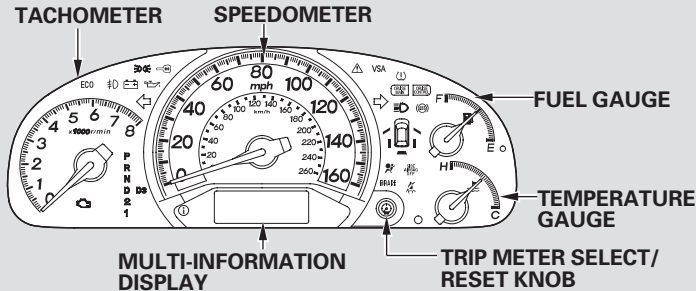

### Temperature Gauge

This shows the temperature of the engine's coolant. During normal operation, the pointer should rise to about the middle of the gauge. In severe driving conditions, the pointer may rise to the upper zone. If it reaches the red (hot) mark, pull safely to the side of the road. For instructions and precautions on checking the engine's cooling system, see page 369.

### Fuel Gauge

This shows how much fuel you have. It may show slightly more or less than the actual amount. The needle returns to the bottom after you turn off the ignition.

### NOTICE

*Avoid driving with an extremely low fuel level. Running out of fuel could cause the engine to misfire, damaging the catalytic converter.*



## Gauges

---

### Odometer

The odometer shows the total distance your vehicle has been driven. It measures miles in U.S. models and kilometers in Canadian models. It is illegal under U.S. federal law and Canadian provincial regulations to disconnect, reset, or alter the odometer with the intent to change the number of miles or kilometers indicated.

### Trip Meter

This meter shows the number of miles (U.S.) or kilometers (Canada) driven since you last reset it.

There are two trip meters: Trip A and Trip B. Switch between these displays and the outside temperature display by pressing the Select/Reset knob repeatedly.

Each trip meter works independently, so you can keep track of two different distances.

To reset a trip meter, display it and then press and hold the Select/Reset knob until the number resets to “0.0.” Both trip meters will reset if the vehicle’s battery goes dead or is disconnected.

### Outside Temperature Indicator

*If equipped*

This indicator displays the outside temperature in Fahrenheit (U.S. models) or Centigrade (Canadian models). To see the outside temperature, press and release the Select/Reset button until the temperature is displayed.

The temperature sensor is in the front bumper. The temperature reading can be affected by heat reflection from the road surface, engine heat, and the exhaust from surrounding traffic. This can cause an incorrect temperature reading when your speed is under 19 mph (30 km/h). When you start your trip, the sensor is not fully acclimatized, therefore it may take several minutes until the proper temperature is displayed.

In certain weather conditions, temperature readings near freezing (32°F, 0°C) could mean that ice is forming on the road surface.

On the Touring model, the odometer, trip meter, and the outside temperature indicator are displayed in the multi-information display. See page [77](#) for more information.

## **Check Fuel Cap Indicator** (Odometer/trip meter message)

*On LX and EX models*

If your fuel cap is loose or missing, a “CHECK FUEL CAP” message appears as text in the odometer/trip meter display after you start the engine. Turn the engine off and confirm the fuel cap is installed. If it is, loosen the cap, then retighten it at least 3 clicks. When you restart the engine, the message appears again. To clear the message, press and hold the select/reset button until the message is replaced in the odometer/trip meter display.

If the system still detects a loose or missing fuel cap, the Malfunction Indicator Lamp (MIL) comes on. Turn the engine off and check or retighten the fuel cap at least 3 clicks. The MIL goes out after 3 days of normal driving once the cap is tightened or replaced. If it does not go out, have your dealer inspect the vehicle. For more information, see page [372](#).

## Multi-Information Display

---

### *On Touring model only*

The multi-information display in the instrument panel displays various information and messages when the ignition switch is in the ON (II) position. Some of the messages help you operate your vehicle more comfortably.

Others help to keep you aware of the periodic maintenance your vehicle needs for continued trouble-free driving.

There are four types of messages; normal display messages, engine oil life and maintenance messages, system messages, and PAX system warning messages.

You can also customize some vehicle control settings to your liking with the multi-information display and the two buttons on the steering wheel (see page 89 ).

### Normal Display Messages



When you unlock and open the driver's door with the key, the display shows "Welcome DRIVER 1" or "Welcome DRIVER 2" depending on which remote transmitter was used last. (The driver's "ID" is detected by the transmitter.)

If you use the remote transmitter to unlock the driver's door, the display shows "Welcome DRIVER 1" or "Welcome DRIVER 2" depending on



which remote transmitter you use, and the driver's seat moves to the position stored in that transmitter.

When you turn the ignition switch to LOCK (0) and remove the key from the ignition switch, the display shows "Goodbye."

## Multi-Information Display

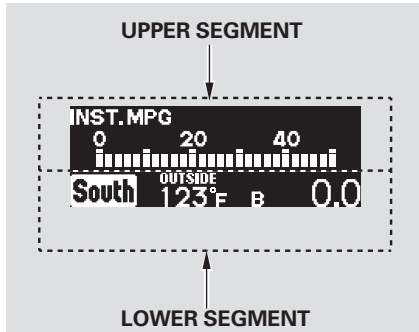

The multi-information display consists of an upper segment and a lower segment. Each segment can display two lines of messages.

In normal display mode, the upper segment displays trip computer and tire pressures, and the lower segment displays the compass, odometer, trip meter, outside temperature, and engine oil life.

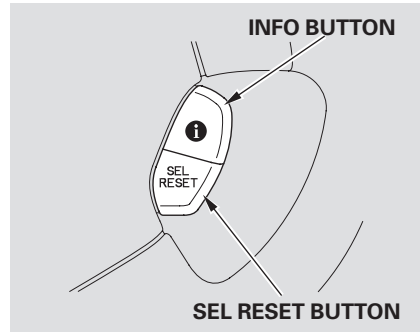

In normal display mode, the upper display is blank when you turn the ignition switch to ON (II). Then each time you press the INFO button, the trip computer changes from "INST. MPG" to "RANGE" to "ELAPSED TIME" to "AVERAGE SPEED" and then to "AVERAGE FUEL A" or "AVERAGE FUEL B" as shown on the next page.

If you press the INFO button when "AVERAGE SPEED" is displayed, the display changes to "TIRE PRESSURE" using both segments. This display is a part of tire pressure monitoring system (TPMS). See page 303 for more information.

Pressing the INFO button again brings the display back to the initial display of the trip computer "INST. MPG."

CONTINUED

## Multi-Information Display

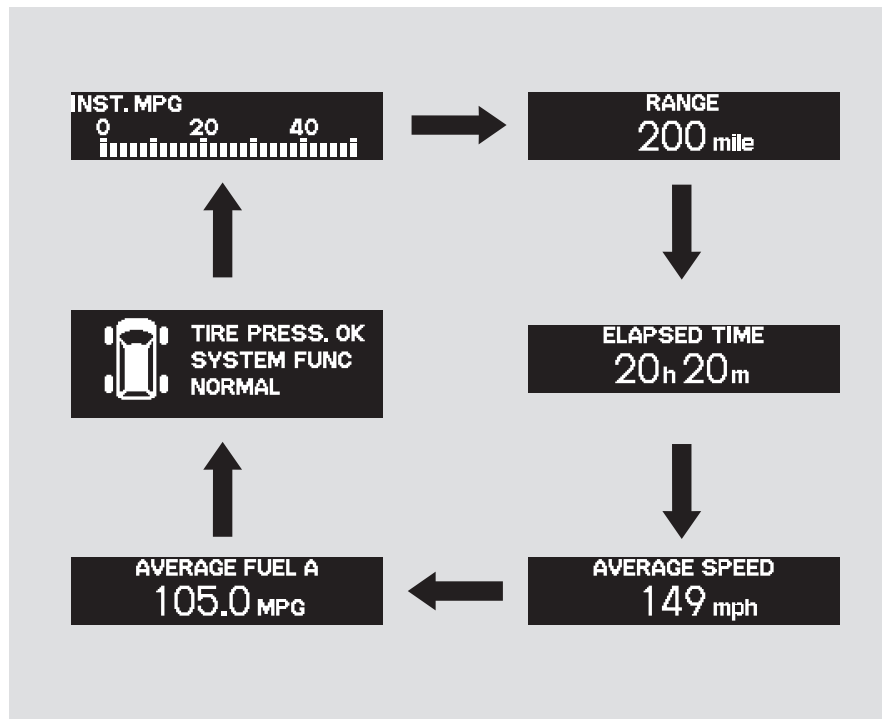

Messages in the trip computer include:

- **INST. MPG:** Your vehicle's current fuel mileage.
- **RANGE:** The estimated distance you can travel on the fuel remaining in the tank. This distance is estimated from the fuel economy you received over the last several miles, so it will vary with changes in speed, traffic, etc.
- **ELAPSED TIME:** The time traveled since you last reset the trip computer.
- **AVERAGE SPEED:** The average speed you are traveling.
- **AVERAGE FUEL A/AVERAGE FUEL B:** Your vehicle's average fuel economy since you last reset the trip computer.

To reset the values in the trip computer, press the Select/Reset button, and hold it for about 1 second.

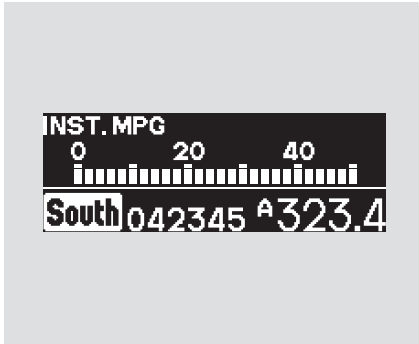

The initial display in the lower segment is shown above. Each time you press the SEL/RESET button on the steering wheel, the display changes from “Odometer/Trip Meter” to “Outside Temperature/Trip Meter” to “Engine Oil Life”, and then back to the initial display as shown in the next column.

In the lower left corner of the display, a compass indicates which direction your vehicle is pointed.

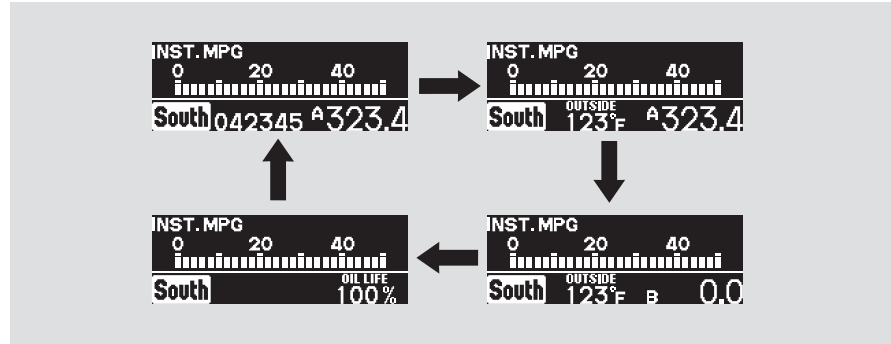

## Trip Meter

While a trip meter is displayed, you can change the display between “TRIP A” and “TRIP B” by pressing the Select/Reset knob in the instrument panel (see page 72 ). To reset a trip meter, display it, and press and hold the Select/Reset knob until the number resets to “0.0.”

“AVERAGE FUEL A” or “AVERAGE FUEL B” will be displayed when average fuel economy is selected in the upper segment depending on which trip meter (TRIP A or TRIP B) is displayed in the lower segment.

# Multi-Information Display

## Engine Oil Life

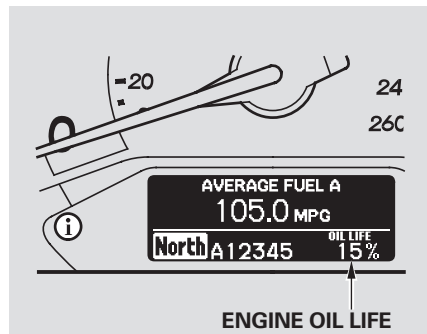

This shows the remaining life of the engine oil. It shows 100% after the engine oil is replaced and the display is reset. The engine oil life is calculated based on engine operating conditions and accumulated engine revolutions.

## Maintenance Messages

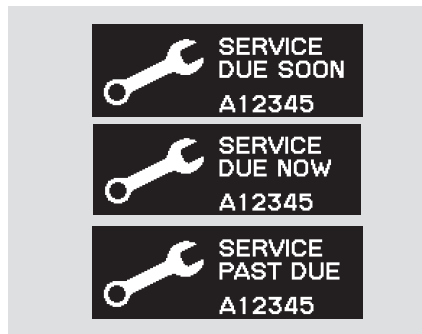

When the engine oil life reaches 15 percent, the display shows “SERVICE DUE SOON” and the code for the maintenance items to be performed.

When the engine oil life reaches 5 percent, the display shows “SERVICE DUE NOW” along with the same maintenance items.

Have your dealer do the indicated maintenance as soon as you see this message, and have them reset the display after completing the service.

If you do not perform the indicated maintenance or do not reset the display, the message changes to “SERVICE PAST DUE” when the engine oil life becomes 0 percent.

These messages appear on the multi-information display each time you turn the ignition switch to ON (II).

For details on engine oil life and maintenance messages, refer to page [317](#).

Also refer to page [314](#) for important maintenance safety precautions.

## System Messages

If there is a problem with your vehicle, for example, the engine oil level is low or a door is not fully closed, the multi-information display will show you the problem. It does this by interrupting the current message with one or more messages. Most of the messages are displayed for about 5 seconds, and then the current message returns. Some messages stay on until the problem is corrected.

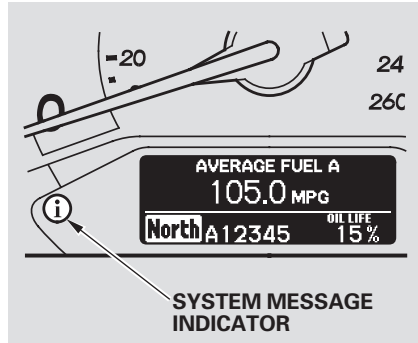

These messages also trigger the appropriate indicator(s) on the instrument panel and cause the system message indicator to come on. The system message indicator does not go off until the problem(s) are corrected.

The following pages describe each system message that can be displayed.

## Fasten Seat Belt



In addition to the seat belt reminder indicator in the instrument panel, the multi-information display interrupts the current display and shows “FASTEN SEAT BELT” if you do not fasten your seat belt while driving. This message remains displayed if you ignore it and do not wear your seat belt while the vehicle is moving.

*CONTINUED*



## Multi-Information Display

### Door and Tailgate Open



If the tailgate or any door(s) is not closed tightly, the display reminds you to close the tailgate or the door(s) before you start driving. This display continues until you close the door(s) or the tailgate. Pressing the INFO button on the steering wheel momentarily change the display to the normal display, but it will come back after 5 seconds.

### Release Parking Brake



If you start driving without releasing the parking brake, the multi-information display interrupts the current display and shows "RELEASE PARKING BRAKE." This message continues, and a chime sounds, until you release the parking brake, or the vehicle speed slows down to less than 0.5 mph (0.8 km/h).

### Remove Key

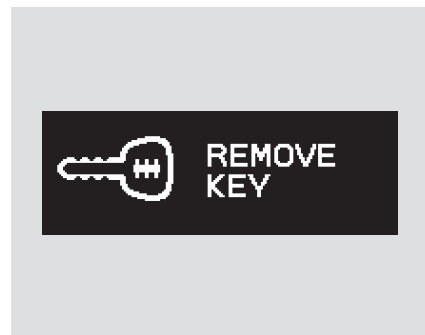

If you leave the key in the ignition switch in the LOCK (0) or ACCESSORY (I) position and open the driver's door, you will see "REMOVE KEY" in the display and hear a reminder beeper.

### Brake Fluid Low

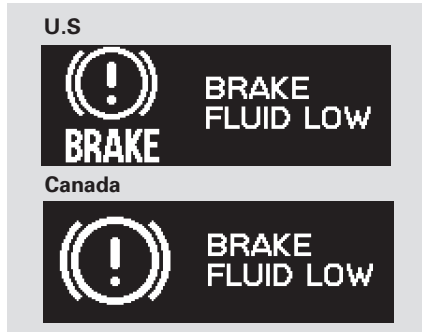

If the brake fluid level is at or below the MIN mark on the side of the brake fluid reservoir in the engine compartment, you will see “BRAKE FLUID LOW.” If you see this message, have the brake system checked by your dealer (see page 373).

### Check Fuel Cap

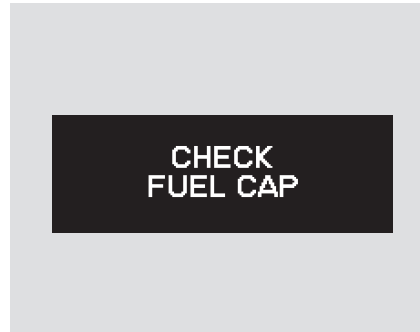

If the fuel fill cap is missing or not tightened properly, you will see “CHECK FUEL CAP.” Make sure the fuel cap is installed and tightened at least 3 clicks.

The CHECK FUEL CAP message should go off after tightening the fuel cap, turning the ignition switch off and on, then driving over 30 mph (48 km/h) for at least 45 seconds. Due to different driving conditions, it may take a few driving trips to make the message go off.

If a loose or missing fuel cap was not the cause of the CHECK FUEL CAP message coming on, the message will turn off and the Malfunction Indicator Lamp will come on. If this happens, have your vehicle checked by your dealer as soon as possible.

CONTINUED

## Multi-Information Display

### Fuel Low



If the level of the fuel in the tank gets low, you will see “FUEL LOW” in the display, and you must refuel soon. The low fuel indicator in the instrument panel will also come on.

### Washer Fluid Low



If the fluid level in the windshield washer reservoir gets low, you will see “WASHER FLUID LOW” in the multi-information display.

### Passenger Side Airbag Off



If the passenger’s side airbag has automatically shut off, you will see “PASSENGER SIDE AIRBAG OFF” in the multi-information display. See page [33](#) for more information.

### Check Tire Pressure *On U.S. Touring model only*



If one or more of your vehicle tires are low on pressure, you will see a “CHECK TIRE PRESSURE” message in the display. See page [303](#) for more information on the tire pressure monitoring system (TPMS).

### Warning: Approaching Object



This message, and the indicator to the left of the message, is a part of the parking sensor system. If you are approaching too close to an object, you will see “WARNING APPROACHING OBJECT” in the display and hear a beeper. See page [271](#) for more information.

The following messages indicate various problems in your vehicle’s systems.

CONTINUED

## Multi-Information Display

### Check TPMS System *On U.S. Touring model only*

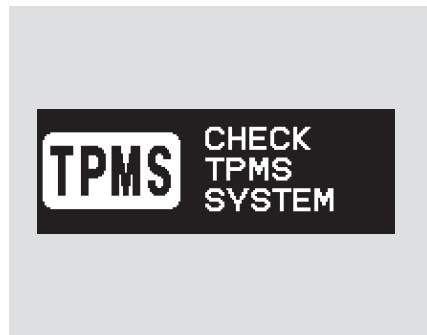

If there is a problem in the tire pressure monitoring system (TPMS), you will see “CHECK TPMS SYSTEM” in the multi-information display. If you see this message, the TPMS is not monitoring tire pressures. Have the TPMS checked by your dealer as soon as possible (see page [303](#)).

### Check VSA System



If there is a problem with the vehicle stability assist (VSA) system, you will see “CHECK VSA SYSTEM” in the multi-information display. If you see this message, have the VSA system checked by your dealer (see page [301](#)).

### Check Engine Oil Level



If the engine oil is very low or has lost pressure, you will see “CHECK ENGINE OIL LEVEL” in the multi-information display. You will also see the low oil pressure indicator in the instrument panel flashing or staying on. If you see this message, you should take immediate action since serious engine damage is possible. Follow the procedure on page [371](#).

## Check Charging System

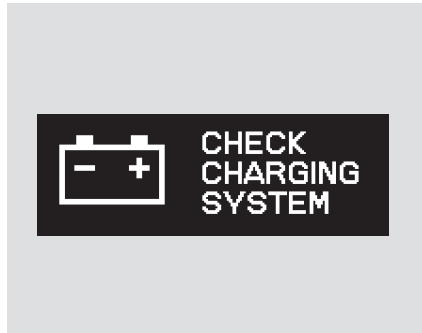

If you see “CHECK CHARGING SYSTEM” in the multi-information display, it means the battery is not being charged. See page [371](#) for more information.

## Check Emission System

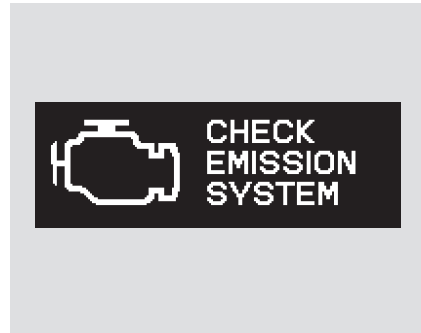

If you see “CHECK EMISSION SYSTEM” in the multi-information display, it means one of the engine’s emission systems may have a problem. Have your vehicle checked by a dealer (see page [372](#) ).

## Check Brake System

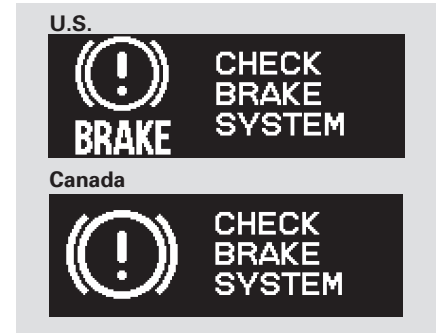

If there is a problem with the brake system, you will see “CHECK BRAKE SYSTEM” in the multi-information display. The parking brake and brake system indicator in the instrument panel will also come on. See page [373](#) for more information.

*CONTINUED*

## Multi-Information Display

### Check Transmission

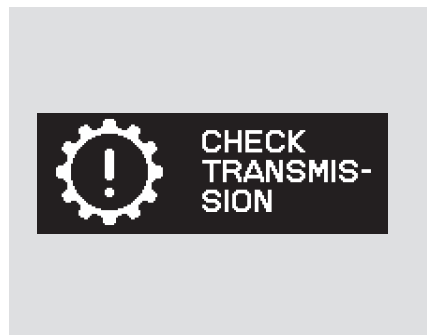

If there is a problem with the automatic transmission, you will see “CHECK TRANSMISSION” in the multi-information display. Avoid rapid acceleration, and have the transmission checked by a dealer as soon as possible.

### Check ABS System

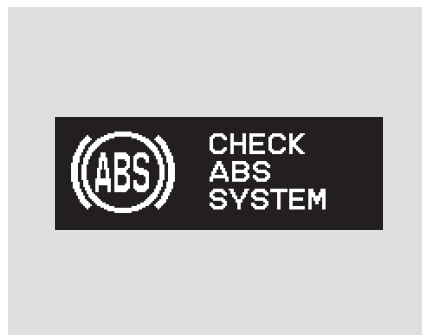

If there is a problem in the anti-lock brake system (ABS), you will see “CHECK ABS SYSTEM” in the multi-information display. If you see this message, have your vehicle checked by a dealer (see page [300](#) ).

### Check Airbag System



If there is a problem with your front airbags, side airbags, passenger’s side airbag automatic cutoff system, automatic seat belt tensioners, or side curtain airbags, you will see “CHECK AIRBAG SYSTEM” in the multi-information display. Take your vehicle to a dealer as soon as possible (see page [32](#) ).

## Check Parking Sensor System



If there is a problem with the parking sensor system, the multi-information display shows a “CHECK PARKING SENSOR SYSTEM” message. See page [271](#) for more information.

## Check Left/Right Sliding Door

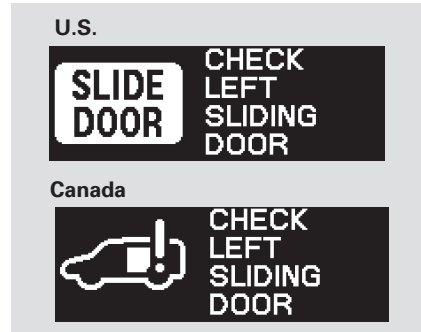

If there is a problem in the power sliding door, the multi-information display shows “CHECK LEFT SLIDING DOOR” or “CHECK RIGHT SLIDING DOOR.” See page [147](#) for more information.

## Check Power Tailgate

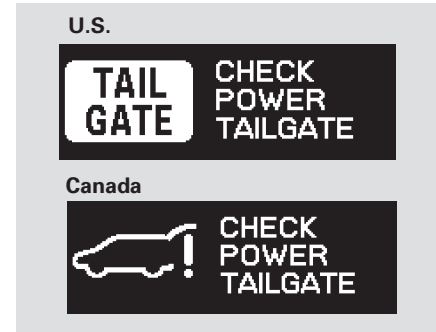

If there is a problem with the power tailgate, the display shows “CHECK POWER TAILGATE.” See page [139](#) for more information.

CONTINUED



## Multi-Information Display

### Check DRL System



#### *Canadian model only*

If there is a problem with the Daytime Running Light (DRL) System, you will see “CHECK DRL SYSTEM” in the multi-information display. If you see this message, have your vehicle checked by a dealer.

### PAX Warning Messages

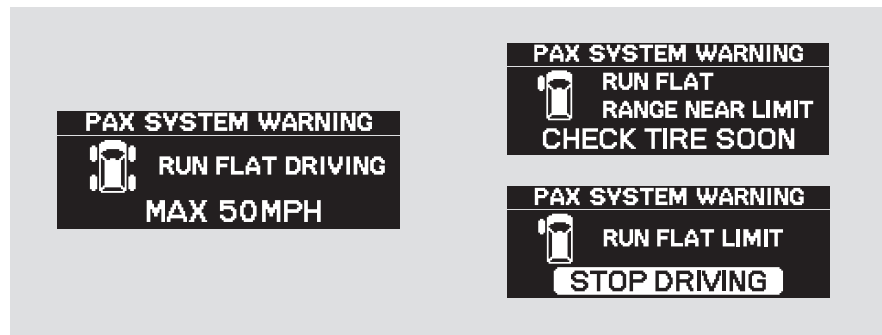

#### *U.S. Touring model only*

Your vehicle is equipped with the Michelin PAX system. The PAX system uses the multi-information display to show you one of three messages while you are driving with a flat tire.

For more information, see page [356](#).

## Customized Settings

You can customize some vehicle control settings for “DRIVER 1” and “DRIVER 2” separately. If “DRIVER 1” or “DRIVER 2” is not displayed, customizing is not possible.

To enter the customizing mode, the vehicle must be stopped and the transmission must be in Park. Press and hold the INFO button on the steering wheel for about 3 seconds while the multi-information display is in its normal message mode.

The first customizing menu is:

- CHANGE SETTING
- DEFAULT ALL

Every time you press the INFO button, the display cycles from “CHANGE SETTING,” “DEFAULT ALL,” “EXIT,” and then back to “CHANGE SETTING” as shown in the next column.

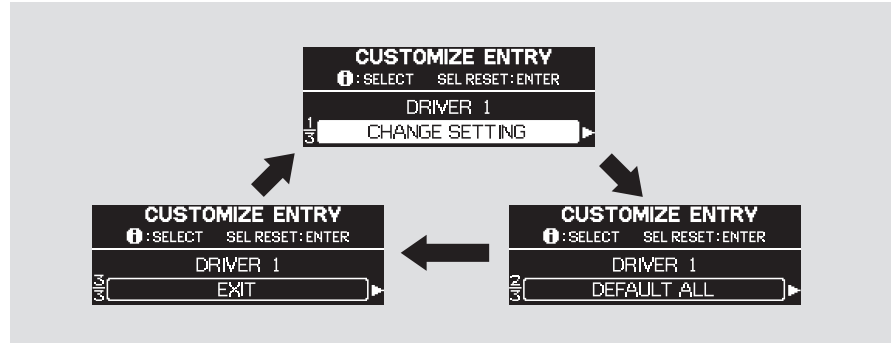

If you want the settings as they were when the vehicle left the factory, select “DEFAULT ALL,” as described on page 90 .

If you want to change any vehicle control settings, select “CHANGE SETTING,” and follow the instructions on page 92 .

Use the INFO button on the steering wheel to see the settings, and the SEL/RESET button to enter your selections.

You can also use the trip meter SELECT/RESET knob in the instrument panel to select and enter your selections while the multi-information display is in the customizing mode. Turn the knob to select a setting and press it to enter your selection.

## Multi-Information Display

### DEFAULT ALL

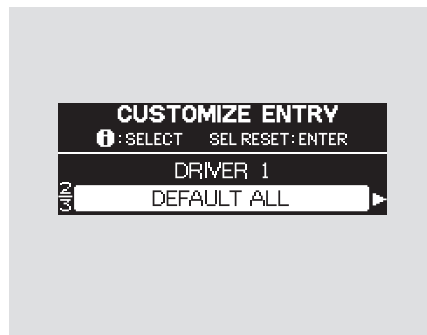

If you want to set the customizable vehicle control settings to the default setting, press the INFO button on the steering wheel until "DEFAULT ALL" is displayed.

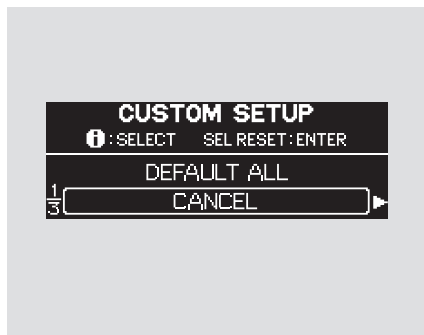

If you want to cancel "DEFAULT ALL," press the INFO button, and you will see "CANCEL." Press the SEL/RESET button, and the display goes back to CUSTOMIZE ENTRY.

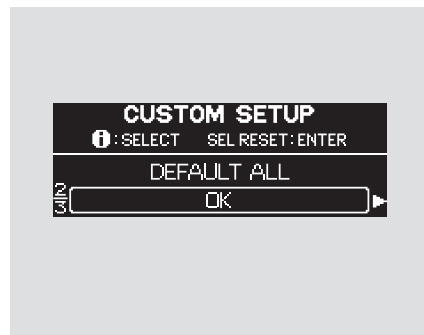

To set the default settings again, press the SEL/RESET button. The display changes as shown above.

Press the SEL/RESET button again to select "DEFAULT ALL."

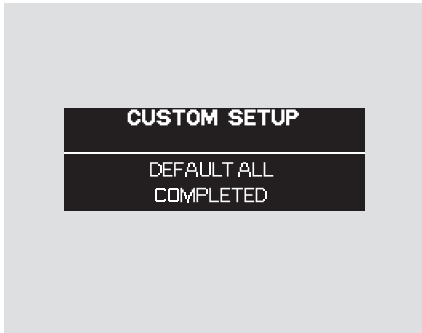

When DEFAULT ALL is completed successfully, you will see the above display for several seconds, and the display will return to “CUSTOMIZE ENTRY.”

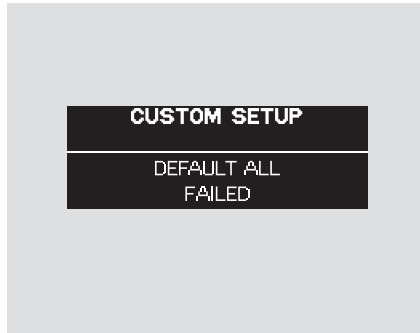

If DEFAULT ALL is not completed successfully, you will see the above display for several seconds, then the display goes back to the normal message mode. Repeat the procedure to select DEFAULT ALL.

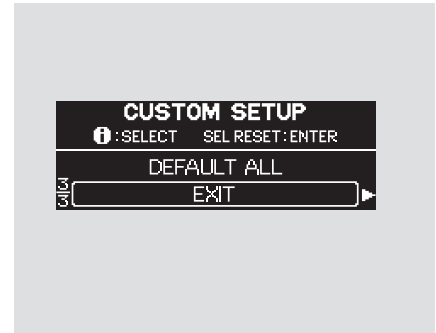

To exit “DEFAULT ALL,” press the INFO button until you see “EXIT,” then press the SEL/RESET button.

## Multi-Information Display

### Change Setting

You can customize some of the vehicle control settings to your preference. Here are the settings you can customize.

- METER SET UP
- POSITION SET UP
- LIGHTING SET UP
- DOOR/WINDOW SET UP
- WIPER SET UP

While the multi-information display is showing “CHANGE SETTING,” press the SEL/RESET button. The display will change to the initial display of CUSTOMIZE GROUP.

Then, each time you press the INFO button, the display changes as shown in the next column.

Press the INFO button until you see the setup you want to customize, and press the SEL/RESET button to enter your selection.

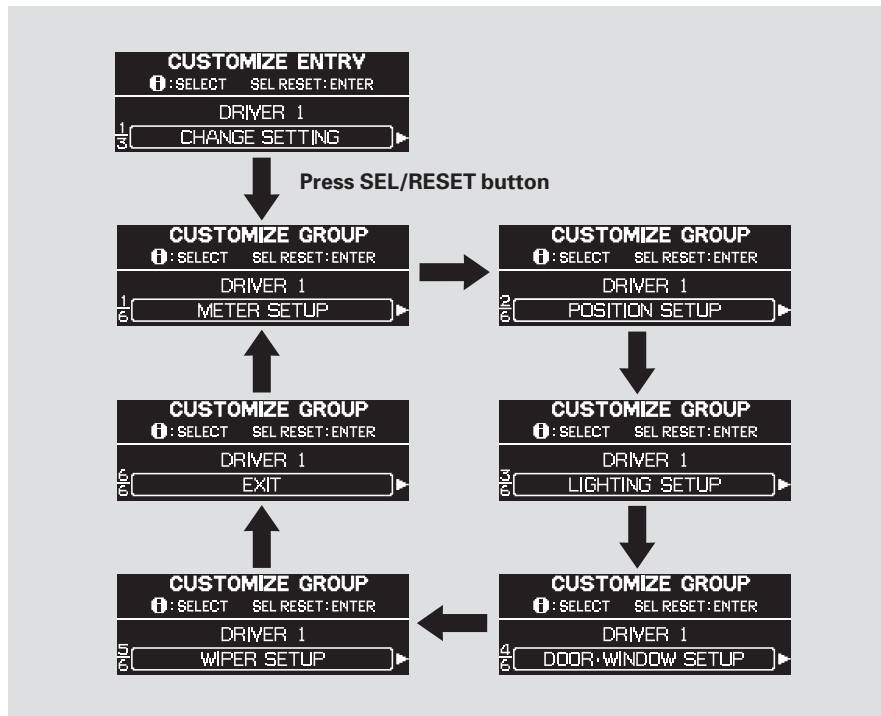

## Meter Setup

There are four custom settings items in the Meter Setup:

- LANGUAGE SELECTION
- ADJUST OUTSIDE TEMP. DISPLAY
- TRIP A & AVG. FUEL A RESET with REFUEL
- COMPASS ZONE SELECTION

While “METER SETUP” is displayed, press the SEL/RESET button on the steering wheel. Then, press the INFO button repeatedly. Each time you press the INFO button, the display changes as shown.

To customize a setting, press the INFO button repeatedly until you see the setting, and press the SEL/RESET button. Then, follow the procedures described on the following pages.

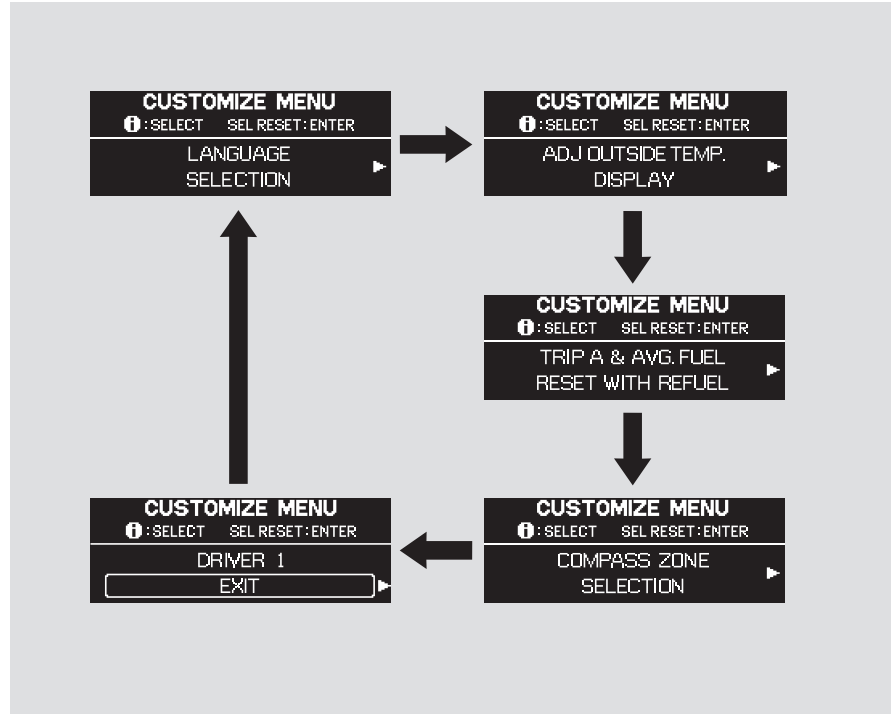

# Multi-Information Display

## Language Selection

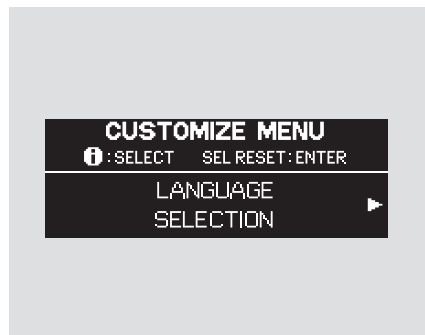

While the multi-information display is showing “METER SETUP,” press the SEL/RESET button on the steering wheel. The display changes to “LANGUAGE SELECTION.” Press the SEL/RESET button again to enter the language selection mode.

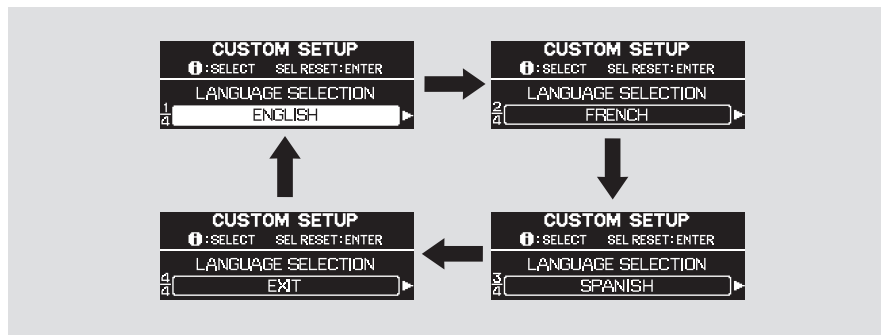

There are three selectable languages, English, French, and Spanish. Each time you press the INFO button, the display changes as shown.

Select the language you want by pressing the INFO button, and press the SEL/RESET button to enter your selection.



When language selection is successfully completed, the display changes to the screen shown above for several seconds, then goes back to “CUSTOMIZE MENU.”

All the messages in the multi-information display will be in the language you selected.



If you fail to select a language properly, you will see the above display for several seconds, then the display goes back to “CUSTOMIZE MENU.” Repeat the setup.

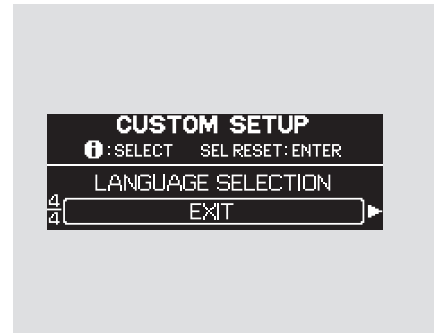

To exit “LANGUAGE SELECTION,” press the INFO button repeatedly until you see “EXIT,” and press the SEL/RESET button. The display goes back to “CUSTOMIZE MENU.”

*CONTINUED*



## Multi-Information Display

### *Outside Temperature Display Adjustment*

If you sometimes find that the temperature reading is always several degrees below or above the actual temperature, adjust it as described on the following pages.

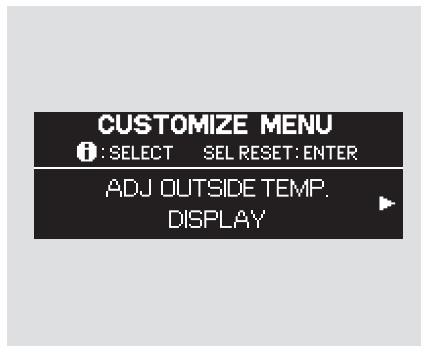

While the multi-information display shows "METER SETUP," press the SEL/RESET button on the steering wheel. The display changes to the "CUSTOMIZE MENU." Press the INFO button twice, and you will see "ADJ. OUTSIDE TEMP. DISPLAY" as shown above.



Press the SEL/RESET button. The display changes as shown above. The highlighted number is the current adjustment above or below the outside temperature. Press the INFO button repeatedly until the appropriate number appears, and press the SEL/RESET button to enter your selection.

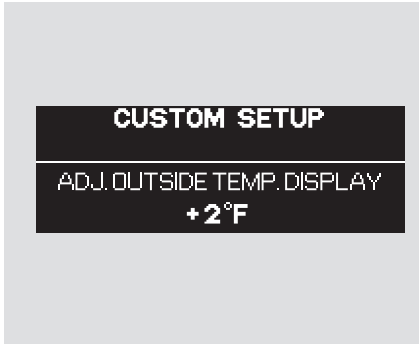

When your selection is successfully entered, you will see the above display for several seconds, and then the display changes to "EXIT."

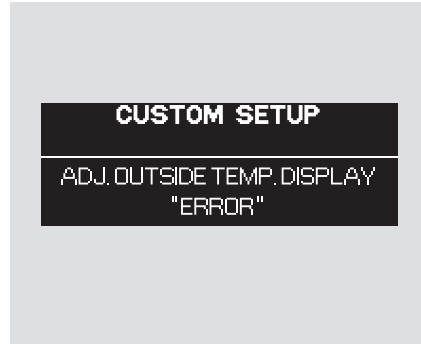

If you fail to enter the desired adjustment properly, you will see the above display for several seconds, then the display goes back to "CUSTOMIZE MENU." Repeat the adjustment.

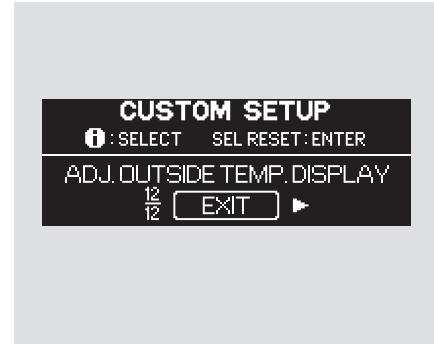

To exit "ADJUST OUTSIDE TEMP. DISPLAY," press the INFO button until you see "EXIT," and press the SEL/RESET button. The display goes back to "CUSTOMIZE MENU."

*CONTINUED*

## Multi-Information Display

### *Trip A & Avg. Fuel Reset with Refuel*

To cause “Trip meter A” and “Average Fuel Economy” to reset every time you refuel your vehicle, adjust it as described on the following pages.

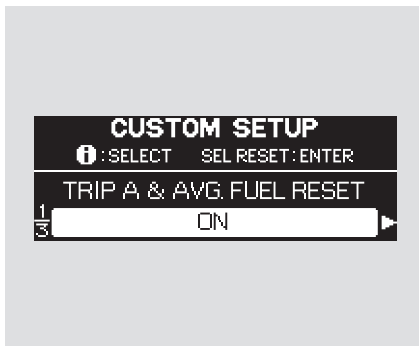

While the multi-information display shows “METER SETUP” of the “CUSTOMIZE GROUP,” press the SEL/RESET button on the steering wheel. The display changes to “CUSTOMIZE MENU.” Press the INFO button repeatedly until you see “TRIP A & AVG. FUEL RESET WITH FUEL” in the lower segment as shown above.

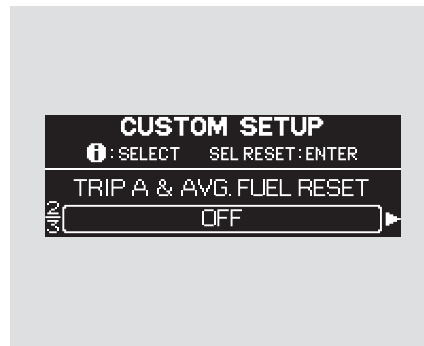

Press the SEL/RESET button. The display changes as shown above. The lower segment changes between “ON” and “OFF” each time you press the INFO button. Enter your selection by pressing the SEL/RESET button.

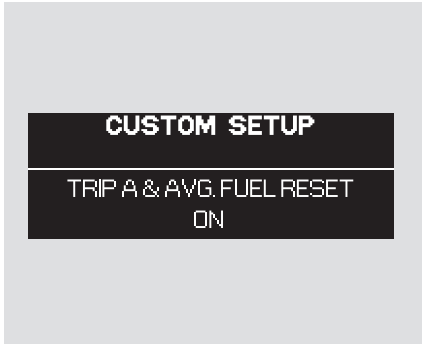

When your selection is successfully entered, you will see the above display for several seconds, and then the display goes back to "CUSTOMIZE MENU."



If you fail to enter your selection, you will see the above display for several seconds, then the display goes back to "CUSTOMIZE MENU." Repeat the setup.



To exit "TRIP A & AVG. FUEL WITH REFUEL," press the INFO button until you see "EXIT," and press the SEL/RESET button. The display goes back to "CUSTOMIZE MENU."

CONTINUED

## Multi-Information Display

### **Compass Zone Selection**

*On models without Navigation System*

In most areas, there is a variation between magnetic north and true north. Zone selection is required so the compass can compensate for this variation. To check and select the zone set into the compass, do the procedure on the following pages.

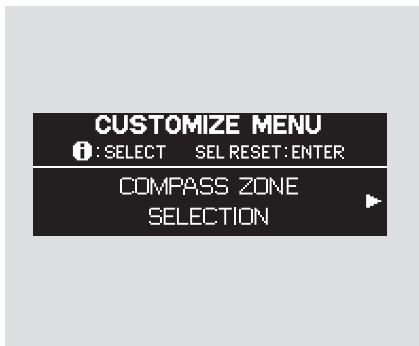

While the multi-information display shows "METER SETUP," press the SEL/RESET button on the steering wheel. The display changes to the "CUSTOMIZE MENU." Press the INFO button repeatedly until you see "COMPASS ZONE SELECTION" in the lower segment as shown above.

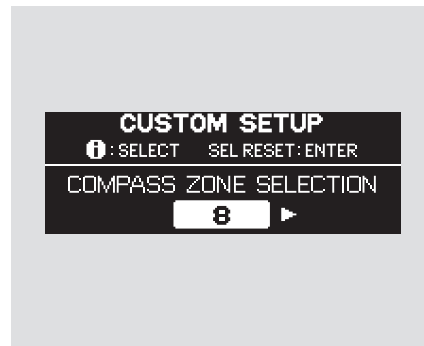

Press the SEL/RESET button. The display changes as shown above. The highlighted "-" display in the lower segment is the zone number; it changes from "1" thru "15" each time you press the INFO button.

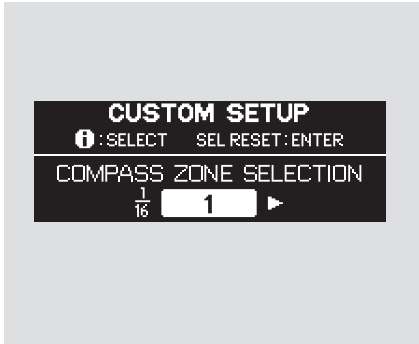

Find the zone for your area on the map shown in the next column.

Press the INFO button until you see your zone number in the lower segment. Then press the SEL/RESET button to enter your zone number.

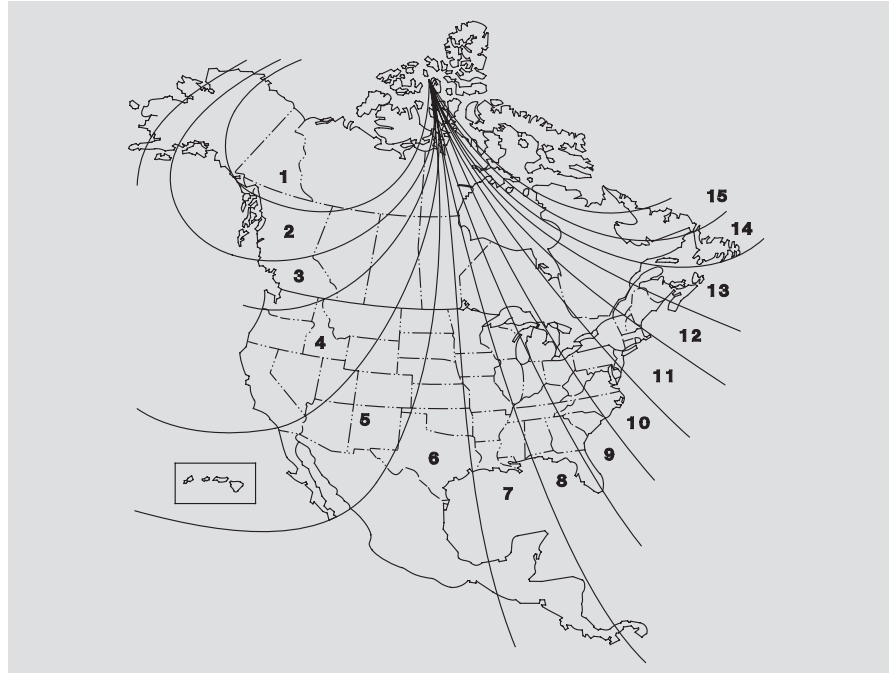

*CONTINUED*

## Multi-Information Display



When your zone number is successfully entered, you will see the above display for several seconds, then the display changes to "CUSTOMIZE MENU."



If you fail to enter your zone number, you will see the above display for several seconds, then the display goes back to "CUSTOMIZE MENU." Repeat the setup.

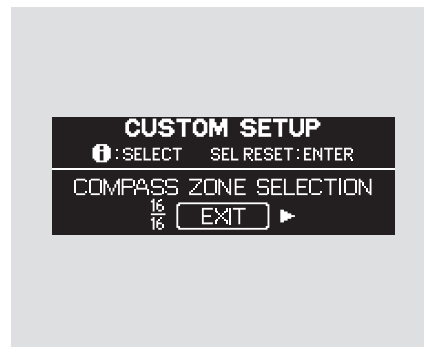

To exit "COMPASS ZONE SELECTION," press the INFO button until you see "EXIT," and press the SEL/RESET button. The display goes back to "CUSTOMIZE MENU."

## Position Setup

When “MEMORY POSITION LINK” is set to “ON,” the driver’s seat moves to the position stored in memory when you open the driver’s door after unlocking it with the remote transmitter.

Refer to page 161 to set the seat position memory. Also refer to page 135 for remote transmitter use.

## Memory Position Setup

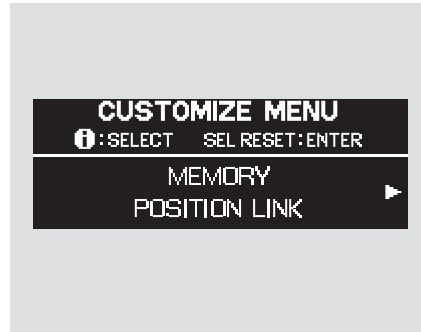

While the multi-information display shows “POSITION SETUP,” press the SEL/RESET button on the steering wheel. The display changes to “MEMORY POSITION LINK” as shown above.

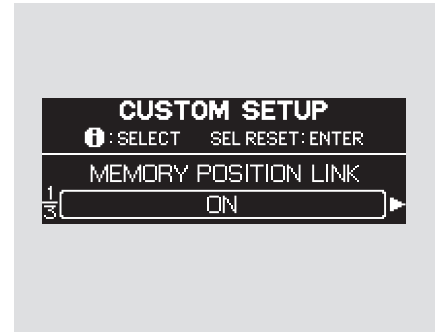

Press the SEL/RESET button. The display changes as shown above.

Each time you press the INFO button, the display changes between “MEMORY POSITION LINK ON” and “MEMORY POSITION LINK OFF.”

*CONTINUED*



## Multi-Information Display

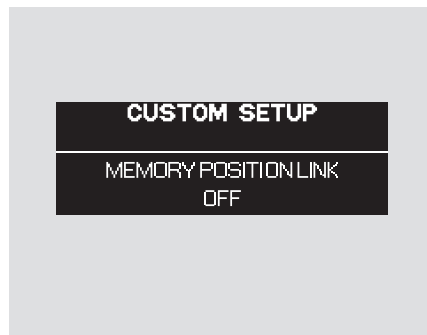

Select "ON" or "OFF" by pressing the INFO button, and enter your selection by pressing the SEL/RESET button.

When your selection is entered, you will see the above display for several seconds, then the display goes back to "CUSTOMIZE MENU."

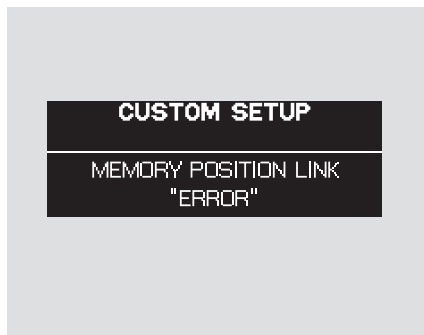

If you fail to enter your selection, you will see the above display for several seconds, and the display goes back to "CUSTOMIZE MENU." Repeat the setup.

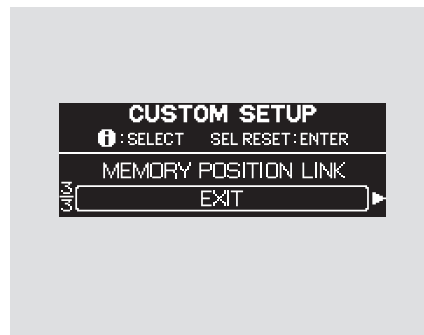

To exit "MEMORY POSITION LINK," press the INFO button until you see "EXIT," then press the SEL/RESET button.

## Lighting Setup

There are two custom settings in the Lighting Setup:

- INTERIOR LIGHT DIMMING TIME
- HEADLIGHT AUTO OFF TIMER

While the “LIGHTING SETUP” is displayed, press the SEL/RESET button on the steering wheel. The display changes between “INTERIOR LIGHT DIMMING TIME” and “HEADLIGHT AUTO OFF TIMER.”

## Interior Light Dimming Time

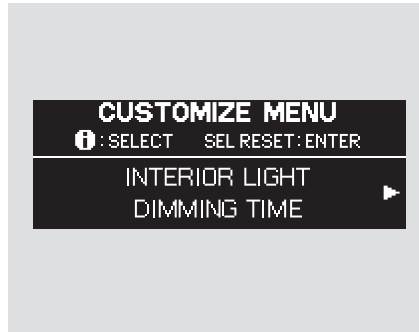

The interior lights fade out when you close all doors and the tailgate. You can change the time that the interior lights fade out.

While the multi-information display shows “LIGHTING SETUP,” press the SEL/RESET button on the steering wheel. The display changes to “INTERIOR LIGHT DIMMING TIME” as shown above.

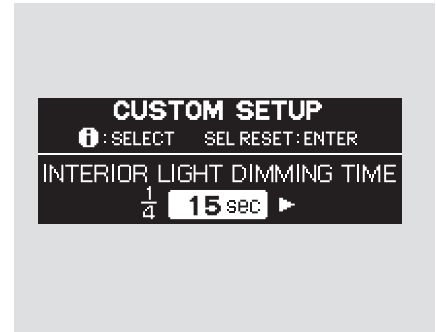

Press the SEL/RESET button. The display changes as shown above.

Each time you press the INFO button, the highlighted number changes from “15 sec,” to “30 sec,” and then to “60 sec.”

CONTINUED

## Multi-Information Display



Press the INFO button repeatedly until the desired time appears, then press the SEL/RESET button to enter your selection.

When your selection is entered, you will see the above display for several seconds, and then the display goes back to "CUSTOMIZE MENU."

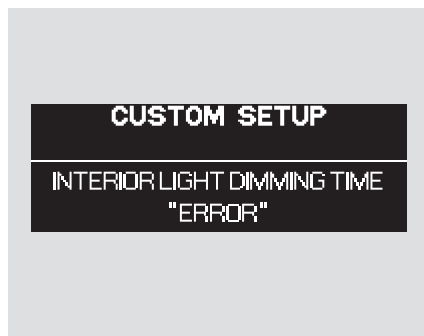

If you fail to enter your selection, you will see the above display for several seconds, and the display goes back to "CUSTOMIZE MENU." Repeat the setup.

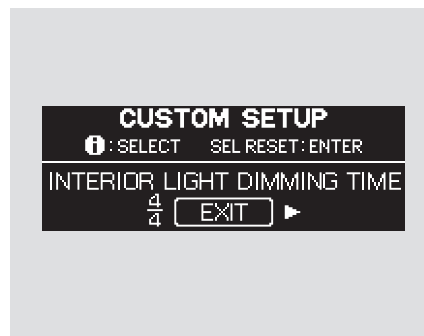

To exit "INTERIOR LIGHT DIMMING TIME," press the INFO button until you see "EXIT," then press the SEL/RESET button.

## Headlight Auto Off Timer



While the multi-information display shows "LIGHTING SETUP," press the SEL/RESET button on the steering wheel. Then press the INFO button to display "HEADLIGHT AUTO OFF TIMER" as shown above.

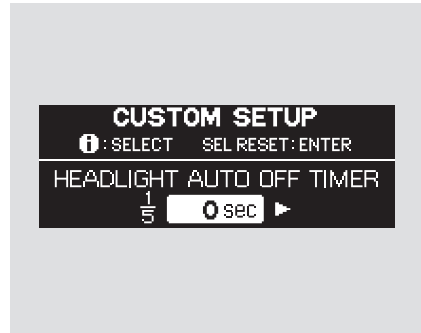

Press the SEL/RESET button. The display changes as shown above.

Each time you press the INFO button, the highlighted number changes from "0 sec," to "15 sec," to "30 sec," and then to "60 sec."



Press the INFO button repeatedly until the desired time appears, then press the SEL/RESET button to enter your selection.

When your selection is entered, you will see the above display for several seconds, and then the display goes back to "CUSTOMIZE MENU."

CONTINUED

## Multi-Information Display

---

The headlights, parking lights, taillights, and license plate light turn off after the selected time when you remove the key from the ignition switch and close the driver's door.

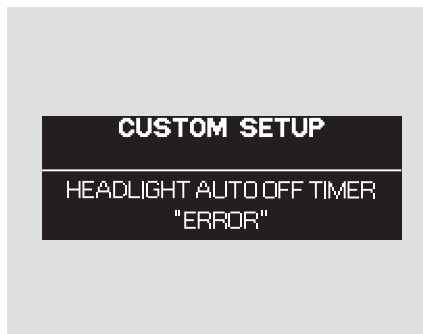

If you fail to enter your selection, you will see the above display for several seconds, and the display goes back "CUSTOMIZE MENU." Repeat the setup.

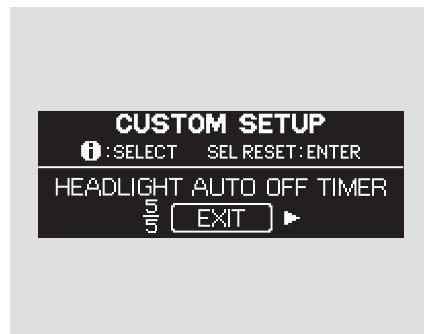

To exit "HEADLIGHT AUTO OFF TIMER," press the INFO button until you see "EXIT," then press the SEL/RESET button.

### Door and Window Setup

There are four custom settings in the Door and Window Setup:

- AUTO DOOR LOCK
- AUTO DOOR UNLOCK
- KEYLESS LOCK ACKNOWLEDGEMENT
- SECURITY RELOCK TIMER

While the multi-information display shows “DOOR, WINDOW SETUP,” press the SEL/RESET button on the steering wheel. Each time you press the INFO button, the display changes as shown in the next column.

To customize a setting, press the INFO button repeatedly until you see the setting you want to customize, and press the SEL/RESET button. Then follow the procedures described on the following pages.

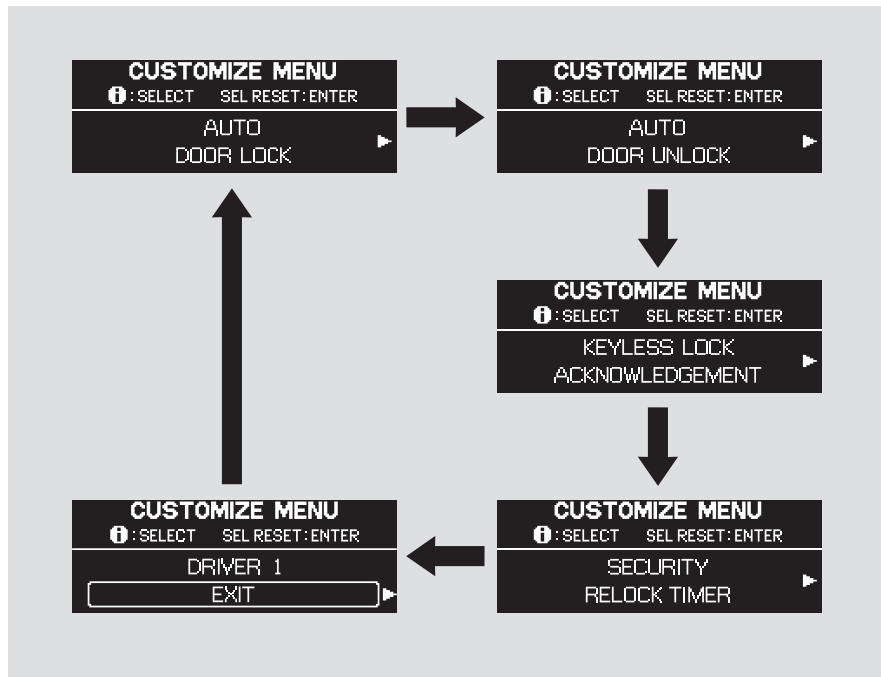

# Multi-Information Display

## Auto Door Lock

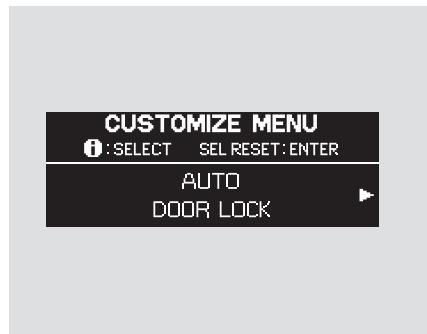

To customize the auto door locking feature, do this:

While the multi-information display shows “DOOR-WINDOW SETUP,” press the SEL/RESET button on the steering wheel. The display changes to “AUTO DOOR LOCK” as shown above.

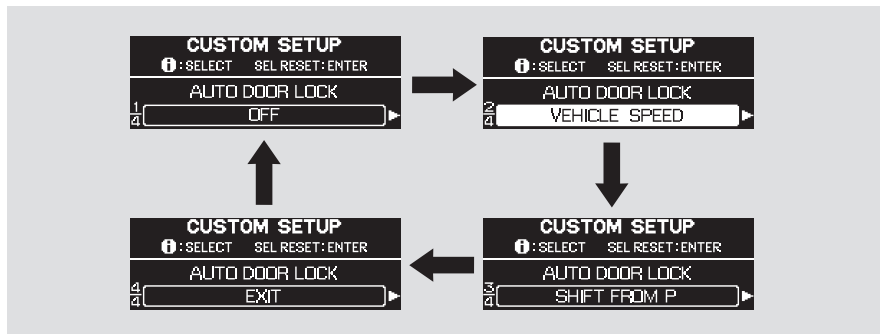

Press the SEL/RESET button again, then press the INFO button. Each time you press the INFO button, the display changes from “OFF,” to “VEHICLE SPEED,” to “SHIFT FROM P,” and then to “EXIT” as shown above.

There are three possible settings:

**OFF:** The auto door lock is deactivated all the time.

**SHIFT FROM P:** The doors lock whenever you move the shift lever out of P.

**VEHICLE SPEED:** The doors lock when the vehicle speed reaches 10 mph (16 km/h).

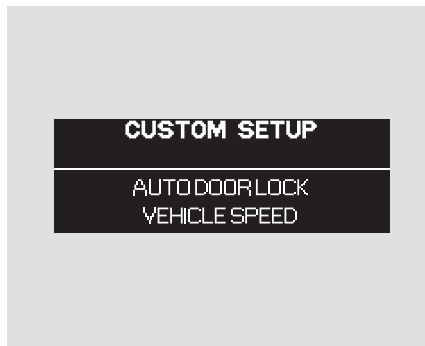

Press the INFO button repeatedly until the desired condition appears, then press the SEL/RESET button to enter your selection.

When your selection is entered, you will see the above display for several seconds, and then the display goes back to "CUSTOMIZE MENU."

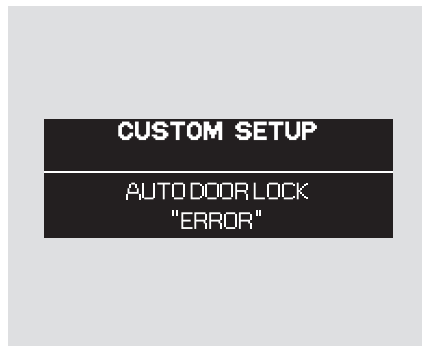

If you fail to enter your selection, you will see the above display for several seconds, and the display goes back to "CUSTOMIZE MENU." Repeat the setup.

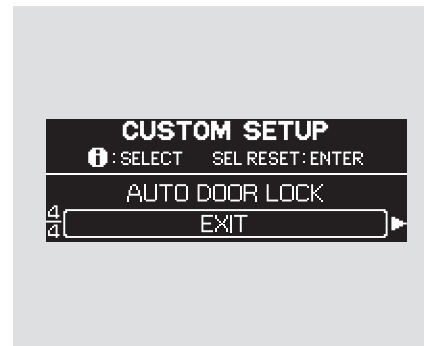

To exit "AUTO DOOR LOCK," press the INFO button until you see "EXIT," then press the SEL/RESET button.

*CONTINUED*



## Multi-Information Display

### Auto Door Unlock

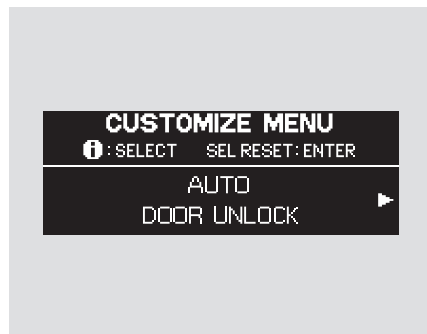

To customize the auto door unlocking feature, do this:

While the multi-information display shows “DOOR-WINDOW SETUP,” press the SEL/RESET button on the steering wheel. Then press the INFO button once. The display changes to “AUTO DOOR UNLOCK” as shown above.

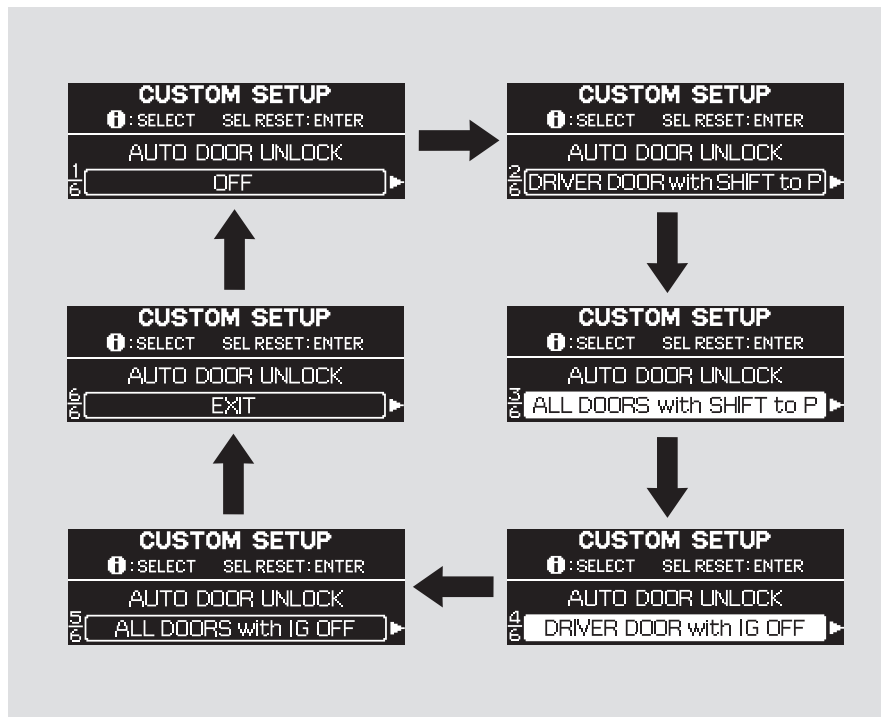

Press the SEL/RESET button again to enter “Auto Door Unlock,” then press the INFO button. Each time you press the INFO button, the display changes from “OFF,” to “DRIVER DOOR with SHIFT to P,” to “ALL DOORS with SHIFT to P,” to “DRIVER DOOR with IG OFF,” and then to “EXIT” as shown on the previous page.

- **OFF:** The auto door unlock is deactivated all the time.
- **DRIVER DOOR with SHIFT to P:** The driver’s door unlocks when you move the shift lever to P.
- **ALL DOORS with SHIFT to P:** All doors unlock when you move the shift lever to P.
- **DRIVER DOOR with IG OFF:** The driver’s door unlocks when you turn the ignition switch to LOCK (0).
- **ALL DOORS with IG OFF:** All doors unlock when you turn the ignition switch to LOCK (0).



Press the INFO button repeatedly until the desired condition appears, and press the SEL/RESET button to enter your selection.

When your selection is entered, you will see the above display for several seconds, and then the display goes back to “CUSTOMIZE MENU.”

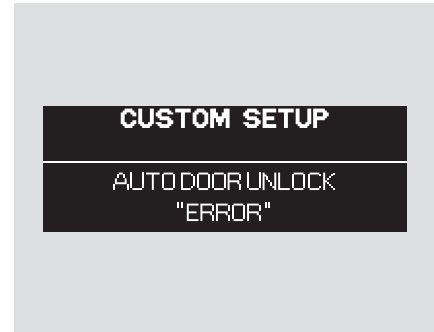

If you fail to enter your selection, you will see the above display for several seconds, and the display goes back to “CUSTOMIZE MENU.” Repeat the setup.

To exit “AUTO DOOR UNLOCK,” press the INFO button until you see “EXIT,” then press the SEL/RESET button.

*CONTINUED*

## Multi-Information Display

### *Keyless Lock Acknowledgment*

When you push the LOCK button on the remote transmitter, some exterior lights flash, and a beeper sounds when you push the LOCK button again within 5 seconds to verify that the doors and the tailgate are locked and the security system has set (see page 133 ). You can customize the exterior lights not to flash and the beeper not to sound.

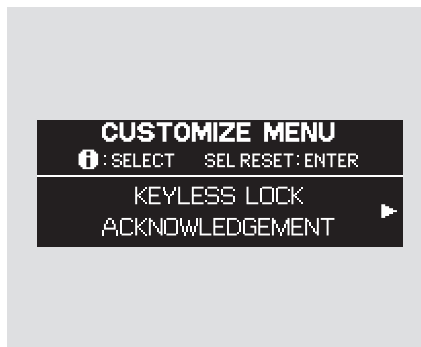

While the multi-information display shows “DOOR·WINDOW SETUP,” press the SEL/RESET button on the steering wheel. Then press the INFO button repeatedly until you see “KEYLESS LOCK ACKNOWLEDGMENT” as shown above.

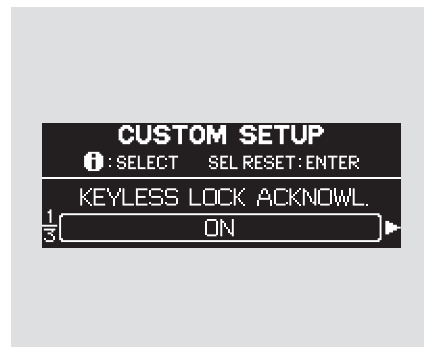

Press SEL/RESET button, then press the INFO button.

Each time you press the INFO button, the display changes to “ON,” to “OFF,” then to “EXIT.”

Select “ON” or “OFF” by pressing the INFO button, and enter your selection by pressing the SEL/RESET button.

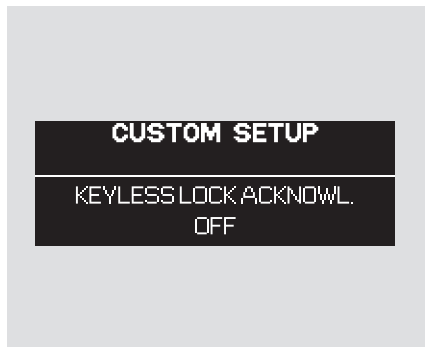

When your selection is entered, you will see the above display for several seconds, and then the display changes to “CUSTOMIZE MENU.”

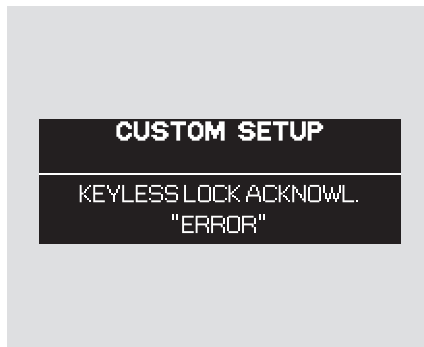

If you fail to enter your selection, you will see the above display for several seconds, and the display goes back to “CUSTOMIZE MENU.” Repeat the setup.

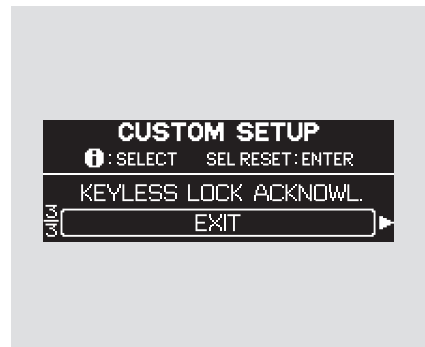

To exit “KEYLESS LOCK ACKNOWLEDGMENT,” press the INFO button until you see “EXIT,” then press the SEL/RESET button.

*CONTINUED*

## Multi-Information Display

### *Security Relock Timer*

If you unlock the doors and the tailgate with the remote transmitter, but do not open any of the doors or the tailgate within 30 seconds, the doors and the tailgate automatically relock and the security system sets.

You can change this relock time from 30 seconds to 60 or 90 seconds.

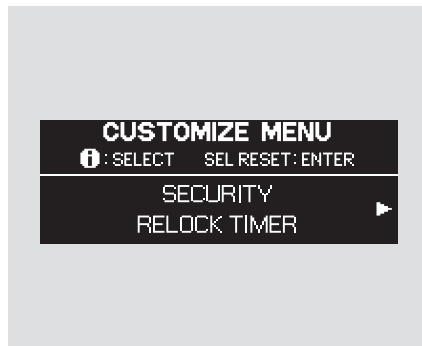

While the multi-information display shows “DOOR·WINDOW SETUP,” press the SEL/RESET button on the steering wheel. Then press the INFO button repeatedly until you see “SECURITY RELOCK TIMER” as shown above.

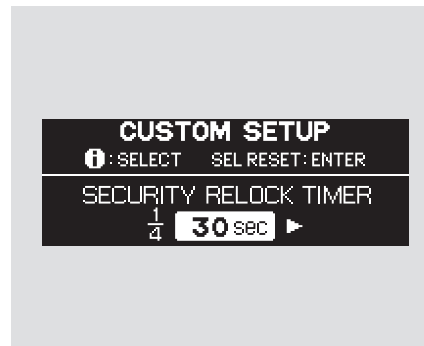

Press the SEL/RESET button, then press the INFO button.

Each time you press the INFO button, the time changes from “30 sec,” to “60 sec,” and then to “90 sec.”

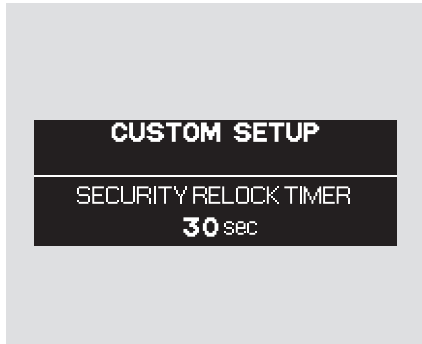

Select the desired relock time by pressing the INFO button, and enter your selection by pressing the SEL/RESET button.

When your selection is entered, you will see the above display for several seconds, and then the display goes back to "CUSTOMIZE MENU."

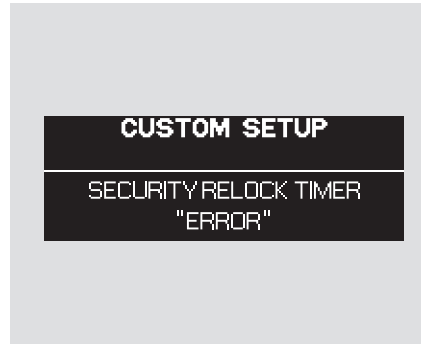

If you fail to enter your selection, you will see the above display for several seconds, and the display goes back to "CUSTOMIZE MENU."  
Repeat the setup.

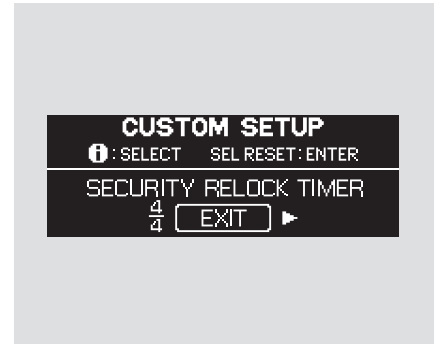

To exit "SECURITY RELOCK TIMER," press the INFO button until you see "EXIT," then press the SEL/RESET button.

## Multi-Information Display

### Wiper Setup

When “WIPER SETUP” is shown on the multi-information display, the action of the windshield wipers can be changed. To do this, refer to the following procedure.

### Front Wiper Action



With “WIPER SETUP” shown on the multi-information display, press the SEL/RESET button on the steering wheel. The display changes to “FRONT WIPER ACTION” as shown above.

Press the SEL/RESET button, then press the INFO button.

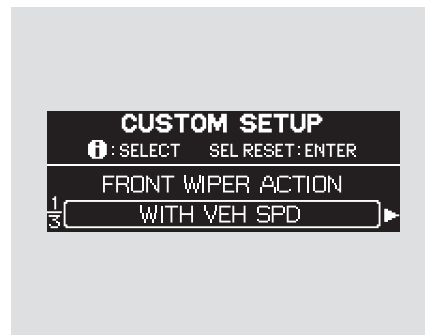

Each time you press the INFO button, the display changes from “WITH VEH SPD,” to “INTERMITTENT,” and then to “EXIT.”

Press the INFO button to select “WITH VEH SPD” or “INTERMITTENT,” and enter your selection by pressing the SEL/RESET button.

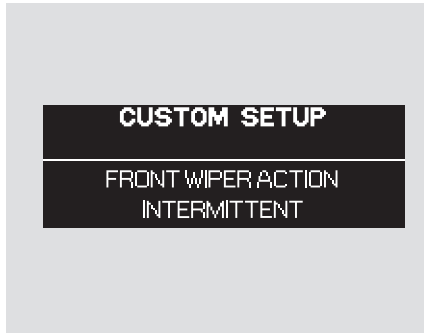

If you set the front wiper action to “WITH VEH SPD,” the front wipers run intermittently and the wiper interval is varied automatically according to the vehicle’s speed when the wiper switch is in the “INT” position. If you set it to “INTERMITTENT,” the wipers run at regular intervals.

When your selection is entered, you will see the above display for several



seconds, and then the display goes back to “CUSTOMIZE MENU.”

If you fail to enter your selection, you will see the above display for several seconds, and the display goes back to “CUSTOMIZE MENU.” Repeat the setup.

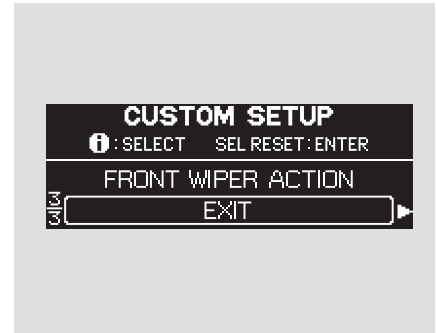

To exit “FRONT WIPER ACTION,” press the INFO button until you see “EXIT,” then press the SEL/RESET button.



# Controls Near the Steering Wheel

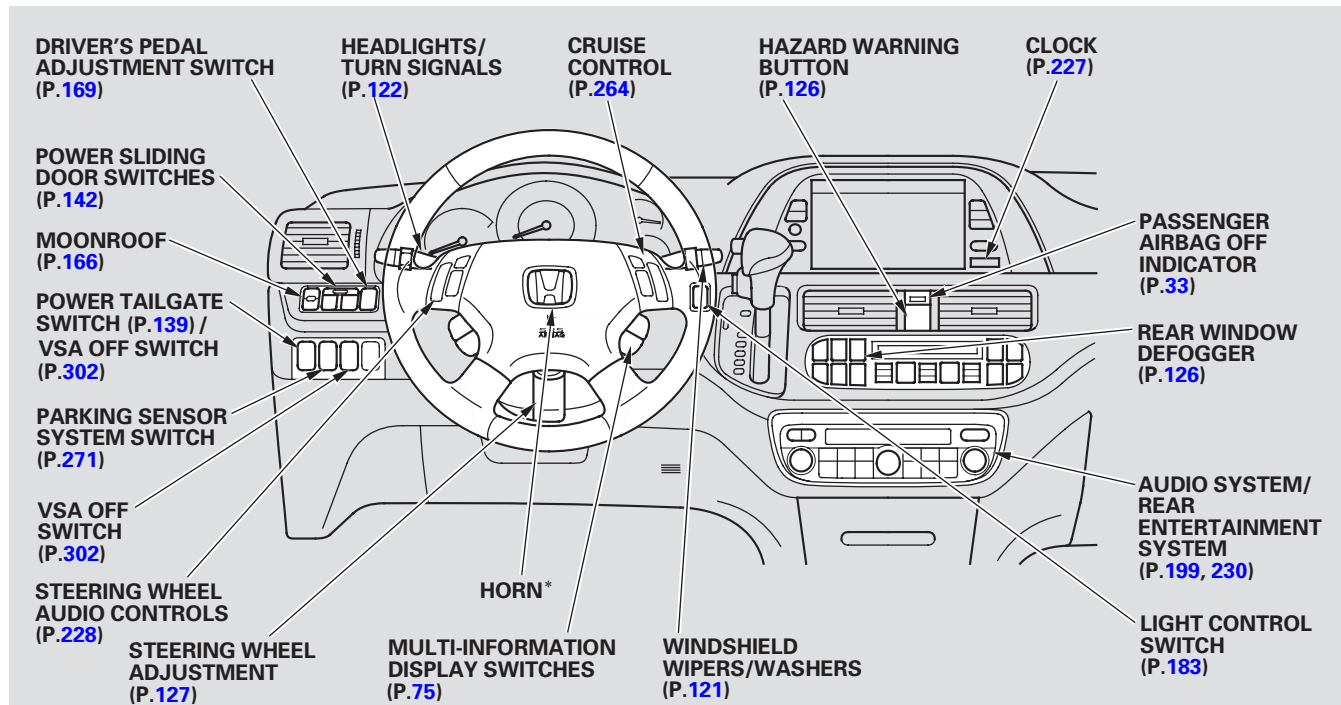

\*: To use the horn, press the pad around the “H” logo.

# Windshield Wipers and Washers

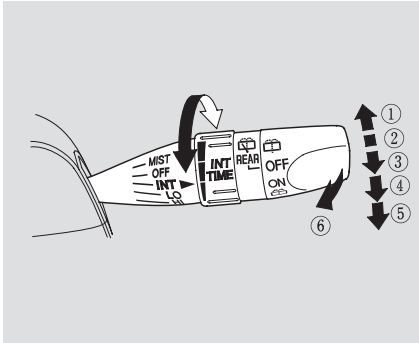

1. MIST
2. OFF
3. INT – Intermittent
4. LO – Low speed
5. HI – High speed
6. Windshield Washers

Push the right lever up or down to select a position.

**MIST:** The wipers run at high speed until you release the lever.

**OFF:** The wipers are not activated.

**INT** – The length of the wipe interval is varied automatically according to the vehicle's speed. Vary the delay by turning the INT TIME ring.

If you turn it to the shortest delay, the wipers will change to low speed operation when the vehicle speed exceeds 12 mph (20 km/h).

**LO** – The wipers run at low speed.

**HI** – The wipers run at high speed.

**Windshield Washer:** Pull the wiper control lever toward you and hold it. The washers spray until you release the lever. The wipers run at low speed, then complete one more sweep after you release the lever.

*On Touring model*

You can customize some windshield wiper settings. See page 118 for more information.

# Windshield Wipers and Washers, Turn Signal, Headlights

## Rear Window Wiper and Washer

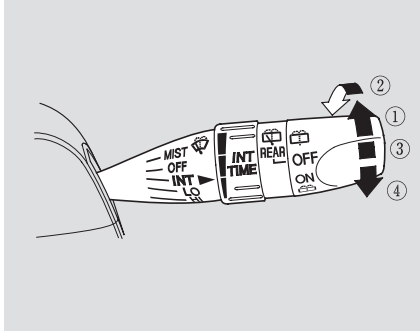

1. Rotate the switch clockwise to turn the rear window wiper ON.
2. Hold past ON to turn the window wiper on and the window washer on.
3. OFF
4. Rotate the switch counterclockwise to spray the window washer without activating the wiper.

## Turn Signal and Headlights

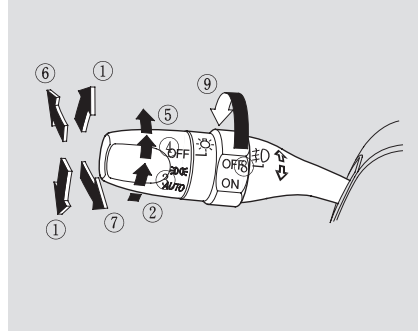



1. Turn signal
2. Off
3. Parking and indicator lights
4. AUTO (Touring model only)
5. Headlights on
6. High beams
7. Flash high beams
8. Fog lights off (Touring model only)
9. Fog lights on (Touring model only)

**Turn Signal** — Push down on the left lever to signal a left turn and up to signal a right turn. To signal a lane change, push lightly on the lever and hold it. The lever will return to center when you release it or complete a turn.

**Headlights On** — Rotating the switch on the left lever to the “” position turns on the parking lights, taillights, instrument panel lights, side-marker lights, and rear license plate lights.

Turning the switch to the “” position turns on the headlights. If you leave the lights on with the ignition switch in ACCESSORY (I) or LOCK (0), you will hear a reminder chime when you open the driver’s door.

When the light switch is in the “ ” or “ ” position, the lights on indicator comes on as a reminder. This indicator stays on if you leave the light switch on and turn the ignition switch to the ACCESSORY (I) or LOCK (0) position.

**High Beams** – To switch from low beams to high beams, push the left lever forward until you hear a click. The blue high beam indicator will come on (see page 69 ). Pull it back to return to low beams. To flash the high beams, pull the lever back lightly, then release it. The high beams will stay on as long as you hold the lever back.

## Fog Lights

*Touring model only*

Turn the fog lights on and off by turning the switch next to the headlight switch.

You can use the fog lights only when the headlights are on low beam.

*On Touring model*

**AUTO** – The automatic lighting feature turns on the headlights, all other exterior lights, and the instrument panel lights when it senses low ambient light.

To turn on the automatic lighting, turn the light switch to AUTO at any time. The lights will come on automatically when the outside light level becomes low (at dusk, for example). The lights on indicator comes on as a reminder. The lights and indicator turn off automatically when the system senses high ambient light.

The lights turn off automatically when you turn the ignition switch to LOCK (0). To turn them on again, either turn the ignition switch to ON (II), or turn the light switch to  .

Even with the automatic lighting feature turned on, we recommend that you turn on the lights manually when driving at night or in a dense fog, or when you enter dark areas such as long tunnels or parking structures.

Do not leave the light switch in AUTO if you will not be driving the vehicle for an extended period (a week or more). You should also turn off the lights if you plan to leave the engine idling or the engine off for a long time.

CONTINUED

## Headlights

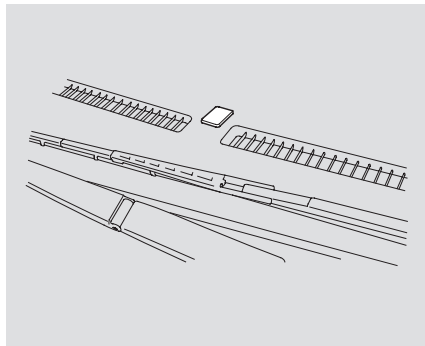



The automatic lighting feature is controlled by a sensor located on top of the dashboard. Do not cover this sensor or spill liquids on it.

### **Automatic Lighting Off Feature**

*On EX and Touring models only*

This turns off the headlights, parking lights, taillights, side marker lights, license plate lights, and instrument panel lights within 15\* seconds of removing the key from the ignition switch and closing the driver's door.

This feature activates if you leave the headlight switch in the “ ” or “ ” position, remove the key, then open and close the driver's door. If you remove the key from the ignition switch with the headlight switch on, but do not open the door and get out, the lights turn off after 10 minutes.

The lights turn on again when you unlock or open the driver's door. If you unlock the door, but do not open it within 15\* seconds, the lights go off. With the driver's door open, you will hear a lights-on reminder chime.

\*On the Touring model, this time is changeable. See page [107](#) for how to select and set the time.

## Daytime Running Lights (Canadian Models)

With the headlight switch off, the high beam headlights and the high beam indicator come on with reduced brightness when you turn the ignition switch to ON (II) and release the parking brake. They remain on until you turn the ignition switch off, even if you set the parking brake.

The headlights revert to normal operation when you turn them on with the switch.

## Instrument Panel Brightness

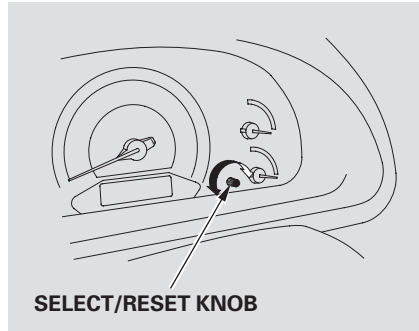

The knob on the instrument panel controls the brightness of the instrument panel lights. Turn the knob to adjust the brightness.

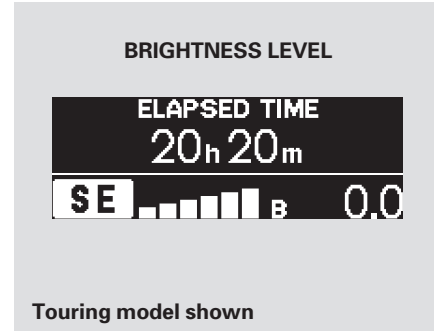

The level of brightness is shown on the multi-information display on the Touring model or in the odometer/trip meter display on LX and EX models while you adjust it. It goes out 5 seconds after you finish adjusting.

## Hazard Warning Button, Rear Window Defogger

### Hazard Warning Button

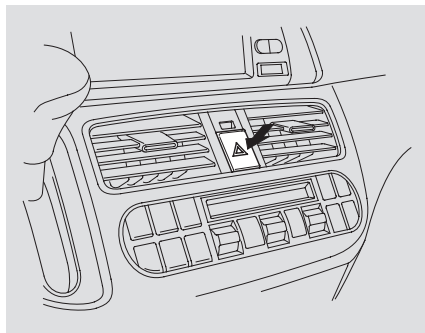

Push the red button between the center air vents to turn on the hazard warning lights (four-way flashers). This causes all four outside turn signals and both indicators in the instrument panel to flash. Use the hazard warning lights if you need to park in a dangerous area near heavy traffic, or if your vehicle is disabled.

### Rear Window Defogger

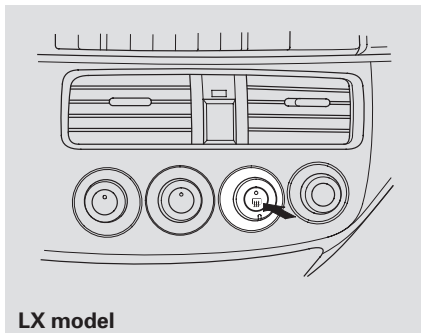

The rear window defogger will clear fog, frost, and thin ice from the window. Push the defogger button to turn it on and off. The indicator in the button comes on to show the defogger is on. It shuts off when you turn off the ignition. You have to turn the defogger on again when you restart the vehicle.

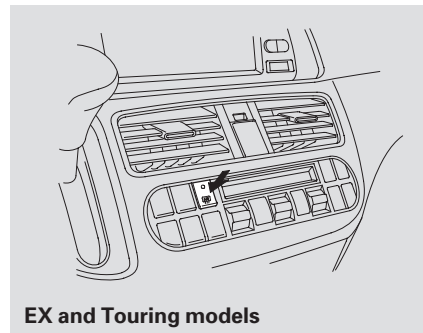

Make sure the rear window is clear and you have good visibility before starting to drive.

The defogger wires on the inside of the rear window can be accidentally damaged. When cleaning the glass, always wipe side-to-side.

# Steering Wheel Adjustment

Make any steering wheel adjustment before you start driving.

## **⚠ WARNING**

Adjusting the steering wheel position while driving may cause you to lose control of the vehicle and be seriously injured in a crash.

Adjust the steering wheel only when the vehicle is stopped.

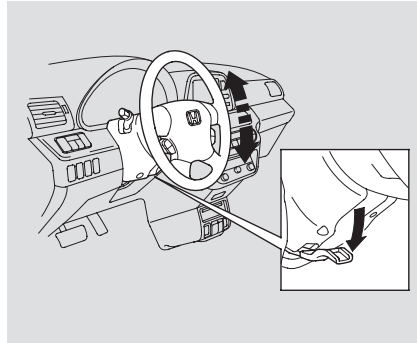

1. Push the lever under the steering column all the way down.
2. Move the steering wheel so it points toward your chest, not toward your face. Make sure you can see the instrument panel gauges and indicators.

3. Push the lever up to lock the steering wheel in position.
4. Make sure you have securely locked the steering wheel in place by trying to move it up and down.



## Keys and Locks

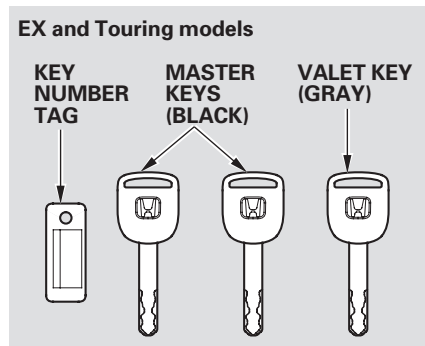

The master key fits all the locks on your vehicle. The valet key works only in the ignition and the door locks. You can keep the glove box locked when you leave your vehicle and the valet key at a parking facility.

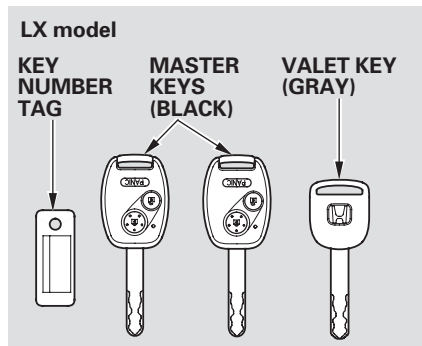

You should have received a key number tag with your keys. You will need this key number if you ever have to get a lost key replaced. Use only Honda-approved key blanks.

These keys contain electronic circuits that are activated by the Immobilizer System. They will not work to start the engine if the circuits are damaged.

- Protect the keys from direct sunlight, high temperature, and high humidity.
- Do not drop the keys or set heavy objects on them.
- Keep the keys away from liquids. If they get wet, dry them immediately with a soft cloth.

### *On EX and Touring models*

The keys do not contain batteries. Do not try to take them apart.

The immobilizer system protects your vehicle from theft. If an improperly-coded key (or other device) is used, the engine will not start.

When you turn the ignition switch to ON (II), the immobilizer system indicator should come on for a few seconds, then go out. If the indicator starts to blink, it means the system does not recognize the coding of the key. Turn the ignition switch to LOCK (0), remove the key, reinsert it, and turn the switch to ON (II) again.

The system may not recognize your key's coding if another immobilizer key or other metal object (i.e. key fob) is near the ignition switch when you insert the key.

If the system repeatedly does not recognize the coding of your key, contact your dealer.

Do not attempt to alter this system or add other devices to it. Electrical problems could result that may make your vehicle undriveable.

If you have lost your key and you cannot start the engine, contact your dealer.

*As required by the FCC:*

*This device complies with Part 15 of the FCC rules. Operation is subject to the following two conditions: (1) This device may not cause harmful interference, and (2) this device must accept any interference received, including interference that may cause undesired operation.*

*Changes or modifications not expressly approved by the party responsible for compliance could void the user's authority to operate the equipment.*

*This device complies with Industry Canada Standard RSS-210. Operation is subject to the following two conditions: (1) this device may not cause interference, and (2) this device must accept any interference that may cause undesired operation of the device.*

## Ignition Switch

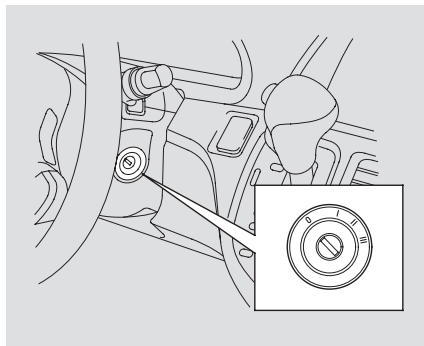

The ignition switch has four positions: LOCK (0), ACCESSORY (I), ON (II), and START (III).

**LOCK (0)** – You can insert or remove the key only in this position. To turn the key, the shift lever must be in Park, and you must push the key in slightly.

If the front wheels are turned, the anti-theft lock may make it difficult to turn the key. Firmly turn the steering wheel to the left or right as you turn the key.

**ACCESSORY (I)** – You can operate the audio system and the accessory power sockets in this position.

**ON (II)** – This is the normal key position when driving. Several of the indicators on the instrument panel come on as a test when you turn the ignition switch from ACCESSORY (I) to ON (II).

**START (III)** – Use this position only to start the engine. The switch returns to ON (II) when you let go of the key.

You will hear a reminder beeper if you leave the key in the ignition switch in the LOCK (0) or ACCESSORY (I) position and open the driver's door. Remove the key to turn off the beeper.

The shift lever must be in Park before you can remove the key from the ignition switch.

On LX model

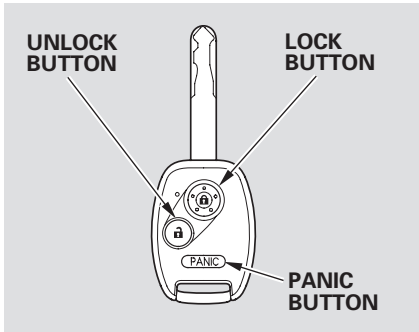

**LOCK** – Press this button once to lock all doors and the tailgate. Some exterior lights will flash. When you push LOCK button twice within 5 seconds, you will hear a beep to verify that the doors and the tailgate are locked. You cannot lock the doors and the tailgate if any door or the tailgate is not fully closed or if the key is in the ignition switch.

**UNLOCK** – Press this button once to unlock the driver's door. Press it twice to unlock the other doors and the tailgate. Some exterior lights will flash twice each time you press the button. If you do not open any door or the tailgate within 30 seconds, they will automatically relock.

When you press the UNLOCK button, the front and rear individual map lights, depending on their switch positions, will come on (see page 183). If you do not open any door or the tailgate, the lights stay on for about 30 seconds, then go out. If you relock the doors and the tailgate with the remote transmitter before 30 seconds have elapsed, the lights will go off immediately.

**PANIC** – Press and hold this button for about 1 second to attract attention; the horn will sound and the exterior lights will flash for about 30 seconds. To cancel panic mode, press any other button on the remote transmitter or turn the ignition switch to ON (II).

### **Remote Transmitter Care**

Refer to page 135 for how to take care of your remote transmitter.

CONTINUED

## Remote Transmitter

### Replacing the Transmitter Battery

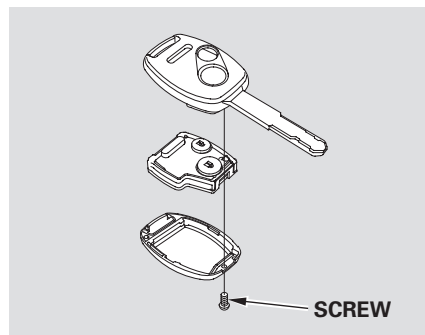

If it takes several pushes on the button to lock or unlock the doors and the tailgate, replace the battery as soon as possible.

Battery type: CR1616

To replace the battery:

1. Remove the screw at the base of the transmitter with a small Phillips-head screwdriver.

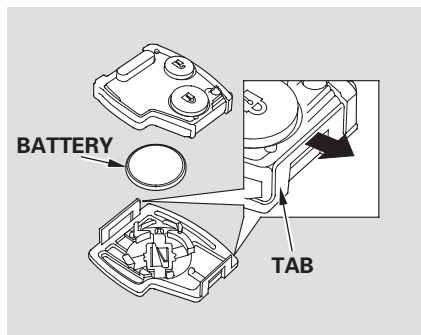

2. Separate the transmitter by prying its middle seam with your fingernail.
3. Inside the transmitter, separate the inner cover from the keypad by releasing the two tabs on the cover.

4. Remove the old battery from the back of the inner cover, and note the polarity. Make sure the polarity of the new battery is the same (+ side facing down), then insert it into the back of the cover.

On EX and Touring models

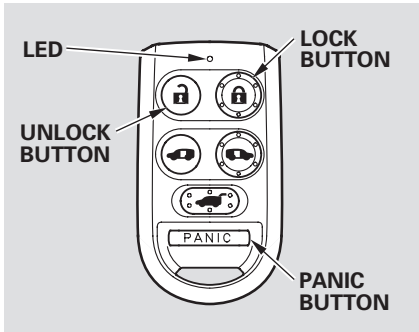

**LOCK** – Press this button once to lock all doors and the tailgate. Some exterior lights will flash. When you push LOCK twice within 5 seconds, you will hear a beep to verify that the doors and the tailgate are locked and the security system has set.

**UNLOCK** – Press this button once to unlock the driver's door. Press it twice to unlock the other doors and the tailgate. Some exterior lights will flash twice each time you press the button.

If you do not open any doors or the tailgate within 30 seconds, they will automatically relock and the security system sets.

On the Touring model, you can change this setting (see page 116 ).

If you press the LOCK button and the PASSENGER'S SIDE SLIDING DOOR button at the same time for about 1 second, the LED in the remote transmitter will blink twice, and all doors and the tailgate will unlock simultaneously when you press the UNLOCK button. To cancel this feature, press the LOCK button and the PASSENGER'S SIDE SLIDING DOOR button at the same

time. The LED will blink once.

When you press the UNLOCK button, the front and rear individual map lights, depending on their switch positions, will come on (see page 183 ). If you do not open any door or the tailgate, the lights stay on for about 30 seconds, then go out. If you relock the doors and the tailgate with the remote transmitter before 30 seconds have elapsed, the lights will go off immediately.

**PANIC** – Press and hold this button for about 1 second to attract attention; the horn will sound and the exterior lights will flash for about 30 seconds. To cancel panic mode, press any other button on the remote transmitter or turn the ignition switch to ON (II).

## Remote Transmitter

### Opening or Closing the Power Sliding Doors

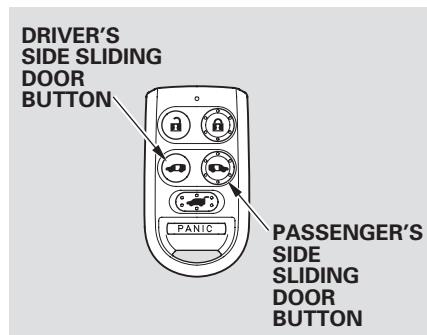

You can open or close each sliding door with the remote transmitter when the doors are unlocked. Push and hold the right button to open or close the passenger's side door, and the left button to open or close the driver's side door.

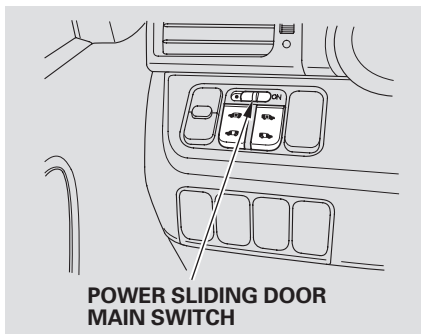

If the power sliding door MAIN switch on the dashboard is in the OFF position, you cannot open or close the sliding doors with the remote transmitter.

### Opening or Closing the Power Tailgate

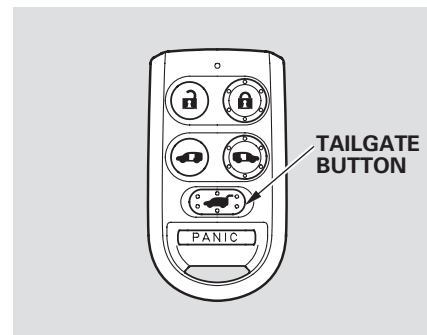

*On Touring model only*  
You can open or close the power tailgate with the remote transmitter when the doors are unlocked. Press and hold the TAILGATE button to open or close the power tailgate. When the tailgate begins to move, you will hear a beep, and some front and rear lights will flash.

## Recalling a Memorized Seat Position

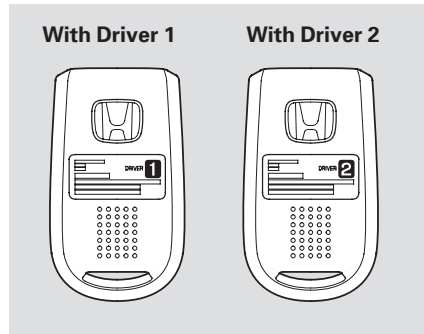

*On Touring model only*  
Each remote transmitter activates the driver's seat position memory system and customized vehicle control settings (see page 89). When you open the driver's door after unlocking it with the remote transmitter, the driver's seat moves to the positions stored in memory. You will hear two beeps when the movement is completed.

The driver's seat position memory activation (Driver 1, Driver 2) is shown on the back of each transmitter. Make sure you store your seat position in the memory that is activated by the transmitter you normally carry.

You can turn off driver's seat position memory activation with the remote transmitter. Press and hold the LOCK and UNLOCK buttons at the same time. The LED in the remote transmitter will blink twice. Then release the buttons, and press the UNLOCK button.

Most of the customized settings will return to the default settings.

To turn it back on, repeat this procedure. The LED will come on for 1 second to indicate the feature has been turned on.

## Remote Transmitter Care

- Avoid dropping or throwing the transmitter.
- Protect the transmitter from extreme temperature.
- Do not immerse the transmitter in any liquid.
- If you lose a transmitter, the replacement needs to be reprogrammed by your dealer.



## Remote Transmitter

### Replacing the Transmitter Battery

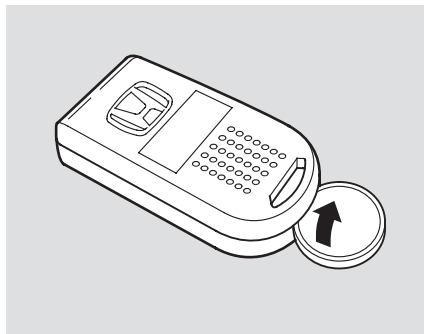

If it takes several pushes on the button to lock or unlock the doors and the tailgate, replace the battery as soon as possible.

Battery type: CR2025

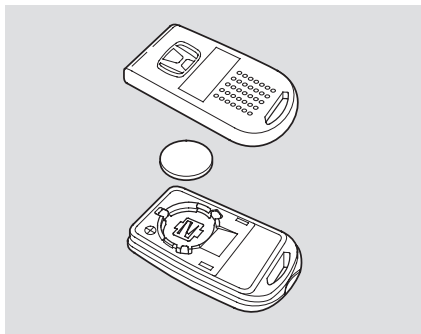

To replace the battery, separate the halves by carefully prying on the edge with a coin. Remove the old battery, and insert a new battery with the + side facing up. Snap the two halves of the transmitter case back together.

*As required by the FCC:  
This device complies with Part 15 of the FCC rules. Operation is subject to the following two conditions: (1) This device may not cause harmful interference, and (2) this device must accept any interference received, including interference that may cause undesired operation.*

*Changes or modifications not expressly approved by the party responsible for compliance could void the user's authority to operate the equipment.*

*This device complies with Industry Canada Standard RSS-210.  
Operation is subject to the following two conditions: (1) this device may not cause interference, and (2) this device must accept any interference that may cause undesired operation of the device.*

## Power Door Locks

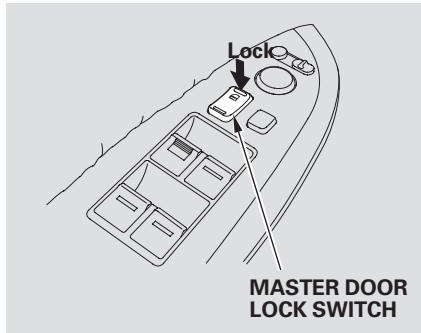

To lock the doors and the tailgate, press the front of the master door lock switch on either front door, press the lock tab on the driver's door, or use the outside lock on the driver's door.

Pressing the rear of the master door lock switch will unlock all doors and the tailgate.

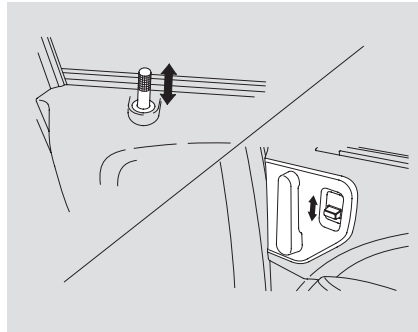

The lock tab on any door locks and unlocks that door.

All doors and the tailgate can be locked from the outside by using the key in the driver's door. To unlock only the driver's door, insert the key, turn the key, and release it. The remaining doors and the tailgate unlock when you turn the key a second time within a few seconds.

## *Lockout Prevention*

With the driver's door open and the key in the ignition, both master door lock switches are disabled. They are not disabled if the driver's door is closed. Pushing the front of the master door lock switch on the open passenger's door will lock all doors and the tailgate.

## Door Locks

### Childproof Door Locks

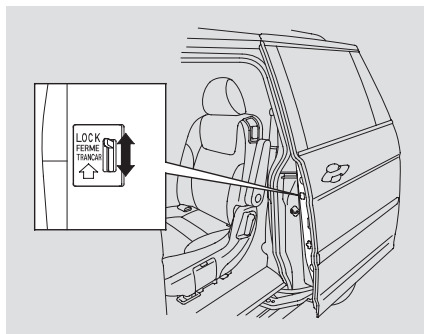

The childproof door locks are designed to prevent children seated in the rear from accidentally opening the rear sliding doors. Each door has a lock lever near the edge. With the lever in the LOCK position, the door cannot be opened from the outside regardless of the position of the lock tab. To open the door, pull the lock tab up and use the outside door handle.

*On EX and Touring models*  
With the childproof door locks on, automatic operation with the inside door handle is disabled.

### Tailgate

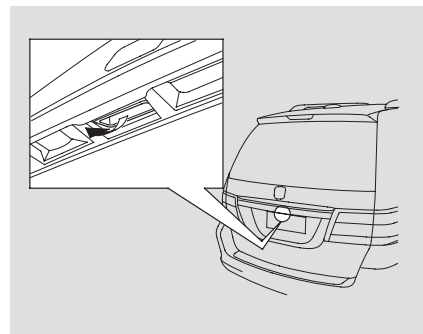

*LX and EX models*  
To open the tailgate, pull the handle, then lift up. To close the tailgate, use the inner handle to pull it down, then press down on the back edge.

Keep the tailgate closed at all times while driving to avoid damaging the tailgate and to prevent exhaust gas from getting into the interior. See **Carbon Monoxide Hazard** on page [56](#).

### Power Tailgate

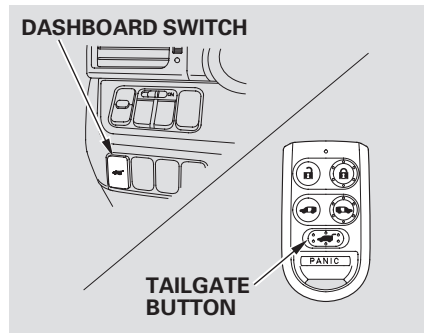

*On Touring model only*  
The tailgate can be opened and closed with the remote transmitter or the switch on the dashboard when both front doors are unlocked.

Press and hold the tailgate button on the remote transmitter or the dashboard switch for about 1 second to open or close the tailgate. Each time you press the button on the remote transmitter or the dashboard switch, you will hear a beep.

If you push the same button or switch again while the tailgate is opening or closing, you will hear three beeps, and the tailgate will stop moving, reverse direction, and stop at the fully opened or closed position.

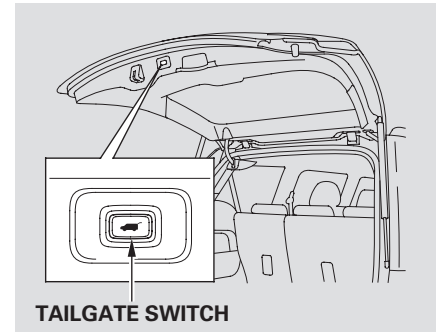

The tailgate can also be closed by pressing the button on the tailgate. If you press the button again while the tailgate is closing, you will hear three beeps, and the tailgate will stop moving, reverse direction, and stop at the fully opened position.

To open or close the tailgate manually, see page [138](#).

*CONTINUED*

## Door Locks

---

### *Auto-Reverse*

The power tailgate has an auto-reverse feature. If it meets resistance while opening or closing, it will beep three times and reverse direction. However, the tailgate may not reverse immediately. Always make sure passengers and objects are clear of the tailgate before opening or closing it.

### **⚠ WARNING**

Closing a power tailgate while anyone is in the path of the tailgate can cause serious injury.

Make sure everyone is clear before closing the power tailgate.

Also check that passengers, especially children, do not have their hands on the edge of the tailgate or on the tailgate still. The auto reverse feature stops working when the tailgate is about to latch so the motor can pull the tailgate shut.

If your vehicle's battery is disconnected, goes dead, or the fuse is removed while the tailgate is fully open, the power tailgate needs to be reset. After connecting the battery or installing the fuse, close the tailgate fully by hand.

The power tailgate may not open or close under the these conditions:

- The vehicle is parked on a steep hill.
- When the vehicle is swayed in a strong wind.

- When the tailgate or the roof is covered with snow or ice.

Do not install any accessories on the tailgate. It may cause the tailgate not to function properly. If there is snow or ice on the tailgate, make sure to remove it before you operate the tailgate.

If you pull the tailgate release handle while the tailgate is opening or closing, it will stop moving. You need to open or close it the rest of the way manually.

The tailgate has sensors on both sides. Be careful not to damage them. If the sensors are damaged, the power tailgate does not function properly.

If you try to drive off with the tailgate not closed completely, a beeper sounds and a “DOOR & TAILGATE OPEN” message is shown on the multi-information display.

Keep the tailgate closed at all times while driving to avoid damaging the tailgate and to prevent exhaust gas from getting into the interior. See **Carbon Monoxide Hazard** on page 56 .

If there is a problem in the power tailgate system, you will see a “CHECK POWER TAILGATE” message on the multi-information display. Have the system checked by your dealer.

With this message shown in the multi-information display, you can still open or close the tailgate manually.

### Unlocking the Tailgate

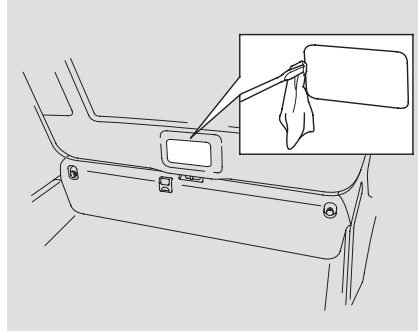

*On Touring model only*  
If the power door lock system cannot unlock the tailgate, unlock it manually.

Use a small flat-tipped screwdriver to remove the cover on the back of the tailgate.

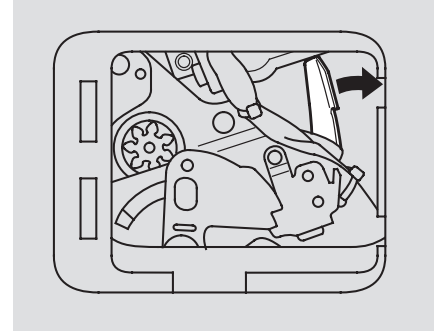

Push the release lever to the right as shown.

If you need to unlock the tailgate manually, it means there is a problem with the tailgate. Have the vehicle checked by your dealer.

CONTINUED

## Door Locks, Sliding Doors

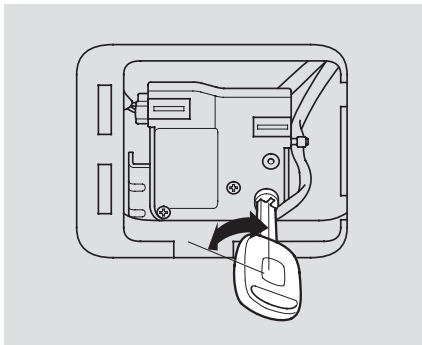

*On LX and EX models*

If you cannot open the tailgate, remove the cover on the back of the tailgate (see page 141). Use the key to unlock the tailgate as shown, then pull the outer handle to open the tailgate.

### Opening and Closing Manual Sliding Doors

*LX model*

To open, pull the inside or outside door handle, and slide the door back. It will latch in the fully open position. When opening from the inside, the childproof door lock must be unlocked.

To close, pull either handle, and slide the door closed. Make sure the door is closed and latched securely before driving, and all passengers are clear of the sliding doors before closing them.

When opening a sliding door, it stops about halfway if the window is open more than 3 in (8 cm). If the vehicle is facing downhill, the sliding door will slam shut when you release the door handle. Always close the window fully before opening the sliding door.

### Power Sliding Doors

*On EX and Touring models*

The doors are electrically powered and can be operated with the remote transmitter, the door handles, or the dashboard switches. To operate the doors:

- The shift lever must be in Park or Neutral. To operate the doors with the shift lever in Neutral, the ignition switch must be in the ON (II) position with the brake pedal pressed or the parking brake applied.
- The MAIN switch must be in the ON position.
- The doors must be unlocked.

*When the shift lever is in Park:*

If you shift out of Park while a door is closing, you will hear a beep until the door closes.

If you shift out of Park while a door is opening, you will hear a continuous tone and the door will stop moving. Stop the vehicle and close the door.

*When the shift lever is in Neutral and the ignition switch is in the ON position:*

If you shift out of Neutral or release the brake pedal or the parking brake while a door is closing, you will hear a beep until the door closes.

If you shift out of Neutral or release the brake pedal or the parking brake while a door is opening, you will hear a continuous tone and the door will stop moving. Stop the vehicle and close the door.

## **Door Handles**

To open the door with the inside door handle, pull the handle backward. Push it forward to close the door. If you pull backward or push forward on the door handle while a door is opening or closing, the door stops moving. Pull backward or push forward to open or close the door fully.

To open or close the door with the outside door handle, pull the door handle. If you pull the door handle while a door is opening or closing, the door stops moving. If you pull the door handle again, the door will open fully.

## **Dashboard Switches**

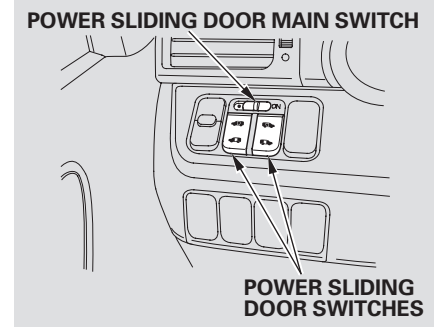

The dashboard switches to the left of the steering column allow you to open or close the power sliding doors.

The MAIN switch on the dashboard controls power to the sliding doors.

CONTINUED



## Sliding Doors

To open a power sliding door, push and release the bottom of the appropriate switch. If you forget to unlock the door, you will hear three beeps. Unlock the door and try again.

To close a sliding door, push and release the top of the switch.

To stop a door, push either the top or bottom of the switch. The door will stop and you will hear three beeps. Push the switch again to resume movement.

When the MAIN switch is in the OFF position, you have to operate the doors manually.

### Remote Transmitter

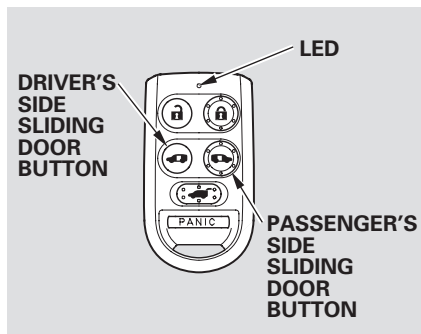

To open and close a power sliding door, press and hold the appropriate button for at least 1 second. If you forget to unlock the door, you will hear three beeps. Unlock the door, and try again.

To stop movement, push the appropriate door button; you will hear three beeps. Push and hold the same button again for at least 1 second and the door will reverse direction.

### Auto-Reverse

Each power sliding door has an auto-reverse feature. If a door meets resistance while closing, it will beep three times and reverse direction. However, the door may not reverse immediately and may cause some bruising or discomfort. Always make sure passengers and objects are clear of the doors before closing them.

If a rear window is open more than 3 in (8 cm), the power sliding door is designed to stop about halfway to avoid accidents. If this happens, close the door with the door handles, the dashboard switch, or the remote transmitter. Close the window and open the sliding door. Make sure the window is fully closed before you operate the power sliding door.

### ***Manually Opening/Closing the Power Sliding Door***

You can manually open or close the sliding doors. The MAIN switch must be in the OFF position. To open a door, pull the inside or outside door handle, and slide the door back. It will latch in the fully open position. To close, pull either handle and slide the door forward. When the door is almost closed, the auto-closer will pull the door shut.

### **Important Sliding Door Precautions**

#### *On EX and Touring models*

Before operating the sliding doors, check that passengers, especially children, do not have their hands on the edge of the sliding door or on the door pillar. The auto-reverse motor stops working when the door is about to latch so the auto-closer can pull the door shut.

If there is an obstacle in the door sill, the power sliding door may not open or close properly. When removing the obstacle from the door sill, make sure to turn off the main switch on the dashboard.

When replacing a flat tire, make sure to turn off the power sliding door main switch on the dashboard.

#### *On all models*

Do not allow anyone to step on the lower arm of the sliding door while the door is open. This could damage the sliding door mechanism.

When you drive with children in your vehicle, use the childproof door locks (see page 138). This will prevent children from opening the doors accidentally.

Do not put any item in the door pocket sticks out from the pocket. It can prevent the doors from opening or closing properly, and damage the vehicle body.

### **⚠ WARNING**

Closing a sliding door while any part of a passenger is in the door's path can cause serious injury.

Make sure all passengers are clear of the doorway before closing a sliding door.

## Sliding Doors

---

### Refueling

When you release the fuel fill door, the driver's side sliding door automatically locks so it cannot open and interfere with the fuel door. If a passenger attempts to unlock the door by cycling the lock knob several times, the door can be opened.

If a passenger needs to get out while you are refueling, instruct that person to exit on the passenger's side.

When you close the fuel fill door, the driver's side sliding door unlocks if it was unlocked when you opened the fuel fill door.

#### *On EX and Touring models*

If you open the fuel fill door while the driver's side sliding door is opening, the sliding door stops. If this happens, the door must be operated manually.

### Parking on a Hill

When parking facing downhill, make sure the doors are latched in the fully open position, and then hold the door open for your passengers. Do not pull the inside or outside door handle, or the door will slam shut.

#### *On EX and Touring models*

Make sure the main switch on the dashboard is in the ON position.

When parking facing downhill on a steep grade, the power sliding doors may not open or close as they do normally.

If you leave the vehicle on a steep downhill with a power sliding door half open and the engine off, the magnetic lock will turn off after 30 minutes and the sliding door will automatically open or close. In this case you will hear a continuous tone.

If your vehicle is facing a downhill, do not turn the main switch to OFF while the door is opening because the door may slam shut.

## Pinch Sensor

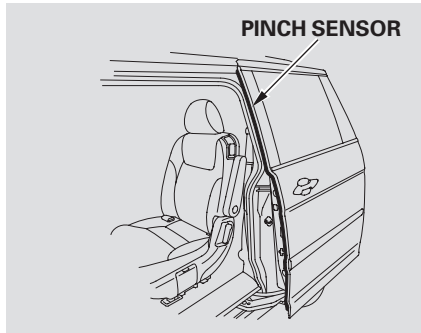

*On EX and Touring models*  
Each sliding door has a pinch sensor on the front edge. Do not damage this sensor, or the power sliding door may not operate properly.

## Power Sliding Door Problems

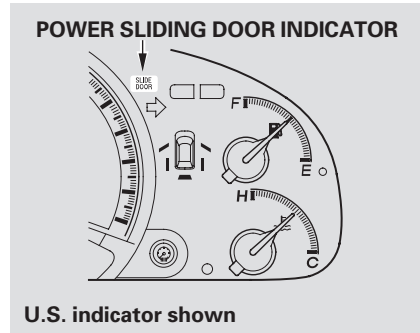

*On EX model*  
If the power sliding door indicator comes on and stays on, there is a problem in the system. Turn the MAIN switch to OFF, and have the system inspected by a dealer.

### *On Touring model*

If there is a problem in the power sliding door system, you will see a "CHECK LEFT SLIDING DOOR" message or "CHECK RIGHT SLIDING DOOR" message in the multi-information display (see page 87 ). If this message stays on, turn the MAIN switch to OFF, and have the system inspected by your dealer.

If the battery is disconnected or goes dead, close the sliding door completely by hand. If it still does not operate properly after the battery is reconnected, have your vehicle checked by a dealer.

## Seats

---

### Passenger Seating *Convertible Second Row Bucket Seats*

There are bucket seats with armrests for two front passengers, bucket seats with armrests for two passengers in the second row, and a bench seat for three passengers in the third row.

For greater cargo capacity, the seats in the second row can be removed, and the bench seat in the third row can be folded into the floor.

The EX model has a stowable second row plus-one seat that can be installed between the second row bucket seats when needed. The plus-one seat can also be used as a second row center console, or stored in the floor storage area. For more information, see page [156](#).

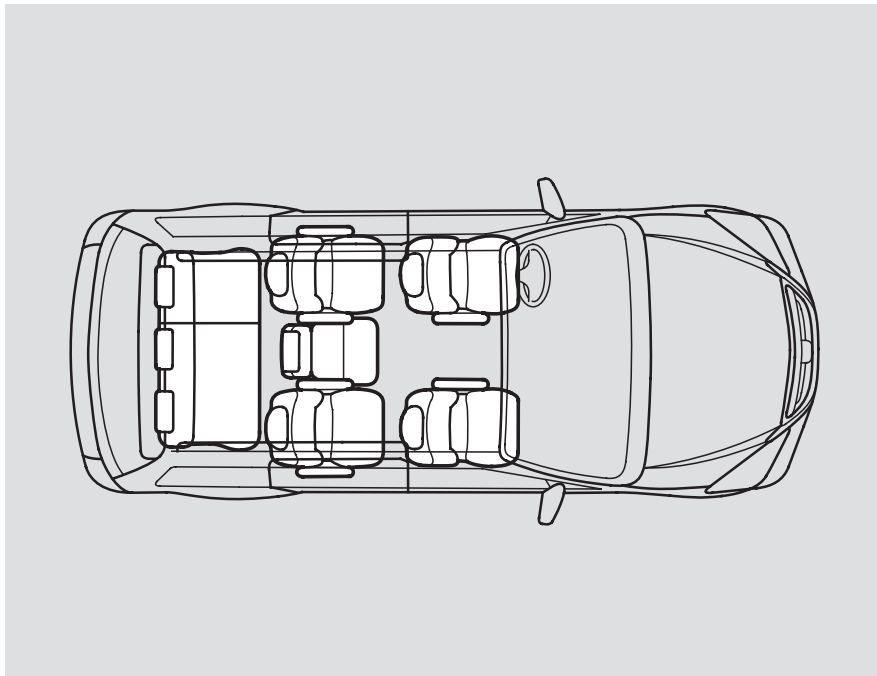

The EX and Touring models have a power adjustable driver's seat. The LX model has manual driver's seat adjustments.

The front passenger's seat, and the seats in the second and third rows adjust manually.

Make all seat adjustments before you start driving.

## Manual Seat Adjustments

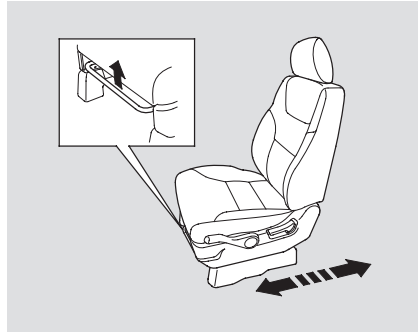

*See pages 13 – 15 for important safety information and warnings about how to properly position the seats and seat-backs.*

To adjust the seat forward and backward, pull up on the bar under the seat cushion's front edge. Move the seat to the desired position and release the bar. Try to move the seat to make sure it is locked in position.

To adjust the bucket seats in the second row, pull up the bar on the front of the seat bottom.

The third row seats do not adjust forward and backward.

CONTINUED

## Seats

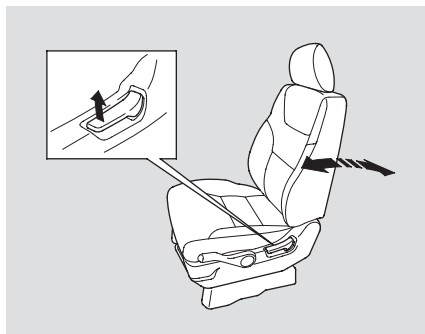

To change the seat-back angle of the front seat, pull up on the lever on the outside of the seat bottom.

To change the seat-back angle of the bucket seats in the second row, pull forward on the lever on the outside of the seat-back.

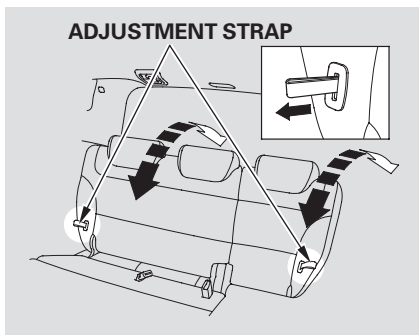

The left and right halves of the third seat-back can be adjusted separately. To adjust the angle, pull the adjustment strap on the outside of each seat-back, move the seat-back to the desired position, and release the adjustment strap. Let the seat-back latch in the new position.

### Driver's Seat Manual Height Adjustment

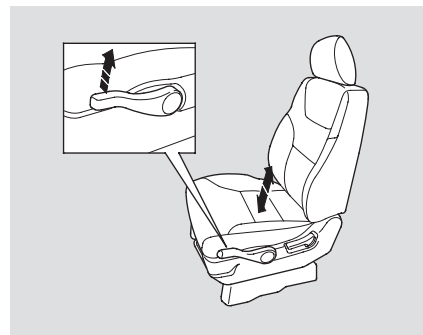

#### *On LX model*

The height of your driver's seat is adjustable. Pull up the lever on the outside of the seat cushion to raise the seat bottom or push the lever down to lower the seat cushion.

Make all adjustments before you start driving.

## Power Seat Adjustments

*On EX and Touring models*

*See pages 13 – 15 for important safety information and warnings about how to properly position the seats and seat-backs.*

The controls for the adjustable driver's power seat are on the outside edge of the seat bottom. You can adjust the power seat with the ignition switch in any position. Make all seat adjustments before you start driving.

Moving the long horizontal switch adjusts the seat bottom in several directions. The seat bottom adjusts in the direction you move the switch. The short vertical switch adjusts the seat back angle.

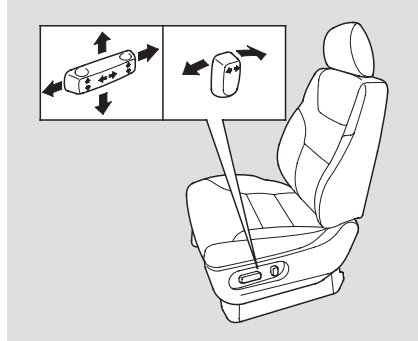

Moves the seat forward and backward.

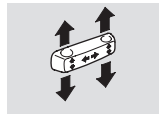

Moves the front of the seat up or down and the rear of the seat up or down.

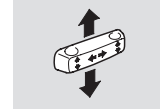

Raises or lowers the seat.

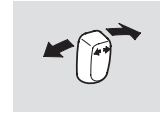

Adjusts the seat-back angle forward or backward.



# Seats

## Driver's Lumbar Support



*On EX and Touring models*  
To change the lumbar support, move the lever on the right side of the seat-back forward or backward. Keep moving the lever forward or backward until you find a suitable position.

## Armrests

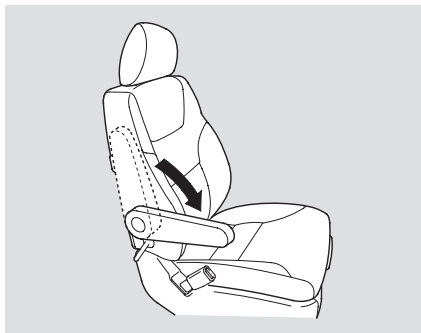

An armrest is located on each of the front seats and on each side of the second row seats. Pivot it down to use it. When you remove the bucket seats in the second row, pivot the armrests up out of the way.

*On EX with Leather and Touring models*  
The angle of the armrest on each front seat is adjustable. Pivot the armrest down, and pull it up to the desired angle.

## Head Restraints

See page 15 for important safety information and a warning about how to properly position the head restraints.

Your vehicle is equipped with head restraints in all seating positions to help protect you and your passengers from whiplash and other injuries.

They are most effective when you adjust them so the back of the occupant's head rests against the center of the restraint.

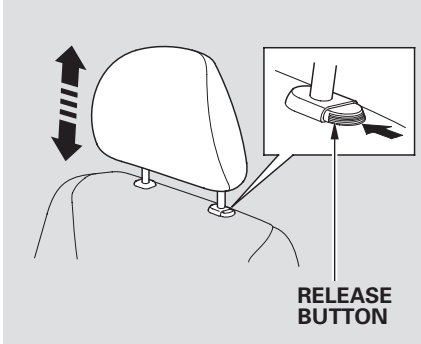

All head restraints adjust for height. You need both hands to adjust the restraint. Do not attempt to adjust it while driving. To raise it, pull upward. To lower the restraint, push the release button sideways, and push the restraint down.

### Third Seat Access

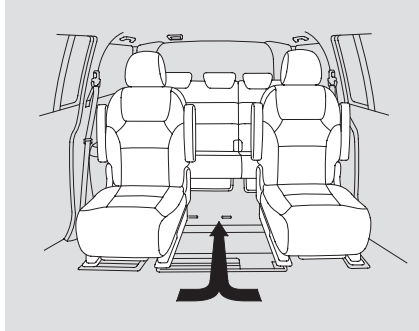

To get into or out of the third row seat, walk between the second row seats.

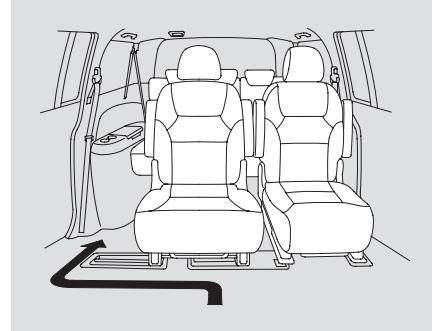

When the seat on the passenger's side is moved to the center, walk through the passenger's side to get into or out of the third row seat.

On the Touring model, you need to remove the second row console before you can make this seat adjustment.

*CONTINUED*

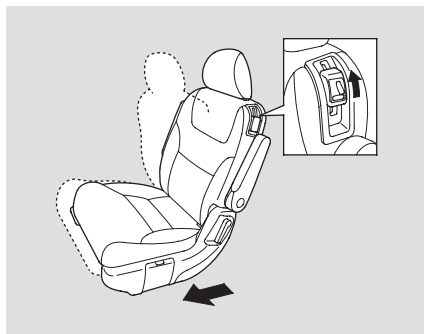

To get into or out of the third row seat, pull up the release lever on the shoulder of each second row bucket seat. The seat-back will tilt forward and the whole seat will slide forward.

### Moving the Second Row Bucket Seat

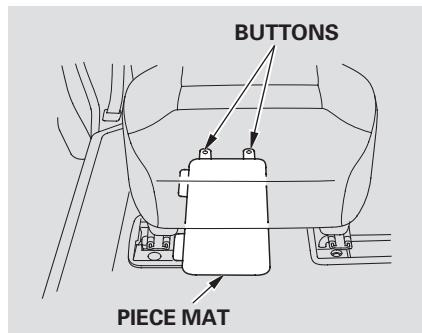

The second row bucket seat on the passenger's side can be moved to the center to provide access to the third row seat.

Remove the piece mat and the floor cover from under the passenger's side bucket seat. To remove the piece mat, unfasten the two buttons on the rear edge.

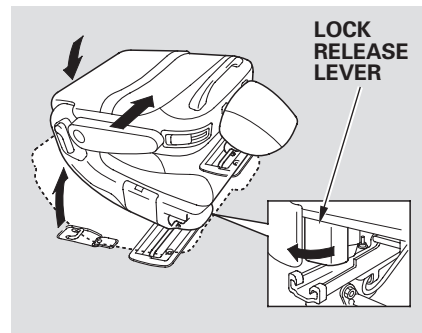

Unlock the seat from the floor by pulling the lock release lever under the seat cushion's front edge and lifting the rear of the seat.

Slide the seat toward the center of the vehicle. Push the back of the seat down over the floor hooks. Make sure the seat is securely locked in place.

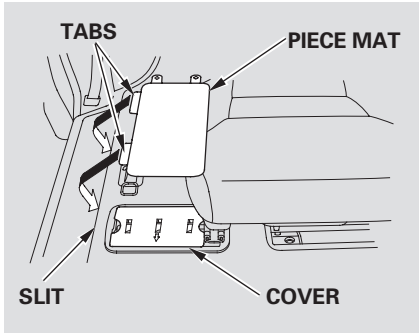

Install the floor covers over the outer floor anchor and install the piece mat over the floor cover. Insert the tabs on the piece mat into the slit on the floor. Fasten the buttons on the mat to the floor.

Make sure the seat is securely locked in place before driving. A seat that is not locked in place could fly around and cause injury in a sudden stop or crash.

Reverse this procedure to move the seat back to the outside.

When the passenger's side bucket seat is in the outside position, and the plus-one seat or the second row console is not used, install the floor mat and the piece mat over the center floor anchors between the bucket seats. Make sure to fasten the buttons on the mat to the floor.

## Removing the Bucket Seats in the Second Row

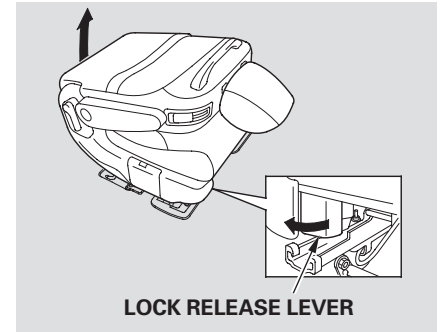

Both seats can be removed to give more cargo capacity.

To remove a seat:  
 Pull up the seat-back angle adjustment lever, and fold the seat-back forward.  
 Unlock the seat from the floor by pulling the lock release lever under the seat cushion's front edge and lifting the rear of the seat.

## Seats

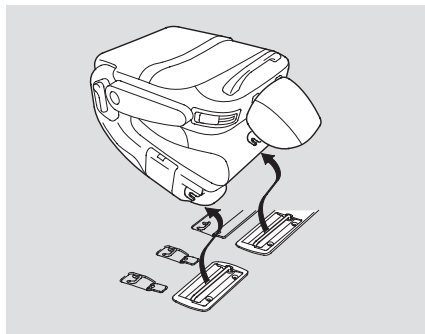

Unhook the front of the seat from the floor by pulling it back slightly, then pivoting it upward.

Always remove an unsecured seat from the vehicle before driving. A seat that is not locked in place could be thrown about and cause injury in a sudden stop or crash.

To reinstall the seat, hook the front of the seat to the floor, then push the back into the locks. Make sure both the front and the back of the seat are securely latched before driving.

### Installing the Stowable Second Row Plus-One Seat

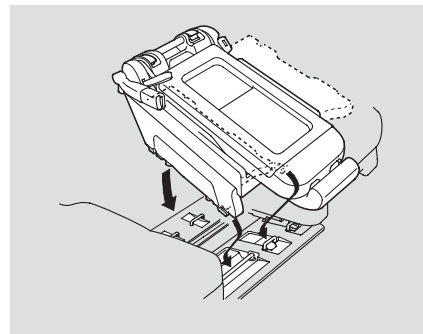

*On EX model only*  
You can install the stowable plus-one seat between the second row bucket seats.

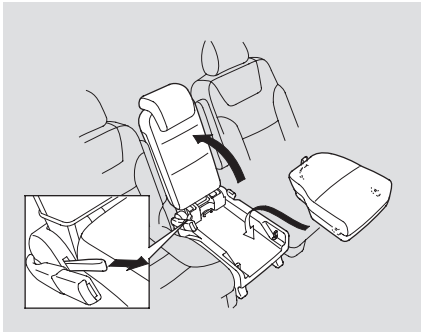

To install the stowable plus-one seat, pull the leg folding lever to unfold the leg, hook the front of the seat to the floor, then push down the back until it locks. Make sure both the front and back of the seat are securely latched. Pull up the seat-back, and adjust the seat-back angle to the desired position while pulling the seat-back angle adjustment strap on the outside of the seat bottom.

Install the seat cushion on the seat bottom plate. To install the cushion, hook the front of the cushion first, then push down the rear until the cushion is securely positioned.

To use the plus-one seat as a center console, remove its seat cushion by pulling up the seat cushion strap. Then pivot the seat-back forward until it is flat. Store the seat cushion in the floor storage area.

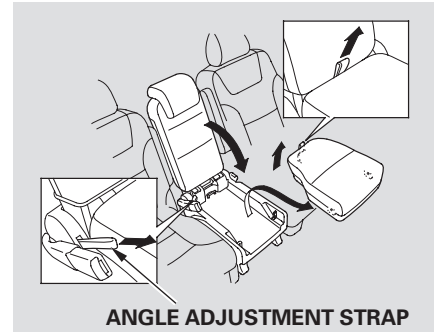

**ANGLE ADJUSTMENT STRAP**

To remove the seat, lower the head restraint all the way down. Remove the seat cushion by pulling the strap on the seat cushion, and fold the seat-back forward.

*CONTINUED*

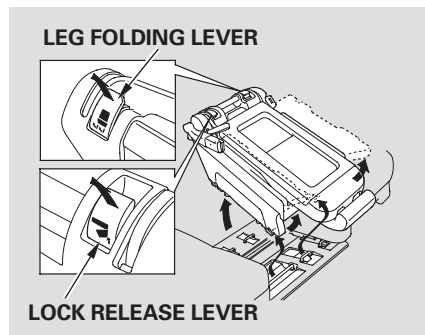

Unlock the seat from the floor by pulling the lock release lever and the leg folding lever on the bottom of the seat-back, and lift the rear of the seat. Unhook the front of the seat from the floor by pulling it back slightly, then pivoting it upward.

Always remove an unsecured seat from the vehicle before driving. A seat that is not locked in place could be thrown about and cause injury in a sudden stop or crash.

The stowable plus-one seat assembly can be stored in the floor storage area between the front seats and the second row seats. To do this, remove the Lazy Susan from the floor storage area.

### Folding the One-Motion Third Row “Magic Seat”

To create more cargo space, you can fold the one-motion third row “Magic Seat” into the floor recess.

1. Unlatch the detachable seat belt anchor center seat belt, and let the belt retract all the way into the ceiling. Place the latch plate and anchor latch into their holding slots.
2. Lower the head restraints fully.

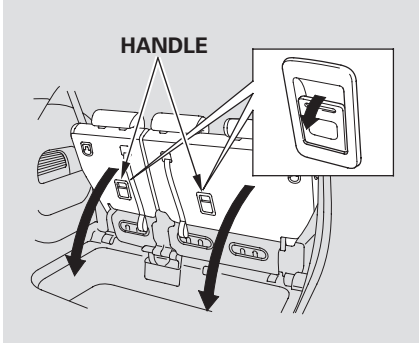

3. Pull the handle on each seat-back to unlock the front seat legs.
4. Pivot the seat into the cargo area floor recess.

Make sure all items in the cargo area are secured. Loose items can fly forward and cause injury if you have to brake hard. See **Carrying Cargo** on page [286](#).

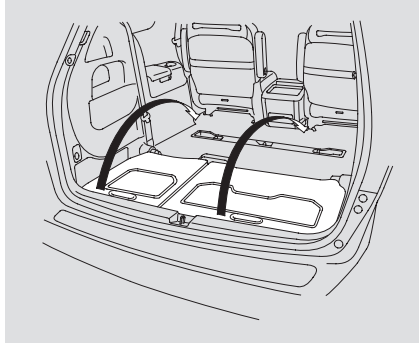

To return the seat to the upright position:

1. Pull the seat out of the recess by pulling on the handle. Pivot the seat forward all the way. The front seat legs will automatically latch.

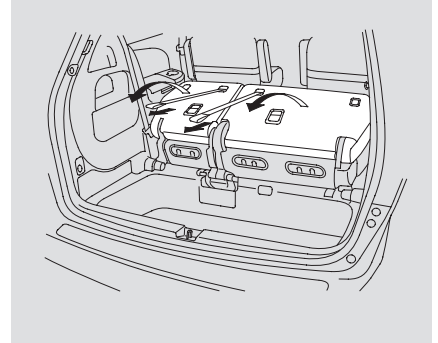

2. Pull the seat-back upright with the strap. Make sure the seat is securely locked.



## Seat Heaters

---

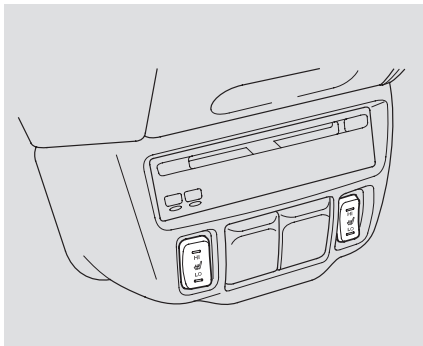

*On EX with Leather and Touring models*  
Both front seats are equipped with seat heaters. The passenger seat only has heaters in the seat bottom because of the side airbag system. The ignition switch must be in the ON (II) position to use them. The seat heater switches are located on the dashboard above the center pocket. Push the top of the switch, HI, to rapidly heat up the seat. After the seat reaches a comfortable temperature, select LO by pushing

the bottom of the switch. This will keep the seat warm.

In HI, the heater turns off when the seat gets warm, and turns back on after the seat's temperature drops.

In LO, the heater does not cycle with temperature change.

Follow these precautions when using the seat heaters:

- Use the HI setting only to heat the seats quickly, because it draws large amounts of current from the battery.
- If the engine is left idling for an extended period, do not use the seat heaters, even on the LO setting. It can weaken the battery, causing hard starting.

# Driver's Seat Position Memory System

## *On Touring model only*

Your vehicle has a memory feature for the driver's seat position.

Two seat positions can be stored in separate memories. You select a memorized position by pushing the appropriate button or appropriate remote transmitter (Driver 1 or Driver 2).

## Storing a Driver's Seat Position in Memory

Store a driver's seat position only when the vehicle is parked.

1. Turn the ignition switch to ON (II). You cannot add a new seat position in memory unless the ignition switch is in the ON (II) position. You can recall a memorized position with the ignition switch in any position.
2. Adjust the seat to a comfortable position (see page 151).

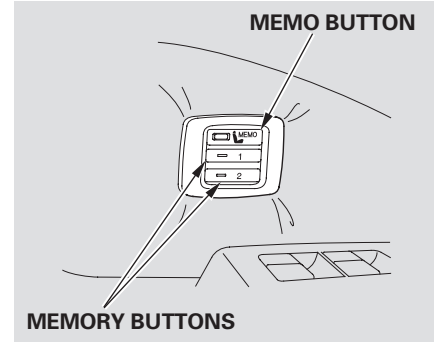

3. Press and release the MEMO button on the control panel. You will hear a beep. Immediately press and hold one of the memory buttons (1 or 2) until you hear two beeps. The indicator in the memory button will come on. The current driver's seat position is now stored.

CONTINUED

## Driver's Seat Position Memory System

Doing any of the following after pressing the MEMO button will cancel the storing procedure.

- Not pressing a memory button within 5 seconds.
- Readjusting the seat position.

Each memory button stores only one seat position. Storing a new position erases the previous position stored in that button's memory. If you want to add a new position while retaining the current one, use the other memory button.

### Selecting a Memorized Position

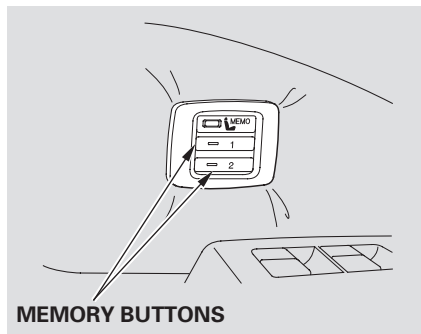

To select a memorized position, do this:

1. Make sure the shift lever is in Park. Press on the brake pedal.
2. Press the desired memory button (1 or 2) until you hear a beep, then release the button.

The system will move the driver's seat to the memorized position. The indicator in the selected memory button will flash during movement. When the adjustment is complete, you will hear two beeps, and the indicator will stay on.

To stop the system's automatic adjustment, do any of these actions:

- Press any button on the control panel: MEMO, 1, or 2.
- Push any of the adjustment switches for the seat.
- Shift out of Park.

If desired, you can use the adjustment switches to change the seat position after it is in its memorized position. If you change the memorized position, the indicator in the memory button will go out. To keep this seat position for later use, you must store it in the driver's seat position memory.

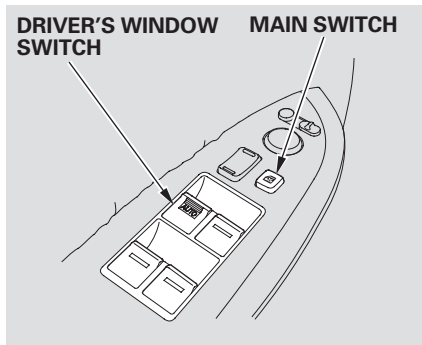

Turn the ignition switch to ON (II) to raise or lower any window. To open the window, push the switch down to the first detent and hold it. Release the switch when you want the window to stop. Pull back on the switch and hold it to close the window.

The windows will operate for up to 10 minutes after you turn off the ignition switch. Opening either front door cancels this function.

### **⚠ WARNING**

Closing a power window on someone's hands or fingers can cause serious injury.

Make sure your passengers are away from the windows before closing them.

**AUTO** – To open/close the driver's window, push the window switch firmly down or up to the second detent, and release it. The window will automatically go up or down all the way. To stop the window, pull/push on the window switch briefly.

If the MAIN switch is OFF, the passenger windows cannot be raised or lowered. Keep the MAIN switch off when you have children in the vehicle so they do not injure themselves by operating the windows unintentionally.

**AUTO REVERSE** – If the driver's window senses any obstacle while it is closing automatically, it will reverse direction and then stop. To close the window, remove the obstacle, then use the window switch again.

Auto reverse stops sensing when the window is almost closed. You should always check that all passengers and objects are away from the window before closing it.

*CONTINUED*

## Power Windows

If your vehicle's battery is disconnected or goes dead, or the driver's window fuse is removed, the AUTO REVERSE function will be disabled. The power window system needs to be reset after reconnecting the battery or installing the fuse.

1. Start the engine. Push down and hold the driver's window switch until the window is fully open.
2. Pull and hold the driver's window switch to close the window completely, then hold the switch for a second or two more.

If the power windows do not operate properly after resetting, have your vehicle checked by your dealer.

### Opening the Windows with the Remote Transmitter

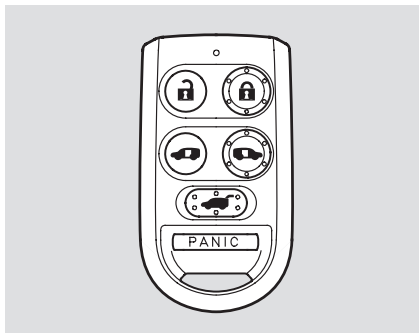

*On EX and Touring models*

You can open all of the windows from the outside with the remote transmitter.

1. Press the UNLOCK button once to unlock the driver's door.

2. Press the UNLOCK button a second time, and hold it. The passenger's doors unlock, and all four windows start to open. To stop the windows, release the button.
3. To open the windows further, press the button again and hold it. If the windows stop before the desired position, repeat steps 1 and 2.

You cannot close the windows with the remote transmitter.

### Opening/Closing the Windows with the Key

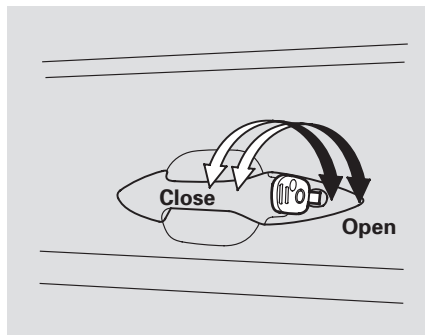

*On EX and Touring models*

You can open and close the windows with the key in the driver's door lock.

To open:

1. Insert the key in the driver's door lock.
2. Turn the key clockwise, then release it.

3. Turn the key clockwise again, and hold it. All four windows start to open. To stop the windows, release the key.
4. To open the windows further, turn and hold the key again (within 15 seconds).

To close:



1. Insert the key in the driver's door lock.
2. Turn the key counterclockwise, then release it.
3. Turn the key counterclockwise again, and hold it. All four windows start to close. To stop the windows, release the key.
4. To close the windows further, turn and hold the key again (within 15 seconds).

If the windows stop before the desired position, repeat steps 2 and 3.

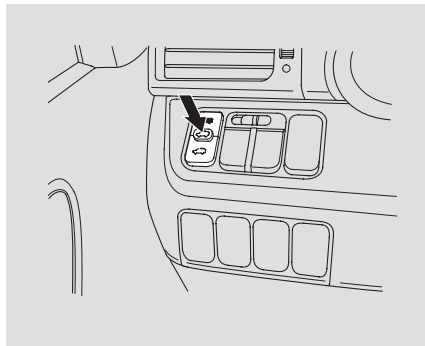
## Moonroof



*On EX with Leather and Touring models*  
The moonroof can be tilted up in the back for ventilation, or it can be slid back into the roof. Use the switch under the left dashboard vent to operate the moonroof. You must turn the ignition switch to ON (II) for the moonroof to operate.

To tilt up the back of the moonroof, press and hold the center button (  ). To close the moonroof, press and hold the top of the switch (  ). To open the moonroof, press and hold the bottom of the switch (  ).

### **WARNING**

Opening or closing the moonroof on someone's hands or fingers can cause serious injury.

Make sure all hands and fingers are clear of the moonroof before opening or closing it.

### **NOTICE**

*If you try to open the moonroof in below-freezing temperatures, or when it is covered with snow or ice, you can damage the moonroof panel or its motor.*

The moonroof has a key-off delay. You can still open and close the moonroof for up to 10 minutes after you turn off the ignition. The key-off delay cancels as soon as you open either front door. You must then turn the ignition to ON (II) for the moonroof to operate.

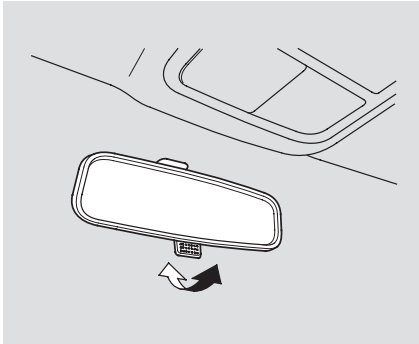

Keep the inside and outside mirrors clean and adjusted for best visibility. Be sure to adjust the mirrors before you start driving.

### *On LX and EX models*

The inside mirror has day and night positions. The night position reduces glare from headlights behind you. Flip the tab on the bottom edge of the mirror to select the day or night position.

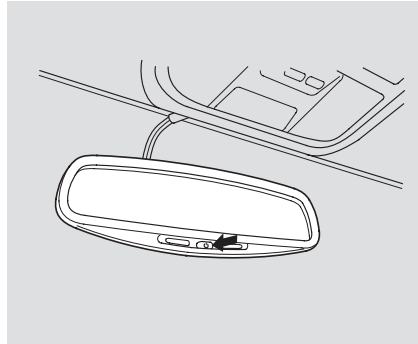

### *On Touring model*

The inside mirror can automatically darken to reduce glare. To turn on this feature, press the button on the bottom of the mirror. The AUTO indicator comes on as a reminder. When it is on, the mirror darkens when it senses the headlights of a vehicle behind you, then returns to normal visibility when the lights are gone. Press the button again to turn off this sensing.

## Adjusting the Power Mirrors

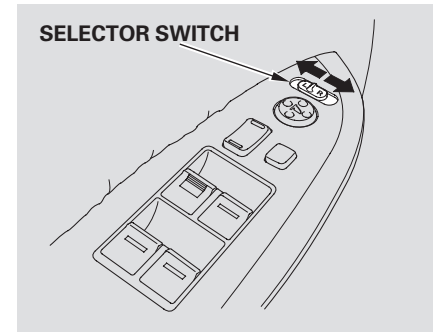

1. Turn the ignition switch to ON (II).
2. Move the selector switch to L (driver's side) or R (passenger's side).

CONTINUED



## Mirrors

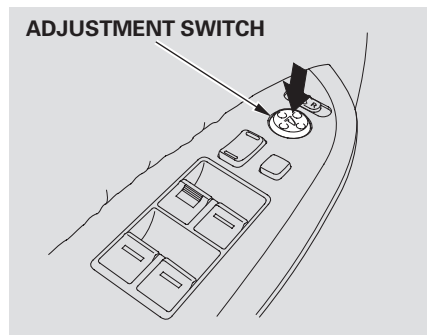

3. Push the appropriate edge of the adjustment switch to move the mirror right, left, up, or down.

When you finish, move the selector switch to the center (off) position. This turns the adjustment switch off to keep your settings.

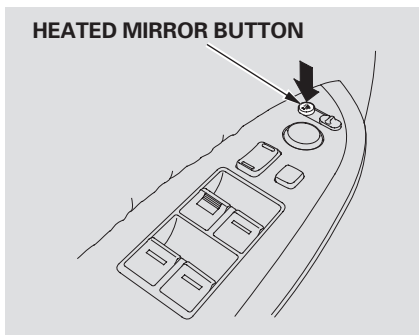

*On EX and Touring models*  
The outside mirrors are heated to remove fog and frost. With the ignition switch in the ON (II) position, turn on the heaters by pressing the button. The indicator in the button comes on as a reminder. Press the button again to turn the heaters off.

## Parking Brake

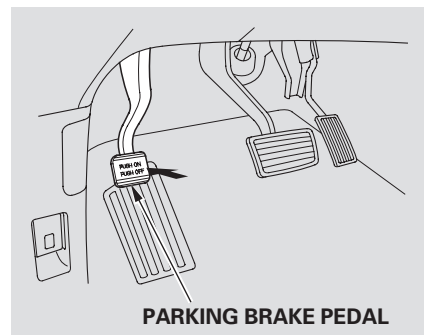

To apply the parking brake, push the parking brake pedal down with your foot. To release the parking brake, push on the pedal again. The parking brake indicator on the instrument panel should go out when the parking brake is fully released with the engine running (see page 63).

# Parking Brake, Adjustable Driver's Foot Pedals

## NOTICE

*Driving the vehicle with the parking brake applied can damage the rear brakes and axles.*

## Adjustable Driver's Foot Pedals

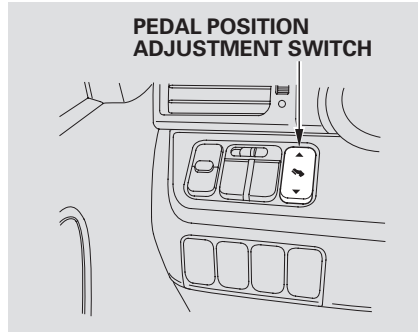

*On Touring model only*

You can adjust the position of the brake pedal, and accelerator pedal when the shift lever is in the Park position. Push the top of the adjustment switch to move the pedals forward, and the bottom to move them backward.

To adjust the pedals:

1. Push and hold the top of the adjustment switch until pedals are closest to you.
2. Adjust your seat and the steering wheel so you can operate the controls and steering wheel easily.
3. Push and hold the bottom of the adjustment switch until pedals are in the position you can press them fully and comfortably.

Do not adjust the pedals with your foot on or under either pedal.

## Interior Convenience Items

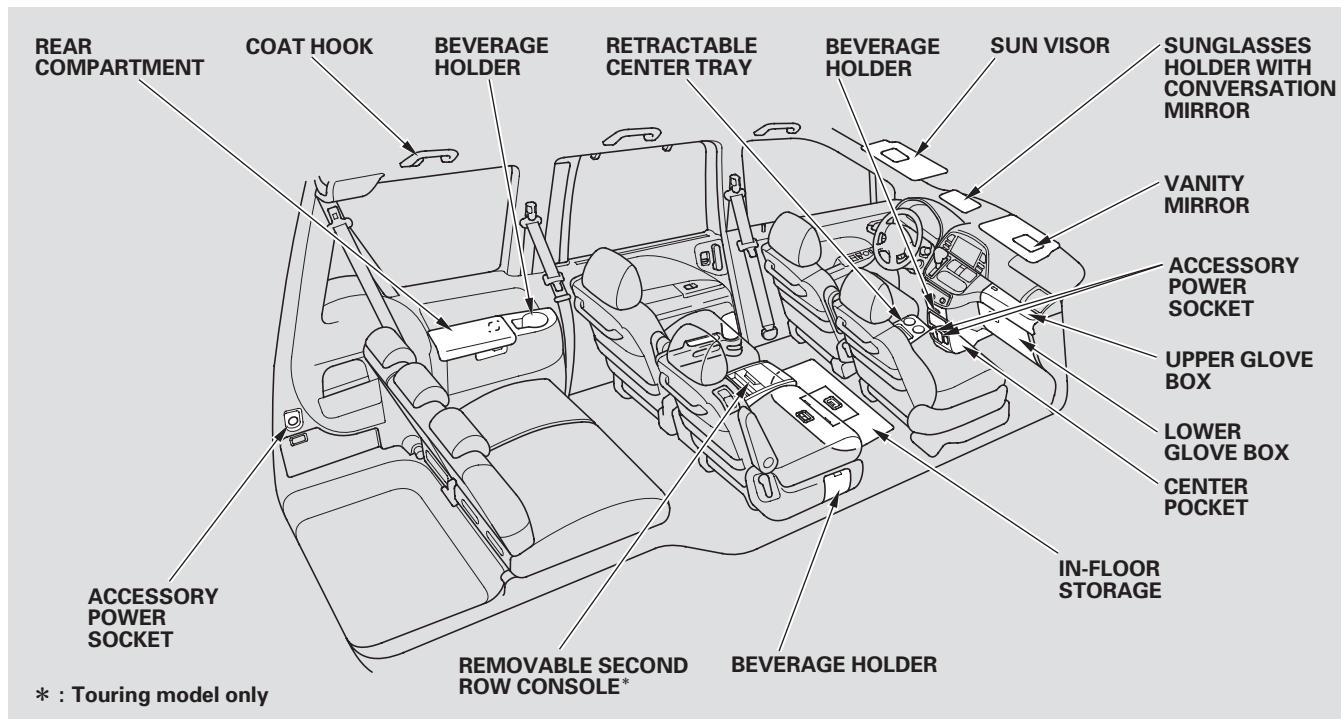

### Retractable Center Tray

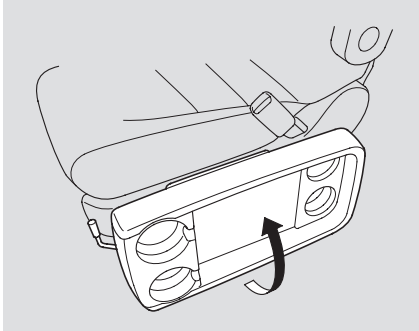

To use the retractable center tray, pull up the outside edge of the tray until it latches. To store it, pull the lever and lower the tray.

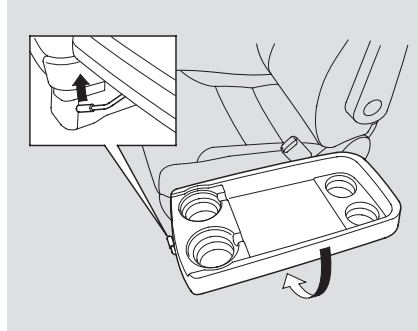

Sitting on or getting under the tray, or putting heavy objects on the tray, may damage or deform it.

Do not keep items on the tray while driving. They may fall down or fly around when you go around corners or brake hard.

### Beverage Holders

Be careful when you are using the beverage holders. A spilled liquid that is very hot can scald you or your passengers. Spilled liquids can damage the upholstery, carpeting, and electrical components in the interior.

*CONTINUED*

## Interior Convenience Items

---

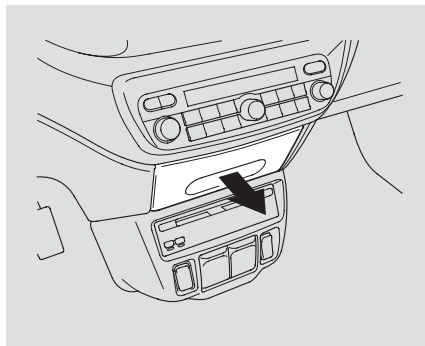

To use the front beverage holder, pull the handle.

Additional beverage holders for the front seat passengers are in the retractable center tray.

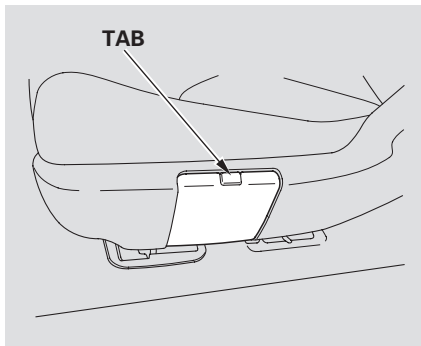

Each second row seat has a beverage holder on the outside of the seat cushion. To use the beverage holder, push on the tab. The beverage holder will swing open. To close, pivot it up and push it in until it latches.

To protect the beverage holder, the bottom tray is designed to break away if you try to place a heavy object on it. If this happens, hold the edge of the bottom tray and pull it up until you feel a detent.

Be careful not to damage an open beverage holder when you get into or out of the vehicle.

The beverage holders for the third seat passengers are in the armrests on the rear side panels.

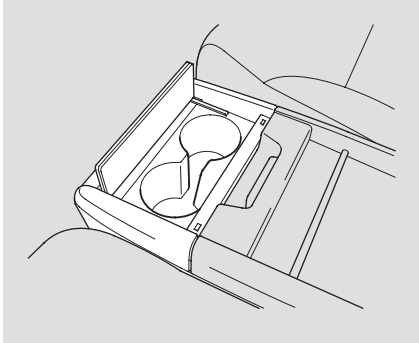

### *On Touring model*

The removable second row console has a beverage holder on the front.

To use the beverage holder, push on the front lid. The lid will swing open. To close, lower the lid, and push it down until it latches.

### Integrated Sunshades

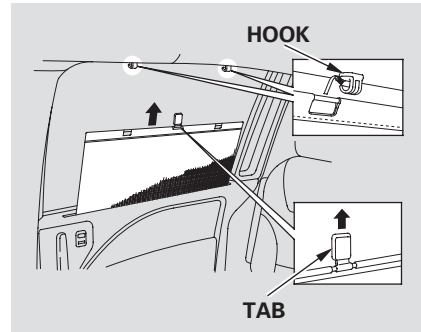

### *On EX and Touring models*

Each rear sliding door has an integrated sunshade. To use a sunshade, hold the tab on the top and pull the sunshade all the way up. Insert the holes on the sunshade into the hooks on the window frame. To store the shade, unhook it, and let it retract all the way down.

## Interior Convenience Items

### Sunglasses Holder

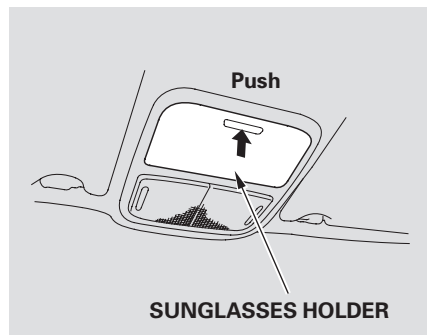

To open the sunglasses holder, push on the front edge. It will unlatch and swing down. To close it, push it until it latches. Make sure the holder is closed while you are driving.

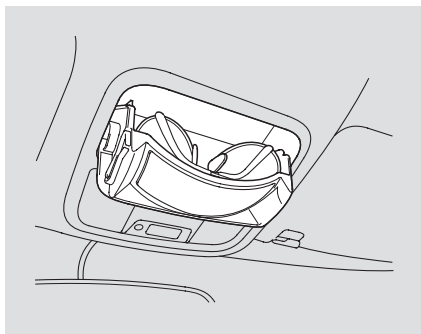

To open the sunglasses holder, push on the front edge. Make sure the holder is closed while you are driving. Some larger styles of sunglasses may not fit in the holder.

You may also store small items in this holder. Make sure they are small enough to let the holder close and latch, and that they are not heavy enough to cause the holder to pop open while driving.

### Conversation Mirror

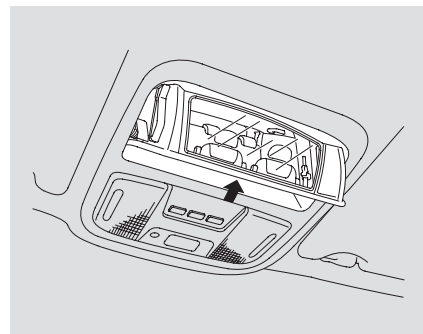

#### *On EX and Touring models*

The sunglasses holder uses a convex mirror for its bottom panel. You can see all the vehicle passengers on this mirror. To use the mirror, open the sunglasses holder, push it to the first detent, and release it.

## Sun Visor

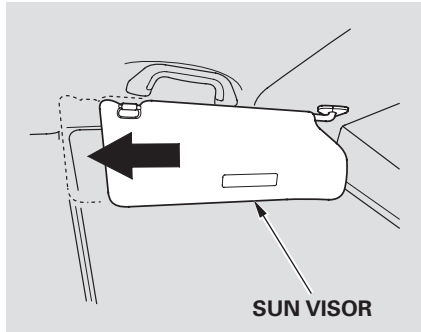

To use the sun visor, pull it down. When using the sun visor for the side window, remove the support rod from the clip, and swing it out. In this position, the sun visor can be adjusted by moving it on its slider.

Make sure you put the sun visor back in place when you are getting into or out of the vehicle.

## Vanity Mirror

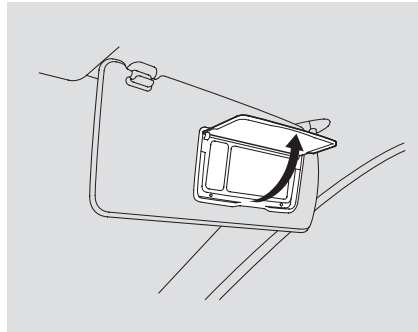

Pull up the vanity mirror cover to use it. The lights come on only when the parking lights are on.

The vanity mirror light will not come on if the sun visor is slid outward.

## Rear Compartment

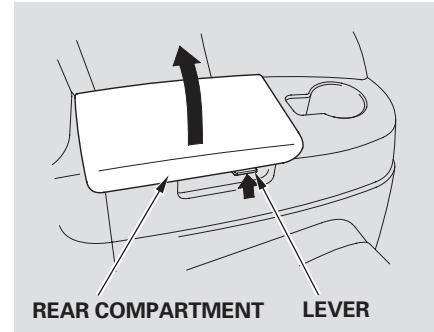

To open the compartment, pull the lever and lift the lid. To close, lower the lid and push it down until it latches.



## Interior Convenience Items

### Removable Second Row Console

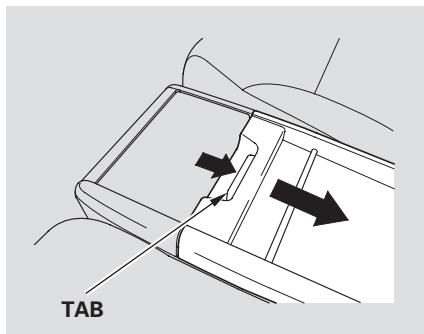

*On Touring model only*  
There is a removable console between the second row bucket seats.

To open the console, push the tab, and slide the lid to the rear.

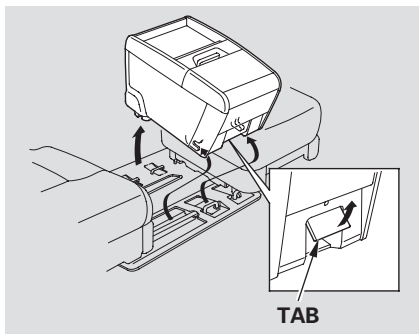

To remove the console, pull up the tab at the front edge to unlock the rear of the console from the floor.

Unhook the front of the console from the floor by pulling it back slightly, then pivoting it upward.

To reinstall the console, hook the front of it to the floor, then push down the back until it locks. Make sure the console is securely locked in place. A console that is not locked in place could fly around and cause injury in a sudden stop or crash.

If you remove the second seat center console, store it in a safe place outside the vehicle.

## In-Floor Storage Area

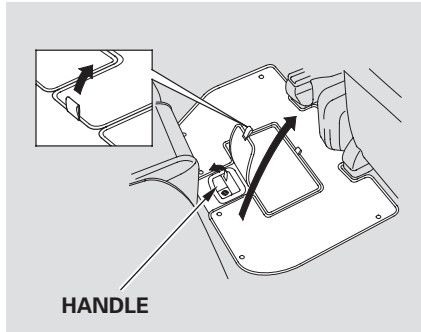

There is a large storage area under the floor between the front seats and the second row bucket seats.

To place or remove large items from the storage area, pull off the carpet near the second seat, and pull the handle to open the large lid.

On EX and Touring models, this handle can be locked with the master key.

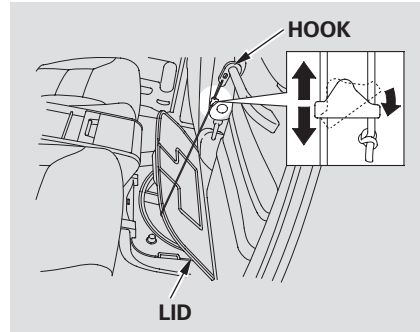

To keep the lid open, attach the hook to the grab rail on the back of the front seat-back.

You can adjust the length of the hook strap. Pull down the upper edge of the stopper, and slide it up or down.

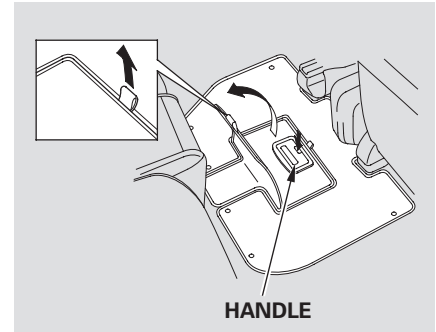

To place or remove small items from the storage area, pull off the carpet in the center of the lid, and pull the handle to open the small lid.

CONTINUED

## Interior Convenience Items

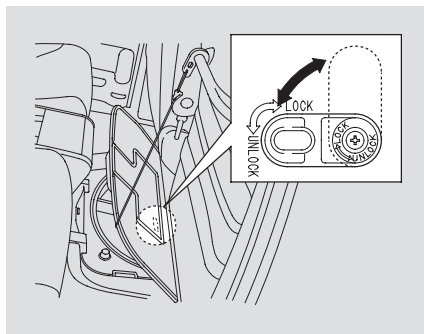

To lock the small lid, open the large lid, and turn the lock knob clockwise.

You can store items in the floor storage area up to 22 lbs (10 kg). Do not exceed this weight limit, or you may damage the floor storage area.

The inside of the storage area can get very hot. Do not store any items that should be kept cool, or items that can be easily damaged, warped, or deformed by heat.

Dust, sand, etc., can accumulate in the floor storage area. If you spill liquid on the floor around the floor storage area, it can get inside the storage area, and the moisture can be trapped inside. Always keep the inside of the storage area dry and clean.

To prevent items from being thrown about the vehicle and possibly hurting someone in an accident or sudden stop, be sure the storage area lids are securely closed before driving away.

### STOWABLE SECOND ROW PLUS-ONE SEAT

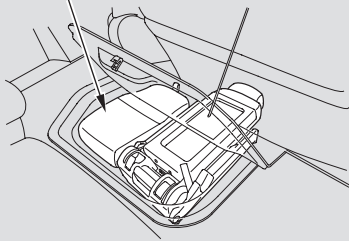

On EX and Touring models, the floor storage area has a Lazy Susan inside which makes it easier to find items through the small lid.

The Lazy Susan can be removed. When it is removed, a larger item, such as the stowable second row plus-one seat, can be stored.

### LAZY SUSAN

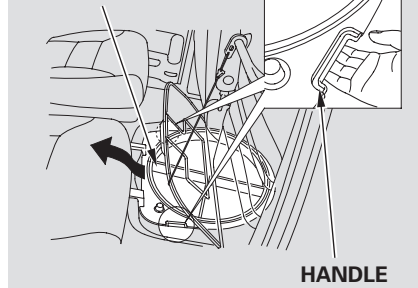

To remove the Lazy Susan, open the large lid. Attach the hook to the grab rail on the back of the front seat to keep the lid open. Hold the two handles on the edge of the Lazy Susan, and pull it out of the storage area. Store the removed Lazy Susan in a safe place outside the vehicle. Do not place it on the vehicle floor or seat, or in the cargo area. It can fly around the interior in a crash.

## Interior Convenience Items

### Lower Glove Box

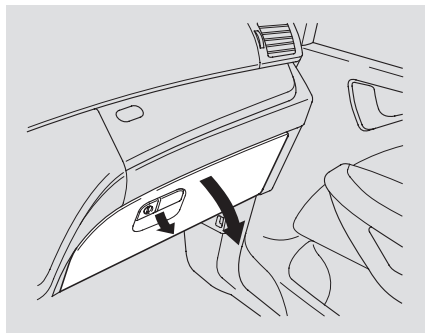

Open the lower glove box by pulling the bottom of the handle. Close it with a firm push. Lock or unlock the glove box with the master key.

### **⚠ WARNING**

An open glove box can cause serious injury to your passenger in a crash, even if the passenger is wearing the seat belt.

Always keep the glove boxes closed while driving.

### Upper Glove Box

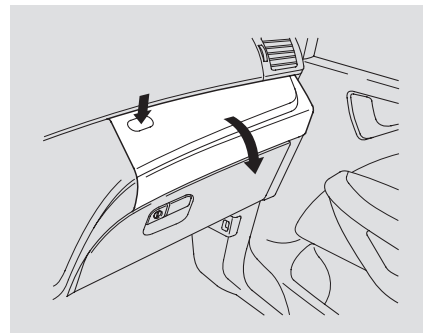

Open the upper glove box by pressing the button. The lid will swing open. Close it with a firm push.

## Center Pocket

### Vehicles without RES

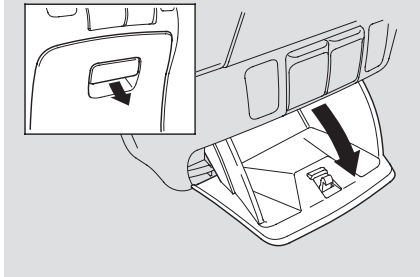

Open the center pocket by pulling the handle. Close it with a firm push.

### Vehicles with RES

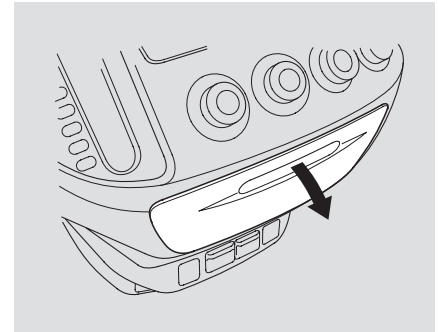
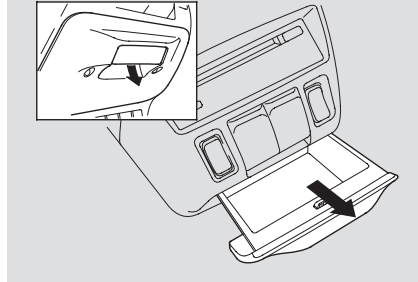

On vehicles without navigation system, there is another pocket under the heating and cooling system control panel. Pull the handle to open it. Close it with a firm push.

## Interior Convenience Items

### Accessory Power Sockets

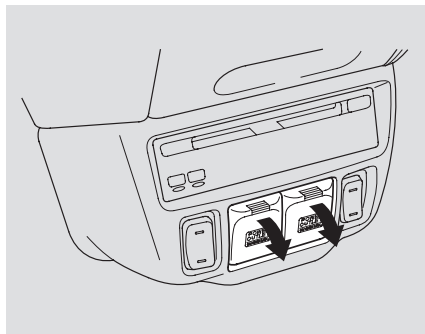

There are three accessory power sockets in your vehicle. Two accessory power sockets are above the center pocket for the front seat passengers, and another is on the cargo area sidewall on the driver's side.

These sockets are intended to supply power for 12 volt DC accessories that are rated 120 watts or less (10 amps).

None of the sockets will power an automotive type cigarette lighter element. When more than one socket is being used, the combined power rating of the accessories should be 120 watts or less (10 amps).

### AC Power Outlet

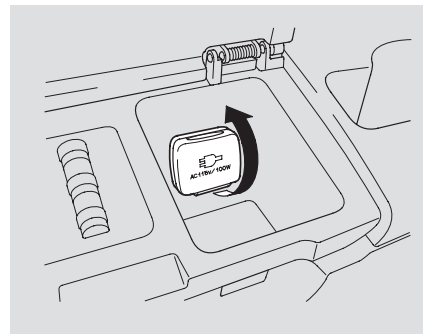

There is a 115 volt AC power outlet in the rear compartment on the driver's side. To use the AC power outlet, open the rear compartment lid and open the outlet cover. Insert the plug into the receptacle slightly, turn it 90° clockwise, then push in the plug all the way.

Always run the engine when you use the AC Power Outlet.

The maximum capacity for this power outlet is 115 volt AC at 100 watts or less. If you use an appliance which requires more than 100 watts, it automatically stops supplying the power. If this happens, turn the ignition switch off and turn it on again.

**NOTE:** The AC power outlet is not designed for electric appliances which require high initial peak wattage such as cathode-ray tube type televisions, refrigerators, electric pumps, etc. It is also not suitable for devices that process precise data such as medical equipment or measuring instruments. Any appliances that require an extremely stable power supply such as microcomputer-controlled electric blankets, touch sensor lamps, etc., should not be connected to this outlet.

### Light Control Switch

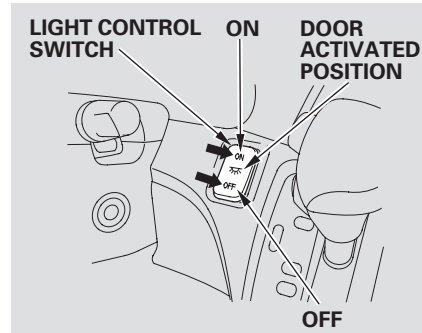

The light control switch has three positions: OFF, Door Activated, and ON.

*When this switch is in the OFF position:*

- None of the lights come on when a door or the tailgate is opened.
- The individual map lights in the front can be turned on and off by pressing the lenses.

- The individual map lights in the second and third rows cannot be turned on.
- The cargo area light can be turned on with the switch in the light.

*When the switch is in the Door Activated position:*

- The individual map lights in the front come on when any door is opened. When the doors are closed, each light can be turned on and off by pressing the lenses.
- The individual map lights in the second and third rows come on when any door is opened. When the doors are closed, each light can be turned on and off by pushing on the lens.

CONTINUED



## Interior Lights

When the light control switch is in the ON position:

- All the individual map lights come on and stay on as long as the switch remains in the ON position.

*On EX and Touring models*

The lights go out about 30 seconds after all the doors and the tailgate are closed. They go out immediately after all doors are locked.

With the light control switch in the Door Activated position, all the individual map lights come on when you unlock the door with the remote transmitter (see page [133](#)).

With any door or the tailgate left open, the lights stay on about 3 minutes, then go out.

### Individual Map Lights

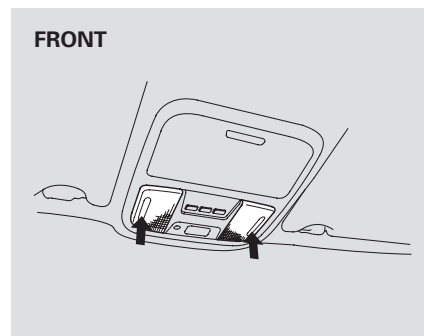

Turn on the front and rear individual map lights by pushing the lens of each light. Push the lens again to turn it off. You can also operate these lights with the light control switch (see page [183](#)).

REAR

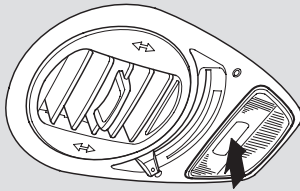

## Cargo Area Light

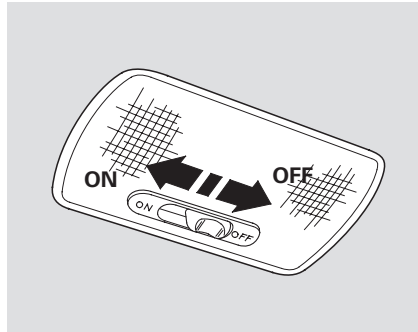

The cargo area light has a three-position switch. In the OFF position, the light does not come on. In the center position, it comes on when you open the tailgate. In the ON position, it stays on continuously.

## Ignition Switch Light

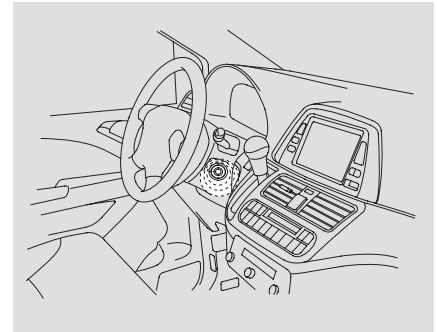

The ignition switch light comes on when you open the driver's door, and stays on several seconds after you close the door.

## Interior Lights

---

### Courtesy Lights



The courtesy lights in the front doors come on when you open any door.

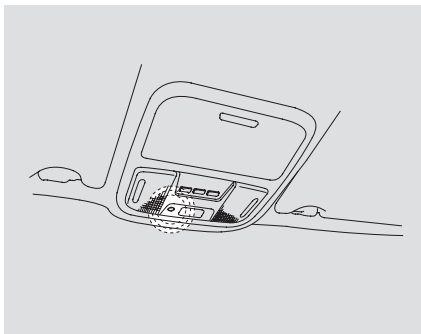

The courtesy light between the map lights comes on when you turn the parking lights on. To adjust its brightness, turn the Select/Reset knob on the instrument panel.

The heating and air conditioning systems in your vehicle provide a comfortable driving environment in all weather conditions.

The standard audio system has many features. This section describes those features and how to use them. (If you selected an optional audio system, refer to the operating instructions that came with it.)

Your vehicle has an anti-theft audio system that requires a code number to enable it.

The security system helps to discourage vandalism and theft of your vehicle.

Vents, Heating, and A/C .....	188
Using Automatic Climate Control .....	193
Using the Rear A/C Unit .....	194
Rear Climate Control .....	197
Climate Control Sensors .....	198
Playing the AM/FM Radio .....	199
AM/FM Radio Reception .....	205
Playing the XM Satellite Radio ....	207
Playing a CD .....	212
CD Changer .....	215
Protecting Your CDs .....	221
CD Changer Error Messages .....	222
Playing a Tape .....	223
Steering Wheel Controls .....	228
Radio Theft Protection .....	229
Rear Entertainment System .....	230
Playable DVDs .....	258
Security System .....	263
Cruise Control .....	264
HomeLink Universal Transceiver .....	267
Parking Sensor System .....	271
Rear View Camera and Monitor ..	275



## Fan Control

### *LX model*

Turn the dial clockwise to increase the fan speed and airflow. Turn the dial counterclockwise to decrease it.

### *EX and Touring models*

Press the   button to increase the fan speed and airflow. Press the   button to decrease it.

## Temperature Control

### *LX model*

Turning this dial clockwise increases the temperature of the airflow.

### *EX and Touring models*

The driver's side temperature and the passenger's side temperature can be set separately. On the Touring model, the rear passenger compartment temperature can also be set separately. Press the top () of the appropriate temperature control button to increase the temperature of airflow. Press the

bottom () of the button to decrease it. Each set temperature is shown in the display. When you turn the A/C off, the system cannot regulate the inside temperature if you set the temperature control below the outside temperature.

When you set the temperature to its lower limit or its upper limit, it will be displayed as "Lo" or "Hi".

### **SYNC Button**

#### *On EX and Touring models*

When you press this button, the indicator in the button comes on, and the passenger's side temperature (and the temperature of the rear passenger compartment on the Touring model) is synchronized to the driver's side set temperature. Changing the passenger's side temperature (or the temperature of the rear passenger compartment on the Touring model) makes the indicator to go off, and takes the

system out of SYNC mode.

### **Air Conditioning (A/C) Button**

This button turns the air conditioning on and off. On the LX model, the indicator in the button is on when the A/C is on. On the EX and Touring models, you will see A/C ON or A/C OFF in the display.

### **Recirculation Button**

When the indicator in the button is on, air from the vehicle's interior is sent throughout the system again. When the indicator is off, air is brought in from the outside of the vehicle (fresh air mode).

The outside air intakes for the heating and cooling system are at the base of the windshield. Keep this area clear of leaves and other debris.

CONTINUED

## Vents, Heating, and A/C

### Rear Window Defogger Button

This button turns the rear window defogger on and off (see page 126).

### Mode Control

Use the mode control dial or button to select the vents the air flows from. Some air will flow from the dashboard vents in all modes.

 Air flows from the center and corner vents in the dashboard.

 Airflow is divided between the vents in the dashboard and the floor vents.

 Air flows from the floor vents.

 Airflow is divided between the floor vents and the defroster vents at the base of the windshield.

 Air flows from the defroster vents at the base of the windshield.

When you select , the system automatically switches to fresh air mode and turns on the A/C. The passenger's temperature cannot be set separately from the driver's.

### On LX model only

 The system automatically turns on the A/C and switches to recirculation mode. Air flows from the center and side vents in the dashboard.

### REAR/REAR LOCK Button

#### On Touring model only

When you want to change the temperature of the rear passenger compartment, press the REAR button. The indicator in the button comes on, and you can change the temperature using the rear temperature control button. When you press the REAR LOCK button, the indicator in the button comes on, the rear A/C passenger control panel is disabled, and you cannot

change any settings from it. See page 197 for how to operate the rear passenger control panel.

### On EX model

You can change the fan speed of the rear system from the front control panel. Press the REAR button, the indicator in the button comes on. Push the rear fan control button up or down to increase or decrease the rear fan speed. When you press the REAR LOCK button, the indicator in the button comes on, and the rear passenger control panel is disabled.

See page 196 for how to operate the rear passenger control panel.

## Ventilation

The flow-through ventilation system draws in outside air, circulates it through the interior, then exhausts it through vents near the rear side panels.

1. Set the temperature control dial or button to the lower limit.
2. Make sure the A/C is off.
3. Select  and fresh air mode.
4. Set the fan to the desired speed.

## Using the Heater

The heater uses engine coolant to warm the air. If the engine is cold, it will be several minutes before you feel warm air coming from the system.

1. Select  and fresh air mode.
2. Set the fan to the desired speed.
3. Adjust the warmth of the air with the temperature control dial or buttons.

## Using the A/C

Air conditioning places an extra load on the engine. Watch the engine coolant temperature gauge (see page 71 ). If it moves near the red mark, turn off the A/C until the gauge reads normally.

1. Press the A/C button. The indicator in the button comes on (LX model) or “A/C ON” is shown in the display (EX and Touring models) when a fan speed is selected.
2. Make sure the temperature is set to the lower limit.
3. Select  .
4. If the outside air is humid, select recirculation mode. If the outside air is dry, select fresh air mode.
5. Set the fan to the desired speed.

*If the interior is very warm, you can cool it down more rapidly by partially opening the windows, turning on the A/C, and setting the fan to maximum speed in fresh air mode.*

CONTINUED



## Vents, Heating, and A/C

---

### Dehumidify the Interior



Air conditioning, as it cools, removes moisture from the air. When used in combination with the heater, it makes the interior warm and dry.

1. Switch the fan on.
2. Turn on the air conditioning.
3. Select  and fresh air mode.
4. Adjust the temperature to your preference.

This setting is suitable for all driving conditions whenever the outside temperature is above 32°F (0°C).



### To Defog and Defrost

To remove fog from the inside of the windows:

1. Set the fan to high.
2. Select . The system automatically switches to the fresh air mode and turns on the A/C.  
*On U.S. vehicles*  
The indicator in the A/C button will not come on (LX model), or the A/C ON indicator will not come on (EX and Touring models).
3. Adjust the temperature so the airflow feels warm.
4. Select  to help clear the rear window.

When you switch to another mode from , the A/C stays on. Press the A/C button to turn it off.

### To Remove Exterior Frost or Ice From the Windows

1. Select . The system automatically switches to fresh air mode and turns on the A/C.  
*On U.S. vehicles*  
The indicator in the A/C button will not come on (LX model), or the A/C ON indicator will not come on (EX and Touring models).
2. Select .
3. Set the fan and temperature controls to maximum level.

To clear the windows faster, you can close the dashboard corner vents by rotating the wheel next to each vent. This will send more warm air to the windshield defroster vents. Once the windshield is clear, select fresh air mode to avoid fogging the windows. For your safety, make sure you have a clear view through all the windows before driving.

### Using Automatic Climate Control

*EX, and Touring models*

The automatic climate control system adjusts the fan speed and airflow levels to maintain the interior temperature you select.

1. Press the Auto button. The indicator in the button comes on.
2. Set the desired temperature with the temperature control button. You will see AUTO in the system's display. You can set the driver's side temperature and passenger's side temperature (and the temperature of the rear passenger compartment on the Touring model) separately. The system automatically selects the proper mix of conditioned and/or heated air that will, as quickly as possible, raise or lower the interior temperature to your preference.

If you set the temperature to its lower or its upper limit, the system runs at full cooling or heating only. It does not regulate the interior temperature.

When you press a fan control button, the fan is taken out of AUTO mode.

### Semi-automatic Operation

You can manually select various functions of the climate control system when it is in fully automatic mode. All other features remain automatically controlled. Making any manual selection causes the word AUTO in the display to go out.

### To Turn Everything Off

*LX model*

Turn the fan speed and temperature control dials all the way to the left, and turn the rear controller dial to OFF position.

*EX and Touring models*

Press the OFF button and REAR button (indicator is off).

- Keep the system completely off for short periods only.
- To keep stale air and mustiness from collecting, you should have the fan running at all times.

## Vents, Heating, and A/C

### Using the Rear A/C Unit

#### *LX and EX models*

You can adjust the airflow of the rear A/C unit with the rear controller dial on the front control panel. The rear passengers can also adjust the direction and the amount of airflow on the rear control panel.

#### *Touring model*

You can adjust the temperature of the rear A/C unit with the REAR button and the rear temperature control button on the front control panel.

### Rear Controller Dial

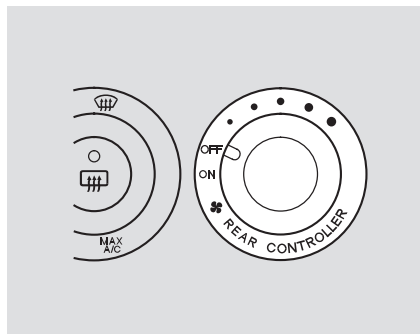

#### *LX model*

**OFF** – No air flows to the rear vents, and the rear control panel is turned off.

When you select a fan speed with the rear controller dial, the rear control panel is disabled.

**ON** – The rear A/C passenger control panel is enabled. A second row passenger can then adjust the fan speed, airflow, and temperature. Turning the rear controller dial to the right increases the rear fan speed.

## REAR A/C Controls

*EX model*

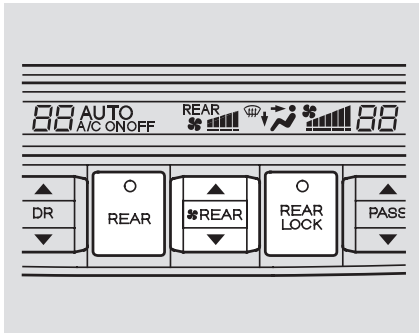

**REAR Button** – When the indicator in this button is off, no air flows to the rear vents, and the rear control panel is turned off. When the indicator in this button is on, the fan speed of the rear passenger compartment can be adjusted with the rear fan speed control button. A second row passenger can also adjust the temperature, fan speed, and airflow.

## *Touring model*

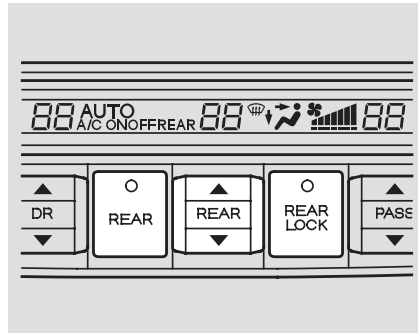

**REAR Button** – When the indicator in this button is off, no air flows to the rear vents, and the rear control panel is turned off. When the indicator in this button is on, the temperature of the rear passenger compartment can be adjusted with the rear temperature control button. A second row passenger can also adjust the temperature, fan speed, and airflow.

**REAR LOCK Button** – When the indicator in this button is on, the rear control panel is disabled, and the rear system is controlled by the front control panel.

# Vents, Heating, and A/C

## Rear Control Panel

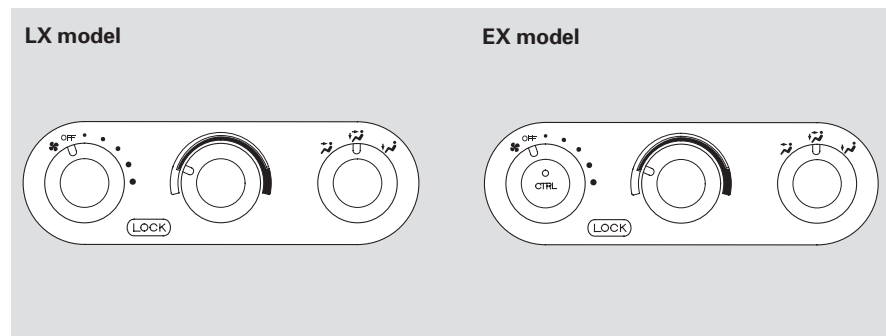

### *LX model*

You can use the rear control panel when the rear controller dial on the front control panel is in the ON position.

### *EX model*

You can use the rear control panel when the indicator in the REAR LOCK button on the front control panel is off.

When you press the CTRL button in the left dial, the indicator comes on, and the fan speed is regulated by the outer ring of the fan control dial.

Turn the fan speed control dial clockwise to increase fan speed and airflow.

Select the vents the air flows from with the mode control dial.

When  is selected, air flows from the rear ceiling vents.

When  is selected, air flows from the rear floor vents.

When  is selected, airflow is divided between the rear floor vents and rear ceiling vents.

Turn the rear temperature control dial clockwise to increase the temperature of the airflow.

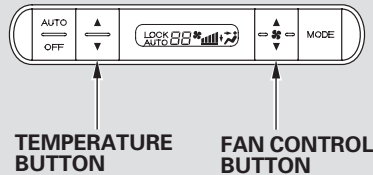

## Touring model



### Touring model

You can use the rear control panel when the indicator in the REAR LOCK button on the front control panel is off. Press the top (▲) of the temperature control button to increase the temperature of airflow, and the bottom (▼) of the button to decrease it. The temperature you adjust is shown in the system display.

Press the top (▲) of the fan control button to increase the fan speed and airflow. Press the bottom (▼) of the button to decrease it. The level of the fan speed is shown in the display.

Each time you press the mode button, the mode display changes from , to , then to .

When  is selected, air flows from the rear ceiling vents.

When  is selected, air flows from the rear floor vents.

When  is selected, airflow is divided between the rear floor vents and rear ceiling vents.

Pressing the AUTO button puts the system in automatic operation mode. The rear system automatically adjusts the fan speed and airflow levels to maintain the selected

temperature of the rear passenger compartment.

Pressing the OFF button shuts off the rear climate control system.

## Rear Climate Control, Climate Control Sensors

### Rear Ceiling Vents

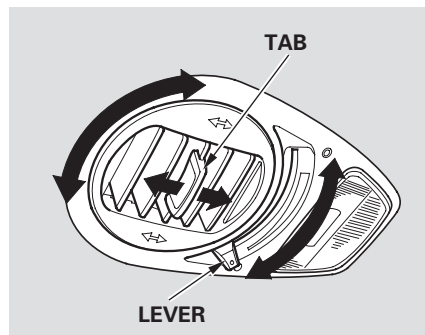

The direction and quantity of airflow from each rear ceiling vent is adjustable.

To adjust the direction of air coming from a rear ceiling vent, move the tab in the center of each vent back-and-forth, and rotate the vent with the tab. The lever next to each vent can be opened and closed to regulate the amount of airflow.

### Sunlight and Temperature Sensors

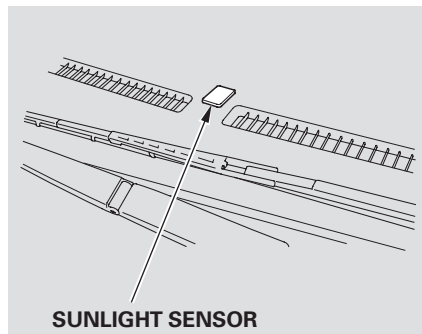

The climate control system has three sensors. A sunlight sensor is in the top of the dashboard, and a temperature sensor is next to the steering column. There is also a rear sensor on the rear sidewall near the exhaust vent. Do not cover the sensors or spill any liquid on them.

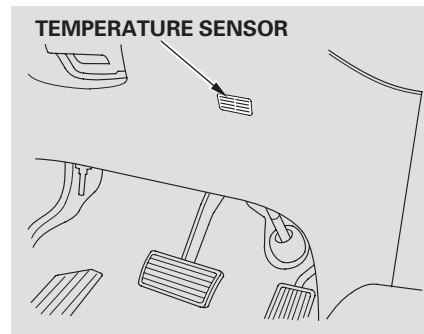

*LX model*

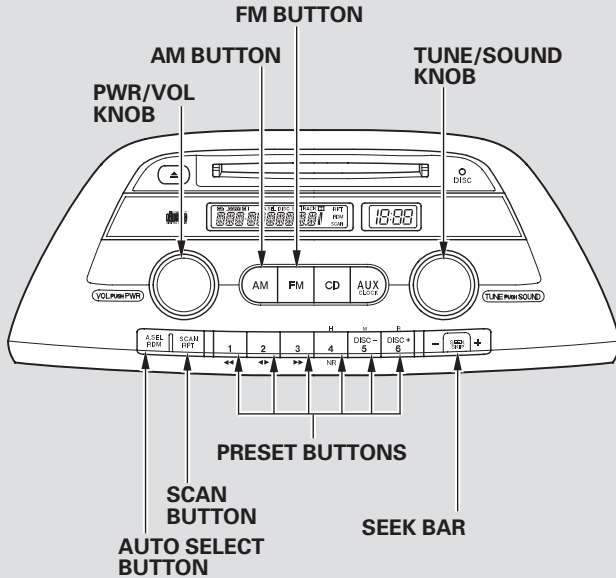

*EX model without RES*

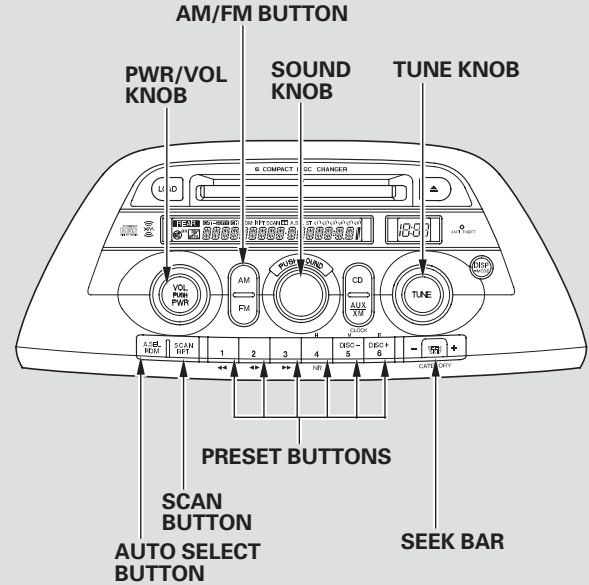



# Playing the AM/FM Radio

*EX and Touring models with RES without Navigation System*

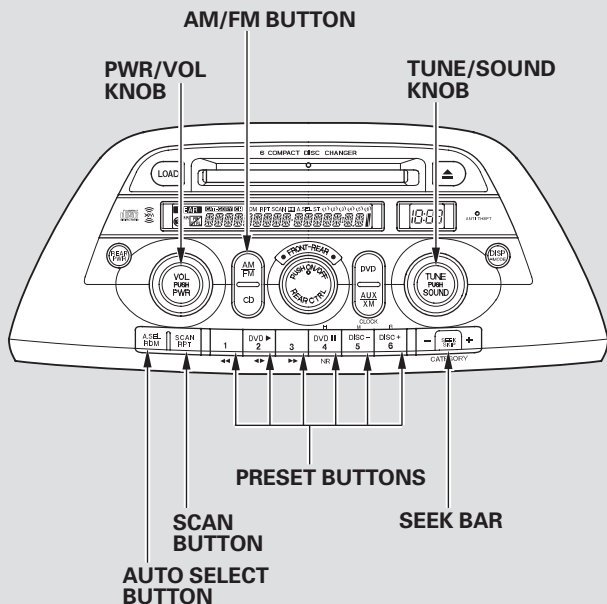

*Touring model with RES and Navigation System*

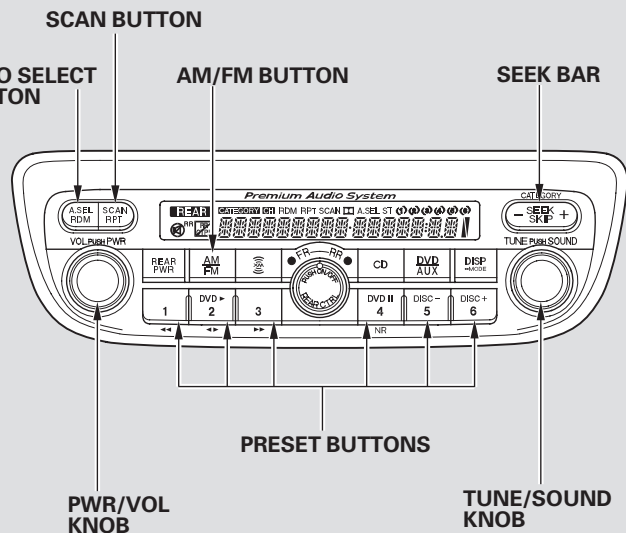

### To Play the AM/FM Radio

The ignition switch must be in the ACCESSORY (I) or ON (II) position. Turn the system on by pushing the PWR/VOL knob. Adjust the volume by turning the same knob.

The band and frequency that the radio was last tuned to is displayed. To change bands, press the AM or FM button, or AM/FM button. On the FM band, ST will be displayed if the station is broadcasting in stereo. Stereo reproduction in AM is not available.

### To Select a Station

You can use any of five methods to find radio stations on the selected band: **TUNE**, **SEEK**, **SCAN**, the preset buttons, and **AUTO SELECT**.

**TUNE** — Use the TUNE knob to tune the radio to a desired frequency. Turn the knob right to tune to a higher frequency, or left to tune to a lower frequency.

**SEEK** — The SEEK function searches up and down from the current frequency to find a station with a strong signal. To activate it press the + or – side of the bar, then release it.

**SCAN** — The SCAN function samples all stations with strong signals on the selected band. To activate it, press the SCAN button, then release it. You will see SCAN in the display. The system will scan for a station with a strong signal. When it finds one, it will stop and play that station for about 5 seconds.

If you do nothing, the system will then scan for the next strong station and play it for 5 seconds. When it plays a station you want to listen to, press the SCAN button again.

**Preset** — Each preset button can store one frequency on AM, and two frequencies on FM.

1. Select the desired band, AM or FM. FM1 and FM2 let you store two frequencies with each preset button.
2. Use the TUNE, SEEK, or SCAN function to tune the radio to a desired station.
3. Pick a preset button, and hold it until you hear a beep.
4. Repeat steps 1 through 3 to store a total of six stations on AM and twelve stations on FM.

*CONTINUED*

## Playing the AM/FM Radio

---

The preset frequencies will be lost if your vehicle's battery goes dead, is disconnected, or the radio fuse is removed.

**AUTO SELECT** — If you are traveling far from home and can no longer receive your preset stations, you can use the auto select feature to find stations in the local area.

Press the A. SEL button. "A.SEL" flashes in the display, and the system goes into scan mode for several seconds. It stores the frequencies of six AM, and twelve FM stations in the preset buttons.

You will see a "0" displayed after pressing a preset button if auto select cannot find a strong station for every preset button.

If you do not like the stations auto select has stored, you can store other frequencies on the preset buttons. Use the TUNE, SEEK, or SCAN functions to find stations, then store them in the preset buttons as described.

*To turn off Auto Select*, press the A. SEL button. This restores the presets you originally set.

### Adjusting the Sound

Press the SOUND (TUNE) knob repeatedly to display the bass (BAS), treble (TRE), balance (BAL), and fader (FAD) settings.

Each mode is shown in the display as it changes. Turn the SOUND (TUNE) knob to adjust the setting to your liking. When the level reaches the center, you will see " [ " in the display. The system will automatically return the display to the selected audio mode about 5 seconds after you stop adjusting a

mode.

**Treble/Bass** — Use the TRE/BAS modes to adjust the tone to your liking.

**Balance/Fader** — These two modes adjust the strength of the sound coming from each speaker. BAL adjusts the side-to-side strength, while FAD adjusts the front-to-back strength.

## Operating the Radio on the Navigation System Screen

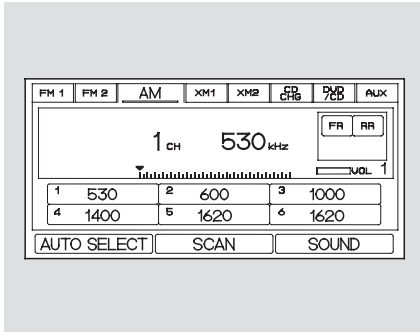

*On models with Navigation System*  
In addition to the knobs and buttons on the radio control panel, you can operate some of the radio controls on the navigation system screen.

While you are listening to the radio, you can change to another band by pressing the AUDIO button next to the navigation system screen, and then touching the desired band icon

(FM1, FM2, or AM).

AUTO SELECT, SCAN, and SEEK are adjustable from the navigation screen. For an explanation of these functions, see pages [201](#) and [202](#).

**AUTO SELECT** – Touch the AUTO SELECT icon to activate the auto select function. You will see AUTO SEL flashing in the upper display.

**SCAN** – Touch the SCAN icon to activate the scan function. You will see SCAN in the display. Touch the icon again to deactivate it.

## Adjusting the Sound

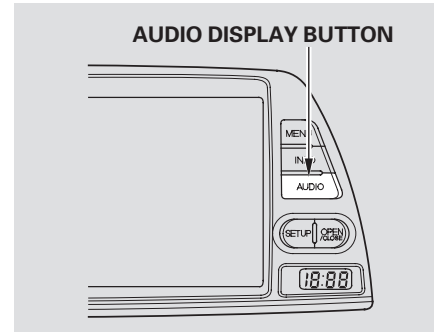

You can also adjust the sound from the navigation screen.

To adjust the sound, push the AUDIO DISPLAY button, then enter the sound grid by touching the SOUND icon on the display.

CONTINUED

## Playing the AM/FM Radio

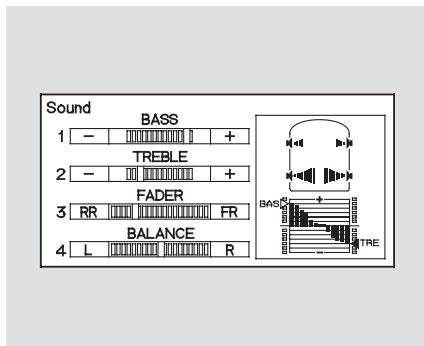

**Treble/Bass** – To adjust the treble and bass, touch + or – on each side of the treble or bass adjustment bar. The adjustment bar shows you the current setting.

**Left/Right Balance and Front/Rear Fader** – These modes adjust the strength of the sound coming from each speaker. Left/Right balance adjusts the side-to-side strength, while Front/Rear fader adjust the front-to-back strength. To adjust the left/right balance, touch the “L” or “R” icon.

To adjust the front/rear fader, touch the “FR” or “RR” icon.

To see the audio display when you are finished adjusting the sound, wait 5 seconds.

### Audio System Lighting

You can use the instrument panel brightness control knob to adjust the illumination of the audio system (see page 125). The audio system illuminates when the parking lights are on, even if the radio is off.

## Radio Frequencies

The radio can receive the complete AM and FM bands.

Those bands cover these frequencies:

AM band: 530 to 1,710 kilohertz

FM band: 87.7 to 107.9 megahertz

Radio stations on the AM band are assigned frequencies at least ten kilohertz apart (530, 540, 550).

Stations on the FM band are assigned frequencies at least 0.2 megahertz apart (87.9, 88.1, 88.3).

Stations must use these exact frequencies. It is fairly common for stations to round-off the frequency in their advertising, so your radio could display a frequency of 100.9 even though the announcer may identify the station as “FM101.”

## Radio Reception

How well the radio receives stations is dependent on many factors, such as the distance from the station's transmitter, nearby large objects, and atmospheric conditions.

A radio station's signal gets weaker as you get farther away from its transmitter. If you are listening to an AM station, you will notice the sound volume becoming weaker and the station drifting in and out. If you are listening to an FM station, you will see the stereo indicator flickering off and on as the signal weakens. Eventually, the stereo indicator will go off and the sound will fade completely as you get out of range of the station's signal.

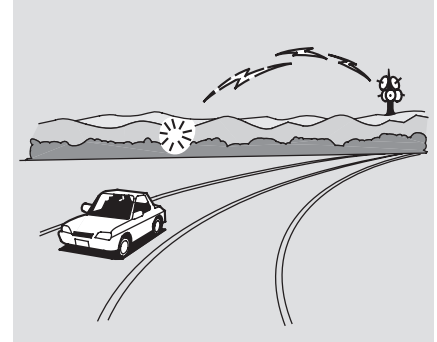

Driving very near the transmitter of a station that is broadcasting on a frequency close to the frequency of the station you are listening to can also affect your radio's reception. You may temporarily hear both stations, or hear only the station you are close to.

*CONTINUED*

## AM/FM Radio Reception

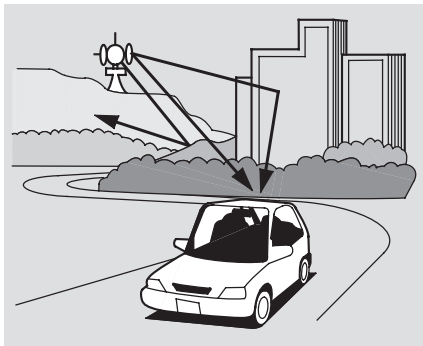

Radio signals, especially on the FM band, are deflected by large objects such as buildings and hills. Your radio then receives both the direct signal from the station's transmitter, and the deflected signal. This causes the sound to distort or flutter. This is a main cause of poor radio reception in city driving.



Radio reception can be affected by atmospheric conditions such as thunderstorms, high humidity, and even sunspots. You may be able to receive a distant radio station one day and not receive it the next day because of a change in conditions.

Electrical interference from passing vehicles and stationary sources can cause temporary reception problems.

*As required by the FCC:  
Changes or modifications not expressly  
approved by the party responsible for  
compliance could void the user's  
authority to operate the equipment.*

## Touring model with RES and Navigation System

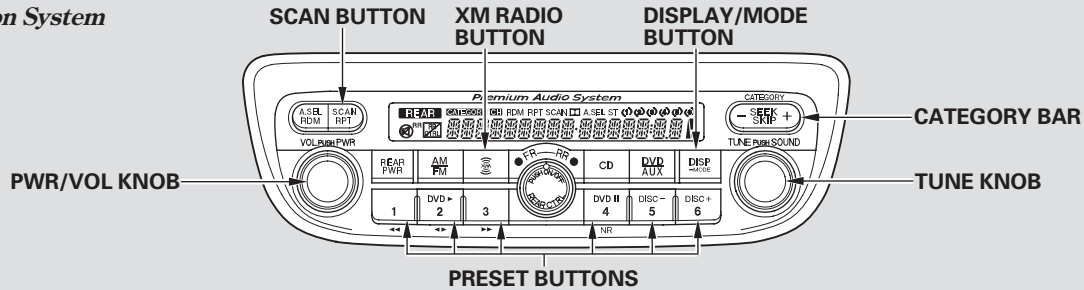

## EX model without RES

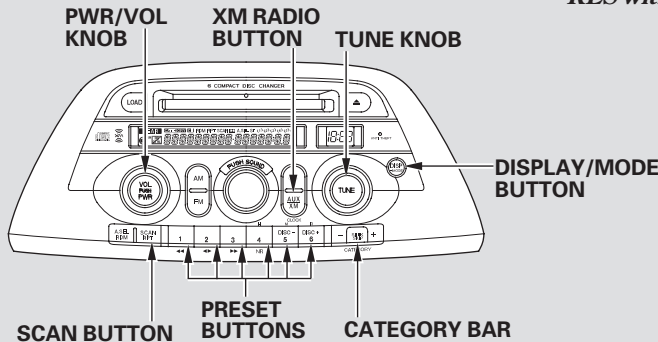

## EX and Touring models with RES without Navigation System

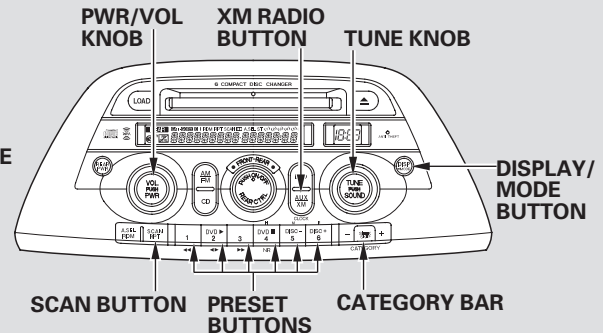



## Playing the XM® Satellite Radio

*U.S. EX and Touring models only*  
Your audio system is capable of receiving XM® Satellite Radio anywhere in the United States, except Hawaii and Alaska. XM® is a registered trademark of XM Satellite Radio, Inc. XM radio receives signals from two satellites to produce clear, high-quality digital reception. It offers many channels in several categories. Along with a large selection of different types of music, XM radio allows you to view channel and category selections in the display. The navigation system screen also shows all XM information when the AUDIO button is pressed.

### Operating the XM Radio

To listen to XM radio, turn the ignition switch to ACCESSORY (I) or ON (II). Push the PWR/VOL knob to turn on the audio system, and press the “XM” button. Adjust the volume by turning the PWR/

VOL knob. The last channel you listened to will show in the display.

You can also change to the XM radio while you are listening to an FM station, AM station, CD, etc., by touching the XM1 or XM2 icon on the audio display (navigation system screen).

**MODE** – To switch between channel mode and category mode, press and hold the DISP/MODE button until the mode changes.

In channel mode, you can select all of the available channels. In category mode, such as Jazz, Rock, Classical, etc., you can select all of the channels within that category. Each time you press and release the DISP/MODE button, the display changes in the following sequence: Channel name, channel number, category, artist name, and music title.

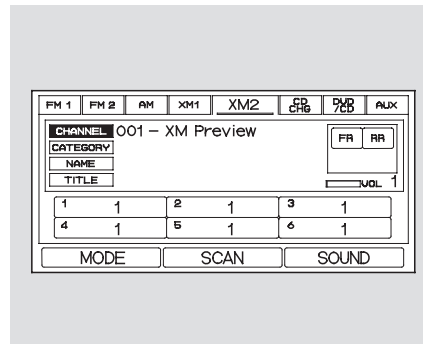

On the audio display, you will see the selected CHANNEL (number), CATEGORY, NAME (artist name), and TITLE (music title).

You may experience periods when XM Radio does not transmit the artist's name and song title information. If this happens, there is nothing wrong with your system.

On models with a rear entertainment system and a navigation system, you cannot listen to XM Radio and a disc at the same time. For example, when XM Radio is playing on the front speakers, you cannot listen to a disc on the rear speakers, or vice versa.

**TUNE** – Turn the tune knob left or right to select channels. In the category mode, you can only select channels within that category.

**CATEGORY** – Press either side of the bar (– or +) to select another category.

**SCAN** – The scan function gives you a sampling of all channels while in the channel mode. In the category mode, only the channels within that category are scanned. To activate scan, press the SCAN/RPT button or touch the SCAN icon on the audio display. The system plays each channel in numerical order for a few

seconds, then selects the next channel. When you hear a channel you want to continue listening to, press the button or touch the icon again.

**Preset** – You can store up to 12 preset channels using the six preset buttons or preset icons on the audio display. Each button stores one channel from the XM1 band and one channel from the XM2 band.

To store a channel:

1. Press the XM RADIO button. Either XM1 or XM2 will show in the display.
2. Use the TUNE knob, or the CATEGORY or SCAN buttons to tune to a desired channel. You can also touch the SCAN icon on the audio display.

In the category mode, only channels within that category can be selected. In the channel mode, all channels

can be selected.

3. Pick the preset button (icon) you want for that channel. Press and hold the button (icon) until you hear a beep.
4. Repeat steps 2 and 3 to store the first six channels.
5. Press the XM RADIO button again or touch the other XM icon (XM1 or XM2) on the audio display. Store the next six channels using steps 2 and 3.

Once a channel is stored, press and release the proper preset button (icon) to tune to it.

The presets will be lost if your vehicle's battery goes dead, is disconnected, or the radio fuse is removed.

## Playing the XM® Satellite Radio

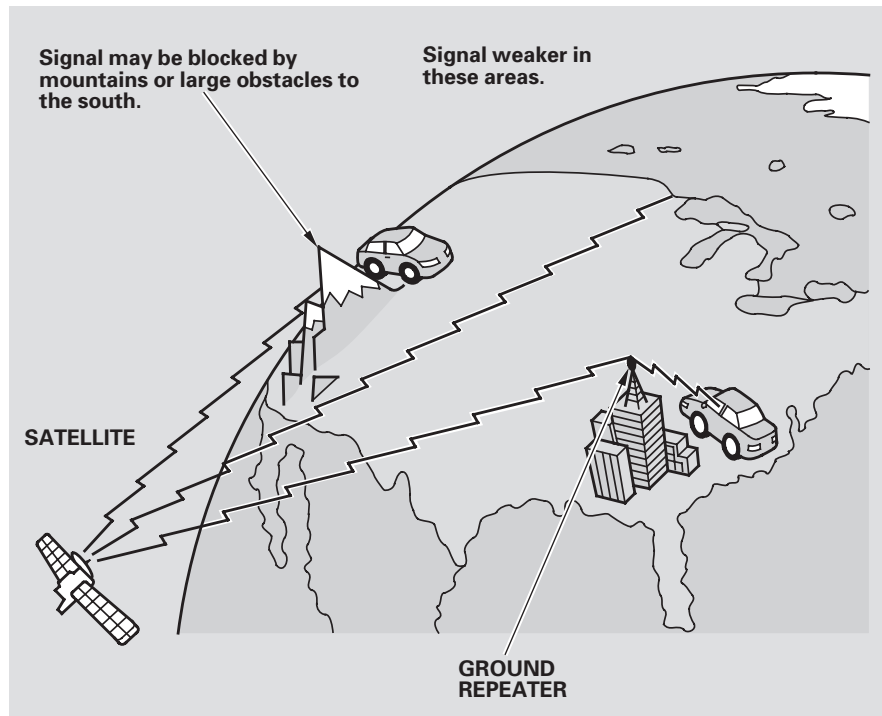

The XM satellites are in orbit over the equator; therefore, objects south of the vehicle may cause satellite reception interruptions. To help compensate for this, ground-based repeaters are placed in major metropolitan areas. Satellite signals are more likely to be blocked by tall buildings and mountains the farther north you travel from the equator.

Depending on where you drive, you may experience reception problems. Interference can be caused by any of these conditions:

- Driving on the north side of an east/west mountain road
- Driving on the north side of a large commercial truck on an east/west road.
- Driving in the tunnels.
- Driving on a road beside a vertical wall, steep cliff, or hill to the south of you.
- Driving on the lower level of a multi-tiered road.
- Driving on a single lane road alongside dense trees taller than 50 ft. (15 m) to the south of you.

There may be other geographic situations that could affect XM radio reception.

*As required by the FCC:  
Changes or modifications not expressly approved by the party responsible for compliance could void the user's authority to operate the equipment.*

### **Receiving Satellite Radio Service**

If your XM Radio service has expired or you purchased your vehicle from a previous owner, you can listen to a sampling of the broadcasts available on XM Satellite Radio. With the ignition switch in the ACCESSORY (I) or ON (II) position, push the PWR/VOL knob to turn on the audio system and press the XM RADIO button. A variety of music types and styles will play.

If you decide to purchase XM Satellite Radio service, contact XM Radio at [www.xmradio.com](http://www.xmradio.com), or at 1-800-852-9696. You will need to give them your radio I.D. number and your credit card number. To get your radio I.D. number, turn the TUNE

knob until "0" appears in the display. Your I.D. will appear in the display.

After you've registered with XM Radio, keep your audio system in the satellite radio mode while you wait for activation. This should take about 30 minutes.

While waiting for activation, make sure your vehicle remains in an open area with good reception. Once your audio system is activated, "category" or "CH" will appear in the display, and you'll be able to listen to XM radio broadcasts. XM Radio will continue to send an activation signal to your vehicle for at least 12 hours from the activation request. If the service has not been activated after 36 hours, contact XM Radio.

# Playing a CD, CD Changer

*LX model*

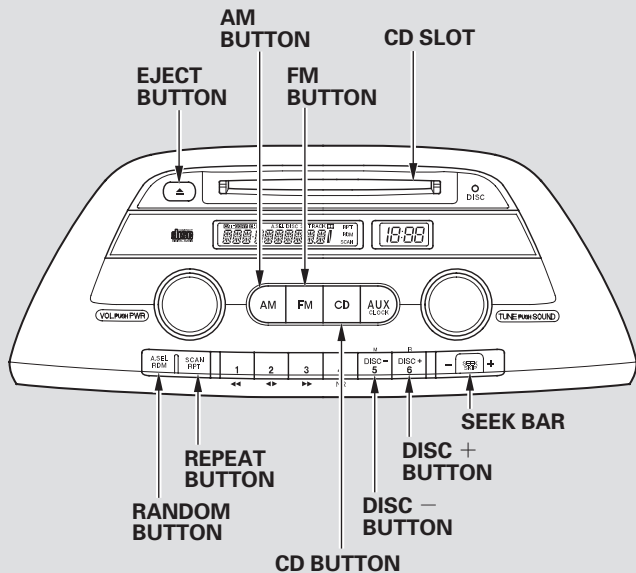

*EX model without RES*

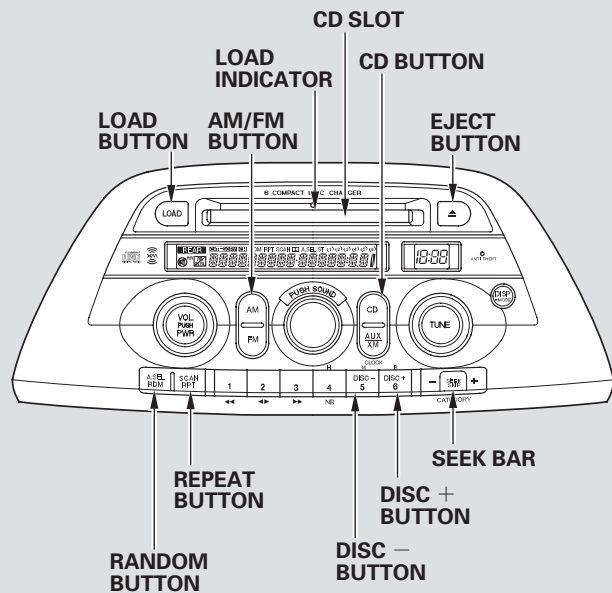

# Playing a CD, CD Changer

*EX and Touring models with RES without Navigation System*

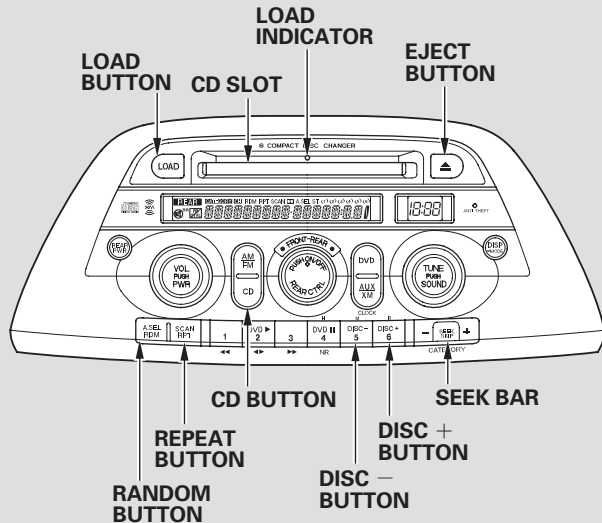

*Touring model with RES and Navigation System*

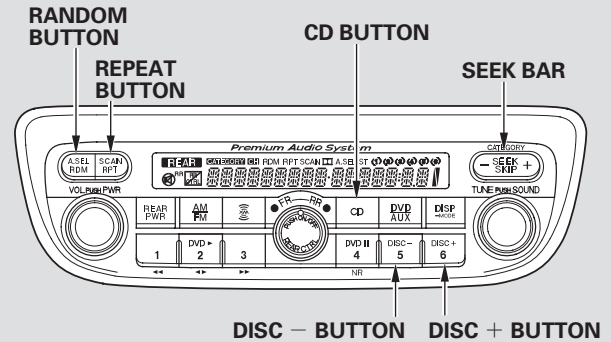
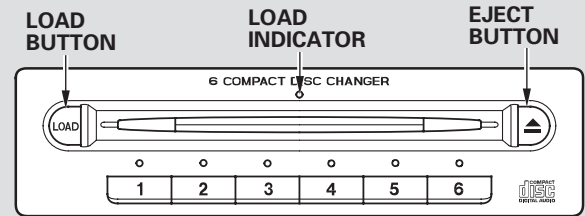

## Playing a CD, CD Player

---

### CD Player

#### *LX model*

With the ignition in the ACCESSORY (I) or ON (II) position, insert a CD into the CD slot. The drive will pull the CD in the rest of the way and begin to play it. You operate the CD player with the same controls used for the radio. The number of the track playing is shown in the display. The system will continuously play a CD until you change modes.

#### **NOTICE**

*Do not use CDs with adhesive labels. The label can curl up and cause the CD to jam in the unit.*

### To Change Tracks (SKIP)

Each time you press and release the + side of the SKIP bar, the player skips forward to the beginning of the next track. Press and release the – side of the SKIP bar to skip backward to the beginning of the previous track.

To move rapidly within a track, press and hold the + or – side of the SKIP bar. You will see CUE or REW in the display.

**REPEAT** – To continuously replay a track, press and release the RPT button. You will see RPT in the display. Press the RPT button again to turn it off.

**RANDOM** – This feature plays the tracks in random order. To activate Random Play, press and release the RDM button. You will see RDM in the display. This continues until you press the RDM button again.

### To Stop Playing a CD

Press the eject button ( ▲ ) to remove the CD. If you eject the CD, but do not remove it from the slot, the system will automatically reload the CD after 15 seconds and put it in pause mode. To begin playing, press the CD button.

Press the AM or FM button to switch to the radio while a CD is playing. Press the CD button to play the CD.

If you turn the system off while a CD is playing, either with the PWR/VOL knob or by turning off the ignition, the CD will stay in the drive. When you turn the system back on, the CD will begin playing where it left off.

### Operating the CD Changer

#### *EX and Touring models*

Your audio system has an in-dash CD changer that holds up to six CDs, providing several hours of continuous entertainment. You operate this CD changer with the same controls used for the radio.

To load CDs or operate the CD changer, the ignition switch must be in the ACCESSORY (I) or ON (II) position.

#### **NOTICE**

*Do not use CDs with adhesive labels. The label can curl up and cause the CD to jam in the unit.*

#### *On vehicles with navigation system*

The CD changer is behind the navigation system screen. To use the CD changer, press the OPEN button beside the screen. The screen folds back, and the CD changer appears.

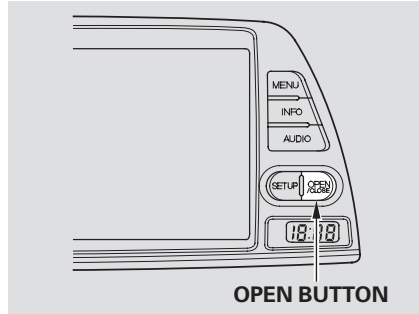

To return the screen to the upright position, press the OPEN button again. Do not use the folded screen as a tray. If you put a cup, for example, on the screen, the liquid inside the cup may spill on the screen when you go over a bump.

### Loading CDs in the Changer

#### *On vehicles with navigation system*

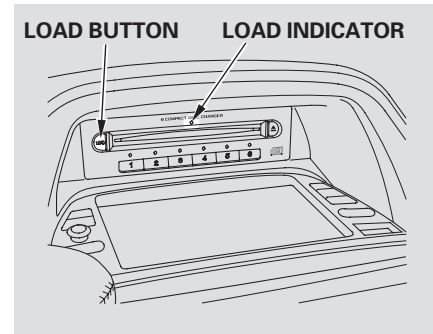

To load multiple CDs in one operation:

1. Press and hold the LOAD button beside the CD slot until you see "LOADING" in the display, then release the button.

*CONTINUED*



## Playing a CD, CD Changer

---

2. The indicators above the Disc buttons of the empty positions will blink, and the green load indicator above the CD slot comes on.
3. Insert a CD into the CD slot. Insert it only about halfway; the drive will pull it in the rest of the way. You will see “BUSY” in the display. The CD load indicator turns red and blinks as the CD is loaded.
4. When **LOADING** appears again in the display, insert the next CD into the CD slot.
5. Repeat this until all six positions are loaded. The system will then begin playing the first CD loaded.

If you stop loading CDs before all six positions are filled, the system will wait for 10 seconds, then stop the load operation and begin playing the last CD loaded.

To load a single CD:

1. Press and release the **LOAD** button.
2. The indicators above the Disc buttons of the empty positions will blink, and the green CD load indicator comes on. When you see “LOAD” in the display, insert the disc into the CD slot. Insert it only about halfway; the drive will pull it in the rest of the way.
3. The system will load the CD, and begin playing it.

If you press the **LOAD** button while a CD is playing, the system will stop playing that CD and start the loading sequence. It will then play the CD just loaded.

You can also load a CD into an empty position while a CD is playing by pressing the appropriate Disc button. Select an empty Disc button (the indicator above the button is off), and press the button. The system will stop playing the current CD and start the loading sequence. It will then play the CD just loaded.

*On vehicles without navigation system*  
To load multiple CDs in one operation:

1. Press and hold the Load button until you hear a beep and see “LOAD” in the display, then release the button.
2. On the upper right side of the display, the disc number for an empty position will begin blinking, and the green CD load indicator will come on.
3. Insert the CD into the CD slot. Insert it only about halfway; the drive will pull it in the rest of the way. You will see “BUSY” in the display. The CD Loaded indicator turns red and blinks as the CD is loaded.

4. When LOAD appears again in the display, insert the next CD into the CD slot.
5. Repeat this until all six positions are loaded. The system will then begin playing last CD loaded.

If you are not loading CDs into all six positions, press the LOAD button again after the last CD has loaded. The system will begin playing the last CD loaded.

If you stop loading CDs before all six positions are filled, the system will wait for ten seconds, then stop the load operation and begin playing the last CD loaded.

To load a single CD:

1. Press and release the LOAD button.
2. When the disc number for an empty position starts to blink and the green CD load indicator comes on, you will see LOAD in the display. Insert the disc into the CD slot. Insert it only about halfway, the drive will pull it in the rest of the way.
3. The system will load the CD, and begin playing it.

## Playing a CD, CD Changer

---

### To Play a CD

Select the CD changer by pressing the CD button. You will see “CD” in the display. The system will begin playing the last selected disc in the CD changer. You will see the disc and track numbers displayed.

When that CD ends, the next CD in the CD changer is loaded and played. After the last CD finishes, the system returns to CD 1.

To select a different CD, press the appropriate preset button (1 – 6). If you select an empty position in the CD changer, the system will go into the loading sequence.

You can use the SKIP bar while a disc is playing to select passages and change tracks.

To move rapidly within a track, press and hold the – or + side of the SKIP bar. You will hear a beep and the system will continue to move through the track. Press the + side of the SKIP bar to move forward, or the – side to move backward. Release the bar when the system reaches the point you want.

On models with a rear entertainment system and a navigation system, you cannot listen to a disc and XM Radio at the same time. For example, when a disc is playing on the front speakers, you cannot listen to XM Radio on the rear speakers, or vice versa.

### To Change Tracks

Each time you press the + side of the SKIP bar, the system skips forward to the beginning of the next track. Press and release the – side to skip backward to the beginning of the current track. Press it again to skip to the beginning of the previous track.

### Track Scan

When you press the SCAN button or touch the TRACK SCAN icon on the upper display, the first track of the current disc plays for about 10 seconds. You will see SCAN in the upper display and in the audio display. To hear the rest of the track, press the SCAN button or touch the TRACK SCAN icon again within 10 seconds. If you don't, the system advances to the next track, plays about 10 seconds of it, and continues through the rest of the tracks the same way.

### Disc Scan

When you press and hold the SCAN button until you see D-Scan in the display, or when you touch the DISC SCAN icon on the upper display, the first track of the current CD plays for about 10 seconds. You will see D-SCAN in the display and DISC SCAN in the upper display. To hear the rest of the CD, press the SCAN button or touch the DISC SCAN icon again, within 10 seconds. If you don't, the system advances to the next disc, plays about 10 seconds of it, and continues throughout the rest of the CDs the same way. When the system reaches the last disc, DISC SCAN is cancelled, and the CD plays normally.

### Track Repeat

When you press and release the RPT button or touch the TRACK RPT icon on the upper display, the system continuously replays the current track. As a reminder, you will see REPEAT (TRACK RÉPEAT) in the display. To turn this feature off, press the RPT button, or touch the TRACK REPEAT icon again.

### Disc Repeat

When you press and hold the RPT button until REPEAT is in the display, or when you touch the DISC RPT icon on the audio display, the system continuously replays the current disc. As a reminder, you will see D-RPT (DISC RPT) in the display.

## Playing a CD, CD Changer

---

### Random Play

When you press the RDM button or touch the TRACK RANDOM icon on the upper display, the system plays the tracks of the current disc in random order. You will see RANDOM (TRACK RANDOM) in the display. To turn this feature off, press the RDM button (touch TRACK RANDOM) again. Operation of TRACK SCAN, DISC SCAN, TRACK REPEAT, DISC REPEAT, and TRACK RANDOM on the upper display is possible only when the audio display is in the upright position.

### To Stop Playing a Disc

To take the system out of CD mode, press the AM/FM button or SAT RADIO button (U.S. models). Each time you press the AM/FM button, the system changes to the next mode (AM, FM1, or FM2). When you return to CD mode by pressing the CD button, play will continue

where it left off.

If you turn the system off while a CD is playing, either with the PWR/VOL knob or the ignition switch, play will continue at the same point when you turn it back on.

### Removing CDs from the Changer

To remove the disc that is currently playing, press the eject button. You will see "EJECT" in the display. When you remove the disc from the slot, the system automatically begins the load sequence so you can load another disc in that position. If you do not load another CD, within 15 seconds, the system selects the previous mode [AM, FM1, FM2, or XM Radio (U.S. models)].

If you do not remove the CD from the slot, the system will reload the CD after 15 seconds and put the CD changer in pause mode. To begin playing the CD, press the CD button.

To remove the disc from the changer, first select it by pressing the appropriate disc button or corresponding number on the preset button. When that disc begins playing, press the eject button.

When you press the eject button while listening to the radio, or with the audio system turned off, the disc that was last selected is ejected. After that disc is ejected, pressing the eject button again will eject the next disc in numerical order. By doing this six times, you can remove all the discs from the changer.

You can also eject discs when the ignition switch is on or off:

To eject one disc, press and release the eject button.

To eject all discs, press and hold the eject button until the indicators above the disc buttons blink.

### General Information

- When using CD-R discs, use only high quality CDs labeled for audio use.
- When recording a CD-R, the recording must be closed for it to be used.
- CD-RW discs will not work in this unit.
- Play only standard round CDs. Odd-shaped CDs may jam in the drive or cause other problems.
- Handle your CDs properly to prevent damage and skipping.

### Protecting CDs

When a CD is not being played, store it in its case to protect it from dust and other contamination. To prevent warpage, keep CDs out of direct sunlight and extreme heat.

To clean a CD, use a clean soft cloth. Wipe across the CD from the center to the outside edge.

A new CD may be rough on the inner and outer edges. The small plastic pieces causing this roughness can flake off and fall on the recording surface of the CD, causing skipping or other problems. Remove these pieces by rubbing the inner and outer edges with the side of a pencil or pen.

Never try to insert foreign objects in the CD player or the CD changer.

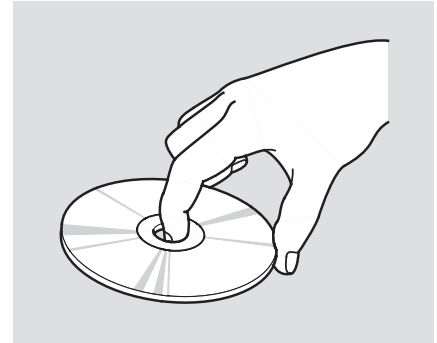

Handle a CD by its edges; never touch either surface. Do not place stabilizer rings or labels on the CD. These, along with contamination from fingerprints, liquids, and felt-tip pens, can cause the CD to not play properly, or possibly jam in the drive.

## CD Changer Error Messages

---

If you see an error message in the display while playing a CD, find the cause in the chart to the right. If you cannot clear the error message, take the vehicle to your dealer.

Message	Cause	Solution
CD MECHA	Mechanical Error	Press the disc eject button, and remove the disc(s). Check for an error indication. Insert the disc(s) again. If the code does not disappear or the disc(s) cannot be removed, consult your dealer.
CD HEAT	High Temperature	Will disappear when the temperature returns to normal.

*LX model*

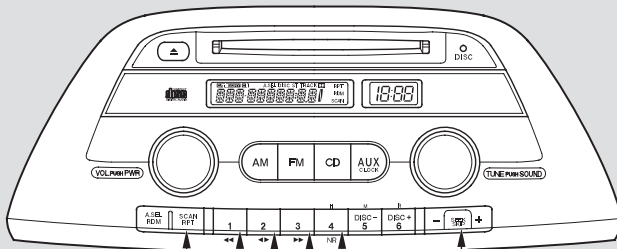

REPEAT  
BUTTON

FF BUTTON

PLAY/PROG  
BUTTON

REW  
BUTTON

NR BUTTON

SKIP BAR

*EX model without RES*

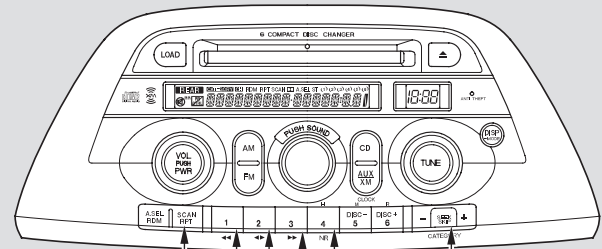

REPEAT  
BUTTON

FF BUTTON

PLAY/PROG  
BUTTON

REW  
BUTTON

NR BUTTON

SKIP BAR



# Playing a Tape

*EX and Touring models with RES without Navigation System*

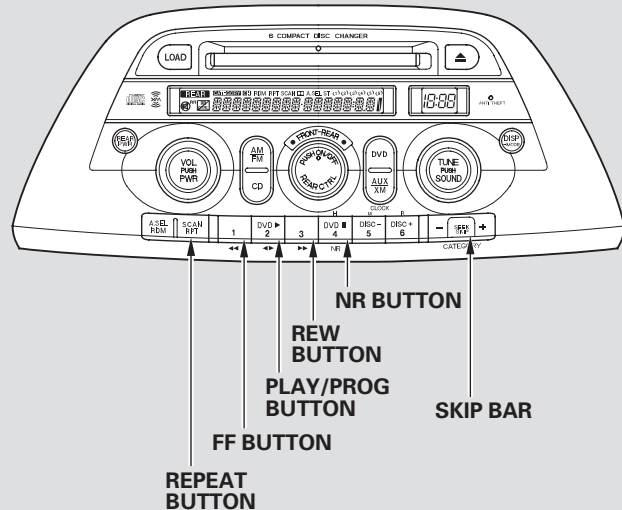

*Touring model with RES and Navigation System*

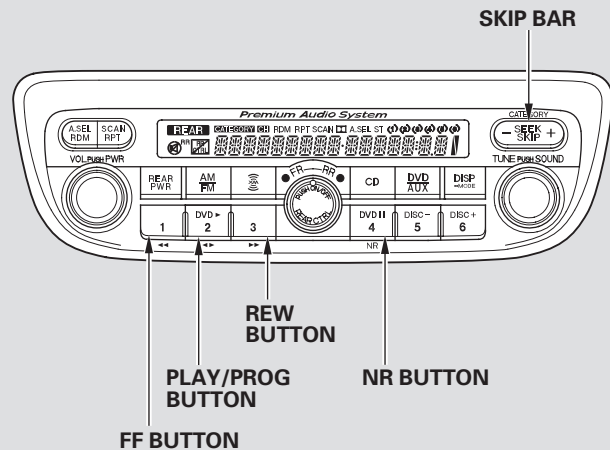

## To Play a Tape

*Optional on all models*

The ignition switch must be in the ACCESSORY (I) or ON (II) position. Make sure the open side of the tape is facing right, then insert the tape most of the way into the slot. The system will pull the tape in the rest of the way, and begin to play it.

The tape direction indicator will come on to show you which side of the tape is playing. The ▲ indicates the side you inserted upward is now playing. If you want to play the other side, press the PLAY/PROG button. When the player reaches the end of the tape, it will automatically reverse direction and play the other side.

Dolby\* noise reduction turns on when you insert a tape. The □□ indicator will come on in the display. If the tape was not recorded in Dolby, turn it off by pressing the NR button. Dolby remains off until you press the NR button again.

\* Dolby noise reduction is manufactured under license from Dolby Laboratories Licensing Corporation. "DOLBY" and the double-D symbol □□ are trademarks of Dolby Laboratories Licensing Corporation.

## To Stop Playing a Tape

To remove the tape, press the EJECT button. If you want to turn the player off, press the PWR/VOL knob or turn off the ignition. The tape will remain in the drive. When you turn the system back on, the tape will begin playing where it left off.

To switch to the radio or CD player while a tape is playing, press the AM or FM button or AM/FM button, or CD button. To change back to the tape player, press the AUX button.

## Tape Search Functions

**FF/REW** – To rewind the tape, push the REW button. You will see REW in the display. To fast forward the tape, push the FF button. You will see FF displayed. Press the FF, REW, or PLAY/PROG button to take the system out of rewind or fast forward.

CONTINUED

## Playing a Tape

---

**SKIP** — Press the — side of the SKIP bar to find the beginning of the current song or passage. Press the + side of the SKIP bar to find the beginning of a song or passage. When the system reaches the beginning of a song or passage, it begins to play it.

**REPEAT** — Press the RPT button to continuously play a song or passage. You will see RPT displayed. The track will repeat until you press the RPT button again.

**NOTE:** The SKIP and REPEAT functions use silent periods on the tape to find the end of a song or passage. These features may not work if there is almost no gap between selections, a high noise level, or a silent period in the middle of a selection.

### Caring for the Tape and Player

The tape player picks up dirt and oxides from the tape. This contamination builds up over time and causes the sound quality to degrade. To prevent this, you should clean the player after every 30 hours of use.

If you do not clean the tape player regularly, it may eventually become impossible to remove the contamination with a normal cleaning kit. Your dealer has a cleaning kit available.

Use 100-minute or shorter tapes. Tapes longer than that may break or jam the drive.

If the tape is loose, tighten it by turning the hub with a pencil or your finger. If the label is peeling off, remove it or it could cause the tape to jam in the player. Never try to insert a warped or damaged tape in

the player.

Store tapes in their cases to protect them from dust and moisture. Never place tapes where they will be exposed to direct sunlight, high heat, or high humidity. If a tape is exposed to extreme heat or cold, let it reach a moderate temperature before inserting it into the player.

Never try to insert foreign objects into the tape player.

*LX model*

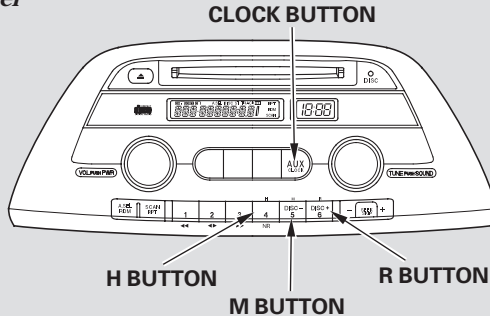

*EX model*

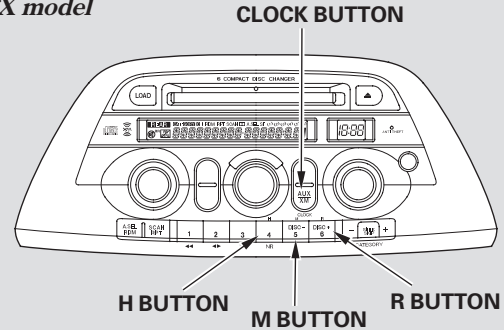

*On models without Navigation System*  
If your vehicle's battery is disconnected or goes dead, you will need to set the clock.

Press and hold the **CLOCK** button until the clock flashes. Change the hours by pressing the **H** button until the numbers advance to the desired time. Change the minutes by pressing the **M** button until the numbers advance to the desired time.

When you are finished, press the **CLOCK** button again.

You can quickly set the time to the nearest hour. If the displayed time is before the half hour, pressing and holding the **CLOCK** button, then pressing the **R** (**RESET**) button sets the clock back to the previous hour. If the displayed time is after the half hour, the clock sets forward to the beginning of the next hour.

For example: 1:06 will reset to 1:00  
1:52 will reset to 2:00

*On models with Navigation System*  
Refer to the Navigation system manual for how to adjust the time.

## Steering Wheel Controls

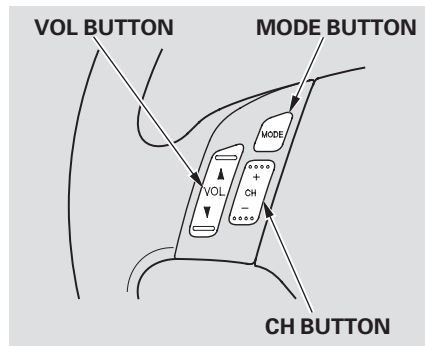

### *On EX and Touring models*

Three controls for the audio system are mounted in the steering wheel hub. These let you control basic functions without removing your hand from the steering wheel.

The VOL button adjusts the volume up (▲) or down (▼). Press the top or bottom of the button and hold it until the desired volume is reached, then release it.

The MODE button changes the mode. Pressing the button repeatedly selects FM1, FM2, AM, XM Radio (U.S. models), CD (if a disc is loaded) or a tape (if the optional tape player is installed and a tape is loaded).

If you are listening to the radio, use the CH button to change stations. Each time you press the top (+) of the button, the system goes to the next preset station on the band you are listening to. Press the bottom (–) to go back to the previous station.

If you are playing a CD, the system skips to the beginning of the next track each time you press the top (+) of the CH button. Press the bottom (–) to return to the beginning of the current track. Press it again to return to the previous track. You will see the disc and track numbers in the display.

If you are playing a tape, press the top (+) of the CH button to advance to the next selection. Press the bottom (–) to go back to the previous selection. The system senses a silent period, then goes back to play mode.

### *On EX and Touring models*

Your vehicle's audio system will disable itself if it is disconnected from electrical power for any reason. To make it work again, you must enter a specific five-digit code with the preset buttons. Because there are hundreds of number combinations possible from the five digits, making the system work without knowing the exact code is nearly impossible.

You should have received a card that lists your audio system code number and serial number. It is best to store this card in a safe place at home. In addition, you should write the audio system's serial number in this Owner's Manual.

If you should happen to lose the card, you must obtain the code number from a Honda dealer. To do this, you will need the system's serial number.

If your vehicle's battery is disconnected or goes dead, or the radio fuse is removed, the audio system will disable itself. If this happens, you will see " [000] " in the frequency display the next time you turn on the system. Use the preset buttons to enter the five-digit code. The code is located on the radio code card included in your Owner's Manual kit. When it is entered correctly, the radio will start playing.

If you make a mistake entering the code, do not start over; complete the five-digit sequence, then enter the correct code. You have ten tries to enter the correct code. If you are unsuccessful in ten attempts, you must then leave the system on for 1 hour before trying again.

You will have to store your favorite stations in the preset buttons after the system begins working. Your original settings were lost when the power was disconnected.

# Rear Entertainment System

## Models with Navigation System

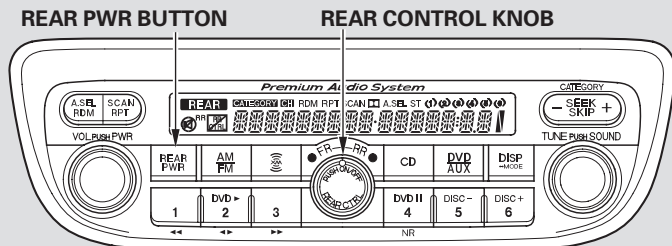

## Overhead Screen Unit

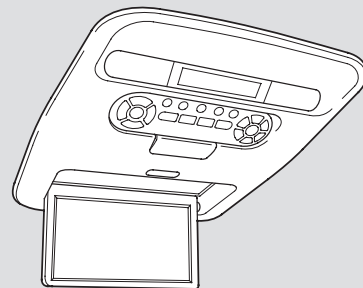

## Models without Navigation System

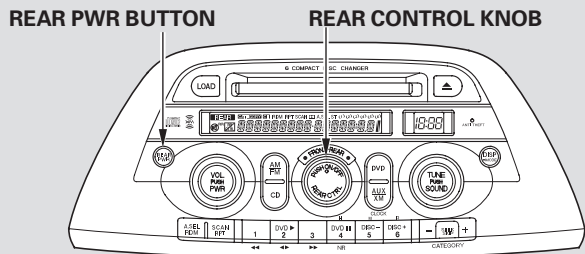

## DVD Player

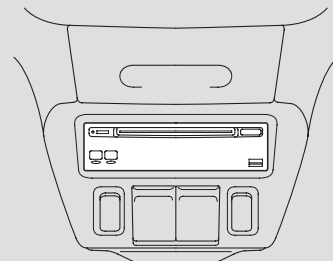

*Available on EX with Leather and Touring models*

Your vehicle is equipped with a rear entertainment system that includes a DVD player for the enjoyment of the rear passengers.

With this system, the rear passengers can enjoy a different entertainment source (radio, CD changer, DVD player, or optional tape player) than the front seat occupants. The audio is broadcast through the supplied wireless headphones.

The ignition switch must be in the ACCESSORY (I) or ON (II) position to operate the rear entertainment system.

### To Turn On the System

Press the REAR PWR button. To turn on the rear controls (ceiling panel/remote control), press the RR CTRL knob. The system's icon shows in the upper display. Your passengers can then operate the rear system with the control panel in the ceiling. The rear control panel can be used as a remote control when it is detached from the ceiling unit. Press the RR CTRL knob again to turn the rear controls off. You will see the Rear Controls Off icon in the upper display.

The rear system selects the source it was last set to. If that source has been removed (the DVD has been ejected from the player, for example), you will see "DVD EJECT" in the display. You must select another source.

### Rear Speakers

When you turn on the system, the rear speakers are automatically turned off if the rear system selects a different entertainment source than the front system. You will see the Rear Speakers Off icon in the upper display. The sound for the rear system is sent to the wireless headphones.

If you want to turn the rear speakers on again, press and hold the REAR PWR button until the Rear Speakers Off icon goes off.

**NOTE:** The rear speakers are connected to the front system, so they will always play the source that the front system is set to.



## Rear Entertainment System

### To Select Rear Entertainment from the Front Control Panel

To operate the rear entertainment system from the front panel, turn the RR CTRL knob clockwise. The amber RR LED comes on to show that the control panel is enabled.

To play the radio, the buttons for the front entertainment system have the same functions.

If CDs are loaded in the CD changer, select CD. If a CD is loaded in the lower player, select DVD/AUX.

### Operating the DVD Player from the Front Control Panel

The DVD player in your rear entertainment system can play DVD video discs and CDs.

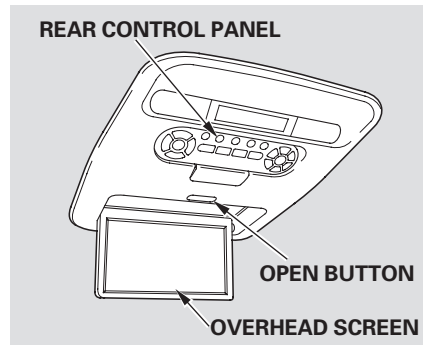

Open the overhead screen by pushing the OPEN button. The screen will swing down part-way. Pivot the screen the rest of the way. If you pivot the screen too far forward, past the second detent, the display will turn off. Pivot the screen back to the second or first detent to turn the display back on. To close the screen, pivot it up until it latches.

# Rear Entertainment System

## Models with Navigation System

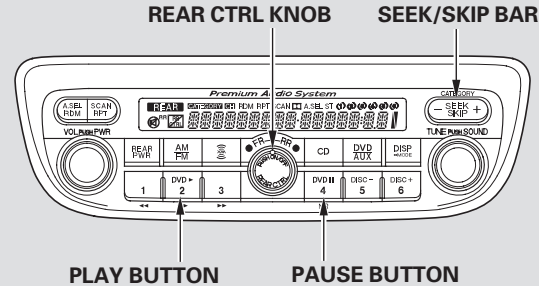

## Models without Navigation System

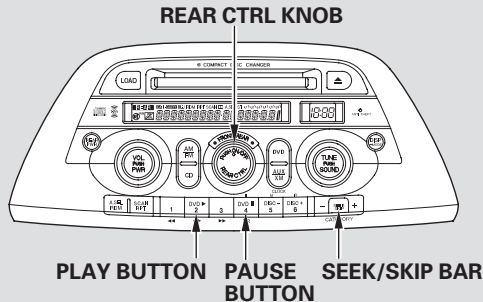

Turn the Rear CTRL knob clockwise. The amber Rear LED comes on to show that the control panel is now enabled.

Insert a DVD into the DVD/CD player below the front panel.

Push the DVD in halfway, the drive will pull it in the rest of the way.

**PLAY** — Press the PLAY button if the DVD does not start playing automatically.

**PAUSE** — Press the PAUSE button to pause the DVD. Press the button again or press PLAY to resume. Pause works only with the DVD player.

CONTINUED

## Rear Entertainment System

---

**SEEK/SKIP** – Press and hold the + side to move forward; you will see “CUE” in the display. Press and hold the – side to move backward; you will see “REV” in the display. Release the bar when the system reaches the point you want.

Each time you press and release the + side of the SEEK/SKIP bar, the system skips forward to the beginning of the next track or chapter. Press and release the – side of the bar to skip backward to the beginning of the current track or chapter. Press it again to skip to the beginning of the previous track or chapter.

**EJECT** – Press the eject button to remove the DVD from the drive.

### **To Return to Front Audio Controls**

To return front panel control to the front audio system, turn the REAR CTRL knob counterclockwise.

### **Using the Rear Control Panel**

To turn on the rear entertainment system from the rear control panel, press the PWR button. Use the AM/FM button, XM RADIO button (U.S. models), CD button, DVD/AUX button (U.S. models), or AUX button (Canadian models) to select the entertainment source. The selected source will be shown in the display. Make sure the rear control operation has not been disabled with the REAR CTRL knob on the front panel.

## To Play the Radio from the Rear Control Panel

Use the ▲ and ▼ buttons to select a station from the radio preset buttons. Press the ▲ button to tune the radio to a higher frequency, or press the ▼ button to tune to a lower frequency. Pressing the ◀◀ or ▶▶ button causes the system to search up or down the band for a station with a strong signal. You will see SEEK in the display.

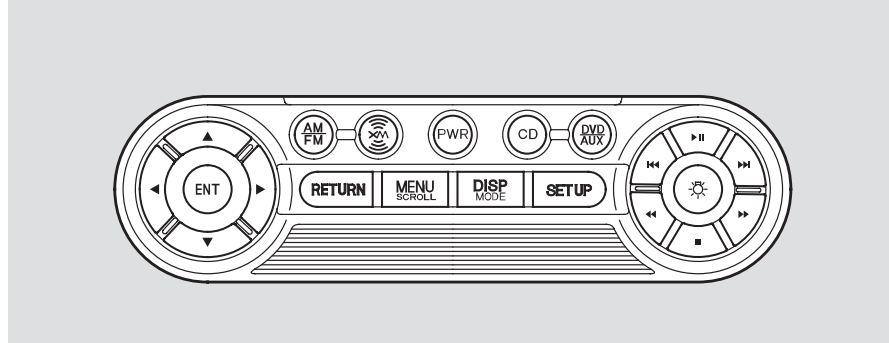

## To Play the XM Radio from the Rear Control Panel

Use the ▲ and ▼ buttons to select a station from the radio preset buttons. Press the ▶▶ button to search up the channels in the channel mode. The system will search up the channels within the category when the radio is in the category mode. Press the ◀◀ button to search down the channels in the channel mode. The system will search down the channels within the category

when the radio is in the category mode.

*CONTINUED*

## Rear Entertainment System

---

Press the ►► or ◀◀ button to select another category.

Pressing and holding the DISP button for more than 5 seconds will change the search mode between Channel Search and Category Search. Each time you press and release the DISP button, the display above the rear control panel changes in the following sequence: Channel Number, Category Name, Music Name, Artist Name, Channel Name, and back to Channel Number.

### To Play a CD from the Rear Control Panel

If CDs are loaded in the CD changer, select them by pressing the CD button. If a CD is loaded in the DVD player, press the DVD/AUX button. Press the ►► button to skip to the beginning of the next track. Press the ◀◀ button to return to the beginning of the current track.

To move rapidly within a track, press and hold the ►► or ◀◀ button. The system will continue to move through the track. Press the ►► button to move forward, or the ◀◀ button to move backward.

Release the button when the system reaches the point you want.

If CDs are loaded in the CD changer and the overhead screen is not open, pressing the ▲ or ▼ button changes the discs.

### To Play the Optional Tape Player from the Rear Control Panel

To rewind the tape, push the ◀◀ button. You will see REW in the display. To fast forward the tape, push the ►► button. You will see FF displayed.

Press the ►► button to find the beginning of the current song or passage. Press the ◀◀ button to find the beginning of the next song or passage.

Press the ►|| button to change the tape direction.

### To Play a DVD from the Rear Control Panel

The video screen is for use by rear seat passengers only. The driver and front seat passenger should not try to view the screen while driving.

Open the overhead screen by pushing the OPEN button. The screen will swing down part-way. Pivot the screen the rest of the way. If you pivot the screen too far forward, past the second detent, the display will turn off. Pivot the screen back to the second or first detent to turn the display back on. To close the screen, pivot it up until it latches.

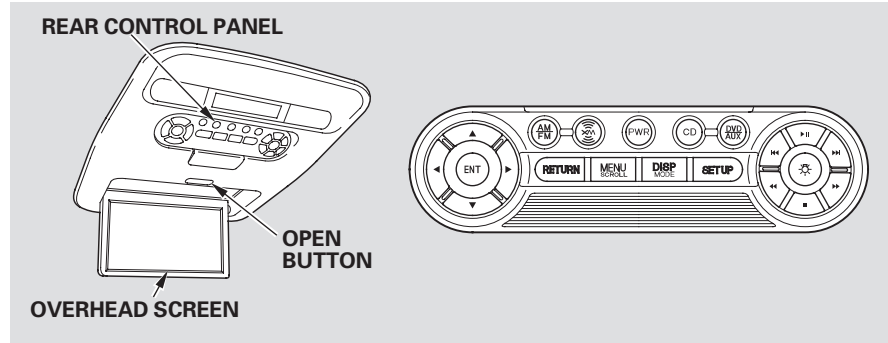

Press the **▶||** button when you want to pause the DVD. Press this button again to go back to PLAY.

Press the **▶▶** button to skip to the beginning of the next chapter. Press the **◀◀** button to return to the beginning of the current chapter.

To move rapidly within a chapter, press and hold the **▶▶▶** or **◀◀◀** button. The system will continue to move through the

chapter. Press the **▶▶▶** button to move forward, or the **◀◀◀** button to move backward. Release the button when the system reaches the point you want.

To select the menu on the DVD, press the MENU/SCROLL button (U.S. models) or MENU button (Canadian models). Use the **▲**, **▼**, **▶**, and **◀** buttons to move to the desired menu selection, then press the ENT button to enter your selection.

# Rear Entertainment System

## DISP Button

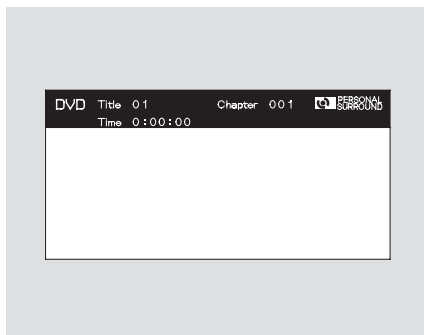

When you press the DISP button while a DVD is playing, the title, chapter, elapsed time, and personal surround logo are displayed (STATUS 1).

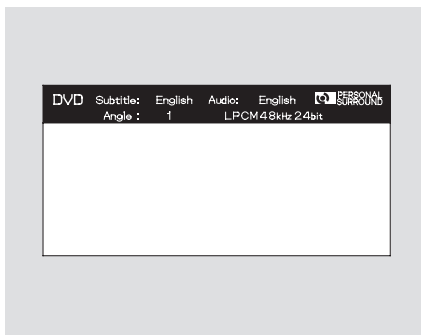

When you press the DISP button again, the subtitle, audio, angle, sound characteristics, and personal surround logo are displayed (STATUS 2).

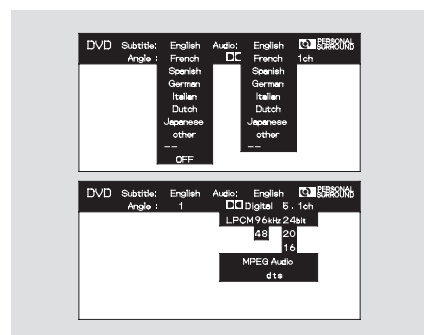

To go back to play, press the DISP button.

## MENU Button

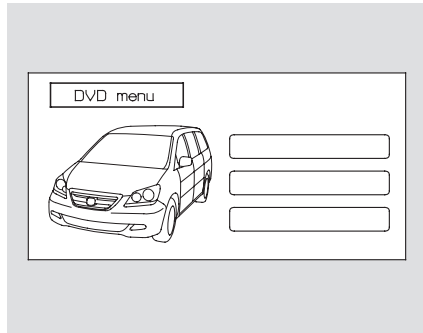

When you press the MENU button while a DVD is playing, the DVD's main menu is displayed. To go back to play, press the RETURN button.

## System Messages

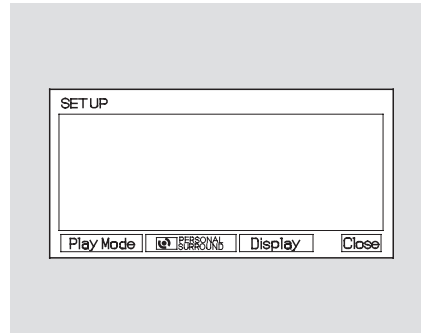

When you press the SETUP button while a DVD is playing, the DVD's setup menu is displayed at the bottom of the screen. You can then change various settings of play mode, personal surround, and display. To go back to play without changing any setting, press the RETURN or SETUP button, or select "Close" by pressing the ► or ◀ button, then press the ENT button.

## Play Mode

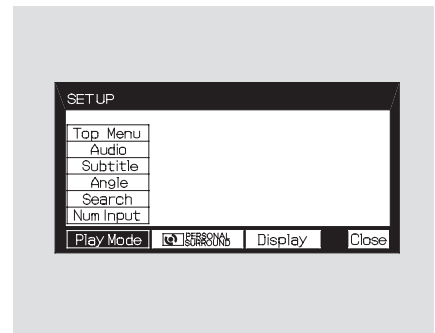

When you select "Play Mode" by pressing the ► or ◀ button, the play mode setup menu is displayed above the "Play Mode" icon.

CONTINUED



## Rear Entertainment System

### Top Menu

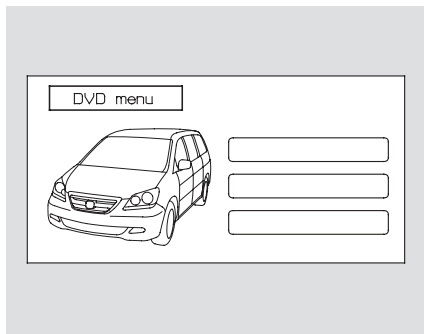

When you select “TOP MENU” using the ▼ or ▲ button, the DVD’s title menu is displayed. This menu is also displayed when you press the MENU button while a DVD is not playing.

To go back to play, press the return button.

### Audio

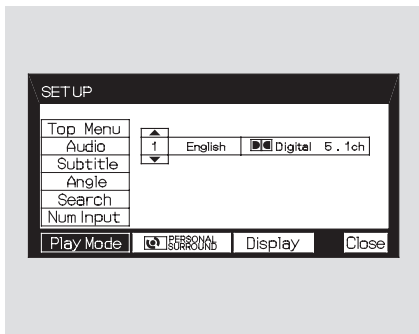

When you select “Audio” from the play mode setup menu by pressing the ▼ or ▲ button, you will see a submenu of the dubbed language.

Select the desired language by pressing the ▼ or ▲ button. The sound characteristics (Dolby Digital, LPCM, MPEG Audio, dts) recorded with the selected language are also displayed next to the language.

The selectable languages vary from DVD to DVD, and this feature may not be available on some DVDs.

Press the RETURN or ENT button to go back to the play mode setup menu.

## Subtitle

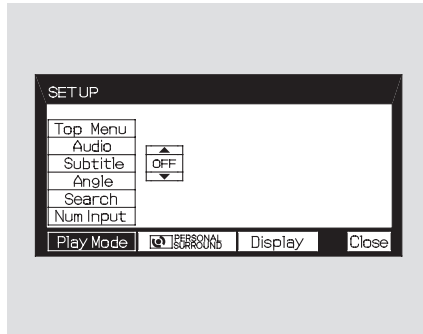

To turn the subtitle on and off, select “Subtitle” from the setup menu by pressing the ▼ or ▲ button. You will see submenu “OFF” or “ON.” Select “OFF” or “ON” by pressing the ▼ or ▲ button.

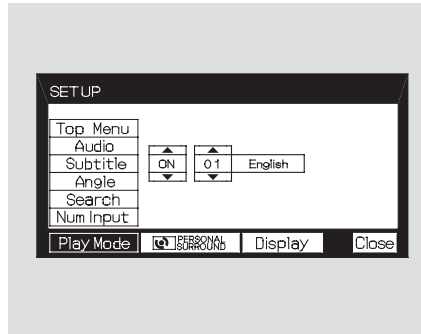

If more than one subtitle language is available, you will see the language currently selected when you select “ON” in the previous step. Select the desired subtitle language by pressing the ▼ or ▲ button. Press the RETURN or ENT button to go back to the play mode setup menu.

## Angle

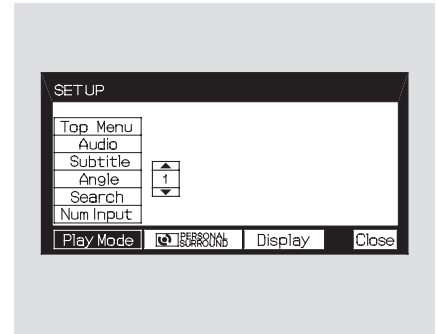

On some DVDs, the scenes are recorded by more than one camera, giving different viewpoints of the same scene. To change the angle, select “Angle” from the setup menu. You will see a submenu if there are different angles available. Select the number on the submenu by pressing the ▼ or ▲ button. Press the RETURN or ENT button to go back to the play mode setup menu.

*CONTINUED*

# Rear Entertainment System

## Search

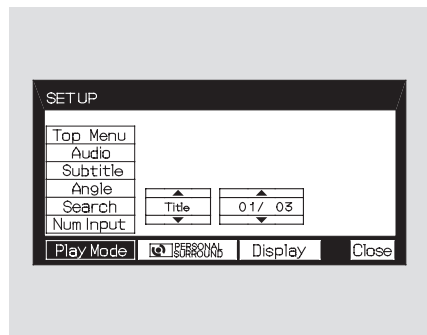

When you select the “Search” from the play mode setup menu, you will see the submenu shown above. In the left submenu, you can select between “Title” and “Chapter.” The right submenu displays the current title or chapter number and the total number of titles or chapters.

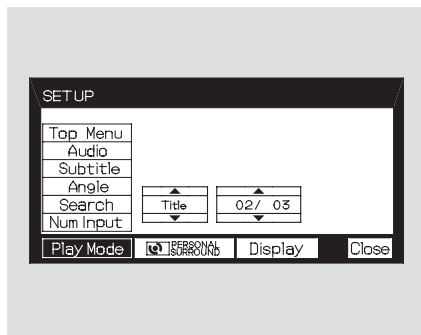

To do a title search, select “Title” by pressing the ▼ or ▲ button. Change the number on the right submenu by pressing the ▼ or ▲ button, and press the ENT button to begin the title search. If you press the RETURN button, the display returns to the play mode setup menu without doing the search.

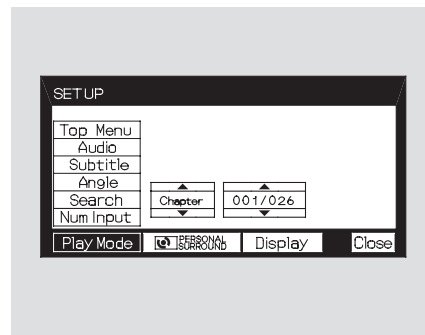

To do a chapter search, select “Chapter” by pressing the ▼ or ▲ button. Change the number on the right submenu by pressing the ▼ or ▲ button, and press the ENT button to begin the chapter search. If you press the RETURN button, the display returns to the play mode setup menu without doing the search.

## Num Input

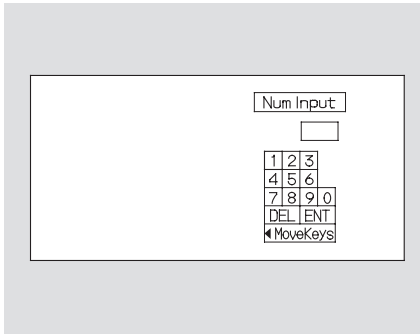

A numerical command can be issued to a DVD by inputting a two digit number, and a button number can be selected on the screen.

Select the "Num Input" from the play mode setup menu. The screen will change as shown above. If you select the "Move Key" using the ▼, ▲, ►, or ◀ button, and press the ENT button, the Num Input display on the screen will

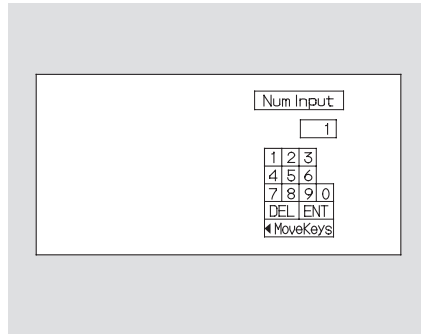

change from the left side to right side or right to left.

Select the first digit number using the ▼, ▲, ►, or ◀ button, and enter it by pressing the ENT button. If you want to change the number, select "DEL," and press the ENT button, then select and enter the new number.

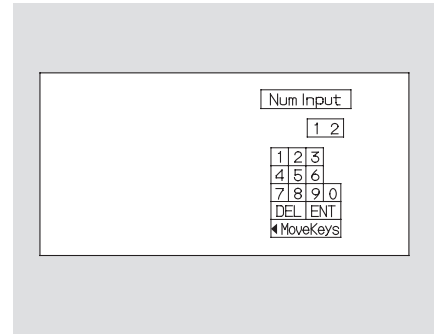

Select and enter the second digit number the same way. The cursor will automatically move to the "ENT" icon when you press the ENT button. Press the ENT button to enter the number command. To go back to the DVD screen, press the RETURN button.

*CONTINUED*

# Rear Entertainment System

## Personal Surround

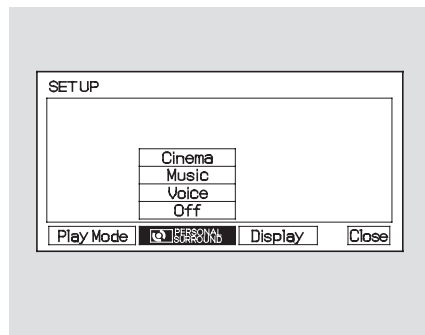

When you select “PERSONAL SURROUND” by pressing the ► or ◀ button, the personal surround setup menu is displayed above the “PERSONAL SURROUND” icon.

Selecting one of the sound effects, Cinema, Music, or Voice, from the personal surround menu allows you to change the sound in your headphones to match the disc you

are playing.

Select “Cinema,” “Music,” or “Voice” by pressing the ▼ or ▲ button, and enter your selection by pressing the ENT button. The “PERSONAL SURROUND” logo is displayed in the upper right corner of the screen.

If you select “Off,” the logo disappears, and there will be no special sound effect.

## Display

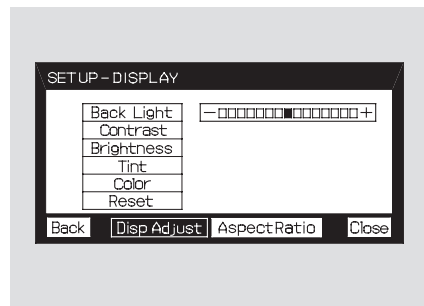

To adjust the display, select “Display” by pressing the ► or ◀ button, and enter your selection by pressing the ENT button. The display changes as shown above. You can adjust these display settings:

- Back Light
- Contrast
- Brightness
- Tint
- Color



# Rear Entertainment System

---

## Screen Mode

You can set the screen mode to these settings:

- Normal
- Wide
- Zoom
- Full

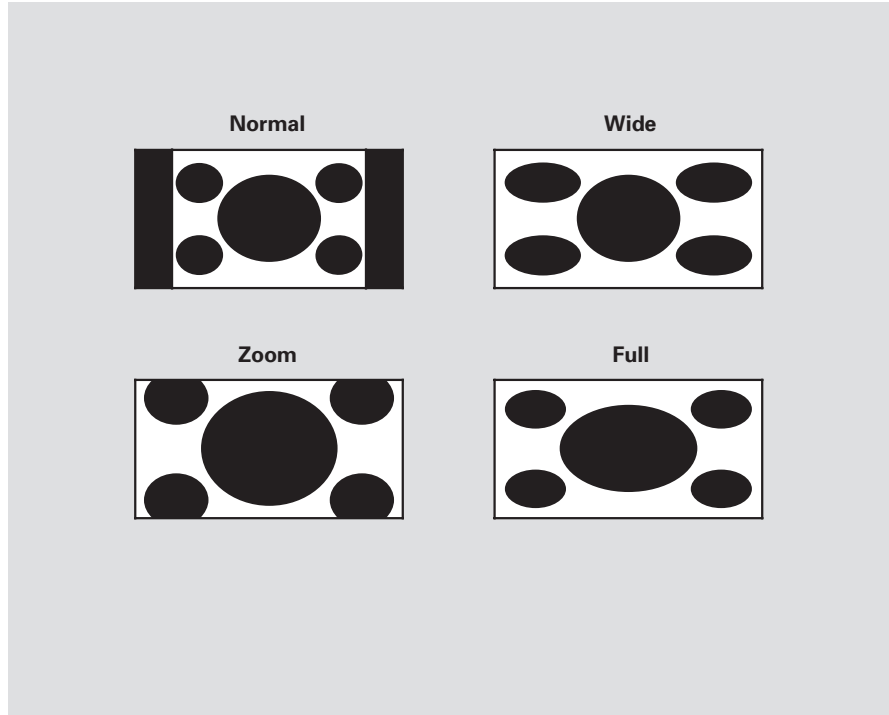

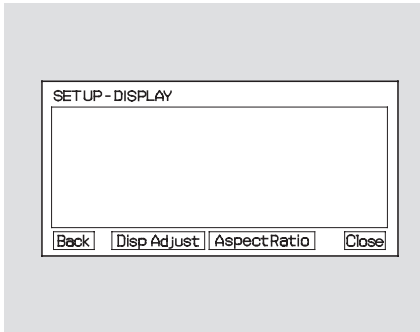

Select the “Aspect Ratio” by pressing the ► or ◀ button, then press the ENT button.

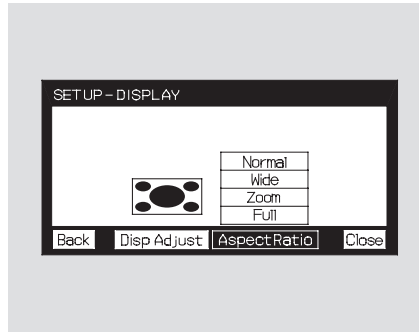

The selectable setting menu is displayed, and the current setting is highlighted in blue.

Select the desired setting by pressing the ▼ or ▲ button, then press the ENT button.

The selected setting will be highlighted in blue for one second, and the screen returns to the play mode in the selected setting.

CONTINUED



# Rear Entertainment System

## INITIAL SETTINGS Menu

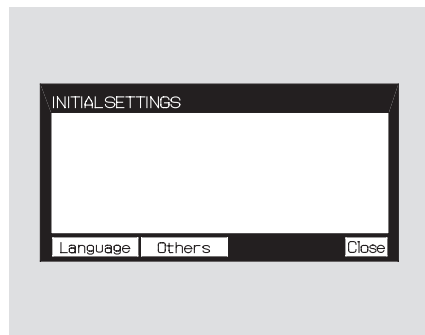

When you press the SETUP button on the rear control panel when a DVD is not playing, the "INITIAL SETTINGS" menu is displayed.

There are two selectable menus: "Language" and "Others."

## INITIAL SETTINGS (Language)

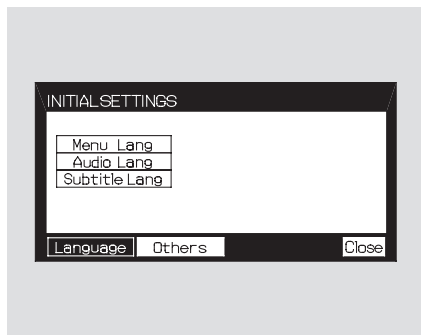

When you select "Language" with the ► or ◀ button, the menu shown above appears.

To return to the stop or prestop screen, select "Close" using the ► or ◀ button, and then press the ENT, or the SETUP button.

## Menu Language

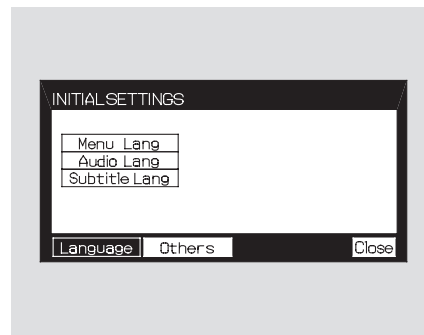

To select the language used in the DISC menus, select "Menu Lang" by pressing the ▼ or ▲ button. You will see the submenu next to "Menu Lang."

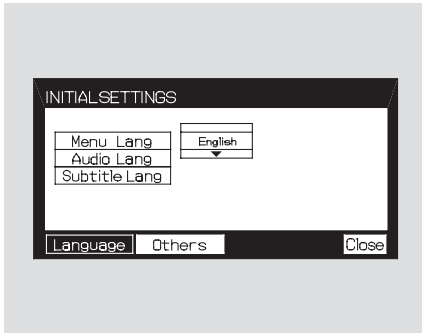

Select the desired language by pressing the ▼ or ▲ button, and then pressing the ENT button.

The selectable languages are, English, French, Spanish, German, Italian, Dutch, and Japanese.

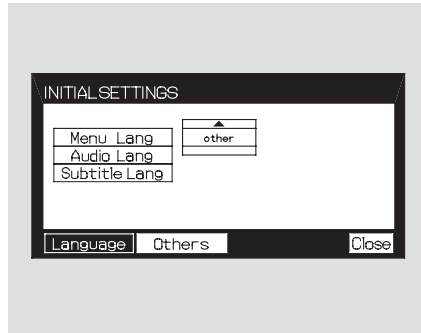

If you want another language than those listed, you need to enter the code number of the desired language. Select "other," and press the ENT button. The display changes as shown in the next column.

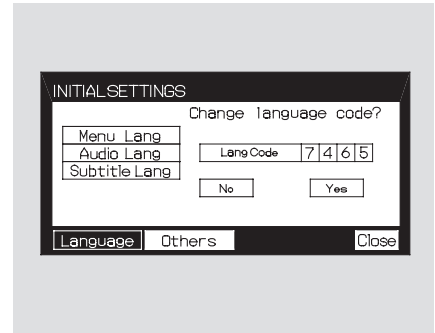

If you select the "No," and press the ENT button, the display returns to the initial screen of the "Language" menu.

*CONTINUED*

# Rear Entertainment System

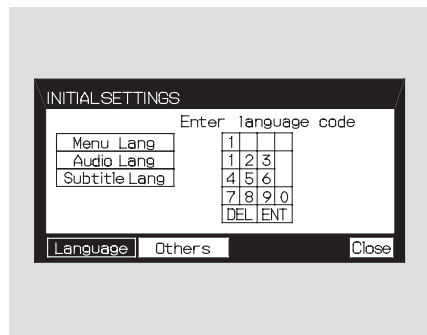

If you select “Yes,” the display changes to the language code input mode. Select the first number digit using the  $\blacktriangledown$ ,  $\blacktriangle$ ,  $\blacktriangleright$ , or  $\blacktriangleleft$  button, and press the ENT button to enter it. Repeat this until all four digits are filled. When the fourth digit is entered, the cursor automatically moves to “ENT” on the display. Press the ENT button on the control panel to enter the new language code.

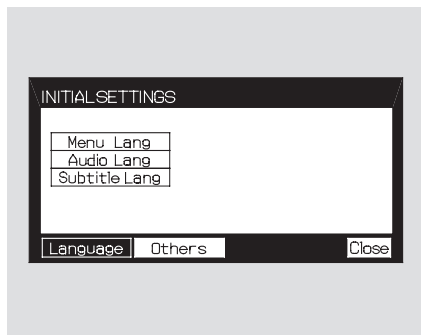

If you made a mistake entering a number digit, select “DEL” on the display with the  $\blacktriangledown$ ,  $\blacktriangle$ ,  $\blacktriangleright$ , or  $\blacktriangleleft$  button, and press the ENT button on the control panel. Then select and enter the correct number digit as described. The display returns to the initial “Language” menu screen.

## Audio Language

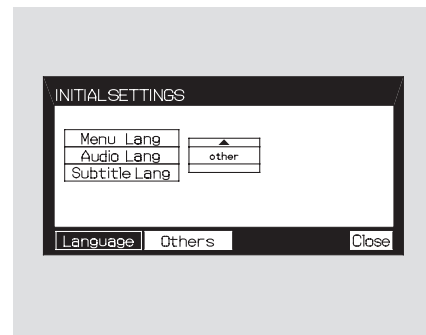

You can select the dubbed language before playing DVDs. Select “Audio Lang” by pressing the  $\blacktriangledown$  or  $\blacktriangle$  button. You will see the submenu next to “Audio Lang.”

Follow the same instructions you used to set the menu language.

## Subtitle Language

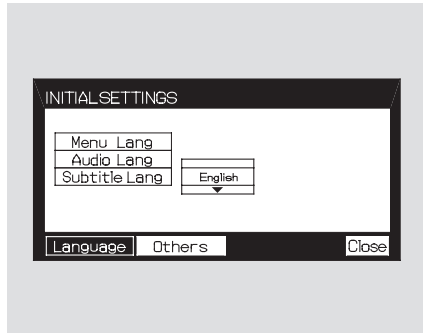

You can select the subtitle language before playing DVDs. Select “Subtitle Lang” by pressing the ▼ or ▲ button. You will see the submenu next to the “Subtitle Lang.”

Follow the same instructions you used to set the menu language.

## INITIAL SETTINGS (Others)

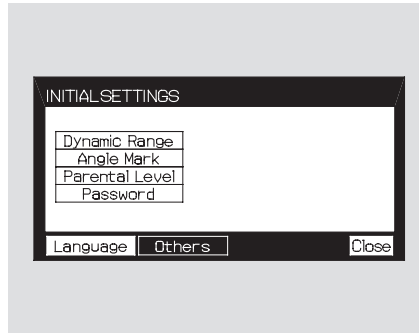

When you select “Others” at the bottom of the “INITIAL SETTINGS” screen, the above menu appears on the screen.

## Dynamic Range

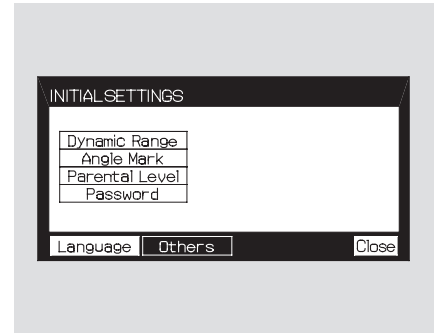

“Dynamic Range” reduces the differences between the loud and quiet sound levels throughout the disc. When this is on, the louder sounds are lowered, and quieter sounds are increased.

CONTINUED

## Rear Entertainment System

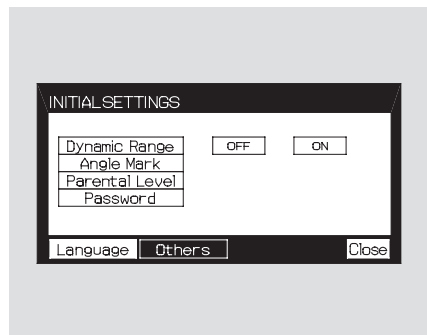

When you select the “Dynamic Range” by pressing the ▼ or ▲ button, you will see the submenu next to the “Dynamic Range” as shown above.

To turn “Dynamic Range” on or off, select “ON” or “OFF” by pressing the ► or ◀ button, and then press the ENT button.

### Angle Mark

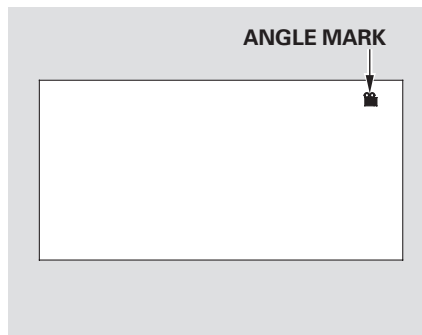

When you switch to another angle while playing a DVD, the angle mark is displayed in the upper right corner of the screen.

You can set the system to display or not display this angle mark.

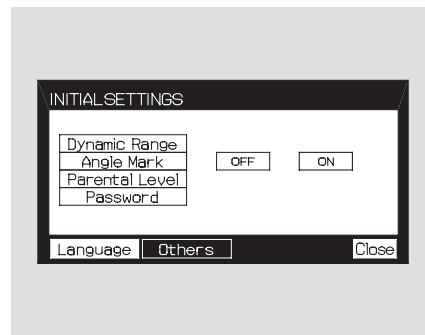

Select “Angle Mark” by pressing the ▼ or ▲ button. The above submenu appears. If you want the angle mark to be displayed, select “ON” with the ► or ◀ button, and then press the ENT button. The display returns to the “Others” menu.

## Parental Control Level

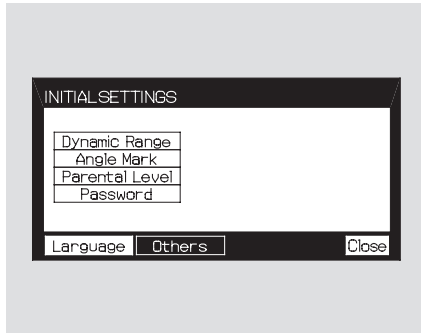

You can place an auditory restriction by changing the parental control level. The higher the level number, the lower the restriction.

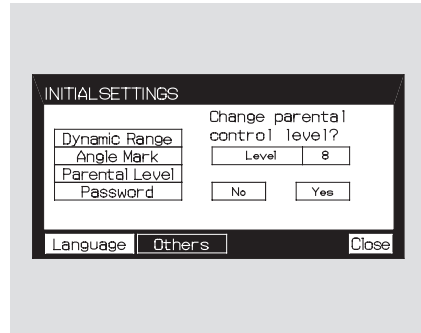

Select "Parental Level" by pressing the ▼ or ▲ button. You will see the submenu shown above. If you select "No," and press the ENT button, the display returns to the "Others" menu.

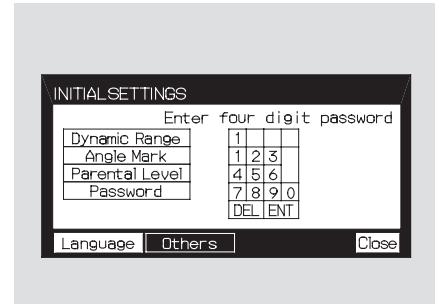

When you select and enter "Yes," the display changes as shown above. To change the level, you need to enter your four digit password. Select the number for the first digit by pressing the ▼, ▲, ►, or ◀ button, and enter it by pressing the ENT button. Repeat this until all four digits are filled. When you enter the fourth number, the cursor automatically moves to "ENT" on the display. Press the ENT button on the control panel.

*CONTINUED*

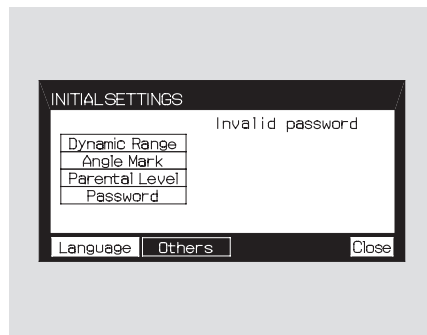

If the system does not recognize the password you entered, you will see the above display. Repeat the parental control level steps until you enter the correct password.

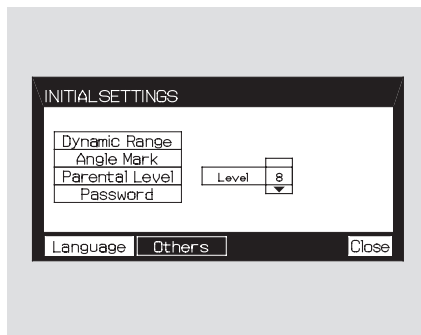

If you enter the password correctly, you can then change the parental control level.

Once you correctly enter the password, press the ▼ or ▲ button to change the level, and then press the ENT button to enter your selection.

## Changing the Password

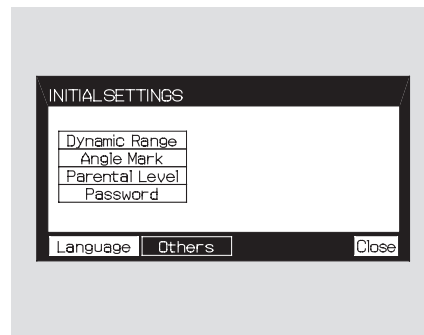

The password was set to “1111” when the vehicle left the factory.

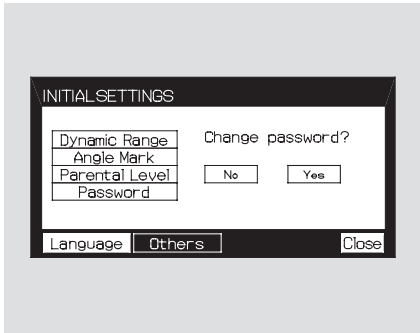

To change the password, select “Password.” You will see the above menu displayed. Select “Yes” by pressing the **▶** or **◀** button, then press the ENT button.

If you select “No,” and press the ENT button, the display returns to the “Others” menu.

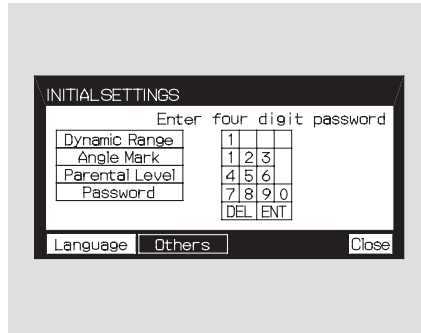

Select the first digit by pressing the **▼**, **▲**, **▶**, or **◀** button, and enter it by pressing the ENT button. Repeat this until all four digits are entered. When you enter the fourth number, the cursor automatically moves to “ENT” on the display. Press the ENT button on the control panel.

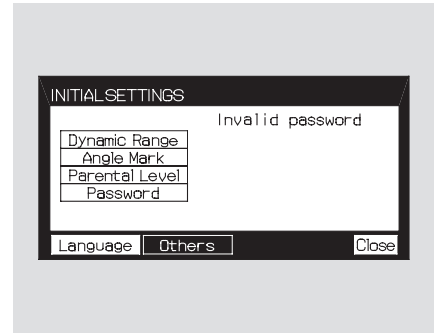

If the system does not recognize the password you entered, you will see the above display. Repeat the password setting steps until you enter the correct password.

*CONTINUED*



## Rear Entertainment System

---

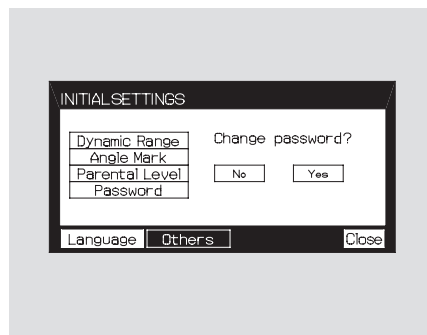

If you forget the password, select “Password,” and press the ▲ button 10 times.

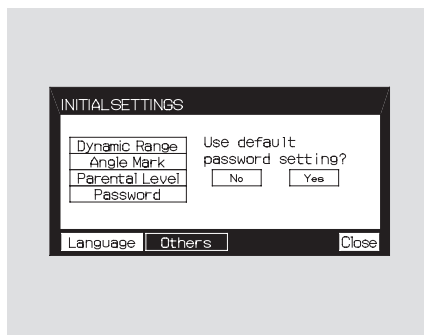

The display changes as shown above. If you want to use the default password (1111), select “Yes,” and press the ENT button.

The message “Default password setting applied” is displayed for 5 seconds.

## Remote Control

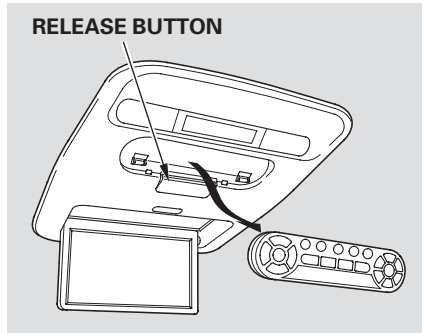

The rear control panel can be detached from the ceiling unit and used as a remote control. To remove it from the ceiling unit, press the release button. The control panel will swing down partway. Pivot it down further past the detent until it detaches from the hinge. To reinstall it, reverse the procedure.

## Replacing the Remote Control Batteries

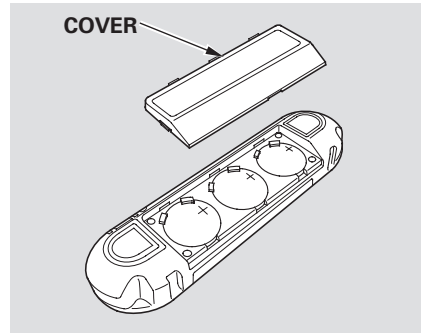

If it takes several pushes on the button to operate the rear entertainment system, have your dealer replace the batteries as soon as possible.

Battery type: BR3032

*As required by the FCC: This device complies with Part 15 of the FCC rules. Operation is subject to the following two conditions: (1) This device may not cause harmful interference, and (2) this device must accept any interference received, including interference that may cause undesired operation.*

*Changes or modifications not expressly approved by the party responsible for compliance could void the user's authority to operate the equipment.*

*This device complies with Industry Canada Standard RSS-210. Operation is subject to the following two conditions: (1) this device may not cause interference, and (2) this device must accept any interference that may cause undesired operation of the device.*

## Rear Entertainment System

---

### Playable DVDs



There are various types of DVDs available. Some of them are not compatible with your system.

The DVD player in your rear entertainment system can play DVDs and CDs bearing the above marks on their packages or jackets.

Those packages or jackets should also bear the designation of “1” or “ALL”. DVD-ROMs cannot be played in this system.

### Protecting DVDs

The tips on how to handle and protect DVDs are basically the same as those for compact discs. Refer to “Protecting Your CDs” on page [221](#).

### DVD Player Error Messages

If you see an error message in the screen while operating the DVD player, find the cause in the chart to the right. If you cannot clear the message, take your vehicle to a dealer.

Message	Solution
ERROR F0	Eject the disc and reinsert it.
ERROR F2	
Invalid region code	Use a disc with the regional designation of "1" or "All".
Invalid disc	The disc is not playable in this unit. Eject the disc, and insert a disc compatible with this system.
Parental control active. Change level to view.	Reinsert the disc, and increase the parental control level (see pages 253 and 254 ).

## Rear Entertainment System

### Wireless Headphones

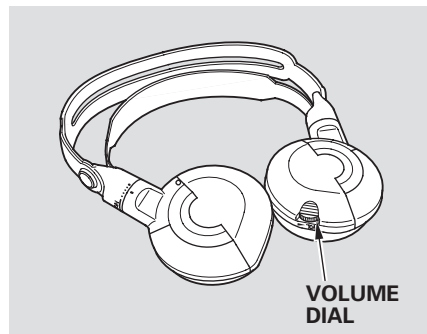

Some state and local government agencies prohibit the use of headphones by the driver of a motor vehicle. Always obey applicable laws and regulations.

The audio for the rear entertainment system is sent to the wireless headphones that come with the system. When using the headphones, make sure you wear them correctly: L (left) and R (right) are marked on the sides of the frame. The antennas are in the front of the earpieces. If you wear the headphones backwards, the antennas will be aimed away from the system, affecting the sound quality and range.

To use the headphones, pivot the earpieces outward. This turns them on. To adjust the volume, turn the dial on the bottom of the right earpiece. When you remove the headphones, the earpieces automatically pivot inward, and the headphones turn off. When not in use, store the headphones in the pocket of either front seat.

### Replacing Batteries

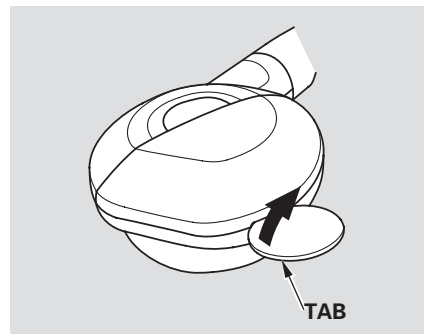

Each headphone uses one AAA battery. The battery is under the cover on the left earpiece. To remove the cover, insert a coin in the slot and twist it slightly to pry the cover away from the earpiece. Pull the cover outward, and pivot it out of the way.

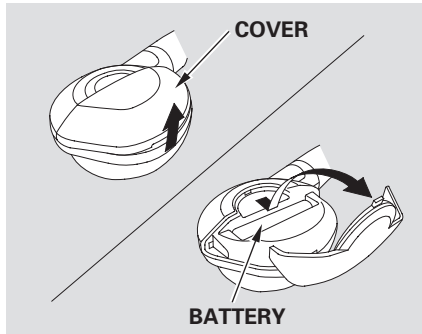

Remove the battery. Install the new battery in the earpiece as shown in the diagram next to the battery slot. Slide the cover back into place on the earpiece, then press down on the back edge to lock it in place.

## Auxiliary Input Jacks

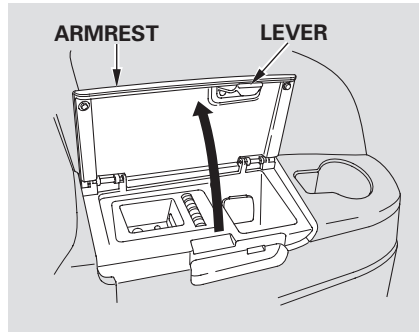

Auxiliary input jacks and headphone connectors for the rear entertainment system are under the third seat armrest on the driver's side. To access these connectors, open the cover by pulling up on the lever.

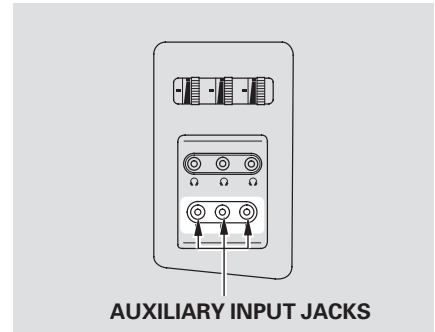

The system will accept auxiliary inputs from standard video games and video equipment. Some video game power supplies may cause poor picture quality.

V = Video jack  
L = Left audio jack  
R = Right audio jack

CONTINUED

## Rear Entertainment System

---

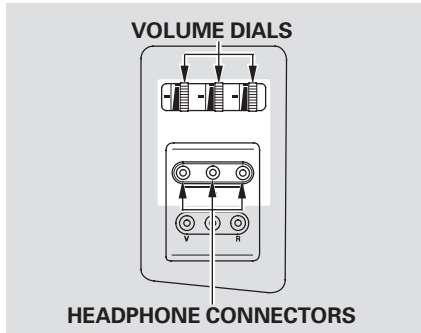

There are three headphone connectors for the third seat passengers. Each connector has its own volume control.

### *On EX and Touring models*

The security system helps to protect your vehicle and valuables from theft. The horn sounds and a combination of headlights, parking lights, side marker lights and taillights flashes if someone attempts to break into your vehicle or remove the radio. This alarm continues for 2 minutes, then the alarm stops. To reset an alarming system before the 2 minutes have elapsed, unlock either front door with the key or the remote transmitter.

The security system automatically sets 15 seconds after you lock the doors, hood, and the tailgate. For the system to activate, you must lock the doors and the tailgate from the outside with the key, the lock tab, the door lock switch, or the remote transmitter. The security system indicator in the instrument panel starts blinking immediately to show you the system is setting itself.

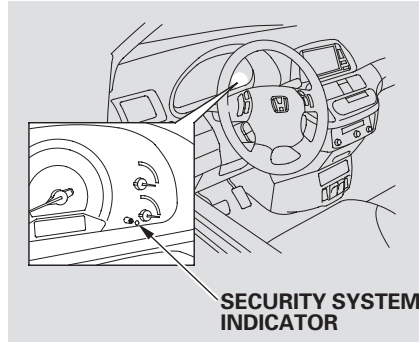

Once the security system is set, opening any door, the tailgate, or the hood without using the key or the remote transmitter, will cause it to alarm. It also alarms if the radio is removed from the dashboard or the wiring is cut.

The security system will not set if the hood, tailgate, or any door is not fully closed. If the system will not set, check the Door and Tailgate Open Monitor on the instrument panel (see page 67), to see if the doors and the tailgate are fully closed. Since it is not part of the monitor display, manually check the hood.

Do not attempt to alter this system or add other devices to it.



## Cruise Control

Cruise control allows you to maintain a set speed above 25 mph (40 km/h) without keeping your foot on the accelerator pedal. It should be used for cruising on straight, open highways. It is not recommended for city driving, winding roads, slippery roads, heavy rain, or bad weather.

### **⚠ WARNING**

Improper use of cruise control can lead to a crash.

Use cruise control only when traveling on open highways in good weather.

### Using Cruise Control

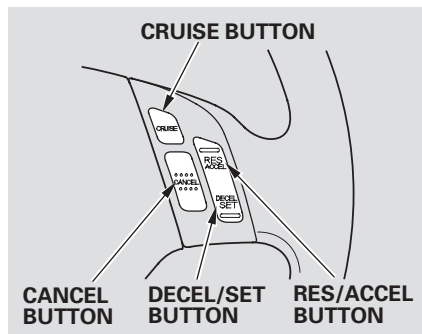

1. Push the CRUISE button on the steering wheel. The CRUISE MAIN indicator on the instrument panel comes on.
2. Accelerate to the desired cruising speed above 25 mph (40 km/h).

3. Press and release the DECEL/SET button on the steering wheel. The CRUISE CONTROL indicator on the instrument panel comes on to show the system is now activated.

Cruise control may not hold the set speed when you are going up and down hills. If your speed increases going down a hill, use the brakes to slow down to the desired speed. This will cancel cruise control. To resume the set speed, press the RES/ACCEL button. The CRUISE CONTROL indicator on the instrument panel comes on.

When climbing a steep hill, the automatic transmission may downshift to hold the set speed.

### Changing the Set Speed

You can increase the set speed in any of these ways:

- Press and hold the RES/ACCEL button. When you reach the desired speed, release the button.
- Push the accelerator pedal, accelerate to the desired speed, and press the DECEL/SET button.
- To increase the speed in very small amounts, tap the RES/ACCEL button. Each time you do this, your vehicle will speed up about 1 mph (1.6 km/h).

You can decrease the set speed in any of these ways:

- Press and hold the DECEL/SET button. Release the button when you reach the desired speed.
- To slow down in very small amounts, tap the DECEL/SET button repeatedly. Each time you do this, your vehicle will slow down about 1 mph (1.6 km/h).
- Tap the brake pedal lightly with your foot. The CRUISE CONTROL indicator on the instrument panel goes out. When the vehicle slows to the desired speed, press the DECEL/SET button.

Even with cruise control turned on, you can still use the accelerator pedal to speed up for passing. After completing the pass, take your foot off the accelerator pedal. The vehicle will return to the set speed.

Resting your foot on the brake pedal causes cruise control to cancel.

*CONTINUED*

## Cruise Control

---

### Cancelling Cruise Control

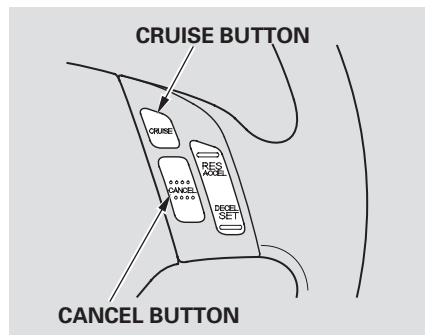

You can cancel cruise control in any of these ways:

- Tap the brake pedal.
- Push the CANCEL button on the steering wheel.
- Push the CRUISE button on the steering wheel.

### Resuming the Set Speed

When you push the CANCEL button or tap the brake pedal, the system remembers the previously set speed. To return to that speed, accelerate to above 25 mph (40 km/h), and then press and release the RES/ACCEL button. The CRUISE CONTROL indicator comes on. The vehicle accelerates to the same speed as before.

Pressing the CRUISE button turns the system completely off and erases the previous set speed.

## *On EX and Touring models*

The HomeLink® Universal Transceiver built into your vehicle can be programmed to operate up to three remote controlled devices around your home, such as garage doors, lighting, or home security systems.

## **General Information**

If you are training HomeLink to operate a garage door or gate, you should unplug the motor for that device during training. Repeatedly pressing the remote control button could burn out the motor.

HomeLink stores the code in a permanent memory. There should be no need to retrain HomeLink if your vehicle's battery goes dead or is disconnected. If your garage door opener was manufactured before April 1982, you may not be able to program HomeLink to operate it. They do not have the safety feature

that causes the motor to stop and reverse if an obstacle is detected during closing, increasing the risk of injury.

## **Important Safety Precautions**

Always refer to the opening instructions and safety information that came with your garage door opener or other equipment you intend to operate with HomeLink. If you do not have this information, contact the manufacturer of the equipment.

## **Training HomeLink**

**Before you begin** — If you just received your vehicle and have not trained any of the buttons in HomeLink before, you should erase any previously learned codes before training the first button.

To do this, press and hold the two outside buttons on the HomeLink Transceiver for about 20 seconds, or until the red indicator flashes. Release the buttons, then go to step 1.

If you are training the second or third buttons, go directly to step 1.

*CONTINUED*

## HomeLink Universal Transceiver

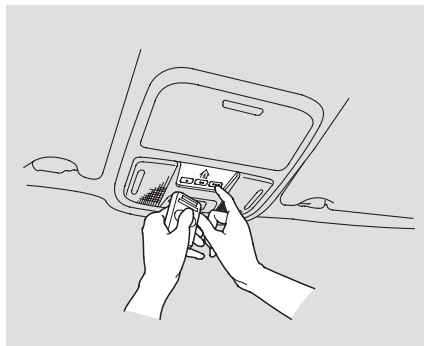

1. Unplug the garage door opener motor from the house current.
2. Hold the end of the garage door opener remote control 2 to 5 inches from HomeLink. Make sure you are not blocking your view of the red indicator in HomeLink.

3. Press and hold the remote control button and one of the HomeLink buttons at the same time.

### NOTICE

*The remote control you are training from may stop transmitting after 2 seconds. This is not enough for HomeLink to learn the code. Release and press the button on the remote control every 2 seconds until HomeLink has learned the code.*

4. The red indicator in HomeLink should begin flashing. It will flash slowly at first, then rapidly.
5. When the red indicator flashes rapidly, release both buttons. HomeLink should have learned the code from the remote control.

6. Plug in the garage door opener motor, then test the HomeLink button by pushing it. If the button does not work, repeat the procedure to train it again. If it still does not work, you may have a variable or rolling code garage door opener. See if you do by pressing and holding the HomeLink button you just trained. If the red indicator blinks for 2 seconds then stays on, you have a rolling code garage door opener. Go to “Training with a Rolling Code System” (see page 269).
7. Repeat these steps to train the other two HomeLink buttons to operate any other remotely controlled devices around your home (lighting, automatic gate, security system, etc.).

## Training With a Rolling Code System

For security purposes, newer garage door opening systems use a “rolling” or variable code. Information from the remote control and the garage door opener are needed before HomeLink can operate the garage door opener.

The “Training HomeLink” procedure trains HomeLink to the proper garage door opener code. The following procedure synchronizes HomeLink to the garage door opener so it sends and receives the correct codes.

1. Make sure you have properly completed the “Training HomeLink” procedure.
2. Find the “Training” button on your garage door opener unit. The location will vary, depending on the manufacturer.

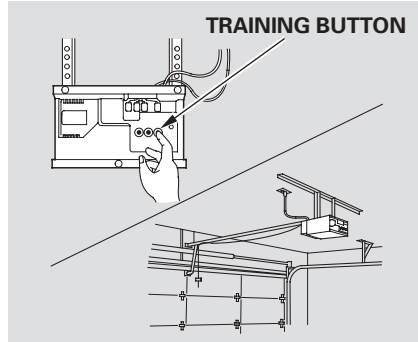

3. Press the training button on the garage door opener unit until the indicator next to the button comes on. The indicator may blink, or come on and stay on. You then have approximately 30 seconds to complete the following steps.

4. Press and hold the button on HomeLink for 3 to 4 seconds.
5. Press and hold the HomeLink button again for 3 to 4 seconds. This should turn off the training indicator on the garage door opener unit. (Some systems may require you to press the button up to three times.)
6. Press the HomeLink button again. It should operate the garage door.

# HomeLink Universal Transceiver

---

## Erasing Codes

To erase the codes stored in all three buttons, press and hold the two outside buttons until the red indicator begins to flash, then release the buttons.

You should erase all three codes before selling the vehicle.

## Retraining a Button

To train an already programmed HomeLink button with a new device, you do not have to erase all the memory. Train the selected button over the existing memory code following the steps under “Training HomeLink”.

## Customer Assistance

If you have problems with training the HomeLink Universal Transceiver, or would like information on home products that can be operated by HomeLink, call (800) 355-3515. On the Internet, go to [www.homelink.com](http://www.homelink.com).

HomeLink® is a registered trademark of Johnson Controls, Inc.

*As required by the FCC:*

*This device complies with Part 15 of the FCC rules. Operation is subject to the following two conditions: (1) This device may not cause harmful interference, and (2) this device must accept any interference received, including interference that may cause undesired operation.*

*Changes or modifications not expressly approved by the party responsible for compliance could void the user's authority to operate the equipment.*

*This device complies with Industry Canada Standard RSS-210. Operation is subject to the following two conditions: (1) this device may not cause interference, and (2) this device must accept any interference that may cause undesired operation of the device.*

# Parking Sensor System

## *On Touring model*

Your vehicle has a parking sensor system. The system lets you know the approximate distance between your vehicle and most obstacles while you are parking. When the system is on and your vehicle is nearing an obstacle, you will hear beeping and see parking messages in the multi-information display.

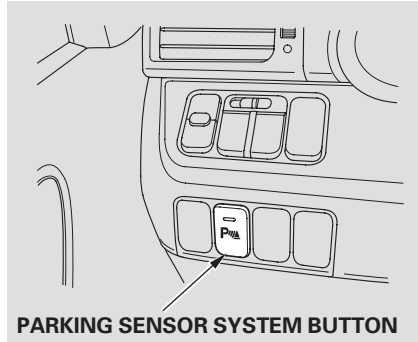

To activate the system, push the button on the dashboard with the ignition in the ON (II) position. The indicator in the button comes on when the system is on. To turn the system off, push the button again.

All obstacles may not always be sensed. Even when the system is on, you should look for obstacles near your vehicle to make sure it is safe to park.



The system has two front corner sensors, two rear corner sensors, and a rear center sensor. The rear center sensor works only when the shift lever is in Reverse (R), and the vehicle speed is less than 5 mph (8 km/h).

The corner sensors work only when the shift lever is in any position other than P and the vehicle speed is less than 5 mph (8 km/h).



# Parking Sensor System







## Multi-Information Display Messages and Beeper Operation

When you turn the system on, all indicators come on in the multi-information display, and a beeper sounds once.







When the system senses an obstacle, the appropriate indicator comes on, and a beeper sounds as shown in the following tables.

### Corner Sensor Operation

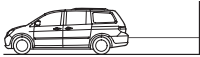
Example shown: Obstacle is at the left front of the vehicle

	About 16-20 in (40-50 cm)	About 12-16 in (30-40 cm)	About 12 in (30 cm) or less
Distance			
Indicators and Messages	Upper left indicator stays on 	Upper left indicator stays on 	Upper left indicator stays on 
Beeper	Short beeps	Very short beeps	Continuous beep

## Rear Center Sensor Operation

Distance	About 40-70 in (1-1.8 m) 	About 24-40 in (0.6-1 m) 	About 24 in (0.6 m) or less 
Indicators and Messages	Bottom indicator stays on 	Bottom indicator stays on 	Bottom indicator stays on 
Beeper	Short beeps	Very short beeps	Continuous beeps



If the system develops a problem, you will see a “CHECK PARKING SENSOR SYSTEM” message in the multi-information display, and a beeper sounds continuously. Very often, a sensor covered with mud, ice, snow, etc. is the cause of this message. Check the sensors first. If the message stays on or the beeper does not stop, have the system checked by your dealer.

*CONTINUED*

## Parking Sensor System

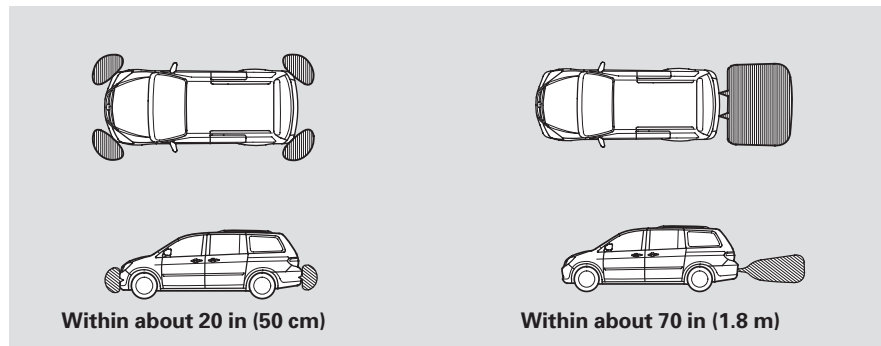

The range of the corner sensors and the rear center sensor are limited. Each corner sensor is capable of sensing an obstacle only when your vehicle is 20 in (50 cm) or closer. The rear center sensor senses an obstacle that is behind your vehicle 70 in (1.8 m) or closer.

Do not put any accessories on or around the sensors.

The system may not function properly under these conditions:

- The sensors are covered with snow, ice, mud, etc.
- When the vehicle is on a rough road, on grass, or on a hill.

- After the vehicle has been sitting out in hot or cold weather.
- When the system is affected by some electrical equipment or devices generating an ultrasonic wave.
- When operating the vehicle in bad weather.

The system may not sense thin or low objects, or sonic-absorptive materials such as snow, cotton, or sponge.

The system cannot sense objects directly under the bumper.

*Canadian Owners:  
This device complies with Industry Canada Standard RSS-210. Operation is subject to the following two conditions:  
(1) this device may not cause interference, and (2) this device must accept any interference that may cause undesired operation of the device.*

On EX with Leather and Touring models

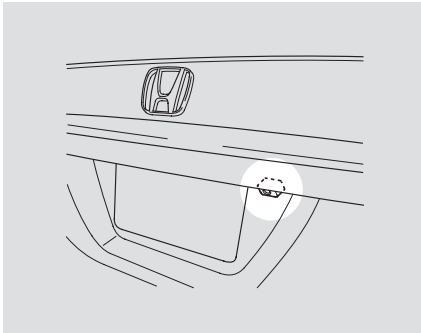

Whenever you shift to R (Reverse) with the ignition switch in the ON (II) position, the rear view is shown on the navigation system screen.

For the best picture, always keep the rear view camera clean, and do not cover the camera lens.

When in reverse, the touch screen and Navi “hard” buttons are locked out, except the “ZOOM” button. Touching the “▼” or “▲” button allows you to adjust the brightness of the rear view camera image.

### NOTICE

*The camera brightness cannot be adjusted by voice control.*

Since the rear view camera display area is limited, you should always back up slowly and carefully, and look behind you for obstacles.



Before you begin driving your vehicle, you should know what gasoline to use and how to check the levels of important fluids. You also need to know how to properly store luggage or packages. The information in this section will help you. If you plan to add any accessories to your vehicle, please read the information in this section first.

Break-in period.....	278
Gasoline Type .....	278
Service Station Procedures .....	279
Refueling.....	279
Opening and Closing the Hood.....	280
Oil Check.....	281
Engine Coolant Check .....	282
Fuel Economy .....	283
Improving Fuel Economy .....	283
Accessories and Modifications ....	284
Carrying Cargo .....	286

## Break-in Period, Gasoline Type

---

### Break-in Period

Help assure your vehicle's future reliability and performance by paying extra attention to how you drive during the first 600 miles (1,000 km). During this period:

- Avoid full-throttle starts and rapid acceleration.
- Avoid hard braking for the first 200 miles (300 km).
- Do not change the oil until the scheduled maintenance time.
- Do not tow a trailer.

You should also follow these recommendations with an overhauled or exchanged engine, or when the brakes are replaced.

### Gasoline Type

Your vehicle is designed to operate on unleaded gasoline with a pump octane number of 86 or higher. Use of a lower octane gasoline can cause a persistent, heavy metallic rapping noise that can lead to engine damage.

We recommend quality gasolines containing detergent additives that help prevent fuel system and engine deposits.

In addition, in order to maintain good performance, fuel economy, and emissions control, we strongly recommend, in areas where it is available, the use of gasoline that does NOT contain manganese-based fuel additives such as MMT.

Use of gasoline with these additives may adversely affect performance, and cause the malfunction indicator lamp on your instrument panel to come on. If this happens, contact

your dealer for service.

Some gasoline today is blended with oxygenates such as ethanol or MTBE. Your vehicle is designed to operate on oxygenated gasoline containing up to 10 percent ethanol by volume and up to 15 percent MTBE by volume. Do not use gasoline containing methanol.

If you notice any undesirable operating symptoms, try another service station or switch to another brand of gasoline.

For further important fuel-related information, please refer to your **Quick Start Guide**.

## Refueling

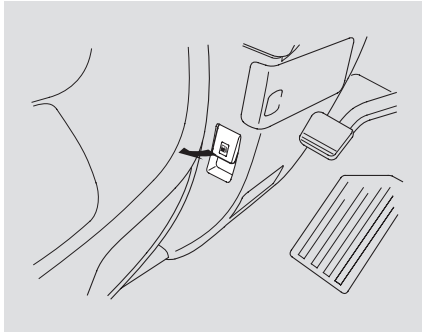

1. Park with the driver's side closest to the service station pump.
2. Open the fuel fill door by pulling on the handle under the lower left corner of the dashboard.

Before refueling, make sure the rear sliding door on the driver's side is closed.

3. Remove the fuel fill cap slowly. You may hear a hissing sound as pressure inside the tank escapes. The fuel fill cap is attached to the fuel filler with a tether. Insert the attachment on the fuel fill cap into the slit on the fuel fill door.
4. Stop filling the tank after the fuel nozzle automatically clicks off. Do not try to "top off" the tank. Leave some room for the fuel to expand with temperature changes.

*If the fuel nozzle keeps clicking off even though the tank is not full, there may be a problem with your vehicle's fuel vapor recovery system. The system helps keep fuel vapors from going into the atmosphere. Consult your dealer.*

## **⚠ WARNING**

Gasoline is highly flammable and explosive. You can be burned or seriously injured when handling fuel.

- Stop the engine, and keep heat, sparks, and flame away.
- Handle fuel only outdoors.
- Wipe up spills immediately.

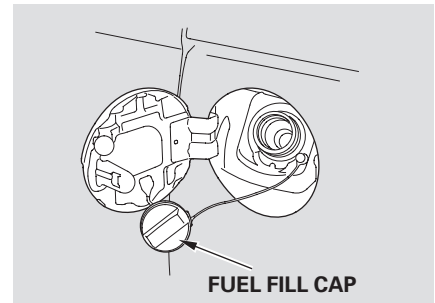

CONTINUED



## Service Station Procedures

- Screw the fuel fill cap back on until it clicks at least three times. If you do not properly tighten the cap, the malfunction indicator lamp may come on (see page 372 ). On the Touring model, you will also see a “CHECK FUEL CAP” message on the multi-information display.
- Push the fuel fill door closed until it latches.

### Opening and Closing the Hood



1. Park the vehicle, and set the parking brake. Pull the hood release handle located under the lower left corner of the dashboard. The hood will pop up slightly.

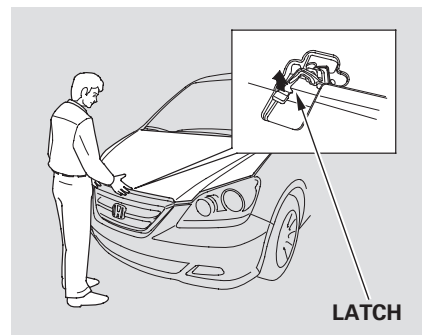

2. Put your fingers under the front edge of the hood. The hood latch handle is above the “H” logo. Pull up on this handle until it releases the hood. Lift the hood.

If the hood latch handle moves stiffly, or you can open the hood without lifting the handle, the mechanism should be cleaned and lubricated.

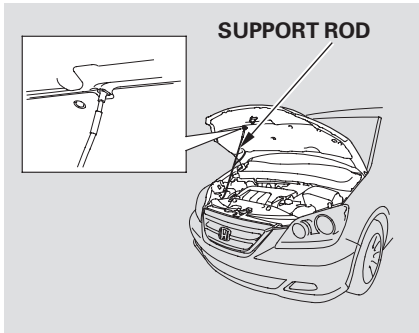

3. Pull the support rod out of its clip and insert the end into the hole on the passenger's side of the hood.

To close the hood, lift it up slightly to remove the support rod from the hole. Put the support rod back into its holding clip. Lower the hood to about a foot (30 cm) above the fender, then let it drop. Make sure it is securely latched.

## Oil Check

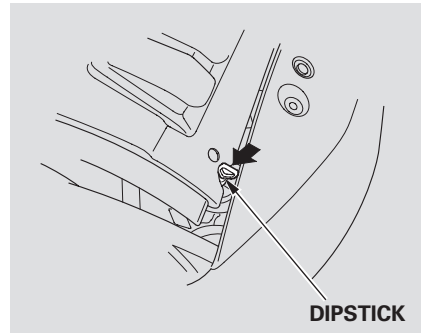

Wait a few minutes after turning the engine off before you check the oil.

1. Remove the dipstick (orange loop).
2. Wipe off the dipstick with a clean cloth or paper towel.
3. Insert it all the way back in its hole.

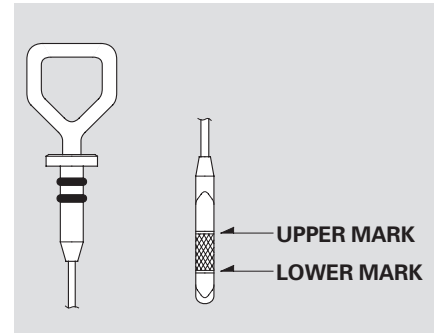

4. Remove the dipstick again, and check the level. It should be between the upper and lower marks.

If it is near or below the lower mark, see **Adding Engine Oil** on page [328](#).

## Service Station Procedures

---

### Engine Coolant Check

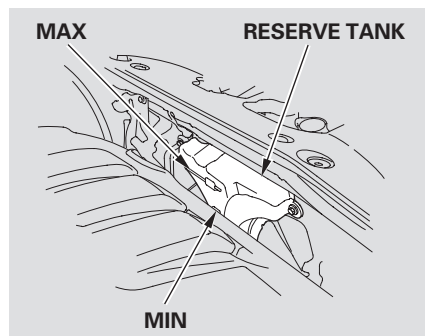

Look at the coolant level in the radiator reserve tank. Make sure it is between the MAX and MIN lines. If it is below the MIN line, see **Adding Engine Coolant** on page 331 for information on adding the proper coolant.

Refer to **Owner's Maintenance Checks** on page 323 for information about checking other items on your vehicle.

## Improving Fuel Economy

- Always maintain your vehicle according to the maintenance messages. See **Owner's Maintenance Checks** (page 323).

*For example*, an underinflated tire causes more “rolling resistance,” which uses more fuel.

The build-up of snow or mud on your vehicle's underside adds weight and rolling resistance. Frequent cleaning helps your fuel mileage and reduces the chance of corrosion.

- Drive moderately. Rapid acceleration, abrupt cornering, and hard braking use more fuel.
- Always drive in the highest gear possible.

- Try to maintain a constant speed. Every time you slow down and speed up, your vehicle uses extra fuel. Use cruise control when appropriate.
- Combine several short trips into one.
- The air conditioning puts an extra load on the engine which makes it use more fuel. Use the fresh-air ventilation when possible.

## Accessories and Modifications

---

Modifying your vehicle, or installing some non-Honda accessories, can make it unsafe. Before you make any modifications or add any accessories, be sure to read the following information.

### Accessories

Your dealer has Honda accessories that allow you to personalize your vehicle. These accessories have been designed and approved for your vehicle, and are covered by warranty.

Although non-Honda accessories may fit on your vehicle, they may not meet factory specifications, and could adversely affect your vehicle's handling and stability (see page [285](#) ).

### WARNING

Improper accessories or modifications can affect your vehicle's handling, stability, and performance, and cause a crash in which you can be hurt or killed.

Follow all instructions in this owner's manual regarding accessories and modifications.

When properly installed, cellular phones, alarms, two-way radios, and low-powered audio systems should not interfere with your vehicle's computer controlled systems, such as your airbags and anti-lock brakes.

Before installing any accessory:

- Make sure the accessory does not obscure any lights, or interfere with proper vehicle operation or performance.
- Be sure electronic accessories do not overload electrical circuits (see page [376](#) ) or interfere with the proper operation of your vehicle.
- Before installing any electronic accessory, have the installer contact your dealer. If possible, have your dealer inspect the final installation.

### Modifying Your Vehicle

Removing parts from your vehicle, or replacing components with non-Honda components could seriously affect your vehicle's handling, stability, and reliability.

Some examples are:

- Lowering the vehicle with a non-Honda suspension kit that significantly reduces ground clearance can allow the undercarriage to hit speed bumps or other raised objects, which could cause the airbags to deploy.
- Raising your vehicle with a non-Honda suspension kit can affect the handling and stability.
- Non-Honda wheels, because they are a universal design, can cause excessive stress on suspension components.

- Larger or smaller wheels and tires can interfere with the operation of your vehicle's anti-lock brakes and other systems.
- Modifying your steering wheel or any other part of your vehicle's safety systems could make the systems ineffective.

See **Additional Safety Precautions** on page [35](#).

If you plan to modify your vehicle, consult your dealer.

## Carrying Cargo

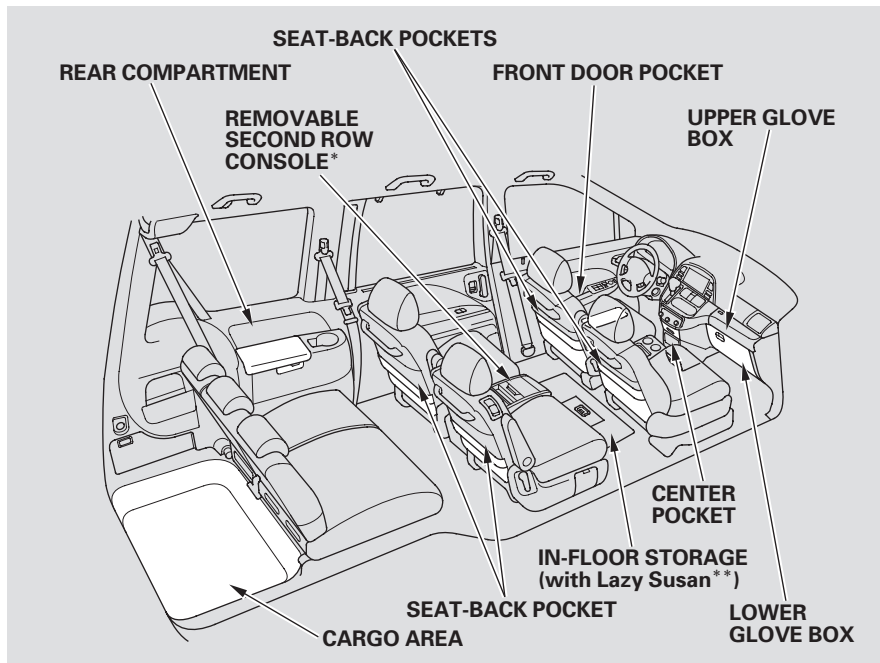

\* : Touring model only

\*\* : EX and Touring models only

Your vehicle has several convenient storage areas:

- Glove box (upper and lower)
- In-floor storage (with Lazy Susan\*\*)
- Front door and seat-back pockets
- Rear cargo area, including the second row seats when removed, and the third row seat when folded flat
- Removable second row console
- Center pocket
- Rear compartment
- Roof-rack (if installed)

However, carrying too much cargo, or improperly storing it, can affect your vehicle's handling, stability, stopping distance, and tires, and make it unsafe. Before carrying any type of cargo, be sure to read the following pages.

The maximum load for your vehicle is:

LX model: 1,349 lbs (612 kg)

EX model: 1,388 lbs (630 kg)

EX with Leather: 1,322 lbs (600 kg)

Touring model: 1,208 lbs (548 kg)

This figure includes, cargo, accessories, and the tongue weight if you are towing a trailer.

To determine the correct cargo and luggage load limit:

1. Locate the statement, “the combined weight of occupants and cargo should never exceed 1,208 lbs (548 kg)” on your vehicle’s placard (on the driver’s doorjamb) if your vehicle is the Touring model, for example.
2. Determine the combined weight of the driver and passengers that will be riding in your vehicle.
3. Subtract the combined weight of the driver and passengers from the maximum load.
4. The resulting figure equals the available amount of cargo and luggage load capacity.  
  
For example, If your vehicle is the Touring model, and if there will be five 150 lbs (70 kg) occupants in your vehicle, the amount of available cargo and luggage load capacity is 458 lbs (198 kg).  
$$5 \times 150 \text{ lbs (70 kg)} = 750 \text{ lbs (350 kg)}$$
$$1,208 \text{ lbs (548 kg)} - 750 \text{ lbs (350 kg)} = 458 \text{ lbs (198 kg)}$$
5. Determine the combined weight of accessories, luggage, and cargo being loaded in the vehicle. The weight may not safely exceed the available cargo and luggage load capacity calculated in step 4 [458 lbs (198 kg) in this example].

6. If your vehicle will be towing a trailer, the load from your trailer will be transferred to your vehicle. Consult this manual to determine how this reduces the available cargo and luggage load capacity of your vehicle.

### **WARNING**

Overloading or improper loading can affect handling and stability and cause a crash in which you can be hurt or killed.

Follow all load limits and other loading guidelines in this manual.



## Carrying Cargo

---

### Carrying Items in the Passenger Compartment

- Store or secure all items that could be thrown around and hurt someone during a crash.
- Be sure items placed on the floor behind the front seats cannot roll under the seats and interfere with the pedals or seat operation.
- Keep the glove boxes closed while driving. If either are open, a passenger could be injured during a crash or sudden stop.

### Carrying Cargo in the Cargo Area or on a Roof Rack

- Distribute cargo evenly on the floor of the cargo area, placing the heaviest items on the bottom and as far forward as possible. Tie down items that could be thrown about the vehicle during a crash or sudden stop.
- If you carry large items that prevent you from closing the tailgate, exhaust gas can enter the passenger area. To avoid the possibility of **carbon monoxide poisoning**, follow the instructions on page [56](#) .
- If you place items near the rear windows, be sure they are below the bottom of the windows. If cargo is higher, it could interfere with proper operation of the side curtain airbags.

- If you carry any items on a roof rack, be sure the total weight of the rack and the items does not exceed 150 lb (68 kg).

If you use an accessory roof rack, the roof rack weight limit may be lower. Refer to the information that came with your roof rack.

## Cargo Net

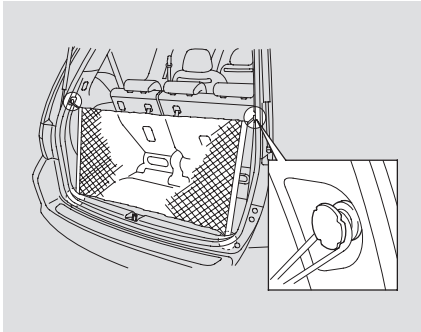

*On EX and Touring models*  
You can use the cargo net to secure items in the cargo area, and store small items between the two halves of the net. To install the cargo net, hook the loops on the four corners of the net to the tabs at both sides of the tailgate sill.

## Cargo Hooks

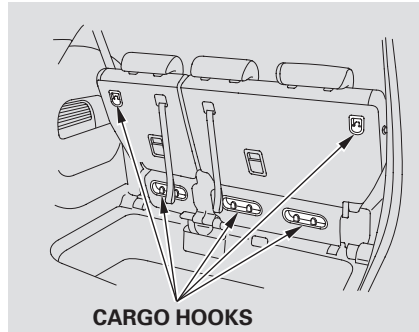

There are cargo hooks for plastic grocery bags on the back of the third row seat. They are designed to hold light items. Heavy objects may damage the hooks.



This section gives you tips on starting the engine under various conditions, and how to operate the automatic transmission. It also includes important information on parking your vehicle, the braking system, the vehicle stability assist system, the tire pressure monitoring system, and facts you need if you are planning to tow a trailer.

- Preparing to Drive ..... 292
- Starting the Engine..... 293
- Automatic Transmission..... 294
- Parking Tips ..... 298
- Braking System..... 299
- Anti-lock Brakes (ABS) ..... 300
- Vehicle Stability Assist (VSA) System..... 301
- Tire Pressure Monitoring System (TPMS) ..... 303
- Towing a Trailer ..... 306

## Preparing to Drive

---

You should do the following checks and adjustments before you drive your vehicle.

1. Make sure all windows, mirrors, and outside lights are clean and unobstructed. Remove frost, snow, or ice.
2. Check that the hood is fully closed.
3. Visually check the tires. If a tire looks low, use a gauge to check its pressure.
4. Check that any items you may be carrying are stored properly or fastened down securely.
5. Check the seat adjustment (see page [149](#) ).
6. Check the adjustment of the inside and outside mirrors (see page [167](#) ).
7. Check the steering wheel adjustment (see page [127](#) ).
8. Make sure the doors and the tailgate are securely closed and locked.
9. Fasten your seat belt. Check that your passengers have fastened their seat belts (see page [16](#) ).
10. When you start the engine, check the gauges and indicators in the instrument panel (see page [61](#) ).

1. Apply the parking brake.
2. In cold weather, turn off all electrical accessories to reduce the drain on the battery.
3. Make sure the shift lever is in Park. Press on the brake pedal.

### NOTICE

*The immobilizer system protects your vehicle from theft. If an improperly-coded key (or other device) is used, the engine's fuel system is disabled. See **Immobilizer System** on page 129.*

4. Without touching the accelerator pedal, turn the ignition key to the START (III) position. Do not hold the key in START for more than 15 seconds at a time. If the engine does not start right away, pause for at least 10 seconds before trying again.
5. If the engine does not start within 15 seconds, or starts but stalls right away, repeat step 4 with the accelerator pedal pressed halfway down. If the engine starts, release pressure on the accelerator pedal so the engine does not race.

6. If the engine fails to start, press the accelerator pedal all the way down and hold it there while starting to clear flooding. If the engine still does not start, return to step 5.

### NOTICE

*The engine is harder to start in cold weather. Also, the thinner air found at altitudes above 8,000 feet (2,400 meters) adds to this problem.*

# Automatic Transmission

## Shift Lever Position Indicators

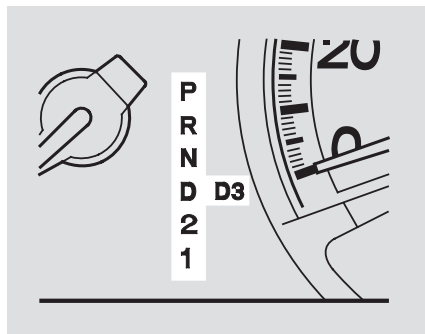

These indicators on the instrument panel show which position the shift lever is in.

The “D” indicator comes on for a few seconds when you turn the ignition switch to ON (II). If it flashes while driving (in any shift position), it indicates a possible problem in the transmission.

If the malfunction indicator lamp comes on along with the “D” indicator, there is a problem in the automatic transmission control system. Avoid rapid acceleration, and have the transmission checked by your dealer as soon as possible.

## Shifting

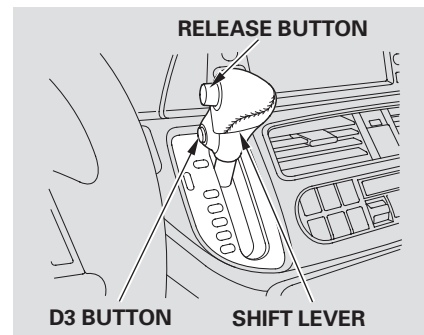

To shift from any position, press firmly on the brake pedal and press the release button on the side of the shift lever. You cannot shift out of Park when the ignition switch is in the LOCK (0) or ACCESSORY (I) position.

To shift from:	Do this:
P to R	Press the brake pedal, and press the release button.
R to P N to R D <sub>3</sub> to 2 2 to 1	Press the release button.
1 to 2 2 to D D to N N to D R to N	Move the lever.
D <sub>3</sub> to D D to D <sub>3</sub>	Press the D <sub>3</sub> button.

**Park (P)** – This position mechanically locks the transmission. Use Park whenever you are turning off or starting the engine. To shift out of Park, you must press on the brake pedal and have your foot off the accelerator pedal. Press the release button on the side of the shift lever to move it.

If you have done all of the above and still cannot move the lever out of Park, see **Shift Lock Release** on page 297 .

**Reverse (R)** – Press the brake pedal and press the release button to shift from Park to Reverse. To shift from Reverse to Neutral, come to a complete stop and then shift.

**Neutral (N)** – Use Neutral if you need to restart a stalled engine, or if it is necessary to stop briefly with the engine idling. Shift to the Park position if you need to leave your vehicle for any reason. Press on the brake pedal when you are moving the shift lever from Neutral to another gear.

**Drive (D)** – Use this position for normal driving. The transmission automatically selects a suitable gear for your speed and acceleration. You may notice the transmission shifting up at higher speeds when the engine is cold. This helps the engine warm up faster.

CONTINUED



## Automatic Transmission

---

**Drive (D3)** – To use D3, press the D3 button when the shift lever is in the “D” position. This position is similar to D, except only the first three gears are selected instead of all five. Use D3 when towing a trailer in hilly terrain, or to provide engine braking when going down a steep hill. D3 can also keep the transmission from cycling between third and fourth gears in stop-and-go driving.

**Second (2)** – This position locks the transmission in second gear. It does not downshift to first gear when you come to a stop.

Use Second gear:

- For more power when climbing.
- To increase engine braking when going down steep hills.
- For starting out on a slippery surface or in deep snow.
- When driving downhill with a trailer.

**First (1)** – This position locks the transmission in First gear. By upshifting and downshifting through 1, 2, and D, you can operate this transmission much like a manual transmission without a clutch pedal.

### Engine Speed Limiter

If you exceed the maximum speed for the gear you are in, the engine speed will enter into the tachometer’s red zone. If this occurs, you may feel the engine cut in and out. This is caused by a limiter in the engine’s computer controls. The engine will run normally when you reduce the RPM below the red zone.

## Shift Lock Release

Do this if pushing on the brake pedal and pressing the release button does not shift the transmission out of park:

1. Set the parking brake.
2. Make sure the ignition switch is in the LOCK (0) position.

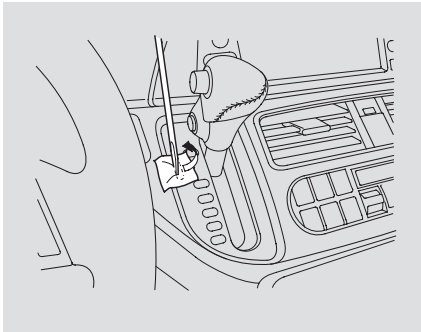

3. Put a cloth on the edge of the shift lock release slot cover. Using a small flat-tipped screwdriver or a

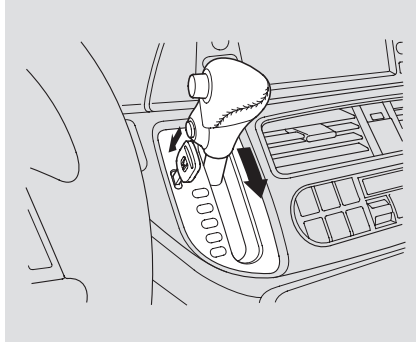

metal fingernail file, carefully pry on the edge of the cover to remove it.

4. Insert the key in the shift lock release slot.
5. Push down on the key while you pull the shift lever towards you and move it out of Park to Neutral.

6. Remove the key from the shift lock release slot, then install the cover. Press the brake pedal, and restart the engine.

If you need to use the shift lock release, it means your vehicle is developing a problem. Have it checked by your dealer.

## Parking

---

Always use the parking brake when you park your vehicle. Make sure the parking brake is set firmly or your vehicle may roll if it is parked on an incline.

Set the parking brake before you put the transmission in Park. This keeps the vehicle from moving and putting pressure on the parking mechanism in the transmission.

### **Parking Tips**

- Make sure the moonroof and the windows are closed.
  - Turn off the lights.
  - Place any packages, valuables, etc. in the cargo area, or take them with you.
  - Lock the doors and the tailgate.
  - Never park over dry leaves, tall grass, or other flammable materials. The hot three way catalytic converter could cause these materials to catch on fire.
- If the vehicle is facing uphill, turn the front wheels away from the curb.
  - If the vehicle is facing downhill, turn the front wheels toward the curb.
  - Make sure the parking brake is fully released before driving away. Driving with the parking brake partially set can overheat or damage the rear brakes.

Your vehicle is equipped with disc brakes at all four wheels. A power assist helps reduce the effort needed on the brake pedal. The anti-lock brake system (ABS) helps you retain steering control when braking very hard.

Resting your foot on the pedal keeps the brakes applied lightly, builds up heat, and reduces their effectiveness. It also keeps your brake lights on all the time, confusing drivers behind you.

Constant application of the brakes when going down a long hill builds up heat and reduces their effectiveness. Use the engine to assist the brakes by taking your foot off the accelerator and downshifting to a lower gear.

Check the brakes after driving through deep water. Apply the brakes moderately to see if they feel normal. If not, apply them gently and frequently until they do. Be extra cautious in your driving.

### **Braking System Design**

The hydraulic system that operates the brakes has two separate circuits. Each circuit works diagonally across the vehicle (the left-front brake is connected with the right-rear brake, etc.). If one circuit should develop a problem, you will still have braking at two wheels.

### **Brake Wear Indicators**

If the brake pads need replacing, you will hear a distinctive, metallic screeching sound when you apply the brake pedal. If you do not have the brake pads replaced, they will screech all the time. It is normal for the brakes to occasionally squeal or squeak when you apply them.

## Anti-lock Brakes (ABS)

The anti-lock brake system (ABS) helps prevent the brakes from locking up, and helps you retain steering control by pumping the brakes rapidly, much faster than a person can do it.

*You should never pump the brake pedal.* Let the ABS work for you by always keeping firm, steady pressure on the brake pedal. This is sometimes referred to as “stomp and steer.”

You will feel a pulsation in the brake pedal when the ABS activates, and you may hear some noise. This is normal: it is the ABS rapidly pumping the brakes. On dry pavement, you will need to press on the brake pedal very hard before the ABS activates. However, you may feel the ABS activate immediately if you are trying to stop on snow or ice.

### ABS Indicator

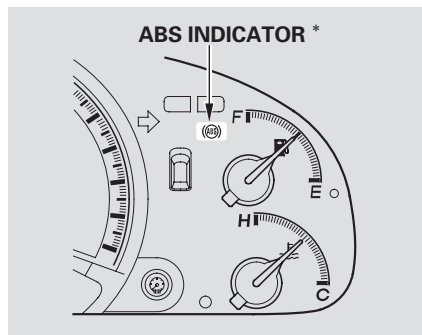

If the ABS indicator comes on, the anti-lock function of the braking system has shut down. The brakes still work like a conventional system, but without anti-lock. You should have your dealer inspect your vehicle as soon as possible.

**Important Safety Reminders**  
**ABS does not reduce the time or distance it takes to stop the vehicle;** it only helps with steering control during braking.

**ABS will not prevent a skid that results from changing direction abruptly,** such as trying to take a corner too fast or making a sudden lane change.

**ABS cannot prevent a loss of stability.** Always steer moderately when you are braking hard. Severe or sharp steering wheel movement can still cause your vehicle to veer into oncoming traffic or off the road.

**A vehicle with ABS may require a longer distance to stop** on loose or uneven surfaces, such as gravel or snow, than a vehicle without anti-lock.

# Vehicle Stability Assist (VSA) System

The vehicle stability assist (VSA) system helps to stabilize the vehicle during cornering if the vehicle turns more or less than desired. It also assists you in maintaining traction while accelerating on loose or slippery road surfaces. It does this by regulating the engine's output, and by selectively applying the brakes.

When VSA activates, you may notice that the engine does not respond to the accelerator in the same way it does at other times.

The VSA system cannot enhance the vehicle's driving stability in all situations and does not control your vehicle's entire braking system. It is still your responsibility to drive and corner at reasonable speeds and to leave a sufficient margin of safety.



## VSA Activation Indicator

When VSA activates, you will see the VSA activation indicator blink.



## VSA System Indicator

If the VSA system indicator comes on while driving, pull to the side of the road when it is safe, and turn off the engine. Reset the system by restarting the engine. If the VSA system indicator stays, or comes back on while driving, have the VSA system inspected by your dealer.

If the indicator does not come on when the ignition switch is turned to ON (II), there may be a problem with the VSA system. Have your dealer inspect your vehicle as soon as possible.

*On Touring model only*

You will also see a "CHECK VSA SYSTEM" message on the multi-information display if there is a problem with the VSA system.

If the low tire pressure indicator comes on (see page 66), or the multi-information display shows a "CHECK TPMS SYSTEM" message (see page 84), the VSA system automatically turns on even if you turn it off with the VSA OFF button.

CONTINUED

## Vehicle Stability Assist (VSA) System

Without VSA, your vehicle still has normal braking and cornering ability, but it does not have VSA traction and stability enhancement.

### VSA OFF Button

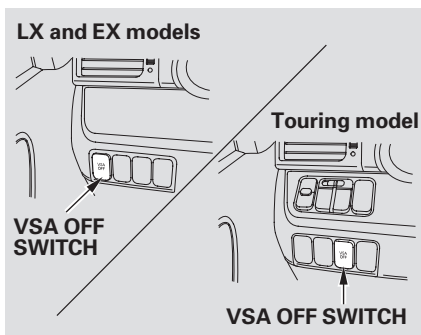

This button is under the driver's side vent. Press it to turn the VSA system on or off.

When VSA is off, the VSA activation indicator comes on as a reminder.

VSA is turned on every time you start the engine, even if you turned it off the last time you drove the vehicle.

### VSA and Tire Sizes

Driving with varying tire or wheel sizes may cause the VSA to malfunction. When replacing tires, make sure they are of the same size and type as your original tires (see page 349).

Deactivate the VSA system if you need to drive with the compact spare tire installed (all models except U.S. Touring).

If you install winter tires, make sure they are the same size as those that were originally supplied with your vehicle. Exercise the same caution during winter driving as you would if your vehicle was not equipped with VSA.

## Tire Pressure Monitoring System (TPMS)



TIRE PRESS OK  
SYSTEM FUNC  
NORMAL

*On U.S. Touring model only*  
Your vehicle is equipped with a tire pressure monitoring system (TPMS) that turns on every time you start the engine and monitors the pressure in your tires while driving.

You will see the above display on the multi-information display when you turn the ignition switch to ON (II) and press the INFO button on the steering wheel six times.

TIRE PRESSURE

35 |  | 35

35 |  | 35 PSI

To see the inflation pressures of all four tires, press the SEL/RESET button on the steering wheel. The display changes as shown above.



CHECK  
TIRE  
PRESSURE

Each tire has its own pressure sensor. If the air pressure of a tire becomes significantly low, the sensor in that tire immediately sends a signal that causes the low tire pressure indicator in the instrument panel to come on. If this happens, you will see which tire is losing the pressure in the multi-information display along with a “CHECK TIRE PRESSURE” message.

*CONTINUED*



## Tire Pressure Monitoring System (TPMS)



### Low Tire Pressure Indicator

When the low tire pressure indicator is on, one or more of your tires is significantly under-inflated. You should stop and check your tires as soon as possible, and inflate them to the proper pressure as indicated on the vehicle's tire information placard. Driving on a significantly under-inflated tire causes the tire to overheat and can lead to tire failure. Under-inflation also reduces fuel efficiency and tire tread life, and may affect the vehicle's handling and stopping ability. Each tire, including the spare should be checked monthly when cold, and set to the recommended inflation pressure as specified in the vehicle placard and owner's manual (see page [346](#) ).

It is possible that the pressures shown in the multi-information display and the pressures you manually measure are slightly different.

If the difference is significant and you cannot make the low tire pressure indicator and message in the multi-information display go out after inflating the tires to the specified values, have your dealer check the system as soon as possible.



If a flat tire is causing the low tire pressure indicator to come on, you will see the above message in the multi-information display.

# Tire Pressure Monitoring System (TPMS)

Because your vehicle is equipped with the Michelin PAX system, you can continue to drive up to about 125 miles (200 km). If you have a flat tire, take your vehicle to the nearest Honda dealer or authorized Michelin PAX system dealer.

For more information on the Michelin PAX system, refer to page 356 .

## TPMS System Failure

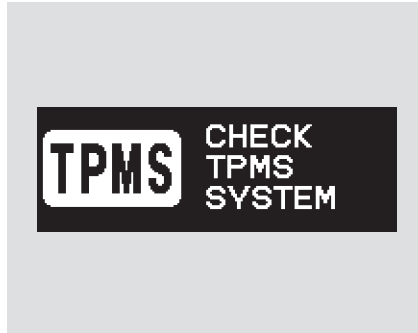

If there is a problem with the TPMS, you will see the above message in the multi-information display.

If you see this message, the system is off and is not monitoring the tire pressures. Have the system checked by your dealer as soon as possible.

If the low tire pressure indicator comes on, or the multi-information display shows a “CHECK TPMS SYSTEM” message, the VSA system automatically turns on even when the VSA system is turned off by pressing the VSA OFF button (see page 301 ). If this happens, you cannot turn the VSA system off by pressing the VSA OFF button again.

## Changing a Tire with TPMS

The tires on your vehicles are PAX tires, and you cannot replace or repair a flat tire. Replacement or repair of tires must be performed by a Honda dealer or an authorized Michelin PAX system dealer.

## Towing a Trailer

Your vehicle has been designed to primarily carry passengers and their cargo. You can also use it to tow a trailer if you carefully observe the load limits, use the proper equipment, and follow the guidelines in this section.

### WARNING

Exceeding any load limit or improperly loading your vehicle and trailer can cause a crash in which you can be seriously hurt or killed.

Check the loading of your vehicle and trailer carefully before starting to drive.

### Load Limits

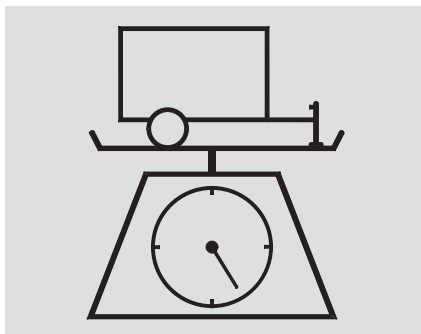

- **Total Trailer Weight:** The maximum allowable weight of the trailer and everything in or on it depends on several factors. See page 307 for the driving limits for your towing situation. Towing a load that is too heavy can seriously affect your vehicle's handling and performance. It can also damage the engine and drivetrain.

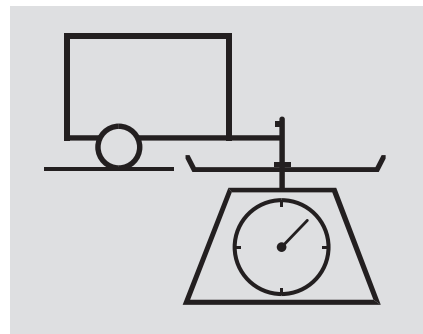

- **Tongue Load:** The weight that the tongue of a fully-loaded trailer puts on the hitch should be approximately 10 percent of the total trailer weight. Too much tongue load reduces front-tire traction and steering control. Too little tongue load can make the trailer unstable and cause it to sway.

Maximum Total Trailer Weight

Number of Occupants* <sup>1</sup>	Equipped with transmission cooler and power steering fluid cooler* <sup>2</sup>
1	3,500 lbs (1,580 kg)
2	3,350 lbs (1,520 kg)
3	3,200 lbs (1,450 kg)
4	3,050 lbs (1,380 kg)
5	2,900 lbs (1,310 kg)
6	2,750 lbs (1,250 kg)
7	2,600 lbs (1,180 kg)* <sup>3</sup> 1,550 lbs (700 kg)* <sup>4</sup>
8* <sup>3</sup>	650 lbs (290 kg)

- \* 1: Including driver. Based on 150 lbs (70 kg) per occupant.
- \* 2: See page 309 for information about fluid coolers.
- \* 3: LX and EX models
- \* 4: Touring model

To achieve a proper tongue load, start by loading 60 percent of the load toward the front of the trailer and 40 percent toward the rear, then re-adjust the load as needed.

- **Gross Vehicle Weight Rating (GVWR):**  
The maximum allowable weight of the vehicle, all occupants, all cargo, and the tongue load is 5,952 lbs (2,700 kg).
- **Gross Axle Weight Rating (GAWR):**  
The maximum allowable weight of the vehicle, all occupants, all cargo, and the tongue load must not exceed 2,833 lbs (1,285 kg) on the front axle, and 3,197 lbs (1,450 kg) on the rear axle.
- **Gross Combined Weight Rating (GCWR):**  
The maximum allowable weight of the fully loaded vehicle and trailer is 8,410 lbs (3,815 kg) (see page 386).

## Towing a Trailer

---

### Checking Loads

The best way to confirm that vehicle and trailer weights are within limits is to have them checked at a public scale.

Using a suitable scale or a special tongue load gauge, check the tongue load the first time you set up a towing combination (a fully-loaded vehicle and trailer), then recheck the tongue load whenever the conditions change.

### Towing Equipment and Accessories

Towing generally requires a variety of supplemental equipment, depending on the size of your trailer, how much load you are towing, and where you tow. To ensure the best quality, we recommend that you purchase Honda equipment whenever possible.

Discuss your needs with your trailer sales or rental agency, and follow the guidelines in this section. Also make sure that all equipment is properly installed and meets federal, state, province, and local regulations.

### Hitches

Any hitch used on your vehicle must be properly bolted to the underbody, using the six threaded holes provided. A hitch and the required fluid coolers designed especially for your Odyssey can be obtained from your Honda dealer.

### Weight Distributing Hitch

If the total trailer weight is more than 1,850 lbs (840 kg), you must also use a weight distributing hitch. This device transfers weight from the vehicle's rear wheels to the front wheels, and to the trailer's wheels. Carefully follow the hitch maker's instructions for proper installation and adjustment.

### Safety Chains

Always use safety chains when you tow a trailer. Make sure the chains are secured to the trailer and hitch, and that they cross under the tongue and can catch the trailer if it becomes unhitched. Leave enough slack to allow the trailer to turn corners easily, but do not let the chains drag on the ground.

## ***Sway Control***

If the total trailer weight exceeds 2,000 lbs (900 kg), you should install a sway control device to minimize swaying that can occur in crosswinds and in normal and emergency driving maneuvers. Your trailer maker can tell you what kind of sway control you need and how to install it.

## ***Transmission Fluid Cooler and Power Steering Fluid Cooler***

To help prevent overheating, a transmission fluid cooler and a power steering fluid cooler are required for trailer towing. These coolers are available only from your Honda dealer.

## ***Trailer Brakes***

Honda recommends that any trailer having a total weight of 1,000 lbs (450 kg) or more be equipped with its own electric or surge-type brakes.

If you choose electric brakes, be sure they are electrically actuated. Do not attempt to tap into your vehicle's hydraulic system. No matter how successful it may seem, any attempt to attach trailer brakes to your vehicle's hydraulic system will lower braking effectiveness and create a potential hazard.

See your trailer dealer for more information on installing electric brakes.

## ***Trailer Lights***

Trailer lights and equipment must comply with federal, state, province, and local regulations. Check the requirements for the areas where you plan to tow, and use only equipment designed for your vehicle.

CONTINUED

## Towing a Trailer

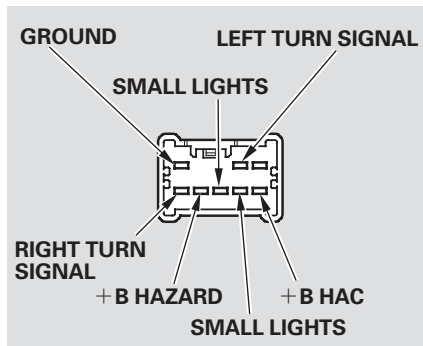

Your vehicle has a trailer lighting connector behind the right side panel in the cargo area. Refer to the drawing above for the purpose of each pin.

To use the trailer lighting connector, you will need a wiring harness and converter. This comes with the Honda hitch (see page 308), or it may be obtained separately from your dealer.

If you use a non-Honda trailer lighting harness and converter, you can get the connector and pins that mate with the connector in your vehicle from your dealer.

Since lighting and wiring vary by trailer type and brand, you should have a qualified technician install a suitable connector between the vehicle and the trailer. Improper equipment or installation can cause damage to your vehicle's electrical system and affect your vehicle warranty.

### *Spare Tires*

When towing a trailer, we recommend that you carry a full-size spare wheel and tire for your vehicle and trailer. If you use the compact spare tire that came with your vehicle, it could adversely affect vehicle handling. See page 349 for proper tire size, page 364 for how to store a full size wheel and tire, and

page 360 for information on changing a flat tire.

Remember to unhitch the trailer before changing a flat. Ask your trailer sales or rental agency where and how to store the trailer's spare tire.

### *U.S. Towing model*

Because of the Michelin PAX system, you must not change a flat tire by yourself, or use a compact spare tire on your vehicle.

### *Additional Towing Equipment*

Many states and provinces require special outside mirrors when towing a trailer. Even if they don't, you should install special mirrors if you cannot clearly see behind you, or if the trailer creates a blind spot. Ask your trailer sales or rental agency if any other items are recommended or required for your towing situation.

## Pre-Tow Checklist

When preparing to tow, and before driving away, be sure to check the following:

- The vehicle has been properly serviced, and the tires, brakes, suspension, cooling system, and lights are in good operating condition.
- The trailer has been properly serviced and is in good condition.
- All weights and loads are within limits.
- The hitch, safety chains, and any other attachments are secure.

- All items in or on the trailer are properly secured and cannot shift while you drive.
- Your vehicle tires and spare are properly inflated, and the trailer tires and spare are inflated as recommended by the trailer maker.

## Driving Safely With a Trailer

The added weight, length, and height of a trailer will affect your vehicle's handling and performance, so driving with a trailer requires some special driving skills and techniques.

For your safety and the safety of others, take time to practice driving maneuvers before heading for the open road, and follow the guidelines below.

### *Towing Speeds and Gears*

Drive slower than normal in all driving situations, and obey posted speed limits for vehicles with trailers. Use the D position when towing a trailer on level roads. Do not exceed 55 mph (88 km/h). At higher speeds, the trailer may sway or affect vehicle handling.



## Towing a Trailer

---

### ***Making Turns and Braking***

Make turns more slowly and wider than normal. The trailer tracks a smaller arc than your vehicle, and it can hit or run over something the vehicle misses. Allow more time and distance for braking. Do not brake or turn suddenly as this could cause the trailer to jackknife or turn over.

### ***Driving on Hills***

When climbing hills, closely watch your temperature gauge. If it nears the red mark, turn the air conditioning off, reduce speed and, if necessary, pull to the side of the road to let the engine cool.

If the automatic transmission shifts frequently while going up a hill, shift to D3.

If you must stop when facing uphill, use the foot brake or parking brake. Do not try to hold the vehicle in place by pressing on the accelerator, as this can cause the automatic transmission to overheat.

When driving down hills, reduce your speed, and shift down to 2nd gear. Do not “ride” the brakes, and remember, it will take longer to slow down and stop when towing a trailer.

### ***Handling Crosswinds and Buffeting***

Crosswinds and air turbulence caused by passing trucks can disrupt your steering and cause trailer swaying. When being passed by a large vehicle, keep a constant speed, and steer straight ahead. Do not try to make quick steering or braking corrections.

### ***Backing Up***

Always drive slowly and have someone guide you when backing up. Grip the *bottom* of the steering wheel; then turn the wheel to the left to get the trailer to move to the left, and turn the wheel right to move the trailer to the right.

### ***Parking***

Follow all normal precautions when parking, including putting the transmission in Park and firmly setting the parking brake. Also, place wheel chocks at each of the trailer’s tires.

This section explains why it is important to keep your vehicle well maintained and how to follow basic maintenance safety precautions.

This section also includes instructions on how to read the maintenance messages in the odometer/trip meter display or multi-Information display, a maintenance record, and instructions for simple maintenance tasks you may want to take care of yourself.

If you have the skills and tools to perform more complex maintenance tasks on your vehicle, you may want to purchase the service manual. See page 401 for information on how to obtain a copy, or see your dealer.

Maintenance Safety.....	314
Maintenance Minder.....	315
Maintenance Record.....	325
Fluid Locations.....	327
Adding Engine Oil.....	328
Changing the Oil and Filter.....	329
Engine Coolant.....	331
Windshield Washers.....	333
Automatic Transmission Fluid.....	334
Brake Fluid.....	335
Power Steering Fluid.....	336
Timing Belt.....	336
Lights.....	337
Cleaning the Seat Belts.....	343
Floor Mats.....	343
Wiper Blades.....	344
Tires.....	346
Checking the Battery.....	352
Vehicle Storage.....	353

## Maintenance Safety

All service items not detailed in this section should be performed by a certified technician or other qualified mechanic.

### Important Safety Precautions

To eliminate potential hazards, read the instructions before you begin, and make sure you have the tools and skills required.

- Make sure your vehicle is parked on level ground, the parking brake is set, and the engine is off.
- To clean parts, use a commercially available degreaser or parts cleaner, not gasoline.
- To reduce the possibility of fire or explosion, keep cigarettes, sparks, and flames away from the battery and all fuel-related parts.
- Wear eye protection and protective clothing when working with the battery or compressed air.

### ⚠ WARNING

Improperly maintaining this vehicle or failing to correct a problem before driving can cause a crash in which you can be seriously hurt or killed.

Always follow the inspection, maintenance recommendations, and schedules in this owner's manual.

### Potential Vehicle Hazards

- **Carbon Monoxide poison from engine exhaust.** Be sure there is adequate ventilation whenever you operate the engine.
- **Burns from hot parts.** Let the engine and exhaust system cool before touching any parts.

- **Injury from moving parts.** Do not run the engine unless instructed to do so.

### ⚠ WARNING

Failure to properly follow maintenance instructions and precautions can cause you to be seriously hurt or killed.

Always follow the procedures and precautions in this owner's manual.

Some of the most important safety precautions are given here. However, we cannot warn you of every conceivable hazard that can arise in performing maintenance. Only you can decide whether or not you should perform a given task.

Your vehicle displays engine oil life and maintenance service items in the odometer/trip meter display on the LX and EX models, or in the multi-information display on the Touring model, to show you when you should have your dealer perform engine oil replacement and indicated maintenance service.

Based on the engine operating conditions and accumulated engine revolutions, the onboard computer in your vehicle calculates the remaining engine oil life and displays it as a percentage.

## Engine Oil Life Indicator On LX and EX models

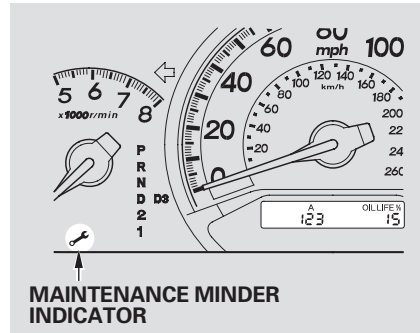

To see the current engine oil life, turn the ignition switch to ON (II), and push and release the SELECT/RESET knob on the instrument panel 3 times.

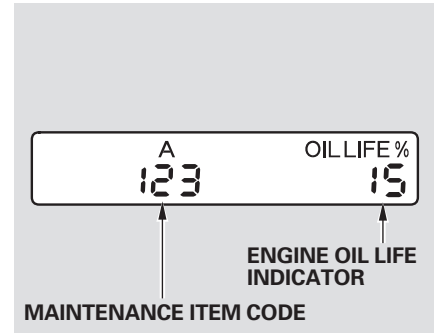

If the oil life is 15 percent or less, you will see the oil life indicator for several seconds every time you turn the ignition switch to ON (II). The maintenance minder indicator will also come on, and the maintenance item code(s) for other scheduled maintenance items needing service will be displayed next to the engine oil life indicator.

CONTINUED

## Maintenance Minder

---

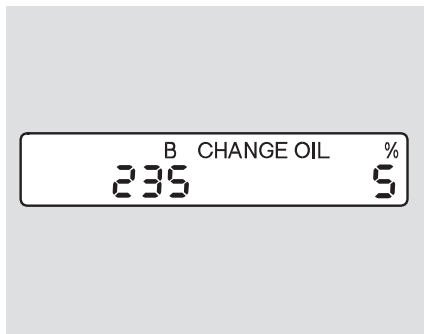

When the remaining engine oil life is less than 5 percent, you will see a “CHANGE OIL” message in the odometer/trip meter display, along with the same maintenance item code(s), every time you turn the ignition switch to ON (II).

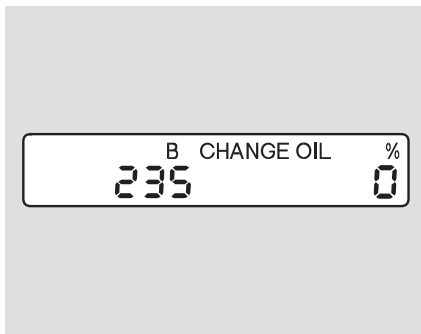

When the remaining engine oil life is 0 percent, you will see the above display. In this display, the remaining oil life indicator will be blinking. This display comes on and stays on every time you turn the ignition switch to ON (II). When you see this message, have the indicated maintenance performed by your dealer as soon as possible.

You can change the display to the odometer, the trip meter, or the outside temperature by pushing the SELECT/RESET knob on the instrument panel.

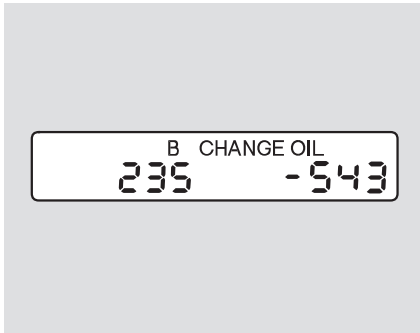

If you still do not perform the indicated maintenance, you will see a negative mileage, for example “-543,” blinking in the display. This negative mileage means that you should have performed the indicated maintenance 543 miles ago. Immediately have the indicated maintenance done by your dealer.

*On Touring model*

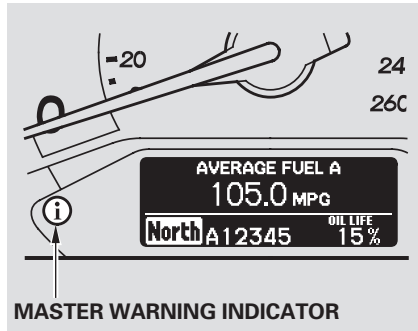

To see the current engine oil life, turn the ignition switch to ON (II), then push and release the SEL/RESET button on the steering wheel three times.

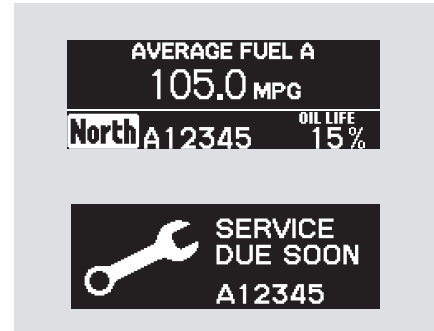

When the remaining engine oil life is 15 percent or less, the display shows a “SERVICE DUE SOON” message along with the maintenance item code(s) for other scheduled maintenance items needing service.

When you turn the ignition switch to ON (II), the master warning indicator will also come on.

*CONTINUED*

## Maintenance Minder

---

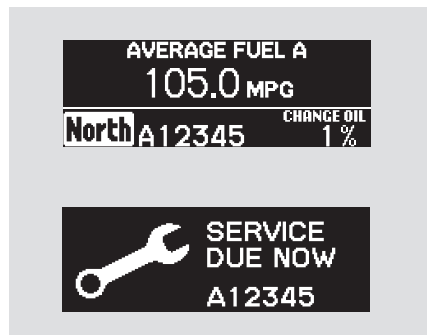

When the remaining engine oil life is less than 5 percent, you will see the above display. The display then changes to “SERVICE DUE NOW.” Have the indicated maintenance done as soon as possible.

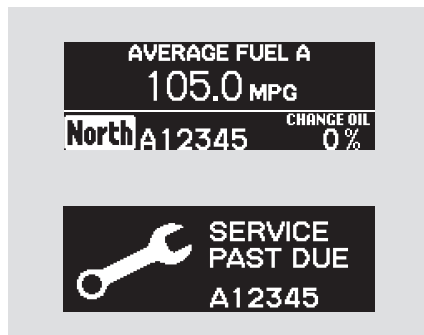

When the remaining engine oil life is less than 0 percent and you have not done the required maintenance, you will see the above display for several seconds. In this display, “0” will be blinking.

The display then changes to “SERVICE PAST DUE.”

These messages will come on every time you turn the ignition switch to ON (II).

Immediately have the service performed, and make sure to reset the display as described on page [320](#).

You can change the display to the odometer, the trip meter, or the outside temperature by pushing the SEL/RESET button on the steering wheel.

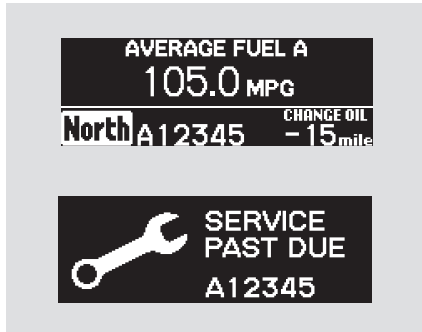

If you still do not get the indicated maintenance done, you will see a negative mileage, for example “-15” blinking. This negative mileage display means you should have done the indicated maintenance 15 miles ago. Immediately have the indicated maintenance done by your dealer.

## Maintenance Main Items and Sub Items

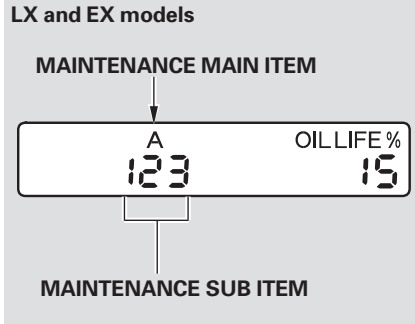

All the maintenance items displayed in the odometer/trip meter or the multi-information display are in code.

For an explanation of the maintenance codes, see page [324](#).

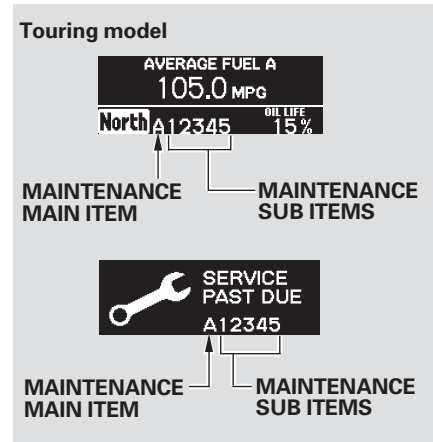



# Maintenance Minder

## Resetting the Engine Oil Life Indicator

*On LX and EX models*

Your dealer will reset the display after completing the required maintenance service. You will see “OIL LIFE 100%” on the odometer/trip meter display the next time you turn the ignition switch to ON (II).

If maintenance service is done by someone other than your dealer, reset the maintenance minder as follows:

1. Turn the ignition switch to ON (II).
2. Press the SELECT/RESET knob until the engine oil life indicator is displayed.

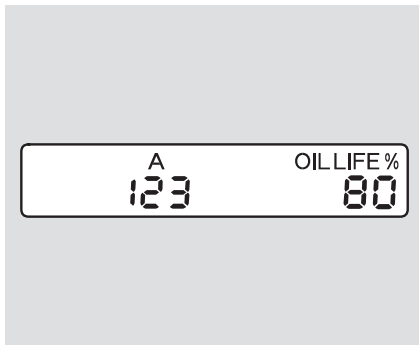

3. Press the SELECT/RESET knob for about 10 seconds. The engine oil life and the maintenance item code(s) will blink.

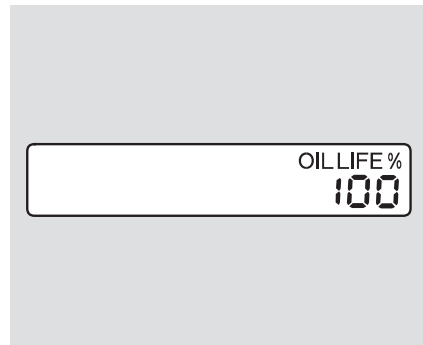

4. Press the SELECT/RESET knob for more than 5 seconds. The maintenance items code(s) will disappear, and the engine oil life will reset to “100.”

*On Touring model*

1. Turn the ignition switch to ON (II).
2. Press the SEL/RESET button on the steering wheel until the engine oil life is displayed.

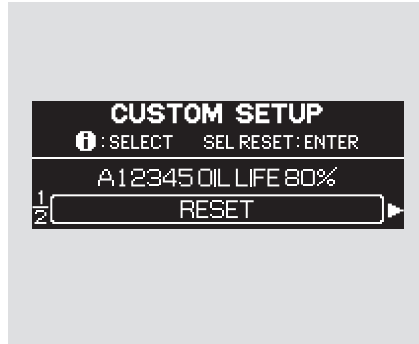

3. Press the SEL/RESET knob in the instrument panel for about 10 seconds. The display will change to the "CUSTOM SETUP" mode.
4. Press the SEL/RESET button on the steering wheel. The maintenance item code(s) will disappear, and the engine oil life will reset to "100."

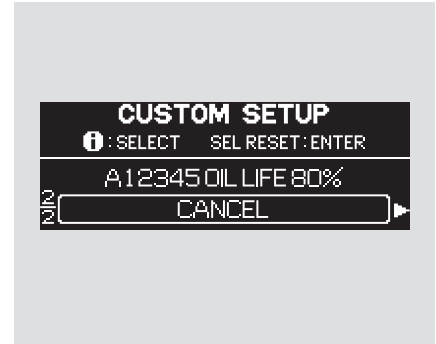

5. If you want to cancel resetting, press the INFO button on the steering wheel. The display changes as shown. Press the SEL/RESET button. This cancels the resetting procedure, and the screen returns to the normal display mode.

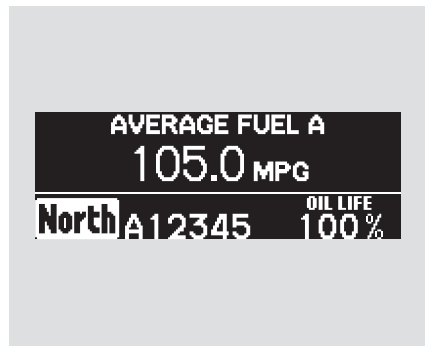

6. When you select “RESET” and press the SEL/RESET button, the multi-information display resets as shown above.

### Important Maintenance Precautions

If you have the required service done but do not reset the display, or reset the display without doing the service, the system will not show the proper maintenance intervals. This can lead to serious mechanical problems because you will no longer have an accurate record of when maintenance is needed.

Your authorized Honda dealer knows your vehicle best and can provide competent, efficient service.

However, service at a dealer is not mandatory to keep your warranties in effect. Maintenance may be done by any qualified service facility or person who is skilled in this type of automotive service. Make sure to have the service facility or person reset the display as previously described. Keep all receipts as proof of completion, and have the person who does the work fill out the maintenance record. Check your warranty booklet for more information.

We recommend the use of Honda parts and fluids whenever you have maintenance done. These are manufactured to the same high-quality standards as the original components, so you can be confident of their performance and durability.

U.S. Vehicles:

**Maintenance, replacement, or repair of emissions control devices and systems may be done by any automotive repair establishment or individual using parts that are “certified” to EPA standards.**

According to state and federal regulations, failure to perform maintenance on the items marked with # will not void your emissions warranties. However, all maintenance services should be performed in accordance with the intervals indicated by the odometer/trip meter display or the multi-information display.

## Owner’s Maintenance Checks

You should check the following items at the specified intervals. If you are unsure of how to perform any check, turn to the appropriate page listed.

- Engine oil level — Check every time you fill the fuel tank. See page [281](#) .
- Engine coolant level — Check the radiator reserve tank every time you fill the fuel tank. See page [282](#) .
- Automatic transmission — Check the fluid level monthly. See page [334](#) .
- Brakes — Check the fluid level monthly. See page [335](#) .
- Tires — Check the tire pressure monthly. Examine the tread for wear and foreign objects. See page [347](#) .

- Lights — Check the operation of the headlights, parking lights, taillights, high-mount brake light, and license plate lights monthly. See page [337](#) .

# Maintenance Minder

Symbol	Maintenance Main Items
A	<ul style="list-style-type: none"> <li>• Replace engine oil*<sup>1</sup></li> </ul>
B	<ul style="list-style-type: none"> <li>• Replace engine oil and oil filter</li> <li>• Rotate tires</li> <li>• Inspect front and rear brakes</li> <li>• Check parking brake adjustment</li> <li>• Inspect these items:                             <ul style="list-style-type: none"> <li>• Tie rod ends, steering gear box, and boots</li> <li>• Suspension components</li> <li>• Driveshaft boots</li> <li>• Brake hoses and lines (including ABS)</li> <li>• All fluid levels and condition of fluids</li> <li>• Exhaust system<sup>#</sup></li> <li>• Fuel lines and connections<sup>#</sup></li> </ul> </li> </ul>

\* 1 : If the message "SERVICE DUE NOW" does not appear more than 12 months after the display is reset, change the engine oil every year.

# : See information on maintenance and emissions warranty in the first column on page 323.

NOTE: • Independent of the maintenance messages in the multi-information display, replace the brake fluid every 3 years.  
 • Inspect idle speed every 160,000 miles (256,000 km).  
 • Adjust the valves during services A, B, 1, 2, or 3 if they are noisy.

Symbol	Maintenance Sub Items
1	<ul style="list-style-type: none"> <li>• Rotate tires</li> </ul>
2	<ul style="list-style-type: none"> <li>• Replace air cleaner element If you drive in dusty conditions, replace every 15,000 miles (24,000 km).</li> <li>• Replace dust and pollen filter If you drive primarily in urban areas that have high concentrations of soot in the air from industry and from diesel-powered vehicles, replace every 15,000 miles (24,000 km).</li> <li>• Inspect drive belt</li> </ul>
3	<ul style="list-style-type: none"> <li>• Replace transmission fluid Driving in mountainous areas at very low vehicle speeds or trailer towing results in higher transmission temperatures. This requires transmission fluid changes more frequently than recommended by the Maintenance Minder. If you regularly drive your vehicle under these conditions, have the transmission fluid changed every 30,000 miles (48,000 km).</li> </ul>
4	<ul style="list-style-type: none"> <li>• Replace spark plugs</li> <li>• Replace timing belt and inspect water pump If you drive regularly in very high temperatures (over 110°F, 43°C), or in very low temperatures (under -20°F, 29°C), replace every 60,000 mile<sup>#</sup> (U.S.)/100,000 km (Canada)</li> <li>• Inspect valve clearance</li> </ul>
5	<ul style="list-style-type: none"> <li>• Replace engine coolant</li> </ul>

# Maintenance Record

You or the servicing dealer can record all completed maintenance here. When maintenance is performed, record the mileage, circle the coded item(s) completed, and write in any other non-coded items (such as brake fluid replacement) below the codes. Keep the receipts for all work done on your vehicle.

Mileage	Maintenance Performed	Signature
		Date
mi km	A B 1 2 3 4 5	
mi km	A B 1 2 3 4 5	
mi km	A B 1 2 3 4 5	
mi km	A B 1 2 3 4 5	
mi km	A B 1 2 3 4 5	
mi km	A B 1 2 3 4 5	
mi km	A B 1 2 3 4 5	

Mileage	Maintenance Performed	Signature
		Date
mi km	A B 1 2 3 4 5	
mi km	A B 1 2 3 4 5	
mi km	A B 1 2 3 4 5	
mi km	A B 1 2 3 4 5	
mi km	A B 1 2 3 4 5	
mi km	A B 1 2 3 4 5	
mi km	A B 1 2 3 4 5	

Maintenance

# Maintenance Record

Mileage	Maintenance Performed	Signature
		Date
mi km	A B 1 2 3 4 5	
mi km	A B 1 2 3 4 5	
mi km	A B 1 2 3 4 5	
mi km	A B 1 2 3 4 5	
mi km	A B 1 2 3 4 5	
mi km	A B 1 2 3 4 5	
mi km	A B 1 2 3 4 5	
mi km	A B 1 2 3 4 5	

Mileage	Maintenance Performed	Signature
		Date
mi km	A B 1 2 3 4 5	
mi km	A B 1 2 3 4 5	
mi km	A B 1 2 3 4 5	
mi km	A B 1 2 3 4 5	
mi km	A B 1 2 3 4 5	
mi km	A B 1 2 3 4 5	
mi km	A B 1 2 3 4 5	
mi km	A B 1 2 3 4 5	

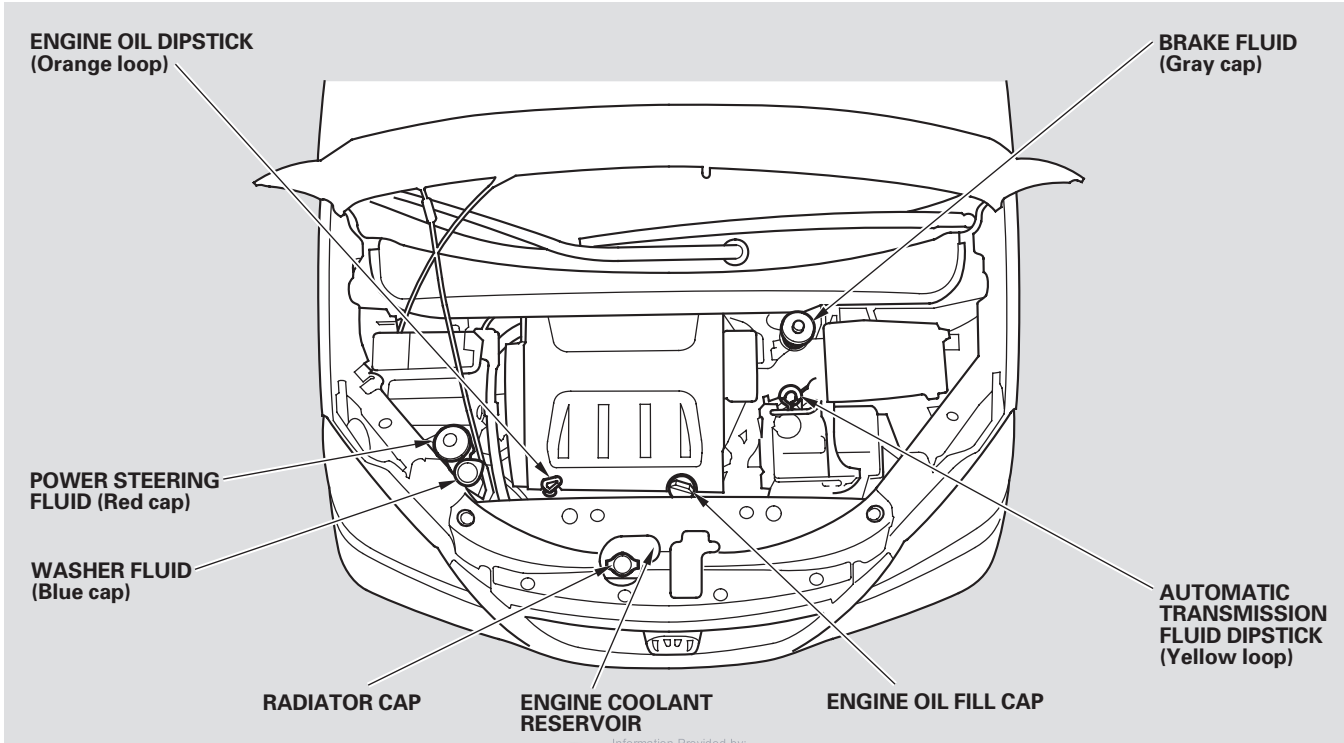



## Adding Engine Oil

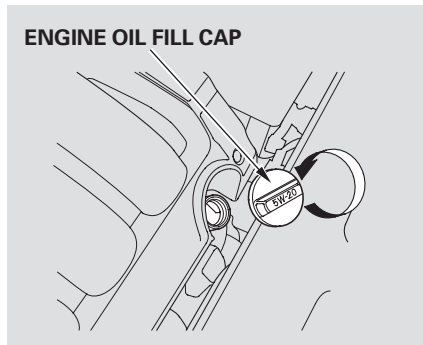

Unscrew and remove the engine oil fill cap on top of the valve cover. Pour in the oil slowly and carefully so you do not spill. Clean up any spills immediately. Spilled oil could damage components in the engine compartment.

Install the engine oil fill cap, and tighten it securely. Wait a few minutes, and recheck the oil level. Do not fill above the upper mark; you could damage the engine.

**Recommended Engine Oil**  
Oil is a major contributor to your engine's performance and longevity. Always use a premium-grade 5W-20 detergent oil displaying the API Certification Seal. This seal indicates the oil is energy conserving, and that it meets the American Petroleum Institute's latest requirements.



Honda Motor Oil is the preferred 5W-20 lubricant for your vehicle. It is highly recommended that you use Honda Motor Oil in your vehicle for optimum engine protection. Make sure the API Certification Seal says "For Gasoline Engines."

The oil viscosity or weight is provided on the container's label. 5W-20 oil is formulated for year-round protection of your vehicle to improve cold weather starting and fuel economy.

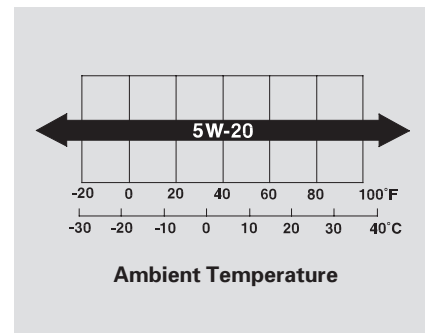

# Adding Engine Oil, Changing the Oil and Filter

## Synthetic Oil

You may use a synthetic motor oil if it meets the same requirements given for a conventional motor oil: it displays the API Certification Seal, and it is the proper weight. You must follow the oil and filter change intervals shown on the odometer/trip meter display or on the multi-information display.

## Engine Oil Additives

Your vehicle's engine does not require any oil additives. Additives may adversely affect engine or transmission performance and durability.

## Changing the Oil and Filter

Always change the oil and filter according to the maintenance messages shown on the odometer/trip meter display or on the multi-information display. The oil and filter collect contaminants that can damage your engine if they are not removed regularly.

Changing the oil and filter requires special tools and access from underneath the vehicle. The vehicle should be raised on a service station-type hydraulic lift for this service. Unless you have the knowledge and proper equipment, you should have this maintenance done by a skilled mechanic.

1. Run the engine until it reaches normal operating temperature, then shut it off.

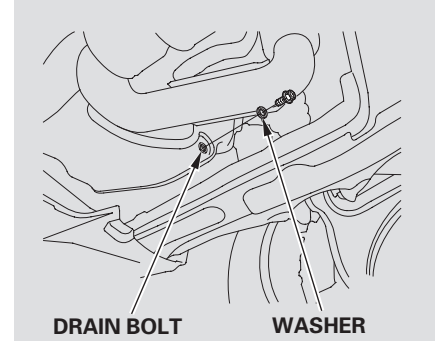

2. Open the hood, and remove the engine oil fill cap. Remove the oil drain bolt and washer from the bottom of the engine. Drain the oil into an appropriate container.

## Changing the Oil and Filter

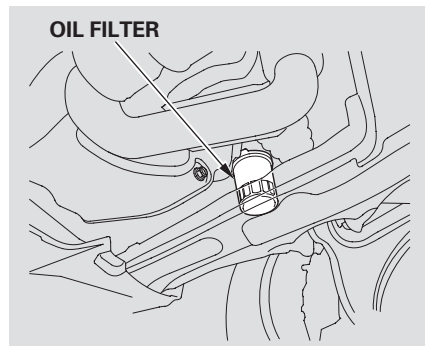

3. Remove the oil filter, and let the remaining oil drain. A special wrench (available from your dealer) is required.
4. Install a new oil filter according to the instructions that come with it.
5. Put a new washer on the drain bolt, then reinstall the drain bolt. Tighten the drain bolt to:  
29 lbf-ft (39 N·m , 4.0 kgf·m)

6. Refill the engine with the recommended oil.

Engine oil change capacity  
(including filter):  
4.5 US qt (4.3 ℓ)

7. Replace the engine oil fill cap. Start the engine. The oil pressure indicator should go out within 5 seconds. If it does not, turn off the engine, and check your work.
8. Let the engine run for several minutes, then check the drain bolt and oil filter for leaks.
9. Turn off the engine and let it sit for several minutes, then check the oil level on the dipstick. If necessary, add more oil.

### NOTICE

*Improper disposal of engine oil can be harmful to the environment. If you change your own oil, please dispose of the used oil properly. Put it in a sealed container, and take it to a recycling center. Do not discard it in a trash bin or dump it on the ground.*

## Adding Engine Coolant

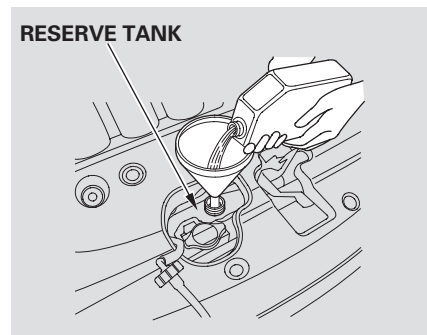

If the coolant level in the reserve tank is at or below the MIN line, add coolant to bring it up to between the MIN and MAX lines. Inspect the cooling system for leaks.

Always use Honda All Season Antifreeze/Coolant Type 2. This coolant is pre-mixed with 50 percent antifreeze and 50 percent water. Never add straight antifreeze or plain water.

If Honda antifreeze/coolant is not available, you may use another major-brand non-silicate coolant as a temporary replacement. Make sure it is a high-quality coolant recommended for aluminum engines. Continued use of any non-Honda coolant can result in corrosion, causing the cooling system to malfunction or fail. Have the cooling system flushed and refilled with Honda antifreeze/coolant as soon as possible.

If the reserve tank is completely empty, you should also check the coolant level in the radiator.

### **⚠ WARNING**

Removing the radiator cap while the engine is hot can cause the coolant to spray out, seriously scalding you.

Always let the engine and radiator cool down before removing the radiator cap.

CONTINUED

## Engine Coolant

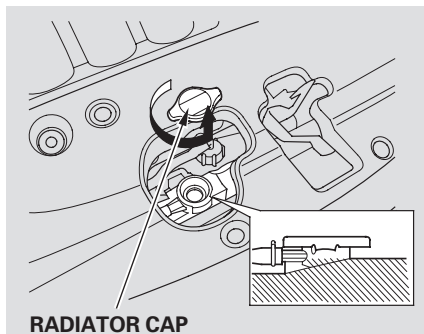

1. When the radiator and engine are cool, relieve any pressure in the cooling system by turning the radiator cap counterclockwise, without pressing down.
2. Remove the radiator cap by pushing down and turning counterclockwise.



3. The coolant level should be up to the base of the filler neck. Add coolant if it is low.

Pour the coolant slowly and carefully so you do not spill. Clean up any spill immediately; it could damage components in the engine compartment.

4. Put the radiator cap back on, and tighten it fully.
5. Pour coolant into the reserve tank. Fill it to halfway between the MAX and MIN marks. Put the cap back on the reserve tank.

Do not add any rust inhibitors or other additives to your vehicle's cooling system. They may not be compatible with the coolant or engine components.

Check the fluid level in the windshield washer reservoir at least monthly during normal use. This reservoir supplies the windshield and rear window washers.

Check the fluid level by removing the cap and looking at the level gauge attached to the cap.

*On Canadian models:* The low washer level indicator comes on when the level is low (see page 69).

*On the Touring model:* You will see a “WASHER FLUID LOW” message on the multi-information display when the level is low.

Fill the reservoir with a good-quality windshield washer fluid. This increases the cleaning capability and prevents freezing in cold weather.

When you refill the reservoir, clean the edges of the windshield wiper blades with windshield washer fluid on a clean cloth. This will help to condition them.

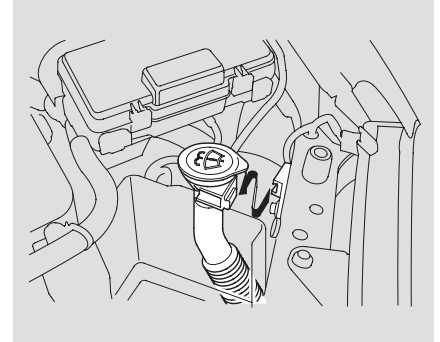

### NOTICE

*Do not use engine antifreeze or a vinegar/water solution in the windshield washer reservoir. Antifreeze can damage your vehicle's paint, while a vinegar/water solution can damage the windshield washer pump. Use only commercially-available windshield washer fluid.*

## Automatic Transmission Fluid

Check the fluid level with the engine at normal operating temperature.

1. Park the vehicle on level ground. Shut off the engine.

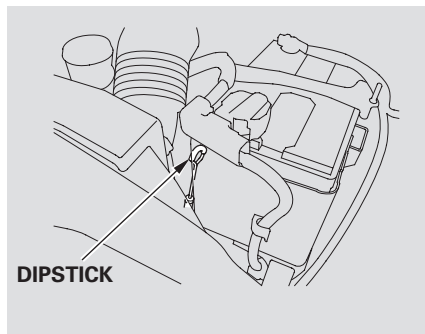

2. Remove the dipstick (yellow loop) from the transmission, and wipe it with a clean cloth.

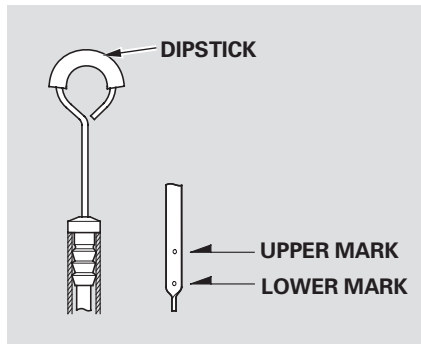

3. Insert the dipstick, all the way into the transmission as shown.
4. Remove the dipstick, and check the fluid level. It should be between the upper and lower marks.

5. If the level is below the lower mark, remove the fill plug, and add fluid to bring it to the upper mark.

Pour the fluid slowly and carefully so you do not spill any. Clean up any spills immediately; it could damage components in the engine compartment.

Always use Honda ATF-Z1 (Automatic Transmission Fluid). If it's not available, you may use a DEXRON® III automatic transmission fluid as a temporary replacement. However, continued use can affect the shift quality. Have the transmission flushed and refilled with Honda ATF-Z1 as soon as it is convenient.

# Automatic Transmission Fluid, Brake Fluid

To thoroughly flush the transmission, the technician should drain and refill it with Honda ATF-Z1, then drive the vehicle for a short distance. Do this three times. Then drain and refill the transmission a final time.

6. Insert the dipstick all the way back into the transmission securely as shown in the illustration.

The transmission should be drained and refilled with new fluid when this service is indicated on a maintenance message on the odometer/trip meter display or on the multi-information display.

If you are not sure how to add fluid, contact your dealer.

## Brake Fluid

Check the brake fluid level in the reservoirs monthly.

Replace the brake fluid according to the time recommendations in the maintenance minder schedule.

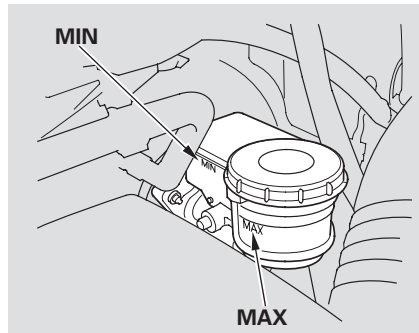

The fluid level should be between the MIN and MAX marks on the side of the reservoir. If the level is at or below the MIN mark, your brake system needs attention. Have the brake system inspected for leaks or worn brake pads.

Always use Honda Heavy Duty Brake Fluid DOT 3. If it is not available, you should use only DOT 3 or DOT 4 fluid, from a sealed container, as a temporary replacement.

Using any non-Honda brake fluid can cause corrosion and decrease the life of the system. Have the brake system flushed and refilled with Honda Heavy Duty Brake Fluid DOT 3 as soon as possible.

Pour the fluid slowly and carefully so you do not spill any. Clean up any spills immediately; it could damage components in the engine compartment.

Brake fluid marked DOT 5 is not compatible with your vehicle's braking system and can cause extensive damage.



# Power Steering Fluid, Timing Belt

## Power Steering Fluid

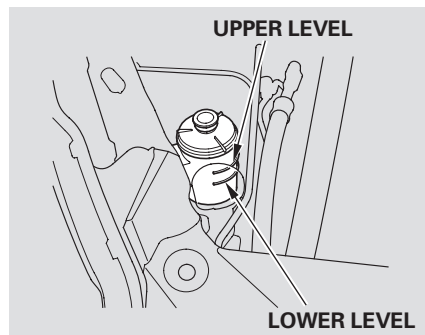

Check the level on the side of the reservoir when the engine is cold. The fluid should be between the UPPER LEVEL and LOWER LEVEL. If not, add power steering fluid to the UPPER LEVEL mark.

Pour the fluid slowly and carefully so you do not spill. Clean up any spill immediately; it could damage components in the engine compartment.

Always use Honda Power Steering Fluid. You may use another power steering fluid as an emergency replacement, but have the power steering system flushed and refilled with Honda PSF as soon as possible.

A low power steering fluid level can indicate a leak in the system. Check the fluid level frequently, and have the system inspected as soon as possible.

### NOTICE

*Turning the steering wheel to full left or right lock and holding it there can damage the power steering pump.*

## Timing Belt

The timing belt should be replaced at the intervals shown in the maintenance minder schedule.

Replace the belt at 60,000 miles (100,000 km) if you regularly drive your vehicle in one or more of these conditions:

- In very high temperatures (over 110°F, 43°C).
- In very low temperatures (under -20°F, -29°C).

## Headlight Aiming

The headlights were properly aimed when your vehicle was new. If you regularly carry heavy items in the cargo area or pull a trailer, readjustment may be required. Adjustments should be done by your dealer or other qualified mechanic.

## Replacing a Headlight Bulb

Your vehicle has halogen headlight bulbs, two on each side. When replacing a bulb, handle it by its base and protect the glass from contact with your skin or hard objects. If you touch the glass, clean it with denatured alcohol and a clean cloth.

### NOTICE

*Halogen headlight bulbs get very hot when lit. Oil, perspiration, or a scratch on the glass can cause the bulb to overheat and shatter.*

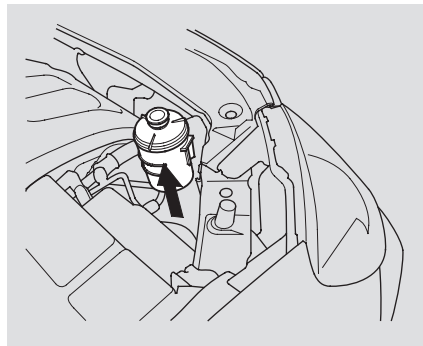

The high beam headlight bulb and the low beam headlight bulb are replaced the same way.

1. Open the hood. To change the high beam headlight bulb on the passenger's side, remove the power steering fluid reservoir from its holder by pulling it straight up.

CONTINUED

# Lights

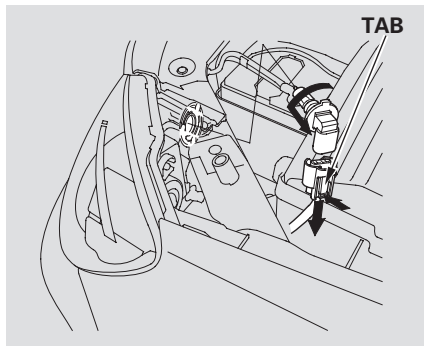

2. Remove the electrical connector from the bulb by pushing on the tab and pulling the connector down.
3. Remove the bulb by turning it one-quarter turn counterclockwise.
4. Insert the new bulb into the hole, and turn it one-quarter turn clockwise to lock it in place.

5. Push the electrical connector back onto the bulb. Make sure it is on all the way.
6. Turn on the headlights to test the new bulb.
7. If you replaced the high beam headlight bulb on the passenger's side, reinstall the power steering fluid reservoir.

## Replacing a Front Turn Signal Bulb

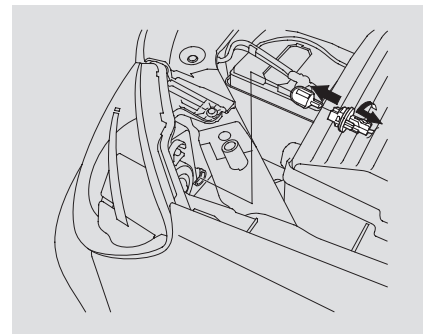

1. Open the hood. Remove the socket from the headlight assembly by turning it one-quarter turn counterclockwise.
2. Pull the burned out bulb straight out of its socket. Push the new bulb straight into the socket until it bottoms.

3. Insert the socket back into the headlight assembly. Turn it clockwise to lock it in place.
4. Turn on the lights to make sure the new bulb is working.

## Replacing a Front Parking/Side Marker Bulb

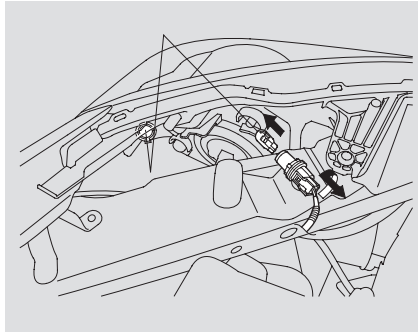

1. Open the hood. Remove the socket from the headlight assembly by turning it one-quarter turn counterclockwise.
2. Pull the bulb straight out of its socket. Push the new bulb straight into the socket until it bottoms.

3. Insert the socket back into the headlight assembly. Turn it clockwise to lock it in place.
4. Turn on the lights to make sure the new bulb is working.

# Lights

## Replacing a Front Fog Light Bulb

*Touring model only*

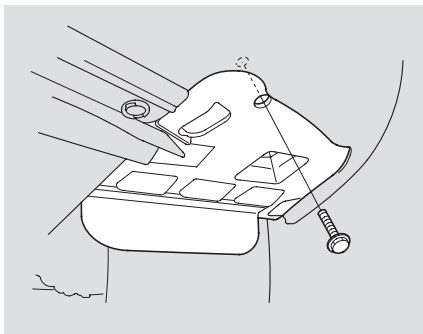

1. Use a wrench to remove the mounting bolt from the underbody through the hole in the splash shield.
2. Remove the fog light assembly from the bumper by pulling its inner edge first, then the whole assembly out of the bumper.

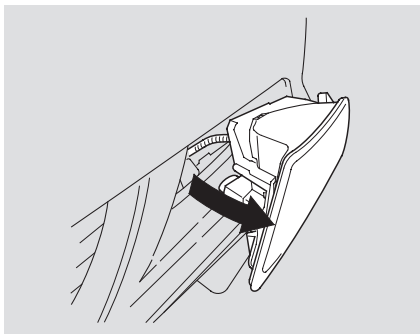

3. Remove the electrical connector from the bulb by pushing on the tab and pulling the connector down.
4. Remove the bulb from the fog light assembly by turning it one-quarter turn counterclockwise.

5. Insert the new bulb into the assembly and turn it one-quarter turn clockwise to lock it in place.
6. Push the electrical connector onto the new bulb.
7. Turn on the fog lights to test the new bulb.
8. Reinstall the fog light assembly into the bumper. Tighten the mounting bolt.

## Replacing a Rear Turn Signal or Brake Light Bulb

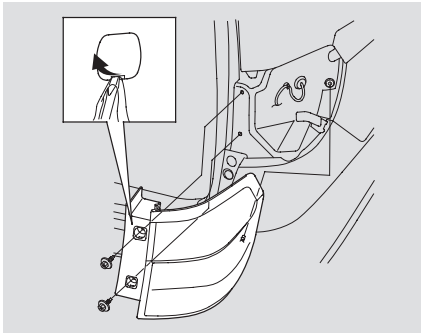

1. Remove the two bolt covers on the rear pillar by prying on the bottom edge with a flat-tip screwdriver. Remove the bolts with a Phillips-head screwdriver, and remove the light assembly from the rear pillar.
2. Determine which of the two bulbs is burned out: turn signal or brake/taillight.

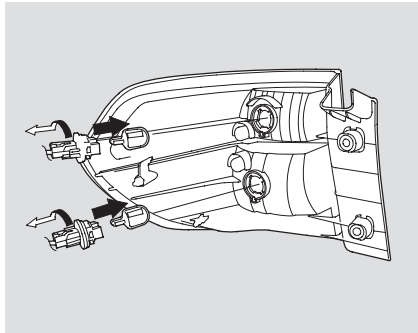

3. Remove the socket by turning it one-quarter turn counterclockwise.
4. Remove the bulb by pulling it straight out of its socket. Push the new bulb straight into the socket until it bottoms.
5. Test the lights to make sure the new bulb is working.

6. Put the socket back into the light assembly, and turn it clockwise to lock it in place.
7. Install the rear light assembly in the rear pillar. Tighten the two bolts. Snap the bolt covers into position.

# Lights

## Replacing a Taillight or Back-up Light Bulb

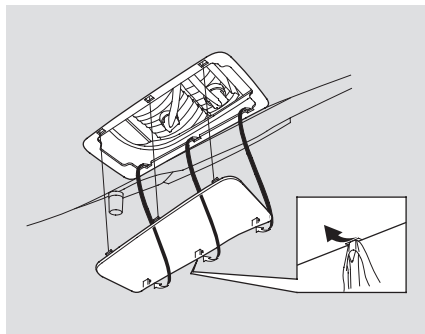

1. Open the tailgate. Place a cloth on the edge of the middle of the light cover. Remove the cover by carefully prying on its edge.
2. Determine which bulb is burned out: taillight or back-up light.

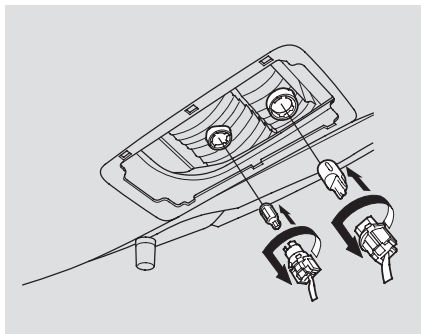

3. Remove the socket from the light assembly by turning it one-quarter turn counterclockwise.
4. Pull the bulb straight out of its socket. Push a new bulb into the socket until it bottoms. Reinstall the assembly.

5. Test the lights to make sure the new bulb is working.
6. Reinstall the light cover.

# Cleaning the Seat Belts, Floor Mats

## Cleaning the Seat Belts

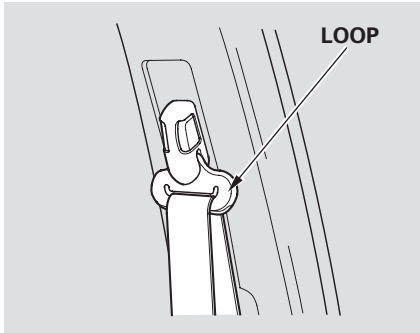

If your seat belts get dirty, use a soft brush with a mixture of mild soap and warm water to clean them. Do not use bleach, dye, or cleaning solvents. Let the belts air dry before you use the vehicle.

Dirt build-up in the loops of the seat belt anchors can cause the belts to retract slowly. Wipe the insides of the loops with a clean cloth dampened in mild soap and warm water or isopropyl alcohol.

## Floor Mats

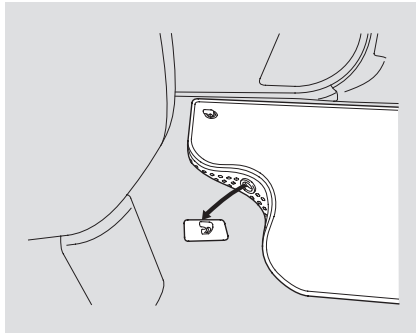

The driver's floor mat that came with your vehicle hooks over the floor mat anchor. This keeps the floor mat from sliding forward and possibly interfering with the pedals.

If you remove the driver's floor mat, make sure to re-anchor it when you put it back in your vehicle.

If you use a non-Honda floor mat, make sure it fits properly and that it can be used with the floor mat anchors. Do not put additional floor mats on top of the anchored mats.



# Wiper Blades

Check the condition of the wiper blades at least every six months. Replace them if you find signs of cracking in the rubber, and areas that are getting hard, or if they leave streaks and unwiped areas when used.

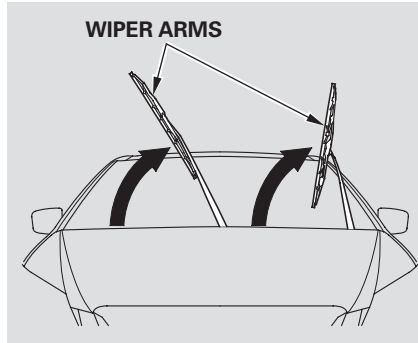

1. Raise the wiper arm off the windshield.  
Front windshield: Raise the driver's side first, then the passenger's side.

## NOTICE

*Do not open the hood when the wiper arms are raised, or you will damage the hood and the arms.*

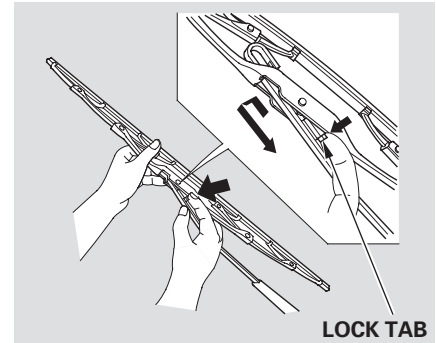

2. Disconnect the blade assembly from the wiper arm by pushing in the lock tab. Hold the lock tab in while you push the blade assembly toward the base of the arm.

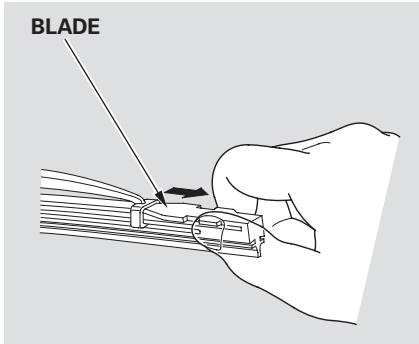

3. Remove the blade from its holder by grasping the tabbed end of the blade. Pull firmly until the tabs come out of the holder.

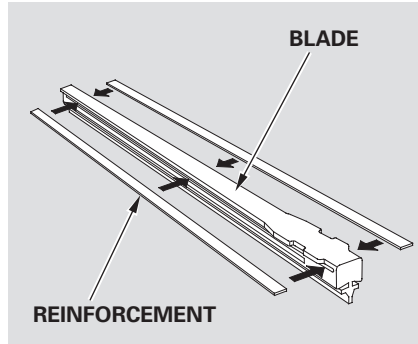

4. Examine the new wiper blades. If they have no plastic or metal reinforcement along the back edge, remove the metal reinforcement strips from the old wiper blade, and install them in the slots along the edge of the new blade.

5. Slide the new wiper blade into the holder until the tabs lock.
6. Slide the wiper blade assembly onto the wiper arm. Make sure it locks in place.
7. Lower the wiper arm against the windshield.  
Front windshield: Lower the passenger's side first, then the driver's side.

# Tires

To safely operate your vehicle, your tires must be the proper type and size, in good condition with adequate tread, and correctly inflated.

The following pages give more detailed information on how to take care of your tires and what to do when they need to be replaced.

## **⚠ WARNING**

Using tires that are excessively worn or improperly inflated can cause a crash in which you can be seriously hurt or killed.

Follow all instructions in this owner's manual regarding tire inflation and maintenance.

## **Inflation Guidelines**

Keeping the tires properly inflated provides the best combination of handling, tread life, and riding comfort.

- Underinflated tires wear unevenly, adversely affect handling and fuel economy, and are more likely to fail from being overheated.
- Overinflated tires can make your vehicle ride more harshly, are more prone to damage from road hazards, and wear unevenly.

*On U.S. Touring model only*

The tire pressure monitoring system (TPMS) warns you when a tire pressure is low. See page [303](#) for more information.

We recommend that you visually check your tires every day. If you think a tire might be low, check it immediately with a tire gauge.

## **LX and EX**

Tire Size	Cold Tire Pressure for Normal Driving
235/65R16 103T	Front: 33 psi (230 kPa , 2.3 kgf/cm <sup>2</sup> ) Rear: 35 psi (240 kPa , 2.4 kgf/cm <sup>2</sup> )

## **EX with Leather and Canadian Touring models**

Tire Size	Cold Tire Pressure for Normal Driving
235/65R16 103T	Front: 35 psi (240 kPa , 2.4 kgf/cm <sup>2</sup> ) Rear: 35 psi (240 kPa , 2.4 kgf/cm <sup>2</sup> )

The compact spare tire pressure is: 60 psi (420 kPa , 4.2 kgf/cm<sup>2</sup>)

## U.S. Touring model

Tire Size	Cold Tire Pressure for Normal Driving
235-710R460A 104T	Front: 33 psi (230 kPa , 2.3 kgf/cm <sup>2</sup> ) Rear: 35 psi (240 kPa , 2.4 kgf/cm <sup>2</sup> )

For convenience, the recommended tire sizes and cold air pressures are on a label on the driver's doorjamb.

Tire pressure for high speed driving is the same as for normal driving.

For additional technical information, see page [390](#).

Use a gauge to measure the air pressure at least once a month. Even tires that are in good condition may lose one to two psi (10 to 20 kPa, 0.1 to 0.2 kgf/cm<sup>2</sup>) per month. Remember to check the spare tire at the same time.

Check the air pressures when the tires are cold. This means the vehicle has been parked for at least three hours, or driven less than 1 mile (1.6 km). Add or release air, if needed, to match the recommended cold tire pressures.

If you check the pressure when the tires are hot [driven for several miles (kilometers)], you will see readings 4 to 6 psi (30 to 40 kPa, 0.3 to 0.4 kgf/cm<sup>2</sup>) higher than the cold reading. This is normal; do not release air to match the cold pressure. The tires will be underinflated.

Tubeless tires have some ability to self-seal if they are punctured. You should look closely for punctures if a tire starts losing pressure.

You should get your own tire pressure gauge and use it whenever you check your tire pressures. This will make it easier for you to tell if a pressure loss is due to a tire problem and not due to a variation between gauges.

### Tire Inspection

Every time you check inflation, you should also examine the tires for damage, foreign objects, and wear.

You should look for:

- Bumps or bulges in the tread or side of the tire. Replace the tire if you find either of these conditions.
- Cuts, splits, or cracks in the side of the tire. Replace the tire if you can see fabric or cord.
- Excessive tread wear.

*CONTINUED*

# Tires

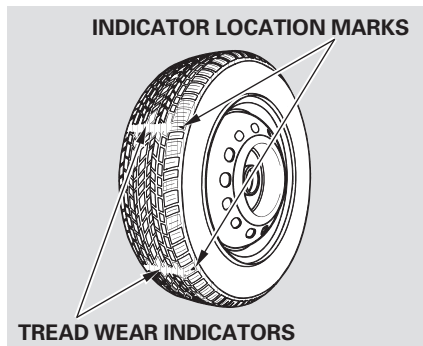

Your vehicle's tires have tread wear indicators molded into the tread. When the tread wears down to that point, you will see a 1/2 inch (12.7 mm) wide band running across the tread. This shows there is less than 1/16 inch (1.6 mm) of tread left on the tire. A tire that is this worn gives very little traction on wet roads. You should replace the tire if you can see the tread wear indicator in three or more places around the tire.

## Tire Maintenance

In addition to proper inflation, correct wheel alignment helps to decrease tire wear. If you find a tire is worn unevenly, have your dealer check the wheel alignment.

Have your dealer check the tires if you feel a consistent vibration while driving. A tire should always be rebalanced if it is removed from the wheel. When you have new tires installed, make sure they are balanced. This increases riding comfort and tire life. For best results, have the installer perform a dynamic balance.

*On some models*

### NOTICE

*Improper wheel weights can damage your vehicle's aluminum wheels. Use only genuine Honda wheel weights for balancing.*

## Tire Rotation

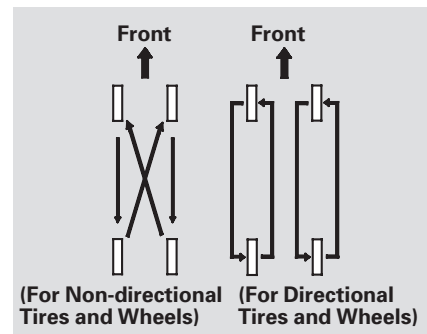

To help increase tire life and distribute wear more evenly, rotate the tires every 7,500 miles (12,000 km). Move the tires to the positions shown in the chart each time they are rotated. If you purchase directional tires, rotate only front-to-back.

## Replacing Tires

Replace your tires with radial tires of the same size, load range, speed rating, and maximum cold tire pressure rating (as shown on the tire's sidewall). Mixing radial and bias-ply tires on your vehicle can reduce braking ability, traction, and steering accuracy. Using tires of a different size or construction can cause the ABS to work inconsistently.

It is best to replace all four tires at the same time. If that is not possible or necessary, replace the two front tires or two rear tires as a pair. If you replace just the front tires, move the rear tires to the front, and install the new tires on the rear. Replacing just one tire can seriously affect your vehicle's handling.

If you ever replace a wheel, make sure that the wheel's specifications match those of the original wheels.

## WARNING

Installing improper tires on your vehicle can affect handling and stability. This can cause a crash in which you can be seriously hurt or killed.

Always use the size and type of tires recommended in this owner's manual.

## Wheels and Tires

Wheel:  
LX, and EX models  
16 x 7J

Touring model  
225 x 460A

Tire:  
LX, and EX models  
235/65R16 103T

Touring model  
235-710R460A 104T

See page [389](#) for DOT tire quality grading information, and page [390](#) for tire size information.

Replacement wheels are available at your dealer.

# Tires

---

## Winter Driving

Tires marked “M + S” or “All Season” on the sidewall have an all-weather tread design suitable for most winter driving conditions.

For the best performance in snowy or icy conditions, you should install snow tires or tire chains. They may be required by local laws under certain conditions.

## Snow Tires

If you mount snow tires on your vehicle, make sure they are radial tires of the same size and load range as original tires. Mount snow tires on all four wheels. The traction provided by snow tires on dry roads may be lower than your original tires. Check with the tire dealer for maximum speed recommendations.

For snow tire information on the Touring model, see page [351](#) .

## Tire Chains

Because your vehicle has limited tire clearance, mount only SAE Class “S” cable-type traction devices, with rubber chain tensioners on the front tires. Use traction devices only when required by driving conditions or local laws. Make sure they are the correct size for your tires. Metal link-type “chains” should not be used.

When installing cables, follow the manufacturer’s instructions, and mount them as tight as you can. Make sure they are not contacting the brake lines or suspension. Drive slowly with them installed. If you hear them coming into contact with the body or chassis, stop and investigate. Remove them as soon as you begin driving on cleared roads.

For tire chain information on the Touring model, see page [351](#) .

## NOTICE

*Traction devices that are the wrong size or improperly installed can damage your vehicle’s brake lines, suspension, body, and wheels. Stop driving if they are hitting any part of the vehicle.*

## Michelin PAX System

*On U.S. Touring model only*

Your vehicle is equipped with the Michelin PAX System which, together with the Tire Pressure Monitoring System (TPMS), enables you to continue driving even if one or more of your tires loses its pressure.

The tires and wheels on your vehicle are specially designed for the PAX system, and the PAX system is specifically designed and fine-tuned for your vehicle.

Because of these reasons, use only the wheels and tires designated in this owner's manual. Never mix PAX system wheels or tires with conventional wheels or tires.

There are no snow tires compatible with the PAX system, and not all tire chains are suitable for use on the PAX system tires. To prevent tire chain damage to your PAX system tire or wheel, ensure that no part of the chain contacts the PAX system.

Do not replace the PAX system tires and wheels with conventional tires and wheels. Doing so would disable the PAX system and the tire pressure monitoring system (TPMS), and may void your new vehicle warranty.

## ***Important Precautions***

- Never use a tire repair agent in a PAX system tire, and never repair a PAX system tire by yourself. Repair or replacement must be done a Honda dealer or an authorized Michelin PAX system dealer.
- If you must continue driving with a flat tire, follow all the procedures and precautions described on page [356](#).



## Checking the Battery

### TEST INDICATOR WINDOW

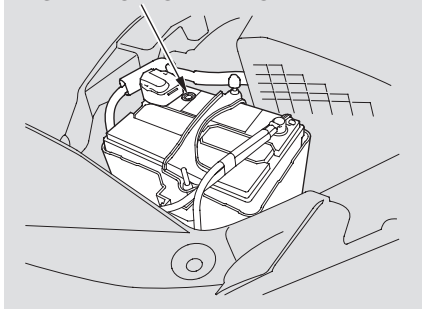

Check the condition of the battery monthly by looking at the test indicator window. The label on the battery explains the test indicator's colors.

Check the terminals for corrosion (a white or yellowish powder). To remove it, cover the terminals with a solution of baking soda and water. It will bubble up and turn brown. When this stops, wash it off with plain water. Dry off the battery with a cloth or paper towel. Coat the terminals with grease to help prevent future corrosion.

If additional battery maintenance is needed, see your dealer or a qualified technician.

**WARNING:** Battery posts, terminals, and related accessories contain lead and lead compounds. **Wash your hands after handling.**

If you need to connect the battery to a charger, disconnect both cables to prevent damaging your vehicle's electrical system. Always disconnect the negative (–) cable first, and reconnect it last.

### **WARNING**

The battery gives off explosive hydrogen gas during normal operation.

A spark or flame can cause the battery to explode with enough force to kill or seriously hurt you.

Wear protective clothing and a face shield, or have a skilled mechanic do the battery maintenance.

If you need to park your vehicle for an extended period (more than one month), there are several things you should do to prepare it for storage. Proper preparation helps prevent deterioration and makes it easier to get your vehicle back on the road. If possible, store your vehicle indoors.

- Fill the fuel tank.
- Change the engine oil and filter.
- Wash and dry the exterior completely.
- Clean the interior. Make sure the carpeting, floor mats, etc., are completely dry.
- Leave the parking brake off. Put the transmission in Park.

- Block the rear wheels.
- If the vehicle is to be stored for a longer period, it should be supported on jackstands so the tires are off the ground.
- Leave one window open slightly (if the vehicle is being stored indoors).
- Disconnect the battery.
- Support the front and rear wiper blade arms with a folded towel or rag so they do not touch the windshield.
- To minimize sticking, apply a silicone spray lubricant to all door and tailgate seals. Also, apply a vehicle body wax to the painted surfaces that mate with the door and tailgate seals.

- Cover the vehicle with a “breathable” cover, one made from a porous material such as cotton. Non-porous materials, such as plastic sheeting, trap moisture, which can damage the paint.
- If possible, periodically run the engine until it reaches full operating temperature (the cooling fans cycle twice). Preferably, do this once a month.



This section covers the more common problems that motorists experience with their vehicles. It gives you information about how to safely evaluate the problem and what to do to correct it. If the problem has stranded you on the side of the road, you may be able to get going again. If not, you will also find instructions on getting your vehicle towed.

- Driving with a Flat Tire ..... 356
- Compact Spare Tire..... 359
- Changing a Flat Tire ..... 360
- If the Engine Won't Start..... 366
  - Nothing Happens or the Starter Motor Operates Very Slowly..... 366
  - The Starter Operates Normally ..... 366
- Jump Starting ..... 367
- If the Engine Overheats ..... 369
- Low Oil Pressure Indicator ..... 371
- Charging System Indicator..... 371
- Malfunction Indicator Lamp ..... 372
- Readiness Codes..... 372
- Brake System Indicator ..... 373
- Closing the Moonroof ..... 374
- Fuses ..... 375
- Fuse Locations ..... 375
- Emergency Towing ..... 381

## Driving With a Flat Tire

### Michelin PAX System

*On U.S. Touring model only*

Your vehicle is equipped with the Michelin PAX system. Since each Michelin PAX system tire has an inner support ring that allows it to continue running without air, it may be difficult to immediately judge from its appearance if a tire is punctured. Your vehicle is also equipped with a tire pressure monitoring system (TPMS), and this system may be your first detection of a flat tire.



The TPMS monitors the air pressure of all four tires whenever the ignition switch is in the ON (II) position. It will immediately sense if a tire starts to lose its pressure, and give you warning with the low tire pressure indicator in the instrument panel and a “CHECK TIRE PRESSURE” message on the multi-information display. If the indicator and the warning message do not come back on again after you inflate the tire to the specified value (see page 346), it



was probably a natural loss of the air pressure and you can continue driving as before.

If the indicator and the message come on again, you probably have a flat tire. In this case, you will see a “PAX SYSTEM WARNING” message in the multi-information display.

With the PAX system tires, you can drive up to about 125 miles (200 km) even if one or more of your tires are punctured. This allows you to drive to the nearest Honda dealer or authorized Michelin PAX system dealer to have the tire(s) repaired.

If you get a flat tire, never try to repair it yourself, and never replace a flat tire with a compact spare tire.

Follow the instructions shown by the multi-information display, and drive very carefully.



The above message shows that you are driving your vehicle on a flat tire, and should observe the "RUN FLAT DRIVING" speed limit of 50 mph (80 km/h). Drive to your nearest Honda dealer or authorized Michelin PAX system dealer, or call the PAX help hotline at 1-877-PAXTIRE (1-877-729-5473).



If the display changes to the above message, it means that "RUN FLAT DRIVING" is nearing the limit, and you have to stop driving soon. Take your vehicle to the nearest Honda dealer or authorized Michelin PAX system dealer as soon as possible.

*CONTINUED*

## Driving With a Flat Tire

---



If you see the above message on the multi-information display, you have reached the limit of run flat driving, and you should stop driving immediately. Be aware that if you continue to drive, the noise and vibration level from the tire will increase significantly, and the tire may no longer be repairable.

Call a professional towing service who can transport your vehicle on flat-bed equipment. Never tow your

vehicle behind another vehicle with a rope or chain. Flat-bed equipment is the only way to transport your vehicle.

### Important Safety Precautions

Although your vehicle is capable of run flat driving, you should always observe the following:

- Do not drive faster than 50 mph (80 km/h).
- Drive carefully. Your vehicle may handle differently from when the tires are properly inflated, especially when cornering.
- In its run flat mode, a PAX system tire is somewhat noisier than when it is fully inflated, this is normal.

- Stop driving immediately when you see a “RUN FLAT LIMIT STOP DRIVING” message on the multi-information display. Continuous driving after this message will make it impossible to repair the tire.

If you cannot find a Honda dealer or an authorized Michelin PAX system dealer where you are driving, call the PAX help hotline at 1-877-PAXTIRE (1-877-729-8473).

### *All models except U.S. Touring*

Use the compact spare tire as a temporary replacement only. Get your regular tire repaired or replaced, and put it back on your vehicle as soon as you can.

Check the inflation pressure of the compact spare tire every time you check the other tires. It should be inflated to:  
60 psi (420 kPa , 4.2 kgf/cm<sup>2</sup>)

Follow these precautions:

- Never exceed 50 mph (80 km/h) under any circumstances.
- This tire gives a harsher ride and less traction on some road surfaces. Use greater caution while driving.

- Do not mount snow chains on the compact spare tire.
- Do not use the compact spare tire if you are towing a trailer.
- Do not use your compact spare tire on another vehicle unless it is the same make and model.
- Turn off the VSA system (see pages 301 and 302). Driving with the compact spare tire may activate the VSA.

### INDICATOR LOCATION MARK

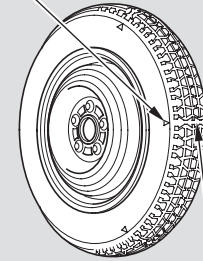

### TREAD WEAR INDICATOR BAR

Replace the tire when you can see the tread wear indicator bars. The replacement should be the same size and design tire, mounted on the same wheel. The spare tire is not designed to be mounted on a regular wheel, and the spare wheel is not designed for mounting a regular tire.



## Changing a Flat Tire

If you have a flat tire while driving, stop in a safe place to change it. Drive slowly along the shoulder until you get to an exit or an area that is far away from the traffic lanes.

### **⚠ WARNING**

The vehicle can easily roll off the jack, seriously injuring anyone underneath.

Follow the directions for changing a tire exactly, and never get under the vehicle when it is supported only by the jack.

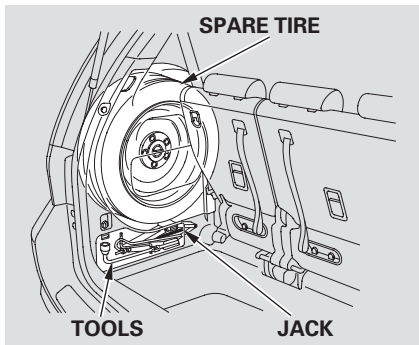

1. Park the vehicle on firm, level, and non-slippery ground. Put the transmission in Park. Apply the parking brake. If you are towing a trailer, unhitch the trailer.
2. Turn on the hazard warning lights, and turn the ignition switch to LOCK (0). Have all the passengers get out of the vehicle while you change the tire.

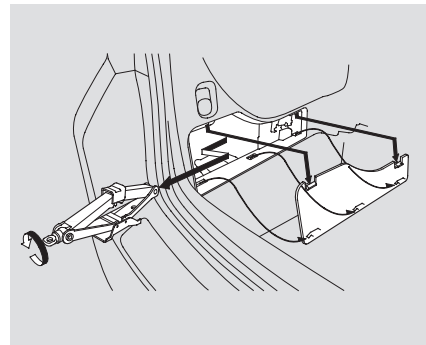

3. The jack is behind a cover in the cargo area on the driver's side, and tools are on the back of the cover. Remove the cover by pushing the tabs down and pulling the cover out.
4. Turn the jack's end counterclockwise to loosen it, then remove the jack.

## Changing a Flat Tire

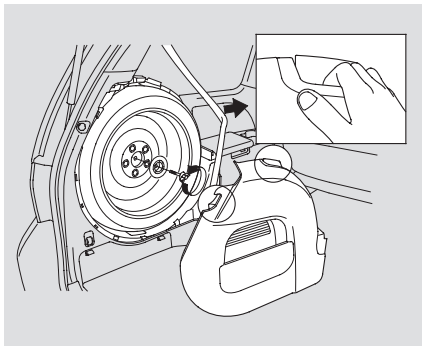

5. The spare tire is stored behind a cover on the sidewall of the cargo area on the driver's side.

Remove the cover by holding the two handles and pulling the cover out.

6. Unscrew the wing bolt, and take the spare tire out of its holder.

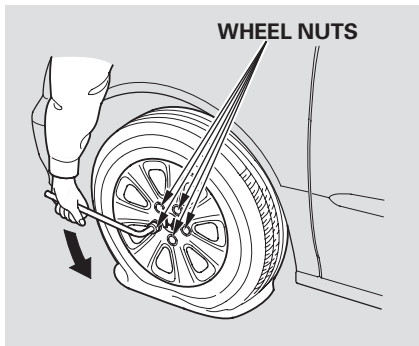

7. *On EX model*  
If you are changing a rear tire, close the sliding door. Then turn off the sliding door MAIN switch.
8. Loosen each wheel nut 1/2 turn with the wheel nut wrench.

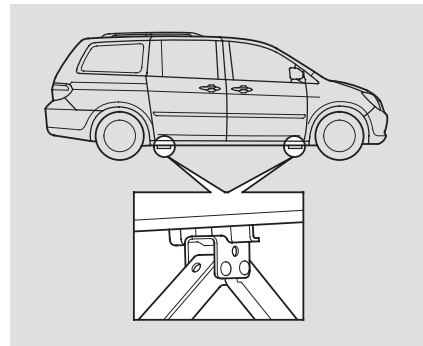

9. Place the jack under the jacking point nearest the tire you need to change. Turn the end bracket clockwise until the top of the jack contacts the jacking point. Make sure the jacking point tab is resting in the jack notch.

CONTINUED

## Changing a Flat Tire

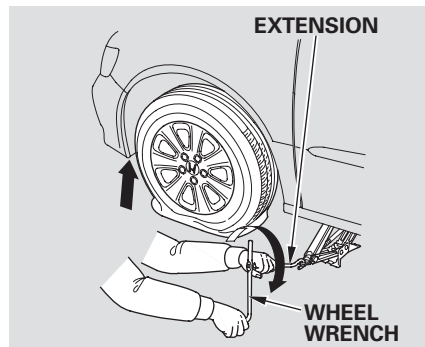

10. Use the extension and the wheel nut wrench as shown to raise the vehicle until the flat tire is off the ground.
11. Remove the wheel nuts, then remove the flat tire. Handle the wheel nuts carefully; they may be hot from driving. Place the flat tire on the ground with the outside surface facing up.

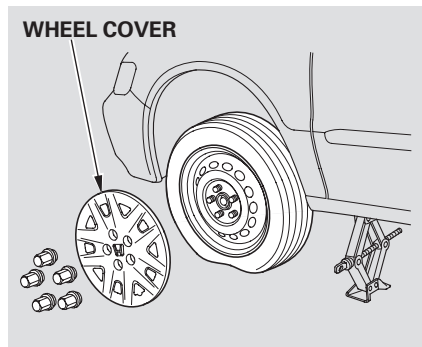

- On LX model*
- Do not attempt to forcibly pry the wheel cover off with a screwdriver or other tool. The wheel cover cannot be removed without first removing the wheel nuts.

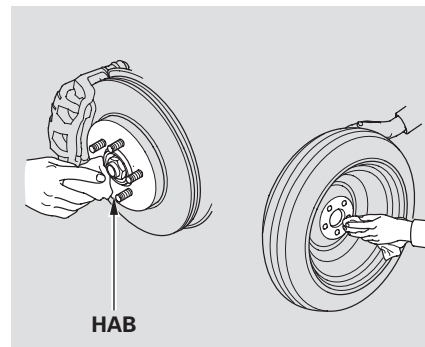

12. Before mounting the spare tire, wipe any dirt off the mounting surface of the wheel and hub with a clean cloth. Wipe the hub carefully; it may be hot from driving.

## Changing a Flat Tire

13. Put on the spare tire. Put the wheel nuts back on finger-tight, then tighten them in a crisscross pattern with the wheel nut wrench until the wheel is firmly against the hub. Do not try to tighten them fully.
14. Lower the vehicle to the ground, and remove the jack.

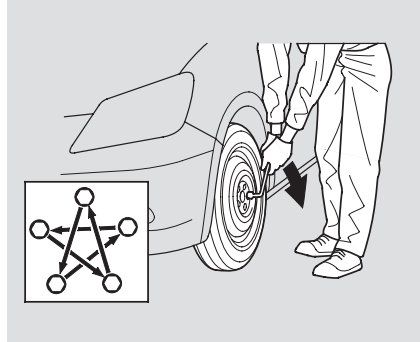

15. Tighten the wheel nuts securely in the same crisscross pattern. Have the wheel nut torque checked at the nearest automotive service facility.  
Tighten the wheel nuts to:  
94 lbf-ft (127 N·m , 13 kgf·m)
16. Put the flat tire in the supplied vinyl bag. This bag is in the jack storage area.

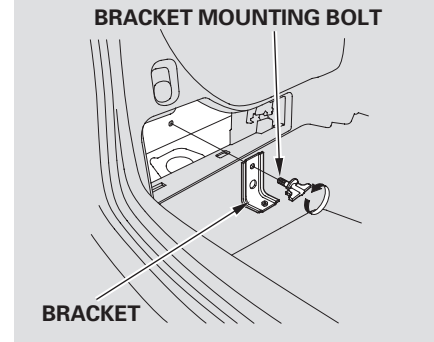

17. Remove the bracket from the jack storage area by unscrewing the bracket mounting bolt.
18. You will find a u-shaped slit on the carpet behind the seat bottom of the third seat. Pull up the carpet at the slit, and remove the plastic screw with a coin.

CONTINUED

## Changing a Flat Tire

19. Adjust the seat-back of the third seat to an upright position. Install the bracket mounting bolt on the attachment point as shown, and tighten the bolt. Make sure the bracket is securely locked.

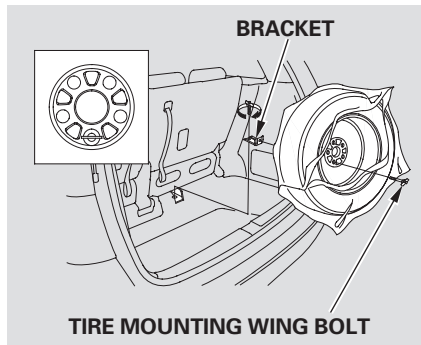

20. Install the flat tire on the bracket with the inside of the wheel facing toward you. Install the tire mounting wing bolt to the bracket through one of the five wheel nut holes as shown. Poke a hole in the vinyl bag as needed. Secure the flat tire by tightening the wing bolt.

21. Store the jack in its holder. To store the jack, align the locator stud in the holder with the hole in the jack base. Turn the jack's end bracket clockwise to lock it in place. Store the tools in the holders on the back of the jack storage cover.

22. Store the plastic screw in a noticeable place.

Make sure to reinstall the plastic screw after the flat tire is repaired and installed on the vehicle.

23. *On LX model*  
Store the wheel cover in the spare tire storage area.

24. Install the spare tire storage cover.

### **⚠ WARNING**

Loose items can fly around the interior in a crash and could seriously injure the occupants.

Store the wheel, jack, and tools securely before driving.

### ***Storing a Flat Tire on the Folded Third Seat***

When the third seat is folded, the flat tire is secured to the floor on top of the folded seat.

1. Pull up the U-shaped carpet piece, fold it, and tack the end under the carpet.
2. Remove the plastic screw as described in the previous procedure.

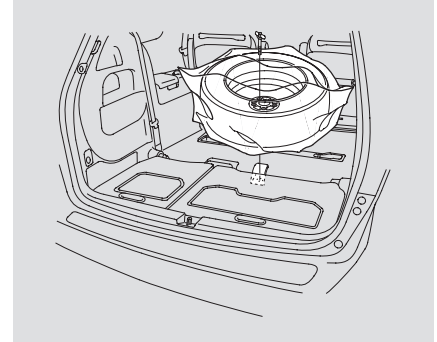

3. Place the flat tire face down on the attachment point. Put the tire mounting wing bolt in the attachment point through one of the five wheel nut holes as shown. Poke holes in the vinyl bag. Secure the flat tire by tightening the wing bolt.
4. Follow step 21 through 24 on page [364](#).

## If the Engine Won't Start

---

Diagnosing why the engine won't start falls into two areas, depending on what you hear when you turn the key to START (III):

- You hear nothing, or almost nothing. The engine's starter motor does not operate at all, or operates very slowly.
- You can hear the starter motor operating normally, or the starter motor sounds like it is spinning faster than normal, but the engine does not start up and run.

### Nothing Happens or the Starter Motor Operates Very Slowly

When you turn the ignition switch to START (III), you do not hear the normal noise of the engine trying to start. You may hear a clicking sound or series of clicks, or nothing at all. Check these things:

- Check the transmission interlock. The transmission must be in Park or Neutral or the starter will not operate.
- Turn the ignition switch to ON (II). Turn on the headlights, and check their brightness. If the headlights are very dim or do not come on at all, the battery is discharged. See **Jump Starting** on page [367](#).
- Turn the ignition switch to START (III). If the headlights do not dim, check the condition of the fuses. If the fuses are OK, there is probably something wrong with the electrical circuit for the ignition switch or starter motor. You will need a qualified technician to determine the problem (see **Emergency Towing** on page [381](#)).

If the headlights dim noticeably or go out when you try to start the engine, either the battery is discharged or the connections are corroded. Check the condition of the battery and terminal connections (see page [352](#)). You can then try jump starting the vehicle from a booster battery (see page [367](#)).

### The Starter Operates Normally

In this case, the starter motor's speed sounds normal, or even faster than normal, when you turn the ignition switch to START (III), but the engine does not run.

- Are you using the proper starting procedure? Refer to **Starting the Engine** on page [293](#).

## If the Engine Won't Start, Jump Starting

- Are you using a properly coded key? An improperly coded key will cause the immobilizer system indicator in the instrument panel to blink rapidly (see page 129).
- Do you have fuel? Check the fuel gauge; the low fuel indicator may not be working.
- There may be an electrical problem, such as no power to the fuel pump. Check all the fuses (see page 376).

If you find nothing wrong, you will need a qualified technician to find the problem. See **Emergency Towing** on page 381.

### Jump Starting

Although this seems like a simple procedure, you should take several precautions.

#### **⚠ WARNING**

A battery can explode if you do not follow the correct procedure, seriously injuring anyone nearby.

Keep all sparks, open flames, and smoking materials away from the battery.

You cannot start your vehicle by pushing or pulling it.

### To Jump Start Your Vehicle:

1. Open the hood, and check the physical condition of the battery. In very cold weather, check the condition of the electrolyte. If it seems slushy or frozen, do not try jump starting until it thaws.

#### **NOTICE**

*If a battery sits in extreme cold, the electrolyte inside can freeze. Attempting to jump start with a frozen battery can cause it to rupture.*

2. Turn off all the electrical accessories: heater, A/C, climate control, audio system, lights, etc. Put the transmission in Neutral or Park, and set the parking brake.

CONTINUED



## Jump Starting

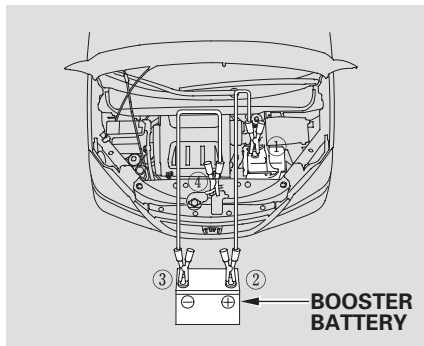

The numbers in the illustration show you the order to connect the jumper cables.

3. Connect one jumper cable to the positive (+) terminal on your vehicle's battery. Connect the other end to the positive (+) terminal on the booster battery.

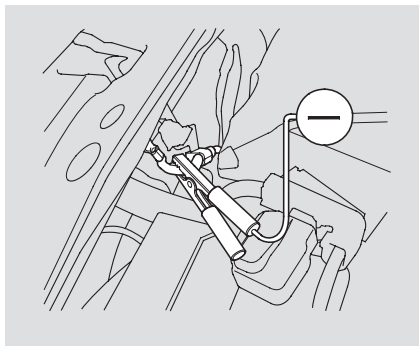

4. Connect the second jumper cable to the negative (-) terminal on the booster battery. Connect the other end to the grounding strap as shown. Do not connect this jumper cable to any other part of the engine.

5. If the booster battery is in another vehicle, have an assistant start that vehicle and run it at a fast idle.
6. Start the vehicle. If the starter motor still operates slowly, check that the jumper cables have good metal-to-metal contact.
7. Once the vehicle is running, disconnect the negative cable from your vehicle, then from the booster battery. Disconnect the positive cable from the vehicle, and then from the booster battery.

Keep the ends of the jumper cables away from each other and any metal on the vehicle until everything is disconnected. Otherwise, you may cause an electrical short.

The pointer of the vehicle's temperature gauge should stay in the midrange. If it climbs to the red mark, you should determine the reason (hot day, driving up a steep hill, etc.).

If your vehicle overheats, you should take immediate action. The only indication may be the temperature gauge climbing to or above the red mark. Or you may see steam or spray coming from under the hood.

### NOTICE

*Driving with the temperature gauge pointer at the red mark can cause serious damage to your engine.*

### WARNING

Steam and spray from an overheated engine can seriously scald you.

Do not open the hood if steam is coming out.

1. Safely pull to the side of the road. Put the transmission in Park, and set the parking brake. Turn off all accessories, and turn on the hazard warning indicators.
2. If you see steam and/or spray coming from under the hood, turn off the engine. Wait until you see no more signs of steam or spray, then open the hood.

3. If you do not see steam or spray, leave the engine running, and watch the temperature gauge. If the high heat is due to overloading, the engine should start to cool down almost immediately. If it does, wait until the temperature gauge comes down to the midpoint, then continue driving.
4. If the temperature gauge stays at the red mark, turn off the engine.

## If the Engine Overheats

---

5. Look for any obvious coolant leaks, such as a split radiator hose. Everything is still extremely hot, so use caution. If you find a leak, it must be repaired before you continue driving (see **Emergency Towing** on page 381).
6. If you do not find an obvious leak, check the coolant level in the radiator reserve tank. Add coolant if the level is below the MIN mark.
7. If there was no coolant in the reserve tank, you may need to add coolant to the radiator. Let the engine cool down until the pointer reaches the middle of the temperature gauge, or lower, before checking the radiator.

### **WARNING**

Removing the radiator cap while the engine is hot can cause the coolant to spray out, seriously scalding you.

Always let the engine and radiator cool down before removing the radiator cap.

8. Using gloves or a large heavy cloth, turn the radiator cap counterclockwise, without pushing down, to the first stop. After the pressure releases, push down on the cap, and turn it until it comes off.
9. Start the engine, and set the temperature control dial to maximum (climate control to FULL AUTO at 90°F/32°C). Add coolant to the radiator up to the base of the filler neck. If you do not have the proper coolant mixture available, you can add plain water. Remember to have the cooling system drained and refilled with the proper mixture as soon as you can.
10. Put the radiator cap back on tightly. Run the engine, and watch the temperature gauge. If it goes back to the red mark, the engine needs repair (see **Emergency Towing** on page 381).
11. If the temperature stays normal, check the coolant level in the radiator reserve tank. If it has gone down, add coolant to the MAX mark. Put the cap back on tightly.

# Low Oil Pressure Indicator, Charging System Indicator

## Low Oil Pressure Indicator



This indicator should never come on when the engine is running. If it starts flashing or stays on, the oil pressure has dropped very low or lost pressure. Serious engine damage is possible and you should take immediate action.

### NOTICE

*Running the engine with low oil pressure can cause serious mechanical damage almost immediately. Turn off the engine as soon as you can safely get the vehicle stopped.*

#### *On Touring model*

You will also see a “CHECK ENGINE OIL LEVEL” message in the multi-information display when this indicator comes on.

1. Safely pull off the road, and shut off the engine. Turn on the hazard warning indicators.
2. Let the vehicle sit for a minute. Open the hood, and check the oil level (see page 281 ). An engine very low on oil can lose pressure during cornering and other driving maneuvers.
3. If necessary, add oil to bring the level back to the full mark on the dipstick (see page 328 ).
4. Start the engine, and watch the oil pressure indicator. If it does not go out within 10 seconds, turn off the engine. There is a mechanical problem that needs to be repaired before you can continue driving (see **Emergency Towing** on page 381 ).

## Charging System Indicator



If the charging system indicator comes on brightly when the engine is running, the battery is not being charged.

Immediately turn off all electrical accessories. Try not to use other electrically operated controls such as the power windows. Keep the engine running; starting the engine will discharge the battery rapidly.

Go to a service station or garage where you can get technical assistance.

#### *On Touring model*

You will also see a “CHECK CHARGING SYSTEM” message in the multi-information display when this indicator comes on.

# Malfunction Indicator Lamp, Readiness Codes

## Malfunction Indicator Lamp



If this indicator comes on while driving, it means one of the engine's emissions control systems may have a problem. Even though you may feel no difference in your vehicle's performance, continued operation may cause serious damage.

If you have recently refueled your vehicle, the indicator could come on because of a loose or missing fuel fill cap. Tighten the cap until it clicks at least three times. Tightening the cap will not turn the indicator off immediately; it takes at least three days of normal driving.

If the indicator remains on, or the fuel cap was not loose or missing, have your vehicle checked by a dealer as soon as possible.

### NOTICE

*If you keep driving with the malfunction indicator lamp on, you can damage your vehicle's emissions controls and engine. Those repairs may not be covered by your vehicle's warranties.*

This indicator may also come on along with the "D" indicator.

#### *On Touring model*

You will also see a "CHECK EMISSION SYSTEM" message in the multi-information display when this indicator comes on.

## Readiness Codes

Your vehicle has certain "readiness codes" that are part of the on-board diagnostics for the emissions systems. In some states, part of the emissions testing is to make sure these codes are set. If they are not set, the test cannot be completed.

If your vehicle battery has been disconnected or gone dead, these codes are erased. It takes at least three days of driving under various conditions to set the codes again.

To check if they are set, turn the ignition switch to ON (II), without starting the engine. The malfunction indicator lamp will come on for 20 seconds. If it then goes off, the readiness codes are set. If it blinks 5 times, the readiness codes are not set. If possible, do not take your vehicle for a state emissions test until the readiness codes are set. Refer to **State Emissions Testing** for more information (see page [395](#)).

**U.S.** **Canada** The brake system indicator normally comes on when you turn the ignition switch to ON (II), and as a reminder to check the parking brake. It will stay on if you do not fully release the parking brake.

If the brake system indicator comes on while driving, the brake fluid level is probably low. Press lightly on the brake pedal to see if it feels normal. If it does, check the brake fluid level the next time you stop at a service station (see page [335](#)).

If the fluid level is low, take your vehicle to a dealer, and have the brake system inspected for leaks or worn brake pads.

However, if the brake pedal does not feel normal, you should take immediate action. A problem in one part of the system's dual circuit design will still give you braking at two wheels. You will feel the brake pedal go down much farther before the vehicle begins to slow down, and you will have to press harder on the pedal.

Slow down by shifting to a lower gear, and pull to the side of the road when it is safe. Because of the long distance needed to stop, it is hazardous to drive the vehicle. You should have it towed and repaired as soon as possible (see **Emergency Towing** on page [381](#)).

If you must drive the vehicle a short distance in this condition, drive slowly and carefully.

If the ABS indicator and the VSA indicator come on with the brake system indicator, have the vehicle inspected by your dealer immediately.

### *On Touring model*

You will also see a "CHECK BRAKE SYSTEM" message on the multi-information display when this indicator comes on.

## Closing the Moonroof

If the electric motor will not close the moonroof, do the following:

1. Check the fuse for the moonroof motor (see page 379). If the fuse is blown, replace it with one of the same or lower rating.
2. Try closing the moonroof. If the new fuse blows immediately or the moonroof motor still does not operate, you can close the moonroof manually.
3. Get the moonroof wrench out of the tool kit in the cargo area.

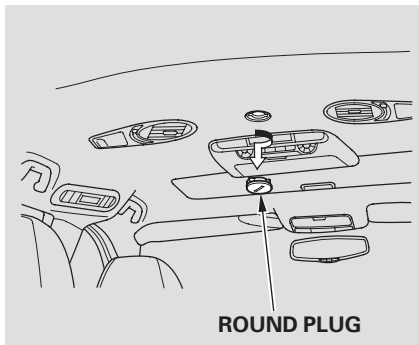

4. Use a screwdriver or coin to remove the round plug in the center of the headliner.

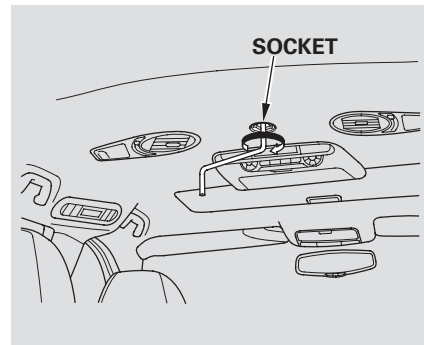

5. Insert the moonroof wrench into the socket behind this plug. Turn the wrench until the moonroof is fully closed.
6. Remove the wrench. Reinstall the round plug.

If you need to close the moonroof manually, it means the moonroof opening/closing function is developing a problem. Have your vehicle checked by your dealer.

## DRIVER'S SIDE INTERIOR

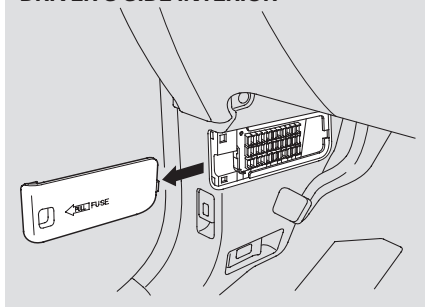

The vehicle's fuses are contained in four fuse boxes (three, if the vehicle does not have a rear entertainment system).

The interior fuse boxes are located under the dashboard on the driver's and passenger's side.

## PASSENGER'S SIDE INTERIOR

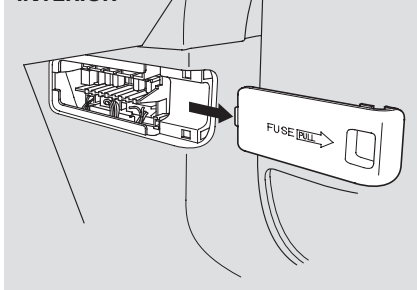

To open the passenger's fuse box, pull the right edge of the cover.

The primary under-hood fuse box is on the passenger's side. To open it, push the tabs as shown.

The secondary under-hood fuse box is behind the primary fuse box.

## PRIMARY UNDER-HOOD FUSE BOX

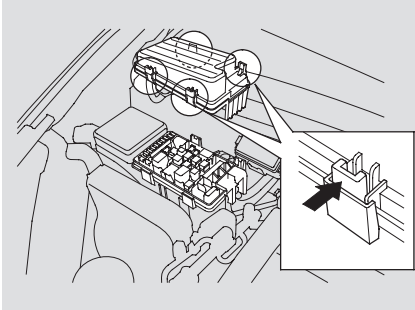

## SECONDARY UNDER-HOOD FUSE BOX

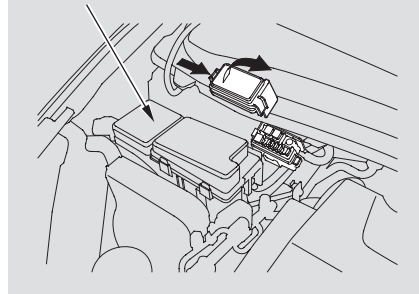



# Fuses

## Checking and Replacing Fuses

If something electrical in your vehicle stops working, the first thing you should check for is a blown fuse. Determine from the chart on pages 378 through 380, or the diagram on the fuse box lid, which fuse or fuses control that device. The diagram for the interior driver's side fuse box is on the kick panel below the fuse box. Check those fuses first, but check all the fuses before deciding that a blown fuse is the cause. Replace any blown fuses, and check if the device works.

1. Turn the ignition switch to LOCK (0). Make sure the headlights and all other accessories are off.
2. Remove the cover from the fuse box.

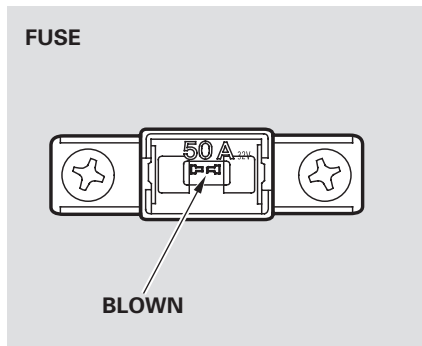

3. Check each of the large fuses in the primary under-hood fuse box by looking through the top at the wire inside. Removing these fuses requires a Phillips-head screwdriver.

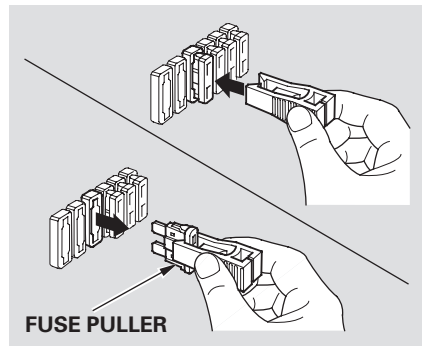

4. Check the smaller fuses in the under-hood fuse box and all the fuses in the interior fuse boxes by pulling out each fuse with the fuse puller provided in the primary under-hood fuse box.

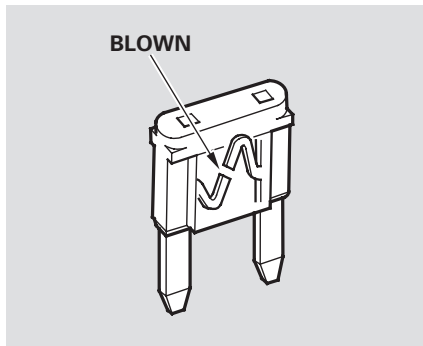

5. Look for a burned wire inside the fuse. If it is burned, replace the fuse with one of the spare fuses of the same rating or lower.

If you cannot drive the vehicle without fixing the problem, and you do not have a spare fuse, take a fuse of the same rating or a lower rating from one of the other circuits. Make sure you can do without that circuit temporarily (such as the accessory power socket or radio).

If you replace the blown fuse with a spare fuse that has a lower rating, it might blow out again. This does not indicate anything wrong. Replace the fuse with one of the correct rating as soon as you can.

### NOTICE

*Replacing a fuse with one that has a higher rating greatly increases the chances of damaging the electrical system. If you do not have a replacement fuse with the proper rating for the circuit, install one with a lower rating.*

6. If the replacement fuse of the same rating blows in a short time, there is probably a serious electrical problem with your vehicle. Leave the blown fuse in that circuit, and have your vehicle checked by a qualified mechanic.

If the driver's power window fuse is removed, the AUTO feature of the driver's window will be disabled. You should reset the AUTO feature (see page 162 ).

*On EX, and Touring models*

If the radio fuse is removed, the audio system will disable itself. The next time you turn on the radio you will see " E E E " in the frequency display. Use the preset buttons to enter the five-digit code (see page 229 ).

CONTINUED

# Fuse Locations

## PRIMARY UNDER-HOOD FUSE BOX

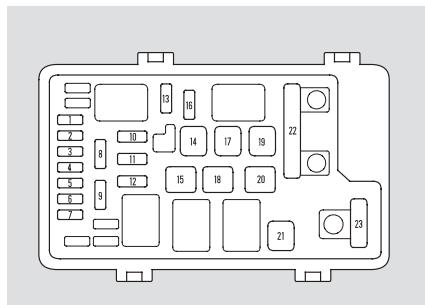

## SECONDARY UNDER-HOOD FUSE BOX

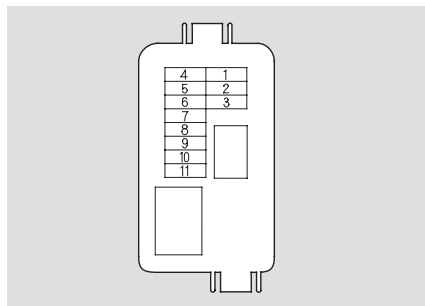

No.	Amps.	Circuits Protected
1	10 A	Left Headlight Low
2	30 A	Rear Defroster Coil
3	10 A	Left Headlight High
4	15 A	Small Lights
5	10 A	Right Headlight Low
6	10 A	Right Headlight High
7	7.5 A	Back Up
8	15 A	FI ECU
9	30 A	Condenser Fan
10	—	Not used
11	30 A	Cooling Fan
12	7.5 A	MG Clutch

No.	Amps.	Circuits Protected
1	—	Not Used
2	40 A	Left Power Sliding Door*
3	40 A	Right Power Sliding Door*
4	40 A	Power Tailgate*
5	20 A	Premium
6	20 A	AC Inverter

No.	Amps.	Circuits Protected
13	20 A	Horn, Stop
14	30 A	Defroster
15	40 A	Back Up
16	15 A	Hazard
17	30 A	VSA Motor
18	30 A	VSA
19	30 A	Option 1
20	40 A	Option 2
21	40 A	Heater Motor
22	70 A	+B AS F/B
	120 A	Battery
23	50 A	+B IGI Main
	40 A	Power Window

\* : If equipped

No.	Amps.	Circuits Protected
7	10 A	Front Fog Light*
8	10 A	ACM
9	7.5 A	TPMS*
10	—	Not Used
11	7.5 A	Rear Entertainment System*

\* : If equipped

## INTERIOR FUSE BOX Driver's Side

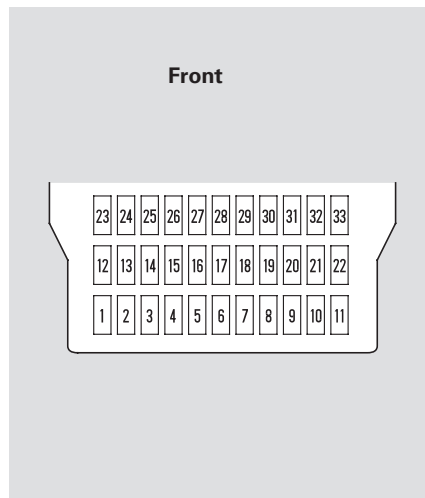

No.	Amps.	Circuits Protected
1	—	Not Used
2	15 A	IG Coil
3	10 A	Daytime Running Light*
4	15 A	LAF
5	7.5 A	Radio
6	7.5 A	Interior Lights
7	7.5 A	Back Up
8	20 A	Door Lock
9	10 A	Front Accessory Socket
10	7.5 A	OPDS
11	30 A	IG, Wiper
12	—	Not Used
13	20 A	Left PSD Closer**
14	20 A	Dr Power Seat Slide**
15	20 A	ADJ Pedals**
16	20 A	Dr Power Seat Recline**
17	20 A	Power Tailgate Closer**

\* : Canadian models

\*\* : If equipped

No.	Amps.	Circuits Protected
18	15 A	IG PCU
19	15 A	IG Fuel Pump
20	10 A	IG Washer
21	7.5 A	IG Meter
22	10 A	IG SRS
23	7.5 A	IGP
24	20 A	Left Rear Window
25	20 A	Right Rear Window
26	20 A	Passenger's Window
27	20 A	Driver's Window
28	20 A	Moonroof
29	—	Not Used
30	10 A	IG HAC
31	—	Not Used
32	10 A	ACC
33	7.5 A	HAC Option

# Fuse Locations

## INTERIOR FUSE BOX Passenger's Side

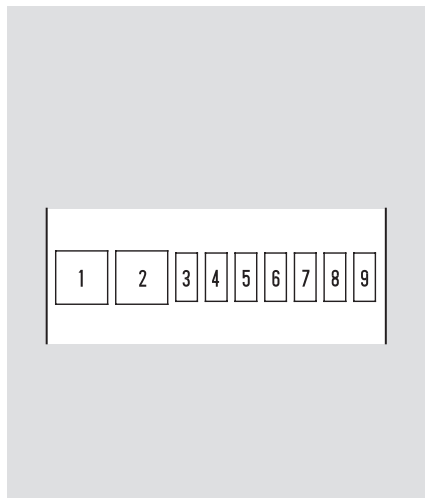

No.	Amps.	Circuits Protected
1	30 A	Rear Blower
2	—	Not Used
3	15 A	DBW
4	20 A	Door Lock
5	—	Not Used
6	15 A	Heated Seat
7	7.5 A	Instrument Panel
8	20 A	Right Power Sliding Door*
9	10 A	Accessory Sockets

\* : If equipped

If your vehicle needs to be towed, call a professional towing service or organization. Never tow your vehicle with just a rope or chain. It is very dangerous.

There are two ways to tow your vehicle.

**Flatbed Equipment** — The operator loads your vehicle on the back of a truck. **This is the best way to transport your vehicle, and it is only way to transport a Touring model.**

**Wheel-lift Equipment** — The tow truck uses two pivoting arms that go under the tires (front or rear) and lift them off the ground. The other two tires remain on the ground. **This is an acceptable way to tow your vehicle except for the Touring model.**

If, due to damage, your vehicle must be towed with the front wheels on the ground, do the following:

- Release the parking brake.
- Start the engine.
- Shift to D, then to N.
- Turn off the engine.

## NOTICE

*Improper towing preparation will damage the transmission. Follow the above procedure exactly. If you cannot shift the transmission or start the engine, your vehicle must be transported with the front wheels off the ground.*

With the front wheels on the ground, it is best to tow the vehicle no farther than 50 miles (80 km), and keep the speed below 35 mph (55 km/h).

CONTINUED

## Emergency Towing

---

If you decide to tow your vehicle with all four wheels on the ground, make sure you use a properly-designed and attached tow bar. Prepare the vehicle for towing as described previously, and leave the ignition switched in the ACCESSORY (I) position so the steering wheel does not lock. Make sure the radio and any items plugged into the accessory power sockets are turned off so they do not run down the battery.

### NOTICE

*The steering system can be damaged if the steering wheel is locked. Leave the ignition switch in Accessory (I), and make sure the steering wheel turns freely before you begin towing.*

### NOTICE

*Trying to lift or tow your vehicle by the bumpers will cause serious damage. The bumpers are not designed to support the vehicle's weight.*

The diagrams in this section give you the dimensions and capacities of your vehicle, and the locations of the identification numbers. It also includes information you should know about your vehicle's tires and emissions control systems.

Identification Numbers.....	384	Emissions Controls.....	392
Specifications .....	386	The Clean Air Act.....	392
DOT Tire Quality Grading		Crankcase Emissions Control	
(U.S Vehicles) .....	388	System.....	392
Uniform Tire Quality		Evaporative Emissions Control	
Grading .....	388	System.....	392
Treadwear .....	388	Onboard Refueling Vapor	
Traction.....	388	Recovery .....	392
Temperature .....	389	Exhaust Emissions Controls ...	393
Tire Labeling.....	390	PGM-FI System .....	393
		Ignition Timing Control	
		System.....	393
		Exhaust Gas Recirculation	
		(EGR) System.....	393
		Three Way Catalytic	
		Converter.....	393
		Replacement Parts.....	393
		Three Way Catalytic Converter...	394
		State Emissions Testing .....	395
		Testing of Readiness Codes....	395



## Identification Numbers

Your vehicle has several identifying numbers in various places.

The vehicle identification number (VIN) is the 17-digit number your dealer uses to register your vehicle for warranty purposes. It is also necessary for licensing and insuring your vehicle. The easiest place to find the VIN is on a plate fastened to the top of the dashboard. You can see it by looking through the windshield on the driver's side. It is also on the certification label attached to the driver's doorjamb, and is stamped on the engine compartment bulkhead. The VIN is also provided in bar code on the certification label.

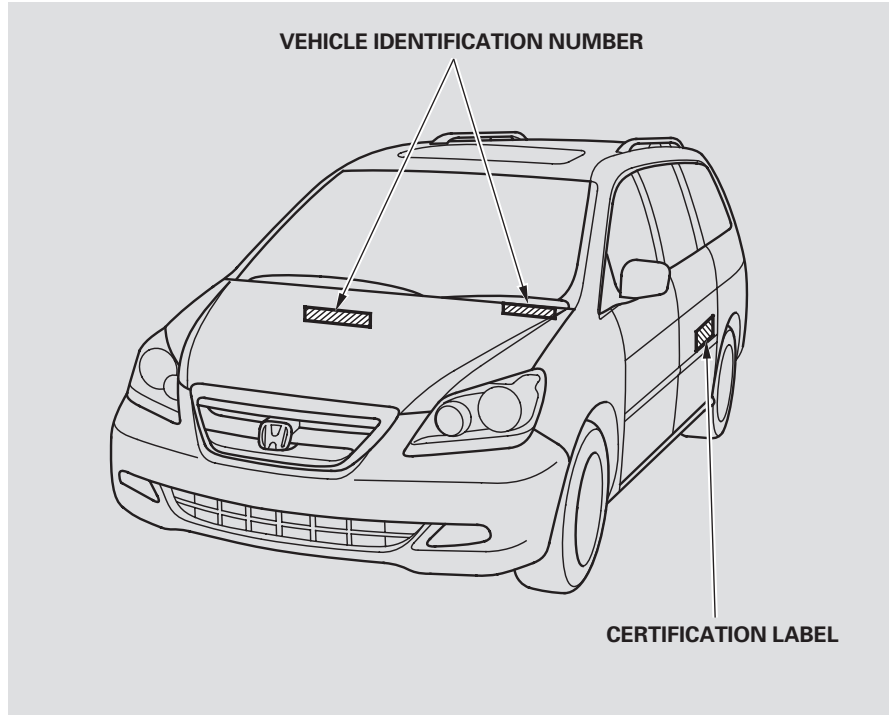

## Identification Numbers

The engine number is stamped into the engine block. It is on the front.

The transmission number is on a label on the side of the transmission.

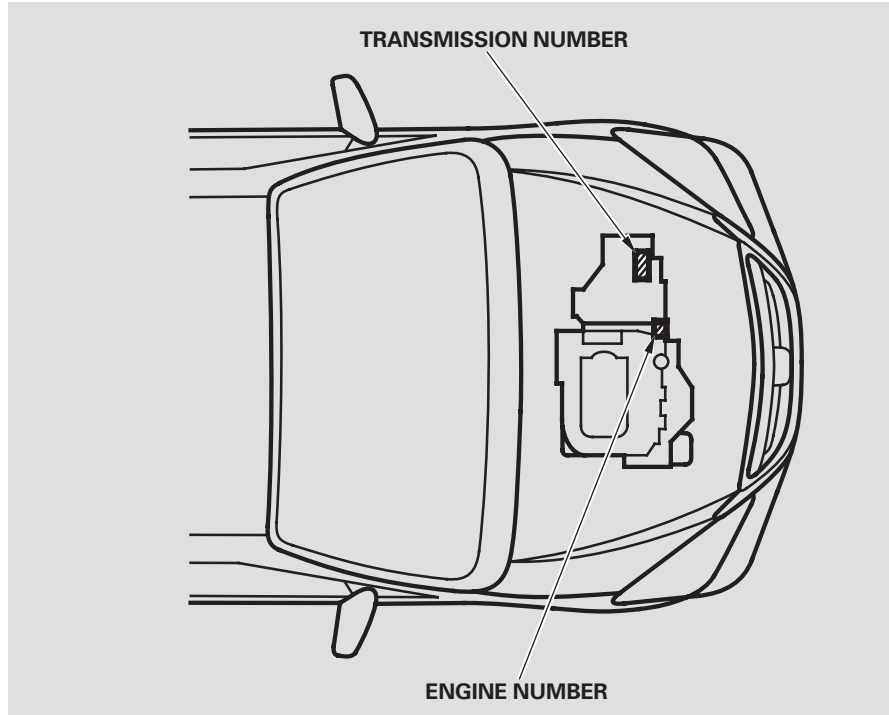

# Specifications

## Dimensions

Length	201.0 in (5,106 mm)
Width	77.1 in (1,958 mm)
Height	68.8 in (1,748 mm) <sup>*1</sup> 70.0 in (1,778 mm) <sup>*2</sup>
Wheelbase	118.1 in (3,000 mm)
Track	Front 66.7 in (1,694 mm) Rear 66.8 in (1,697 mm)

\* 1 : LX

\* 2 : EX, Touring

## Weights

Gross vehicle weight rating	See the tire information label attached to the driver's doorjamb.
Gross combined weight rating (GCWR)	8,210 lbs (9,815 kg)

## Engine

Type	Water cooled 4-stroke SOHC VTEC, 6-cylinder, gasoline engine
Bore x Stroke	3.50 x 3.66 in (89.0 x 93.0 mm)
Displacement	212 cu-in (3,471 cm <sup>3</sup> )
Compression ratio	10.0 : 1
Spark plugs	NGK: IZFR5K-11 DENSO: PKJ16DR-M11

## Air Conditioning

Refrigerant type	HFC-134a (R-134a)
Charge quantity	32 – 34 oz (850 – 900 g)
Lubricant type	ND-OIL8

## Capacities

Fuel tank		Approx. 21 US gal (80 ℓ)
Engine coolant	Change <sup>*1</sup>	1.85 US gal (7.0 ℓ)
	Total	2.48 US gal (9.4 ℓ)
Engine oil	Change <sup>*2</sup>	
	Including filter	4.5 US qt (4.3 ℓ)
	Without filter	4.2 US qt (4.0 ℓ)
	Total	5.3 US qt (5.0 ℓ)
Automatic transmission fluid	Change	3.3 US qt (3.1 ℓ)
	Total	8.5 US qt (8.0 ℓ)
Windshield washer reservoir	U.S. Vehicles	2.6 US qt (2.5 ℓ)
	Canada Vehicles	4.8 US qt (4.5 ℓ)

\* 1 : Including the coolant in the reserve tank and that remaining in the engine.

Reserve tank capacity:  
0.16 US gal (0.6 ℓ)

\* 2 : Excluding the oil remaining in the engine.

## Lights

Headlights	High	12 V – 60 W (HB3)
	Low	12 V – 51 W (HB4)
Front turn signal		12 V – 21 W
Front fog lights		12 V – 35 W
Front turn signal lights		12 V – 21 W
Front parking/side marker lights		12 V – 1.5 CP (Amber)
Rear turn signal lights		12 V – 21 W (Amber)
Stop/Taillights		12 V – 21/5 W
Taillights		12 V – 3 CP
Back-up lights		12 V – 21 W
License plate light		12 V – 5 W
High-mount brake light		12 V – 16 W
Individual map lights	Front	12 V – 5 W
	Rear	12 V – 5 W
Vanity mirror lights		12 V – 2 W
Cargo area light		12 V – 8 W
Door courtesy light		12 V – 4 W (2 CP)

## Battery

Capacity	12 V – 60 AH/5 HR
	12 V – 72 AH/20 HR

## Fuses

Interior	Driver's side	See page 379 or the fuse label attached to the dashboard.
	Passenger's side	See page 380 or the fuse label attached to the inside of the fuse box door under the dashboard.
Under-hood		See page 378 or the fuse box cover.

## Alignment

Toe-in	Front	0.00 in (0.0 mm)
	Rear	0.08 in (2.0 mm)
Camber	Front	0°
	Rear	–0°30'
Caster	Front	2°32'

## Tires

Size	Front/Rear	235/65R16 103T *1 235-710R460A 104T *2
	Spare	T135/80D17 103M
Pressure	Front	33 psi (230 kPa , 2.3 kgf/cm <sup>2</sup> ) 35 psi (240 kPa , 2.4 kgf/cm <sup>2</sup> ) *3
	Rear	35 psi (240 kPa , 2.4 kgf/cm <sup>2</sup> )
	Spare	60 psi (420 kPa , 4.2 kgf/cm <sup>2</sup> )

\*1 : LX, EX, and Canadian Touring models

\*2 : U.S. Touring model

\*3 : EX with Leather and Canadian Touring models

## DOT Tire Quality Grading (U.S. Vehicles)

---

The tires on your car meet all U.S. Federal Safety Requirements. All tires are also graded for treadwear, traction, and temperature performance according to Department of Transportation (DOT) standards. The following explains these gradings.

### **Uniform Tire Quality Grading**

Quality grades can be found where applicable on the tire sidewall between the tread shoulder and the maximum section width. For example:

**Treadwear 200**

**Traction AA**

**Temperature A**

All passenger car tires must conform to Federal Safety Requirements in addition to these grades.

### **Treadwear**

The treadwear grade is a comparative rating based on the wear rate of the tire when tested under controlled conditions on a specified government test course. For example, a tire graded 150 would wear one and one-half (1 1/2) times as well on the government course as a tire graded 100. The relative performance of tires depends upon the actual conditions of their use, however, and may depart significantly from the norm due to variations in driving habits, service practices, and differences in road characteristics and climate.

### **Traction – AA, A, B, C**

The traction grades, from highest to lowest, are AA, A, B, and C. Those grades represent the tire's ability to stop on wet pavement as measured under controlled conditions on specified government test surfaces of asphalt and concrete. A tire marked C may have poor traction performance.

**Warning:** The traction grade assigned to this tire is based on straight-ahead braking traction tests, and does not include acceleration, cornering, hydroplaning, or peak traction characteristics.

### Temperature – A, B, C

The temperature grades are A (the highest), B, and C, representing the tire's resistance to the generation of heat and its ability to dissipate heat when tested under controlled conditions on a specified indoor laboratory test wheel. Sustained high temperature can cause the material of the tire to degenerate and reduce tire life, and excessive temperature can lead to sudden tire failure. The grade C corresponds to a level of performance which all passenger car tires must meet under the Federal Motor Vehicle Safety Standard No. 109. Grades B and A represent higher levels of performance on the laboratory test wheel than the minimum required by law.

Warning: The temperature grade for this tire is established for a tire that is properly inflated and not overloaded. Excessive speed, underinflation, or excessive loading, either separately or in combination, can cause heat buildup and possible tire failure.

## Tire Labeling

---

The tires that came on your vehicle have a number of markings. Those you should be aware of are described below.

### ***Tire Size***

Whenever tires are replaced, they should be replaced with tires of the same size. Following is an example of tire size with an explanation of what each component means.

235/65R16 103T

235 — Tire width in millimeters.

65 — Aspect ratio (the tire's section height as a percentage of its width).

R — Tire construction code (R indicates radial).

16 — Rim diameter in inches.

103 — Load index (a numerical code associated with the maximum load the tire can carry).

T — Speed symbol (an alphabetical code indicating the maximum speed rating).

### ***Tire Identification Number***

Tire Identification Number (TIN) is a group of numbers and letters that look like the following example TIN.

DOT B97R FW6X 2202

DOT — This indicates that the tire meets all requirements of the U.S. Department of Transportation.

B97R — Manufacturer's identification mark.

FW6X — Tire type code.

2202 — Date of manufacture.

### ***Maximum Tire Pressure***

Max Press — The maximum air pressure the tire can hold.

### ***Maximum Tire Load***

Max Load — The maximum load the tire can carry at maximum air pressure.

## PAX System Tire Labeling

The PAX system tires have different markings from conventional tire markings. Following is an example of PAX system tire size with an explanation of what each component means.

235-710R460A 104T

- 235 Tire width in millimeters.
- 710 Outside diameter of the tire in millimeters.
- R Tire construction code (R indicates radial)
- 460 Nominal diameter at the rim seat in millimeters.
- A Symmetric

- 104 Load index (a numerical code associated with the maximum load the tire can carry).
- T Speed symbol (an alphabetical code indicating the maximum speed rating).



## Emissions Controls

---

The burning of gasoline in your vehicle's engine produces several by-products. Some of these are carbon monoxide (CO), oxides of nitrogen (NOx) and hydrocarbons (HC). Gasoline evaporating from the tank also produces hydrocarbons. Controlling the production of NOx, CO, and HC is important to the environment. Under certain conditions of sunlight and climate, NOx and HC react to form photochemical "smog." Carbon monoxide does not contribute to smog creation, but it is a poisonous gas.

### **The Clean Air Act**

The United States Clean Air Act\* sets standards for automobile emissions. It also requires that automobile manufacturers explain to owners how their emissions controls work and what to do to maintain them. This section summarizes how the emissions controls work. Scheduled maintenance is on pages [323](#) and [324](#).

\* In Canada, Honda vehicles comply with the Canadian emission requirements, as specified in an agreement with Environment Canada, at the time they are manufactured.

### **Crankcase Emissions Control System**

Your vehicle has a positive crankcase ventilation system. This keeps gasses that build up in the engine's crankcase from going into the atmosphere. The positive

crankcase ventilation valve routes them from the crankcase back to the intake manifold. They are then drawn into the engine and burned.

### **Evaporative Emissions Control System**

As gasoline evaporates in the fuel tank, an evaporative emissions control canister filled with charcoal adsorbs the vapor. It is stored in this canister while the engine is off. After the engine is started and warmed up, the vapor is drawn into the engine and burned during driving.

### **Onboard Refueling Vapor Recovery**

The onboard refueling vapor recovery (ORVR) system captures the fuel vapors during refueling. The vapors are adsorbed in a canister filled with activated carbon. While driving, the fuel vapors are drawn into the engine and burned off.

## Exhaust Emissions Controls

The exhaust emissions controls include four systems: PGM-FI, ignition timing control, exhaust gas recirculation and three way catalytic converter. These four systems work together to control the engine's combustion and minimize the amount of HC, CO, and NOx that comes out the tailpipe. The exhaust emissions control systems are separate from the crankcase and evaporative emissions control systems.

### *PGM-FI System*

The PGM-FI system uses sequential multiport fuel injection. It has three subsystems: air intake, engine control, and fuel control. The powertrain control module (PCM) uses various sensors to determine how much air is going into the engine. It then controls how much fuel to inject under all operating conditions.

### *Ignition Timing Control System*

This system constantly adjusts the ignition timing, reducing the amount of HC, CO, and NOx produced.

### *Exhaust Gas Recirculation (EGR) System*

The exhaust gas recirculation (EGR) system takes some of the exhaust gas and routes it back into the intake manifold. Adding exhaust gas to the air/fuel mixture reduces the amount of NOx produced when the fuel is burned.

### *Three Way Catalytic Converter*

The three way catalytic converter is in the exhaust system. Through chemical reactions, it converts HC, CO, and NOx in the engine's exhaust to carbon dioxide (CO<sub>2</sub>), nitrogen (N<sub>2</sub>), and water vapor.

## Replacement Parts

The emissions control systems are designed and certified to work together in reducing emissions to levels that comply with the Clean Air Act. To make sure the emissions remain low, you should use only new Honda replacement parts or their equivalent for repairs. Using lower quality parts may increase the emissions from your vehicle.

The emissions control systems are covered by warranties separate from the rest of your vehicle. Read your warranty manual for more information.

## Three Way Catalytic Converter

---

The three way catalytic converter contains precious metals that serve as catalysts, promoting chemical reactions to convert the exhaust gasses without affecting the metals. The catalytic converter is referred to as a three-way catalyst, since it acts on HC, CO, and NO<sub>x</sub>. A replacement unit must be an original Honda part or its equivalent.

The three way catalytic converter must operate at a high temperature for the chemical reactions to take place. It can set on fire any combustible materials that come near it. Park your vehicle away from high grass, dry leaves, or other flammables.

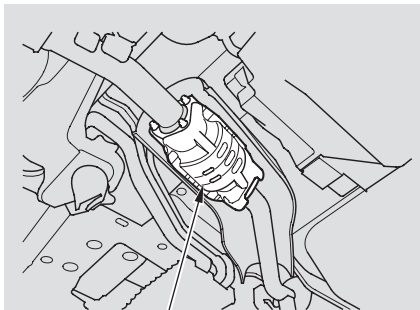

**THREE WAY CATALYTIC CONVERTER**

A defective three way catalytic converter contributes to air pollution, and can impair your engine's performance. Follow these guidelines to protect your vehicle's three way catalytic converter.

- Always use unleaded gasoline. Even a small amount of leaded gasoline can contaminate the catalyst metals, making the three way catalytic converter ineffective.

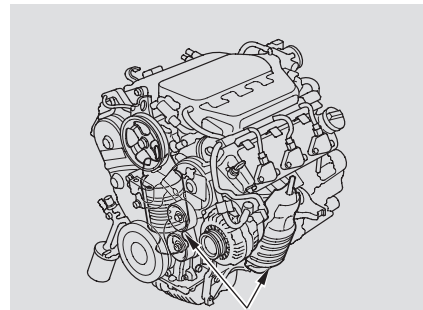

**THREE WAY CATALYTIC CONVERTERS**

- Keep the engine tuned-up.
- Have your vehicle diagnosed and repaired if it is misfiring, back-firing, stalling, or otherwise not running properly.

### Testing of Readiness Codes

If you take your vehicle for a state emissions test shortly after the battery has been disconnected or gone dead, it may not pass the test. This is because of certain “readiness codes” that must be set in the on-board diagnostics for the emissions systems. These codes are erased when the battery is disconnected, and set again only after several days of driving under a variety of conditions.

If the testing facility determines that the readiness codes are not set, you will be requested to return at a later date to complete the test. If you must get the vehicle retested within the next two or three days, you can condition the vehicle for retesting by doing the following.

- Make sure the gas tank is nearly, but not completely full (around 3/4).
- Make sure the vehicle has been parked with the engine off for 6 hours or more.
- Make sure the ambient temperature is between 40° and 95° F.

- Without touching the accelerator pedal, start the engine, and let it idle for 20 seconds.
- Keep the vehicle in Park (automatic transmission). Increase the engine speed to 2,000 rpm and hold it there until the temperature gauge rises to at least 1/4 of the scale (approximately 3 minutes).

*CONTINUED*

## State Emissions Testing

---

- Select a nearby lightly traveled major highway where you can maintain a speed of 50 to 60 mph (80 to 97 km/h) for at least 20 minutes. Drive on the highway in D (A/T). Do not use the cruise control. When traffic allows, drive for 90 seconds without moving the accelerator pedal. (Vehicle speed may vary slightly; this is okay.) If you cannot do this for a continuous 90 seconds because of traffic conditions, drive for at least 30 seconds, then repeat it two more times (for a total of 90 seconds).
- Then drive in city/suburban traffic for at least 10 minutes. When traffic conditions allow, let the vehicle coast for several seconds without using the accelerator pedal or the brake pedal.
- Stop the vehicle and turn the ignition switch off. Leave the vehicle for 30 minutes.

If the testing facility determines the readiness codes are still not set, see your dealer.

# Warranty and Customer Relations

---

Customer Service	
Information.....	398
Warranty Coverages .....	399
Reporting Safety Defects	
(U.S. Vehicles) .....	400
Authorized Manuals.....	401

## Customer Service Information

---

Honda dealership personnel are trained professionals. They should be able to answer all your questions. If you encounter a problem that your dealership does not solve to your satisfaction, please discuss it with the dealership's management. The service manager or general manager can help. Almost all problems are solved in this way.

If you are dissatisfied with the decision made by the dealership's management, contact your Honda Customer Service Office.

U.S. Owners:  
American Honda Motor Co., Inc.  
Automobile Customer Service  
Mail Stop 500-2N-7A  
1919 Torrance Boulevard  
Torrance, California 90501-2746

Tel: (800) 999-1009

Canadian Owners:  
**CUSTOMER RELATIONS  
RELATIONS AVEC LA CLIENTÉLE**

Honda Canada Inc.  
715 Milner Avenue  
Toronto, ON  
M1B 2K8

Tel: 1-888-9-HONDA-9  
Fax: Toll-free 1-877-939-0909  
Toronto (416) 287-4776

In Puerto Rico and the U.S. Virgin Islands:  
Bella International  
P.O. Box 190816  
San Juan, PR 00919-0816

Tel: (787) 250-4327

When you call or write, please give us this information:

- Vehicle Identification Number (see page 384)
- Name and address of the dealer who services your vehicle
- Date of purchase
- Mileage on your vehicle
- Your name, address, and telephone number
- A detailed description of the problem
- Name of the dealer who sold the vehicle to you

### U.S. Owners

Your new vehicle is covered by these warranties:

***New Vehicle Limited Warranty*** — covers your new vehicle, except for the battery, emissions control systems, and accessories, against defects in materials and workmanship.

***Emissions Control Systems Defects Warranty and Emissions Performance Warranty*** — these two warranties cover your vehicle's emissions control systems. Time, mileage, and coverage are conditional. Please read your warranty manual for exact information.

***Original Equipment Battery Limited Warranty*** — this warranty gives up to 100 percent credit toward a replacement battery.

***Seat Belt Limited Warranty*** — a seat belt that fails to function properly is covered for the useful life of the vehicle.

***Rust Perforation Limited Warranty*** — all exterior body panels are covered for rust-through from the inside for the specified time period with no mileage limit.

***Accessory Limited Warranty*** — Honda accessories are covered under this warranty. Time and mileage limits depend on the type of accessory and other factors. Please read your warranty manual for details.

***Replacement Parts Limited Warranty*** — covers all Honda replacement parts against defects in materials and workmanship.

***Replacement Battery Limited Warranty*** — provides prorated coverage for a replacement battery purchased from your dealer.

***Replacement Muffler Lifetime Limited Warranty*** — provides coverage for as long as the purchaser of the muffler owns the vehicle.

Restrictions and exclusions apply to all these warranties. Please read the 2005 Honda Warranty Information booklet that came with your vehicle for precise information on warranty coverages. Your vehicle's original tires are covered by their manufacturer. Tire warranty information is in a separate booklet.

### Canadian Owners

Please refer to the 2005 Warranty Manual that came with your vehicle.



## Reporting Safety Defects (U.S. Vehicles)

---

If you believe that your vehicle has a defect which could cause a crash or could cause injury or death, you should immediately inform the National Highway Traffic Safety Administration (NHTSA) in addition to notifying American Honda Motor Co., Inc.

If NHTSA receives similar complaints, it may open an investigation, and if it finds that a safety defect exists in a group of vehicles, it may order a recall and remedy campaign. However, NHTSA cannot become involved in individual problems between you, your dealer, or American Honda Motor Co., Inc.

To contact NHTSA, you may either call the Auto Safety Hotline toll-free at 1-800-424-9393 (or 366-0123 in Washington D.C. area) or write to: NHTSA, U.S. Department of Transportation, Washington, D.C. 20590. You can also obtain other information about motor vehicle safety from the Hotline.

## Purchasing Factory Authorized Manuals (U.S. only)

The publications shown below can be purchased from Helm Incorporated. You can order in any of three ways:

- Detach and mail the order form on the right half of this page
- Call Helm Inc. at 1-800-782-4356 (credit card orders only)
- Go online at [www.helminc.com](http://www.helminc.com)

If you are interested in other years or models, contact Helm Inc. at 1-800-782-4356.

Publication Form Number	Form Description	Price Each*
61SHJ00	2005 Honda Odyssey Service Manual	\$70.00
61SHJ00EL	2005 Honda Odyssey Electrical Troubleshooting Manual	\$50.00
61SHJ30	2005 Honda Odyssey Body Repair Manual	\$44.00
31SHJ600	2005 Honda Odyssey Owner's Manual	\$34.00
31SHJ700	2005 Honda Odyssey Navigation System Owner's Manual	\$29.00
31SHJM00	2005 Honda Odyssey Honda Service History	\$12.00
31SHJQ00	2005 Honda Odyssey Quick Start Guide	\$12.00
HON-R	Order Form for Previous Years- Indicate Year and Model Desired	FREE

\* Prices are subject to change without notice and without incurring obligation.

*Valid only for sales within the United States. Canadian owners should contact their authorized Honda dealer.*

**ORDER TOLL FREE: 1-800-782-4356**

**(NOTE: For Credit Card Holder Orders Only)**

Monday-Friday 8:00 A.M. — 6:00 P.M. EST

**MINIMUM CREDIT CARD PURCHASE \$10.00**

**OR**

By completing this form you can order the materials desired. You can pay by check or money order, or charge to your credit card. Mail to Helm Incorporated at the address shown on the back of the order form.

2005 HONDA	PUBLICATION NUMBER	VEHICLE MODEL		Qty	Price Each*	Total Price
		Name	Year			
* Prices are subject to change without notice and without incurring obligation.  Orders are mailed within 10 days. Please allow adequate time for delivery.					TOTAL MATERIAL	
					Mich. Purchases Add 6% Sales Tax	
					HANDLING CHARGE	\$6.95
					GRAND TOTAL	

Authorized Manuals

# Authorized Manuals

S H I P T O	NOTE: Dealers and Companies please provide dealer or company name, and also the name of the person to whose attention the shipment should be sent. For purchases outside U.S.A. please write to the address shown below for a quotation.	
	_____	_____
	Customer Name	Attention
	_____	_____
	Street Address — No P.O. Box Number	Apartment Number
_____	_____	
City	State & Zip Code	
Daytime Telephone Number (     ) _____		

P A Y M E N T	<input type="checkbox"/> Check or money order enclosed payable to Helm Inc — U.S. funds only. Do not send cash				
	<input type="checkbox"/> Master Card <input type="checkbox"/> VISA <input type="checkbox"/> Check here if your billing address is different from the shipping address shown above.				
	Account Number _____     Expiration: Mo. Yr. _____				
	<table border="1" style="width: 100%; border-collapse: collapse;"><tr><td style="width: 25%; height: 20px;"> </td><td style="width: 25%; height: 20px;"> </td><td style="width: 25%; height: 20px;"> </td><td style="width: 25%; height: 20px;"> </td></tr></table>				
	_____	_____			
CUSTOMER SIGNATURE	DATE				

These Publications cannot be returned for credit without receiving advance authorization within 14 days of delivery. On returns, a restocking fee may be applied against the original order.

**HELM** P.O. BOX 07280-DETROIT, MICHIGAN 48207-1-800-782-4356

## Service Manual:

This manual covers maintenance and recommended procedures for repair to engine and chassis components. It is written for the journeyman mechanic, but is simple enough for most mechanically-inclined owners to understand.

## Electrical Troubleshooting Manual:

This manual complements the service manual by providing in-depth troubleshooting information for each electrical circuit in your vehicle.

## Body Repair Manual:

This manual describes the procedures involved in the replacement of damaged body parts.

## A

Accessories.....	284
ACCESSORY (Ignition Key Position).....	130
Accessory Power Sockets.....	182
AC Power Outlet.....	182
Additives, Engine Oil.....	329
Adjustable Driver's Foot Pedals.....	169
Advanced Airbag System.....	29
Airbag (SRS).....	11, 25
Air Conditioning System.....	188
Rear A/C Control.....	194, 197
Air Outlets (Vents).....	191
Air Pressure, Tires.....	346
Alcohol in Gasoline.....	278
Antifreeze.....	331
Anti-lock Brakes (ABS) Indicator.....	65, 300
Operation.....	300
Anti-theft, Audio System.....	229
Anti-theft Steering Column Lock.....	130
Armrests.....	152
Audio Controls, Remote.....	228

Audio System.....	199
Automatic Seat Belt Tensioners....	23
Automatic Lighting Off Feature..	124
Automatic Speed Control.....	264
Automatic Transmission.....	294
Capacity, Fluid.....	386
Checking Fluid Level.....	334
Shifting.....	294
Shift Lever Position Indicators.....	294
Shift Lever Positions.....	294
Shift Lock Release.....	297

## B

Battery	
Charging System Indicator.....	63, 371
Jump Starting.....	367
Maintenance.....	352
Specifications.....	387
Before Driving.....	277
Belts, Seat.....	10, 22
Beverage Holders.....	171
Booster Seats.....	53

Brakes	
Anti-lock System (ABS).....	300
Break-in, New Linings.....	278
Bulb Replacement.....	341
Fluid.....	335
Parking.....	169
System Indicator.....	63, 373
Wear Indicators.....	299
Braking System.....	299
Break-in, New Vehicle.....	278
Brightness Control, Instruments..	125
Brights, Headlights.....	122
Bulb Replacement	
Back-up Lights.....	342
Brake Lights.....	341
Front Parking Lights.....	339
Front Side Marker Lights.....	339
Front Turn Signal Light.....	338
Headlights.....	337
Rear Bulbs.....	341, 342
Rear Turn Signal Light.....	341
Specifications.....	387
Bulbs, Halogen.....	337

CONTINUED

# Index

## C

Cancel Button.....	266
Capacities Chart.....	386
Carbon Monoxide Hazard .....	56
Cargo Area Light.....	185
Cargo Hooks .....	289
Cargo, How to Carry .....	286
Cargo Net .....	289
CAUTION, Explanation of .....	ii
CD Care .....	221
CD Changer.....	215
CD Changer Error Message .....	222
CD Player.....	212
Center Pocket .....	181
Center Tray .....	171
Certification Label.....	384
Chains, Tires .....	350
Changing Oil	
How to.....	329
When to.....	315
Changing a Flat Tire .....	360
Charging System Indicator ....	63, 371
Checklist, Before Driving.....	292
Childproof Door Locks .....	138
Child Safety .....	36
Booster Seats .....	53
Child Seats.....	43
Important Safety Reminders.....	40
Infants .....	41
Larger Children .....	51
LATCH.....	45
Risks with Airbags.....	37
Small Children.....	42
Tethers.....	51
Where Should A Child Sit?.....	37
Child Seats.....	43
LATCH Anchorage System .....	45
Tether Anchorage Points .....	50
Cleaning	
Seat Belts.....	343
Climate Control System.....	193
Clock .....	227
Code, Audio System .....	229
CO in the Exhaust .....	392
Cold Weather, Starting in.....	293
Compact Spare Tire.....	359
Consumer Information *.....	398
Controls, Instruments and.....	59
Conversation Mirror .....	174

Coolant	
Adding.....	331
Checking.....	282
Proper Solution .....	331
Temperature Gauge.....	71
Crankcase Emissions Control	
System.....	392
Cruise Control Indicator .....	69
Cruise Control Operation .....	264
Cup Holders.....	171
Customer Service Office .....	398

## D

DANGER, Explanation of .....	ii
Dashboard .....	4, 60
Daytime Running Lights.....	125
Daytime Running Lights	
Indicator.....	69
Dead Battery .....	367
Defects, Reporting Safety.....	400
Defogger, Rear Window .....	126
Defrosting the Windows.....	192
Dimensions.....	386
Dimming the Headlights .....	122

Dipstick	
Automatic Transmission.....	334
Engine Oil.....	281
Directional Signals.....	122
Disc Brake Wear Indicators.....	299
Disposal of Used Oil.....	330
Doors	
Locking and Unlocking.....	137
Lockout Prevention.....	137
Manual Sliding Doors.....	142
Monitor Light.....	67
Power Door Locks.....	137
Power Sliding Doors.....	142
DOT Tire Quality Grading.....	388
Driver and Passenger Safety.....	7
Driver's Seat Position Memory	
System.....	161
Driving.....	291
Economy.....	283
DVD Error Message.....	259
DVD Player.....	230

## E

Economy, Fuel.....	283
--------------------	-----

Emergencies.....	355
Battery, Jump Starting.....	367
Brake System Indicator.....	373
Changing a Flat Tire.....	360
Charging System Indicator.....	371
Checking the Fuses.....	376
Closing the Moonroof.....	374
Driving with a Flat Tire.....	356
Hazard Warning Flashers.....	126
Jump Starting.....	367
Low Oil Pressure Indicator.....	371
Malfunction Indicator Lamp.....	372
Overheated Engine.....	369
Towing.....	381
Emergency Brake.....	169
Emergency Flashers.....	126
Emergency Towing.....	381
Emissions Controls.....	392
Emissions Testing, State.....	395
Engine	
Coolant Temperature Gauge.....	71
Engine Speed Limiter.....	296
If It Won't Start.....	366
Malfunction Indicator	
Lamp.....	63, 372
Oil Pressure Indicator.....	63, 371

Oil, What Kind to Use.....	328
Overheating.....	369
Specifications.....	387
Starting.....	293
Evaporative Emissions Controls..	392
Exhaust Fumes.....	56
Exhaust Gas Recirculation	
System.....	393
Expectant Mothers, Use of Seat	
Belts by.....	20

## F

Fan, Interior.....	189
Features, Comfort and	
Convenience.....	187
Filling the Fuel Tank.....	279
Filters, Oil.....	329
Flashers, Hazard Warning.....	126
Flat Tire, Changing a.....	360
Floor Mats.....	343
Floor Storage Area.....	177

CONTINUED



Indicators.....	63
ABS (Anti-lock Brake) .....	65, 300
Brake (Parking and Brake System) .....	63, 373
Charging System .....	63, 371
Cruise Control.....	69
DRL (Daytime Running Lights) .....	69
Fog Light .....	69
Fuel Economy .....	70
High Beam.....	69
Key (Immobilizer System) .....	67
Lights On.....	66
Low Fuel .....	68
Low Oil Pressure .....	63, 371
Low Tire Pressure .....	66
Maintenance Required.....	70
Side Airbag Off .....	33, 64
SRS .....	32, 64
System Message.....	70
Turn Signal and Hazard Warning .....	68
Vehicle Stability Assist (VSA) System.....	65
VSA Activation .....	65
Washer Level .....	69

Individual Map Lights .....	184
Infant Restraint .....	41
Infant Seats.....	43
LATCH Anchorage System .....	45
Lower Anchors .....	45
Tether Anchorage Points .....	50
Inflation, Proper Tire .....	346
In-Floor Storage Area.....	177
Inside Mirror .....	167
Inspection, Tire.....	347
Instrument Panel .....	4, 60
Instrument Panel Brightness .....	125
Integrated Sunshade .....	173
Interior Lights.....	183
Introduction.....	i

## J

Jacking up the Vehicle .....	361
Jack, Tire .....	360
Jump Starting .....	367

## K

Keys.....	128
-----------	-----

## L

Label, Certification.....	384
Lane Change, Signaling .....	122
Lap/Shoulder Belts.....	17, 22
LATCH Anchorage System.....	45
Lazy Susan.....	179
Light Control Switch .....	183
Lights	
Bulb Replacement .....	337
Indicator .....	63
Interior .....	183
Parking.....	122
Turn Signal.....	122
Load Limits.....	287, 306
LOCK (Ignition Key Position) ....	130
Locks	
Anti-theft Steering Column .....	130
Fuel Fill Door .....	279
Glove Box .....	180
Lockout Prevention .....	137
Power Door .....	137
Sliding Doors.....	142
Tailgate .....	138

CONTINUED



# Index

Low Coolant Level.....	282
Low Fuel Indicator .....	68
Low Oil Pressure Indicator ....	63, 371
Lower Anchors.....	45
Lower Glove Box.....	180
Lubricant Specifications Chart ...	386
Luggage Net (Cargo Net) .....	289
Luggage, Storing (Cargo) .....	286

## M

Maintenance.....	313
Minder .....	315-324
Owner Maintenance Checks....	323
Record.....	325-326
Required Indicator.....	70
Safety.....	314
Malfunction Indicator Lamp ..	63, 372
Manual Sliding Doors.....	142
Meters, Gauges.....	71
Michilen PAX System .....	356
Mirrors, Adjusting .....	167
Modifications.....	284
Modifying Your Vehicle.....	284
Moonroof .....	166

Moving the Second Row Bucket Seat.....	154
Multi-Information Display .....	74

## N

Neutral Gear Position.....	295
New Vehicle Break-in .....	278
NOTICE, Explanation of.....	i
Numbers, Identification .....	384

## O

Octane Requirement, Gasoline ...	278
Odometer.....	72
Odometer, Trip .....	72
Oil	
Change, How to .....	329
Change, When to .....	315
Checking Engine .....	281
Pressure Indicator .....	63, 371
Selecting Proper Viscosity Chart .....	328
ON (Ignition Key Position) .....	130
Onboard Refueling Vapor Recovery .....	392

Outside Mirrors.....	167
Overheating, Engine .....	369
Owner Maintenance Checks.....	323
Oxygenated Fuels.....	278

## P

Panel Brightness Control .....	125
Park Gear Position.....	295
Parking.....	298
Parking Brake .....	169
Parking Brake and Brake System Indicator.....	63, 373
Parking Lights.....	122
Parking Sensor System .....	271
Parking Over Things that Burn...	298
Passenger Airbag Off Indicator....	33
PAX System.....	356
PGM-FI System.....	393
Power Door Locks.....	137
Power Sliding Doors	
Indicator.....	67
Operation .....	142
Switches.....	143
Power Socket Locations.....	182
Power Tailgate .....	139

Power Windows .....	163
Pregnancy, Using Seat Belts .....	20
Protecting Adults and Teens.....	14
Additional Safety Precautions.....	20
Advice for Pregnant Women.....	20
Protecting Children .....	36
Protecting Infants.....	41
Protecting Larger Children.....	51
Protecting Small Children .....	42
Using Child Seats with Tethers.....	50
Using LATCH .....	45

## R

Radiator Overheating.....	369
Radio/CD Sound System.....	199
Readiness Codes.....	372
Rear Audio Control Panel.....	234
Rear A/C Unit.....	194
Rear Entertainment System.....	230
Rear Lights, Bulb Replacement.....	341, 342
Rearview Camera and Monitor ...	275
Rear View Mirror.....	167
Rear Window Defogger .....	126

Rear Window Wiper and Washer.....	122
Reclining the Seat Backs.....	150, 151
Reclining the Second Seats .....	150
Reclining the Third Seat.....	150
Reminder Indicators.....	64
Remote Audio Controls.....	228
Remote Control (RES) .....	257
Remote Transmitter .....	131
Removable Second Row Console .....	176
Removing the Second Seats .....	155
Replacement Information Engine Oil and Filter .....	329
Fuses .....	376
Light Bulbs.....	337
Timing Belt.....	336
Tires .....	349
Wiper Blades.....	344
Replacing Seat Belts After a Crash.....	23
Reserve Tank, Engine Coolant .....	282, 331
Retractable Center Tray .....	171
Reverse Gear Position.....	295
Roof Rack .....	288

Rotation, Tire .....	348
----------------------	-----

## S

Safety Belts.....	10, 22
Safety Defects, Reporting* .....	400
Safety Features .....	9
Airbags.....	11
Seat Belts .....	10
Safety Labels, Location of .....	57
Safety Messages.....	ii
Seat Belts.....	10, 22
Additional Information.....	22
Automatic Seat Belt Tensioners.....	23
Cleaning.....	343
Lap/Shoulder Belt .....	22
Maintenance.....	23
Reminder Indicator and Beeper.....	22, 64
Replacement.....	23
System Components.....	22
Use During Pregnancy.....	20
Wearing a Lap/Shoulder Belt....	16
Seat Heaters .....	160

CONTINUED

# Index

Seats .....	148	Off Indicator .....	33, 64	With a Dead Battery .....	367
Adjustments .....	149, 151	Side Marker Lights, Bulb		State Emissions Testing .....	395
Drivers Lumbar Support.....	152	Replacement.....	339	Steam Coming from Engine.....	369
Folding the Third Seat .....	158	Signaling Turns.....	122	Steering Wheel	
Head Restraints .....	152	Sliding Doors.....	142	Adjustment .....	127
Installing the Stowable Second		Snow Tires.....	350	Anti-theft Column Lock .....	130
Row Plus-One Seat .....	156	Sound System.....	199	Buttons.....	75, 228
Manual Height Adjustment.....	150	Spare Tire		Stereo Sound System .....	199
Passenger Seating .....	148	Inflating.....	359	Storing Your Vehicle .....	353
Reclining the Second Seat .....	150	Specifications .....	387	Stowable Second Row Plus-One	
Reclining the Third Seat.....	150	Spark Plugs.....	387	Seat .....	156
Removing the Second Seats ....	155	Specifications Charts.....	386	Sunglasses Holder .....	174
Third Seat Access.....	153	Speed Control.....	264	Sun Visor.....	175
Security System .....	263	Speedometer .....	71	Supplemental Restraint System	
Sensors		SRS, Additional Information.....	25	Servicing .....	34
Front Passenger's Weight		Additional Safety Precautions...	35	SRS Indicator.....	32, 64
Sensors.....	29	Airbag Service.....	34	System Components.....	25
Driver's Seat Position Sensor ....	29	How the SRS Indicator Works...	32	Synthetic Oil.....	329
Serial Number .....	384	How Your Airbags			
Service Intervals .....	315	Work .....	27, 30, 32		
Service Manual* .....	401	SRS Components .....	25		
Service Station Procedure .....	279	SRS Indicator.....	32, 64		
Setting the Clock .....	227	START (Ignition Key Position) ...	130		
Shift Lever Position Indicators ....	294	Starting the Engine.....	293		
Shift Lock Release.....	297	In Cold Weather at High			
Side Airbags .....	11, 30	Altitude .....	293		

## T

Tachometer .....	71
Tailgate .....	138
Opening the.....	138
Open Monitor Light .....	67
Taillights, Changing Bulbs...	341, 342

Taking Care of the Unexpected ..	355	Rotating.....	348	Unleaded Gasoline.....	278
Technical Descriptions		Snow .....	350	Upper Glove Box.....	180
Emissions Control Systems.....	392	Specifications .....	387	Used Oil, How to Dispose of .....	330
Three Way Catalytic Converter.....	393	Tire Chains.....	350		
Temperature Gauge .....	71	Tools, Tire Changing .....	360	<b>V</b>	
Temperature, Inside Sensor.....	198	Towing		Vanity Mirror .....	176
Tensioners, Seat Belts .....	23	A Trailer.....	306	Vehicle Capacity Load .....	287, 306
Tether Anchorage Points .....	50	Emergency Wrecker.....	381	Vehicle Dimensions.....	386
Theft Protection.....	229	Equipment and Accessories.....	308	Vehicle Identification Number.....	384
Three Way Catalytic Converter..	393	Weight Limit .....	287, 306	Vehicle Storage.....	353
Tilt the Steering Wheel.....	127	Trailer Loading .....	308	Ventilation .....	191
Time, Setting the .....	227	Trailer Towing Tips.....	311	VIN .....	384
Timing Belt.....	336	Transmission		Viscosity, Oil.....	328
Tire Chains .....	350	Checking Fluid Level .....	334		
Tire, How to Change a Flat .....	360	Fluid Selection.....	334	<b>W</b>	
Tires .....	346	Identification Number.....	384	WARNING, Explanation of .....	ii
Air Pressure .....	346	Shifting the Automatic.....	294	Warning Labels, Location of .....	57
Balancing .....	348	Treadwear .....	388	Warranty Coverages* .....	399
Checking Wear .....	347	Trip Meter .....	72, 77	Washer, Windshield	
Compact Spare.....	359	Turn Signals .....	122	Checking the Fluid Level .....	333
DOT Tire Quality Grading .....	388			Level Indicator .....	69
Inflation.....	346	<b>U</b>		Operation.....	121
Inspection .....	347	Unexpected, Taking Care			
Labeling .....	390	of the .....	355		
Replacing .....	349	Uniform Tire Quality Grading .....	388		

# Index

---

Wheels	
Adjusting the Steering .....	127
Alignment and Balance .....	348
Compact Spare .....	359
Wrench .....	362
Windows	
Auto Reverse .....	163
Operating the Power .....	163
Rear, Defogger .....	126
Windshield	
Cleaning .....	121
Defroster .....	192
Washers .....	121
Wipers, Windshield	
Changing Blades .....	344
Operation .....	121
Rear Windshield Wiper and Washer .....	122
Wireless Headphones .....	260
Worn Tires .....	347
Wrecker, Emergency Towing .....	381

\* : U.S. only

## Service Information Summary

---

### **Gasoline:**

Unleaded gasoline, pump octane number of 86 or higher.

### **Fuel Tank Capacity:**

21 US gal (80 ℓ)

### **Recommended Engine Oil:**

API Premium grade 5W-20 detergent oil (see page [328](#)).

Oil change capacity (including filter):

4.5 US qt (4.3 ℓ)

### **Automatic Transmission Fluid:**

Honda ATF-Z1 (Automatic Transmission Fluid) preferred, or a DEXRON® III ATF as a temporary replacement (see page [334](#)).

### **Power Steering Fluid:**

Honda Power Steering Fluid preferred, or another brand of power steering fluid as a temporary replacement. Do not use ATF (see page [336](#)).

### **Brake Fluid:**

Honda Heavy Duty Brake Fluid DOT 3 preferred, or a DOT 3 or DOT 4 brake fluid as a temporary replacement (see page [335](#)).

### **Tire Pressure (measured cold):**

LX, EX, and U.S. Touring models:  
Front:

33 psi (230 kPa , 2.3 kgf/cm<sup>2</sup>)

Rear:

35 psi (240 kPa , 2.4 kgf/cm<sup>2</sup>)

EX with Leather and Canadian Touring models:

Front:

35 psi (240 kPa , 2.4 kgf/cm<sup>2</sup>)

Rear:

35 psi (240 kPa , 2.4 kgf/cm<sup>2</sup>)

Compact Spare Tire:

60 psi (420 kPa , 4.2 kgf/cm<sup>2</sup>)