

2001 Odyssey Online Reference Owner's Manual

Use these links (and links throughout this manual) to navigate through this reference.
For a printed owner's manual, click on authorized manuals or go to www.helminc.com.

Contents

Owner's Identification Form

Introduction	i
A Few Words About Safety	ii
Your Vehicle at a Glance	2
Driver and Passenger Safety	5
Proper use and care of your vehicle's seat belts, and Supplemental Restraint System.	
Instruments and Controls	59
Instrument panel indicator and gauge, and how to use dashboard and steering column controls.	
Comfort and Convenience Features	135
How to operate the climate control system, the audio system, and other convenience features.	
Before Driving	195
What gasoline to use, how to break-in your new vehicle, and how to load luggage and other cargo.	
Driving	209
The proper way to start the engine, shift the transmission, and park, plus towing a trailer.	
Maintenance	235
The Maintenance Schedule shows you when you need to take your vehicle to the dealer.	
Appearance Care	293
Tips on cleaning and protecting your vehicle. Things to look for if your car ever needs body repairs.	
Taking Care of the Unexpected	301
This section covers several problems motorists sometimes experience, and how to handle them.	
Technical Information	331
ID numbers, dimensions, capacities, and technical information.	
Warranty and Customer Relations (U.S. and Canada)	345
A summary of the warranties covering your new Honda, and how to contact us.	
Authorized Manuals (U.S. only)	351
How to order manuals and other technical literature.	
Index	I

Service Information Summary

A summary of information you need when you pull up to the fuel pump.

Navigation System

Congratulations ! Your selection of a 2001 Honda Odyssey was a wise investment. It will give you years of driving pleasure.

One of the best ways to enhance the enjoyment of your new Honda is to read this manual. In it, you will learn how to operate its driving controls and convenience items. Afterwards, keep this owner's manual in your vehicle so you can refer to it at any time.

Several warranties protect your new Honda. Read the warranty booklet thoroughly so you understand the coverages and are aware of your rights and responsibilities.

Maintaining your vehicle according to the schedules given in this manual helps to keep your driving trouble-free while it preserves your investment. When your vehicle needs maintenance, keep in mind that your Honda dealer's staff is specially trained in servicing the many systems unique to your Honda. Your Honda dealer is dedicated to your satisfaction and will be pleased to answer any questions and concerns.

California Proposition 65 Warning

WARNING: This product contains or emits chemicals known to the State of California to cause cancer and birth defects or other reproductive harm.

As you read this manual, you will find information that is preceded by a **NOTICE** symbol. This information is intended to help you avoid damage to your Honda, other property, or the environment.

A Few Words About Safety

Your safety, and the safety of others, is very important. And operating this vehicle safely is an important responsibility.

To help you make informed decisions about safety, we have provided operating procedures and other information on labels and in this manual. This information alerts you to potential hazards that could hurt you or others.

Of course, it is not practical or possible to warn you about all the hazards associated with operating or maintaining your vehicle. You must use your own good judgement.

You will find this important safety information in a variety of forms, including:

- **Safety Labels** — on the vehicle.
- **Safety Messages** — preceded by a safety alert symbol  and one of three signal words: **DANGER**, **WARNING**, or **CAUTION**.

These signal words mean:

You **WILL** be **KILLED** or **SERIOUSLY HURT** if you don't follow instructions.

You **CAN** be **KILLED** or **SERIOUSLY HURT** if you don't follow instructions.

You **CAN** be **HURT** if you don't follow instructions.

- **Safety Headings** — such as Important Safety Reminders or Important Safety Precautions.
- **Safety Section Instructions** — such as Driver and Passenger Safety.
- **Instructions** — how to use this vehicle correctly and safely.

This entire book is filled with important safety information — please read it carefully.

Your Vehicle at a Glance

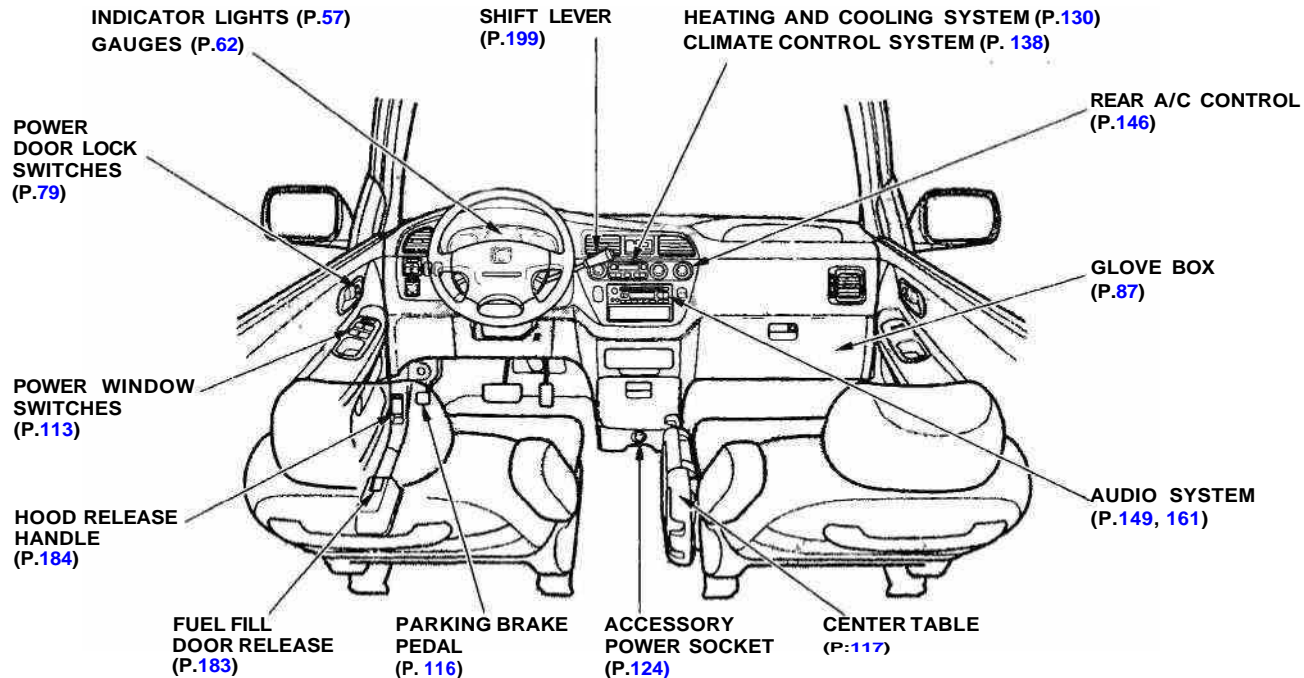

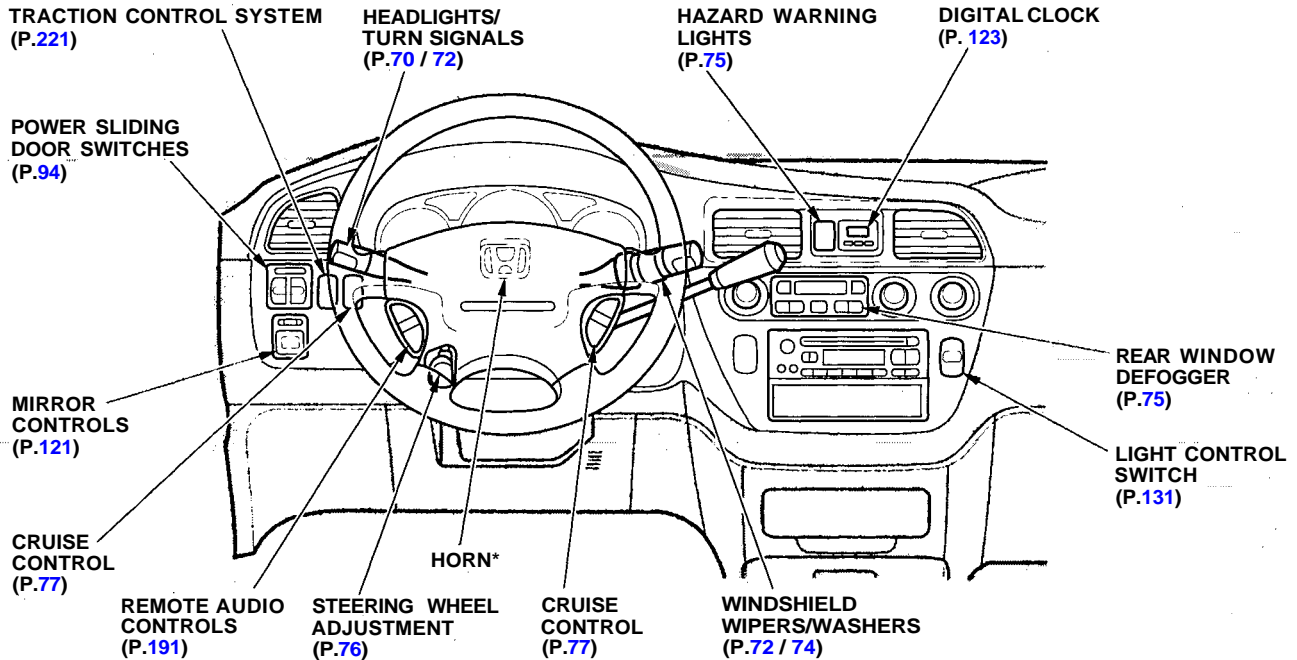

*: To use the horn, press the pad around the "H" logo.

This section gives you important information about how to protect yourself and your passengers. It shows you how to use seat belts properly. It explains your Supplemental Restraint System. And it tells you how to properly restrain infants and children in your vehicle.

Important Safety Precautions.....	6
Your Vehicle's Safety Features.....	7
Seat Belts.....	8
Airbags.....	9
Seats & Seat-Backs.....	10

Head Restraints.....	10
Door Locks.....	10
Pre-Drive Safety Checklist.....	11
Protecting Adults.....	12
1. Close and Lock the Doors.....	12
2. Adjust the Front Seats.....	12
3. Adjust the Seat-Backs.....	13
4. Adjust the Head Restraints....	14
5. Fasten and Position the Seat Belts.....	15
6. Adjust the Steering Wheel....	19
7. Maintain a Proper Sitting Position.....	19
Advice for Pregnant Women.....	20
Additional Safety Precautions....	20
Protecting Children.....	22
All Children Must Be Restrained.....	22
Children Should Sit in the Back Seat.....	23
The Passenger's Airbag Poses Serious Risks to Children.....	24
If You Must Drive with Several Children.....	26
If a Child Requires Close Attention.....	26

Additional Safety Precautions....	27
General Guidelines for Using Child Seats.....	28
Protecting Infants.....	32
Protecting Small Children.....	37
Protecting Larger Children.....	41
Using Child Seats with Tethers.....	45
Using the Lower Anchorages....	47
Additional Information About Your Seat Belts.....	49
Seat Belt System Components...	49
Lap/Shoulder Belt.....	49
Seat Belt Maintenance.....	51
Additional Information About Your SRS.....	52
SRS Components.....	52
How Your Airbags Work.....	52
How the Automatic Seat Belt Tensioners Work.....	54
How the SRS Indicator Light Works.....	54
SRS Service.....	55
Additional Safety Precautions....	56
Carbon Monoxide Hazard.....	57
Safety Labels.....	58

Important Safety Precautions

You'll find many safety recommendations throughout this section, and throughout this manual. The recommendations on this page are the ones we consider to be the most important.

Always Wear Your Seat Belt

A seat belt is your best protection in all types of collisions. Airbags supplement seat belts, but airbags are designed to inflate only in a moderate to severe frontal collision. So even though your vehicle is equipped with airbags, make sure you and your passengers always wear your seat belts, and wear them properly. (See page [15](#).)

Restrain All Children

Children are safest when they are properly restrained in a back seat, not the front seat. A child who is too small for a seat belt must be properly restrained in a child safety seat. (See page [22](#).)

Be Aware of Airbag Hazards

While airbags can save lives, they can cause serious or fatal injuries to occupants who sit too close to them, or are not properly restrained. Infants, young children, and short adults are at the greatest risk. Be sure to follow all instructions and warnings in this manual. (See page [9](#).)

Don't Drink and Drive

Alcohol and driving don't mix. Even one drink can reduce your ability to respond to changing conditions, and your reaction time gets worse with every additional drink. So don't drink and drive, and don't let your friends drink and drive, either.

Control Your Speed

Excessive speed is a major factor in crash injuries and deaths. Generally, the higher the speed the greater the risk, but serious accidents can also occur at lower speeds. Never drive faster than is safe for current conditions, regardless of the maximum speed posted.

Keep Your Vehicle in Safe Condition

Having a tire blowout or a mechanical failure can be extremely hazardous. To reduce the possibility of such problems, check your tire pressures and condition frequently, and perform all regularly scheduled maintenance. (See page [240](#).)

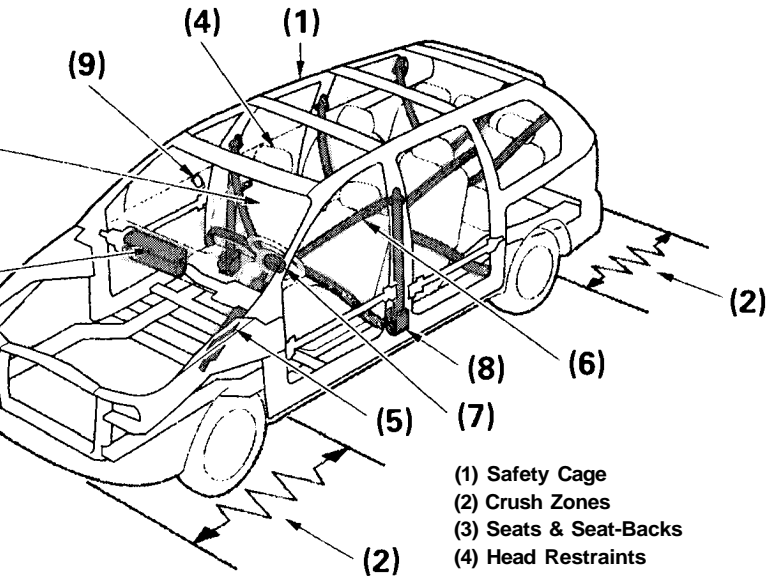

- (1) Safety Cage
- (2) Crush Zones
- (3) Seats & Seat-Backs
- (4) Head Restraints
- (5) Collapsible Steering Column
- (6) Seat Belts
- (7) Airbags
- (8) Seat Belt Tensioners
- (9) Door Locks

Your vehicle is equipped with many safety features that work together to protect you and your passengers during a crash.

Some safety features do not require any action on your part. These include a strong steel framework that forms a safety cage around the passenger compartment; front and rear crush zones that are designed to crumple and absorb energy during a crash; a collapsible steering column and seat belt tensioners that automatically tighten the front seat belts in the event of a crash.

These safety features are designed to reduce the severity of injuries in a crash. However, you and your passengers can't take full advantage of these safety features unless you remain sitting in a proper position and ***always wear your seat belts properly.*** In fact, some safety features can contribute to injuries if they are not used properly.

Your Vehicle's Safety Features

Seat Belts

For your safety, and the safety of your passengers, your vehicle is equipped with seat belts in all seating positions.



Your seat belt system also includes a light on the instrument panel to remind you and your passengers to fasten your seat belts.

Why Wear Seat Belts

Seat belts are the single most effective safety device for adults and larger children. (Infants and smaller children must be properly restrained in child seats.)

Not wearing a seat belt properly increases the chance of serious injury or death in a crash, even though your vehicle has airbags.

In addition, most states and all Canadian provinces require you to wear seat belts.

Not wearing a seat belt properly increases the chance of serious injury or death in a crash, even if you have airbags.

Be sure you and your passengers always wear seat belts and wear them properly.

When properly worn, seat belts:

- Keep you connected to the vehicle so you can take advantage of the vehicle's built-in safety features.
- Help protect you in almost every type of crash, including side and rear impacts and rollovers. (Your airbag can only be helpful in a moderate to severe frontal

collision.)

- Help keep you from being thrown against the inside of the vehicle and against other occupants.
- Keep you from being thrown out of the vehicle.
- Help keep you in a good position should the airbags ever deploy. A good position reduces the risk of injury from an inflating airbag, and allows you to get the best advantage from the airbag.

Of course, seat belts cannot completely protect you in every crash. But in most cases, seat belts can reduce your risk of serious injury.

What you should do: Always wear your seat belt, and make sure you wear it properly.

Airbags

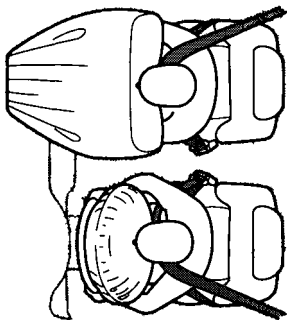

Your vehicle has a Supplemental Restraint System (SRS) with frontal airbags to help protect the driver and a front seat passenger.

This system also includes an indicator light on the instrument panel to alert you to a possible problem with the system.

The most important things you need to know about your airbags are:

- ***Airbags do not replace seat belts.*** The seat belts are the occupants' primary protection in all types of collisions. The airbags supplement the seat belts by providing extra protection for the head and chest of each front seat occupant in a moderate to severe frontal collision.
- ***Airbags offer no protection in side impacts, rear impacts, rollovers, or minor collisions.*** Airbags are designed to deploy only during a moderate to severe frontal collision.
- ***Airbags can pose serious hazards.*** To do their job, airbags must inflate with tremendous force and speed. So while airbags save lives, they can cause serious injuries to adults and larger children who are

not wearing seat belts, are not wearing them properly, are sitting too close to the airbag, or are not sitting in a proper position. Infants and small children are at an even greater risk of injury or death.

What you should do: Always wear your seat belt properly, and sit upright and as far back as possible from the steering wheel or dashboard.

Your Vehicle's Safety Features

Seats & Seat-Backs

Your vehicle's seats are designed to keep you in a comfortable, upright position so you can take full advantage of the protection offered by seat belts and the energy absorbing materials in the seats.

How you adjust your seats and seat-backs can also affect your safety. For example, sitting too close to the steering wheel or dashboard increases the risk of you or your passenger being injured by striking the inside of the vehicle, or by an inflating airbag.

Reclining a seat-back too far reduces the seat belt's effectiveness and increases the chance that the seat's occupant will slide under the seat belt in a crash and be seriously injured.

What you should do: Move the front seats as far back as possible, and keep adjustable seat-backs in an upright position whenever the vehicle is moving.

Head Restraints

Head restraints can help protect you from whiplash and other injuries. For maximum protection, the back of your head should rest against the center of the head restraint.

Door Locks

Keeping your doors locked reduces the chance of being thrown out of the vehicle during a crash. It also helps prevent occupants from accidentally opening a door and falling out, and outsiders from unexpectedly opening your doors.

Pre-Drive Safety Checklist

To make sure you and your passengers get the maximum protection from your vehicle's safety features, check the following each time before you drive away:

- All adults, and children who have outgrown child safety seats, are wearing their seat belts and wearing them properly (see page 15).
- Any infant or small child is properly restrained in a child seat in a back seat (see page 22).
- Front seat occupants are sitting upright and as far back as possible from the steering wheel and dashboard (see page 12).
- Seat-backs are upright (see page 13).

- Head restraints are properly adjusted (see page 14).
- All doors and the tailgate are closed and locked (see page 12).
- All cargo is properly stored or secured (see page 205).

The rest of this section gives more detailed information about how you can maximize your safety.

Remember, however, that no safety system can prevent all injuries or deaths that can occur in severe crashes, even when seat belts are properly worn and the airbags deploy.

Protecting Adults

Introduction

The following pages provide instructions on how to properly protect the driver and other adult occupants.

These instructions also apply to children who have outgrown child seats and are large enough to wear lap/shoulder belts. (See page 41 for important additional guidelines on how to properly protect larger children.)

1. Close and Lock the Doors

After everyone has entered the vehicle, be sure the doors and tailgate are closed and locked.

Your vehicle has a door and tailgate monitor light on the instrument panel to indicate when a specific door or the tailgate is not tightly closed.

For safety, locking the doors reduces the chance that a passenger, especially a child, will open a door while the vehicle is moving and accidentally fall out. It also reduces the chance of someone being thrown out of the vehicle during a crash.

For security, locked doors can prevent an outsider from unexpectedly opening a door when you come to a stop.

See page 83 for how to lock the doors.

2. Adjust the Front Seats

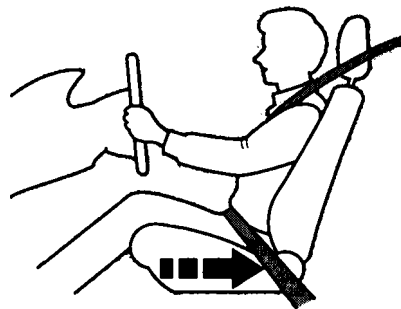

Any driver who sits too close to the steering wheel is at risk of being seriously injured or killed by striking the steering wheel, or from being struck by an inflating airbag during a crash.

To reduce the chance of injury, wear your seat belt properly, sit upright with your back against the seat, and move the seat as far back as possible from the steering wheel while still maintaining full control of the vehicle. Also make sure your front seat passenger moves the seat as far to the rear as possible.

Sitting too close to an airbag can result in serious injury or death if the airbags inflate.

Always sit as far back from the airbags as possible.

Most shorter drivers can get far enough away from the steering wheel and still reach the pedals. However, if you are concerned about sitting too close, we recommend that you investigate whether some type of adaptive equipment may help.

Once your seat is adjusted correctly, rock it back and forth to make sure the seat is locked in position.

See page [105](#) for how to adjust the front seats.

3 .Adjust the Seat-Backs

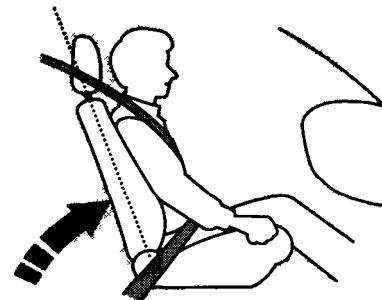

Adjust the driver's seat-back to a comfortable, upright position, leaving ample space between your chest and the airbag cover in the center of the steering wheel. If you sit too close to the steering wheel, you could be injured if the airbag inflates.

CONTINUED

A front passenger should also adjust the seat-back to an upright position, but as far from the dashboard as possible. A passenger who sits too close to the dashboard could be injured if the airbag inflates.

Reclining a seat-back so that the shoulder part of the belt no longer rests against the occupant's chest reduces the protective capability of the belt. It also increases the chance of sliding under the belt in a crash and being seriously injured. The farther a seat-back is reclined, the greater the risk of injury.

Reclining the seat-back too far can result in serious injury or death in a crash.

Adjust the seat-back to an upright position and sit well back in the seat.

See page [106](#) for how to adjust seat-backs.

4. Adjust the Head Restraints

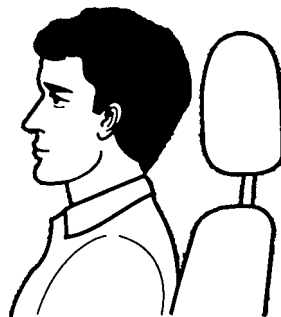

Before driving, make sure everyone with an adjustable head restraint has properly positioned the head restraint. The restraint should be positioned so the back of the occupant's head rests against the center of the restraint. A taller person should adjust the restraint as high as possible.

Improperly positioning head restraints reduces their effectiveness and you can be seriously injured in a crash.

Make sure head restraints are in place and positioned properly before driving.

Properly adjusted head restraints will help protect occupants from whiplash and other crash injuries.

See page [110](#) for how to adjust the head restraints.

5. Fasten and Position the Seat Belts

Using a Lap/Shoulder Belt (Except the center position of the third row)

Insert the latch plate into the buckle, then tug on the belt to make sure the belt is securely latched. Also check that the belt is not twisted, because a twisted belt can cause serious injuries in a crash.



Position the lap part of the belt as low as possible across your hips, then pull up on the shoulder part of the belt so the lap part fits snugly. This lets your strong pelvic bones take the force of a crash and reduces the chance of internal injuries.

CONTINUED

Protecting Adults

If necessary, pull up on the belt again to remove any slack from the shoulder part, then check that the belt rests across the center of your chest and over your shoulder. This spreads the forces of a crash over the strongest bones in your upper body.

Improperly positioning the seat belts can cause serious injury or death in a crash.

Make sure all seat belts are properly positioned before driving.

If the seat belt touches or crosses your neck, or if it crosses your arm instead of your shoulder, you need to adjust the seat belt anchor height.

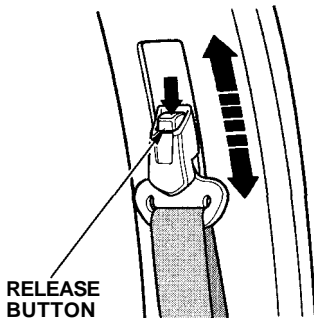

The front seats and middle row seats have adjustable seat belt anchors. To adjust the height of a seat belt anchor, press the release button and slide the anchor up or down as needed (it has four positions).

Never place the shoulder portion of a lap/shoulder belt under your arm or behind your back. This could cause very serious injuries in a crash.

Using the Lap/Shoulder Belt in the Center Position of the Third Row

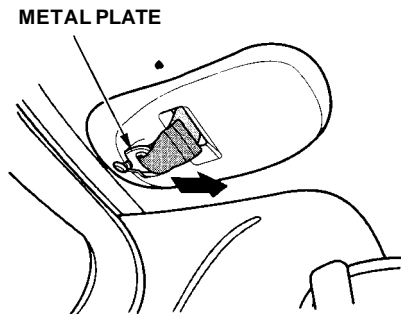

Unlatch the metal plate of the shoulder belt from the anchor on the ceiling and extend the belt by pulling the metal plate.

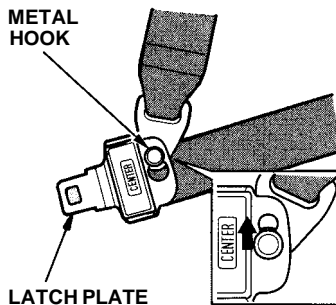

Attach the metal hook on the edge of the shoulder belt to the metal loop on the latch plate of the lap belt marked CENTER. Make sure the shoulder belt is securely attached and it is not twisted. A twisted belt can cause serious injuries in a crash.

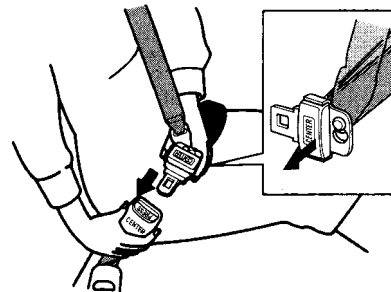

Insert the latch plate of the lap belt into the buckle marked CENTER. If the belt is too short, hold the latch plate at a right angle and pull on the plate to extend the belt. Then insert the latch plate into the buckle, and tug on the lap and shoulder belts to make sure the belt is securely latched.

CONTINUED

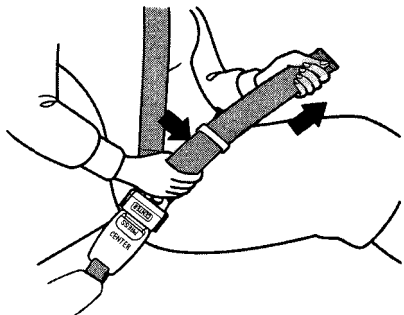

Position the lap belt as low as possible across your hips, then pull on the loose end of the lap belt for a snug but comfortable fit. This lets your strong pelvic bones take the force of a crash and reduces the chance of internal injuries.

If necessary, pull up on the shoulder belt again to remove any slack from the shoulder belt, then check that the belt rests across the center of your chest and over your shoulder. This spreads the forces of a crash over the strongest bones in your upper body.

Never place the shoulder portion of a lap/shoulder belt under your arm or behind your back. This could cause very serious injuries in a crash.

If a Seat Belt Doesn't Work Properly

If a seat belt does not seem to work as it should, it may not protect the occupant in a crash. ***No one should sit in a seat with an inoperative seat belt.*** Anyone using a seat belt that is not working properly can be seriously injured or killed. Have your Honda dealer check the belt as soon as possible.

See page [49](#) for additional information about your seat belt system and how to take care of your belts.

6. Adjust the Steering Wheel

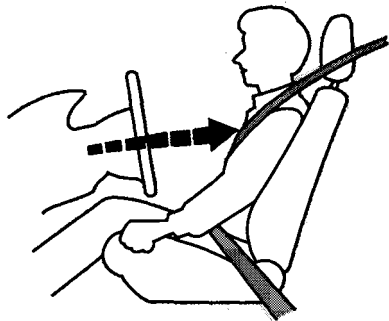

Adjust the steering wheel, if needed, so that the wheel points toward your chest, not toward your face.

Pointing the steering wheel toward your chest provides optimal protection from the airbag.

See page [76](#) for how to adjust the steering wheel.

7. Maintain a Proper Sitting Position

After all occupants have adjusted their seats and put on seat belts, it is very important that they continue to sit upright, well back in their seats, with their feet on the floor, until the vehicle is parked and the engine is off.

Sitting improperly can increase the chance of injury during a crash. For example, if an occupant slouches, lies down, turns sideways, sits forward, leans forward or sideways, or puts one or both feet up, the chance of injury during a crash is greatly increased.

In addition, an occupant who is out of position in the front seat can be seriously or fatally injured by striking interior parts of the vehicle, or by being struck by an inflating airbag.

Sitting improperly or out of position can result in serious injury or death in a crash.

Always sit upright, well back in the seat, with your feet on the floor.

Remember, to get the best protection from your vehicle's airbags and other safety features, you must sit properly and wear your seat belt properly.

Advice for Pregnant Women



Because protecting the mother is the best way to protect her unborn child, a pregnant woman should always wear a seat belt whenever she drives or rides in a vehicle.

Remember to keep the lap portion of the belt as low as possible across your hips.

Pregnant women should also sit upright and as far back as possible from the steering wheel or dashboard. This will reduce the risk of injuries to both the mother and her unborn child that can be caused by a crash or an inflating airbag.

Each time you have a check-up, ask your doctor if it's okay for you to drive.

Additional Safety Precautions

- **Never let passengers ride in the cargo area or on top of a folded-down back seat.** All passengers must sit in locked, upright seats and be properly restrained by seat belts.
- **Passengers should not stand up or change seats while the vehicle is moving.** A passenger who is not wearing a seat belt during a crash or emergency stop can be thrown against the inside of the vehicle, against other occupants, or out of the vehicle.
- **Two people should never use the same seat belt.** If they do, they could be very seriously injured in a crash.

- **Do not put any accessories on seat belts.** Devices intended to improve occupant comfort or reposition the shoulder part of a seat belt can severely compromise the protective capability of the seat belt and increase the chance of serious injury in a crash.
- **Do not place hard or sharp objects between yourself and an airbag.** Carrying hard or sharp objects on your lap, or driving with a pipe or other sharp object in your mouth, can result in injuries if your airbags inflate.
- **Keep your hands and arms away from the airbag covers.** If your hands or arms are close to the airbag covers in the center of the steering wheel and on top of the dashboard, they could be injured if the airbags inflate.
- **Do not attach or place objects on the airbag covers.** Any object attached to or placed on the covers marked "SRS AIRBAG," in the center of the steering wheel and on top of the dashboard, could interfere with the proper operation of the airbags. Or, if the airbags inflate, the objects could be propelled inside the car and hurt someone.



Children depend on adults to protect them. However, despite their best intentions, many parents and other adults may not know how to *properly* protect young passengers.

So if you have children, or if you ever need to drive with a grandchild or other children in your vehicle, be sure to read this section.

Children who are unrestrained or improperly restrained can be seriously injured or killed in a crash.

Any child too small for a seat belt should be properly restrained in a child seat. A larger child should be properly restrained with a seat belt.

All Children Must Be Restrained

Each year, many children are injured or killed in vehicle crashes because they are either unrestrained or not properly restrained. In fact, vehicle accidents are the number one cause of death of children ages 12 and under.

To reduce the number of child deaths and injuries, every state and Canadian province requires that infants and children be restrained whenever they ride in a vehicle.

Any child who is too small to wear a seat belt should be properly restrained in a child seat. (See page [28](#).)

A larger child should always be restrained with a seat belt. (See page [41](#).)

Additional Precautions to Parents

- ***Never hold an infant or child on your lap.*** If you are not wearing a seat belt in a crash, you could be thrown forward into the dashboard and crush the child.

If you are wearing a seat belt, the child can be torn from your arms during a crash. For example, if your vehicle crashes into a parked vehicle at 30 mph (48 km/h), a 20-lb (9 kg) infant will become a 600-lb (275 kg) force, and you will not be able to hold on.

- ***Never put a seat belt over yourself and an infant or child.*** During a crash, the belt could press deep into the child and cause very serious injuries.

Children Should Sit in the Back Seat

According to accident statistics, children of all ages and sizes are safer when they are restrained in the back seat, not the front seat. The National Highway Traffic Safety Administration and Transport Canada recommend that all children ages 12 and under be properly restrained in a back seat.

In a back seat, children are less likely to be injured by striking hard interior parts during a collision or hard braking. Also, children cannot be injured by an inflating airbag when they ride in the back.

The Passenger's Airbag Poses Serious Risks to Children

Airbags have been designed to help protect adults in a moderate to severe frontal collision. To do this, the passenger's airbag is quite large, and it inflates with tremendous speed.

Infants

Never put a rear-facing child seat in the front seat of a vehicle equipped with a passenger's airbag. If the airbag inflates, it can hit the back of the child seat with enough force to kill or very seriously injure an infant.

Small Children

Placing a forward-facing child seat in the front seat of a vehicle equipped with a passenger's airbag can be hazardous. If the vehicle seat is too far forward, or the child's head is thrown forward during a collision, an inflating airbag can strike the child with enough force to kill or very seriously injure a small child.

Larger Children

Children who have outgrown child seats are also at risk of being injured or killed by an inflating passenger's airbag. Whenever possible, larger children should sit in a back seat, properly restrained with a seat belt. (See page [41](#) for important information about protecting larger children.)

U.S. Models

To remind you of the passenger's airbag hazards, and that children must be properly restrained in a back seat, your vehicle has warning labels on the dashboard and on the driver's and front passenger's visors. Please read and follow the instructions on these labels.

⚠ WARNING	
	<p>DEATH or SERIOUS INJURY can occur</p> <ul style="list-style-type: none"> • Children 12 and under can be killed by the air bag • The BACK SEAT is the SAFEST place for children • NEVER put a rear-facing child seat in the front • Sit as far back as possible from the air bag • ALWAYS use SEAT BELTS and CHILD RESTRAINTS

⚠ WARNING	
Children Can Be KILLED or INJURED by Passenger Air Bag	
<p>The back seat is the safest place for children 12 and under. Make sure all children use seat belts or child seats.</p>	

Canadian Models

To remind you of the airbag hazards, your vehicle has warning labels on the driver's and front passenger's visors. Please read and follow the instructions on these labels.

<p>CAUTION</p> <p>TO AVOID SERIOUS INJURY:</p> <ul style="list-style-type: none"> • FOR MAXIMUM SAFETY PROTECTION IN ALL TYPES OF CRASHES, YOU MUST ALWAYS WEAR YOUR SAFETY BELT. • DO NOT INSTALL REARWARD-FACING CHILD SEATS IN ANY FRONT PASSENGER SEAT POSITION. • DO NOT SIT OR LEAN UNNECESSARILY CLOSE TO THE AIR BAG. • DO NOT PLACE ANY OBJECTS OVER THE AIR BAG OR BETWEEN THE AIR BAG AND YOURSELF. • SEE THE OWNER'S MANUAL FOR FURTHER INFORMATION AND EXPLANATIONS. 	<p>PRÉCAUTION:</p> <p>POUR ÉVITER DES BLESSURES GRAVES:</p> <ul style="list-style-type: none"> • POUR PROFITER D'UNE PROTECTION MAXIMALE LORS D'UNE COLLISION BOUCLEZ TOUJOURS VOTRE CEINTURE DE SÉCURITÉ. • N'INSTALLEZ JAMAIS UN SIÈGE POUR ENFANTS FAISANT FACE À L'ARRIÈRE SUR LE SIÈGE DU PASSAGER AVANT. • NE VOUS APPUYEZ PAS ET NE VOUS ASSEYEZ PAS PRES DU COUSSIN GONFLABLE. • NE DEPOSEZ AUCUN OBJET SUR LE COUSSIN GONFLABLE OU ENTRE LE COUSSIN GONFLABLE ET VOUS. • LISEZ LE GUIDE UTILISATEUR POUR DE PLUS AMPLES RENSEIGNEMENTS.
---	--

If You Must Drive with Several Children

Your vehicle has two rows of back seats where children can be properly restrained.

If you ever have to carry a group of children (when carpooling for example), and a child must ride in front:

- Place the largest child in the front seat, provided the child is large enough to wear a seat belt properly (see page 41).
- Move the vehicle seat as far to the rear as possible (see page 12).
- Have the child sit upright and well back in the seat (see page 19).
- Make sure the seat belt is properly positioned and secured (see page 15).

If a Child Requires Close Attention

Many parents say they prefer to put an infant or small child in the front passenger seat so they can watch the child, or because the child requires attention.

Placing a child in the front seat exposes the child to hazards from the airbag, and paying close attention to a child distracts the driver from the important task of driving, placing both of you at risk.

If a child requires physical attention or frequent visual contact, we strongly recommend that another adult ride with the child in a back seat. The back seat is far safer for a child than the front.

Additional Safety Precautions

- **Use childproof door locks to prevent children from opening the doors.** Using this feature will prevent children from opening the doors and accidentally falling out (see page 89).
- **Do not leave children alone in your vehicle.** Leaving children without adult supervision is illegal in most states and Canadian provinces, and can be very hazardous. For example, infants and small children left in a vehicle on a hot day can die from heatstroke. And children left alone with the key in the ignition can accidentally set the vehicle in motion, possibly injuring themselves or others.

General Guidelines for Using Child Seats

The following pages give general guidelines for selecting and installing child seats for infants and small children.

Selecting a Child Seat

To provide proper protection, a child seat should meet three requirements:

- 1. The child seat should meet safety standards.** The child seat should meet Federal Motor Vehicle Safety Standard 213 (FMVSS 213) or Canadian Motor Vehicle Safety Standard 213 (CMVSS 213). Look for the manufacturer's statement of compliance on the box and seat.
- 2. The child seat should be of the proper type and size to fit the child.**

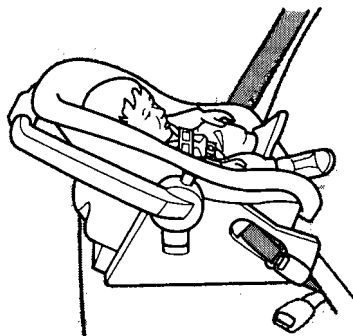

Infants: Children up to about one year old should be restrained in a rear-facing, reclining child seat. Only a rear-facing seat provides the proper support to protect an infant's head, neck, and back. See page [32](#) for additional information on protecting infants.

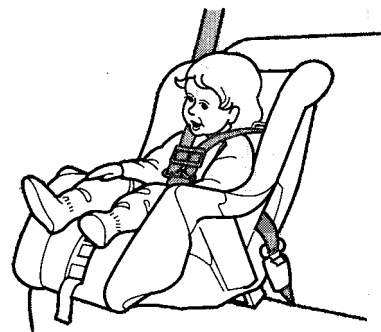

Small Children: A child who is too large for a rear-facing child seat, and who can sit up without support, should be restrained in a forward-facing child seat. See page [37](#) for additional information on protecting small children.

3. *The child seat should fit the vehicle seating position (or positions) where it will be used.*

Due to variations in the design of child seats, vehicle seats, and seat belts, all child seats will not fit all vehicle seating positions.

However, Honda is confident that one or more child seat models can fit and be properly installed in all recommended seating positions in your vehicle.

Before purchasing a child seat, we recommend that parents test the child seat in the specific vehicle seating position (or positions) where they intend to use the seat. If a previously purchased child seat does not fit, you may need to buy a different one that will fit.

Your vehicle has lower anchorages installed for use with Child Restraint Anchorage System-compatible child seats. For more information, see page [47](#).

CONTINUED

Placing a Child Seat

This page briefly summarizes Honda's recommendations on where to place rear-facing and forward-facing child seats in your vehicle.

Airbags Pose Serious Risks to Children

The passenger's airbag inflates with enough force to kill or seriously injure an infant in a rear-facing child seat.

A small child in a forward-facing child seat is also at risk. If the vehicle seat is too far forward, or the child's head is thrown forward during a collision, an inflating airbag can kill or seriously injure the child.

If a small child must ride in the front, follow the instructions provided in this section.

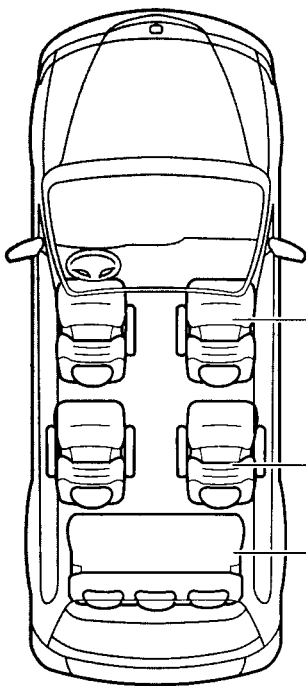

Front Passenger's Seat

Infants: Never in the front seat, due to the passenger's airbag hazard.

Small children: Not recommended, due to the passenger's airbag hazard. If a small child must ride in front, move the vehicle seat to the rear-most position and secure a front-facing child seat with the seat belt (see page 38).

Back Seats

Infants: Recommended positions.

Properly secure a rear-facing child seat (see page 33).

Small children: Recommended positions. Properly secure a front-facing child seat with the seat belt (see page 38).

Installing a Child Seat

After selecting a proper child seat, and a good position to install the seat, there are three main steps in installing the seat:

- 1. Properly secure the child seat to the vehicle.** All child seats are designed to be secured to the vehicle with the lap part of a lap/shoulder belt. Some child seats can be secured to the vehicle's lower anchorages instead. A child whose seat is not properly secured to the vehicle can be endangered in a crash. See pages 33, 38 and 47 for instructions on how to properly secure child seats in this vehicle.
- 2. Make sure the child seat is firmly secured.** After installing a child seat, push and pull the seat forward and from side to side to verify that it is secure.

To provide security during normal driving maneuvers as well as during a collision, we recommend that parents secure a child seat as firmly as possible.

However, a child seat does not need to be "rock solid." In some vehicles or seating positions, it may be difficult to install a child seat so that it does not move at all. Some side-to-side or back-and-forth movement can be expected and should not reduce the child seat's effectiveness.

If the child seat is not secure, try installing it in a different seating position, or use a different style of child seat that can be firmly secured in the desired seating position.

- 3. Secure the child in the child seat.**

Make sure the child is properly strapped in the child seat according to the child seat maker's instructions. A child who is not properly secured in a child seat can be thrown out of the seat in a crash and be seriously injured.

Storing a Child Seat

When you are not using a child seat, either remove it and store it in a safe place, or make sure it is properly secured. An unsecured child seat can be thrown around the vehicle during a crash or sudden stop and injure someone.

Protecting Infants

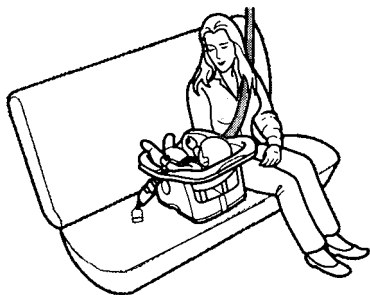

Child Seat Type

Only a rear-facing child seat provides proper support for a baby's head, neck, and back. Infants up to about one year of age must be restrained in a rear-facing child seat.

Two types of seats may be used: a seat designed exclusively for infants, or a convertible seat used in the rear-facing, reclining mode.

Placing a rear-facing child seat in the front seat can result in serious injury or death if the airbags inflate.

Always place a rear-facing child seat in the back seat, not the front.

We recommend that an infant be restrained in a rear-facing child seat until the infant reaches the seat maker's weight or height limit and is able to sit up without support.

Rear-Facing Child Seat Placement

In this vehicle, a rear-facing child seat can be placed in any seating position in a back seat, but not in the front seat.

Never put a rear-facing child seat in the front seat.

If the passenger's airbag inflates, it can hit the back of the child seat with enough force to kill or seriously injure an infant. If an infant must be closely watched, we recommend that another adult sit in a back seat with the baby.

Do not put a rear-facing child seat in a forward-facing position.

If placed facing forward, an infant could be very seriously injured during a frontal collision.

When properly installed, a rear-facing child seat may prevent the driver or a front-seat passenger from moving the seat as far back as recommended (see page 12). Or it may prevent them from locking the seat-back in the desired upright position (see page 13).

In either case, we recommend that you place the child seat in another back seating position, or leave the affected seat unoccupied. If the problem cannot be solved, you may wish to get a smaller rear-facing child seat.

Installing a Rear-Facing Child Seat with a Lap/Shoulder Belt

The lap/shoulder belts in the outer back seats have a locking mechanism that must be activated to secure a child seat.

The following pages provide instructions on how to secure a rear-facing child seat with this type of seat belt.

See page 35 for how to secure a rear-facing child seat in the center position on the third seat with the lap part of the lap/shoulder belt.

For tips on installing a rear-facing child seat with either type of seat belt, see page 36 .

If you have a child seat designed to attach to the vehicle's lower anchorages, follow the instructions on page 47 .

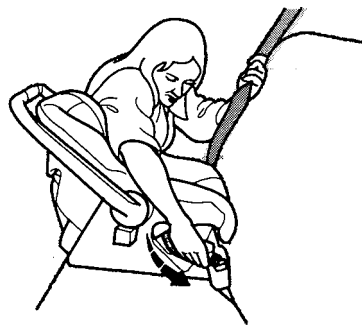

1. With the child seat in the desired back seating position, route the belt through the child seat according to the seat maker's instructions, then insert the latch plate into the buckle.

CONTINUED

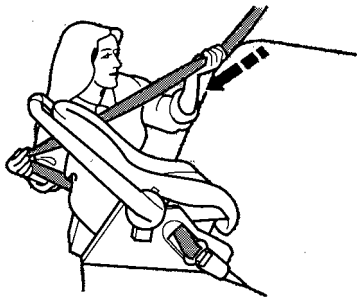

2. To activate the lockable retractor, slowly pull the shoulder part of the belt all the way out until it stops, then let the belt feed back into the retractor (you might hear a clicking noise as the belt retracts).

3. After the belt has retracted, tug on it. If the belt is locked, you will not be able to pull it out. If you can pull the belt out, it is not locked and you will need to repeat these steps.



4. After confirming that the belt is locked, grab the shoulder part of the belt near the buckle and pull up to remove any slack from the lap part of the belt. Remember, if the lap part of the belt is not tight, the child seat will not be secure. To remove slack, it may help to put weight on the child seat, or push on the back of the seat, while pulling up on the belt.

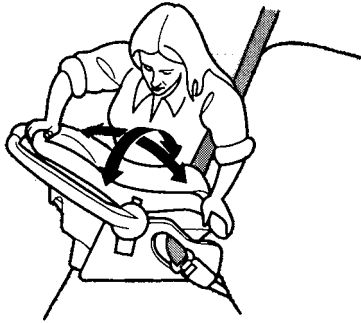

5. Push and pull the child seat forward and from side to side to verify that it is secure enough to stay upright during normal driving maneuvers. If the child seat is not secure, unlatch the belt, allow it to retract fully, then repeat these steps.

To deactivate the locking mechanism and remove a child seat, unlatch the buckle, unrout the seat belt, and let the belt fully retract.

Installing a Rear-Facing Child Seat in the Center Position of the Third Seat

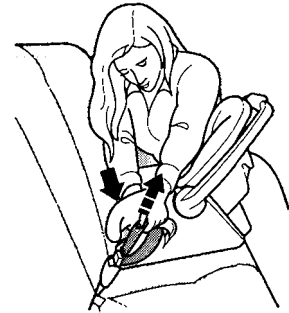

To install a rear-facing child seat in the center position of the third seat, use the lap part of the lap/shoulder belt. Follow instruction number 1 on page 33 for routing and latching the seat belt.

CONTINUED

Then pull hard on the loose end of the belt to remove the any slack (it may help to put weight on the child seat while pulling on the belt). Finally, follow instruction number 5 on page 34 to verify that the child seat is secured.

Rear-Facing Child Seat Installation Tips

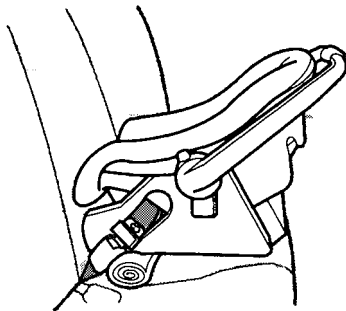

For proper protection, an infant must ride in a reclined, or semi-reclined position. To determine the proper reclining angle, check with the baby's doctor or follow the seat maker's recommendations.

To achieve the desired reclining angle, it may help to put a rolled up towel under the toe of the child seat, as shown.

Protecting Small Children

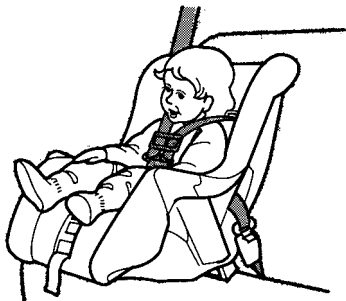

Child Seat Type

A child who can sit up without support, and who fits within the child seat maker's weight and height limits, should be restrained in a forward-facing, upright child seat.

Of the different seats available, we recommend those that have a five-point harness system as shown.

We also recommend that a small child stay in the child seat as long as possible, until the child reaches the weight or height limit for the seat.

Child Seat Placement

In this vehicle, the best place to install a forward-facing child seat is in one of the seating positions in a back seat.

Placing a forward-facing child seat in the front seat of a vehicle equipped with a passenger's airbag can be hazardous. If the vehicle seat is too far forward, or the child's head is thrown forward during a collision, an inflating passenger's airbag can strike the child with enough force to cause very serious or fatal injuries. If a small child must be closely watched, we recommend that another adult sit in a back seat with the child.

CONTINUED

Improperly placing a forward-facing child seat in the front seat can result in serious injury or death if the airbags inflate.

If you must place a forward-facing child seat in front, move the vehicle seat as far back as possible and properly restrain the child.

If it is necessary to put a forward-facing child seat in the front, move the vehicle seat as far to the rear as possible, be sure the child seat is firmly secured to the vehicle, and the child is properly strapped in the seat.

Installing a Child Seat with a Lap/Shoulder Belt

The lap/shoulder belts in the outer back and front passenger seating positions have a locking mechanism that must be activated to secure a child seat.

The following pages provide instructions on how to secure a forward-facing child seat with this type of seat belt.

See page [40](#) for how to secure a forward-facing child seat in the center position on the third seat with the lap part of the lap/shoulder belt.

If you have a child seat designed to attach to the vehicle's lower anchorages, follow the instructions on page [47](#).

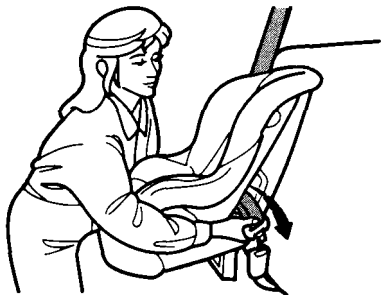

1. With the child seat in the desired seating position, route the belt through the child seat according to the seat maker's instructions, then insert the latch plate into the buckle.

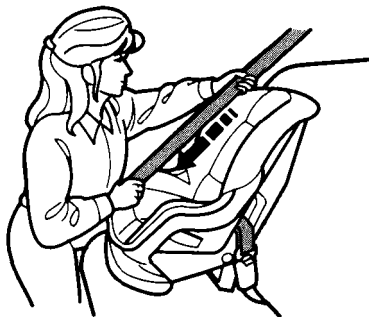

2. To activate the lockable retractor, slowly pull the shoulder part of the belt all the way out until it stops, then let the belt feed back into the retractor (you might hear a clicking noise as the belt retracts).

3. After the belt has retracted, tug on it. If the belt is locked, you will not be able to pull it out. If you can pull the belt out, it is not locked and you will need to repeat these steps.



4. After confirming that the belt is locked, grab the shoulder part of the belt near the buckle and pull up to remove any slack from the lap part of the belt. Remember, if the lap part of the belt is not tight, the child seat will not be secure. It may help to put weight on the child seat, or push on the back of the seat, while pulling up on the belt.

CONTINUED

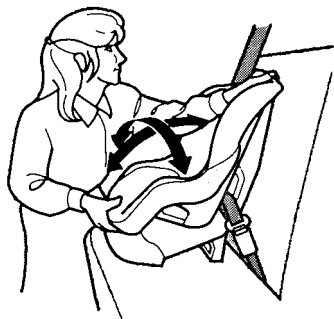

5. Push and pull the child seat forward and from side to side to verify that it is secure enough to stay upright during normal driving maneuvers. If the child seat is not secure, unlatch the belt, allow it to retract fully, then repeat these steps.

To deactivate the locking mechanism in order to remove a child seat, unlatch the buckle, unrout the seat belt, and let the belt fully retract.

Installing a Child Seat in the Center Position of the Third Seat

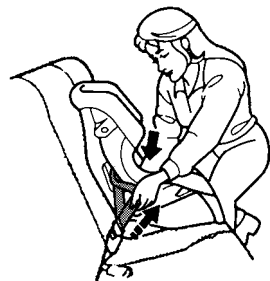

To install a forward-facing child seat in the center position of the third seat, use the lap part of the lap/shoulder belt. Follow instruction number 1 on page [39](#) for routing and latching the seat belt.

Then pull hard on the loose end of the belt to remove the any slack (it may help to put weight on the child seat while pulling on the belt). Finally, follow instruction number 5 on page 40 to verify that the child seat is secured.

Protecting Larger Children

When a child reaches the recommended weight or height limit for a forward-facing child seat, the child should sit in the back seat and wear a lap/shoulder belt.

If a child is too short for the shoulder part of the belt to properly fit, we recommend that the child use a booster seat until the child is tall enough to use the seat belt without a booster.

The following pages give instructions on how to check proper seat belt fit, what kind of booster seat to use if one is needed, and important precautions for a child who must sit in the front seat.

Allowing a larger child to sit improperly in the front seat can result in injury or death if the airbags inflate.

If a larger child must sit in front, make sure the child moves the seat as far back as possible and wears the seat belt properly.

CONTINUED

Checking Seat Belt Fit

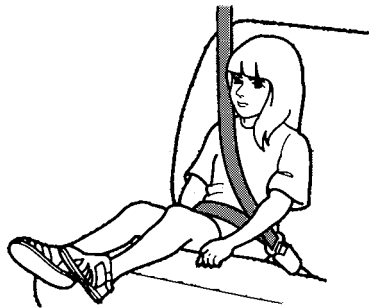

To determine if a lap/shoulder belt properly fits a child, have the child put on the seat belt. Follow the instructions on page 15. Then check how the belt fits.

If the shoulder part of the belt rests over the child's collarbone and against the center of the chest, as shown, the child is large enough to wear the seat belt.

However, if the belt touches or crosses the child's neck, the child needs to use a booster seat.

Do not let a child wear a seat belt across the neck. This could result in serious neck injuries during a crash.

Do not let a child put the shoulder part of a seat belt behind the back or under the arm. This could cause very serious injuries during a crash. It also increases the chance that the child will slide under the belt in a crash and be injured.

Do not put any accessories on a seat belt. Devices intended to improve occupant comfort or reposition the shoulder part of a seat belt, severely compromise the protective capability of the seat belt and increase the chance of serious injury in a crash.

Two children should never use the same seat belt. If they do, they could be very seriously injured in a crash.

Using a Booster Seat

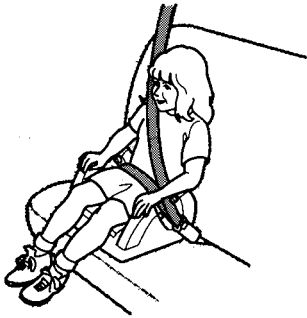

If a child needs a booster seat, we recommend choosing a style that allows the child to use the lap/shoulder belt directly, without a shield, as shown.

Whichever style you select, follow the booster seat maker's instructions.

A child may continue using a booster seat until the tops of the ears are even with the top of the seat-back. A child of this height should be tall enough to use the lap/shoulder belt without a booster.

When Can a Larger Child Sit in Front

The National Highway Traffic Safety Administration and Transport Canada recommend that all children ages 12 and under be properly restrained in a back seat.

The back seat is the safest place for a child of any age or size.

In addition, the passenger's airbag poses serious risks to children. If the seat is too far forward, or the child's head is thrown forward during a collision, or the child is unrestrained or out of position, an inflating airbag can kill or seriously injure the child.

Of course, children vary widely. And while age may be one indicator of when a child can safely ride in the front, there are other important factors you should consider.

CONTINUED

Physical Size

Physically, a child must be large enough for the lap/shoulder belt to properly fit over the hips, chest, and shoulder (see pages 15 and 41). If the seat belt does not fit properly, the child should not sit in the front.

Maturity

To safely ride in front, a child must be able to follow the rules, including sitting properly and wearing the seat belt properly throughout a ride.

If you decide that a child can safely ride up front, be sure to:

- Carefully read the owner's manual and make sure you understand all seat belt instructions and all safety information.
- Move the vehicle seat to the rear-most position.
- Have the child sit up straight, back against the seat, and feet on or near the floor.
- Check that the child's seat belt is properly positioned and secured.
- Supervise the child. Even mature children sometimes need to be reminded to fasten the seat belts or sit properly.

Using Child Seats with Tethers

Your vehicle has attachment points for a tether-style child seat to be installed on the second or third row as shown.

Since a tether can provide additional security, we recommend using a tether whenever one is required or available.

Second Seat Installation:

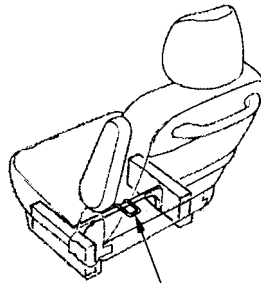

TETHER ATTACHMENT POINT

Each second row bucket seat has a tether attachment point on the underside of the seat cushion.

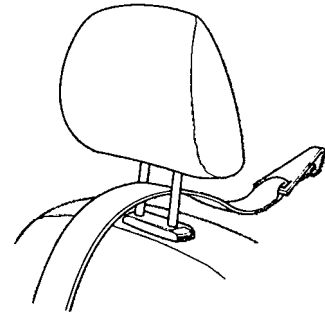

Lift the head restraint, then route the tether strap over the seat-back between the legs of the head restraint.

CONTINUED

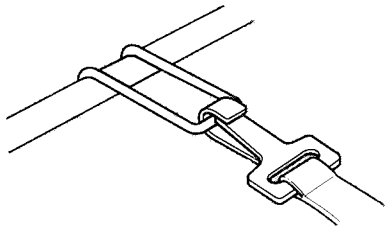

Attach the tether strap hook to the tether attachment point and tighten the strap according to the child seat marker's instruction. Make sure the strap is not twisted.

Third Seat Installation:

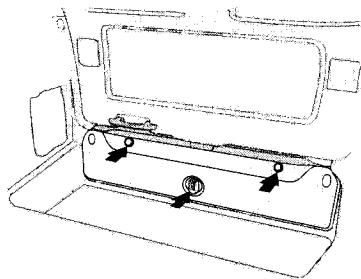

There are three attachment points on the tailgate sill. Select the attachment point you want to use, and remove the plug with a small flat-tipped screwdriver or fingernail file.

Install the anchor plate and mounting hardware. The hardware is available for purchase from your Honda dealer (part number 82410-SE3-C01). For Canadian models, the hardware is supplied with the vehicle.

When installing tether hardware, make sure the toothed washer is on the bottom of the bolt. Tighten the bolt to:

16lbf.ft (22N.m,2.2kgf.m)

If a torque wrench was not used, see your Honda dealer as soon as possible to verify proper installation.

To attach the tether to the child seat, follow the child seat maker's instructions.

If you are not sure how to install the tether, or you need mounting hardware, contact your Honda dealer.

Using the Lower Anchorages

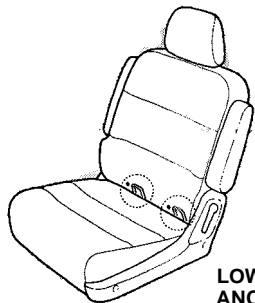

LOWER ANCHORAGES

Your vehicle is equipped with lower anchorages at the second row seats. These anchorages are located between the seat-back and seat bottom and are only to be used with a child seat designed to attach to the lower anchorages.

The exact location of each anchor is marked with a small circle above the lower anchor point.

To install a child seat designed to attach to the lower anchorages:

1. Move the seat belt buckle or seat belt tongue away from the anchorages.
2. Make sure there are no foreign objects around the anchorages. Foreign objects could get in the way of a secure connection between the child seat and the anchorage.

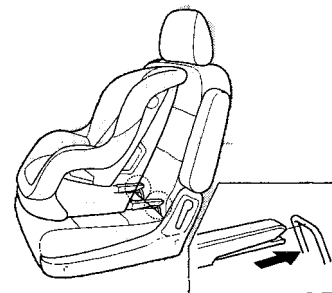

RIGID TYPE

3. Put the child seat in a second row vehicle seat and attach the child seat to the lower anchorages according to the child seat maker's instructions.

CONTINUED

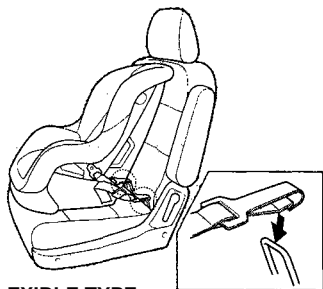

FLEXIBLE TYPE

4. Follow the child seat maker's instructions for any additional advice on adjusting or tightening the fit.

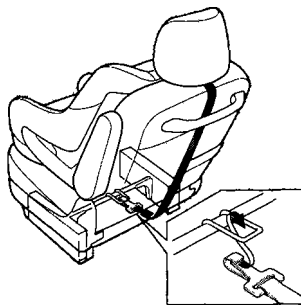

5. Attach the tether strap hook to the tether anchorage point and tighten the strap according to the child seat maker's instructions.
6. Push and pull the child seat forward and from side to side to verify that it is secure enough to stay upright during normal driving maneuvers.

Seat Belt System Components

Your seat belt system includes lap/shoulder belts in all seven seating positions.



The system also includes a light on the instrument panel to remind you and your passengers to fasten your belts. If the driver's seat belt is not fastened before the ignition is turned ON (II), the light will come on and a beeper will also sound. The beeper will stop after a few seconds, but the light will stay on until the driver's seat belt is fastened.

Lap/Shoulder Belt

Your vehicle has two types of lap/shoulder belts. The center position of the third seat has a combination of a lap belt and a shoulder belt. For maximum safety, they are designed to be used together.

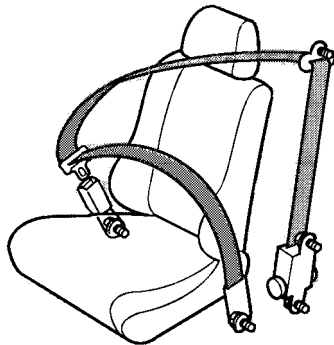

All other seating positions have a one-piece lap/shoulder belt. This seat belt goes over your shoulder, across your chest and across your hips.

To fasten the belt, insert the latch plate into the buckle, then tug on the belt to make sure the buckle is latched.

To unlock the belt, push the red PRESS button on the buckle. Guide the belt across your body so that it retracts completely. After exiting the vehicle, be sure the belt is out of the way and will not get closed in the door.

All seat belts have an emergency locking retractor. In normal driving, the retractor lets you move freely in your seat while it keeps some tension on the belt. During a collision or sudden stop, the retractor automatically locks the belt to help restrain your body.

CONTINUED

Additional Information About Your Seat Belts

The seat belts in all positions except the driver's and the center position of the third seat have an additional locking mechanism that must be activated to secure a child seat. (See pages [33](#) and [38](#) for instructions on how to secure child seats with this type of seat belt.)

If the shoulder part of the belt is pulled all the way out, the locking mechanism will activate. The belt will retract, but it will not allow the passenger to move freely.

To deactivate the locking mechanism, unlatch the buckle and let the seat belt fully retract. To refasten the belt, pull it out only as far as needed.

See page [15](#) for instructions on how to wear the lap/shoulder belt properly.

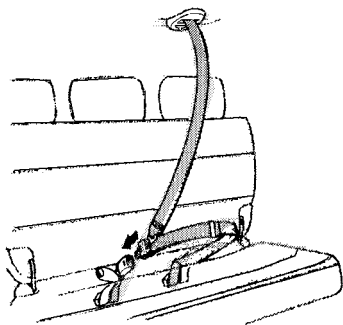

The combination lap belt and shoulder belt in the center position of the third seat goes over your shoulder, across your chest and over your hips. The shoulder belt has an emergency locking retractor that works in combination with the lap belt.

To fasten the seat belt, unlatch the metal plate of the shoulder belt from the anchor on the ceiling and extend the belt by pulling the metal plate.

Attach the metal hook on the edge of the shoulder belt to the metal loop on the latch plate of the lap belt marked **CENTER**, then tug on the shoulder belt to make sure it is securely attached.

Insert the latch plate of the lap belt into the buckle marked **CENTER**, then tug on the lap belt to make sure the buckle is latched.

To unlock the belt, push the red **PRESS** button on the buckle and detach the shoulder belt from the lap belt.

See page [17](#) for how to lengthen the lap belt, and how to properly position the lap and shoulder belts.

Seat Belt Maintenance

For safety, you should check the condition of your seat belts regularly.

Pull each belt out fully and look for frays, cuts, burns, and wear. Check that the latches work smoothly and that the lap/shoulder belts retract easily. Any belt not in good condition or not working properly will not provide good protection and should be replaced as soon as possible.

U.S. Models

Honda provides a lifetime warranty on seat belts. Honda will repair or replace any seat belt component that fails to function properly during normal use. Please see your *Honda Warranty Information* booklet for details.

If a seat belt is worn during a crash, you should have your dealer inspect the belt, and replace it if necessary. A belt that has been worn during a crash may not provide the same level of protection in a subsequent crash. The dealer should also inspect the anchors for damage and replace them if needed.

Not checking or maintaining seat belts can result in serious injury or death if the seat belts do not work properly when needed.

Check your seat belts regularly and have any problem corrected as soon as possible.

For information on how to clean your seat belts, see page [297](#).

SRS Components

Your Supplemental Restraint System (SRS) includes:

- Two front airbags. The driver's airbag is stored in the center of the steering wheel; the front passenger's airbag is stored in the dashboard. Both are marked "SRS AIRBAG."
- Automatic seat belt tensioners that tighten the front seat belts during a moderate to severe frontal collision.
- Sensors that can detect a moderate to severe frontal collision.
- A sophisticated electronic system that continually monitors information about the sensors, the control unit, and the airbag activators when the ignition is ON (II).

- An indicator light on the instrument panel that alerts you to a possible problem with the system (see page 54).
- Emergency backup power in case your vehicle's electrical system is disconnected in a crash.

How Your Airbags Work

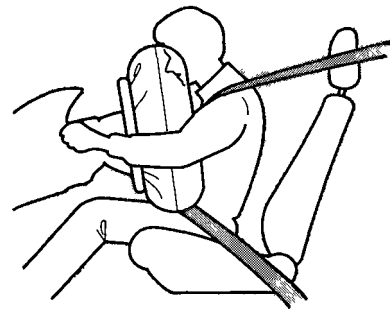

If you ever have a moderate to severe frontal collision, the sensors will detect rapid deceleration and signal the control unit to instantly inflate the airbags and activate the automatic seat belt tensioners.

During a crash, your seat belt helps restrain your lower body and torso, while the tensioner tightens and locks the seat belt to help keep you in place. Your airbag provides a cushion to help restrain and protect your head and chest.

Since both airbags use the same sensors, both airbags normally inflate at the same time. However, it is possible for only one airbag to inflate.

This can occur when the severity of a collision is at the margin, or threshold, that determines whether or not the airbags will deploy. In such cases, the seat belt will provide sufficient protection, and the supplemental protection offered by the airbag would be minimal.

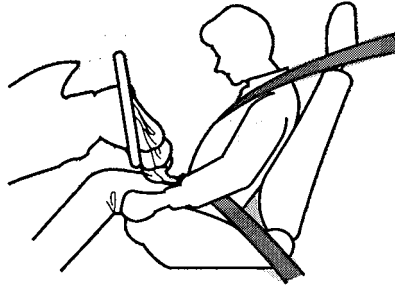

After inflating, the airbags immediately deflate, so they won't interfere with the driver's visibility, or the ability to steer or operate other controls.

The total time for inflation and deflation is approximately one-tenth of a second, so fast that most occupants are not aware that the airbags deployed until they see them lying in their laps.

After a crash, you may see what looks like smoke. This is actually powder from the airbag's surface. Although the powder is not harmful, people with respiratory problems may experience some temporary discomfort. If this occurs, get out of the vehicle as soon as it is safe to do so.

U.S. Owners

For additional information on how your airbags work, see the booklet titled *SRS: What You Need to Know About Airbags* that came with your owner's manual.

Canadian Owners

For additional information on how your airbags work, ask your dealer for a copy of the booklet titled *SRS: What You Need to Know About Airbags*.

How the Automatic Seat Belt Tensioners Work

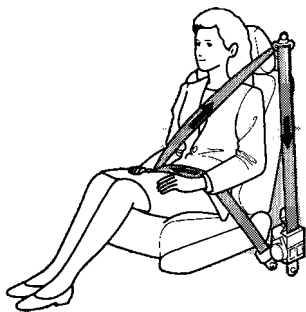

Your Honda has automatic seat belt tensioners for added protection during a moderate to severe frontal collision.

If your airbags inflate, the tensioners immediately tighten the front seat belts to help hold the occupants in place. The belts will remain tight until you unbuckle them in the normal way.

How the SRS Indicator Light Works

SRS The purpose of the SRS light is to alert you to a potential problem with your Supplemental Restraint System. This light will also alert you to a potential problem with your automatic seat belt tensioners.

When you turn the ignition ON (II), this indicator will light briefly then go out. This tells you that the system is working properly.

If the light comes on at any other time, or does not come on at all, you should have the system checked by your dealer. For example:

- If the SRS indicator light does not come on after you turn the ignition ON (II).
- If the light stays on after the engine starts.

- If the light comes on or flashes on and off while you drive.

If you see any of these indications, your airbags and seat belt tensioners may not deploy when you need them. See your Honda dealer as soon as possible.

Ignoring the SRS indicator light can result in serious injury or death if the airbags do not inflate when needed.

Have your vehicle checked by a dealer as soon as possible if the SRS light alerts you to a potential problem.

SRS Service

Your Supplemental Restraint System is virtually maintenance-free, and there are no parts you can safely service. However, you must have your vehicle serviced if:

- ***Your airbags ever inflate.*** The airbags, seat belt tensioners, and control unit must be replaced. Do not try to remove or replace the airbags yourself. This must be done by a Honda dealer or a knowledgeable body shop.
- ***The SRS indicator light alerts you to a problem.*** Take your vehicle to an authorized Honda dealer as soon as possible. If you ignore this indication, the airbags might not inflate when you need them (see page 54).

Additional Safety Precautions

- Do not attempt to deactivate your airbags. Together, airbags and seat belts provide the best protection in a moderate to severe frontal collision.
- Do not tamper with SRS components or wiring for any reason. Tampering could cause the airbags to deploy, possibly causing very serious injury.

See page [204](#) for further information and precautions relating to your SRS.

Your vehicle's exhaust contains carbon monoxide gas. You should have no problem with carbon monoxide entering the vehicle in normal driving if you maintain your vehicle properly. Have the exhaust system inspected for leaks whenever:

- The vehicle is raised for an oil change.
- You notice a change in the sound of the exhaust.
- The vehicle was in an accident that may have damaged the underside.

Carbon monoxide gas is toxic. Breathing it can cause unconsciousness and even kill you.

Avoid any enclosed areas or activities that expose you to carbon monoxide.

High levels of carbon monoxide can collect rapidly in enclosed areas, such as a garage. Do not run the engine with the garage door closed. Even with the door open, run the engine only long enough to move the vehicle out of the garage.

With the tailgate open, air flow can pull exhaust gas into your vehicle's interior and create a hazardous condition. If you must drive with the tailgate open, open all the windows and set the heating and cooling system/climate control system as shown below.

If you must sit in your parked vehicle, even in an unconfined area, with the engine running, adjust the heating and cooling system/climate control system as follows:

1. Select the Fresh Air mode.
2. Select the  mode.
3. Turn the fan on high speed.
4. Set the temperature control to a comfortable setting.

These labels are in the locations shown. They warn you of potential hazards that could cause serious injury. Read these labels carefully.

If a label comes off or becomes hard to read, contact your Honda dealer for a replacement.

HOOD

WARNING

The airbag inflator is explosive and, if accidentally deployed, can seriously hurt you. Follow Service Manual instructions carefully.

ATTENTION

Le gonfleur SRS est explosible, et s'il se déploie accidentellement, il risque de provoquer des blessures graves ou de tuer. Suivre attentivement les instructions du manuel d'entretien.

DASHBOARD

U.S. models only

WARNING

Children Can Be KILLED or INJURED by Passenger Air Bag

The back seat is the safest place for children 12 and under. Make sure all children use seat belts or child seats.

SUN VISOR

U.S. models

WARNING



DEATH or SERIOUS INJURY can occur

- Children 12 and under can be killed by the air bag
- The BACK SEAT is the SAFEST place for children
- NEVER put a rear-facing child seat in the front
- Sit as far back as possible from the air bag
- ALWAYS use SEAT BELTS and CHILD RESTRAINTS

Canadian models

CAUTION

- TO AVOID SERIOUS INJURY:
- FOR MAXIMUM SAFETY PROTECTION IN ALL TYPES OF CRASHES, YOU MUST ALWAYS WEAR YOUR SAFETY BELT
- DO NOT INSTALL REARWARD-FACING CHILD SEATS IN ANY FRONT PASSENGER SEAT POSITION
- DO NOT SIT OR LEAN UNNECESSARILY CLOSE TO THE AIR BAG
- DO NOT PLACE ANY OBJECTS OVER THE AIR BAG OR BETWEEN THE AIR BAG AND YOURSELF
- SEE THE OWNER'S MANUAL FOR FURTHER INFORMATION AND EXPLANATIONS.

PRÉCAUTION:

- POUR ÉVITER DES BLESSURES GRAVES:
- POUR PROFITER D'UNE PROTECTION MAXIMALE LORS D'UNE COLLISION ROULEZ TOUJOURS VOTRE CEINTURE DE SÉCURITÉ
- N'INSTALLÉZ JAMAIS UN SIÈGE POUR ENFANTS FAISANT FACE À L'ARRIÈRE SUR LE SIÈGE DU PASSAGER À AVANT
- NE VOUS ASSEYEZ PAS ET NE VOUS ASSEYEZ PAS PRÈS DU COUSSIN GONFLABLE
- NE DÉPOSEZ AUCUN OBJET SUR LE COUSSIN GONFLABLE OU ENTRE LE COUSSIN GONFLABLE ET VOUS
- LISEZ LE GUIDE D'UTILISATEUR POUR DE PLUS AMPLES RENSEIGNEMENTS

RADIATOR CAP

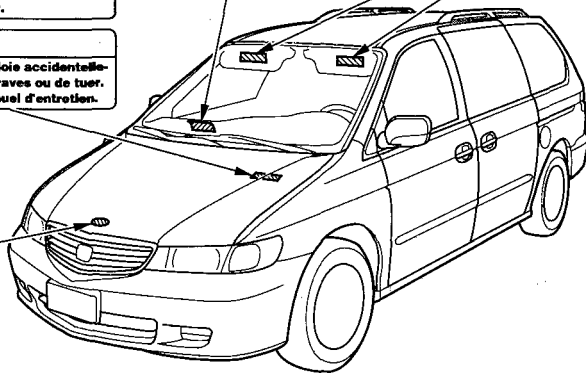

This section gives information about the controls and displays that contribute to the daily operation of your Honda. All the essential controls are within easy reach.

Control Locations.....	60	Rear Window Wiper and Washer.....	74	Driver's Seat Power Adjustments.....	108
Indicator Lights.....	61	Hazard Warning.....	75	Armrests.....	109
Gauges.....	66	Rear Window Defogger.....	75	Head Restraints.....	110
Controls Near the Steering Wheel.....	69	Steering Wheel Adjustment.....	76	Third Seat Access.....	111
Headlights.....	70	Steering Wheel Controls.....	77	Moving the Second Row Bucket Seat.....	112
Automatic Lighting Off Feature.....	71	Cruise Control.....	77	Removing the Bucket Seats in the Second Row.....	114
Daytime Running Lights.....	71	Remote Audio Controls.....	80	Folding the Third Seat.....	115
Instrument Panel Brightness.....	71	Keys and Locks.....	80	Power Windows.....	118
Turn Signals.....	72	Keys.....	80	Mirrors.....	121
Windshield Wipers.....	72	Immobilizer System.....	81	Parking Brake.....	122
Windshield Washers.....	74	Ignition Switch.....	82	Digital Clock.....	123
		Power Door Locks.....	83	Center Table.....	123
		Remote Transmitter.....	85	Beverage Holder.....	124
		Childproof Door Locks.....	89	Sunglasses Holder.....	126
		Tailgate.....	89	Sun Visor.....	127
		Glove Box.....	91	Vanity Mirror.....	127
		Manual Sliding Doors.....	92	Rear Compartment.....	128
		Power Sliding Doors.....	93	Center Pocket.....	128
		HomeLink Universal Transmitter.....	99	Coin Holder.....	128
		Seats.....	104	Storage Box.....	129
		Passenger Seating.....	104	Coat Hook.....	129
		Seat Adjustments.....	105	Accessory Power Sockets.....	130
		Driver's Seat Manual Height Adjustment.....	107	Interior Lights.....	131

Control Locations

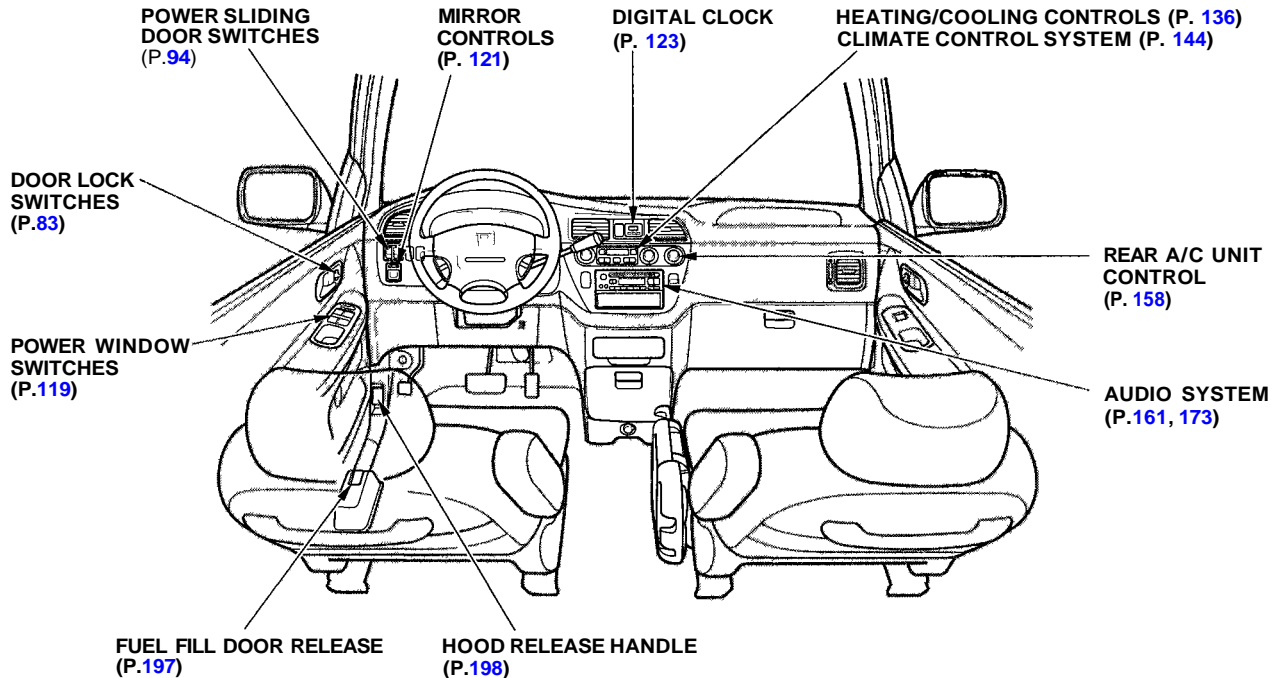

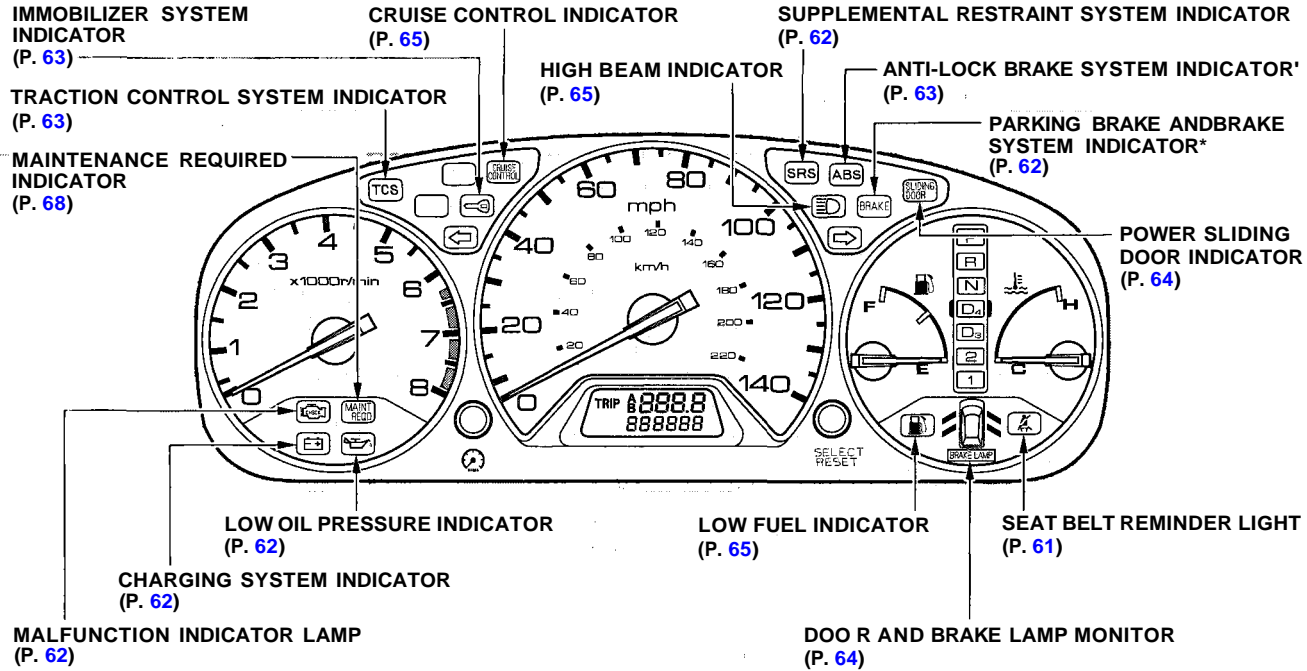

* The U.S. instrument panel is shown. Differences for the Canadian models are noted in the text.

The instrument panel has many indicators to give you important information about your vehicle.



Seat Belt Reminder Light

This indicator lights when you turn the ignition switch ON (II). It is a reminder to you and your passengers to protect yourselves by fastening the seat belts. A beeper also sounds if you have not fastened your seat belt.

If you do not fasten your seat belt, the beeper will stop after a few seconds but the light stays on until you do. Both the light and the beeper stay off if you fasten your seat belt before turning on the ignition.



Malfunction Indicator Lamp

See page [320](#).



Low Oil Pressure Indicator

The engine can be severely damaged if this light flashes or stays on when the engine is running. For complete information, see page [318](#).



Charging System Indicator

If this light comes on when the engine is running, the battery is not being charged. For complete information, see page [319](#).



Supplemental Restraint System Indicator

This indicator lights when you turn the ignition switch ON (II). If it comes on at any other time, it indicates a problem in the supplemental restraint system. For complete information, see page [54](#).



Parking Brake and Brake System Indicator

This light has two functions:

1. This indicator comes on when you turn the ignition switch ON (II). It is a reminder to check the parking brake. Driving with the parking brake not fully released can damage the brakes and tires.
2. If the indicator remains lit after you have fully released the parking brake while the engine is running, or if it comes on while driving, it can indicate a problem in the brake system. For complete information, see page [322](#).

U.S.

Canada

ABS



Anti-lock Brake System (ABS) Indicator

This light normally comes on for a few seconds when you turn the ignition switch ON (II), and when the ignition switch is turned to START (III). If this light comes on at any other time, there is a problem in the ABS. If this happens, take the vehicle to your dealer to have it checked. With the light on, your vehicle still has normal braking ability but no anti-lock. For complete information, see page [219](#).

TCS Traction Control System (TCS) Indicator

This indicator has three functions:

1. It comes on as a reminder that you have turned off the Traction Control System.
2. It flashes when the TCS is regulating wheelspin.
3. If it comes on and stays on when the Traction Control System is on, it indicates that there is a problem in the TCS.

This light also comes on when you turn the ignition ON (II) and goes off after the engine starts. See page [221](#) for more information on the TCS.



Immobilizer System Indicator

This indicator comes on for a few seconds when you turn the ignition switch ON (II). It will then go off if you have inserted a properly-coded ignition key. If it is not a properly-coded key, the indicator will blink and the engine will not start (see page [81](#)).

This indicator also blinks several times when you turn the ignition switch from ON (II) to ACCESSORY (I) or LOCK (0).

SLIDING DOOR Power Sliding Door Indicator

EX model only

This indicator comes on for a few seconds when you turn the ignition switch ON (II). If it comes on at any other time, there is a problem in the power sliding door system. With this light on, move the main switch on the dashboard to the OFF position, and have the system checked by your Honda dealer as soon as possible. You can still open or close each sliding door manually. For more information on the power sliding doors, see page 94.

Turn Signal and Hazard Warning Indicators

The left or right turn signal light blinks when you signal a lane change or turn. If the light does not blink or blinks rapidly, it usually means one of the turn signal bulbs is burned out (see page 283). Replace the bulb as soon as possible, since other drivers cannot see that you are signalling.

When you turn on the Hazard Warning switch, both turn signal lights blink. All turn signals on the outside of the vehicle should flash.

Door and Brake Lamp Monitor

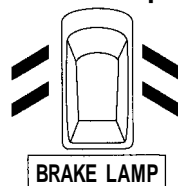

The appropriate light comes on in this display if the tailgate or any door is not closed tightly. If a brake light does not work, the **BRAKE LAMP** indicator comes on when you push the brake pedal with the ignition switch ON (II).

A burned out brake light is a hazard when drivers behind you cannot tell you are braking. Have your brake lights repaired right away. All the lights in the monitor display come on when you turn the ignition switch ON (II). The lights go off after the engine starts and the tailgate and all doors are closed tightly.

DRL

"Daytime Running Lights" Indicator

Canadian models only

This indicator lights when you turn the ignition switch to ON (II) with the headlight switch off and the parking brake set. It should go off if you turn on the headlights or release the parking brake. If it comes on at any other time, it means there is a problem with the DRL. There may also be a problem with the high beam headlights.

CRUISE CONTROL

Cruise Control Indicator

This lights when you set the cruise control. See page [77](#) for information on operating the cruise control.



High Beam Indicator

This light comes on with the high beam headlights. See page [70](#) for information on the headlight controls.

On Canadian models, this indicator comes on with reduced brightness when the Daytime Running Lights (DRL) are on (see page [71](#)).



Low Fuel Indicator

This light comes on as a reminder that you must refuel soon.



Washer Level Indicator

Canadian models only

This light comes on when the washer fluid level is low. Add washer fluid when you see this light come on (see page [258](#)).

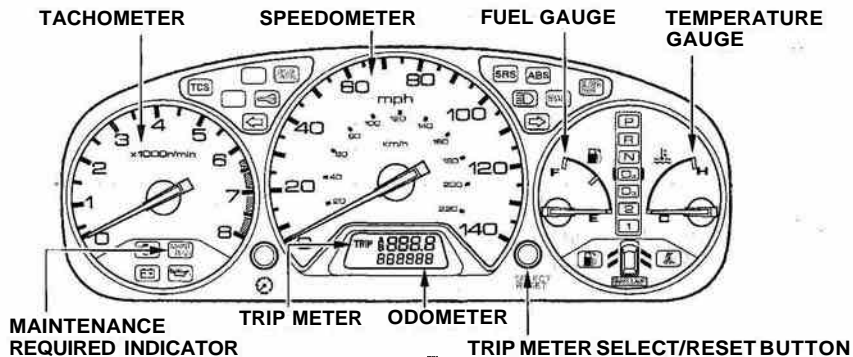

Speedometer

U.S. Models

This shows your speed in miles per hour (mph). The smaller inner numbers are the speed in kilometers per hour (km/h).

Canadian Models

This shows your speed in kilometers per hour (km/h). The smaller inner numbers are the speed in miles per hour (mph).

Tachometer

The tachometer shows the engine speed in revolutions per minute (rpm). To protect the engine from damage, never drive with the tachometer needle in the red zone.

Odometer

The odometer shows the total distance your vehicle has been driven. It measures miles in U.S. models and kilometers in Canadian models. It is illegal under U.S. federal law and Canadian provincial regulations to disconnect, reset, or alter the odometer with the intent to change the number of miles or kilometers indicated.

Trip Meter

This meter shows the number of miles (U.S.) or kilometers (Canada) driven since you last reset it.

There are two trip meters: Trip A and Trip B. Switch between these displays by pressing the Select/Reset button repeatedly. Each trip meter works independently, so you can keep track of two different distances.

To reset a trip meter, display it, and then press and hold the Select/Reset button until the number resets to "0.0".

Temperature Gauge

This shows the temperature of the engine's coolant. During normal operation, the pointer should rise from the bottom white mark to about the middle of the gauge. In severe driving conditions, such as very hot weather or a long period of uphill driving, the pointer may rise to near the upper white mark. If it reaches the red (Hot) mark, pull safely to the side of the road. Turn to page [315](#) for instructions and precautions on checking the engine's cooling system.

Fuel Gauge

This shows how much fuel you have. It is most accurate when the vehicle is on level ground. It may show slightly more or less than the actual amount when you are driving on curvy or hilly roads.

The needle returns to the bottom after you turn off the ignition. The gauge shows the fuel level reading immediately after you turn the ignition switch back ON (II).

Maintenance Required Indicator

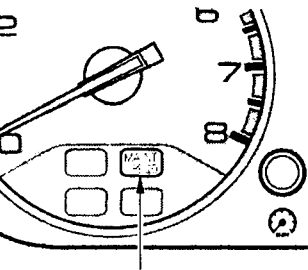

MAINTENANCE REQUIRED INDICATOR

The indicator reminds you that it is time to take your vehicle in for scheduled maintenance.

Refer to the Maintenance Schedules for Normal and Severe Driving Conditions on pages [240 — 244](#).

After the first 6,000 miles (9,600 km), the Maintenance Required Indicator will be reset, it will come on for two seconds when you turn the ignition switch ON (II).

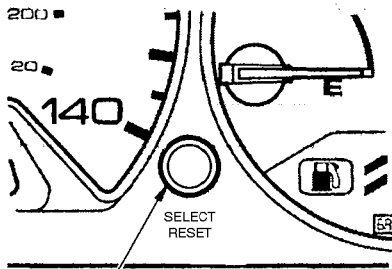

SELECT/RESET BUTTON

Between 6,000 miles (9,600 km) and 7,500 miles (12,000 km) this indicator will light for two seconds when you first turn the ignition switch ON (II), and then flash for ten seconds.

If you exceed 7,500 miles (12,000 km) without having the scheduled maintenance performed, this indicator will remain on as a constant reminder.

Your dealer will reset this indicator after completing the scheduled maintenance. If this maintenance is done by someone other than your Honda dealer, reset the indicator as follows.

1. Turn off the engine.
2. Press and hold the select/reset button in the instrument panel, then turn the ignition switch ON (II).
3. Hold the button until the indicator resets (approximately ten seconds).

The two levers on the steering column contain controls for driving features you use most often. The left lever controls the turn signals, headlights, and high beams. The right lever controls the windshield washers and wipers.

The switches for the hazard warning lights and rear window defogger are located to the right of the steering column.

The controls under the left air vent are for the TCS, the cruise control, the power sliding doors and the power mirrors.

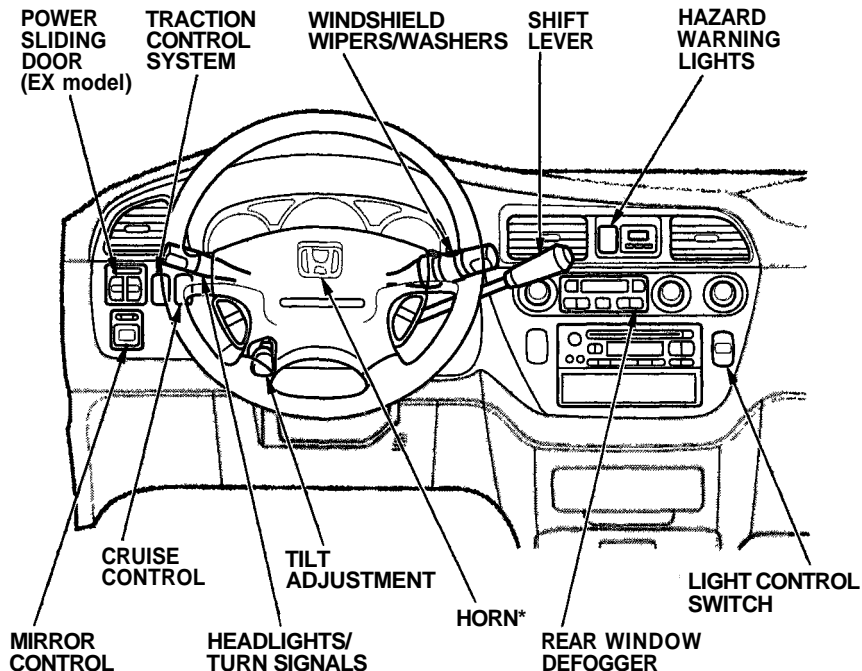

The tilt adjustment lever on the underside of the steering column allows you to tilt the steering wheel.

* To use the horn, press the pad around the "H" logo.

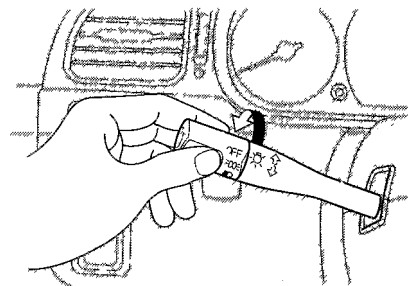

Headlights



The rotating switch on the left lever controls the lights. Turning this switch to the “ ” position turns on the parking lights, taillights, instrument panel lights, side-marker lights, and rear license plate lights. Turning the switch to the “ ” position turns on the headlights.

If you leave the lights on with the ignition switch in ACCESSORY (I) or LOCK (0), you will hear a reminder chime when you open the driver's door.

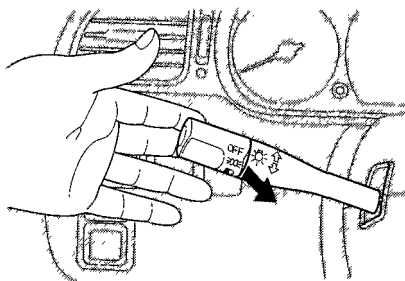

To change between low beams and high beams, pull the turn signal lever until you hear a click, then let go. The blue high beam indicator will light (see page [65](#)).



To flash the high beams, pull the turn signal lever back lightly, then release it. The high beams will come on and go off.

The high beams will stay on for as long as you hold the lever back, no matter what position the headlight switch is in.

Automatic Lighting Off Feature

On EX model

The Automatic Lighting Off feature turns off the headlights, parking lights, taillights, side marker lights, license plate lights and instrument panel lights within 15 seconds of removing the key from the ignition switch and closing the driver's door.

This feature activates if you leave the headlight switch in the  or  position, remove the key, open, then close the driver's door. If you remove the key from the ignition switch with the headlight switch on, but do not open the door and get out, the lights will turn off after 10 minutes.

The lights will turn on again when you unlock or open the driver's door. If you unlock the door, but do not open it within 15 seconds, the lights will go off. With the driver's door open, you will hear a lights-on reminder chime.

Daytime Running Lights (Canadian Models)

With the headlight switch off, the high beam headlights come on with reduced brightness when you turn the ignition switch to ON (II) and release the parking brake. They remain on until you turn the ignition off, even if you set the parking brake.

The headlights revert to normal operation when you turn them on with the switch.

Instrument Panel Brightness

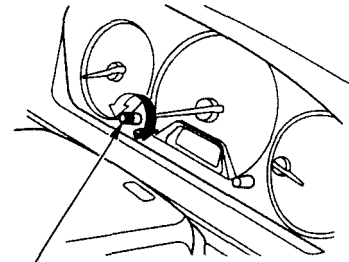

INSTRUMENT PANEL BRIGHTNESS CONTROL KNOB

The knob on the instrument panel controls the brightness of the instrument panel lights. Turn the knob to adjust the brightness.

Controls Near the Steering Wheel

Turn Signals

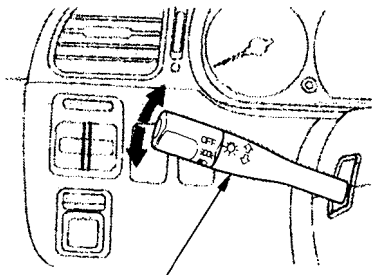

TURN SIGNAL LEVER

Signal a turn or lane change with this lever. Push down on the lever to signal a left turn, and up to signal a right turn. If you push it up or down all the way, the turn signal continues to blink even when you release the lever. It shuts off automatically as you complete the turn.

To signal a lane change, push lightly on the turn signal lever in the proper direction and hold it. The lever will return to the center position as soon as you release it.

Windshield Wipers

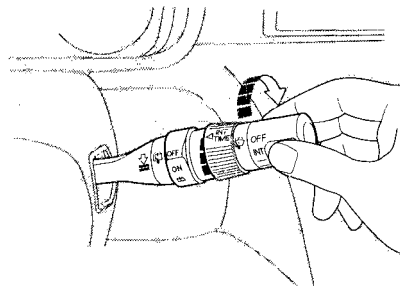

The right lever controls the windshield wipers and washers. The rotary switch at the end of the lever has three positions:

- INT: intermittent
- : low speed
- == : high speed

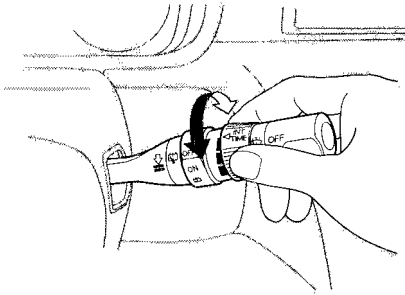

In intermittent, the wipers operate every few seconds. You can vary how often the wipers sweep the windshield by turning the INT TIME ring next to the rotary switch. The sweep interval will change slightly with speed; getting shorter as you drive faster. In low speed and high speed, the wipers run continuously.

If you turn the INT TIME ring to the shortest delay, the wipers will change from intermittent to low speed operation when vehicle speed exceeds 12 mph (20 km/h).

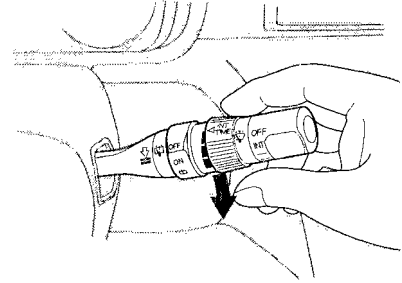

To operate the wipers in mist mode, push the control lever down. The wipers run at high speed until you release the lever. This gives you a quick way to clear the windshield.

Controls Near the Steering Wheel

Windshield Washers

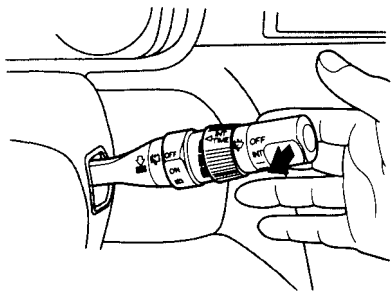

To clean the windshield, pull back on the wiper control lever. The washers spray until you release the lever. The wipers run at low speed while you're pulling the lever, then complete one more sweep of the windshield after you release it.

Rear Window Wiper and Washer

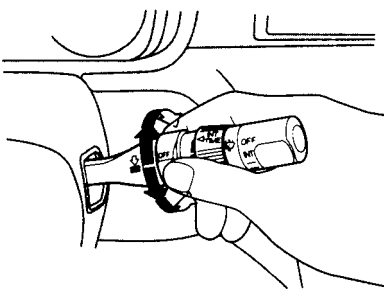

The rear window wiper switch is located next to the windshield wiper switch.

To activate the rear windshield wiper, turn the switch "ON". If you turn the switch "ON", the rear windshield wiper swings twice and then will sweep the glass approximately every seven seconds. If you wish to use the wiper and washer, turn and hold the switch one position up from "ON".

Hazard Warning

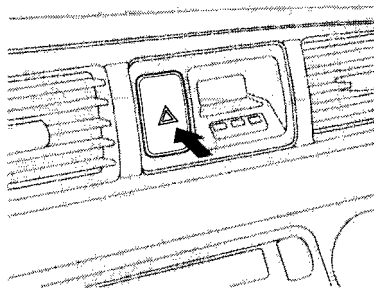

Push the red button to the left of the clock to turn on the hazard warning lights (four-way flashers). This causes all four outside turn signals and both indicators in the instrument panel to flash. Use the *hazard* warning lights if you need to park in a dangerous area near heavy traffic, or if your vehicle is disabled.

Rear Window Defogger

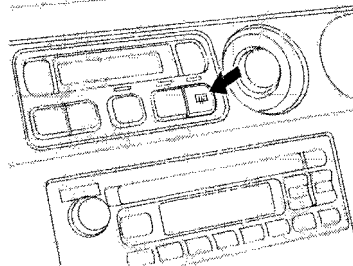

EX model

The rear window defogger will clear fog, frost, and thin ice from the window. Push the defogger button to turn it on and off. The light above the button lights to show the defogger is on. If you do not turn it off, the defogger will shut itself off after about 15 minutes. It also shuts off when you turn off the ignition. You have to turn it on again when you restart the vehicle.

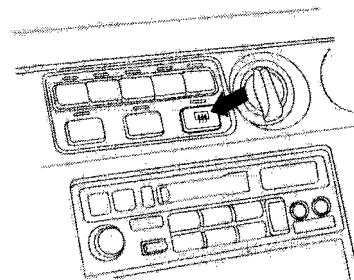

LX model

Make sure the rear window is clear and you have good visibility before starting to drive.

The defogger wires on the inside of the rear window can be accidentally damaged. When cleaning the glass, always wipe side to side.

Steering Wheel Adjustment

See page 19 for important safety information about how to properly position the steering wheel.

Make any steering wheel adjustment before you start driving.

Adjusting the steering wheel position while driving may cause you to lose control of the vehicle and be seriously injured in a crash.

Adjust the steering wheel only when the vehicle is stopped.

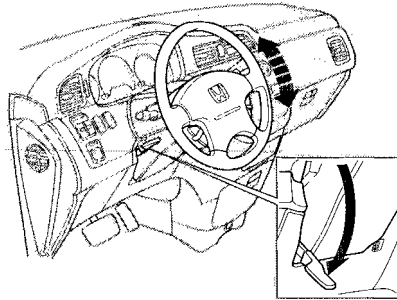

To adjust the steering wheel upward or downward:

1. Push the lever under the steering column all the way down.
2. Move the steering wheel to the desired position, making sure the wheel points toward your chest, not toward your face. Make sure you can see the instrument panel gauges and the indicator lights.

3. Push the lever up to lock the steering wheel in that position.
4. Make sure you have securely locked the steering wheel in place by trying to move it up and down.

Cruise Control

Cruise control allows you to maintain a set speed above 25 mph (40 km/h) without keeping your foot on the accelerator pedal. It should be used for cruising on straight, open highways. It is not recommended for conditions such as city driving, winding roads, slippery roads, heavy rain, or bad weather. You should have full control of the vehicle under those conditions.

Improper use of the cruise control can lead to a crash.

Use the cruise control only when traveling on open highways in good weather.

Using the Cruise Control

CRUISE CONTROL MASTER SWITCH

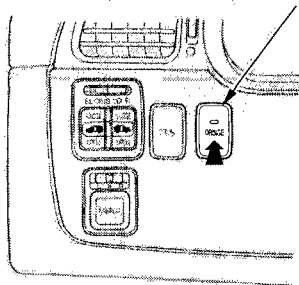

1. Push in the Cruise Control Master Switch to the left of the steering column. The indicator in the switch will light.
2. Accelerate to the desired cruising speed above 25 mph (40 km/h).

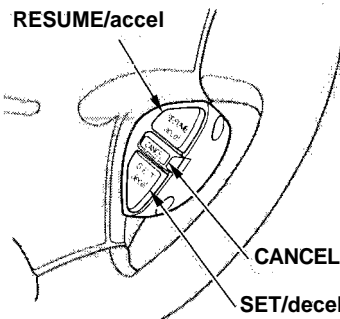

3. Press and release the SET/decel button on the steering wheel. The CRUISE CONTROL light on the instrument panel comes on to show the system is now activated.

CONTINUED

The cruise control may not hold the set speed when you are going up and down hills. If your speed increases going down a hill, use the brakes to slow down to the desired speed. This will cancel the cruise control. To resume the set speed, press the RESUME/accel button. The CRUISE CONTROL light on the instrument panel comes on.

When climbing a steep hill, the automatic transmission may downshift to hold the set speed.

Changing the Set Speed

You can increase the set cruising speed in any of these ways:

- Press and hold the RESUME/accel button. The vehicle will accelerate. When you reach the desired cruising speed, release the button.
- Push on the accelerator pedal. Accelerate to the desired cruising speed and press the SET/decel button.
- To increase your speed in very small amounts, tap the RESUME/accel button repeatedly. Each time you do this, your vehicle will speed up about 1 mph (1.6 km/h).

You can decrease the set cruising speed in any of these ways:

- Press and hold the SET/decel button. The vehicle will decelerate. Release the button when you reach the desired speed.
- To slow down in very small amounts, tap the SET/decel button repeatedly. Each time you do this, your vehicle will slow down about 1 mph (1.6 km/h).
- Tap the brake pedal lightly with your foot. The CRUISE CONTROL light on the instrument panel will go out. When the vehicle slows to the desired speed, press the SET/decel button. The vehicle will then maintain the desired speed.

Even with the cruise control turned on, you can still use the accelerator pedal to speed up for passing. After completing the pass, take your foot off the accelerator pedal. The vehicle will return to the set cruising speed.

Resting your foot on the brake pedal will cause the cruise control to cancel.

Cancelling the Cruise Control

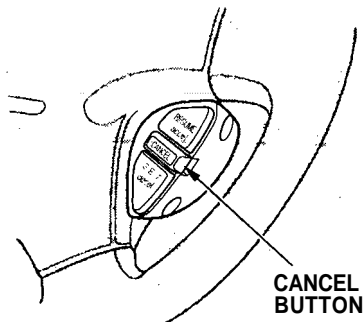

You can cancel the cruise control in any of these ways:

- Tap the brake pedal.
- Push the CANCEL button on the steering wheel.
- Press the Cruise Control Master Switch.

When you push the CANCEL button, or tap the brake pedal, the CRUISE CONTROL light on the instrument panel will go out and the vehicle will begin to slow down. You can use the accelerator pedal in the normal way. The system remembers the previously-set cruising speed. To return to that speed, accelerate to above 25 mph (40 km/h) and then press and release the RESUME/ accel button. The CRUISE CONTROL light comes on. The vehicle will accelerate to the same cruising speed as before.

Pressing the Cruise Control Master Switch turns the system completely off and erases the previous cruising speed from memory. To use the system again, refer to ***Using the Cruise Control.***

Remote Audio Controls

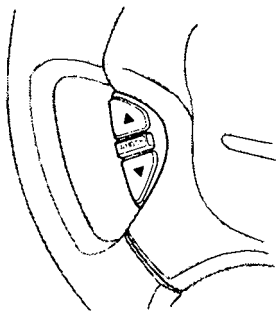

On EX model

These buttons let you control some functions of the audio system without removing your hands from the wheel. Refer to page [185](#) for a complete explanation.

Keys

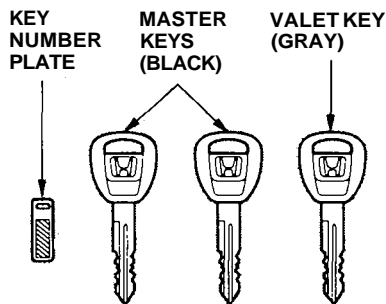

Your vehicle comes with two master keys and a valet key. The master key fits all the locks on your vehicle:

- Ignition
- Doors
- Glove box
- Tailgate

The valet key works only in the ignition and the door locks. You can keep the glove box locked when you leave your vehicle and valet key at a parking facility.

You should have received a key number plate with your keys. You will need this key number if you ever have to get a lost key replaced. Keep the plate stored in a safe place. If you need to replace a key, use only Honda-approved key blanks.

These keys contain electronic circuits that are activated by the Immobilizer System. They will not work to start the engine if the circuits are damaged.

- Protect the keys from direct sunlight, high temperature, and high humidity.
- Do not drop the keys or set heavy objects on them.
- Keep the keys away from liquids. If they get wet, dry them immediately with a soft cloth.

The keys do not contain batteries. Do not try to take them apart.

Remote Transmitter

Some models also come with a remote transmitter; see page [85](#) for an explanation of its operation.

Immobilizer System

The Immobilizer System protects your vehicle from theft. A properly-coded master or valet key must be used in the ignition switch for the engine to start. If an improperly-coded key (or other device) is used, the engine's fuel system is disabled.

When you turn the ignition switch to ON (II), the Immobilizer System indicator should come on for a few seconds, then go out. If the indicator starts to blink, it means the system does not recognize the coding of the key. Turn the ignition switch to LOCK (0), remove the key, reinsert it, and turn the switch to ON (II) again.

The system may not recognize your key's coding if another immobilizer key or other metal object is near the ignition switch when you insert the key. To make sure the system recognizes the key code:

- Do not keep other immobilizer keys on the same key ring.
- Use a plastic or leather key fob, not metal.
- Keep other keys away from your vehicle's key and the ignition switch while trying to start the engine.

If the system repeatedly does not recognize the coding of your key, contact your Honda dealer. This indicator will also blink several times when you turn the ignition switch from ON (II) to ACCESSORY (I) or LOCK (0). Do not attempt to alter this system or add other devices to it. Electrical problems could result that may make your vehicle undriveable. If you have lost your key and you cannot start the engine, contact your Honda dealer.

CONTINUED

As required by the FCC:

This device complies with Part 15 of the FCC rules. Operation is subject to the following two conditions: (1) This device may not cause harmful interference, and (2) this device must accept any interference received, including interference that may cause undesired operation.

Changes or modifications not expressly approved by the party responsible for compliance could void the user's authority to operate the equipment.

This device complies with Industry Canada Standard RSS-210.

Operation is subject to the following two conditions: (1) this device may not cause interference, and (2) this device must accept any interference that may cause undesired operation of the device.

Ignition Switch

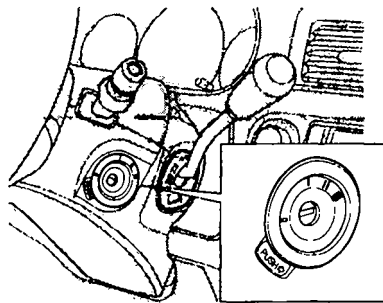

The ignition switch is on the right side of the steering column. It has four positions:

- LOCK (0)
- ACCESSORY (I)
- ON (II)
- START (III)

LOCK (0) — You can insert or remove the key only in this position. To switch from ACCESSORY to LOCK, you must push the key in slightly as you turn it. The shift lever must also be in Park. The anti-theft lock will lock the steering column when you remove the key.

If the front wheels are turned, the anti-theft lock may sometimes make it difficult to turn the key from LOCK to ACCESSORY. Firmly turn the steering wheel to the left or to the right as you turn the key.

ACCESSORY (I) — In this position, you can operate the audio system and the accessory power socket.

ON (II) — This is the normal key position when driving. All features and accessories on the vehicle are usable. Several of the lights on the instrument panel come on as a test when you turn the ignition switch from ACCESSORY to ON.

START (III) — Use this position only to start the engine. The switch returns to ON (II) when you let go of the key.

The engine will not start if the Immobilizer System does not recognize the key's coding (see page 81).

You will hear a reminder beeper if you leave the key in the ignition switch in the LOCK (0) or ACCESSORY (I) position and open the driver's door. Remove the key to turn off the beeper.

Power Door Locks

MASTER DOOR LOCK SWITCH

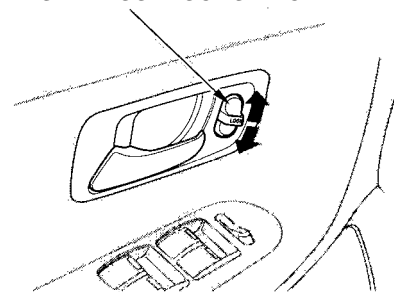

Each front door has a master door lock switch. Either switch locks and unlocks all doors and the tailgate. Push the switch down to lock all doors and the tailgate, and up to unlock them.

CONTINUED

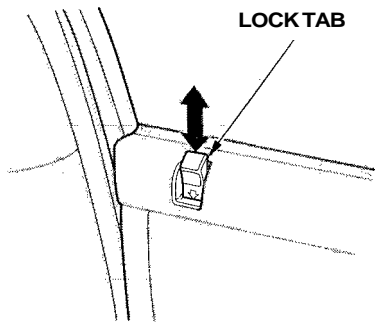

Each front door has a lock tab on the top. When you push down the lock tab on the driver's door, all the doors and the tailgate lock. Pulling up the lock tab on the driver's door unlocks only that door. The lock tab on the front passenger's door locks and unlocks only that door.

To lock the front passenger's door when getting out of the vehicle, push the lock tab down and close the door.

To lock the driver's door, along with the remaining doors and the tailgate, push the lock tab down or push the master switch down, then close the door.

All doors and the tailgate can be locked from the outside by using the key in either front door. To unlock only the driver's door from the outside, turn the key and release it. If you turn the key and hold it, all doors and the tailgate will unlock. All four doors and the tailgate will unlock when you unlock the passenger's door with the key.

Lockout Prevention

If you forget and leave the key in the ignition switch, Lockout Prevention will not allow you to lock the driver's door. With the driver's door open and the key in the ignition, both master door lock switches are disabled. However, if the driver's door is not open, the master door lock switches are not disabled. Pushing the switch down on the open passenger's door will lock all doors. If you try to lock an open driver's door by pushing in the lock tab, the tabs on both front doors pop out and the lock knobs on the rear sliding doors slide out. Pushing in the lock tab on the passenger's door only locks that door.

Remote Transmitter

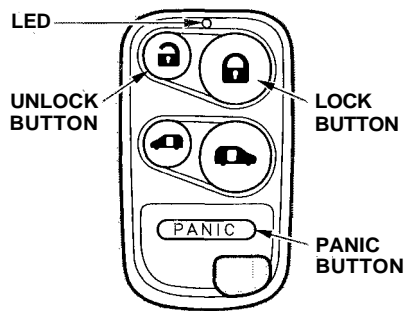

On EX model

You can lock and unlock your vehicle with the remote transmitter. When you push the LOCK button, all doors and the tailgate lock. The parking lights, side marker lights, taillights and instrument panel lights flash once.

When you push the UNLOCK button once, only the driver's door unlocks. The remaining doors and the tailgate unlock when you push the button a second time. The parking lights, side marker lights, taillights and instrument panel lights flash twice when you push the button the first time.

When you press the UNLOCK button, the front and rear individual map lights and the cargo area light, depending on their switch positions, will come on (see page 133). If you do not open any door or the tailgate, the lights stay on for about 10 seconds, then go out. If you relock the doors and the tailgate with the remote transmitter before 10 seconds have elapsed, the lights will go off immediately.

If you unlock the doors and the tailgate with the remote transmitter, but do not open any door or the tailgate within 30 seconds, all doors and the tailgate automatically relock.

You cannot lock the doors and the tailgate with the remote transmitter if any door or the tailgate is not fully closed. You cannot lock or unlock the doors and the tailgate with the key in the ignition switch.

CONTINUED

Opening or Closing the Power Sliding Doors

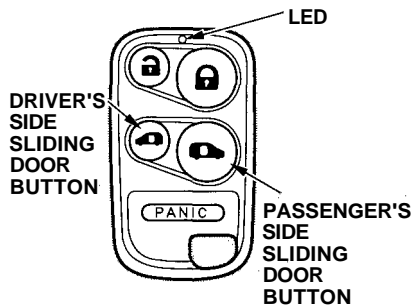

You can open or close each rear sliding door with the remote transmitter. The right button controls the passenger's side door and the left button controls the driver's side door.

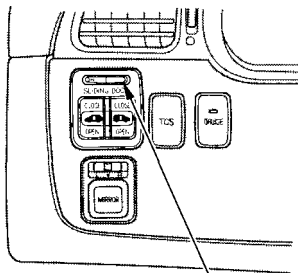

POWER SLIDING DOOR MAIN SWITCH

If the power sliding door MAIN switch on the dashboard is in the OFF position, you cannot open or close the sliding doors with the remote transmitter.

Panic Mode

Panic mode allows you to remotely activate your vehicle's horn and lights to attract attention. When activated, the horn will sound, and the headlights, parking lights, side marker lights, taillights and instrument panel lights will flash for about 30 seconds. To activate panic mode, press and hold the PANIC button for about one second.

To cancel Panic mode before 30 seconds, press any button on the remote transmitter. You can also turn the ignition switch to ON (II).

Panic mode will not activate if the key is in the ON (II) position.

Replacing the Battery

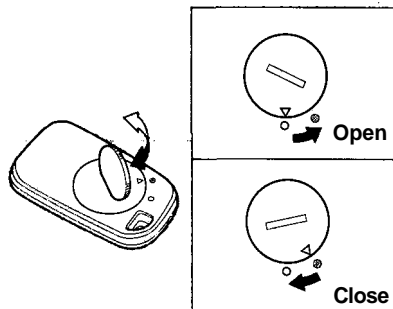

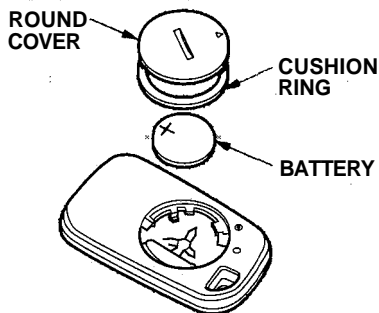

When the remote transmitter's battery begins to get weak, it may take several pushes on the button to lock or unlock the doors and the tailgate, and the LED will get dim. Replace the battery as soon as possible.

Battery type: CR2025



To replace the battery, remove the round cover on the back of the transmitter by turning it counterclockwise with a coin.

Remove the old battery and note the polarity. Make sure the polarity of the new battery is the same (+ side facing up), then insert it in the transmitter.

Reinstall the O-ring. Align the  mark on the cover with the  mark on the transmitter, then set the cover in place and turn it clockwise.

CONTINUED

Transmitter Care

Avoid severe shock to the transmitter, such as dropping or throwing it. Also, protect it from extreme hot or cold temperatures.

Clean the transmitter case with a soft cloth. Do not use strong cleaners or solvents that could harm the case. Immersing the transmitter in any liquid will harm the transmitter and cause it to not function properly.

If you lose a transmitter, you will need to have the replacement programmed to your vehicle's system by your Honda dealer. Any other transmitters you have will also need to be reprogrammed.

As required by the FCC:

This device complies with Part 15 of the FCC rules. Operation is subject to the following two conditions: (1) This device may not cause harmful interference, and (2) this device must accept any interference received, including interference that may cause undesired operation.

Changes or modifications not expressly approved by the party responsible for compliance could void the user's authority to operate the equipment.

This device complies with Industry Canada Standard RSS-210. Operation is subject to the following two conditions: (1) this device may not cause interference, and (2) this device must accept any interference that may cause undesired operation of the device.

Childproof Door Locks

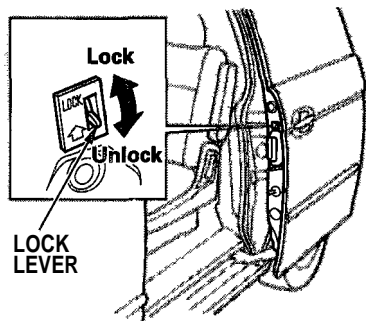

The childproof door locks are designed to prevent children seated in the rear from accidentally opening the rear sliding doors. Each door has a lock lever near the edge. With the lever in the LOCK position, the door cannot be opened from the inside regardless of the position of the lock knob. To open the door, slide the lock knob forward and use the outside door handle.

On EX model

With the childproof door locks on, automatic operation with the inside door handle is disabled.

Tailgate

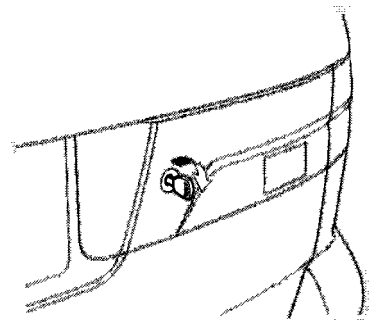

Use your key to lock and unlock the tailgate.

On the EX model, you can also lock and unlock the tailgate with the remote transmitter (see page 85).

CONTINUED

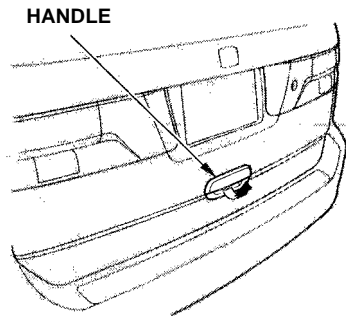

To open the tailgate, pull the handle, then lift up the tailgate.

To close the tailgate, pull the tailgate down, then press down on the back edge.

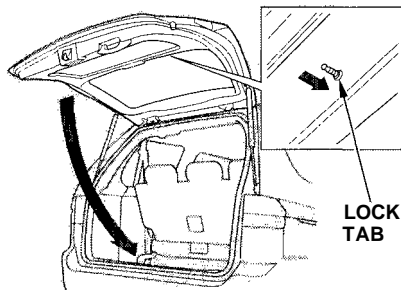

The tailgate also has a lock tab on the inside.

To lock the tailgate without the key or the remote transmitter, push the lock tab down and close the tailgate.

See page [206](#) for information on cargo loading. Keep the tailgate closed at all times while driving to avoid damaging the tailgate, and to prevent exhaust gas from getting into the interior. See **Carbon Monoxide Hazard** on page [57](#).

Glove Box

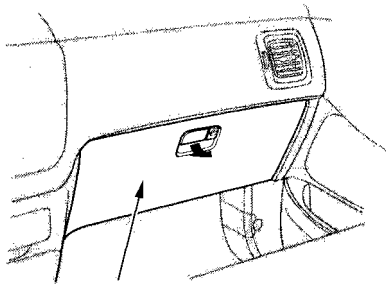

GLOVE BOX

Open the glove box by pulling the bottom of the handle. Close it with a firm push. Lock or unlock the glove box with the master key.

An open glove box can cause serious injury to your passenger in a crash, even if the passenger is wearing the seat belt.

Always keep the glove box closed while driving.

Manual Sliding Doors (LX Model)

Your Honda is equipped with dual sliding doors. Be sure all passengers are clear of the sliding doors before closing them.

Opening and Closing the Doors

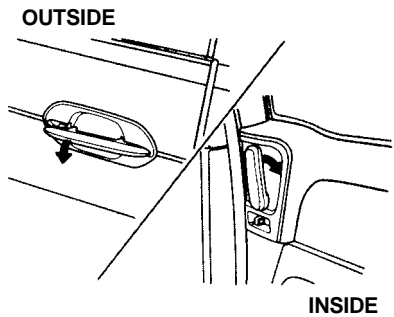

To open a manual sliding door, pull the inside or outside door handle and slide the door back. It will latch in the fully-open position.
To close the door, pull either handle and slide the door closed. Make sure the door is closed and latched

securely before driving.

Locking the Doors

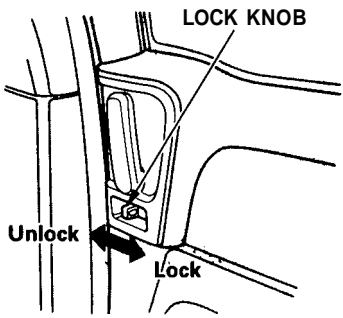

Each sliding door has a lock knob under the inside door handle. Slide the lock knob forward to unlock, and backward to lock.

When you drive with children in your vehicle, use the childproof door locks (see page 89). This will prevent children from opening the doors accidentally.

A Note About Refueling

Before refueling, make sure the driver's side sliding door is fully closed. When you release the fuel fill door, the driver's side sliding door automatically locks so it cannot open and interfere with the fuel door. If a passenger attempts to unlock the door by cycling the lock knob several times, the door may unlock and can be opened.

If a passenger needs to get out of the vehicle while you are refueling, instruct that person to exit on the passenger's side, not the driver's side.

After you close the fuel fill door, the sliding door does not automatically unlock. You must unlock it manually.

Parking Facing Downhill

When parking facing downhill, make sure the manual doors are latched in the fully-open position, then hold the door open while allowing your passengers to enter or exit the vehicle. Do not pull the inside or outside door handle, or the latch will release and the door will slam shut.

Power Sliding Doors

Your Honda is equipped with dual power sliding doors. The doors on the EX model are electrically powered and can be operated with the remote transmitter, the door handles, or the switches on the dashboard.

Be sure all passengers are clear of the sliding doors before closing them.

Closing a power sliding door while any part of a passenger is in the door's path can cause serious injury.

Make sure all passengers are clear of the doorway before closing a sliding door.

The power sliding doors operate with the ignition switch in any position. In addition:

- The shift lever must be in Park.
- The MAIN switch on the dashboard must be in the ON position.
- The sliding door you want to operate must be unlocked.
- To open the door with the inside handle, the childproof door lock on the door you want to operate must be unlocked (see page 89).

Make sure both sliding doors are closed before you start driving.

If you shift out of Park while a door is closing, you will hear a beep until the power sliding door closes completely.

CONTINUED

Power Sliding Doors (EX Model)

If you shift out of Park while a door is opening, you will hear a continuous tone and the door will stop moving. If you keep driving with the door open, the tone continues until you stop and close the door.

About the Main Switch

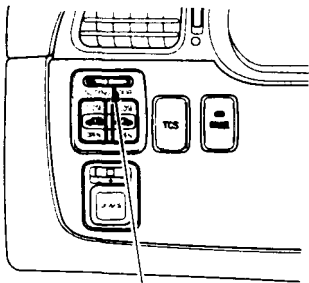

POWER SLIDING DOOR MAIN SWITCH

The MAIN switch on the dashboard controls electrical power to the sliding doors. During normal operation, leave the MAIN switch in the ON position.

When the MAIN switch is off, the electrical power is off and you will not be able to use the dashboard switches or the remote transmitter to open or close the power sliding doors.

When the MAIN switch is off, you must operate each sliding door manually. To open or close a door, pull the inside or outside door handle and slide the door. The door will be difficult to move; this is normal. Do not use force or try to move the door rapidly, you could damage the motor.

Operating the Doors With the Dashboard Switches

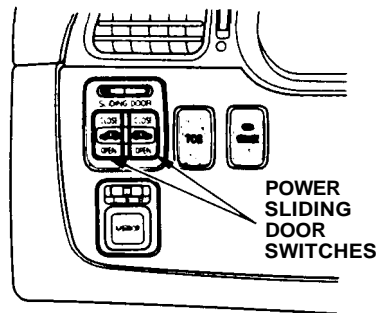

The dashboard switches to the left of the steering column allow you to open or close each sliding door. The left switch controls the sliding door on the left side, and the right switch controls the sliding door on the right side.

To open a door, make sure the door is unlocked. Then push and release the bottom of the switch. If you forget to unlock the door first, you will hear three beeps. Unlock the door and try again.

To close a sliding door, push and release the top of the appropriate switch.

To stop the power sliding door's movement, push either the top or the bottom of the appropriate switch. The door will stop, and you will hear three beeps.

To start the door moving again, push the switch again: bottom to open, or top to close.

Operating the Doors With the Remote Transmitter

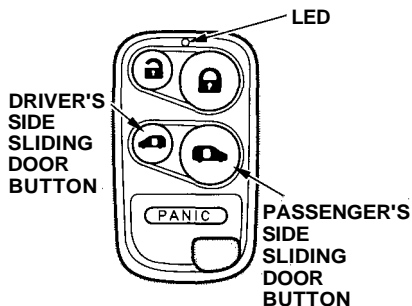

You can open or close each sliding door with the remote transmitter. The right button controls the passenger's side sliding door, and the left button controls the driver's side sliding door.

To open a sliding door, make sure the door is unlocked. Then press the appropriate button for at least two seconds. If you forget to unlock the door first, you will hear three beeps. Unlock the door and try again.

To close a sliding door, press the appropriate button for at least two seconds.

To stop the power sliding door's movement, push the appropriate door button on the remote transmitter. The door will stop, and you will hear three beeps.

If you push the same button again, the door will reverse direction.

CONTINUED

Power Sliding Doors (EX Model)

Operating the Doors With the Door Handles

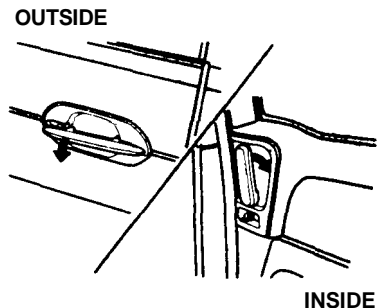

With the sliding door fully-closed or fully-open, pull the outside or inside door handle, then release it.

Once the door begins to move, the door handles cannot be used to stop the door. If you need to stop the door for any reason, use the dashboard switches or the remote transmitter.

Locking the Doors

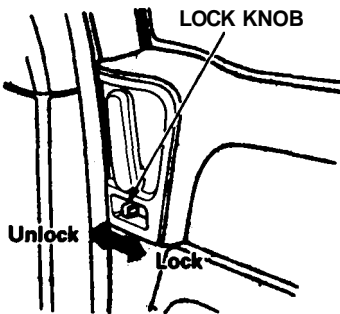

Each sliding door has a lock knob under the inside door handle. Slide the lock knob forward to unlock, and backward to lock the doors. You can also use the lock and unlock buttons on the remote transmitter.

When you drive with children in your vehicle, use the childproof door locks (see page [89](#)). This will prevent children from opening the doors accidentally.

Sliding Doors and Obstacles

Each power sliding door has an auto-reverse feature. If a door meets resistance while closing, it will beep three times and automatically reverse direction. However, the door may not immediately reverse direction (like some elevator doors), and the force of a closing door may cause bruising or discomfort. Always make sure passengers and any objects are well away from the power sliding doors before closing them.

Also check that passengers, especially children, do not have their hands on the edge of the sliding door or on the door pillar. The auto-reverse feature stops working when the door is about to latch so the motor can pull the door shut.

If a person or object is in the way after the door begins to close, the door handles cannot be used to stop the door. To stop the door, use the dashboard switches or the remote transmitter.

A Note About Refueling

Before refueling, make sure the driver's side sliding door is fully closed. When you release the fuel fill door, the driver's side sliding door automatically locks so it cannot open and interfere with the fuel door. If a passenger attempts to unlock the door by cycling the lock knob several times, the door may unlock and can be opened.

If a passenger needs to get out of the vehicle while you are refueling, instruct that person to exit on the passenger's side, not the driver's side.

After you close the fuel fill door, the sliding door does not automatically unlock. You must unlock it manually.

Parking Facing Downhill

When parking facing downhill on a steep grade, the power sliding doors may not open or close as they do normally.

- Make sure the MAIN switch is in the ON position. This allows the power assist to keep the doors from slamming shut. If the MAIN switch is off, the door can slam shut and possibly injure someone.
- Make sure the power sliding doors are latched in the fully-open position, then hold the door open while allowing your passengers to enter or exit the vehicle. Do not pull the inside or outside door handle, or the latch will release and the door will close.

How to Reset the Power Sliding Doors

If your vehicle's battery is disconnected or goes dead while a sliding door is open, the power sliding door system needs to be reset. After reconnecting the battery:

- Close each sliding door completely by hand; or
- Move the MAIN switch on the dashboard to the ON position. Push and hold the top of each door switch until each sliding door closes completely.

If the power sliding doors are closed, the system will reset itself automatically once the battery has been reconnected. If the power sliding doors do not operate properly after resetting, have your vehicle checked by a Honda dealer.

CONTINUED

Power Sliding Door Indicator

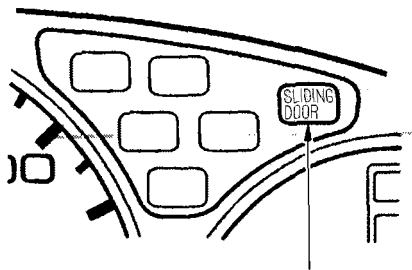

POWER SLIDING DOOR INDICATOR

If the Power Sliding Door indicator comes on and stays on, it indicates a problem in the system. Turn the MAIN switch off to turn off the indicator. Have the system inspected by your Honda dealer as soon as possible.

The HomeLink Universal Transmitter built into your vehicle can be programmed to operate remotely-controlled devices around your home, such as garage doors, lighting, or home security systems. It can replace up to three remote transmitters.

Customer Assistance

If you have problems with training the HomeLink Universal Transmitter, or would like information on home products that can be operated by the transmitter, call (800) 355-3515. On the Internet, go to www.homelink.jci.com.

Important Safety Precautions

Always refer to the operating instructions and safety information that came with your garage door opener or other equipment you intend to operate with the HomeLink Universal Transmitter. If you do not have this information, you should contact the manufacturer of the equipment.

While training or using the transmitter, make sure you have a clear view of the garage door or gate, and that no one will be injured by its movement.

General Information

If you are training the transmitter to operate a garage door or gate, it is recommended that you unplug the motor for that device during training. Repeatedly pressing the remote control button could burn out the motor.

The HomeLink transmitter stores the code in a permanent memory. There should be no need to retrain the transmitter if your vehicle's battery goes dead or is disconnected.

If your garage door opener was manufactured before April 1982, you may not be able to program the HomeLink Universal Transmitter to operate it. Garage door openers manufactured before that date do not have a safety feature that causes them to stop and reverse if an obstacle is detected during closing, increasing the risk of injury. If you have questions, call (800) 355-3515.

CONTINUED

Training the Transmitter

Before you can use the HomeLink Universal Transmitter to operate devices around your home, it must "learn" the proper codes. For example, to train the transmitter to open and close the garage door:

Before you begin — If you just took delivery of your vehicle and have not trained any of the buttons in the HomeLink transmitter before, you should erase any previously learned codes before training the first button. To do this, press and hold the two outside buttons on the HomeLink transmitter for about 20 seconds until the red light flashes. Release the buttons, then proceed to Step 1.

If you are training the second or third buttons, go directly to Step 1.

1. Unplug the garage door opener motor from the house current.
2. Hold the end of the garage door opener remote control 2 to 5 inches from the HomeLink transmitter. Make sure you are not blocking your view of the red light in the transmitter.

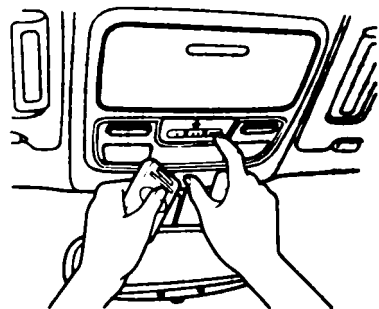

3. Select the transmitter button you want to train.
4. Press the button on the remote control and the button on the transmitter at the same time. Hold down both buttons.

Canadian Owners:

The remote control you are training from may stop transmitting after two seconds. This is not long enough for the HomeLink transmitter to learn the code. Release and press the button on the remote control every two seconds until the transmitter has learned the code.

5. The red light in the transmitter should begin flashing. It will flash slowly at first, then rapidly.
6. When the red light flashes rapidly, release both buttons. The transmitter should have learned the code from the remote control.
7. Plug in the garage door opener motor, then test the transmitter button by pushing it. It should operate the garage door.

If the button does not work, repeat this procedure to train it again. If it

still does not work, you may have a variable or rolling code garage door opener. Test this by pressing and holding the HomeLink transmitter button you just trained. If the red light blinks for two seconds, then stays on, you have a rolling code garage door opener. You may be able to verify this with the manufacturer's documentation. Go to "Training With a Rolling Code System."

8. Repeat these steps to train the other two transmitter buttons to operate any other remotely-controlled devices around your home (lighting, automatic gate, security system, etc.).

Training With a Rolling Code System

For security purposes, newer garage door opening systems use a "rolling" or variable code. Information from the remote control and the garage door opener are needed before the HomeLink transmitter can operate the garage door opener.

The "Training the Transmitter" procedure trains the HomeLink transmitter to the proper garage door opener code. The following procedure synchronizes the HomeLink transmitter to the garage door opener so they send and receive the correct codes.

CONTINUED

HomeLink Universal Transmitter

It may be helpful to have someone assist you with this procedure.

1. Make sure you have properly completed the 'Training the Transmitter' procedure.
2. Find the "Training" button on your garage door opener unit. The location will vary, depending on the manufacturer. The manufacturer's documentation may help.

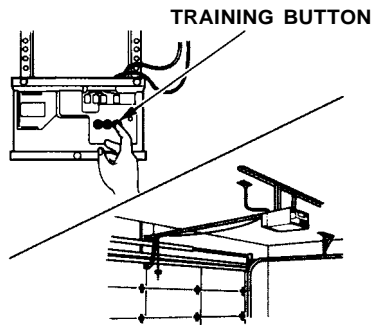

3. Press the Training button on the garage door opener unit until the light next to the button comes on, then release it. The light may blink, or come on and stay on. You then have approximately 30 seconds to complete the following steps.

4. Press and release the button on the HomeLink transmitter. (The same button you trained with the 'Training the Transmitter' procedure.)
5. Press and release the HomeLink transmitter button again. This should turn off the training light on the garage door opener unit. (Some systems may require you to press and release the button up to three times.)
6. Press the transmitter button again. It should operate the garage door.

Retraining a Button

To train an already programmed transmitter button to operate a new device:

1. Select the transmitter button you want to train.
2. Press and hold the transmitter button until the red light begins to flash slowly (approximately 20 seconds).
3. While continuing to hold the transmitter button, place the remote control for the device 2 to 5 inches from the HomeLink transmitter.
4. Press and hold the button on the remote control. Hold both buttons until the red light begins to flash rapidly.

5. Release both buttons. The transmitter should now be trained to operate the device.

Erasing Codes

To erase the codes stored in all three buttons, press and hold the two outside buttons until the red light begins to flash, then release the buttons.

You should erase all three codes before selling the vehicle.

As required by the FCC:

This device complies with Part 15 of the FCC rules. Operation is subject to the following two conditions: (1) This device may not cause harmful interference, and (2) this device must accept any interference received, including interference that may cause undesired operation.

Changes or modifications not expressly approved by the party responsible for compliance could void the user's authority to operate the equipment.

This device complies with Industry Canada Standard RSS-210.

Operation is subject to the following two conditions: (1) this device may not cause interference, and (2) this device must accept any interference that may cause undesired operation of the device.

Passenger Seating *Convertible Second Row Bucket Seats* *Seats*

There are bucket seats with armrests for two front passengers, bucket seats with armrests for two passengers in the second row, and a bench seat for three passengers in the third row.

For greater cargo capacity, the seats in the second row can be removed, and the bench seat in the third row can be folded into the floor.

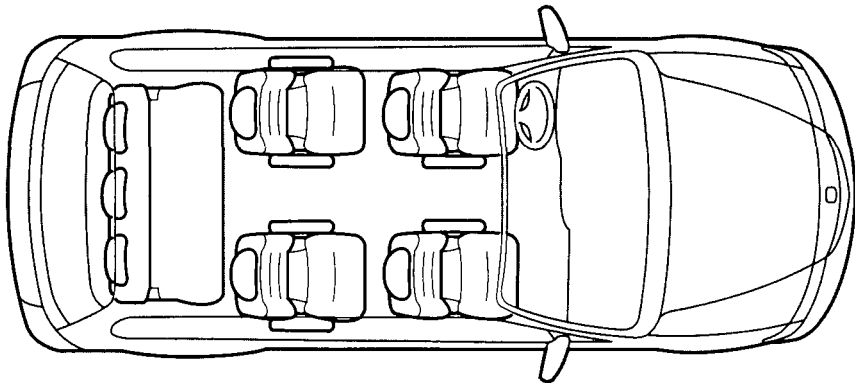

Seat Adjustments

See pages 12 —13 for important safety information and warnings about how to properly position seats and seat-backs.

The EX model has a power adjustable driver's seat. All other models have manual driver's seat adjustments.

The front passenger's seat, and the seats in the second and third rows adjust manually.

Make all seat adjustments before you start driving.

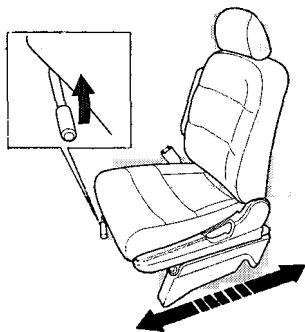

To adjust the seat forward and backward, pull up on the lever under the seat cushion's front edge. Move the seat to the desired position and release the lever. Try to move the seat to make sure it is locked in position.

To adjust the bucket seats in the second row, pull up on the lever on the front of the seat bottom.

CONTINUED

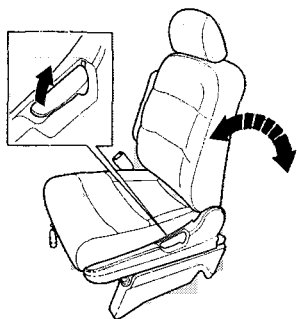

To change the seat-back angle of the front seats, pull up on the lever on the outside of the seat bottom.

To change the seat-back angle of the bucket seats in the second row, pull forward on the lever on the outside of the seat-back.

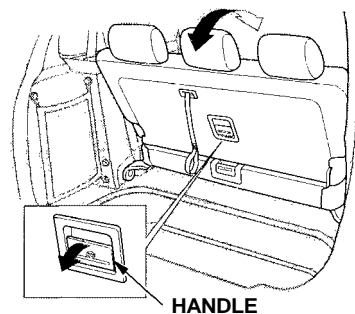

To adjust the seat-back angle of the third seat, open the tailgate. Pull on the handle on the back of the seat-back, move the seat-back to the desired position, and release the handle. Let the seat-back latch in the new position.

Driver's Seat Manual Height Adjustment

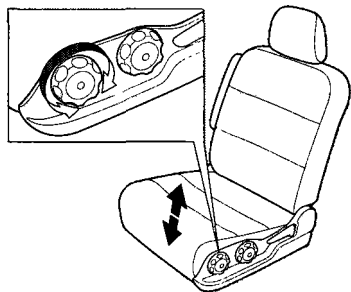

On LX model

The height of your driver's seat is adjustable. Turn the front dial on the outside of the seat cushion to raise the front of the seat bottom and turn the rear dial to raise the rear.

Make all adjustments before you start driving.

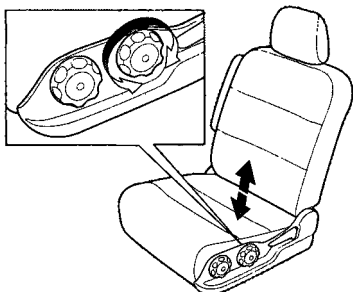

Driver's Seat Power Adjustments

On EX model

See pages 12 — 13 for important safety information and warnings about how to properly position seats and seat-backs.

The two power seat adjustment switches are on the outside edge of the seat bottom. The horizontal switch adjusts the seat bottom in several directions. The short vertical switch adjusts the seat-back angle.

You can adjust the seat with the ignition switch in any position. Make all seat adjustments before you start driving.

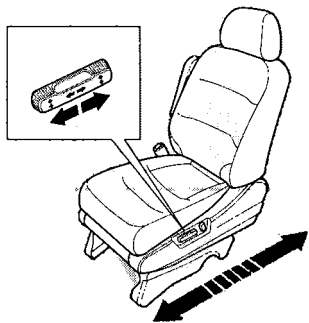

Push the horizontal switch forward or backward to move the seat forward or backward.

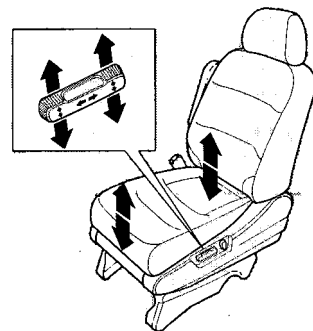

Pull up or push down on the front of the switch to move the seat bottom's front edge up or down. Pull up or push down on the rear of the switch to move the rear of the seat bottom up or down.

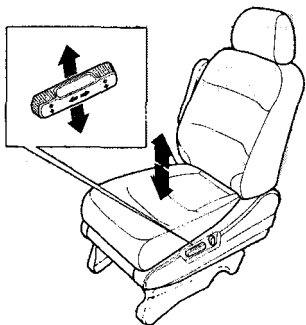

Pull the center of the horizontal switch up to raise the seat. Push it down to lower the seat.

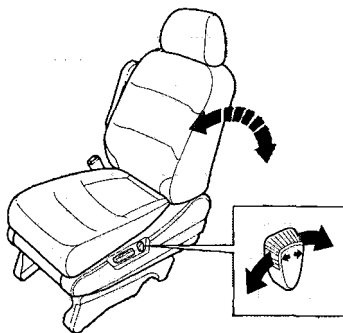

Adjust the seat-back angle by pushing the rear switch in the direction you want to move.

Armrests

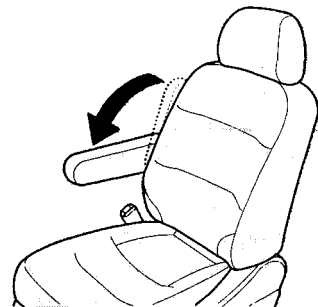

An armrest is located on each of the front seats and on each side of the second row seats. Pivot it down to use it. When you remove the bucket seats or the bench seat in the second row, pivot the armrests up out of the way.

Head Restraints

See page 14 for important safety information and a warning about how to properly position the head restraints.

Your vehicle is equipped with head restraints in all seating positions. The head restraints help protect you and your passengers from whiplash and other injuries. They are most effective when you adjust them so the back of the occupant's head rests against the center of the restraint. A taller person should adjust the restraint as high as possible.

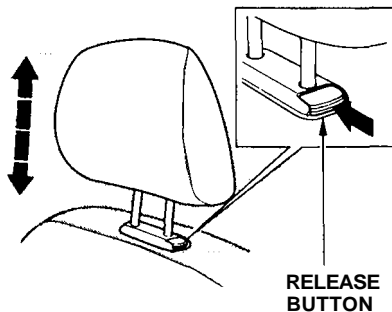

The head restraints adjust for height. You need both hands to adjust the restraint. Do not attempt to adjust it while driving. To raise it, pull upward. To lower the restraint, push the release button sideways and push the restraint down.

To remove a head restraint for cleaning or repair, pull it up as far as it will go. Push the release button and pull the restraint out of the seat-back.

Third Seat Access

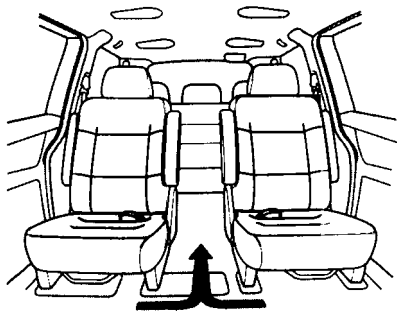

To get into or out of the third row seat, walk between the second row seats.

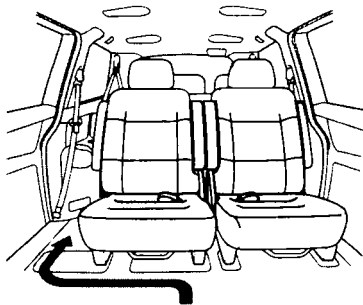

When the seat on the passenger's side is moved to the center, walk through the passenger's side to get into or out of the third row seat.

Moving the Second Row Bucket Seat

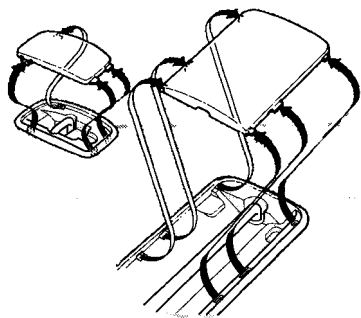

The second row bucket seat on the passenger's side can be moved to the center to provide access to the third row seat.

Remove the two floor covers between the bucket seats in the second row by carefully prying on the back edge of the covers with a flat-tipped screwdriver.

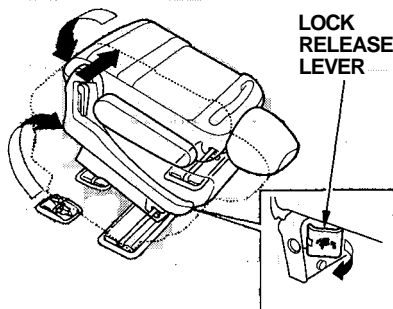

Unlock the seat from the floor by pulling the lock release lever under the seat cushion's front edge and lifting the rear of the seat.

Slide the seat toward the center of the vehicle.

Push the back of the seat down over the floor hooks. Make sure the seat is securely locked in place.

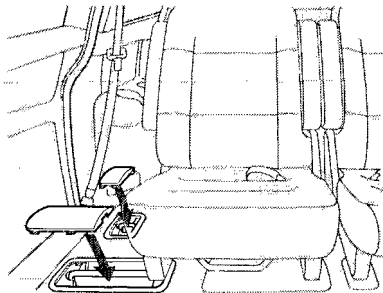

Install the floor covers over the outer floor hooks on the passenger's side as shown.

Make sure the seat is securely locked in place before driving. A seat that is not locked in place could fly around and cause injury in a sudden stop or crash.

Reverse this procedure to move the seat back to the outside.

Removing the Bucket Seats in the Second Row

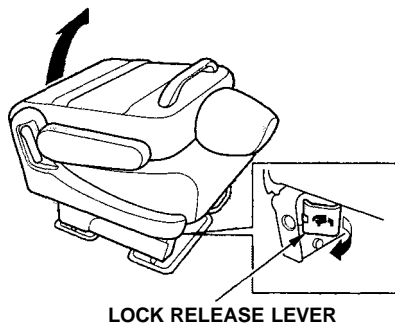

Both seats can be removed to give more cargo capacity.

To remove a seat:

Pull up the seat-back angle adjustment lever, and fold the seat-back forward.

Unlock the seat from the floor by pulling the lock release lever under the seat cushion's front edge and lifting the rear of the seat.

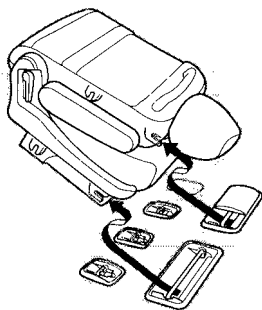

Unhook the front of the seat from the floor by pulling it back slightly, then pivoting it upward.

Always remove an unlocked seat from the vehicle before driving. A seat that is not locked in place could fly around and cause injury in a sudden stop or crash.

To reinstall the seat, hook the front of the seat to the floor, then push the back into the locks. Make sure both the front and the back of the seat are securely latched before driving.

Folding the Third Seat

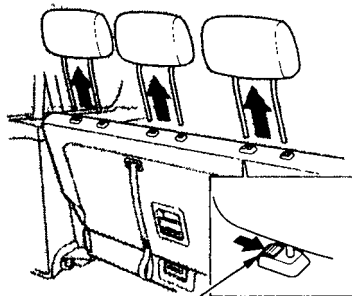

RELEASE BUTTON

To create more cargo space, you can fold the third seat into the floor recess.

To fold the third seat:

1. Remove the head restraints by pushing the release buttons and pulling the restraints out.

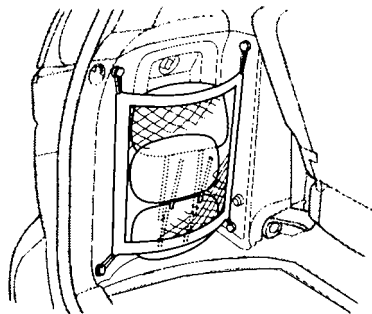

2. Store the head restraints in the side cargo net. To install the side cargo net, hook the four loops on the net to the tabs on the left side panel.

Make sure the head restraint legs are inside the cargo net so they do not damage the seat as you fold it.

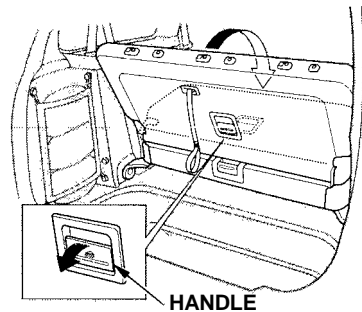

HANDLE

3. Unlock the seat-back by pulling the handle. Push the seat-back forward.

CONTINUED

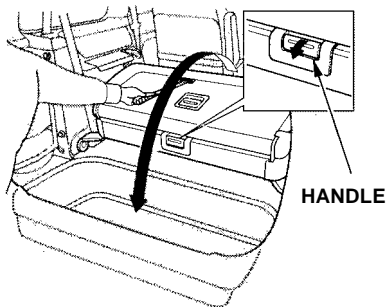

4. Pull the handle on the back of the seat cushion while you pull the entire seat towards you with the strap. Pivot the seat into the floor recess.

Make sure the center shoulder belt is stored in the holder and the outer shoulder belts are positioned on each hook whenever the third seat is folded.

Make sure all items in the cargo area are secured. Loose items can fly forward and cause injury if you have to brake hard. See **Carrying Cargo** on page [205](#).

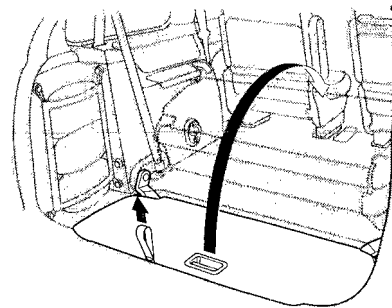

To return the seat to the upright position:

1. Pull the seat out of the recess by pulling on the handle and the strap. Pivot the seat forward all the way.

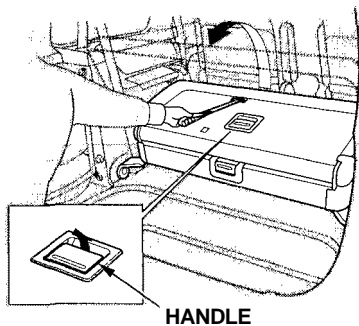
**HANDLE**

2. Pull up on the handle on the seat-back, and pull the seat-back upright with the strap. Make sure the seat is securely locked in place.
3. Reinstall the head restraints.

Power Windows

Your vehicle's front windows are electrically-powered. Turn the ignition switch to ON (II) to raise or lower either window.

The rear windows are also electrically-powered (see page [120](#)).

DRIVER'S WINDOW SWITCH **MAIN SWITCH**

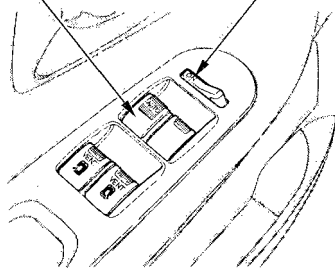

Each front door has a switch that controls its window. To open the window, push the switch down and hold it. Release the switch when you want the window to stop. Close the window by pulling back on the switch and holding it.

The driver's door armrest has a master power window control panel. To open the front passenger's window, push down on the switch and hold it down until the window reaches the desired position. To close the window, pull back on the window switch. Release the switch when the window gets to the position you want.

Closing a power window on someone's hands or fingers can cause serious injury.

Make sure your passengers are away from the windows before closing them.

The master control panel also contains these extra features:

AUTO — To open the driver's window fully, push the window switch firmly down and release it. The window automatically goes all the way down. To stop the window from going all the way down, pull back on the window switch briefly.

To open the driver's window only partially, push the window switch down lightly and hold it. The window will stop as soon as you release the switch.

The AUTO function only works to lower the driver's window. To raise the window, you must pull back on the window switch and hold it until the window reaches the desired position.

The MAIN switch controls power to the front passenger's window and the rear power windows. With this switch off, the front passenger's window cannot be raised or lowered and the rear windows cannot be opened or closed. The MAIN switch does not affect the driver's window. Keep the MAIN switch off when you have children in the vehicle so they do not injure themselves by operating the windows unintentionally.

CONTINUED

The power window system has a key-off delay function. The windows will still operate for up to ten minutes after you turn off the ignition. Opening either front door cancels the delay function. You must turn the ignition switch ON (II) again before you can operate the windows.

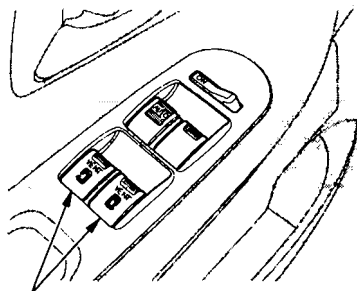

REAR WINDOW SWITCHES

You can open or close each rear window with the switches on the driver's door armrest. The right switch controls the passenger's side rear window and the left switch controls the driver's side window. To open the window, push the switch down and hold it. Release the switch when you want the window to stop. Close the window by pulling back on the switch and holding it.

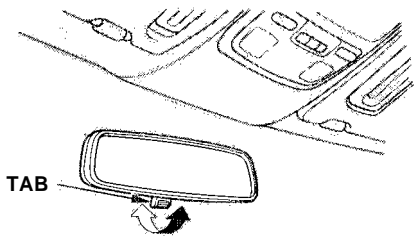

Keep the inside and outside mirrors clean and adjusted for best visibility. Be sure to adjust the mirrors before you start driving.

The inside mirror has day and night positions. The night position reduces glare from headlights behind you. Flip the tab on the bottom edge of the mirror to select the day or night position.

Adjusting the Power Mirrors

SELECTOR SWITCH

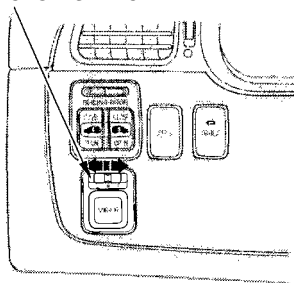

Adjust the outside mirrors with the adjustment switch on the left side of the dashboard:

1. Turn the ignition switch ON (II).
2. Move the selector switch to L (driver's side) or R (passenger's side).

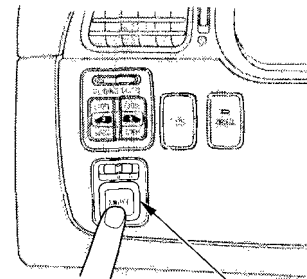

ADJUSTMENT SWITCH

3. Push the appropriate edge of the adjustment switch to move the mirror right, left, up or down.
4. When you finish, move the selector switch to the center (off) position. This turns off the adjustment switch so you can't move a mirror out of position by accidentally bumping the switch.

CONTINUED

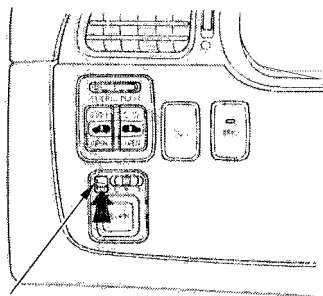

HEATED MIRROR BUTTON

Canadian Models

The outside mirrors are heated to remove fog and frost. With the ignition switch ON (II), turn on the heaters by pressing the button. The light in the button comes on as a reminder. Press the button again to turn the heaters off.

Parking Brake

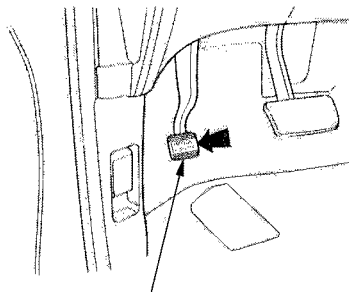

PARKING BRAKE PEDAL

To apply the parking brake, push the parking brake pedal down with your foot. To release the parking brake, push on the pedal again. The parking brake light on the instrument panel should go out when the parking brake is fully released with the engine running, (see page 62.)

NOTICE

Driving the vehicle with the parking brake applied can damage the rear brakes and axles.

Clock

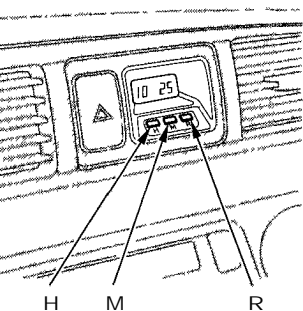

the clock:

the ignition switch ON (II) to
play the time.

2. Press and hold the H button until the hour advances to the desired time.
3. Press and hold the M button until the numbers advance to the desired time.

You can use R to quickly set the time to the nearest hour. If the displayed time is before the half hour, pressing R sets the clock back to the previous hour. If the displayed time is after the half hour, pressing R sets the clock forward to the beginning of the next hour.

For example:

- 1:06 would RESET to 1:00.
- 1:52 would RESET to 2:00.

Center Table

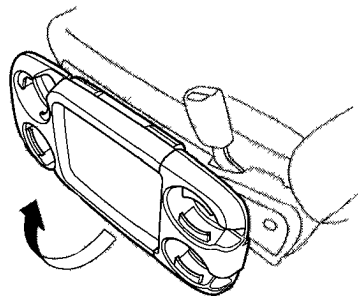

To use the center table, pull up the outside edge of the table until it latches. To store it, pull the lever to lower the table.

Center Table, Beverage Holder

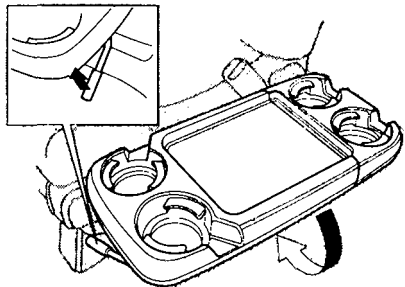

Sitting on or getting under the table, or putting heavy objects on the table, may damage or deform it.

Do not put any items on the table while driving. They may fall down or fly around when you go around corners or brake hard.

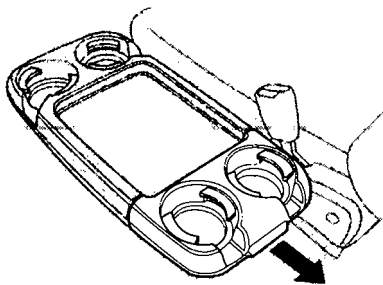

The center table can be extended by pulling on the rear.

Beverage Holder

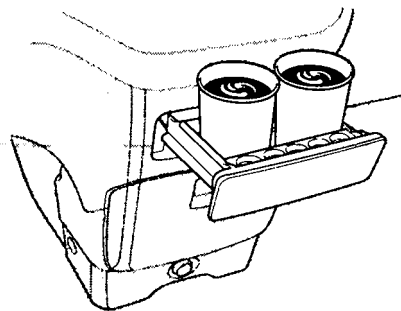

To use the front beverage holder, pull on the bottom edge. Push the holder all the way in to close it.

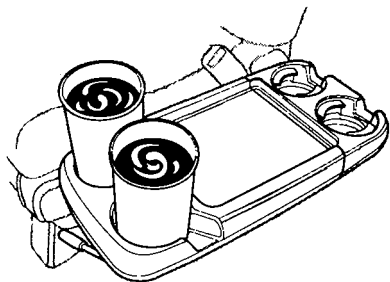

Additional beverage holders for the front seat passengers, and the beverage holders for the passengers in the second row, are in the center table.

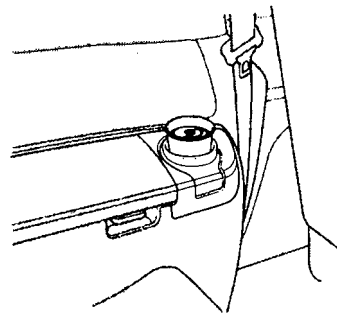
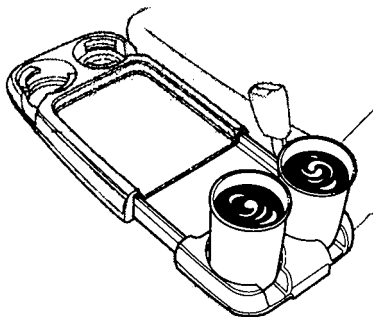

The beverage holders for the third seat passengers are located in the armrests on the rear side panels.

Be careful when you are using the beverage holder. A spilled liquid that is very hot can scald you or your passengers. Spilled liquids can also damage the upholstery, carpeting, and electrical components in the interior.

Sunglasses Holder

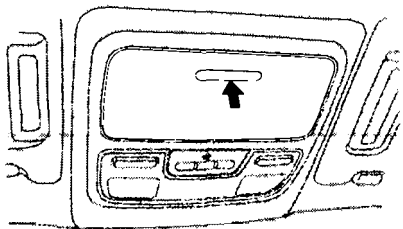

To open the sunglasses holder, push on the front edge. It will unlatch and swing down. To close it, push it until it latches. Make sure the holder is closed while you are driving.

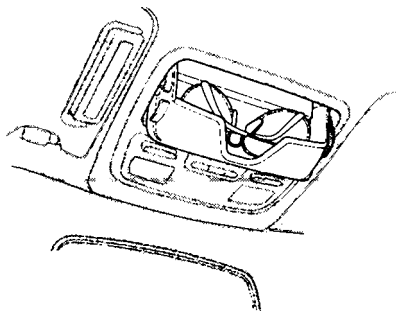

Some larger styles of sunglasses may not fit in the holder.

Sun Visor

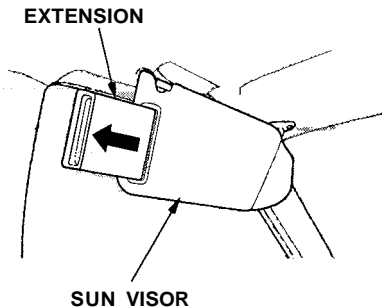

To use the sun visor, pull it down. You can also use the sun visor at the side window. Remove the support rod from the clip and swing the sun visor toward the side window. In this position, the sun visor can be extended by sliding out the extension.

Make sure you put the sun visor back in place when you are getting into or out of the vehicle. Do not use the sun visor extension over the rear view mirror.

Vanity Mirror

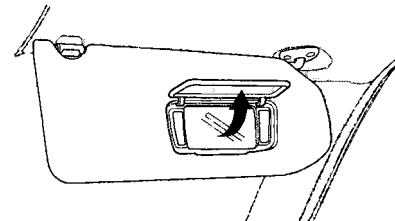

To use a vanity mirror on the back of the sun visor, pull up the cover.

The light beside the mirror comes on only when the parking lights are on.

Rear Compartment, Center Pocket, Coin Holder

Rear Compartment

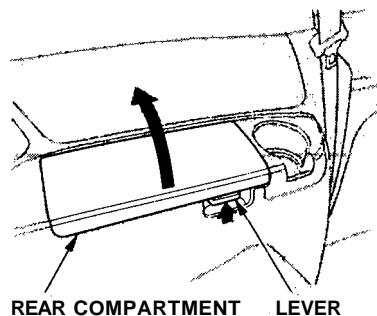

A storage compartment is located by the third seat on the driver's side. To open the compartment, pull the lever and lift the lid. To close, lower the lid and push it down until it latches.

Center Pocket

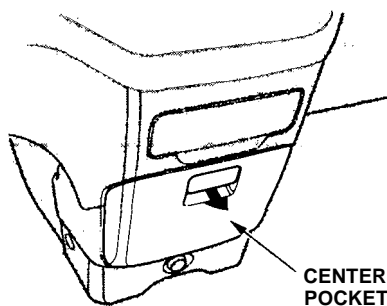

Open the center pocket by pulling the handle. Close it with a firm push.

On EX model

The light in the pocket comes on when the instrument panel lights are on.

Coin Holder

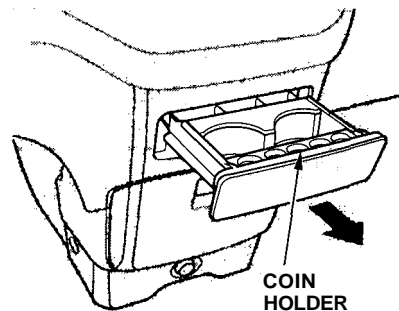

The coin holder is located in the front beverage holder. To open it, pull on the bottom edge. Close it with a firm push.

Storage Box

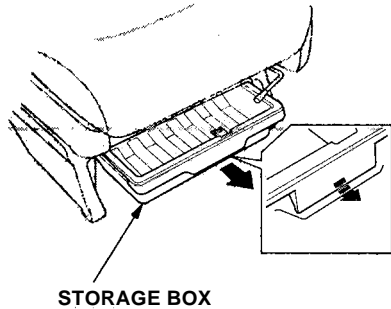

On EX model
A storage box is located under the front passenger's seat. To use it, pull the handle and slide the box out.

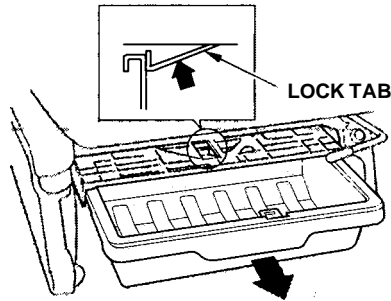

To remove the box for cleaning, push on the lock tab under the seat bottom and pull the tray out. Do not try to force the box. You could damage it.

Coat Hook

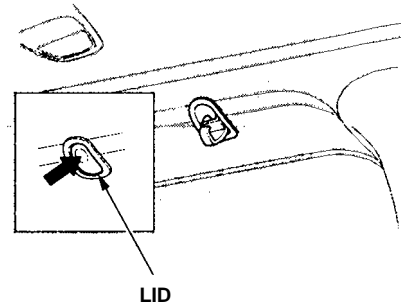

To use a coat hook, push on the lid. Close it with a firm push.

Make sure the coat hook is closed when you are not using it. This hook is not designed for large or heavy items.

Accessory Power Sockets

FRONT

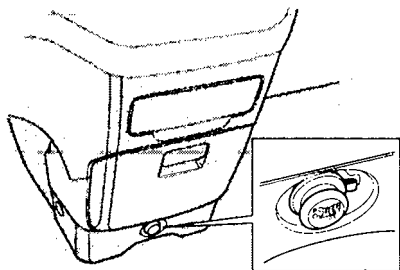

Your vehicle has two accessory power sockets. The front accessory power socket is located under the center pocket. The rear socket is behind the third seat on the driver's side.

REAR

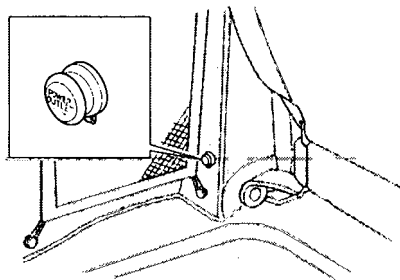

To use an accessory power socket, pull out on the cover. The ignition switch must be in ACCESSORY (I) or ON (II).

These sockets are intended to supply power for 12 volt DC accessories that are rated 120 watts or less (10 amps).

When both sockets are being used, the combined power rating of both accessories should be 120 watts or

less (10 amps).

They will not power an automotive type cigarette lighter element.

Light Control Switch

LIGHT CONTROL SWITCH

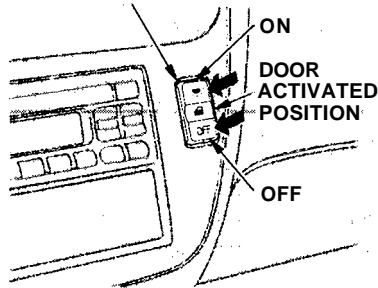

The light control switch controls the interior lights: the individual map lights by the sun visors, the individual map lights above the second and third row passengers, and the cargo area light. This switch has three positions: OFF, Door Activated, and ON.

When this switch is in the OFF position:

- None of the lights come on when a door or the tailgate is opened.
- The individual map lights in the front can be turned on and off with the switches next to the lights.
- The individual map lights in the second and third rows cannot be turned on.
- The cargo area light can be turned on with the switch in the light.

When the switch is in the Door Activated position:

- The individual map lights in the front come on when any door or the tailgate is opened. When the doors and the tailgate are closed, each light can be turned on and off with the switch next to the light.
- The individual map lights in the second and third rows come on when any door or the tailgate is opened. When the doors and the tailgate are closed, each light can be turned on and off by pushing on the lens.

CONTINUED

- The cargo area light comes on when any door or the tailgate is opened if the switch in the light is in the door activated (center) position. When the doors and the tailgate are closed, it can be turned on with the switch in the light.

When the switch is in the ON position:

- All the individual map lights come on and stay on as long as the switch remains in the ON position.
- The cargo area light comes on and stays on if the switch in the light is in the door activated (center) position.

On EX model

The lights go out about six seconds after all the doors and the tailgate are closed.

With the light control switch in the Door Activated position, all the individual map lights and the cargo area light (with the switch in the center position) come on when you unlock the door with the remote transmitter (see page [85](#)).

With any door or the tailgate left open, the lights stay on about three minutes, then go out.

Individual Map Lights

FRONT

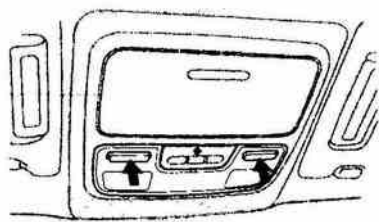

Turn on the front individual map lights by pushing the button next to each light. Push the button again to turn it off. You can also operate these lights with the light control switch (see page 131).

REAR

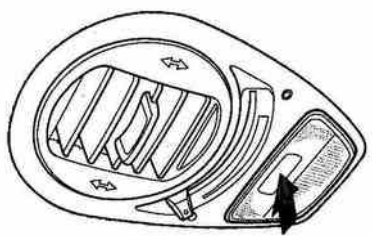

Turn on each rear individual map light by pushing the lens when the ignition switch is in the ACCESSORY (I) or ON (II) position. Push the lens again to turn it off. You can also operate these lights with the light control switch (see page 131).

Cargo Area Light

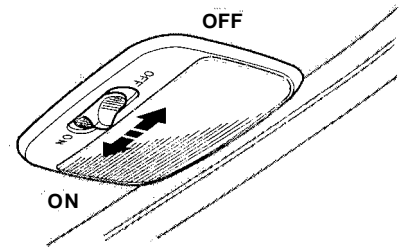

The cargo area light has a three-position switch. In the OFF position, the light does not come on. In the center position, it comes on when you open the tailgate. In the ON position, it stays on continuously.

This light also works with the light control switch (see page 131).

Ignition Switch Light

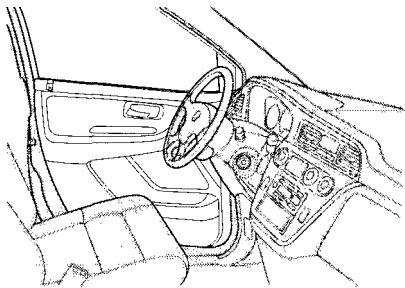

The ignition switch light comes on when you open the driver's door, and stays on several seconds after you close the door.

The heating and air conditioning systems in your Honda provide a comfortable driving environment in all weather conditions.

The standard audio system has many features. This section describes those features and how to use them. (If you selected an optional audio system, refer to the operating instructions that came with it.)

On EX model

Your Honda has an anti-theft audio system that requires a code number to enable it.

Heating and Cooling.....	136	Operating the Optional CD Player/Changer.....	169
What Each Control Does.....	136	CD Changer Error Indications.....	172
How to Use the System.....	139	Audio System (EX).....	173
To Turn Everything Off.....	143	AM/FM/CD Audio System.....	173
Climate Control System.....	144	Operating the Radio.....	174
(EX model without Navigation System)		Adjusting the Sound.....	178
Fully-automatic Operation.....	146	Audio System Lighting.....	179
Semi-automatic Operation.....	148	Radio Frequencies.....	179
(EX model with Navigation System)		Radio Reception.....	179
Fully-automatic Operation.....	152	Operating the CD Player.....	181
Semi-automatic Operation.....	153	Operating the CD Changer.....	183
Sunlight Sensor/ Temperature Sensor.....	157	Protecting Compact Discs.....	184
Rear A/C Unit.....	158	CD Player Error Indications.....	185
Audio System (LX).....	161	CD Changer Error Indications.....	186
AM/FM/Cassette Stereo Audio System.....	161	Operating the Cassette Player.....	187
Operating the Radio.....	162	Tape Search Functions.....	188
Adjusting the Sound.....	165	Caring for the Cassette Player.....	190
Audio System Lighting.....	166	Remote Audio Controls.....	191
Operating the Cassette Player.....	166	Theft Protection.....	192
Tape Search Functions.....	166	Security System.....	193

Heating and Cooling

On LK model

Proper use of the Heating and Cooling system can make the interior dry and comfortable, and keep the windows clear for best visibility.

What Each Control Does

Fan Control Dial

Turning this dial clockwise increases the fan's speed, which increases air flow.

Temperature Control Dial

Turning this dial clockwise increases the temperature of the air flow.

Air Conditioning (A/C) Button

This button turns the air conditioning ON and OFF. The indicator above the button lights when the A/C is on.

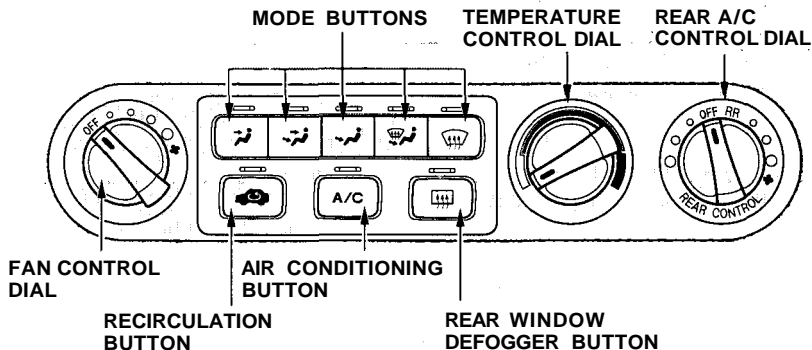

Recirculation Button

This button controls the source of the air going into the system. When the indicator above this button is lit, air from the vehicle's interior is sent through the system again (Recirculation mode). When the indicator is off, air is brought in from outside the vehicle (Fresh Air mode).

Rear Window Defogger Button

This button turns the rear window defogger on and off (see page 75).

Rear A/C Control Dial

With this dial, you can adjust the rear A/C unit heating, cooling, and air flow (see page 158).

Mode Buttons

Use the MODE buttons to select the vents the air flows from. Some air will flow from the dashboard corner vents in all modes.

 Air flows from the center and corner vents in the dashboard.



 Air flow is divided between the vents in the dashboard and the floor vents.

 Air flows from the floor vents.

 Air flow is divided between the floor vents and the defroster vents at the base of the windshield.

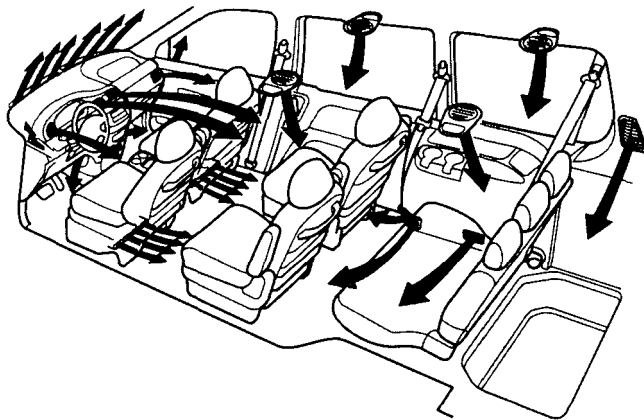
 Air flows from the defroster vents at the base of the windshield.



When you select  or , the system automatically switches to Fresh Air mode and turns on the A/C. In this case you cannot turn it off.

When you select , the system automatically switches to Fresh Air mode.

Vent Controls

CENTER VENTS

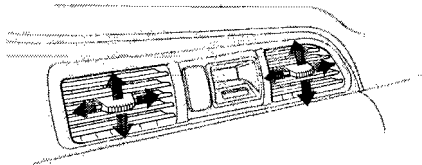

You can adjust the direction of the air coming from the dashboard vents by moving the tab in the center of each vent up-and-down and side-to-side.

CORNER VENT

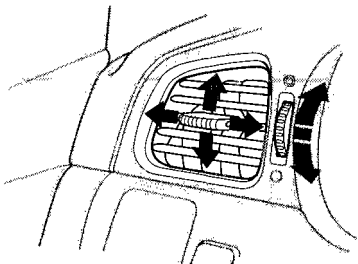

The vents in the corners of the dashboard can be opened and closed with the dials next to them.

REAR CEILING VENT

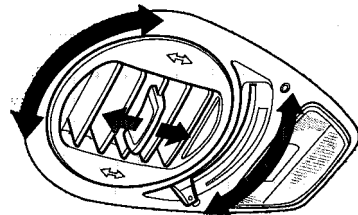

There are four vents in the ceiling (see page [160](#)).

How to Use the System

This section covers how to set up the system controls for ventilation, heating, cooling, dehumidifying, and defrosting.

The engine must be running for the heater and air conditioning to generate hot and cold air. The heater uses engine coolant to warm the air. If the engine is cold, it will be several minutes before you feel warm air coming from the system.

The air conditioning does not rely on engine temperature.

It is best to leave the system in Fresh Air mode under almost all conditions. Keeping the system in Recirculation mode, particularly with the A/C off, can cause the windows to fog up. Switch to Recirculation mode when you are driving through smoky or dusty conditions, then switch back to Fresh Air mode when the condition

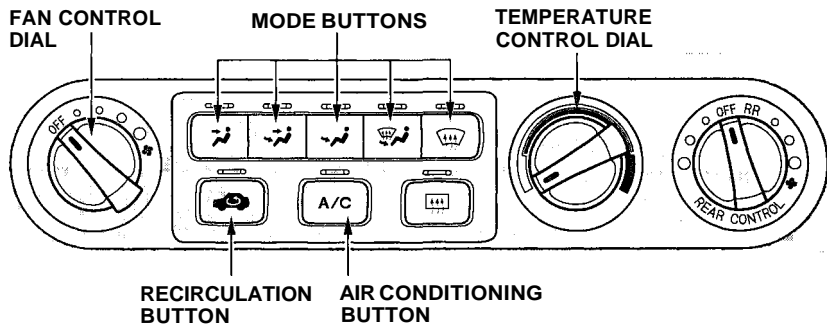

clears.

The outside air intakes for the heating and cooling system are at the base of the windshield. Keep these clear of leaves and other debris.

Ventilation

The flow-through ventilation system draws in outside air, circulates it through the interior, then exhausts it through vents near the rear side panels.

1. Turn the temperature control dial all the way to the left. Make sure the A/C is off.
2. Select  and Fresh Air mode.
3. Set the fan to the desired speed.

CONTINUED

Heating and Cooling

To Cool with A/C

1. Turn on the A/C by pressing the button. The light above the button comes on when a fan speed is selected.
2. Make sure the temperature control dial is all the way to the left.
3. Select .
4. If the outside air is humid, select Recirculation mode. If the outside air is dry, select Fresh Air mode.
5. Set the fan to the desired speed.

If the interior is very warm from being parked in the sun, you can cool it down more rapidly by setting up the controls this way:

1. Start the engine.
2. Turn on the A/C by pressing the button. Make sure the temperature control dial is turned all the way to the left.
3. Set the fan to maximum speed.
4. Open the windows partially. Select  and Fresh Air mode.

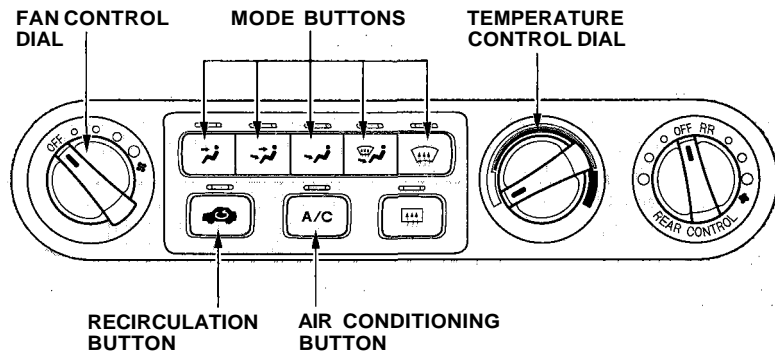

When the interior has cooled down to a more comfortable temperature, close the windows and set the controls as described for normal cooling.

Air conditioning places an extra load on the engine. Watch the engine coolant temperature gauge (see page 67) when driving in stop-and-go traffic or climbing a long, steep hill. If it moves near the red zone, turn off the A/C until the gauge reads normally.

To Heat

To warm the interior:

1. Start the engine.
2. Select  and Fresh Air mode.
3. Set the fan to the desired speed.
4. Adjust the warmth of the air with the temperature control dial.

To Heat and Dehumidify with Air Conditioning



Air conditioning, as it cools, removes moisture from the air. When used in combination with the heater, it makes the interior warm and dry.

1. Switch the fan on.
2. Turn on the air conditioning.
3. Select  and Fresh Air mode.
4. Adjust the temperature control dial so the mixture of heated and cooled air feels comfortable.

This setting is suitable for all driving conditions whenever the outside temperature is above 32° F (0°C).

To Defog and Defrost

To remove fog from the inside of the windows:

1. Switch the fan on.
2. Select  .
When you select  , the system automatically switches to Fresh Air mode and turns on the A/C.
3. Adjust the temperature control dial so the air flow from the defroster vents feels warm.
4. Turn on the rear window defogger to help clear the rear window.
When you switch to another mode from  , the A/C stays on.
Press the A/C button to turn it off.

CONTINUED

Heating and Cooling

To remove exterior frost or ice from the windshield and side windows after the vehicle has been sitting out in cold weather:

1. Start the engine.

2. Select .

When you select , the system automatically switches to Fresh Air mode and turns on the A/C.

3. Switch the fan and temperature controls to maximum.

To rapidly remove exterior frost or ice from the windshield (on very cold days), first select the Recirculation mode. Once the windshield is clear, select the Fresh Air mode to avoid fogging the windows.

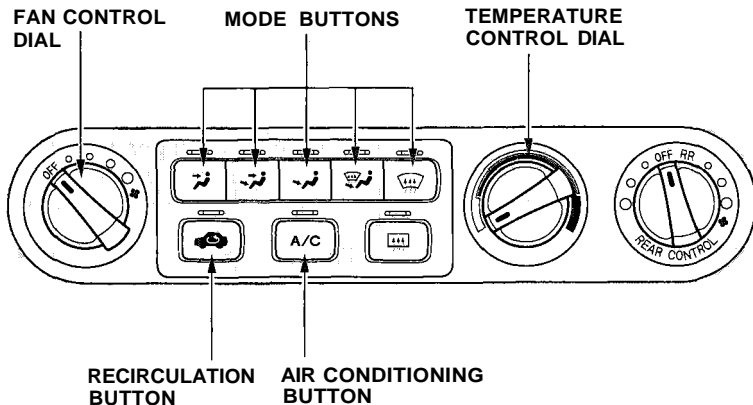

These settings direct all the air flow to the defroster vents at the base of the windshield and the side window defroster vents. The air flow will get warmer and clear the windows faster as the engine warms up. You can close the corner vents with the dial beside each vent. This will send more warm air to the windshield defroster vents.

For safety, make sure you have a clear view through all the windows before driving away.

To Turn Everything Off

To shut off the system temporarily, turn the fan speed and temperature control dials all the way to the left.

You should shut the system completely off only for the first few minutes of driving in cold weather, until the engine coolant warms up enough to operate the heater. Keep the fan on at all other times so stale air does not build up in the interior.

Climate Control System

On EX model

The automatic climate control system in your Honda picks the proper combination of air conditioning, heating, and ventilation to maintain the interior temperature you select. The system also adjusts the fan speed and air flow levels.

Your vehicle also has a rear A/C unit that allows the rear passengers to adjust the heating, cooling, and air flow (see page 158).

The direction of air flow from the vents in the center and each corner of the dashboard is adjustable. Move the tab in the center of each vent up-and-down and side-to-side.

The corner vents can be opened and closed with the dials next to them.

CENTER VENTS

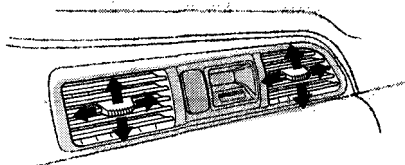

There are four vents in the ceiling (see page 160).

The climate control system draws air through the exterior vents at the bottom of the windshield. Keep these vents clear of leaves and other debris.

CORNER VENT

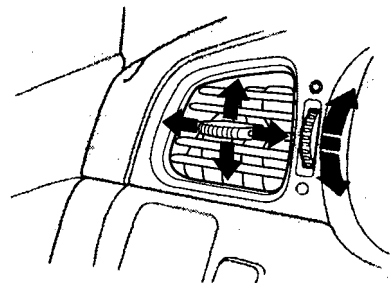

For the climate control system to provide heating and cooling, the engine must be running.

REAR CEILING VENT

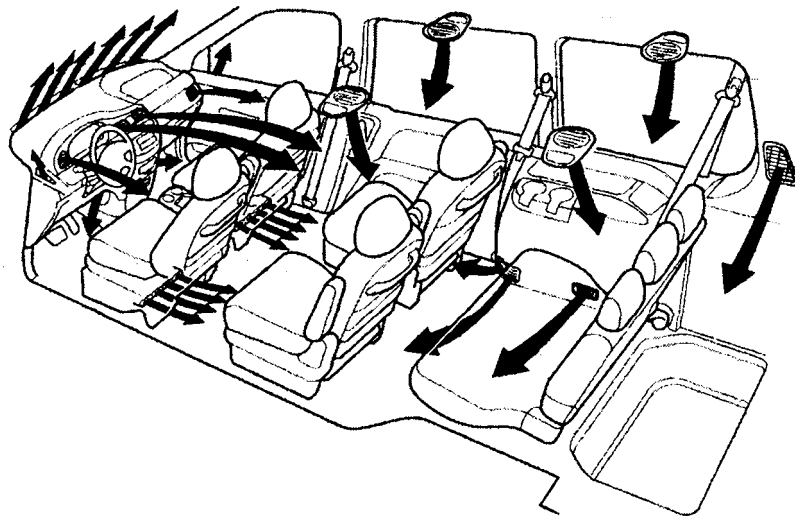
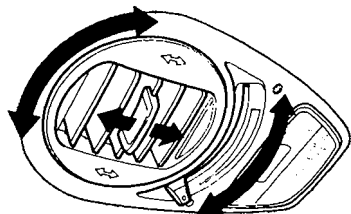

Climate Control System

EX model without Navigation System

Fully-automatic Operation

To put the Automatic Climate Control in fully-automatic mode, press the AUTO button and set the fan control dial to AUTO, then set the desired temperature by turning the temperature control dial. You will see FULL AUTO in the system's display. The light above the

 button also shows you which mode, Recirculation or Fresh Air, is selected.

The system automatically selects the proper mix of conditioned and/or heated air that will, as quickly as possible, raise or lower the interior temperature from its current level to the set temperature.

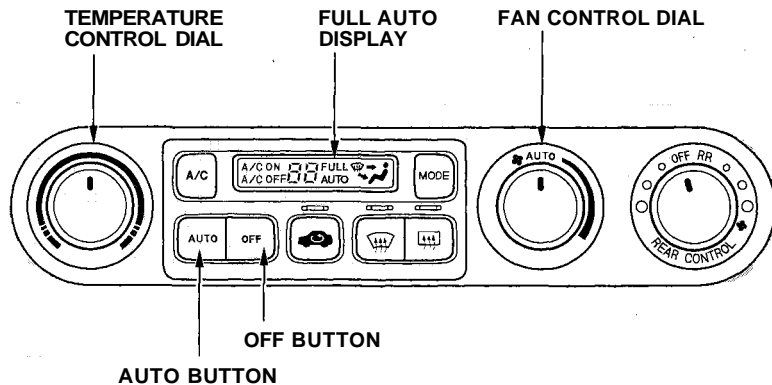

When you set the temperature to its lower limit (60°F/18°C) or its upper limit (90°F/32°C), the system runs at full cooling or heating only. It does not regulate the interior temperature. When the temperature is set between the lower and upper limits, the system regulates the interior temperature to the set value.

Pressing the OFF button shuts the climate control system completely off. Keep the system completely off only for short periods. To keep stale air and mustiness from collecting, you should have the fan running at all times.

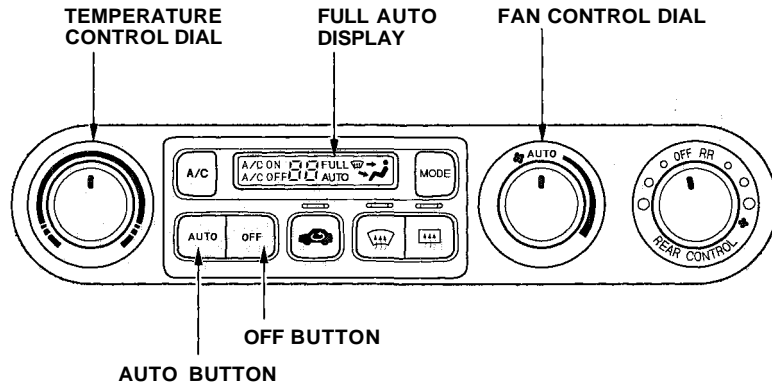

Climate Control System

Semi-automatic Operation

You can manually select various functions of the Climate Control system when it is in FULL AUTO. All other features remain automatically controlled. Making any manual selection causes the word FULL to go out.

Air Conditioning (A/C) Button

Press the A/C button to turn the air conditioning on and off. You will see A/C ON or A/C OFF in the display.

When you turn the A/C off, the system cannot regulate the inside temperature if you set the dial below the outside temperature. With the A/C on, use the temperature control dial to adjust the temperature of the air flow to a comfortable setting.

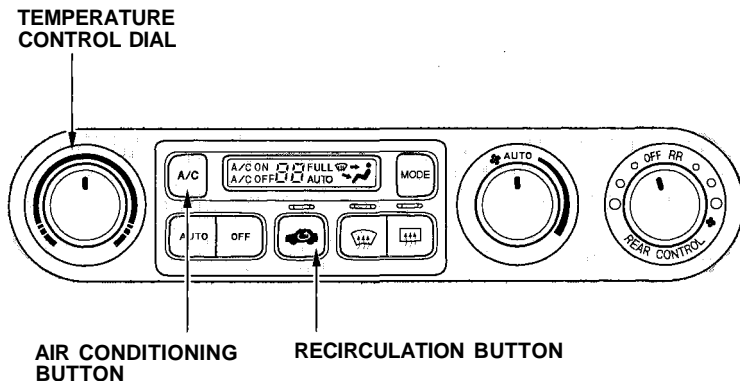

Recirculation Button

This button controls the source of the air going into the system. When the indicator above this button is lit, air from the vehicle's interior is sent through the system again (Recirculation mode). When the indicator is off, air is brought in from outside the vehicle (Fresh Air mode).

You can, for example, manually put the system in recirculation mode when driving through an area of smoke or fumes.

Fan Control Dial

You can manually select the fan speed by turning the fan control dial. When you turn the dial clockwise, the fan is taken out of automatic mode and starts to run at its lowest speed. Turning the dial fully clockwise increases the fan's speed, which increases air flow.

Rear A/C Control Dial

With this dial, you can adjust the rear A/C unit heating, cooling, and air flow (see page 158).

Mode Button

Use the MODE button to select the vents the air flows from. Some air will flow from the dashboard corner vents in all modes. Each time you press the MODE button, the display shows the mode selected. Press the button four times to see all the modes.

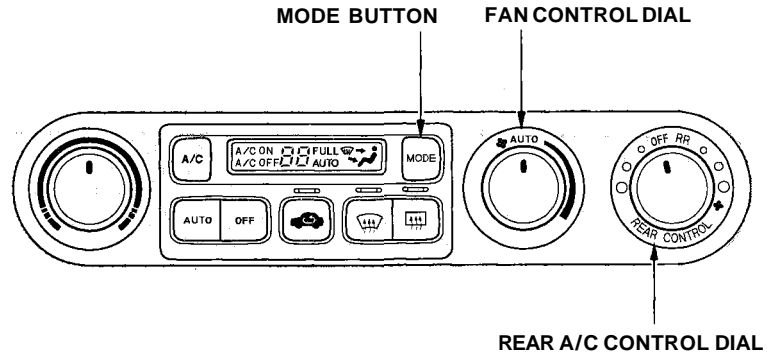



CONTINUED

Climate Control System

 The main air flow is divided between the floor vents and defroster vents at the base of the windshield.

 The main air flow comes from the floor vents.

 The main air flow is divided between the dashboard vents and the floor vents.

 The main air flow comes from the dashboard vents.

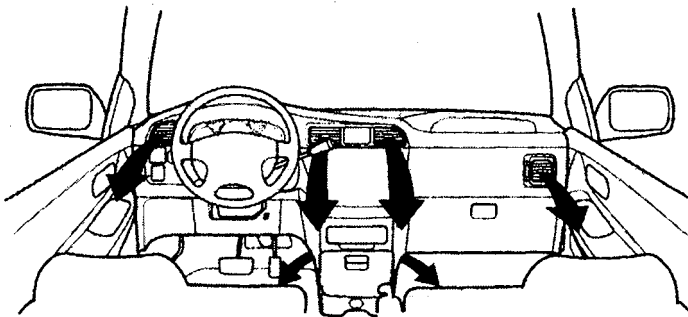
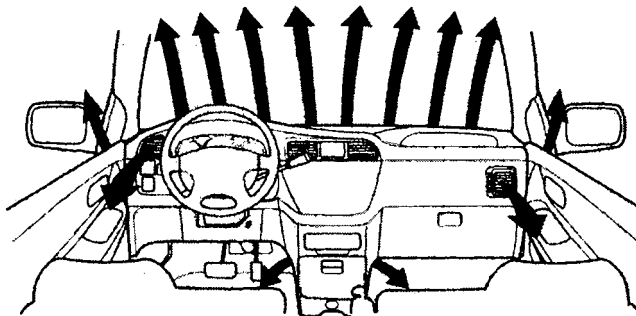

The  button directs the main air flow to the windshield for faster defrosting. It also overrides any MODE selection you may have made.

When you select , the A/C turns on automatically and the system selects Fresh Air mode. If the fan control dial is in AUTO, the fan speed increases automatically. If it is not in AUTO, manually increase the fan speed or set the dial to AUTO. You can increase air flow to the windshield by closing the side vents in the dashboard.

When you turn off  by pressing the button again, the system returns to its former settings.

Rear Window Defogger Button

This button turns the rear window defogger on and off (see page [75](#)).

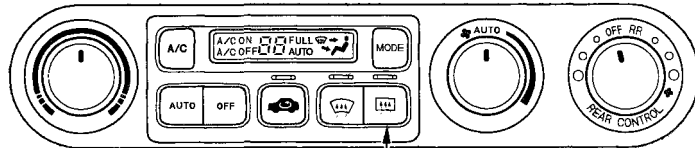
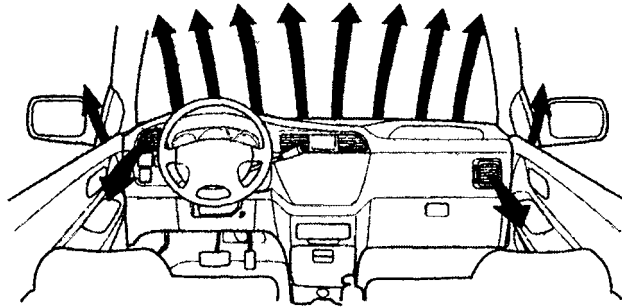

REAR WINDOW DEFOGGER BUTTON

Climate Control System

EX model with Navigation System

Fully-automatic Operation

To put the Automatic Climate Control in fully-automatic mode, press the AUTO button. Then set the desired temperature by pressing either side of the TEMP button: ▲ to raise the temperature above the displayed value, or ▼ to lower the temperature.

The system automatically selects the proper mix of conditioned and/or heated air that will, as quickly as possible, raise or lower the interior temperature from its current level to the set temperature.

When you set the temperature to its lower limit (60°F/18°C) or its upper limit (90°F/32°C), the system runs at full cooling or heating only. It does not regulate the interior temperature. When the temperature is set between the lower and upper limits, the system regulates the interior

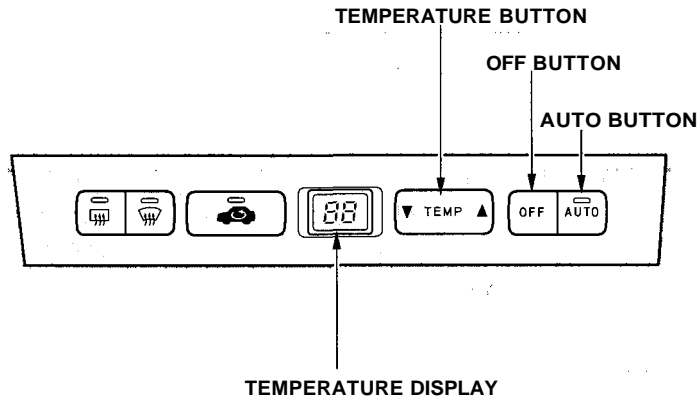

temperature to the set value.

In cold weather, the fan will not come on automatically until the vehicle has been driven for a short time and the heater starts to develop warm air.

Pressing the OFF button shuts the climate control system completely off. Keep the system completely off only for short periods. To keep stale air and mustiness from collecting, you should have the fan running at all times.

Semi-automatic Operation

You can manually select various functions of the Climate Control system when it is in FULL AUTO. All other features remain automatically controlled. Some of these functions appear in the Navigation System display. Press the A/C button next to the display to show these functions.

Air Conditioning (A/C) Buttons

Pressing "ON" or "OFF" in the display turns the air conditioning on and off. You will see A/C ON or A/C OFF activated in the display.

When you turn the A/C off, the system cannot regulate the inside temperature if you set it below the outside temperature. With the A/C on, use the temperature buttons to adjust the temperature of the air flow to a comfortable setting.

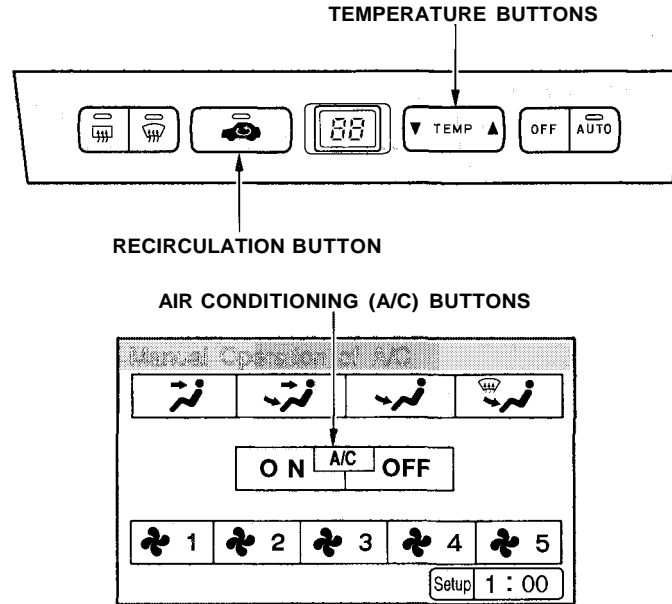

CONTINUED

Climate Control System

Recirculation Button

This button controls the source of the air going into the system. When the indicator above this button is lit, air from the vehicle's interior is sent through the system again (Recirculation mode). When the indicator is off, air is brought in from outside the vehicle (Fresh Air mode).

You can, for example, manually put the system in recirculation mode when driving through an area of smoke or fumes.

Fan Control Icons

You can manually select the fan speed by pressing any of the fan control icons.

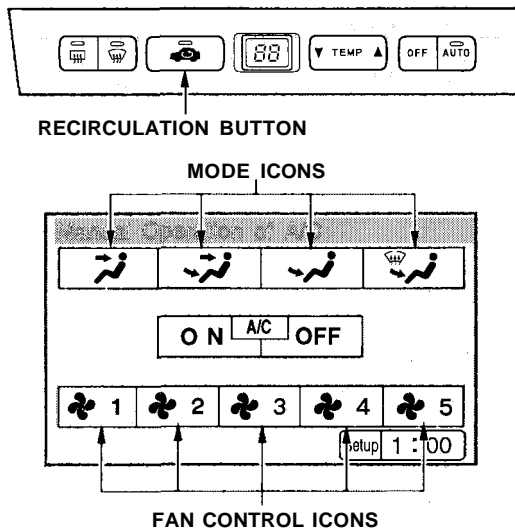



Mode Icons

Use the MODE icons to select the vents the air flows from. Some air will flow from the dashboard corner vents and the side vents in all modes.

 The main air flow is divided between the floor vents and defroster vents at the base of the windshield.

 The main air flow comes from the floor vents.

 The main air flow is divided between the dashboard vents and the floor vents.

 The main air flow comes from the dashboard vents.

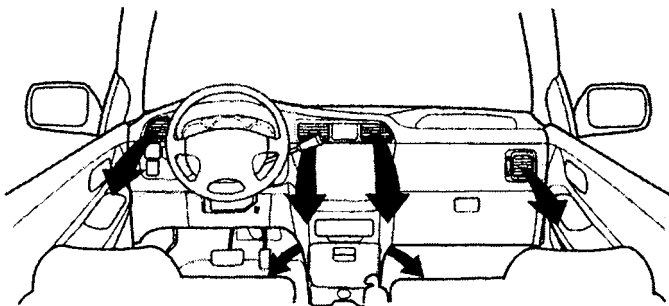
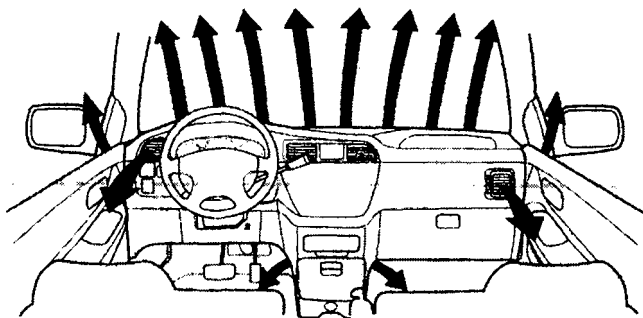

CONTINUED

Climate Control System

The  button directs the main air flow to the windshield for faster defrosting. It also overrides any MODE selection you may have made.

When you select , the A/C turns on automatically and the system selects Fresh Air mode. For faster defrosting, manually set the fan speed to high. You can also increase air flow to the windshield by closing the side vents in the dashboard.

When you turn off  by pressing the button again, the system returns to its former settings.

Rear Window Defogger Button

This button turns the rear window defogger on and off (see page [75](#)).

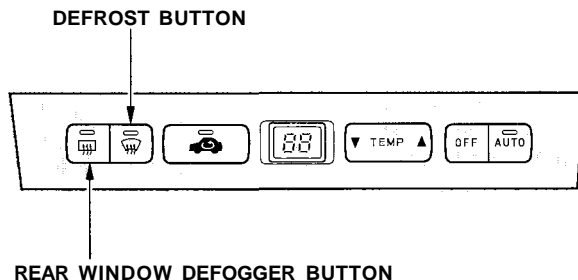
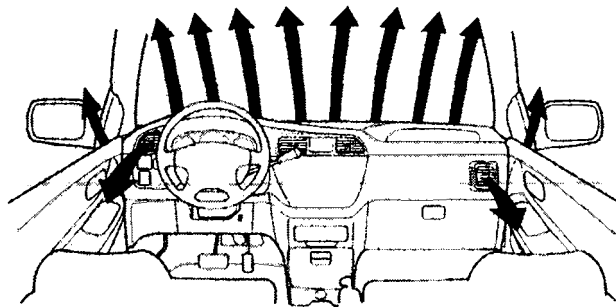

Sunlight Sensor/Temperature Sensor

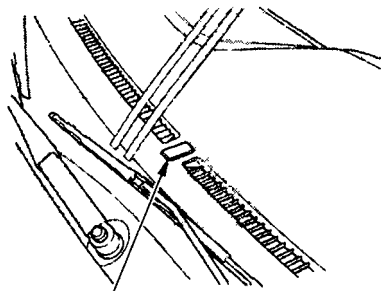

SUNLIGHT SENSOR

The climate control system has two sensors. A sunlight sensor is located in the top of the dashboard and a temperature sensor is next to the steering column. Do not cover the sensors or spill any liquid on them.

TEMPERATURE SENSOR

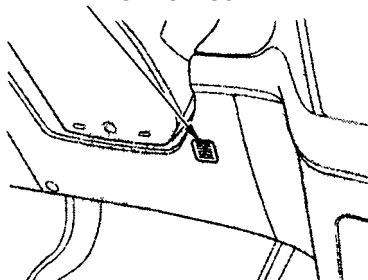

Rear A/C Unit

Your vehicle has two controls for the rear A/C unit. The rear A/C control dial is located on the climate control panel, and the rear A/C passenger control panel is on the ceiling behind the driver's seat.

You can adjust the heating, cooling, and air flow of the rear A/C unit with these control dials. The rear passengers can also adjust the direction and the amount of air flow with the rear ceiling vents.

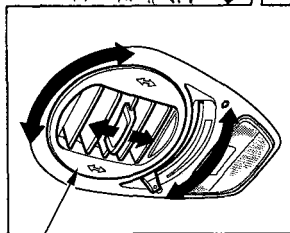
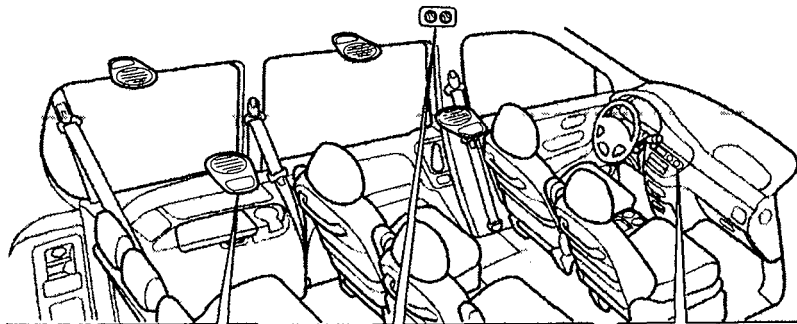

REAR CEILING VENT

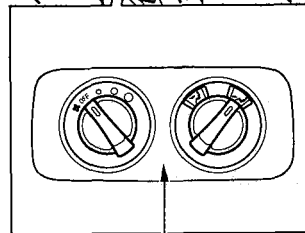

REAR A/C PASSENGER
CONTROL PANEL

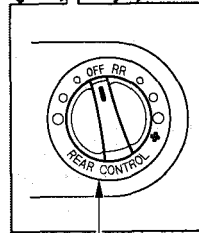

REAR A/C
CONTROL DIAL

Rear A/C Control Dial

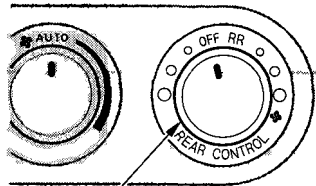

REAR A/C CONTROL DIAL

When this dial is in the OFF position, no air flows to the rear vents, and the rear control panel is turned off.

Turning the dial counterclockwise from the OFF position increases the rear fan speed and air flow. The air flows from the rear ceiling vents.

When this dial is in the RR position, the rear A/C passenger control panel is enabled. A second row passenger can then adjust the fan speed and air flow.

Turning the dial clockwise from the RR position turns off the rear A/C passenger control panel, and increases the rear fan speed. The air flows from the rear floor vents.

Rear A/C Passenger Control Panel

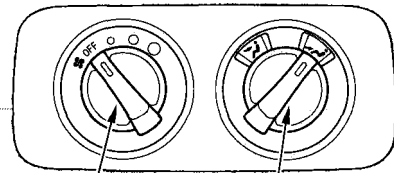

FAN SPEED CONTROL DIAL

HEATING/COOLING/
AIR FLOW CONTROL DIAL

When the rear A/C control dial on the front panel is in the RR position, the passenger in the second row can use the rear A/C passenger control panel to adjust the fan speed and air flow.

The fan speed control dial changes the speed of the rear fan; turn it clockwise to increase fan speed and air flow.

CONTINUED

Climate Control System

The heating/cooling/air flow control dial selects the temperature and level of the air flow.

When the dial is in the  position, heated air flows from the rear floor vents.

When the dial is in the  position cooled air flows from the rear ceiling vents. Cooled air can be selected when the A/C switch on the front control panel is turned on.

Rear Ceiling Vents

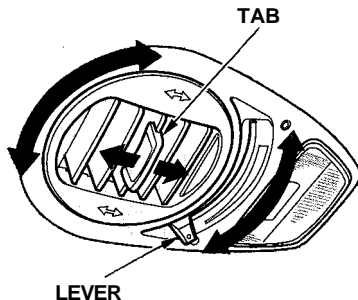

The direction and quantity of air flow from each rear ceiling vent is adjustable.

To adjust the direction of the air coming from a rear ceiling vent, move the tab in the center of each vent back-and-forth, and rotate the vent with the tab. The lever next to each vent can be opened and closed to regulate the amount of air flow.

AM/FM/Cassette Stereo Audio System

On LX model

Your Honda's audio system provides clear reception on both AM and FM bands, while the preset buttons allow you to easily select your favorite stations.

The cassette system features Dolby B* noise reduction, automatic sensing of chromium-dioxide (CrO₂) tape, and autoreverse for continuous play.

* Dolby noise reduction manufactured under license from Dolby Laboratories Licensing Corporation. "DOLBY" and the double-D symbol  are trademarks of Dolby Laboratories Licensing Corporation.

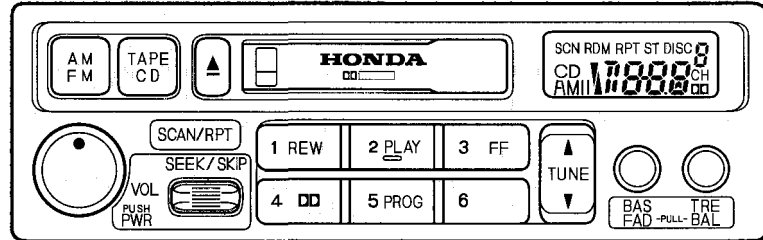

Operating the Radio

The ignition switch must be in ACCESSORY CD or ON (II) to operate the audio system. Turn the system on by pushing the PWR/VOL knob.

Adjust the volume by turning the PWR/VOL knob.

The band and frequency that the radio was last tuned to is displayed. To change bands, press the AM/FM button. On the FM band, ST will be displayed if the station is broadcasting in stereo. Stereo reproduction on AM is not available.

You can use any of four methods to find radio stations on the selected band: TUNE, SEEK, SCAN or the Preset buttons.

TUNE — Use the TUNE bar to tune the radio to a desired frequency. Press the upper part (▲) to tune to a higher frequency, or the lower part (▼) to tune to a lower frequency. The frequency numbers will start to change rapidly. Release the bar when the display reaches the desired frequency. To change the frequency in small increments, press and release the TUNE bar quickly.

SEEK — The SEEK function searches the band for a station with a strong signal. To activate it, push the SEEK switch up or down, then release it. Depending on which way you push the switch, the system scans upward or downward from the current frequency. It stops when it finds a station with a strong signal.

SCAN — The SCAN function samples all the stations with strong signals on the selected band. To activate it, press the SCAN button, then release it. SCN shows in the display. The system will scan up the band for a station with a strong signal. When it finds a strong signal, it will stop and play that station for approximately five seconds. If you do nothing, the system will then scan for the next strong station and play that for five seconds. When it plays a station that you want to continue listening to, press the SCAN button again.

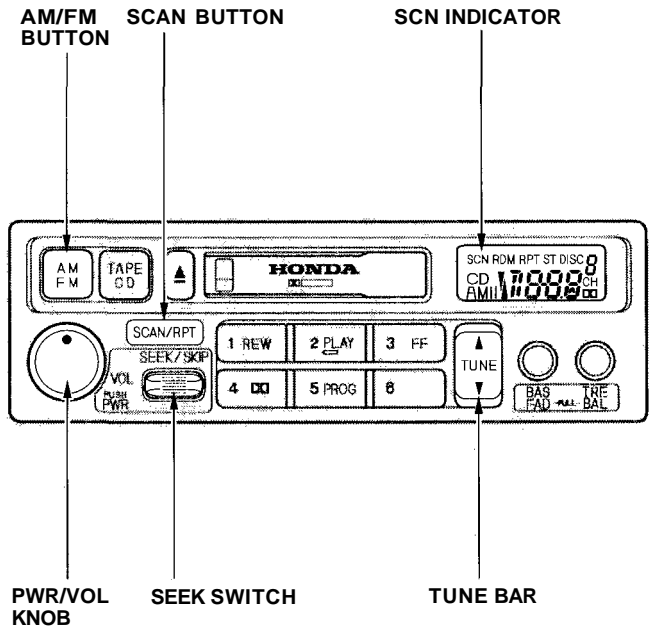

CONTINUED

Preset — You can store the frequencies of your favorite radio stations in the six preset buttons. Each button will store one frequency on the AM band, and two frequencies on the FM band.

To store a frequency:

1. Select the desired band, AM or FM. FM1 and FM2 let you store two frequencies with each Preset button.
2. Use the TUNE or SEEK function to tune the radio to a desired station.
3. Pick the Preset button you want for that station. Press the button and hold it until you hear a beep.
4. Repeat steps 1 to 3 to store a total of six stations on AM and twelve on FM.

AM/FM BUTTON

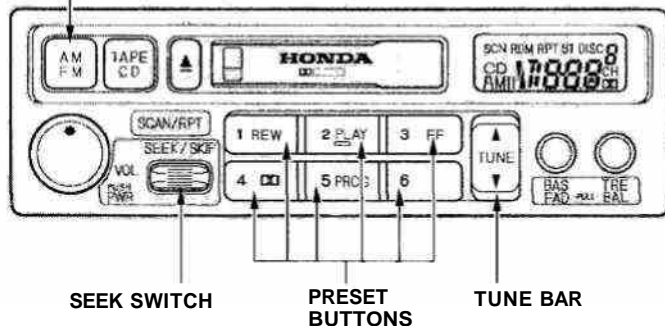

Once a station's frequency is stored, simply press and release the proper Preset button to tune to it. The preset frequencies will be lost if your vehicle's battery goes dead, is disconnected, or the radio fuse is removed.

Adjusting the Sound

Balance/Fader — These two controls adjust the strength of the sound coming from each speaker. The Balance control adjusts the side-to-side strength, while the Fader control adjusts the front-to-back strength.

To adjust the fader, push on the BASS/FADER control knob to get it to pop out. Pull it out slightly farther, and adjust the front-to-back sound to your liking. Push the knob back in when you are done so you cannot change the setting by accidentally bumping it.

To adjust the balance, push on the TREBLE/BALANCE control knob to get it to pop out. Pull it out slightly farther, and adjust the side-to-side sound to your liking. Push the knob back in when you are done so you cannot change the setting by accidentally bumping it.

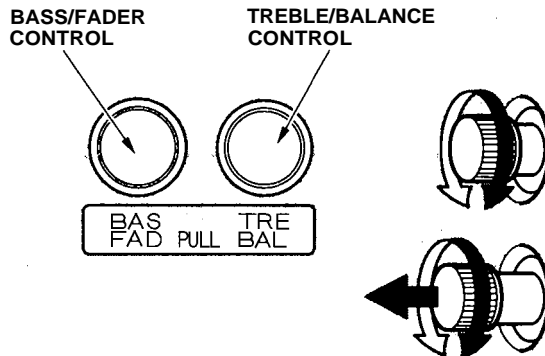

Treble/Bass — Use these controls to adjust the tone to your liking.

To adjust the Treble level, push on the TREBLE/BALANCE control knob to get it to pop out. Without pulling it out farther, turn the knob to adjust the treble level. Push the knob back in when you are done so you cannot change the setting by accidentally bumping it.

To adjust the Bass level, push on the BASS/FADER control knob to get it to pop out. Without pulling it out farther, turn the knob to adjust the bass level. Push the knob back in when you are done so you cannot change the setting by accidentally bumping it.

Radio Frequencies and Reception

For information, See page [179](#).

Audio System Lighting

You can use the instrument panel brightness control knob to adjust the illumination of the audio system (see page 71). The audio system illuminates when the parking lights are on, even if the radio is turned off.

Operating the Cassette Player

Turn the audio system ON. Make sure the tape opening on the cassette is facing to the right, then insert the cassette most of the way into the slot. The system will pull it in the rest of the way, and begin to play.

The tape direction indicator will light to show you which side of the cassette is playing. The ▲ indicates the side you inserted facing upward is now playing. If you want to play the other side, press the PROG button.

Dolby B noise reduction turns on when you insert a cassette. If the tape was not recorded with Dolby B noise reduction, turn it off by pressing the  button.

When the system reaches the end of the tape, it will automatically reverse direction and play the other side. If you want to remove the cassette from the drive, press the EJECT button.

Tape Search Functions

With a cassette playing, you can use the FF, REW, SKIP, or REPEAT function to find a desired program.

FF/REW — Fast Forward and Re-wind move the tape rapidly. To re-wind the tape, push the REW button. You will see REW in the display. To fast forward the tape, push the FF button. You will see FF displayed. Press the PLAY button to take the system out of rewind or fast forward.

If the system reaches the end of the tape while in fast forward or rewind, it automatically stops that function, reverses direction, and begins to play.

SKIP — The Skip Function allows you to find the beginning of a song or passage. To find the beginning of the song or passage currently playing, push the SKIP switch down. You will see REW flashing in the display as the tape rewinds. To find the beginning of the next song, push the SKIP switch up. You will see FF flashing in the display as the tape fast forwards. When the system finds the beginning of a song or passage, it goes back to PLAY mode.

REPEAT — The Repeat function continuously replays the current song or passage. Press the RPT button to activate it; you will see RPT displayed as a reminder. When the system reaches the end of the song or passage currently playing, it will automatically go into rewind. When it senses the beginning of the same song or passage, the system returns to PLAY mode. It will continue to repeat this same program until you deactivate REPEAT by pressing the button again.

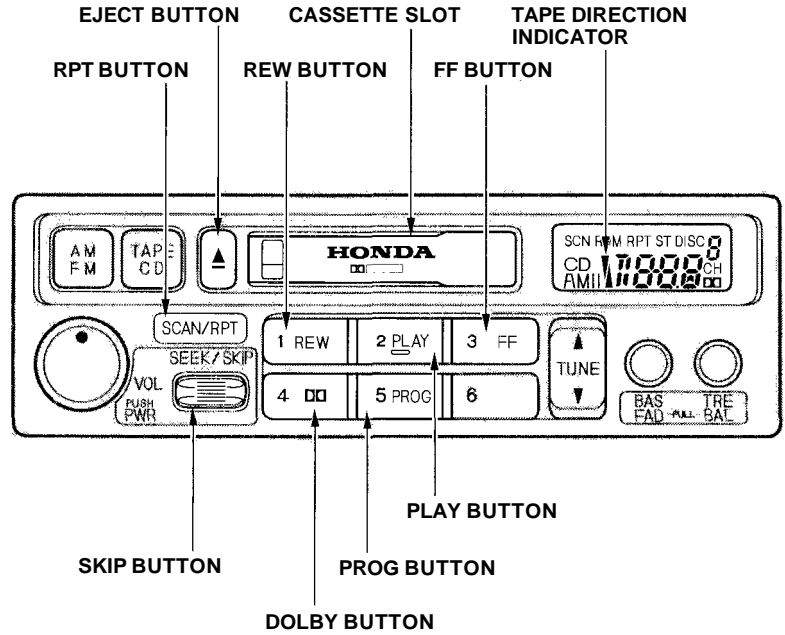

CONTINUED

The SKIP and REPEAT functions use silent periods on the tape to find the end of a song or passage. These features may not work to your satisfaction if there is almost no gap between selections, a high noise level between selections, or a silent period in the middle of a selection.

Caring for Cassettes

Damaged cassettes can jam inside the drive or cause other problems. See page 190 for information on cassette care and protection.

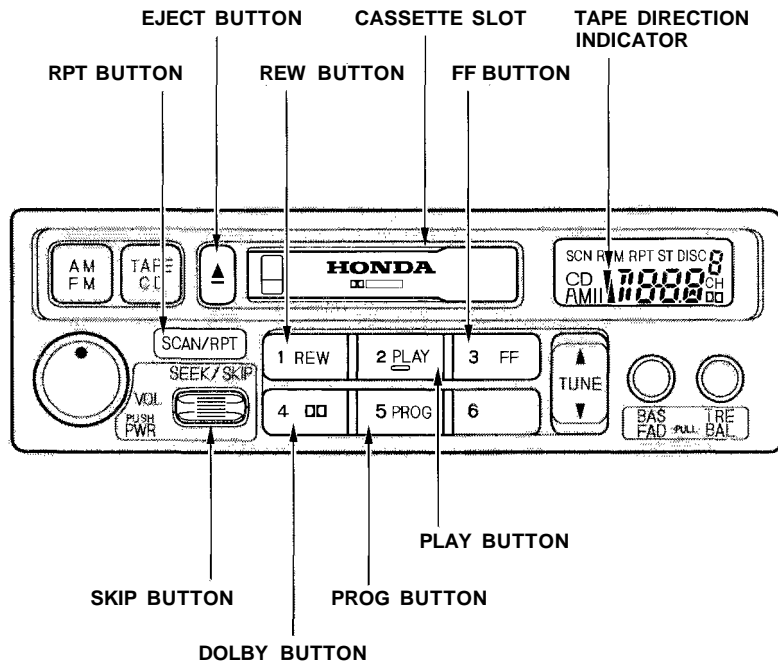

Operating the Optional CD Player/Changer

A Compact Disc changer is available from your dealer. It holds up to six discs, providing several hours of continuous entertainment. You operate the CD changer with the same controls used for the radio and cassette player.

Your dealer also has an accessory in-dash single CD player available that is operated by the radio controls. To operate this unit, use the instructions (except for those relating to multiple discs) in this section.

Using the instructions that came with the changer, load the desired CDs in the magazine, and load the magazine in the changer. Play only standard round discs. Odd-shaped CDs may jam in the drive or cause other problems.

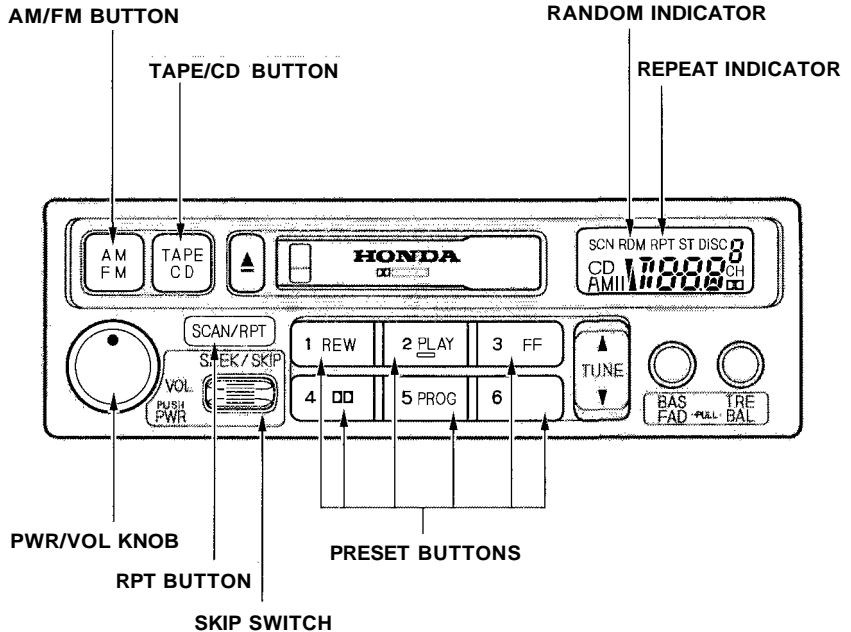

CONTINUED

To operate the CD changer or player, the ignition must be in ACCESSORY (I) or ON (II) and the audio system must be on.

Press the CD button until "CD" appears in the display. The system will start to play the first track of the first disc in the magazine. Play only standard round discs.

When that disc ends, the next disc in the magazine is loaded and played. After the last disc finishes, the system returns to disc 1.

To select a different disc, press the appropriate preset button (1 — 6). If you select an empty slot in the magazine, the changer will, after finding that slot empty, try to load the CD in the next slot. This continues until it finds a CD to load and play.

You can use the SKIP switch to select tracks within a disc. If you push and release the SKIP switch, the system will move to the beginning of a track. Push the switch up to move to the beginning of the next track, and push the switch down to move to the beginning of the current track.

If you push and hold the SKIP switch, you will hear a beep and the system will continue to move across tracks. Release the switch when you think it has reached the desired place on the disc.

REPEAT — When you activate the Repeat feature by pressing the RPT button, the system continuously replays the current track. You will see RPT in the display as a reminder. Press the RPT button again to turn it off.

RANDOM PLAY — This feature, when activated, plays the tracks on a CD in random order, rather than in the order they are recorded on the CD. To activate Random Play, press and hold the RPT button until you see RDM in the display. The system will then select and play tracks randomly on the current disc. When all tracks on that disc have been played, the next disc is loaded and played randomly. This continues until you deactivate Random Play by pressing RPT again.

If the system is in Repeat mode, you must turn it off by pressing RPT before you can select Random Play. Then press the button again until you see RDM displayed.

To take the system out of CD mode, press the AM/FM button or insert a cassette in the player. If a tape is already in the cassette player, press the TAPE button. When you return to CD mode, play will continue at the same disc and track.

If you turn the system off while a CD is playing, either with the PWR/VOL knob or the ignition switch, play will continue at the same disc and track when you turn it back on.

Protecting Compact Discs

For information on how to handle and protect compact discs, see page [184](#).

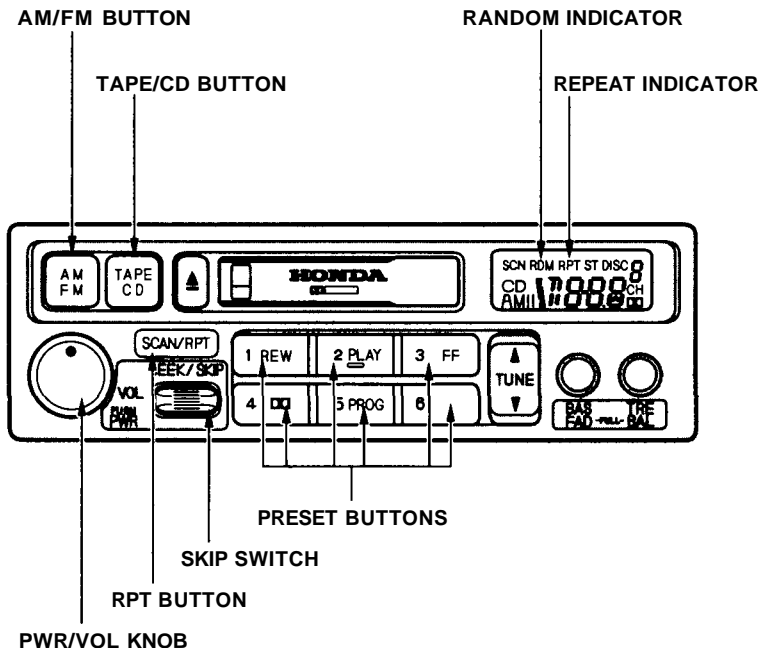

CD Changer Error Indications

If you see an error indication in the display while operating the CD changer, find the cause in the chart to the right. If you cannot clear the error indication, take the vehicle to your Honda dealer.

Indication	Cause	Solution
CD E01	Disc-changer malfunction.	If the code disappears within a few seconds, unit is OK. Press the magazine eject button and pull out the magazine, check for error indication. Insert the magazine again. If the code does not disappear or the magazine cannot be pulled out, consult your Honda dealer.
	CD magazine ejection impossible.	Press the magazine eject button. If the magazine does not eject, consult your Honda dealer.
CD E02	Disc is in changer mechanism.	Press the magazine eject button, and insert an empty magazine.
CD --H	High temperature.	Will disappear when the temperature returns to normal.
CD EEE	Misconnection or disconnection of CD changer.	See your Honda dealer.
CD ---	No CD magazine in the CD changer.	Insert CD magazine.
CD 1-00 ^{Disc}	No CD in magazine.	Insert a CD in the magazine.

AM/FM/CD Audio System

On EX model

Your Honda's audio system provides clear reception on both AM and FM bands, while the preset buttons allow you to easily select your favorite stations.

The anti-theft feature will disable the system if it is disconnected from the vehicle's battery. To get the system working again, you must enter a code number (see page 192).

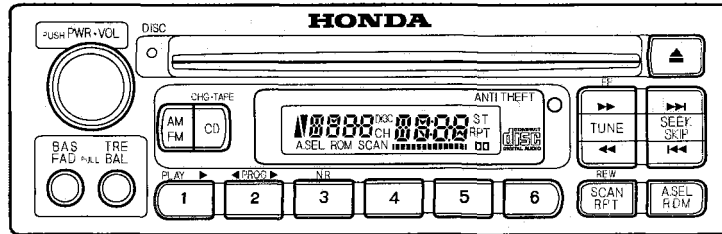





Operating the Radio

The ignition switch must be in ACCESSORY CD or ON (II) to operate the audio system. Turn the system on by pushing the PWR/VOL knob. Adjust the volume by turning the same knob.

The band and frequency that the radio was last tuned to is displayed. To change bands, press the AM/FM button. On the FM band, ST will be displayed if the station is broadcasting in stereo. Stereo reproduction on AM is not available.

You can use any of four methods to find radio stations on the selected band: TUNE, SEEK, SCAN or the Preset buttons.

TUNE — Use the TUNE bar to tune the radio to a desired frequency. Press the  side of the bar to tune to a higher frequency, and the  side to tune to a lower frequency. The frequency numbers will start to change rapidly. Release the bar when the display reaches the desired frequency. To change the frequency in small increments, press and release the TUNE bar quickly.

SEEK — The SEEK function searches the band for a station with a strong signal. To activate it, press the SEEK bar on either the  or  side, then release it. Depending on which side you press, the system scans upward or downward from the current frequency. It stops when it finds a station with a strong signal.

SCAN — The SCAN function samples all the stations with strong signals on the selected band. To activate it, press the SCAN button, then release it. When the system is in the SCAN mode, SCAN shows in the display. The system will scan up the band for a station with a strong signal. When it finds one, it will stop and play that station for approximately five seconds. If you do nothing, the system will then scan for the next strong station and play that for five seconds. When it plays a station that you want to continue listening to, press the SCAN button again.

Preset — You can store the frequencies of your favorite radio stations in the six preset buttons. Each button will store one frequency on the AM band, and two frequencies on the FM band.

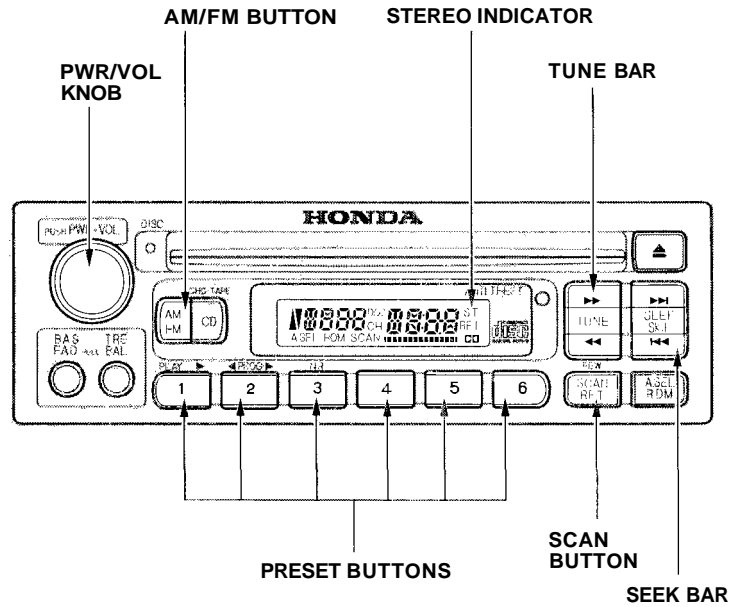

CONTINUED

Audio System

To store a frequency:

1. Select the desired band, AM or FM. FM1 and FM2 let you store two frequencies with each Preset button.
2. Use the TUNE or SEEK function to tune the radio to a desired station.
3. Pick the Preset button you want for that station. Press the button and hold it until you hear a beep.
4. Repeat steps 1 to 3 to store a total of six stations on AM and twelve on FM.

Once a station's frequency is stored, simply press and release the proper Preset button to tune to it.

The preset frequencies will be lost if your vehicle's battery goes dead, is disconnected, or the radio fuse is removed.

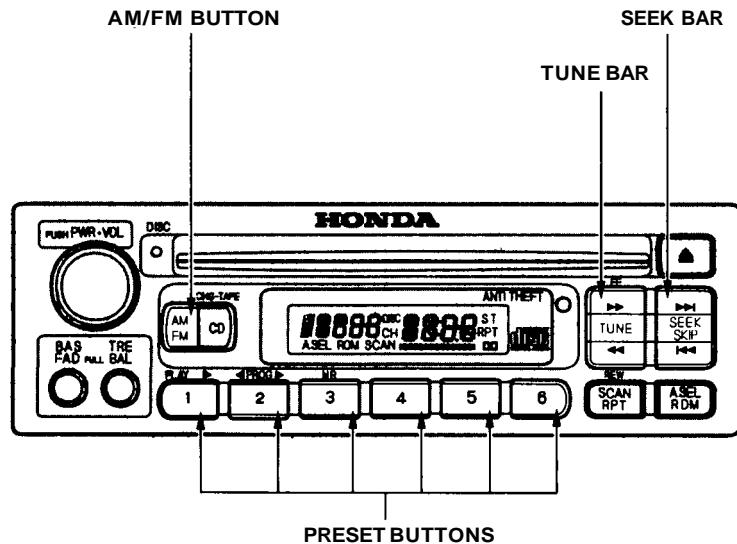

AUTO SELECT — If you are traveling far from home and can no longer receive the stations you preset, you can use the Auto Select feature to find stations in the local area.

To activate Auto Select, press the A. SEL button. A. SEL will flash in the display, and the system will go into scan mode for several seconds. It automatically scans both bands, looking for stations with strong signals. It stores the frequencies of six AM stations and twelve FM stations in the preset buttons. You can then use the preset buttons to select those stations.

If you are in a remote area, Auto Select may not find six strong AM stations or twelve strong FM stations. If this happens, you will see a "0" displayed when you press any preset button that does not have a station stored.

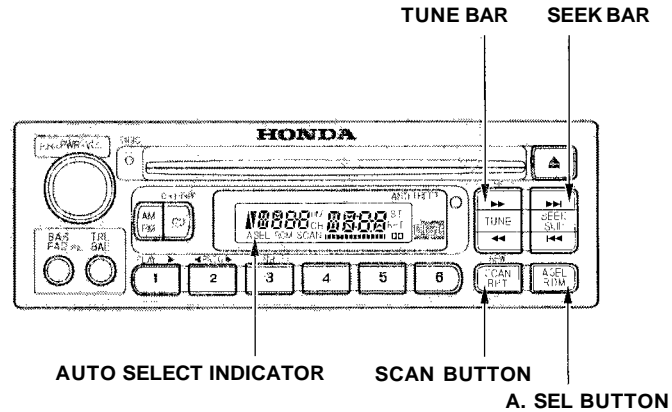

If you do not like the stations Auto Select has stored, you can store other frequencies in the preset buttons. Use the TUNE, SEEK, or SCAN function to find the desired frequencies, then store them in the selected preset buttons as described previously.

Auto Select does not erase the frequencies that you preset previously. When you return home, turn off Auto Select by pressing the A. SEL button. The preset buttons will then select the frequencies you originally set.

Adjusting the Sound

Balance/Fader — These two controls adjust the strength of the sound coming from each speaker. The Balance control adjusts the side-to-side strength, while the Fader control adjusts the front-to-back strength.

To adjust the fader, push on the BASS/FADER control knob to get it to pop out. Pull it out slightly farther, and adjust the front-to-back sound to your liking. Push the knob back in when you are done so you cannot change the setting by accidentally bumping it.

To adjust the balance, push on the TREBLE/BALANCE control knob to get it to pop out. Pull it out slightly farther, and adjust the side-to-side sound to your liking. Push the knob back in when you are done so you cannot change the setting by accidentally bumping it.

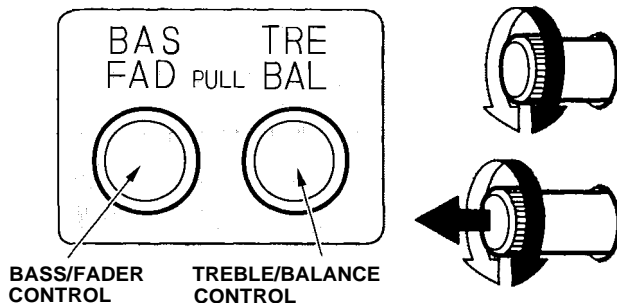

Treble/Bass — Use these controls to adjust the tone to your liking.

To adjust the Treble level, push on the TREBLE/BALANCE control knob to get it to pop out. Without pulling it out farther, turn the knob to adjust the treble level. Push the knob back in when you are done so you cannot change the setting by accidentally bumping it.

To adjust the Bass level, push on the BASS/FADER control knob to get it to pop out. Without pulling it out farther, turn the knob to adjust the bass level. Push the knob back in when you are done so you cannot change the setting by accidentally bumping it.

Audio System Lighting

You can use the instrument panel brightness control knob to adjust the illumination of the audio system (see page 71). The audio system illuminates when the parking lights are on, even if the radio is turned off.

Radio Frequencies

Your Honda's radio can receive the complete AM and FM bands. Those bands cover these frequencies:

AM band:

530 to 1,710 kilohertz

FM band:

87.7 to 107.9 megahertz

Radio stations on the AM band are assigned frequencies at least ten kilohertz apart (530, 540, 550). Stations on the FM band are assigned frequencies at least 0.2 megahertz apart (87.9, 88.1, 88.3).

Stations must use these exact frequencies. It is fairly common for stations to round-off the frequency in their advertising, so your radio could display a frequency of 100.9 even though the announcer may identify the station as "FM101."

Radio Reception

How well your Honda's radio receives stations is dependent on many factors, such as the distance from the station's transmitter, nearby large objects, and atmospheric conditions.

A radio station's signal gets weaker as you get farther away from its transmitter. If you are listening to an AM station, you will notice the sound volume becoming weaker, and the station drifting in and out. If you are listening to an FM station, you will see the stereo indicator flickering off and on as the signal weakens. Eventually, the stereo indicator will

go off and the sound will fade completely as you get out of range of the station's signal.

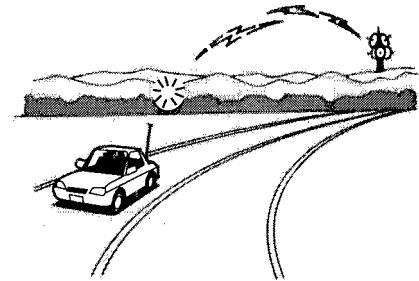

Driving very near the transmitter of a station that is broadcasting on a frequency close to the frequency of the station you are listening to can also affect your radio's reception. You may temporarily hear both stations, or hear only the station you are close to.

CONTINUED

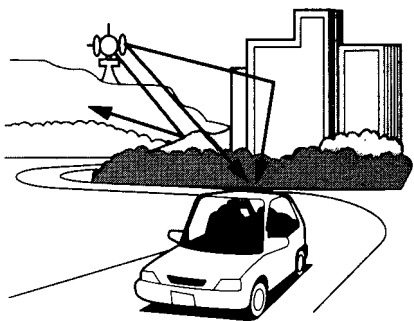

Radio signals, especially on the FM band, are deflected by large objects such as buildings and hills. Your radio then receives both the direct signal from the station's transmitter, and the deflected signal. This causes the sound to distort or flutter. This is a main cause of poor radio reception in city driving.



Radio reception can be affected by atmospheric conditions such as thunderstorms, high humidity, and even sunspots. You may be able to receive a distant radio station one day and not receive it the next day because of a change in conditions.

Electrical interference from passing vehicles and stationary sources can cause temporary reception problems.

*As required by the FCC:
Changes or modifications not expressly
approved by the party responsible for
compliance could void the user's
authority to operate the equipment.*

Operating the CD Player

You operate the CD player with the same controls used for the radio.

With the ignition switch in ACCESSORY (I) or ON (II), insert the disc into the CD slot. Push the disc in halfway, the drive will pull in the rest of the way and begin to play. The number of the track that is playing is shown in the display.

You can also play 3-inch (8-cm) discs without using an adapter ring. In all cases, play only standard round discs. Odd-shaped CDs may jam in the drive or cause other problems.

When the system reaches the end of the disc, it will return to the beginning and play that disc again.

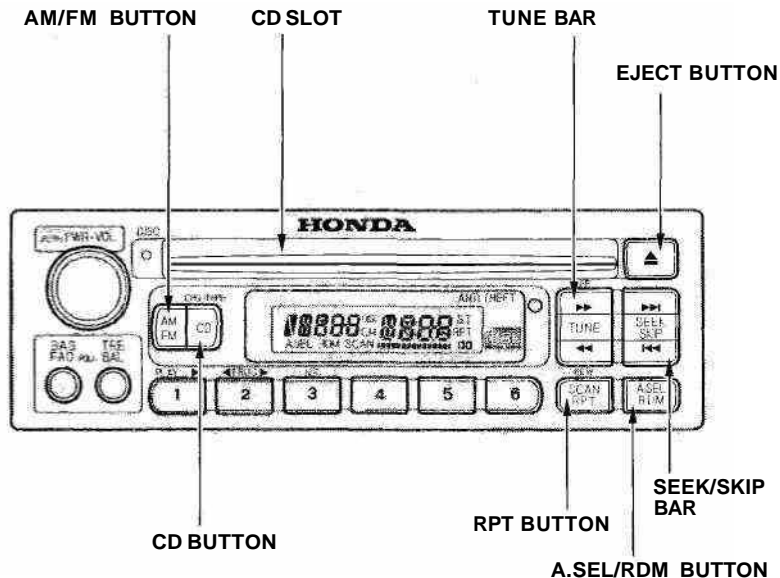

CONTINUED



You can switch to the radio while a CD is playing by pressing the AM/FM button. Press the CD button to return to playing the CD. The CD will begin playing where it left off.



If you turn the system off while a CD is playing, either with the PWR/VOL knob or by turning off the ignition, the disc will stay in the drive. When you turn the system back on, the CD will begin playing where it left off.

Press the eject button to remove the disc from the drive.

If you eject the disc, but do not remove it from the slot, the system will automatically reload the disc after 15 seconds and put the CD player in pause mode. To begin playing the disc, press the CD button.

You can use the TUNE and SEEK/SKIP bars while a disc is playing to select passages and change tracks.

To move rapidly within a track, press and hold the TUNE bar. Press the  side to move forward. You will see CUE in the display. Press the  side to move backward. You will see REW displayed. Release the bar when the system reaches the point you want.

Each time you press and release the  side of the SEEK/SKIP bar, the system skips forward to the beginning of the next track. Press the  side to skip backward to the beginning of the current track. Press it again to skip to the beginning of the previous track.

REPEAT — To activate the Repeat feature, press and release the RPT button. You will see RPT in the display. The system continuously replays the current track. Press the RPT button again to turn it off.

RANDOM PLAY — This feature, when activated, plays the tracks on the CD in random order, rather than in the order they are recorded on the CD. To activate Random Play, press and release the A. SEL/RDM button. You will see RDM in the display. The system will then select and play tracks randomly. This continues until you deactivate Random Play by pressing A. SEL/RDM again.

If the system is in Repeat mode, you must turn it off by pressing the RPT button before selecting Random Play.

Operating the CD Changer (Optional)

A Compact Disc changer is available for your vehicle. It holds up to six discs, providing several hours of continuous entertainment. You operate this CD changer with the same controls used for the in-dash CD player.

Load the desired CDs in the magazine and load the magazine in the changer according to the instructions that came with the unit. Play only standard round discs. Odd-shaped CDs may jam in the drive or cause other problems.

To select the CD changer, press the CD button. The disc and track numbers will be displayed.

To select a different disc, press the appropriate preset button (1 — 6). If you select an empty slot in the magazine, the changer will, after finding that slot empty, try to load the CD in the next slot. This continues until it finds a CD to load and play.

If you load a CD in the in-dash player while the changer is playing a CD, the system will stop the changer and begin playing the in-dash CD. To select the changer again, press the CD button. Play will begin where it left off. Use the CD button to switch between the player and the changer.

If you eject the in-dash CD while it is playing, the system will automatically switch to the CD changer and begin play where it left off. If there are no CDs in the changer, the display will flash. You will have to select another mode (AM or FM) with the button.

When you switch back to CD mode, the system selects the same unit (in-dash or changer) that was playing when you switched out of CD mode.

To use the SKIP, REPEAT, and RANDOM functions, refer to the in-dash player operating instructions.

Protecting Compact Discs

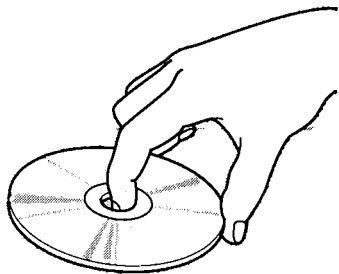

Handle a CD by its edges; never touch either surface. Contamination from fingerprints, liquids, felt-tip pens, and labels can cause the CD to not play properly, or possibly jam in the drive.

When a CD is not being played, store it in its case to protect it from dust and other contamination. To prevent warpage, keep CDs out of direct sunlight and extreme heat.

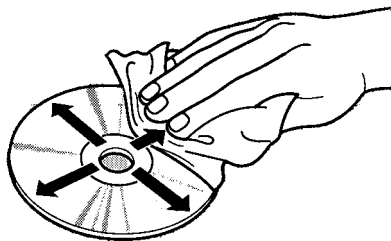

To clean a disc, use a clean soft cloth. Wipe across the disc from the center to the outside edge.

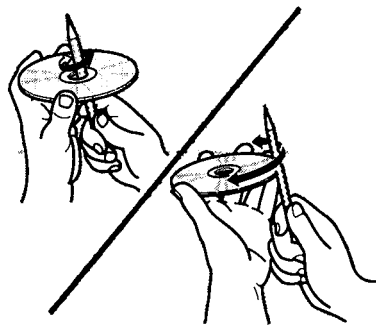

A new CD may be rough on the inner and outer edges. The small plastic pieces causing this roughness can flake off and fall on the recording surface of the disc, causing skipping or other problems. Remove these pieces by rubbing the inner and outer edges with the side of a pencil or pen.

Never try to insert foreign objects in the CD player or the magazine.

CD Player Error Indications

If you see an error indication in the display while operating the CD player, find the cause in the chart to the right. If you cannot clear the error indication, take the vehicle to your Honda dealer.

Indication	Cause	Solution
CD E-00	System Error FOCUS Error	Press the EJECT button and pull out the disc. Check if the disc is inserted correctly in CD player. Make sure the disc is not scratched or damaged.
CD E-01	Mechanical Error	Press the EJECT button and pull out the disc. Check the disc for damage or deformation. If the CD cannot be pulled out or the error indication does not disappear after the disc is ejected, see your Honda dealer. Do not try to force the disc out of the player.
CD E-02	Communication Error LSI Error	Consult your Honda dealer.

CD Changer Error Indications

If you see an error indication in the display while operating the CD changer, find the cause in the chart to the right. If you cannot clear the error indication, take the vehicle to your Honda dealer.

Indication	Cause	Solution
CD 0 ^{DISC} E-00	System Error FOCUS Error	Press the magazine eject button and pull out the magazine, check for error indication. Insert the magazine again. If the code does not disappear or the magazine cannot be pulled out, consult your Honda dealer.
CD 0 ^{DISC} E-01	Mechanical Error	Press the magazine eject button and pull out the magazine, check for error indication. Insert the magazine again. If the code does not disappear or the magazine cannot be pulled out, consult your Honda dealer.
CD 0 ^{DISC} E-02	Communication Error LSI Error	See your Honda dealer.
CD 0 ^{DISC} ---H	High temperature.	Will disappear when the temperature returns to normal.
CD 0 ^{DISC} ----	No CD magazine in the CD changer.	Insert CD magazine.
	No CD in the CD magazine.	Insert CD.

Operating the Cassette Player (Optional)

The cassette system features Dolby B* noise reduction, automatic sensing of chromium-dioxide (CrO₂) tape, and autoreverse for continuous play.

Make sure the tape opening on the cassette is facing to the right, then insert the cassette most of the way into the slot. The system will pull it in the rest of the way, and begin to play.

* Dolby noise reduction manufactured under license from Dolby Laboratories Licensing Corporation. "DOLBY" and the double-D symbol  are trademarks of Dolby Laboratories Licensing Corporation.

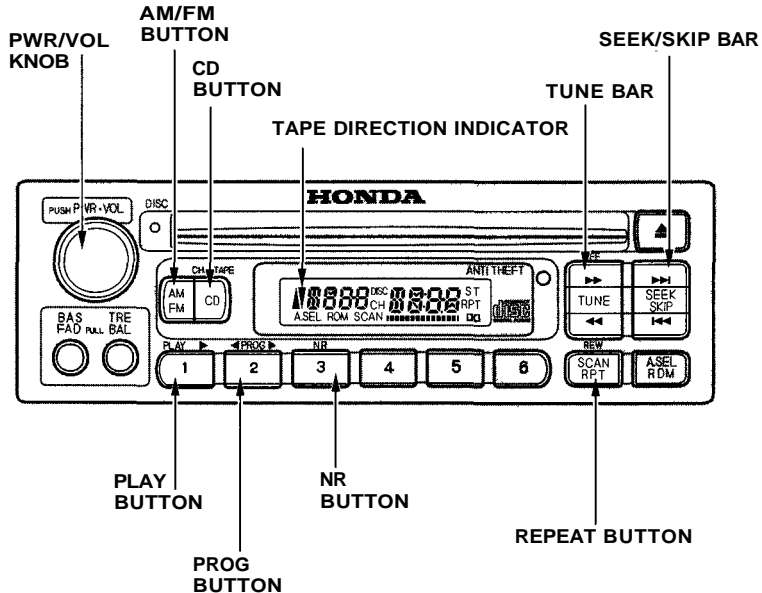

CONTINUED

The tape direction indicator will light to show you which side of the cassette is playing. The ▲ indicates the side you inserted facing upward is now playing. If you want to play the other side, press the PROG button.

Dolby B noise reduction turns on when you insert a cassette. If the tape was not recorded with Dolby B noise reduction, turn it off by pressing the NR button. Dolby remains off until you turn it on by pressing the button again.

When the system reaches the end of the tape, it will automatically reverse direction and play the other side. If you want to remove the cassette from the drive, press the EJECT button on the cassette player.

If you turn the system off while a tape is playing, either with the PWR/VOL knob or by turning off the ignition, the cassette will remain in the drive. When you turn the system back on, the cassette player will be in pause mode. To begin playing, press the PLAY button.

To switch to the radio or CD player while a tape is playing, press the AM/FM, or CD button. To change back to the cassette player, push the CD button.

Tape Search Functions

With a cassette playing, you can use the FF, REW, SKIP, or REPEAT function to find a desired program.

FF/REW — Fast Forward and Rewind move the tape rapidly. Press and release the ►► side of the TUNE bar to fast forward the tape, or the ◀◀ side to rewind. You will see FF or REW flashing in the display. To stop fast forward or rewind, press either side of the TUNE bar or the PLAY button. If the system reaches the end of the tape while in fast forward or rewind, it automatically stops that function, reverses direction, and begins to play.

SKIP — The Skip function allows you to find the beginning of a song or passage. To activate SKIP, press the SEEK/SKIP bar. Press the **▶▶** side to advance to the beginning of the next song or passage, or the **◀◀** side to return to the beginning of the current song or passage. FF or REW will flash in the display as the tape moves. When the system reaches the beginning of the next song or passage (FF), or the beginning of the current one (REW), it goes back to PLAY mode.

REPEAT — The Repeat function continuously replays the current song or passage. Press the RPT button to activate it; you will see RPT displayed as a reminder. When the system reaches the end of the song or passage currently playing, it will automatically go into rewind. When it senses the beginning of the same song or passage, the system returns to PLAY mode. It will continue to repeat this same program until you deactivate REPEAT by pressing the button again.

The SKIP and REPEAT functions use silent periods on the tape to find the end of a song or passage. These features may not work to your satisfaction if there is almost no gap between selections, a high noise level between selections, or a silent period in the middle of a selection.

Caring for the Cassette Player

The cassette player picks up dirt and oxides from the tape. This contamination builds up over time and causes the sound quality to degrade. To prevent this, you should clean the player after every 30 hours of use. Your dealer has a cleaning kit available.

If you do not clean the cassette player regularly, it may eventually become impossible to remove the contamination with a normal cleaning kit.

Use 100-minute or shorter cassettes. Cassettes longer than that use thinner tape that may break or jam the drive.

Look at the cassette before you insert it. If the tape is loose, tighten it by turning a hub with a pencil or your finger.

If the label is peeling off, remove it from the cassette or it could cause the cassette to jam in the player. Never try to insert a warped or damaged cassette in the player.

When they are not in use, store cassettes in their cases to protect them from dust and moisture. Never place cassettes where they will be exposed to direct sunlight, high heat, or high humidity. If a cassette is exposed to extreme heat or cold, let it reach a moderate temperature before inserting it in the player.

Never try to insert foreign objects into the cassette player.

If you see the error indication “TAPPE Err” (LX model)/“TAPE Err” (EX model) on the display, press the EJECT button and remove the cassette from the unit. Make sure the tape is not damaged. If the cassette will not eject or the error indication stays on after the cassette ejects, take the vehicle to your Honda dealer.

On LX model

If a problem develops in the connection between the cassette player and the radio, you will see “TETE” in the display. Take the vehicle to your Honda dealer.

Remote Audio Controls

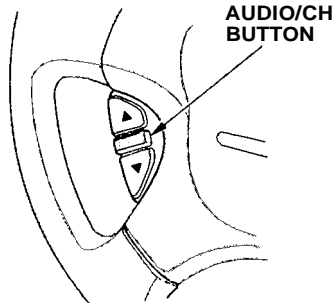

On EX model

Two controls for the audio system are mounted in the steering wheel hub. These let you control basic functions without removing your hand from the wheel.

The top and bottom buttons adjust the volume up (▲) or down (▼). Press the proper button and hold it until the desired volume is reached, then release it.

The AUDIO/CH button has three functions, depending on whether you are listening to the radio, or playing a cassette or CD.

If you are listening to the radio, use the AUDIO/CH button to change stations. Each time you press this button, the system advances to the next preset station on the band you are listening to. You will see the number of the selected Preset button in the display. To change bands, press the AM/FM button on the audio system's front panel.

If you are playing a cassette, use the AUDIO/CH button to advance to the next selection. You will see "FF" blinking in the display when you press the AUDIO/CH button. The system fast forwards until it senses a silent period, then goes back to PLAY.

If you are playing a CD, the system skips to the beginning of the next track each time you push the AUDIO/CH button. You will see the disc and track number in the display.

Theft Protection

On EX model

Your vehicle's audio system will disable itself if it is disconnected from electrical power for any reason. To make it work again, the user must enter a specific five-digit code in the Preset buttons. Because there are hundreds of number combinations possible from five digits, making the system work without knowing the exact code is nearly impossible.

You should have received a card that lists your audio system's code number and serial number. It is best to store this card in a safe place at home. In addition, you should write the audio system's serial number in this Owner's Manual. If you should happen to lose the card, you must obtain the code number from your Honda dealer. To do this, you will need the system's serial number.

If your vehicle's battery is disconnected or goes dead, or the radio fuse is removed, the audio system will disable itself. If this happens, you will see “ **LOCK** ” in the frequency display the next time you turn on the system. Use the Preset buttons to enter the five-digit code. If it is entered correctly, the radio will start playing.

If you make a mistake entering the code, do not start over or try to correct your mistake. Complete the five-digit sequence, then enter the correct code. You have ten tries to enter the correct code. If you are unsuccessful in ten attempts, you must then leave the system on for one hour before trying again.

You will have to store your favorite stations in the Preset buttons after the system begins working. Your original settings were lost when power was disconnected.

On EX model

The security system helps to protect your vehicle and valuables from theft. The horn sounds and a combination of headlights, parking lights, side marker lights and taillights flashes if someone attempts to break into your vehicle or remove the radio. This alarm continues for two minutes, then the alarm stops. To reset an alarming system before the two minutes have elapsed, unlock either front door with the key or the remote transmitter.

The security system sets automatically fifteen seconds after you lock the doors, hood, and tailgate. For the system to activate, you must lock the doors from the outside with the key, or remote transmitter. The security system light next to the low oil pressure indicator starts blinking immediately to show you the system is setting itself.

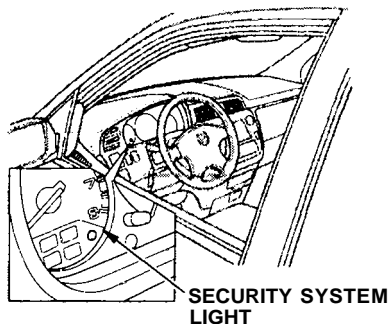

Once the security system is set, opening any door (without using the key or the remote transmitter), or the hood, will cause it to alarm. It also alarms if the radio is removed from the dashboard or the wiring is cut.

With the system set, you can still open the tailgate with the master key or the remote transmitter without triggering the alarm. The alarm will sound if the tailgate lock is forced, or the tailgate is opened with the tailgate release handle.

The security system will not set if the hood, tailgate, or any door is not fully closed. If the system will not set, check the Door Lamp Monitor on the instrument panel (see page 64), to see if the doors and tailgate are fully closed. Since it is not part of the monitor display, manually check the hood.

Do not attempt to alter this system or add other devices to it.

Before you begin driving your Honda, you should know what gasoline to use, and how to check the levels of important fluids. You also need to know how to properly store luggage or packages. The information in this section will help you. If you plan to add any accessories to your vehicle, please read the information in this section first.

Break-in Period.....	196
Gasoline.....	196
Service Station Procedures	197
Filling the Fuel Tank.....	197
Opening the Hood.....	198
Oil Check.....	200
Engine Coolant Check.....	201
Fuel Economy.....	202
Vehicle Condition.....	202
Driving Habits.....	202
Accessories and Modifications....	203
Carrying Cargo.....	205

Break-in Period

Help assure your vehicle's future reliability and performance by paying extra attention to how you drive during the first 600 miles (1,000 km). During this period:

- Avoid full-throttle starts and rapid acceleration.
- Avoid hard braking. New brakes need to be broken-in by moderate use for the first 200 miles (300 km).
- Do not change the oil until the recommended time or mileage interval shown in the maintenance schedule.

You should follow these same recommendations with an overhauled or exchanged engine, or when the brakes are replaced.

We also recommend that you should not tow a trailer during the first 500 miles (800 km).

Gasoline

Your Honda is designed to operate on unleaded gasoline with a pump octane number of 86 or higher. Use of a lower octane gasoline can cause a persistent, heavy metallic rapping noise in the engine that can lead to mechanical damage.

We recommend gasolines containing detergent additives that help prevent fuel system and engine deposits.

Using gasoline containing lead will damage your vehicle's emissions controls. This contributes to air pollution.

In Canada, some gasolines contain an octane-enhancing additive called MMT. If you use such gasolines, your emission control system performance may deteriorate and the Malfunction Indicator Lamp on your instrument panel may turn on. If this happens, contact your authorized Honda dealer for service.

Filling the Fuel Tank

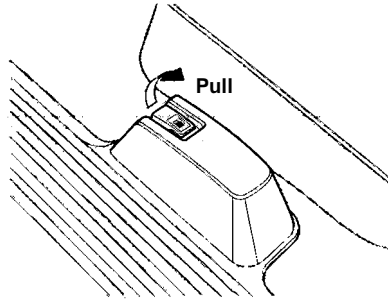

1. Because the fuel fill cap is on the driver's side of the vehicle, park with that side closest to the service station pumps.
2. Open the fuel fill door by pulling on the handle to the left of the driver's seat.

Before refueling, make sure the rear sliding door on the driver's side is closed.

Gasoline is highly flammable and explosive. You can be burned or seriously injured when handling fuel.

- Stop the engine and keep heat, sparks, and flame away.
- Handle fuel only outdoors.
- Wipe up spills immediately.

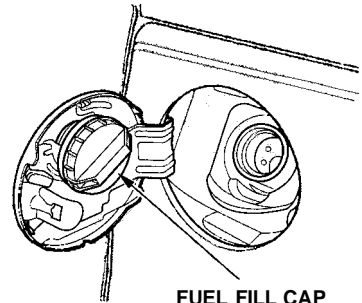

CONTINUED

3. Remove the fuel fill cap slowly. You may hear a hissing sound as pressure inside the tank escapes. Place the cap in the holder on the fuel fill door.
4. Stop filling the tank after the fuel nozzle automatically clicks off. Do not try to "top off" the tank, leave some room for the fuel to expand with temperature changes.

Your vehicle has an on-board refueling vapor recovery system to help keep fuel vapors from going into the atmosphere. If the fuel pump keeps clicking off even though the tank is not full, there may be a problem with this system. Consult your dealer.

5. Screw the fuel fill cap back on, tighten it until it clicks several times. If you do not properly tighten the cap, the Malfunction Indicator Lamp may come on (see page [320](#)).
6. Push the fuel fill door closed until it latches.

Opening the Hood

HOOD RELEASE HANDLE

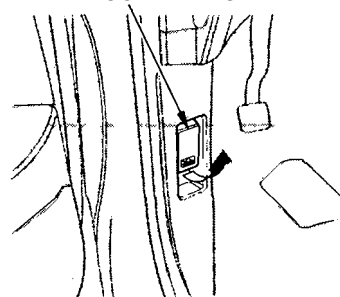

1. Shift to Park or Neutral and set the parking brake. Pull the hood release handle located under the lower left corner of the dashboard. The hood will pop up slightly.

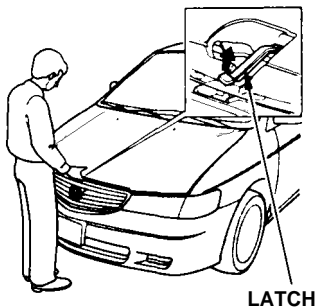

LATCH

If you can open the hood without lifting the hood latch handle, or the hood latch handle moves stiffly or does not spring back as before, the mechanism should be cleaned and lubricated (see page [264](#)).

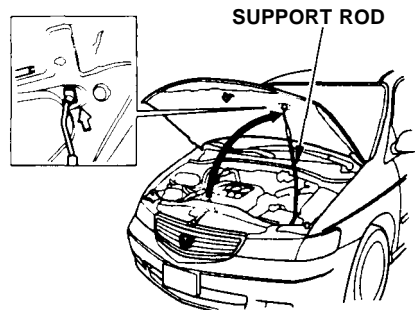

SUPPORT ROD

2. Standing in front of the vehicle, put your fingers under the front edge of the hood. The hood latch handle is above the "H" logo. Pull up on this handle until it releases the hood. Lift the hood.

3. Pull the support rod out of its clip and insert the end into the hole on the driver's side of the hood.

CONTINUED

To close the hood, lift it up slightly to remove the support rod from the hole. Put the support rod back into its holding clip. Lower the hood to about a foot (30 cm) above the fender, then let it drop. After closing the hood, make sure it is securely latched.

Oil Check

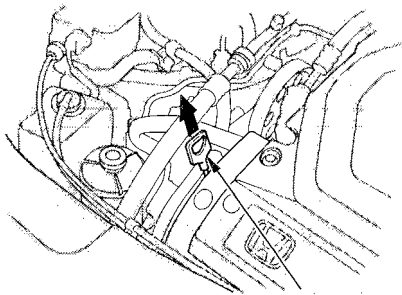

DIPSTICK

Check the engine oil level every time you fill the vehicle with fuel. Wait a few minutes after turning the engine off before you check the oil.

1. Remove the dipstick (orange handle).

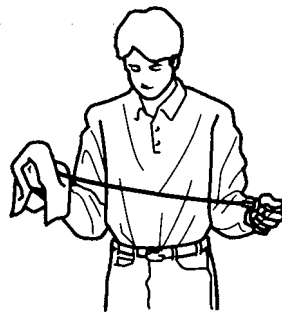

2. Wipe the dipstick with a clean cloth or paper towel.

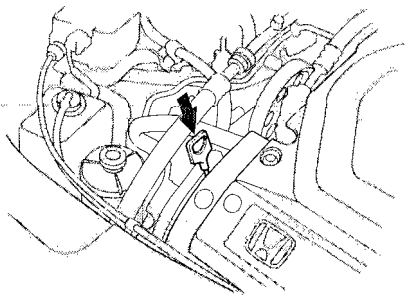

3. Insert it all the way back in its tube.



UPPER MARK
LOWER MARK

4. Remove the dipstick again and check the level. It should be between the upper and lower marks.

If it is near or below the lower mark, see **Adding Oil** on page [249](#) .

Engine Coolant Check

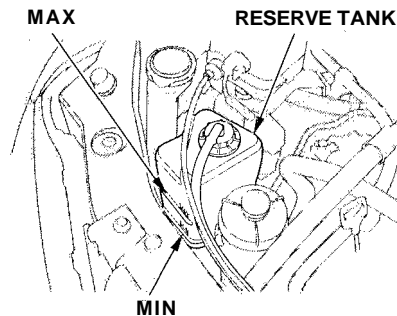

Look at the coolant level in the radiator reserve tank. Make sure it is between the MAX and MIN lines. If it is below the MIN line, see **Adding Engine Coolant** on page [253](#) for information on adding the proper coolant.

Refer to **Owner Maintenance Checks** on page [247](#) for information on checking other items in your Honda.

The condition of your vehicle and your driving habits are the two most important things that affect the fuel mileage you get.

Vehicle Condition

Always maintain your vehicle according to the maintenance schedule. This will keep it in top operating condition.

An important part of that maintenance is the **Owner Maintenance Checks** (see page 247). For example, an underinflated tire causes more "rolling resistance," which uses fuel. It also wears out faster, so check the tire pressure at least monthly.

In winter, the build-up of snow on your vehicle's underside adds weight and rolling resistance. Frequent cleaning helps your fuel mileage and reduces the chance of corrosion.

Driving Habits

You can improve fuel economy by driving moderately. Rapid acceleration, abrupt cornering, and hard braking use more fuel.

Always drive in the highest gear that allows the engine to run and accelerate smoothly.

Depending on traffic conditions, try to maintain a constant speed. Every time you slow down and speed up, your vehicle uses extra fuel. Use the cruise control, when appropriate, to increase fuel economy.

A cold engine uses more fuel than a warm engine. It is not necessary to "warm-up" a cold engine by letting it idle for a long time. You can drive away in about a minute, no matter how cold it is outside. The engine will warm up faster, and you get better fuel economy. To cut down on the number of "cold starts," try to combine several short trips into one.

The air conditioning puts an extra load on the engine which makes it use more fuel. Turn off the A/C to cut down on air conditioning use. Use the flow-through ventilation when the outside air temperature is moderate.

Modifying your vehicle, or installing some non-Honda accessories, can make your vehicle unsafe. Before you make any modifications or add any accessories, be sure to read the following information.

Accessories

Your dealer has genuine Honda accessories that allow you to personalize your vehicle. These accessories have been designed and approved for your vehicle, and are covered by warranty.

Non-Honda accessories are usually designed for universal applications. Although aftermarket accessories may fit on your vehicle, they may not meet factory specifications, and could adversely affect your vehicle's handling and stability. (See "Modifications" on page 204 for additional information.)

Improper accessories or modifications can affect your vehicle's handling, stability and performance, and cause a crash in which you can be hurt or killed.

Follow all instructions in this owner's manual regarding accessories and modifications.

When properly installed, cellular phones, alarms, two-way radios, and low-powered audio systems should not interfere with your vehicle's computer-controlled systems, such as the SRS and anti-lock brake system.

However, if electronic accessories are improperly installed, or exceed your vehicle's electrical system capacity, they can interfere with the

operation of your vehicle, or even cause the airbags to deploy.

Before installing any accessory:

- Make sure the accessory does not obscure any lights, or interfere with proper vehicle operation or performance.
- Be sure electronic accessories do not overload electrical circuits (see page 323).
- Have the installer contact your Honda dealer for assistance before installing any electronic accessory.

If possible, have your dealer inspect the final installation.

Modifications

Do not remove any original equipment or modify your vehicle in any way that would alter its design or operation. This could make your vehicle unsafe and illegal to drive.

For example, do not make any modifications that would change the ride height of your vehicle, or install wheels and tires with a different overall diameter.

Such modifications can adversely affect handling, and interfere with the operation of the vehicle's anti-lock brakes and other systems.

In addition, any modifications that decrease ground clearance increase the chance of undercarriage parts striking a curb, speed bump, or other raised object, which could cause your airbags to deploy.

Do not modify your steering wheel or any other part of your Supplemental Restraint System. Modifications could make the system ineffective.

Additional Safety Precaution

Do not attach or place objects on the airbag covers. Any object attached to or placed on the covers marked "SRS AIRBAG," in the center of the steering wheel and on top of the dashboard, could interfere with the proper operation of the airbags. Or, if the airbags inflate, the objects could be propelled inside the vehicle and hurt someone.

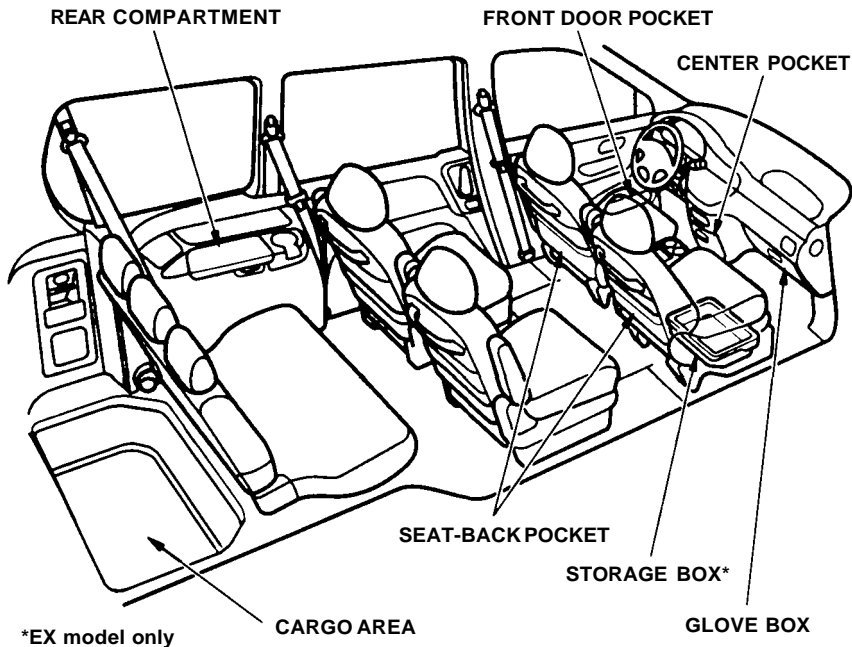

Your vehicle has several convenient storage areas so you can stow cargo safely.

The glove box, and the pockets in the front doors and seat-backs, are designed for small, lightweight items. The cargo area is intended for larger, heavier items. In addition, the seats in the second row can be removed and the bench seat in the third row can be folded into the floor to allow you to carry more cargo or longer items.

However, carrying too much cargo, or improperly storing it, can affect your vehicle's handling, stability and operation and make it unsafe. Before carrying any type of cargo, be sure to read the following pages.

Load Limit

The maximum load for your vehicle is 1,277 lbs (580 kg).

This figure includes the total weight of all occupants, cargo, accessories, and the tongue weight if you are towing a trailer.

To figure out how much cargo you can carry:

- Add up the weight of all occupants.
- If you are towing a trailer, add the tongue weight to the number above.
- Subtract the total from 1,277 lbs (580 kg).

The final number is the total weight of cargo you can carry.

When you load luggage, the total weight of the vehicle, all passengers, cargo, and trailer tongue load must not exceed the Gross Vehicle Weight Rating (GVWR). The load for the front and rear axles also must not exceed the Gross Axle Weight Rating (GAWR). The GVWR and GAWR are printed on the tire information label attached to the driver's doorjamb (see page [334](#)).

Overloading or improper loading can affect handling and stability and cause a crash in which you can be hurt or killed.

Follow all load limits and other loading guidelines in this manual.

Carrying Items in the Passenger Compartment

- Store or secure all items that could be thrown around and hurt someone during a crash.
- Be sure items placed on the floor behind the front seats cannot roll under the seats and interfere with the driver's ability to operate the pedals, or with the proper operation of the seats.
- Keep the glove box closed while driving. If the lid is open, a passenger could injure their knees during a crash or sudden stop.

Carrying Cargo in the Cargo Area or on a Roof Rack

- Distribute cargo evenly on the floor of the cargo area, placing the heaviest items on the bottom and as far forward as possible. Tie down items that could be thrown about the vehicle during a crash or sudden stop.
- If you carry large items that prevent you from closing the tailgate, exhaust gas can enter the passenger area. To avoid the possibility of **carbon monoxide poisoning**, follow the instructions on page 57.

- If you can carry any items on a roof rack, be sure the total weight of the rack and the items on it does not exceed 150 lb.

If you use an accessory roof rack, the roof rack weight limit may be lower. Refer to the information that came with your roof rack.

Side Cargo Net

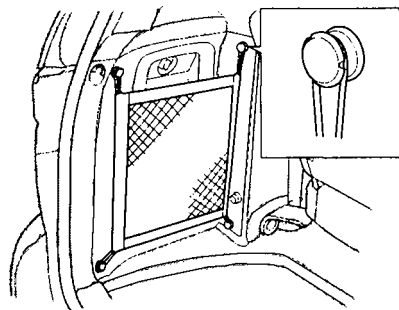

The side cargo net can be installed on the driver's side panel in the cargo area to secure small items. To install the side cargo net, hook each loop on the four corners of the net to the tabs on the left side panel. When you fold down the third seat, store the head restraints in the side cargo net.

Cargo Net

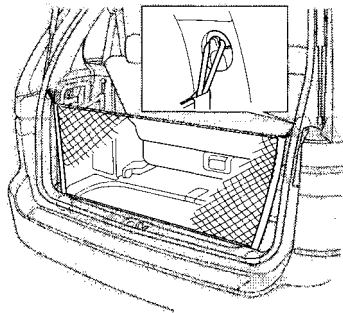

On EX model

You can use the cargo net to secure items in the cargo area, and store small items between the two halves of the net. To install the cargo net, hook the loops on the four corners of the net to the tabs at both sides of the tailgate sill.

This section gives you tips on starting the engine under various conditions, and how to operate the automatic transmission. It also includes important information on parking your vehicle, the braking system, the Traction Control System, and facts you need if you are planning to tow a trailer.

Preparing to Drive.....	210
Starting the Engine.....	211
Starting in Cold Weather at High Altitude	211
Automatic Transmission.....	212
Shift Lever Position Indicator..	212
Shift Lever Positions.....	213
Engine Speed Limiter	215
Shift Lock Release.....	215
Parking.....	217
The Braking System.....	218
Brake Wear Indicators.....	218
Brake System Design.....	219
Anti-lock Brakes.....	219
Important Safety Reminders.....	220
ABS Indicator.....	220
Traction Control System.....	221
TCS ON/OFF Switch.....	222
TCS Indicator.....	223
Driving in Bad Weather.....	224
Towing a Trailer.....	226

Preparing to Drive

You should do the following checks and adjustments every day before you drive your vehicle.

1. Make sure all windows, mirrors, and outside lights are clean and unobstructed. Remove frost, snow, or ice.
2. Check that the hood and tailgate are fully closed.
3. Visually check the tires. If a tire looks low, use a gauge to check its pressure.
4. Check that any items you may be carrying with you inside are stored properly or fastened down securely.
5. Check the adjustment of the seat (see page [105](#)).
6. Check the adjustment of the inside and outside mirrors (see page [121](#)).
7. Check the adjustment of the steering wheel (see page [76](#)).
8. Make sure the doors and tailgate are securely closed and locked.
9. Fasten your seat belt. Check that your passengers have fastened their seat belts (see page [15](#)).
10. Turn the ignition switch ON (II). Check the indicator lights in the instrument panel.
11. Start the engine (see page [211](#)).
12. Check the gauges and indicator lights in the instrument panel (see page [61](#)).

1. Apply the parking brake.
2. In cold weather, turn off all electrical accessories to reduce the drain on the battery.
3. Make sure the shift lever is in Park. Press on the brake pedal.
4. Without touching the accelerator pedal, turn the ignition key to the START (III) position. If the engine does not start right away, do not hold the key in START (III) for more than 15 seconds at a time. Pause for at least 10 seconds before trying again.
5. If the engine does not start within 15 seconds, or starts but stalls right away, repeat step 4 with the accelerator pedal pressed half-way down. If the engine starts, release pressure on the accelerator pedal so the engine does not race.
6. If the engine still does not start, press the accelerator pedal all the way down and hold it there while starting in order to clear flooding. As before, keep the ignition key in the START (III) position for no more than 15 seconds. Return to step 5 if the engine does not start. If it starts, lift your foot off the accelerator pedal so the engine does not race.
2. Push the accelerator pedal half-way to the floor and hold it there while starting the engine. Do not hold the ignition key in START (III) for more than 15 seconds. When the engine starts, release the accelerator pedal gradually as the engine speeds up and smooths out.
3. If the engine fails to start in step 2, push the accelerator pedal to the floor and hold it there while you try to start the engine for no more than 15 seconds. If the engine does not start, return to step 2.

Starting in Cold Weather at High Altitude (Above 8,000 feet/ 2,400 meters)

An engine is harder to start in cold weather. The thinner air found at high altitude above 8,000 feet (2,400 meters) adds to the problem. Use the following procedure:

1. Turn off all electrical accessories to reduce the drain on the battery.

Automatic Transmission

Your Honda's transmission has four forward speeds, and is electronically controlled for smoother shifting. It also has a "lock-up" torque converter for better fuel economy. You may feel what seems like another shift when the converter locks.

Shift Lever Position Indicator

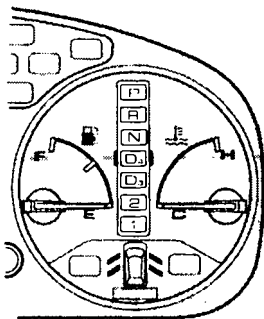

This indicator on the instrument panel shows which position the shift lever is in.

The "D4" indicator comes on for a few seconds when you turn the ignition switch ON (II). If it flashes while driving (in any shift position), it indicates a possible problem in the transmission. Avoid rapid acceleration and have the transmission checked by an authorized Honda dealer as soon as possible.

The malfunction indicator lamp may come on along with the "D4" indicator if there is a problem in the automatic transmission control system.

Shift Lever Positions

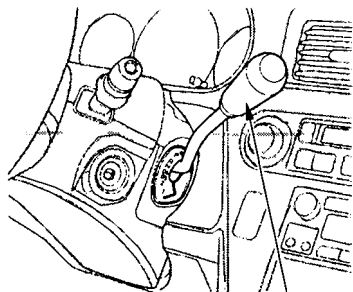

SHIFT LEVER

The shift lever has seven positions. It must be in Park or Neutral to start the engine. When you are stopped in D₄, D₃, 2, 1, N or R, press firmly on the brake pedal, and keep your foot off the accelerator pedal.

To shift from:	Do this:
P to R	Press the brake pedal and pull the shift lever towards you.
R to P N to R D ₃ to 2 2 to 1	Pull the shift lever towards you.
1 to 2 2 to D ₃ D ₃ to D ₄ D ₄ to N D ₄ to D ₃ N to D ₄ R to N	Move the lever.

Park (P) — This position mechanically locks the transmission. Use Park whenever you are turning off or starting the engine. To shift out of Park, you must press on the brake pedal and have your foot off the accelerator pedal. Pull the shift lever towards you, then move it out of Park.

If you have done all of the above and still cannot move the lever out of Park, see Shift Lock Release on page [216](#).

You must also pull the shift lever towards you to shift into Park. To avoid transmission damage, come to a complete stop before shifting into Park. The shift lever must be in Park before you can remove the key from the ignition switch.

CONTINUED

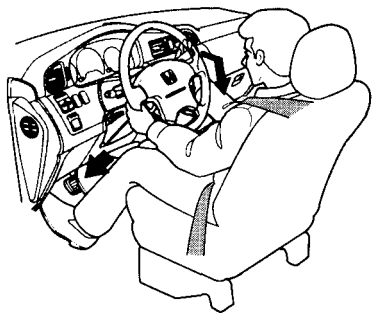

Reverse (R) — To shift to Reverse from Park, see the explanation under Park. To shift to Reverse from Neutral, come to a complete stop and then shift. Pull the shift lever towards you before shifting into Reverse from Neutral.

Neutral (N) — Use Neutral if you need to restart a stalled engine, or if it is necessary to stop briefly with the engine idling. Shift to Park position if you need to leave the vehicle for any reason. Press on the brake pedal when you are moving the shift lever from Neutral to another gear.

Drive (D4) — Use this position for your normal driving. The transmission automatically selects a suitable gear for your speed and acceleration. You may notice the transmission shifting up at higher speeds when the engine is cold. This helps the engine warm up faster.

Drive (D3) — This position is similar to D4, except only the first three gears are selected. Use D3 when towing a trailer in hilly terrain, or to provide engine braking when going down a steep hill. D3 can also keep the transmission from cycling between third and fourth gears in stop-and-go driving.

For faster acceleration when in D3 or D4, you can get the transmission to automatically downshift by pushing the accelerator pedal to the floor. The transmission will shift down one or two gears, depending on your speed.

Second (2) — To shift to Second, pull the shift lever towards you, then shift to the lower gear. This position locks the transmission in second gear. It does not downshift to first gear when you come to a stop. Second gives you more power when climbing, and increased engine braking when going down steep hills. Use second gear when starting out on a slippery surface or in deep snow. It will help reduce wheelspin. When driving down hill with a trailer, use the Second position.

First (1) — To shift from Second to First, pull the shift lever towards you, then shift to the lower gear. With the lever in this position, the transmission locks in First gear. By upshifting and downshifting through 1, 2, D3 and D4, you can operate this transmission much like a manual transmission without a clutch pedal.

Engine Speed Limiter

If you exceed the maximum speed for the gear you are in, the engine speed will enter into the tachometer's red zone. If this occurs, you may feel the engine cut in and out. This is caused by a limiter in the engine's computer controls. The engine will run normally when you reduce the RPM below the red zone.

Shift Lock Release

This allows you to move the shift lever out of Park if the normal method of pushing on the brake pedal and pulling the shift lever does not work.

1. Set the Parking brake.
2. Remove the key from the ignition switch.
3. Place a cloth on the edge of the shift lock release slot cover on the steering column. Remove the cover by carefully prying on the edge with a small flat-tipped screwdriver (not included in the tool kit).

CONTINUED

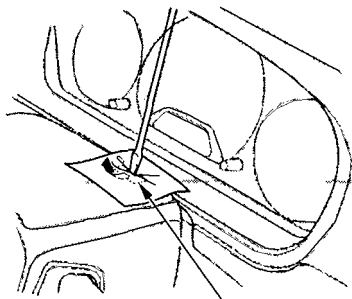

SHIFT LOCK RELEASE SLOT COVER

4. Insert the key in the Shift Lock Release slot.
5. Push down on the key while you pull the shift lever towards you and move it out of Park to Neutral.

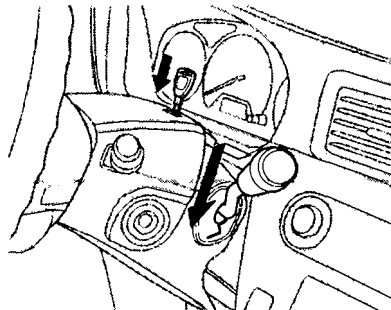

6. Remove the key from the Shift Lock Release slot, then install a new cover. Depress the brake pedal and restart the engine.

If you need to use the Shift Lock Release, it means your vehicle is developing a problem. Have the vehicle checked by your Honda dealer.

Always use the parking brake when you park your vehicle. The indicator on the instrument panel shows that the parking brake is not fully released; it does not indicate that the parking brake is firmly set. Make sure the parking brake is set firmly or your vehicle may roll if it is parked on an incline.

Set the parking brake before you put the transmission in Park. This keeps the vehicle from moving and putting pressure on the parking mechanism in the transmission — making it easier to move the shift lever out of Park when you want to drive away.

If the vehicle is facing uphill, turn the front wheels away from the curb.

If the vehicle is facing downhill, turn the front wheels toward the curb.

Make sure the parking brake is fully released before driving away. Driving with the parking brake partially set can overheat or damage the rear brakes.

Parking Tips

- Make sure the windows are closed.
- Turn off the lights.
- Place any packages, valuables, etc., in the cargo area or take them with you.
- Lock the doors with the key or the remote transmitter.
- Never park over dry leaves, tall grass, or other flammable materials. The three way catalytic converter gets very hot, and could cause these materials to catch on fire.

Your Honda is equipped with front disc brakes. The brakes on the rear wheels are drum. A power assist helps reduce the effort needed on the brake pedal. The ABS helps you retain steering control when braking very hard.

Put your foot on the brake pedal only when you intend to brake. Resting your foot on the pedal keeps the brakes applied lightly, causing them to build up heat. Heat build-up can reduce how well your brakes work. It also keeps your brake lights on all the time, confusing drivers behind you.

Constant application of the brakes when going down a long hill builds up heat and reduces their effectiveness. Use the engine to assist the brakes by downshifting to a lower gear and taking your foot off the accelerator pedal.

Check your brakes after driving through deep water. Apply the brakes moderately to see if they feel normal. If not, apply them gently and frequently until they do. Since a longer distance is needed to stop with wet brakes, be extra cautious and alert in your driving.

Brake Wear Indicators

The front disc brakes on all vehicles have audible brake wear indicators. When the brake pads need replacing, you will hear a distinctive metallic "screeching" sound when you apply the brakes. If you do not have the brake pads replaced, they will begin screeching all the time.

Your brakes may sometimes squeal or squeak when you apply them lightly. Do not confuse this with the brake wear indicators. They make a very audible "screeching."

Brake System Design

The hydraulic system that operates the brakes has two separate circuits. Each circuit works diagonally across the vehicle (the left-front brake is connected with the right-rear brake, etc.). If one circuit should develop a problem, you will still have braking at two wheels.

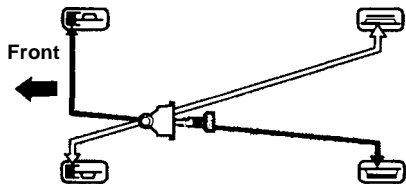

Anti-lock Brakes

Your vehicle has an Anti-lock Brake System (ABS) as standard equipment. ABS helps to prevent the wheels from locking up and skidding during hard braking, allowing you to retain steering control.

When the front tires skid, you lose steering control; the vehicle continues straight ahead even though you turn the steering wheel. The ABS helps to prevent lock-up and helps you retain steering control by pumping the brakes rapidly; much faster than a person can do it.

The ABS also balances the front-to-rear braking distribution according to vehicle loading.

You should never pump the brake pedal, this defeats the purpose of the ABS. Let the ABS work for you by always keeping firm, steady pressure on the brake pedal as you steer away from the hazard. This is sometimes referred to as *"stomp and steer."*

You will feel a pulsation in the brake pedal when the ABS activates, and you may hear some noise. This is normal, it is the ABS rapidly pumping the brakes.

Activation varies with the amount of traction your tires have. On dry pavement, you will need to press on the brake pedal very hard before you activate the ABS. However, you may feel the ABS activate immediately if you are trying to stop on snow or ice.

CONTINUED

The Braking System

Important Safety Reminders

ABS does not reduce the time or distance it takes to stop the vehicle, it only helps with steering control during braking. You should always maintain a safe following distance from other vehicles.

ABS will not prevent a skid that results from changing direction abruptly, such as trying to take a corner too fast or making a sudden lane change. Always drive at a safe, prudent speed for the road and weather conditions.

ABS cannot prevent a loss of stability. Always steer moderately when you are braking hard. Severe or sharp steering wheel movement can still cause your vehicle to veer into oncoming traffic or off the road.

A vehicle with ABS may require a longer distance to stop on loose or uneven surfaces, such as gravel or snow, than a vehicle without anti-lock. Slow down and allow a greater distance between vehicles under those conditions.

ABS Indicator

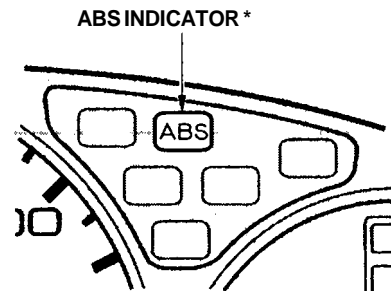

* U.S. indicator shown

The ABS is self-checking. If anything goes wrong, the ABS indicator on the instrument panel comes on (see page 63). This means the anti-lock function of the braking system has shut down. The brakes still work like a conventional system without anti-lock, providing normal stopping ability. You should have the dealer inspect your vehicle as soon as possible.

If the ABS indicator and the brake system indicator come on together, and the parking brake is fully released, the front-to-rear braking distribution system may also shut down.

Test your brakes as instructed on page 322 . If the brakes feel normal, drive slowly and have your vehicle repaired by your dealer as soon as possible. Avoid sudden hard braking which could cause the rear wheels to lock up and possibly lead to a loss of control.

The TCS indicator will come on along with the ABS indicator if there is a problem with the anti-lock brake system.

Traction Control System

Your Honda is equipped with a Traction Control System (TCS) to assist you in maintaining traction while driving slowly on loose or slippery surfaces. The TCS assists only in low-speed, low-traction conditions; up to approximately 18 mph(30km/h).

The TCS monitors the speed of all four wheels. When it senses a front wheel losing traction, it applies braking to that wheel. The TCS indicator flashes when this occurs.

TRACTION CONTROL SYSTEM INDICATOR

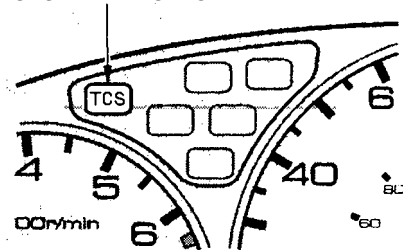

Driving with TCS requires no special skills or technique. The TCS does not control your vehicle's whole braking system and cannot prevent skidding if you enter a corner too fast. It is still your responsibility to drive at reasonable speeds and to leave a sufficient margin of safety.

CONTINUED

Traction Control System

When starting out or driving at low speeds on a loose or slippery road surface, you may notice that the vehicle does not respond to the accelerator in the same way it does at other times. This is a sign the TCS is activating. You will see the TCS indicator light flash.

You should still install winter tires on your vehicle during the winter. Make sure to use the same size originally supplied with vehicle. Exercise the same caution in winter driving as you would if your vehicle was not equipped with TCS.

Driving with the compact spare tire installed (see page 302) may activate the TCS. You should turn off the system.

If the brakes overheat while the TCS is activating, the TCS indicator will stop flashing and stay on temporarily. This indicates that the TCS system has turned off. After the brakes have cooled down (usually for about 10 minutes), the TCS will turn back on and the indicator will turn off.

TCS ON/OFF Switch

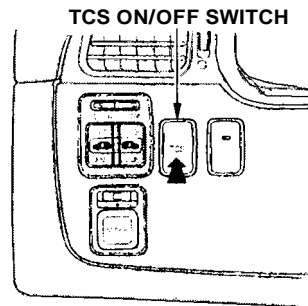

This switch is under the side vent. It lets you turn the Traction Control System on and off. You cannot turn off the TCS while the TCS indicator light is flashing.

Deactivate the system by pressing the TCS On/Off switch. The TCS indicator light comes on as a reminder. Pressing the switch again turns the system back on.

The Traction Control System turns on every time you start the engine, even if you turned it off the last time you drove the vehicle.

TCS Indicator

The TCS indicator comes on or flashes under the following conditions:

- When you turn the ignition switch to ON (II).
- When you manually turn off the TCS.
- It flashes when the TCS is regulating wheelspin.
- If the system's diagnostics senses a problem in the TCS, the indicator will come on and stay on.
- If the brakes overheat, the indicator will come on.

If the TCS indicator comes on and stays on for more than 10 minutes while driving, pull to the side of the road when it is safe and turn off the engine. Reset the system by restarting the engine, and watch the TCS indicator. If the indicator remains on, or comes back on while driving, have the system inspected by your Honda dealer. You can still drive the vehicle without TCS.

This indicator will come on along with the ABS indicator if there is a problem in the anti-lock brake system (see **ABS Indicator** on page [220](#)).

The TCS indicator may occasionally come on for one or two seconds and then go out. This is normal.

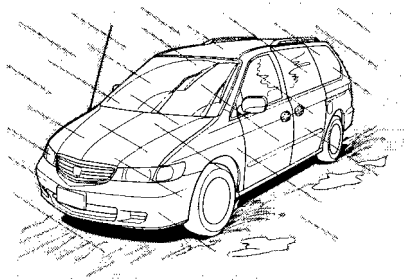

Rain, fog, and snow conditions require a different driving technique because of reduced traction and visibility. Keep your vehicle well-maintained and exercise greater caution when you need to drive in bad weather. The cruise control should not be used in these conditions.

Driving Technique — Always drive slower than you would in dry weather. It takes your vehicle longer to react, even in conditions that may seem just barely damp. Apply smooth, even pressure to all the controls. Abrupt steering wheel movements or sudden, hard application of the brakes can cause loss of control in wet weather. Be extra cautious for the first few miles (kilometers) of driving while you adjust to the change in driving conditions. This is especially true in snow. A person can forget some snow-driving techniques during the summer months. Practice is needed to relearn those skills.

Exercise extra caution when driving in rain after a long dry spell. After months of dry weather, the first rains bring oil to the surface of the roadway, making it slippery.

Visibility — Being able to see clearly in all directions and being visible to other drivers are important in all weather conditions. This is more difficult in bad weather. To be seen more clearly during daylight hours, turn on your headlights.

Inspect your windshield wipers and washers frequently. Keep the windshield washer reservoir full of the proper fluid. Have the windshield wiper blades replaced if they start to streak the windshield or leave parts unwiped. Use the defroster and air conditioning to keep the windows from fogging up on the inside (see pages [141](#) and [151/156](#)).

Traction — Check your tires frequently for wear and proper pressure. Both are important in preventing "hydroplaning" (loss of traction on a wet surface). In the winter, mount snow tires on all four wheels for the best handling.

Watch road conditions carefully, they can change from moment to moment. Wet leaves can be as slippery as ice. "Clear" roads can have patches of ice. Driving conditions can be very hazardous when the outside temperature is near freezing. The road surface can become covered with areas of water puddles mixed with areas of ice, so your traction can change without warning.

Be careful when downshifting. If traction is low, you can lock up the drive wheels for a moment and cause a skid.

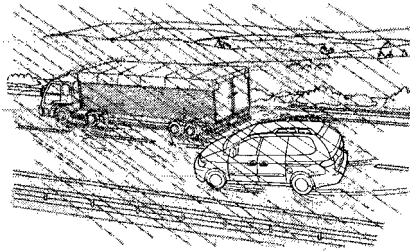

Be very cautious when passing, or being passed by other vehicles. The spray from large vehicles reduces your visibility, and the wind buffeting can cause you to lose control.

Towing a Trailer

Your Odyssey has been designed to tow a trailer, as well as for carrying passengers and their cargo.

To safely tow a trailer, you must observe the load limits, use the proper equipment, and follow the guidelines in this section.

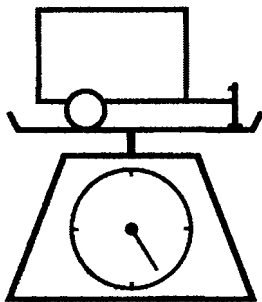

Load Limits

- **Total Trailer Weight:** As shown in the load limits table (See page [227](#)), how much weight you can tow is limited by the number of occupants in your vehicle and whether or not you have installed a transmission fluid cooler. (See page [229](#) for information about transmission fluid coolers.)

Towing a load that is too heavy can seriously affect your vehicle's handling and performance. It can also damage the engine and drivetrain.

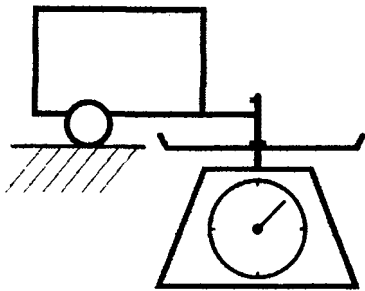

- Tongue Load:** The weight that the tongue of a fully-loaded trailer puts on the hitch should be approximately 10 percent of the trailer weight. Too little tongue load can make the trailer unstable and cause it to sway. Too much tongue load reduces front-tire traction and steering control.

Number of Occupants*	Maximum Total Trailer Weight	
	With Transmission Fluid Cooler	Without Transmission Fluid Cooler
2	3,500 lbs (1,580 kg)	2,000 lbs (900 kg)
3	3,350 lbs (1,520 kg)	1,850 lbs (830 kg)
4	3,200 lbs (1,450 kg)	1,700 lbs (770 kg)
5	3,050 lbs (1,380 kg)	1,550 lbs (700 kg)
6	2,900 lbs (1,310 kg)	1,400 lbs (630 kg)
7	850 lbs (385 kg)**	850 lbs (385 kg)**

* : Including driver. Based on 150 lbs (70 kg) per occupant.

** : Weight limited to avoid exceeding rear GAWR (see page 228).

To achieve a proper tongue load, start by loading 60 percent of the load toward the front of the trailer and 40 percent toward the rear, then re-adjust the load as needed.

CONTINUED

- **Gross Vehicle Weight Rating (GVWR):**

The total weight of the vehicle, all occupants, all cargo, *and* the tongue load must not exceed:
5,565 lbs (2,525 kg)

- **Gross Axle Weight Rating (GAWR):**

The total weight of the vehicle, all occupants, all cargo, and the tongue load must not exceed:

2,775 lbs (1,260 kg)
on the front axle

2,840 lbs (1,290 kg)
on the rear axle

- **Gross Combined Weight Rating (GCWR):**

The total weight of the vehicle, all occupants and cargo, and the trailer and everything in or on it, must not exceed:

8,160 lbs (3,700 kg)
with transmission fluid cooler

6,660 lbs (3,025 kg)
without transmission fluid cooler

Exceeding load limits or improperly loading your vehicle and trailer can cause a crash in which you can be seriously injured or killed.

Check the loading of your vehicle and trailer carefully before starting to drive.

Checking Loads

The best way to confirm that vehicle and trailer weights are within limits is to have them checked at a public scale.

Using a suitable scale or a special tongue load gauge, check the tongue load the first time you set up a towing combination (a fully-loaded vehicle and trailer), then recheck the tongue load whenever the conditions change.

Towing Equipment and Accessories

Towing can require a variety of equipment, depending on the size of your trailer, how it will be used, and how much load you are towing.

Discuss your needs with your trailer sales or rental agency, and follow the guidelines in the rest of this section. Also make sure that all equipment is properly installed and that it meets federal, state, province, and local regulations.

Hitches

Any hitch used on your vehicle must be properly bolted to the underbody, using the six threaded holes provided. A hitch designed especially for your Odyssey can be obtained from your Honda dealer.

Weight Distributing Hitch

If the total trailer weight is more than 2,000 lbs (900 kg), you must also use a weight distributing hitch. This device transfers weight from the vehicle's rear wheels to the front wheels, and to the trailer's wheels. Carefully follow the hitch maker's instructions for proper installation and adjustment.

Safety Chain

Always use a safety chain. Make sure that it is secured to both the trailer and hitch, and that it cross under the tongue so it can catch the trailer if it becomes unhitched. Leave enough slack to allow the trailer to turn corners easily, but do not let the chain drag on the ground.

Sway Control

If the total trailer weight exceeds 2,000 lbs (900 kg), you should install a sway control device to minimize swaying that can occur in crosswinds and in normal and emergency driving maneuvers. Your trailer maker can tell you what kind of sway control you need and how to install it.

Transmission Fluid Cooler

If the total trailer weight is more than 2,000 lbs (900 kg), you must also have a transmission fluid cooler installed. This device will help prevent transmission overheating, which could cause serious damage. A transmission fluid cooler designed for your Odyssey can be obtained from your Honda dealer.

CONTINUED

Towing a Trailer

Trailer Brakes

Honda recommends that any trailer having a total weight of 1,000 lbs (450 kg) or more be equipped with its own electric or surge-type brakes.

If you choose electric brakes, be sure they are electronically actuated. Do not attempt to tap into your vehicle's hydraulic system. No matter how successful it may seem, any attempt to attach trailer brakes to your vehicle's hydraulic system will lower braking effectiveness and create a potential hazard.

Trailer Lights

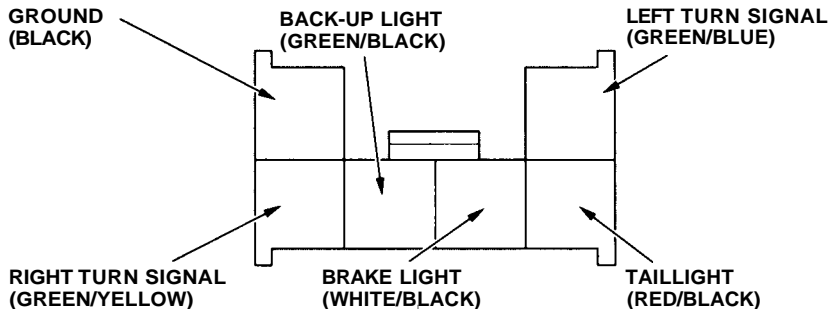

Your vehicle has a trailer lighting connector located behind the left side panel in the cargo area. Refer to the drawing above for the wiring color code and purpose of each pin.

To use the trailer lighting connector, you will need a wiring harness and converter. This comes with the Honda hitch (see page [229](#)), or it may be obtained separately from your dealer.

If you use a non-Honda trailer lighting harness and converter, you can get the connector and pins that mate with the connector in your vehicle from your Honda dealer.

Since lighting and wiring vary in trailer type and brand, you should also have a qualified mechanic install a suitable connector between the vehicle and the trailer.

Spare Vehicle Tire

When towing a trailer, you should carry a full-size wheel and tire as a spare in case you have a flat. If you use the compact spare tire that came with the vehicle, it may adversely affect vehicle handling. See page [323](#) for information on proper tire size, and page [309](#) for information on how to store a full-size tire. When storing a full-size spare tire in the trailer, follow the trailer maker's instructions.

Additional Trailer Equipment

Many states and Canadian provinces require special outside mirrors when towing a trailer. Even if they don't, you should install special mirrors if you cannot clearly see behind you, or if the trailer creates a blind spot.

Ask your trailer sales or rental agency if any other items are recommended or required for your towing situation.

Pre-Tow Checklist

When preparing to tow, and before driving away, be sure to check the following:

- The vehicle has been properly serviced, and the tires, brakes, suspension, and cooling system are in good operating condition.
- All weights and loads are within limits (see pages [227](#) and [228](#)).
- The hitch, safety chains, and any other attachments are secure.
- All items on and in the trailer are properly secured and cannot shift while you drive.
- The lights and brakes on your vehicle and the trailer are working properly.

- Your vehicle tires and spare are properly inflated (see page [335](#)), and the trailer tires and spare are inflated as recommended by the trailer maker.
- You may want to fill the fuel tank with premium fuel. Premium fuel provides improved performance.

CONTINUED

Driving Safely With a Trailer

The added weight, length, and height of a trailer will affect your vehicle's handling and performance, so driving with a trailer requires some special driving skills and techniques.

For your safety and the safety of others, take time to practice driving maneuvers before heading for the open road, and follow the guidelines discussed below.

Towing Speeds and Gears

Drive slower than normal in all driving situations, and obey posted speed limits for vehicles with trailers. Use the D₄ position when towing a trailer on level roads. D₃ is the proper shift lever position to use when towing a trailer in hilly terrain. (See "***Driving on Hills***" in the next column for additional gear information.)

Making Turns and Braking

Make turns more slowly and wider than normal. The trailer tracks a smaller arc than your vehicle, and it can hit or run over something the vehicle misses. Allow more time and distance for braking. Do not brake or turn suddenly as this could cause the trailer to jackknife or turn over.

Driving on Hills

When climbing hills, closely watch your temperature gauge. If it nears the red mark, turn the air conditioning off, reduce speed and, if necessary, pull to the side of the road to let the engine cool.

If the automatic transmission shifts frequently between 3rd and 4th gears while going up a hill, shift to D₃.

If you must stop when facing uphill, use the foot brake or parking brake. Do not try to hold the vehicle in place by pressing on the accelerator, as this can cause the automatic transmission to overheat.

When driving down hills, reduce your speed and shift down to 2nd gear. Do not "ride" the brakes, and remember it will take longer to slow down and stop when towing a trailer.

Handling Crosswinds and Buffeting

Crosswinds and air turbulence caused by passing trucks can disrupt your steering and cause trailer swaying. When being passed by a large vehicle, keep a constant speed and steer straight ahead. Do not try to make quick steering or braking corrections.

Backing Up

Always drive slowly and have someone guide you when backing up. Grip the *bottom* of the steering wheel; then turn the wheel to the left to get the trailer to move to the left, and turn the wheel right to move the trailer to the right.

Parking

Follow all normal precautions when parking, including putting the transmission in Park and firmly setting the parking brake. Also, place wheel chocks at each of the trailer's tires.

This section explains why it is important to keep your vehicle well maintained and to follow basic maintenance safety precautions.

This section also includes Maintenance Schedules for normal driving and severe driving conditions, a Maintenance Record, and instructions for simple maintenance tasks you may want to take care of yourself.

If you have the skills and tools to perform more complex maintenance tasks on your Honda, you may want to purchase the Service Manual. See page 351 for information on how to obtain a copy, or see your Honda dealer.

Maintenance Safety.....	236	Wiper Blades.....	269
Important Safety Precautions..	237	Air Conditioning System.....	271
Maintenance Schedule.....	238	Air Conditioning Filter.....	272
Required Maintenance Record....	245	Drive Belts.....	272
Owner Maintenance Checks.....	247	Timing Belt.....	273
Fluid Locations.....	248	Tires.....	273
Engine Oil.....	249	Inflation.....	273
Adding Oil.....	249	Inspection.....	275
Recommended Oil.....	249	Maintenance.....	276
Synthetic Oil.....	250	Tire Rotation.....	276
Additives.....	251	Replacing Tires and Wheels....	277
Changing the Oil and Filter.....	251	Wheels and Tires.....	278
Cooling System.....	253	Winter Driving.....	278
Adding Engine Coolant.....	253	Snow Tires.....	279
Replacing Engine Coolant.....	255	Tire Chains.....	279
Windshield Washers.....	258	Lights.....	280
Automatic Transmission Fluid....	259	Headlight Aiming.....	282
Brake Fluid.....	260	Replacing Bulbs.....	282
Brake System.....	260	Storing Your Vehicle.....	291
Power Steering.....	261		
Air Cleaner Element.....	262		
Hood Latch.....	264		
Spark Plugs.....	264		
Replacement.....	264		
Specifications.....	266		
Battery.....	267		

Regularly maintaining your vehicle is the best way to protect your investment. Proper maintenance is essential to your safety and the safety of your passengers. It will also reward you with more economical, trouble-free driving and help reduce air pollution.

Improperly maintaining this vehicle or failing to correct a problem before driving can cause a crash in which you can be seriously hurt or killed.

Always follow the inspection and maintenance recommendations and schedules in this owner's manual.

This section includes instructions for simple maintenance tasks, such as checking and adding oil. Any service items not detailed in this section should be performed by a Honda technician or other qualified mechanic.

Some of the most important safety precautions are given here. However, we cannot warn you of every conceivable hazard that can arise in performing maintenance. Only you can decide whether or not you should perform a given task.

Failure to properly follow maintenance instructions and precautions can cause you to be seriously hurt or killed.

Always follow the procedures and precautions in this owner's manual.

Important Safety Precautions

Before you begin any maintenance, make sure your vehicle is parked on level ground and that the parking brake is set. Also, be sure the engine is off. This will help to eliminate several potential hazards:

- **Carbon monoxide poisoning from engine exhaust.** Be sure there is adequate ventilation whenever you operate the engine.
- **Burns from hot parts.** Let the engine and exhaust system cool before touching any parts.
- **Injury from moving parts.** Do not run the engine unless instructed to do so.

Read the instructions before you begin, and make sure you have the tools and skills required.

To reduce the possibility of fire or explosion, be careful when working around gasoline or batteries. Use a commercially available degreaser or parts cleaner, not gasoline, to clean parts. Keep cigarettes, sparks, and flames away from the battery and all fuel-related parts.

You should wear eye protection and protective clothing when working near the battery or when using compressed air.

The Maintenance Schedule specifies how often you should have your vehicle serviced and what things need attention. It is essential that you have your vehicle serviced as scheduled to retain its high level of safety, dependability, and emissions control performance.

The services and time or distance intervals shown in the maintenance schedule assume you will use your vehicle as normal transportation for passengers and their possessions. You should also follow these recommendations:

- Avoid exceeding your vehicle's load limit. This puts excess stress on the engine, brakes, and many other parts of your vehicle. The load limit is shown on the tire information label on the driver's doorjamb.

- Operate your vehicle on reasonable roads within the legal speed limit.
- Drive your vehicle regularly over a distance of several miles (kilometers).
- Always use unleaded gasoline with the proper octane rating (see page [196](#)).

Which Schedule to Follow:

Service your vehicle according to the time and mileage periods on one of the Maintenance Schedules on the following pages. Select the schedule for "Severe Conditions" if most of your driving is done under one or more of the conditions listed on that page. Otherwise, follow the schedule for "Normal Conditions."

Your authorized Honda dealer knows your vehicle best and can provide competent, efficient service. However, service at a dealer is not mandatory to keep your warranties in effect. Maintenance may be done by any qualified service facility or person who is skilled in this type of automotive service. Keep all the receipts as proof of completion, and have the person who does the work fill out the Maintenance Record. Check your warranty booklet for more information.

We recommend the use of genuine Honda parts and fluids whenever you have maintenance done. These are manufactured to the same high-quality standards as the original components, so you can be confident of their performance and durability.

U.S. Vehicles:

Maintenance, replacement or repair of emissions control devices and systems may be done by any automotive repair establishment or individual using parts that are "certified" to EPA standards.

According to state and federal regulations, failure to perform maintenance on the items marked with # will not void your emissions warranties. However, Honda recommends that all maintenance services be performed at the recommended time or mileage period to ensure long-term reliability.

Service at the indicated distance or time — whichever comes first.	miles x 1,000	15	30	45	60	75	90	105	120	
	km x 1,000	24	48	72	96	120	144	168	192	
	months	12	24	36	48	60	72	84	96	
Replace engine oil	Replace every 7,500 miles (12,000 km) or 12 months									
Replace engine oil filter	●	●	●	●	●	●	●	●	●	
Check engine oil and coolant	Check oil and coolant at each fuel stop									
Replace air cleaner element		●		●		●		●	●	
Inspect valve clearance	Adjust only if noisy							●		
Replace spark plugs								●		
Replace timing belt [†] , and inspect water pump								●		
Inspect and adjust drive belts		●		●		●		●	●	
Inspect idle speed [†]								●		
Replace engine coolant	120,000 miles (192,000 km) or 120 months, thereafter every 60,000 miles (96,000 km) or 60 months									
Replace transmission fluid			●		●		●		●	
Inspect front and rear brakes	●	●	●	●	●	●	●	●	●	
Replace brake fluid	Every 36 months									
Check parking brake adjustment	●	●	●	●	●	●	●	●	●	
Replace air conditioning filter		●		●		●		●	●	
Rotate tires (Check tire inflation and condition at least once per month)	Rotate tires every 7,500 miles (12,000 km)									
Visually inspect the following items:										
Tie rod ends, steering gear box, and boots										
Suspension components										
Driveshaft boots										
Brake hoses and lines (including ABS)	●	●	●	●	●	●	●	●	●	
All fluid levels and condition of fluids										
Cooling system hoses and connections										
Exhaust system [†]										
Fuel lines and connections [†]										

: See information on maintenance and emissions warranty, last column, page 239.

U.S. Owners

Follow the Normal Conditions Maintenance Schedule if the severe driving conditions specified in the Severe Conditions Maintenance Schedule do not apply.

NOTE: If you only *OCCASIONALLY* drive under a "severe" condition, you should follow the Normal Conditions Maintenance Schedule.

Canadian Owners

Follow the Maintenance Schedule for Severe Conditions.

Service at the indicated distance or time, whichever comes first. Do the items in **A, B, C** as required for each distance/time interval. Follow this schedule if the severe driving conditions described in the Severe Conditions Schedule on the next page do not apply.

Canadian owners: Follow the schedule for Severe Conditions.

7,500 mi/12,000 km/-	Do items in A.
15,000 mi/24,000 km/1 yr	Do items in A, B.
22,500 mi/36,000 km/-	Do items in A.
30,000 mi/48,000 km/2 yrs	Do items in A, B, C.
37,500 mi/60,000 km/-	Do items in A.
45,000 mi/72,000 km/3 yrs	<input type="checkbox"/> Replace transmission fluid. Do items in A, B, D.
52,500 mi/84,000 km/-	Do items in A.
60,000 mi/96,000 km/4 yrs	Do items in A, B, C.
67,500 mi/108,000 km/-	Do items in A.
75,000 mi/120,000 km/5 yrs	<input type="checkbox"/> Replace transmission fluid. Do items in A, B.
82,500 mi/132,000 km/-	Do items in A.
90,000 mi/144,000 km/6 yrs	Do items in A, B, C, D.
97,500 mi/156,000 km/-	Do items in A.
105,000 mi/168,000 km/7 yrs	<input type="checkbox"/> Replace timing belt [‡] , and inspect water pump. <input type="checkbox"/> Replace transmission fluid. <input type="checkbox"/> Inspect idle speed [‡] . <input type="checkbox"/> Inspect valve clearance. <input type="checkbox"/> Replace spark plugs. Do items in A, B.
112,500 mi/180,000 km/-	Do items in A.
120,000 mi/192,000 km/8 yrs	Do items in A, B, C.
120,000 mi/192,000 km/10 yrs thereafter every 60,000 mi/96,000 km/5 yrs	<input type="checkbox"/> Replace engine coolant

NOTE:

- Check engine oil and coolant at each fuel stop.
- Check and adjust valve clearance, cold engine, only if noisy.

A	<input type="checkbox"/> Replace engine oil. <input type="checkbox"/> Rotate tires (follow pattern on page 276).
B	<input type="checkbox"/> Replace engine oil filter. <input type="checkbox"/> Inspect front and rear brakes. <input type="checkbox"/> Check parking brake adjustment. <input type="checkbox"/> Inspect tie rod ends, steering gearbox and boots. <input type="checkbox"/> Inspect suspension components. <input type="checkbox"/> Inspect driveshaft boots. <input type="checkbox"/> Inspect brake hoses and lines (including ABS). <input type="checkbox"/> Check all fluid levels, condition of fluids, and check for leaks. <input type="checkbox"/> Inspect cooling system hoses and connections. <input type="checkbox"/> Inspect exhaust system [‡] . <input type="checkbox"/> Inspect fuel lines and connections [‡] .
C	<input type="checkbox"/> Replace air cleaner element. <input type="checkbox"/> Inspect and adjust drive belts. <input type="checkbox"/> Replace air conditioning filter.
D	<input type="checkbox"/> Replace brake fluid every 3 years (independent of mileage).

#: See information on maintenance and emissions warranty, fast column, page 239.

Service as indicated distance or time – whichever comes first.	miles x 1,000	15	30	45	60	75	90	105	120
	km x 1,000	24	48	72	96	120	144	168	192
	months	12	24	36	48	60	72	84	96
Replace engine oil and oil filter	Replace every 3,750 miles (6,000 km) or 6 months								
Check engine oil and coolant	Check oil and coolant at each fuel stop								
Clean (○) or replace (●) air cleaner element – Use normal schedule except in dusty conditions	○	●	○	●	○	●	○	●	○
Inspect valve clearance	Adjust only if noisy								●
Replace spark plugs									●
Replace timing belt* ¹ and inspect water pump									●
Inspect and adjust drive belts	●			●			●		●
Inspect idle speed ²									●
Replace engine coolant	120,000 miles (192,000 km) or 120 months, thereafter every 60,000 miles (96,000 km) or 60 months								
Replace transmission fluid	●			●			●		●
Inspect front and rear brakes	Inspect every 7,500 miles (12,000 km) or 6 months								
Replace brake fluid	Every 36 months								
Check parking brake adjustment	●	●	●	●	●	●	●	●	●
Replace air conditioning filter* ²		●		●		●		●	●
Lubricate all hinges, locks and latches	●	●	●	●	●	●	●	●	●
Rotate tires (Check tire inflation and condition at least once per month)	Rotate tires every 7,500 miles (12,000 km)								
Visually inspect the following items:									
Tie rod ends, steering gear box, and boots Suspension components Driveshaft boots	Every 7,500 miles (12,000 km) or 6 months								
Brake hoses and lines (including ABS) All fluid levels and conditions of fluids Cooling system hoses and connections Exhaust system ² Fuel lines and connections ² Lights and controls Vehicle underbody	●	●	●	●	●	●	●	●	●

U.S. Owners

Follow the Severe Conditions Maintenance Schedule if you drive your vehicle *MAINLY* under one or more of the following conditions:

- Driving less than 5 miles (8 km) per trip or, in freezing temperatures, driving less than 10 miles (16 km) per trip.
- Driving in extremely hot [over 90° F (32° C)] conditions.
- Extensive idling or long periods of stop-and-go driving.
- Trailer towing, driving with a roof top carrier, or driving in mountainous conditions.
- Driving on muddy, dusty, or de-iced roads.

* 1: Refer to page 273 for replacement information under special driving conditions.

* 2: Refer to page 272 for replacement information under special driving conditions.

: See page 239.

Canadian Owners

Follow the Maintenance Schedule for Severe Conditions.

Use this schedule if your vehicle is MAINLY driven in the following Severe Conditions, or normally driven in Canada; otherwise use the Normal Schedule. Service at the indicated distance or time, whichever comes first. Do the items in **A, B, C, D** as required for each distance/time.

Severe Conditions:

- Driving less than 5 miles (8 km) per trip or, in freezing temperatures, driving less than 10 miles (16 km) per trip.
- Driving in extremely hot (over 90°F/32°C) conditions.
- Extensive idling or long periods of stop-and-go driving.
- Trailer towing, driving with a roof rack, or driving in mountainous conditions.
- Driving on muddy, dusty, or de-iced roads.

3,750 mi/6,000 km/-	Do items in A.
7,500 mi/12,000 km/6 mos	Do items in A, B.
11,250 mi/18,000 km/-	Do items in A.
15,000 mi/24,000 km/1 yr	<input type="checkbox"/> Clean air cleaner element. Do items in A, B, C.
18,750 mi/30,000 km/-	Do items in A.
22,500 mi/36,000 km/1½ yrs	Do items in A, B.
26,250 mi/42,000 km/-	Do items in A.
30,000 mi/48,000 km/2 yrs	Do items in A, B, C, D.
33,750 mi/54,000 km/-	Do items in A.
37,500 mi/60,000 km/2½ yrs	Do items in A, B.
41,250 mi/66,000 km/-	Do items in A.
45,000 mi/72,000 km/3 yrs	<input type="checkbox"/> Clean air cleaner element. Do items in A, B, C, E.
48,750 mi/78,000 km/-	Do items in A.
52,500 mi/84,000 km/3½ yrs	Do items in A, B.

A	<input type="checkbox"/> Replace engine oil and filter.
B	<input type="checkbox"/> Inspect front and rear brakes.
	<input type="checkbox"/> Rotate tires (follow pattern on page 276).
	<input type="checkbox"/> Inspect tie rod ends, steering gearbox and boots.
	<input type="checkbox"/> Inspect suspension components.
C	<input type="checkbox"/> Inspect driveshaft boots.
	<input type="checkbox"/> Check parking brake adjustment.
	<input type="checkbox"/> Lubricate all hinges, locks and latches, with multipurpose grease.
	<input type="checkbox"/> Inspect brake hoses and lines (including ABS).
	<input type="checkbox"/> Check all fluid levels, condition of fluids, and check for leaks.
	<input type="checkbox"/> Inspect cooling system hoses and connections.
	<input type="checkbox"/> Inspect exhaust system [†] .
	<input type="checkbox"/> Inspect fuel lines and connections [†] .
<input type="checkbox"/> Check all lights.	
<input type="checkbox"/> Inspect the underbody.	

56,250 mi/90,000 km/-	Do items in A.
60,000 mi/96,000 km/4 yrs	<input type="checkbox"/> Replace timing belt* ^{1,2} . Do items in A, B, C, D.
63,750 mi/102,000 km/-	Do items in A.
67,500 mi/108,000 km/4½ yrs	Do items in A, B.
71,250 mi/114,000 km/-	Do items in A.
75,000 mi/120,000 km/5 yrs	<input type="checkbox"/> Clean air cleaner element. Do items in A, B, C.
78,750 mi/126,000 km/-	Do items in A.
82,500 mi/132,000 km/5½ yrs	Do items in A, B.
86,250 mi/138,000 km/-	Do items in A.
90,000 mi/144,000 km/6 yrs	Do items in A, B, C, D, E.
93,750 mi/150,000 km/-	Do items in A.
97,500 mi/156,000 km/6½ yrs	Do items in A, B.
101,250 mi/162,000 km/-	Do items in A.
105,000 mi/168,000 km/7 yrs	<input type="checkbox"/> Replace timing belt* ^{1,2} , and inspect water pump. <input type="checkbox"/> Inspect valve clearance. <input type="checkbox"/> Clean air cleaner element. <input type="checkbox"/> Replace spark plugs. <input type="checkbox"/> Inspect idle speed ² . Do items in A, B, C.
108,750 mi/174,000 km/-	Do items in A.
112,500 mi/180,000 km/7½ yrs	Do items in A, B.
116,250 mi/186,000 km/-	Do items in A.
120,000 mi/192,000 km/8 yrs	<input type="checkbox"/> Replace timing belt* ^{1,2} . Do items in A, B, C, D.
120,000 mi/192,000 km/10 yrs thereafter every 60,000 mi/ 96,000 km/5 yrs	<input type="checkbox"/> Replace engine coolant

D	<input type="checkbox"/> Replace air cleaner element. <input type="checkbox"/> Inspect and adjust drive belts. <input type="checkbox"/> Replace transmission fluid. <input type="checkbox"/> Replace air conditioning filter.* ²
E	<input type="checkbox"/> Replace brake fluid every 3 years (independent of mileage).

: See information on maintenance and emissions warranty, last column, page 239.

* 1: See timing belt on page 273 to determine need for replacement.

* 2: See air conditioning filter on page 272 for replacement information under special driving conditions.

NOTE:

- Check engine oil and coolant at each fuel stop.
- Check and adjust valve clearance, cold engine, only if noisy.

Required Maintenance Record (for Normal and Severe Schedules)

You or the servicing dealer can record all completed maintenance here, whether you follow the schedule for normal conditions (page 240) or severe conditions (page 242). Keep the receipts for all work done on your vehicle.

3,750 mi 6,000 km	Signature or dealer stamp	mi/km
		Date
7,500 mi 12,000 km (or 6 mo)		mi/km
		Date
11,250 mi 18,000 km		mi/km
		Date
15,000 mi 24,000 km (or 1 year)		mi/km
		Date
18,750 mi 30,000 km		mi/km
		Date
22,500 mi 36,000 km (or 1½ years)		mi/km
		Date
26,250 mi 42,000 km		mi/km
		Date
30,000 mi 48,000 km (or 2 years)		mi/km
		Date

33,750 mi 54,000 km	Signature or dealer stamp	mi/km
		Date
37,500 mi 60,000 km (or 2½ years)		mi/km
		Date
41,250 mi 66,000 km		mi/km
		Date
45,000 mi 72,000 km (or 3 years)		mi/km
		Date
48,750 mi 78,000 km		mi/km
		Date
52,500 mi 84,000 km (or 3½ years)		mi/km
		Date
56,250 mi 90,000 km		mi/km
		Date
60,000 mi 96,000 km (or 4 years)		mi/km
		Date

Required Maintenance Record (for Normal and Severe Schedules)

63,750 mi 102,000 km	Signature or dealer stamp	mi/km
		Date
67,500 mi 108,000 km (or 4½ years)		mi/km
		Date
71,250 mi 114,000 km		mi/km
		Date
75,000 mi 120,000 km (or 5 years)		mi/km
		Date
78,750 mi 126,000 km		mi/km
		Date
82,500 mi 132,000 km (or 5½ years)		mi/km
		Date
86,250 mi 138,000 km		mi/km
		Date
90,000 mi 144,000 km (or 6 years)		mi/km
		Date

93,750 mi 150,000 km	Signature or dealer stamp	mi/km
		Date
97,500 mi 156,000 km (or 6½ years)		mi/km
		Date
101,250 mi 162,000 km		mi/km
		Date
105,000 mi 168,000 km (or 7 years)		mi/km
		Date
108,750 mi 174,000 km		mi/km
		Date
112,500 mi 180,000 km (or 7½ years)		mi/km
		Date
116,250 mi 186,000 km		mi/km
		Date
120,000 mi 192,000 km (or 8 years)		mi/km
		Date

You should check the following items at the specified intervals. If you are unsure of how to perform any check, turn to the page given.

- Engine oil level — Check every time you fill the fuel tank. See page [200](#).
- Engine coolant level — Check the radiator reserve tank every time you fill the fuel tank. See page [201](#).
- Windshield washer fluid — Check the level in the reservoir monthly. If weather conditions cause you to use the washers frequently, check the reservoir each time you stop for fuel. See page [258](#).
- Automatic transmission — Check the fluid level monthly. See page [259](#).
- Brakes — Check the fluid level monthly. See page [260](#).
- Tires — Check the tire pressure monthly. Examine the tread for wear and foreign objects. See page [273](#).
- Lights — Check the operation of the headlights, parking lights, taillights, high-mount brake light, turn signals, brake lights, and license plate light monthly. See page [280](#).

Fluid Locations

ENGINE OIL DIPSTICK
(Orange loop)

BRAKE FLUID
(Gray cap)

WASHER FLUID
(Blue cap)

COOLANT
RESERVOIR

POWER STEERING
FLUID (Red cap)

RADIATOR CAP

ENGINE OIL FILL CAP

AUTOMATIC
TRANSMISSION
FLUID DIPSTICK
(Yellow loop)

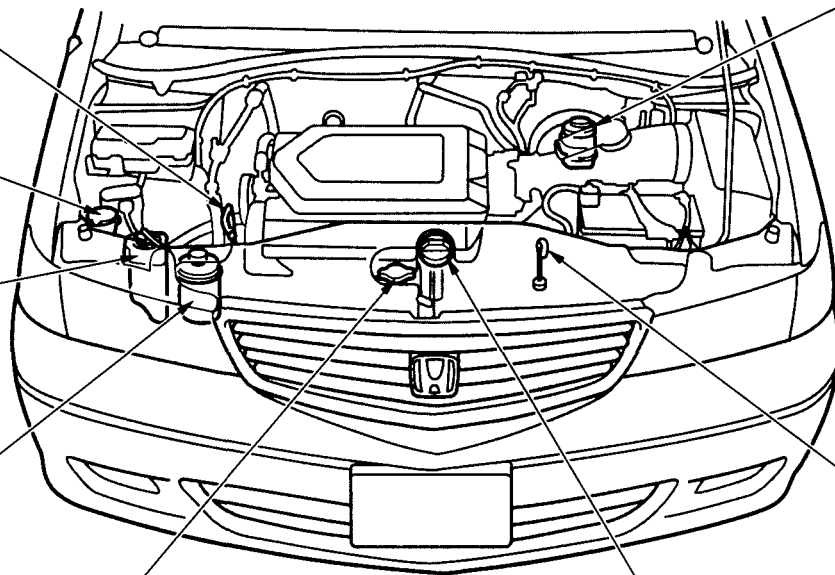

Adding Oil

ENGINE OIL FILL CAP

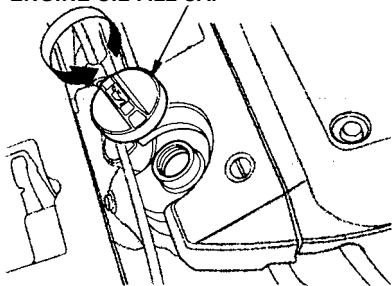

To add oil, unscrew and remove the engine oil fill cap on top of the valve cover. Pour in the oil, and install the engine oil fill cap. Tighten it securely. Wait a few minutes and recheck the oil level. Do not fill above the upper mark; you could damage the engine.

Recommended Oil

Oil is a major contributor to your engine's performance and longevity. Always use a premium-grade detergent oil displaying the API Certification Seal. This seal indicates the oil is energy conserving, and that it meets the American Petroleum Institute's latest requirements. It is highly recommended that you use Honda Motor Oil in your vehicle for as long as you own it.

Make sure the API Certification Seal says "For Gasoline Engines."



API CERTIFICATION SEAL

CONTINUED

Engine Oil

The numbers on the container's label tell you the oil's viscosity or weight. Select the oil for your vehicle according to this chart.

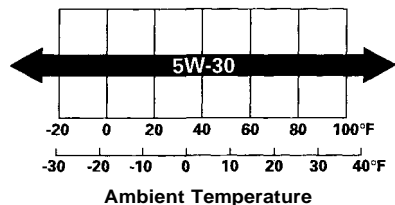

An oil with a viscosity of 5W-30 is preferred for improved fuel economy and year-round protection of your Honda.

Synthetic Oil

You may use a synthetic motor oil if it meets the same requirements given for conventional motor oil: it displays the API Certification Seal, and it is the proper weight as shown on the chart. When using synthetic oil, you must follow the oil and filter change intervals given in the maintenance schedule.

Additives

Your Honda does not require any oil additives. Additives may adversely affect your engine's or transmission's performance and durability.

Changing the Oil and Filter

Always change the oil and filter according to the time and distance (miles/kilometers) recommendations in the maintenance schedule. The oil and filter collect contaminants that can damage your engine if they are not removed regularly.

Changing the oil and filter requires special tools and access from underneath the vehicle. The vehicle should be raised on a service station-type hydraulic lift for this service. Unless you have the knowledge and proper equipment, you should have this maintenance done by a skilled mechanic.

1. Run the engine until it reaches normal operating temperature, then shut it off.

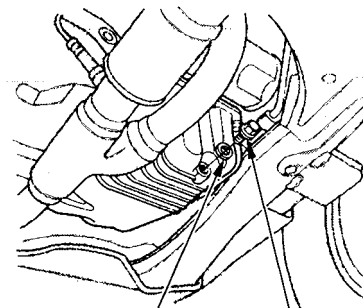

WASHER DRAIN BOLT

2. Open the hood and remove the engine oil fill cap. Remove the oil drain bolt and washer from the bottom of the engine. Drain the oil into an appropriate container.

CONTINUED

OIL FILTER

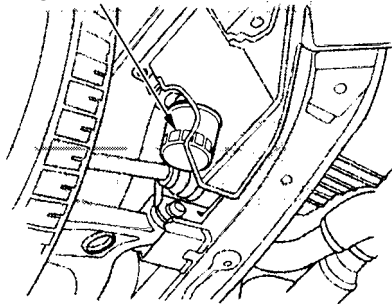

3. Remove the oil filter and let the remaining oil drain. A special wrench (available from your Honda dealer) is required to remove the filter.
4. Install a new oil filter according to instructions that come with it.
5. Put a new washer on the drain bolt, then reinstall the drain bolt.
Tighten it to:
29 lbf.ft (39N.m, 4.0 kgf.m)

6. Refill the engine with the recommended oil.
Engine oil change capacity (including filter):
4.6 US qt (4.4ℓ , 3.9 Imp qt)
7. Replace the engine oil-fill cap.
Start the engine. The oil pressure indicator light should go out within five seconds. If it does not, turn off the engine and reinspect your work.
8. Let the engine run for several minutes and check the drain bolt and oil filter for leaks.
9. Turn off the engine, let it sit for several minutes, then check the oil level. If necessary, add oil to bring the level to the upper mark on the dipstick.

NOTICE

Improper disposal of engine oil can be harmful to the environment. If you change your own oil, please dispose of the used oil properly. Put it in a sealed container and take it to a recycling center. Do not discard it in a trash bin or dump it on the ground.

Adding Engine Coolant

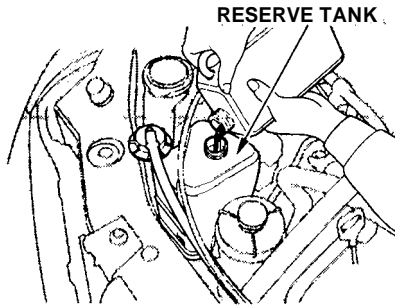

If the coolant level in the reserve tank is at or below the MIN line, add coolant to bring it up to the MAX line. Inspect the cooling system for leaks. This coolant should always be a mixture of 50 percent antifreeze and 50 percent water. Never add straight antifreeze or plain water.

Always use Honda All Season Antifreeze/Coolant Type 2. This coolant is pre-mixed with 50 percent antifreeze and 50 percent water. It does not require any additional mixing.

If it is not available, you may use another major-brand non-silicate coolant as a temporary replacement. Make sure it is a high-quality coolant recommended for aluminum engines. However, continued use of any non-Honda coolant can result in corrosion, causing the cooling system to malfunction or fail. Have the cooling system flushed and refilled with Honda antifreeze/coolant as soon as possible.

If the reserve tank is completely empty, you should also check the coolant level in the radiator.

Removing the radiator cap while the engine is hot can cause the coolant to spray out, seriously scalding you.

Always let the engine and radiator cool down before removing the radiator cap.

CONTINUED

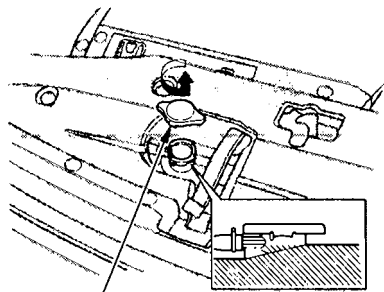

RADIATOR CAP

1. Make sure the engine and radiator are cool.
2. Turn the radiator cap counter-clockwise, without pressing down on it, until it stops. This relieves any pressure remaining in the cooling system.
3. Remove the radiator cap by pushing down and turning counterclockwise.

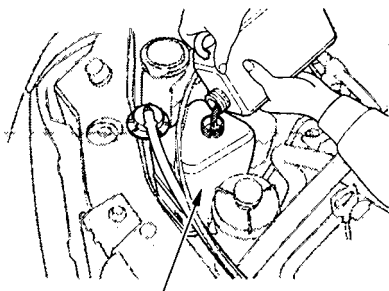

RESERVE TANK

4. The coolant level should be up to the base of the filler neck. Add coolant if it is low.
5. Put the radiator cap back on. Tighten it fully.
6. Pour coolant into the reserve tank. Fill it to halfway between the MAX and MIN marks. Put the cap back on the reserve tank.

Do not add any rust inhibitors or other additives to your vehicle's cooling system. They may not be compatible with the coolant or engine components.

Replacing Engine Coolant

The cooling system should be completely drained and refilled with new coolant according to the time and distance recommendations in the maintenance schedule. Only use Honda All Season Antifreeze/Coolant Type 2.

This coolant is a mixture of 50 percent anti-freeze and 50 percent water. Premixing is not required.

Draining the coolant requires access to the underside of the vehicle. Unless you have the tools and knowledge, you should have this maintenance done by a skilled mechanic.

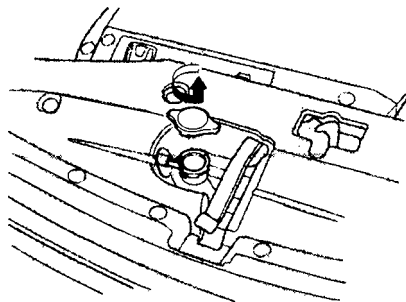

1. Turn the ignition ON (II). Turn the heater temperature control dial fully clockwise. Turn the ignition off. Open the hood. Make sure the engine and radiator are cool to the touch.
2. Remove the radiator cap.

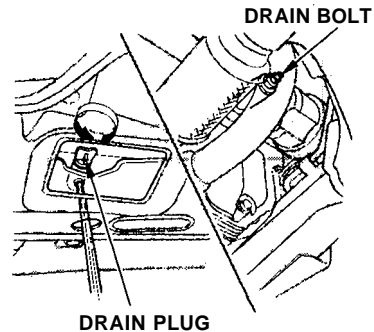

3. Loosen the drain plug on the bottom of the radiator. The coolant will drain through the splash guard. Loosen the drain bolt.

CONTINUED

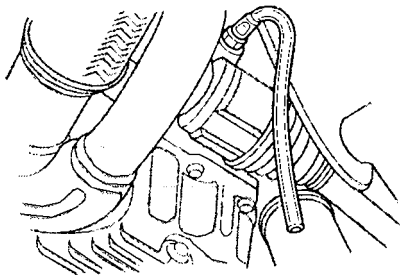

4. Install a rubber hose on the drain bolt in the back of the engine block. Loosen the drain bolt.

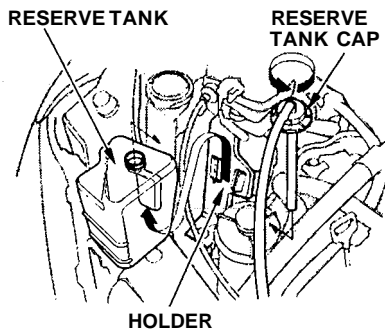

5. Remove the reserve tank from its holder by pulling it straight up. Drain the coolant, then put the tank back in its holder.

6. When the coolant stops draining, tighten the drain plug at the bottom of the radiator.
7. Tighten the drain bolt at the rear of the engine cylinder block securely.
Tightening torque:
7 lbf.ft (10 N.m, 1.0 kgf.m)

FILLER NECK

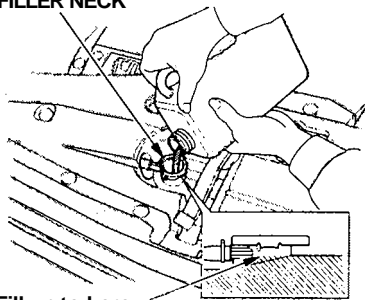

Fill up to here

3. Pour Honda All Season Antifreeze/Coolant Type 2 into the radiator up to the base of the filler neck. This coolant is a mixture of 50 percent antifreeze and 50 percent water. Pre-mixing is not required.
The cooling system capacity is:
1.98 US gal (7.5ℓ , 1.65 Imp gal)

9. Fill the reserve tank to the MAX mark. Install the reserve tank cap.
10. Install the radiator cap, and tighten it to the first stop.
11. Start the engine and let it run until the radiator cooling fan comes on at least twice. Then stop the engine.
12. Remove the radiator cap. Fill the radiator with coolant up to the base of the filler neck.
13. Install the radiator cap, and tighten it fully.

Windshield Washers

Check the level in the windshield washer reservoir at least monthly during normal usage. In bad weather, when you use the washers often, check the level every time you stop for fuel. This reservoir supplies the windshield and rear window washers.

The windshield washer reservoir is located behind the passenger's side headlight.

Check the reservoir's fluid level by removing the cap and looking at the level gauge attached to the cap.

On Canadian models

The low washer level indicator will light when the level is low (see page 65).

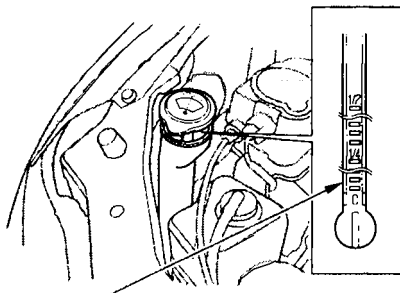

LEVEL GAUGE

Fill the reservoir with a good-quality windshield washer fluid. This increases the cleaning capability and prevents freezing in cold weather.

When you refill the reservoir, clean the edges of the windshield wiper blades with windshield washer fluid on a clean cloth. This will help to condition the blade edges.

NOTICE

Do not use engine antifreeze or a vinegar/water solution in the windshield washer reservoir.

Antifreeze can damage your vehicle's paint, while a vinegar/water solution can damage the windshield washer pump.

Use only commercially-available windshield washer fluid.

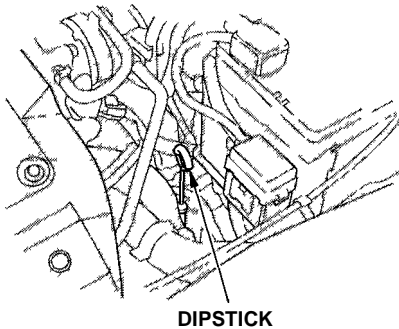

Check the fluid level with the engine at normal operating temperature.

1. Park the vehicle on level ground. Shut off the engine.
2. Remove the dipstick (yellow loop) from the transmission and wipe it with a clean cloth.
3. Insert the dipstick all the way into the transmission.

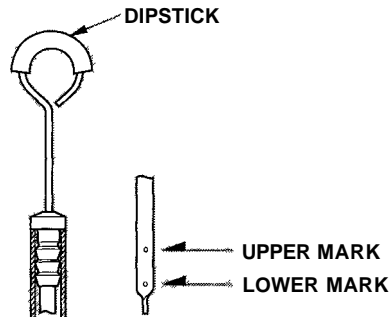

4. Remove the dipstick and check the fluid level. It should be between the upper and lower marks.
5. If the level is below the lower mark, remove the fill plug and add fluid to bring it to the upper mark. Always use Honda ATF-Z1 (Automatic Transmission Fluid). If it is not available, you may use a DEXRON[®] III automatic transmission fluid as a temporary

replacement. However, continued use can affect shift quality. Have the transmission drained and refilled with Honda ATF-Z1 as soon as it is convenient.

6. Insert the dipstick all the way back in the transmission.

The transmission should be drained and refilled with new fluid according to the time and distance recommendations in the maintenance schedule.

If you are not sure how to add fluid, contact your Honda dealer.

To thoroughly flush the transmission, the technician should drain and refill it with Honda ATF-Z1 (Automatic Transmission Fluid), then drive the vehicle a short distance. Do this three times. Then drain and refill the transmission a final time.

Brake Fluid

Check the fluid level in the brake fluid reservoir monthly.

The brake fluid should be replaced according to the time and distance recommendations in the maintenance schedule.

Always use Honda Heavy Duty Brake Fluid DOT 3. If it is not available, you should use only DOT 3 or DOT 4 fluid, from a sealed container, as a temporary replacement. However, the use of any non-Honda brake fluid can cause corrosion and decrease the life of the system. Have the brake system flushed and refilled with Honda Heavy Duty Brake Fluid DOT 3 as soon as possible.

Brake fluid marked DOT 5 is not compatible with your vehicle's braking system and can cause extensive damage.

Brake System

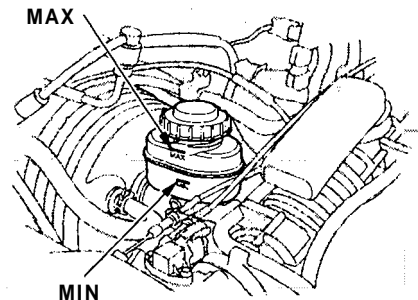

The fluid level should be between the MIN and MAX marks on the side of the reservoir. If the level is at or below the MIN mark, your brake system needs attention. Have the brake system inspected for leaks or worn brake pads.

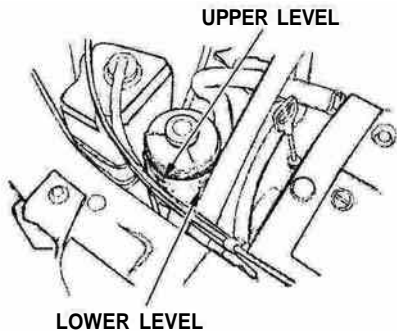

Check the level when the engine is cold. Look at the side of the reservoir. The fluid should be between the UPPER LEVEL and LOWER LEVEL. If it is below the LOWER LEVEL, add power steering fluid to the UPPER LEVEL.

Always use Honda Power Steering Fluid. If it is not available, you may use another power steering fluid as an emergency replacement. However, continued use can cause increased wear and poor steering in cold weather. Have the power steering system flushed and refilled with Honda PSF as soon as possible.

A low power steering fluid level can indicate a leak in the system. Check the fluid level frequently and have the system inspected as soon as possible.

NOTICE

Turning the steering wheel to full left or right lock and holding it there can damage the power steering pump.

Air Cleaner Element

The air cleaner element should be cleaned or replaced according to the time and distance recommendations in the maintenance schedule.

Cleaning (Severe Conditions)

Clean the air cleaner element by blowing compressed air through it in the opposite direction to normal air flow. If you do not have access to compressed air (such as a service station), ask your Honda dealer to do this service.

Follow the replacement procedure for removal and reinstallation.

Replacement

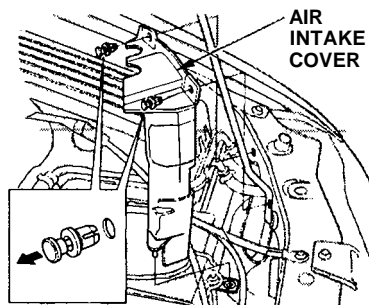

The air cleaner element is inside the air cleaner housing on the driver's side of the engine compartment. To replace it:

1. Remove the two pins holding the air intake cover by pulling the head on each pin. Remove the air intake cover.

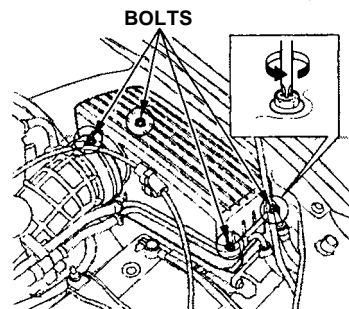

2. Loosen the four bolts by using a Phillips-head screwdriver.

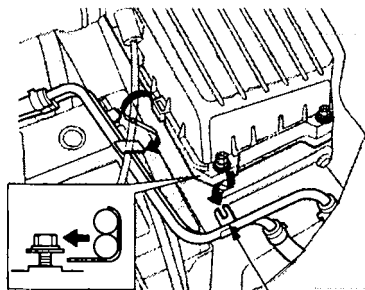

CLIP

3. Disconnect the clip from the bolt on the air cleaner housing, then remove the air cleaner housing cover.
4. Remove the old air cleaner element.
5. Carefully clean the inside of the air cleaner housing with a damp rag.

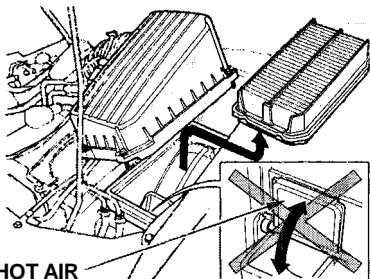

HOT AIR VALVE

The coolant lines inside the air cleaner housing may be warm.

Do not open the hot air valve when cleaning the inside of the air cleaner housing.

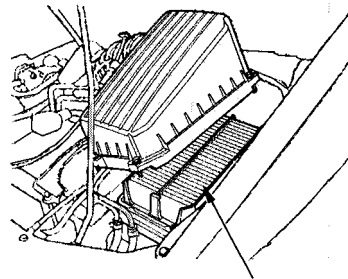

AIR CLEANER ELEMENT

6. Place the new air cleaner element in the air cleaner housing.
7. Reinstall the air cleaner housing cover. Reinstall the clip on the bolt; make sure the clip is under the washer. Tighten the four bolts.
8. Reinstall the air intake cover. Reinstall the two pins and secure them by pushing on the heads until they lock.

Hood Latch

LATCH ASSEMBLY

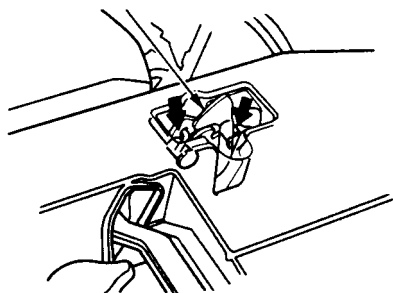

Clean the hood latch assembly with a mild cleaner, then lubricate it with a multipurpose grease. Lubricate all the moving parts (pointed by arrows), including the pivot. Follow the time and distance recommendations in the Maintenance Schedule. If you are not sure how to clean and grease the latch, contact your Honda dealer.

Spark Plugs

The spark plugs in your vehicle are a special platinum-tipped design for longer life. The spark plugs should be replaced according to the time and distance recommendations in the maintenance schedule.

Replacement

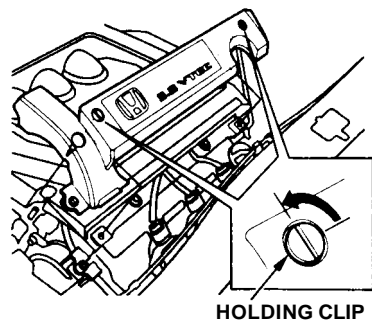

1. Loosen the two holding clips by turning the heads one-quarter turn counterclockwise with a flat-tipped screwdriver. Remove the cover on the front cylinder bank by pulling it straight up.
2. Clean up any dirt and oil that have collected around the ignition coils.

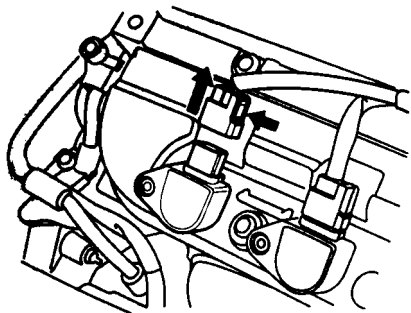

3. Disconnect the wire connector from the ignition coil by pushing on the lock tab and pulling on the connector. Pull on the plastic connector, not the wires.

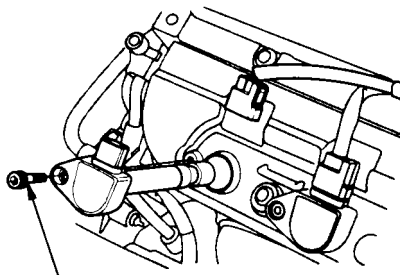

HEXAGON SOCKET HEAD CAP BOLT

4. Use a wrench to remove the hexagon socket head cap bolt holding the ignition coil. Remove the ignition coil by pulling it straight out.
5. Remove the spark plug with a five-eighths inch (16 mm) spark plug socket.

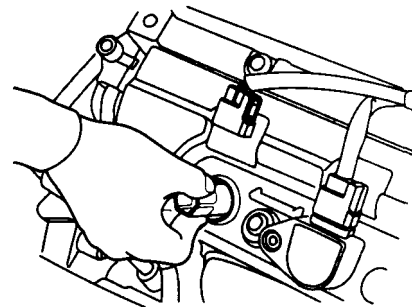

6. Put the new spark plug into the socket; then screw it into the hole. Screw it in by hand so you do not crossthead it.

CONTINUED

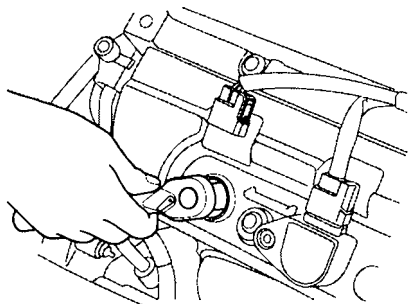

7. Torque the spark plug. (If you do not have a torque wrench, tighten the spark plug two-thirds of a turn after it contacts the cylinder head.)
Tightening torque:
13 lbf.ft (18 N.m , 1.8 kgf.m)

NOTICE

Tighten the spark plugs carefully. A spark plug that is too loose can overheat and damage the engine. Overtightening can cause damage to the threads in the cylinder head.

8. Install the ignition coil. Reinstall the hexagon socket head cap bolt.
9. Push the wire connector onto the ignition coil. Make sure it locks in place.
10. Repeat this procedure for the other five spark plugs.
11. Reinstall the cover on the front cylinder bank while putting its mounting clip in the hole on the passenger's side. Secure the cover by turning the heads of the two holding clips one-quarter turn clockwise with a flat-tipped screwdriver.

Specifications:

NGK: PZFR5F-11
DENSO: PKJ16CR-L11

Spark Plug Gap:
0.04 in (1.1 mm) $^{+0}_{-0.1\text{mm}}$

Check the condition of your vehicle's battery monthly. You should check the color of the test indicator window, and for corrosion on the terminals.

TEST INDICATOR WINDOW

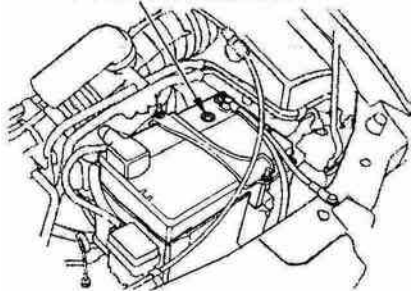

Check the battery condition by looking at the test indicator window on the battery. The label on the battery explains the test indicator's colors.

Check the battery terminals for corrosion (a white or yellowish powder). To remove it, cover the terminals with a solution of baking soda and water. It will bubble up and turn brown. When this stops, wash it off with plain water. Dry off the battery with a cloth or paper towel. Coat the terminals with grease to help prevent future corrosion.

WARNING: Battery posts, terminals and related accessories contain lead and lead compounds. **Wash hands after handling.**

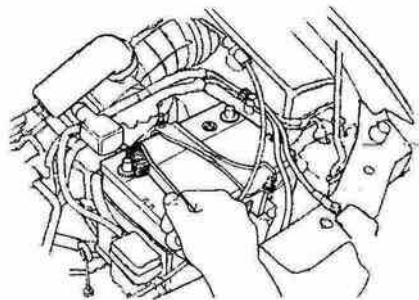

If the terminals are severely corroded, clean them with baking soda and water. Then use a wrench to loosen and remove the cables from the terminals. Always disconnect the negative (—) cable first and reconnect it last. Clean the battery terminals with a terminal cleaning tool or wire brush. Reconnect and tighten the cables, then coat the terminals with grease.

CONTINUED

If you need to connect the battery to a charger, disconnect both cables to prevent damage to the vehicle's electrical system.

The battery gives off explosive hydrogen gas during normal operation.

A spark or flame can cause the battery to explode with enough force to kill or seriously hurt you.

Wear protective clothing and a face shield, or have a skilled mechanic do the battery maintenance.

On EX model

If your vehicle's battery is disconnected or goes dead, the audio system will disable itself. The next time you turn on the radio you will see “ [0000] ” in the frequency display. Use the Preset buttons to enter the five-digit code (see page [192](#)).

NOTICE

Charging the battery with the cables connected can seriously damage your vehicle's electronic controls. Detach the battery cables before connecting the battery to a charger.

On EX model

If your vehicle's battery is disconnected or goes dead while the sliding doors are open, the power sliding door system needs to be resynchronized (see page [97](#)).

Check the condition of the wiper blades at least every six months. Look for signs of cracking in the rubber, or areas that are getting hard. Replace the blades if you find these signs, or they leave streaks and unwiped areas when used.

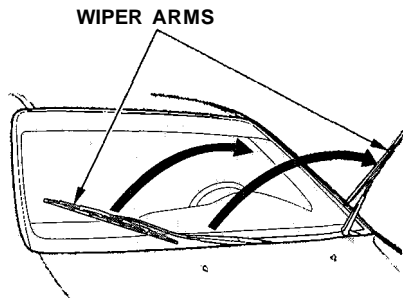

To replace a wiper blade:

1. Raise the wiper arm off the windshield.
Front windshield: Raise the driver's side first, then the passenger's side.

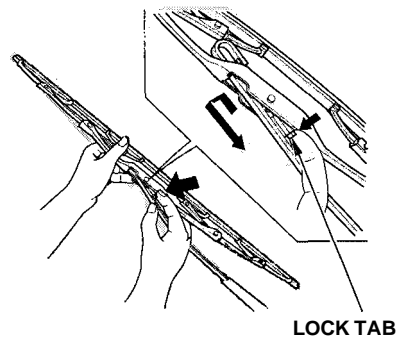

2. Disconnect the blade assembly from the wiper arm by pushing in the lock tab. Hold it in while you push the blade assembly toward the base of the arm.

CONTINUED

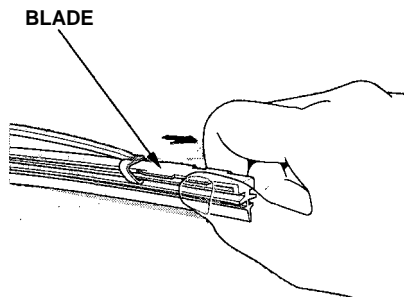

3. Remove the blade from its holder by grasping the tabbed end of the blade. Pull firmly until the tabs come out of the holder.

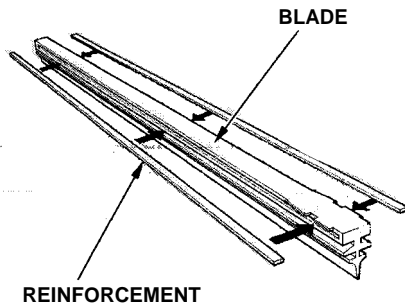

4. Examine the new wiper blades. If they have no plastic or metal reinforcement along the back edge, remove the metal reinforcement strips from the old wiper blade and install them in the slots along the edge of the new blade.

5. Slide the new wiper blade into the holder until the tabs lock.
6. Slide the wiper blade assembly onto the wiper arm. Make sure it locks in place.
7. Lower the wiper arm down against the windshield.
Front windshield: Lower the passenger's side first, then the driver's side.

Your vehicle's air conditioning is a sealed system. Any major maintenance, such as recharging, should be done by a qualified mechanic. You can do a couple of things to make sure the air conditioning works efficiently.

Periodically check the engine's radiator and air conditioning condenser for leaves, insects, and dirt stuck to the front surface. These block the air flow and reduce cooling efficiency. Use a light spray from a hose or a soft brush to remove them.

NOTICE

The condenser and radiator fins bend easily. Only use a low-pressure spray or soft-bristle brush to clean them.

**AIR CONDITIONING
CONDENSER**

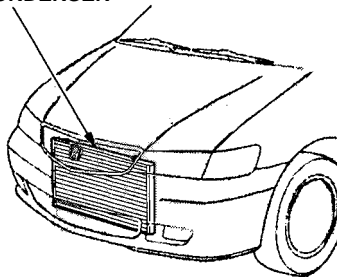

Run the air conditioning at least once a week during the cold weather months. Run it for at least ten minutes while you are driving at a steady speed with the engine at normal operating temperature. This circulates the lubricating oil contained in the refrigerant.

If the air conditioning does not get as cold as before, have your dealer check the system. Recharge the system with Refrigerant HFC-134a (R-134a). (See Specifications on page 334.)

NOTICE

Whenever you have the air conditioning system serviced, make sure the service facility uses a refrigerant recycling system. This system captures the refrigerant for reuse. Releasing refrigerant into the atmosphere can damage the environment.

Air Conditioning Filter

The air conditioning filter removes pollen and dust that is brought in from the outside through the heating and cooling system/climate control system.

This filter should be replaced every 30,000 miles (48,000 km) under normal conditions. It should be replaced every 15,000 miles (24,000 km) if you drive primarily in urban areas that have high concentrations of soot in the air from industry and diesel-powered vehicles. Replace it more often if air flow from the heating and cooling system/climate control system becomes less than usual. Have the air conditioning filter replaced by your Honda dealer.

Drive Belts

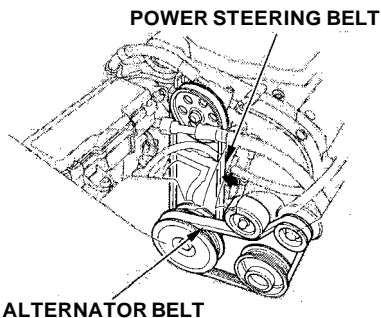

Check the condition of the two drive belts (power steering belt and alternator belt). Examine the edges of each belt for cracks or fraying.

Check the tension of the power steering belt by pushing on it with your thumb midway between the pulleys.

The belt should have the following "play" or deflection.

Power steering belt:

0.51 — 0.65 in (13.0 — 16.5 mm)

If you see signs of wear or looseness, have your dealer adjust or replace the belts.

Timing Belt

The timing belt should normally be replaced at the intervals shown in the maintenance schedule.

Replace the belt at 60,000 miles (U.S.) or 100,000 km (Canada) if you regularly drive your vehicle in one or more of these conditions:

- In very high temperatures (over 110° F, 43° C).
- In very low temperatures (under — 20°F,— 29°C).

Tires

To safely operate your vehicle, your tires must be the proper type and size, in good condition with adequate tread, and correctly inflated. The following pages give more detailed information on how and when to check air pressure, how to inspect your tires for damage and wear, and what to do when your tires need to be replaced.

Using tires that are excessively worn or improperly inflated can cause a crash in which you can be seriously hurt or killed.

Follow all instructions in this owner's manual regarding tire inflation and maintenance.

Inflation

Keeping the tires properly inflated provides the best combination of handling, tread life and riding comfort. Underinflated tires wear unevenly, adversely affect handling and fuel economy, and are more likely to fail from being overheated. Overinflated tires can make your vehicle ride more harshly, are more prone to damage from road hazards, and wear unevenly.

We recommend that you visually check your tires every day. If you think a tire might be low, check it immediately with a tire gauge.

CONTINUED

Use a gauge to measure the air pressure at least once a month. Even tires that are in good condition may lose one to two psi (10 to 20 kPa, 0.1 to 0.2 kgf/cm²) per month.

Remember to check the spare tire at the same time you check all the other tires.

Check the pressure in the tires when they are cold. This means the vehicle has been parked for at least three hours. If you have to drive the vehicle before checking the tire pressure, the tires can still be considered "cold" if you drive less than 1 mile (1.6 km).

If you check the pressure when the tires are hot (the vehicle has been driven several miles), you will see readings 4 to 6 psi (30 to 40 kPa, 0.3 to 0.4 kgf/cm²) higher than the cold reading. This is normal. Do not let air out to match the specified cold pressure. The tire will be underinflated.

You should get your own tire pressure gauge and use it whenever you check your tire pressures. This will make it easier for you to tell if a pressure loss is due to a tire problem and not due to a variation between gauges.

Recommended Tire Pressures for Normal Driving

The following chart shows the recommended cold tire pressures for most normal driving conditions and speeds. Tire pressures for high speed driving are the same as for normal driving.

Tire Size	Cold Tire Pressure for Normal Driving
P215/65R16 96T	35 psi (240 kPa , 2.4 kgf/cm ²)

The compact spare tire pressure is:
60 psi (420 kPa , 4.2 kgf/cm²)

These pressures are also given on the tire information label on the driver's doorjamb.

Tubeless tires have some ability to self-seal if they are punctured. However, because leakage is often very slow, you should look closely for punctures if a tire starts losing pressure.

Inspection

Every time you check inflation, you should also examine the tires for damage, foreign objects, and wear. You should look for:

- Bumps or bulges in the tread or side of the tire. Replace the tire if you find either of these conditions.
- Cuts, splits, or cracks in the side of the tire. Replace the tire if you can see fabric or cord.
- Excessive tread wear.

INDICATOR LOCATION MARKS

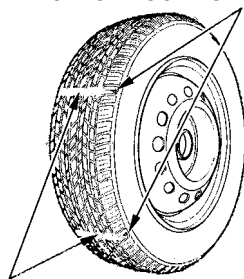

TREAD WEAR INDICATORS

Your vehicle's tires have wear indicators molded into the tread. When the tread wears down to that point, you will see a 1/2 inch (12.7 mm) wide band running across the tread. This shows there is less than 1/16 inch (1.6 mm) of tread left on the tire. A tire that is this worn gives very little traction on wet roads. You should replace the tire if you can see the tread wear indicator in three or more places around the tire.

Maintenance

In addition to proper inflation, correct wheel alignment helps to decrease tire wear. If you find a tire is worn unevenly, have your dealer check the wheel alignment.

The tires were properly balanced by the factory. They may need to be rebalanced at some time before they are worn out. Have your dealer check the tires if you feel a consistent vibration while driving. A tire should always be rebalanced if it is removed from the wheel for repair.

Make sure the installer balances the wheels when you have new tires installed. This increases riding comfort and tire life. Your vehicle's original tires were dynamic or "spin" balanced at the factory. For best results, have the installer perform a dynamic balance.

NOTICE

*On some models
Improper wheel weights can damage
your vehicle's aluminum wheels. Use
only genuine Honda wheel weights for
balancing.*

Tire Rotation

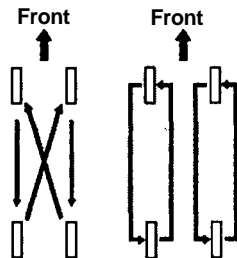

(For Non-directional Tires and Wheels) (For Directional Tires and Wheels)

To help increase tire life and distribute wear more evenly, you should have the tires rotated every 7,500 miles (12,000 km). Move the tires to the positions shown in the chart each time they are rotated.

When shopping for replacement tires, you may find that some tires are "directional." This means they are designed to rotate only in one direction. If you use directional tires, they should be rotated only front-to-back.

Replacing Tires and Wheels

The tires that came with your vehicle were selected to match the performance capabilities of the vehicle while providing the best combination of handling, ride comfort, and long life. You should replace them with radial tires of the same size, load range, speed rating, and maximum cold tire pressure rating (as shown on the tire's sidewall). Mixing radial and bias-ply tires on your vehicle can reduce its braking ability, traction, and steering accuracy.

Installing improper tires on your vehicle can affect handling and stability. This can cause a crash in which you can be seriously hurt or killed.

Always use the size and type of tires recommended in this owner's manual.

It is best to replace all four tires at the same time. If that is not possible or necessary, then replace the two front tires or the two rear tires as a pair. Replacing just one tire can seriously affect your vehicle's handling.

CONTINUED

The ABS works by comparing the speed of the wheels. When replacing tires, use the same size originally supplied with the vehicle. Tire size and construction can affect wheel speed and may cause the system to work inconsistently.

If you ever need to replace a wheel, make sure the wheel's specifications match those of the original wheel that came on your vehicle. Replacement wheels are available at your Honda dealer.

Wheels and Tires

Wheel:

16x61/2JJ

Tire:

P215/65R1696T

See page [336](#) for information about DOT Tire Quality Grading.

Winter Driving

Tires that are marked "M+S" or "All Season" on the sidewall have an all-weather tread design. They should be suitable for most winter driving conditions. Tires without these markings are designed for optimum traction in dry conditions. They may not provide adequate performance in winter driving. For the best performance in snowy or icy conditions, you should install snow tires or tire chains. They may be required by local laws under certain conditions.

Snow Tires

If you mount snow tires on your Honda, make sure they are radial tires of the same size and load range as the original tires. Mount snow tires on all four wheels to balance your vehicle's handling in all weather conditions. Keep in mind the traction provided by snow tires on dry roads may not be as high as your vehicle's original equipment tires. You should drive cautiously even when the roads are clear. Check with the tire dealer for maximum speed recommendations.

Tire Chains

Because your Honda has limited tire clearance, mount only SAE Class "S" cable-type traction devices on the front tires. Use traction devices only when required by driving conditions or local laws. Make sure they are the correct size for your tires.

Metal link-type "chains" should not be used. No matter how tight they seem to be installed, they can come into contact with the body and suspension, causing serious damage.

When installing cables, follow the manufacturer's instructions and mount them as tightly as you can. Drive slowly with them installed. If you hear them coming in contact with the body or chassis, stop and investigate. Make sure the cables are installed tightly, and that they are not contacting the brake lines or suspension. Remove them as soon as you begin

driving on cleared roads.

NOTICE

Traction devices that are the wrong size or improperly installed can damage your vehicle's brake lines, suspension, body, and wheels. Stop driving if they are hitting any part of the vehicle.

Lights

Check the operation of your vehicle's exterior lights at least once a month. A burned out bulb can create an unsafe condition by reducing your vehicle's visibility and the ability to signal your intentions to other drivers.

HEADLIGHT

TURN SIGNAL/
SIDE MARKER/
PARKING LIGHTS

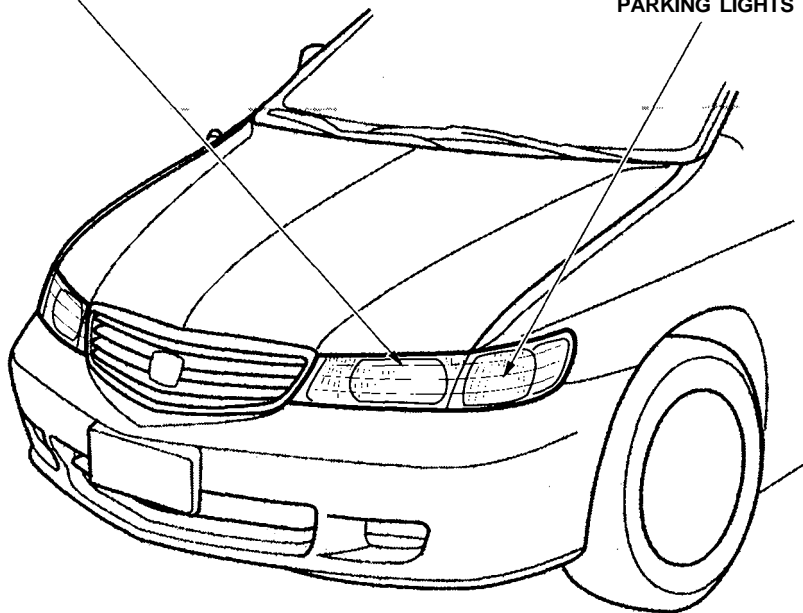

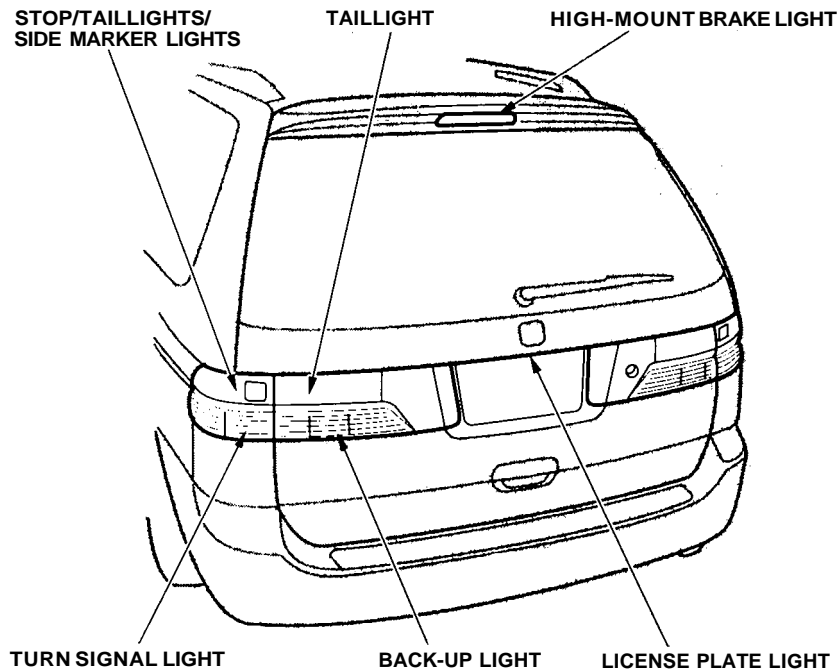

Check the following:

- Headlights (low and high beam)
- Parking lights
- Taillights
- Brake lights
- High-mount brake light
- Turn signals
- Back-up lights
- Hazard light function
- License plate light
- Side marker lights
- Daytime running lights (Canadian models)

If you find any bulbs are burned out, replace them as soon as possible. Refer to the chart on page [335](#) to determine what type of replacement bulb is needed.

Headlight Aiming

The headlights were properly aimed when your vehicle was new. If you regularly carry heavy items in the cargo area or pull a trailer, readjustment may be required. Adjustment of the headlights should be performed by a Honda technician or other qualified mechanic.

Replacing a Headlight Bulb

Your vehicle has halogen headlight bulbs, one on each side. When replacing a bulb, handle it by its steel base and protect the glass from contact with your skin or hard objects. If you touch the glass, clean it with denatured alcohol and a clean cloth.

NOTICE

Halogen headlight bulbs get very hot when lit. Oil, perspiration, or a scratch on the glass can cause the bulb to overheat and shatter.

1. Open the hood.

If you need to change the headlight bulb on the driver's side, remove the air intake cover (see page [262](#)).

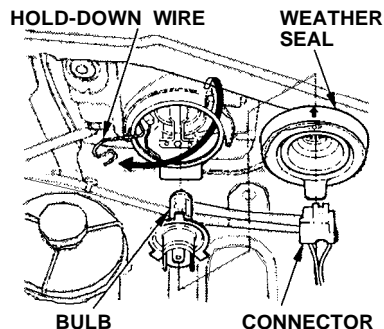

2. Remove the electrical connector from the bulb by pulling the connector straight back.
3. Remove the rubber weather seal by pulling on the tab.
4. Unclip the end of the hold-down wire from its slot. Pivot it out of the way and remove the bulb.

5. Insert the new bulb into the hole, making sure the tabs are in their slots. Pivot the hold-down wire back in place and clip the end into the slot.
6. Install the rubber seal over the back of the headlight assembly. Make sure it is right side up; it is marked "TOP."
7. Push the electrical connector onto the new bulb. Turn on the headlights to test the new bulb.
8. (Driver's side)
Reinstall the air intake cover.

Replacing the Front Side Marker/ Turn Signal and Parking Light Bulb

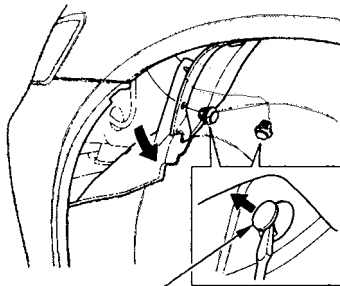

HOLDING CLIP

1. If you are changing the bulb on the driver's side, start the engine, turn the steering wheel all the way to the right, and turn off the engine. If you are changing the bulb on the passenger's side, turn the steering wheel to the left.

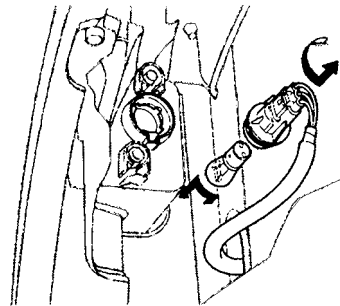

2. Use a flat-tipped screwdriver to remove the two holding clips from the inner fender.
3. Pull the inner fender cover away from the fender and bumper.

CONTINUED

4. Remove the socket from the headlight assembly by turning it one-quarter turn counterclockwise.
5. Remove the burned out bulb from the socket by pushing it in and turning counterclockwise until it unlocks.
6. Install the new bulb in the socket. Turn it clockwise to lock it in place.
7. Insert the socket back into the headlight assembly. Turn it clockwise to lock it in place.
8. Test the lights to make sure the new bulb is working.
9. Put the inner fender in place. Install the two holding clips. Lock each clip in place by pushing on the center.

Replacing Rear Bulbs (in Fenders)

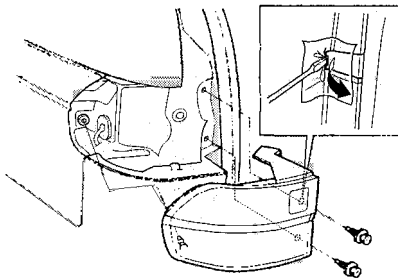

1. Open the tailgate. Release the covers by inserting a flat-tip screwdriver into the slot until the cover bows slightly. Then pivot the screwdriver 90° and pull it straight out of the slot.
2. Use a Phillips-head screwdriver to remove the taillight assembly mounting screw under each cover.

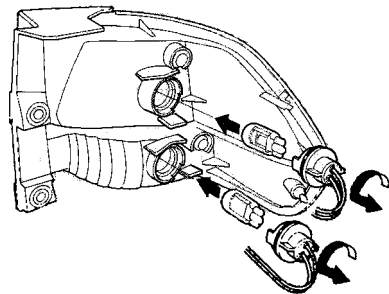

3. Pull the taillight assembly out of the body by sliding it backward.
4. Determine which of the two bulbs is burned out: stop/taillight/side marker light or turn signal light.

5. Remove the socket by turning it one-quarter turn counterclockwise.
6. Pull the bulb straight out of its socket.
Push the new bulb straight into the socket until it bottoms.
7. Reinstall the socket into the light assembly by turning it clockwise until it locks.
8. Test the lights to make sure the new bulb is working.
9. When reinstalling the taillight assembly, align and pop the snap fasteners in place. Tighten the two mounting screws and reinstall the covers in place.

Replacing Rear Bulbs (in Tailgate)

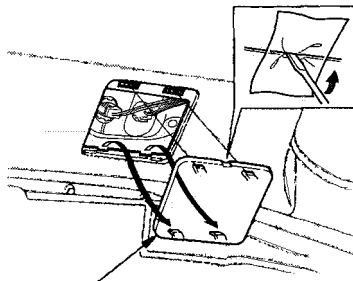

TAILLIGHT COVER

1. Open the tailgate. Place a cloth on the edge of the taillight cover. Remove it by carefully prying in the notch on its edge with a small flat-tipped screwdriver.

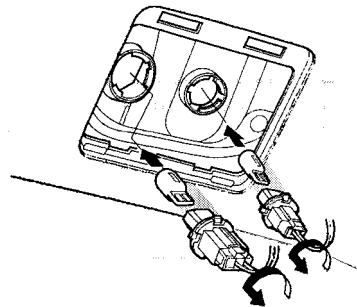

2. Determine which of the two bulbs is burned out: taillight or back-up light.
3. Remove the socket by turning it one-quarter turn counterclockwise.

CONTINUED

4. Pull the bulb straight out of its socket.
Push the new bulb straight into the socket until it bottoms.
5. Insert the socket back into the light assembly. Turn it clockwise to lock it in place.
6. Test the lights to make sure the new bulb is working.
7. Reinstall the taillight cover.

Replacing a High-mount Brake Light Bulb

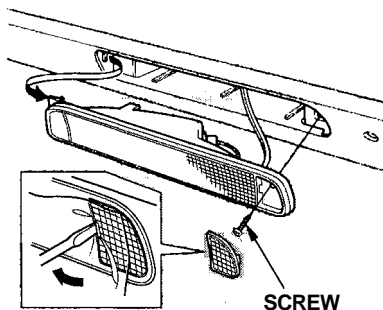

1. Place a cloth on the middle edge of a part of the lens on the passenger's side. Remove a part of the lens by carefully prying on its edge with a small flat-tipped screwdriver.
2. Use a Phillips-head screwdriver to remove the screw under the lens.

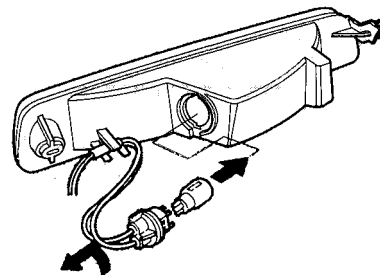

3. Pull the light assembly out of the tailgate.
4. Remove the socket from the light assembly by turning it one-quarter turn counterclockwise.
5. Pull the bulb straight out of its socket.
Push the new bulb straight into the socket until it bottoms.

- Put the socket back into the light assembly and turn it clockwise to lock it in place.
- Test the light to make sure the new bulb is working.
- Put the light assembly back into the tailgate. Install the screw and tighten it securely. Reinstall the lens piece.

Replacing a Rear License Plate Bulb

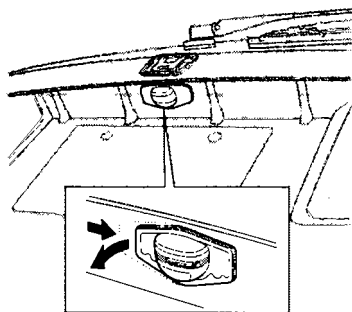

- Remove the license light assembly by carefully prying on the left edge of the lens with a flat-tip screwdriver and pulling the assembly out.

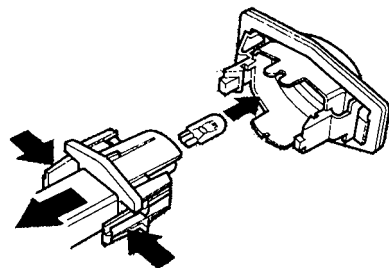

- Remove the lens from the bulb holder by pulling the lens while squeezing the tabs on both sides of the holder.
- Pull the bulb straight out of its socket. Push the new bulb in until it bottoms in the socket.

CONTINUED

4. Turn on the parking lights and check that the new bulb is working.
5. Put the lens back on the bulb holder and push it until it latches.
6. Slide the left side of the light assembly into the hole. Push on the right side to latch the assembly into place.

Replacing Bulbs in the Interior Lights

The individual map lights, cargo area light, and the vanity mirror lights come apart the same way. They do not all use the same bulb.

FRONT INDIVIDUAL MAP LIGHT

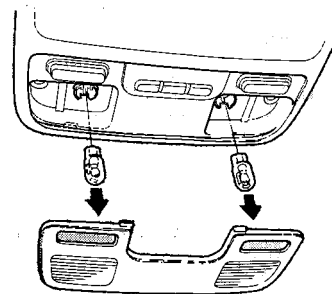

1. Remove the lens by carefully prying on the edge of the lens with a fingernail file or a small flat-tip screwdriver. Do not pry on the edge of the housing around the lens.

Front individual map light:

Pry on the front edge in front of both map lights.

Rear individual map light:

Pry on the middle edge of the lens near the vent.

Cargo area light:

Pry on the rear edge to the left and right of center.

REAR INDIVIDUAL MAP LIGHT

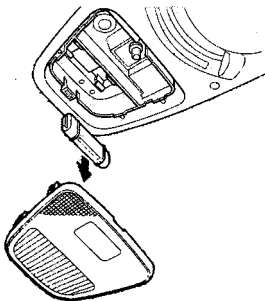

2. Remove the bulb by pulling it straight out of its metal tabs.

CARGO AREA LIGHT

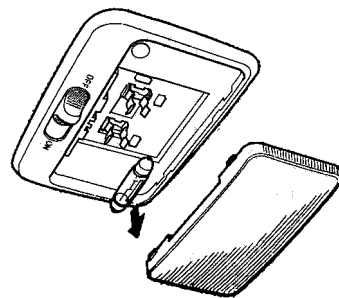

3. Push the new bulb into the metal tabs. Snap the lens back in place.

CONTINUED

SUN VISOR

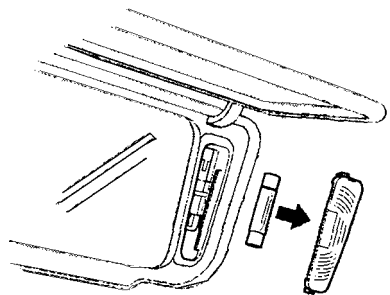

If you need to park your vehicle for an extended period (more than one month), there are several things you should do to prepare it for storage. Proper preparation helps prevent deterioration and makes it easier to get your vehicle back on the road. If possible, store your vehicle indoors.

- Fill the fuel tank.
- Change the engine oil and filter (see page [251](#)).
- Wash and dry the exterior completely.
- Clean the interior. Make sure the carpeting, floor mats, etc. are completely dry.
- Leave the parking brake off. Put the transmission in Park.

- Block the rear wheels.
- If the vehicle is to be stored for a longer period, it should be supported on jackstands so the tires are off the ground.
- Leave one window open slightly (if the vehicle is being stored indoors).
- Disconnect the battery.
- Support the front and rear wiper blade arms with a folded towel or rag so they do not touch the windshield.
- To minimize sticking, apply a silicone spray lubricant to all door and tailgate seals. Also, apply a vehicle body wax to the painted surfaces that mate with the door and tailgate seals.

- Cover the vehicle with a "breathable" cover, one made from a porous material such as cotton. Nonporous materials, such as plastic sheeting, trap moisture, which can damage the paint.
- If possible, run the engine for a while periodically (preferably once a month).

If you store your vehicle for 12 months or longer, have your Honda dealer perform the inspections called for in the 24 months/30,000 miles (48,000 km) maintenance schedule (Normal Conditions) as soon as you take it out of storage (see page [240](#)). The replacements called for in the maintenance schedule are not needed unless the vehicle has actually reached that time or mileage.

Regular cleaning and polishing of your Honda helps to keep it "new" looking. This section gives you hints on how to clean your vehicle and preserve its appearance: the paint, brightwork, wheels and interior. Also included are several things you can do to help prevent corrosion.

Exterior Care.....	294
Washing.....	294
Waxing.....	295
Aluminum Wheels.....	295
Paint Touch-up.....	295
Interior Care.....	296
Carpeting.....	296
Floor mats.....	296
Fabric.....	297
Vinyl.....	297
Seat Belts.....	297
Windows.....	298
Air Fresheners.....	298
Corrosion Protection.....	299
Body Repairs.....	300

Washing

Frequent washing helps preserve your vehicle's beauty. Dirt and grit can scratch the paint, while tree sap and bird droppings can permanently ruin the finish.

Wash your vehicle in a shady area, not in direct sunlight. If the vehicle is parked in the sun, move it into the shade and let the exterior cool down before you start.

Only use the solvents and cleaners recommended in this Owner's Manual.

NOTICE

Chemical solvents and strong cleaners can damage the paint, metal, and plastic on your vehicle.

- Rinse the vehicle thoroughly with cool water to remove loose dirt.
- Fill a bucket with cool water. Mix in a mild detergent, such as dishwashing liquid or a product made especially for car washing.
- Wash the vehicle using the water and detergent solution and a soft-bristle brush, sponge, or soft cloth. Start at the top and work your way down. Rinse frequently.
- Check the body for road tar, tree sap, etc. Remove these stains with tar remover or turpentine. Rinse it off immediately so it does not harm the finish. Remember to re-wax these areas, even if the rest of the vehicle does not need waxing.
- When you have washed and rinsed the whole exterior, dry it with a chamois or soft towel. Letting it air-dry will cause dulling and water spots.

As you dry the vehicle, inspect it for chips and scratches that could allow corrosion to start. Repair them with touch-up paint (see page 295).

NOTICE

The radio antenna on your vehicle does not need to be removed when you use a "drive-through" car wash. However, if you remove the antenna, make sure to reinstall it and tighten it securely using an appropriate tool.

Waxing

Always wash and dry the whole vehicle before waxing it. You should wax your vehicle, including the metal trim, whenever water sits on the surface in large patches. It should form into beads or droplets after waxing.

You should use a quality liquid or paste wax. Apply it according to the instructions on the container. In general, there are two types of products:

Waxes — A wax coats the finish and protects it from damage by exposure to sunlight, air pollution, etc. You should use a wax on your Honda when it is new.

Polishes — Polishes and cleaner/waxes can restore the shine to paint that has oxidized and lost some of its shine. They normally contain mild abrasives and solvents that remove

the top layer of the finish. You should use a polish on your Honda if the finish does not have its original shine after using a wax.

Cleaning tar, insects, etc. with removers also takes off the wax. Remember to re-wax those areas, even if the rest of the vehicle does not need waxing.

Aluminum Wheels

On some models

Clean your Honda's aluminum alloy wheels as you do the rest of the exterior. Wash them with the same solution, and rinse them thoroughly.

The wheels have a protective clear-coat that keeps the aluminum from corroding and tarnishing. Using harsh chemicals, including some commercial wheel cleaners, or stiff brushes can damage this clear-coat. Only use a mild detergent and soft brush or sponge to clean the wheels.

Paint Touch-up

Your dealer has touch-up paint to match your vehicle's color. The color code is printed on a sticker on the driver's doorjamb. Take this code to your dealer so you are sure to get the correct color.

Inspect your vehicle frequently for chips or scratches in the paint. Repair them right away to prevent corrosion of the metal underneath. Use the touch-up paint only on small chips and scratches. More extensive paint damage should be repaired by a professional.

Carpeting

Vacuum the carpeting frequently to remove dirt. Ground-in dirt will make the carpet wear out faster.

Periodically shampoo the carpet to keep it looking new. Use one of the foam-type carpet cleaners on the market. Follow the instructions that come with the cleaner, applying it with a sponge or soft brush. Keep the carpeting as dry as possible by not adding water to the foam.

Floor Mats

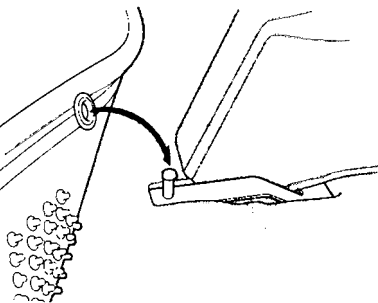

The genuine Honda driver's floor mat was designed to hook over the floor mat anchor. This keeps the floor mat from sliding forward and possibly interfering with the pedals.

If you remove the floor mat, make sure to re-anchor it when you put it back in your vehicle.

If you replace it, use a genuine Honda floor mat that is designed to be used with the floor mat anchor in your vehicle.

If you use a non-Honda floor mat in the driver's footwell, make sure it fits properly and that it can be used with the floor mat anchor.

Do not put additional floor mats on top of the anchored mat, otherwise the additional mats may slide forward and interfere with the pedals.

Fabric

Vacuum dirt and dust out of the material frequently. For general cleaning, use a solution of mild soap and lukewarm water, letting it air dry. To clean off stubborn spots, use a commercially-available fabric cleaner. Test it on a hidden area of the fabric first, to make sure it does not bleach or stain the fabric. Follow the instructions that come with the cleaner.

Vinyl

Remove dirt and dust with a vacuum cleaner. Wipe the vinyl with a soft cloth dampened in a solution of mild soap and water. Use the same solution with a soft-bristle brush on more difficult spots. You can also use commercially-available spray or foam-type vinyl cleaners.

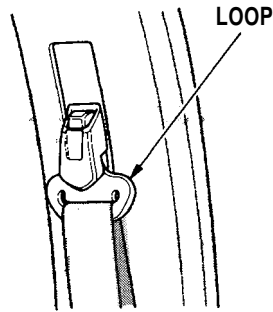
Seat Belts

If your seat belts get dirty, you can use a soft brush with a mixture of mild soap and warm water to clean them. Do not use bleach, dye, or cleaning solvents. They can weaken the belt material. Let the belts air-dry before you use the vehicle.

Dirt build-up in the loops of the seat belt anchors can cause the belts to retract slowly. Wipe the insides of the loops with a clean cloth dampened in mild soap and warm water or isopropyl alcohol.

Windows

Clean the windows, inside and out, with a commercially-available glass cleaner. You can also use a mixture of one part white vinegar to ten parts water. This will remove the haze that builds up on the inside of the windows. Use a soft cloth or paper towels to clean all glass and clear plastic surfaces.

NOTICE

The rear window defogger wires are bonded to the inside of the glass. Wiping vigorously up-and-down can dislodge and break the defogger wires. When cleaning the rear window, use gentle pressure and wipe side-to-side.

Air Fresheners

If you want to use an air freshener/deodorizer in the interior of your vehicle, it is best to use a solid type. Some liquid air fresheners contain chemicals that may cause parts of the interior trim and fabric to crack or discolor.

If you use a liquid air freshener, make sure you fasten it securely so it does not spill as you drive.

Two factors normally contribute to causing corrosion in your vehicle:

1. Moisture trapped in body cavities. Dirt and road salt that collects in hollows on the underside of the vehicle stays damp, promoting corrosion in that area.
2. Removal of paint and protective coatings from the exterior and underside of the vehicle.

Many corrosion-preventive measures are built into your Honda. You can help keep your vehicle from corroding by performing some simple periodic maintenance:

- Repair chips and scratches in the paint as soon as you discover them.
- Inspect and clean out the drain holes in the bottom of the doors and body.
- Check the floor coverings for dampness. Carpeting and floor mats may remain damp for a long time, especially in winter. This dampness can eventually cause the floor panels to corrode.

- Use a high-pressure spray to clean the underside of your vehicle. This is especially important in areas that use road salt in winter. It is also a good idea in humid climates and areas subject to salt air. Be careful of the ABS wheel sensors and wiring at each wheel.
- Have the corrosion-preventive coatings on the underside of your vehicle inspected and repaired periodically.

Body Repairs

Body repairs can affect your vehicle's resistance to corrosion. If your vehicle needs repairs after a collision, pay close attention to the parts used in the repair and the quality of the work.

Make sure the repair facility uses genuine Honda replacement body parts. Some companies make sheet metal pieces that seem to duplicate the original Honda body parts, but are actually inferior in fit, finish, and corrosion resistance. Once installed, they do not give the same high-quality appearance.

When reporting your collision to the insurance company, tell them you want genuine Honda parts used in the repair. Although most insurers recognize the quality of original parts, some may try to specify that the repairs be done with other available parts. You should investigate this before any repairs have begun.

Take your vehicle to your authorized Honda dealer for inspection after the repairs are completed. Your dealer can make sure that quality materials were used, and that corrosion-preventive coatings were applied to all repaired and replaced parts.

This section covers the more-common problems that motorists experience with their vehicles. It gives you information about how to safely evaluate the problem and what to do to correct it. If the problem has stranded you on the side of the road, you may be able to get going again. If not, you will also find instructions on getting your vehicle towed.

Compact Spare Tire.....	302
Changing a Flat Tire.....	303
If Your Engine Won't Start.....	312
Nothing Happens or the Starter Motor Operates Very Slowly.....	312
The Starter Operates Normally.....	313
Jump Starting.....	313
If Your Engine Overheats.....	315
Low Oil Pressure Indicator.....	318
Charging System Indicator.....	319
Malfunction Indicator Lamp	320
Readiness Codes.....	321
Brake System Indicator.....	322
Fuses.....	323
Checking and Replacing.....	324
Emergency Towing.....	329

Compact Spare Tire

Your vehicle has a compact spare tire that takes up less space. Use this spare tire as a temporary replacement only. Get your regular tire repaired or replaced and put it back on your vehicle as soon as you can.

Check the inflation pressure of the compact spare tire every time you check the other tires. It should be inflated to:
60 psi (420 kPa , 4.2 kgf/cm²)

Follow these precautions whenever you are using the compact spare tire:

- Do not exceed 50 mph (80 km/h) under any circumstances.
- This tire gives a harsher ride and less traction on some road surfaces than the regular tire. Use greater caution while driving on this tire.

- Do not mount snow chains on the compact spare.
- Do not use the compact spare tire if you are towing a trailer.
- The wheel of the compact spare tire is designed especially to fit your vehicle. Do not use your spare tire on another vehicle unless it is the same make and model.
- Turn off the Traction Control System (see page 221). Driving with the compact spare tire may activate the TCS.

INDICATOR LOCATION MARK

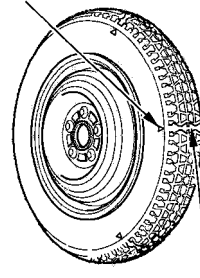

TREAD WEAR INDICATOR BAR

The compact spare tire has a shorter tread life than a regular tire. Replace it when you can see the tread wear indicator bars. The replacement should be the same size and design tire, mounted on the same wheel. The compact spare tire is not designed to be mounted on a regular wheel, and the compact wheel is not designed for mounting a regular tire.

If you have a flat tire while driving, stop in a safe place to change it. Stopping in traffic or on the shoulder of a busy road is dangerous. Drive slowly along the shoulder until you get to an exit or an area to stop that is far away from the traffic lanes.

The vehicle can easily roll off the jack, seriously injuring anyone underneath.

Follow the directions for changing a tire exactly, and never get under the vehicle when it is supported only by the jack.

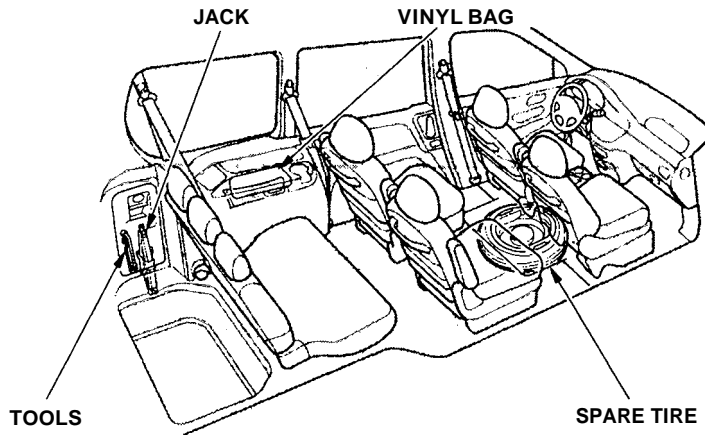

1. Park the vehicle on firm, level and non-slippery ground away from traffic. Put the transmission in Park. Apply the parking brake.

2. Turn on the hazard warning lights and turn the ignition switch to LOCK (0). Have all the passengers get out of the vehicle while you change the tire.

CONTINUED

Changing a Flat Tire

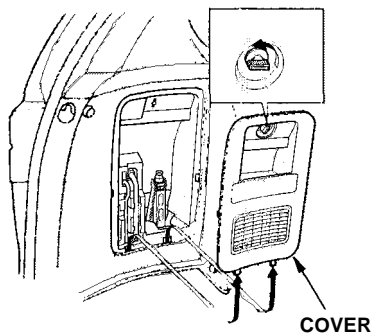

3. Open the tailgate.
Remove the cargo net.
4. The tools and jack are behind a cover in the cargo area on the driver's side. Remove the cover by turning the handle counterclockwise, then pulling out the cover.

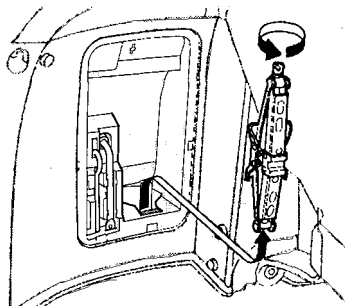

5. Take the tools out of the storage compartment.
6. Turn the jack's end bracket counterclockwise to loosen it, then remove the jack.

7. The spare tire is stored under the floor between the first and second row of seats. If the front seats are adjusted to the rear-most position, move the seats forward slightly and adjust the seat-backs to an upright position (see page 105).

Lift up the center table (see page 123).

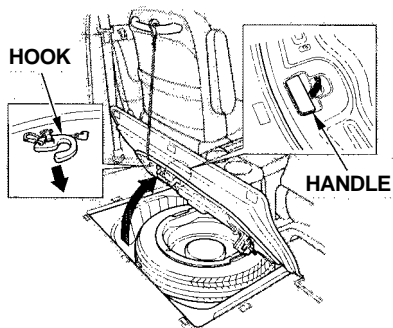

8. Open either of the rear sliding doors. Pull the floor carpet up by lifting up on the edge, then raise the floor lid by pulling up on the handle. To keep the floor carpet and lid out of the way, pull out the hook on the back of the floor lid and attach it into the seat-back handle on the driver's seat.

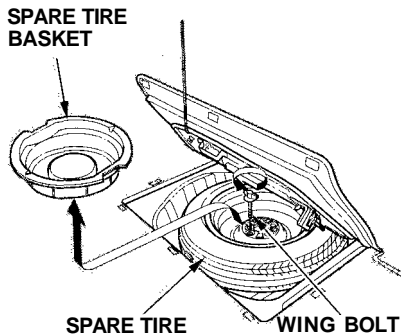

9. *On EX model*
Remove the spare tire basket.
10. Unscrew the wing bolt and take the spare tire out of its well. After you have removed the spare tire, screw this wing bolt back into place.

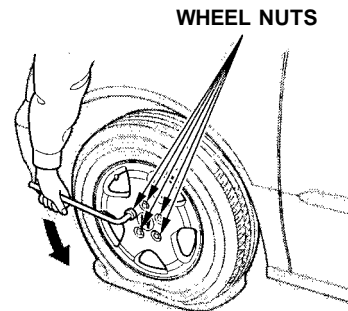

11. *On EX model*
If you are changing a rear tire, close the sliding door. Then turn off the sliding door MAIN switch.
12. Loosen the five wheel nuts 1/2 turn with the wheel wrench.

CONTINUED

Changing a Flat Tire

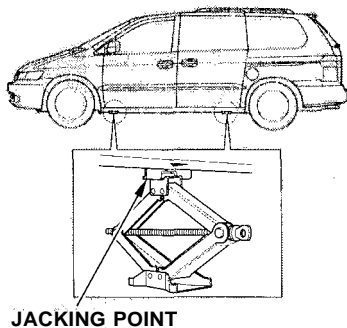

13. Locate the jacking point nearest the tire you need to change. It is pointed to by a \triangle mark molded into the underside of the body. Place the jack under the jacking point. Turn the end bracket clockwise until the top of the jack contacts the jacking point. Make sure the jacking point tab is resting in the jack notch.

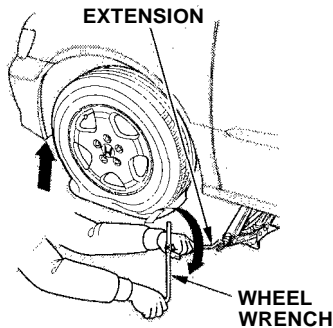

14. Use the extension and wheel wrench as shown to raise the vehicle until the flat tire is off the ground.

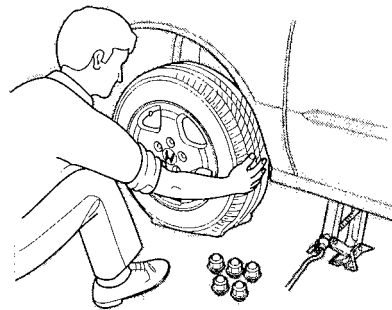

15. Remove the wheel nuts and flat tire. Temporarily place the flat tire on the ground with the outside surface of the wheel facing up. You could scratch the wheel if you put it face down.

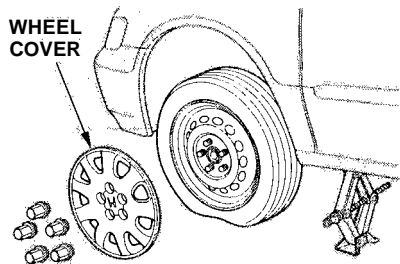

On LX model
Do not attempt to forcibly pry the wheel cover off with a screwdriver or other tool. The wheel cover cannot be removed without first removing the wheel nuts.

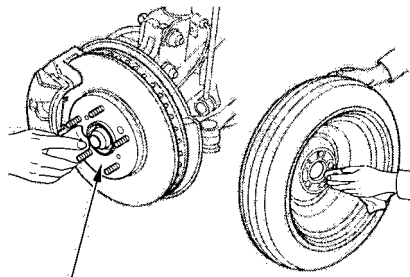

16. Before mounting the spare tire, wipe any dirt off the mounting surface of the wheel and hub with a clean cloth. Wipe the hub carefully, it may be hot from driving.

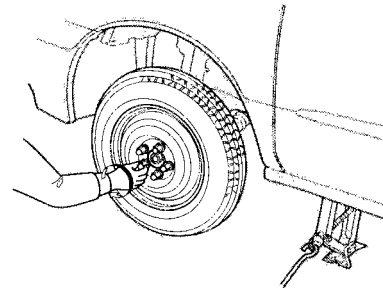

17. Put on the spare tire. Put the wheel nuts back on finger-tight, then tighten them in a crisscross pattern with the wheel wrench until the wheel is firmly against the hub. Do not try to tighten them fully.

CONTINUED

Changing a Flat Tire

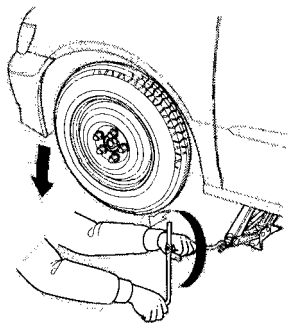

18. Lower the vehicle to the ground and remove the jack.

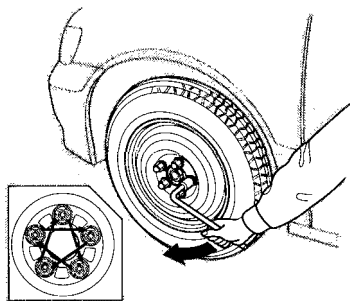

19. Tighten the wheel nuts securely in the same crisscross pattern. Have the wheel nut torque checked at the nearest automotive service facility.
Tighten the wheel nuts to:
80 lbf.ft (108N.m, 11 kgf.m)

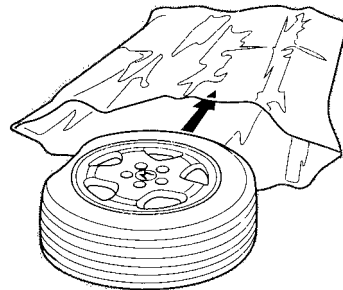

20. Put the flat tire in the supplied vinyl bag. This bag is stored in the rear compartment on the driver's side panel in the third row. Knot the top of the vinyl bag.

21. Storing the flat tire behind the third seat

When the third seat is not folded, the flat tire is secured behind the third seat.

On EX model

Turn on the sliding door MAIN switch so you can open the door.

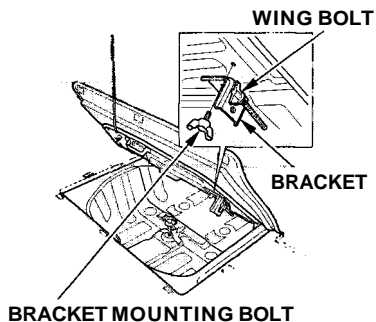

Remove the bracket and the wing bolt from the spare tire lid by unscrewing the bracket mounting bolt.

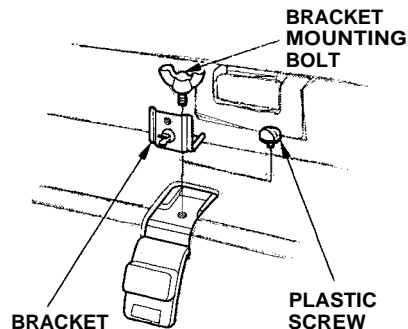

22. You will find a u-shaped slit on the carpet behind the seat bottom of the third seat. Pull up the carpet at the slit and remove the plastic screw with a coin.

CONTINUED

Changing a Flat Tire

Adjust the seat-back of the third seat to the upright position (see page 106). Install the bracket and the bracket mounting bolt to the attachment point as shown, and tighten the bolt. Make sure the bracket is securely locked.

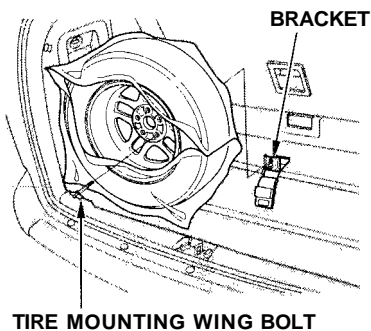

Install the flat tire on the bracket with the inside of the wheel facing toward you. Put the tire mounting wing bolt in the attachment point through one of the five wheel nut holes and the bracket as shown. Poke holes in the vinyl bag. Secure the flat tire by tightening the wing bolt.

23. Storing the Flat Tire on the Floor
When the third seat is folded, the flat tire is secured to the floor on top of the folded seat. Pull up the carpet on the attachment point and remove the plastic screw as described in the previous procedure.

Remove the wing bolt from the bracket that is attached to the spare tire lid.

TIRE MOUNTING WING BOLT

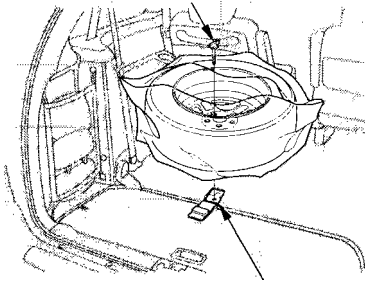

ATTACHMENT POINT

Place the flat tire face down on the attachment point. Put the tire mounting wing bolt in the attachment point through one of the five wheel nut holes as shown. Poke holes in the vinyl bag. Secure the flat tire by tightening the wing bolt.

24. Store the jack in its holder. Turn the jack's end bracket clockwise to lock it in place. Store the tools. Replace the cover.

25. Close the tailgate.

26. Store the plastic screw in the spare tire well.

On LX model

Store the wheel cover in the spare tire well. Make sure it will not get scratched or damaged.

On EX model

Store the spare tire basket in the spare tire well.

Loose items can fly around the interior in a crash and could seriously injure the occupants.

Store the wheel, jack and tools securely before driving.

27. Unclip the hook from the seat back handle on the driver's seat and lower the floor lid and the carpet.

Make sure to adjust the front seats properly before you start driving (see page 105).

If Your Engine Won't Start

Diagnosing why your engine won't start falls into two areas, depending on what you hear when you turn the key to START (III):

- You hear nothing, or almost nothing. The engine's starter motor does not operate at all, or operates very slowly.
- You can hear the starter motor operating normally, or the starter motor sounds like it is spinning faster than normal, but the engine does not start up and run.

Nothing Happens or the Starter Motor Operates Very Slowly

When you turn the ignition switch to START (III), you do not hear the normal noise of the engine trying to start. You may hear a clicking sound or series of clicks, or nothing at all. Check these things:

- Your vehicle has the Immobilizer System. You should use a properly-coded master or valet key to start the engine (see page 81). A key that is not properly coded will cause the immobilizer system indicator in the dash panel to blink rapidly.
- Check the transmission interlock. The transmission must be in Park or Neutral or the starter will not operate.
- Turn the ignition switch to ON (II). Turn on the headlights and check their brightness. If the headlights are very dim or don't light at all, the battery is discharged. See **Jump Starting** on page 313.
- Turn the ignition switch to START (III). If the headlights do not dim, check the condition of the fuses. If the fuses are OK, there is probably something wrong with the electrical circuit for the ignition switch or starter motor. You will need a qualified technician to determine the problem. (See **Emergency Towing** on page 329.)

If the headlights dim noticeably or go out when you try to start the engine, either the battery is discharged or the connections are corroded. Check the condition of the battery and terminal connections (see page 267). You can then try jump starting the vehicle from a booster battery (see page 313).

The Starter Operates Normally

In this case, the starter motor's speed sounds normal, or even faster than normal, when you turn the ignition switch to START (III), but the engine does not run.

- Are you using the proper starting procedure? Refer to **Starting the Engine** on page 211.
- Do you have fuel? Turn the ignition switch to ON (II) for a minute and watch the fuel gauge. The low fuel level warning light may not be working, so you were not reminded to fill the tank.
- There may be an electrical problem, such as no power to the fuel pump. Check all the fuses (see page 323).

If you find nothing wrong, you will need a qualified technician to find the problem. See **Emergency Towing** on page 329.

Jump Starting

If your vehicle's battery has run down, you may be able to start the engine by using a booster battery. Although this seems like a simple procedure, you should take several precautions.

A battery can explode if you do not follow the correct procedure, seriously injuring anyone nearby.

Keep all sparks, open flames, and smoking materials away from the battery.

You cannot start a Honda by pushing or pulling it.

To jump start your vehicle, follow these directions closely:

1. Open the hood and check the physical condition of the battery (see page 267). In very cold weather, check the condition of the electrolyte. If it seems slushy or like ice, do not try jump starting until it thaws.

NOTICE

If a battery sits in extreme cold, the electrolyte inside can freeze.

Attempting to jump start with a frozen battery can cause it to rupture.

2. Turn off all the electrical accessories: heater, A/C, climate control, stereo system, lights, etc. Put the transmission in Neutral or Park and set the parking brake.

CONTINUED

Jump Starting

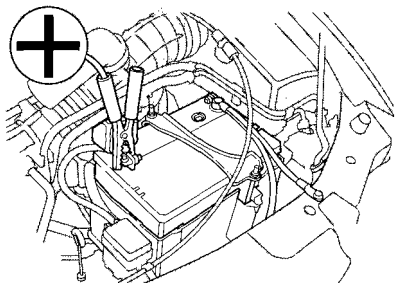

3. Connect one jumper cable to the positive (+) terminal on your Honda's battery. Connect the other end to the positive (+) terminal on the booster battery.

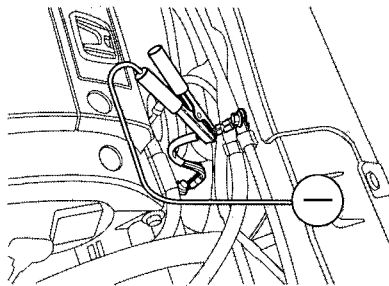

4. Connect the second jumper cable to the negative (-) terminal on the booster battery. Connect the other end to the grounding strap as shown. Do not connect this jumper cable to any other part of the engine.
5. If the booster battery is in another vehicle, have an assistant start that vehicle and run it at a fast idle.

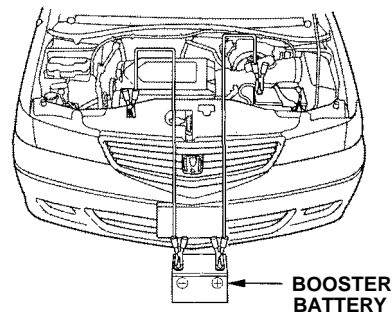

6. Start your vehicle. If the starter motor still operates slowly, check the jumper cable connections to make sure they have good metal-to-metal contact.

7. Once your vehicle is running, disconnect the negative cable from your vehicle, then from the booster battery. Disconnect the positive cable from your vehicle, then the booster battery.

Keep the ends of the jumper cables away from each other and any metal on the vehicle until all are disconnected. Otherwise, you may cause an electrical short.

If Your Engine Overheats

The pointer of your vehicle's temperature gauge should stay in the midrange under most conditions. It may go higher if you are driving up a long steep hill on a very hot day. If it climbs to the red mark, you should determine the reason.

NOTICE

Driving with the temperature gauge pointer at the red mark can cause serious damage to your engine.

Your vehicle can overheat for several reasons, such as lack of coolant or a mechanical problem. The only indication may be the temperature gauge climbing to or above the red mark. Or you may see steam or spray coming from under the hood. In either case, you should take immediate action.

Steam and spray from an overheated engine can seriously scald you.

Do not open the hood if steam is coming out.

CONTINUED

If Your Engine Overheats

1. Safely pull to the side of the road. Put the transmission in Neutral or Park and set the parking brake. Turn off the heating and cooling/ climate control system and all other accessories. Turn on the hazard warning indicators.
2. If you see steam and/or spray coming from under the hood, turn off the engine.
3. If you do not see steam or spray, leave the engine running and watch the temperature gauge. If the high heat is due to overloading (climbing a long, steep hill on a hot day with the A/C running, for example), the engine should start to cool down almost immediately. If it does, wait until the temperature gauge comes down to the midpoint then continue driving.
4. If the temperature gauge stays at the red mark, turn off the engine.
5. Wait until you see no more signs of steam or spray, then open the hood.
6. Look for any obvious coolant leaks, such as a split radiator hose. Everything is still extremely hot, so use caution. If you find a leak, it must be repaired before you continue driving (see **Emergency Towing** on page [329](#)).
7. If you don't find an obvious leak, check the coolant level in the radiator reserve tank (see page [201](#)). If the level is below the MIN mark, add coolant to halfway between the MIN and MAX marks.

8. If there was no coolant in the reserve tank, you may also have to add coolant to the radiator. Let the engine cool down until the pointer reaches the middle of the temperature gauge, or lower, before checking the radiator.

Removing the radiator cap while the engine is hot can cause the coolant to spray out, seriously scalding you.

Always let the engine and radiator cool down before removing the radiator cap.

9. Using gloves or a large heavy cloth, turn the radiator cap counterclockwise, without pushing down, to the first stop. This releases any remaining pressure in the cooling system. After the pressure releases, push down on the cap and turn it until it comes off.

10. Start the engine and set the temperature control dial to maximum (climate control to FULL AUTO at 90° F/32° C). Add coolant to the radiator up to the base of the filler neck. If you do not have the proper coolant mixture available, you can add plain water. Remember to have the cooling system drained and refilled with the proper mixture as soon as you can.

11. Put the radiator cap back on tightly. Run the engine and watch the temperature gauge. If it goes back to the red mark, the engine needs repair. (See **Emergency Towing** on page 329.)

12. If the temperature stays normal, check the coolant level in the radiator reserve tank. If it has gone down, add coolant to the MAX mark. Put the cap back on tightly.

Low Oil Pressure Indicator

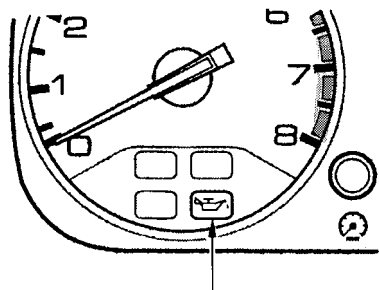

LOW OIL PRESSURE INDICATOR

This indicator should light when the ignition switch is ON (II), and go out after the engine starts. It should never come on when the engine is running. If it starts flashing, it indicates that the oil pressure dropped very low for a moment, then recovered. If the indicator stays on with the engine running, it shows that the engine has lost oil pressure and serious engine damage is possible. In either case, you should take immediate action.

NOTICE

Running the engine with low oil pressure can cause serious mechanical damage almost immediately. Turn off the engine as soon as you can safely get the vehicle stopped.

1. Safely pull off the road and shut off the engine. Turn on the hazard warning indicators.
2. Let the vehicle sit for a minute. Open the hood and check the oil level (see page 200). Although oil level and oil pressure are not directly connected, an engine that is very low on oil can lose pressure during cornering and other driving maneuvers.
3. If necessary, add oil to bring the level back to the full mark on the dipstick (see page 249).
4. Start the engine and watch the oil pressure indicator. If the light does not go out within ten seconds, turn off the engine. There is a mechanical problem that needs to be repaired before you can continue driving. (See **Emergency Towing** on page 329.)

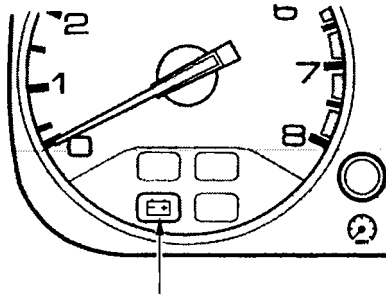

CHARGING SYSTEM INDICATOR

This indicator should come on when the ignition switch is ON (II), and go out after the engine starts. If it comes on brightly when the engine is running, it indicates that the charging system has stopped charging the battery.

Immediately turn off all electrical accessories: radio, heater, A/C, climate control, rear defogger, cruise control, etc. Try not to use other electrically-operated controls such as the power windows. Keep the engine running and take extra care not to stall it. Starting the engine will discharge the battery rapidly.

By eliminating as much of the electrical load as possible, you can drive several miles (kilometers) before the battery is too discharged to keep the engine running. Drive to a service station or garage where you can get technical assistance.

Malfunction Indicator Lamp

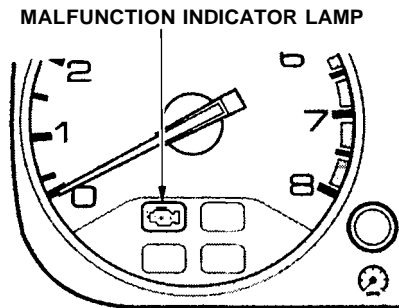

This indicator should light when the ignition switch is ON (II), and go out after the engine starts. If it comes on at any other time, it indicates one of the engine's emissions control systems may have a problem. Even though you may feel no difference in your vehicle's performance, it can reduce your fuel economy and cause your vehicle to put out excessive emissions. Continued operation may cause serious damage.

If you have recently refueled your vehicle, the cause of this indicator coming on could be a loose or missing fuel fill cap. Check the cap and tighten it until it clicks several times. Replace the fuel fill cap if it is missing. Tightening the cap will not make the indicator turn off immediately; it takes at least three driving trips.

If the indicator remains on past three driving trips, or the fuel cap was not loose or missing, have the vehicle checked by the dealer as soon as possible. Drive moderately until the dealer has inspected the problem. Avoid full-throttle acceleration and driving at high speed.

You should also have the dealer inspect your vehicle if this indicator comes on repeatedly, even though it may turn off as you continue driving.

NOTICE

If you keep driving with the malfunction indicator lamp on, you can damage your vehicle's emissions controls and engine. Those repairs may not be covered by your vehicle's warranties.

This indicator may also come on along with the "D4" indicator.

Readiness Codes

Your vehicle has certain "readiness codes" that are part of the on-board diagnostics for the emissions systems. In some states, part of the emissions testing is to make sure these codes are set. If they are not set, the test cannot be completed.

If your vehicle's battery has been disconnected or gone dead, these codes are erased. It takes several days of driving under various conditions to set the codes again.

If possible, do not take your car for a state emissions test until the readiness codes are set. To check if they are set, turn the ignition ON (II), but do not start the engine. The Malfunction Indicator Lamp will come on for 20 seconds. If it then goes off, the readiness codes are set. If it blinks 5 times, the readiness codes are not set. See State Emissions Testing on pages [343](#) and [344](#).

Brake System Indicator

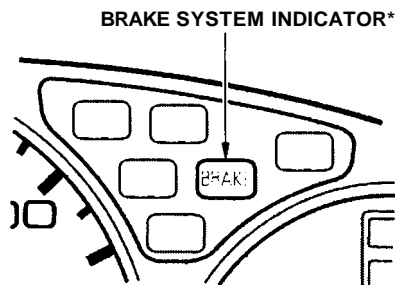

*U.S. indicator shown

The Brake System Indicator normally comes on when you turn the ignition switch ON (II). It is a reminder to check the parking brake. It comes on and stays lit if you do not fully release the parking brake.

If it comes on at any other time, it indicates a problem with the vehicle's brake system. In most cases, the problem is a low fluid level in the brake fluid reservoir. Press lightly on the brake pedal to see if it feels normal. If it does, check the brake fluid level the next time you stop at a service station (see page 260). If the fluid level is low, take the vehicle to your dealer and have the brake system inspected for leaks or worn brake pads.

However, if the brake pedal does not feel normal, you should take immediate action. Because of the brake system's dual-circuit design, a problem in one part of the system will still give you braking at two wheels. You will feel the brake pedal go down much farther before the vehicle begins to slow down, and you will have to press harder on the pedal. The distance needed to stop will be much longer.

Slow down by shifting to a lower gear, and pull to the side of the road when it is safe. Because of the longer distance needed to stop, it is hazardous to drive the vehicle. You should have it towed, and repaired as soon as possible. (See **Emergency Towing** on page 329.)

If you must drive the vehicle a short distance in this condition, drive slowly and cautiously.

If the ABS indicator and the TCS indicator (on EX model) come on with this indicator, have the vehicle inspected by your dealer immediately.

All the electrical circuits in your vehicle have fuses to protect them from a short circuit or overload. These fuses are located in three fuse boxes.

DRIVER'S SIDE INTERIOR

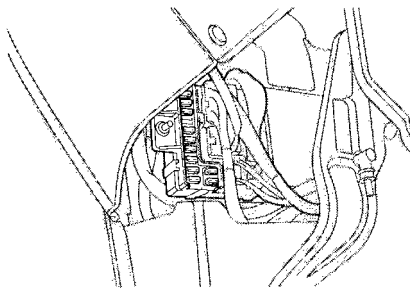

The interior fuse boxes are located underneath the dashboard on each side.

PASSENGER'S SIDE INTERIOR

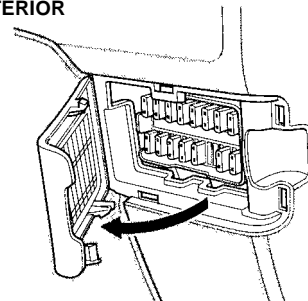

To open the fuse box on the passenger's side, pull the right edge of the cover.

CONTINUED

UNDER-HOOD

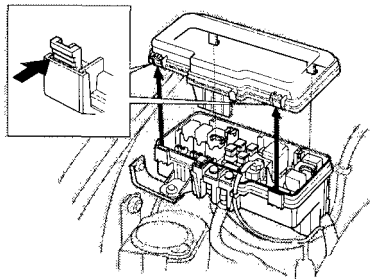

The primary under-hood fuse box is located in the back of the engine compartment on the passenger's side. To open it, push the tabs as shown.

UNDER-HOOD

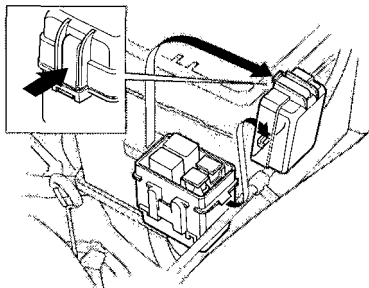

The secondary fuse box is in the engine compartment next to the battery.

Checking and Replacing Fuses

If something electrical in your vehicle stops working, the first thing you should check for is a blown fuse. Determine from the chart on pages [327](#) and [328](#), or the diagram on the fuse box lid (the diagram for the driver's side interior fuse box is on the kick panel below the fuse box), which fuse or fuses control that component. Check those fuses first, but check all the fuses before deciding that a blown fuse is not the cause. Replace any blown fuses and check the component's operation.

1. Turn the ignition switch to LOCK (0). Make sure the headlights and all other accessories are off.
2. Remove the cover from the fuse box.

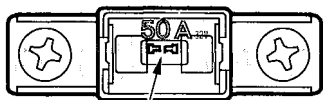

BLOWN

3. Check each of the large fuses in the primary under-hood fuse box by looking through the top at the wire inside. Removing these fuses requires a Phillips-head screwdriver.

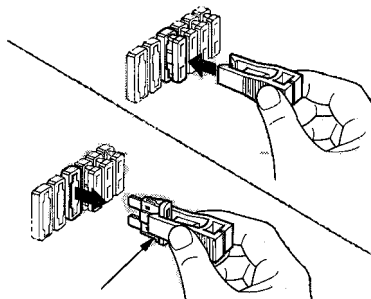

FUSE PULLER

4. Check the smaller fuses in the under-hood fuse box and all the fuses in the interior fuse boxes by pulling out each fuse with the fuse puller provided in the primary under-hood fuse box.

BLOWN

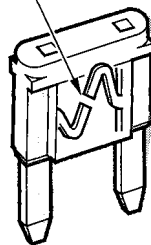

5. Look for a burned wire inside the fuse. If it is burned, replace it with one of the spare fuses of the same rating or lower.

CONTINUED

If you cannot drive the vehicle without fixing the problem, and you do not have a spare fuse, take a fuse of the same rating or a lower rating from one of the other circuits. Make sure you can do without that circuit temporarily (such as the accessory power socket or radio).

If you replace the blown fuse with a spare fuse that has a lower rating, it might blow out again. This does not indicate anything wrong. Replace the fuse with one of the correct rating as soon as you can.

NOTICE

Replacing a fuse with one that has a higher rating greatly increases the chances of damaging the electrical system. If you do not have a replacement fuse with the proper rating for the circuit, install one with a lower rating.

6. If the replacement fuse of the same rating blows in a short time, there is probably a serious electrical problem in your vehicle. Leave the blown fuse in that circuit and have your vehicle checked by a qualified mechanic.

On EX model

If the radio fuse is removed, the audio system will disable itself. The next time you turn on the radio you will see “ **CODE** ” in the frequency display. Use the Preset buttons to enter the five-digit code (see page [192](#)).

PRIMARY UNDER-HOOD FUSE BOX

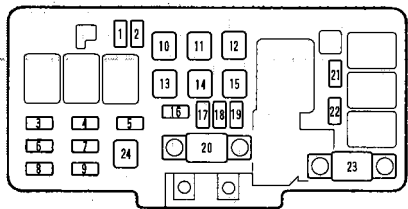

No.	Amps.	Circuits Protected
1	20 A	Spare Fuse
2	30 A	Spare Fuse
3	15 A	Right Headlight
4	15 A	ACG S
5	15 A	Hazard
6	—	Not Used
7	20 A	Stop
8	15 A	Left Headlight
9	20 A	ABS F/S
10	40 A	Power Window Motor
11	30 A	Power Sliding Door*
12	30 A	Rear Defroster
13	40 A	Back Up, ACC

No.	Amps.	Circuits Protected
14	40 A	Power Seat*
15	40 A	Heater Motor
16	30 A	Cooling Fan
17	7.5 A	Spare Fuse
18	10 A	Spare Fuse
19	15 A	Spare Fuse
20	120 A	Battery
21	30 A	Condenser Fan
22	7.5 A	MG Clutch
23	50 A	Ignition Switch (IG 1 Main)
24	30 A	ABS Motor

* : EX model

SECONDARY UNDER-HOOD FUSE BOX

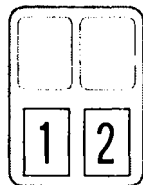

No.	Amps.	Circuits Protected
1	30 A	Power Sliding Door*
2	40 A	Rear A/C

* : EX model

CONTINUED

Fuses

INTERIOR FUSE BOX

Driver's Side

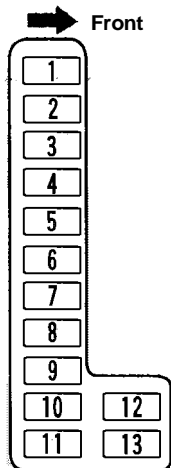

No.	Amps.	Circuits Protected
1	15 A	Fuel Pump
2	10 A	SRS
3	7.5 A	Heater Control, A/C Clutch Relay, Cooling Fan Relay
4	7.5 A	Power Mirror
5	7.5 A	Daytime Running Light*
6	15 A	ECU (PCM), Cruise Control
7	15 A	IG Coil
8	7.5 A	ACC Relay
9	10 A	Back-up Lights, Instrument Lights
10	7.5 A	Turn Signals
11	10 A	Rear Wiper
12	30 A	Front Wiper
13	7.5 A	Starter Signal

* : On Canadian models

Passenger's Side

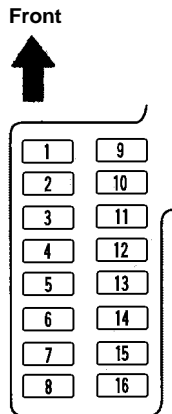

No.	Amps.	Circuits Protected
1	20 A	Driver's Side Automatic Sliding Door
2	20 A	Power Seat Reclining* ¹
3	10 A	BSC
4	20 A	Power Seat Sliding* ¹
5	20 A	Passenger's Side Automatic Sliding Door
6	10 A	Daytime Running Light* ²
7	7.5 A	Left Power Vent
8	20 A	Front Passenger's Power Window
9	15 A	ACC Socket
10	15 A	Small Light, License Light
11	15 A	Interior Light, Radio
12	20 A	Power Door Locks
13	7.5 A	Clock, Back Up
14	7.5 A	ABS Motor Check
15	20 A	Driver's Power Window
16	7.5 A	Right Power Vent

* 1 : EX

* 2 : Canadian models

If your vehicle needs to be towed, call a professional towing service or, if you belong to one, an organization that provides roadside assistance. Never tow your vehicle behind another vehicle with just a rope or chain. It is very dangerous.

There are three popular types of professional towing equipment.

Flat-bed Equipment—The operator loads your vehicle on the back of a truck. **This is the best way to transport your Honda.**

Wheel-lift Equipment—The tow truck uses two pivoting arms that go under the tires (front or rear) and lift them off the ground. The other two tires remain on the ground. **This is an acceptable way to tow your Honda.**

Sling-type Equipment—The tow truck uses metal cables with hooks on the ends. These hooks go around parts of the frame or suspension and the cables lift that end of the vehicle off the ground. Your vehicle's suspension and body can be seriously damaged. **This method of towing is unacceptable.**

If your Honda cannot be transported by flat-bed, it should be towed by wheel-lift equipment with the front wheels off the ground. If, due to damage, your vehicle must be towed with the front wheels on the ground, do the following.

- Release the parking brake.
- Start the engine.
- Shift to D₄, then to N.
- Turn off the engine.

NOTICE

Improper towing preparation will damage the transmission. Follow the above procedure exactly. If you cannot shift the transmission or start the engine, your vehicle must be transported with the front wheels off the ground.

With the front wheels on the ground, it is best to tow the vehicle no farther than 50 miles (80 km), and keep the speed below 35 mph (55 km/h).

CONTINUED

If you decide to tow your vehicle with all four wheels on the ground, make sure you use a properly-designed and attached tow bar. Prepare the vehicle for towing as described above, and leave the ignition switch in Accessory (I) so the steering wheel does not lock. Make sure the radio and any items plugged into the accessory power socket are turned off so they do not run down the battery.

NOTICE

Trying to lift or tow your vehicle by the bumpers will cause serious damage. The bumpers are not designed to support the vehicle's weight.

NOTICE

The steering system can be damaged if the steering wheel is locked. Leave the ignition switch in Accessory (I), and make sure the steering wheel turns freely before you begin towing.

The diagrams in this section give you the dimensions and capacities of your Honda, and the locations of the identification numbers. It also includes information you should know about your vehicle's tires and emissions control systems.

Identification Numbers.....	332	Oxygenated Fuels.....	338
Specifications.....	334	Driving in Foreign Countries.....	339
DOT Tire Quality Grading.....	336	Emissions Controls.....	340
Treadwear.....	336	The Clean Air Act.....	340
Traction.....	336	Crankcase Emissions Control System.....	340
Temperature.....	337	Evaporative Emissions Control System.....	340
		Onboard Refueling Vapor Recovery.....	340
		Exhaust Emissions Controls....	341
		PGM-FI System.....	341
		Ignition Timing Control System.....	341
		Exhaust Gas Recirculation (EGR) System.....	341
		Three Way Catalytic Converter.....	341
		Replacement Parts.....	341
		Three Way Catalytic Converter...	342
		State Emissions Testing.....	343

Identification Numbers

Your vehicle has several identifying numbers located in various places.

The Vehicle Identification Number (VIN) is the 17-digit number your Honda dealer uses to register your vehicle for warranty purposes. It is also necessary for licensing and insuring your vehicle. The easiest place to find the VIN is on a plate fastened to the top of the dashboard. You can see it by looking through the windshield on the driver's side. It is also on the Certification label attached to the driver's doorjamb, and is stamped on the engine compartment bulkhead. The VIN is also provided in bar code on the Certification label.

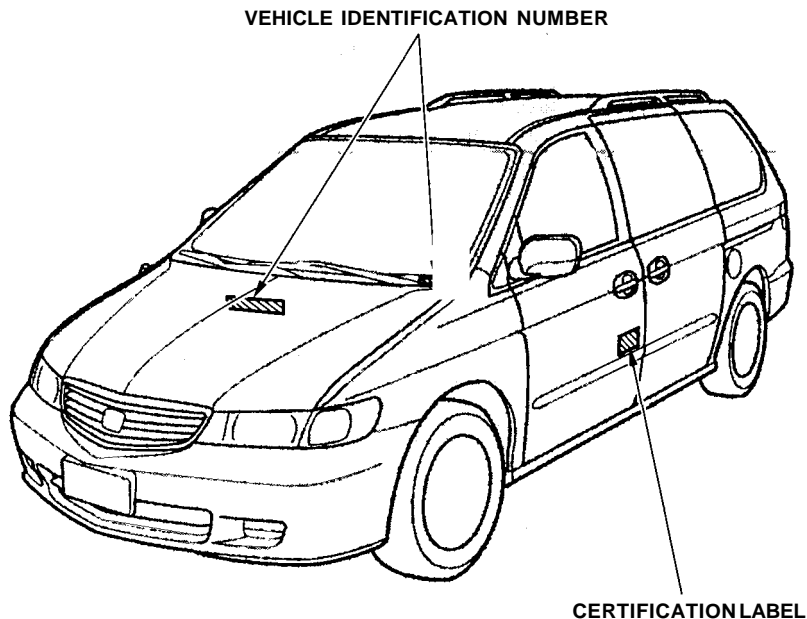

The Engine Number is stamped into the engine block. It is on the front.

The Transmission Number is on a label on top of the transmission.

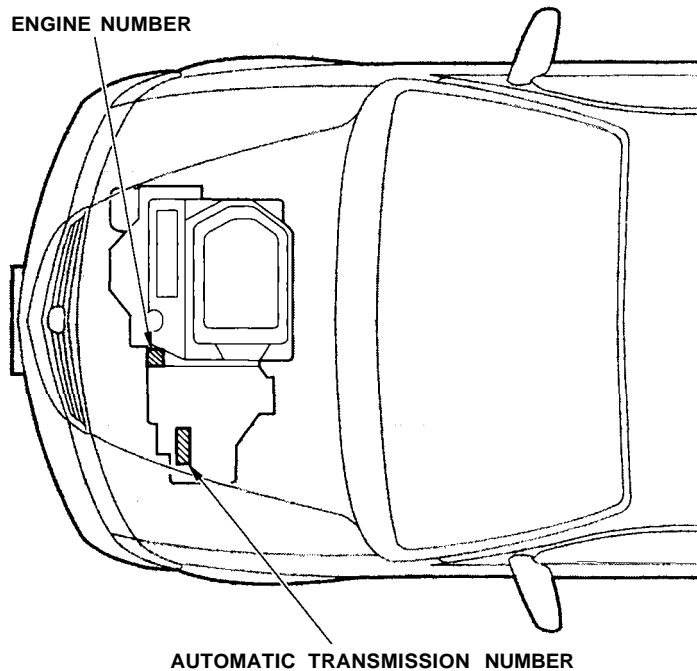

Specifications

Dimensions

Length	201.2 in (5,110 mm)
Width	75.6 in (1,920 mm)
Height	68.5 in (1,740 mm)* ¹ 69.7 in (1,770 mm)* ²
Wheelbase	118.1 in (3,000 mm)
Track	66.1 in (1,680 mm)
Front	
Rear	66.1 in (1,680 mm)

* 1 : LX

* 2 : EX

Weights

Gross vehicle weight rating	See the tire information label attached to the driver's doorjamb.
Gross combined weight rating (GCWR)	8,160 lbs (3,700 kg)

Air Conditioning

Refrigerant type	HFC-134a (R-134a)
Charge quantity	32–34 oz (850–900 g)
Lubricant type	ND-OIL8

Capacities

Fuel tank		Approx. 20.00 US gal (75.7 ℓ , 16.65 Imp gal)
Engine coolant	Change* ¹ Total	1.98 US gal (7.5 ℓ , 1.65 Imp gal) 2.48 US gal (9.4 ℓ , 2.07 Imp gal)
Engine oil	Change** Including filter	4.6 US qt (4.4 ℓ , 3.9 Imp qt)
	Without filter	4.2 US qt (4.0 ℓ , 3.5 Imp qt)
	Total	5.3 US qt (5.0 ℓ , 4.4 Imp qt)
Automatic transmission fluid	Change Total	3.1 US qt (2.9 ℓ , 2.6 Imp qt) 7.6 US qt (7.2 ℓ , 6.3 Imp qt)
Windshield washer reservoir	U.S. Vehicles Canada Vehicles	2.6 US qt (2.5 ℓ , 2.2 Imp qt) 4.8 US qt (4.5 ℓ , 4.0 Imp qt)

* 1 : Including the coolant in the reserve tank and that remaining in the engine.

Reserve tank capacity:

0.16 US gal (0.6ℓ , 0.13 Imp gal)

* 2 : Excluding the oil remaining in the engine.

Lights

Headlights	High/Low	12 V — 60/55 W (HB2)
Front turn signal/parking/side marker lights		12 V — 24/2.2 CP
Rear turn signal lights		12 V — 21 W
Stop/Taillights/Rear side marker lights		12 V — 21/5 W
Taillights		12 V — 2 CP
Back-up lights		12 V — 21 W
License plate light		12 V — 3 CP
High-mount brake light		12 V — 21 CP (18 W)
Individual map lights	Front	12 V — 4 CP
	Rear	12 V — 10 W
Cargo area light		12 V — 8 W
Vanity mirror lights		12 V — 1.8 W

Battery

Capacity	12 V — 52 AH/5 HR
	12 V — 65 AH/20 HR

Fuses

Interior	Driver's side	See page 328 or the fuse label attached to the dashboard.
	Passenger's side	See page 328 or the fuse label attached to the inside of the fuse box door under the dashboard.
Under-hood		See page 327 or the fuse box cover.

Engine

Type	Water cooled 4-stroke SOHC VTEC, 6-cylinder, gasoline engine
Bore x Stroke	3.50 x 3.66 in (89.0 x 93.0 mm)
Displacement	212 cu-in (3,471 cm ³)
Compression ratio	9.4 : 1
Spark plugs	See spark plug maintenance section page 266.

Alignment

Toe-in	Front	0.00 in (0.0 mm)
	Rear	0.00 in (0.0 mm)
Camber	Front	0°
	Rear	-0°30'
Caster	Front	2°07'

Tires

Size	Front/Rear	P215/65R16 96T
	Spare	T135/80D16 101M
Pressure	Front/Rear	35 psi (240 kPa , 2.4 kgf/cm ²)
	Spare	60 psi (420 kPa , 4.2 kgf/cm ²)

Uniform Tire Quality Grading

Quality grades can be found where applicable on the tire sidewall between the tread shoulder and the maximum section width.

For example:

Treadwear 200

Traction AA

Temperature A

DOT Quality Grades

All passenger car tires must conform to Federal Safety Requirements in addition to these grades.

Treadwear

The treadwear grade is a comparative rating based on the wear rate of the tire when tested under controlled conditions on a specified government test course. For example, a tire graded 150 would wear one and one-half (1 1/2) times as well on the government course as a tire graded 100. The relative performance of tires depends upon the actual conditions of their use, however, and may depart significantly from the norm due to variations in driving habits, service practices and differences in road characteristics and climate.

Traction — AA, A, B, C

The traction grades, from highest to lowest, are AA, A, B, and C. Those grades represent the tire's ability to stop on wet pavement as measured under controlled conditions on specified government test surfaces of asphalt and concrete. A tire marked C may have poor traction performance.

Warning: The traction grade assigned to this tire is based on straight-ahead braking traction tests, and does not include acceleration, cornering, hydroplaning, or peak traction characteristics.

Temperature — A, B, C

The temperature grades are A (the highest), B, and C, representing the tire's resistance to the generation of heat and its ability to dissipate heat when tested under controlled conditions on a specified indoor laboratory test wheel. Sustained high temperature can cause the material of the tire to degenerate and reduce tire life, and excessive temperature can lead to sudden tire failure. The grade C corresponds to a level of performance which all passenger car tires must meet under the Federal Motor Vehicle Safety Standard No. 109. Grades B and A represent higher levels of performance on the laboratory test wheel than the minimum required by law.

Warning: The temperature grade for this tire is established for a tire that *is* properly inflated and not overloaded. Excessive speed, underinflation, or excessive loading, either separately or in combination, can cause heat buildup and possible tire failure.

Oxygenated Fuels

Some conventional gasolines are being blended with alcohol or an ether compound. These gasolines are collectively referred to as oxygenated fuels. To meet clean air standards, some areas of the United States and Canada use oxygenated fuels to help reduce emissions.

If you use an oxygenated fuel, be sure it is unleaded and meets the minimum octane rating requirement.

Before using an oxygenated fuel, try to confirm the fuel's contents. Some states/provinces require this information to be posted on the pump.

The following are the U.S. EPA and Canadian CGSB approved percentages of oxygenates:

ETHANOL (ethyl or grain alcohol)
You may use gasoline containing up to 10 percent ethanol by volume. Gasoline containing ethanol may be marketed under the name "Gasohol."

MTBE (Methyl Tertiary Butyl Ether)
You may use gasoline containing up to 15 percent MTBE by volume.

METHANOL (methyl or wood alcohol)
Your vehicle was not designed to use fuel that contains methanol. Methanol can corrode metal parts in the fuel system, and also damage plastic and rubber components. This damage would not be covered by your warranties.

If you notice any undesirable operating symptoms, try another service station or switch to another brand of gasoline.

Fuel system damage or performance problems resulting from the use of an oxygenated fuel containing more than the percentages of oxygenates given above are not covered under warranty.

If you are planning to take your Honda outside the U.S. or Canada, contact the tourist bureaus in the areas you will be traveling in to find out about the availability of unleaded gasoline with the proper octane rating.

If unleaded gasoline is not available, be aware that using leaded gasoline in your Honda will affect performance and fuel mileage, and damage its emissions controls. It will no longer comply with U.S. and Canadian emissions regulations, and will be illegal to operate in North America. To bring your vehicle back into compliance will require the replacement of several components, such as the oxygen sensors and the three way catalytic converter. These replacements are not covered under warranty.

The burning of gasoline in your vehicle's engine produces several by-products. Some of these are carbon monoxide (CO), oxides of nitrogen (NOx) and hydrocarbons (HC). Gasoline evaporating from the tank also produces hydrocarbons. Controlling the production of NOx, CO, and HC is important to the environment. Under certain conditions of sunlight and climate, NOx and HC react to form photochemical "smog." Carbon monoxide does not contribute to smog creation, but it is a poisonous gas.

The Clean Air Act

The United States Clean Air Act* sets standards for automobile emissions. It also requires that automobile manufacturers explain to owners how their emissions controls work and what to do to maintain „ them. This section summarizes how the emissions controls work. Scheduled maintenance is on page [240](#).

* In Canada, Honda vehicles comply with the Canadian Motor Vehicle Safety Standards (CMVSS) for Emissions valid at the time they are manufactured.

Crankcase Emissions Control System

Your vehicle has a Positive Crankcase Ventilation System. This keeps gasses that build up in the engine's crankcase from going into the atmosphere. The Positive Crankcase Ventilation valve routes them

from the crankcase back to the intake manifold. They are then drawn into the engine and burned.

Evaporative Emissions Control System

As gasoline evaporates in the fuel tank, an evaporative emissions control canister filled with charcoal adsorbs the vapor. It is stored in this canister while the engine is off. After the engine is started and warmed up, the vapor is drawn into the engine and burned during driving.

Onboard Refueling Vapor Recovery

The Onboard Refueling Vapor Recovery (ORVR) system captures the fuel vapors during refueling. The vapors are adsorbed in a canister filled with activated carbon. While driving, the fuel vapors are drawn into the engine and burned off.

Exhaust Emissions Controls

The exhaust emissions controls include four systems: PGM-FI, Ignition Timing Control, Exhaust Gas Recirculation and Three Way Catalytic Converter. These four systems work together to control the engine's combustion and minimize the amount of HC, CO, and NOx that comes out the tailpipe. The exhaust emissions control systems are separate from the crankcase and evaporative emissions control systems.

PGM-FI System

The PGM-FI System uses sequential multiport fuel injection. It has three subsystems: Air Intake, Engine Control, and Fuel Control. The Powertrain Control Module (PCM) uses various sensors to determine how much air is going into the engine. It then controls how much fuel to inject under all operating conditions.

Ignition Timing Control System

This system constantly adjusts the ignition timing, reducing the amount of HC, CO and NOx produced.

Exhaust Gas Recirculation (EGR) System

The Exhaust Gas Recirculation (EGR) system takes some of the exhaust gas and routes it back into the intake manifold. Adding exhaust gas to the air/fuel mixture reduces the amount of NOx produced when the fuel is burned.

Three Way Catalytic Converter

The three way catalytic converter is in the exhaust system. Through chemical reactions, it converts HC, CO, and NOx in the engine's exhaust to carbon dioxide (CO₂), dinitrogen (N₂), and water vapor.

Replacement Parts

The emissions control systems are designed and certified to work together in reducing emissions to levels that comply with the Clean Air Act. To make sure the emissions remain low, you should use only new genuine Honda replacement parts or their equivalent for repairs. Using lower quality parts may increase the emissions from your vehicle.

The emissions control systems are covered by warranties separate from the rest of your vehicle. Read your warranty manual for more information.

Three Way Catalytic Converter

The three way catalytic converter contains precious metals that serve as catalysts, promoting chemical reactions to convert the exhaust gasses without affecting the metals. The catalytic converter is referred to as a three-way catalyst, since it acts on HC, CO, and NOx. A replacement unit must be an original Honda part or its equivalent.

The three way catalytic converter must operate at a high temperature for the chemical reactions to take place. It can set on fire any combustible materials that come near it. Park your vehicle away from high grass, dry leaves, or other flammables.

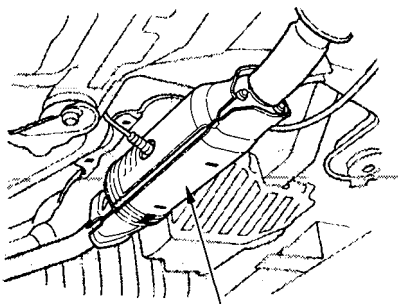

THREE WAY CATALYTIC CONVERTER

A defective three way catalytic converter contributes to air pollution, and can impair your engine's performance. Follow these guidelines to protect your vehicle's three way catalytic converter.

- Always use unleaded gasoline. Even a small amount of leaded gasoline can contaminate the catalyst metals, making the three way catalytic converter ineffective.

- Keep the engine tuned-up.
- Have your vehicle diagnosed and repaired if it is misfiring, back-firing, stalling, or otherwise not running properly.

Testing of Readiness Codes

If you take your vehicle for a state emissions test shortly after the battery has been disconnected or gone dead, it may not pass the test. This is because of certain "readiness codes" that must be set in the on-board diagnostics for the emissions systems. These codes are erased when the battery is disconnected, and set again only after several days of driving under a variety of conditions.

If the testing facility determines that the readiness codes are not set, you will be requested to return at a later date to complete the test. If you must get the vehicle re-tested within the next two or three days, you can condition the vehicle for re-testing by doing the following.

- Make sure the gas tank is nearly, but not completely, full (around 3/4).
- Make sure the vehicle has been parked with the engine off for 8 hours or more.
- Make sure the ambient temperature is between 20° and 95° F.

- Without touching the accelerator pedal, start the engine and let it idle for 20 seconds.
- Keep the vehicle in Park (automatic transmission). Increase the engine speed to 2,000 rpm and hold it there until the temperature gauge rises to at least 1/4 of the scale (approximately 3 minutes).

CONTINUED

- Select a nearby lightly traveled major highway where you can maintain a speed of 50 to 60 mph (80 to 90 km/h) for at least 20 minutes. Drive on the highway in D4 (A/T). Do not use the cruise control. When traffic allows, drive for 90 seconds without moving the accelerator pedal. (Vehicle speed may vary slightly; this is okay.) If you cannot do this for a continuous 90 seconds because of traffic conditions, drive for at least 30 seconds, then repeat it two more times (for a total of 90 seconds).

- Then drive in city/suburban traffic for at least 10 minutes. When traffic conditions allow, let the vehicle coast for several seconds without using the accelerator pedal or the brake pedal.

If the testing facility determines the readiness codes are still not set, see your Honda dealer.

Customer Relations	
Information.....	346
U.S. Zone Office Map.....	347
Canada Zone Office Map.....	348
Warranty Coverages.....	349
Reporting Safety Defects	
(U.S. Vehicles).....	350
Authorized Manuals.....	351

Honda dealership personnel are trained professionals. They should be able to answer all your questions. If you encounter a problem that your dealership does not solve to your satisfaction, please discuss it with the dealership's management. The Service Manager or General Manager can help. Almost all problems are solved in this way.

If you are dissatisfied with the decision made by the dealership's management, contact your Honda Customer Relations Zone Office. Refer to the U.S. and Canadian Zone Office maps on the following pages.

When you call or write, please give us this information:

- Vehicle Identification Number (see page [332](#))
- Name and address of the dealer who services your vehicle
- Date of purchase
- Mileage on your vehicle
- Your name, address, and telephone number
- A detailed description of the problem
- Name of the dealer who sold the vehicle to you

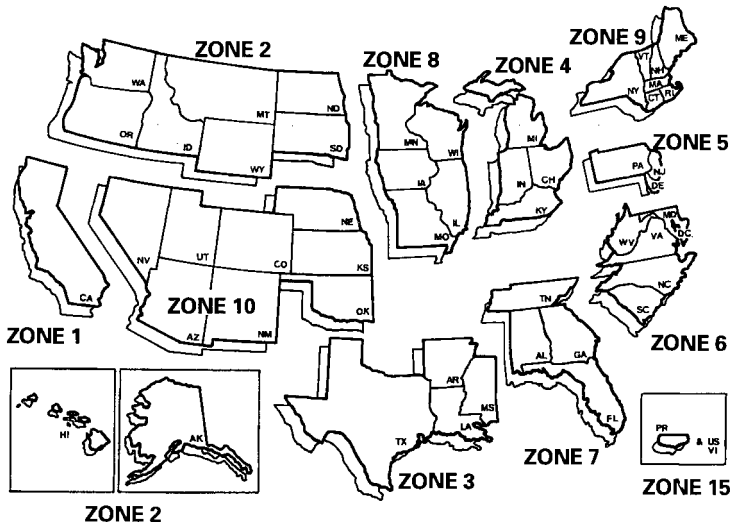

The addresses and telephone numbers are subject to change. If you cannot reach your Zone office, ask your Honda dealer for the current information.

1 Western Zone
P.O. Box 2260
700 Van Ness Avenue
Torrance, California
90501-1490
(310)781-4565

2 Northwestern Zone
P.O. Box 20186
12439 N.E. Airport Way
Portland, Oregon 97230
(503) 256-0943
(also includes Alaska and Hawaii)

3 South Central Zone
4529 Royal Lane
Irving, Texas 75063
(972) 929-5481

4 Central Zone
101 South Stanfield Road
Troy, Ohio 45373
(937) 332-6250

5 Northeastern Zone
115 Gaither Drive
Mt. Laurel, New Jersey 08054
(856) 235-5533
Includes: NYC Metro area and
Fairfield County, CT area

6 Mid-Atlantic Zone
902 Wind River Ln., Suite 200
Gaithersburg, Maryland 20878
(301)990-2020

7 Southeastern Zone
P.O. Box 1606
1500 Morrison Parkway
Alpharetta, Georgia 30009-1606
(770) 442-2045

8 North Central Zone
601 Campus Drive, Suite A-9
Arlington Heights, Illinois 60004
(847) 870-5600

9 New England Zone
555 Old County Road
Windsor Locks, Connecticut 06096
(860) 623-3310
See Zone 5 for:
NYC Metro area and
Fairfield County, CT area

10 West Central Zone
1600 South Abilene Street, Suite D
Aurora, Colorado 80012
(303) 696-3935

15 Puerto Rico and U.S. V.I.
Bella International
P.O. Box 190816
San Juan, PR 00919-0816
(787) 250-4318

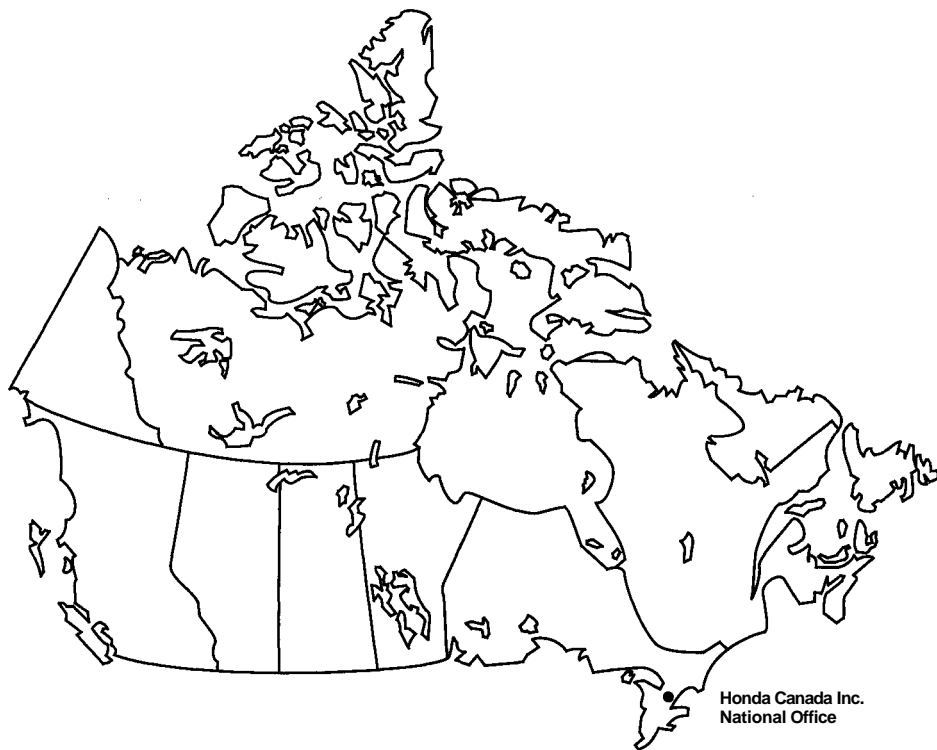

Honda Canada Inc.
National Office

CUSTOMER RELATIONS RELATIONS AVEC LA CLIENTELE

Honda Canada Inc.
715 Milner Avenue
Toronto, ON
M1B2K8

Tel: 1-888-9-HONDA-9

Fax: Toll-free 1-877-939-0909
Toronto (416)287-4776

U.S. Owners

Your new Honda is covered by these warranties:

New Vehicle Limited Warranty — covers your new vehicle, except for the battery, emissions control systems and accessories, against defects in materials and workmanship.

Emissions Control Systems Defects Warranty and Emissions Performance Warranty — these two warranties cover your vehicle's emissions control systems. Time, mileage, and coverage are conditional. Please read the warranty manual for exact information.

Original Equipment Battery Limited Warranty — this warranty gives up to 100 percent credit toward a replacement battery.

Seat Belt Limited Warranty — a seat belt that fails to function properly is covered for the useful life of the vehicle.

Rust Perforation Limited Warranty — all exterior body panels are covered for rust-through from the inside for the specified time period with no mileage limit.

Accessory Limited Warranty — Genuine Honda Accessories are covered under this warranty. Time and mileage limits depend on the type of accessory and other factors. Please read your warranty manual for details.

Replacement Parts Limited Warranty — covers all genuine Honda replacement parts against defects in materials and workmanship.

Replacement Battery Limited Warranty — provides prorated coverage for a replacement battery purchased from a Honda dealer.

Replacement Muffler Lifetime Limited Warranty — provides coverage for as long as the purchaser of the muffler owns the vehicle.

Restrictions and exclusions apply to all these warranties. Please read the 2001 Honda Warranty Information booklet that came with your car for precise information on warranty coverages. Your Honda's original tires are covered by their manufacturer. Tire warranty information is in a separate booklet.

Canadian Owners

Please refer to the 2001 Warranty Manual that came with your car.

Reporting Safety Defects (U.S. Vehicles)

If you believe that your vehicle has a defect which could cause a crash or could cause injury or death, you should immediately inform the National Highway Traffic Safety Administration (NHTSA) in addition to notifying American Honda Motor Co., Inc.

If NHTSA receives similar complaints, it may open an investigation, and if it finds that a safety defect exists in a group of vehicles, it may order a recall and remedy campaign. However, NHTSA cannot become involved in individual problems between you, your dealer, or American Honda Motor Co., Inc.

To contact NHTSA, you may either call the Auto Safety Hotline toll-free at 1-800-424-9393 (or 366-0123 in Washington D.C. area) or write to: NHTSA, U.S. Department of Transportation, Washington, D.C. 20590. You can also obtain other information about motor vehicle safety from the Hotline.

Purchasing Factory Authorized Manuals (U.S. only)

The following publications covering the operation and servicing of your vehicle can be obtained from Helm Incorporated, either by filling out the attached form or, for credit card holders, calling the toll-free phone number on the form. For manuals prior to the year shown below, contact Helm Incorporated, P.O. Box 07280, Detroit, Michigan 48207, or call 1-800-782-4356.

Publication Form Number	Form Description	Price Each*
61SOX02	1999-2001 Honda Odyssey Service Manual	\$66.00
61SOX02EL	1999-2001 Honda Odyssey Electrical Troubleshooting Manual	\$46.00
61SOX30	1999-2001 Honda Odyssey Body Repair Manual	\$40.00
31SOX620	2001 Honda Odyssey Owner's Manual	\$30.00
31SOX720	2001 Honda Odyssey Navigation System Owner's Manual	\$27.00
HON-R	Order Form for Previous Years- Indicate Year and Model Desired	FREE
* Prices are subject to change without notice and without incurring obligation.		

Valid only for sales within the U.S. Canadian owners should contact their authorized Honda dealer.

ORDER TOLL FREE: 1-800-782-4356

(NOTE: For Credit Card Holder Orders Only)

Monday-Friday 8:00 A.M. — 6:00 P.M. EST

MINIMUM CREDIT CARD PURCHASE \$10.00

OR

By completing this form you can order the materials desired. You can pay by check or money order, or charge to your credit card. Mail to Helm Incorporated at the address shown on the back of the order form.

2001 HON	PUBLICATION NUMBER	VEHICLE MODEL		Qty	Price Each*	Total Price
		Name	Year			
* Prices are subject to change without notice and without incurring obligation.					TOTAL MATERIAL	
					Mich. Purchases Add 6% Sales Tax	
Orders are mailed within 10 days. Please allow adequate time for delivery.					HANDLING CHARGE	\$6.00
					GRAND TOTAL	

S H I P T O	NOTE: Dealers and Companies please provide dealer or company name, and also the name of the person to whose attention the shipment should be sent. For purchases outside U.S.A. please write to the address shown below for a quotation.	
	Customer Name _____	Attention _____
	Street Address - No P.O. Box Number _____	Apartment Number _____
	City _____	State & Zip Code _____
	Daytime Telephone Number () _____	

P A Y M E N T	<input type="checkbox"/> Check or money order enclosed payable to Helm Inc - U.S. funds only. Do not send cash				
	<input type="checkbox"/> Master Card <input type="checkbox"/> VISA <input type="checkbox"/> Check here if your billing address is different from the shipping address shown above.				
	Account Number _____ Expiration: Mo. Yr. _____				
	<table border="1" style="width: 100%; height: 20px;"><tr><td style="width: 25%;"></td><td style="width: 25%;"></td><td style="width: 25%;"></td><td style="width: 25%;"></td></tr></table>				
_____ CUSTOMER SIGNATURE DATE					

These Publications cannot be returned for credit without receiving advance authorization within 14 days of delivery. On returns, a restocking fee may be applied against the original order.

HELM P.O. BOX 07280-DETROIT, MICHIGAN 48207 • 1-800-782-4356

Service Manual:

This manual covers maintenance and recommended procedures for repair to engine and chassis components. It is written for the Journeyman mechanic, but is simple enough for most mechanically-inclined owners to understand.

Electrical Troubleshooting Manual:

This manual complements the Service Manual by providing in-depth troubleshooting information for each electrical circuit in your vehicle.

Body Repair Manual:

This manual describes the procedures involved in the replacement of damaged body parts.

A

Accessories and Modifications....	203
Accessories.....	203
Additional Safety Precaution....	204
Modifications.....	204
ACCESSORY (Ignition Key Position).....	83
Accessory Power Sockets.....	130
Additives, Engine Oil.....	251
Airbag (SRS).....	9, 53
Air Cleaner Element.....	262
Air Conditioning Filter.....	272
Air Conditioning System.....	136, 144
Maintenance.....	271
Rear A/C Control.....	158
Usage.....	136, 144
Air Outlets (Vents).....	138, 144
Air Pressure, Tires.....	273
Alcohol in Gasoline.....	338
Aluminum Wheels, Cleaning.....	295
Antifreeze.....	253
Anti-lock Brakes (ABS) Indicator.....	63, 220
Operation.....	219
Anti-theft, Audio System.....	192

Anti-theft Steering Column Lock ..	82
Appearance Care.....	293
Armrests.....	109
Audio Controls, Remote.....	191
Audio System.....	161, 173
Automatic Seat Belt Tensioners....	54
Automatic Lighting Off Feature....	71
Automatic Speed Control.....	77
Automatic Transmission.....	212
Capacity, Fluid.....	334
Checking Fluid Level.....	259
Shifting.....	213
Shift Lever Position Indicator..	212
Shift Lever Positions.....	213
Shift Lock Release.....	216

B

Battery Charging System Indicator.....	62, 319
Jump Starting.....	313
Maintenance.....	267
Specifications.....	335
Before Driving.....	195
Belts, Seat.....	8, 49

Beverage Holder.....	124
Body Repair.....	300
Brakes Anti-lock System (ABS).....	219
Break-in, New Linings	196
Bulb Replacement.....	284
Fluid.....	260
Parking.....	122
System Indicator.....	62, 322
Wear Indicators.....	218
Braking System.....	218
Break-in, New Vehicle	196
Brightness Control, Instruments...	71
Brights, Headlights.....	70
Bulb Replacement Back-up Lights.....	285
Brake Lights.....	284
Cargo Area Light.....	288
Front Parking Lights.....	283
Front Side Marker Lights.....	283
Headlights.....	282
High-mount Brake Light.....	286
Individual Map Lights.....	288
License Plate Light.....	287

CONTINUED

Bulb Replacement	
Rear Bulbs.....	284, 285
Specifications.....	335
Turn Signal Lights.....	283
Bulbs, Halogen.....	282

C

Cancel Button.....	79
Capacities Chart.....	334
Carbon Monoxide Hazard.....	57
Cargo Area Light.....	133
Cargo Net.....	208
Carrying Cargo.....	205
Cassette Player	
Care.....	190
Operation.....	166, 187
CAUTION, Explanation of.....	ii
CD Changer.....	169, 183
CD Player.....	169, 181
Center Pocket.....	128
Center Table.....	123
Certification Label.....	332
Chains.....	279
Changing Oil	
How to.....	251

When to.....	240
Changing a Flat Tire.....	303
Changing Engine Coolant.....	255
Charging System Indicator....	62, 319
Checklist, Before Driving.....	210
Childproof Door Locks.....	89
Child Safety.....	22
Child Seat.....	28
Tether Anchorage Points.....	45
Cleaner Element, Air.....	262
Cleaning	
Aluminum Wheels.....	295
Carpeting.....	296
Exterior.....	294
Fabric.....	297
Interior.....	296
Seat Belts.....	297
Vinyl.....	297
Windows.....	298
Climate Control System.....	144
Clock, Setting the.....	123
Coat Hook.....	129
Code, Audio System.....	192
CO in the Exhaust.....	340
Coin Holder.....	128
Cold Weather, Starting in.....	211

Compact Spare.....	302
Consumer Information*.....	346
Controls, Instruments and.....	59
Coolant	
Adding.....	253
Checking.....	201
Proper Solution.....	253
Replacing.....	255
Temperature Gauge.....	67
Corrosion Protection.....	299
Crankcase Emissions Control	
System.....	340
Cruise Control Operation.....	77
Customer Relations Office.....	346

D

DANGER, Explanation of.....	ii
Dashboard.....	2, 60
Daytime Running Lights.....	71
Defects, Reporting Safety.....	350
Defogger, Rear Window.....	75
Defrosting the Windows.....	141, 151
Dimensions.....	334
Dimming the Headlights.....	70

Dipstick	
Automatic Transmission.....	259
Engine Oil.....	200
Directional Signals.....	72
Disc Brake Wear Indicators.....	218
Disposal of Used Oil.....	252
Doors	
Locking and Unlocking.....	83
Lockout Prevention.....	84
Manual Sliding Doors.....	92
Monitor Light.....	64
Power Door Locks.....	83
Power Sliding Doors.....	94
DOT Tire Quality Grading.....	336
Drive Belts.....	272
Driver and Passenger Safety.....	5
Driving.....	209
Economy.....	202
In Bad Weather.....	224
In Foreign Countries.....	339

E

Economy, Fuel.....	202
Emergencies on the Road.....	301
Battery, Jump Starting.....	313

Emergencies on the Road	
Brake System Indicator.....	322
Changing a Flat Tire.....	303
Charging System Indicator.....	319
Checking the Fuses.....	323
Low Oil Pressure Indicator.....	318
Malfunction Indicator Lamp....	320
Overheated Engine.....	315
Emergency Brake.....	122
Emergency Flashers.....	75
Emergency Towing.....	329
Emissions Controls.....	340
Emissions Testing, State.....	343
Engine	
Coolant Temperature Gauge....	67
Drive Belts.....	272
Malfunction Indicator	
Lamp.....	62, 320
Oil Pressure Indicator.....	62, 318
Oil, What Kind to Use.....	249
Overheating.....	315
Specifications.....	335
Starting.....	211
Ethanol in Gasoline	338
Evaporative Emissions Controls..	340
Exhaust Fumes.....	57

Exhaust Gas Recirculation	
System.....	341
Expectant Mothers, Use of Seat	
Belts by.....	20
Exterior, Cleaning the.....	294

F

Fabric, Cleaning.....	297
Fan, Interior.....	136, 148
Features, Comfort and	
Convenience.....	135
Filling the Fuel Tank.....	197
Filters	
Air.....	262
Air Conditioning.....	272
Oil.....	251
Flashers, Hazard Warning.....	75
Flat Tire, Changing a.....	303
Floor Mat.....	296
Fluids	
Automatic Transmission.....	259
Brake.....	260
Power Steering.....	261

CONTINUED

Fluids	
Windshield Washer.....	258
FM Stereo Radio	
Reception.....	162, 174
Folding the Third Seat.....	115
Foreign Countries, Driving in.....	339
Four-way Flashers.....	75
Fuel.....	196
Fill Door and Cap.....	197
Gauge.....	67
Octane Requirement.....	196
Oxygenated.....	338
Reserve Indicator.....	65
Tank, Filling the.....	197
Fuses, Checking the.....	324

G

Gas Mileage, Improving.....	202
Gasohol.....	338
Gasoline.....	196
Fuel Reserve Indicator.....	65
Gauge.....	67
Octane Requirement.....	196
Tank, Filling the.....	197
Gas Station Procedures.....	197

Gauges	
Engine Coolant Temperature	67
Fuel.....	67
Speedometer.....	66
Tachometer.....	66
GAWR (Gross Axle Weight Rating)	228
GCWR (Gross Combined Weight Rating)	228
Gearshift Lever Positions.....	213
Glass Cleaning.....	298
Glove Box.....	91
GVWR (Gross Vehicle Weight Rating)	228

H

Halogen Headlight Bulbs.....	282
Hazard Warning Flashers.....	75
Headlights.....	70
Aiming.....	282
Automatic Lighting Off.....	71
Daytime Running Lights.....	71
High Beam Indicator.....	65
Reminder Chime.....	70
Replacing Halogen Bulbs	282

Turning on.....	70
Head Restraints.....	110
Heated Mirror.....	122
Heating and Cooling.....	136
High Altitude, Starting at.....	211
High-Low Beam Switch	70
HomeLink Universal Transmitter.....	99
Hood Latch.....	264
Hood, Opening the.....	198
Horn.....	69
Hydroplaning.....	225

I

Identification Number, Vehicle....	332
Ignition	
Keys.....	80
Switch.....	82
Timing Control System.....	341
Immobilizer System.....	81
Important Safety Precautions.....	6
Indicators, Instrument Panel.....	61
Individual Map Lights.....	133
Infant Restraint.....	32

Infant Seats.....	28
Tether Anchorage Points.....	45
Inflation, Proper Tire	273
Inside Mirror.....	121
Inspection, Tire.....	275
Instrument Panel.....	2, 60
Instrument Panel Brightness.....	71
Interior Cleaning.....	296
Interior Lights.....	131
Introduction.....	i

J

Jacking up the Vehicle.....	306
Jack, Tire.....	304
Jump Starting.....	313

K

Keys.....	80
-----------	----

L

Label, Certification.....	332
Lane Change, Signaling.....	72
Lap/Shoulder Belts.....	15, 49

Light Control Switch.....	131
Lights	
Bulb Replacement.....	282
Indicator.....	61
Interior.....	131
Parking.....	70
Turn Signal.....	72
Load Limits.....	206, 226
LOCK (Ignition Key Position).....	82
Locks	
Anti-theft Steering Column.....	82
Fuel Fill Door.....	197
Glove Box.....	91
Lockout Prevention.....	84
Power Door.....	83
Sliding Doors.....	92
Tailgate.....	89
Low Coolant Level.....	201
Low Fuel Indicator.....	65
Low Oil Pressure Indicator....	62, 318
Lubricant Specifications Chart....	334
Luggage.....	205

M

Maintenance.....	235
Owner Maintenance Checks....	247
Record.....	245-246
Required Indicator.....	68
Safety.....	236
Schedule.....	240-244
Malfunction Indicator Lamp..	62, 320
Manual Sliding Doors.....	92
Meters, Gauges.....	66
Methanol in Gasoline.....	338
Mirrors, Adjusting.....	121
Moving the Second Row Bucket Seat.....	112

N

Neutral Gear Position.....	214
New Vehicle Break-in.....	196
NOTICE, Explanation of.....	i
Numbers, Identification.....	332

CONTINUED

O

Octane Requirement, Gasoline....	196
Odometer.....	66
Odometer, Trip.....	67
Oil	
Change, How to.....	251
Change, When to.....	240
Checking Engine.....	200
Pressure Indicator.....	62, 318
Selecting Proper Viscosity Chart.....	250
ON (Ignition Key Position).....	83
Operation in Foreign Countries...	339
Outside Mirrors.....	121
Overheating, Engine.....	315
Owner Maintenance Checks.....	247
Oxygenated Fuels.....	338

P

Paint Touch-up.....	295
Panel Brightness Control.....	71
Park Gear Position.....	213
Parking.....	217
Parking Brake.....	122

Parking Lights.....	70
Parking Over Things that Burn...	217
PGM-FI System.....	341
Polishing and Waxing.....	295
Power Sliding Doors	
Indicator.....	64, 98
Operation.....	94
Switches.....	94
Pre-Drive Safety Checklist.....	11
Pregnancy, Using Seat Belts.....	20
Protecting Adults.....	12
Additional Safety Precautions...	20
Advice for Pregnant Women.....	20
Protecting Children.....	22
Protecting Infants.....	32
Protecting Larger Children.....	41
Protecting Small Children.....	37
Using Child Seats with Tethers.....	45
Lower Anchorages.....	47

R

Radiator Overheating.....	315
Radio/CD Sound System.....	173
Readiness Codes.....	321

Rear A/C Unit.....	158
Rear Compartment.....	128
Rear Lights, Bulb Replacement.....	284, 285
Rear View Mirror.....	121
Rear Window Defogger.....	75
Rear Windows.....	120
Rear Window Wiper and Washer..	74
Reclining the Seat Backs.....	106, 109
Reclining the Second Seats.....	106
Reclining the Third Seat.....	106
Reminder Lights.....	61
Remote Audio Controls.....	191
Remote Transmitter.....	85
Removing the Second Seats.....	114
Replacement Information	
Air Cleaner Element.....	262
Coolant.....	255
Engine Oil and Filter.....	251
Fuses.....	323
Light Bulbs.....	282
Schedule.....	238
Spark Plugs.....	264
Timing Belt.....	273
Tires.....	277

Wiper Blades.....	269
Replacing Seat Belts After a Crash.....	51
Reserve Tank, Engine Coolant....	201
Reverse Gear Position.....	214
Rotation, Tire.....	276

S

Safety Belts.....	8, 49
Safety Defects, Reporting*.....	350
Safety Features.....	7
Air bags.....	9
Door Locks.....	10
Head Restraints.....	10
Seat Belts.....	8
Seats & Seat-Backs.....	10
Safety Labels, Location of.....	58
Safety Messages.....	ii
Seat Belts.....	8, 49
Additional Information.....	49
Automatic Seat Belt Tensioners.....	54
Cleaning.....	297
Lap/Shoulder Belt.....	49
Maintenance.....	51

Reminder Light and Beeper.....	49, 61
System Components.....	49
Use During Pregnancy.....	20
Wearing a Lap/Shoulder Belt....	15
Seats.....	104
Adjustments.....	105
Folding the Third Seat.....	115
Head Restraints.....	110
Manual Height Adjustment.....	107
Passenger Seating.....	104
Reclining the Second Seat.....	106
Reclining the Third Seat.....	106
Removing the Second Seats....	114
Third Seat Access.....	111
Security System.....	193
Serial Number.....	332
Service Intervals.....	240
Service Manual*.....	351
Service Station Procedures	197
Setting the Clock.....	123
Shift Lever Position Indicator.....	212
Shift Lock Release.....	215
Side Marker Lights, Bulb Replacement.....	283
Signaling Turns.....	72

Sliding Doors.....	92
Snow Tires.....	279
Solvent-type Cleaners.....	294
Sound System.....	161, 173
Spare Tire Inflating.....	302
Specifications.....	335
Spark Plugs.....	264
Specifications Charts.....	334
Speed Control.....	77
Speedometer.....	66
SRS, Additional Information.....	52
Additional Safety Precautions....	56
How the Automatic Seat Belt Tensioners Work.....	54
How the SRS Indicator Works...	54
How Your Airbags Work.....	52
SRS Components.....	52
SRS Service.....	55
SRS Indicator.....	54, 62
START (Ignition Key Position)....	83

CONTINUED

Index

Starting the Engine.....	211
In Cold Weather at High	
Altitude.....	211
With a Dead Battery.....	313
State Emissions Testing.....	343
Steam Coming from Engine.....	315
Steering Wheel	
Adjustment.....	76
Anti-theft Column Lock.....	82
Stereo Sound System.....	161, 173
Storing Your Vehicle.....	291
Storage Box.....	129
Sunglasses Holder.....	126
Sun Visor.....	127
Supplemental Restraint System	
Servicing.....	55
SRS Indicator.....	54, 62
System Components.....	52
Synthetic Oil.....	250

T

Tachometer.....	66
Tailgate.....	89
Opening the.....	89
Open Monitor Light.....	64

Taillights, Changing Bulbs in.....	285
Taking Care of the Unexpected..	301
Tape Player.....	166, 187
Technical Descriptions	
Emissions Control Systems.....	340
Oxygenated Fuels.....	338
Three Way Catalytic	
Converter.....	342
Temperature Gauge.....	67
Tensioners, Seat Belts.....	54
Tether Anchorage Points.....	45
Theft Protection.....	192
Three Way Catalytic Converter...	342
Time, Setting the.....	123
Timing Belt.....	273
Tire Chains.....	279
Tire, How to Change a Flat.....	303
Tires.....	273
Air Pressure.....	273
Balancing.....	276
Checking Wear.....	275
Compact Spare.....	302
DOT Tire Quality Grading.....	336
Inflation.....	273
Inspection.....	275
Replacing.....	277

Rotating.....	276
Snow.....	279
Specifications.....	335
Tire Chains.....	279
Towing	
A Trailer.....	226
Emergency Wrecker.....	329
Traction Control System (TCS)...	221
Transmission	
Checking Fluid Level.....	259
Fluid Selection.....	259
Identification Number.....	333
Shifting the Automatic.....	213
Treadwear.....	336
Trip Meter.....	67
Turn Signals.....	72
Tools, Tire Changing.....	303

U

Underside, Cleaning.....	299
Unexpected, Taking Care	
of the.....	301
Uniform Tire Quality Grading....	336
Unleaded Gasoline.....	196
Upholstery Cleaning.....	296

Used Oil, How to Dispose of..... 252

V

Vanity Mirror..... 127
 Vehicle Capacity Load..... 206, 226
 Vehicle Dimensions..... 334
 Vehicle Identification Number..... 332
 Vehicle Storage..... 291
 Ventilation..... 139, 144
 VIN..... 332
 Vinyl Cleaning..... 297
 Viscosity, Oil..... 250

W

WARNING, Explanation of..... ii
 Warning Labels, Location of..... 58
 Warranty Coverages*..... 349
 Washer, Windshield
 Checking the Fluid Level..... 258
 Level Indicator..... 65
 Operation..... 74
 Washing..... 294
 Waxing and Polishing..... 295

Wheels

Adjusting the Steering..... 76
 Alignment and Balance..... 276
 Compact Spare..... 302
 Wrench..... 305

Windows

Cleaning..... 298
 Operating the Power..... 118
 Rear..... 120
 Rear, Defogger..... 75

Windshield

Cleaning..... 72
 Defroster..... 141, 151
 Washers..... 74

Wipers, Windshield

Changing Blades..... 269
 Operation..... 72
 Rear Windshield Wiper and
 Washer..... 74

Worn Tires..... 275

Wrecker, Emergency Towing..... 329

* : U.S. and Canada only

Service Information Summary

Gasoline:

Unleaded gasoline, pump octane number of 86 or higher.

Fuel Tank Capacity:

20.00 US gal (75.7 l, 16.65 Imp gal)

Recommended Engine Oil:

API Service SJ "Energy Conserving" oil, SAE 5W-30 viscosity (see page [249](#)).

Oil change capacity (including filter):

4.6 US qt (4.4 l, 3.9 Imp qt)

Automatic Transmission Fluid:

Honda ATF-Z1 (Automatic Transmission Fluid) preferred, or a DEXRON® III ATF as a temporary replacement (see page [259](#)).

Power Steering Fluid:

Honda Power Steering Fluid preferred, or another brand of power steering fluid as a temporary replacement. Do not use ATF (see page [261](#)).

Brake Fluid:

Honda Heavy Duty Brake Fluid DOT 3 preferred, or a DOT 3 or DOT 4 brake fluid as a temporary replacement (see page [260](#)).

Tire Pressure (measured cold):

Front/Rear:

35 psi (240 kPa, 2.4 kgf/cm²)

Compact Spare Tire:

60 psi (420 kPa, 4.2 kgf/cm²)