

1996 Accord Wagon Online Reference Owner's Manual

Use these links (and links throughout this manual) to navigate through this reference.
For a printed owner's manual, click on authorized manuals or go to www.helminc.com.

Contents

Owner's Identification Form

Introduction	i
A Few Words About Safety	ii
Driver and Passenger Safety	3
Proper use and care of your vehicle's seat belts, and Supplemental Restraint System.	
Instruments and Controls	27
Instrument panel indicator and gauge, and how to use dashboard and steering column controls.	
Comfort and Convenience Features	59
How to operate the climate control system, the audio system, and other convenience features.	
Before Driving	81
What gasoline to use, how to break-in your new vehicle, and how to load luggage and other cargo.	
Driving	93
The proper way to start the engine, shift the transmission, and park, plus towing a trailer.	
Maintenance	107
The Maintenance Schedule shows you when you need to take your vehicle to the dealer.	
Appearance Care	149
Tips on cleaning and protecting your vehicle. Things to look for if your vehicle ever needs body repairs.	
Taking Care of the Unexpected	155
This section covers several problems motorists sometimes experience, and how to handle them.	
Technical Information	175
ID numbers, dimensions, capacities, and technical information.	
Warranty and Customer Relations (U.S. and Canada)	187
A summary of the warranties covering your new Acura, and how to contact us.	
Authorized Manuals (U.S. only)	191
How to order manuals and other technical literature.	
Index	I

Gas Station Information

Information you need when you pull up to the fuel pump.

Congratulations! Your selection of a 1996 Honda Accord Wagon was a wise investment. It will give you years of driving pleasure.

One of the best ways to enhance the enjoyment of your new Honda is to read this manual. In it, you will learn about your vehicle's many safety features, and how to operate its driving controls and convenience items. Afterwards, keep this owner's manual in your vehicle so you can refer to it at any time.

Several warranties protect your new Honda. Read the warranty booklet thoroughly so you understand the coverages and are aware of your rights and responsibilities.

Maintaining your vehicle according to the schedules given in this manual helps to keep your driving trouble-free while it preserves your investment. When your vehicle needs maintenance, keep in mind that your Honda dealer's staff is specially trained in servicing the many systems unique to your Honda. Your Honda dealer is dedicated to your satisfaction and will be pleased to answer any questions and concerns.

Safety Messages

Your safety and the safety of others is very important. We have provided many important safety messages in this manual and on the vehicle. Please read these messages carefully.

A safety message alerts you to potential hazards that could hurt you or others. Each safety message is preceded by a safety alert symbol  and one of three words, **DANGER**, **WARNING** or **CAUTION**. These mean:

You **WILL** be **KILLED** or **SERIOUSLY HURT** if you don't follow instructions.

You **CAN** be **KILLED** or **SERIOUSLY HURT** if you don't follow instructions.

You **CAN** be **HURT** if you don't follow instructions.

Each safety message tells you what the hazard is, what can happen, and what you can do to avoid or reduce injury.

You will also see another important symbol:

NOTICE

Your Honda or other property can be damaged if you don't follow instructions.

The purpose of these messages is to help prevent damage to your vehicle, other property, or the environment.

Driver and Passenger Safety

This section gives you important information about occupant protection. It shows how to use seat belts properly. It explains the Supplemental Restraint System. And it gives useful information about how to protect infants and children in your car.

Your Occupant Protection System	4
The Seat Belt System and How It Works	5
Why Wear Seat Belts	5
Important Safety Reminders	5
Seat Belt System Components	5
Lap/Shoulder Belt	6
Lap Belt	6
Wearing Seat Belts Properly	7
Wearing a Lap/Shoulder Belt	7
Wearing the Lap Belt	9
Advice for Pregnant Women	10
Seat Belt Maintenance	10

Supplemental Restraint System	11
SRS Components	11
What Happens in a Crash .	11
Important Facts About Airbags	12
How the Driver's Airbag Works	13
How the Passenger's Airbag Works	14
How the SRS Indicator Light Works ...	15
System Service	15
System Service Precautions	15
Additional Safety Information	16
Seat-Back Position	16
Head Restraint Position ...	16
Door Locks	17
Storing Cargo Safely	17
Driving With Pets	17
Child Safety	18
Where Should Children Sit?	18
Important Safety Reminders	19

General Guidelines for Restraining Children Under 40 lb (18 kg)	19
Restraining an Infant Who Weighs Less Than 20 lb (9 kg)	20
Restraining a Child Who Weighs Between 20 and 40 lb (9 and 18 kg)	20
Restraining a Child Who Weighs Over 40 lb (18 kg)	21
Securing a Child Seat With a Lap/Shoulder Belt .	22
Using Child Restraints With Tethers	22
Storing a Child Seat	23
Alcohol and Drugs	23
Carbon Monoxide Hazard ...	24
Safety Labels	25

Your Occupant Protection System

Your Honda is equipped with seat belts and other features that work together to protect you and your passengers during a crash.

Seat belts are the most important part of your occupant protection system. When worn properly, seat belts can reduce the chance of serious injury or death in a crash.

For added protection during a severe frontal collision, your Accord has a Supplemental Restraint System (SRS) with a driver's airbag and a front passenger's airbag.

Two indicator lights are also part of your safety system. One reminds you to make sure you and your passengers wear your seat belts. The other alerts you to a possible problem with your

supplemental restraint system (see page 14).

The seats, head restraints, and door locks also play a role in occupant safety. For example, reclining the seat-back can decrease the effectiveness of your seat belt. Head restraints can help protect your neck and head, especially during rear-end impacts. Door locks help keep your doors from being accidentally opened during a crash.

To get the maximum protection from your occupant protection system, check the following before you drive away:

- Everyone in the car is wearing a seat belt properly (see page 7).

- Infants or small children are properly secured in a child safety seat (see page 18).
- All doors and the tailgate are closed and locked (see page 16).
- Seat-backs are upright and head restraints are properly adjusted (see pages 16 and 48).
- There are no loose items that could be thrown around and hurt someone during a crash or sudden stop (see page 16).

By following these guidelines, you can reduce injuries to yourself and your passengers in many crash situations. Remember, however, that no safety system can prevent all injuries or deaths that can occur in severe crashes.

Why Wear Seat Belts

Wearing seat belts and wearing them properly is fundamental to your safety and the safety of your passengers.

During a crash or emergency stop, seat belts can help keep you from being thrown against the inside of the car, against other occupants, or out of the car.

Of course, seat belts cannot completely protect you in every crash. But, in most cases, seat belts reduce your chance of serious injury. They can even save your life. That is why many states require you to wear seat belts.

Not wearing a seat belt increases the chance of being killed or seriously hurt in a crash.

Be sure you and your passengers always wear seat belts and wear them properly.

Important Safety Reminders

Seat belts are designed for adults and larger children. All infants and small children must be properly restrained in child safety seats (see page 18).

A pregnant woman needs to wear a seat belt to protect herself and her unborn child (see page 9).

Two people should never use the same seat belt. If they do, they could be very seriously injured in a crash.

Do not place the shoulder portion of a lap/shoulder belt under your arm or behind your back. This could increase the chance of serious injuries in a crash.

Do not put shoulder belt pads or other accessories on seat belts. They can reduce the effectiveness of the belts and increase the chance of injury.

Seat Belt System Components

Your Honda has seat belts in all five seating positions. The front seats and the outside positions of the rear seat have lap/shoulder belts. The center position of the rear seat has a lap belt.

continued

The Seat Belt System and How It Works

Your seat belt system also includes a light on the instrument panel to remind you to fasten your seat belt and to make sure your passengers fasten theirs. This light comes on when you turn on the ignition if you have not fastened your seat belt. A beeper also sounds for several seconds (see page 30).

The following pages cover more about the seat belt components and how they work.

Lap/Shoulder Belt

This style of seat belt has a single belt that goes over your shoulder, across your chest and across your hips.

Each lap/shoulder belt has an emergency locking retractor. In normal driving, the retractor lets you move freely in your seat while it keeps some tension on

the belt. During a collision or sudden stop, the retractor automatically locks the belt to help restrain your body.

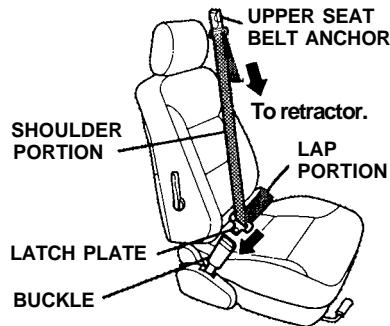

The lap/shoulder belt retractor in each passenger seating position has an additional locking mechanism that is intended to secure a child seat (see page 21). If the shoulder part of the belt is pulled all the way out, this mechanism will

engage. The belt will retract, but it will not allow the passenger to move freely. If the belt feels too tight, unlatch it, let it retract fully, then pull it out as far as needed.

Lap Belt

The lap belt has one manually adjusted belt that fits across the hips. It is similar to safety belts used in airplanes.

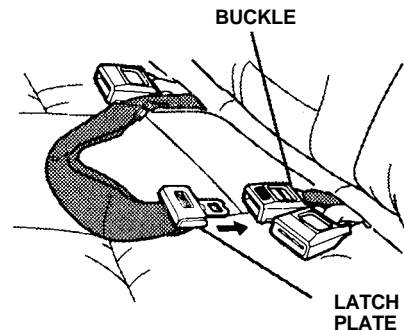

The Seat Belt System and How It Works

Wearing Seat Belts Properly

You can increase the effectiveness of your seat belts if you take a little time to read the following pages and make sure you know how to wear seat belts properly.

Not wearing a seat belt properly increases the chance of serious injury or death in a crash.

Be sure you and your passengers always wear seat belts and wear them properly.

Wearing a Lap/Shoulder Belt

Before putting on the seat belt, move the driver's seat back as far as is practical while still

allowing you to maintain full control of the vehicle. Make sure the seat-back is upright (see page 16). The front seat passenger should move the seat as far back as possible.

1. Pull the latch plate across your body, and insert it into the buckle. Tug on the belt to make sure the latch is securely locked.

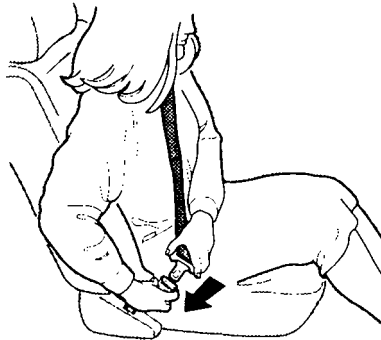

2. Check to see that the belt is not twisted.
3. Position the lap portion of the belt as low as possible across your hips, not across your stomach. This lets your strong pelvic bones take the force of a crash.

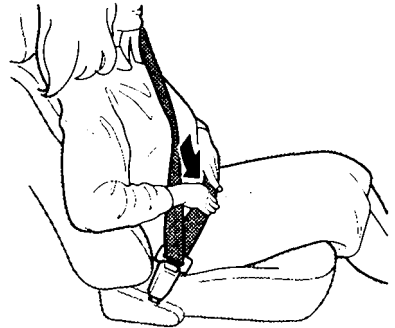

continued

The Seat Belt System and How It Works

4. Pull up on the shoulder part of the belt to remove any slack. Make sure the belt goes over your collarbone and across your chest.

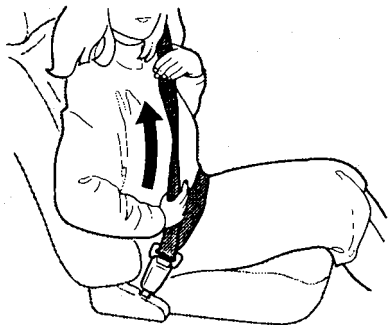

5. If the shoulder belt crosses your neck, you need to adjust the belt anchor height or your seating position.

Front seats: Adjust the belt anchor by squeezing the two buttons and sliding the anchor downward (it has four positions).

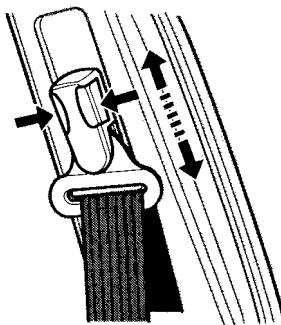

Rear seats: Move toward the center of the seat until the belt fits over your collarbone.

To unlatch the seat belt, push the red PRESS button on the buckle. Guide the belt across your body to the door pillar. After you exit the vehicle, make sure the seat belt is out of the way and will not get closed in the door.

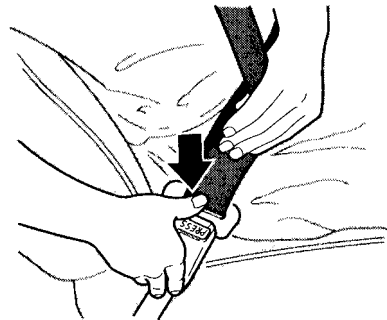

The Seat Belt System and How It Works

Wearing the Lap Belt

1. Pull the latch plate across your hips, and insert it into the buckle marked CENTER.

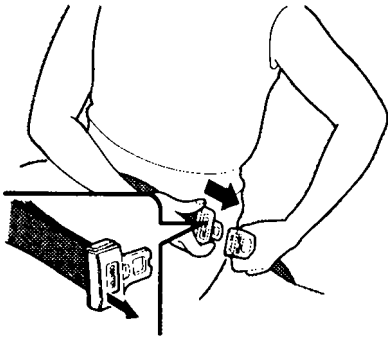

If the belt is too short, hold the latch plate at a right angle, and pull to extend the belt. Insert the latch plate into the buckle.

2. Position the belt so it fits as low as possible across your hips and pelvic bones, not across your stomach. Pull the loose end of the belt to adjust for a snug but comfortable fit.

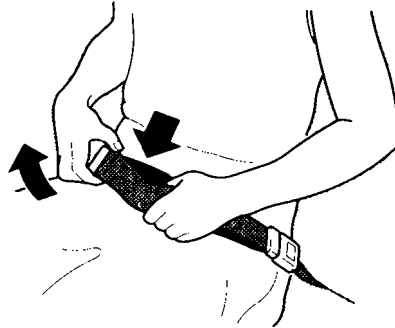

To unlatch the belt, push the red PRESS button on the buckle.



Advice for Pregnant Women

Protecting the mother is the best way to protect her unborn child. Therefore, a pregnant woman should wear a properly positioned seat belt whenever she drives or rides in a car.

continued

The Seat Belt System and How It Works, Supplemental Restraint System

If possible, use the lap/shoulder seat belt, remembering to keep the lap portion as low as possible (see page [7](#)).

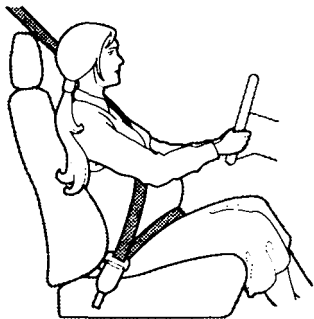

Each time you have a check-up, ask your doctor if it's okay for you to drive and how you should position a lap/shoulder seat belt.

Seat Belt Maintenance

For safety, you should check the condition of your seat belts regularly.

Pull out each belt fully and look for frays, cuts, burns, and wear. Check to see that the latches work smoothly and the lap/shoulder belts retract easily. Any belt not in good condition or not working properly should be replaced.

If a seat belt is worn during a crash, have your dealer replace the belt and check the anchors for damage.

For information on how to clean your seat belts, see page [152](#).

Supplemental Restraint System

Your Accord is equipped with a Supplemental Restraint System (SRS) to help protect the head and chest of the driver and a front seat passenger during a severe frontal collision.

This system does not replace your seat belts. It supplements, or adds to, the protection offered by seat belts and other occupant protection features.

Not wearing seat belts increases the chance of serious injury or death in a crash, even if you have airbags.

Be sure you and your passengers always wear seat belts and wear them properly.

SRS Components

Your supplement restraint system includes:

- One airbag in the steering wheel for the driver and another in the dashboard for the passenger.
- Sensors that can detect a severe frontal collision.
- A sophisticated electronic system that continually monitors the sensors, control unit, airbag activators, and all related wiring when the ignition is ON (II).
- An indicator light on the instrument panel to alert you to a possible problem with the system.
- Emergency backup power in case your car's electrical system is disconnected in a crash.

What Happens in a Crash

If you ever have a severe frontal collision, the sensors will detect rapid deceleration and signal the control unit to instantly inflate the airbags.

During a crash, your seat belts will help to restrain your lower body and torso. The airbags will provide a cushion to absorb crash energy and help keep the head and chest of the driver and front passenger from striking the interior of the car.

After inflating, the airbags will immediately deflate. The entire process, from detection to deflation, takes a fraction of a second. This process occurs so quickly that you may not hear the loud noise created by the airbag inflators or realize what has happened.

After the crash, you may see what looks like smoke. This is actually powder from the airbag's surface. People with respiratory problems may experience some temporary discomfort from the chemicals used by the airbag's activators.

Supplemental Restraint System

Important Facts

About Airbags

Airbags inflate only when needed; **in a severe frontal collision**. A severe collision would be similar to a crash into a parked car at 25 mph. Airbags will not inflate in a moderate frontal collision, or during a rear impact, side impact, or rollover - even if the impact is severe.

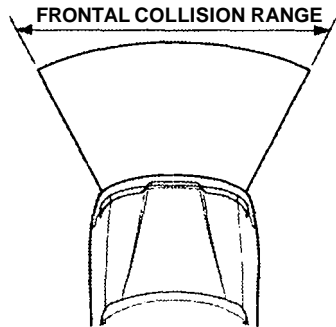

Airbags inflate and deflate only once. They cannot protect you during any additional impacts that occur during a crash sequence.

Injuries, including fatal injuries, can occur in a severe collision, even if seat belts are worn properly and the airbags inflate. No safety system can provide complete protection in a severe crash.

Just from viewing the vehicle damage after a crash, it is very difficult to accurately determine if the airbags should or should not have inflated. In some cases where the airbag did not inflate, extensive visible damage indicated that the car absorbed much of the crash energy, and the airbags were not needed. In other cases, a severe jolt, such as an impact to the undercarriage,

may not cause extensive body damage but may cause the airbags to inflate.

How the Driver's Airbag Works

If you ever have a severe frontal collision, your airbag will instantly inflate to help protect your head and chest.

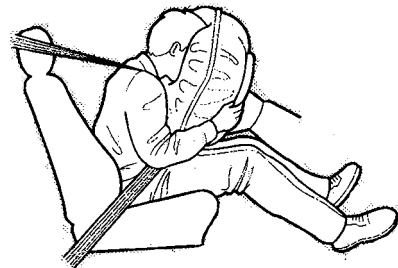

To do its job, the airbag inflates with considerable force. So, while it can reduce serious injuries and even save your life, the airbag might cause some facial abrasions or other injuries. To reduce the possibility of injury, you should always sit as far from the steering wheel as practical while still maintaining full vehicle control.

After the bag completely inflates, it immediately starts deflating so it won't interfere with your visibility, ability to steer, or ability to operate other controls.

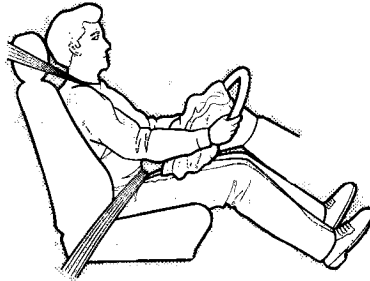

The total time for inflating and deflating is a fraction of a second. You may not even be aware that the airbag has been fully inflated.

The airbag is stored in the center of the steering wheel. For safety, do not attach any items to the steering wheel. They could interfere with the proper operation of the airbag. Or, if the airbag inflates, the items could be propelled inside the car and hurt someone.

Supplemental Restraint System

How the Passenger's Airbag Works

If you have a severe frontal collision, the passenger's airbag will inflate at the same time as the driver's airbag.

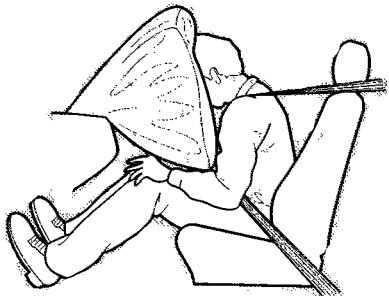

This airbag is quite large and inflates with considerable force. It can seriously hurt a front seat passenger who is not in the proper position and wearing the seat belt properly.

Front seat passengers should move the seat as far back as practical and sit well back in the seat.

We strongly recommend that you do not put an infant seat in the front passenger's seat. If the airbag inflates, it can hit the infant seat with great force. The infant seat can be dislodged or struck with enough force to cause serious injury to the infant.

If a toddler seat is used in the front passenger's seat, the vehicle seat should be moved as far back as possible. If the passenger bag inflates, it could seriously hurt a toddler who is not in the proper position or properly restrained.

The passenger's airbag is stored near the top of the dashboard, under a lid marked SRS. Do not

place any objects on top of this lid. If the airbag inflates, those objects can be propelled inside the car and possibly hurt someone.

SRS How the SRS Indicator Light Works

The purpose of the SRS light on your instrument panel is to alert you to a potential problem with your supplemental restraint system.

Have the system checked if:

- The light does not come on when you turn the ignition ON (II).
- The light stays on after the engine starts.
- The light comes on or flashes while you are driving.

If you see any of these indications, the airbag may not work when needed in an accident. Take the car to your dealer promptly for diagnosis and service.

System Service

Your supplemental restraint system is virtually maintenance-free. There are no parts you can safely service. You must have the system serviced by an authorized Honda dealer:

- *If your airbags ever inflate.* The airbags and control unit must be replaced. Do not try to remove or discard the airbags by yourself. This must be done by a Honda dealer.

- *If the SRS indicator light alerts you of a problem.* Have the supplemental restraint system checked as soon as possible. Otherwise, your airbags might not inflate when you need them.
- *When the car is 10 years old.* Have the dealer inspect the system. The production date is on the driver's doorjamb for your convenience.

System Service Precautions

Do not modify your steering wheel or any other part of the supplemental restraint system. Modifications could make the system ineffective.

Do not tamper with the system's components or wiring. This could cause the airbags to inflate inadvertently, possibly injuring someone very seriously.

Tell anyone who works on your car that you have a supplemental restraint system. Failure to follow the procedures and precautions in the official Honda service manual could result in personal injury or damage to the system.

Scrapping an entire car that has uninflated airbags can be dangerous. Get assistance from a Honda dealer if your car must be scrapped.

If you sell your car, please be sure to tell the new owner that the car has a supplemental restraint system. Alert them to the information and precautions in this part of the Owner's Manual.

Additional Safety Information

The seat belts and airbags are obviously important parts of your occupant protection system.

In addition, you should know that sitting upright, adjusting the head restraint properly, locking the doors, and stowing things properly can also increase your safety and possibly even save your life.

Seat-Back Position

The seat-backs should be in an upright position for you and your passengers to get the most protection from the seat belts.

If you recline a seat-back, you reduce the protective capability of your seat belt. The farther a seat-back is reclined, the greater the risk that you will slide under the belt in a severe crash and be very seriously injured.

For information on how to adjust the seat-back, see page [48](#).

Head Restraint Position

Head restraints can help protect you from whiplash and other injuries. For the best protection, adjust the top of the restraint so it is even with the tops of your ears, or as high as possible. For instructions on adjusting the head restraints, see page [49](#).

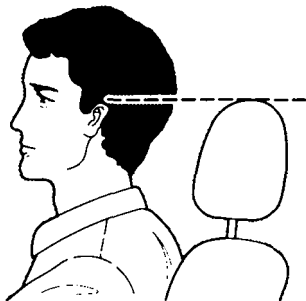

Door Locks

It is not safe to leave your car doors unlocked. A passenger, especially a child, could open a door and accidentally fall out. Also, there is a greater chance of being thrown out of the car during a crash when the doors are not locked.

Storing Cargo Safely

Before you drive, make sure you first securely store or tie down any items that could be thrown around the car and hurt someone or interfere with your ability to operate the controls.

Do not put any items on top of the tonneau cover. They can block your view, and they could be thrown about the car in a crash.

Be sure to keep compartment doors closed when the car is moving. If a front passenger hits the door of an open glove box, for example, he could injure his knees.

For information on loading cargo, see page 88.

Driving With Pets

Loose pets can be a hazard while you are driving. An unrestrained pet can interfere with your ability to drive the car. In a crash or sudden stop, loose pets or cages can be thrown around inside the car and hurt you or your passengers. It is also for their safety that pets should be properly restrained in your car.

The recommended way to restrain a medium-sized or larger dog is with a special traveling

harness. This harness can be secured to the rear seat with a seat belt. Travel harnesses are available at pet stores.

A small dog, cat, or other small animal will be safest in a pet carrier with rigid sides. Choose a style that allows you to secure it to the car's seat by routing a seat belt through the carrier's handle.

For further information, contact your veterinarian or local animal protection society.

Child Safety

Children depend on adults to protect them. To help make sure we do, every state has laws requiring infants and young children to be properly restrained whenever they ride in a car.

An infant or child who is not properly restrained can be killed or seriously injured in a crash.

Be sure any child too small for seat belts is properly secured in a child restraint.

Child Safety

Where Should Children Sit?

According to accident statistics, children of all sizes and ages are safer when they are properly restrained in the rear seat rather than the front seat.

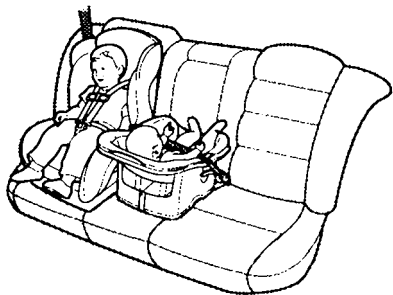

We recommend that, whenever possible, you secure your child's infant or toddler seat in the center position of the rear seat with the lap belt.

We strongly recommend that you do not put an infant seat in the front passenger's seat. If the airbag inflates, it can hit the infant seat with great force. The infant seat can be dislodged or struck with enough force to cause very serious injury to the infant.

If a toddler seat is used in the front passenger's seat, the vehicle seat should be moved as far back as possible. If the passenger bag inflates, it could seriously hurt a toddler who is not in the proper position or properly restrained.

We also recommend that any child who is too large to use an infant or toddler seat ride in one of the outside positions of the rear seat. The child should then wear the lap/shoulder belt properly for protection.

If a child is not large enough to wear the lap/shoulder belt properly, you should use a booster seat.

Important Safety Reminders

Never hold a baby or child on your lap when riding in a car. If you are wearing your seat belt, the violent forces created during a crash will tear the child from your arms. The child could be seriously hurt or killed.

If you are holding a child and not wearing a seat belt in a crash, you could crush the child against the car's interior.

Never put your seat belt over yourself and a child. During a crash, the belt could press deep into the child causing serious internal injuries.

Two children should never use the same seat belt. If they do, they could be very seriously injured in a crash.

If you are driving with small children in the car, you should use the childproof door locks to prevent them from opening the rear doors (see page 46).

For their safety, do not leave children alone in your car without adult supervision.

General Guidelines for Restraining Children Under 40 lb (18kg)

Use an approved child seat. The seat must meet Federal Motor Vehicle Safety Standard 213 (FMVSS-213). Look for the manufacturer's statement of compliance on the box and seat.

Use a seat of the right size. Make sure the seat fits your child. Check the seat's instructions and labels for height and weight limits.

Secure the child seat to the car. All approved child seats are designed to be secured in the car seat by the lap belt or the lap belt portion of a lap/shoulder belt. A child whose seat is not properly secured to the car can be endangered in a crash.

To properly route a seat belt through a child seat, follow the seat-maker's instructions. If you use a lap/shoulder belt, follow the instructions on page 21.

Secure the child in the child seat. Make sure the infant or child is firmly secured to the child seat. Use the straps provided, and carefully follow the manufacturer's instructions.

Restraining an Infant Who Weighs Less Than 20 lb (9 kg)

An infant up to about 20 lb (9 kg) must be restrained in an infant seat or a convertible seat designed for a baby. Because infants must ride in a reclining position, be sure the infant seat always faces the REAR of the car as shown.



continued

Child Safety

We recommend that, whenever possible, you put the infant seat in the center position of the rear seat and secure it to the car with the lap belt.

If you decide to put an infant seat in any other seating position, be sure to follow the instructions on page 21.

We strongly recommend that you do not put an infant seat in the front passenger's seat. If the airbag inflates, it can hit the infant with great force. The infant seat can be dislodged or struck with enough force to cause serious injury to the infant.

Restraining a Child Who Weighs Between 20 and 40 lb (9 and 18 kg)

Toddler seats are designed for children who weigh between 20 and 40 lb (9 and 18 kg).

The preferred place to put a toddler seat is in the center position of the rear seat. Use the car's lap belt to secure the seat to the car.

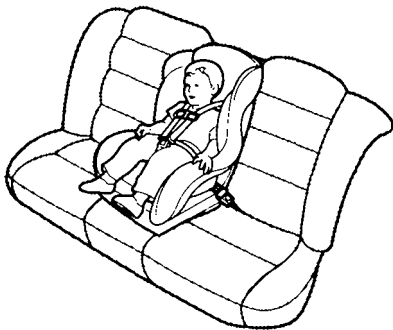

If you decide to put a toddler seat in any other seating position, be sure to follow the instructions on page 21.

If you are using a toddler seat in the front passenger's seat, move the passenger's seat as far back as possible before installing the child seat. If the passenger bag inflates, it could seriously hurt a toddler who is not in the proper position or properly restrained.

Restraining a Child Who Weighs Over 40 lb (18 kg)

We recommend that, whenever possible, a child who has outgrown a toddler seat ride in one of the outside positions of the rear seat and use a lap/shoulder belt.

Put the lap/shoulder belt on your child and check its fit. The

shoulder belt should fit over the collarbone and across the chest. The lap belt should sit low on your child's hips, not across the stomach.

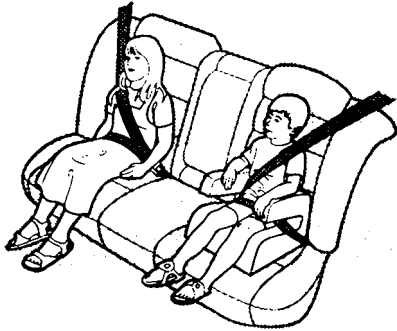

If the shoulder belt crosses the neck, have your child move toward the center of the rear seat until the belt fits properly. If the belt still crosses the child's neck, you should use a booster seat.

Several styles of booster seats are available. We recommend a design that allows the child to use the car's lap/shoulder belt.

Whichever style you select, follow the booster seat manufacturer's instructions.

Securing a Child Seat With a Lap/Shoulder Belt

The lap/shoulder belt retractors in the passenger seating positions have a built-in locking mechanism intended to secure a child seat. When you are placing a child seat in one of these outside seating positions, do the following:

1. Place the child restraint in the desired seating position. Route the lap/shoulder belt through the seat according to the seat manufacturer's instructions.
2. Insert the latch plate into the buckle. Make sure it is fully latched.
3. Slowly pull the shoulder portion of the belt out of the retractor until it stops.
4. Allow the belt to slowly feed back into the retractor. You should hear a clicking noise that indicates the locking mechanism has engaged.
5. After the belt has retracted fully, pull up on the shoulder portion to remove any slack.

continued

Child Safety

6. Push and pull on the child seat to verify that it is held firmly in place. If not, unlatch the seat belt, allow it to retract fully, and repeat these steps.

To unlatch the seat belt, push the red PRESS button on the buckle. Guide the belt across to the door pillar. If the belt doesn't retract easily, pull it out and check for twists or kinks.

Using Child Restraints With Tethers

Your Honda has three attachment points for tether-style child seats. Two are on the floor behind each rear seat. A third attachment point is at the headliner at the tailgate opening. To access, remove the plug cap.

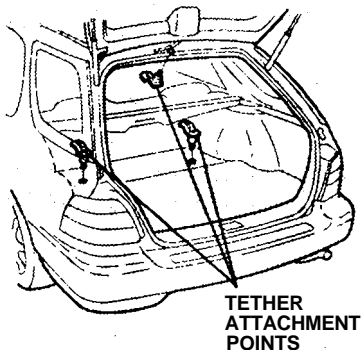

If you are not sure how to install the bracket, have it installed by your authorized Honda dealer.

If you need an anchor plate and mounting hardware, you can obtain them by writing to:

American Honda Motor Co., Inc.
Consumer Affairs
1919 Torrance Blvd.
Torrance, CA 90501-2746

Storing a Child Seat

When you are not using an infant seat or other child restraint, either remove it or make sure it is properly secured so it cannot be thrown around the car during a crash.

Driving a car requires your full attention and alertness. Traffic conditions change rapidly. You must be able to react just as rapidly. Alcohol or drugs directly affect your alertness and ability to react. Even prescription and non-prescription medicines can have this effect.

There are laws that deal with drunken driving. These laws define how much alcohol it takes in your system to be legally "drunk." However, your judgement and reaction time get worse with every drink - even the first one.

The safest thing you can do is never drink and drive. This can be done if you plan ahead. If you know you are going to be drinking, make plans to ride with a friend who will not be drinking.

What if you find that you've been drinking and cannot get a ride from a friend? Find alternative transportation. Call a taxi. Take a bus. Many communities have transportation services devoted to shuttling people who have been drinking.

If you have no choice but to drive, stop drinking and give yourself lots of time to sober up. Time is the only thing that can make you sober. Things like coffee or a cold shower don't speed up the process.

If you see friends trying to get behind the wheel after drinking, stop them. Drive them yourself or arrange other transportation. If you think you are interfering, remember that your interference will keep them from sharing the road with you.

Carbon Monoxide Hazard

Your car's exhaust contains carbon monoxide gas. You should have no problem with carbon monoxide entering the car in normal driving if you maintain your car properly. Have the exhaust system inspected for leaks whenever:

- The car is raised for an oil change.
- You notice a change in the sound of the exhaust.
- The car was in an accident that may have damaged the underside.

Carbon monoxide gas is toxic. Breathing it can cause unconsciousness and can even kill you.



Avoid any enclosed areas or activities that expose you to carbon monoxide.

High levels of carbon monoxide can collect rapidly in enclosed areas, such as a garage. Do not run the engine with the garage door closed. Even with the door open, run the engine only long enough to move the car out of the garage.

With the tailgate open, air flow can pull exhaust gas into your car's interior and create a hazardous condition. If you must

drive with the tailgate open, open all the windows and set the heating and cooling system as shown below.

If you must sit in your parked car, even in an unconfined area, with the engine running, adjust the heating and cooling system as follows:

1. Push the  button.
2. Select the  mode.
3. Turn the fan on high speed.
4. Set the temperature control to a comfortable setting.

These labels are in the locations shown. They warn you of potential hazards that could cause serious injury. Read these labels carefully, and don't remove them.

If a label comes off or becomes hard to read, contact your Honda dealer for a replacement.

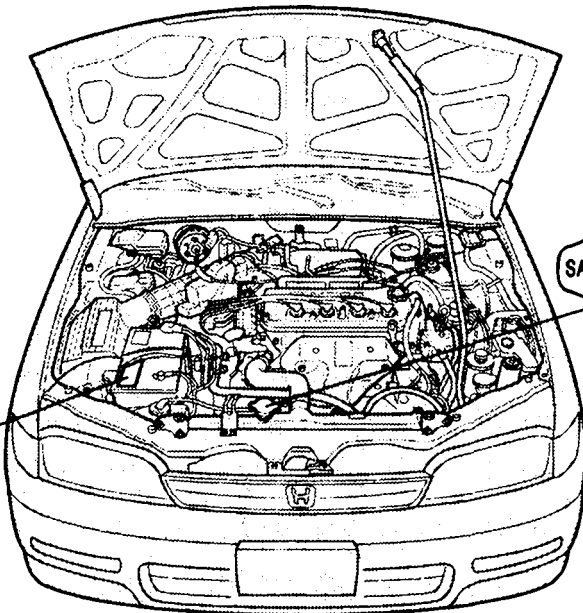

RADIATOR CAP



BATTERY

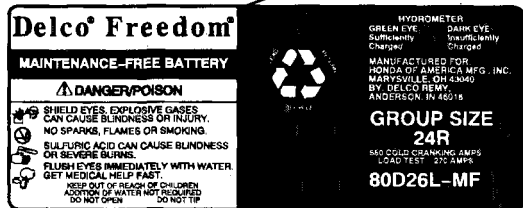

This section gives information about the controls and displays that contribute to the daily operation of your Honda. All the essential controls are within easy reach.

Control Locations	28	Turn Signals	37	Seat Adjustments	48
Indicator Lights	29	Windshield Wipers	37	Front Seat Adjustments . . .	48
Gauges	33	Rear Window Wiper/Washer	38	Driver's Seat Power Height Adjustment	49
Speedometer	33	Windshield Washers	38	Driver's Lumbar Support ..	49
Tachometer	33	Hazard Warning	39	Head Restraints	49
Odometer	33	Rear Window Defogger	39	Folding Rear Seat	50
Trip Meter	33	Steering Wheel Adjustment	40	Rear Seat Armrest	50
Fuel Gauge	34	Steering Wheel Controls	40	Power Windows	50
Temperature Gauge	34	Cruise Control	40	Moonroof	52
Maintenance Required Indicator	34	Keys and Locks :	43	Mirrors	53
Controls Near the Steering Wheel	35	Keys	43	Adjusting the Power Mirrors	53
Headlights	36	Ignition Switch	44	Parking Brake	54
Instrument Panel Brightness	37	Power Door Locks	45	Digital Clock	54
		Door Locks	45	Beverage Holder	55
		Remote Transmitter	45	Console Compartment	56
		Childproof Door Locks	46	Coin Box	56
		Glove Box	47	Cigarette Lighter	56
		Tailgate	47	Ashtrays	57
				Interior Light	57
				Courtesy Lights	58

Control Locations

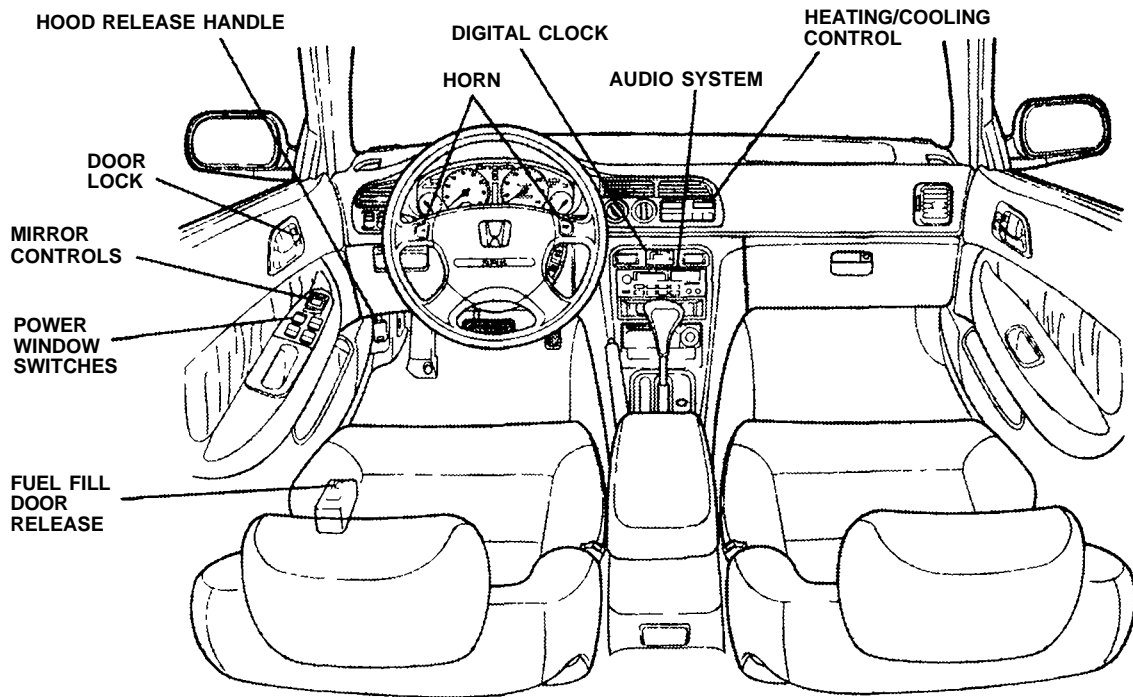

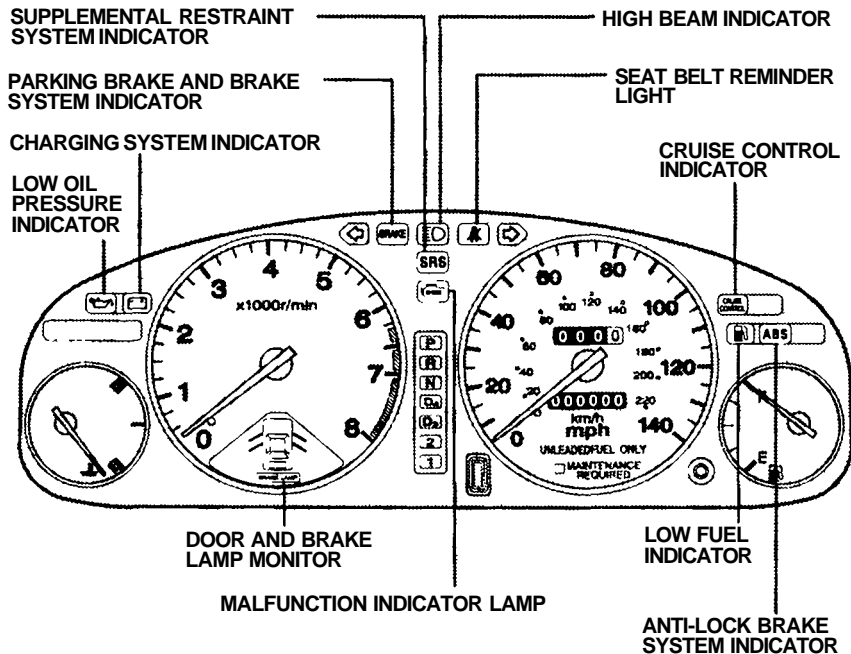

The instrument panel has many indicators to give you important information about your car.

Lamp Check

Many of the indicator lights come on when you turn the ignition switch ON (II), allowing you to see that they are working. If an indicator does not light during this test, it cannot alert you if that system develops a problem. Have the dealer check your car for burned-out bulbs or other problems.

Indicator Lights



Seat Belt Reminder Light

This indicator lights when you turn the ignition ON (II). It is a reminder to you and your passengers to protect yourselves by fastening the seat belts. A beeper also sounds if you have not fastened your seat belt.

If you do not fasten your seat belt, the beeper will stop after a few seconds but the light stays on until you do. Both the light and the beeper stay off if you fasten your seat belt before turning on the ignition.



Charging System Indicator

If this light comes on when the engine is running, the battery is not being charged. For complete information, see page [166](#).



Low Oil Pressure Indicator

The engine can be severely damaged if this light comes on when the engine is running. For complete information, see page [165](#).



Parking Brake and Brake System Indicator Light

This light has two functions:

1. It lights as a reminder that you have set the parking brake. Driving with the parking brake set can damage the brakes and tires, and cause the anti-lock brake system to turn off on cars equipped with ABS.

2. It can indicate the brake fluid level is low if it remains lit after you release the parking brake or comes on while driving. This is normally due to worn brake pads. Have your dealer check the braking system for worn pads or fluid leaks.



Supplemental Restraint System Indicator

See page [14](#).

ABS

Anti-Lock Brake System (ABS) Indicator

On cars equipped with ABS

This light normally comes on when you turn the ignition ON (II) and goes off after the engine starts. If it comes on at any other time, there is a problem in the ABS. If this happens, stop the car in a safe place, and turn off the engine. Reset the system by restarting the engine. Watch the ABS light.

If it does not go off, or comes back on again while driving, take the car to your dealer to have it checked. With the light on, your car still has normal braking ability but no anti-lock.



Malfunction Indicator Lamp

See page [167](#).

Door and Brake Lamp Monitor

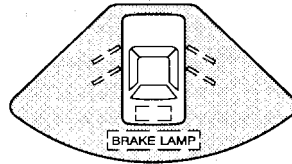

The appropriate light comes on in this display if the tailgate or any door is not closed tightly. If a brake lamp (except for the high-mount stoplight) does not work, the **BRAKE LAMP** indicator comes on when you push the brake pedal with the ignition switch ON (II).

A burned out brake light is a hazard when drivers behind you cannot tell you are braking. Have your brake lights repaired right away.

All the lights in the monitor display come on for a few seconds when you turn the ignition switch ON (II).

Indicator Lights



Turn Signal and Hazard Warning Indicators

The left or right turn signal light blinks when you signal a lane change or turn. If the light does not blink or blinks rapidly, it usually means one of the turn signal bulbs is burned out (see page 143). Replace it as soon as possible, since other drivers cannot see that you are signaling.

When you turn on the Hazard Warning switch, both turn signal lights blink. All turn signals on the outside of the car should flash.



High Beam Indicator

This light comes on with the high beam headlights. See page

36 for information on the headlight controls.



Cruise Control Indicator

This lights when you set the cruise control. See page 40 for information on operating the cruise control.



Low Fuel Indicator

This light comes on as a reminder that you must refuel soon.

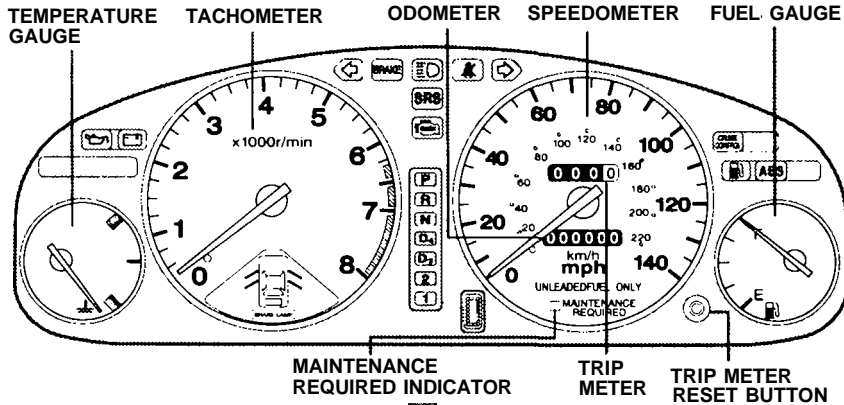

Speedometer

This shows your speed in miles per hour. The smaller inner numbers are the speed in kilometers per hour.

Tachometer

The tachometer shows the engine speed in revolutions per minute (rpm). To protect the engine from damage, never drive with the tachometer needle in the red zone.

Odometer

The odometer shows the total miles your car has been driven. It is illegal under federal law to disconnect, reset, or alter the odometer with the intent to change the number of miles indicated.

Trip Meter

This meter shows the number of miles driven since you last reset it. To reset it, push the trip meter reset button.

Gauges

Fuel Gauge

This shows how much fuel you have. It is most accurate when the car is on level ground. It may show slightly more or less than the actual amount when you are driving on curvy or hilly roads.

The gauge stays at the same fuel level reading after you turn off the ignition. When you add fuel, the gauge slowly changes to the new reading after you turn the ignition back ON (II).

Temperature Gauge

This shows the temperature of the engine's coolant. During normal operation, the pointer should rise from the bottom white mark to about the middle of the gauge. In severe driving conditions, such as very hot weather or a long period of uphill driving, the pointer may rise to

the upper white mark. If it reaches the red (hot) mark, pull safely to the side of the road. Turn to page [121](#) for instructions and precautions on checking the engine's cooling system.

Maintenance Required Indicator

This indicator reminds you that it is nearing 7,500 miles (12,000 km) since the last scheduled maintenance. Refer to the Maintenance Schedules for Normal and Severe Driving Conditions on page [112 - 113](#).

When the distance driven since the last scheduled maintenance nears 7,500 miles (12,000 km), the indicator will turn yellow. If you exceed 7,500 miles (12,000 km), the indicator will turn red.

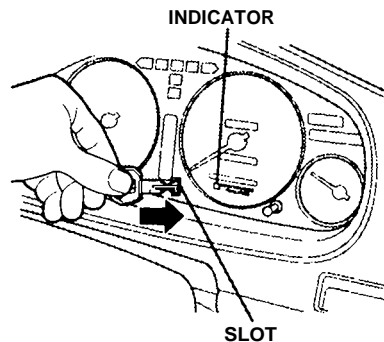

Your dealer will reset the indicator when he performs the scheduled maintenance. If someone else performs the maintenance, reset the indicator by inserting your key in the slot below the indicator.

Controls Near the Steering Wheel

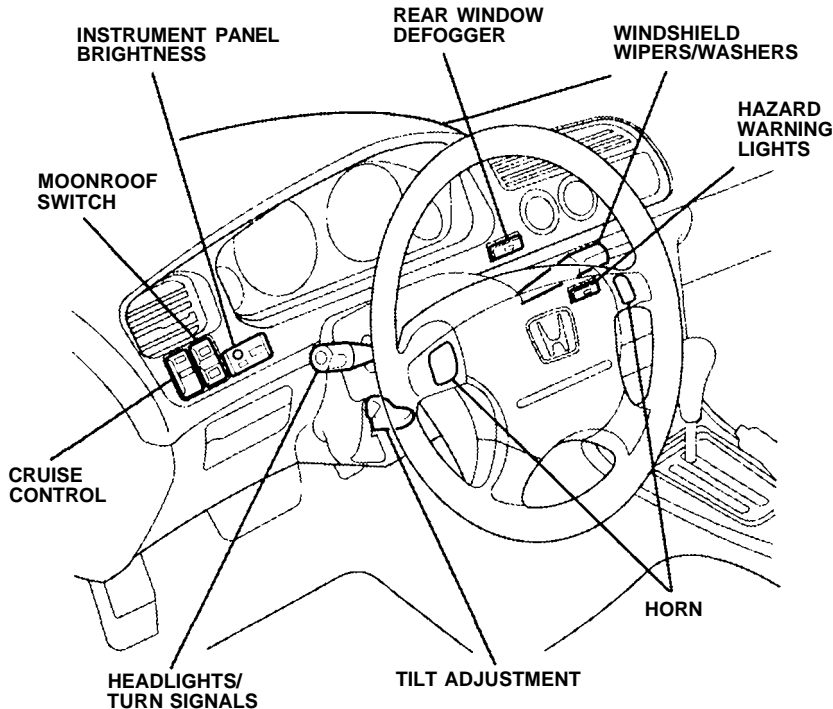

The two levers on the steering column contain controls for driving features you use most often. The left lever controls the turn signals, headlights, and high beams. The right lever controls the windshield washers and wipers.

The rear window defogger switch is on the dashboard to the right of the steering column.

The controls under the left air vent are for the moonroof, cruise control, and instrument panel brightness.

The tilt adjustment lever on the underside of the steering column allows you to tilt the steering wheel.

Controls Near the Steering Wheel

Headlights

The rotating switch on the left lever controls the lights. Turning this switch to the first position “•” turns on the parking lights, tail lights, instrument panel lights, side-marker lights, and rear license plate lights. Turning the switch to the second position “●” turns on the headlights.

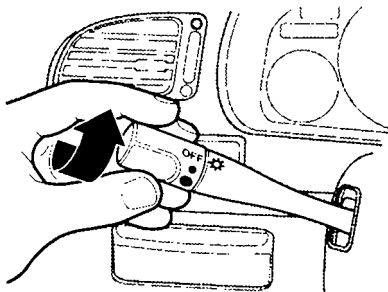

If you leave the lights on with the ignition switch in ACCESSORY (I) or LOCK (0), you will hear a reminder chime when you open the driver's door.

To change between low beams and high beams, pull the turn signal lever toward you until you hear a click, and then let go. The high beam indicator will light (see page [32](#)).

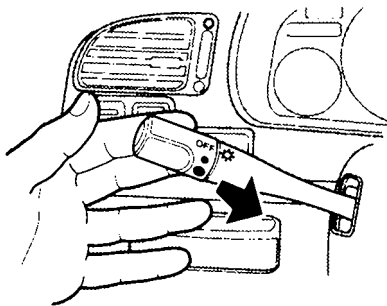

To flash the high beams, pull back and hold the turn signal lever. Release the lever, and the high beams will go off.

The high beams will stay on for as long as you hold the lever, no matter what position the headlight switch is in.

Instrument Panel Brightness

The knob on the dashboard to the left of the instrument panel controls the brightness of the instrument panel lights. Push the knob to get it to pop out. Turn the knob to adjust the brightness. Push the knob back in to lock your adjustment.

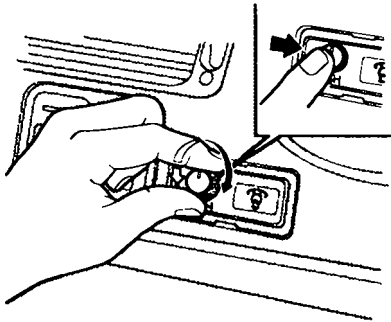

Turn Signals

Signal a turn or lane change with this lever. Push down on the lever to signal a left turn, and up to signal a right turn. If you push it up or down all the way, the turn signal continues to blink even when you release the lever. It shuts off automatically as you complete the turn.

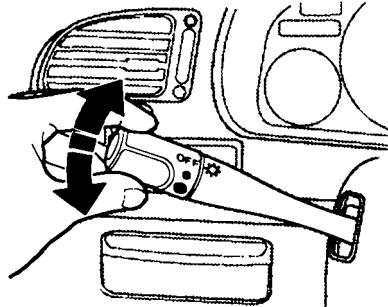

To signal a lane change, push lightly on the turn signal lever in

the proper direction, and hold it. The lever will return to the center position as soon as you release it.

Windshield Wipers

The right lever controls the windshield wipers and washers. The rotary switch at the end of the lever has three positions: INT: intermittent

- : low speed
- == : high speed

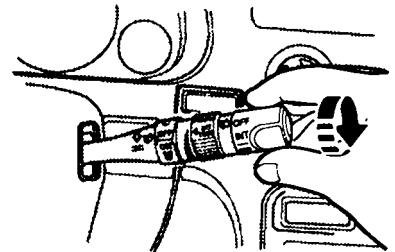

continued

Controls Near the Steering Wheel

In intermittent, the wipers operate every few seconds. You can adjust this delay by turning the INT TIME ring on the lever. This allows you to vary how often the windshield wipers sweep when driving in light rain or snow.

In low speed and high speed, the wipers run continuously.

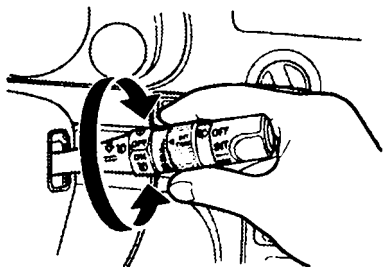

To operate the wipers in mist mode, push the control lever down. The washers will spray water and the wipers will run at high speed until you release the lever. This gives you a quick way to clear the windshield.

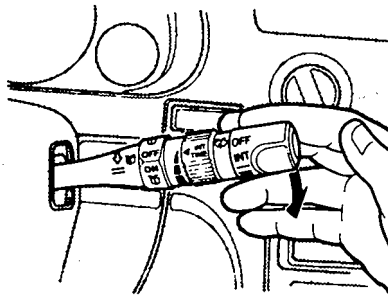

Rear Window Wiper/Washer

The rear window wiper switch is located next to the intermittent ring.

To activate the rear windshield wiper, turn the switch "ON." If you wish to use the wiper and washer, turn and hold the switch one position up from "ON."

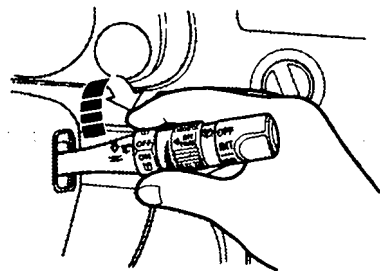

Windshield Washers

To clean the front windshield, pull back on the wiper control lever. The washers spray until you release the lever. The wipers run at low speed while you're

pulling the lever, then complete one more sweep of the windshield after you release it.

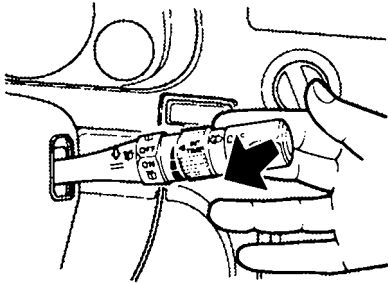

Hazard Warning

Push the red button to the left of the clock to turn on the hazard warning lights (four-way flashers). This causes all four outside turn signals and both indicators in the instrument panel to flash. Use the hazard

warning lights if you need to park in a dangerous area near heavy traffic or if your car is disabled.

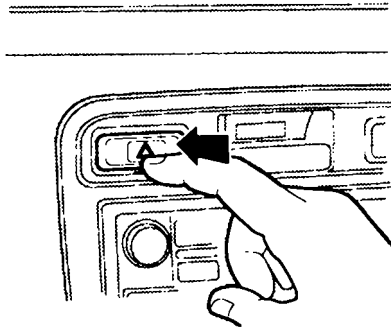

Rear Window Defogger

The rear window defogger will clear fog, frost, and thin ice from the window. Push the defogger button to turn it on and off. The light in the button lights to show the defogger is on. If you do not turn it off, the defogger will shut

itself off after about 25 minutes. It also shuts off when you turn off the ignition. You have to turn it on again when you restart the car.

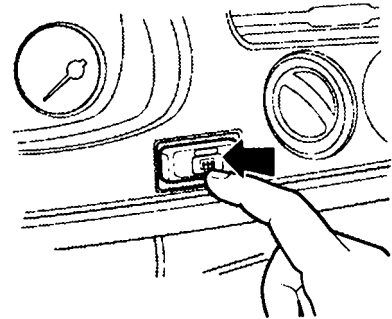

Make sure the rear window is clear and you have good visibility before starting to drive.

The defogger wires on the inside of the rear window can be accidentally damaged. When cleaning the glass, always wipe side to side.

Controls Near the Steering Wheel, Steering Wheel Controls

Steering Wheel Adjustment

You can adjust the steering wheel height to suit your preference. Do this before you begin driving.

Adjusting the steering wheel position while driving may cause you to lose control of the car and be seriously injured in a crash.

Adjust the steering wheel when the car is stopped.

1. Adjust the seat so you are a comfortable distance from the pedals and can operate them safely.

2. The lever to tilt the steering wheel is under the steering column to the left. Push this lever all the way down.

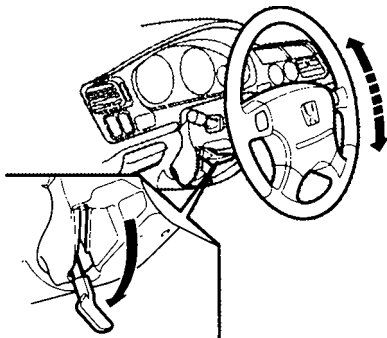

3. Move the steering wheel up or down to the desired position. Position the wheel so you can see all the instrument panel gauges and warning lights. Push the lever up to lock the steering wheel in that position.

4. Make sure you have securely locked the steering wheel in place by trying to move it up and down.

Steering Wheel Controls

Cruise Control

Cruise control allows you to maintain a set speed above 25 mph (40 km/h) without keeping your foot on the accelerator pedal. It is for cruising on straight, open highways. It is not recommended for conditions such as city driving, winding roads, slippery roads, heavy rain, or bad weather. You should have full control of the car under those conditions.

Improper use of the cruise control can lead to a crash.

Use the cruise control only when traveling on open highways in good weather.

NOTICE

The cruise control, as it operates, moves the accelerator pedal. You can damage your car's accelerator mechanism by resting your foot under the pedal and blocking the movement.

Using the Cruise Control

1. Push in the Cruise Control Master Switch to the left of the steering column. The indicator in the switch will light.

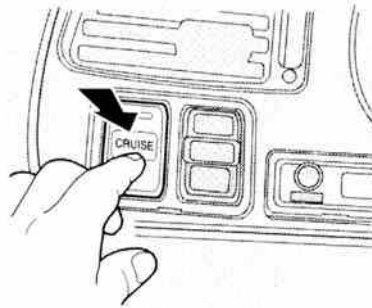

2. Accelerate to the desired cruising speed above 25 mph (40 km/h).

3. Press and hold the SET/decel button on the steering wheel until the CRUISE CONTROL light on the instrument panel comes on. This shows the system is now activated.

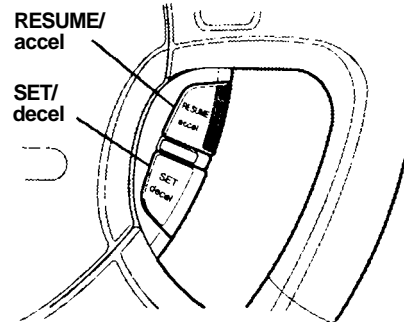

The set speed may vary slightly, particularly on hills.

Steering Wheel Controls

Changing the Set Speed

You can increase the set cruising speed in either of two ways:

- Press and hold the RESUME/accel button. The car will accelerate slowly. When you reach the desired cruising speed, release the button.
- Push on the accelerator pedal. Accelerate to the desired cruising speed, and press the SET/decel button.

You can decrease the set cruising speed in either of two ways:

- Press and hold the SET/decel button. The car will decelerate. Release the button when you reach the desired speed.
- Tap the brake or clutch pedal lightly with your foot. The CRUISE CONTROL light on the

instrument panel will go out. When the car slows to the desired speed, press the SET/decel button. The car will then maintain the desired speed.

Even with the cruise control turned on, you can still use the accelerator pedal to speed up for passing. After completing the pass, take your foot off the accelerator pedal. The car will return to the set cruising speed.

Resting your foot on the brake or clutch pedal will cause the cruise control to cancel.

Canceling the Cruise Control

You can cancel the cruise control in any of these ways:

- Tap the brake or clutch pedal.

- Press the SET/decel and RESUME/accel buttons at the same time.
- Press the Cruise Control Master Switch.

When you tap the brake or clutch pedal (manual transmission cars), or press the SET and RESUME buttons at the same time, the CRUISE CONTROL light on the instrument panel will go out and the car will begin to slow down. You can use the accelerator pedal in the normal way.

If you use the brake or clutch pedal to cancel cruise control, the system retains the previously set cruising speed. To return to that speed, accelerate to above 25 mph (40 km/h), and press the RESUME/accel button until the CRUISE CONTROL light comes

on. The car will accelerate to the same cruising speed as before.

If you cancel cruise control by pressing the SET and RESUME BUTTONS at the same time, the previously set cruising speed is erased. To use the cruise control, accelerate to the desired cruising speed, and press the SET/decel button.

Pressing the Cruise Control Master Switch turns the system completely off and erases the previous cruising speed from memory. To use the system again, refer to **Using the Cruise Control**.

Keys

Your car comes with two kinds of keys: a master key and a valet key. The master key fits all locks on your car

- Ignition
- Doors
- Tailgate
- Glove box

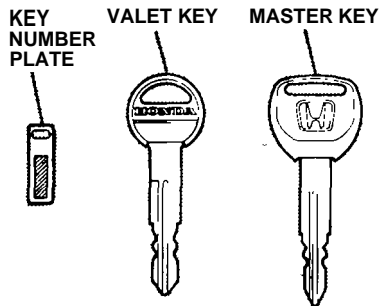

The valet key works only in the ignition and the door locks. You can keep the glove box locked when you leave your car and valet key at a parking facility.

You should have received a key number plate with your set of keys. You will need this number if you have to get a lost key replaced. Keep the plate stored in a safe place. When replacing keys, use only Honda-approved key blanks.

Remote Transmitter

EX models

Your car also comes with a remote transmitter; see page [45](#) for operation.

Keys and Locks

Ignition Switch

The ignition switch is on the right side of the steering column. It has four positions:

- LOCK (0)
- ACCESSORY (I)
- ON (II)
- START (III)

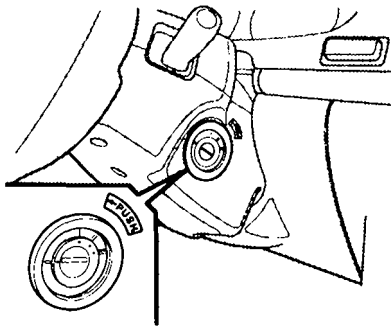

LOCK (0) — You can insert or remove the key only in this

position. When you turn the key from LOCK to ACCESSORY, you may have to turn the steering wheel to release the anti-theft lock. To switch from ACCESSORY to LOCK, you must push the key in slightly as you turn it. If your car has an automatic transmission, it must also be in Park. The anti-theft lock will lock the steering column when you remove the key.

Removing the key from the ignition switch while driving locks the steering. This can cause you to lose control.

Remove the key from the ignition switch only when parked.

ACCESSORY (I) — In this position, you can operate the audio system and cigarette lighter.

ON (II) — This is the normal key position when driving. All features and accessories on the car are usable. Several of the lights on the instrument panel come on as a test when you turn the ignition switch from ACCESSORY to ON (see page 29).

START (III) — Use this position only to start the engine. The switch returns to ON when you let go of the key.

You will hear a reminder beeper if you open either front door with the key in the LOCK or ACCESSORY position. Remove the key to turn it off.

Power Door Locks

The master door lock switch allows control of all door locks and the tailgate from the driver's door. Push the master door lock switch down to lock all doors including the tailgate, and pull up to unlock them.

MASTER DOOR LOCK SWITCH

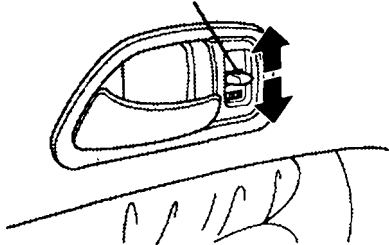

Door Locks

Each door has a lock tab on top of the door panel. When you push in the lock tab on the driver's door, all doors lock. Pulling out the lock tab on the driver's door only unlocks that door. The lock tab on each passenger's door only locks and unlocks that door.

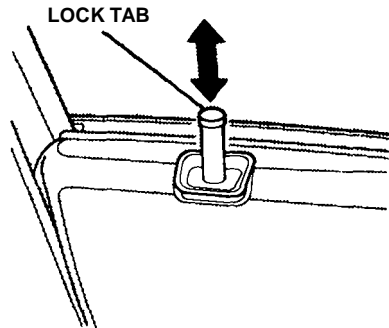

To lock any passenger's door when getting out of the car, push the lock tab in and close the door. To lock the driver's door, pull the outside door handle and push the lock tab in. Release the handle, then close the door.

All doors can be locked from the outside by using the key in either front door. All four doors will unlock when you use the key to unlock the passenger's door.

To unlock the driver's door from the outside, turn the key and release it. If you turn the key and hold it, all doors will unlock.

Remote Transmitter

EX models

You can lock and unlock your car using the remote transmitter. If you push "Lock," on the

continued

Keys and Locks

transmitter, all doors and the tailgate will lock.



One push on "Unlock" unlocks the driver's door and turns on the interior light; if you push "Unlock" again, all doors and the tailgate will unlock.

If you use the unlock feature on the remote transmitter and a door or the tailgate is not opened within 20 seconds, all doors and the tailgate will automatically lock. If the key is in the ignition,

the remote transmitter will not work.

This device complies with Part 15 of the FCC rules. Operation is subject to the following two conditions: (1) This device may not cause harmful interference, and (2) this device must accept any interference received, including interference that may cause undesired operation.

Changes or modifications not expressly approved by the party responsible for compliance should void the user's authority to operate the equipment.

Childproof Door Locks

The childproof door locks are designed to prevent children seated in the rear from accidentally opening the rear doors. Each rear door has a lock

lever near the edge. With the lever in the LOCK position, the rear doors cannot be opened from the inside regardless of the position of the lock tab. To open either rear door, pull the lock tab up and use the outside door handle.

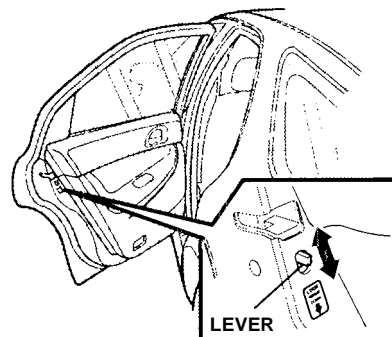

Glove Box

Open the glove box by pulling the bottom of the handle. Close it with a firm push. Lock or unlock the glove box with the master key.

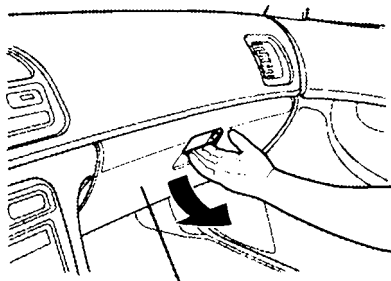

GLOVE BOX

The glove box light comes on only when the instrument panel lights are on.

An open glove box can cause serious injury to your passenger in a crash, even if the passenger is wearing a seat belt.

Always keep the glove box closed while driving.

Tailgate

Use your key to lock and unlock the tailgate. (For EX models, your remote transmitter will also lock and unlock the tailgate.)

To open the tailgate, pull the handle, and then lift up the tailgate.

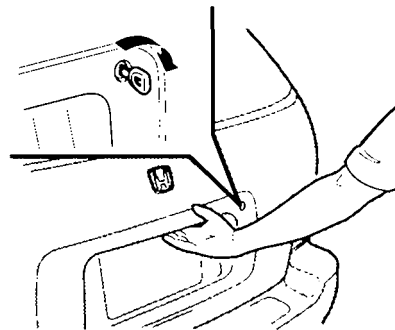

Seat Adjustments

Adjust the seat before you start driving.

Front Seat Adjustments

To adjust the seat forward and backward, pull up on the lever under the seat cushion's front edge. Move the seat to the desired position, and release the lever. Try to move the seat to make sure it is locked in position.

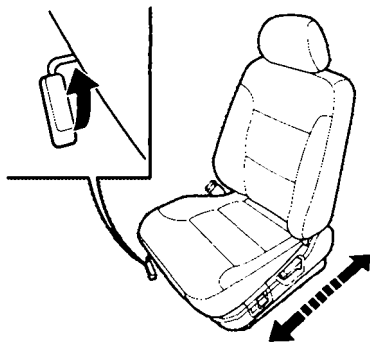

To change the angle of the seat-back, pull up on the lever on the outside of the seat bottom. Move the seat-back to the desired position, and release the lever. Let the seat-back latch in the new position.

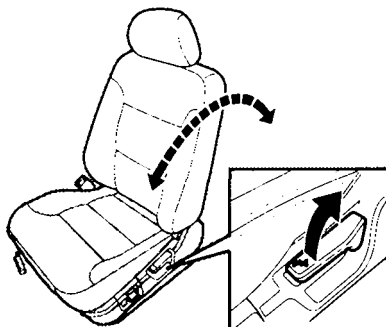

Reclining the seat-back can decrease the protection you get from your seat belt in a crash.

You can slide under the seat belt and be seriously injured.

Adjust the seat-back to an upright position, and sit well back in the seat.

Driver's Seat Power Height Adjustment

On EX models

The height of your driver's seat is power adjustable. Pull up on the switch to raise the seat. Push it down to lower the seat.

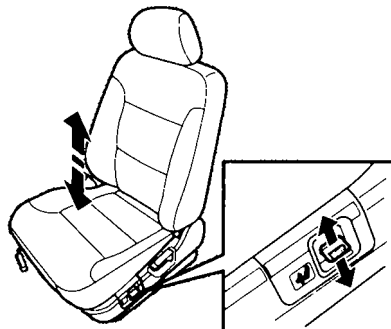

Driver's Lumbar Support

On EX models

Vary the lumbar support by moving the lever on the right

side of the seat-back. Pivot the lever forward until it stops, then let it return. Doing this several times adjusts the lumbar support through its full range.

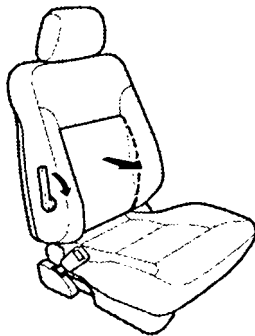

Head Restraints

The front head restraints help protect you and your passenger from whiplash and other injuries. They are most effective when you adjust them so the top of the

restraint is even with the top of your ears.

The front head restraints adjust for height. You need both hands to adjust the restraint. Do not attempt to adjust it while driving. To raise it, pull upward. To lower the restraint, push the release button sideways and push the restraint down.

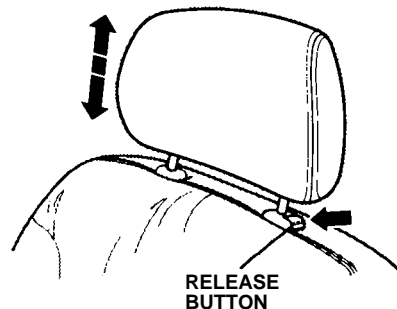

continued

Seat Adjustments, Power Windows

To remove a head restraint for cleaning or repair, pull it up as far as it will go. Press the release button and pull the restraint out of the seat-back.

Driving your car without head restraints can lead to serious injury to you and your passenger in a crash.

Make sure the head restraints are in place and adjusted properly before driving.

Folding Rear Seat

The backs of the rear seats fold down to provide more cargo space.

Pull up the release button at the top of the seat-back, and move the seat-back forward.

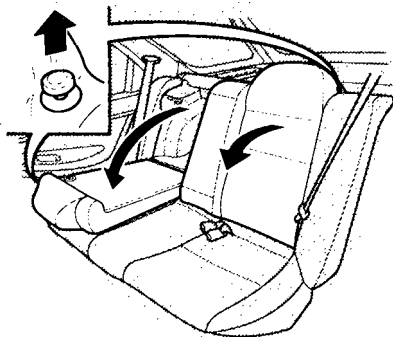

Rear Seat Armrest

On EX models

The rear seat armrest is located at the center of the rear seat.

Pivot it down to use it.

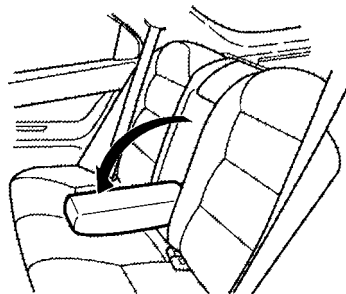

Power Windows

Your car's windows are electrically powered. Turn the ignition switch to ON (II) to raise or lower a window.

Each door has a switch that controls its window. To open the window, push the switch down and hold it. Release the switch when you want the window to stop. Close the window by pushing the switch up and

holding it. The rear windows open only halfway.

The driver's armrest has a master power window control panel. To open the passenger's window, push down on the appropriate switch, and hold it down until the window reaches the desired position. To close the window, push up on the window switch. Release the switch when the window gets to the position you want.

DRIVER'S WINDOW SWITCH

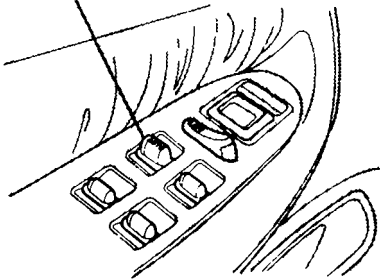

The master control panel also contains these extra features:

AUTO — To open the driver's window fully, push the window switch firmly down and release it. The window automatically goes all the way down. To stop the window from going all the way down, push the window switch up briefly.

To open the driver's window only partially, push the window switch down lightly and hold it. The window will stop as soon as you release the switch.

The AUTO function only works to lower the driver's window. To raise the window, you must push the window switch up and hold it until the window reaches the desired position.

The MAIN switch controls power to the passengers' windows. With this switch off, the passengers' windows cannot be raised or lowered. The MAIN switch does not affect the driver's window. Keep the MAIN switch off when you have children in the car so they do not injure themselves by operating the window unintentionally.

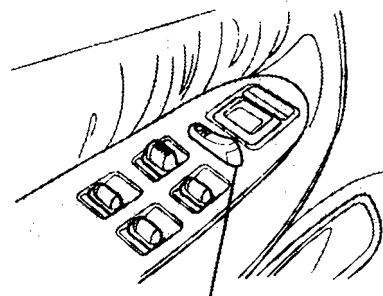

MAIN SWITCH

continued

Power Windows, Moonroof



The power window system has a key-off delay function. The windows will still operate for up to 10 minutes after you turn off the ignition. Opening either front door cancels the delay function. You must turn the ignition ON (II) again before you can raise or lower the windows.

Closing a power window on a child's hands or fingers can cause serious injury.

Make sure children are away from the windows before closing them.

Moonroof

On EX models

Use the switches on the dashboard under the left vent to operate the moonroof. The ignition must be ON (II). Push and hold the  switch to open the moonroof. Release the switch when the moonroof reaches the desired position. To close the moonroof, press and hold the  switch.

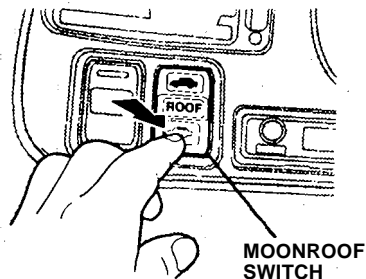

The moonroof has a key-off delay. You can still open and

close the moonroof for up to 10 minutes after you turn off the ignition. The key-off delay cancels as soon as you open either front door. You must then turn the ignition ON (II) for the moonroof to operate.

Closing the moonroof on someone's hands or fingers can cause serious injury.

Make sure passengers are clear of the moonroof before closing it.

NOTICE

If you try to open the moonroof in below-freezing temperatures, or when it is covered with snow or ice, you can damage the moonroof panel or motor.

Mirrors

Keep the inside and outside mirrors clean and adjusted for best visibility. Be sure to adjust the mirrors before you start driving.

The inside mirror has day and night positions. The night position reduces glare from headlights behind you. Flip the tab on the bottom edge of the mirror to select the day or night position.

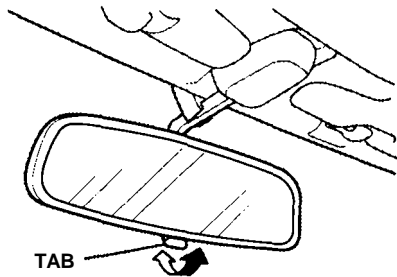

Adjusting the Power Mirrors

Adjust the outside mirrors with the adjustment switch on the driver's door armrest.

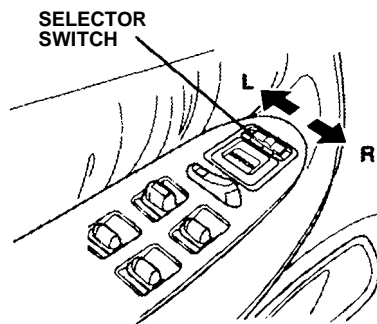

1. Turn the ignition switch ON (II).
2. Move the selector switch to L (driver's side) or R (passenger's side).

3. Push the appropriate edge of the adjustment switch to move the mirror right, left, up, or down.

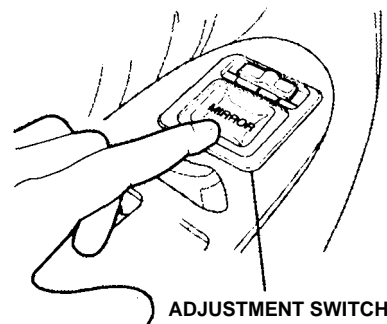

4. When you finish, move the selector switch to the center (OFF) position. This turns off the adjustment switch so you can't move a mirror out of position by accidentally bumping the switch.

Parking Brake, Digital Clock

Parking Brake

To apply the parking brake, pull the lever up fully. To release it, pull up slightly, push the button, and lower the lever. The parking brake light on the instrument panel should go out when the parking brake is fully released (see page 30). If you try to drive the car without releasing the parking brake, the ABS cannot work properly.

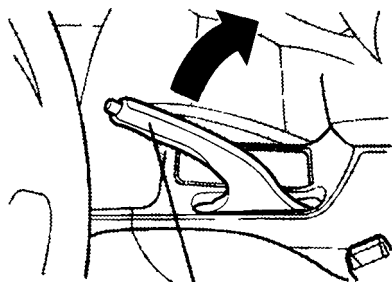

PARKING BRAKE LEVER

NOTICE

Driving the car with the parking brake applied can damage the rear brakes and axles.

Digital Clock

The digital clock displays the time with the ignition switch ON (II). To see the time with the ignition off, press and hold the front cover under the clock.

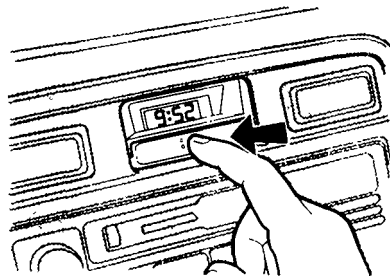

To set the clock:

1. Turn the ignition switch ON (II) to display the time.

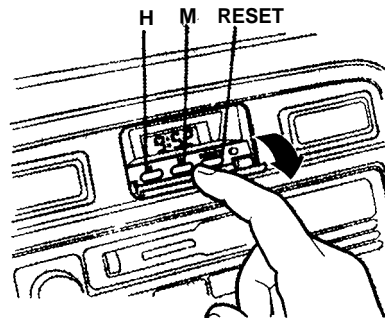

2. Swing down the front cover of the wide button under the clock display. You will see H, M, and RESET buttons.
3. Press and hold the H button until the hour advances to the desired time.

4. Press and hold the M button until the minutes advance to the desired time.

You can use the RESET button to quickly set the time to the nearest hour. If the displayed time is before the half hour, pressing RESET sets the clock back to the previous hour. If the displayed time is after the half hour, pressing RESET sets the clock forward to the beginning of the next hour.

For example:

- 1:06 would RESET to 1:00.
- 1:52 would RESET to 2:00.

Beverage Holder

To open the beverage holder, push on the top. The beverage holder lid is spring-loaded and will pop open. To close it, push it down until it latches.

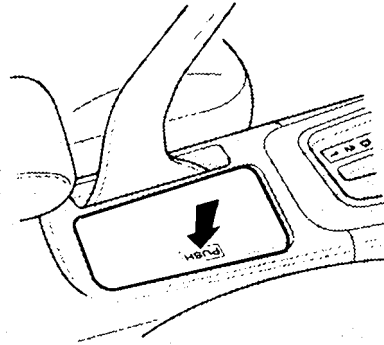

Use the beverage holder only when the car is parked. If you place cups in the holder while driving, the liquid may spill when you go over bumps or around corners.

The inner liner can be removed if you want to hold a larger cup.

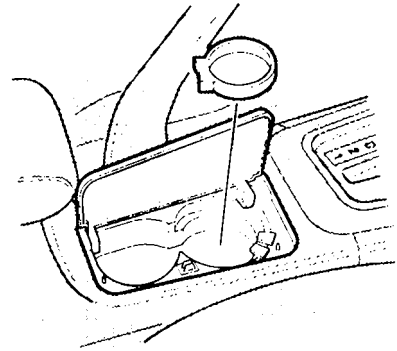

Be careful when you are using the beverage holder. A spilled liquid that is very hot can scald you or your passenger. Spilled liquids can also damage the upholstery, carpeting, and electrical components in the interior.

Console Compartment, Coin Box, Cigarette Lighter

Console Compartment

To open the console compartment, pull up the front edge of the lid.

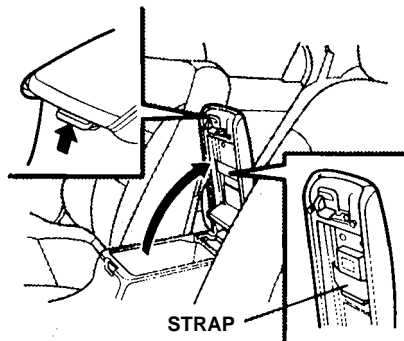

A strap is provided under the console cover to hold your garage door opener.

Coin Box

To open the coin box, pull the upper edge. Close it with a firm push.

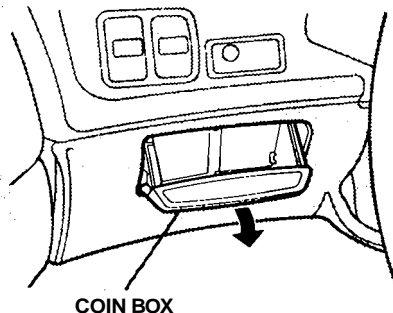

Cigarette Lighter

The ignition switch must be in ACCESSORY (I) or ON (II) for the cigarette lighter to work. To heat up the lighter, push it in. It will pop out when it is ready for use. Do not hold the lighter in while it is heating up, you could cause it to overheat.

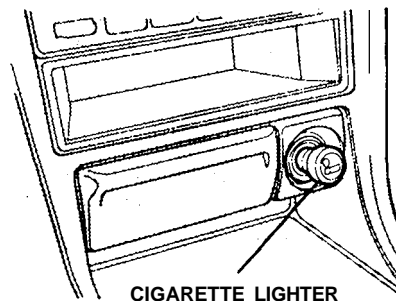

Ashtrays

Open the front ashtray by swinging the lid down. Push it in to close it.

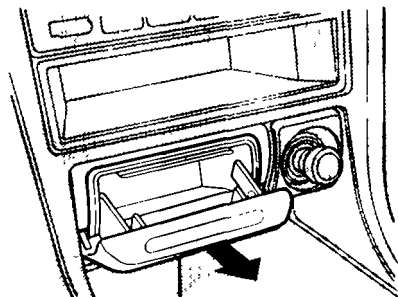

ASHTRAY

To remove the ashtray for emptying, open the lid, and then pull the ashtray straight out.

The rear ashtray is at the rear end of the center console. Open the ashtray by swinging the upper edge of the lid down. To

remove the ashtray for emptying, open it, and then lift up and out.

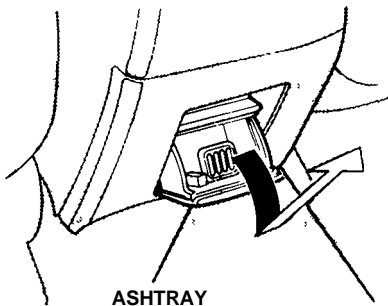

ASHTRAY

NOTICE

Use the ashtray only for cigarettes, cigars, and other smoking materials. To prevent a possible fire and damage to your car, don't put paper or other things that can burn in the ashtrays.

Interior Light

The interior light has a three-position switch. In the OFF (forward) position, the light does not come on. In the center position, the interior light comes on when you open either front door. In the ON (rearward) position, the interior light stays on continuously.

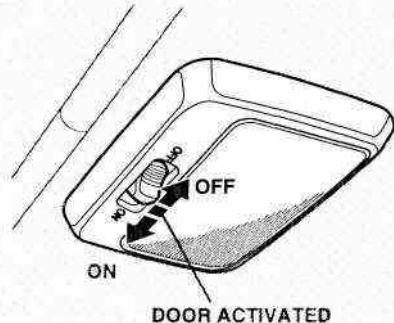

Courtesy Lights

Each front and rear door has a courtesy light. This light (with the front interior light switch in the center position) comes on when you open either front door.

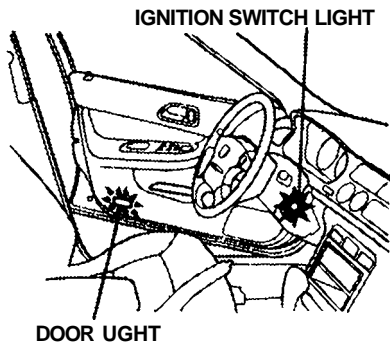

Your car also has a courtesy light in the ignition switch. This light comes on when you open the driver's door. It remains on for several seconds after the door is closed.

Some models have lighted vanity mirrors. The light beside the mirror comes on only when the light switch is turned on.

SUN VISOR

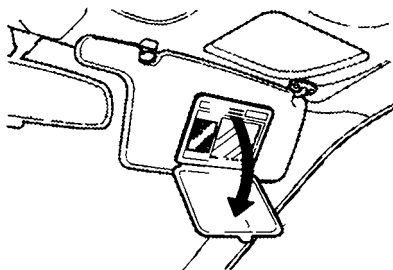

Spotlight

Turn on the spotlight by pushing the button next to each light. Push the button again to turn it off. You can use the spotlights at all times.

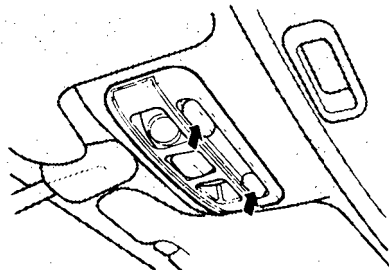

The heating and air conditioning systems in your Honda provide a comfortable driving environment in all weather conditions.

The audio system that is standard equipment on some models has many features. This section describes those features and how to use them. (If you selected an optional audio system, refer to the operating instructions that came with it.)

Heating and Cooling	60
What Each Control Does	61
How to Use the System	62
To Turn Everything Off	65
Audio System	66
Operating the Radio	66
Adjusting the Sound	69
Radio Frequencies	70
Radio Reception	70
Operating the Cassette Player	72
Caring for the Cassette Player	74
Operating the Optional CD Changer	75
Protecting Compact Discs	77
CD Error Indications	78
Theft Protection	79

Heating and Cooling

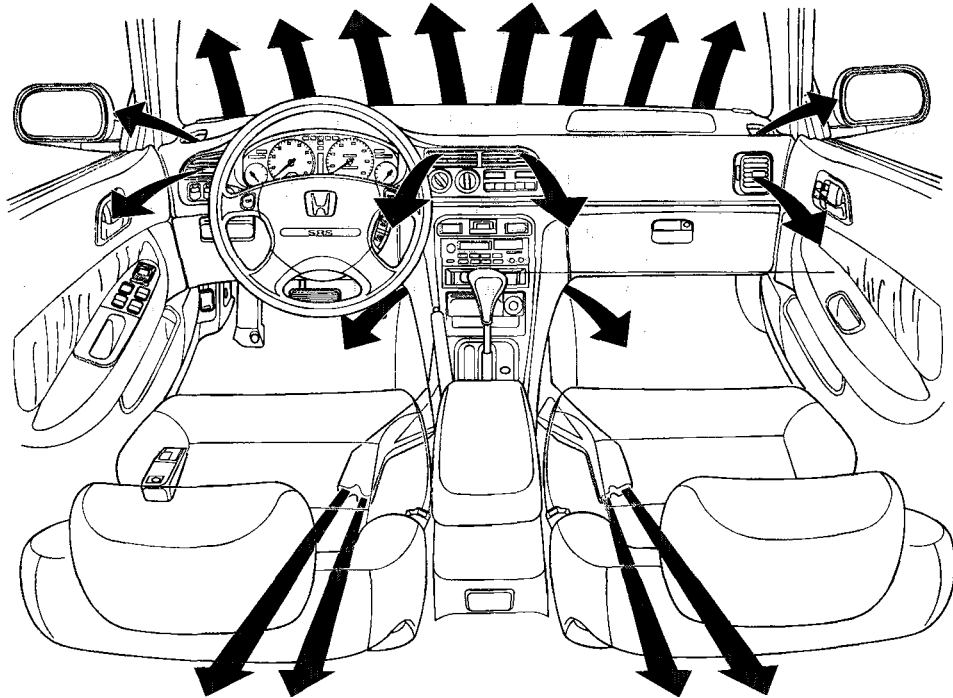

Proper use of the heating and cooling system can make the interior dry and comfortable, and keep the windows clear for best visibility.

What Each Control Does

Fan Control Dial

Turning this dial clockwise increases the fan speed, which increases air flow.

Temperature Control Dial

Turning this dial clockwise increases the temperature of air flow.

Air Conditioning (A/C) Switch

This switch turns the air conditioning ON and OFF. The indicator in the switch lights when the A/C is ON.

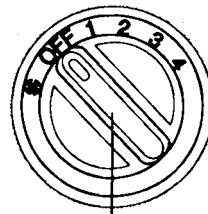

FAN CONTROL DIAL

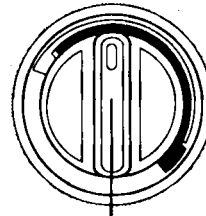

TEMPERATURE CONTROL DIAL

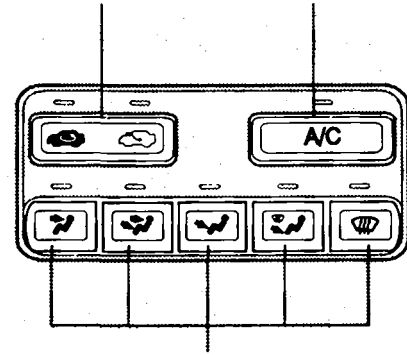

RECIRCULATION/
FRESH AIR BUTTON

AIR CONDITIONING
SWITCH



MODE BUTTONS

Recirculation/Fresh Air Button

This button controls the source of air going into the system. In recirculation mode (), air from the vehicle's interior is sent through the system again. In fresh air mode (), air is brought in from outside the vehicle.

Mode Buttons

These buttons let you select which vents the air flows from.

 Air flows from the center and corner vents in the dashboard.

continued

Heating and Cooling

 Air flow is divided between the vents in the dashboard and the floor vents.

 Air flows from the floor vents.

 Air flow is divided between the floor vents and the defroster vents at the base of the windshield.

 Air flows from the defroster vents at the base of the windshield.

Vent Controls

You can adjust the direction of the air coming from the dashboard vents by moving the tab in the center of each vent up-and-down and side-to-side.

CENTER VENT

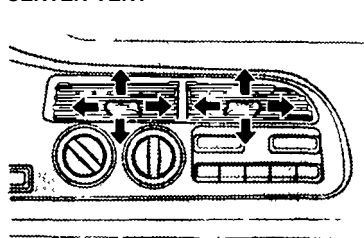

The vents in the corners of the dashboard can be opened and closed with the dials next to them.

SIDE VENT

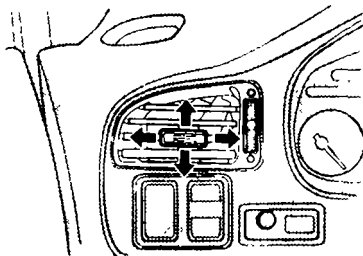





How to Use the System

This section covers how to set up the system controls for ventilation, heating, cooling, dehumidifying, and defrosting.

The engine must be running for the heater and air conditioning

to generate hot and cold air. The heater uses engine coolant to warm the air. If the engine is cold, it will be several minutes before you feel warm air coming from the system.

The air conditioning does not rely on engine temperature.

It is best to leave the system in  mode under almost all conditions. Keeping the system in  mode, particularly with the A/C off, can cause the windows to fog up. Switch to  mode when you are driving through smoky or dusty conditions, then switch back to  mode when the condition clears.

The outside air intakes for the heating and cooling system are at the base of the windshield. Keep these clear of leaves and other debris.

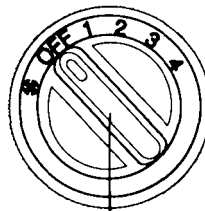

FAN CONTROL DIAL

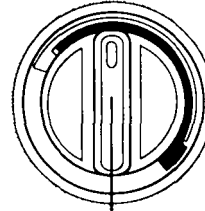

TEMPERATURE CONTROL DIAL

RECIRCULATION/
FRESH AIR BUTTON

AIR CONDITIONING
SWITCH

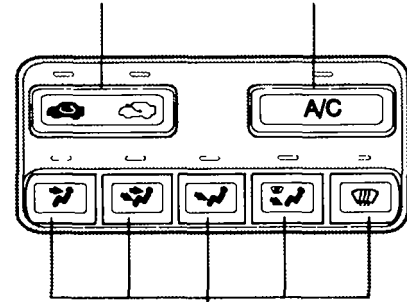



MODE BUTTONS

Ventilation

The flow-through ventilation system draws in outside air, circulates it through the interior, then exhausts it through vents near the rear windows.

1. Turn the temperature control dial all the way to the left. Make sure the A/C is off.



2. Select  and .
3. Set the fan to the desired speed.

To Cool With A/C



1. Turn on the A/C by pressing the button. The light above the button should come on.

continued

Heating and Cooling

2. Make sure the temperature control lever is all the way to the left.
3. Select  and .
4. Set the fan to the desired speed.

If the interior is very warm from being parked in the sun, you can cool it down more rapidly by setting the controls this way:

1. Start the engine.
2. Turn on the A/C by pressing the button. Make sure the temperature control dial is all the way to the left.
3. Set the fan to maximum speed.
4. Open the windows partially. Select  and .



When the interior has cooled down to a more comfortable

temperature, close the windows and set the controls as described for normal cooling.

Air conditioning places an extra load on the engine. Watch the engine coolant temperature gauge (see page 34) when driving in stop-and-go traffic or climbing a long, steep hill. If it moves near the red zone, turn off the A/C until the gauge reads normally.



To Heat

To warm the interior:

1. Start the engine.
2. Select  and .
3. Set the fan to the desired speed.
4. Adjust the warmth of the air with the temperature control lever.

To Heat and Dehumidify With Air Conditioning



Air conditioning, as it cools, removes moisture from the air. When used in combination with the heater, it makes the interior warm and dry.

1. Switch the fan on.
2. Turn on the air conditioning.
3. Select  and .
4. Adjust the temperature control dial so the mixture of heated and cooled air feels comfortable.

This setting is suitable for all driving conditions whenever the outside temperature is above 32 °F (0°C).

To Defog and Defrost



To remove fog from the inside of the windows:

1. Switch the fan on.
2. Turn on the air conditioning.
3. Select  and .
4. Adjust the temperature control lever so the airflow from the defroster vents feels warm.
5. Turn on the rear window defogger to help clear the rear window.

To remove exterior frost or ice from the windshield and side windows after the car has been sitting out in cold weather:

1. Start the engine.
2. Select  and .

3. Switch the fan and temperature controls to maximum.

To rapidly remove exterior frost or ice from the windshield (on very cold days), first select . Once the windshield is clear, select  to avoid fogging the windows.

These settings direct all the air flow to the defroster vents at the base of the windshield and the side window defroster vents. The air flow will get warmer and clear the windows faster as the engine warms up. You can close the side and upper vents with the dial beside each vent. This will send more warm air to the windshield defroster vents.

For safety, make sure you have a clear view through all the windows before driving away.

To Turn Everything Off

To shut off the system temporarily, turn the fan speed and temperature control dials all the way to the left.

You should shut the system completely off for only the first few minutes of driving in cold weather, until the engine coolant warms up enough to operate the heater. Keep the fan on at all other times so stale air does not build up in the interior.

Audio System

AM/FM/Cassette Stereo Audio System

Your Honda's audio system provides clear reception on both AM and FM bands, while the preset buttons allow you to easily select your favorite stations.

The cassette system features Dolby B* noise reduction, automatic sensing of chromium-dioxide (CrO₂) tape, and autoreverse for continuous play.

EX model only - The anti-theft feature will disable the system if it is disconnected from the car's battery. To get the system working again, you must enter a code number (see page 79).

*Dolby noise reduction manufactured under license from Dolby Laboratories Licensing Corporation. "Dolby" and the symbol  are trademarks of Dolby Laboratories Licensing Corporation.

Operating the Radio

The ignition switch must be in ACCESSORY (I) or ON (II) to operate the audio system. Turn the system on and adjust the volume by turning the ON/VOL knob.

The band and frequency that the radio was last tuned to is displayed. To change bands, press the AM or FM button. On the FM band, ST will be displayed if the station is broadcasting in stereo. Stereo reproduction on AM is not available.

You can use any of three methods to find radio stations on the selected band: **TUNE**, **SEEK**, or the **Preset** buttons.

TUNE — Use the TUNE/SEEK switch to tune the radio to a desired frequency. Push the TUNE/SEEK switch up to tune to a higher frequency, or push down

to tune to a lower frequency. The frequency numbers will start to change rapidly. Release the switch when the display reaches the desired frequency. To change the frequency in small increments, push and release the TUNE/SEEK switch quickly.

SEEK — The SEEK function searches the band for a station with a strong signal. To activate it, push the TUNE/SEEK switch until you hear a beep, then release it. Depending on which direction you pushed the switch, the system scans upward or downward from the current frequency. It stops when it finds a station with a strong signal.

Preset — You can store the frequencies of your favorite radio stations in the six preset buttons. Each button will store one frequency on the AM band, and two on the FM band.

To store a frequency:

1. Select the desired band, AM or FM. FM1 and FM2 let you store two frequencies with each Preset button.
2. Use the TUNE or SEEK function to tune the radio to a desired station.
3. Pick the Preset button you want for that station. Press the button and hold it until you hear a beep.
4. Repeat steps 1 through 3 to store a total of six stations on AM and 12 on FM.

Once a station's frequency is stored, simply press and release the proper Preset button to tune to it.

The preset frequencies will be lost if your vehicle's battery goes dead or is disconnected.

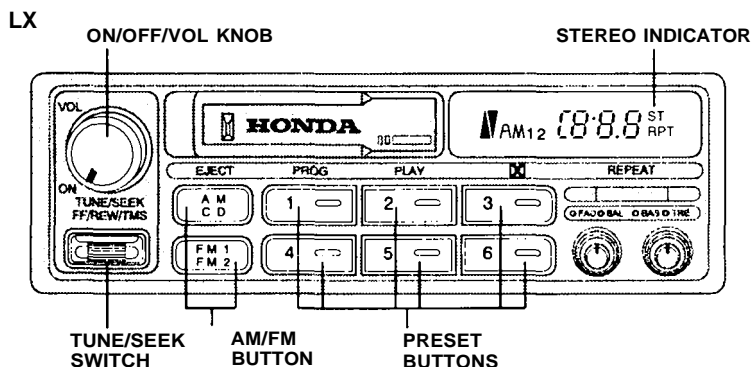
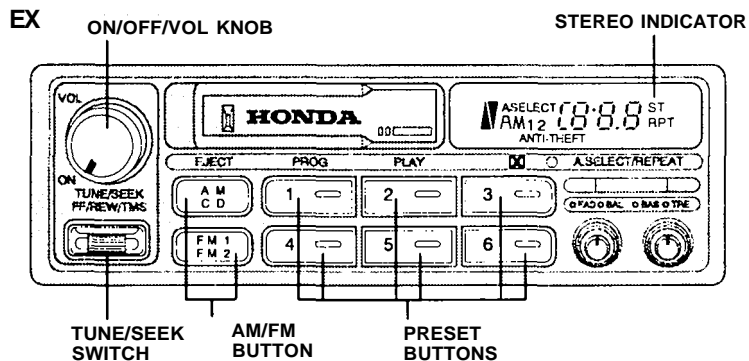

Audio System

EX model

AUTO SELECT — If you are traveling far from home and can no longer receive the stations you preset, you can use the Auto Select feature to find stations in the local area.

To activate Auto Select, press the A.SELECT button. A.SELECT will appear in the display, and the system will go into scan mode for several seconds. It automatically scans both bands, looking for stations with strong signals. It stores the frequencies of six AM stations and twelve FM stations in the preset buttons. You can then use the preset buttons to select those stations.

If you are in a remote area, Auto Select may not find six strong AM stations or twelve strong FM stations. If this happens, you will see a "0" displayed when you

press any preset button that does not have a station stored.

With Auto Select on, you cannot manually store any frequencies in the preset buttons. If you do not like the stations found by Auto Select, you can use the TUNE and SEEK functions to find other stations.

Auto Select does not erase the frequencies that you preset previously. When you return home, turn off Auto Select by pressing the A.SELECT button. The preset buttons will then select the frequencies you originally set.

EX

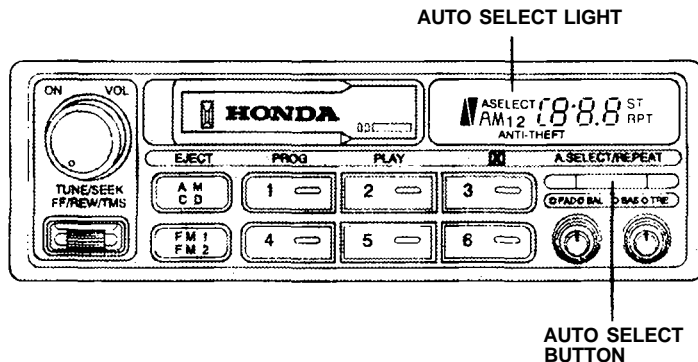

Adjusting the Sound

Balance/Fader — These two controls adjust the strength of the sound coming from each speaker. The Balance control adjusts the side-to-side strength, while the Fader control adjusts the front-to-back strength.

To use these controls, push on the knob to get them to pop out. Adjust the Fader to your liking by turning the outside ring. Adjust the Balance by turning the knob. Push the controls back in when you are done.

Treble/Bass — Use these controls to adjust the tone to your liking. Push on the controls to get them to pop out. Adjust the Bass by turning the outer ring. Adjust the Treble by turning the knob. Push the controls back in when you are finished so you cannot change the settings by accidentally bumping them.

○ FAD • BAL ○ BAS • TRE

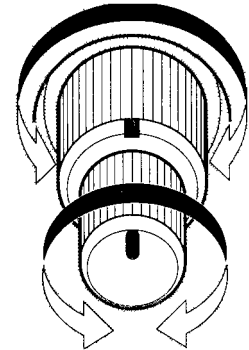
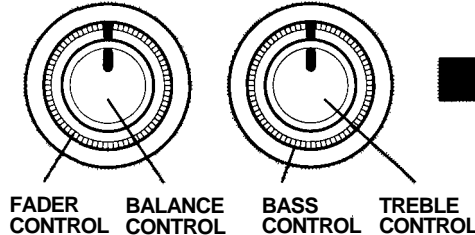

You can use the Balance control knob to turn off the illumination of the audio system. Push the Balance/Fader controls so they pop out, then pull the Balance control knob out slightly farther.

Check the Balance control knob if the audio system does not illuminate with the instrument panel lights.

Audio System

Radio Frequencies

Your Honda's radio can receive the complete AM and FM bands. Those bands cover these frequencies:

AM band: 530 to 1,710 kilohertz

FM band: 87.7 to 107.9 megahertz

Radio stations on the AM band are assigned frequencies at least 10 kilohertz apart (530, 540, 550).

Stations on the FM band are assigned frequencies at least 0.2 megahertz apart (87.9, 88.1, 88.3).

Stations must use these exact frequencies. It is fairly common for stations to round-off the frequency in their advertising, so your radio could display a frequency of 100.9 even though the announcer may identify the station as "FM101."

Radio Reception

How well your Honda's radio receives stations is dependent on many factors, such as the distance from the station's transmitter, nearby large objects, and atmospheric conditions.

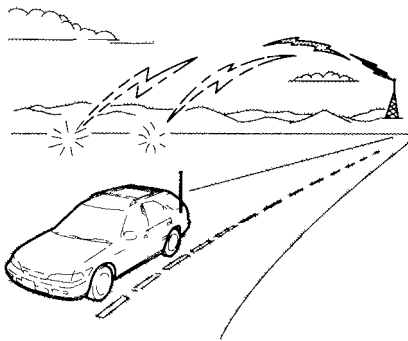

A radio station's signal gets weaker as you get farther away from its transmitter. If you are listening to an AM station, you will notice the sound volume becoming weaker, and the station drifting in and out. If you are listening to an FM station, you will see the stereo indicator flickering off and on as the signal weakens. Eventually, the stereo indicator will go off and the sound will fade completely as you get out of range of the station's signal.

Driving very near the transmitter of a station that is broadcasting on a frequency close to the frequency of the station you are listening to can also affect your radio's reception. You may temporarily hear both stations, or hear only the station you are close to.

Radio signals, especially on the FM band, are deflected by large objects such as buildings and hills. Your radio then receives both the direct signal from the station's transmitter, and the deflected signal. This causes the sound to distort or flutter. This is a main cause of poor radio reception in city driving.

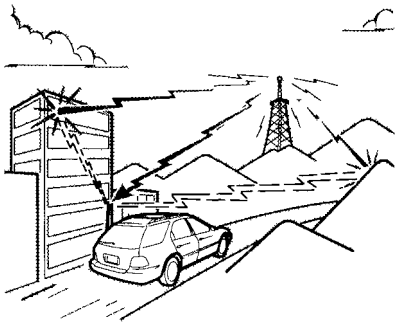

Radio reception can be affected by atmospheric conditions such as thunderstorms, high humidity, and even sunspots. You may be able to receive a distant radio station one day and not receive it the next day because of a change in conditions.

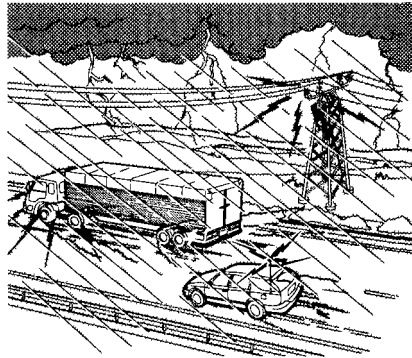

Electrical interference from passing vehicles and stationary sources can cause temporary reception problems.

Audio System

Operating the Cassette Player

Turn the audio system ON. Make sure the tape opening on the cassette is facing to the right, then insert the cassette most of the way into the slot. The system will pull it in the rest of the way and begin to play.

The tape direction indicator will light to show you which side of the cassette is playing. The ▲ indicates the side you inserted facing upward is now playing. If you want to play the other side, press the PROG button.

Dolby B noise reduction turns on when you insert a cassette. If the cassette was not recorded using Dolby noise reduction, turn it off by pressing the  button.

When the system reaches the end of the tape, it will automatically reverse direction and play the other side. If you want to remove the cassette from the drive, press one of the EJECT buttons (AM/CD or FM1/FM2).

The system will automatically eject the cassette whenever you turn off the system or the ignition switch.

Tape Search Functions

With a cassette playing, you can use the FF, REW, TMS, or REPEAT functions to find a desired program.

FF/REW— Push down the FF/REW/TMS switch to rewind the tape rapidly. Push the switch up to fast forward. Press the PLAY button to take the system out of rewind or fast forward. If

the system reaches the end of the tape while in fast forward or rewind, it automatically stops that function, reverses direction, and begins to play.

TMS— The Tape Music Search function allows you to find the beginning of a song or passage. To activate TMS, press the TMS button. The light in the button will remain on as a reminder that it is activated. Then press FF or REW to move the tape forward or backward. When the system reaches the beginning of the next song or passage (FF), or the beginning of the current one (REW), it goes back to PLAY mode. Deactivate TMS by pressing the TMS button again.

REPEAT — The Repeat function continuously replays the current song or passage. Press the REPEAT button to activate it; you will see RPT displayed as a reminder. When the system reaches the end of the song or passage currently playing, it will automatically go into rewind. When it senses the beginning of the same song or passage, the system returns to PLAY mode. It will continue to repeat this same program until you deactivate REPEAT by pressing the button again.

The TMS and REPEAT functions use silent periods on the tape to find the end of a song or passage. These features may not work to your satisfaction if there is almost no gap between selections, a high noise level between selections, or a silent period in the middle of a selection.

EX

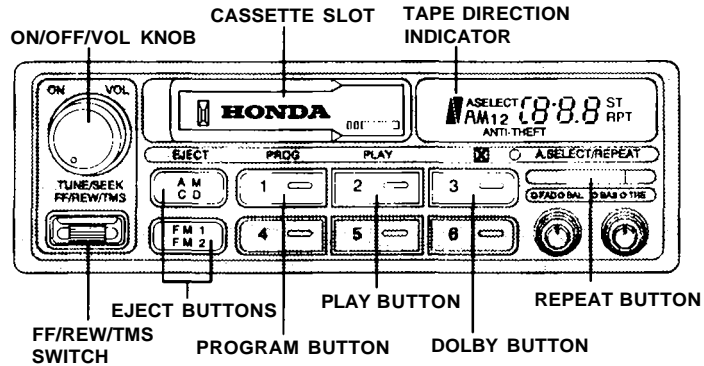

LX

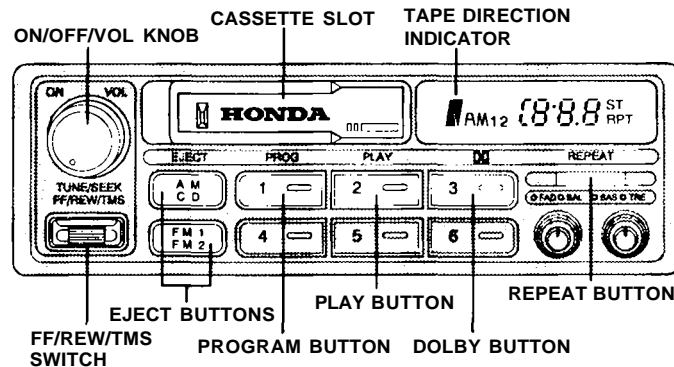

Audio System

Caring for the Cassette Player

The cassette player picks up dirt and oxides whenever you play a tape. This contamination builds up over time and causes the sound quality to degrade. To prevent this, you should clean the cassette drive after every 30 hours of use. Your Honda dealer has a cleaning kit available.

If you do not clean the cassette drive regularly, it may eventually become impossible to remove the deposits with a normal cleaning kit.

The player automatically ejects cassettes that do not play properly. If it ejects a cassette before it begins to play, it is probably defective and should not be inserted again. You may have a cassette suddenly stop playing, reverse directions once or twice, and then eject. This is normally

an indication the tape is wound unevenly. It should play after the tape is manually rewound.

Use 100-minute or shorter cassettes. Cassettes longer than that use thinner tape that may break or jam the drive.

Look at the cassette before you insert it. If the tape is loose, tighten it by turning a hub with a pencil or your finger. If the label is peeling off, remove it from the cassette or it could cause the cassette to jam in the player. Never try to insert a warped or damaged cassette in the player.

Do not leave cassettes sitting where they will be exposed to direct sunlight, high heat, or high humidity, such as on top of the dashboard or in the player. If a cassette is exposed to extreme heat or cold, let it reach a

moderate temperature before inserting it in the player.

After 30 hours of tape use, you will see CLEAN flashing for 5 seconds in the display when you insert a tape into the tape slot. If you are already regularly cleaning the tape drive at least every 30 hours, reset the indicator by pressing the Preset 6 button while the system is in the tape operation mode. Hold the button until you hear a beep and the CLEAN indicator goes out.

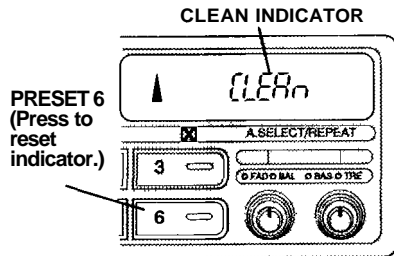

Operating the Optional CD Changer

A Compact Disc changer is available through your dealer. It holds up to six discs, providing several hours of continuous entertainment. You operate the CD changer with the same controls used for the radio and cassette player.

Your dealer also has an accessory in-dash single CD player available that is operated by the radio controls. To operate this unit, use the instructions (except for those relating to multiple discs) in this section.

Using the instructions that came with the changer, load the desired CDs in the magazine, and load the magazine in the changer.

To operate the CD changer, the ignition must be in Accessory (I) or ON (II) and the audio system must be on. If you are listening to a cassette, eject it.

Press the CD button until "CD" appears in the display. The system will start to play the first track of the first disc in the magazine. When that disc ends, the next disc in the magazine is loaded and played. After the last disc finishes, the system returns to disc 1.

EX

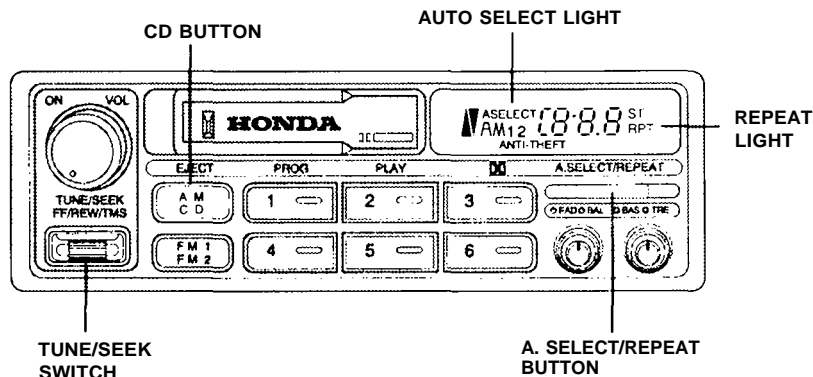

Audio System

To select a different disc than the one that is playing, press the appropriate preset button (1-6). The system will load that disc and begin playing it from the first track.

You can use the FF/REW/TMS switch to select tracks within a disc. If you push up and release the FF/REW/TMS switch, the system will move to the beginning of the next track. Push the switch down to move to the beginning of the current track.

If you push and hold the FF/REW/TMS switch up or down, the system will continue to move forward or back across the tracks. Release the bar when you think it has reached the desired place on the disc.

REPEAT — To activate the Repeat feature press the Repeat button until you see RPT in the display. The system continuously replays the current track. Press the Repeat button again to turn it off.

EX model only — **RANDOM PLAY**
- This feature, when activated, plays the tracks on a CD in random order, rather than in the order they are recorded on the CD. To activate Random Play, press and hold the A.SELECT/REPEAT button until you see A.SELECT in the display. The system will then select and play tracks randomly on the current disc. When all tracks on that disc have been played, the next disc is loaded and played randomly. This continues until you deactivate Random Play by pressing A.SELECT/REPEAT again.

If the system is in Repeat mode, you must turn it off by pressing A.SELECT/REPEAT before you can select Random Play. Then press and hold the button again until you see A.SELECT displayed.

To take the system out of CD mode, press the AM or FM1/FM2 buttons or insert a cassette in the player. When you return to CD mode, play will continue at the same disc and track.

If you turn the system off while a CD is playing, either with the ON/VOL knob or the ignition switch, play will continue at the same disc and track when you turn it back on.

Protecting Compact Discs

Handle a CD by its edges; never touch either surface.

Contamination from fingerprints, liquids, felt-tip pens, and labels can cause the CD to not play properly, or possibly jam in the drive.

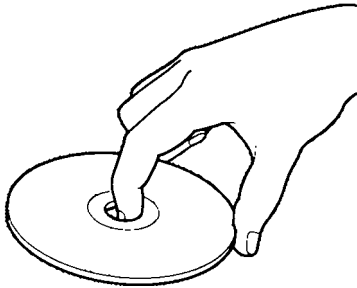

When a CD is not being played, store it in its case to protect it from dust and other contamination. To prevent warpage, keep CDs out of direct sunlight and extreme heat.

To clean a disc, use a clean soft cloth. Wipe across the disc from the center to the outside edge.

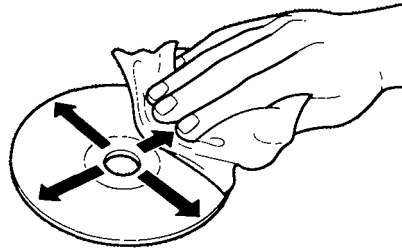

A new CD may be rough on the inner and outer edges. The small plastic pieces causing this roughness can flake off and fall on the recording surface of the disc, causing skipping or other problems. Remove these pieces by rubbing the inner and outer edges with the side of a pencil or pen.

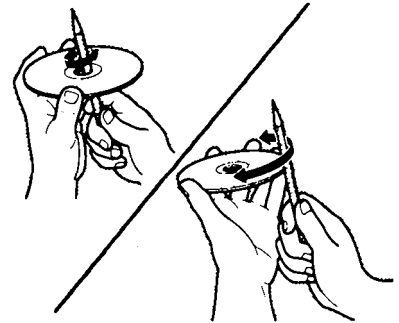

Never try to insert foreign objects in the CD player or the magazine.

Audio System

CD Error Indications

If you see an error indication in the display while in CD mode, find the cause in the chart to the right. If you cannot clear the error indication, take the car to your Honda dealer.

Indication	Cause	Solution
<i>E - 01</i>	Disc-changer malfunction.	Consult your Honda dealer.
<i>E - 02</i>	Disc is in changer mechanism.	Press the magazine eject button, and insert an empty magazine.
<i>E - 03</i> <i>E - 04</i> <i>E - 05</i>	Disc-changer malfunction.	If the code disappears within a few seconds, unit is OK. If it does not, consult your Honda dealer.
<i>E - 06</i>	Disc-changer malfunction.	Press the magazine eject button and pull out the magazine, check for error indication. Insert the magazine again. If the magazine cannot be pulled out, consult your Honda dealer.
<i>E - 07</i>	CD magazine ejection impossible.	Press the magazine eject button. If the magazine does not eject, consult your Honda dealer.
<i>- - - H</i>	High temperature.	Will disappear when the temperature returns to normal.
<i>E - EE</i>	Misconnection or disconnection of CD changer.	See your Honda dealer.
<i>- - - -</i>	No CD magazine in the CD changer.	Insert CD magazine.
<i>0 - 00</i>	No CD in magazine.	Insert CD in magazine.

EX model

Your car's audio system will disable itself if it is disconnected from electrical power for any reason. To make it work again, the user must enter a specific five-digit code with the Preset buttons. Because there are hundreds of number combinations possible from five digits, making the system work without knowing the exact code is nearly impossible.

You should have received a card that lists your audio system's code number and serial number. It is best to store this card in a safe place at home. In addition, you should write the audio system's serial number in this Owner's Manual. If you should happen to lose the card, you must obtain the code number from your Honda dealer. To do

this you will need the system's serial number.

If your car's battery is disconnected or goes dead, the audio system will disable itself. If this happens, you will see "Code" in the frequency display the next time you turn on the system. Use the Preset buttons to enter the five-digit code. If it is entered correctly, the radio will start playing.

If you make a mistake entering the code, do not start over or try to correct your mistake. Complete the five-digit sequence, then enter the correct code. You have three tries to enter the correct code. If you are unsuccessful in three attempts, you must then leave the system on for one hour before trying again.

You will have to store your favorite stations in the Preset buttons after the system begins working. Your original settings were lost when power was disconnected.

Before you begin driving your Honda, you should know what gasoline to use, and how to check the levels of important fluids. You also need to know how to properly store luggage or packages. The information in this section will help you.

Break-in Period	82
Gasoline	82
Oxygenated Fuels	82
Driving in Foreign Countries	83
Service Station Procedures ..	84
Filling the Fuel Tank	84
Opening the Hood	85
Oil Check	86
Engine Coolant Check ..	87
Fuel Economy	87
Vehicle Condition	87
Driving Habits	87
Loading Cargo	88
Cargo Area	89
Storage Compartments	89
Cargo Area Tonneau Cover	89
Accessories	91

Break-in Period, Gasoline

Break-in Period

Help assure your car's future reliability and performance by paying extra attention to how you drive during the first 600 miles (1,000 km). During this period:

- Avoid full-throttle starts and rapid acceleration.
- If you need to add oil, use the engine oil recommended in this Owner's Manual.
- Avoid hard braking. New brakes need to be broken-in by moderate use for the first 200 miles (300 km).

You should follow these same recommendations with an overhauled or exchanged engine, or when the brakes are replaced.

Gasoline

Your Honda is designed to operate most effectively on unleaded gasoline. Use an unleaded gasoline with a pump octane number of 86 or higher. Use of a lower octane gasoline can cause a persistent, heavy metallic rapping noise in the engine that can lead to mechanical damage.

We recommend using gasoline containing detergent additives that help prevent fuel system and engine deposits.

Using gasoline containing lead will damage your car's emission controls. This contributes to air pollution and can void certain parts of your warranty.

Oxygenated Fuels

Some conventional gasolines are being blended with alcohol or an ether compound. These gasolines are collectively referred to as oxygenated fuels. To meet clean air standards, some areas of the United States and Canada use oxygenated fuels to help reduce emissions.

If you use an oxygenated fuel, be sure it is unleaded and meets the minimum octane rating requirement.

Before using an oxygenated fuel, try to confirm the fuel's contents. Some states/provinces require this information to be posted on the pump.

The following are the EPA-approved percentages of oxygenates:

ETHANOL (ethyl or grain alcohol) — You may use gasoline containing up to 10% ethanol by volume. Gasoline containing ethanol may be marketed under the name "Gasohol."

MTBE (Methyl Tertiary Butyl Ether) — You may use gasoline containing up to 15% MTBE by volume.

METHANOL (methyl or wood alcohol) — You may use gasoline containing up to 5% methanol by volume as long as it also contains cosolvents and corrosion inhibitors to protect the fuel system. Gasoline containing more than 5% methanol by volume may cause starting and/or performance problems. It

may also damage metal, rubber, and plastic parts of your fuel system.

If you notice any undesirable operating symptoms, try another service station or switch to another brand of gasoline.

Fuel system damage or performance problems resulting from the use of an oxygenated fuel containing more than the percentages of oxygenates given previously are not covered under warranty.

Driving in Foreign Countries

If you are planning to take your Honda outside the U.S. or Canada, contact the tourist bureaus in the areas you will be traveling in to find out about the availability of unleaded gasoline with the proper octane rating.

If unleaded gasoline is not available, be aware that using leaded gasoline in your Honda will affect performance and fuel mileage, and damage its emissions controls. It will no longer comply with U.S. and Canadian emissions regulations, and will be illegal to operate in North America. To bring your car back into compliance will require the replacement of several components, such as the oxygen sensor and the catalytic converter. These replacements are not covered under warranty.

Service Station Procedures

Filling the Fuel Tank

1. Because the fuel fill cap is on the driver's side of the car, park with that side closest to the service station pumps.
2. Open the fuel fill door by pulling on the handle to the left of the driver's seat.

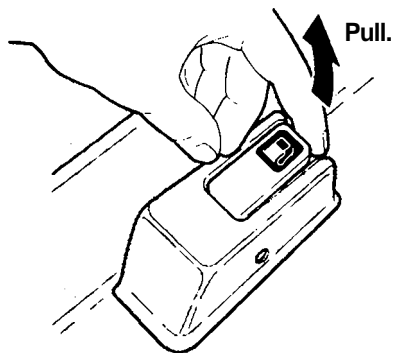

3. Remove the fuel fill cap slowly. You may hear a hissing sound as pressure inside the tank escapes.

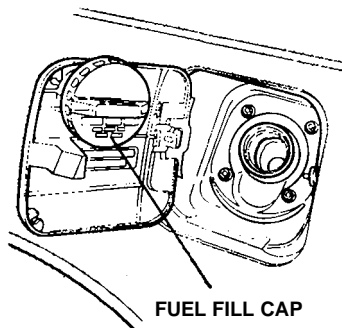

Gasoline is highly flammable and explosive. You can be burned or seriously injured when handling fuel.

- Stop the engine and keep heat, sparks, and flame away.
 - Handle fuel only outdoors.
 - Wipe up spills immediately.
4. Stop filling the tank after the gas pump automatically clicks off. Do not try to "top off" the tank; leave some room for the fuel to expand with temperature changes.
 5. Screw the fuel fill cap back on; tighten it until it clicks.

6. Push the fuel fill door closed until it latches.

Opening the Hood

1. Shift to Park or Neutral, and set the parking brake. Pull the hood release handle located under the left lower corner of the dashboard. The hood will pop up slightly.



2. Standing in front of the car, put your fingers under the front edge of the hood to the right of center. Slide your hand to the left until you feel the hood latch handle. Push this handle to the left until it releases the hood. Lift the hood.

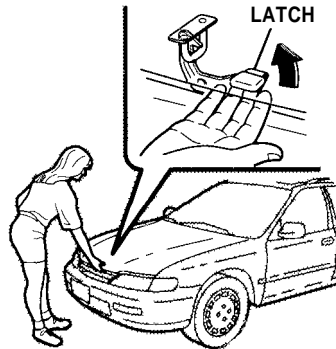

3. Pull the support rod out of its clip, and insert the end into the hole on the driver's side of the hood.

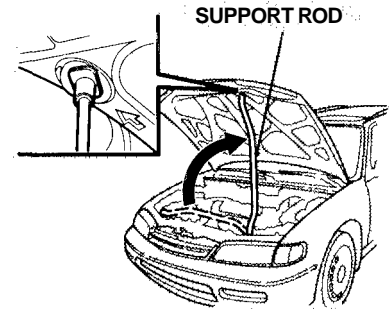

To close the hood, lift it up slightly to remove the support rod from the hole. Put the support rod back into its holding clip. Lower the hood to about a foot above the fender, and then let it drop.

Service Station Procedures

Oil Check

Check the engine oil level every time you fill the car with fuel. Wait at least two minutes after turning the engine off before you check the oil.

1. Remove the dipstick (orange handle).

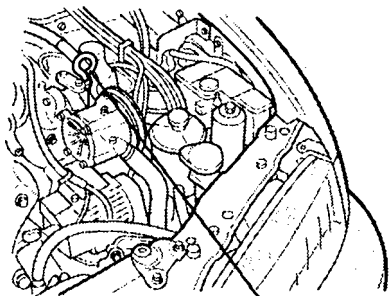

DIPSTICK

2. Wipe the dipstick with a clean cloth or paper towel.

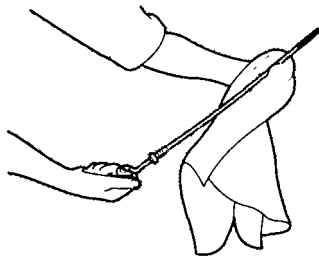

3. Insert it all the way back in its tube.

4. Remove the dipstick again, and check the level. It should be between the upper and lower marks.

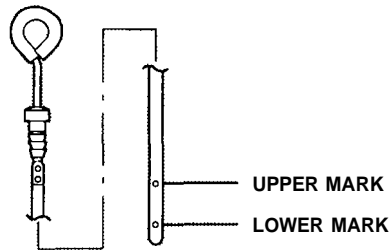

If it is near or below the lower mark, see **Adding Oil** on page 118.

Engine Coolant Check

Look at the coolant level in the radiator reserve tank. Make sure it is between the MAX and MIN lines. If it is below the MIN line, see **Adding Engine Coolant** on page 121 for information on adding the proper coolant.

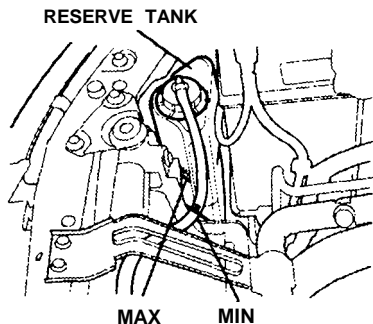

Refer to **Periodic Checks** on page 116 for information on checking other items in your Honda.

Fuel Economy

The condition of your car and your driving habits are the two most important things that affect the fuel mileage you get.

Vehicle Condition

Always maintain your car according to the maintenance schedule. This will keep it in top operating condition.

An important part of that maintenance is the **Periodic Checks** (see page 116). For example, an underinflated tire causes more "rolling resistance," which uses fuel. It also wears out faster, so check the tire pressure at least monthly.

In winter the buildup of snow on your car's underside adds weight and rolling resistance. Frequent cleaning helps your fuel mileage

and reduces the chance of corrosion.

Driving Habits

You can improve fuel economy by driving moderately. Rapid acceleration, cornering, and hard braking use more fuel.

Always drive in the highest gear that allows the engine to run and accelerate smoothly.

Depending on traffic conditions, try to maintain a constant speed. Every time you slow down and speed up, your car uses extra fuel. Use the cruise control, when appropriate, to increase fuel economy.

A cold engine uses more fuel than a warm engine. It is not necessary to "warm-up" a cold engine by letting it idle for a long time. You can drive away within

continued

Fuel Economy, Loading Cargo

30 seconds, no matter how cold it is outside. The engine will warm up faster, and you get better fuel economy. To cut down on the number of "cold starts," try to combine several short trips into one.

Air conditioning puts an extra load on the engine which makes it use more fuel. Turn off the A/C to cut down on air conditioning use. Use the flow-through ventilation when the outside air temperature is moderate.

Loading Cargo

The maximum load you can carry in your Honda is 950 lb (430 kg). It includes the total weight of all passengers and their belongings, and any accessories. This 950 lb (430 kg) figure is shown as the Vehicle Capacity Weight on the tire

information label attached to the driver's side doorjamb.

To figure out how much cargo you can carry, do this:

- Figure the total "occupant weight" you will be transporting. To do this, multiply the number of people (driver and all passengers) by 150 lb(70kg).
- Subtract this number from the Vehicle Capacity Weight (950 lb/430 kg).
- If you are towing a trailer, subtract the tongue weight. See **Towing a Trailer** on page 103.

This final number is the total weight of cargo you can load in or on the car. With five occupants (driver and four passengers), the maximum recommended weight for cargo is 200 lb (90 kg).

EX model - If you put cargo on the roof, secure all items and make sure the cargo does not exceed 100 pounds. Never exceed the load limits for the vehicle.

Where you store cargo and how well you secure it are just as important as how much it weighs. Make sure you load cargo so it will not shift while driving. Items stored in the cargo area should be placed as far forward as possible. You could store additional items on the floor behind the front seats. Make sure they cannot roll under the front seat and interfere with the pedals.

If you must carry large objects that prevent you from closing the tailgate, be aware that exhaust gas can enter the interior. See **Carbon Monoxide Hazard** on page 24.

Cargo Area

A passenger should never sit in the open cargo area while the car is moving. They should sit in one of the seats and wear their seat belt. With the rear seats folded, the length of the cargo area is 64.5 inches (1,640 mm). The width at the tailgate opening is 43 inches (1,107 mm). The width between the wheelwells is 33 inches (846 mm). The rear opening height is 27 inches (710 mm).

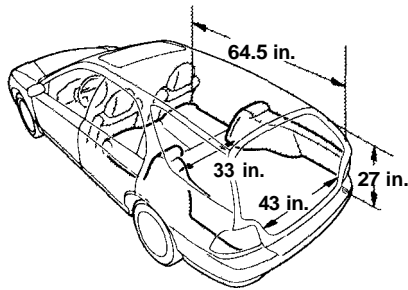

Storage Compartments

You can store smaller items in any of the three storage compartments in the cargo area. Two compartments are on either side of the tire compartment. The third is in the right side panel.

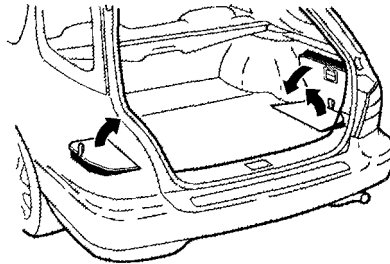

Cargo Area Tonneau Cover

When extended, the tonneau cover conceals your parcels and protects them from direct sunlight. To extend the tonneau cover, pull the cover's leading edge out of its housing, and slip

the brackets in the hooks provided at both sides of the tailgate opening.

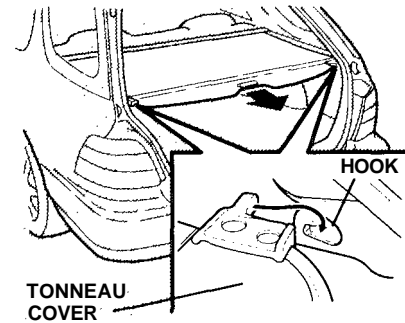

To retract the cover, slip the brackets out of the hooks, and guide the cover so it rolls back fully into its housing.

NOTICE

Do not store parcels on the tonneau cover. The tonneau cover may break if weight is placed on it.

continued

Loading Cargo

To remove the tonneau cover housing unit, press the release on one side, carefully lift it out of the holder, and rest it on the trim.

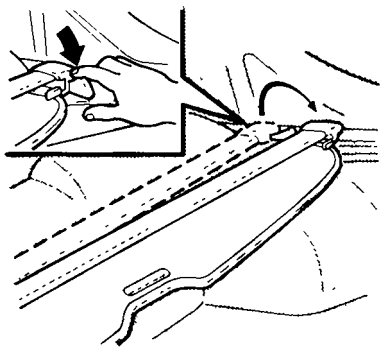

Release the other side, then remove the unit. Store the unit in an area where it will not be damaged.

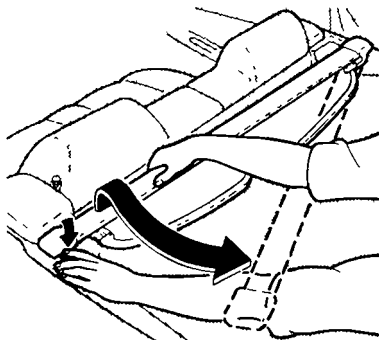

NOTICE

If you lift the housing unit more than 6 inches (150 mm) or pull it too far rearward, you may risk damaging the unit.

Your Honda dealer has many Genuine Honda Accessories that allow you to personalize your car. These have all been approved for installation and use on your car and are covered by warranty.

Some non-Honda accessories you can buy in the "aftermarket" are designed for universal application. Although they may fit your Honda, they may not be within factory specifications. For example, aftermarket wheels may not meet Honda's specifications for width and offset. They could cause suspension problems which would not be covered by your warranty. Improperly designed accessories can adversely affect your car's handling and stability.

Your car has several computer-controlled systems,

including the SRS system, the engine's fuel injection, and the anti-lock brake system. Strong electronic interference can affect their operation.

Electronic communications equipment, such as cellular telephones and two-way radios are regulated by the FCC and should not interfere with your car's systems. Improper installation or using electrical equipment not intended for mobile use may interfere with your car's operation. If you want to install a cellular telephone, other mobile communications equipment, or even add-on stereo amplifiers, please discuss it first with your Honda dealer.

In many cases, improper installation is the real cause of problems with aftermarket accessories. Have these

accessories installed by qualified technicians who are familiar with your Honda. If possible, have your Honda dealer inspect the final installation.

This section gives you tips on starting the engine under various conditions and how to operate the 5-speed manual and automatic transmissions. It also includes important information on your car's braking system and facts you need if you are planning to tow a trailer.

Preparing to Drive	94
Starting the Engine	94
Starting in Cold Weather at High Altitude	95
5-Speed Manual	
Transmission	95
Recommended Shift Points	96
Maximum Speeds	97
Automatic Transmission	97
Shift Lever Position Indicator	97
Shift Lever Positions	98
Maximum Speeds	100
Shift Lock Release	100
The Braking System	101
Brake Wear Indicators ...	101
Brake System Design	101
Anti-Lock Brakes	102
Towing a Trailer	103

Preparing to Drive, Starting the Engine

You should do the following checks and adjustments every day before you drive your car.

1. Make sure all windows, mirrors, and outside lights are clean and unobstructed. Remove frost, snow, or ice.
2. Check that the hood and trunk are fully closed.
3. Visually check the tires. If a tire looks low, use a gauge to check its pressure.
4. Check that any items you may be carrying with you inside are stored properly or fastened down securely.
5. Check the adjustment of the seat (see page 48).
6. Check the adjustment of the inside and outside mirrors (see page 53).
7. Check the adjustment of the steering wheel (see page 40).

8. Make sure the doors are securely closed and locked.
9. Fasten your seat belt. Check that your passengers have fastened their seat belts (see page 7).
10. Turn the ignition ON (II). Check the indicator lights in the instrument panel.
11. Start the engine.
12. Check the gauges and indicator lights in the instrument panel (see page 29).

Starting the Engine

1. Apply the parking brake.
2. In cold weather, turn off all electrical accessories to reduce the drain on the battery.

3. *Manual transmission:* Push the clutch pedal all the way down. START (III) does not function unless the clutch pedal is depressed.
Automatic transmission: Make sure the shift lever is in Park. Press on the brake pedal.
4. Without touching the accelerator pedal, turn the ignition key to the START (III) position. If the engine does not start right away, do not hold the key in START (III) for more than 15 seconds at a time. Pause for at least 10 seconds before trying again.
5. If the engine does not start within 15 seconds or starts but stalls right away, repeat step 4 with the accelerator pedal pressed. If the engine starts, release pressure on the accelerator pedal so the engine does not race.

Starting the Engine, 5-Speed Manual Transmission

6. If the engine still does not start, press the accelerator pedal all the way down and hold it there while starting to clear any flooding. As before, keep the ignition key in the START (III) position for no more than 15 seconds. Return to step 5 if the engine does not start. If it starts, lift your foot off the accelerator pedal so the engine does not race.

Starting in Cold Weather at High Altitude (Above 8,000 Feet/2,400 Meters)

An engine is harder to start in cold weather. The thinner air found at high altitude above 8,000 feet (2,400 meters) adds to the problem. Use the following procedure:

1. Turn off all electrical accessories to reduce the drain on the battery.

2. Press the accelerator pedal halfway down, and hold it there while starting the engine. Do not hold the ignition key in START (III) for more than 15 seconds. When the engine starts, release the accelerator pedal gradually as the engine speeds up and smooths out.
3. If the engine fails to start in step 2, press the accelerator pedal all the way down, and hold it there while you try to start the engine for no more than 15 seconds. If the engine does not start, return to step 2.

5-Speed Manual Transmission

The manual transmission is synchronized in all forward gears for smooth operation. It has a lockout so you cannot shift directly from Fifth to Reverse. When shifting up or down, make sure you press the clutch pedal down all the way, shift to the next gear, and let the pedal up gradually. When you are not shifting, do not rest your foot on the clutch pedal. This can cause your clutch to wear out faster.

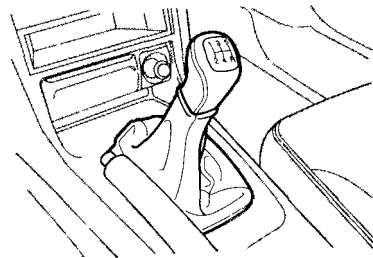

continued

5-Speed Manual Transmission

Come to a full stop before you shift into reverse. You can damage the transmission by trying to shift into reverse with the car moving. Push down the clutch pedal, and pause for a few seconds before shifting into reverse, or shift into one of the forward gears for a moment. This stops the gears so they won't "grind."

When slowing down, you can get extra braking from the engine by shifting to a lower gear. This extra braking can help you maintain a safe speed and prevent your brakes from overheating while going down a steep hill. Before downshifting, make sure engine speed will not go into the red zone in the lower gear. Refer to the Maximum Speeds chart.

Rapid slowing or speeding up can cause loss of control on slippery surfaces. If you crash, you can be injured.

Use extra care when driving on slippery surfaces.

Recommended Shift Points

Drive in the highest gear that lets the engine run and accelerate smoothly. This will give you the best fuel economy and effective emissions control. The following shift points are recommended:

Shift up	Normal acceleration
1 st to 2 nd	15 mph (24 km/h)
2 nd to 3 rd	28 mph (45 km/h)
3 rd to 4 th	41 mph (66 km/h)
4 th to 5 th	52 mph (84 km/h)

Shift up	Cruise from acceleration
1 st to 2 nd	7 mph (11 km/h)
2 nd to 3 rd	22 mph (35 km/h)
3 rd to 4 th	33 mph (53 km/h)
4 th to 5 th	48 mph (77 km/h)

5-Speed Manual Transmission, Automatic Transmission

Maximum Speeds

The speeds in these tables are the maximums for the given gears. If you exceed these speeds, the engine speed will enter into the tachometer's red zone. If this occurs, you may feel the engine cut in and out. This is caused by a limiter in the engine's computer controls. The engine will run normally when you reduce the rpm below the red zone.

Gear	Maximum speeds
1 st	30 mph (49 km/h)
2 nd	56 mph (91 km/h)
3 rd	86 mph (139 km/h)
4 th	113 mph (182 km/h)
5 th	Top speed

Automatic Transmission

Your Honda's transmission has four forward speeds and is electronically controlled for smoother shifting. It also has a "lock-up" torque converter for better fuel economy. You may feel what seems like another shift when the converter locks.

Shift Lever Position Indicator

This indicator between the tachometer and speedometer shows which shift position the shift lever is in. The "D4" indicator comes on for a few seconds when you turn the ignition switch ON (II). If it flashes while driving (in any shift position), it indicates a possible problem in the transmission. Avoid rapid acceleration and have the transmission checked by an authorized Honda dealer as soon as possible.

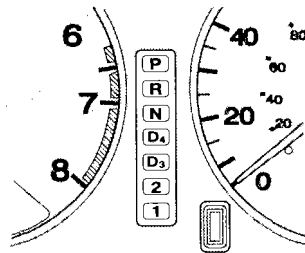

continued

Automatic Transmission

Shift Lever Positions

The shift lever has seven positions. It must be in Park or Neutral to start the engine. When you are stopped in D₄, D₃, 2, 1 or R, press firmly on the brake pedal, and keep your foot off the accelerator pedal.

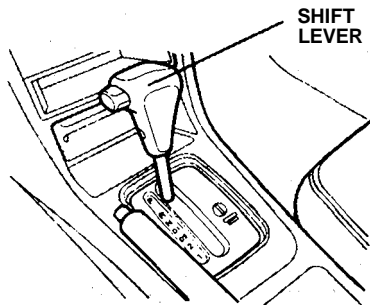

To shift from:	Do this:
P to R	Press the brake pedal, and press the release button.
R to P N to R D ₃ to 2 2 to 1	Press the release button.
1 to 2 2 to D ₃ D ₃ to D ₄ D ₄ to N D ₄ to D ₃ N to D ₄ R to N	Move the lever.

Park (P) — This position mechanically locks the transmission. Use Park whenever you are turning off or starting the engine. To shift out of Park, you must press on the brake pedal and have your foot off the accelerator pedal. Press the release button on the side of the shift lever to move it.

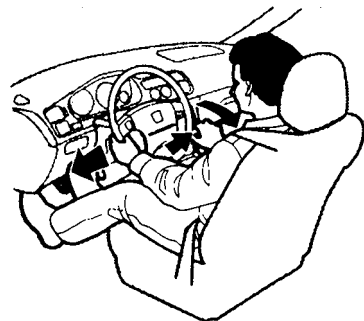

If you have done all of the above and still cannot move the lever

out of Park, see **Shift Lock Release** on page 100.

You must also press the release button to shift into Park. To avoid transmission damage, come to a complete stop before shifting into Park. The shift lever must be in Park before you can remove the key from the ignition switch.

Reverse (R) — To shift to Reverse from Park, see the explanation under Park. To shift to Reverse from Neutral, come to a complete stop and then shift. Press the release button before shifting into Reverse from Neutral.

Neutral (N) — Use Neutral if you need to restart a stalled engine or you need to stop briefly with the engine idling. Shift to Park position if you need to leave the car for any reason. Press on the brake pedal when you are

moving the shift lever from Neutral to another gear.

Drive (D4) — Use this position for your normal driving. The transmission automatically selects a suitable gear for your speed and acceleration. You may notice the transmission shifting up at higher speeds when the engine is cold. This helps the engine warm up faster.

Drive (D3) — This position is similar to D4, except only the first three gears may be selected. Use D3 when towing a trailer in hilly terrain or to provide engine braking when going down a steep hill. D3 can also keep the transmission from cycling between third and fourth gears in stop-and-go driving.

For faster acceleration when in D3 or D4, you can get the transmission to automatically

downshift by pushing the accelerator pedal to the floor. The transmission will shift down one or two gears, depending on your speed.

Second (2) - To shift to Second, press the release button on the side of the shift lever. This position locks the transmission in second gear. It does not downshift to first gear when you come to a stop. Second gives you more power when climbing, and increased engine braking when going down steep hills. Use second gear when starting out on a slippery surface or in deep snow. It will help reduce wheel spin.

Whenever you move the shift lever to a lower gear, the transmission downshifts only if the engine's redline will not be exceeded in the lower gear.

continued

Automatic Transmission

First (1) — To shift from Second to First, press the release button on the side of the shift lever. With the lever in this position, the transmission locks in First gear. By upshifting and downshifting through 1, 2, D3, and D4, you can operate this transmission much like a manual transmission without a clutch pedal.

Maximum Speeds

The speeds in these tables are the maximums for the given position. If you exceed these speeds, the engine speed will enter into the tachometer's red zone. If this occurs, you will feel the engine cut in and out. This is caused by a limiter in the engine's computer controls. The engine will run normally when you reduce the rpm below the red zone.

Position	Maximum speeds
1	33 mph (54 km/h)
2	61 mph (99 km/h)
D3	100 mph (160 km/h)
D4	Top speed

Shift Lock Release

This allows you to move the shift lever out of Park if the normal method of pushing on the brake pedal and pressing the release button does not work.

1. Set the parking brake.
2. Remove the key from the ignition switch.
3. Insert the key in the Shift Lock Release slot next to the shift lever.
4. Push down on the key while you press the release button and move the shift lever out of Park to Neutral.

5. Remove the key from the Shift Lock Release slot. Return the key to the ignition switch, depress the brake pedal, and restart the engine.

RELEASE BUTTON

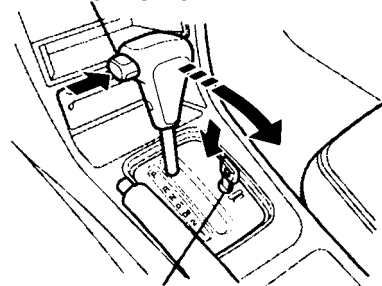

SHIFT LOCK RELEASE SLOT

If you need to use the Shift Lock Release, it could mean your car is developing a problem. Have the car checked by your Honda dealer.

The Braking System

Your Honda is equipped with front disc brakes. The brakes on the rear wheels may be disc or drum, depending on the model. The braking system is power assisted to reduce the effort needed on the brake pedal.

Put your foot on the brake pedal only when you intend to brake. Resting your foot on the pedal keeps the brakes applied lightly, causing them to build up heat. Heat buildup can reduce how well your brakes work. It also keeps your brake lights on all the time, confusing drivers behind you.

Constant application of the brakes when going down a long hill builds up heat and reduces their effectiveness. Use the engine to assist the brakes by downshifting to a lower gear and taking your foot off the accelerator pedal.

Brake Wear Indicators

The front disc brakes and rear brakes of ABS-equipped cars have audible brake wear indicators. When the brake pads need replacing, you will hear a distinctive metallic "screeching" sound when you apply the brakes. If you do not have the brake pads replaced, they will screech all the time.

Your brakes may sometimes squeal or squeak when you apply them lightly. Do not confuse this with the brake wear indicators. They make a very audible "screeching."

Brake System Design

The hydraulic system that operates the brakes has two separate circuits. Each circuit works diagonally across the car (the left-front brake is connected with the right-rear brake, etc.). If

one circuit should develop a problem, you will still have braking at two wheels.

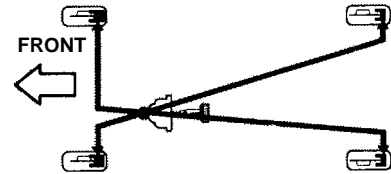

If this happens, you will notice that the brake pedal goes down much farther and you need to press on it much harder. A much longer distance will be needed to stop the car.

Slow the car by downshifting to a lower gear and removing your foot from the accelerator pedal. Pull to the side of the road as soon as it is safe. Because of the longer stopping distance needed,

continued

The Braking System

brake system failure is very hazardous. You should have your car towed, but if you must drive the car in this condition, be extremely cautious. Have your car repaired as soon as possible.

Anti-Lock Brakes

The EX Wagon has an Anti-lock Brake System (ABS) as standard equipment. ABS helps you to maintain steering control during hard braking. It does this by helping to prevent the wheels from locking up and skidding.

The ABS is always "ON." It requires no special effort or driving technique. You will feel a pulsation in the brake pedal when the ABS activates.

Activation varies with the amount of traction your tires have. On dry pavement, you will need to press on the brake pedal

very hard before you feel the pedal pulsation that means the ABS has activated. However, you may feel the ABS activate immediately if you are trying to stop on snow or ice. Under all conditions, the ABS is helping to prevent the wheels from locking so you can retain steering control. You should continue to press on the brake pedal with the same force.

You may feel a slight movement of the brake pedal just after you start the engine. This is the ABS working.

The ABS is self-checking. If anything goes wrong, the ABS indicator on the instrument panel comes on (see page 31). This means the anti-lock function of the braking system has shut down. The brakes still work like a conventional system, providing normal stopping ability. You

should have the dealer inspect your car as soon as possible.

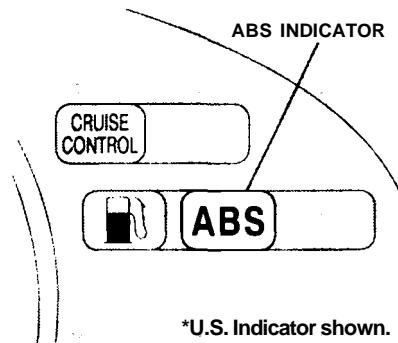

A car with ABS may require a longer distance to stop on loose or uneven surfaces than an equivalent car without anti-lock brakes. The ABS cannot make up for road conditions or bad judgment. It is still your responsibility to drive at reasonable speeds for weather and traffic conditions and to leave a margin of safety.

Towing a Trailer

Your Honda is designed primarily to carry passengers and their cargo. You can use it to tow a trailer if you carefully observe some general rules.

- The total weight of the trailer and everything loaded in it must not exceed 1,000 lb (450 kg).
- The "tongue load" should never exceed 100 lb (45 kg). This is the amount of weight the trailer puts on the hitch when it is fully loaded. As a rule of thumb, the tongue load should be 10% of the total trailer package.

For example, if the trailer and its load weigh 500 lb (225 kg), the tongue load should be 50 lb (22.5 kg). Adjust the trailer's cargo to change the tongue load. Start by putting

approximately 60% of the cargo toward the front and 40% toward the rear. Never load the trailer so the back is heavier than the front. This takes weight off your car's rear axle and reduces traction.

- The combined weight of the car, all passengers and their luggage, and tongue load must not exceed the Gross Vehicle Weight Rating. The GVWR is printed on the Certification Label attached to the driver's doorjamb (see page 176).
- The combined weight of the car, all passengers and their luggage, and tongue load also must not exceed the Gross Axle Weight Rating. The GAWR is also shown on the Certification label. It tells you the maximum load for the front and rear axles. It is

possible that your towing package does not exceed the GVWR but does exceed the GAWR. Improper trailer loading, and/or too much luggage in the trunk can overload the rear axle. Redistribute the load, and check the axle weights again.

Improperly loading your car and trailer can seriously affect its steering and braking performance, causing a crash in which you can be seriously injured.

Check the loading of your car and trailer carefully before starting to drive.

continued

Towing a Trailer

The best way to confirm that your total towing package is within these specifications is to get it weighed. Load the car and trailer as you normally would while towing, and take them to a public scale. Have them check the total weight and the weight at each axle, and then compare them to the specifications.

Trailer Hitches

Your Honda dealer, or the Honda Customer Relations Zone Office, can give you advice on the proper hitch for your car. Never use a hitch that mounts only to the rear bumper. The bumper is not designed to handle that type of load. The hitch should bolt to the under-body of the car and distribute the load over a wide area. Always have a trailer hitch installed by a qualified technician.

NOTICE

A trailer hitch that is not adequate for the size of the trailer, or a hitch that is improperly installed, can cause damage to the underside of your car.

Mirrors

Many states and provinces have laws requiring special outside mirrors when you are towing a trailer. Check the laws in your area. You may want to install mirrors, even if they are not required. Hook up the trailer and see how much it obscures your ability to see behind you with the standard mirrors. If you cannot see directly behind you, or have a large blind spot next to the trailer or the car, you should install mirrors intended for towing.

Connecting the Trailer

Most trailers that have a gross weight of 1,000 lb (450 kg) do not have their own braking system. If you are thinking of getting a trailer that does have brakes, make sure they are electrically operated. There are no provisions in your car to tap into its hydraulic braking system. Any attempt to attach the trailer's brakes to your car's hydraulic system, no matter how successful it may seem, will lower braking effectiveness and create a potential hazard.

Always use a safety chain when towing a trailer. Connect the safety chain securely at both ends. Make sure the chain crosses under the tongue so it will catch the trailer if it becomes unhitched. Leave enough slack in the chain so it can't bind in a sharp turn. Do not let it drag on the ground.

Your car has a trailer lighting connector under the cargo area floor. To use the connector, lift the floor and attach the hook at the end of the strap to the roof line.

You will find the connector under the left side box. Refer to the drawing below for the wiring color code and purpose of each connector pin.

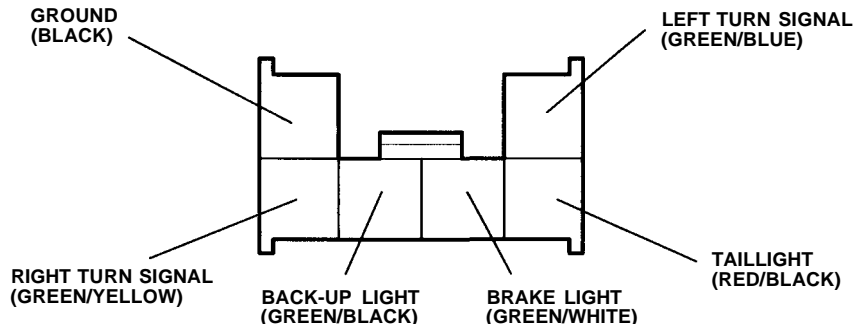

Before Starting Out

As you are preparing to tow your trailer, do the following:

- Measure the trailer's tongue load. You can do this with a bathroom scale.
- Verify that the hitch and safety chain are securely fastened.
- Check the condition and air pressure of all tires on the trailer and your car. Low tire

pressure can seriously affect the handling. Also, check the spare tire.

- With everything loaded and the trailer connected, check that the rear of the car is not sagging. If so, redistribute the load in the car.
- Check that all lights on the car and trailer are working properly.

Towing Safety

Your car will not stop as quickly with a trailer in tow. Leave extra distance between your car and other vehicles. Avoid braking or turning suddenly. This could cause the trailer to jackknife or possibly turn over.

Keep in mind that your total vehicle is now much longer. Leave more room when making

continued

Towing a Trailer

turns. The trailer tracks a smaller arc than the car and can hit or run over something that the car misses. When passing another vehicle, make sure the trailer is clear before changing lanes.

The car/trailer combination is more affected by crosswinds and buffeting. When being passed by a large vehicle, keep a constant speed and steer straight ahead. If there is too much wind buffeting, slow down to get out of the other vehicle's air turbulence.

Towing a trailer puts an extra load on your car. You should have your car serviced according to the maintenance schedule under severe driving conditions on page [113](#).

This extra load is magnified when you are driving in hilly terrain. Watch the temperature

gauge closely when climbing hills. If it gets near the hot area, turn off the air conditioning (if it is on). If this does not reduce the heat, it may be necessary to pull to the side of the road and wait for the engine to cool. If the automatic transmission shifts frequently between 3rd and 4th gears, put it in D3. This will help prevent the transmission from overheating. Help keep the brakes from overheating by shifting to a lower gear when going downhill.

If you have to stop while going uphill, do not hold the car in place by pressing the accelerator. This can cause the automatic transmission to overheat. Use the parking brake or footbrake.

When parking your car and trailer, especially on a hill, be

sure to follow all the normal precautions. Turn your front wheels into the curb, set the parking brake firmly, and put the transmission in 1st or Reverse (manual) or Park (automatic). In addition, place wheel chocks at each of the trailer's tires.

Backing up with a trailer is difficult and takes practice. Drive slowly, make small movements with the steering wheel, and have someone stand outside to guide you. Grip the steering wheel on the bottom (rather than the usual position near the top). Move your hand to the left to get the trailer to move to the left, and right to move the trailer right.

This section explains why it is important to keep your car well maintained and to follow basic maintenance safety precautions.

This section also includes Maintenance Schedules for normal driving and severe driving conditions, a Maintenance Record, and instructions for simple maintenance tasks you may want to take care of yourself.

If you have the skills and tools to perform more complex maintenance tasks on your Honda, you may want to purchase the Service Manual. See page 191 for information on how to obtain a copy, or see your Honda dealer.

Maintenance Safety	108
Maintenance Schedule	110
Maintenance Record	114

Periodic Checks	116
Fluid Locations	117
Engine Oil	118
Adding Oil	118
Recommended Oil	118
Synthetic Oil	119
Additives	119
Changing the Oil and Filter	119
Cooling System	121
Adding Engine Coolant ...	121
Replacing Engine Coolant	122
Windshield Washers	125
Transmission Fluid	125
Automatic Transmission .	125
5-Speed Manual Transmission	126
Brake and Clutch Fluid	127
Brake System	127
Anti-Lock Brake System ..	128
Clutch System	128
Power Steering	129
Air Cleaner Element	129

Spark Plugs	131
Replacement	131
Specifications	132
Battery	132
Windshield Wipers	134
Air Conditioning System	135
Drive Belts	136
Tires	137
Inflation	137
Inspection	138
Maintenance	139
Tire Rotation	139
Replacing Tires and Wheels	140
Wheels and Tires	140
Winter Driving	140
Snow Tires	141
Tire Chains	141
Lights	141
Replacing Bulbs	142
Storing Your Car	148

Maintenance Safety

Regularly maintaining your car is the best way to protect your investment. Proper maintenance is essential to your safety and the safety of your passengers. It will also reward you with more economical, trouble-free driving and help reduce air pollution.

Improperly maintaining this car or failing to correct a problem before driving can cause a crash in which you can be seriously hurt and killed.

Always follow the inspection and maintenance recommendations and schedules in this owner's manual.

This section includes instructions for simple maintenance tasks, such as checking and adding oil. Any service items not detailed in this section should be performed by a Honda technician or other qualified mechanic.

Some of the most important safety precautions are given below. However, we cannot warn you of every conceivable hazard that can arise in performing maintenance. Only you can decide whether or not you should perform a given task.

Failure to properly follow maintenance instructions and precautions can cause you to be seriously hurt or killed.

Always follow the procedures and precautions in this owner's manual.

Important Safety Precautions

Before you begin any maintenance, make sure that your car is parked on level ground and the parking brake is set. Also, be sure the engine is off. This will help to eliminate several potential hazards:

- **Carbon monoxide poisoning from engine exhaust.** Be sure there is adequate ventilation whenever you operate the engine.
- **Burns from hot parts.** Let the engine and exhaust system cool before touching any parts.
- **Injury from moving parts.** Do not run the engine unless instructed to do so.

Read the instructions before you begin, and make sure you have the tools and skills required.

To reduce the possibility of fire or explosion, be careful when working around gasoline or batteries. Use a nonflammable solvent, not gasoline, to clean parts. Keep cigarettes, sparks and flames away from the battery and all fuel-related parts. You should wear eye protection and protective clothing when working near the battery or when using compressed air.

Maintenance Schedule

Maintenance Schedule

The Maintenance Schedule specifies how often you should have your car serviced and what things need attention. It is essential that your car be serviced as scheduled to retain its high level of safety, dependability, and emissions control performance.

The services and time or mileage intervals shown in the maintenance schedule assume you will use your car as normal transportation for passengers and their possessions. You should also follow these recommendations:

- Avoid exceeding your car's load limit. This puts excess strain on the engine, brakes, and many other parts of your car. The load limit is shown on the label on the driver's doorjamb.
- Operate your car on reasonable roads within the legal speed limit.
- Drive your car regularly over a distance of several miles (kilometers).
- Always use unleaded gasoline with a pump octane number of 86 or higher (see page [82](#)).

Which Schedule to Follow

Service your car according to the time and mileage periods on one of the Maintenance Schedules on the following pages. Select the schedule for "Severe Conditions" if most of your driving is done under one or more of the conditions listed on that page. Otherwise, follow the schedule for "Normal Conditions."

Your authorized Honda dealer knows your car best and can provide competent, efficient service. However, service at a dealer is not mandatory to keep your warranties in effect.

Maintenance may be done by any qualified service facility or person who is skilled in this type of automotive service. Keep all the receipts as proof of completion, and have the person who does the work fill out the Maintenance Record. Check your warranty booklet for more information.

We recommend the use of Genuine Honda parts and fluids whenever you have maintenance done. These are manufactured to the same high quality standards as the original components, so you can be confident of their performance and durability.

U.S. Cars:

Maintenance, replacement, or repair of emissions control devices and systems may be done by any automotive repair establishment or individual using parts that are "certified" to EPA standards.

According to state and federal regulations, failure to perform maintenance on the items marked with an asterisk (*) will not void your emissions warranties. However, Honda recommends that all maintenance services be performed at the recommended time or mileage period to ensure long-term reliability.

Maintenance Schedule (Normal Conditions)

Service at the indicated distance or time – whichever comes first.	miles x 1,000	15	30	45	60	75	90	105
	km x 1,000	24	48	72	96	120	144	168
	months	12	24	36	48	60	72	84
Replace engine oil	Replace every 7,500 miles (12,000 km) or 12 months							
Replace engine oil filter	●	●	●	●	●	●	●	●
Check engine oil and coolant	Check oil and coolant at each fuel stop							
Replace air cleaner element		●		●		●		●
Inspect valve clearance		●		●		●		●
Replace spark plugs		●		●		●		●
Inspect distributor cap* and rotor*				●				
Replace timing belt*, timing balancer belt*, and inspect water pump							●	
Inspect and adjust drive belts		●		●		●		●
Inspect idle speed*					●			
Replace engine coolant				●		●		●
Replace transmission fluid (MT, AT)							●	
Inspect front and rear brakes	●	●	●	●	●	●	●	●
Replace brake fluid (including ABS)			●				●	
Check parking brake adjustment	●	●	●	●	●	●	●	●
Rotate tires (Check tire inflation and condition at least once per month)	Rotate tires every 7,500 miles (12,000 km)							
Visually inspect the following items:								
Brake hoses and lines (including ABS) All fluid levels and condition of fluids Tie rod ends, steering gear box, and boots Suspension components Driveshaft boots Cooling system hoses and connections Exhaust system* Fuel lines and connections*	●	●	●	●	●	●	●	●
Inspect supplemental restraint system	10 years after production							

Follow the Normal Conditions Maintenance Schedule if the severe driving conditions specified in the Severe Conditions Maintenance Schedule on the next page do not apply.

Maintenance Schedule (Severe Conditions)

Service at the indicated distance or time – whichever comes first.	miles x 1,000	15	30	45	60	75	90	105
	km x 1,000	24	48	72	96	120	144	168
	months	12	24	36	48	60	72	84
Replace engine oil and oil filter	Replace every 3,750 miles (6,000 km) or 6 months							
Check engine oil and coolant	Check oil and coolant at each fuel stop							
Clean (○) or replace (●) air cleaner element Use normal schedule except dusty conditions	○	●	○	●	○	●	○	○
Inspect valve clearance		●		●		●		
Replace spark plugs		●		●		●		
Inspect distributor cap* and rotor*				●				
Replace timing belt*, timing balancer belt*, and inspect water pump	Replace every 60,000 miles (96,000 km)							
Inspect and adjust drive belts		●		●		●		
Inspect idle speed*				●				
Replace engine coolant				●		●		●
Replace transmission fluid (MT, AT)		●		●		●		●
Inspect front and rear brakes	Inspect every 7,500 miles (12,000 km) or 6 months							
Replace brake fluid (including ABS)				●				●
Check parking brake adjustment	●	●	●	●	●	●	●	●
Rotate tires (Check tire inflation and condition at least once per month)	Rotate tires every 7,500 miles (12,000 km)							
Visually inspect the following items:								
Tie rod ends, steering gear box, and boots Suspension components Driveshaft boots	Every 7,500 miles (12,000 km) or 6 months							
Brake hoses and lines (including ABS) All fluid levels and conditions of fluids Cooling system hoses and connections Exhaust system* Fuel pipes, hoses, and connections*	●	●	●	●	●	●	●	●
Inspect supplemental restraint system	10 years after production							

Follow the Severe Conditions Maintenance Schedule if you drive your vehicle *MAINLY* under one or more of the following conditions:

- Driving less than 5 miles (8 km) per trip or, in freezing temperatures, driving less than 10 miles (16 km) per trip.
- Driving in extremely hot [over 90°F (32°C)] conditions.
- Extensive idling or long periods of stop-and-go driving.
- Trailer towing, driving with a car-top carrier, or driving in mountainous conditions.
- Driving on muddy, dusty, or de-iced roads.

NOTE: If you only *OCCASIONALLY* drive under a "severe" condition, you should follow the Normal Conditions Maintenance Schedule on the previous page.

Required Maintenance Record

Have your servicing dealer record all Required Maintenance below. Keep receipts for all work done on your car.

7,500 Mi. 12,000 km (or 6 Mo.)	(Sign or Stamp)	Mi. (km)
		Date
15,000 Mi. 24,000 km (or 12 Mo.)	(Sign or Stamp)	Mi. (km)
		Date
22,500 Mi. 36,000 km (or 18 Mo.)	(Sign or Stamp)	Mi. (km)
		Date
30,000 Mi. 48,000 km (or 24 Mo.)	(Sign or Stamp)	Mi. (km)
		Date
37,500 Mi. 60,000 km (or 30 Mo.)	(Sign or Stamp)	Mi. (km)
		Date
45,000 Mi. 72,000 km (or 36 Mo.)	(Sign or Stamp)	Mi. (km)
		Date
52,500 Mi. 84,000 km (or 42 Mo.)	(Sign or Stamp)	Mi. (km)
		Date

60,000 Mi. 96,000 km (or 48 Mo.)	(Sign or Stamp)	Mi. (km)
		Date
67,500 Mi. 108,000 km (or 54 Mo.)	(Sign or Stamp)	Mi. (km)
		Date
75,000 Mi. 120,000 km (or 60 Mo.)	(Sign or Stamp)	Mi. (km)
		Date
82,500 Mi. 132,000 km (or 66 Mo.)	(Sign or Stamp)	Mi. (km)
		Date
90,000 Mi. 144,000 km (or 72 Mo.)	(Sign or Stamp)	Mi. (km)
		Date
97,500 Mi. 156,000 km (or 78 Mo.)	(Sign or Stamp)	Mi. (km)
		Date
105,000 Mi. 168,000 km (or 84 Mo.)	(Sign or Stamp)	Mi. (km)
		Date

Non-Scheduled Maintenance Record

Record additional maintenance for severe driving conditions or non-scheduled maintenance on this page (see page 113).

Maintenance Performed:	(Sign or Stamp)	Mi. (km)
		Date
Maintenance Performed:	(Sign or Stamp)	Mi. (km)
		Date
Maintenance Performed:	(Sign or Stamp)	Mi. (km)
		Date
Maintenance Performed:	(Sign or Stamp)	Mi. (km)
		Date
Maintenance Performed:	(Sign or Stamp)	Mi. (km)
		Date
Maintenance Performed:	(Sign or Stamp)	Mi. (km)
		Date

Maintenance Performed:	(Sign or Stamp)	Mi. (km)
		Date
Maintenance Performed:	(Sign or Stamp)	Mi. (km)
		Date
Maintenance Performed:	(Sign or Stamp)	Mi. (km)
		Date
Maintenance Performed:	(Sign or Stamp)	Mi. (km)
		Date
Maintenance Performed:	(Sign or Stamp)	Mi. (km)
		Date
Maintenance Performed:	(Sign or Stamp)	Mi. (km)
		Date

MAINTENANCE RECORD

Periodic Checks

You should check the following items at the specified intervals. If you are unsure of how to perform any check, turn to the page given.

- Engine oil level - Check every time you fill the fuel tank. See page [86](#).
- Engine coolant level - Check the radiator reserve tank every time you fill the fuel tank. See page [87](#).
- Windshield washer fluid - Check the level in the reservoir monthly. If weather conditions cause you to use the washers frequently, check the reservoir each time you stop for fuel. See page [125](#).
- Tires - Check the tire pressure monthly. Examine the tread for wear and foreign objects. See page [138](#).

- Lights - Check the operation of the headlights, parking lights, taillights, high-mount brake light, turn signals, brake lights, and license plate lights monthly. See page [141](#).

Fluid Locations

BRAKE FLUID
(Gray cap)

CLUTCH FLUID
(Gray cap)
(5-Speed Manual
Transmission only)

**ENGINE OIL
FILLER CAP**

ENGINE OIL DIPSTICK
(Orange loop)

**COOLANT
RESERVOIR**

**ANTI-LOCK BRAKE
RESERVOIR**
(Gray cap)
(For cars equipped
with ABS)

**AUTOMATIC
TRANSMISSION
FLUID DIPSTICK**
(Yellow loop)

**POWER STEERING
FLUID** (Red cap)

WASHER FLUID
(Blue cap)

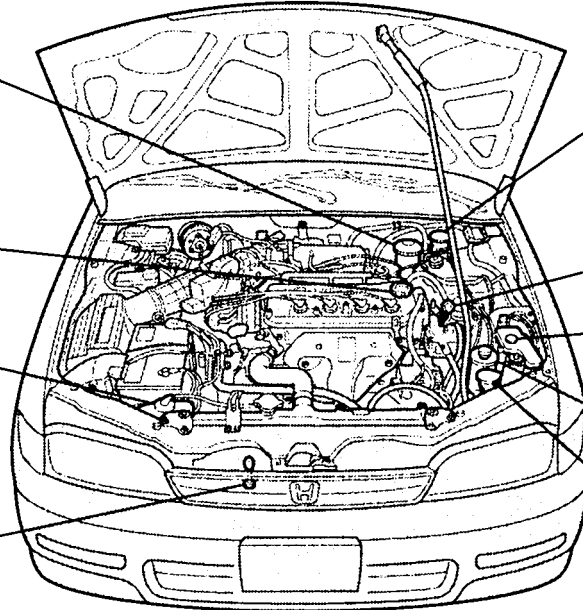

Engine Oil

Adding Oil

To add oil, unscrew and remove the engine oil fill cap on top of the valve cover. Pour in the oil, and replace the fill cap. Tighten it securely. Wait a few minutes, and recheck the oil level. Do not fill above the upper mark; you could damage the engine.

ENGINE OIL FILL CAP

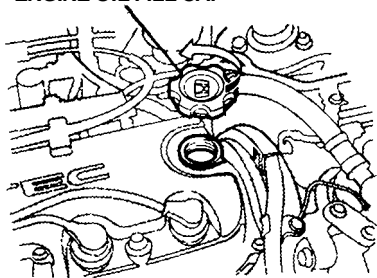

Recommended Oil

Oil is a major contributor to your engine's performance and

longevity. Always use a premium-grade detergent oil.

You can determine an oil's SAE viscosity and Service Classification from the API Service label on the oil container.

A fuel-efficient oil is recommended for your Honda. This is shown on the API Service label by the words "Energy Conserving II." This oil is formulated to help your engine use less fuel.

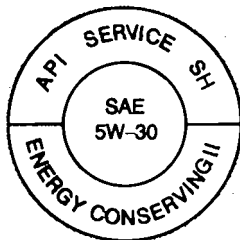

API SERVICE LABEL

The oil container may also display the API Certification seal. Make sure it says "For Gasoline Engines."



API CERTIFICATION SEAL

The SAE numbers tell you the oil's viscosity or weight. Select the oil for your car according to this chart.

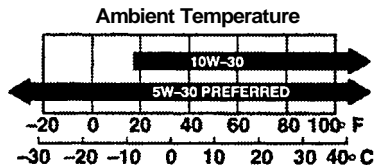

An oil with a viscosity of 5W-30 is preferred for improved fuel economy and year-round protection in your Honda. You may use a 10W-30 oil if the temperature in your area never goes below 20 °F (-7 °C).

Synthetic Oil

You may use a synthetic motor oil if it meets the same

requirements given for conventional motor oil: energy conserving, a service classification of SH, and the proper weight as shown on the chart. When using synthetic oil, you must follow the oil and filter change intervals given in the maintenance schedule.

Additives

Your Honda does not need any oil additives. Purchasing additives for the engine or transmission will not increase your car's performance or longevity. It only increases the cost of operating your car.

Changing the Oil and Filter

Always change the oil and filter according to the time and distance (miles/kilometers) recommendations on the maintenance schedule. The oil and filter collect contaminants that can damage your engine if they are not removed regularly.

Changing the oil and filter requires special tools and access from underneath the car. The car should be raised on a service station-type hydraulic lift for this service. Unless you have the knowledge and proper equipment, you should have this maintenance done by a skilled mechanic.

1. Run the engine until it reaches normal operating temperature, and then shut it off.

continued

Engine Oil

2. Open the hood, and remove the oil fill cap. Remove the oil drain bolt and washer from the bottom of the engine. Drain the oil into an appropriate container.

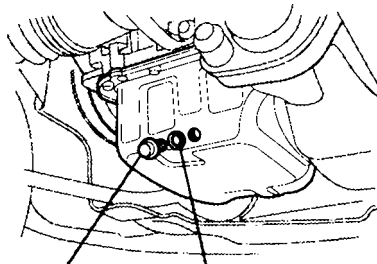

DRAIN BOLT WASHER

3. Remove the oil filter, and let the remaining oil drain. A special wrench (available from your Honda dealer) is required to remove the filter.

OIL FILTER WRENCH

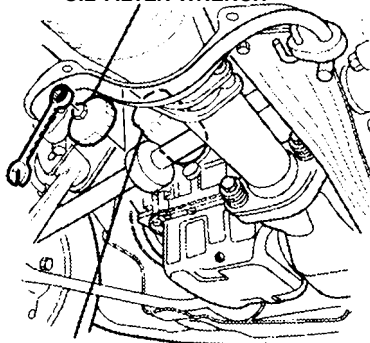

OIL FILTER

4. Install a new oil filter according to the instructions that come with it.

5. Put a new washer on the drain bolt with the flat side toward the engine, and then reinstall the drain bolt. Tighten it to 33 lb-ft (4.5 kg-m, 44 N.m).
6. Refill the engine with the recommended oil. Engine oil capacity (including filter):
LX
4.0 U.S. qt (3.8ℓ)
EX
4.5 U.S. qt (4.3ℓ)
7. Replace the oil fill cap. Start the engine. The indicator light should go out within five seconds. If it does not, turn off the engine and inspect your work.
8. Let the engine run for several minutes; then, check the drain bolt and washer and the oil filter for leaks.

- Turn off the engine, and wait for several minutes; then, check the oil level. If necessary, add oil to bring the level to the upper mark on the dipstick.

NOTICE

If you change your own oil, please dispose of the used oil properly. Put it in a sealed container, and take it to a recycling center. Do not discard it in a waste bin or dump it on the ground.

Adding Engine Coolant

If the coolant level in the reserve tank is at or below the MIN line, add coolant to bring it up to the MAX line. Inspect the cooling system for leaks. This coolant should always be a mixture of 50 percent antifreeze and 50 percent water. Never add straight antifreeze or plain water.

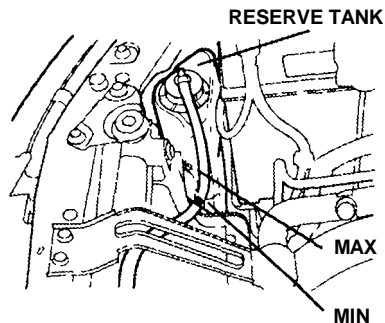

Always use Genuine Honda Antifreeze/Coolant. The cooling system contains many aluminum components that can corrode if an improper antifreeze is used. Some antifreeze, even though labeled as safe for aluminum parts, may not provide adequate protection.

If the reserve tank is completely empty, you should also check the coolant level in the radiator.

Removing the radiator cap while the engine is hot can cause the coolant to spray out, seriously scalding you.

Always let the engine and radiator cool down before removing the radiator cap.

continued

Cooling System

1. Make sure the engine and radiator are cool.
2. Turn the radiator cap counterclockwise, without pressing down on it, until it stops. This relieves any pressure remaining in the cooling system.

RADIATOR CAP

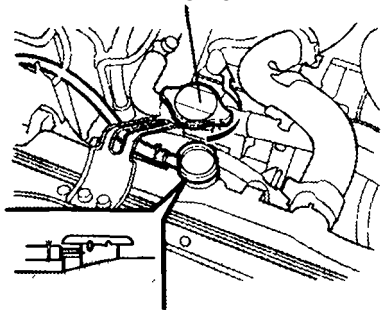

3. Remove the radiator cap by pushing down and turning counterclockwise.

4. The coolant level should be up to the base of the filler neck. Add coolant if it is low.

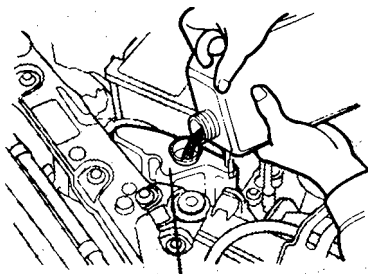

RESERVE TANK

5. Put the radiator cap back on. Tighten it fully.
6. Pour coolant into the reserve tank. Fill it to halfway between the MAX and MIN marks. Put the cap back on the reserve tank.

Do not add any rust inhibitors or other additives to your car's cooling system. They may not be compatible with the coolant or engine components.

Replacing Engine Coolant

The cooling system should be completely drained and refilled with new coolant according to the time and mileage recommendations in the maintenance schedule. Only use the recommended antifreeze.

Draining the coolant requires access to the underside of the car. Unless you have the tools and knowledge, you should have this maintenance done by a skilled mechanic.

1. Turn the heater temperature control lever to maximum heat. Open the hood. Make sure the engine and radiator are cool to the touch.
2. Remove the radiator cap.

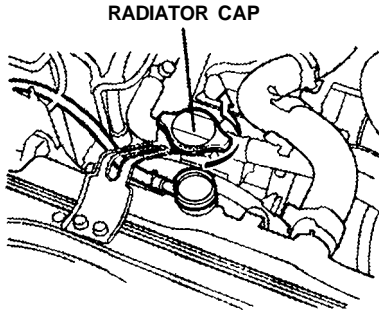

drain bolt from the engine block.

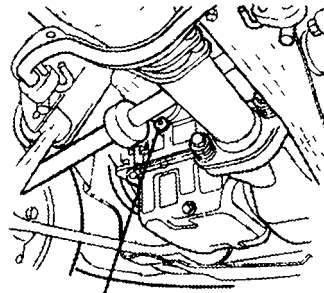
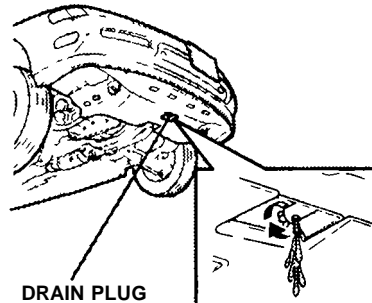

3. Loosen the drain plug in the bottom of the radiator. The coolant will drain through the splash guard. Remove the

4. Remove the reserve tank from its holder by pulling it straight up. Drain the coolant, and then put the tank back in its holder.

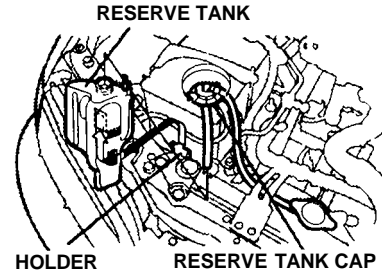

5. When the coolant stops draining, tighten the drain plug in the bottom of the radiator. Apply non-hardening sealant to the drain bolt threads, and reinstall the bolt in the engine block. Tighten the bolt to 61 lb-ft (8.5 kg-m, 83 N.m).

continued

Cooling System

6. Mix the recommended antifreeze with an equal amount of purified or distilled water in a clean container. The cooling system capacity is:

With 5-speed manual transmission:

5.7 U.S. qt (5.4 ℓ)

With automatic transmission:

5.6 US. qt.(5.3ℓ)

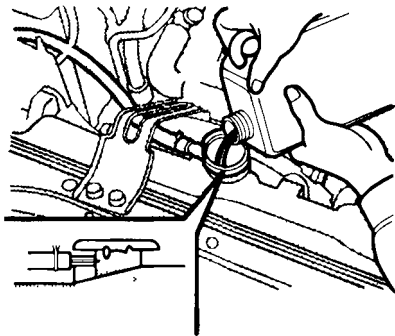

7. Pour coolant into the radiator up to the base of the filler neck.
8. Loosen the bleeder bolt on top of the engine. Tighten it again when coolant comes out in a steady stream with no bubbles.

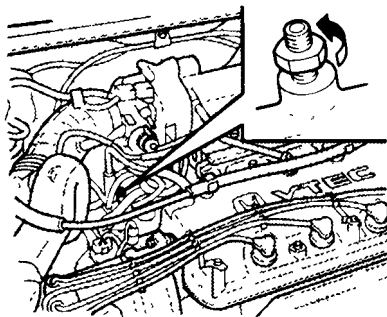

9. Refill the radiator to the base of the filler neck. Put the cap on the radiator, and tighten it only to the first stop. Start

the engine, and let it run until it warms up (the radiator cooling fan comes on at least twice).

10. Turn off the engine. Check the level in the radiator, and add coolant if needed. Install the radiator cap, and tighten it fully.
11. Fill the reserve tank to the MAX mark. Install the reserve tank cap.

RESERVE TANK

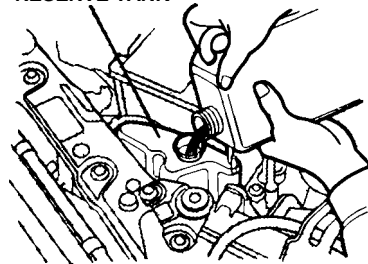

Windshield Washers

Check the level in the windshield washer reservoir at least monthly during normal usage. In bad weather, when you use the washers often, check the level every time you stop for fuel.

The windshield washer reservoir is located behind the driver's side headlight. Check the reservoir's fluid level by removing the cap and looking at the dipstick.

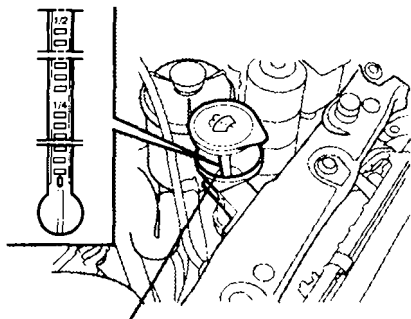

LEVEL GAUGE

Fill the reservoir with a good-quality windshield washer fluid. This increases the cleaning capability and prevents freezing in cold weather.

NOTICE

Do not use engine antifreeze or a vinegar/water solution in the windshield washer reservoir.

Antifreeze can damage your car's paint, while a vinegar/water solution can damage the windshield washer pump.

Use only commercially available windshield washer fluid.

Transmission Fluid

Automatic Transmission

Check the fluid level with the engine at normal operating temperature.

1. Park the car on level ground. Shut off the engine.
2. Remove the dipstick (yellow loop) from the transmission, and wipe it with a clean cloth.

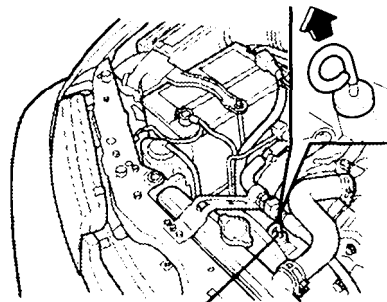

DIPSTICK

continued

Transmission Fluid

- insert the dipstick all the way into the transmission securely as shown in the illustration.
- Remove the dipstick and check the fluid level. It should be between the upper and lower marks.

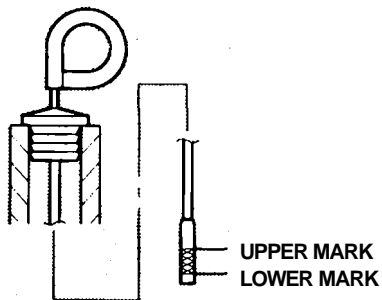

- If the level is below the lower mark, add fluid into the tube to bring it to the upper mark. Use Honda Premium Formula

Automatic Transmission Fluid or an equivalent DEXRON II Automatic Transmission Fluid (ATF) only.

- Insert the dipstick all the way back in the transmission. Make sure that the notch fits in the dipstick guide and the dipstick is all the way down.

The transmission should be drained and refilled with new fluid according to the time and distance recommendations in the Maintenance Schedules.

5-Speed Manual Transmission

Check the fluid level with the transmission at normal operating temperature and the vehicle sitting on level ground. Remove the transmission filler bolt and carefully feel inside the bolt hole with your finger. The fluid level should be up to the edge of the

bolt hole. If it is not, add Honda Manual Transmission Fluid until it starts to run out of the hole. Reinstall the filler bolt and tighten it securely.

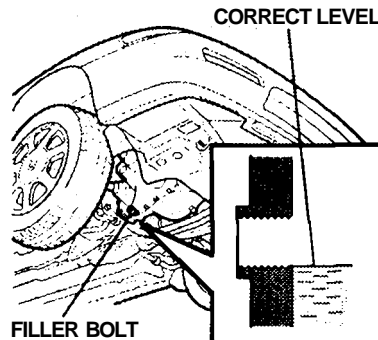

If Honda MTF is not available, you may use an SG or SH-rated motor oil with a viscosity of 10W-30 or 10W-40 temporarily. Motor oil can cause increased transmission wear and high shifting effort, so you should

have the transmission drained and refilled with Honda MTF as soon as possible.

The transmission should be drained and refilled with new oil according to the time and distance recommendations in the Maintenance Schedules.

Brake and Clutch Fluid

Check the fluid level in the reservoirs monthly. There are up to three reservoirs, depending on which model. They are:

- Brake fluid reservoir (all models)
- Clutch fluid reservoir (5-speed manual transmission only)
- ABS reservoir for cars with ABS option

The brake fluid in the brake and anti-lock brake systems should be replaced every 3 years or 45,000 miles (72,000 km), whichever comes first.

Brake System

The fluid level should be between the MIN and MAX marks on the side of the reservoir. If the level is at or below the MIN mark,

your brake system needs attention. Have the brake system inspected for leaks or worn brake pads.

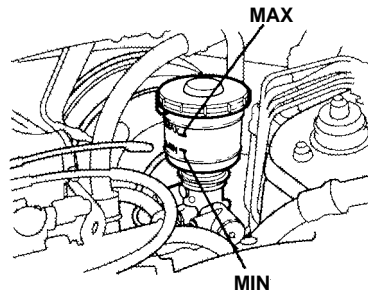

If you add brake fluid to bring it up to the MAX mark, use Genuine Honda Brake Fluid or an equivalent from a sealed container that is marked DOT 3 or DOT 4 only. Brake fluid marked DOT 5 is not compatible with your car's braking system.

continued

Brake and Clutch Fluid

Anti-Lock Brake System

The fluid should be between the MIN and MAX marks on the side of the reservoir. If it is at or below the MIN mark, it may indicate a problem in ABS. Have the dealer inspect the system and add fluid.

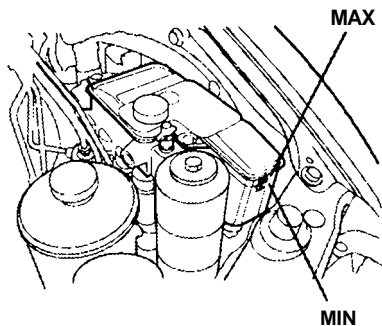

If the fluid level is half an inch or more above the MAX mark, it may indicate a problem in the ABS. Have your dealer inspect the system as soon as possible.

If you add brake fluid to bring it up to the MAX mark, use the same DOT 3 or DOT 4 brake fluid specified for the brake system.

Clutch System

The fluid level should be between the MIN and MAX marks on the side of the reservoir. If it is not, add brake fluid to bring it up to that level. Use the same DOT 3 or DOT 4 brake fluid specified for the brake system.

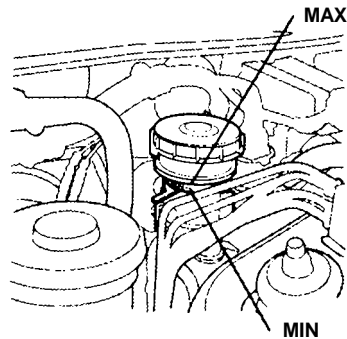

Low fluid level can indicate a leak in the clutch system. Have this system inspected as soon as possible.

Power Steering

You should check the fluid level in the power steering reservoir monthly. Check the level when the engine is cold. Look at the side of the reservoir. The fluid should be between the UPPER LEVEL and LOWER LEVEL. If it is below the LOWER LEVEL, add power steering fluid to the UPPER LEVEL.

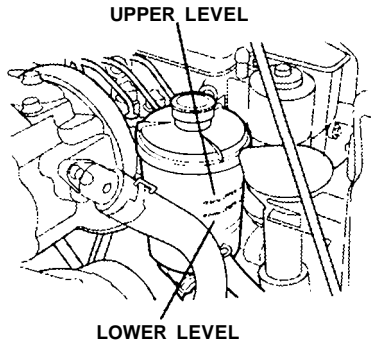

NOTICE

Using automatic transmission fluid or another brand of power steering fluid will damage the system. Use only Genuine Honda Power Steering Fluid-V.

A low power steering fluid level can indicate a leak in the system. Check the fluid level frequently and have the system inspected as soon as possible.

NOTICE

Turning the steering wheel to full left or right lock and holding it there can damage the power steering pump.

Air Cleaner Element

The air cleaner element should be cleaned or replaced according to the time or distance recommendations in the Maintenance Schedules.

Cleaning (Severe Conditions)

Clean the air cleaner element by blowing compressed air through it in the opposite direction to normal air flow. If you do not have access to compressed air (such as a gas station), ask your Honda dealer to do this service.

Follow the replacement procedure for removal and reinstallation.

continued

Air Cleaner Element

Replacement

The air cleaner element is inside the air cleaner housing on the passenger's side of the engine compartment. To replace it:

1. Remove the air cleaner duct by pulling it straight out.

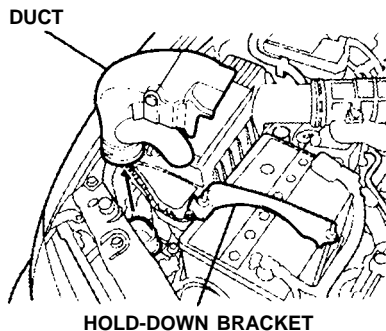

HOLD-DOWN BRACKET

2. Loosen the screws from the battery hold-down bracket, and push the bracket away from the air cleaner.

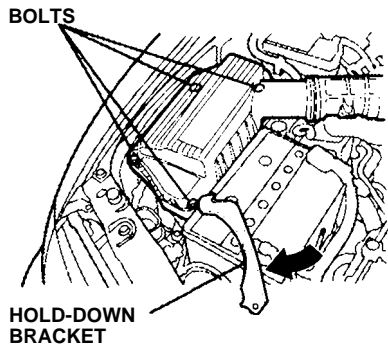

3. Loosen the four bolts, and remove the air cleaner housing cover.

4. Remove the old air cleaner element. Clean the inside of the housing with a damp rag.

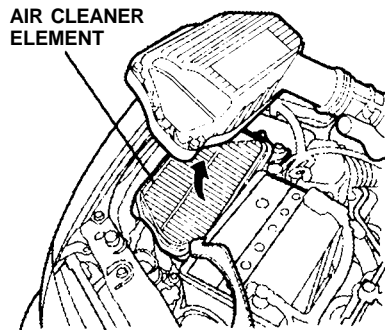

5. Place the new air cleaner element in the housing.
6. Reinstall the housing cover and the duct, and tighten the four bolts.
7. Reinstall the battery hold-down bracket, and tighten the screws.

Spark Plugs

The original spark plugs in your car need to be replaced every 2 years or 30,000 miles (48,000 km), whichever comes first.

Replacement

1. Clean up any dirt and oil that have collected around the spark plug caps.
2. Remove the spark plug cap by pulling it straight out.

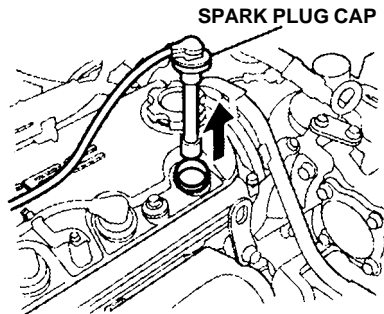

3. Remove the spark plug with a 16 mm (5/8 inch) spark plug socket.
4. Put the new spark plug into the socket; then screw it into the hole. Screw it in by hand so you do not crossthread it.

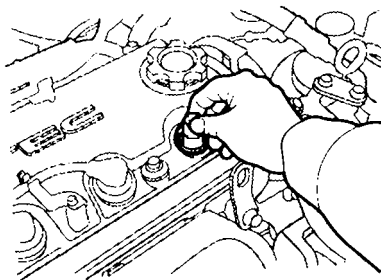

5. Torque the spark plug. (If you do not have a torque wrench, tighten the spark plug two-thirds turn after it contacts the cylinder head.)

Tightening torque: 13 lb-ft
(1.8 kg-m, 18 N.m).

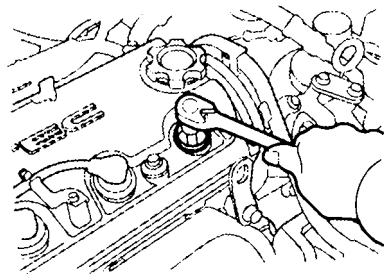

NOTICE

Tighten the spark plugs carefully. A spark plug that is too loose can overheat and damage the engine. Overtightening can cause damage to the threads in the cylinder head.

continued

Spark Plugs, Battery

6. Install the spark plug cap.
7. Repeat this procedure for the other three spark plugs.

Spark Plug Specifications

Normal driving conditions

NGK: **ZFR5F-11**
Nippondenso: **KJ16CR-L11**

Hot climates or continuous high speed driving

NGK: **ZFR6F-11**
Nippondenso: **KJ20CR-L11**

Spark plug gap
0.039 - 0.043 in. (1.0-1.1 mm)

Battery

Check the condition of the battery monthly. You should check for proper electrolyte level and corrosion on the terminals.

The battery contains sulfuric acid (electrolyte) which is highly corrosive and poisonous.

Getting electrolyte in your eyes or on your skin can cause serious burns.

Wear protective clothing and eye protection when working on or near the battery.

Emergency Procedures

Eyes - Flush with water from a cup or other container for at least 15 minutes. (Water under pressure can damage the eye.) Immediately call a physician or 911.

Skin - Remove contaminated clothing. Flush the skin with large quantities of water. Call a physician immediately.

Swallowing - Drink water or milk. Call your local Poison Control Center or a physician immediately.

Check the battery condition by looking at the test indicator window on the battery. The label on the battery explains the test indicator's colors.

TEST INDICATOR WINDOW

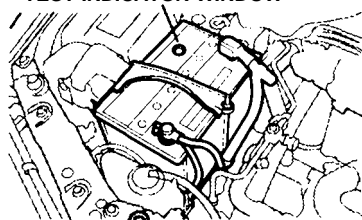

Check the battery terminals for corrosion (a white or yellowish powder). To remove it, cover the terminals with a solution of baking soda and water. It will bubble up and turn brown. When

this stops, wash it off with plain water. Dry off the battery with a cloth or paper towel. Coat the terminals with grease to help prevent future corrosion.

If the terminals are severely corroded, clean them with baking soda and water. Then use a wrench to loosen and remove the cables from the terminals. Always disconnect the negative (-) cable first and reconnect it last.

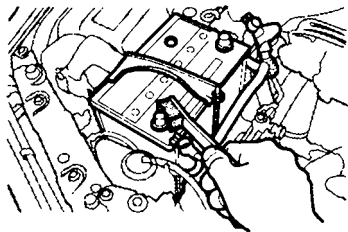

Clean the battery terminals with a terminal cleaning tool or wire brush. Reconnect and tighten the

cables, and then coat the terminals with grease.

If you need to connect the battery to a charger, disconnect both cables to prevent damage to the car's electrical system.

The battery gives off explosive hydrogen gas during normal operation.

A spark or flame can cause the battery to explode with enough force to kill or seriously hurt you.

Wear protective clothing and a face shield, or have a skilled mechanic do the battery maintenance.

If your car's battery is disconnected or goes dead, the audio system will disable itself. The next time you turn on the radio you will see "Code" in the frequency display. Use the Preset buttons to enter the five-digit code (see page 79).

NOTICE

Charging the battery with the cables connected can seriously damage your car's electronic controls. Detach the battery cables before connecting the battery to a charger.

Windshield Wipers

Windshield Wipers

Check the condition of the windshield wiper blades at least every six months. Look for signs of cracking in the rubber or areas that are getting hard. Replace the blades if you find these signs, or they leave streaks and unwiped areas when used.

To replace the blade, do this:

1. Raise the wiper arm off the windshield.

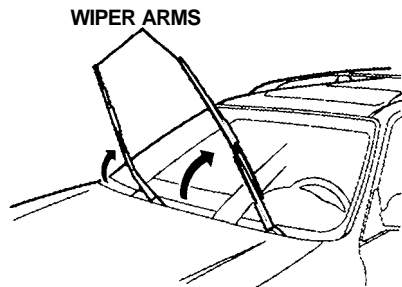

2. Disconnect the blade assembly from the wiper arm by pushing in the lock tab. Hold it in while you push the blade assembly toward the base of the arm.

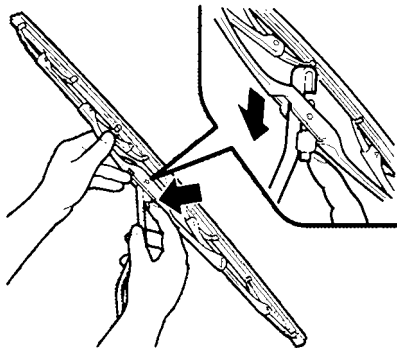

3. Remove the blade from its holder by grasping the tabbed end of the blade. Pull firmly until the tabs come out of the holder.

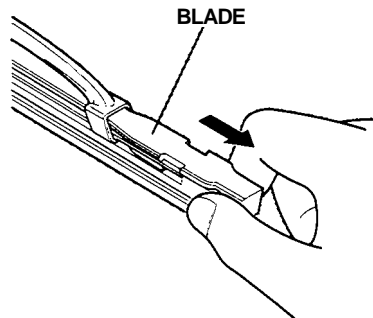

4. Examine the new wiper blades. If they have no plastic or metal reinforcement along the back edge, remove the metal reinforcement strips from the old wiper blade, and

install them in the slots along the edge of the new blade.

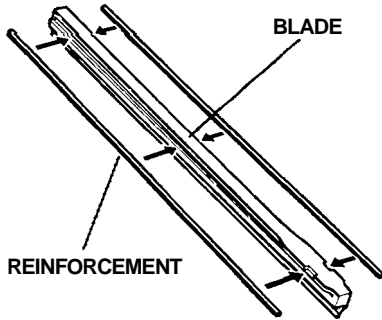

5. Slide the new wiper blade into the holder until the tabs lock.
6. Slide the new blade assembly onto the wiper arm. Make sure it locks in place.
7. Lower the wiper arm down against the windshield.

Air Conditioning System

Your car's air conditioning is a sealed system. Any major maintenance, such as recharging, should be done by a qualified technician. You can do a couple of things to make sure the air conditioning works efficiently.

AIR
CONDITIONING
CONDENSER

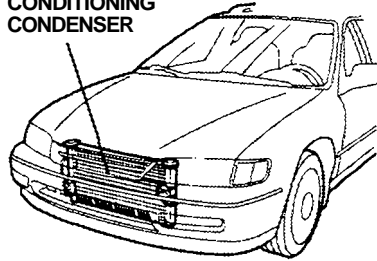

Periodically check the engine's radiator and air conditioning condenser for leaves, insects, and dirt stuck to the front

surface. These block the air flow and reduce cooling efficiency. Use a light spray from a hose or a soft brush to remove them.

NOTICE

The condenser and radiator fins bend easily. Only use a low-pressure spray or soft-bristle brush to clean them.

Run the air conditioning at least once a week during the cold weather months. Run it for at least 10 minutes while you are driving at a steady speed with the engine at normal operating temperature. This circulates the lubricating oil contained in the refrigerant.

If the air conditioning does not get as cold as before, have your dealer check the system.

continued

Air Conditioning, Drive Belts

Recharge the system with Refrigerant HFC-134a (R-134a). See **Specifications** on page 179.

NOTICE

Whenever you have the air conditioning system serviced, make sure the service facility uses a refrigerant recycling system. This system captures the refrigerant for reuse. Releasing refrigerant into the atmosphere can damage the environment.

Drive Belts

Check the condition of the two drive belts. Examine the edges of each belt for cracks or fraying. Check the tension of each belt by pushing on it with your thumb midway between the pulleys.

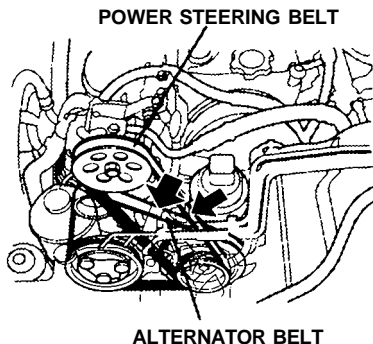

The belts should have the following "play" or deflection.

Alternator belt:

(on cars without A/C)
0.41-0.49 in. (10.5-12.5 mm)

(on cars with A/C)
0.31-0.41 in. (8.0-10.5 mm)

Power steering belt:

0.51-0.63 in. (13.0-16.0 mm)

If you see signs of wear or looseness, have your dealer adjust or replace the belts.

Tires

To safely operate your car, your tires must be the proper type and size, in good condition with adequate tread, and correctly inflated. The following pages give more detailed information on how and when to check air pressure, how to inspect your tires for damage, and what to do when your tires need to be replaced.

Using tires that are excessively worn or improperly inflated can cause a crash in which you can be seriously hurt or killed.

Follow all instructions in this owner's manual regarding tire inflation and maintenance.

Inflation

Keeping the tires properly inflated provides the best combination of handling, tread life, and riding comfort. Underinflated tires wear unevenly, adversely affect handling and fuel economy, and are more likely to fail from being overheated. Overinflated tires can make your car ride more harshly, are more prone to damage from road hazards, and wear unevenly.

We recommend that you visually check your tires every day and use a gauge to measure the air pressure at least once a month. If you think a tire might be low, check it immediately. Remember to check the spare tire at the same time you check all the other tires.

Check the pressure in the tires when they are cold. This means the car has been parked for at least three hours. If you have to drive the car before checking the tire pressure, the tires can still be considered "cold" if you drive less than one mile (1.6 km).

If you check the pressure when the tires are hot (the car has been driven several miles), you will see readings four to six psi higher than the cold reading. This is normal. Do not let air out to match the specified cold pressure. The tire will be underinflated.

Recommended Tire Pressures for Normal Driving

The following chart shows the recommended cold tire pressures for most normal

continued

Tires

driving conditions and speeds. Tire pressures for high speed driving are shown on page 180.

Tire Size	Cold Tire Pressure for Normal Driving
195/60 R15 88H	32 psi (2.2 kg/cm ² , 220 kpa)

These pressures are also given on the tire information label on the driver's doorjamb.

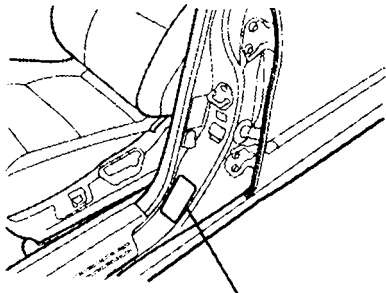

TIRE INFORMATION LABEL

You should get your own tire pressure gauge and use it whenever you check your tire pressures. This will make it easier for you to tell if a pressure loss is due to a tire problem and not due to a variation between gauges.

Tubeless tires have some ability to self-seal if they are punctured. However, because leakage is often very slow, you should look closely for punctures if a tire starts losing pressure.

Inspection

Every time you check inflation, you should also examine the tires for damage, foreign objects, and wear.

You should look for:

- Bumps or bulges in the tread or side of the tire. Replace the tire if you find either of these conditions.
- Cuts, splits, or cracks in the side of the tire. Replace the tire if you can see fabric or cord.
- Excessive tread wear.

Your car's tires have wear indicators molded into the tread. When the tread wears down to that point, you will see a 1/2 inch (12.7 mm) wide band running across the tread. This shows there is less than 1/16 inch (1.6 mm) of tread left on the tire. A tire that is this worn gives very little traction

on wet roads. You should replace the tire if you can see the tread wear indicator in three or more places around the tire.

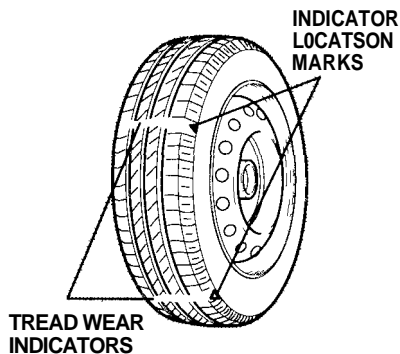

Maintenance

In addition to proper inflation, correct wheel alignment helps to decrease tire wear. You should get your car's wheel alignment checked every 12 months or 15,000 miles (24,000 km).

The tires were properly balanced by the factory. They may need to be rebalanced at some time before they are worn out. Have your dealer check the tires if you feel a consistent vibration while driving. A tire should always be rebalanced if it is removed from the wheel for repair.

Make sure the installer balances the wheels when you have new tires installed. This increases riding comfort and tire life. Your car's original tires were dynamic or "spin" balanced at the factory. For best results, have the installer perform a dynamic balance.

NOTICE

Improper wheel weights can damage your car's aluminum wheels. Use only genuine Honda wheel weights for balancing.

Tire Rotation

To help increase tire life and distribute wear more evenly, you should have the tires rotated every 7,500 miles (12,000 km). Move the tires to the positions shown in the chart each time they are rotated.

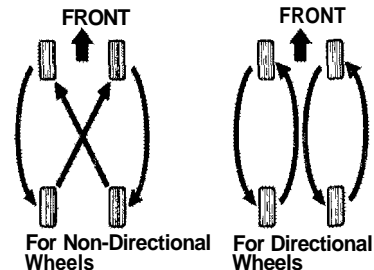

When shopping for replacement tires, you may find that some tires are "directional." This means they are designed to rotate only in one direction. If you use directional tires, they should be rotated only front-to-back.

continued

Tires

Replacing Tires and Wheels

The tires that came with your car were selected to match the performance capabilities of the car and provide the best combination of handling, ride comfort, and long life. You should replace them with radial tires of the same size, load range, and speed rating. Mixing radial and bias-ply or bias-belted tires on your car can reduce its braking ability, traction, and steering accuracy.

Installing improper tires on your car can affect handling and stability. This can cause a crash in which you can be seriously hurt or killed.

Always use the size and type of tires recommended in this owner's manual.

It is best to replace all four tires at the same time. If that is not possible or necessary, then replace the two front tires or the two rear tires as a pair. Replacing just one tire can seriously affect your car's handling.

The ABS works by comparing the speed of the wheels. When replacing tires, use the same size originally supplied with the car. Tire size and construction can affect wheel speed and may cause the system to work inconsistently.

If you ever need to replace a wheel, make sure the wheel's specifications match those of the original wheel that came on your car. Replacement wheels are available at your Honda dealer.

Wheels and Tires

Wheel:

EX

15 x 5 1/2 JJ (AL)

LX

15 x 5 1/2 JJ

Tire:

195/60 R15 88H

See **Tire Information** on page [180](#) for additional information about tire and wheel size designations. See page [181](#) for information about DOT Tire Quality Grading.

Winter Driving

Tires that are marked "M + S" or "All Season" on the sidewall have an all-weather tread design. They should be suitable for most winter driving conditions. Tires

without these markings are designed for optimum traction in dry conditions. They may not provide adequate performance in winter driving. For the best performance in snowy or icy conditions, you should install snow tires or tire chains. They may be required by local laws under certain conditions.

Snow Tires

If you mount snow tires on your Honda, make sure they are radial tires of the same size and load range as the original tires. Mount snow tires on all four wheels to balance your car's handling in all weather conditions. Keep in mind the traction provided by snow tires on dry roads may not be as high as your car's original equipment tires. You should drive cautiously even when the roads are clear. Check with the

tire dealer for maximum speed recommendations.

Tire Chains

Mount snow chains on your car when warranted by driving conditions or required by local laws. Make sure the chains are the correct size for your tires. Install them only on the front tires. If metal chains are used, they must be SAE class "S." Cable-type traction devices can also be used.

When installing chains, follow the manufacturer's instructions and mount them as tightly as you can. Drive slowly with chains installed. If you hear the chains contacting the body or chassis, stop and tighten them. If they still make contact, slow down until it stops. Remove the chains

as soon as you begin driving on cleared roads.

NOTICE

Chains of the wrong size or that are improperly installed can damage your car's brake lines, suspension, body, and wheels. Stop driving if you hear the chains hitting any part of the car.

Lights

Check the operation of your car's exterior lights at least once a month. A burned out bulb can create an unsafe condition by reducing your car's visibility and the ability to signal your intentions to other drivers.

Check the following:

- Headlights (low and high beam)

continued

Lights

- Parking lights
- Taillights
- Brake lights
- High-mount brake light
- Turn signals
- Back-up lights
- Hazard light function
- License plate light
- Side marker lights

If you find any bulbs are burned out, replace them as soon as possible. Refer to the chart on page 179 to determine what type of replacement bulb is needed.

Replacing a Headlight Bulb

Your car has halogen headlight bulbs, two on each side. When replacing a bulb, handle it by its steel base, and protect the glass from contact with your skin or hard objects. If you touch the glass, clean it with denatured alcohol and a clean cloth.

NOTICE

Halogen headlight bulbs get very hot when lit. Oil, perspiration, or a scratch on the glass can cause the bulb to overheat and shatter.

1. Open the hood. If you need to change the headlight bulb on the passenger's side, remove the radiator reserve tank and the intake air tube.
2. Remove the electrical connector from the bulb by squeezing the connector to

unlock the tab while you push down on the connector.

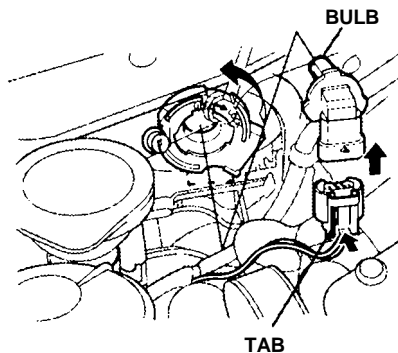

3. Remove the bulb by turning it one-quarter turn counterclockwise.
4. Insert the new bulb into the hole, and turn the bulb in one-quarter turn clockwise.
5. Push the electrical connector back onto the bulb. Make sure it is on all the way.

6. Turn on the headlights to test the new bulb.
7. (Passenger's side)
Reinstall the radiator reserve tank and the intake air tube.

Replacing a Front Turn Signal Light Bulb

1. Use a long-handled, #2 Phillips screwdriver to loosen the turn signal assembly mounting screw.

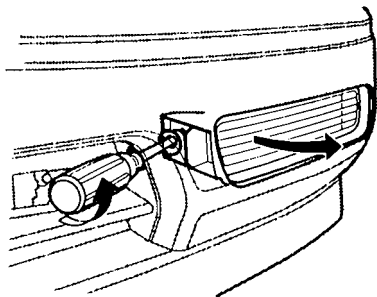

2. Remove the turn signal assembly from the bumper.
3. Remove the bulb holder from the turn signal assembly by turning it counterclockwise.

TURN SIGNAL ASSEMBLY

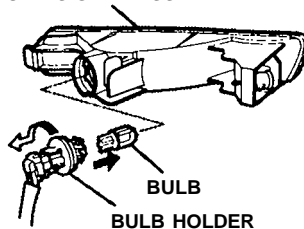

4. Remove the burned out bulb from the socket by pushing it in and turning counterclockwise until it unlocks. Install the new bulb.
5. Push the bulb holder into the turn signal assembly, and turn it clockwise until it locks.

6. Test the turn signals to make sure the new bulb is working.
7. Put the turn signal assembly into the bumper. Make sure the tabs on the turn signal assembly fit into the bumper slots. Tighten the mounting screw.

Replacing Front Side Marker and Parking Light Bulbs

1. Use a Phillips screwdriver to remove the screw from the top of the fender.

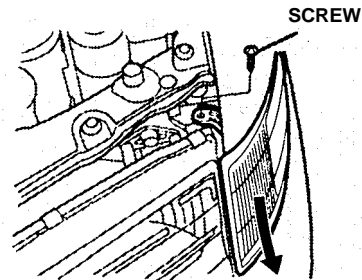

continued

Lights

2. Move the side marker light assembly forward until it pops out of the body.
3. Turn the bulb holder one-quarter turn counterclockwise to remove it from the lens.

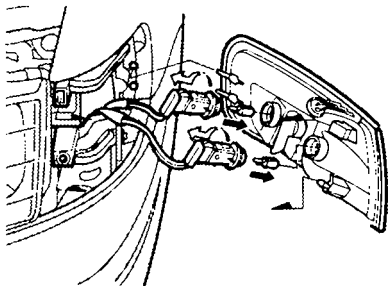

4. Pull the bulb straight out of its socket. Push the new bulb straight into the socket until it bottoms.

5. Put the bulb holder back into its hole in the lens, and turn it clockwise until it locks.
6. Turn on the parking lights, and check that the new bulb is working.
7. Put the side marker assembly back into the body. Push on the front edge until it snaps into place. Install the mounting screw, and tighten it securely.

Replacing Rear Bulbs

1. Open the tailgate, and remove the taillight assembly cover.
2. Pull the taillight assembly out of the body.
3. To open the tabs on the taillight assembly, push in on the tab and lift it up. (You may use a flat-tip screwdriver

to gently pry it open.) Remove the screws under each tab. Then, slide the taillight assembly diagonally out.

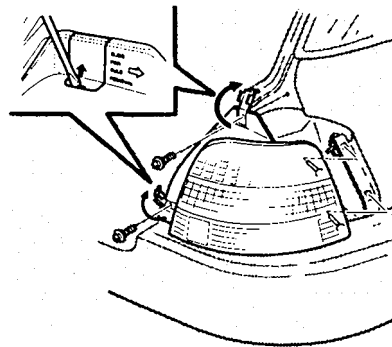

4. Determine which of the three bulbs is burned out: tail/stoplight, back-up light, or turn signal. Remove that bulb by turning it one-quarter turn

counterclockwise and pulling it out of the socket.

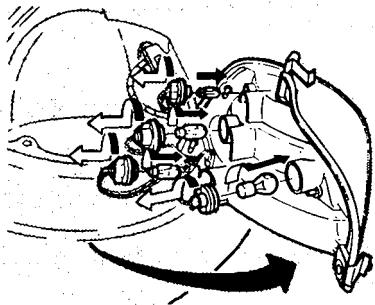

5. Install the new bulb in the socket.
6. Reinstall the bulb holder assembly by lining up the bulbs with their holes in the lens assembly; then turn the assembly one-quarter turn clockwise to lock it in place.
7. Test the lights to make sure the new bulb is working.

8. When reinstalling the taillight assembly, align and pop the snap fasteners in place. Install and then tighten the screws. Lock the tabs in place,

Replacing a High-Mount Brake Light Bulb

1. Open the tailgate. Undo the two fasteners on the side of the cover by pushing on the center of each fastener's head until the center pops in.

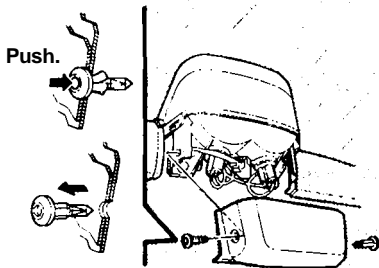

2. Use a thin, flat blade to wedge the fastener's head out. When both fasteners are out, remove the high-mount brake light cover.
3. Remove the socket by turning it one-quarter turn counterclockwise.

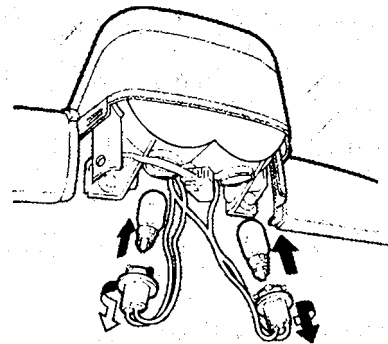

4. Pull the bulb out of its socket. Push the new bulb into the socket.

continued

Lights

5. Test the brake light to make sure the new bulb is working.
6. Reinstall the cover.
7. Reset the center section of the fastener through the fastener's head. Make sure that the fingers on the fastener are folded and flush to the fastener and that the center section protrudes beyond the head.
8. Install each reset fastener into the cover. Secure each fastener by pushing on the center until it locks (the center is flush with the head).

Replacing a Rear License Bulb

1. Open the tailgate. Remove the assembly cover and the bulb assembly.

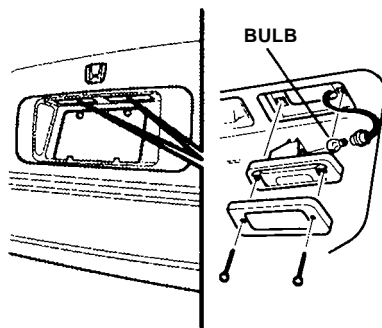

2. Remove the socket from the light assembly by turning it one-quarter turn counterclockwise.

3. Pull the bulb straight out of the socket.
4. Install the new bulb in the socket.
5. Turn on the parking lights, and check that the new bulb is working.
6. Reinstall the socket. Turn it clockwise until it locks.

Replacing Bulbs in the Interior Courtesy Lights

The courtesy lights in the doors and roof come apart in the same way. They do not use the same bulb.

1. Remove the lens by carefully prying on the edge of the lens with a fingernail file or a small flat-tip screwdriver. Do not pry on the edge of the housing around the lens.

Door Light:

Pry on the top middle of the lens.

DOOR LIGHT

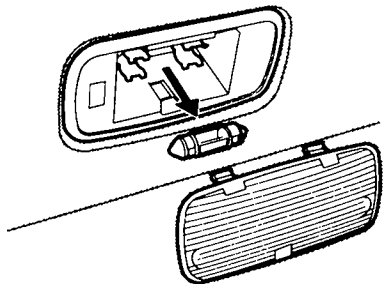

Interior/Cargo Light:

Pry on the front edge of the lens in the middle.

INTERIOR LIGHT/CARGO LIGHT

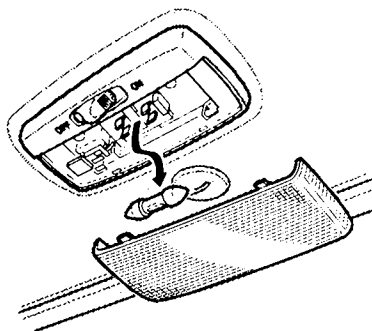

2. Remove the bulb by pulling it straight out of its metal tabs.

3. Push the new bulb into the metal tabs. Snap the lens back in place.

MAP LIGHT

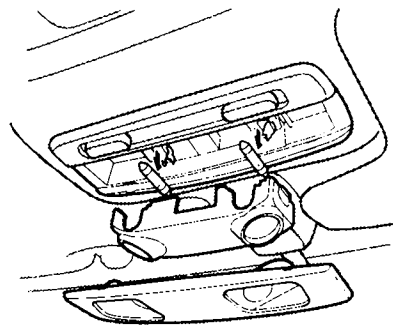

Storing Your Car

If you need to park your car for an extended period (more than one month), you should do several things to prepare it for storage. Proper preparation helps prevent deterioration and makes it easier to get your car back on the road. If possible, store your car indoors.

- Fill the fuel tank.
- Change the engine oil and filter (see page 119).
- Wash and dry the exterior completely.
- Clean the interior. Make sure the carpeting, floor mats, etc. are completely dry.
- Leave the parking brake off. Put the transmission in Reverse (5-speed manual) or Park (automatic).
- Block the rear wheels.

- If the car is to be stored for a longer period, it should be supported on jackstands so the tires are off the ground.
- Leave one window open slightly (if the car is being stored indoors).
- Disconnect the battery.
- Cover the car with a "breathable" car cover, one made from a porous material such as cotton. Nonporous materials, such as plastic sheeting, trap moisture, which can damage the paint.
- If possible, periodically run the engine for a while (preferably once a month).
- Support the front and rear wiper blade arms with a folded towel or rag so they do not touch the windshield.

- To minimize the seal sticking, apply a silicone spray lubricant to all door and trunk seals. Also, apply a car body wax to the painted surfaces that mate with the door and trunk seals.

If you store your car for 12 months or longer, have your Honda dealer perform the inspections called for in the 24 months/30,000 miles (48,000 km) maintenance schedule as soon as you take it out of storage (see pages 110 - 113). The replacements called for in the maintenance schedule are not needed unless the car has actually reached that time or mileage.

Regular cleaning and polishing of your Honda helps to keep it "new" looking. This section gives you hints on how to clean your car and preserve its appearance: the paint, brightwork, wheels, and interior. Also included are several things you can do to help prevent corrosion.

Exterior Care	150
Washing	150
Power Antenna Cleaning .	150
Waxing	151
Aluminum Wheels	151
Paint Touch-Up	151
Interior Care	152
Carpeting	152
Fabric	152
Vinyl	152
Seat Belts	152
Windows	153
Air Fresheners	153
Corrosion Protection	153
Body Repairs	154

Exterior Care

Washing

Frequent washing helps preserve your car's beauty. Dirt and grit can scratch the paint, while tree sap and bird droppings can permanently ruin the finish.

Wash your car in a shady area, not in direct sunlight. If the car is parked in the sun, move it into the shade and let the exterior cool down before you start.

NOTICE

Chemical solvents and strong cleaners can damage the paint, metal and plastic on your car.

- Rinse the car thoroughly with cool water to remove loose dirt.
- Fill a bucket with cool water. Mix in a mild detergent, such as dishwashing liquid or a

product made especially for car washing.

- Wash the car, using the water and detergent solution and a soft-bristle brush, sponge, or soft cloth. Start at the top and work your way down. Rinse frequently.
- Check the body for road tar, tree sap, etc. Remove these stains with tar remover or turpentine. Rinse it off immediately so it does not harm the finish. Remember to re wax these areas, even if the rest of the car does not need waxing.
- When you have washed and rinsed the whole exterior, dry it with a chamois or soft towel. Letting it air-dry will cause dulling and water spots.

As you dry the car, inspect it for chips and scratches that could allow corrosion to start. Repair them with touch-up paint (see page 151).

Power Antenna Cleaning

Every time you wash your car, clean the antenna mast with a dry cloth and mild detergent. Scrub the antenna in upward strokes to avoid bending it.

Make sure the antenna works smoothly by turning the stereo off and on several times with the ignition switch ON (II). The antenna does not need lubricating. If you use a "drive-through" car wash, make sure you turn the stereo off first. This retracts the antenna to prevent damage from the brushes in the car wash.

Waxing

Always wash and dry the whole car before waxing it. You should wax your car, including the metal trim, whenever water sits on the surface in large patches. It should form into beads or droplets after waxing.

You should use a quality liquid or paste wax. Apply it according to the instructions on the container. In general, there are two types of products:

Waxes — A wax coats the finish and protects it from damage by exposure to sunlight, air pollution, etc. You should use a wax on your Honda when it is new.

Polishes — Polishes and cleaner/waxes can restore the shine to paint that has oxidized and lost some of its shine. They normally

contain mild abrasives and solvents that remove the top layer of the finish. You should use a polish on your Honda if the finish does not have its original shine after using a wax.

Cleaning tar, insects, etc. with removers also takes off the wax. Remember to re wax those areas, even if the rest of the car does not need waxing.

Aluminum Wheels

EX models

Clean your Honda's aluminum alloy wheels as you do the rest of the exterior. Wash them with the same solution, and rinse them thoroughly.

The wheels have a protective clear-coat that keeps the aluminum from corroding and tarnishing. Using harsh

chemicals, including some commercial wheel cleaners or stiff brushes can damage this clear-coat. Only use a mild detergent and soft brush or sponge to clean the wheels.

Paint Touch-Up

Your dealer has touch-up paint to match your car's color. The color code is printed on a sticker on the driver's doorjamb. Take this code to your dealer so you are sure to get the correct color.

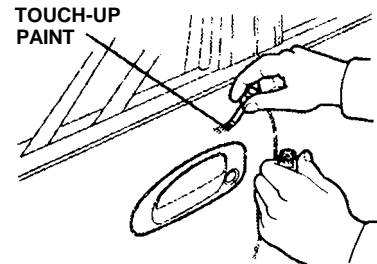

continued

Exterior Care, Interior Care

Inspect your car frequently for chips or scratches in the paint. Repair them right away to prevent corrosion of the metal underneath. Use the touch-up paint on small chips and scratches. More extensive damage should be repaired by a professional.

Carpeting

Vacuum the carpeting frequently to remove dirt. Ground-in dirt will make the carpet wear out faster. Periodically shampoo the carpet to keep it looking new. Use one of the foam-type carpet cleaners on the market: Follow the instructions that come with the cleaner, applying it with a sponge or soft brush. Keep the carpeting as dry as possible by not adding water to the foam.

Fabric

Vacuum dirt and dust out of the material frequently. For general cleaning, use a solution of mild soap and lukewarm water, letting it air dry. To clean off stubborn spots, use a commercially available fabric cleaner. Test it on a hidden area of the fabric first, to make sure it does not bleach or stain the fabric. Follow the instructions that come with the cleaner.

Vinyl

Remove dirt and dust with a vacuum cleaner. Wipe the vinyl with a soft cloth dampened in a solution of mild soap and water. Use the same solution with a soft-bristle brush on more difficult spots. You can also use commercially available spray or foam-type vinyl cleaners.

Seat Belts

If your seat belts get dirty, you can use a soft brush to clean them with a mixture of mild soap and warm water. Do not use bleach, dye, or cleaning solvents. They can weaken the belt material. Let the belts air-dry before you use the car.

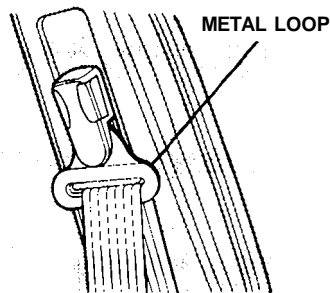

Dirt buildup in the metal loops of the seat belt anchors can cause the belts to retract slowly. Wipe the insides of the loops with a clean cloth dampened in mild

soap and warm water or isopropyl alcohol.

Windows

Clean the windows, inside and out, with a commercially available glass cleaner. You can also use a mixture of one part white vinegar to ten parts water. This will remove the haze that builds up on the inside of the windows. Use a soft cloth or paper towels to clean all glass and clear plastic surfaces.

NOTICE

The rear window defogger wires are bonded to the inside of the glass. Wiping vigorously up and down can dislodge and break the defogger wires. When cleaning the rear window, use gentle pressure and wipe side to side.

Air Fresheners

If you want to use an air freshener/deodorizer in the interior of your Accord, you should use a solid type. Some liquid air fresheners contain chemicals that may cause parts of the interior trim and fabric to crack or discolor.

If you use a liquid air freshener, make sure you fasten it securely so it does not spill as you drive.

Corrosion Protection

Two factors normally contribute to causing corrosion in your car:

1. Moisture trapped in body cavities. Dirt and road salt that collects in hollows on the underside of the car stays damp, promoting corrosion in that area.

2. Removal of paint and protective coatings from the exterior and underside of the car.

Many corrosion-preventive measures are built into your Honda. You can help keep your car from corroding by performing some simple periodic maintenance:

- Repair chips and scratches in the paint as soon as you discover them.
- Inspect and clean out the drain holes in the bottom of the doors and body.
- Check the floor coverings for dampness. Carpeting and floor mats may remain damp for a long time, especially in winter. This dampness can eventually cause the floor panels to corrode.

continued

Corrosion Protection, Body Repairs

- Have the corrosion-preventive coatings on the underside of your car inspected and repaired periodically.

Body Repairs

Body repairs can affect your car's resistance to corrosion. If your car needs repairs after a collision, pay close attention to the parts used in the repair and the quality of the work.

Make sure the repair facility uses genuine Honda replacement body parts. Some companies make sheet metal pieces that seem to duplicate the original Honda body parts, but are actually inferior in fit, finish, and corrosion resistance. Once installed, they do not give the same high-quality appearance.

When reporting your collision to the insurance company, tell them you want genuine Honda parts used in the repair. Although most insurers recognize the quality of original parts, some may try to specify that the repairs be done with other available parts. You should investigate this before any repairs are begun.

Take your car to your authorized Honda dealer for inspection after the repairs are completed. He can make sure that quality materials were used and that corrosion-preventive coatings were applied to all repaired and replaced parts.

This section covers the more common problems that motorists experience with their cars. It gives you information about how to safely evaluate the problem and what to do to correct it. If the problem has stranded you on the side of the road, you may be able to get going again. If not, you will also find instructions on getting your car towed.

Changing a Flat Tire	156
If Your Engine Won't Start ...	160
Nothing Happens or the Starter Motor Operates Very Slowly	160
The Starter Operates Normally	161
Jump Starting	162
If Your Engine Overheats	163
Low Oil Pressure Indicator ..	165
Charging System Indicator ..	166
Malfunction Indicator Lamp .	167
Closing the Moonroof	168
Fuses	169
Checking and Replacing ..	169
Towing	174

Changing a Flat Tire

If you have a flat tire while driving, stop in a safe place to change it. Stopping in traffic or on the shoulder of a busy road is dangerous. Drive slowly along the shoulder until you get to an exit or an area to stop that is far away from the traffic lanes.

The car can easily roll off the jack, seriously injuring anyone underneath.

Follow the directions for changing a tire exactly, and never get under the car when it is supported only by the jack.

1. Park the car on firm, level ground away from traffic. Turn on the hazard warning

lights, and turn the ignition to LOCK (0).

2. Put the transmission in Park (automatic) or Reverse (5-speed). Set the parking brake. Have all of the passengers get out of the car when you change the tire.
3. Open the tailgate. Raise the cargo area floor by lifting up on the back edge. Attach the hook to the roof line.

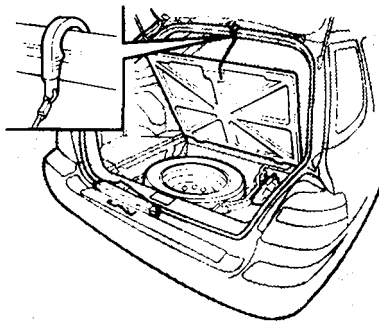

4. Take the tool kit out of the cargo area.
5. Unscrew the wing bolt, and take the spare tire out of its well.

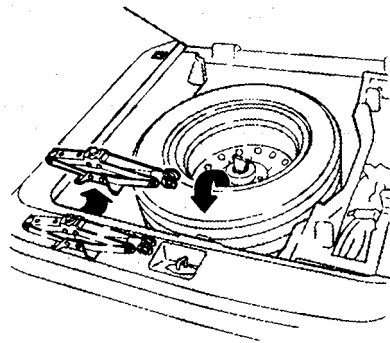

6. Turn the end bracket on the jack counterclockwise to loosen it, and then remove the jack.

Changing a Flat Tire

7. Loosen the four wheel nuts one-half turn with the wheel wrench.

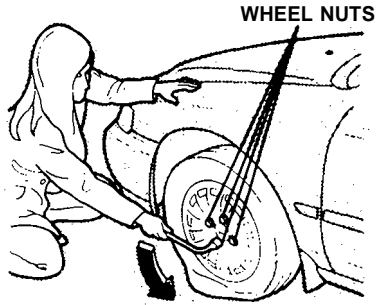

8. Locate the jacking point nearest the tire you need to change. It is pointed to by an arrow molded into the underside of the body. Place the jack under the jacking point. Turn the end bracket clockwise until the top of the jack contacts the jacking

point. Make sure the jacking point tab is resting in the jack notch.

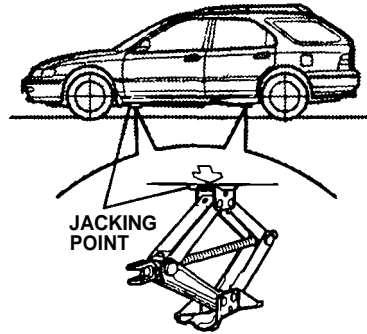

9. Use the extension and wheel wrench as shown.

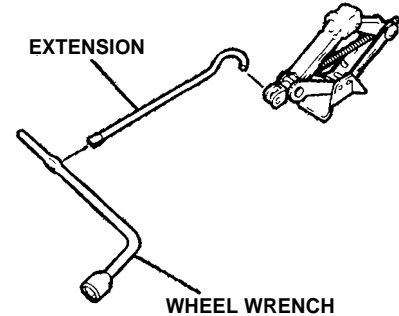

continued

Changing a Flat Tire

10. Raise the Car until the flat tire is off the ground.

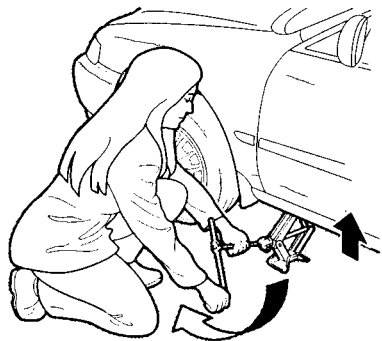

11. Remove the wheel nuts and flat tire.

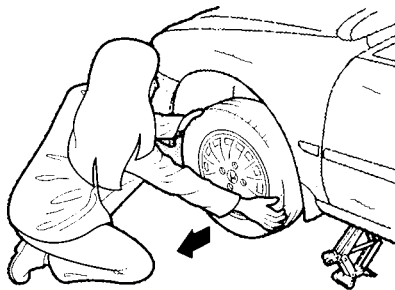

Temporarily place the flat tire on the ground with the outside surface of the wheel facing up. Putting the wheel face down could mar the wheel's finish.

12. Before mounting the spare tire, wipe any dirt off the mounting surface of the wheel and hub with a clean cloth.

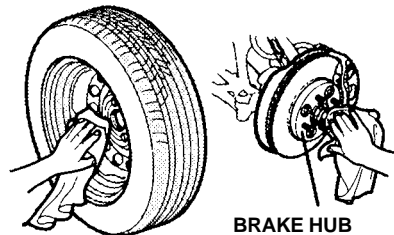

Changing a Hat Tire

13. Put on the spare tire. Put the wheel nuts back on finger-tight, and tighten them in a crisscross pattern with the wheel wrench until the wheel is firmly against the hub. Do not try to tighten them fully.

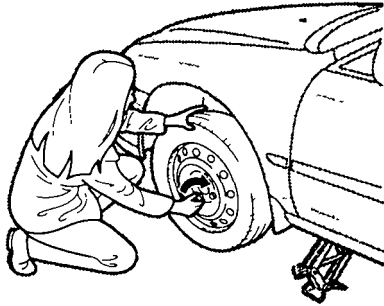

14. Lower the car to the ground, and remove the jack.

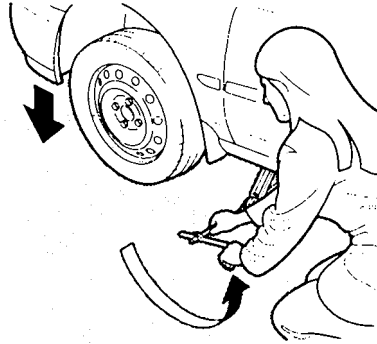

15. Tighten the wheel nuts securely in the same crisscross pattern. Have the wheel nut torque checked at the nearest automotive service facility. Tighten the wheel nuts to 110 N.m (11 kg-m, 80 lb-ft).

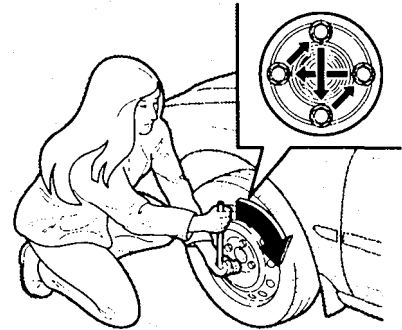

16. Remove the wheel cover or center cap. Place the flat tire face down in the spare tire well.

continued

Changing a Flat Tire, If Your Engine Won't Start

17. Remove the spacer cone from the wing bolt, turn it over, and put it back on the bolt.

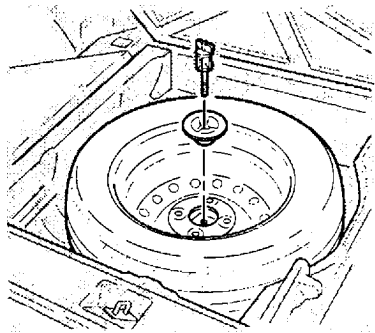

18. Secure the flat tire by screwing the wing bolt back into its hole.

Loose items can fly around the interior in a crash and could seriously injure the occupants.

Store the wheel, jack and tools securely before driving.

19. Store the jack in the cargo area with the end bracket on the right side. Turn the end bracket on the jack clockwise to lock it in place. Store the tool kit.
20. Store the wheel cover or center cap in the trunk. Make sure it does not get scratched or damaged.

If Your Engine Won't Start

Diagnosing why your engine won't start falls into two areas, depending on what you hear when you turn the key to START (III):

- You hear nothing, or almost nothing. The engine's starter motor does not operate at all, or operates very slowly.
- You can hear the starter motor operating normally, but the engine does not start up and run.

Nothing Happens or the Starter Motor Operates Very Slowly

When you turn the ignition switch to START (III), you do not hear the normal noise of the engine trying to start. You may hear a clicking sound or series of

clicks, or nothing at all. Check these things:

- Check the transmission interlock. If you have a 5-speed, the clutch pedal must be pushed all the way to the floor or the starter will not operate. With an automatic transmission, it must be in Park or Neutral.
- Turn the ignition switch to ON (II). Turn on the headlights and check their brightness. If the headlights are very dim or don't light at all, the battery is discharged. See **Jump Starting**.

- Turn the ignition switch to START (III). If the headlights do not dim, check the condition of the fuses. If the fuses are OK, there is probably something wrong with the electrical circuit for the ignition switch or starter motor. You will need a qualified technician to determine the problem. See **Towing** on page 174.

If the headlights dim noticeably or go out when you try to start the engine, either the battery is discharged or the connections are corroded. Check the condition of the battery and terminal connections (see page 132). You can then try jump starting the car from a booster battery (see page 162).

The Starter Operates Normally

In this case, the starter motor sounds normal when you turn the ignition switch to START (III), but the engine does not run.

- Are you using the proper starting procedure? Refer to **Starting the Engine** on page 94.
- Do you have fuel? Turn the ignition switch to ON (II) for a minute, and watch the fuel gauge.
- There may be an electrical problem, such as no power to the fuel pump. Check all the fuses (see page 169).

If you find nothing wrong, you will need a qualified technician to find the problem. See **Towing** on page 174.

Jump Starting

If your car's battery has run down, you may be able to start the engine by using a booster battery. Although this seems like a simple procedure, you should take several precautions.

A battery can explode if you do not follow the correct procedure, seriously injuring anyone nearby.

Keep all sparks, open flames, and smoking materials away from the battery.

You cannot start a Honda with an automatic transmission by pushing or pulling it.

To jump start your car follow these directions closely:

1. Open the hood and check the physical condition of the battery (see page 132). In very cold weather, check the condition of the electrolyte. If it seems slushy or like ice, do not try jump starting until it thaws.

NOTICE

If a battery sits in extreme cold, the electrolyte inside can freeze. Attempting to jump start with a frozen battery can cause it to rupture or explode.

2. Turn off all the electrical accessories: heater, A/C, stereo system, lights, etc. Put the transmission in Neutral or Park, and set the parking brake.

3. Connect one jumper cable to the positive (+) terminal on the booster battery. Connect the other end to the positive (+) terminal on your Honda's battery.

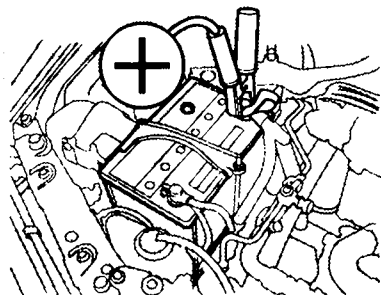

Jump Starting, If Your Engine Overheats

4. Connect the second jumper cable to the negative (—) terminal on the booster battery. Connect the other end to the grounding strap as shown. Do not connect this jumper cable to any other part of the engine.

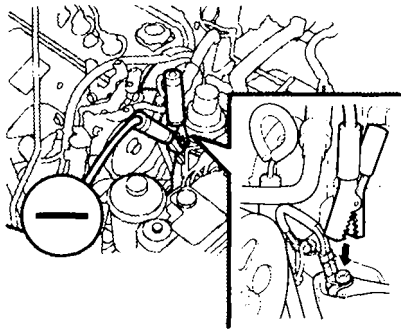

5. If the booster battery is in another car, have an assistant start that car and run it at a fast idle.

6. Start your car. If the starter motor still operates slowly, check the jumper cable connections to make sure they have good metal-to-metal contact.

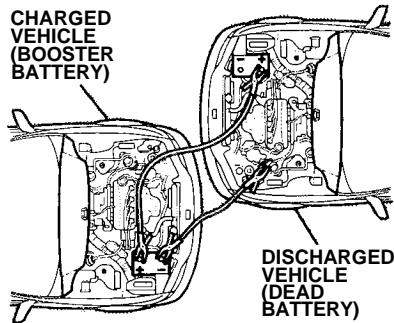

7. Once your car is running, disconnect the negative cable from your car and then from the booster battery. Disconnect the positive cable from your car and then from the booster battery.

If Your Engine Overheats

The pointer of your car's temperature gauge should stay in the midrange under most conditions. It may go higher if you are driving up a long steep hill on a very hot day. If it climbs to the red mark, you should determine the reason.

NOTICE

Driving with the temperature gauge pointer at the red mark can cause serious damage to your engine.

continued

If Your Engine Overheats

Your car can overheat for several reasons, such as lack of coolant or a mechanical problem. The only indication may be the temperature gauge climbing to or above the red mark. Or you may see steam or spray coming from under the hood. In either case, you should take immediate action.

Steam and spray from an overheated engine can seriously scald you.

Do not open the hood if steam is coming out.

1. Safely pull to the side of the road. Put the transmission in Neutral or Park, and set the parking brake. Turn off the

heating and cooling system and all other accessories. Turn on the hazard warning indicators.

2. If you see steam and/or spray coming from under the hood, turn off the engine.
3. If you do not see steam or spray, leave the engine running and watch the temperature gauge. If the high heat is due to overloading (climbing a long, steep hill on a hot day with the A/C running, for example), the engine should start to cool down almost immediately. If it does, wait until the temperature gauge comes down to the midpoint, and then continue driving.
4. If the temperature gauge stays at the red mark, turn off the engine.

5. Wait until you see no more signs of steam or spray; then open the hood.
6. Look for any obvious coolant leaks, such as a split radiator hose. Everything is still extremely hot, so use caution. If you find a leak, it must be repaired before you continue driving (see **Towing** on page 174).
7. If you don't find an obvious leak, check the coolant level in the radiator reserve tank (see page 87). If the level is below the MIN mark, add coolant to halfway between the MIN and MAX marks.
8. If there was no coolant in the reserve tank, you may also have to add coolant to the radiator.

Let the engine cool down until the pointer reaches the

If Your Engine Overheats, Low Oil Pressure Indicator

middle of the temperature gauge, or lower, before checking the radiator.

Removing the radiator cap while the engine is hot can cause the coolant to spray out, seriously scalding you.

Always let the engine and radiator cool down before removing the radiator cap.

- Using gloves or a large heavy cloth, turn the radiator cap counterclockwise, without pushing down, to the first stop. This releases any remaining pressure in the cooling system. After the pressure releases, push down on the cap and turn it until it comes off.

- Start the engine and set the heater control lever to maximum. Add coolant to the radiator up to the base of the fill neck. If you do not have the proper coolant mixture available, you can add plain water. Remember to have the cooling system drained and refilled with the proper mixture as soon as you can.
- Put the radiator cap back on tightly. Run the engine and watch the temperature gauge. If it goes back to the red mark, the engine needs repair. (See **Towing** on page [174](#).)
- If the temperature stays normal, check the coolant level in the radiator reserve tank. If it has gone down, add coolant to the MAX mark. Put the cap back on tightly.

Low Oil Pressure Indicator

This indicator should light when the ignition is ON (II), and go out after the engine starts. If it comes on when the engine is running, it indicates that the oil pressure has dropped and serious engine damage is possible. Take immediate action.

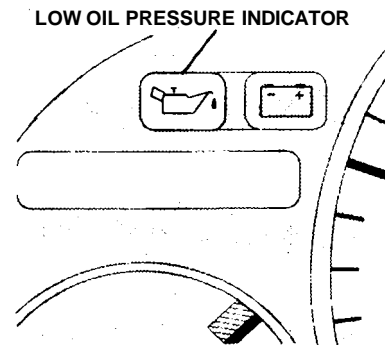

continued

Low Oil Pressure Indicator, Charging System Indicator

NOTICE

Running the engine with low oil pressure can cause serious mechanical damage almost immediately. Turn off the engine as soon as you can safely get the car stopped.

1. Safely pull off the road and shut off the engine.
2. Let the car sit for a minute. Open the hood and check the oil level (see page 86). Although oil level and oil pressure are not directly connected, an engine that is very low on oil can lose pressure during cornering and other driving maneuvers.
3. If necessary, add oil to bring the level back to the full mark on the dipstick (see page 118).

4. Start the engine and watch the oil pressure indicator. If the indicator does not go out within 10 seconds, turn off the engine. There is a mechanical problem that needs to be repaired before you can continue driving. (See **Towing** on page 174.)

Charging System Indicator

This indicator should come on when the ignition is ON (II), and go out after the engine starts. If it comes on brightly when the engine is running, it indicates that the charging system has stopped charging the battery.

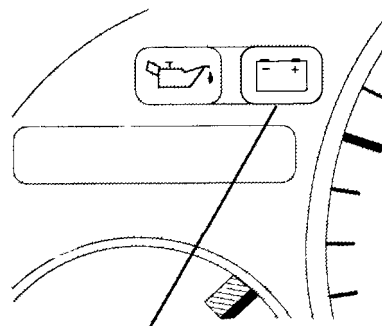

CHARGING SYSTEM INDICATOR

Immediately turn off all electrical accessories: radio, heater, A/C, rear defogger, cruise control, etc.

Charging System Indicator, Malfunction Indicator Lamp

Try not to use other electrically operated controls such as the power windows. Keep the engine running and take extra care not to stall it. Starting the engine will discharge the battery rapidly.

By eliminating as much of the electrical load as possible, you can drive several miles before the battery is too discharged to keep the engine running. Drive to a service station or garage where you can get technical assistance.

Malfunction Indicator Lamp

This indicator comes on for a few seconds when you turn the switch ON (II). If it comes on at any other time, it indicates one of the engine's emissions control systems may have a problem. Even though you may feel no difference in your car's performance, it can reduce your

fuel economy and cause your car to put out excessive emissions. Continued operation may cause serious damage.

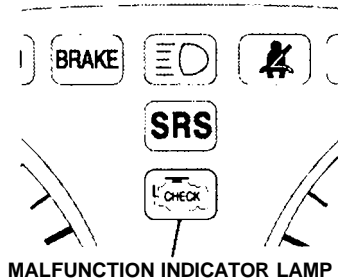

If this indicator comes on, safely pull off the road and turn off the engine. Restart the engine and watch the indicator. If it stays on, have your car checked by the dealer as soon as possible. Drive moderately until the dealer has inspected the problem. Avoid

full-throttle acceleration and driving at high speed.

You should also have the dealer inspect your car if the indicator comes on frequently, even though it goes off when you follow the above procedure.

NOTICE

If you keep driving with the malfunction indicator lamp/check engine light on, you can damage your car's emission controls and engine. Those repairs may not be covered by your car's warranties.

Closing the Moonroof

If the electric motor will not close the moonroof, do the following:

1. Check the fuse for the moonroof motor (see page 169). If the fuse is blown, replace it with one of the same or lower rating.
2. Try closing the moonroof. If the new fuse blows immediately or the moonroof motor still does not operate, you can close the moonroof manually.
3. Get the tool out of the tool kit located under the cargo area floor.

4. Use a screwdriver or coin to remove the round plug in the center of the headliner.

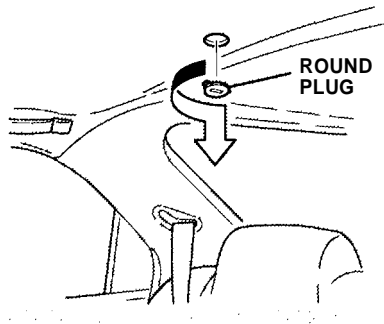

5. Insert the moonroof wrench into the socket behind this plug. Turn the wrench until the moonroof is fully closed.

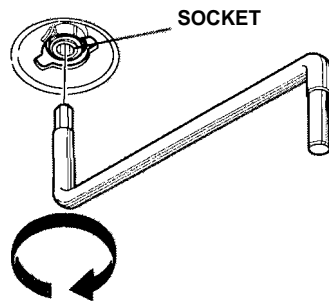

6. Remove the wrench. Replace the round plug.

All the electrical circuits in your car have fuses to protect them from a short circuit or overload. These fuses are located in two or three fuse boxes.

The under-hood fuse box is located in the front of the engine compartment on the passenger's side. To open, push the tab as shown.

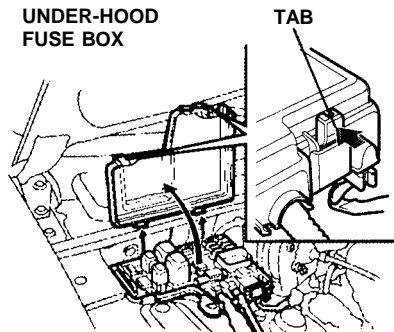

Only cars equipped with ABS have an ABS fuse box. It is in the front of the engine compartment on the passenger's side.

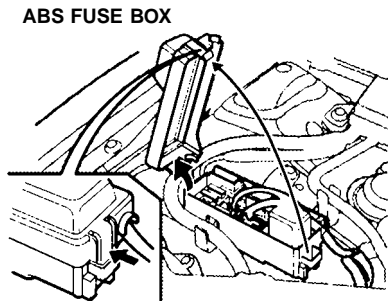

The interior fuse box is underneath the dashboard on the driver's side. To open, turn the knob.

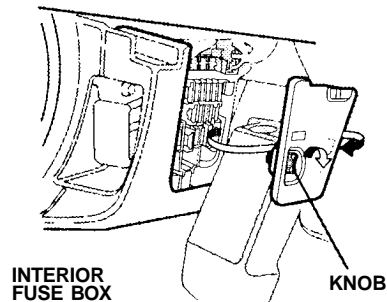

Checking and Replacing

If something electrical in your car stops working, the first thing you should check for is a blown fuse. Determine from the chart on the fuse box cover or inside the fuse box which fuse or fuses control that component. Check

continued

Fuses

those fuses first, but check all the fuses before deciding that a blown fuse is not the cause. Replace any blown fuses, and check the component's operation.

1. Turn the ignition switch to LOCK (0). Make sure the headlights and all other accessories are off.
2. Remove the cover from the fuse box.
3. Check each of the large fuses in the under-hood fuse box by looking through the top at the wire inside. Removing these fuses requires a Phillips screwdriver.

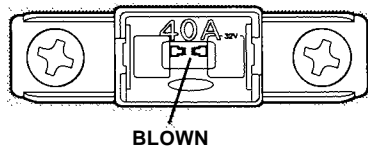

4. Check the smaller fuses in the under-hood fuse box and all the fuses in the interior fuse box by pulling out each fuse with the fuse puller provided in the interior fuse box.

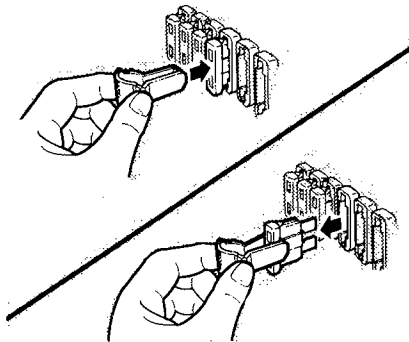

5. Look for a burned wire inside the fuse. If it is burned out, replace it with one of the spare fuses of the same rating or lower.

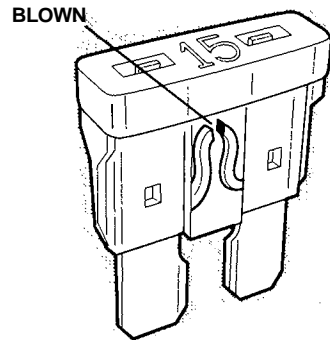

If you cannot drive the car without fixing the problem, and you do not have a spare fuse, take a fuse of the same rating or a lower rating from one of the other circuits. Make sure you can do without that circuit

temporarily (such as the cigarette lighter or radio).

If you replace the blown fuse with a spare fuse that has a lower rating, it might blow out again. This does not indicate anything wrong. Replace the fuse with one of the correct rating as soon as you can.

NOTICE

Replacing a fuse with one that has a higher rating greatly increases the chances of damaging the electrical system. If you do not have a replacement fuse with the proper rating for the circuit, install one with a lower rating.

6. If the replacement fuse of the same rating burns out in a short time, there is probably a serious electrical problem in your car. Leave the blown fuse in that circuit and have your car checked by a qualified technician.

Fuses

UNDERHOOD FUSE BOX

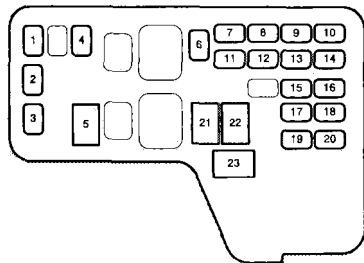

No.	Amps.	Circuits Protected
1	20A	Cooling Fan
2	20A	Right Headlight
3	20A	Left Headlight
4	10A	Daytime Running Lights ^(n/a)
5	50A	Ignition Switch
6	20A	Rear Right Power Window
7	20A	Front Right Power Window
8	30A	Sunroof
9	15A	Condenser Fan
10	7.5A	Back Up (Radio)
11	20A	Rear Left Power Window
12	20A	Front Left Power Window
13	15A	ECU (Injector) (ECM)
14	20A	Door Lock
15	15A	Parking Light

No.	Amps.	Circuits Protected
16	7.5A	Interior Light
17	20A	Power Seat Height
18	15A	Radio, Cigarette Lighter
19	20A	Stop Light, Horn
20	10A	Hazard
21	40A	Heater Blower
22	30A	Rear Defroster
23	80A 100A*	Battery

* EX

ABS FUSE BOX

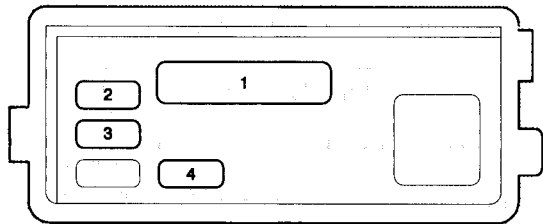

No.	Amps.	Circuits Protected
1	40A	ABS Motor
2	20A	ABS B1
3	15A	ABS B2
4	10A	ABS Unit

INTERIOR FUSE BOX

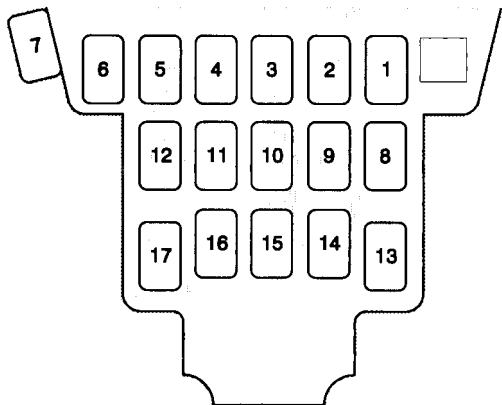

No.	Amps.	Circuits Protected
1	10A	Radio Motor Antenna
2	7.5A	Day Light
3	7.5A	Starter Signal
4	7.5A	Heater Control, AC Clutch, and Cooling Fan Relays
5	7.5A	Power Mirror
6	10A	Spare Fuse
7	7.5A	Turn Signals
8	10A	Spare Fuse
9	30A	Wiper, Washer
10	10A	Power Window Relay, Rear Wiper, Moonroof Relay
11	7.5A	ECU (Cruise Control), Electronic A/T (ECU)
12	20A	Spare Fuse
13	7.5A	Spare Fuse
14	10A	SRS
15	15A	Fuel Pump
16	10A	Back-Up Lights, Meter Lights (Turn Signals)
17	15A	Spare Fuse

Towing

If your car needs to be towed, call a professional towing service or, if you belong to one, an organization that provides roadside assistance. Never tow your car behind another car with just a rope or chain. It is very dangerous.

Emergency Towing

There are three popular methods of towing a car:

Flatbed Equipment—The operator loads your car on the back of a truck. This is the best way of transporting your Honda.

Wheel Lift Equipment—The tow truck uses two pivoting arms that go under the tires (front or rear) and lift them off the ground. The other two tires remain on the ground.

Sling-Type Equipment—The tow truck uses metal cables with hooks on the ends. These hooks go around parts of the frame or suspension, and the cables lift that end of the car off the ground. Your car's suspension and body can be seriously damaged if this method of towing is attempted.

If your Honda cannot be transported on a flatbed truck, it should be towed with the front wheels off the ground. If, due to damage, your car must be towed with the front wheels on the ground, do the following:

5-Speed Manual Transmission

- Release the parking brake.
- Shift the transmission to Neutral.

Automatic Transmission

- Release the parking brake.
- Start the engine.

- Shift to D4, then to N.
- Turn off the engine.

NOTICE

Improper towing preparation will damage the transmission. Follow the above procedure exactly. If you cannot shift the transmission or start the engine (automatic transmission), your car must be transported on a flatbed.

- It is best to tow the car no farther than 50 miles (80 km), and keep the speed below 35 mph (55 km/h).

NOTICE

Trying to lift or tow your car by the bumpers will cause serious damage. The bumpers are not designed to support the car's weight.

The diagrams in this section give you the dimensions and capacities of your Honda and the locations of the identification numbers. The explanations of several electronic and mechanical systems on your Honda are for the more technically oriented owner.

Identification Numbers	176
Specifications	178
Tire Information	180
Tire Size Designation	180
Wheel Size Designation ..	180
Tire Speed Ratings	180
Tire Pressure Adjustment for High Speed Driving ..	180
DOT Tire Quality Grading .	181
Treadwear	181
Traction	181
Temperature	182
Emissions Controls	182
The Clean Air Act	182
Crankcase Emissions Control System	183
Evaporative Emissions Control System	183

Exhaust Emissions Controls	183
PGM-FI System	183
Ignition Timing Control System	183
Three-Way Catalytic Converter	183
Exhaust Gas Recirculation (EGR) System	184
Replacement Parts	184
Three-Way Catalytic Converter	184
Anti-Lock Brake System	185

Identification Numbers

Your car has several identifying numbers located in various places.

The Vehicle Identification Number (VIN) is the 17-digit number your Honda dealer uses to register your car for warranty purposes. It is also necessary for licensing and insuring your car.

The easiest place to find the VIN is on a plate fastened to the top of the dashboard. You can see it by looking through the windshield on the driver's side. It is also on the Certification Label attached to the driver's doorjamb, and it is stamped on the engine compartment bulkhead. The VIN is also provided in bar code on the Certification Label.

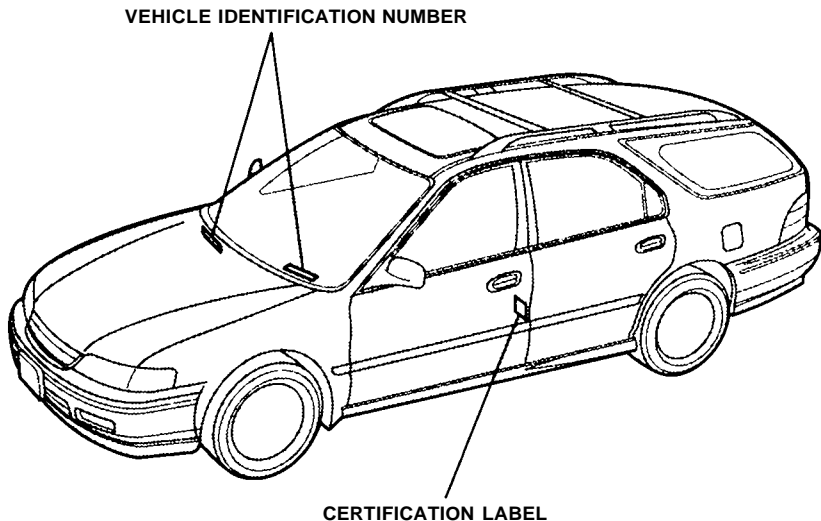

Identification Numbers

The Engine Number is stamped into the engine block.

The Transmission Number is on a label on top of the transmission.

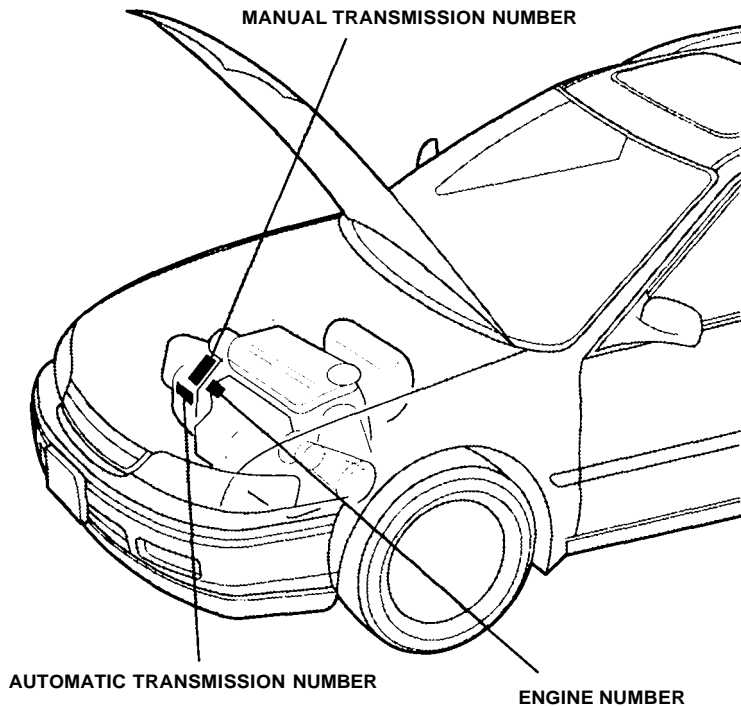

Specifications

Dimensions

Length	187.8 in. (4,770 mm)	
Width	70.1 in. (1,780 mm)	
Height	55.9 in. (1,420 mm)	
Wheelbase	106.9 in. (2,715 mm)	
Track	Front	59.6 in. (1,515 mm)
	Rear	59.1 in. (1,500 mm)

Weights

Gross vehicle weight rating	See the Certification Label attached to the driver's doorjamb.
-----------------------------	--

Engine

Type	Water cooled 4-stroke SOHC* ¹ , SOHC VTEC* ² 4-cylinder gasoline engine
Bore x Stroke	3.35 x 3.74 in. (85.0 x 95.0 mm)
Displacement	132 cu-in. (2,156 cm ³)
Compression ratio	8.8:1
Spark plugs	See spark plug maintenance section page 131.

*1 LX

*2 EX

Capacities

Fuel tank		Approx. 17.0 U.S. gal. (64.5 ℓ, 14.2 Imp gal.)
Radiator coolant	Change * ¹ 5-Speed	5.7 U.S. qt (5.4 ℓ, 1.19 Imp gal.)
	Automatic	5.6 U.S. qt. (5.3 ℓ, 1.16 Imp gal.)
	Total 5-Speed	1.82 U.S. gal. (6.9 ℓ, 1.52 Imp gal.)
	Automatic	1.80 U.S. gal. (6.8 ℓ, 1.50 Imp gal.)
Engine oil	Change * ⁴ Incl. filter	4.0 U.S. qt (3.8 ℓ, 3.3 Imp qt) ^{*2} 4.5 U.S. qt (4.3 ℓ, 3.8 Imp qt) ^{*3}
	W/O filter	3.7 U.S. qt (3.5 ℓ, 3.1 Imp qt) ^{*2} 4.2 U.S. qt (4.0 ℓ, 3.5 Imp qt) ^{*3}
	Total	5.2 U.S. qt (4.9 ℓ, 4.3 Imp qt) ^{*2} 5.9 U.S. qt (5.6 ℓ, 4.9 Imp qt) ^{*3}
5-speed manual transmission oil	Change	2.0 U.S. qt (1.9 ℓ, 1.7 Imp qt)
	Total	2.1 U.S. qt (2.0 ℓ, 1.8 Imp qt)
Automatic transmission fluid	Change	3.4 U.S. qt (3.2 ℓ, 2.8 Imp qt)
	Total	6.3 U.S. qt (6.0 ℓ, 5.3 Imp qt)
Windshield washer reservoir	U.S. cars	2.6 U.S. qt (2.5 ℓ, 2.2 Imp qt)
	Canadian cars	4.8 U.S. qt (4.5 ℓ, 4.0 Imp qt)

*1 Including the coolant in the reserve tank and that remaining in the engine. Reserve tank capacity: 0.6 U.S. qt. (.06 ℓ, 0.13 Imp gal.)

*2 LX

*3 EX

*4 Excluding the oil remaining in the engine.

Lights

Headlights (HI/LO)	12V – 60/55 W
Front turn signal lights	12V – 21W
Front parking lights	12V – 3CP (4.9W)
Rear turn signal lights	12V – 45CP (27W)
Stop/Taillights	12V – 43/3CP (27/5W)
High-mount brake light	12V – 18W
Front side marker lights	12V – 21W
Back-up lights	12V – 32 CP (21W)
License plate lights	12V – 8W
Interior lights (front/rear)	12V – 8W
Cargo area light	12V – 5W
Door courtesy lights	12V – 3.4W
Vanity mirror light	12V – 1.8W

Battery

Capacity	12V – 65AH 20HR
----------	-----------------

Fuses

Interior	See the fuse label attached to the inside of the fuse box door under the dashboard.
Under-hood	See the fuse box cover.

Alignment

Toe-in	Front	0 ± 0.08 in. (0 ± 2 mm)
	Rear	0.08 ± 0.08 in. (2 ± 2 mm)
Camber	Front	$0^{\circ}00' \pm 1^{\circ}$
	Rear	$-0^{\circ}25' \pm 30'$
Caster	Front	$3^{\circ}00' \pm 1^{\circ}$

Tires

Size	Front/Rear	195/60R15 88H
	Spare	195/60R15 88H
Pressure	Front/Rear	32 psi (220 kPa, 2.2 kg/cm ²)
	Spare	32 psi (220 kPa, 2.2 kg/cm ²)

Air Conditioning

Refrigerant Type	HFC-134a (R-134a)
Charge Quantity	21–23 oz. (600-650g)
Lubricant Type	ND oil 8 *1 (N.D. Compressor) Dn. S10X *2 (HADSYS Compressor)

*1 LX
*2 EX

Tire Information

Tire Size Designation

A tire's sidewall is marked with a tire size designation. You will need this information when selecting replacement tires for your car. The following explains what the letters and numbers in the tire size designation mean.

Example tire size designation:

195/60R15 88H

195—Tire width in millimeters.

60—Aspect ratio. The tire's section height as a percentage of its width.

R—Tire construction code (Radial).

15—Rim diameter in inches.

88—Load Index, a numerical code associated with the maximum load the tire can carry.

H—Speed Rating Symbol. See the speed rating chart in this section for additional information.

Wheel Size Designation

Wheels are also marked with important information that you need if you ever have to replace one. The following explains what the letters and numbers in the wheel size designation mean.

Example wheel size designation:

15 X 5¹/₂ JJ

15—Rim diameter in inches.

5¹/₂—Rim width in inches.

JJ—Rim contour designation.

Tire Speed Ratings

The chart shows many of the different speed ratings currently being used for passenger car

tires. The speed rating symbol is part of the tire size designation on the sidewall of the tire. This symbol corresponds to that tire's designed maximum safe operating speed.

Speed Rating Symbol	Maximum Speed
S	112 mph (180 km/h)
T	118 mph (190 km/h)
H	130 mph (210 km/h)
V	149 mph (240 km/h)
Z	Above 149 mph (240 km/h)

Tire Pressure Adjustment for High Speed Driving

Honda strongly recommends that you not drive faster than posted speed limits and conditions

allow. If you decide it is safe to drive at high speeds, be sure to adjust the cold tire pressures as shown below. If you do not adjust the tire pressure, excessive heat can build up and cause sudden tire failure.

Tire Size	Cold Tire Pressure for Speeds Over 100 mph (160 km/h)
195/60R15 88H	35 psi (240 kPa, 2.4 kg/cm ²)

Be sure to readjust the pressure for normal driving speeds. You should wait until the tires are cold before adjusting the tire pressure (see page [137](#)).

DOT Tire Quality Grading

The tires on your car meet all U.S. Federal Safety Requirements. All tires are also graded for treadwear, traction, and temperature performance according to Department of Transportation (DOT) standards. The following explains these gradings.

Treadwear

The treadwear grade is a comparative rating based on the wear rate of the tire when tested under controlled conditions on a specified government test course. For example, a tire graded 150 would wear one-and-one-half (1-1/2) times as well on the government course as a tire graded 100. The relative performance of tires depends upon the actual conditions of their use, however, and may depart significantly from the

norm due to variations in driving habits, service practices, and differences in road characteristics and climate.

Traction

The traction grades, from highest to lowest, are A, B, and C, and they represent the tire's ability to stop on wet pavement as measured under controlled conditions on specified government test surfaces of asphalt and concrete. A tire marked C may have poor traction performance.

Warning: The traction grade assigned to this tire is based on braking (straight ahead) traction tests and does not include cornering (turning) traction.

Tire Information, Emissions Controls

Temperature

The temperature grades are A (the highest), B, and C, representing the tire's resistance to the generation of heat and its ability to dissipate heat when tested under controlled conditions on a specified indoor laboratory test wheel. Sustained high temperature can cause the material of the tire to degenerate and reduce tire life, and excessive temperature can lead to sudden tire failure. The grade C corresponds to a level of performance which all passenger car tires must meet under the Federal Motor Vehicle Safety Standard No. 109. Grades B and A represent higher levels of performance on the laboratory test wheel than the minimum required by law.

Warning: The temperature grade for this tire is established for a tire that is properly inflated and not overloaded. Excessive speed, underinflation, or excessive loading, either separately or in combination, can cause heat buildup and possible tire failure.

Emissions Controls

The burning of gasoline in your car's engine produces several byproducts. Some of these are carbon monoxide (CO), oxides of nitrogen (NOx), and hydrocarbons (HC). Gasoline evaporating from the tank also produces hydrocarbons. Controlling the production of CO, NOx, and HC is important to the environment. Under certain conditions of sunlight and climate, NOx and HC react to form photochemical "smog."

Carbon monoxide does not contribute to smog creation, but it is a poisonous gas.

The Clean Air Act

The Clean Air Act sets standards for automobile emissions. It also requires that automobile manufacturers explain to owners how their emissions controls work and what to do to maintain them. This section summarizes how the emissions controls work. Scheduled maintenance is on page [112](#) - [113](#).

Crankcase Emissions Control System

Your car has a Positive Crankcase Ventilation (PCV) System. This keeps gasses that build up in the engine's crankcase from going into the atmosphere. The PCV valve routes them from the crankcase back to the intake manifold. They are then drawn into the engine and burned.

Evaporative Emissions Control System

As fuel evaporates in the fuel tank, an evaporative emissions control canister filled with charcoal adsorbs the vapor. It is stored in this canister while the engine is off. After the engine is started and warmed up, the vapor is drawn into the engine and burned during driving.

Exhaust Emissions Controls

The exhaust emissions controls include three systems: PGM-FI, ignition timing control, and three-way catalytic converter. These three systems work together to control the engine's combustion and minimize the amount of HC, CO, and NOx that comes out the tailpipe. The exhaust emissions control systems are separate from the crankcase and evaporative emissions control systems.

PGM-FI System

The PGM-FI system uses a sequential multiport fuel injection. It has three sub-systems: air intake, engine control, and fuel control. The engine control module (ECM) uses various sensors to determine how much air is going into the engine. It then controls

how much fuel to inject under all operating conditions.

Ignition Timing Control System

This system constantly adjusts the ignition timing, reducing the amount of HC, CO and NOx produced.

Three-Way Catalytic Converter

The three-way catalytic converter is in the exhaust system. Through chemical reactions, it converts HC, CO, and NOx in the engine's exhaust to carbon dioxide (CO₂), dinitrogen (N₂), and water vapor.

Emission Controls, Three-Way Catalytic Converter

Exhaust Gas Recirculation (EGR) System

The Exhaust Gas Recirculation (EGR) system takes some of the exhaust gas and routes it back into the intake manifold. Adding exhaust gas to the air/fuel mixture reduces the amount of NOx produced when the fuel is burned.

Replacement Parts

The emissions control systems are designed and certified to work together in reducing emissions to levels that comply with the Clean Air Act. To make sure the emissions remain low, you should use only new Genuine Honda replacement parts or their equivalent for repairs. Using lower quality parts may increase the emissions from your car.

The emissions control systems are covered by warranties

separate from the rest of your car. Read your warranty manual for more information.

Three-Way Catalytic Converter

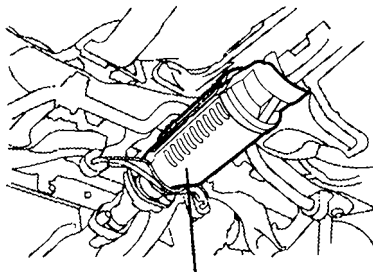

THREE-WAY CATALYTIC CONVERTER

The three-way catalytic converter contains precious metals that serve as catalysts, promoting chemical reactions to convert the exhaust gases without affecting the metals. The catalytic converter is referred to as a three-way catalyst, because

it acts on HC, CO, and NOx. A replacement unit must be an original Honda part or its equivalent.

The three-way catalytic converter must operate at a high temperature for the chemical reactions to take place. It can set on fire any combustible materials that come near it. Park your car away from high grass, dry leaves, or other flammables.

- Always use unleaded gasoline. Even a small amount of leaded gasoline can contaminate the catalyst metals, making the converter ineffective.
- Keep the engine tuned up.
- Have your car diagnosed and repaired if it is misfiring, backfiring, continuing to run after you turn off the engine, stalling, or otherwise not running properly.

Anti-Lock Brake System

The Anti-Lock Brake System (ABS) works by measuring how fast the wheels are turning during braking and comparing their speeds. If any wheel is rotating much slower than the others (on the verge of locking up and skidding), the system reduces hydraulic pressure to that wheel's brake caliper. When that wheel's speed matches the other wheels, the system applies normal hydraulic pressure. This can take place several times per second at each wheel. You feel the ABS working as rapid pulsations in the brake pedal.

Each wheel has a wheel speed sensor assembly. As the wheel rotates, the sensor sends electrical pulses to the ABS control unit. The pulse frequency varies with the wheel speed.

The electrical output of the ABS control unit is connected to the modulator/solenoid unit. During braking, the ABS control unit monitors the pulse frequencies from the four wheels. When the control unit detects a wheel locking up, it energizes the appropriate solenoid in the modulator/solenoid unit. There are three solenoids: one for each front wheel, and one for the rear wheels. The energized solenoid reduces hydraulic pressure to one side of a modulator valve. This, in turn, reduces hydraulic pressure in the brake line going to the affected wheel. When that wheel speeds up because of the reduced braking effort, the control unit de-energizes the solenoid. This builds hydraulic pressure on the modulator valve. The pressure increases in the hydraulic line to the wheel.

For the system to react quickly, the modulator/solenoid unit must have brake fluid under high pressure. This is supplied by a diaphragm-type accumulator that is pressurized by an electric pump. A pressure-sensing switch on the accumulator controls this pump.

The control unit also contains error detection circuitry. It monitors the operation of the wheel sensors, solenoids, pump, and electronics. If the control unit detects any faults, it shuts off power to the pump motor and solenoids. The light on the instrument panel comes on. The brakes then work like a conventional system without anti-lock capabilities.

Warranty Coverages	188
Customer Relations Information	189
Reporting Safety Defects	189
U.S. Zone Office Map	190
Authorized Manuals	191

Warranty Coverages

Your new Honda is covered by these warranties:

New Car Limited Warranty — Covers your new car, except for the battery, emissions control systems and accessories, against defects in materials and workmanship.

Emission Control Systems Defects Warranty and Emissions Performance Warranty — These two warranties cover your car's emission control systems. Time, mileage, and coverage are conditional. Please read the warranty manual for exact information.

Original Equipment Battery Limited Warranty — This warranty gives up to 100 percent credit toward a replacement battery.

Seat Belt Limited Warranty — A seat belt that fails to function properly is covered for the useful life of the car.

Rust Perforation Limited Warranty — All exterior body panels are covered for rust-through from the inside for the specified time period with no mileage limit.

Accessory Limited Warranty — Genuine Honda Accessories are covered under this warranty. Time and mileage limits depend on the type of accessory and other factors. Please read your warranty manual for details.

Replacement Parts Limited Warranty — Covers all Genuine Honda replacement parts against defects in materials and workmanship.

Replacement Battery Limited Warranty — Provides prorated coverage for a replacement battery purchased from a Honda dealer.

Replacement Muffler Lifetime Limited Warranty — Provides coverage for as long as the purchaser of the muffler owns the car.

Restrictions and exclusions apply to all these warranties. Please read the 1996 Honda Warranty booklet that came with your car for precise information on warranty coverages. Your Honda's original tires are covered by their manufacturer. Tire warranty information is in a separate booklet.

Customer Relations Information, Reporting Safety Defects

Customer Relations Information

Honda dealership personnel are trained professionals. They should be able to answer all your questions. If you encounter a problem that your dealership does not solve to your satisfaction, please discuss it with the dealership's management. The Service Manager or General Manager can help. Almost all problems are solved in this way.

If you are dissatisfied with the decision made by the dealership's management, contact your Honda Customer Relations Zone Office. Refer to the U.S. and Canada Zone Office maps on the following pages.

When you call or write, please give us this information:

- Vehicle Identification Number (see page 176)
- Name and address of the dealer who services your car
- Date of purchase
- Mileage on your car
- Your name, address, and telephone number
- A detailed description of the problem
- Name of the dealer who sold the car to you

Reporting Safety Defects

If you believe that your vehicle has a defect that could cause a crash or could cause injury or death, you should immediately inform the National Highway Traffic Safety Administration

(NHTSA) in addition to notifying American Honda Motor Co., Inc.

If NHTSA receives similar complaints, it may open an investigation, and if it finds that a safety defect exists in a group of vehicles, it may order a recall and remedy campaign. However, NHTSA cannot become involved in individual problems between you, your dealer, or American Honda Motor Co., Inc.

To contact NHTSA, you may either call the Auto Safety Hotline toll-free at (800) 424-9393, or (202) 366-0123 in the Washington, D.C. area, or write to this address: NHTSA, U.S. Department of Transportation, Washington, D.C. 20590. You can also obtain other information about motor vehicle safety from the Hotline.

U.S. Zone Office Map

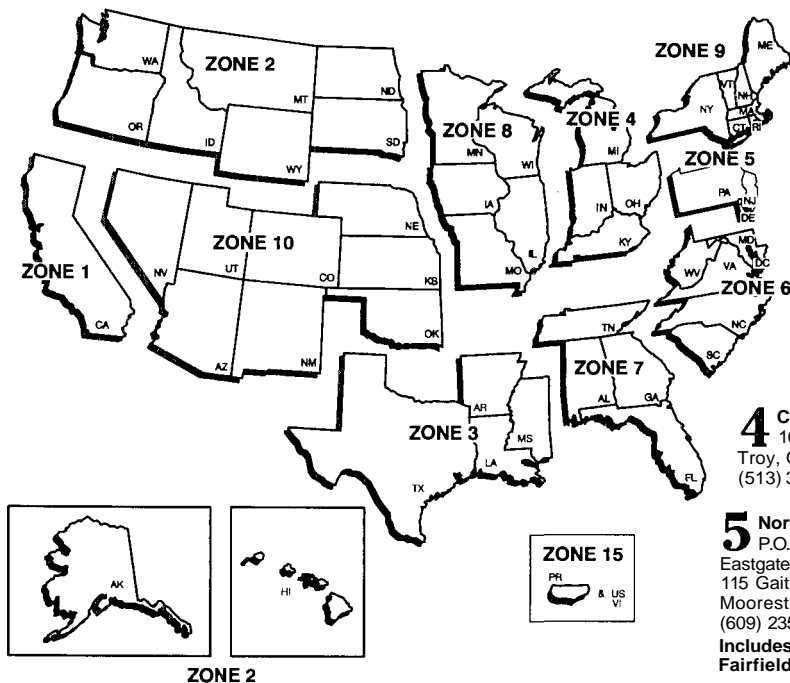

1 Western Zone
P.O. Box 2260
700 Van Ness Avenue
Torrance, California
90501-2260
(310) 781-4565

2 Northwestern Zone
P.O. Box 20186
12439 N.E. Airport Way
Portland, Oregon 97220
(503) 256-0943
(also includes
Alaska and Hawaii)

3 South Central Zone
4529 Royal Lane
Irving, Texas 75063
(214) 929-5481

4 Central Zone
101 South Stanfield Road
Troy, Ohio 45373
(513) 332-6250

5 Northeastern Zone
P.O. Box 337
Eastgate Industrial Park
115 Gaither Drive
Moorestown, New Jersey 08057
(609) 235-5533
**Includes: NYC Metro area and
Fairfield County, CT area**

6 Mid-Atlantic Zone
902 Wind River Ln., Suite 200
Gaithersburg, Maryland 20878
(301)990-2020

7 Southeastern Zone
1500 Morrison Parkway
Alpharetta, Georgia 30201
(404) 442-2045

8 North Central Zone
601 Campus Drive, Suite A-9
Arlington Heights, Illinois 60004
(708) 870-5600

9 New England Zone
555 Old County Road
Windsor Locks, Connecticut 06096
(203)623-3310

**See Zone 5 for: NYC Metro area
and Fairfield County, CT area**

10 West Central Zone
1600 South Abilene Street, Suite D
Aurora, Colorado 80012
(303) 696-3935

15 Puerto Rico and U.S. V.I.
Bella International
P.O. Box 190816
San Juan, PR 00919-0816
(809) 250-8070

The above addresses and telephone numbers are subject to change. If you cannot reach your Zone office, ask your Honda dealer for the current information.

A

- ABS (Anti-lock Brake System) 102, 185
- Accessories 91
- Accessory, (Ignition Key Position) 44
- Adding
 - Automatic Transmission
 - Fluid 125
 - Brake Fluid 127
 - Clutch Fluid 128
 - Engine Coolant 121
 - Engine Oil 118
 - Manual Transmission
 - Fluid 126
 - Power Steering Fluid ... 129
 - Radiator Coolant 121
 - Windshield Washer Fluid 125
- Additional Safety Information 16
 - Door Locks 16
 - Driving With Pets 17
 - Head Restraint Position .. 16

- Seat-Back Position 16
- Storing Cargo Safely 16
- Additives, Engine Oil 119
- Adjustments
 - Head Restraints 49
 - Mirrors 53
 - Seats 48
 - Steering Wheel 35, 40
- Air Cleaner Element 129
- Air Conditioning
 - Maintenance 135
 - Usage 63
- Air Filter. See Air Cleaner Element
- Air Outlets (Vents) 60
- Air Pressure, Tires 179
- Airbag(SRS) 10
- Alcohol and Drugs 23
- Alcohol in Gasoline 82

- Alternator Belt. See Engine Belts
- Antenna Cleaning 150
- Anti-Lock Brakes
 - Indicator Light 31
 - Operation 102
- Anti-Theft Steering
 - Column Lock 44
- Antifreeze..... 121
- Appearance Care 149
- Ashtrays 57
- Audio System 66
- Automatic Transmission 97
 - Capacity, Fluid 178
 - Checking Fluid Level ... 125
 - Shift Lever Position
 - Indicator 97
 - Shift Lever Positions 98
 - Shift Lock Release 100
 - Shifting..... 98

Index

B

Battery	132
Charging System	
Indicator	30
Jump Starting	162
Maintenance	132
Specifications	179
Before Driving	81
Belts, Seat	5
Beverage Holder	55
Body Repair	154
Brakes	
Anti-Lock	
Brake System	102, 185
Break-in	82
Fluid	127
Light, Burned-out	142
Parking.....	54
System Indicator	30
Wear Indicators	101

Brakes, ABS	
Operation	102, 185
System Indicator	31
Braking System	101
Break-in, New Car	82
Brightness Control, Instruments	37
Brights, Headlights	36
Bulb Replacement	
Back-up Lights	144
Brake Lights	144
Front Parking Lights ...	143
Front Side Marker Lights	143
Headlights	142
High-Mount Brake Light	145
Interior Courtesy Lights	146
License Plate Lights ...	146
Parking Light Bulbs	143
Specifications	179
Turn Signal Lights	143
Bulbs, Halogen	142

C

Cables, Jump Starting With	162
Capacities Chart	178
Carbon Monoxide Hazard ...	24
Cargo, Loading	88
Cassette Player	
Care	74
CLEAN Indicator	74
Operation	72
Catalytic Converter, Three-Way	184
CAUTION, Explanation of ...	ii
CD Player	75
Certification Label	176
Chains, Tire	141
Change Oil	
How to	119
When	112
Changing a Flat Tire	156

Changing Engine Coolant . . .	122	Child Safety	17	CO in the Exhaust.....	24, 183
Charging System Indicator ..	30	Guidelines for Restraining		Coin Box	56
Charging System Light ...	166	Infants/Children	19	Cold Weather, Starting in ...	95
Checking		Important Safety		Compact Disc Player	75
Automatic Transmission		Reminders	18	Console Compartment	56
Fluid	125	Where Should		Consumer Information ...	189
Battery Condition	132	Children Sit	18	Control Locations	28
Brake Fluid	127	Child Seat, Securing	21	Controls Near the Steering	
Clutch Fluid	127	Cigarette Lighter	56	Wheel	35
Drive Belts	136	CLEAN Indicator	74	Hazard Warning	39
Engine Coolant	121	Cleaner, Air	129	Headlights	36
Engine Oil	86, 119	Cleaning		Instrument Panel	
Fuses	169	Aluminum Wheels	151	Brightness	37
Manual Transmission		Antenna	150	Rear Window Defogger ...	39
Fluid	126	Carpeting.....	152	Steering Wheel	
Power Steering Fluid ...	129	Exterior	150	Adjustment	40
Radiator Coolant	121	Interior.....	152	Turn Signals	37
Tire Pressure	137	Seat Belts	152	Windshield Washers	38
Windshield Wipers	134	Vinyl	152	Windshield Wipers	37
Checklist, Before Driving ...	94	Clock, Setting the	54	Controls, Instruments and ..	27
		Clutch Fluid	128		

Index

Coolant	
Adding	121
Capacity	178
Checking	121
Proper Solution	121
Temperature Gauge	34
Corrosion Protection	153
Crankcase Emission Control System	183
Cruise Control Operation	40, 41
Cup Holder. See Beverage Holder	
Customer Relations Information	189
Customer Relations Office	190

D

DANGER, Explanation of	ii
Dashboard	28

Dead Battery, What to Do .	162
Defects, Reporting Safety .	189
Defogger, Rear Window	39
Defrosting the Windows	65
DEXRON II Automatic Transmission Fluid	126
Dimensions	178
Dimming the Headlights	36
Dipstick, Automatic Transmission	126
Directional Signals	32
Disabled, Towing Your Car If	174
Disc Brake Wear Indicators	101
Disposal of Used Oil	121
Door and Brake Lamp Monitor	31
Doors Childproof Door Locks ...	46

Glove Box	47
Locking and Unlocking ...	45
Power Door Locks	45
Tailgate	47
DOT Tire Quality Grading .	181
Downshifting, 5-Speed Manual Transmission	96
Drive, Belts	136
Driving Fuel Economy	87
In Foreign Countries	83

E

Economy, Fuel	87
Emergencies on the Road .	155
Battery, Jump Starting .	162
Changing a Flat Tire ...	156
Charging System Indicator	166
Checking the Fuses	169

Malfunction Indicator Lamp	31
Manually Closing Moonroof	168
Oil Pressure Indicator	30
Overheated Engine	163
Emergency Brake	54
Emergency Flashers	32, 39
Emissions Control	182
Engine	
Coolant Temperature Gauge	34
Drive Belts	136
Identification Number .	177
Malfunction Indicator Lamp	31
Oil	
Capacity	178
What Kind to Use	118
Oil Pressure Indicator	30
Overheating	163
Ethanol in Gasoline	83

Evaporative Emissions Control	183
Exhaust Fumes	24
Expectant Mothers, Use of Seat Belts by	9
Exterior, Cleaning the	150

F

Fabric, Cleaning	152
Fan, Interior	61
Features, Comfort and Convenience	59
Filling the Fuel Tank	84
Filters	
Air. See Air Cleaner Element	
Oil	119
5-Speed Manual Transmission	
Shifting	95
Checking Fluid Level ...	126

Flashers, Hazard Warning ...	32
Flat Tire, Changing a	156
Fluids	
Automatic Transmission	125
Brake	127
Clutch	128
5-Speed Manual Transmission	126
Power Steering	129
Windshield Washer	125
Folding Rear Seat	50
Foreign Countries, Driving in	83
Four-Way Flashers	39
Front End, Towing by Emergency Wrecker	174
Fuel	
Fill Door and Cap	84
Filling the Fuel Tank	84
Gauge	34
Octane Requirement	82

Index

- Oxygenated 82
- Tank, Capacity 178
- Fuses, Checking the 169

G

- Gas Mileage, Improving 87
- Gas Station Procedures 84
- Gasohol 83
- Gasoline 82
 - See also Fuel
- Gauge 34
- Tank, Filling the 84
- Gauges
 - Engine Coolant Temperature 34
 - Fuel 34
- Gearshift Lever Positions
 - Automatic Transmission . . . 97
 - 5-Speed Transmission . . . 95
- Glass Cleaning 153

- Glove Box 47

H

- Halogen Headlight Bulbs . . . 142
- Hazard Warning Flashers ... 39
- Head Restraints 49
- Headlights 36
 - High Beam Indicator 32
 - High Beams, Turning on .. 36
 - Low Beams, Turning on .. 36
 - Reminder Chime 36
 - Replacing Halogen Bulbs 142
 - Turning on 36
- Heating and Cooling 61
- High Altitude, Starting at ... 95
- High Beam Indicator 32
- High-Low Beam Switch 36
- Hood, Opening the 85

- Hot Coolant, Warning
 - About 121

I

- Identification Number, Vehicle 176
- If Your Car Has to Be Towed 174
- Ignition
 - Keys 43
 - Switch 44
 - Timing Control System . . 183
- Indicator Lights, Instrument Panel 29
- Infant Restraint 19
- Inflation, Proper Tire 138
- Inside Mirror 53
- Inspection, Tire 137
- Instrument Panel 28

Instrument Panel Brightness	37
Interior Cleaning	152
Interior Light	57
Introduction	i

J

Jack, Tire	156
Jacking up the Car	157
Jump Starting	162

K

Keys	43
------	----

L

Label, Certification	176
Labels, Safety, Location of	25
Lane Change, Signaling	37

Lap Belt	9
Lap/Shoulder Belts	7
Leaking of Exhaust Into Car	24
Lighter, Cigarette	56

Lights

Bulb Replacement	141, 142
Indicator	29
Parking	36
Reminder Chime	36
Turn Signal	37

Loading Cargo	88
---------------	----

LOCK (Ignition Key Position)	44
------------------------------	----

Locks

Anti-Theft Steering Column	44
Childproof Door Locks	46
Fuel Filler Door	84
Glove Box	47
Power Door	45
Tailgate	47

Low Coolant Level	121
Low Oil Pressure Indicator	30
Lower Gear, Downshifting to a	96
Lubricant Specifications Chart	178
Luggage, Loading	88

M

Maintenance

Periodic Items	116
Record	114, 115
Required Indicator	34
Schedule	112

Malfunction Indicator Lamp	167
----------------------------	-----

Manual Transmission	95
---------------------	----

Manually Closing Moonroof	168
---------------------------	-----

Maximum Shift Speeds	97
----------------------	----

Meters, Gauges	33
----------------	----

Index

Methanol in Gasoline	83
Mirrors, Adjusting	53
Moonroof	
Closing Manually	168
Operation	52

N

Neutral Gear Position	99
New Vehicle Break-in	82
NOTICE, Explanation of	ii
Numbers, Identification ..	176

O

Occupant Protection System .	4
Octane Requirement, Gasoline	82
Odometer	33

Odometer, Trip	33
Oil	
Change, How to	119
Change, When to	112
Pressure Indicator	30
Selecting Proper Viscosity	119
Synthetic	119
ON (Ignition Key Position) ..	44
Opening the Hood	85
Operation in Foreign Countries	83
Outside Mirrors	53
Overheating, Engine	163

P

Paint Touch-up	151
Panel Brightness Control ...	37
Park Gear Position	98

Parking Brake	54
Parking Brake and Brake System Light	30
Parking Lights	36
Parking Over Things That Burn	184
PGM-FI System	183
Polishing and Waxing	151
Power	
Door Locks	45
Mirrors	53
Steering	129
Windows	50
Power Steering Belt See Engine Belts	
Pregnancy, Using Seat Belts ..	9
Proper Seat Belt Usage	7

R

Radiator Overheating	164
Radio/Cassette/CD Sound System	66
Radio Reception	70
Rear End Towing	174
Rear Lights, Bulb Replacement	144
Rear Seat, Folding	50
Rear View Mirror	53
Rear Window Defogger	39
Reclining the Seat-Backs	16, 48
Recommended Shift Speeds	96
Remote Transmitter	43, 45
Replacement Information	
Air Cleaner Element	129
Coolant	122
Engine Oil and Filter	119
Fuses	169

Light Bulbs	142
SparkPlugs	131
Tires	140
Wiper Blades	134
Replacing Seat Belts	
After a Crash	10
Reporting Safety Defects	189
Reserve Tank, Coolant	121
Restraint, Child	17
Reverse Gear Position	99
Rotation, Tire	139

S

Safety Belts	5
Safety Defects, Reporting	189
Safety Labels, Location of	25
Safety Messages	ii

Seat Adjustments	
Driver's Lumbar Support	49
Driver's Seat Power	
Height Adjustment	49
Front Seat Adjustments	48
Head Restraints	49
Rear Seat Armrest	50
Seat Belts	
Advice for Pregnant Women	9
Cleaning	152
Frayed or Torn	10
Maintenance	10
Reminder Light	30
Replacement	10
System Components	5
Tether Attachment Points	22
Wearing a Lap/Shoulder Belt	7
Wearing the Lap Belt	9
Seats, Adjusting the	48
Service Manual	191

Index

Service Station Procedures	84
Setting the Clock	54
Shift Lever Position Indicator	97
Shifting	
The Automatic Transmission	97, 98
The 5-Speed Transmission	95
Side Marker Lights, Bulb Replacement in	143
Signaling Turns	37
Snow Chains	141
Snow Tires	141
Solvent-type Cleaners	150
Sound System	66
Spare Tire, Specifications	179
Spark Plugs	
Replacing	131
Specifications	132

Specifications Charts	178
Speed Control	40
Speedometer	33
Spotlight	58
SRS	10
START (Ignition Key Position)	44
Starting the Engine	
In Cold Weather at High Altitude	95
With a Dead Battery	162
Steam Coming From Engine	164
Steering Wheel	
Adjustment	40
Anti-Theft Column Lock	44
Steering Wheel Controls, Cruise Control	40
Stereo Sound System	66
Storing Your Car	148

Supplemental Restraint System	10
Service Precautions	15
Servicing	15
SRS Indicator	14
System Components	11
Synthetic Oil	119

T

Tachometer	33
Taillights, Changing Bulbs in	144
Taking Care of the Unexpected	155
Tape Player	72
Technical Descriptions	
Emissions Control Systems	182
Three-Way Catalytic Converter	184

Tire Information	180
Temperature Gauge	34
Tether Attachment Points ..	22
Three-Way Catalytic Converter	184
Time, Setting the	54
Tire, How to Change a Flat	156
Tire Chains	141
Tires	137
See <i>also</i> label in glove box	
Checking Wear	138
DOT Tire Quality Grading	181
Inflation	137
Inspection	138
Replacing	140
Rotating	139
Snow	141
Spare	156
Specifications	179
Tools, Tire Changing	156

Torn Seat Belts	10
Towing	
A Trailer	103
Emergency Wrecker (Tow Truck)	174
Transmission	
Checking Fluid Level	
Automatic Transmission.....	125
5-Speed Manual Transmission.....	126
Fluid Selection	126
Identification Number ..	177
Shifting the Automatic ...	98
Shifting the 5-Speed Manual.....	96
Transmitter, Remote ...	43, 45
Treadwear	181
Trip Meter	33
Turn Signals	37

U

Unexpected, Taking Care of the	155
Uniform Tire Quality Grading	181
Unleaded Gasoline	82
Upholstery Cleaning	152
Used Oil, How to Dispose of	121

V

Vehicle Capacity Load	88
Vehicle Dimensions	178
Vehicle Identification Number	176
Vehicle Storage	148
Ventilation	63
VIN.....	176

Index

Vinyl Cleaning 152

Viscosity, Oil 118

W

Warning BEEPERS

Key in Ignition 44

Seat Belts 30

Warning Labels, Location of. 25

WARNING, Explanation of ii

Warranty Coverages 188

Washer, Windshield

Checking the Fluid

Level 125

Operation 38

Washing 150

Waxing and Polishing 151

Wheels

Adjusting the Steering ... 40

Alignment and Balance 139

Wrench 157

Windows

Cleaning..... 153

Operating the Power 50

Rear, Defogger 39

Windshield

Cleaning 38

Defroster 65

Wipers, Windshield

Changing Blades 134

Operation 37

Worn Tires 138

Wrecker, Emergency

Towing 174

Gas Station Information

Gasoline

UNLEADED gasoline
Pump octane of 86 or higher

Fuel Tank Capacity

17.0 U.S. gal. (64.5 l)

Recommended Engine Oil

API SH grade
"Energy Conserving II" oil
SAE 5W-30 viscosity

Tire Pressure

(measured cold):

Front/Rear — up to 475 lb:
32 psi (2.2 kg/cm², 220 kpa)

Front — up to 950 lb:
32 psi (2.2 kg/cm², 220 kpa)

Rear — up to 950 lb:
38 psi (2.6 kg/cm², 260 kpa)

Automatic

Transmission Fluid:

Honda Premium Formula
Automatic Transmission Fluid or
an equivalent DEXRON® II type
Automatic Transmission Fluid
(ATF)