

1993 Civic Coupe Online Reference Owner's Manual

Use these links (and links throughout this manual) to navigate through this reference.
For a printed owner's manual, click on authorized manuals or go to www.helminc.com.

Contents

Owner's Identification

Introduction	i
A Few Words About Safety	ii
Driver and Passenger Safety	3
Proper use and care of your vehicle's seat belts, and Supplemental Restraint System.	
Instruments and Controls	29
Instrument panel indicator and gauge, and how to use dashboard and steering column controls.	
Comfort and Convenience Features	63
How to operate the climate control system, the audio system, and other convenience features.	
Before Driving	79
What gasoline to use, how to break-in your new vehicle, and how to load luggage and other cargo.	
Driving	89
The proper way to start the engine, shift the transmission, and park, plus towing a trailer.	
Maintenance	103
The Maintenance Schedule shows you when you need to take your vehicle to the dealer.	
Appearance Care	147
Tips on cleaning and protecting your vehicle. Things to look for if your vehicle ever needs body repairs.	
Taking Care of the Unexpected	155
This section covers several problems motorists sometimes experience, and how to handle them.	
Technical Information	175
ID numbers, dimensions, capacities, and technical information.	
Warranty and Customer Relations (U.S. and Canada)	185
A summary of the warranties covering your new Acura, and how to contact us.	
Authorized Manuals (U.S. only)	191
How to order manuals and other technical literature.	
Index	193

Gas Station Information

A summary of information you need when you pull up to the fuel pump.

Owner's Identification

OWNER _____

ADDRESS _____

STREET

CITY

STATE/PROVINCE

ZIP CODE/
POSTAL CODE

V. I. N. _____

DELIVERY DATE _____

(Date sold to original retail purchaser)

DEALER NAME _____ DEALER NO. _____

ADDRESS _____

STREET

CITY

STATE/PROVINCE

ZIP CODE/
POSTAL CODE

OWNER'S SIGNATURE _____

DEALER'S SIGNATURE _____

This Owner's Manual should be considered a permanent part of the car, and should remain with the car when it is sold.

The information and specifications included in this publication were in effect at the time of approval for printing. Honda Motor Co., Ltd. reserves the right, however, to discontinue or change specifications or design at any time without notice and with out incurring any obligation whatsoever.

Congratulations! Your selection of a 1993 Honda Civic was a wise investment. It will give you years of driving pleasure.

To enhance the enjoyment of your new car, take time to study this manual. In it, you will learn about your car's many conveniences and useful features. Following the service interval and maintenance recommendations will help keep your driving trouble-free while preserving your investment.

Keep this owner's manual in your car so you can refer to it at any time. Please make sure the manual stays with the car if you sell it. The next owner will find it just as helpful.

Several other booklets in the glove box explain the warranties that protect your Honda. We suggest you read them carefully so you understand the coverages and the responsibilities of ownership.

When your car needs scheduled maintenance, keep in mind that your Honda dealer's service staff is specially-trained in the service and maintenance of the many systems unique to your Honda. Your Honda dealer is dedicated to your satisfaction and will be pleased to answer any questions and concerns.

Best wishes and happy motoring.

American Honda Motor Co., Inc.
Honda Canada Inc.

Safety Messages

Your safety and the safety of others is very important. We have provided many important safety messages in this manual and on the vehicle. Please read these messages carefully.

A safety message alerts you to potential hazards that could hurt you or others. Each safety message is preceded by a safety alert symbol  and one of three words, **DANGER, WARNING or CAUTION**. These mean:

YOU WILL be KILLED or SERIOUSLY HURT if you don't follow instructions.

YOU CAN be KILLED or SERIOUSLY HURT If you don't follow instructions.

You CAN be HURT if you don't follow instructions.

Each safety message tells you what the hazard is, what can happen and what you can do to avoid or reduce injury.

You will also see another important symbol:

NOTICE

Your Honda or other property can be damaged if you don't follow instructions.

This section gives you important information about occupant protection. It shows how to use seat belts properly. It explains the Supplemental Restraint System that is standard in most Civics. And it gives useful information about how to protect infants and children in your car.

Your Occupant Protection System	4	Storing Cargo Safely	17
The Seat Belt System and How It Works	5	Driving With Pets	17
Why Wear Seat Belts	5	Child Safety	18
Important Safety Reminders ..	5	Where Should Children Sit? .	18
Seat Belt System Components	6	Important Safety Reminders	19
Lap/Shoulder Belt	6	General Guidelines for Restraining Children Under 40 lbs. (18 kg)	19
Lap Belt	6	Restraining an Infant Who Weighs Less Than 20 lbs. (9 kg)	20
Wearing Seat Belts Properly ..	7	Restraining a Child Who Weighs Between 20 and 40 lbs. (9 and 18 kg)	20
Wearing a Lap/Shoulder Belt .	7	Restraining a Child Who Weighs Over 40 lbs. (18 kg)	21
Wearing the Lap Belt	9	Using a Seat Belt Locking Clip	22
Advice for Pregnant Women .	10	Using Child Restraints With Tethers	22
Seat Belt Maintenance	10	Storing a Child Seat	23
Supplemental Restraint System	11	Alcohol and Drugs	24
Important Safety Reminder .	12	Carbon Monoxide Hazard	25
How the Driver's Airbag Works	12	Reporting Safety Defects (U.S.Cars)	26
How the Passenger's Airbag Works	13	Safety Labels	27
How the SRS Indicator Light Works	14		
System Service	15		
System Service Precautions .	15		
Additional Safety Information .	16		
Seat-back Position	16		
Door Locks	16		

Your Occupant Protection System

Your Honda is equipped with seat belts and other features that work together to protect you and your passengers during a crash.

Seat belts are the most important part of your occupant protection system. When worn properly, seat belts can reduce the chance of serious injury or death in a crash.

For added protection during a severe frontal collision, all Civics sold in the U.S. and Canada have a Supplemental Restraint System (SRS) with a driver's airbag. The U.S. EX with option package also includes an airbag for the front-seat passenger.

Two indicator lights are also part of your safety system. One reminds you to make sure you and your passengers wear your seat belts. The other alerts you to a possible problem with your supplemental restraint system (see page 14).

The seats, head restraints, and door locks also play a role in occupant safety. For example, reclining the seat-back can decrease the effectiveness of your seat belt. Head restraints can help protect your neck and head, especially during rear-end impacts. Door locks help keep your doors from being accidentally opened during a crash.

To get the maximum protection from your occupant protection system, check the following before you drive away:

- Everyone in the car is wearing a seat belt properly (see page 7).
- Infants or small children are properly secured in a child safety seat (see page 18).
- Both doors are closed and locked (see page 16).
- Seat-backs are upright (see page 16).
- There are no loose items that could be thrown around and hurt someone during a crash or sudden stop (see page 17).

By following these guidelines, you can reduce injuries to yourself and your passengers in many crash situations. Remember, however, that no safety system can prevent all injuries or deaths that can occur in severe crashes.

Why Wear Seat Belts

Wearing seat belts, and wearing them properly, is fundamental to your safety and the safety of your passengers.

During a crash or emergency stop, seat belts can help keep you from being thrown against the inside of the car, against other occupants or out of the car.

Of course, seat belts cannot completely protect you in every crash. But, in most cases, seat belts reduce your chance of serious injury: They can even save your life. That is why many states and all Canadian provinces require you to wear seat belts.

Not wearing a seat belt increases the chance of being killed or seriously hurt in a crash.

Be sure you and your passengers always wear seat belts and wear them properly.

Important Safety Reminders

Seat belts are designed for adults and larger children. All infants and small children must be properly restrained in child safety seats (see page 18).

A pregnant woman needs to wear a seat belt to protect herself and her unborn child (see page 10).

Two people should never use the same seat belt. If they do, they could be very seriously injured in a crash.

Do not place the shoulder portion of a lap/shoulder belt under your arm or behind your back. This could increase the chance of serious injuries in a crash.

Do not put shoulder belt pads or other accessories on seat belts. They can reduce the effectiveness of the belts and increase the chance of injury.

The Seat Belt System and How It Works

Seat Belt System Components

Your Honda has seat belts in all five seating positions. The front seats and the outside positions of the rear seat have lap/shoulder belts. The center position of the rear seat has a lap belt. The center position of the rear seat has a lap belt.

Your seat belt system also includes a light on the instrument panel to remind you to fasten your seat belt and to make sure your passengers fasten theirs. This light comes on when you turn on the ignition if you have not fastened your seat belt. A beeper also sounds for several seconds (see page 32).

The following pages cover more about the seat belt components and how they work.

Lap/Shoulder Belt

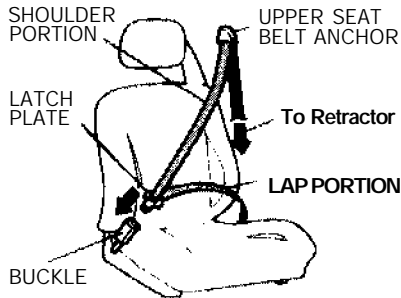

This style of seat belt has a single belt that goes over your shoulder, across your chest and across your hips.

Each lap/shoulder belt has an emergency locking retractor. In normal driving, the retractor lets you move freely in your seat while it keeps some tension on the belt. During a collision or sudden stop, the retractor automatically locks the belt to help restrain your body.

Lap Belt

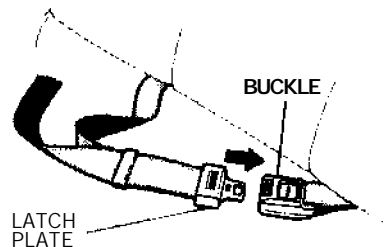

The lap belt has one manually-adjusted belt that fits across the hips. It is similar to safety belts used in airplanes.

Wearing Seat Belts Properly

You can increase the effectiveness of your seat belts if you take a little time to read the following pages and make sure you know how to wear seat belts properly.

Not wearing a seat belt properly increases the chance of serious injury or death in a crash.

Be sure you and your passengers always wear seat belts and wear them properly.

Wearing a Lap/Shoulder Belt



Before putting on a front seat belt, be sure your seat is adjusted forward or backward to a good driving or riding position and the back of your seat is upright (see page 51).

1. Pull the latch plate across your body, and insert it into the buckle. Tug on the belt to make sure the latch is securely locked.
2. Check to see that the belt is not twisted.



3. Position the lap portion of the belt as low as possible across your hips, not across your stomach. This lets your strong pelvic bones take the force of a crash.

continued

The Seat Belt System and How It Works



4. Pull up on the shoulder part of the belt to remove any slack. Make sure the belt goes over your collarbone and across your chest.

5. If the shoulder belt crosses your neck while you are sitting in one of the outside rear seating positions, you need to adjust your seating position. Move toward the center of the seat until the belt fits over your collarbone.

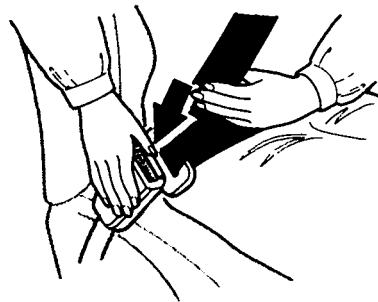

To unlatch the seat belt, push the red PRESS button on the buckle. Guide the belt across your body to the door pillar. If the belt doesn't retract easily, pull it out and check for twists or kinks.

Wearing the Lap Belt

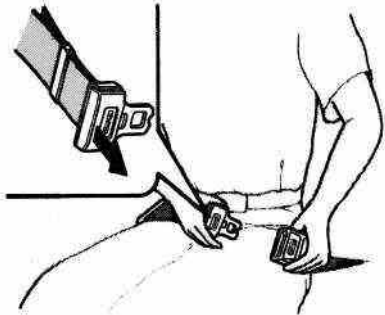

1. Pull the latch plate across your hips, and insert it into the buckle marked CENTER.

If the belt is too short, hold the latch plate at a right angle and pull to extend the belt. Insert the latch plate into the buckle.



2. Position the belt so it fits as low as possible across your hips and pelvic bones, not across your stomach. Pull the loose end of the belt to adjust for a snug but comfortable fit.

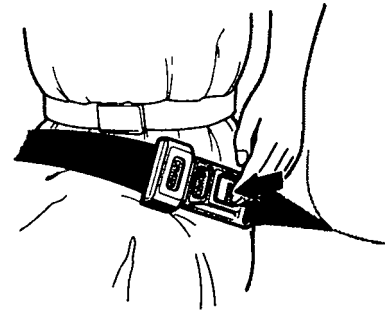

To unlatch the belt, push the red PRESS button on the buckle.

Advice for Pregnant Women

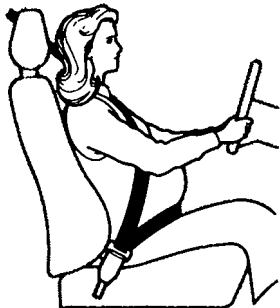

Protecting the mother is the best way to protect her unborn child. Therefore, a pregnant woman should wear a properly-positioned seat belt whenever she drives or rides in a car.

If possible, use the lap/shoulder seat belt, remembering to keep the lap portion as low as possible (see [page 7](#)).

Each time you have a check-up, ask your doctor if its okay for you to drive and how you should position a lap/shoulder seat belt.

Seat Belt Maintenance

For safety, you should check the condition of your seat belts regularly.

Pull out each belt fully and look for frays, cuts, burns and wear. Check to see that the latches work smoothly and the lap/shoulder belts retract easily. Any belt not in good condition or not working properly should be replaced.

If a seat belt is worn during a crash, have your dealer replace the belt and check the anchors for damage.

For information on how to clean your seat belts, see [page 151](#).

Your Civic is equipped with a Supplemental Restraint System (SRS) to help protect your head and chest during a severe frontal collision. *This system does not replace your seat belt.* It supplements, or adds to, the protection offered by your seat belt.

Not wearing a seat belt increases the chance of serious injury or death in a crash, even if you have airbags.

Be sure you and your passengers always wear seat belts and wear them properly.

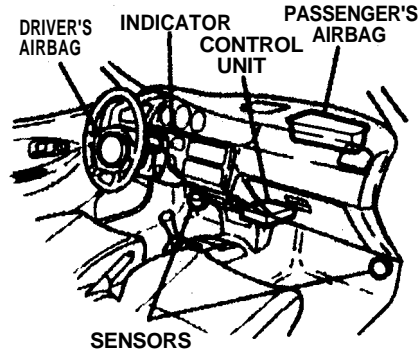

The main components in your SRS are:

- An airbag in the steering wheel for the driver and another in the dashboard for the front passenger (in the U.S. EX with option package model).

- A diagnostic system that, when the ignition is ON 00, continually monitors the sensors, control unit, airbag activator and all related wiring.
- An indicator light to warn you of a possible problem with the system.
- Emergency power backup in case your car's electrical system is disconnected in a crash.

FRONTAL COLLISION RANGE

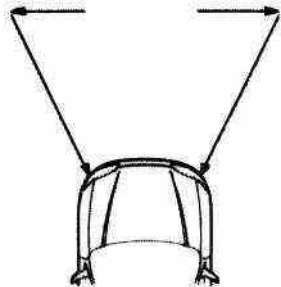

Important Safety Reminder

Even with an airbag, you need to wear a seat belt. The reasons are:

- Airbags only inflate in severe frontal collisions. They offer no protection in rear impacts, side impacts, rollovers or moderate frontal collisions.

- An airbag inflates and deflates very quickly. It cannot protect you during any additional impacts that can occur during a crash.
- A seat belt helps keep you in the proper position when an airbag inflates. An airbag opens with considerable force and can hurt you if you are not in the proper position.

How the Driver's Airbag Works

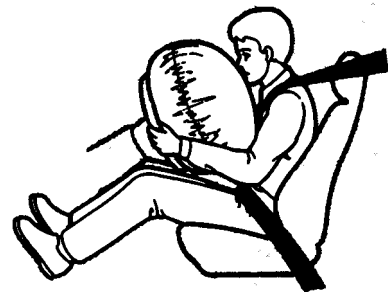

If you ever have a severe frontal collision, your airbag will instantly inflate to help protect your head and chest.

When the airbag inflates, you may hear a fairly loud noise and you might see smoke and powder. This is normal; it is caused by the inflation of the airbag.

To do its job, the airbag inflates with considerable force. So, while it can reduce serious injuries and even save your life, the airbag might cause some facial or other abrasions.

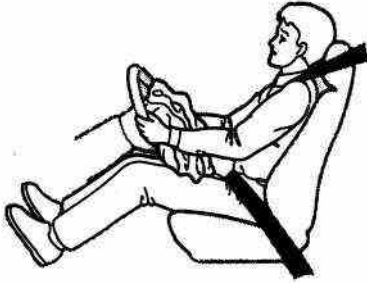

After the bag completely inflates, it immediately starts deflating so it won't interfere with your visibility, ability to steer or ability to operate other controls.

The airbag is stored in the center of the steering wheel. For safety, do not attach any items to the steering wheel. They could interfere with the proper operation of the airbag. Or, if the airbag inflates, the items could be propelled inside the car and hurt someone.

How the Passenger's Airbag Works



On the US. EX with option package model.

If you have a severe frontal collision, the passenger's airbag will inflate at the same time as the driver's airbag.

The airbag is quite large and inflates with considerable force. It can seriously hurt an adult who is not in the proper position and wearing the seat belt properly. The bag's force could also hurt a small child who is not properly restrained in a child seat.

Because of the airbag, we strongly recommend that you do not put an infant seat in the front passenger's seat. If the airbag inflates, it can dislodge the infant seat and seriously injure the infant.

The passenger's airbag is stored near the top of the dashboard, under a lid marked **SRS** (see page 11). Do not place any objects on top of this lid. If the airbag inflates, those objects can be propelled inside the car and possibly hurt someone.

SRS How the SRS Indicator Light Works

The purpose of the **SRS** light on your instrument panel is to alert you of a potential problem with your supplemental restraint system.

Have the system checked if:

- The light does not come on when you turn the ignition ON (II).
- The light stays on after the engine starts.
- The light comes on or flashes while you are driving.

System Service

Your supplemental restraint system is virtually maintenance-free. There are no parts you can safely service.

You must have the system serviced by an authorized Honda dealer:

- *If your airbag ever inflates.* The bag must be replaced. Do not try to remove or discard the airbag by yourself. This must be done by a Honda dealer.
- *If the SRS indicator light alerts you of a problem.* Have the supplemental restraint system checked as soon as possible. Otherwise, your airbag might not inflate when you need it.
- *When the car is 10 years old.* Have the dealer inspect the system. The production date is on the driver's doorjamb for your convenience.

System Service Precautions

Do not modify your steering wheel or any other part of the supplemental restraint system. Modifications could make the system ineffective.

Do not tamper with the system components or wiring. This could cause the airbag to inflate inadvertently, possibly injuring someone very seriously.

Tell anyone who works on your car that you have a supplemental restraint system. Failure to follow the procedures and precautions in the official Honda service manual could result in personal injury or damage to the system.

Scrapping an entire car that has uninflated airbags can be dangerous. Get assistance from a Honda dealer if your car must be scrapped.

If you sell your car, please be sure to tell the new owner that the car has a supplemental restraint system. Alert them to the information and precautions in this part of the Owner's Manual.

Additional Safety Information

The seat belts and airbags are obviously important parts of your occupant protection system.

In addition, you should know that sitting upright, locking the doors, and stowing things properly can also increase your safety and possibly even save your life.

Seat-back Position

The seat-backs should be in an upright position for you and your passengers to get the most protection from the seat belts.

If you recline a seat-back, you reduce the protective capability of your seat belt. The farther a seat-back is reclined, the greater the risk that you will slide under the belt in a severe crash and be very seriously injured.

For information on how to adjust the seat-back, see page [51](#).

Door Locks

It is not safe to leave your car doors unlocked. A passenger, especially a child, could open a door and accidentally fall out. Also, there is a greater chance of being thrown out of the car during a crash when the doors are not locked.

Storing Cargo Safely

Before you drive, make sure you first securely store or tie down any items that could be thrown around the car and hurt someone or interfere with your ability to operate the controls.

Do not put any items on top of the rear shelf. They can block your view and they could be thrown about the car in a crash.

Be sure to keep compartment doors closed when the car is moving. If a front passenger hits the door of an open glove box, for example, he could injure his knees.

Driving With Pets

Loose pets can be a hazard while you are driving. An unrestrained pet can interfere with your ability to drive the car. In a crash or sudden stop, loose pets or cages can be thrown around inside the car and hurt you or your passengers. It is also for their safety that pets should be properly restrained in your car.

The recommended way to restrain a medium-sized or larger dog is with a special traveling harness. This harness can be secured to the rear seat with a seat belt. Travel harnesses are available at pet stores.

A small dog, cat, or other small animal will be safest in a pet carrier with rigid sides. Choose a style that allows you to secure it to the car's seat by routing a seat belt through the carrier's handle.

For further information, contact your veterinarian or local animal protection society.

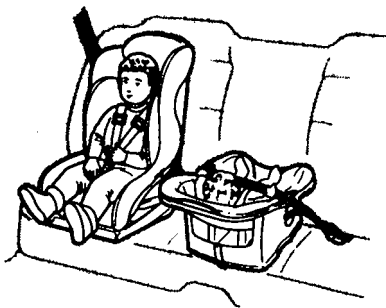

Children depend on adults to protect them. To help make sure we do, every state and Canadian province has laws requiring infants and young children to be properly restrained whenever they ride in a car.

An Infant or child who is not properly restrained can be killed or seriously injured in a crash.

Be sure any child too small for seat belts is properly secured in a child restraint.

Where Should Children Sit?

According to accident statistics, children of all sizes and ages are safer when they are properly restrained in the rear seat rather than the front seat.

We recommend that, whenever possible, you secure your child's infant or toddler seat in the center position of the rear seat with the lap belt.

For cars with passenger airbags, we strongly recommend that you do not put an infant seat in the front passenger seat. If the airbag inflates, it can hit the seat with great force. The infant seat can be dislodged and the baby seriously injured.

We also recommend that any child who is too large to use an infant or toddler seat ride in one of the outside positions of the rear seat. The child should then wear the lap/shoulder belt properly for protection.

Important Safety Reminders

Never hold a baby or child on your lap when riding in a car. If you are wearing your seat belt, the violent forces created during a crash will tear the child from your arms. The child could be seriously hurt or killed.

If you are holding a child and not wearing a seat belt in a crash, you could crush the child against the car's interior.

Never put your seat belt over yourself and a child. During a crash, the belt could press deep into the child causing serious internal injuries.

Two children should never use the same seat belt. If they do, they could be very seriously injured in a crash.

General Guidelines for Restraining Children Under 40 lbs. (18kg)

Use an approved child seat. The seat must meet Federal Motor Vehicle Safety Standard 213 (FMVSS-213) or Canadian Motor Vehicle Safety Standards. Look for the manufacturer's statement of compliance on the box and seat.

Use a seat of the right size. Make sure the seat fits your child. Check the seat's instructions and labels for height and weight limits.

Secure the child seat to the car. All approved child seats are designed to be secured in the car seat by the lap belt or the lap belt portion of a lap/shoulder belt. A child whose seat is not properly secured to the car can be endangered in a crash.

To properly route a seat belt through a child seat, follow the seat-maker's instructions. If you use a lap/shoulder belt, be sure you install a locking clip on the belt (see page 22).

Secure the child in the child seat. Make sure the infant or child is firmly secured to the child seat. Use the straps provided, and carefully follow the manufacturer's instructions.

Restraining an Infant Who Weighs Less Than 20 lbs. (9 kg)



An infant up to about 20 lbs. (9 kg) must be restrained in an infant seat or a convertible seat designed for a baby. Because infants of that size must ride in a reclining position, be sure the infant seat always faces the REAR of the car as shown.

We recommend that, whenever possible, you put the infant seat in the center position of the rear seat and secure it to the car with the lap belt.

Special precaution for U.S. EX with option package model.

We strongly recommend that you do not put an infant seat in the front passenger's seat. In a severe frontal collision, the inflating airbag can hit the infant seat with considerable force. The infant seat can be dislodged, causing serious injury to the infant.

If you decide to put an infant seat in an outside position of the rear seat, you must use a locking clip on the car's lap/shoulder belt (see page 22).

Restraining a Child Who Weighs Between 20 and 40 lbs. (9 and 18 kg)



Toddler seats are designed for children who weigh between 20 and 40 lbs. (9 and 18 kg).

continued

The preferred place to put a toddler seat is in the center position of the rear seat. Use the car's lap belt to secure the seat to the car.

If you decide to put a toddler seat in an outside position of the rear seat, you must use a locking clip on the car's lap/shoulder belt (see page [22](#)).

Restraining a Child Who Weighs Over 40 lbs. (18 kg)

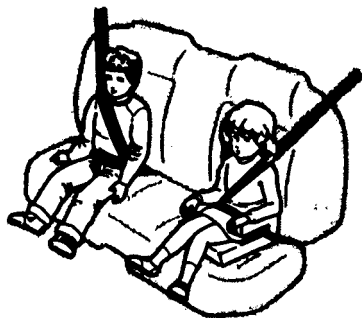

We recommend that, whenever possible, a child who has outgrown a toddler seat ride in one of the outside positions of the rear seat and use a lap/shoulder belt.

Put the lap/shoulder belt on your child and check its fit. The shoulder belt should fit over the collarbone and across the chest. The lap belt should sit low on your child's hips, not across the stomach.

If the shoulder belt crosses the neck, have your child move toward the center of the rear seat until the belt fits properly. If the belt still crosses the child's neck, you should use a booster seat.

Several styles of booster seats are available. We recommend a design that allows the child to use the car's lap/shoulder belt.

Whichever style you select, follow the booster seat manufacturer's instructions.

Using a Seat Belt Locking Clip

Always use a seat belt locking clip when you secure a child seat to your car with a lap/shoulder belt. This helps prevent the seat from shifting position or overturning.

A locking clip is usually included with the child seat. If you need a clip, contact the seat's manufacturer or a store that sells child restraints.

To install a locking clip, do the following:

1. Place the child restraint in the desired position. Route the lap/shoulder belt through the restraint according to the seat manufacturer's instructions.
2. Insert the latch plate into the buckle. Pull on the shoulder part of the belt to make sure there is no slack in the lap portion.

3. Tightly grasp the belt near the latch plate. Pinch both parts of the belt together so they won't slip through the latch plate. Unbuckle the seat belt.

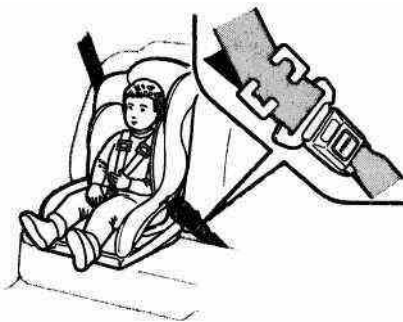

4. Install the locking clip as shown. Position the clip as close as possible to the latch plate.
5. Insert the latch plate into the buckle. Push and pull on the child seat to verify that it is held firmly in place. If it is not,

repeat these steps until the restraint is secure.

Using Child Restraints with Tethers

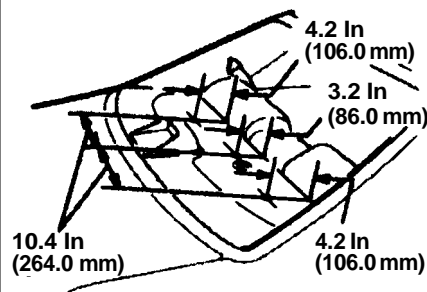

Your Honda has three attachment points for tether-style child seats. Use the dimensions in the above illustration to locate the attachment point you want to use. Cut a 1/2 inch (12.7 mm) diameter

hole in the rear shelf, then install the tether hardware that came with the child seat.

Tighten the bolt to:
16 lb-ft (2.2 kg-m, 22 N.m)

If you are not sure how to install the bracket, have it installed by your authorized Honda dealer.

If you need an anchor plate and mounting hardware, you can obtain them by writing to:

American Honda Motor Co., Inc.
Consumer Affairs
1919 Torrance Blvd.
Torrance, CA 90501-2746

Canadian Cars

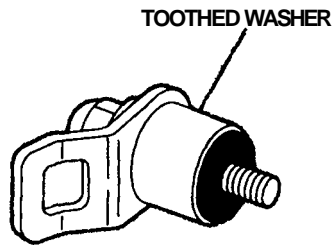

The anchor plate and mounting hardware for a top tether are supplied with the car. When installing, make sure the toothed washer is on the bottom of the bolt.

The supplied anchor plate is designed only for mounting a child restraint. Do not use it for any other purpose.

Storing a Child Seat

When you are not using an infant seat or other child restraint, either remove it or make sure it is properly secured so it cannot be thrown around the car during a crash.

Alcohol and Drugs

Driving a car requires your full attention and alertness. Traffic conditions change rapidly. You must be able to react just as rapidly. Alcohol or drugs directly affect your alertness and ability to react. Even prescription and non-prescription medicines can have this effect.

There are laws that deal with drunken driving. These laws define how much alcohol it takes in your system to be legally "drunk." However, your judgment and reaction time get worse with every drink - even the first one.

The safest thing you can do is never drink and drive. This can be done if you plan ahead. If you know you are going to be drinking, make plans to ride with a friend who will not be drinking.

What if you find that you've been drinking and cannot get a ride from a friend? Find alternative transportation. Call a taxi. Take a bus. Many communities have transportation services devoted to shuttling people who have been drinking.

If you have no choice but to drive, stop drinking and give yourself lots of time to sober up. Time is the only thing that can make you sober. Things like coffee or a cold shower don't speed up the process.

If you see friends trying to get behind the wheel after drinking, stop them. Drive them yourself or arrange other transportation. If you think you are interfering, remember that your interference will keep them from sharing the road with you.

Your car's exhaust contains carbon monoxide gas. You should have no problem with carbon monoxide entering the car in normal driving if you maintain your car properly. Have the exhaust system inspected for leaks whenever:

- The car is raised for an oil change.
- You notice a change in the sound of the exhaust.
- The car was in an accident that may have damaged the underside.



Carbon monoxide gas is toxic. Breathing it can cause unconsciousness and can even kill you.

Avoid any enclosed areas or activities that expose you to carbon monoxide.

High levels of carbon monoxide can collect rapidly in enclosed areas, such as a garage. Do not run the engine with the garage door closed. Even with the door open, run the engine only long enough to move the car out of the garage.

With the trunk lid open, air flow can pull exhaust gas into the trunk. This can get into your car's interior and create a hazardous condition. If you must drive with the trunk lid open, open all the windows and set the heating and cooling system as shown below.

If you must sit in your parked car, even in an unconfined area, with the engine running, adjust the heating and cooling system as follows:

1. Push the  button.
2. Select the  mode.
3. Turn the fan on high speed.
4. Set the temperature control to a comfortable setting.

Reporting Safety Defects (U.S. Cars)

If you believe that your vehicle has a defect that could cause a crash or could cause injury or death, you should immediately inform the National Highway Traffic Safety Administration (NHTSA) in addition to notifying American Honda Motor Co., Inc.

If NHTSA receives similar complaints, it may open an investigation, and if it finds that a safety defect exists in a group of vehicles, it may order a recall and remedy campaign. However, NHTSA cannot become involved in individual problems between you, your dealer, or American Honda Motor Co., Inc.

To contact NHTSA, you may either call the Auto Safety Hotline toll-free at (800) 424-9393 (or (202) 366-0123 in Washington D.C. area) or write to: NHTSA, U.S. Department of Transportation, Washington, D.C. 20590. You can also obtain other information about motor vehicle safety from the Hotline.

These labels are in the locations shown. They warn you of potential hazards that could cause serious injury. Read these labels carefully and don't remove them.

If a label comes off or becomes hard to read, contact your Honda dealer for a replacement.

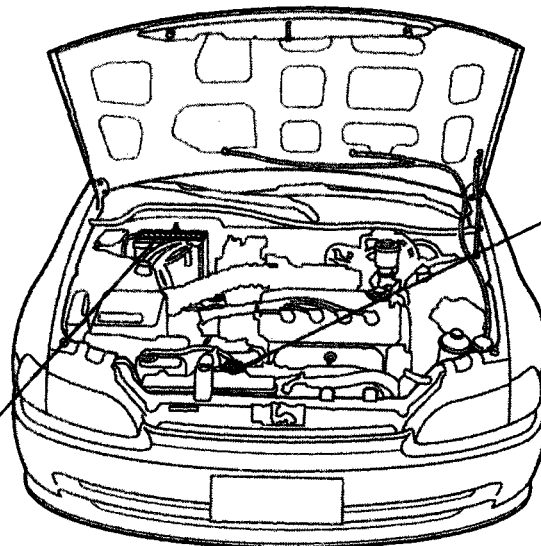

⚠ DANGER	
EXPLOSIVE GASES	Evacuate. Flame and electrical arcs. Provide adequate ventilation when charging or using batteries in an enclosed space.
CHEMICAL HAZARD	Contains sulfuric acid. Contact with skin, even through clothing, may cause severe burns. Wear a face shield and protective clothing. If electrolyte gets into your eyes, irrigate; flush thoroughly with water for at least 15 minutes and seek a physician immediately.
POISON	Batteries: EXTERNAL: Flush with water. INTERNAL: Drink large quantities of water to flush them; follow with milk or vegetable oil. KEEP OUT OF REACH OF CHILDREN
DISTR BY AMERICAN HONDA MOTOR CO. INC. GARDENA CA 90247	

This section gives information about the controls and displays that contribute to the daily operation of your Honda. All the essential controls are within easy reach.

Control Locations	30	Keys and Locks	47
Indicator Lights	31	Keys	47
Gauges	36	Ignition Switch	48
Speedometer	36	Door Locks	49
Tachometer	36	Power Door Locks	49
Odometer	36	Trunk	50
Trip Meter	36	Seat Adjustments	51
Fuel Gauge	37	Front Seat	51
Temperature Gauge	37	Folding Rear Seat	52
Controls Near the		Power Windows	53
Steering Wheel	38	Moonroof	54
Headlights	39	Sunshade	55
Daytime Running Lights	39	Mirrors	55
Instrument Panel Brightness	40	Parking Brake	57
Turn Signals	40	Glove Box	57
Windshield Wipers	41	Digital Clock	58
Windshield Washers	41	Beverage Holder	59
Hazard Warning	42	Vanity Mirror	59
Rear Window Defogger	42	Cigarette Lighter	60
Steering Wheel Adjustment .	43	Ashtrays	60
Steering Wheel Controls	44	Interior Light	61
Cruise Control	44		
Horn	47		

Control Locations

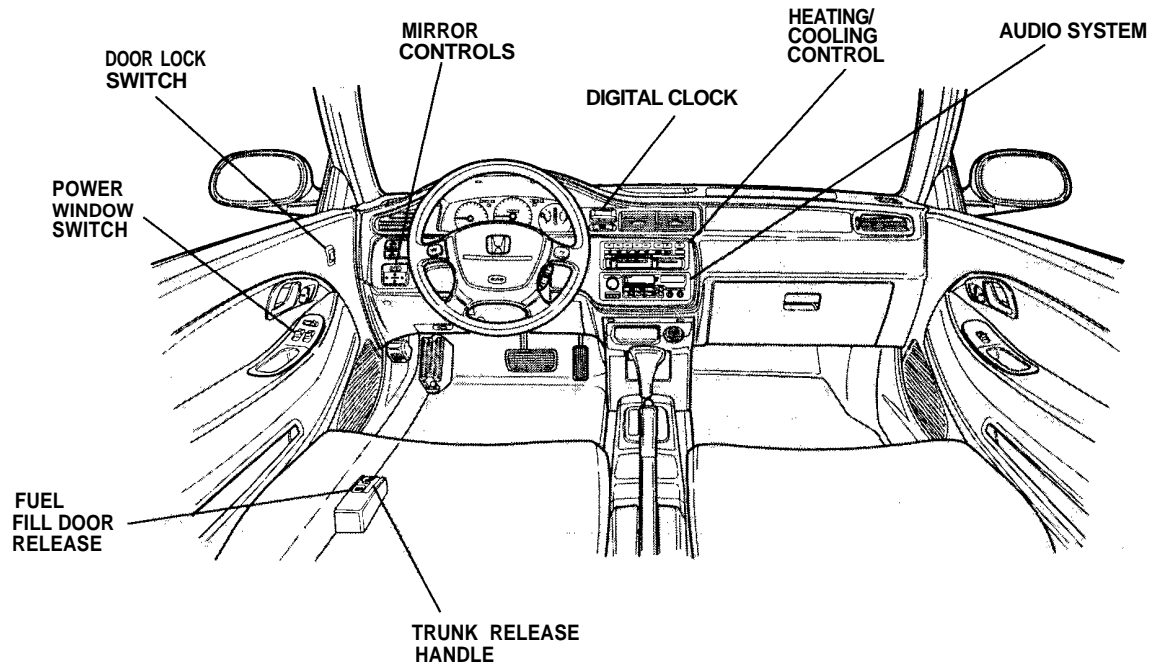

The instrument panel has many indicators to give you important information about your car.

Lamp Check

Many of the indicator lights come on when you turn the ignition switch ON (II), allowing you to see that they are working. The instrument panel should look like the illustration. If an indicator does not light during this test, it cannot alert you if that system develops a problem. Have the dealer check your car for burned-out bulbs or other problems.

* The U.S. instrument panel is shown. Differences for the Canadian model are noted in the text.

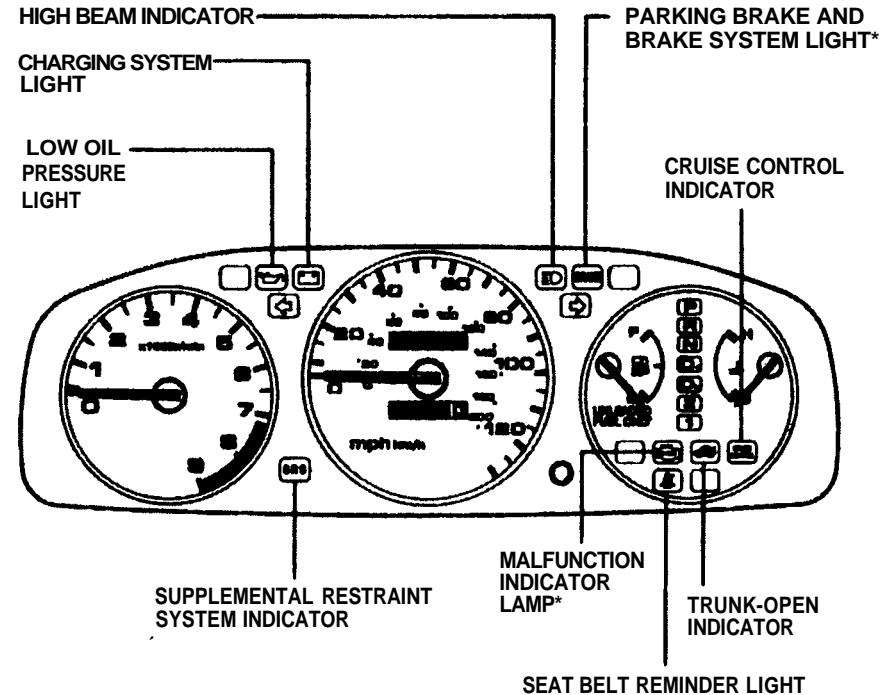

Automatic Transmission Shown

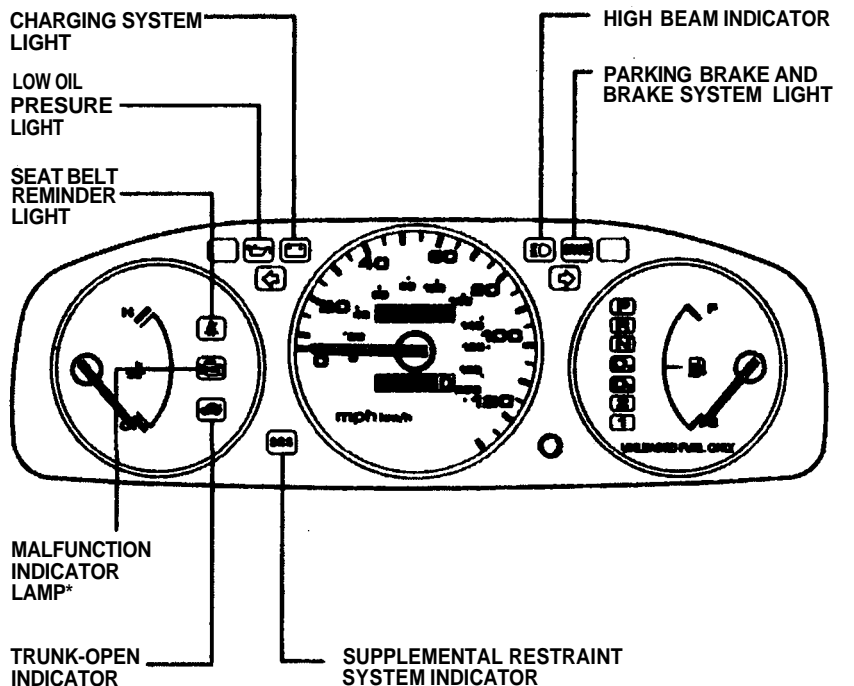

Automatic Transmission Shown



Seat Belt Reminder Light

This indicator lights when you turn the ignition ON (II). It is a reminder to you and your passengers to protect yourselves by fastening the seat belts. A beeper also sounds if you have not fastened your seat belt.

If you do not fasten your seat belt, the beeper will stop after a few seconds but the light stays on until you do. Both the light and the beeper stay off if you fasten your seat belt before turning on the ignition.

* The U.S. instrument panel is shown. Differences for the Canadian model are noted in the text.



Charging System Light

This light indicates the battery is not being charged. It should come on when the ignition is ON (II), and go out after the engine starts. If this light comes on while driving, the battery is not being charged. Turn to page [168](#) for information about what to do.



Low Oil Pressure light

This indicator lights when the oil pressure in the engine drops low enough to cause damage. It should light when the ignition is ON (II) and go out after the engine starts. If this light comes on when the engine is running, there is a possibility of serious engine damage. Safely pull to the side of the road and shut off the engine as soon as you can. Turn to page [167](#) for instructions and precautions on checking the engine.

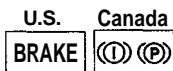

Parking Brake and Brake System Light

This light has two functions:

1. It lights as a reminder that you have set the parking brake. Driving with the parking brake set can damage the brakes and tires.
2. It can indicate the brake fluid level is low if it remains lit after you release the parking brake or comes on while driving. This is normally due to worn brake pads. Have your dealer check the braking system for worn pads or fluid leaks.

SRS

Supplemental Restraint System Indicator

The SRS light normally comes on for a few seconds when you turn the ignition ON (II). If it doesn't, or it stays on after the engine starts, something is wrong with the Supplemental Restraint System. It may also flash on and off to indicate a problem.

If you see any of these indications, the airbag may not work when needed in an accident. Take the car to your dealer promptly for diagnosis and service.



U.S.: Malfunction Indicator Lamp



Canada: Check Engine Light

This light comes on for a few seconds when you turn the ignition switch ON (II). If it comes on at any other time, it indicates one of the engine's emission control systems may have a problem. Turn to page [169](#) for information about what to do.



Trunk-open Indicator

This light comes on if the trunk lid is not closed tightly.



Turn Signal and Hazard Warning Indicators

The left or right turn signal light blinks when you signal a lane change or turn. If the light does not blink or blinks rapidly, it usually means one of the turn signal bulbs is burned out (see page [141](#)). Replace it as soon as possible, since other drivers cannot see that you are signaling.

When you turn on the Hazard Warning switch, both turn signal lights blink. All turn signals on the outside of the car should flash.



High Beam Indicator

This light comes on with the high beam headlights. See page [39](#) for information on the headlight controls.



Cruise Control Indicator

Only on cars equipped with cruise control system.

This lights when you set the cruise control. See page [44](#) for information on operating the cruise control.

Shift Lever Position Indicator (Automatic Transmission only)

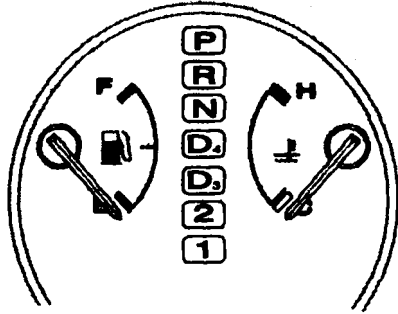

This indicator shows which shift position the lever is in.

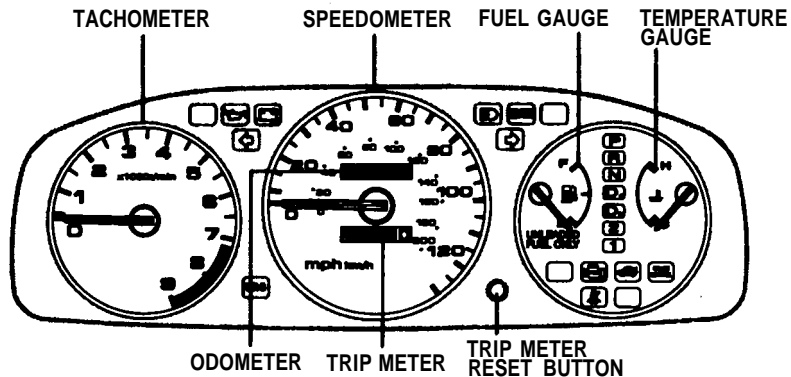

Automate Transmission Shown

Speedometer

U.S. Models

This shows your speed in miles per hour. The smaller inner numbers are the speed in kilometers per hour.

Canadian Models

This shows your speed in kilometers per hour. The smaller inner numbers are the speed in miles per hour.

Tachometer

On EX and EX with option package in U.S., and Si model in Canada.

The tachometer shows the engine speed in revolutions per minute (rpm). To protect the engine from damage, never drive with the tachometer needle in the red zone.

Odometer

The odometer shows the total distance your car has been driven. It measures miles in U.S. models and kilometers in Canadian models. It is illegal under federal law (in the U.S.) and provincial regulations (in Canada) to alter the odometer with the intent to change the number of miles or kilometers indicated.

Trip Meter

This meter shows the number of miles (U.S.) or kilometers (Canada) driven since you last reset it. To reset it, push the trip meter reset button.

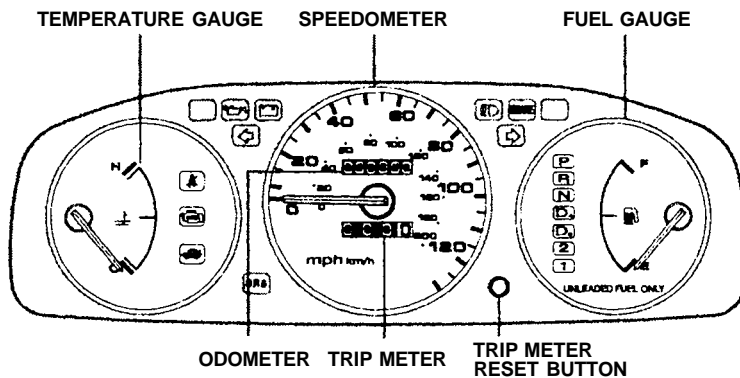

Automatic Transmission Shown

Fuel Gauge

This shows how much fuel you have. It is most accurate when the car is on level ground. It may show slightly more or less than the actual amount when you are driving on curvy or hilly roads.

The gauge stays at the same fuel level reading after you turn off the ignition. When you add fuel, the gauge slowly changes to the new reading after you turn the ignition back ON (II).

Temperature Gauge

This shows the temperature of the engine's coolant. During normal operation, the pointer should rise from the bottom white mark to about the middle of the gauge. In severe driving conditions, such as very hot weather or a long period of uphill driving, the pointer may rise to the upper white mark. If it reaches the red (Hot) mark, pull safely to the side of the road. Turn to page [165](#) for instructions and precautions on checking the engine's cooling system.

Controls Near the Steering Wheel

The two levers on the steering column contain controls for driving features you use most often. The left lever controls the turn signals, headlights, and high beams. The right lever controls the windshield wipers.

The rear window defogger switch is on the dashboard to the right of the steering column.

The controls under the left air vent are for the moonroof, mirrors, cruise control and instrument panel brightness.

The lever on the underside of the steering column allows you to tilt the steering wheel.

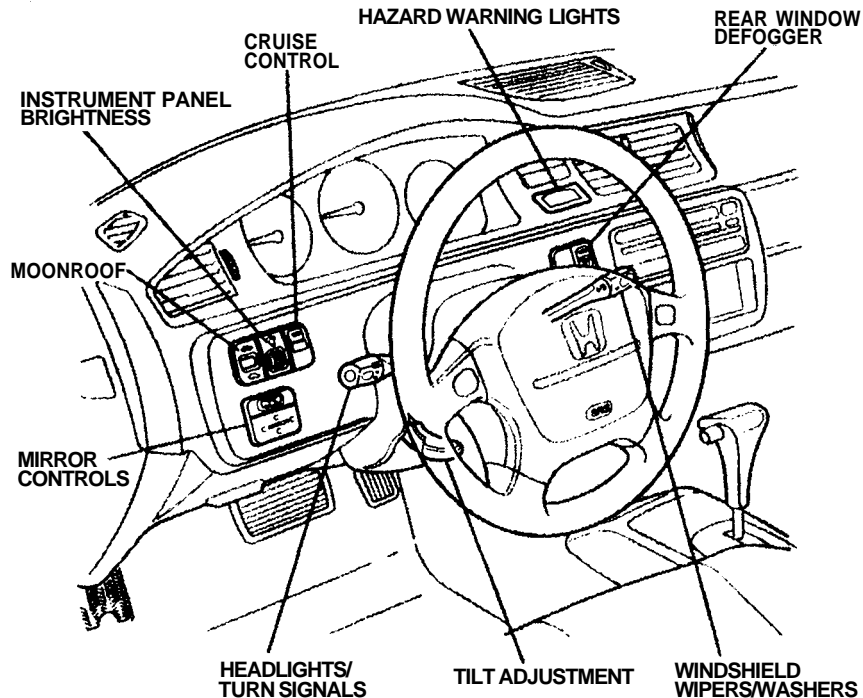

Headlights

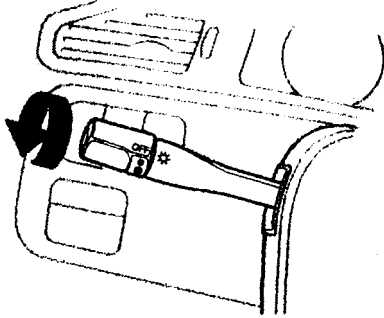

The rotating switch on the left lever controls the lights. Turning this switch to the first position "●" turns on the parking lights, tail lights, instrument panel lights, side-marker lights, and rear license plate lights. Turning the switch to the second position "●" turns on the headlights.

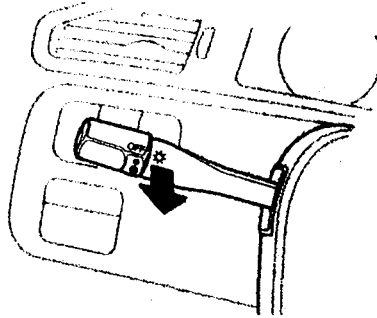

To change between low beams and high beams, pull the turn signal lever toward you until you hear a click, then let go. The high beam indicator will light (see page 34).

To flash the high beams, pull back and hold the turn signal lever. Release the lever and the high beams will go off.

The high beams will stay on for as long as you hold the lever, no matter what position the headlight switch is in.

Daytime Running Lights

Canadian Models

With the headlight switch off, the high beam headlights come on with reduced brightness when you turn the ignition switch to ON (II) and release the parking brake. They remain on until you turn the ignition off, even if you set the parking brake.

The headlights revert to normal operation when you turn them on with the switch.

Controls Near the Steering Wheel

Instrument Panel Brightness

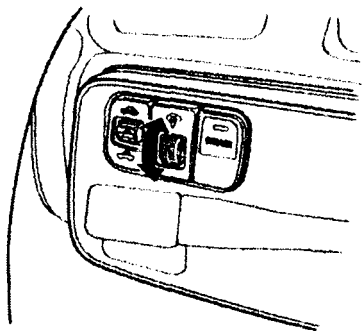

The dial on the dashboard to the left of the instrument panel controls the brightness of the instrument panel lights. Turn the dial to adjust the brightness.

Turn Signals

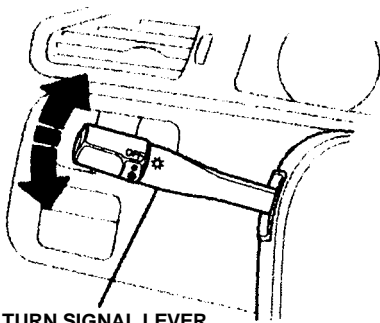

TURN SIGNAL LEVER

Signal a turn or lane change with this lever. Push down on the lever to signal a left turn, and up to signal a right turn. If you push it up or down all the way, the turn signal continues to blink even when you release the lever. It shuts off automatically as you complete the turn.

To signal a lane change, push lightly on the turn signal lever in the proper direction and hold it. The lever will return to the center position as soon as you release it.

Windshield Wipers

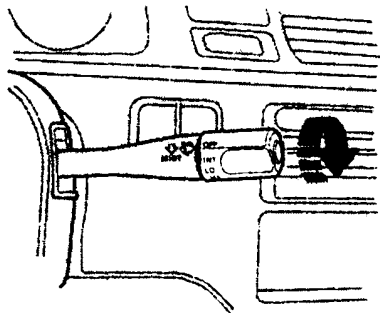

The right lever controls the windshield wipers and washers. The rotary switch at the end of the lever has three positions:
INT— intermittent
LO — low speed
HI — high speed

In intermittent, the wipers operate every few seconds. In low speed and high speed, the wipers run continuously.

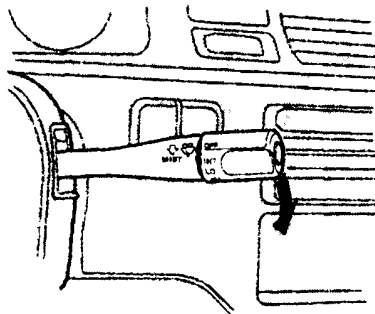

To operate the wipers in mist mode, push the control lever down. The wipers run at high speed until you release the lever. This gives you a quick way to clear the windshield.

Windshield Washers

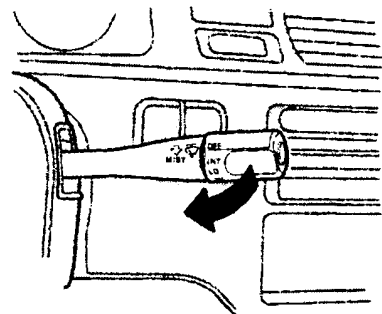

U.S. Models

To clean the windshield, pull the wiper control lever toward you. The washers spray until you release the lever.

Canadian Models

The wipers run at low speed while you're pulling the lever, then complete one more sweep of the windshield after you release it.

Controls Near the Steering Wheel

Hazard Warning

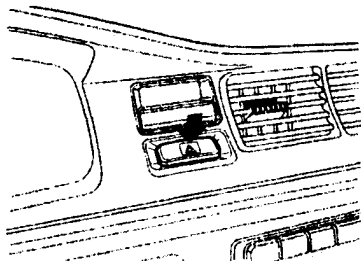

Push the red button under the clock to turn on the hazard warning lights (four-way flashers). This causes all four outside turn signals and both indicators in the instrument panel to flash. Use the hazard warning lights if you need to park in a dangerous area near heavy traffic, or if your car is disabled.

Rear Window Defogger

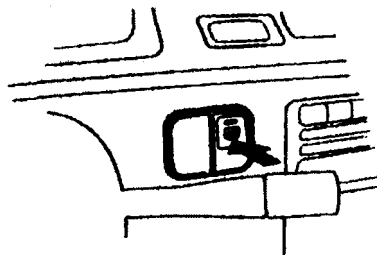

The rear window defogger will clear fog, frost, and thin ice from the window. Push the defogger button to turn it on and off. The light in the button lights to show the defogger is on. If you do not turn it off, the defogger will shut itself off after about 25 minutes. It also shuts off when you turn off the ignition. You have to turn it on again when you restart the car.

Make sure the rear window is clear and you have good visibility before starting to drive.

The defogger wires on the inside of the rear window can be accidentally damaged. When cleaning the glass, always wipe side to side.

Steering Wheel Adjustment

You can adjust the steering wheel height to suit your preference. Do this before you begin driving.

Adjusting the steering wheel position while driving may cause you to lose control of the car and be seriously injured in a crash.

Adjust the steering wheel when the car is stopped.

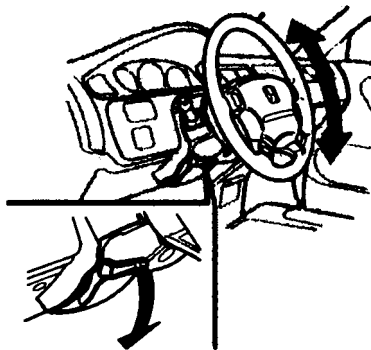

1. Adjust the seat so you are a comfortable distance from the pedals.
2. The lever to tilt the steering wheel is under the steering column to the left. Push this lever all the way down.
3. Move the steering wheel up or down to the desired position. Position the wheel so you can see all the instrument panel gauges and warning lights. Push the lever up to lock the steering wheel in that position.
4. Make sure you have securely locked the steering wheel in place by trying to move it up and down.

Cruise Control

Available only on EX and EX with option package in the U.S., and Si model in Canada.

Cruise control allows you to maintain a set speed above 25 mph (40 km/h) without keeping your foot on the accelerator pedal. It is for cruising on straight, open highways. It is not recommended for conditions such as city driving, winding roads, slippery roads, heavy rain, or bad weather. You should have full control of the car under those conditions.

Improper use of the cruise control can lead to a crash.

Use the cruise control only when traveling on open highways in good weather.

NOTICE

The cruise control, as it operates, moves the accelerator pedal. You can damage your car's accelerator mechanism by resting your foot under the pedal and blocking the movement.

Using the Cruise Control

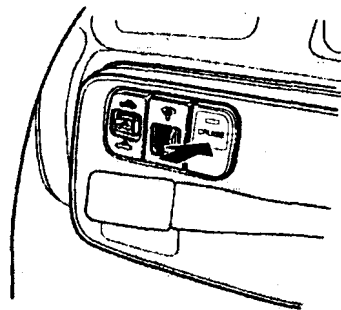

1. Push in the Cruise Control Master Switch to the left of the steering column. The indicator in the switch will light.
2. Accelerate to the desired cruising speed above 25 mph (40 km/h).

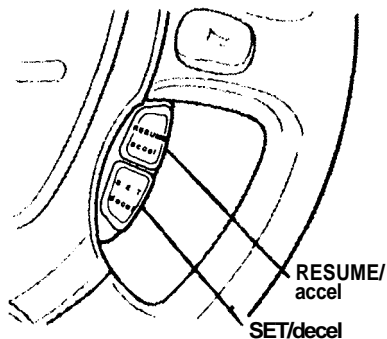

3. Press and hold the SET/decel button on the steering wheel until the CRUISE CONTROL light on the instrument panel comes on. This shows the system is now activated.

The set speed may vary slightly, particularly on hills.

Changing the Set Speed

You can increase the set cruising speed in either of two ways:

- Press and hold the RESUME/accel button. The car will accelerate slowly. When you reach the desired cruising speed, release the button.
- Push on the accelerator pedal. Accelerate to the desired cruising speed and press the SET/decel button.

You can decrease the set cruising speed in either of two ways:

- Press and hold the SET/decel button. The car will decelerate. Release the button when you reach the desired speed.

- Tap the brake or clutch pedal lightly with your foot. The CRUISE CONTROL light on the instrument panel will go out. When the car slows to the desired speed, press the SET/decel button. The car will then maintain the desired speed.

Even with the cruise control turned on, you can still use the accelerator pedal to speed up for passing. After completing the pass, take your foot off the accelerator pedal. The car will return to the set cruising speed.

Resting your foot on the brake or clutch pedal will cause the cruise control to cancel.

Steering Wheel Controls

Canceling the Cruise Control

Any of these actions cause the cruise control to cancel.

- Tap the brake or clutch pedal.
- Press the SET/decel and RESUME/accel buttons at the same time.
- Press the Cruise Control Master Switch

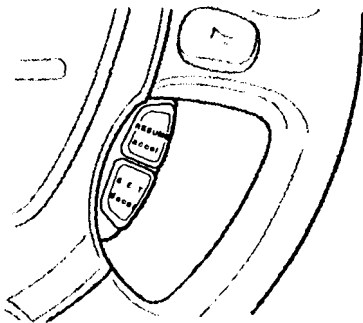

When you tap the brake or clutch pedal, or press the SET and RESUME buttons at the same time, the CRUISE CONTROL light on the instrument panel will go out and the car will begin to slow down. You can use the accelerator pedal in the normal way.

If you use the brake or clutch pedal to cancel cruise control, the system retains the previously-set cruising speed. To return to that speed, accelerate to above 25 mph (40 km/h) and press the RESUME/accel button until the CRUISE CONTROL light comes on. The car will accelerate to the same cruising speed as before.

If you cancel CRUISE CONTROL by pressing the SET and RESUME BUTTONS at the same time, the previously-set cruising speed is erased. To use the cruise control, accelerate to the desired cruising speed and press the SET/decel button.

Pressing the Cruise Control Master Switch turns the system completely off and erases the previous cruising speed from memory. To use the system again, refer to ***Using the Cruise Control.***

Horn

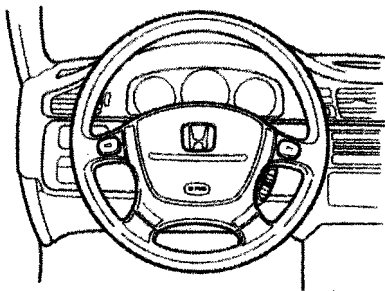

Press either of the buttons on the steering wheel spokes to sound the horn.

Keys

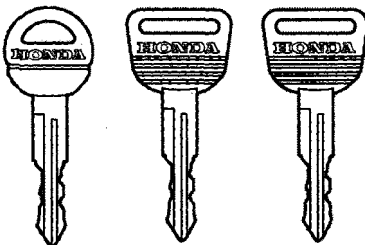

VALET KEY

MASTER KEYS

Your car comes with two kinds of keys: a master key and a valet key. The master key fits all locks on your car.

- Ignition
- Doors
- Trunk
- Trunk release handle
- Rear seat trunk access

The valet key only works the ignition and the door locks. You can keep the trunk, trunk release handle and rear seat trunk access locked when you leave your car and valet key at a parking facility. (See Trunk, page 50.)

Each key has a number stamped on a separate plate that comes with your key. You will need this number if you have to get a lost key replaced. Record this number and keep the plate in a safe place.

Ignition Switch

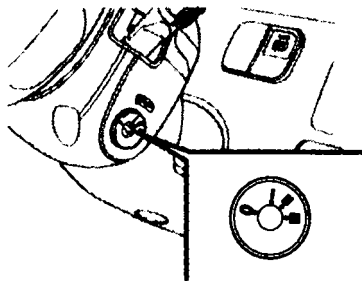

The ignition switch is on the right side of the steering column. It has four positions:

- LOCK (0)
- ACCESSORY (I)
- ON (II)
- START (III)

LOCK (0) — You can insert or remove the key only in this position. When you turn the key from LOCK to ACCESSORY, you may have to turn the steering wheel to release the anti-theft lock. To switch from ACCESSORY to LOCK, you must push the key in slightly as you turn it. If your car has an automatic transmission, it must also be in Park. The anti-theft lock will lock the steering column when you remove the key.

Removing the key from the ignition switch while driving locks the steering. This can cause you to lose control.

Remove the key from the ignition switch only when parked.

ACCESSORY (I) — In this position, you can operate the audio system and cigarette lighter.

ON (II) — This is the normal key position when driving. All features and accessories on the car are usable. Several of the lights on the instrument panel come on as a test when you turn the ignition switch from ACCESSORY to ON (see page 31).

START (III) — Use this position only to start the engine. The switch returns to ON when you let go of the key.

You will hear a reminder beeper if you open either front door with the key in the LOCK or ACCESSORY position. Remove the key to turn it off.

Door Locks

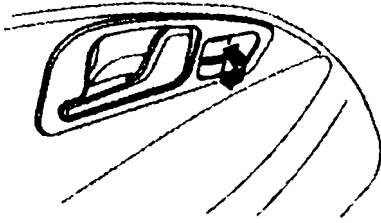

Each door has a lock tab next to the inside door handle. Push the tab forward to lock the door and pull it backward to unlock.

To lock the passenger's door when getting out of the car, push the lock tab forward and close the door. To lock the driver's door, pull the outside door handle and push the lock tab forward. Release the handle then close the door.

Power Door Locks

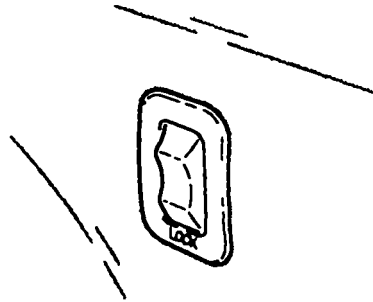

Available on on EX and EX with option package models in the U.S.

This allows control of both door locks from the driver's door. Push the master door lock switch down to lock both doors, and up to unlock them.

Both doors lock when you push the lock tab on the driver's door. Only the driver's door unlocks when you use the key or lock tab. To unlock the passenger's door, use the master door lock switch or the lock tab on each door.

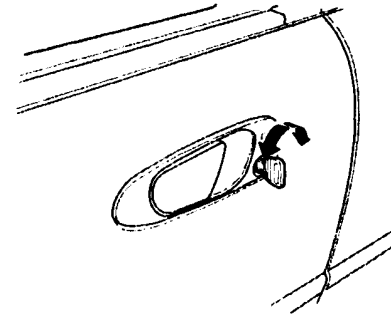

The doors can also be locked and unlocked from the outside with the key.

Trunk

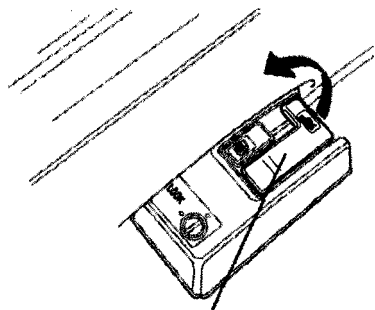

TRUNK RELEASE HANDLE

You can open the trunk in two ways:

- Pull the trunk release handle to the left of the driver's seat.
- Use the master key to open the trunk lock. The valet key does not work in this lock.

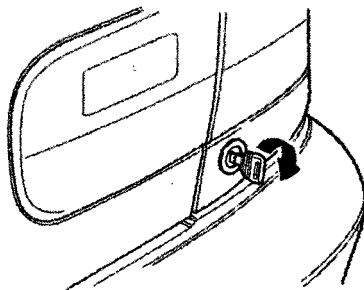

To close the trunk, press down on the trunk lid.

See page [88](#) for cargo loading and weight-limit information. Keep the trunk lid closed at all times while driving to avoid damaging the lid and getting exhaust gas in the interior. See Carbon Monoxide Hazard on page [25](#).

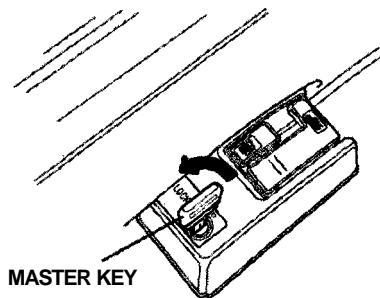

MASTER KEY

To protect items in the trunk when you need to give the key to someone else, lock the trunk release handle with the master key and give the other person the valet key.

Adjust the seat before you start driving.

Front Seat Adjustments

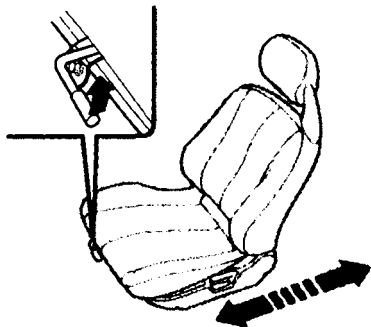

To adjust the seat forward and backward, pull up on the lever under the seat cushion's front edge. Move the seat to the desired position and release the lever. Try to move the seat to make sure it is locked in position.

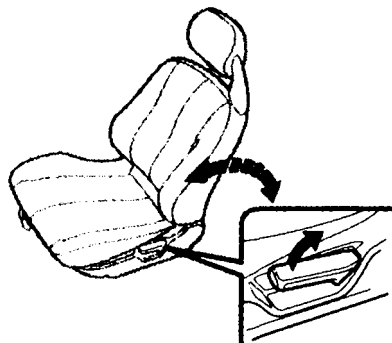

To change the angle of the seat-back, pull up on the lever on the outside of the seat bottom. Move the seat-back to the desired-position and release the lever. Let the seat-back latch in the new position.

Reclining the seat-back can decrease the protection you get from your seat belt in a crash.

You can slide under the seat belt and be seriously injured.

Adjust the seat-back to an upright position and sit well back in the seat.

Folding Rear Seat

Folding Rear Seat

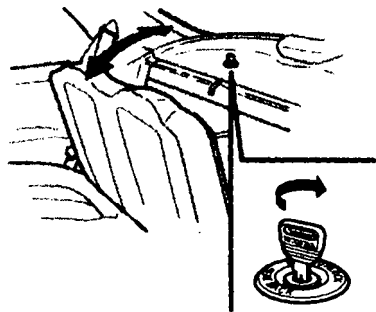

The back of the rear seat folds down, giving you direct access to the trunk. The seat-back can be released from inside the car or inside the trunk.

To fold down the seat-back from inside the car, insert the master key in the lock on the rear shelf. Turn the key clockwise, pull down the top of the seat-back, then release the key.

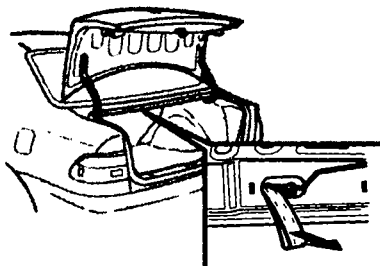

To release the seat-back from inside the trunk, pull the release loop under the rear shelf, push down the seat back then release the loop.

To lock the seat-back upright, push it firmly against the rear shelf. Make sure it is latched in place by pulling on the top of the seat.

Make sure all items in the trunk, or items extending through the opening into the back seat, are tied down. Loose items can fly forward and cause injury if you have to brake hard. See **Loading Cargo** on page [88](#).

Never drive with the seat-back folded down and the trunk lid open. See **Carbon Monoxide Hazard** on page [25](#).

Only on EX and EX with option package in the U.S.

Your car's windows are electrically-powered. Turn the ignition switch to ON (II) to raise or lower a window.

Each door has a switch that controls its window. To open the window, push the switch down and hold it. Release the switch when you want the window to stop. Close the window by pushing the switch up and holding it.

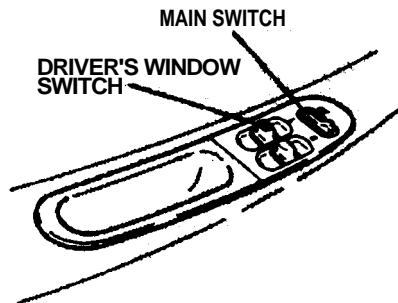

The driver's armrest has a master power window control panel. To open the passenger's window, push down on the appropriate switch and hold it down until the window reaches the desired position. To close the window, push up on the window switch. Release the switch when the window gets to the position you want.

The master control panel also contains these extra features:

AUTO — To open the driver's window fully, push the window switch firmly down and release it. The window automatically goes all the way down. To stop the window from going all the way down, push the window switch up briefly.

To open the driver's window only partially, push the window switch down lightly and hold it. The window will stop as soon as you release the switch.

The AUTO function only works to lower the driver's window. To raise the window, you must push the window switch up and hold it until the window reaches the desired position.

The MAIN switch controls power to the passenger's windows. With this switch off, the passenger's window cannot be raised or lowered. The MAIN switch does not affect the driver's window. Keep the MAIN switch off when you have children in the car so they do not injure themselves by operating the window unintentionally.

Closing a power window on a child's hands or fingers can cause serious injury.

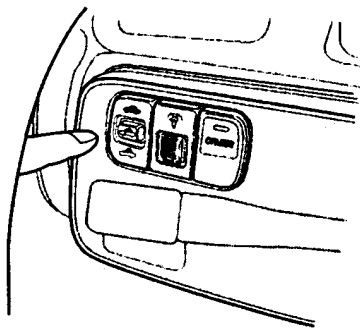

Make sure children are away from the windows before closing them.

Moonroof



Only on EX and EX with option package in the U.S. and Si model in Canada.

Use the switches on the dashboard under the left vent to operate the moonroof. The ignition must be ON (II)-

To lift the rear of the moonroof for ventilation, push the  button. To slide the moonroof back, push the  switch. Hold it until the

moonroof reaches the desired position, then release the switch.

To close the moonroof, press and hold the  switch.

Closing the moonroof on someone's hands or fingers can cause serious injury.

Make sure passengers are clear of the moonroof before closing it.

NOTICE

If you try to open the moonroof in below-freezing temperatures, or when it is covered with snow or ice, you can damage the moonroof panel or motor.

Sunshade

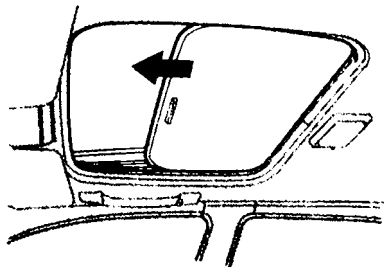

You can slide the sunshade to any position when the moonroof is closed. The sunshade slides open with the moonroof. You must close it manually.

Mirrors

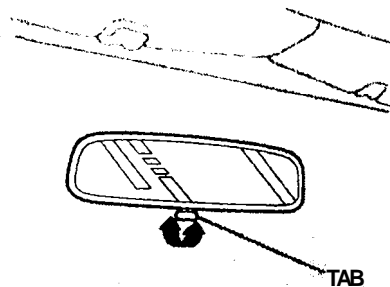

Keep the inside and outside mirrors clean and adjusted for best visibility. Be sure to adjust the mirrors before you start driving.

The inside mirror has day and night positions. The night position reduces glare from headlights behind you. Flip the tab on the bottom edge of the mirror to select the day or night position.

Manual Door Mirrors

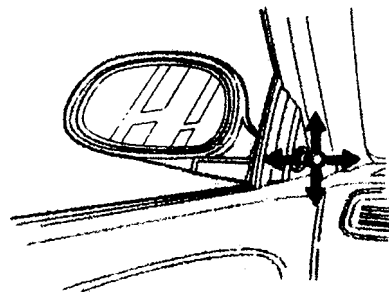

Only on DX models.
The outside mirror on the driver's door can be adjusted by moving the knob on the inside of the door.

Adjusting the Power Mirrors

SELECTOR SWITCH

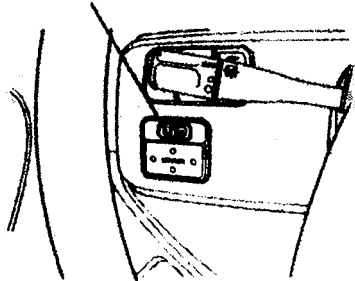

Only on EX and EX option package in the U.S.

Adjust the outside mirrors with the adjustment switch on the left side of the dashboard:

1. Turn the ignition switch ON (II).
2. Move the selector switch to L (driver's side) or R (passenger's side).

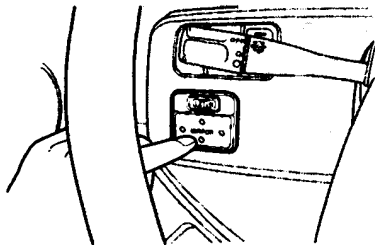

3. Push the appropriate edge of the adjustment switch to move the mirror right, left, up, or down.
4. When you finish, move the selector switch to the center (OFF) position. This turns off the adjustment switch so you can't move a mirror out of position by accidentally bumping it.

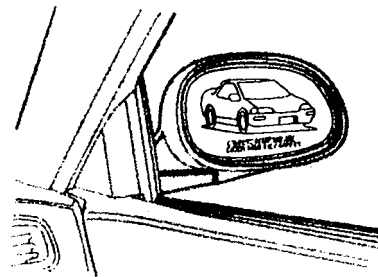

The outside mirror on the passenger's side has curved glass. Objects look farther away than they are. Use this mirror to get a "wide view." Don't use it to judge the distance of things behind you.

Parking Brake

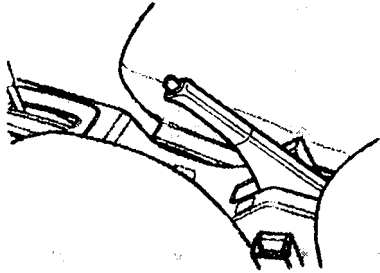

To apply the parking brake, pull the lever up fully. To release it, pull up slightly, push the button, and lower the lever. The parking brake light on the instrument panel should go out when the parking brake is fully released (see page 33).

NOTICE

Driving the car with the parking brake applied can damage the rear brakes and axles.

Glove Box

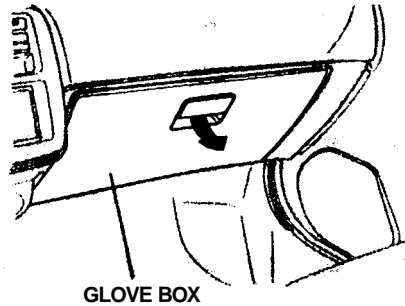

Open the glove box by pulling the handle. Close it with a firm push.

An open glove box can cause serious injury to your passenger in a crash, even if the passenger is wearing the seat belt.

Always keep the glove box closed while driving.

Digital Clock

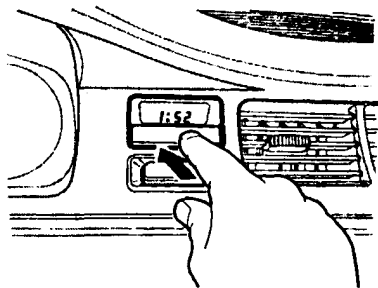

All models except DX

The digital clock displays the time with the ignition switch ON (II). To see the time with the ignition off, press and hold the wide button under the clock.

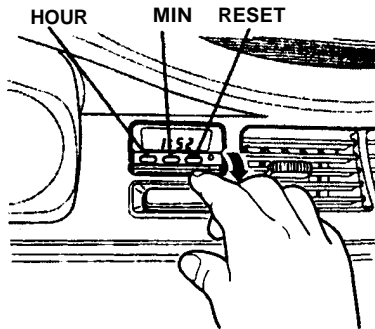

To set the clock:

1. Turn the ignition switch ON (II) to display the time.
2. Swing down the front cover of the wide button under the clock display. You will see HOUR, MIN., and RESET buttons.

3. Press and hold the HOUR button until the hour advances to the desired time.
4. Press and hold the MIN. button until the numbers advance to the desired time.

You can use the RESET button to quickly set the time to the nearest hour. If the displayed time is before the half hour, pressing RESET sets the clock back to the previous hour. If the displayed time is after the half hour, pressing RESET sets the clock forward to the beginning of the next hour.

For example:

- 1:06 would RESET backward to 1:00.
- 1:52 would RESET forward to 2:00.

Beverage Holder

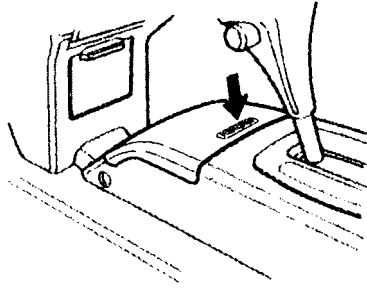

To open the beverage holder, push on the top. The beverage holder lid is spring-loaded and will pop open. To close it, push it down until it latches.

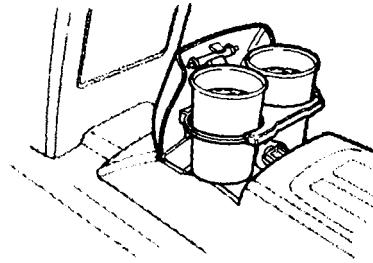

Use the beverage holder only when the car is parked. If you place cups in the holder while driving, the liquid may spill when you go over bumps or around corners.

Be careful when you are using the beverage holder. Spilled liquids can damage the upholstery, carpeting, and electrical components in the interior. If the liquid is very hot, it can scald you or your passengers.

Vanity Mirror

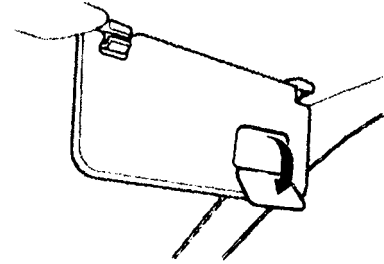

Only on EX and EX with option package in the U.S. and Si model in Canada.

To use the vanity mirror, pull down the sun visor and swing down the cover.

Cigarette Lighter

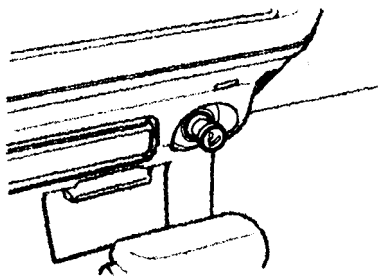

The ignition switch must be in ACCESSORY (I) or ON (II) for the cigarette lighter to work. To heat up the lighter, push it in. It will pop out when it is ready for use. Do not hold the lighter in while it is heating up, you could cause it to overheat.

Ashtrays

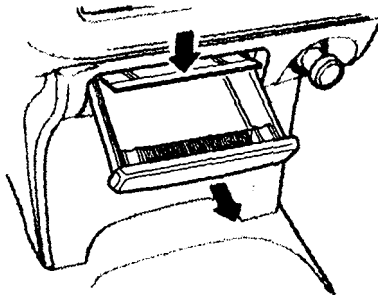

Open the front ashtray by pulling on the bottom edge. Push it in to close it.

To remove the ashtray for emptying, push down on the metal plate inside, then pull the ashtray out completely.

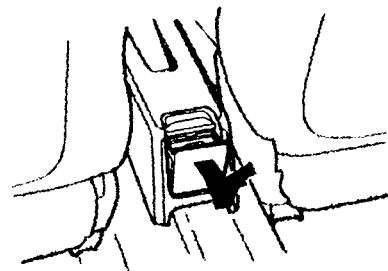

The rear ashtray is at the rear end of the center console. Open the ashtray by swinging the upper edge of the lid down. To remove the ashtray for emptying, open it then lift up and out.

NOTICE

Use the ashtray only for cigarettes, cigars and other smoking materials. To prevent a possible fire and damage to your car, don't put paper or other things that can burn in the ashtrays.

Interior Light

DOOR ACTIVATED

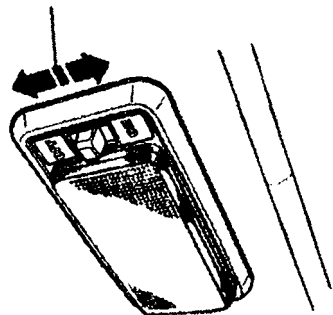

The interior light has a three-position switch. In the OFF (forward) position, the light does not come on. In the center position, the interior light comes on when you open either front door. In the ON (rearward) position, the interior light stays on continuously.

The heating/ventilation system in your car, when combined with the optional air conditioner, provides a comfortable driving environment in all weather conditions.

U.S. EX with option package.

The standard audio system is very versatile. To get the most benefit from this system, read its description in this manual.

For other models

Refer to the operating instructions that came with the optional audio system you selected.

Heating and Cooling	64
What Each Control Does	66
How to Use the System	67
Controlling Air	
Flow Direction	67
Ventilation	67
To Cool with A/C	68
To Dehumidify and Defog with A/C	69
To Heat	70
To Defrost	70
To Turn Everything Off ...	70
Audio System	71
Operating the Radio	71
Presetting	72
Adjusting the Sound	74
Radio Frequencies	75
Operating the	
Cassette Player	75
Cassette Player	78

Heating and Cooling

This system *has* full heating, ventilation, and air conditioning (optional) capabilities. You can adjust the system controls to mix these in various combinations. The air flows into the interior at three possible levels that you can select.

A Genuine Honda air conditioning system is available from your dealer. It meets Honda's high quality standards and is designed to fit your car. If you purchased your car without air conditioning, it can be installed at a later time. Please contact your dealer for more information.

CENTER VENT

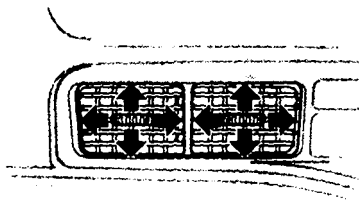

The direction of air flow from the vents in the center and each side of the dashboard is adjustable. Move the tab in the center of each vent up and down and side to side.

The side and upper vents can be opened and closed with the dials next to them.

SIDE VENT

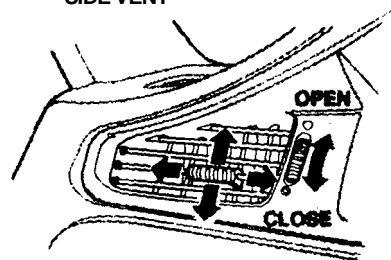

The heating and cooling system draws air through the exterior vents at the bottom of the windshield. Keep these vents clear of leaves and other debris.

UPPER VENT

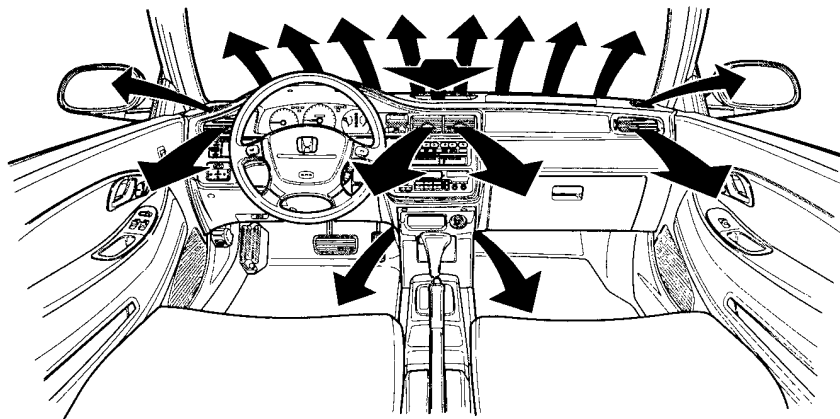
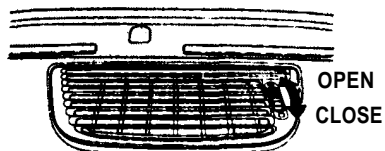

What Each Control Does

Fan Control Lever

Sliding this lever to the right increases the fan speed, which increases air flow.

Temperature Control Lever

Sliding this lever to the right increases the temperature of air flowing through the system.

Mode Buttons

These buttons control the direction of air flow. The indicator light shows which button is controlling air flow.

Air Conditioning (A/C) Switch

This switch turns the air conditioner ON and OFF. The indicator in the switch lights when the A/C is ON.

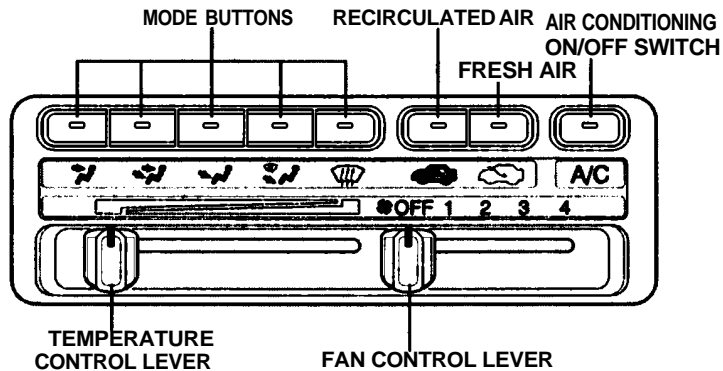



Fresh Air and Recirculation Buttons

These two buttons control the source of air going into the system. In Fresh Air mode, air comes from outside the car. In Recirculation mode, the interior air recycles through the system.

How to Use the System



This section covers the best way to use the system for ventilation, cooling, dehumidifying, defrosting and heating. In most cases, the mode and air source selections are only recommendations. You may prefer different settings.

Use  mode to heat or cool the interior more quickly, or to keep out smoke and dust. Leaving the system in recirculation mode with the air conditioning off can cause the windows to fog up. Switch to  mode as soon as the interior reaches a comfortable temperature or the outside smoky, dusty condition clears.

The engine must be running for the heater and air conditioning system to provide hot and cold air. The heater uses engine coolant to warm the air. If the engine is cold, it will be several minutes before you feel warm air circulating.

Air conditioning does not depend on engine temperature. It can produce cold air almost immediately.

Controlling Air Flow Direction

Air flows into the interior at three levels: Toward the floor , through the dash vents , and toward the windshield and side windows . You select the air flow level or combination of levels with the five mode buttons.

Ventilation

Your car has a flow-through ventilation system. Air enters the car through vents in front of the windshield. It circulates through the interior then exits through vents near the rear window. This system provides fresh air even when the car is standing still. To bring in outside air, press the  button. Set the fan at a comfortable speed.



continued

Heating and Cooling

To Cool with A/C

To operate the air conditioning system, press the air conditioning switch. Set the fan to the desired speed. You can also use the  mode button to direct air out of the dash and heater vents.

To cool the interior down rapidly after the car has been sitting in the sun:

1. Start the engine.
2. Turn on the A/C by pressing the switch.
3. Set the fan to maximum speed.
4. Open the windows partially. Select  and .

When the interior reaches a comfortable temperature, close the windows and set the system for cooling as described above.

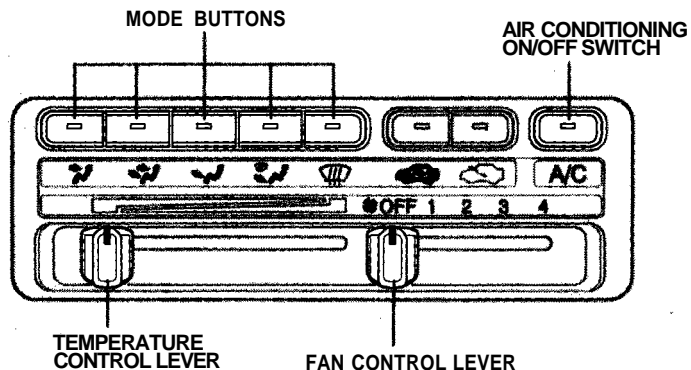

The air conditioning places an extra load on the engine. Watch the coolant temperature gauge (see page 37) when using the A/C in heavy traffic or driving up long hills. If it moves near the red zone, turn off the air conditioning until the gauge reads normally.

To Dehumidify and Defog with A/C

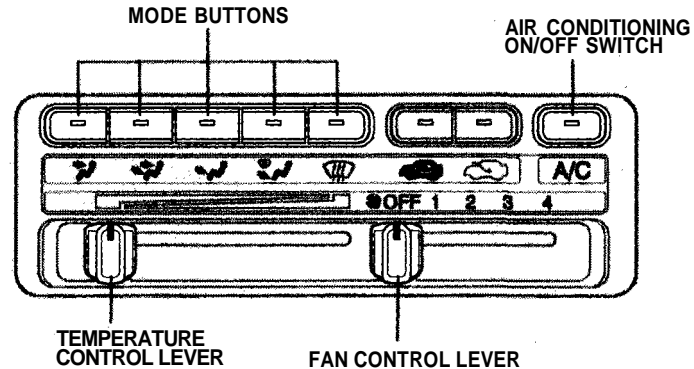

Air conditioning removes moisture from the air as it operates. You can use it to defog the windows quickly in cool or damp weather. Used in combination with the heater, it also makes the interior warm and dry. This setting is best for all driving conditions whenever the outside temperature is above 32° F (0° C).

1. Set the fan to a medium speed.
2. Turn on the air conditioning.
3. Select any desired mode button;  is usually best.
4. Adjust the temperature control lever so the mixture of heated and cooled air is at a comfortable temperature.





Heating and Cooling

To Heat



To warm the interior, press  and . Set the fan to the desired speed. Adjust the warmth of the air with the temperature control lever.

To warm the interior rapidly after the car has been sitting out in cold weather:

1. Start the engine.
2. Select  and .
3. Slide the temperature control lever to maximum heat.
4. Leave the fan OFF for the first few minutes. When the temperature gauge rises above the bottom white mark, set the fan to medium speed.
5. When the interior warms up, switch to fresh air mode and adjust the temperature control lever to a comfortable setting.

To Defrost

To remove frost or ice from the windshield and side windows after the car has been sitting out in cold weather.

1. Start the engine.
2. Select  and .
3. Set the fan and temperature controls to maximum.

These settings direct all the air flow to the defroster vents at the base of the windshield and the side window defroster vents. The air flow will get warmer and clear the windows faster as the engine warms up. You can close the side and upper vents with the dial beside each vent. That will send more warm air to the windshield defroster vents.

For safety, make sure you have a clear view through all the windows before driving away.

To Turn Everything Off

To shut off the system temporarily, slide the fan speed and temperature control levers all the way to the left.

You should only shut the system completely off for the first few minutes of driving in cold weather, until the engine coolant warms up enough to operate the heater. Keep the fan on at all other times so stale air does not build up in the interior.

AM/FM/Cassette Stereo Audio System

U.S. EX with option package.

Your Honda audio system is easy to use, and will give clear AM/FM reception. The preset buttons allow you to select six stations on AM and twelve stations on FM.

The cassette system uses Dolby B* noise reduction to give excellent sound reproduction. The system also senses when a metal (CrO₂) tape is being played and adjusts accordingly.

*Dolby noise reduction manufactured under license from Dolby Laboratories Licensing Corporation. "Dolby" and the  symbol are trademarks of Dolby Laboratories Licensing Corporation.

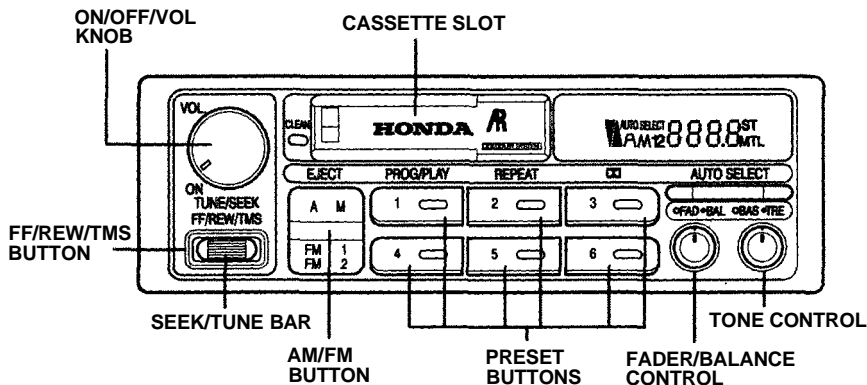

Operating the Radio

The ignition switch must be in ACCESSORY (I) or ON (II) to operate the audio system. Turn the system on by turning the ON/OFF/VOL knob clockwise. The radio comes on and displays the frequency of the station it was last tuned to.

Adjust the volume by turning the ON/OFF/VOL knob.

Select the band you want to listen to by pressing the AM or FM1/FM2 button. You will see the selected band and the frequency in the display.

ST will be displayed next to the frequency if the station is broadcasting in FM stereo. The AM stereo feature is not available.

Audio System

You can use any of three methods to find radio stations on the selected band: TUNE, SEEK, or the Preset buttons.

The TUNE function lets you find a desired frequency. Push the TUNE/SEEK switch up to change to a higher frequency, and down to change to a lower frequency.

To change the frequency up or down a single increment, push and release the TUNE/SEEK switch.

The SEEK function searches the band for stations with a strong signal. Depending on which way you push the TUNE/SEEK switch, the system searches up or down from the current frequency. Push the switch until you hear a beep, then release it. The system searches until it finds a station with a strong signal, then stops. If you do not want to listen to that station, push TUNE/SEEK again.

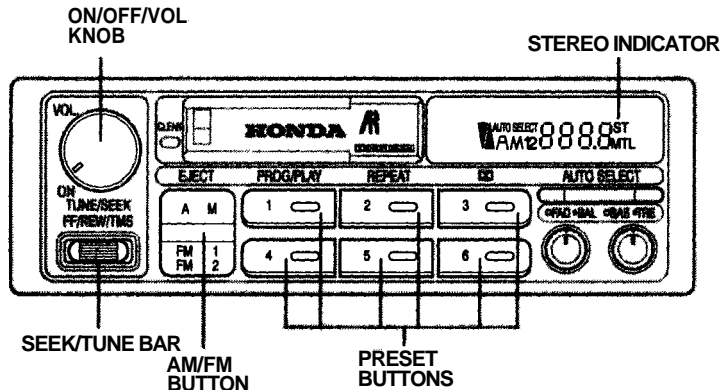

Presetting

The preset buttons allow you to store radio frequencies for later selection. Each button will store one frequency on the AM band, and two on the FM band. To store a frequency:

1. Select the desired band, AM or FM. FM1 and FM2 allow you to store two frequencies with each Preset button.

2. Use the TUNE or SEEK function to tune the radio to a desired station.
3. Pick the Preset button you want for that station. Press the button and hold it until you hear a beep.
4. Repeat steps 1 to 3 to store a total of six stations on AM and twelve on FM.

Once that station's frequency is stored, simply press and release the proper Preset button to tune to it. If you want to change any Preset button's selection, store another frequency as described. The frequencies you preset will be lost if your car's battery goes dead or is disconnected.

The AUTO SELECT function allows you to find stations easily when you are in an unfamiliar area. Press the AUTO SELECT button. The system automatically scans both bands to find six strong stations on AM and twelve on FM, and stores their frequencies in the Preset buttons. You can then use the Preset buttons in the normal manner to select those stations. "AUTO SELECT" stays displayed next to the frequency as a reminder.

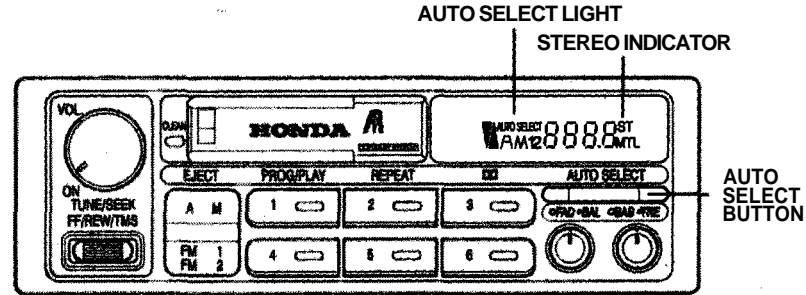

If you are in a remote area, AUTO SELECT may not find enough stations to fill all the available presets. If this is the case, you will see "O" displayed when you press any Preset button that does not have a station stored.

AUTO SELECT does not erase the stations you have manually preset. Turn off AUTO SELECT when you return to your normal reception area by pressing the button again. The light goes out and the Preset buttons can then select the stations you originally set.

Audio System

You cannot manually store radio station frequencies in the Preset buttons when AUTO SELECT is ON. If you do not like the stations found by AUTO SELECT, you can still use the TUNE or SEEK function to find other stations.

Adjusting the Sound

Use the Balance and Fader controls to adjust the sound "direction." The Balance control moves sound left to right. The Fader control moves it front to back.

To use either control, push on the knob to get it to pop out. Adjust the front-to-back sound to your liking with the outside ring.

Adjust the side-to-side sound balance with the knob. Push the knob back in when you are done.

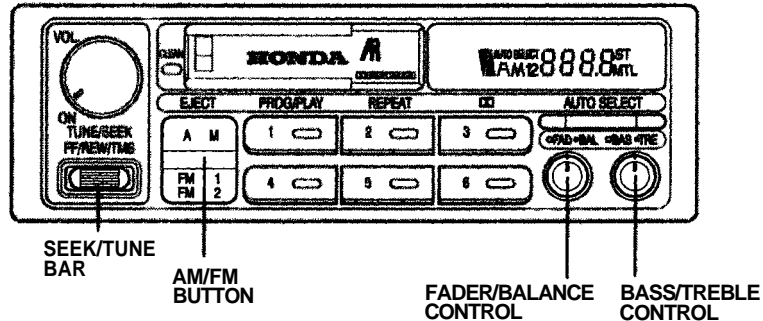

The illumination for the radio controls comes on with the instrument panel lights, even if the radio is off. You can use the Balance control to turn off the radio panel illumination even with the radio on. Push the control knob so it pops out, then pull it out slightly further. Check this control if the control panel lights do not come on with the instrument panel lights.

Use the Bass and Treble controls to adjust the tone quality to your liking. Push on the knob to get the controls to pop out. Adjust the bass level with the outer ring and the treble level with the knob. When finished, push the knobs back in so there is less chance of accidentally changing your settings.

Radio Frequencies

Your Honda's radio can tune in all frequencies in both the AM and FM bands. Those bands cover these frequencies:

AM band

530 kilohertz to 1710 kilohertz

FM band

87.7 megahertz to 107.9 megahertz

Radio stations on the AM band are assigned frequencies at least 10 kilohertz apart (530, 540, 550). Those on the FM band are assigned frequencies at least 0.2 megahertz apart (87.9, 88.1, 88.3).

Stations must use these exact frequencies. It is fairly common for stations to round-off the frequency in their advertising, so your radio will show a frequency of 100.9 even though the announcer may call the station "FM101."

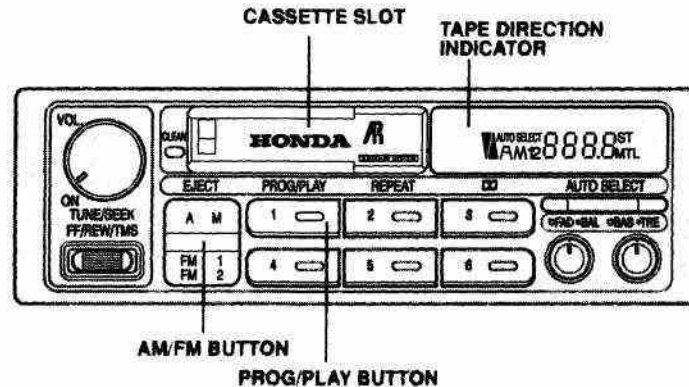

Operating the Cassette Player

Turn the system ON. Insert the cassette into the slot with the tape opening to the right. Push the cassette in most of the way. The drive will pull it in the rest of the way and begin to play.

The ▲ or ▼ will light to show you which side of the cassette is

playing. The ▲ indicates the side you inserted facing upward is now playing. To play the other side of the tape, press the PROG/PLAY button.

The system also has an Auto-reverse feature. It will automatically reverse direction when it reaches the end of the cassette.

Audio System

If the cassette is a metal tape (chromium-dioxide or CrO₂), you will see "MTL" displayed. The system automatically adjusts for the special frequency characteristics of metal tape.

Dolby noise reduction turns on when you insert a cassette. If the tape was not recorded with Dolby B noise reduction, turn it off by pressing the button.

To remove the cassette from the drive, press the EJECT button. The system automatically ejects the cassette whenever you turn off the system or the ignition switch.

Cassette Search Functions

Once a cassette is playing, you can use the FF, REW, TMS, or REPEAT function to look for desired songs or passages.

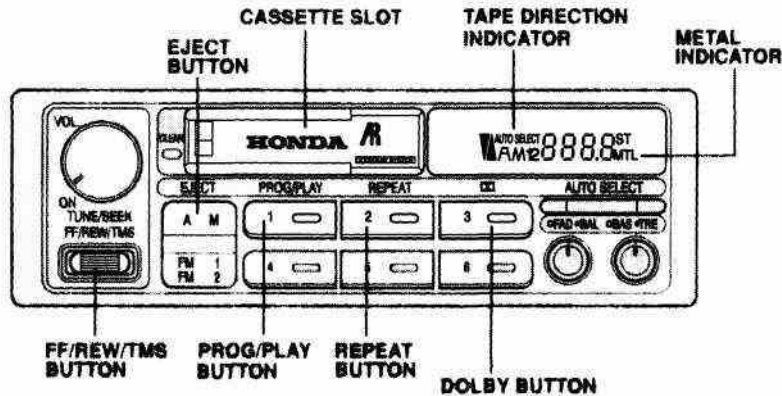

To rewind the tape, push the FF/REW/TMS button down then release it. You will see REW in the display. To fast forward the tape, push the button up then release it. You will see FF displayed. To stop rewind or fast forward, press the PROG/PLAY button. If the system reaches the end of the cassette while in fast forward or rewind, it

automatically stops that function, reverses direction, and begins to play.

Press the REPEAT button to replay the current passage. The light in the button illuminates as a reminder. When the system reaches the end of the song or passage that is being played, it

automatically goes into rewind. When it senses the beginning of that passage, it goes back to play.

The system will continue repeating this passage until you turn off REPEAT by pressing the button again.

The TMS function lets you skip to the beginning of a song or other passage. The tape skips forward or backward, depending on which direction you push the FF/REW/TMS switch.

Activate TMS by pushing the FF/REW/TMS button and holding it until you hear a beep. If you push the button down, you will see REW blinking in the display as the tape rewinds. If you push the button up, you will see FF blinking in the display as the tape fast forwards. When the system senses a silent period on the tape, it goes back to PLAY mode.

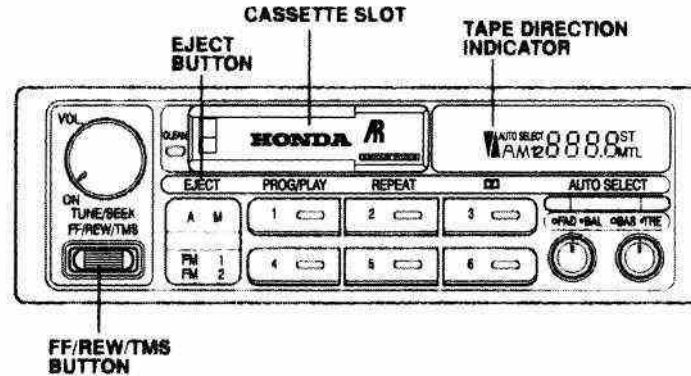

The REPEAT and TMS functions use silent periods on the tape to find the end of a selection. These features may not work satisfactorily on tapes that have almost no gap between songs, a high noise level between songs, or silent periods in the middle of songs.

Caring for the Cassette Player

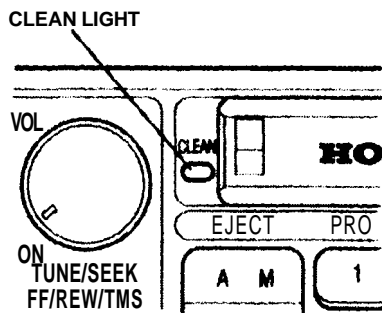

The cassette drive picks up dirt and oxides whenever you play a tape. This builds up over time and causes the sound quality to degrade. To prevent this, you should clean the cassette drive after every 30 hours of use. Your Honda dealer has a cleaning kit available for this purpose.

To remind you, a small red light labelled CLEAN comes on every 30 hours of tape use. If you are already regularly cleaning the tape drive at least every 30 hours, simply push the CLEAN light for five seconds to turn it off.

If you do not clean the cassette drive regularly, it may eventually become impossible to remove the deposits with a normal cleaning kit.

The cassette player automatically ejects cassettes that do not play normally. If it ejects a cassette before it begins to play, it is probably defective and should not be inserted again. You may have a cassette suddenly stop playing, reverse directions once or twice and then eject. This is normally an indication the tape is wound unevenly. It should play normally after being manually rewound.

Use 100-minute or shorter cassettes. Cassettes longer than 100 minutes use thinner tape that may break or jam the drive.

Look at a cassette before you insert it. If the tape is loose, tighten it by turning one of the hubs with a pencil or your finger. If the label is peeling off, do not put it in the player. It may cause the cassette to jam in the drive mechanism when you try to eject it.

Do not leave cassettes sitting where they are exposed to high heat or humidity, such as on top of the dashboard or in the player. If a cassette is exposed to extreme heat or cold, let it reach a moderate temperature before putting it in the player.

Before you begin driving your Honda, you should know what gasoline to use, and how to check the levels of important fluids. You also need to know how to properly stow luggage or packages. This section will help you. If you plan to add any accessories to your car, please read the information in this section first.

Break-in Period	80
Gasoline	80
Oxygenated Fuels	80
Driving in Foreign Countries	81
Service Station Procedures .	82
Filling the Fuel Tank	82
Opening the Hood	83
Fuel Economy	86
Vehicle Condition.....	86
Driving Habits	86
Accessories	87
Loading Cargo	88

Break-in Period

Help assure your car's future reliability and performance by paying extra attention to how you drive during the first 1,000 km (600 miles). During this period:

- Avoid full-throttle starts and rapid acceleration.
- If you need to add oil, use the engine oil recommended in this owner's manual.
- Avoid hard braking. New brakes need to be broken-in by moderate use for the first 300 km (200 miles).

You should follow these same recommendations with an overhauled or exchanged engine, or when the brakes are relined.

Gasoline

Your Honda is designed to operate most effectively on unleaded gasoline with a pump octane number of 86 or higher. Use of a lower octane gasoline can cause a persistent, heavy metallic rapping noise that can lead to engine damage.

Gasolines containing detergent additives designed to help prevent fuel system and engine deposits are recommended. Using gasoline containing lead will damage your car's emission controls. This contributes to air pollution and can void certain parts of your warranty.

Oxygenated Fuels

Some conventional gasolines are being blended with alcohol or an ether compound. These gasolines are collectively referred to as oxygenated fuels. To meet clean air standards, some areas of the United States and Canada use oxygenated fuels to help reduce emissions.

If you use an oxygenated fuel, be sure it is unleaded and meets the minimum octane rating requirement.

Before using an oxygenated fuel, try to confirm the fuel's contents. Some states/provinces require this information to be posted on the pump.

The following are the EPA-approved percentages of oxygenates:

ETHANOL (ethyl or grain alcohol) You may use gasoline containing up to 10% ethanol by volume. Gasoline containing ethanol may be marketed under the name "Gasohol".

MTBE (Methyl Tertiary Butyl Ether). You may use gasoline containing up to 15% MTBE by volume.

METHANOL (methyl or wood alcohol) You may use gasoline containing up to 5% methanol by volume as long as it also contains cosolvents and corrosion inhibitors to protect the fuel system. Gasoline containing more than 5% methanol by volume may cause starting and/or performance problems. It may also damage metal, rubber, and plastic parts of your fuel system.

If you notice any undesirable operating symptoms, try another service station or switch to another brand of gasoline.

Fuel system damage or performance problems resulting from the use of an oxygenated fuel containing more than the percentages of oxygenates given previously are not covered under warranty.

Driving in Foreign Countries

Using any type of leaded gasoline in your Honda will affect performance and damage its emission controls. Unleaded gasoline may not be available in other countries. If you are planning to take your car outside the U.S. or Canada, write to Honda at the address shown for information about any modifications your car may need. Be sure to include the year and model of your car.

U.S. Owners:

American Honda Motor Co., Inc.
Consumer Affairs
1919 Torrance Blvd.
Torrance, CA 90501-2746

Canadian Owners:

Honda Canada Inc.
715 Milner Ave.
Scarborough, Ontario M1B2K8

Filling the Fuel Tank

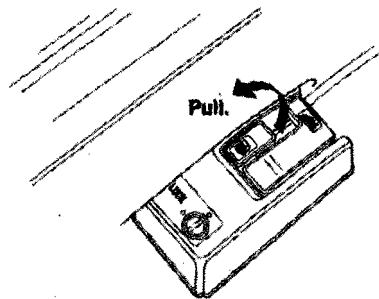

1. The fuel fill is on the driver's side of the car. Park with that side closest to the service station pumps.
2. Open the fuel fill door by pulling on the handle to the left of the driver's seat.

Handling gasoline improperly can cause it to ignite or explode, causing you to be seriously or fatally injured.

Always put out cigarettes and other smoking materials, and keep all sparks and open flames away when you are around gasoline.

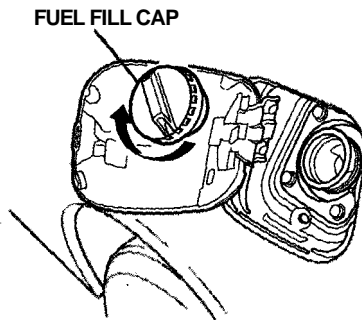

3. Remove the fuel fill cap slowly. You may hear a hissing sound as pressure inside the tank escapes.
4. Stop filling the tank after the gas pump automatically clicks off. Do not try to "top off" the tank, leave some room for the fuel to expand with temperature changes.
5. Screw the fuel fill cap back on, tighten it until it clicks.
6. Push the fuel fill door until it latches.

Opening the Hood



1. Shift to Park or Neutral and set the parking brake. Pull the hood release handle located under the left lower corner of the dashboard. The hood will pop up slightly.

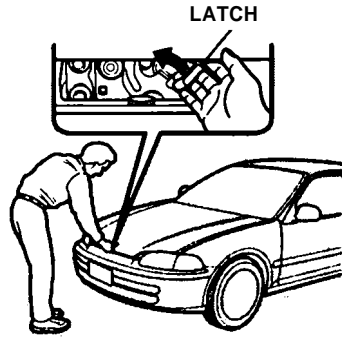

2. Standing in front of the car, put your fingers under the front edge of the hood to the right of center. Slide your hand to the left until you feel the hood latch handle. Push this handle to the left until it releases the hood. Lift the hood.

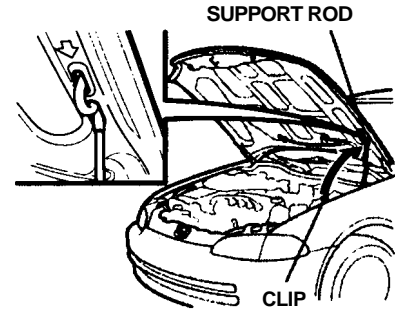

3. Pull the support rod out of its clip and insert the end into the hole on the left side of the hood.

To close the hood, lift it up slightly to remove the support rod from the hole. Put the support rod back into its holding clip. Lower the hood to about a foot above the fender, then let it drop.

Oil Check

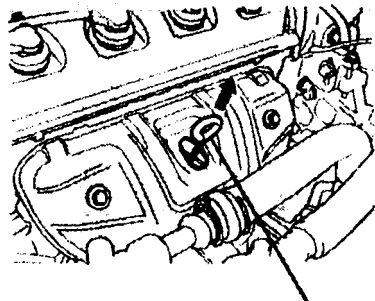

DIPSTICK

Check the engine oil level every time you fill the car with fuel. Wait at least two minutes after turning the engine off before you check the oil.

1. Remove the dipstick (orange handle).

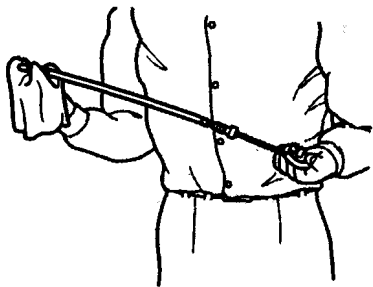

2. Wipe the dipstick with a clean cloth or paper towel.

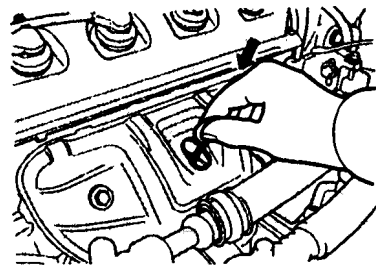

3. Insert it all the way back in its tube.

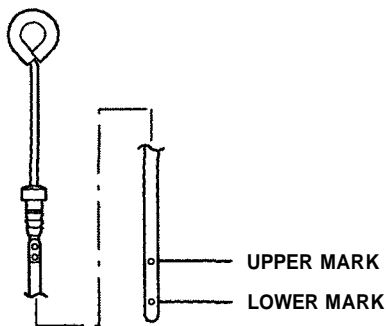

4. Remove it again and check the level. It should be between the upper and lower marks.

If it is near or below the lower mark, see page [111](#) for information on the proper oil and how to add it.

Engine Coolant Check

RESERVE TANK

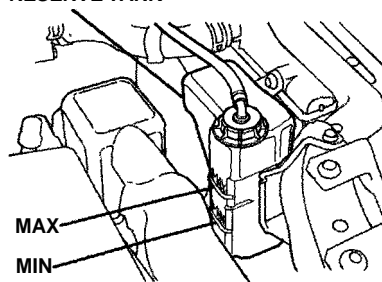

Look at the coolant level in the radiator reserve tank. Make sure it is between the MAX and MIN lines. If it is below the MIN line, see **Adding Coolant** on page [115](#) for information on adding the proper coolant.

Refer to **Periodic Checks** on page [109](#) for information on checking other items in your Honda.

The condition of your car and your driving habits are the two most important things that affect the fuel mileage you get.

Vehicle Condition

Always maintain your car according to the maintenance schedule. This will keep it in top operating condition.

An important part of that maintenance is the **Periodic Checks** (see page 109). For example an underinflated tire causes more "rolling resistance," which uses fuel. It also wears out faster, so check the tire pressure at least monthly. In winter the build-up of snow on your car's underside adds weight and rolling resistance. Frequent cleaning helps your fuel mileage and reduces the chance of corrosion.

Driving Habits

You can improve fuel economy by driving moderately. Rapid acceleration, cornering, and hard braking use more fuel. Always drive in the highest gear that allows the engine to run and accelerate smoothly. Maintain a constant speed while cruising, depending on traffic conditions. Every time you slow down and speed up, your car uses extra fuel. Use the cruise control, when appropriate, to increase fuel economy.

A cold engine uses more fuel than a warm engine. It is not necessary to "warm-up" a cold engine by letting it idle for a long time. You can drive away within thirty seconds, no matter how cold it is outside. The engine will warm up faster, and you get better fuel economy. To cut down on the number of "cold starts," try to combine several short trips into one.

Air conditioning puts an extra load on the engine which makes it use more fuel. Turn off the A/C to cut down on air conditioning use. Use the flow-through ventilation when the outside air temperature is moderate.

Your Honda dealer has many accessories available to personalize your car. Some of these are audio systems, alloy wheels, air conditioning, and color-coordinated carpet floor mats. All Genuine Honda Accessories have been approved by our engineers for installation and use on your car, and are covered by warranty. For a complete guide to the Genuine Honda Accessories available, see your dealer for a 1993 Accessories brochure.

Some non-Honda accessories you can buy in the "aftermarket" are designed for universal applications. Although they may fit your Honda, they may not be within factory specifications. For example, after-market wheels may not meet Honda's specifications for width and offset. They could cause suspension problems which would not be covered by your warranty. Improperly-designed accessories can adversely affect your car's handling and stability.

Your car has several computer-controlled systems, including the SRS system and the engine's fuel injection system. Strong electronic interference can affect their operation.

Electronic communications equipment, such as cellular telephones and two-way radios are regulated by the FCC (CRTC in Canada) and should not interfere with your car's systems. Improper installation, or using electrical equipment not intended for mobile use may interfere with your car's operation. If you want to install a cellular telephone, other mobile communications equipment, or even add-on stereo amplifiers, please discuss it first with your Honda dealer.

In many cases, improper installation is the real cause of problems with after-market accessories. Have these accessories installed by qualified technicians who are familiar with your Honda. If possible, have your Honda dealer inspect the final installation.

Loading Cargo

The maximum load you can carry in your Honda is 850 lbs (385 kg). It includes the total weight of all passengers and their belongings, and any accessories. This 850 lbs (385 kg) figure is shown as the Vehicle Capacity Weight on the tire information label attached to the inside of the glove box.

To figure out how much cargo you can carry:

- Figure the total "occupant weight" you will be transporting. To do this, multiply the number of people (driver and all passengers) by 150 lbs (70 kg).
- Subtract this number from the Vehicle Capacity Weight (850 lbs/385 kg).

This final number is the total weight of cargo you can load in or on the car. With five occupants (driver and four passengers), the maximum recommended weight for cargo is 100 lbs (45 kg).

Where you store this cargo, and how well you secure it are just as important as how much it weighs. Make sure you load cargo so it will not shift while driving. Items stored in the trunk should be placed as far forward as possible. You could store additional items on the floor behind the front seats. Make sure they cannot roll under the front seat and interfere with the pedals.

If you must carry large objects that prevent you from closing the trunk lid, be aware that exhaust gas can enter the interior. See Carbon Monoxide Hazard on page [25](#).

Never place items on the shelf behind the back seat. Those items can fly forward and injure you or your passengers if you brake hard or are involved in a collision.

This section gives you tips on starting the engine under various conditions, and how to operate the 5-speed manual and automatic transmissions. It also includes important, information on your car's braking system.

Preparing to Drive	90
Starting the Engine	91
5-speed Manual	
Transmission.....	91
Automatic Transmission	91
Starting in Cold Weather at	
High Altitude	92
5-speed Manual	
Transmission.....	93
Recommended Shift Points .	94
Maximum Speeds	94
Automatic Transmission	95
Shift Lever Positions	95
Maximum Speeds	98
Shift Lock Release	98
The Braking System	99
Brake Wear Indicators	99
Brake System Design	100
Driving in Bad Weather	101
Towing a Trailer	102

Preparing to Drive

You should do the following checks and adjustments every day before you drive your car.

1. Make sure all windows, mirrors, and outside lights are clean and unobstructed. Remove frost, snow, or ice.
2. Check that the hood and trunk are fully closed.
3. Check that any items you may be carrying with you inside are stored properly or fastened down securely.
4. Check the adjustment of the seat (see page 51).
5. Check the adjustment of the inside and outside mirrors (see page 56).
6. Check the adjustment of the steering wheel (see page 43).
7. Make sure the doors are securely closed and locked.
8. Fasten your seat belt. Check that your passengers have fastened their seat belts (see page 7).
9. Turn the ignition ON (II). Check the indicator lights in the instrument panel.
10. Start the engine.
11. Check the gauges and indicator lights in the instrument panel (see page 31).

5-Speed Manual Transmission

1. Apply the parking brake.
2. In cold weather, turn off all electrical accessories to reduce the drain on the battery.
3. Push the clutch pedal down all the way. START (III) does not function unless the clutch pedal is depressed.
4. Without touching the accelerator pedal, turn the ignition key to the START (III) position. If the engine does not start right away, do not hold the key in START (III) for more than 15 seconds at a time. Pause for at least 10 seconds before trying again.

5. If the engine does not start within 15 seconds, or starts but stalls right away, repeat step 4 with the accelerator pedal pressed half-way down. If the engine starts, release pressure on the accelerator pedal so the engine does not race.
6. If the engine still does not start, press the accelerator pedal all the way down and hold it there while starting in order to clear flooding. As before, keep the ignition key in the START (III) position for no more than 15 seconds. Return to step 5 if the engine does not start. If it starts, lift your foot off the accelerator pedal so the engine does not race.

Automatic Transmission

1. Apply the parking brake.
2. In cold weather, turn off all electrical accessories to reduce the drain on the battery.
3. Make sure the shift lever is in Park: Press on the brake pedal.
4. Without touching the accelerator pedal, turn the ignition key to the START (III) position. If the engine does not start right away, do not hold the key in START (III) for more than 15 seconds at a time. Pause for at least 10 seconds before trying again.

continued

Starting the Engine

5. If the engine does not start within 15 seconds, or starts but stalls right away, repeat step 4 with the accelerator pedal pressed half-way down. If the engine starts, release pressure on the accelerator pedal so the engine does not race.
6. If the engine still does not start, press the accelerator pedal all the way down and hold it there while starting in order to clear flooding. As before, keep the ignition key in the START (Iff) position for no more than 15 seconds. Return to step 5 if the engine does not start. If it starts, lift your foot off the accelerator pedal so the engine does not race.

Starting in Cold Weather at High Altitude (Above 8,000 feet/2,400 meters)

An engine is harder to start in cold weather. The thinner air found at high altitude above 8,000 feet (2,400 meters) adds to the problem. Use the following procedure:

1. Turn off all electrical accessories to reduce the drain on the battery.
 2. Push the accelerator pedal half-way to the floor and hold it there while starting the engine. Do not hold the ignition key in START (III) for more than 15 seconds. When the engine starts, release the accelerator pedal gradually as the engine speeds up and smooths out.
3. If the engine fails to start in step 2, push the accelerator pedal to the floor and hold it there while you try to start the engine for no more than 15 seconds. If the engine does not start, return to step 2.

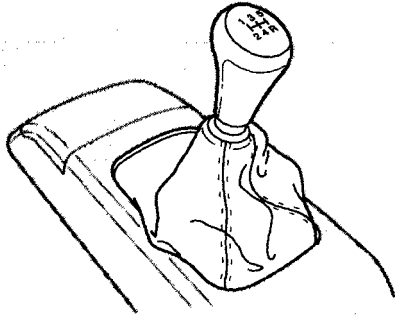

The manual transmission is synchronized in all forward gears for smooth operation. It has a lockout so you cannot shift directly from Fifth to Reverse. When shifting up or down, make sure you push the clutch pedal down all the way, shift to the next gear, and let the pedal up gradually. When you are not shifting, do not rest your foot on the clutch pedal. This can cause your clutch to wear out faster.

Come to a full stop before you shift into reverse. You can damage the transmission by trying to shift into reverse with the car moving. Depress the clutch pedal and pause for a few seconds before putting it in reverse, or shift into one of the forward gears for a moment. This stops the gears so they won't "grind."

You can get extra braking from the engine when slowing down by shifting to a lower gear. This extra braking can help you maintain a safe speed and prevent your brakes from overheating while going down a steep hill. Before downshifting, make sure engine speed will not go into the red zone in the lower gear. Refer to the Maximum Speeds chart.

Rapid stowing or speeding up can cause loss of control on slippery surfaces. If you crash, you can be injured.

Use extra care when driving on slippery surfaces.

Recommended Shift Points

Drive in the highest gear that lets the engine run and accelerate smoothly. This will give you the best fuel economy and effective emissions control. The following shift points are recommended:

Shift up	Normal acceleration
1 st to 2 nd	15 mph (24 km/h)
2 nd to 3 rd	27 mph (43 km/h)
3 rd to 4 th	39 mph (62 km/h)
4 th to 5 th	53 mph (85 km/h)

Shift up	Cruise from acceleration
1 st to 2 nd	9 mph (14 km/h)
2 nd to 3 rd	20 mph (32 km/h)
3 rd to 4 th	33 mph (53 km/h)
4 th to 5 th	48 mph (77 km/h)

Maximum Speeds

The speeds in these tables are the maximums for the given gears. If you exceed these speeds, the engine speed will enter into the tachometer's red zone. If this occurs, you may feel the engine cut in and out. This is caused by a limiter in the engine's computer controls. The engine will run normally when you reduce the RPM below the red zone.

DX

Gear	Maximum speeds
1 st	32 mph (51 km/h)
2 nd	59 mph (95 km/h)
3 rd	88 mph (142 km/h)
4 th	112 mph (181 km/h)
5 th	Top speed

U.S.: EX, EX with option package,
Canada: Si

Gear	Maximum speeds
1 st	34 mph (55 km/h)
2 nd	58 mph (94 km/h)
3 rd	89 mph (143 km/h)
4 th	Top speed
5 th	Top speed

Automatic Transmission

Your Honda's transmission has four forward speeds, and is electronically controlled for smoother shifting. It also has a "lock-up" torque converter for better fuel economy. You may feel what seems like another shift when the converter locks.

Shift Lever Position Indicator

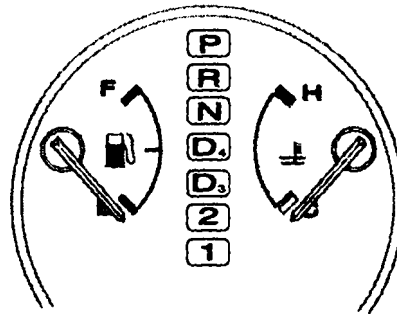

This display is on the instrument panel. It shows you the position of the shift lever.

Shift Lever Positions

RELEASE BUTTON

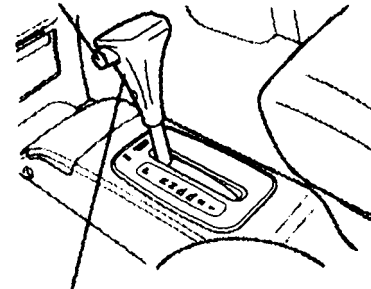

SHIFT LEVER

The shift lever has seven positions. It must be in Park or Neutral to start the engine. When you are stopped in D₄, D₃, 2, 1 or R, press firmly on the brake pedal and keep your foot off the accelerator pedal.

Automatic Transmission

To shift from:	Do this:
P to R	Press the brake pedal and press the release button.
R to P N to R D ₃ to 2 2 to 1	Press the release button.
1 to 2 2 to D ₃ D ₃ to D ₄ D ₄ to N D ₄ to D ₃ N to D ₄	Move the lever.

Park (P) — This position mechanically locks the transmission. Use Park whenever you are turning off or starting the engine. To shift out of Park, you must press on the brake pedal and have your foot off the accelerator pedal. Press the release button on the side of the shift lever to move it.

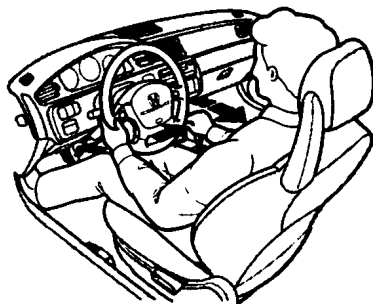

You must also press the release button to shift into Park. To avoid transmission damage, come to a complete stop before shifting into Park. The shift lever must be in Park before you can remove the key from the ignition switch.

If you have done all of the above and still cannot move the lever out of Park, see Shift Lock Release on page 98.

Reverse (R) — To shift to Reverse from Park, see the explanation under Park. To shift to Reverse from Neutral, come to a complete stop and then shift. Press the release button before shifting into Reverse from Neutral.

Neutral (N) — Use Neutral if you need to restart a stalled engine, or if it is necessary to stop briefly with the engine idling. Shift to Park position if you need to leave the car for any reason. Press on the brake pedal when you are moving the shift lever from Neutral to another gear.

Drive (D₄) — Use this position for your normal driving. The transmission automatically selects a suitable gear for your speed and acceleration. You may notice the transmission shifting up at higher speeds when the engine is cold. This helps the engine warm up faster.

Drive (D3) - This position is similar to D4, except only the first three gears are selected. Use D3 to provide engine braking when going down a steep hill. D3 can also keep the transmission from cycling between third and fourth gears in stop-and-go driving.

For faster acceleration when in D3 or D4, you can get the transmission to automatically downshift by pushing the accelerator pedal to the floor. The transmission will shift down one or two gears, depending on your speed.

Second (2) - To shift to Second, press the release button on the side of the shift lever. This position locks the transmission in second gear. It does not downshift to first gear when you come to a stop. Second gives you more power when climbing, and increased engine braking when going down steep hills. Use second gear when starting out on a slippery surface or in deep snow. It will help reduce wheel spin.

Whenever you move the shift lever to a lower gear, the transmission downshifts only if the engine's redline will not be exceeded in the lower gear.

First (1) - To shift from Second to First, press the release button on the side of the shift lever. With the lever in this position, the transmission locks in First gear. By upshifting and downshifting through 1, 2, D3, and D4, you can operate this transmission much like a manual transmission without a clutch pedal.

Automatic Transmission

Maximum Speeds

The speeds in these tables are the maximums for the given position. If you exceed these speeds, the engine speed will enter into the tachometer's red zone. If this occurs, you will feel the engine cut in and out. This is caused by a limiter in the engine's computer controls. The engine will run normally when you reduce the RPM below the red zone.

DX

Position	Maximum speeds
1	37 mph (60 km/h)
2	66 mph (106 km/h)
D ₃	99 mph (160 km/h)
D ₄	Top speed

U.S.: EX, EX with option package
Canada: Si

Position	Maximum speeds
1	42 mph (67 km/h)
2	75 mph (120 km/h)
D ₃	112 mph (180 km/h)
D ₄	Top speed

Shift Lock Release

This allows you to move the shift lever out of Park if the normal method of pushing on the brake pedal and pressing the release button does not work.

1. Set the Parking brake.
2. Remove the key from the ignition switch.
3. Insert the key in the Shift Lock Release slot next to the shift lever.

4. Push down on the key while you press the release button and move the shift lever out of Park to Neutral.

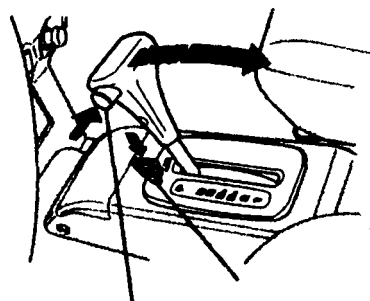

RELEASE BUTTON SHIFT LOCK
RELEASE SLOT

5. Remove the key from the Shift Lock Release slot. Return the key to the ignition switch, depress the brake pedal, and restart the engine.

If you need to use the Shift Lock Release, it could mean your car is developing a problem. Have the car checked by your Honda dealer.

All Civics are equipped with front disc brakes. The brakes on the rear wheels are drum-type. The braking system is power-assisted to reduce the effort needed on the brake pedal.

Put your foot on the brake pedal only when you intend to brake. Resting your foot on the pedal keeps the brakes applied lightly, causing them to build up heat. Heat build up can reduce how well your brakes work. It also keeps your brake lights on all the time, confusing drivers behind you.

Constant application of the brakes when going down a long hill builds up heat and reduces their effectiveness. Use the engine to assist the brakes by downshifting to a lower gear and taking your foot off the accelerator pedal.

Check your brakes after driving through deep water. Apply the brakes moderately to see if they feel normal. If not, apply them gently and frequently until they do. Since a longer distance is needed to stop with wet brakes, be extra cautious and alert in your driving.

Brake Wear Indicators

The front disc brakes on all cars have audible brake wear indicators. When the brake pads need replacing, you will hear a distinctive metallic "screeching" sound when you apply the brakes. If you do not have the brake pads replaced, they will begin screeching all the time.

Your brakes may sometimes squeal or squeak when you apply them lightly. Do not confuse this with the brake wear indicators. They make a very audible "screeching."

The Braking System

Brake System Design

The hydraulic system that operates the brakes has two separate circuits. Each circuit works diagonally across the car (the left-front brake is connected with the right-rear brake, etc.). If one circuit should develop a problem, you will still have braking at two wheels.

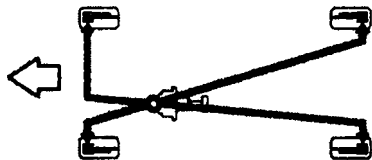

If this happens, you will notice that the brake pedal goes down much farther and you need to press on it much harder. A much longer distance will be needed to stop the car.

Slow the car by downshifting to a lower gear and removing your foot from the accelerator pedal. Pull to the side of the road as soon as it is safe. Because of the longer stopping distance needed, brake system failure is very hazardous. It is best to have your car towed, but if you must drive the car in this condition, be extremely cautious. Have your car repaired as soon as possible.

Driving in Bad Weather

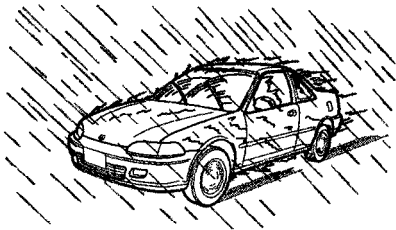

Rain, fog, and snow conditions require a different driving technique because of reduced traction and visibility. Keep your car well-maintained and exercise greater caution when you need to drive in bad weather. The cruise control should not be used in these conditions.

Driving Technique - Always drive slower than you would in dry weather. It takes your car longer to react, even in conditions that may seem just barely damp. Apply smooth, even pressure to all the controls. Abrupt steering wheel movements or sudden, hard application of the brakes can cause loss of control in wet weather. Be extra cautious for the first few miles of driving while you adjust to the change in driving conditions. This is especially true in snow. A person can forget some snow-driving techniques during the summer months. Practice is needed to relearn those skills.

Exercise extra caution when driving in rain after a long dry spell. After months of dry weather, the first rains bring oil to the surface of the roadway, making it slippery.

Visibility - Being able to see clearly in all directions and being visible to other drivers are important in all weather conditions. This is more difficult in bad weather. To be seen more clearly during daylight hours, turn on your headlights.

Inspect your windshield wipers and washers frequently. Keep the windshield washer reservoir full of the proper fluid. Replace the windshield wiper blades if they start to streak the windshield or leave parts unwiped. Use the defrosters and air conditioning to keep the windows from fogging up on the inside (see page 69).

Driving in Bad Weather, Towing a Trailer

Traction — Check your tires frequently for wear and proper pressure. Both are important in preventing "hydroplaning" (loss of traction on a wet surface). In the winter, mount snow tires on all four wheels for the best handling.

Watch road conditions carefully, they can change from moment to moment. Wet leaves can be as slippery as ice. "Clear" roads can have patches of ice. Driving conditions can be very hazardous when the outside temperature is near freezing. The road surface can become covered with areas of water puddles mixed with areas of ice, so your traction can change without warning.

Be careful when downshifting. If traction is low, you can lock up the drive wheels for a moment and cause a skid.

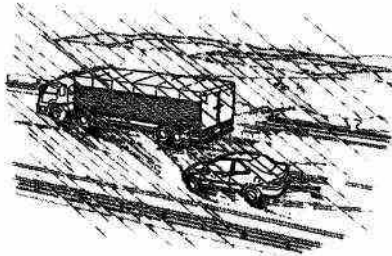

Be very cautious when passing, or being passed by, other vehicles. The spray from large vehicles reduces your visibility, and the wind buffeting can cause you to lose control.

Towing a Trailer

Your car is not designed to tow a trailer. Attempting to do so can void your warranties.

Regularly maintaining your Honda is the best way to protect your investment. You will be rewarded with safer, more economical, trouble-free driving. This section lists items that need to be checked regularly and explains how to check them. It also details some simple maintenance tasks you can do yourself. The maintenance schedules for normal and severe driving conditions show you when these things need to be done.

If you are interested in how to perform more complex maintenance on your Honda, you can purchase the Service Manual. See page 191 for information on how to obtain a copy, or see your Honda dealer.

Maintenance Schedule.....	104	Spark Plugs	126
Maintenance Record	107	Replacement	126
Periodic Checks	109	Specifications	128
Fluid Locations	110	Battery	128
Engine Oil	111	Windshield Wipers	131
Checking Engine Oil	111	Air Conditioning	133
Adding.....	111	Engine Belts	134
Recommended Oil	112	Tires	134
Additives	112	Inflation	134
Oil and Filter Changes	113	Inspection	135
Cooling System	115	Maintenance	136
Checking the Coolant Level	115	Tire Rotation	136
Adding Engine Coolant	115	Replacing Tires	137
Replacing Coolant	116	Wheels and Tires	137
Windshield Washers	119	DOT Tire Quality Grading ..	137
Transmission Oil.....	120	Treadwear	137
Automatic Transmission...	120	Traction	138
5-speed Manual	121	Temperature	138
Transmission.....	121	Winter Driving.....	139
Brake and Clutch Fluid	122	Snow Tires.....	139
Brake System	122	Tire Chains	139
Clutch System	123	Lights	140
Power Steering	124	Replacing Bulbs	140
Air Cleaner Element	NO TAG	Storing Your Car	146
Fuel Filter	126		

Maintenance Schedule

The Required Maintenance Schedule specifies how often you should have your car serviced, and what things need attention. It is essential that your car be serviced as scheduled to retain its high level of safety, dependability, and emission control performance.

The services and time or mileage intervals shown in the maintenance schedule assume you will use your car as normal transportation for passengers and their possessions. You should:

- Avoid exceeding your car's load limit. This puts excess strain on the engine, brakes, and many other parts of your car. The load limit is shown on the label in the glove box.
- Operate your car on reasonable roads within the legal speed limit.

- Drive your car regularly over a distance of several miles (kilometers).
- Always use unleaded gasoline with a pump octane number of 86 or higher.

Your authorized Honda dealer knows your car best, and can provide competent, efficient service. However, service at a dealer is not mandatory to keep your warranties in effect. Maintenance may be done by any qualified service facility or person who is skilled in this type of automotive service. Keep all the receipts as proof of completion, and have the person who does the work fill out the maintenance record on page 105. Check your warranty booklet for more information.

We recommend the use of Genuine Honda parts and fluids or their equivalent whenever you have maintenance done. These are the same high-quality items that went into your car when it was new, so you can be sure they fit and perform flawlessly.

U.S. Care:

Maintenance, replacement or repair of emission control devices and systems may be done by any automotive repair establishment or individual using parts that are "certified" to EPA standards.

Vehicles sold in California have slightly different maintenance requirements. These are noted in the Required Maintenance Schedule. Other maintenance operations are required by California regulations, and condition the emission warranty.

R — Replace I — Inspect After inspection, clean, adjust, repair or replace if necessary.

Service at the interval listed x 1,000 miles (or km) or after that number of months, whichever comes first.	x 1,000 miles	7.5	15	22.5	30	37.5	45	52.5	60	67.5	75	82.5	90	97.5	105
	x 1,000 km	12	24	36	48	60	72	84	96	108	120	132	144	156	168
	months	6	12	18	24	30	36	42	48	54	60	66	72	78	84
Engine and Transmission															
<input type="checkbox"/> Air cleaner element					R				R				R		
Idle speed									I*1						
Positive crankcase ventilation valve									I						
Valve clearance			I		I		I		I		I		I		I
Fuel filter									R*1						
Fuel pipes, hoses, and connections					I*1				I*1				I*1		
Spark plugs					R				R				R		
Distributor ignition cap and rotor									I*1						
Ignition wires									I						
<input checked="" type="checkbox"/> Engine oil and oil filter		R	R	R	R	R	R	R	R	R	R	R	R	R	R
Alternator drive belt					I				I				I		
Cooling system hoses and connections					I*1				I*1				I*1		
• Engine coolant							R				R				R*2
Timing belt													R*3		
Water pump													I		
Three-way catalytic converter heat shield									I						
Exhaust pipe (before catalytic converter)					I*1				I*1				I*1		
Exhaust pipe and muffler (after catalytic converter)			I		I		I		I		I		I		I
Transmission oil					R				R				R		

• : Check oil and coolant level at each fuel stop.

: Under severe driving conditions, service these items more often.

*1: For cars sold in California, this service is recommended only; other areas, it is required.

*2: Thereafter, replace every 2 years or 30,000 miles (48,000 km), whichever comes first.

*3: This service is recommended only.

Maintenance Schedule

R - Replace I - Inspect After inspection, clean, adjust, repair or replace if necessary.

Service at the interval listed x 1,000 miles (or km) or after that number of months, whichever comes first.	x 1,000 miles	7.5	15	22.5	30	37.5	45	52.5	60	67.5	75	82.5	90	97.5	105
	x 1,000 km	12	24	36	48	60	72	84	96	108	120	132	144	156	168
	months	6	12	18	24	30	36	42	48	54	60	66	72	78	84
Brakes															
Front brake pads		I	I	I	I	I	I	I	I	I	I	I	I	I	I
<input type="checkbox"/> Front brake discs and calipers			I		I		I		I		I		I		I
Rear brake drums, wheel cylinders and linings					I				I				I		
Brake hoses and lines			I		I		I		I		I		I		I
Parking brake			I		I				I				I		
Brake fluid					R				R				R		
Steering and suspension, miscellaneous															
Front wheel alignment			I		I		I		I		I		I		I
Steering operation, tie rod ends, steering gear box and boots			I		I				I				I		
<input type="checkbox"/> Power steering system			I		I		I		I		I		I		I
Power steering pump belt					I				I				I		
Suspension mounting bolts			I		I		I		I		I		I		I
Supplemental Restraint System		Inspect system 10 years after production (see page 15).													

Severe Driving Conditions:

Items with an **[R]** or an **[I]** in the chart will need service more often, if you drive under these conditions:

- Repeated short distance driving.
- Dusty conditions.
- Severe cold weather.
- Areas with road salt or other corrosive materials.
- Rough or muddy roads.

The services are:

- Replace the air cleaner element every 15,000 miles (24,000 km) or 12 months under condition B or E.
- Replace engine oil and oil filter every 3,750 miles (6,000 km) or 3 months under condition A or B.
- Inspect front brake discs and calipers every 7,500 miles (12,000 km) or 6 months under condition A, B, D, or E.
- Inspect the power steering system every 7,500 miles (12,000 km) or 6 months under condition B, C, or E.

Required Maintenance Record

Have your servicing dealer record all Required Maintenance below. Keep receipts for all work done on your car.

7,500 MI 12,000 km (or 6 Mo.)	(Sign or Stamp)	Mi (km)
		Date
15,000 MI 24,000 km (or 12 Mo.)	(Sign or Stamp)	Mi (km)
		Date
22,500 MI 36,000 km (or 18 Mo.)	(Sign or Stamp)	Mi (km)
		Date
30,000 MI 48,000 km (or 24 Mo.)	(Sign or Stamp)	Mi (km)
		Date
37,500 MI. 60,000 km (or 30 Mo.)	(Sign or Stamp)	Mi (km)
		Date
45,000 MI. 72,000 km (or 36 Mo.)	(Sign or Stamp)	Mi (km)
		Date
52,500 MI. 84,000 km (or 42 Mo.)	(Sign or Stamp)	Mi (km)
		Date

60,000 MI. 96,000 km (or 48 Mo.)	(Sign or Stamp)	Mi (km)
		Date
67,500 MI. 108,000 km (or 60 Mo.)	(Sign or Stamp)	Mi (km)
		Date
75,000 MI. 120,000 km (or 60 Mo.)	(Sign or Stamp)	Mi (km)
		Date
82,500 MI. 132,000 km (or 66 Mo.)	(Sign or Stamp)	Mi (km)
		Date
90,000 MI. 144,000 km (or 72 Mo.)	(Sign or Stamp)	Mi (km)
		Date
97,500 MI. 156,000 km (or 78 Mo.)	(Sign or Stamp)	Mi (km)
		Date
105,000 MI. 168,000 km (or 84 Mo.)	(Sign or Stamp)	Mi (km)
		Date

Non-Scheduled Maintenance Record

Record additional maintenance for severe driving conditions or non-scheduled maintenance on this page (see page 104).

Maintenance Performed:	(Sign or Stamp)	Mi. (km)
		Date
Maintenance Performed:	(Sign or Stamp)	Mi. (km)
		Date
Maintenance Performed:	(Sign or Stamp)	Mi. (km)
		Date
Maintenance Performed:	(Sign or Stamp)	Mi. (km)
		Date
Maintenance Performed:	(Sign or Stamp)	Mi. (km)
		Date
Maintenance Performed:	(Sign or Stamp)	Mi. (km)
		Date

Maintenance Performed:	(Sign or Stamp)	Mi. (km)
		Date
Maintenance Performed:	(Sign or Stamp)	Mi. (km)
		Date
Maintenance Performed:	(Sign or Stamp)	Mi. (km)
		Date
Maintenance Performed:	(Sign or Stamp)	Mi. (km)
		Date
Maintenance Performed:	(Sign or Stamp)	Mi. (km)
		Date
Maintenance Performed:	(Sign or Stamp)	Mi. (km)
		Date

You should check the following items at the specified intervals. If you are unsure of how to perform any check, turn to the page given.

- Engine oil level - Check every time you fill the fuel tank. See page [84](#).
- Engine coolant level - Check the radiator reserve tank every time you fill the fuel tank. See page [85](#).
- Windshield washer fluid - Check the level in the reservoir monthly. If weather conditions cause you to use the washers frequently, check the reservoir each time you stop for fuel. See page [119](#).
- Automatic transmission - Check the fluid level monthly. See page [120](#).
- Brakes, clutch and power steering - Check the fluid level monthly. See pages [122](#) through [124](#).
- Tires - Check the tire pressure monthly. Examine the tread for wear and foreign objects. See page [135](#).
- Battery - Check its condition and the terminals for corrosion monthly. See page [128](#).
- Air conditioning - Check its operation weekly. See page [133](#).
- Lights - Check the operation of the headlights, parking lights, taillights, high-mount brake light, turn signals, brake lights, and license plate lights monthly. See page [140](#).

Fluid Locations

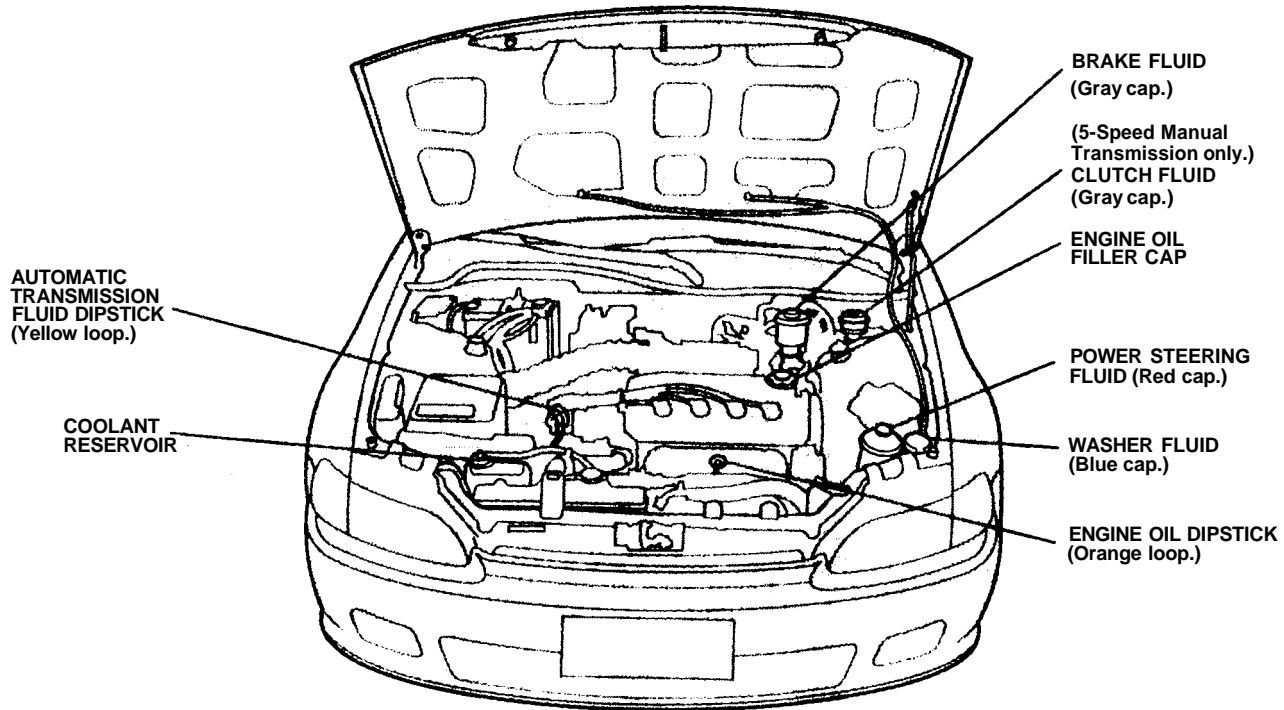

Checking Engine Oil

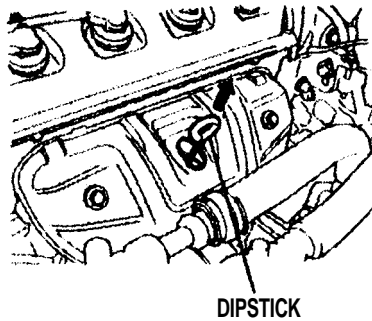

Check the engine oil a couple of minutes after shutting off the engine. This will allow the oil to drain down to the bottom of the engine. Make sure the car is parked on level ground.

1. Pull out the dipstick (orange loop) and wipe it with a cloth or paper towel.
2. Insert it all the way back in its tube.

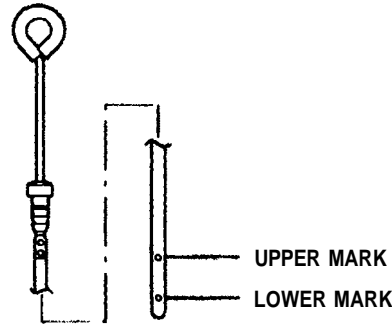

3. Pull it out again and look at the oil level at the end of the dipstick. If it is between the upper and lower marks, the level is correct. Add oil if the level is at or below the lower mark.

Adding

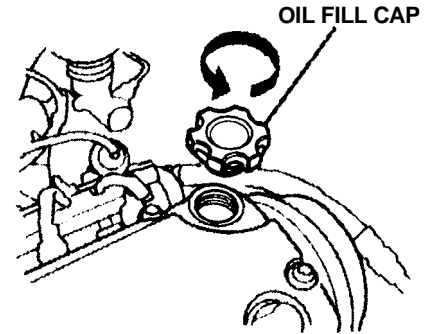

To add oil, unscrew and remove the engine oil fill cap on top of the valve cover. Pour in the oil, and replace the fill cap, and tighten it securely. Wait a few minutes and recheck the oil level. Do not fill above the upper mark; you could damage the engine.

Recommended Oil

Oil is a major contributor to your engine's performance and longevity. Always use a premium-grade detergent oil. You can determine an oil's SAE viscosity and Service Classification from the API Service label on the oil container. It should look like this:

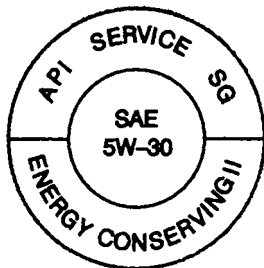

The numbers in the middle tell you the oil's SAE viscosity or weight. Select the oil for your car according to this chart:

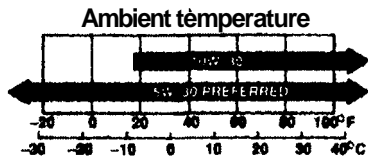

An oil with a viscosity of 5W-30 is preferred for improved fuel economy and year-round protection in your Honda. You may use a 10W-30 oil if the temperature in your area never goes below 20°F (-7°C).

A fuel-efficient oil is recommended for your Honda. This is shown on the API Service label by the words "Energy Conserving II." This oil is formulated to help your engine use less fuel.

The API Service label also tells you the service classification of the oil. Always use an oil that says "API Service SG." This service rating may also include other designations, such as CD. These additional classifications are not a problem, as long as the label also carries the SG classification. An oil that is only classified SF is not recommended.

Additives

Your Honda does not need any oil additives. Purchasing additives for the engine or transmission will not increase your car's performance or longevity. It only increases the cost of operating your car.

Oil and Filter Changes

Always change the oil and filter according to the time and distance (miles, kilometers) recommendations on the maintenance schedule. The oil and filter collect contaminants that can damage your engine if they are not removed regularly.

Changing the oil and filter requires special tools and access from underneath the car. The car should be raised on a service station-type hydraulic lift for this service. Unless you have the knowledge and proper equipment, you should have this maintenance done by a skilled mechanic.

Repeated, prolonged exposure to used motor oil may cause skin cancer.

Wash your hands thoroughly with strong soap as soon as possible after handling used oil.

1. Run the engine until it reaches normal operating temperature, then shut it off.

The oil, engine components and the exhaust system are hot and can burn you.

Use caution and wear protective clothing while working in the engine compartment.

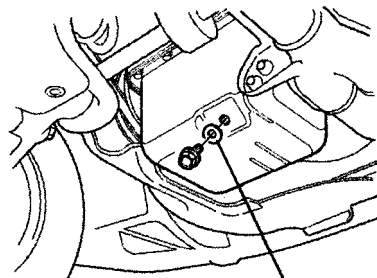

OIL DRAIN BOLT

2. Open the hood and remove the oil fill cap. Remove the oil drain bolt from the bottom of the engine. Drain the oil into an appropriate container.

continued

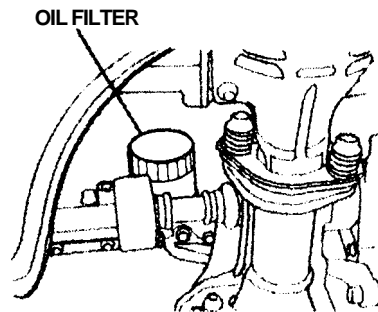

3. Remove the oil filter and let the remaining oil drain. A special wrench (available from your Honda dealer) is required to remove the filter.
4. Install a new oil filter according to the instructions that come with it.

5. Put a new washer on the drain bolt, then reinstall the drain bolt. Tighten it to 40 N.m (4.0 kg-m 29 lb-ft).
6. Refill the engine with the recommended oil. Engine oil capacity (including filter): 3.5 U.S. qt (2.9 Imp. qt. 3.3ℓ).
7. Replace the oil fill cap. Start the engine. The indicator light should go out within five seconds. If it does not, turn off the engine and inspect your work.
8. Let the engine run for several minutes and check the drain bolt and oil filter for leaks.
9. Turn off the engine, let it sit for several minutes, then check the oil level. If necessary, add oil to bring the level to the upper mark on the dipstick.

NOTICE

If you change your own oil, please dispose of the used oil properly. Put it in a sealed container and take it to a recycling center. Do not discard it in a trash bin or dump it on the ground.

The oil and filter should be changed every 6 months or 7,500 miles (12,000 km), whichever comes first. Under severe driving conditions, they should be changed every 3 months or 3,750 miles (6,000 km). See page 106 for a description of severe driving conditions.

Checking the Engine Coolant Level

RESERVE TANK

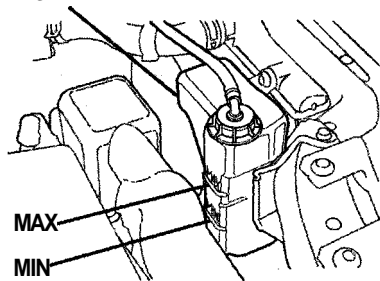

Check the level of the engine coolant by looking at the radiator reserve tank next to the air cleaner element box. If the level is at or below the MIN line, add coolant to bring it up to the MAX line. This coolant should always be a mixture of 50% antifreeze and 50% water. Never add straight antifreeze or plain water.

Always use Genuine Honda Antifreeze/Coolant. The cooling system contains many aluminum components that can corrode if an improper antifreeze is used. Some antifreeze, even though labeled as safe for aluminum parts, may not provide adequate protection.

Adding Engine Coolant

If the reserve tank is completely empty, you should also check the coolant level in the radiator.

Removing the radiator cap while the engine is hot can cause the coolant to spray out, seriously scalding you.

Always let the engine and radiator cool down before removing the radiator cap.

1. Make sure the engine and radiator are cool.

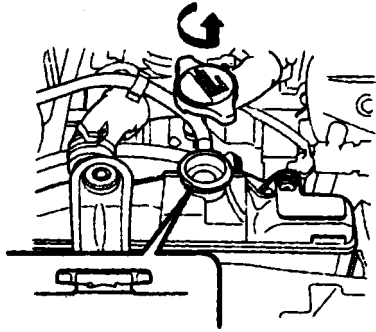

2. Turn the radiator cap counter-clockwise, without pressing down on it, until it stops. This relieves any pressure remaining in the cooling system.
3. Remove the radiator cap by pushing down and turning counterclockwise.

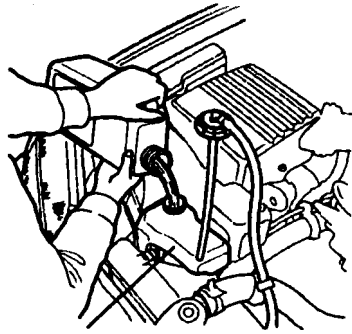

RESERVE TANK

4. The coolant level should be up to the base of the filler neck. Add coolant if it is low.
5. Put the radiator cap back on. Tighten it fully.
6. Pour coolant into the reserve tank. Fill it to halfway between the MAX and MIN marks. Put the cap back on the reserve tank.

Do not add any rust inhibitors or other additives to your car's

cooling system. They may not be compatible with the coolant or engine components.

Replacing Engine Coolant

The cooling system should be completely drained and refilled with new coolant according to the time and mileage recommendations in the maintenance schedule. Only use recommended antifreeze.

Draining the coolant requires access to the underside of the car. Unless you have the tools and knowledge, you should have this maintenance done by a skilled mechanic.

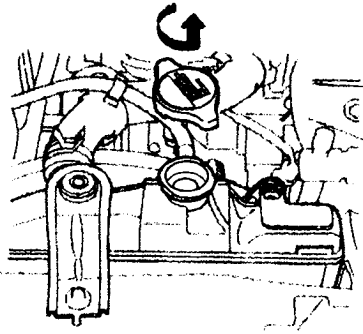

1. Slide the heater temperature control lever to maximum heat. Open the hood. Make sure the engine and radiator are cool to the touch.
2. Remove the radiator cap.

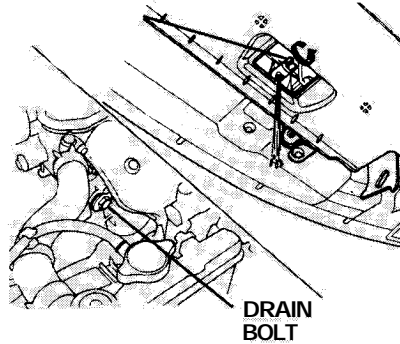

3. Loosen the drain plug in the bottom of the radiator. The coolant will drain through the splash guard. Remove the drain bolt from the engine block.

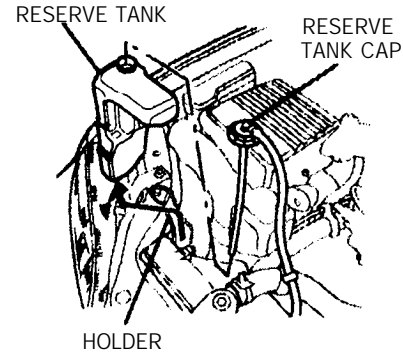

4. Remove the reserve tank from its holder by pulling it straight up. Drain the coolant, then put the tank back in its holder.
5. When the coolant stops draining, tighten the drain plug in the bottom of the radiator. Apply non-hardening sealant to the drain bolt threads and reinstall the bolt in the engine block. Tighten it securely.

continued

Cooling System

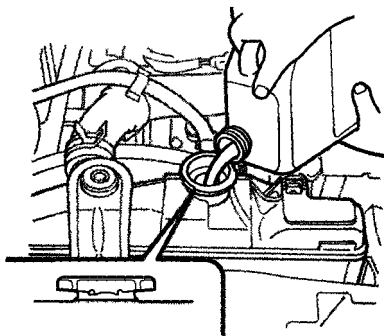

- Mix the recommended antifreeze with an equal amount of purified or distilled water in a clean container. The cooling system capacity is:
With 5-speed manual transmission:
0.95 U.S. gal (0.79 Imp. gal, 3.6ℓ)
With automatic transmission:
DX:
0.92 U.S. gal (0.77 Imp. gal, 3.5 ℓ)
U.S.: EX, EX w/option package
Canada: Si
1.00 U.S.gal (0.841mp. gal, 3.8 ℓ)

BLEEDER BOLT

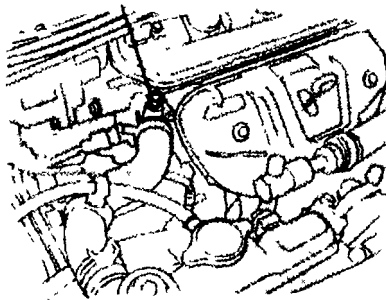

- Pour coolant into the radiator up to the base of the filler neck.
- Loosen the bleeder bolt on top of the engine. Tighten it again when coolant comes out in a steady stream with no bubbles.
- Refill the radiator to the base of the filler neck. Put the cap on the radiator, only tighten it to the first stop. Start the engine and let it run until it warms up (the radiator cooling fan comes on at least twice).

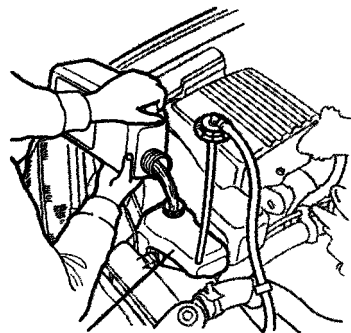

RESERVE TANK

- Turn off the engine. Check the level in the radiator, add coolant if needed. Install the radiator cap, tighten it fully.
- Fill the reserve tank to the MAX mark. Install the reserve tank cap.

Check the level in the windshield washer reservoir at least monthly during normal usage. In bad weather, when you use the washers often, check the level every time you stop for gas.

The windshield washer reservoir is located behind the left headlight. Check the reservoir's fluid level by removing the cap and looking inside.

Fill the reservoir with a good-quality windshield washer fluid. This increases the cleaning capability and prevents freezing in cold weather.

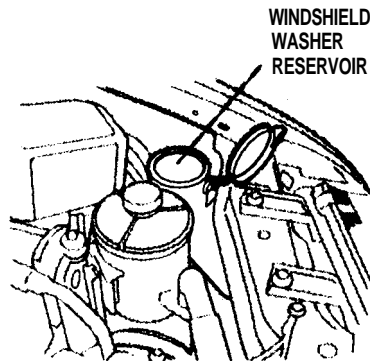

NOTICE

Do not use engine antifreeze or a vinegar/water solution in the windshield washer reservoir.

Antifreeze can damage your car's paint, while a vinegar/water solution can damage the windshield washer pump.

Use only commercially-available windshield washer fluid.

Automatic Transmission

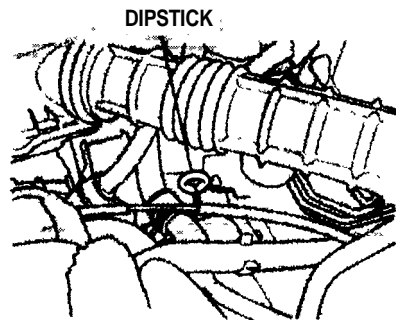

Check the fluid level with the engine at normal operating temperature.

1. Park the car on level ground. Shut off the engine.
2. Remove the dipstick (yellow loop) from the transmission and wipe it with a clean cloth.

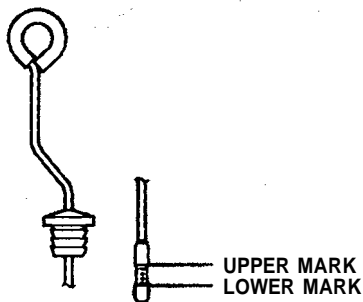

3. Insert the dipstick into the transmission.
4. Remove the dipstick and check the fluid level. It should be between the upper and lower marks.

5. If the level is below the lower mark, add fluid into the tube to bring it to the upper mark. Use Honda Premium Formula Automatic Transmission Fluid or an equivalent DEXRON® II Automatic Transmission Fluid (ATF) only.
6. Insert the dipstick all the way back in the transmission.

The transmission should be drained and refilled with new fluid every 24 months or 30,000 miles (48,000 km), whichever comes first.

5-Speed Manual Transmission

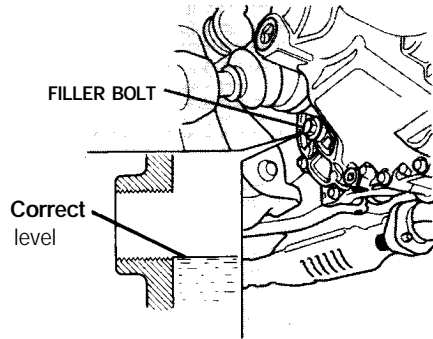

Check the oil level a couple of minutes after shutting off the engine. Make sure the car is on level ground. Remove the transmission filler bolt. The oil level should be up to the edge of the bolt hole. Feel inside the bolt hole with your finger. If you do not feel any oil, slowly add oil until it starts to run out of the hole. Reinstall the filler bolt and tighten it securely.

Only use an SF or SG grade motor oil with viscosity of SAE 10W-30 or 10W-40.

The transmission should be drained and refilled with new oil every 24 months or 30,000 miles (48,000 km) whichever comes first.

Brake and Clutch Fluid

Brake and Clutch Fluid

Check the fluid level in the reservoirs monthly. There are two reservoirs, depending on which model. They are:

- Brake fluid reservoir (all models).
- Clutch fluid reservoir (5-speed manual transmission only).

The brake fluid should be replaced every 2 years or 30,000 miles (48,000km).

Brake System

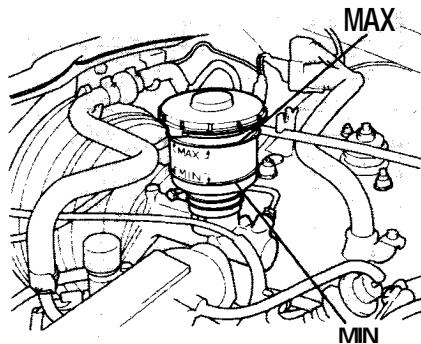

The fluid level should be between the MIN and MAX marks on the side of the reservoir. If the level is at or below the MIN mark, it is an indication that your brake system needs attention. Have the brake system inspected for leaks or worn brake pads.

If you add brake fluid to bring it up to the MAX mark, use Genuine Honda Brake Fluid or an equivalent from a sealed container that is marked DOT 3 or DOT 4 only. Brake fluid marked DOT 5 is not compatible with your car's braking system.

Clutch System

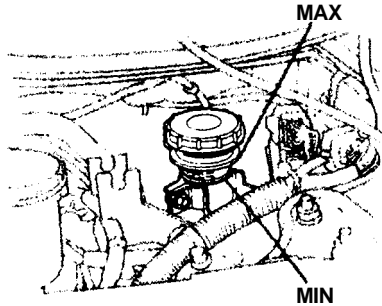

The fluid level should be between the MIN and MAX marks on the side of the reservoir. If it is not, add brake fluid to bring it up to that level. Use the same DOT 3 or DOT 4 brake fluid specified for the brake system.

Low fluid level can indicate a leak in the clutch system. Have this system inspected as soon as possible.

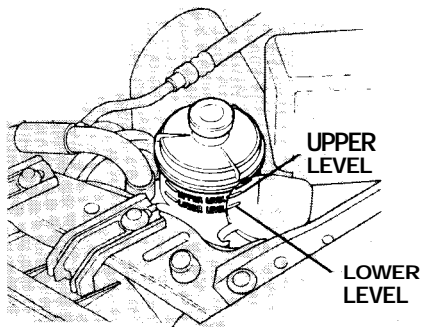

NOTICE

Using automatic transmission fluid or another brand of power steering fluid will damage the system. Use only genuine Honda power steering fluid.

A low power steering fluid level can indicate a leak in the system. Check the fluid level frequently and have the system inspected as soon as possible.

You should check the fluid level in the power steering reservoir monthly. Check the level when the engine is cold. Look at the side of the reservoir. The fluid should be between the UPPER LEVEL and LOWER LEVEL. If it is below the LOWER LEVEL, add power steering fluid to the UPPER LEVEL.

The air cleaner element should be replaced every 2 years or 30,000 miles (48,000 km), whichever comes first. Under severe driving conditions, it should be replaced every 12 months or 15,000 miles (24,000 km), whichever comes first.

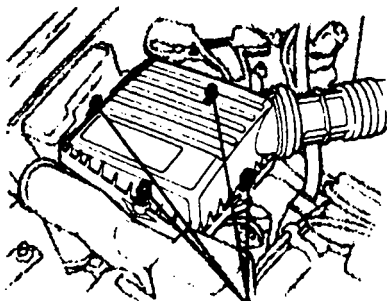

BOLTS

The air cleaner element is inside the box on the passenger's side of the engine compartment. To replace it:

1. Loosen the four bolts and remove the air cleaner housing cover.
2. Remove the old air cleaner element. Clean the inside of the housing with a damp rag.

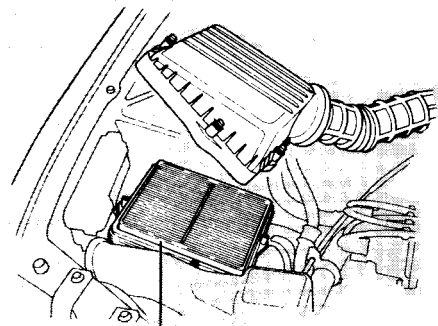

AIR CLEANER ELEMENT

3. Place the new air cleaner element in the housing.
4. Reinstall the housing cover, tighten the four bolts.

Fuel Filter

The fuel filter should be replaced every 4 years or 60,000 miles (96,000 km), whichever comes first.

Have a qualified technician change the fuel filter. Since the fuel system is under pressure, gasoline can spray out and create a hazard if all fuel line connections are not handled correctly.

The filter may require replacement sooner if you happen to buy one or more tankfuls of contaminated gasoline. Have the filter tested or replaced if you suspect it has been clogged by contaminants.

Spark Plugs

The original spark plugs in your car need to be replaced every 2 years or 48,000 km (30,000 miles), whichever comes first.

Replacement

SPARK PLUG CAP

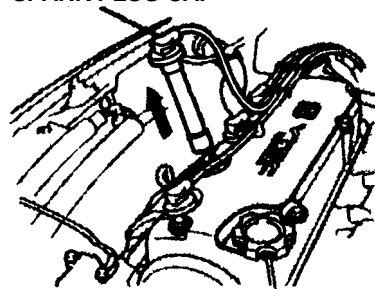

1. Clean up any dirt and oil that have collected around the spark plug caps.
2. Remove the spark plug cap by pulling it straight out.
3. Remove the spark plug, using a 16 mm (5/8 inch) spark plug socket.

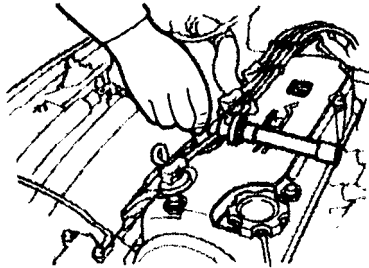

4. Set the gap on the new spark plug with a wire-type spark plug gapping tool. Do not use a blade-type feeler gauge. Plug gap should be: 0.04 in (1.1 mm).
5. Put the new spark plug into the socket, then thread it into the hole. Screw it in by hand so you do not crossthread it.

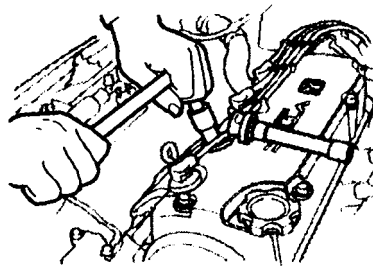

6. Torque the spark plug. (If you do not have a torque wrench, tighten the spark plug one-quarter turn after it contacts the cylinder head.)
Tightening torque:
13 lb-ft (18 Nm, 1.8 kg-m).

NOTICE

Tighten the spark plugs carefully. A spark plug that is too loose can overheat and damage the engine. Overtightening can cause damage to the threads in the cylinder head.

7. Install the spark plug cap.
8. Repeat this procedure for the other three spark plugs.

continued

Spark Plugs, Battery

Spark Plugs Specifications:

DX

Normal driving conditions

NGK: **ZFR5F-11**

Nippondenso: **KJ16CR-L11**

Hot climates, or continuous high speed driving

NGK: **ZFR6F-11**

Nippondenso: **KJ20CR-L11**

U.S.: EX, EX with option package

Canada: Si

Normal driving conditions

NGK: **ZFR5J-11**

Nippondenso: **KJ16CR-L11**

Hot climates, or continuous high speed driving

NGK: **ZFR6J-11**

Nippondenso: **KJ20CR-L11**

Battery

Check the condition of your car's battery monthly. You should check for proper electrolyte level and corrosion on the terminals.

The battery gives off explosive hydrogen gas during normal operation. A spark or open flame can cause the battery to explode with enough force to kill or seriously hurt you.

Wear protective clothing and a face shield, or have a skilled mechanic do the battery maintenance.

The battery contains sulfuric acid (electrolyte) which is highly corrosive and poisonous.

Getting electrolyte in your eyes or on your skin can cause serious burns. Wear protective clothing and eye protection when working near the battery.

Swallowing electrolyte can cause fatal poisoning if immediate action is not taken.

KEEP OUT OF THE REACH OF CHILDREN.

Emergency Procedures

Eyes — Flush with water from a cup or other container for at least 15 minutes. (Water under pressure can damage the eye.) Immediately call a physician or 911.

Skin — Remove contaminated clothing. Flush the skin with large quantities of water. Call a physician immediately.

Swallowing — Drink water or milk. Call your local Poison Control Center or a physician immediately.

TEST INDICATOR WINDOW

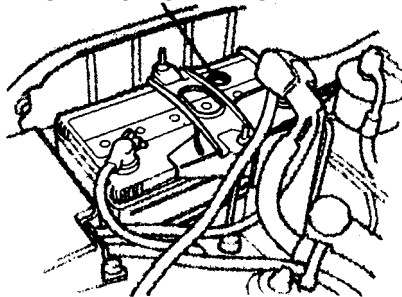

Check the battery condition by looking at the test indicator window on the battery.

Check the battery terminals for corrosion (a white or yellowish powder). To remove it, cover the terminals with a solution of baking soda and water. It will bubble up and turn brown. When this stops, wash it off with plain water. Dry off the battery with a cloth or paper towel. Coat the terminals with grease to help prevent future corrosion.

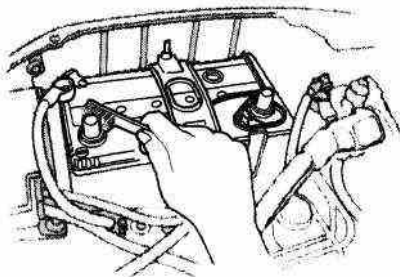

If the terminals are severely corroded, clean them with baking soda and water. Then use a wrench to loosen and remove the cables from the terminals. Always disconnect the negative (-) cable first and reconnect it last. Clean the battery terminals with a terminal cleaning tool or wire brush. Reconnect and tighten the cables, then coat the terminals with grease.

If you need to connect the battery to a charger, disconnect both cables to prevent damage to the car's electrical system.

NOTICE

Charging the battery with the cables connected can seriously damage your car's electronic controls. Detach the battery cables before connecting the battery to a charger.

Check the condition of the windshield wiper blades at least every six months. Look for signs of cracking in the rubber, or areas that are getting hard. Replace the blades if you find these signs, or they leave streaks and unwiped areas when used.

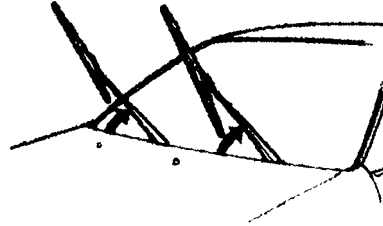

To replace:

1. Raise the wiper arm off the windshield.

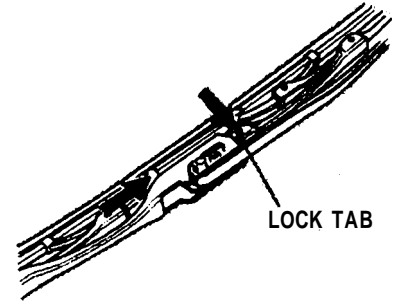

2. Disconnect the blade assembly from the wiper arm by pushing in the lock tab. Hold it in while you push the blade assembly toward the base of the arm.

continued

Windshield Wipers

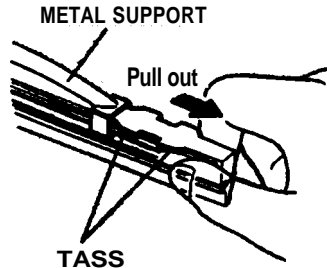

3. Remove the blade from its holder by grasping the tabbed end of the blade. Pull firmly until the tabs come out of the holder.

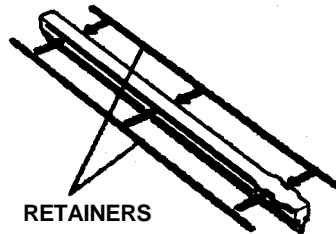

4. Examine the new wiper blades. If they have no plastic or metal reinforcement along the back edge, remove the metal reinforcement strips from the old wiper blade and install them in the slots along the edge of the new blade.
5. Slide the new wiper blade into the holder until the tabs lock.

6. Slide the blade assembly onto the wiper arm. Make sure it locks in place.
7. Lower the wiper arm down against the windshield.

Your car's air conditioning is a sealed system. Any major maintenance, such as recharging, should be done by a qualified technician. There are a couple of things you can do to make sure the air conditioning works efficiently.

AIR CONDITIONING
CONDENSER

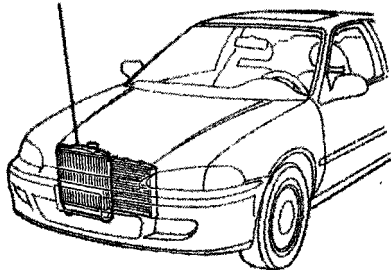

Periodically check the engine's radiator and air conditioning

condenser for leaves, insects, and dirt stuck to the front surface. These block the air flow and reduce cooling efficiency. Use a light spray from a hose or a soft brush to remove them.

NOTICE

The condenser and radiator fins bend easily. Only use a low-pressure spray or soft-bristle brush to clean them.

Run the air conditioning at least once a week during the cold weather months. Run it for at least 10 minutes while you are driving at a steady speed with the engine at normal operating temperature. This circulates the lubricating oil contained in the refrigerant.

If the air conditioning does not get as cold as before, it is probably because some of the refrigerant has leaked from the system. Have your dealer check the system for leaks and recharge the system with Refrigerant 12 (R-12).
Charging quantity:
21-23 oz (600-650 g).

This system uses SUNISO 5GS refrigerant oil.

NOTICE

Whenever you have the air conditioning system serviced, make sure the service facility uses a refrigerant recycling system. This system captures the refrigerant for reuse. Releasing refrigerant into the atmosphere can damage the environment.

Engine Belts

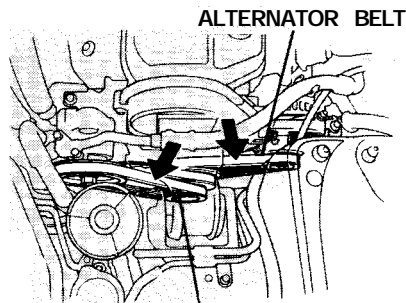

POWER STEERING BELT

Check the condition of the two engine belts. Examine the edges of each belt for cracks or fraying. Check the tension of each belt by pushing on it with your thumb midway between the pulleys.

The belts should have the following "play" or deflection.

Alternator belt:

0.28-0.41 in (7.0-10.5 mm)

Power steering belt:

0.31-0.47 in (8.0-12.0 mm)

If you see signs of wear or looseness, have your dealer adjust or replace the belts.

Tires

Check the inflation and condition of your car's tires at least once a month.

Inflation

Check the pressure in the tires when they are cold. This means the car has been parked for at least three hours. If you have to drive the car before checking the tire pressure, the tires can still be considered "cold" if you drive less than one mile.

If you check the pressure when the tires are hot (the car has been driven several miles), you will see readings 4 to 6 psi (0.3 to 0.4 kg/cm², 28 to 41 kPa) higher than the cold reading. This is normal. Do not let air out to match the specified cold pressure. The tire will be underinflated.

The correct cold tire pressures are:

DX

32 psi (2.2 kg/cm², 220 kPa)

U.S.: EX, EX with option package

Canada: Si

29 psi (2.0 kg/cm², 200 kPa)

Compact spare

60 psi (4.15 kg/cm², 415 kPa)

TIRE INFORMATION LABEL-
U.S.:EX with option package.

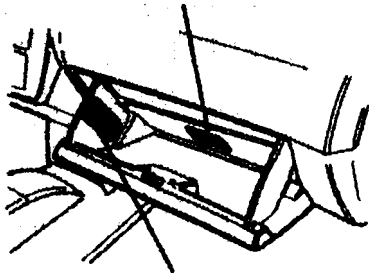

TIRE INFORMATION LABEL - DX,EX, Si

These pressures are also given on the tire information label in the glove box. Remember to check the pressure in the spare tire at the same time.

You should get your own tire pressure gauge and use it at all times. That makes it easier for you to tell if a pressure loss is caused by a tire problem and not a variation between gauges.

Keeping the tires properly inflated provides you with the best combination of riding comfort, handling and tread life. Underinflated tires wear unevenly, reduce you car's handling, and are more likely to fail because of higher temperatures. Overinflated tires make your car ride more harshly, are more prone to damage from road hazards, and wear unevenly.

Inspection

Every time you check inflation, you should also examine the tires for damage, foreign objects, and wear.

You should look for:

- Bumps or bulges in the tread or side of the tire. Replace the tire if you find either of these conditions.
- Cuts, splits, or cracks in the side of the tire. Replace the tire if you can see fabric or cord.
- Excessive tread wear.

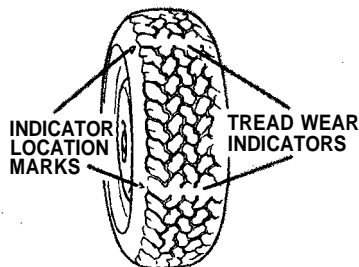

Your car's tires have wear indicators molded into the tread. When the tread wears down to that point, you will see a 1/2 inch (12.7 mm) wide band running across the tread. This shows there is less than 1/16 inch (1.6 mm) of tread left on the tire. A tire that is this worn gives very little traction on wet roads. You should replace the tire if you can see the tread wear indicator in three or more places around the tire.

Maintenance

In addition to proper inflation, correct wheel alignment helps to decrease tire wear. You should get your car's wheel alignment checked every 12 months or 15,000 miles (24,000 km).

The tires were properly balanced by the factory. They may need to be rebalanced at some time before they are worn out. Have your dealer check the tires if you feel a consistent vibration while driving. A tire should always be rebalanced if it is removed from the wheel. Make sure the installer balances the wheels when you have new tires installed. This increases riding comfort and tire life.

Tire Rotation

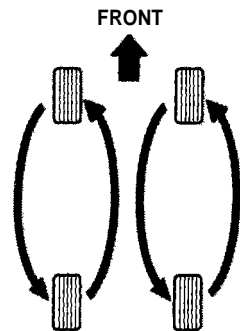

To help increase tire life and distribute wear more evenly, you should have the tires rotated every 7,500 miles (12,000 km). Move the tires to the positions shown in the chart each time they are rotated.

Replacing Tires

The tires that came with your Honda were selected to match the performance capabilities of the car and provide the best combination of handling, ride comfort, and long life. You should replace them with radial tires of the same size, load range, and speed rating. Mixing radial and bias-ply or bias-belted tires on your car can reduce its braking ability, traction, and steering accuracy.

It is best to replace all four tires at the same time. If that is not possible or necessary, then replace the two front tires or the two rear tires as a pair. Replacing just one tire can seriously affect your car's handling.

If you ever need to replace a wheel, make sure you use the same style of wheel that originally came on your Honda. Replacement wheels are available at your Honda dealer.

Wheels and Tires

Wheel:

DX
13 x 5J

U.S.: EX, EX with option package
Canada: Si
14 x 5J

Tire:

DX
P 175/70 R13

U.S.: EX, EX with option package
Canada: Si
P 185/60 R14

DOT Tire Quality Grading (U.S. Cars)

The tires on your car meet all U.S. Federal Safety Requirements. All tires are also graded for treadwear, traction, and temperature performance according to Department of Transportation

(DOT) standards. The following explains these gradings.

Treadwear

The treadwear grade is a comparative rating based on the wear rate of the tire when tested under controlled conditions on a specified government test course. For example, a tire graded 150 would wear one and one half (1-1/2) times as well on the government course as a tire graded 100. The relative performance of tires depends upon the actual conditions of their use, however, and may depart significantly from the norm due to variations in driving habits, service practices and differences in road characteristics and climate.

Traction

The traction grades, from highest to lowest, are A, B, and C, and they represent the tire's ability to stop on wet pavement as measured under controlled conditions on specified government test surfaces of asphalt and concrete. A tire marked C may have poor traction performance.

Warning: The traction grade assigned to this tire is based on braking (straight ahead) traction tests and does not include cornering (turning) traction.

Temperature

The temperature grades are A (the highest), B, and C, representing the tire's resistance to the generation of heat and its ability to dissipate heat when tested under controlled conditions on a specified indoor laboratory test wheel. Sustained high temperature can cause the material of the tire to degenerate and reduce tire life, and excessive temperature can lead to sudden tire failure. The grade C corresponds to a level of performance which all passenger car tires must meet under the Federal Motor Vehicle Safety Standard No. 109. Grades B and A represent higher levels of performance on the laboratory test wheel than the minimum required by law.

Warning: The temperature grade for this tire is established for a tire that is properly inflated and not overloaded. Excessive speed, underinflation, or excessive loading, either separately or in combination, can cause heat build-up and possible tire failure.

Winter Driving

Tires that are marked "M + S" or "All Season" on the sidewall have an all-weather tread design. They should be suitable for most winter driving conditions. Tires without these markings are designed for optimum traction in dry conditions. They may not provide adequate performance in winter driving. For the best performance in snowy or icy conditions, you should install snow tires or tire chains. They may be required by local laws under certain conditions.

Snow Tires

If you mount snow tires on your Honda, make sure they are radial tires of the same size and load range as the original tires. Mount snow tires on all four wheels to balance your car's handling in all weather conditions. Keep in mind the traction provided by snow tires on dry roads may not be as high as your car's original equipment tires. You should drive cautiously even when the roads are clear. Check with the tire dealer for maximum speed recommendations.

Tire Chains

Mount snow chains on your car when warranted by driving conditions or required by local laws. Make sure the chains are the correct size for your tires. Install them only on the front tires. If metal chains are used, they must be SAE class "S." Cable type traction devices can also be used.

When installing chains, follow the manufacturer's instructions and mount them as tightly as you can. Drive slowly with chains installed. If you hear the chains contacting the body or chassis, stop and tighten them. If they still make contact, slow down until it stops. Remove the chains as soon as you begin driving on cleared roads.

NOTICE

Chains of the wrong size or that are improperly installed can damage your car's brake lines, suspension, body, and wheels. Stop driving if you hear the chains hitting any part of the car.

Check the operation of your car's exterior lights at least once a month. A burned out bulb can create an unsafe condition by reducing your car's visibility and the ability to signal your intentions to other drivers. Check the following:

- Headlights (low and high beam).
- Parking lights.
- Taillights.
- Brake lights.
- Turn signals.
- Back-up lights.
- Hazard light function.
- License plate light.
- Side marker lights.

If you find any bulbs are burned out, replace them as soon as possible. Refer to the chart on page 179 to determine what type of replacement bulb is needed.

Replacing a Headlight Bulb

Your car has halogen headlight bulbs, one on each side. When replacing a bulb, handle it by its steel base and protect the glass from contact with your skin or hard objects. If you touch the glass, clean it with denatured alcohol and a clean cloth.

NOTICE

Halogen headlight bulbs get very hot when lit. Oil, perspiration, or a scratch on the glass can cause the bulb to overheat and shatter.

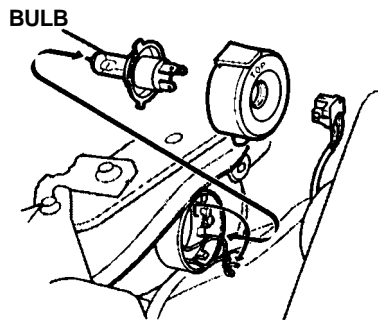

1. Open the hood. If you need to change the headlight bulb on the passenger's side, remove the air intake tube by pulling it straight up.
2. Remove the electrical connector from the bulb by squeezing the connector to unlock the tab on each side. Pull the connector straight back.

3. Remove the rubber weather seal by pulling on the tab.
4. Unclip the end of the hold-down wire from its slot. Pivot it out of the way and remove the bulb.
5. Insert the new bulb into the hole, making sure the tabs are in their slots. Pivot the hold-down wire back in place and clip the end into the slot.
6. Push the rubber weather seal over the bulb. Make sure the tab is on the top.
7. Push the electrical connector onto the tabs of the new bulb. Turn on the headlights to test the new bulb.
8. (Passenger's side)
Reinstall the air intake tube.

Replacing the Front Side Marker/Turn Signal and Parking Light Bulb

SCREW

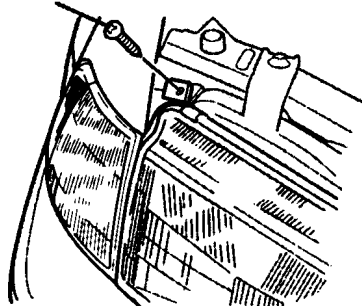

1. Use a Phillips® head screwdriver to remove the screw from the top of the fender.

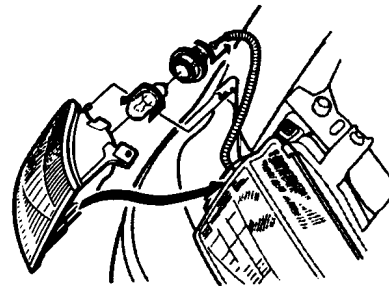

2. Move the side marker light assembly forward until it slides out of the body.
3. Turn the socket one-quarter turn counterclockwise to remove it from the lens.

continued

4. Remove the bulb by pushing it in slightly and turning it counterclockwise.
5. Install the new bulb in the socket. Turn it clockwise to lock it in place.
6. Insert the socket back into the lens. Turn it clockwise to lock it in place.
7. Turn on the parking lights to make sure the new bulb works.
8. To reinstall the light assembly in the fender, line up the guide on the assembly with the metal tab next to the headlight and line up the fingers on the light assembly with the holes in the fender. Push the light assembly straight back.
9. Install the mounting screw and tighten it securely.

Replacing Rear Bulbs (in Fenders)

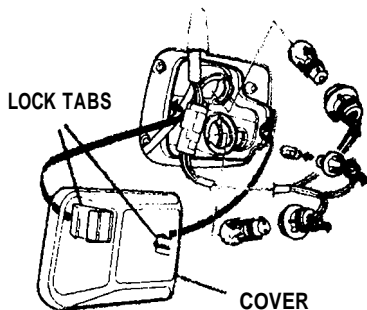

1. Open the trunk.
2. Remove the cover from the inside of the taillight assembly by pushing on the tab.
3. Determine which of the three bulbs is burned out: tail/stoplight, turn signal, or side marker. Remove the socket for that bulb by turning it counterclockwise.
4. To remove either the tail/stoplight bulb or the turn signal bulb, push it in slightly and turn it counterclockwise. To remove the side marker bulb, pull it straight out of the socket.
5. Install the new bulb in the socket. Insert the socket back in the taillight assembly and turn it clockwise to lock it in place.
6. Test the new bulb. Reinstall the cover over the taillight assembly.

Replacing Rear Bulbs (in Trunk Lid)

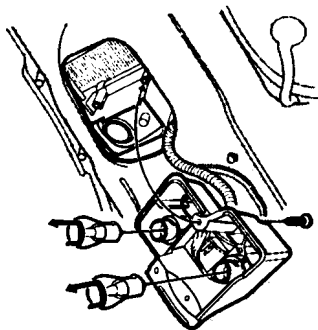

1. Open the trunk.
2. Remove the electrical connector from its hold-down clip by sliding it sideways toward the center of the car.

3. Use a Phillips® head screwdriver to remove the two screws from the bulb holder. Remove the holder from the taillight assembly.
4. Try the taillights and back-up lights to verify which bulb needs replacing. Remove that bulb from the socket by pushing it in slightly and turning it counterclockwise.
5. Install the new bulb in the socket. Test it to make sure it works.
6. Reinstall the bulb holder assembly. Install the two screws and tighten them securely.

High-Mount Brake Light

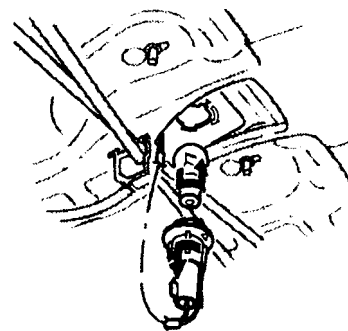

1. Open the trunk and remove the socket from the light assembly by turning it one-quarter turn counterclockwise.
2. Remove the bulb by turning it one-quarter turn counterclockwise.
3. Install the new bulb and reinstall the socket. Make sure the new bulb is working.

Replacing a Rear License Bulb

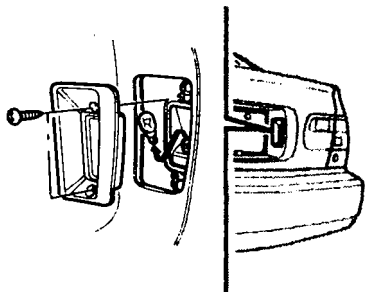

1. Remove the two screws and remove the lens.
2. Pull the bulb straight out of its socket. Push the new bulb in until it bottoms in the socket.

3. Turn on the parking lights and check that the new bulb is working.
4. Reinstall the lens. Reinstall the two screws and tighten them securely.

Replacing Interior and Trunk Light Bulbs

INTERIOR LIGHT

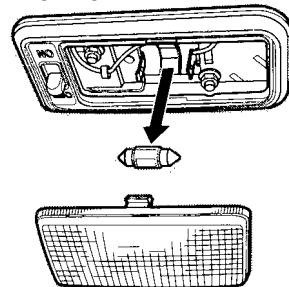

1. Remove the lens by carefully prying on the edge of the lens in the middle with a fingernail file or a small flat-tip screwdriver. Do not pry on the edge of the housing around the lens.

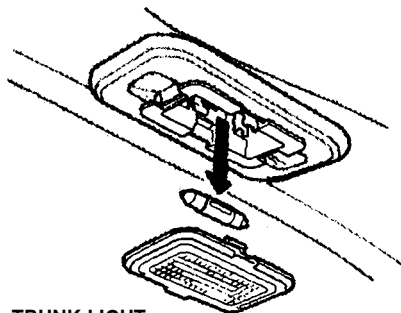

TRUNK LIGHT

2. Remove the bulb by pulling it straight out of its metal tabs.
3. Push the new bulb into the metal tabs. Snap the Jens back in place.

Storing Your Car

If you need to park your car for an extended period (more than 1 month), there are several things you should do to prepare it for storage. Proper preparation helps prevent deterioration and makes it easier to get your car back on the road. It is best to store your car indoors if at all possible.

- Fill the fuel tank.
- Change the engine oil and filter (see page 111).
- Wash and dry the exterior completely.
- Clean the interior. Make sure the carpeting, floor mats, etc. are completely dry.
- Leave the parking brake off. Put the transmission in Reverse (5-speed manual) or Park (automatic).

- Block the rear wheels.
- If the car is to be stored for a longer period, it should be supported on jackstands so the tires are off the ground.
- Leave one window open slightly (if the car is being stored indoors).
- Disconnect the battery.
- Cover the car with a "breathable" car cover, one made from a porous material such as cotton. Nonporous materials, such as plastic sheeting, trap moisture which can damage the paint.
- If possible, run the engine for a while periodically (preferably once a month).

If you store your car for 12 months or longer, have your Honda dealer perform the inspections called for in the 24 months/30,000 miles (48,000 km) maintenance schedule as soon as you take it out of storage (see page 104). The replacements called for in the maintenance schedule are not needed unless the car has actually reached that time or mileage.

Regular cleaning and polishing of your Honda helps to keep it "new" looking. This section gives you hints on how to clean and preserve your car's appearance: the paint, brightwork, wheels and interior. Also included are several things you can do to help prevent corrosion.

Exterior Care	148
Washing	148
Waxing	149
Paint Touch-up	149
Interior Care	151
Carpeting	151
Fabric	151
Vinyl	151
Seat Belts	151
Windows	152
Air Fresheners	152
Corrosion Protection	152
Body Repairs	153

Washing

Frequent washing helps preserve your car's beauty. Dirt and grit can scratch the paint, while tree sap and bird droppings can permanently ruin the finish.

Wash your car in a shady area, not in direct sunlight. If the car is parked in the sun, move it into the shade and let the exterior cool down before you start.

NOTICE

Chemical solvents and strong cleaners can damage the paint, metal and plastic on your car. Only use the solvents and cleaners recommended in this Owner's Manual.

- Rinse the car thoroughly with cool water to remove loose dirt.
 - Fill a bucket with cool water. Mix in a mild detergent, such as dishwashing liquid or a product made especially for car washing.
 - Wash the car, using the water and detergent solution and a soft-bristle brush, sponge or soft cloth. Start at the top and work your way down. Rinse frequently.
 - Check the body for road tar, tree sap, etc. Remove these stains with tar remover or turpentine. Rinse it off immediately so it does not harm the finish. Remember to re wax these areas, even if the rest of the car does not need waxing.
- When you have washed and rinsed the whole exterior, dry it with a chamois or soft towel. Letting it air-dry will cause dulling and water spots.

As you dry the car, inspect it for chips and scratches that could allow corrosion to start. Repair them with touch-up paint (see page [149](#)).

Waxing

Always wash and dry the whole car before waxing it. You should wax your car, including the metal trim, whenever water sits on the surface in large patches. It should form into beads or droplets after waxing.

You should use a quality liquid or paste wax. Apply it according to the instructions on the container. In general, there are two types of products:

Waxes — A wax coats the finish and protects it from damage by exposure to sunlight, air pollution, etc. You should use a wax on your Honda when it is new.

Polishes — Polishes and cleaner/waxes can restore the shine to paint that has oxidized and lost some of its shine. They normally contain mild abrasives and solvents that remove the top layer of the finish. You should use a polish on your Honda if the finish does not have its original shine after using a wax.

Cleaning tar, insects, etc. with removers also takes off the wax. Remember to re-wax those areas, even if the rest of the car does not need waxing.

Paint Touch-up

Your dealer has touch-up paint to match your car's color. The color code is printed on a sticker on the driver's doorjamb. Take this code to your dealer so you are sure to get the correct color.

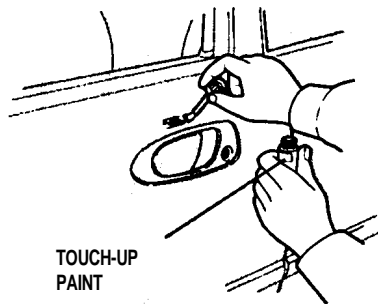

Inspect your car for chipped or scratched paint every time you wash it. Repair it as soon as possible to prevent corrosion. Use the touch-up paint on small chips and scratches. More extensive damage should be repaired by a professional.

Examine the chip or scratch closely before repairing it. If it does not go down to bare metal, clean it with soap and water and apply the touch-up paint. If it does go to the metal, apply a coat of primer first. After this dries, apply the touch-up paint. Build up the paint in the damaged area to the level of the surrounding paint. Several thin coats of paint are better than one thick coat.

Carpeting

Vacuum the carpeting frequently to remove dirt. Ground-in dirt will make the carpet wear out faster. Periodically shampoo the carpet to keep it looking new. Use one of the foam-type carpet cleaners on the market: Follow the instructions that come with the cleaner, applying it with a sponge or soft brush. Keep the carpeting as dry as possible by not adding water to the foam.

Fabric

Vacuum dirt and dust out of the material frequently. For general cleaning, use a solution of mild soap and lukewarm water, letting it air dry. To clean off stubborn spots, use a commercially-available fabric cleaner. Test it on a hidden area of the fabric first, to make sure it does not bleach or stain the fabric. Follow the instructions that come with the cleaner.

Vinyl

Remove dirt and dust with a vacuum cleaner. Wipe the vinyl with a soft cloth dampened in a solution of mild soap and water. Use the same solution with a soft-bristle brush on more difficult spots. You can also use commercially-available spray or foam-type vinyl cleaners.

Seat Belts

If your seat belts get dirty, you can use a soft brush to clean them with a mixture of mild soap and warm water. Do not use bleach, dye, or cleaning solvents. They can weaken the belt material. Let the belts air-dry before you use the car.

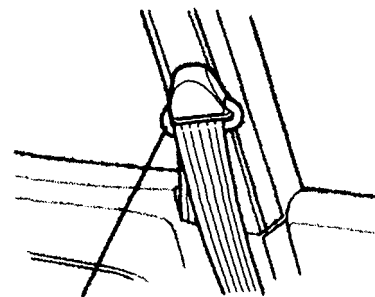

METAL LOOP

Dirt build-up in the metal loops of the seat belt anchors can cause the belts to retract slowly. Wipe the inside of the loops with a clean cloth dampened in mild soap and warm water or isopropyl alcohol.

Windows

Clean the windows, inside and out, with a commercially-available glass cleaner. You can also use a mixture of one part white vinegar to ten parts water. This will remove the haze that builds up on the inside of the windows. Use a soft cloth or paper towels to clean all glass and clear plastic surfaces.

NOTICE

The rear window defogger wires are bonded to the inside of the glass. Wiping vigorously up and down can dislodge and break the defogger wires. When cleaning the rear window, use gentle pressure and wipe side to side.

Air Fresheners

If you want to use an air freshener/deodorizer in the interior of your Civic, it is best to use a solid type. Some liquid air fresheners contain chemicals that may cause parts of the interior trim and fabric to crack or discolor.

If you use a liquid air freshener, make sure you fasten it securely so it does not spill as you drive.

Corrosion Protection

Two factors normally contribute to causing corrosion in your car:

1. Moisture trapped in body cavities. Dirt and road salt that collects in hollows on the underside of the car stays damp, promoting corrosion in that area.
2. Removal of paint and protective coatings from the exterior and underside of the car.

Many corrosion-preventive measures are built into your Honda. You can help keep your car from corroding by performing some simple periodic maintenance:

- Repair chips and scratches in the paint as soon as you discover them.
- Inspect and clean out the drain holes in the bottom of the doors and body.

- Check the floor coverings for dampness. Carpeting and floor mats may remain damp for a long time, especially in winter. This dampness can eventually cause the floor panels to corrode.
- Use a high-pressure spray to clean the underside of your car. This is especially important in areas that use road salt in winter. It is also a good idea in humid climates and areas subject to salt air.
- Have the corrosion-preventive coatings on the underside of your car inspected and repaired periodically.

Body Repairs

Body repairs affect your car's resistance to corrosion. If your car needs repairs after a collision, pay close attention to the parts used in the repair and the quality of the work.

Make sure the repair facility uses genuine Honda replacement body parts. Some companies make sheetmetal pieces that seem to duplicate the original Honda body parts, but are actually inferior in fit, finish, and quality. Once installed, they do not give the same high-quality appearance and level of corrosion resistance.

When reporting your collision to the insurance company, tell them you want genuine Honda parts used in the repair. Although most insurers recognize the higher quality of original parts, some may try to specify that the repairs be done with the "lowest cost" parts available. You should investigate this before any repairs are begun.

Take your car to your authorized Honda dealer for inspection after the repairs are completed. He can make sure that quality materials were used, and that corrosion-preventive coatings were applied to all repaired and replaced parts.

This section covers the more common problems that motorists experience with their cars. It gives you information about how to safely evaluate the problem and what to do to correct it. If the problem has stranded you on the side of the road, you may be able to get going again. If not, you will also find instructions on getting your car towed.

Compact Spare Tire	156
Changing a Flat Tire	157
If Your Engine Won't Start	162
Nothing Happens	162
The Starter Operates	
Normally	163
Jump Starting	163
If Your Engine Overheats	165
Low Oil Pressure Light.....	167
Charging System Indication ..	168
Malfunction Indicator Lamp	
(Check Engine Light)	169
Closing the Moonroof	170
Fuses	171
Checking and Replacing ...	172
Towing	174

Compact Spare Tire

Your car has a compact spare tire that takes up less space. Use this spare tire as a temporary replacement only. Get your regular tire repaired or replaced and put back on your car as soon as you can.

Check the inflation of the compact spare tire every time you check the other tires. It should be inflated to:
60 psi (4.15 kg/cm², 415 kPa).

Follow these precautions whenever you are using the compact spare tire:

- Do not exceed 50 mph (80 km/h) under any circumstances.
- This tire gives a harsher ride and less traction on some road surfaces than the regular tire. Use greater caution while driving on this tire.
- Do not mount snow chains on the compact spare.
- The wheel of the compact spare tire is designed especially to fit your car. Do not use your spare tire on another car unless it is the same make and model.

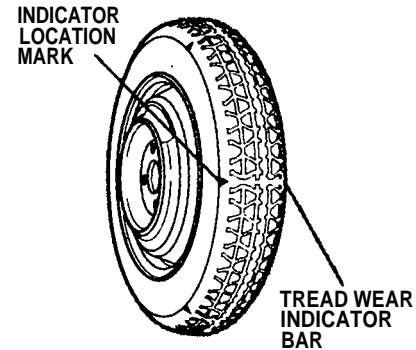

The compact spare tire has a shorter tread life than a regular tire. Replace it when you can see the tread wear indicator bars. The replacement should be the same size and design tire, mounted on the same wheel. The compact spare tire is not designed to be mounted on a regular wheel, and the compact wheel is not designed for mounting a regular tire.

If you have a flat tire while driving, stop in a safe place to change it. Stopping in traffic or on the shoulder of a busy road is dangerous. Drive slowly along the shoulder until you get to an exit or an area to stop that is far away from the traffic lanes.

The car can easily roll off the jack, seriously injuring anyone underneath.

Follow the directions for changing a tire exactly, and never get under the car when it is supported only by the jack.

1. Park the car on firm, level ground away from traffic. Turn on the hazard warning lights and turn the ignition to LOCK (0).

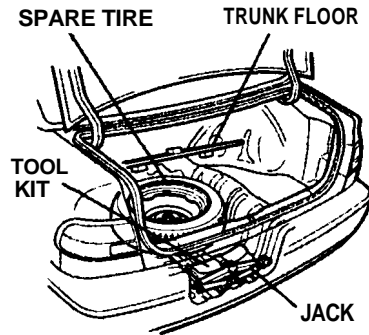

2. Put the transmission in Park (automatic) or Reverse (5-speed). Set the parking brake.
3. Open the trunk. Raise the trunk floor by lifting up on the back edge.
4. Take the tool kit out of the trunk.
5. Unscrew the wing bolt and take the spare tire out of the trunk.

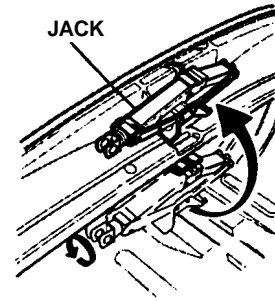

6. Turn the jack's end bracket counterclockwise to loosen it, then remove the jack.

continued

Changing a Flat Tire

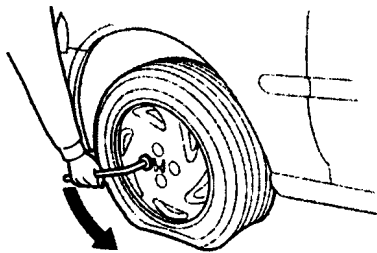

7. Loosen the four wheel nuts $\frac{1}{2}$ turn with the wheel wrench.

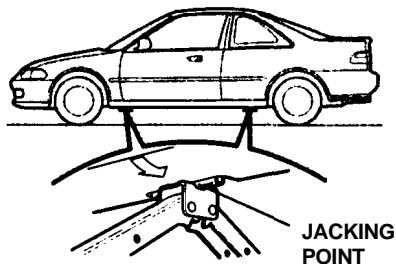

8. Locate the jacking point nearest the tire you need to change. It is pointed to by an arrow molded into the underside of the body. Place the jack under the jacking point. Turn the end bracket clockwise until the top of the jack contacts the jacking point. Make sure the jacking point tab is resting in the jack notch.

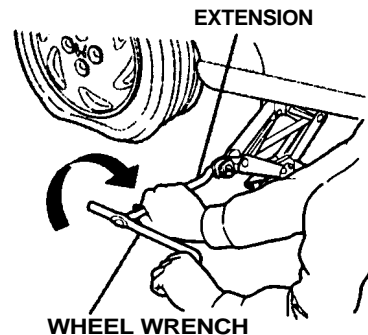

9. Use the extension and wheel wrench as shown to raise the car until the flat tire is off the ground.

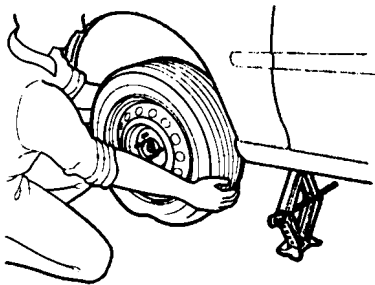

10. Remove the wheel nuts and flat tire. Temporarily place the flat tire on the ground.

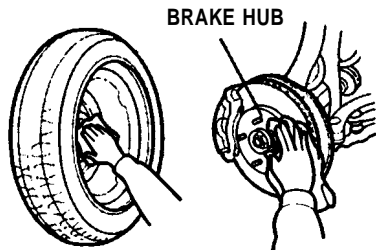

11. Before mounting the spare tire, wipe any dirt off the mounting surface of the wheel and hub with a cloth.

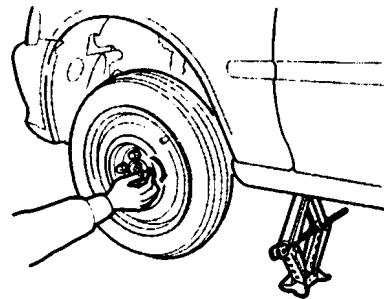

12. Put on the spare tire. Put the wheel nuts back on finger-tight, then tighten them in a crisscross pattern with the wheel wrench until the wheel is firmly against the hub. Do not try to tighten them fully.

continued

Changing a Flat Tire

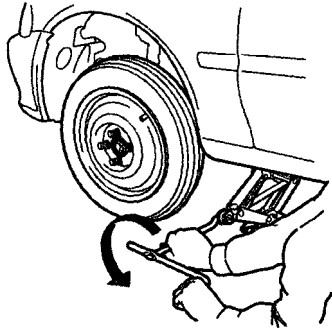

13. Lower the car to the ground and remove the jack.

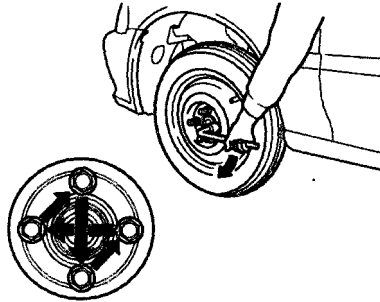

14. Tighten the wheel nuts securely in the same crisscross pattern. Have the wheel nut torque checked at the nearest automotive service facility. Tighten the wheel nuts to: 110 N.m (11 kg-m, 80 lb-ft).

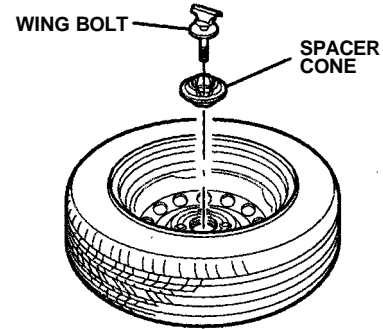

15. Remove the wheel cover or center cap. Place the flat tire face down in the trunk well.
16. Remove the spacer cone from the wing bolt, turn it over, and put it back on the bolt.
17. Secure the flat tire by screwing the wing bolt back into its hole.

18. Store the jack in the trunk with the end bracket on the left side. Turn the jack's end bracket to lock it in place. Store the tool kit.
19. Store the wheel cover or center cap in the trunk.

If Your Engine Won't Start

Diagnosing why your engine won't start falls into two areas, depending on what you hear when you turn the key to START (III):

- You hear nothing, or almost nothing. The engine's starter motor does not operate at all, or operates very slowly.
- You can hear the starter motor operating normally, but the engine does not start up and run.

Nothing Happens or the Starter Motor Operates Very Slowly

When you turn the ignition switch to START (III), you do not hear the normal noise of the engine trying to start. You may hear a clicking sound or series of clicks, or nothing at all. Check these things:

- Check the transmission interlock. If you have a 5-speed, the clutch pedal must be pushed all the way to the floor or the starter will not operate. With an automatic transmission, it must be in Park or Neutral.
- Turn the ignition switch to ON (II). Turn on the headlights and check their brightness. If the headlights are very dim or don't light at all, the battery is discharged. See Jump Starting on page [163](#).

- Turn the ignition switch to START (HI). If the headlights do not dim, check the condition of the fuses. If the fuses are OK, there is probably something wrong with the electrical circuit for the ignition switch or starter motor. You will need a qualified technician to determine the problem. (See Towing on page [174](#).)

If the headlights dim noticeably or go out when you try to start the engine, either the battery is discharged or the connections are corroded. Check the condition of the battery and terminal connections (see page [129](#)). You can then try jump starting the car from a booster battery (see page [163](#)).

The Starter Operates Normally

In this case, the starter motor sounds normal when you turn the ignition switch to START (III), but the engine does not run.

- Are you using the proper starting procedure? Refer to Starting the Engine on page 91.
- Do you have gas? Turn the ignition switch to ON (II) for a minute and watch the fuel gauge.
- There may be an electrical problem, such as no power to the fuel pump. Check all the fuses (see page 171).

If you find nothing wrong, you will need a qualified technician to find the problem. See **Towing** on page 174.

Jump Starting

If your car's battery has run down, you may be able to start the engine by using a booster battery. Although this seems like a simple procedure, there are several precautions you should take. Follow the directions closely.

A battery can explode if you do not follow the correct procedure, seriously injuring anyone nearby.

Keep all sparks, open flames, and smoking materials away from the battery.

You cannot start a Honda with an automatic transmission by pushing or pulling it.

To jump start your car:

1. Open the hood and check the physical condition of the battery (see page 126). In very cold weather, check the condition of the electrolyte. If it seems slushy or like ice, do not try jump starting until it thaws.

NOTICE

If a battery sits in extreme cold, the electrolyte inside can freeze. Attempting to jump start with a frozen battery can cause it to rupture or explode.

2. Turn off all the electrical accessories: heater, A/C, stereo system, lights, etc. Put the transmission in Neutral or Park and set the parking brake.

continued

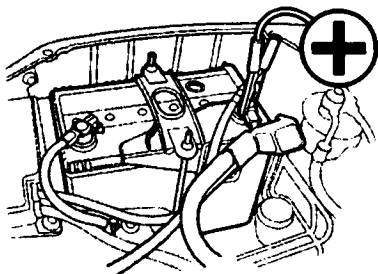

3. Connect one jumper cable to the positive (+) terminal on the booster battery. Connect the other end to the positive terminal on your Honda's battery.

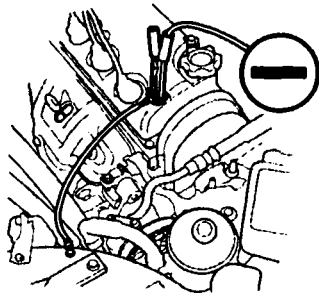

4. Connect the second jumper cable to the negative (-) terminal on the booster battery. Connect the other end to the grounding strap as shown. Do not connect this jumper cable to any other part of the engine.
5. If the booster battery is in another car, have an assistant start that car and run it at a fast idle.

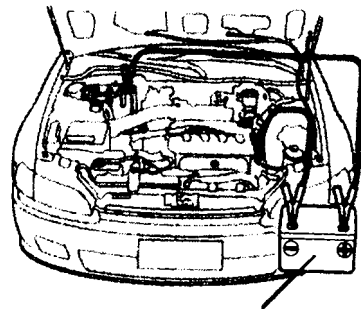

BOOSTER BATTERY

6. Start your car. If the starter motor still operates slowly, check the jumper cable connections to make sure they have good metal-to-metal contact.
7. Once your car is running, disconnect the negative cable from your car, then from the booster battery. Disconnect the positive cable from your car, then the booster battery.

The pointer of your car's temperature gauge should stay in the midrange under most conditions. It may go higher if you are driving up a long steep hill on a very hot day. If it climbs to the red mark, you should determine the reason.

NOTICE

Driving with the temperature gauge pointer at the red mark can cause serious damage to your engine.

Your car can overheat for several reasons, such as lack of coolant or a mechanical problem. The only indication may be the temperature gauge climbing to or above the red mark. Or you may see steam or spray coming from under the hood. In either case, you should take immediate action.

Steam and spray from an overheated engine can seriously scald you.

Do not open the hood if steam is coming out.

1. Safely pull to the side of the road. Put the transmission in Neutral or Park and set the parking brake. Turn off the climate control and all other accessories. Turn on the hazard warning indicators.
2. If you see steam and/or spray coming from under the hood, turn off the engine.
3. If you do not see steam or spray, leave the engine running and watch the temperature gauge. If the high heat is due to overloading (climbing a long, steep hill on a hot day with the A/C running, for example), the engine should start to cool down almost immediately. If it does, wait until the temperature gauge comes down to the midpoint then continue driving.

continued

If Your Engine Overheats

4. If the temperature gauge stays at the red mark, turn off the engine.
5. Wait until you see no more signs of steam or spray, then open the hood.
6. Look for any obvious coolant leaks, such as a split radiator hose. Everything is still extremely hot, so use caution. If you find a leak, it must be repaired before you continue driving (see **Towing** on page 174).
7. If you don't find an obvious leak, check the coolant level in the radiator reserve tank (see page 115). If the level is below the MIN mark, add coolant to halfway between the MIN and MAX marks.
8. If there was no coolant in the reserve tank, you may also have to add coolant to the radiator.

Let the engine cool down until the pointer reaches the middle of the temperature gauge, or lower, before checking the radiator

Removing the radiator cap while the engine is hot can cause the coolant to spray out, seriously scalding you.

Always let the engine and radiator cool down before removing the radiator cap.

9. Using gloves or a large heavy cloth, turn the radiator cap counterclockwise, without pushing down, to the first stop. This releases any remaining pressure in the cooling system. After the pressure releases, push down on the cap and turn it until it comes off.

10. Start the engine and set the heater control lever to maximum. Add coolant to the radiator up to the base of the fill neck. If you do not have the proper coolant mixture available, you can add plain water. Remember to have the cooling system drained and refilled with the proper mixture as soon as you can.
11. Put the radiator cap back on tightly. Run the engine and watch the temperature gauge. If it goes back to the red mark, the engine needs repair. (See **Towing** on page 174.)
12. If the temperature stays normal, check the coolant level in the radiator reserve tank. If it has gone down, add coolant to the MAX mark. Put the cap back on tightly.

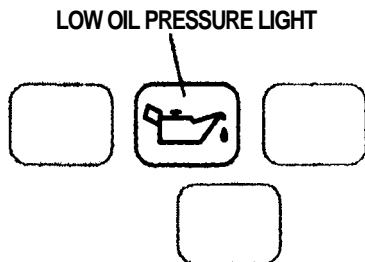

The low oil pressure light should never come on when the engine is running. If this light comes on with the engine running, take immediate action.

NOTICE

Running the engine with low oil pressure can cause serious mechanical damage almost immediately. Turn off the engine as soon as you can safely get the car stopped.

1. Safely pull off the road and shut off the engine.
2. Let the car sit for a minute. Open the hood and check the oil level (see page 111). Although oil level and oil pressure are not directly connected, an engine that is very low on oil can lose pressure during cornering and other driving maneuvers.
3. If necessary, add oil to bring the level back to the full mark on the dipstick (see page 111).
4. Start the engine and watch the oil pressure light. If the light does not go out within 10 seconds, turn off the engine. There is a mechanical problem that needs to be repaired before you can continue driving. (See **Towing** on page 174.)

Charging System Indication

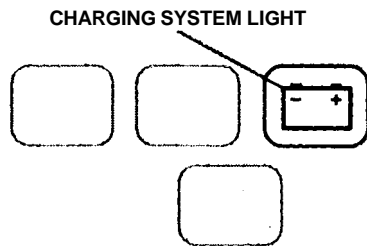

The charging system light should go out after the engine starts. If it comes on brightly with the engine running, the alternator is no longer charging the battery.

Immediately turn off all electrical accessories: radio, heater, A/C, rear defogger, cruise control, etc. Try not to use other electrically-operated controls such as the power windows. Keep the engine running and take extra care not to stall it. Starting the engine will discharge the battery rapidly.

By eliminating as much of the electrical load as possible, you can drive several miles before the battery is too discharged to keep the engine running. Drive to a service station or garage where you can get technical assistance.

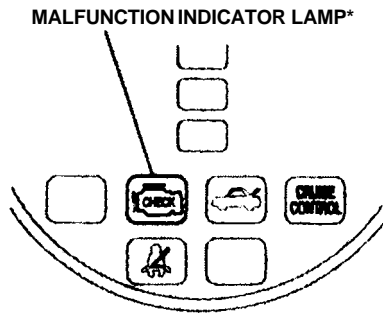

If this indicator comes on while driving, there is a problem with your engine or its emission control systems. Even though you may feel no difference in your car's performance, it can reduce your fuel economy and cause your car to put out excessive emissions. Continued operation may cause serious damage.

* The U.S. instrument panel is shown. Differences for the Canadian model are noted in the text.

If this indicator comes on safely pull off the road and turn off the engine. Restart the engine and watch the indicator. If it stays on, have your car checked by the dealer as soon as possible. Drive moderately until the dealer has inspected the problem. Avoid full-throttle acceleration and driving at high speed.

You should also have the dealer inspect your car if the indicator comes on frequently, even though it goes off when you follow the above procedure.

NOTICE

If you keep driving with the malfunction indicator lamp/check engine light on, you can damage your car's emission controls and engine. Those repairs may not be covered by your car's warranties.

Closing the Moonroof

If the electric motor will not close the moonroof, do the following:

1. Check the fuse for the moonroof motor (see page 171). If the fuse is blown, replace it with one of the same or lower rating.
2. Try closing the moonroof. If the new fuse blows immediately or the moonroof motor still does not operate, you can close the moonroof manually.
3. Get the tool kit out of the trunk.

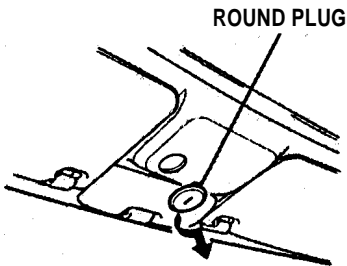

4. Use a screwdriver or coin to remove the round plug between the sun visors.

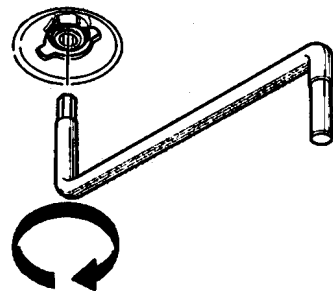

5. Insert the moonroof wrench into the socket behind this plug. Turn the wrench until the moonroof is fully closed.
6. Remove the wrench. Replace the round plug.

All the electrical circuits in your car have fuses to protect them from a short circuit or overload. These fuses are located in two fuse boxes.

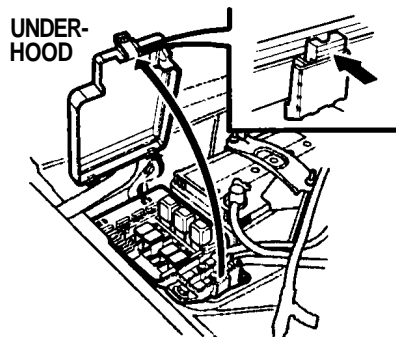

The underhood fuse box is located in the engine compartment next to the battery. To open, push the tab as shown.

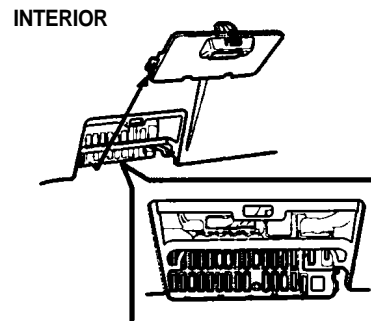

The interior fuse box is underneath the dashboard on the driver's side. Remove the fuse box lid by swinging the lid down and pulling it straight out of its hinges.

Checking and Replacing

If something electrical in your car stops working, the first thing you should check for is a blown fuse. Determine from the chart on the fuse box cover or inside the fuse box which fuse or fuses control that component. Check those fuses first, but check all the fuses before deciding that is not the cause. Replace any blown fuses and check the component's operation.

1. Turn the ignition switch to LOCK (0). Make sure the headlights and all other accessories are off.
2. Remove the cover from the fuse box.

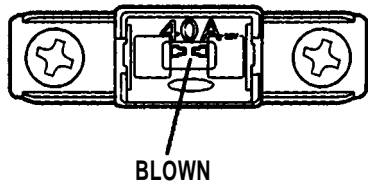

3. Check each of the large fuses in the underhood fuse box by looking through the top at the wire inside. Removing these fuses requires a Phillips head screwdriver.

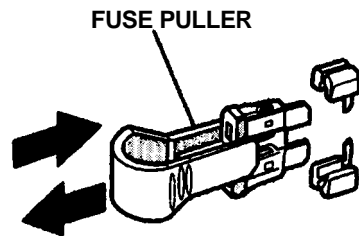

4. Check the smaller fuses in the underhood fuse box and all the fuses in the interior fuse box by pulling out each fuse with the fuse puller provided in the interior fuse box.

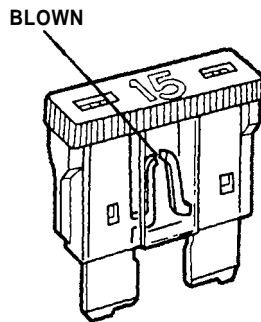

5. Look for a burned wire inside the fuse. If it is burned out, replace it with one of the spare fuses of the same rating or lower.

If you cannot drive the car without fixing the problem, and you do not have a spare fuse, take a fuse of the same rating or a lower rating from one of the other circuits. Make sure you can do without that circuit temporarily (such as the cigarette lighter or radio).

If you replace the burned out fuse with a spare fuse that has a lower rating, it might blow out again. This does not indicate anything wrong. Replace the fuse with one of the correct rating as soon as you can.

NOTICE

Replacing a fuse with one that has a higher rating greatly increases the chances of damaging the electrical system. If you do not have a replacement fuse with the proper rating for the circuit, install one with a lower rating.

6. If the replacement fuse of the same rating burns out in a short time, there is probably a serious electrical problem in your car. Leave the burned out fuse in that circuit and have your car checked by a qualified technician.

Towing

If your car needs to be towed, call a professional towing service or, if you belong to one, an organization that provides roadside assistance. Never tow your car behind another car with just a rope or chain. It is very dangerous.

Emergency Towing

There are three popular methods of towing a car:

Flat-bed Equipment - The operator loads your car on the back of a truck. This is the best way of transporting your Honda.

Wheel Lift Equipment - The tow truck uses two pivoting arms that go under the tires (front or rear) and lift them off the ground. The other two wheels remain on the ground.

Slings-type Equipment - The tow truck uses metal cables with hooks on the ends. These hooks go around parts of the frame or suspension and the cables lift that end of the car off the ground. Your car's suspension and body can be seriously damaged if this method of towing is attempted.

If your Honda cannot be transported by a flat-bed truck, it should be towed with the front wheels off the ground. If, due to damage, your car must be towed with the front wheels on the ground, do the following:

5-Speed Manual Transmission

- Release the parking brake.
- Shift the transmission to Neutral.

Automatic Transmission

- Release the parking brake.
- Start the engine.
- Shift to D4, then to N.
- Turn off the engine.

NOTICE

Improper towing preparation will damage the transmission. Follow the above procedure exactly. If you cannot shift the transmission or start the engine (automatic transmission), your car must be transported on a flat-bed.

- It is best to tow the car no farther than 50 miles (80 km), and keep the speed below 35 mph (55 km/h).

NOTICE

Trying to lift or tow your car by the bumpers will cause serious damage. The bumpers are not designed to support the car's weight.

The diagrams in this section give you the dimensions and capacities of your Honda, and the locations of the identification numbers. The explanations of several electronic and mechanical systems on your Honda are for the more technically-oriented owner.

Identification Numbers	176
Specifications	178
Supplemental Restraint System	180
Emission Controls	181
The Clean Air Act	181
Crankcase Emission Control System	181
Evaporative Emission Control System	181
Exhaust Emission Controls .	182
PGM-FI System	182
Ignition Timing Control System	182
Three-way Catalytic Converter	182
Replacement Parts	182
Three-way Catalytic Converter.....	183

Identification Numbers

Your car has several identifying numbers located in various places.

The Vehicle Identification Number (VIN) is the 17-digit number your Honda dealer uses to register your car for warranty purposes. It is also necessary for licensing and insuring your car. The easiest place to find the VIN is on a plate fastened to the top of the dashboard. You can see it by looking through the windshield on the driver's side. It is also on the Certification label attached to the driver's doorjamb, and is stamped on the engine compartment bulkhead. The VIN is also provided in bar code on the Certification Label.

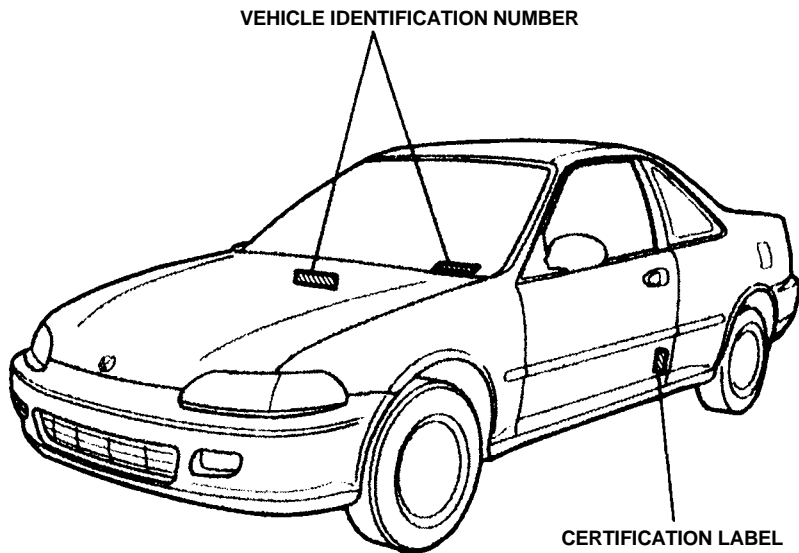

The Engine Number is stamped into the engine block.

The Transmission Number is on a label on top of the transmission.

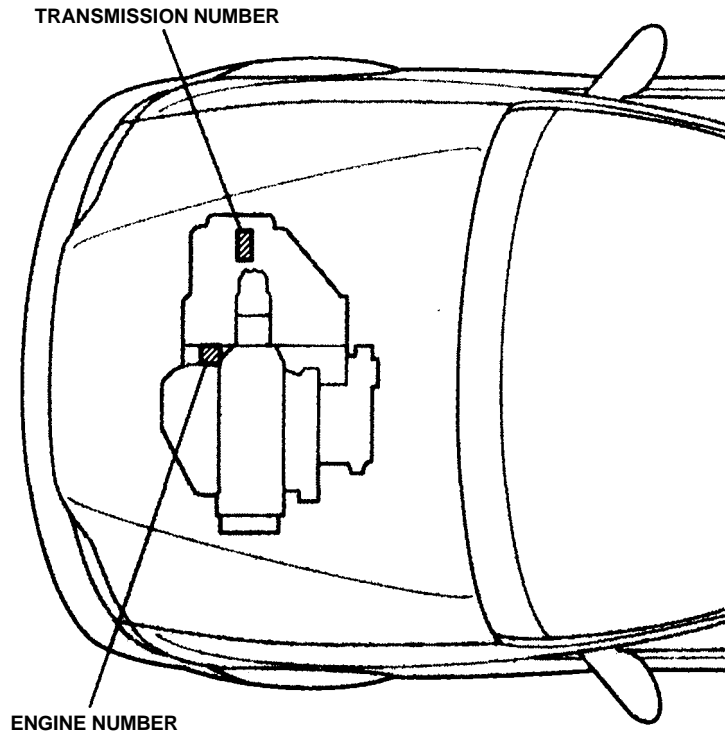

Specifications

Dimensions

Length		172.8 in (4,390 mm)
Width		66.9 in (1,700 mm)
Height		50.9 in (1,294 mm)
Wheelbase		103.2 in (2,622 mm)
Track	Front	58.1 in (1,475 mm)
	Rear	57.7 in (1,465 mm)

Weights

Gross vehicle weight rating	See the certification label attached to the driver's door-jamb.
-----------------------------	---

Engine

Type	Water cooled 4-stroke SOHC 4-cylinder gasoline engine
Bore x Stroke	2.95 x 3.33 in (75.0 x 84.5mm) ^{*1} 2.95 x 3.54 in (75.0 x 90.0mm) ^{*2}
Displacement	91.1 cu-in (1,493 cm ³) ^{*1} 97.0 cu-in (1,590 cm ³) ^{*2}
Compression ratio	9.2:1
Spark plugs	See spark plug maintenance section page 126 .

*1:DX

* 2: US: EX, EX w/option pkg., Canada: Si

Capacities

Fuel tank		Approx. 11.9 US gal (45ℓ , 9.9 Imp gal)
Radiator coolant Change ^{*1}	5 Speed	0.95 US gal (3.6ℓ , 0.79 Imp gal)
	Automatic	0.92 US gal (3.5ℓ , 0.77 Imp gal) ^{*2} 1.00 US gal (3.8ℓ , 0.84 Imp gal) ^{*3}
	Total	
	5 Speed	1.19 US gal (4.5 ℓ , 0.99 Imp gal)
	Automatic	1.16 US gal (4.4 ℓ , 0.97 Imp gal) ^{*2} 1.24 US gal (4.7 ℓ , 1.03 Imp gal) ^{*3}
Engine oil	Change ^{*4}	
	Including filter	3.5 US qt (3.3 ℓ , 2.9 Imp qt)
	Without filter	3.2 US qt (3.0 ℓ , 2.6 Imp qt)
	Total	4.2 US qt (4.0 ℓ , 3.5 Imp qt)
5-speed manual transmission oil	Change	1.9 US qt (1.8 ℓ , 1.6 Imp qt)
	Total	2.0 US qt (1.9 ℓ , 1.7 Imp qt)
Automatic transmission fluid	Change	3.0 US qt (2.8 ℓ , 2.5 Imp qt)
	Total	6.1 US qt (5.9 ℓ , 5.3 Imp qt)
Windshield washer reservoir	US cars	2.6 US qt (2.5 ℓ , 2.2 Imp qt)
	Canadian Cars	4.8 US qt (4.5 ℓ , 4.0 Imp qt)

* 1: Including the coolant in the reserve tank and that remaining in the engine.

Reserve tank capacity:

0.4ℓ (0.11 US gal, 0.09 Imp gal)

*2: DX

*3: US: EX, EX w/option pkg., Canada: Si

*4: Excluding the oil remaining in the engine.

Lights

Headlights (HI/LO)	12V – 60/55 W
Front turn signal/ side marker lights	12V – 43/3 CP (SAE 3497)
Rear turn signal lights	12V – 32CP (SAE1156)
Stop/Taillights	12V – 32/2CP (SAE 2057)
Rear side marker lights	12V – 3 CP (SAE 168)
Back-up lights	12V – 32 CP (SAE 1156)
High-mount brake light	12V – 45CP
License plate lights	12V – 8W
Interior light	12V – 8W
Trunk light	12V – 3.4W

Battery

Capacity	12V – 52AH/5HR
----------	----------------

Fuses

Interior		See the fuse label attached to the inside of the fuse box door under the dashboard.
Underhood		See the fuse box cover.

Alignment

Toe-in	Front	0.00 in (0.0 mm)
	Rear	0.08 in (2.0 mm)
Camber	Front	0°
	Rear	-0°20'
Caster	Front	1°10'

Tires

Size	Front/Rear	P175/70R13 *1 P185/60 R14 *2
	Spare	T105/80D13 *1 T105/70D14 *2
Pressure	Front/Rear	32 psi (2.2 kg/cm ² , 220 kPa) *1 29 psi (2.0 kg/cm ² , 200 kPa) *2
	Spare	60 psi (4.15 kg/cm ² , 415 kPa)

* 1: DX

* 2: US: EX, EX w/option pkg., Canada: Si

Supplemental Restraint System

The Honda Supplemental Restraint System (SRS) is standard on all Civic 2-doors sold in the U.S. and Canada. The SRS includes the steering wheel airbag assembly, sensors in the dashboard, and a control unit with sensors behind the center console.

US. EX with option package.

Your car also has a dashboard-mounted airbag assembly for the front seat passenger.

The sensors are decelerometers, set to trigger in a severe frontal impact that generates more force than a 25 mile per hour crash into a parked vehicle of similar weight. For the SRS to activate, one or both dash sensors and one or both control unit sensors must activate. This duplication is to prevent accidental activation.

When the control unit receives trigger signals from at least two sensors, it sends voltage to the airbag. The control unit stores this charge in capacitors to insure reliability even if a severe impact damages the car's battery or electrical connections.

The electrical charge sent to the airbag assembly ignites its propellant, which burns instantaneously. The gas produced by the burning propellant inflates the airbag instantly.

The airbag is vented so it stays inflated for only an instant and does not block the driver's vision. Smoke from the burned propellant comes out of the airbag and into the car's interior. This is normal and does not mean there is a fire. The airbag collapses onto the driver's lap.

The airbag unit can inflate only one time. After use, your Honda dealer must check the complete Supplemental Restraint System and replace the airbag assembly.

To ensure long-term reliability, the SRS uses gold-plated electrical connections throughout. Exposed components are sealed with epoxy. The control unit monitors the SRS circuitry whenever the ignition is ON (II). If the control unit senses any faults, it turns on the SRS indicator light on the instrument panel. Take the car to your Honda dealer to diagnose and repair the system as soon as possible.

The SRS needs no regular maintenance other than an inspection by your Honda dealer 10 years after manufacture.

The burning of gasoline in your car's engine produces several by-products. Some of these are carbon monoxide (CO), oxides of nitrogen (NOx), and hydrocarbons (HC). Gasoline evaporating from the tank also produces hydrocarbons. Controlling the production of NOx, CO, and HC is important to the environment. Under certain conditions of sunlight and climate, NOx and HC react to form photochemical "smog." Carbon monoxide does not contribute to smog creation, but it is a poisonous gas.

The Clean Air Act

The Clean Air Act* sets standards for automobile emissions. It also requires that automobile manufacturers explain to owners how their emission controls work and what to do to maintain them. This section summarizes how the emission controls work. Scheduled maintenance is on page [104](#).

* In Canada, Honda vehicles comply with the Canadian Motor Vehicle Safety Standards (CMVSS) for Emissions valid at the time they are manufactured.

Crankcase Emission Control System

Your car has a Positive Crankcase Ventilation (PCV) System. This keeps gasses that build up in the engine's crankcase from going into the atmosphere. The PCV valve routes them from the crankcase back to the intake manifold. They are then drawn into the engine and burned.

Evaporative Emission Control System

As fuel evaporates in the fuel tank, an evaporative emission control canister filled with charcoal adsorbs the vapor. It is stored in this canister while the engine is off. After the engine is started and warmed up, the vapor is drawn into the engine and burned during driving.

Exhaust Emission Controls

The exhaust emission controls include three systems: PGM-FI, Ignition Timing Control, and Three-way Catalytic Converter. These three systems work together to control the engine's combustion and minimize the amount of HC, CO, and NOx that comes out the tailpipe. The exhaust emission control systems are separate from the crankcase and evaporative emission control systems.

PGM-FI System

The PGM-FI System on this model is a sequential multiport fuel injection. The PGM-FI System on your car has three sub systems: Air Intake, Engine Control, and Fuel Control: The Engine Control Module (ECM) uses various sensors to determine how much air is going into the engine. It then controls how much fuel to inject under all operating conditions.

Ignition Timing Control System

This system constantly adjusts the ignition timing, reducing the amount of HC, CO and NOx produced.

Three-way Catalytic Converter

The Three-way Catalytic Converter is in the exhaust system. Through chemical reactions, it converts HC, CO, and NOx in the engine's exhaust to carbon dioxide (CO₂), dinitrogen (N₂), and water vapor.

Replacement Parts

The emission control systems are designed and certified to work together in reducing emissions to levels that comply with the Clean Air Act. To make sure the emissions remain low, you should use only new genuine Honda replacement parts or their equivalent for repairs. Using lower quality parts may increase the emissions from your car.

The emissions control systems are covered by warranties separate from the rest of your car. Read your warranty manual for more information.

The Three-way Catalytic Converter contains platinum and rhodium. These metals serve as catalysts, promoting chemical reactions to convert the exhaust gases without affecting the metals. The catalytic converter is referred to as a three-way catalyst, since it acts on HC, CO, and NOx. A replacement unit must be an original Honda part or its equivalent.

The Three-way Catalytic Converter must operate at a high temperature for the chemical reactions to take place. It can set on fire any combustible materials that come near it. Park your car away from high grass, dry leaves, or other flammables.

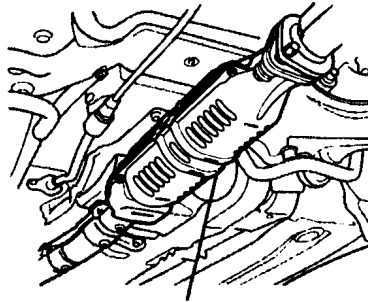

THREE-WAY CATALYTIC CONVERTER

A defective catalytic converter contributes to air pollution, and can impair your engine's performance. Follow these, guidelines to protect your car's Three-way Catalytic Converter.

- Always use unleaded gasoline. Even a small amount of leaded gasoline can contaminate the catalyst metals, making the converter ineffective.
- Keep the engine tuned-up.
- Have your car diagnosed and repaired if it is misfiring, back-firing, continuing to run after you turn off the engine, stalling, or otherwise not running properly.

Warranty and Customer Relations

Warranty Coverages	186
Customer Relations Information	187
U.S. Zone Office Map	188
Canada Zone Office Map	189
Authorized Manuals	191

Warranty Coverages

U.S. Cars

Your new Honda is covered by these warranties:

New Car Limited Warranty — provides coverage for defects in materials and workmanship for 3 years or 36,000 miles.

Emission Control Systems Defects Warranty and Emissions Performance Warranty — these two warranties cover your car's emission control systems. Time, mileage, and coverage are conditional. Please read the warranty manual for exact information.

Original Equipment Battery Limited Warranty — provides coverage for 36 months, with 100% coverage for the first 24 months.

Seat Belt Limited Warranty — A seat belt that fails to function

properly is covered for the useful life of the car.

Rust Perforation Limited Warranty — body panels that rust through from the inside will be repaired or replaced for up to 36 months. There is no mileage limit.

Accessory Limited Warranty — Genuine Honda Accessories are covered under this warranty. Time and mileage limits depend on the type of accessory and other factors. Please read your warranty manual for details.

Replacement Parts Limited Warranty — provides coverage for defects in materials and workmanship for 12 months or 12,000 miles.

Replacement Battery Limited Warranty — provides coverage for up to 36 months, with 100% coverage for the first 12 months.

Replacement Muffler Lifetime Limited Warranty - provides coverage for as long as the purchaser of the muffler owns the car.

There are restrictions and exclusions which apply to all these warranties. Please read the 1993 Honda Warranties booklet that came with your car for precise information on warranty coverages. Your Honda's original tires are covered by their manufacturer. Tire warranty information is in a separate booklet.

Canada Cars

Please refer to the 1993 Warranty and Maintenance Guide that came with your car.

Honda dealership personnel are trained professionals. They should be able to answer all your questions. If you encounter a problem that your dealership does not solve to your satisfaction, please discuss it with the dealership's management. The Service Manager or General Manager can help. Almost all problems are solved in this way.

If you are dissatisfied with the decision made by the dealership's management, contact your Honda Customer Relations Zone Office. Refer to the U.S. and Canadian Zone Office maps on the following pages.

When you call or write, please give us this information:

- Vehicle Identification Number (see page 176).
- Name and address of the dealer who services your car.
- Date of purchase.
- Mileage on your car.
- Your name, address, and telephone number.
- A detailed description of the problem.
- Name of the dealer who sold the car to you.

U.S. Zone Office Map

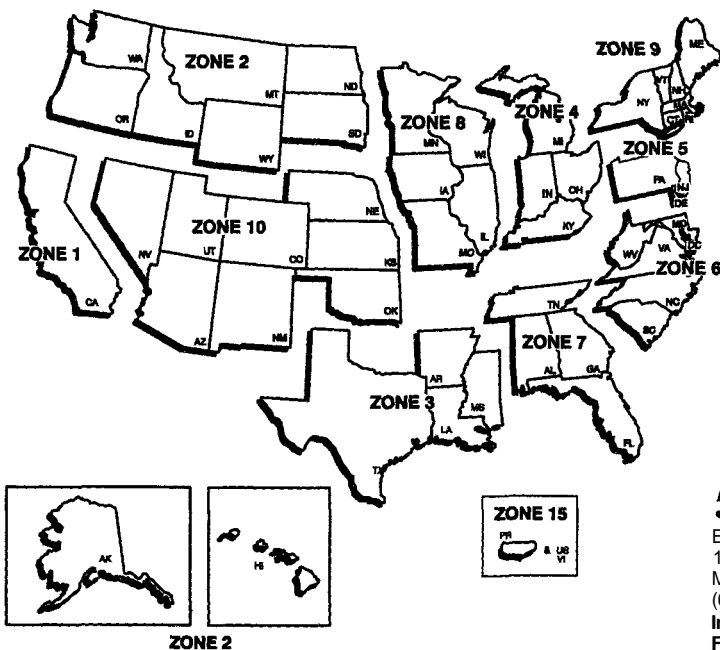

1 Western Zone

P.O. Box 2260
700 Van Ness Avenue
Torrance, California
90509-2260
(310) 781-4565

2 Northwestern Zone

P.O. Box 20186
12439 N.E. Airport Way
Portland, Oregon 97230
(503) 256-0943
(also includes
Alaska and Hawaii)

3 South Central Zone

4529 Royal Lane
Irving, Texas 75063
(972) 929-5481

4 Central Zone

101 South Stanfield Road
Troy, Ohio 45373
(937) 332-6250

5 Northeastern Zone

P.O. Box 337
Eastgate Industrial Park
115 Gaither Drive
Moorestown, New Jersey 08057
(609) 235-5533

**Includes: NYC Metro area and
Fairfield County, CT area**

6 Mid-Atlantic Zone

902 Wind River Ln., Suite 200
Gaithersburg, Maryland 20878
(301) 990-2020

7 Southeastern Zone

1500 Morrison Parkway
Alpharetta, Georgia 30201
(770) 442-2045

8 North Central Zone

601 Campus Drive, Suite A-9
Arlington Heights, Illinois 60004
(847) 870-5600

9 New England Zone

555 Old County Road
Windsor Locks, Connecticut 06060
(860) 623-3310

**See Zone 5 for: NYC Metro area
and Fairfield County, CT area**

10 West Central Zone

1600 South Abilene Street, Suite D
Aurora, Colorado 80012
(303) 696-3935

15 Puerto Rico and U.S. V.I.

Bella International
P.O. Box 190816
San Juan, PR 00919-0816
(787) 250-4318

The above addresses and telephone numbers are subject to change. If you cannot reach your Zone office, ask your Honda dealer for the current information.



Western Zone

Honda Canada Inc.
13240 Worster Court
Richmond, B.C.
V6V 2B8
(604)278-7121

Central Zone

Honda Canada Inc.
715 Milner Avenue
Scarborough, Ontario
M1B 2KB
(416) 299-3400

Quebec Zone

Honda Canada Inc.
1750 rue Eiffel
Boucherville, Quebec
J4B 7W1
(514) 655-6161

Atlantic Zone

Honda Canada Inc.
800 Windmill Road
Dartmouth, N.S.
B3B1L1
(902) 468-4416

Purchasing Factory-Authorized Manuals (U.S. only)

The following publications covering the operation and servicing of your vehicle can be obtained from Helm Incorporated, either by filling out the form or, for credit card holders, by calling toll-free. For manuals prior to the year shown below, contact Helm Incorporated, P.O. Box 07280, Detroit, MI 48207 or call (313)-883-1430.

Publication Form Number	Form Description	Price Each*
61SR301	1993 Civic Coupe Service Manual	\$56.00
61SR301EL	1993 Civic Coupe Electrical Troubleshooting Manual	\$33.00
61SR331	1993 Civic Coupe Body Repair Manual	\$32.00
31SR8600	1993 Civic Coupe Owner's Manual	\$18.00
HON-R	Order Form For Previous Years – Indicate Year And Model Desired.	FREE
*Prices are subject to change without notice and without incurring obligation.		

Valid only for sales within the U.S. Canadian owners should contact their authorized Honda dealer.

ORDER TOLL FREE: 1-800-782-4356 (NOTE: For Credit Card Holder Orders Only) Monday – Friday 8:30 a.m. – 6:00 p.m. EST
MINIMUM CREDIT CARD PURCHASE \$10.00

OR

By completing this form you can order the materials desired. You can pay by check or money order or charge to your credit card. Mail to Helm, Incorporated at the address shown on the back of the order form.

1 9 3 H O N	PUBLICATION NUMBER	VEHICLE MODEL		QTY.	PRICE EACH*	TOTAL PRICE
		NAME	YEAR			
*Prices are subject to change without notice and without incurring obligation.					TOTAL MATERIAL	
Orders are mailed within 10 days. Please allow adequate time for delivery.					Mich. Purchases Add 6% Sales Tax	
					HANDLING CHARGE	\$5.00
					GRAND TOTAL	

S H I P T O	NOTE: Dealers and Companies please provide dealer or company name and also the name of the person to whose attention the shipment should be sent. For purchases outside U.S.A. please write to the above address for quotation.	
	_____ (CUSTOMER NAME)	_____ (ATTENTION)
	_____ (STREET ADDRESS - NO P.O. BOX NUMBERS)	_____ (APT. NO.)
	_____ (CITY)	_____ (STATE) (ZIP CODE)
DAYTIME TELEPHONE NO. _____	AREA CODE () _____	

P A Y M E N T	<input type="checkbox"/> Check or money order enclosed payable to Helm, Inc (U.S. funds only - do not send cash.)																								
	<input type="checkbox"/> MasterCard <input type="checkbox"/> VISA <input type="checkbox"/> Check here if your billing address is different from the shipping address shown above																								
	Account Number <table border="1"><tr><td> </td><td> </td><td> </td><td> </td><td> </td><td> </td><td> </td><td> </td><td> </td><td> </td><td> </td><td> </td><td> </td><td> </td><td> </td><td> </td><td> </td><td> </td><td> </td><td> </td></tr></table> Expiration Mo-Yr <table border="1"><tr><td> </td><td> </td><td> </td><td> </td></tr></table>																								
_____ (CUSTOMER SIGNATURE)	_____ (STATE)																								

These Publications cannot be returned for credit without receiving advance authorization within 14 days of delivery. On returns, a restocking fee may be applied against the original order.

P.O. BOX 07280 • DETROIT, MI 48207 • (313) 883-1430

Service Manual:

This manual covers maintenance and recommended procedures for repair to engine and chassis components. It is written for the Journeyman mechanic, but is simple enough for most mechanically-inclined owners to understand.

Electrical Troubleshooting Manual:

This manual complements the Service Manual by providing in-depth troubleshooting information for each electrical circuit in your car.

Body Repair Manual:

This manual describes the procedures involved in the replacement of damaged body parts.

A

Accessories	
Installation	87
ACCESSORY	
(Ignition Key Position)	48
Adding	
Automatic Transmission Fluid	120
Brake Fluid	122
Clutch Fluid	123
Engine Oil	111
Manual Transmission Fluid ...	121
Power Steering Fluid	124
Radiator Coolant	115
Windshield Washer Fluid	119
Additional Safety Information ...	16
Door Locks	16
Driving with Pets	17
Seat-back Position	16
Storing Cargo Safely	17
Additives, Engine Oil	112
Adjustments	
Mirrors	40, 55
Seats	51

Steering Wheel	38, 43
Airbag(SRS)	12
Driver's Side	12
Passenger's Side	13
Air Cleaner Element	125
Air Conditioning	68
Maintenance	133
Usage	68
Air Filter. See Air Cleaner Element	
Air Outlets (Vents)	64
Air Pressure, Tires	179, 202
Alcohol and Drugs	24
Alcohol in Gasoline	80
Alternator Belt. See Engine Belts	
Anchor Plate, Child Seat	23
Antifreeze	115
Anti-theft Steering Column Lock .	49
Appearance Care	147
Ashtrays	57

Audio System	71
Automatic Speed Control	44
Automatic Transmission	95
Capacity, Fluid	178
Checking Fluid Level	120
Shift Lever Position Indicator ..	35
Shift Lever Positions	95
Shift Lock Release	98
Shifting	96

B

Battery	128
Charging System Light	33
Jump Starting	163
Maintenance	128
Specifications	179
Before Driving	79
Belts, Seat	4
Beverage Holder	59
Body Repair	153

Brakes	
Break-in, New Linings	80
Fluid	122
Light, Burned out	140
Parking	57
System Light	33
Wear Indicators	99
Braking System	100
Break-in, New Car	80
Brightness Control, Instruments	40
Brights, Headlights	39
Bulb Replacement	
Back-up Lights	143
Brake Lights	142
Front Parking Lights	141
Front Side Marker Lights	141
Headlights	140
High-mount Brake Light	143
License Plate Lights	144
Rear Side Marker Lights	142
Specifications	179
Turn Signal Lights	141
Bulbs, Halogen	140

C	
Cables, Jump Starting with	163
Capacities Chart	178
Carbon Monoxide Hazard	25
Cargo, Loading	86
CAUTION, Explanation of	ii
Certification Label	166
Cruise Control Operation	44
Cassette Player	
Care	78
Operation	75
Catalytic Converter, Three-Way	183
Certification Label	176
Chains	139
Change Oil	
How to	113
When	103
Changing a Flat Tire	157
Changing Engine Coolant	116
Charging System Light	33, 168

Check Engine Light (Canada)	34
Checking	
Automatic Transmission Fluid	120
Battery Condition	128
Brake Fluid	122
Clutch Fluid	122
Engine Belts	134
Engine Coolant	115
Engine Light	34
Engine Oil	111
Fuses	172
Manual Transmission Fluid	121
Power Steering Fluid	124
Radiator Coolant	115
Tire Pressure	134
Windshield Wipers	131
Checklist, Before Driving	90
Child Safety	18
Guidelines for Restraining	
Infants/Children	19
Important Safety Reminders	19
Where Should Children Sit?	18
Cigarette Lighter	60
CLEAN light	78

- Cleaner, Air 125
- Cleaning
- Exterior 148
 - Interior 151
 - Seat Belts 151
 - Vinyl 151
- Clock, Setting the 58
- Clutch Fluid 123
- CO in the Exhaust 182
- Cold Weather, Starting in 92
- Compact Spare 156
- Consumer Information 187
- Control Locations 30
- Controls, Instruments and 29
- Controls Near the Steering Wheel
- Daytime Running Lights 39
 - Hazard Warning 42
 - Headlights 39
 - Instrument Panel Brightness .. 40
 - Rear Window Defogger 42
 - Steering Wheel Adjustment ... 43
 - Turn Signals 40
- Windshield Washers 41
- Windshield Wipers 41
- Coolant
- Adding 115
 - Capacity 178
 - Checking 115
 - Proper Solution 115
 - Temperature Gauge 37
- Corrosion Protection 152
- Crankcase Emission
- Control System 181
- Cruise Control Operation 44
- Cup Holder. See Beverage Holder
- Customer Relations Information 187
- Customer Relations Office 187
- D**
- DANGER, Explanation of ii
- Dashboard 30
- Daytime Running Lights 39
- Dead Battery, What to Do 163
- Defects, Reporting Safety 26
- Defogger, Rear Window 42
- Defrosting the Windows 70
- DEXRON® II Automatic
- Transmission Fluid 120
- Dimensions 178
- Dimming the Headlights 39
- Dipstick
- Automatic Transmission 120
 - Engine Oil 111
- Directional Signals 34
- Disabled, Towing Your Car If ... 174
- Disc Brake Wear Indicators 99
- Disposal of Used Oil 114
- Doors
- Locking and Unlocking 49
 - Power Door Locks 49
- DOT Tire Quality Grading 137

Index

- Downshifting, 5-speed
 - Manual Transmission 93
- Driving
 - Fuel Economy 86
 - In Bad Weather 101
 - In Foreign Countries 81

E

- Economy, Fuel 86
- Emergencies on the Road 155
 - Battery, Jump Starting 163
 - Changing a Flat Tire 157
 - Charging System Light 33
 - Check Engine Light (Canada) .. 34
 - Checking the Fuses 172
 - Low Oil Pressure Light..... 33
 - Malfunction Indicator
 - Lamp (U.S.) 34
 - Manually Closing Moonroof .. 170
 - Overheated Engine 165
- Emergency Brake 57
- Emergency Flashers 34

- Emissions Control 181
- Engine
 - Check Light (Canada) 34
 - Coolant Temperature Gauge ... 37
 - Identification Number 177
 - Malfunction Indicator
 - Lamp (U.S.) 34
 - Oil
 - Capacity 178, 200
 - What Kind to Use 200
 - Oil Pressure Light 33
 - Overheating 166
 - Specifications 178
- Engine Belts 134
- Ethanol in Gasoline 81
- Evaporative Emission Controls . 181
- Exhaust Fumes 25
- Expectant Mothers,
 - Use of Seat Belts by 10
- Exterior, Cleaning the 148

F

- Fabric, Cleaning 151
- Fan, Interior 66
- Fan, Radiator 27
- Features, Comfort and
 - Convenience 63
- Filling the Fuel Tank 82
- Filters
 - Air. See Air Cleaner Element
 - Fuel 105, 126
 - Oil..... 105, 113
- First Gear, Shifting 94
- 5-Speed Manual Transmission
 - Checking Fluid
 - Level 105, 121
 - Shifting the 94
- Flashers, Hazard Warning 34
- Flat Tire, Changing a 157

- Fluids
- Automatic Transmission . 120, 200
 - Capacity 178, 200
 - Brake 122
 - Clutch 123
 - Manual Transmission 200
 - Capacity 178, 200
 - Power Steering 124
 - Windshield Washer 119
 - Capacity 178
- FM Stereo Radio Reception 71
- Folding Rear Seat 52
- Foreign Countries, Driving in 81
- Four-way Flashers 42
- Front End, Towing by
 - Emergency Wrecker 174
- Fuel
- Fill Door and Cap 82
 - Filling the 82
 - Filter 126
 - Gauge 37
 - Oxygenated 80
 - Octane Requirement 200
- Tank
- Capacity 178, 200
 - Filling the 82
- Fuses, Checking the 172
- G**
- Gas Mileage, Improving 86
- Gasohol 80
- Gasoline 80, 200
 - See also Fuel
 - Filter 126
 - Gauge 37
 - Octane Requirement 200
 - Tank, Filling the 82
- Gas Station Procedures 82
- Gauges
- Engine Coolant Temperature . . 37
 - Fuel 37
 - Odometer 36
 - Speedometer 36
 - Tachometer 36
 - Trip Meter 36
- Gearshift Lever Positions
- 5-Speed Transmission 93
 - Automatic Transmission 95
- Glass Cleaning 152
- Glove Box 57
- H**
- Halogen Headlight Bulbs 140
- Hazard Warning Flashers 42
- Headlights 39
 - Daytime Running Lights 39
 - High Beam Indicator 34
 - High Beams, Turning on 39
 - Low Beams, Turning on 39
 - Replacing Halogen Bulbs 140
 - Turning on 39
- Heating and Cooling 64
- High Altitude, Starting at 92
- High-Low Beam Switch 34
- Hood, Opening the 83
- Horn 47

Index

Hot Coolant, Warning about	115
Hydraulic Clutch	123
Hydroplaning	102

I

Identification Number, Vehicle	176
If Your Car Has to Be Towed	174
Ignition,	
Keys	47
Switch	48
Timing Control System	182
Indicator Lights, Instrument Panel	
Charging System Light	33
Check Engine (Canada)	34
Cruise Control	34
Engine Malfunction	
Indicator (U.S.)	34
High Beam	34
Lamp Check	31
Low Oil Pressure	33
Parking Brake and	
Brake System Light	33

Seat Belt Reminder	32
Shift Lever Position Indicator	35
Supplemental Restraint System	33
Trunk-open	34
Turn Signal & Hazard Warning	34

Infant Restraint	20
Inflation, Proper Tire	134
Inside Mirror	55
Inspection, Tire	134
Instrument Panel	30
Instrument Panel Brightness	40
Interior Cleaning	151
Interior Light	61
Introduction	i

J

Jack, Tire	157
Jacking up the Car	158
Jump Starting	163

K

Keys	47
------	----

L

Label, Certification	176
Labels, Safety, Location of	27
Lane Change, Signaling	40
Lap Belt	9
Lap/Shoulder Belts	7
Leaking of Exhaust into Car	25
Lighter, Cigarette	60
Lights	
Bulb Replacement	140
Indicator	31
Parking	39
Turn Signal	40
Loading Cargo	86
LOCK (Ignition Key Position)	48

Locking Clip, Seat Belt	22
Locks	
Anti-theft Steering Column	48
Fuel Filler Door	82
Glove Box	57
Power Door	49
Trunk	50
Low Coolant Level	115
Low Oil Pressure	33
Low Oil Pressure Light	167
Lower Gear, Downshifting to a ...	93
Lubricant Specifications Chart	178
Luggage	88

M

Maintenance	103
Periodic Items	110
Record	107 - 108
Schedule	105 - 106
Malfunction Indicator Lamp (U.S.)	34
Manual Transmission.....	93

Manual Transmission	
Fluid	105, 121
Maximum Shift Speeds	94
Meters, Gauges	36
Methanol in Gasoline	81
Mirror, Vanity.....	59
Mirrors, Adjusting the	40, 55
Moonroof	
Closing Manually.....	170
Operation	54

N

Neutral Gear Position	96
New Vehicle Break-in	80
Normal Shift Speeds	94
NOTICE, Explanation of.....	ii
Numbers, Identification.....	176

O

Occupant Protection System	4
Octane Requirement, Gasoline ..	80
Odometer	36
Odometer, Trip	36
Oil	
Change, How to	113
Change, When to	103
Checking Engine	111
Pressure Light	33
Selecting Proper	
Viscosity Chart.....	112
ON (Ignition Key Position)	48
Opening the Hood	83
Opening the Trunk	50
Operation in Foreign Countries ..	81
Outside Mirrors.....	55
Overheating, Engine	165

P

Panel Brightness Control,	40
Park Gear Position	96
Parking Brake	57
Parking Brake and Brake System Light	33
Parking Lights	39
Parking Over Things that Burn .	183
PGM-FI System.....	182
Polishing and Waxing	149
Power	
Door Locks	49
Mirrors	56
Steering	124
Windows	53
Power Steering Belt. See Engine Belts	
Pregnancy, Using Seat Belts	10
Proper Seat Belt Usage	7

R

Radiator Overheating	165
Radio/Cassette Sound System ...	71
Rear End Towing	174
Rear Lights, Bulb Replacement .	142
Rear Seat, Folding	52
Rear View Mirror	55
Rear Window Defogger	42
Reclining the Seat-backs	16, 51
Recommended Shift Speeds	94
Reminder Lights	31
Replacement	
Air Cleaner Element	125
Coolant	116
Engine Oil and Filter	113
Fuel Filter	126
Fuses	172
Light Bulbs	140
Schedule	105 - 106

Spark Plugs.....	126
Tires.....	137
Wiper Blades	131

Replacing Seat Belts	
After a Crash	10
Reporting Safety Defects	26
Reserve Tank, Coolant.....	115
Restraint, Child	18
Between 20 and 40 lbs (9 and 18 kg)	20
Less Than 20 lbs (9 kg)	20
Over 40 lbs (18 kg)	21
Under 40 lbs (18 kg)	19
Reverse Gear Position	96
Rotation, Tire.....	136

S

Safety Belts	4
Safety Defects, Reporting	26

- Safety Labels, Location of 27
- Safety Messages ii
- Seat Belts
 - Advice for Pregnant Women ... 10
 - Child Seat Anchor Plate 23
 - Cleaning 151
 - Frayed or Torn 10
 - Locking Clip 22
 - Maintenance 10
 - Reminder Light and Beeper ... 32
 - Replacement 10
 - System Components..... 6
 - Tether Attachment Points 22
 - Use During Pregnancy 10
 - Wearing a Lap/Shoulder Belt ... 7
 - Wearing the Lap Belt 9
- Seats, Adjusting the 51
- Serial Number 176
- Service Intervals 104
- Service Manual 191
- Service Station Procedures 82
- Setting the Clock 58
- Shift Lever Position Indicator 35, 95
- Shifting
 - The 5-Speed Transmission 93
 - The Automatic Transmission .. 95
- Side Marker Lights,
 - Bulb Replacement in 141
- Signaling Turns 40
- Snow Chains 139
- Snow Tires 139
- Solvent-type Cleaners 148
- Sound System 71
- Spare Tire
 - Inflating 156
 - Inflating (Pressure) 200
 - Specifications 179, 200
- Spark Plugs
 - Replacing 126, 105
 - Specifications 128
- Specifications Charts 178
- Speed Control 44
- Speedometer 36
- SRS Indicator..... 11
- START (Ignition Key Position) ... 48
- Starting the Engine 91
 - In Cold Weather
 - at High Altitude 92
 - With a Dead Battery 163
- Steam Coming from Engine 165
- Steering Wheel
 - Adjustment..... 43
 - Anti-theft Column Lock 48
- Steering Wheel Controls,
 - Cruise Control 44
- Stereo Sound System 71
- Storing Your Car 146
- Sunshade (Moonroof) 55
- Supplemental Restraint System
 - Service Precautions 15
 - Servicing..... 15
 - SRS Indicator 14

System Components..... 11
Technical Description 180

T

Tachometer 36
Taillights, Changing Bulbs in 42
Taking Care of the Unexpected . 155
Tape Player 75
Technical Descriptions
 Three-way Catalytic Converter 183
 Emission Control Systems 181
 Supplemental Restraint
 System 180
Temperature Gauge 37
Tether Attachment Points 22
Time, Setting the 58
Tire Chains 139
Tire, How to Change a Flat 157
Tires 134
 See also label in glove box
 Air Pressure 134, 200

Checking Wear 135
Compact Spare 156
DOT Tire Quality Grading 137
Inflation 134
Inspection 135
Replacing 137
Rotating..... 136
Snow 139
Specifications 179, 200
Tools, Tire Changing 157
Torn Seat Belts 10
Towing
 A Trailer 102
 Emergency Wrecker
 (Tow Truck) 174
Transmission
 Checking Fluid Level
 Automatic Transmission ... 120

5-Speed Manual
 Transmission 121
Fluid Selection 120
Identification Number 177
Shifting the 5-Speed Manual ... 93
Shifting the Automatic 95
Treadwear 137
Trip Meter 36
Trunk-open Indicator Light 34
Turn Signals 40

U

Underside, Cleaning 148
Unexpected, Taking Care of the . 155
Uniform Tire Quality Grading ... 137
Unleaded Gasoline 80
Upholstery Cleaning 151
Used Oil, How to Dispose of.... 114

V

Vanity Mirror	59
Vehicle Capacity Load	88
Vehicle Dimensions	178
Vehicle Identification Number ..	176
Vehicle Storage	146
Ventilation	67
VIN	176
Vinyl Cleaning	151
Viscosity, Oil	112

W

Warning BEEPERS	
Key in Ignition	48
Seat Belts	32
WARNING, Explanation of	ii
Warning Labels, Location of	27
Warranty Coverages	186
Warning Labels, Location of	27
Washer, Windshield	
Checking the Fluid Level	119
Fluid Capacity	178
Operation	41
Washing	148
Waxing and Polishing	149
Wheels	
Adjusting the Steering	43
Alignment and Balance	136
Compact Spare	156
Wrench	158

Windows	
Cleaning	152
Operating the Power	53
Rear, Defogger	42
Windshield, Cleaning	41
Windshield, Defroster	70
Wipers, Windshield	
Changing Blades	131
Operation	41
Worn Tires	136
Wrecker, Emergency Towing . . .	174

Gas Station Information

Gasoline

UNLEADED gasoline
Pump octane of 86 or higher

Fuel Tank Capacity

11.9 US gal (45 l, 9.9 Imp gal)

Recommended Engine Oil

API SG grade
"Energy Conserving II" oil
SAE 5W-30 viscosity

Engine Oil Capacity

including filter
3.5 US qt (3.3 l, 2.9 Imp qt)
without filter
3.2 US qt (3.0 l, 2.6 Imp qt)

Tire Pressure (measured cold):

DX:
32 psi (2.2 kg/cm², 220 kPa)
U.S.: EX, EX w/option package,
Canada: SI
29 psi, (2.0 kg/cm², 200 kPa)

Spare Tire Pressure

60 psi (4.15 kg/cm², 415 kPa)

Tire Size (Front and Rear):

DX:
P175/70R13
U.S.: EX, EX w/option package,
Canada: SI
P185/60R14

Spare Tire:

DX:
T105/80D13
U.S.: EX, EX w/option package,
Canada: SI
T105/70D14

Other Tire Size Information

See label in the glove box.

5 Speed Manual Transmission Oil:

SAE 10W-30 or 10W-40 viscosity
API SF or SG grade recommended

Capacity:
1.9 US qt (1.8 l, 1.6 Imp qt)

Automatic Transmission Fluid:

Automatic Transmission Fluid or
an equivalent DEXTRON® II type
Automatic Transmission Fluid
(ATF)

Capacity:
3.0 US qt (2.8 l, 2.5 Imp qt)