

1991 Accord Wagon Online Reference Owner's Manual

Use these links (and links throughout this manual) to navigate through this reference.
For a printed owner's manual, click on authorized manuals or go to www.helminc.com.

Contents

Owner's Identification Form

Features & Safety	2
What you should know before driving your car.	
Starting & Driving	65
What gas to use, how to change gears, etc.	
Maintenance	85
The Required Maintenance Schedule and some items you can service.	
Emergency Service	122
Changing a flat, jump starting, towing.	
Specifications	130
Dimensions, weights and capacities.	
Consumer Information	132
Reporting Safety Detects, warranty service, vehicle identification numbers, etc.	
Index	140

Introduction

This manual contains important information about the safe operation and maintenance of your car.

We urge you to read this manual carefully, become familiar with the controls it describes, and follow its recommendations, to help make your driving trouble-free and enjoyable.

Statements or labels on the product preceded by the following words are of special significance:

 DANGER indicates severe personal injury or death will result if instructions are not followed.

 WARNING indicates a strong possibility of severe personal injury or death if instructions are not followed.

CAUTION: means hazards or unsafe practices which could cause minor personal injury or product or property damage.

NOTE: gives helpful information.

Break-in Period

During the first 600 miles (1,000 km) of driving, avoid full-throttle starts and cruising for extended periods at a constant speed.

NOTE:

- This break-in procedure also applies to exchanged or overhauled engines.
- During and after the break-in period, drive the car at moderate speeds until the engine is fully warmed up.

During the first 200 miles (300 km), try to avoid severe braking.

Brake misuse during this period will reduce future braking efficiency.

Remember, your Honda Automobile dealer knows your car best, and should be consulted for service assistance and advice.

Master and Valet Keys

Your car is supplied with a master key that fits the ignition and all locks, and a valet key that fits the ignition and doors, but not the glove box or tailgate. The valet key is provided for times when you must leave the key with a parking attendant or repair person, but still want to keep valuables safely locked-up in the glove box.

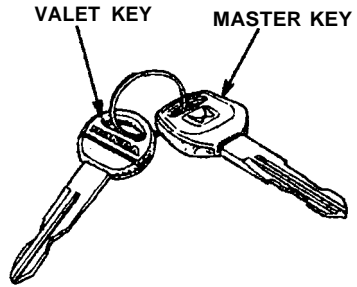

Write down the numbers stamped on all of the keys and keep the information in your wallet or purse in case you ever need to have duplicates made. All keys are double-edged so you can insert them into the locks with either side up.

Using the Master and Valet Key

If a key is used to lock the driver's side door, all doors and the tailgate will lock, but the key will only unlock the driver's door.

If a key is used in the front passenger door, all doors and the tailgate will lock and unlock.

Using the key in the tailgate will lock and unlock the tailgate and all doors.

To open the tailgate, pull the handle, then lift up.

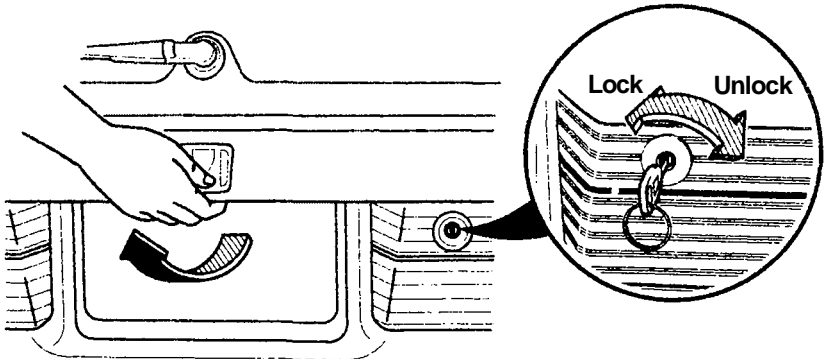
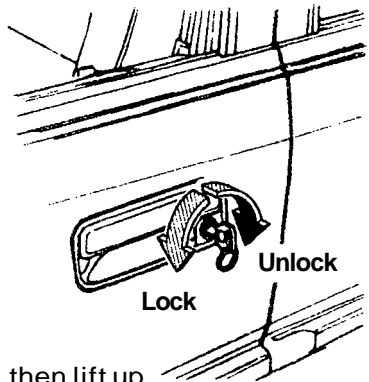

Keys and Locks (cont'd)

Remote Access Key (US Cars: EX, Canada Cars: EX-R)

In addition to the master and valet keys, your car is also supplied with a battery-operated remote access key. Use the remote access key to activate the keyless entry system.



Keyless Entry System

The keyless entry system enables you to operate the locks from outside the car without inserting the key in the keyhole.

The battery in the remote access key recharges each time the key is in the ignition with the engine running.

Using the Remote Access Key (US: EX, Canada: EX-R)

To operate the door locks from outside the car using the remote access key, aim the key blade at the keyless entry window located to the left of the keyhole in the driver's door or tailgate, and press the button in the key. Keep the key blade within 18 inches (50 cm) and in line with the keyless entry window. When the remote access key is used on the driver's door, all doors and the tailgate will lock; but only the driver's door will unlock.

If the remote access key is used on the tailgate, the tailgate and all doors will lock and unlock.

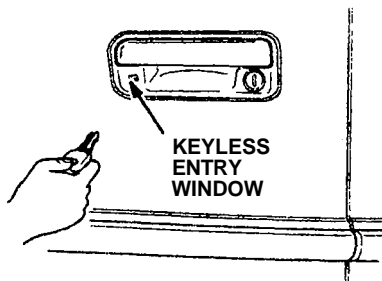

KEYLESS ENTRY WINDOW

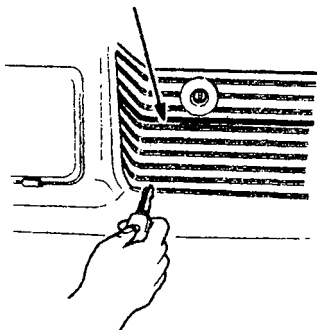

Replacement Key

If you lose your remote access key, you can order a replacement from your Honda dealer. You need the five-digit keyless code number on the aluminum plate that came with your key and the four-digit number on the key blade. Both numbers are equally important and should be stored in a safe yet accessible place.

Take care in handling the remote access key; its electric circuit is very sensitive.

- Avoid dropping heavy objects on the key.
- Keep the key away from areas with high temperatures, high humidity and direct sunlight.
- Do not disassemble the key.
- Use only a mild detergent and water to clean the key; dry the key thoroughly with a soft cloth.
- Use the remote key as your main ignition key. This will allow the battery to be regularly recharged.

The remote access key will not operate if:

- Dirt or moisture is on the key or keyless entry window.
- The key was not used in the ignition regularly and has lost its charge.

Consult your dealer if the keyless entry does not operate properly.

Keys and Locks (cont'd)

Door Plunger

From inside the car, each door and the tailgate can be locked by pushing the plunger down; each door can be unlocked by pulling the plunger up.

Pushing down the plunger on the driver's door locks all doors and the tailgate, but pulling up the plunger unlocks only the driver's door.

Pushing down on the tailgate plunger locks the tailgate and all doors. The plunger on the tailgate is not designed to be pulled up manually for unlocking.

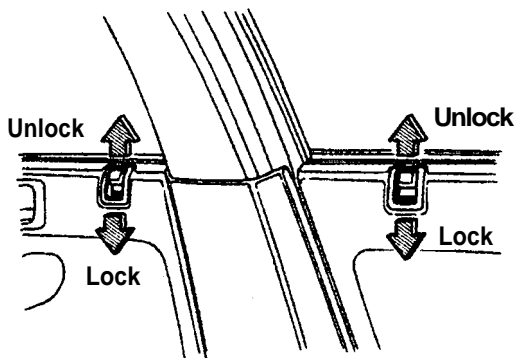

Power Door Locks

All doors and the tailgate can be simultaneously locked and unlocked by operating the master door lock switch on the inside of each front door.

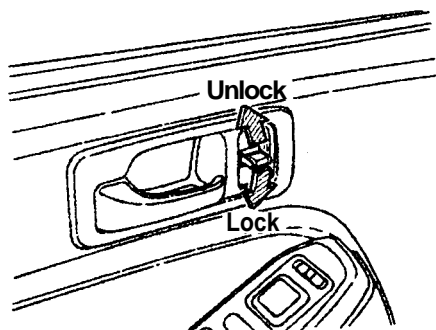

Lockout Prevention

Lockout Prevention keeps you from locking the driver's door or the tailgate when the key is in the ignition and the driver's door or tailgate is open. If you try to lock the driver's door by pushing down the plunger, the tailgate plunger and all other door plungers will pop back up. If you push down the tailgate plunger when the key is in the ignition and the tailgate is open, the tailgate plunger and all other door plungers will pop back up. Also, both master door lock switches will not lock the doors if either front door is open and the key is in the ignition.

The system can be overridden if the outside or inside door handle is held in the open position while the plunger is pushed down. The lock cycles several times and may lock all doors and the tailgate after the door is closed .

Lockout Prevention does not affect the operation of any passenger door lock.

(US Cars: EX, Canada Cars: EX-R)

Lockout Prevention does not affect the operation of the Remote Access Key.

Child Proof Door Locks

The child proof door locks are designed to prevent accidental opening of the rear doors from inside the car. To activate the locks, push down the lock tabs located on each rear door, then close the doors. When the rear doors are locked in this way, they can only be opened from the outside.

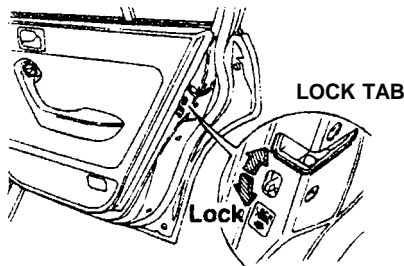

Seats

Front Seat

Adjust the seat position by pulling up on the adjustment lever under the front edge of the seat cushion, and sliding the seat to the desired position. Then release the lever and make sure the seat is locked in position by moving it back and forth.

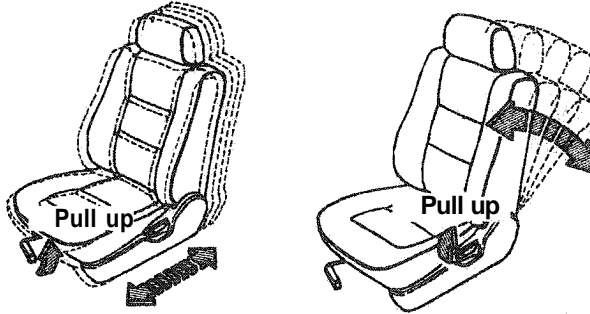

The angle of the seat-back can be changed by pulling up on the lever at the outside edge of the seat and leaning forward or back. Release the lever and let the seat lock into place when it reaches the desired angle.

Seat belts are most effective when the driver and passengers are sitting up straight and well back in each seat.

⚠ WARNING

- **Do not adjust the driver's seat while the car is moving; the seat could move suddenly, causing loss of vehicle control.**
- **To reduce the risk of sliding under the seat belts in a collision, the seat-backs should be reclined no more than is necessary for comfort.**

Driver's Lumbar Support (US: EX, CANADA: EX-R)

To adjust for more or less support of the driver's lower seat-back cushion, turn the knob on the inner side of the seat-back.

⚠ WARNING **Do not try to adjust the lumbar support while driving. Make the adjustment while sitting in your normal driving position before driving away.**

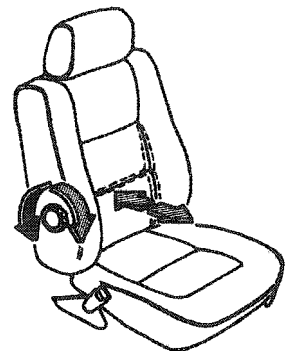

Head Restraints

The head restraints are designed to help reduce injuries due to whiplash. They are located at the top of each front seat-back and have several height positions. The restraints can be adjusted by pulling up to the recommended position. To lower them, slide the button next to the restraint's height adjustment bar while pushing the restraint down. Adjust so the top of the restraint is approximately level with the tops of your ears.

If a head restraint must be removed (for cleaning, fabric repair, etc.) pull the restraint up to its highest position, then slide the button while pulling the restraint out.

To reinstall, reverse the above procedure.

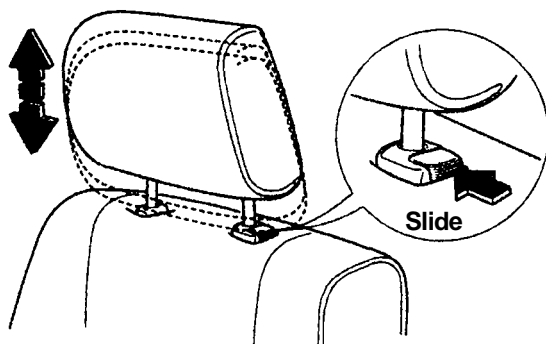

⚠ WARNING

- Do not drive the car with head restraints removed.
- Do not try to adjust head restraints while driving.

Rear Seat Arm Rest

The rear seat arm rest located at the rear seat-back can be used by pulling the tab.

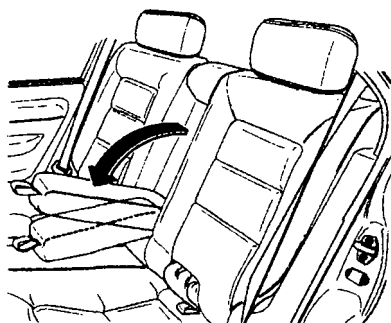

Seats (cont'd)

Folding Rear Seat

Each rear seat-back can be folded down to provide more cargo space. Folding both rear seat-backs down will provide maximum cargo space.

1. Pull on the strap at the center of the seat to lift up the seat cushion.

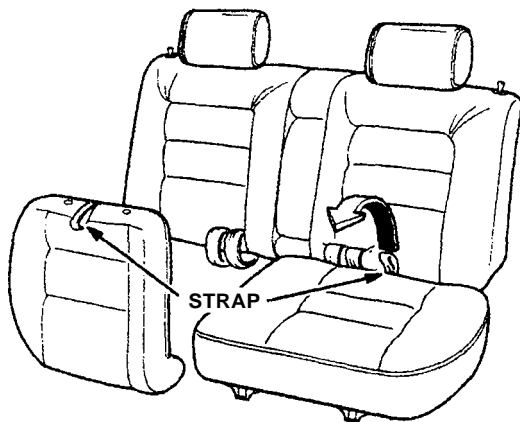

2. Remove the head restraint from the rear seat-back by sliding the button next to the head restraint's height adjustment bar and lifting the head restraint out.

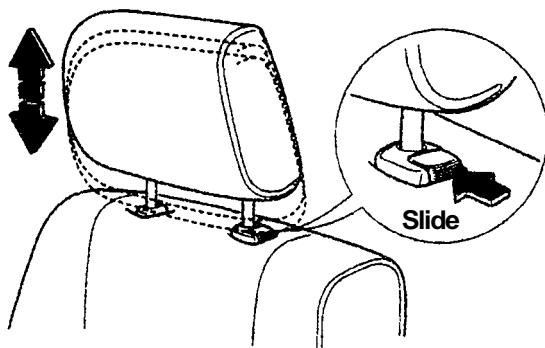

3. Pull up the release knob at the top of the seat-back and fold the seat forward.

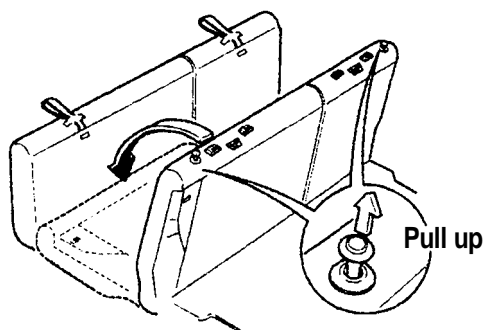

4. Store the head restraint in the holes provided in the seat cushion.

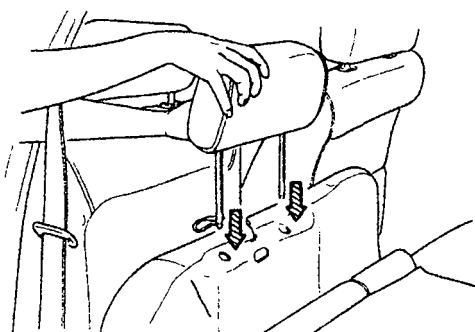

WARNING

- Weight limits shown on the label attached to the driver's door jamb must be observed. The total weight of passengers and cargo must not exceed the total weight limit on the label.
- Make sure the rear seat-back latches engage securely when the seat-back is returned to its normal position.
- Always replace the head restraints when the seat-back is returned to its upright position.
- When transporting luggage or other cargo do not pile it higher than the front seats. This precaution will help prevent such items from becoming dangerous projectiles in an accident.
- Cargo weight should be distributed as far forward as possible for better vehicle handling.

Loading the Car

The maximum your car can carry, including passengers, cargo, and trailer tongue weight, is 950 lbs (431 kg). This is the Vehicle Capacity Weight noted on the tire label attached to the driver's doorjamb.

To calculate the car's load capacity, start with 950 lbs (430 kg). First subtract 150 lbs (68 kg) for each person, including the driver. For example, if there will be five people in the car (750 lbs, 340 kg), you can carry up to 200 lbs (91 kg) of cargo.

If you are towing a trailer, remember to also subtract the trailer tongue weight (see page 78) from the 950 lbs (430 kg) capacity.

After you have determined how much cargo you can carry, remember that where you put cargo is also important. Do not load cargo above the top of the rear seat-back. The maximum you can carry behind the rear seat is 200 lbs (91 kg). To maintain a better weight distribution, place heavier items toward the center of the car.

CAUTION:

- **Do not exceed the maximum weight capacity for your car; overloading may affect vehicle handling and tire life.**
- **Load cargo so it will not contact the printed defroster wires in the rear window. The wires may be damaged if the cargo rubs against them.**

A passenger should never sit in the open cargo area while the car is moving. They should sit in one of the seats and wear their seat belt. With the rear seats folded, the length of the cargo area is 72 in (1850 mm). The width at the tailgate opening is 36 in (915 mm). The width between the wheel wells is 30 in (775 mm). The height of the rear opening is 28 in (725 mm).

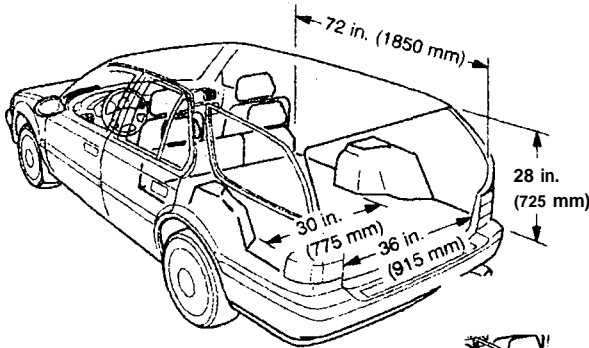

Storage Compartments

You can store smaller items in any of the three storage compartments in the cargo area. Two compartments are under the carpet, on either side of the tire compartment. The third is in the right side panel.

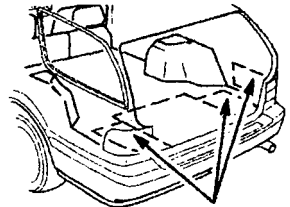

STORAGE
COMPARTMENT
LOCATIONS

Tonneau Cover

When extended, the tonneau cover conceals your parcels and protects them from direct sunlight. To extend the tonneau cover, pull the cover's leading edge out of its housing and slip the brackets over the hooks provided at both sides of the tailgate opening.

To retract the cover, slip the brackets off the hooks and guide the cover so it rolls back fully into its housing.

CAUTION: Do not store parcels on the tonneau cover. The tonneau cover may break if weight is placed on it.

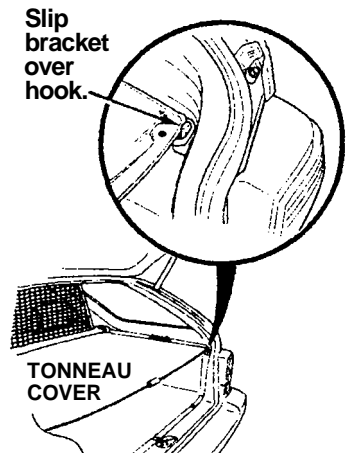

Cargo Area (cont'd)

Package Net

The package net is intended to restrain only light, soft items, such as clothing which do not exceed a total weight of 10 lbs (4.5 kg).

Grasp the net's leading edge and pull it out of the tonneau cover housing. Lock the prongs at both ends of the net into either the floor or ceiling latches.

To store the net, release both prongs from the latches and let it roll back into the tonneau cover housing.

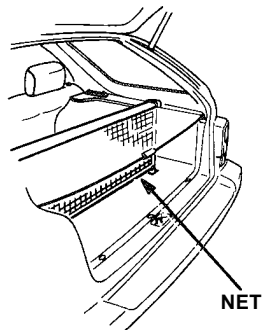

You can select from either of two locations to position the tonneau cover housing unit. One position is directly behind the rear seat and the other is halfway between the rear seat and the tailgate.

To remove the housing unit, depress the latch on the right end of the unit and pull the unit out of the bracket, then pull the opposite end out of its bracket.

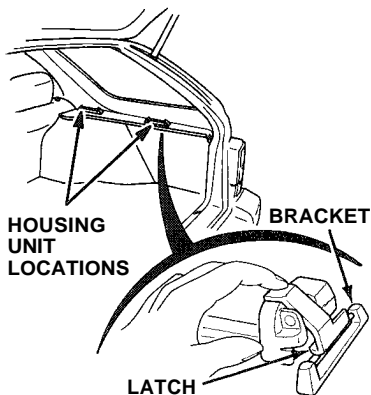

CAUTION: Make sure all objects in the cargo area are secured, otherwise they may become projectiles in an accident.

Secure the tonneau cover housing unit when you are not using it. Use the two straps located in the right side floor storage compartment and strap it to the two floor hooks closest to the tailgate opening in the cargo area. If it is not secured, it may become a dangerous projectile in an accident.

1. Take one strap and loop the free end through a floor hook.
2. Place the housing on the strap and wrap the strap completely around it.
3. Slip the free end through the "D" rings, then separate the rings and slip the strap *over* one ring and *under* the other and pull tight. Repeat this procedure for the other strap and hook.

Your Honda automobile is provided with seat belts to minimize the chance of injury to yourself and your passengers in a sudden stop or accident.

For precautions on using seat belts for children, babies, and pregnant women, see pages [18](#) - [20](#).

Seat belts are most effective when properly worn and when the driver and passengers are sitting up straight and well back in their seats.

⚠ WARNING in the event of a collision, occupants not wearing seat belts could be seriously or fatally injured. Make sure you and all your passengers **ALWAYS** put on the seat belts before driving away.

CAUTION: Be careful the seat belts are not damaged in the door or seat mechanism.

Buckling the Front Seat Belts

The front seat belts are one-piece combination lap/shoulder belts with emergency locking retractors designed to lock only during a sudden stop or impact. Otherwise, they allow you some freedom of movement in the seat.

NOTE: The emergency locking retractor will also activate if the belt is pulled too fast. If the belt locks, release the belt slightly and pull it out more slowly.

1. Before buckling your belt, move the seat to a comfortable distance from the steering wheel, sit straight up and well back in your seat.

2. Take hold of the tongue plate and pull the belt across your lap. Be sure the belt is not twisted or caught on anything.

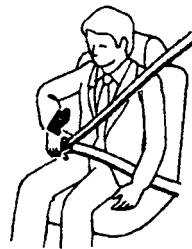

Seat Belts (cont'd)

3. Push the tongue plate into the buckle until it clicks locked. Position the belt across your lap, not your abdomen, as low on your hips as possible.

⚠ WARNING Avoid placing the lap belt across your abdomen. In the event of a collision, the pressure of the belt on the abdomen may increase the extent of injury.



4. To release the belt, push the "PRESS" button in the buckle; the belt should retract automatically when released. If the belt does not fully retract, pull it out and check for kinks or twists.

⚠ WARNING

- Comfort clips sold on the open market are not recommended since they could impair the function and safety of the belts.
- Do not wear the shoulder portion of the belt under your arm or out of position. Such use could increase the chance and amount of injury in an accident.
- Never use one belt for more than one person, child or adult.

Shoulder Anchor Height Adjusting Mechanism

The height of the shoulder anchor can be adjusted to four positions. It is best to use the shoulder belt at the highest adjustment position. However, if the belt is too near your neck, causing discomfort, lower the anchor position one step at a time until the belt is in a comfortable position.

To raise or lower the anchor height adjustment, push the release tabs on the mechanism.

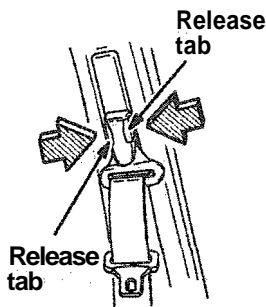

Buckling the Rear Seat Belts

In the rear seat, there are two one-piece combination lap/shoulder belts and a center lap belt. The seat-backs and seat belts provide best restraint when the occupants are sitting well back and straight up in the seat.

The lap/shoulder belts work the same as the two front seat belts.

Make sure both rear shoulder belts are positioned in front of the rear seat-backs whenever the seat-backs are in their upright positions.

To use the center lap belt, push the tongue plate into the buckle until it clicks locked. Position the belt across your lap, not your abdomen and as low on your hips as possible. Pull the loose end of the belt to adjust for a snug but comfortable fit.

A slack belt will greatly reduce the protection afforded to the wearer. Hold the tongue plate perpendicular to the belt as shown.

- To shorten, pull the end of the belt away from the tongue plate.
- To lengthen, pull the tongue plate.

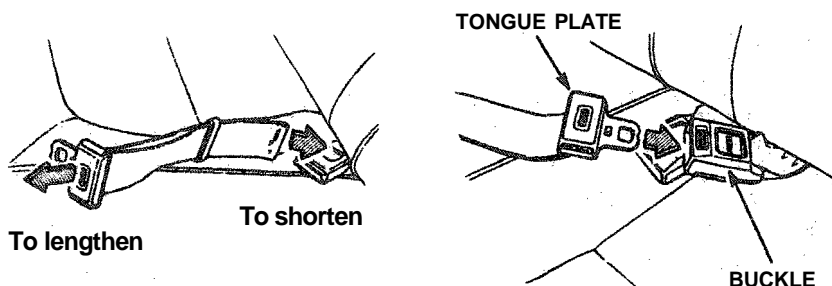

NOTE: When the center lap belt is not in use, store it in the buckle locators.

Fasten Seat Belt Warning Light and Warning Beeper

Both the  light in the instrument panel and the warning beeper will go on for about six seconds when the ignition switch is turned on and the driver's belt is not fastened. The beeper will not go on if the driver's seat belt is fastened before the ignition switch is turned on, but the warning light will come on for about six seconds each time, to remind the driver to have passengers put their seat belts on. If the light and beeper do not work as described, have your dealer check the system.

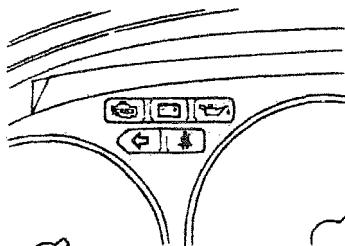

Seat Belts (cont'd)

Child Restraint

Children riding in the car should be restrained to minimize the risk of injury in an accident, sudden stop or sudden maneuver.

According to accident statistics provided to the National Highway Traffic Safety Administration (NHTSA), children are safer when properly restrained in the rear seating positions than in the front seat.

For smaller children, we strongly recommend the use of a commercially available child restraint system that meets the Federal Motor Vehicle Safety Standard (FMVSS) and the applicable Canadian Motor Vehicle Safety Standards because it offers the most protection against injury. All states and virtually all provinces in Canada now have laws which require that small children must be seated in a child passenger seat restraint system. Check local laws.

All child restraint systems are designed to be secured by lap belts or the lap portion of a lap-shoulder belt. Children could be endangered in a crash if their restraints are not properly secured.

Before buying a particular child restraint system, make sure it fits your car seat and seat belts, and fits your child. Follow the child seat manufacturer's instructions when installing the seat.

Children who have outgrown the child restraint system should use one of the seat belts.

- Make sure the belt is snug against the child's body with the shoulder portion going over the shoulder and across the body to evenly distribute the belt's restraining force.
- Check that the lap portion of the belt is positioned low on the child's hipbone and below the abdomen. This way if the car is involved in an accident, the child will be less likely to slide under the seat belts.
- If the belt is too close to the child's neck or throat, you may want to consider putting the child in an automobile booster seat that meets the Federal Motor Vehicle Safety Standard (FMVSS).

⚠ WARNING

- Children should never ride unrestrained in an automobile.
- Never use an infant carrier or child safety seat that "hooks" over a seat-back; it may not provide adequate security in an accident.
- Never allow a child to be held in a person's arms while they are in the moving vehicle. Holding a child in a moving vehicle does not provide the child with any means of protection during an accident, even if the person holding the child is wearing a seat belt.
- Do not allow children to ride in the cargo area of the car.

Installation of Child Seat

All child restraint systems are designed to be secured by lap belts or the lap portion of a lap/shoulder belt.

Children could be endangered in a crash if their child restraints are not properly secured. Follow the child seat manufacturer's instructions when installing the seat.

Your Honda automobile is equipped with attachment points specifically for a rear seat mounted child restraint system which uses a top tether.

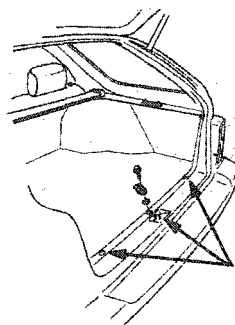

**TETHER
ATTACHMENT
POINTS**

The tether attachment points are located on the floor just in front of the tailgate.

⚠ WARNING When the child restraint system is not in use, remove it from the car or secure it with the seat belt to keep it from becoming a projectile in the event of an accident.

NOTE: See your Honda dealer for installation of the child restraint system.

Seat Belts (cont'd)

U.S. Cars

The child seat's manufacturer provides the anchor plate and attaching hardware if the child seat requires a top tether. An anchor plate kit is also available if you write to:

American Honda Motor Co., Inc.
Consumer Affairs
1919 Torrance Blvd.
Torrance, CA 90501-2746



Anchor Bolt Torque: 16 lb. ft.

Canadian Cars

Your car is supplied with one child seat tether anchor plate stored in the glove box. Bolt size: M8 x 1.25. Bolt torque: 22 N.m (2.2 kg-m). If you are not sure how to install the anchor plate, or you need additional anchor plates, contact your Honda dealer.

Do not remove the toothed washer from the child seat anchor plate. Use the child seat anchor plate with the toothed washer attached to it.

TOOTHED WASHER

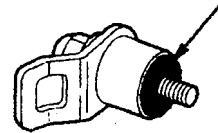

⚠ WARNING

- **Do not use the anchor plate for any other purpose; it is designed exclusively for the installation of a child seat.**
- **Make sure the rear seat-back is locked firmly when installing a child seat.**

Pregnant Women

A pregnant woman should use a lap/shoulder belt to help lessen the chance of injury and/or the amount of injury in an accident.

⚠ WARNING It is desirable that a pregnant woman ask her doctor at each medical check-up if she can drive, and also ask about the most appropriate way of wearing the lap/shoulder belt. If a rear seat lap belt is used, it should be worn as low and snugly as possible over the hips.

Inspection

All parts of the seat belts, including the belt fabric, should be regularly inspected for fraying, loosening, wear and other damage. Keep the belts in good condition at all times to reduce the chance of being injured in an accident, and to minimize any injuries that do occur. Make sure the buckles, retractors, tongue plates, guides and anchors all work properly.

Don't let anything get inside the buckle or the retractor; it could cause latch or retractor failure.

Cleaning

The belts should always be kept clean and dry; wet or damp belts can cause rewinding problems. To clean the belts, pull them all the way out of their retractors and scrub them with warm water and a mild soap; then let them air-dry fully extended, in the shade, with the car windows open.

WARNING

- **Never bleach, dye or clean the belts with chemical solvents; they will weaken the fabric.**
- **Do not remove the seat belts from the car to wash them.**

Replacement

Replace the seat belt if:

1. The belting is cut, punctured, burned, etc.
2. The buckle or retractor does not work properly.
3. It was being worn at the time of a collision (also check for deformation damage at the seat belt anchor points).
4. Its condition is questionable.

Supplemental Restraint System (Airbag)

(US Cars Only)

Your car is equipped with a Supplemental Restraint System (SRS). The Supplemental Restraint System consists of an airbag and a knee bolster.

NOTE: The Supplemental Restraint System can function only when the ignition switch is in the II position.

COMPONENTS of SRS

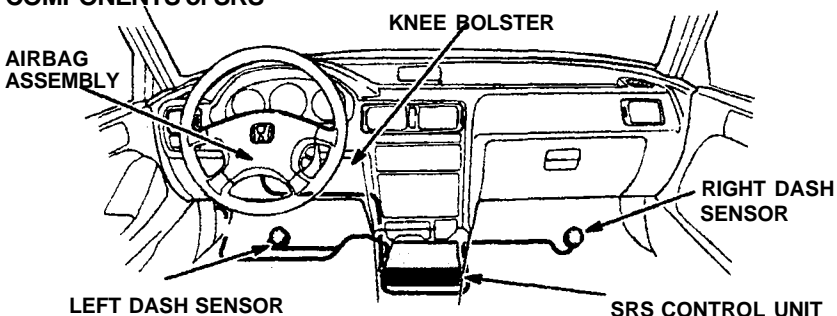

Honda recommends the use of seat belts by all vehicle occupants to reduce the risk of injury in an accident. The SRS, in combination with the seat belt, is most effective when used in conjunction with the seat belt.

⚠ WARNING Make sure you and your passengers always put on your seat belts before driving away. See pages 15 - 17 for seat belt information.

The SRS is designed to deploy in an accident involving a moderate to severe frontal collision, and is not designed to assist the driver in a side impact, rear impact or roll-over accident.

The driver and all passengers should wear their seat belts at all times for maximum protection.

The SRS is designed to function on a one time only basis. In the event the SRS deploys, the airbag module will not function again and must be replaced. As a reminder, the SRS indicator light will stay on continuously after deployment. Only an authorized Honda dealer should repair or replace the system.

⚠ WARNING To avoid accidental deployment of the system or rendering the system inoperative, which may result in serious injury in an accident, no modifications should be made to any components or wiring of the SRS. This includes the installation of "custom" steering wheels or additional trim material, or badges over the steering wheel hub. Installation of additional electrical/electronic equipment on or near SRS components and/or wiring is specifically ill-advised, except by an authorized Honda dealer.

System Monitors

A diagnostic system continually monitors the readiness of the SRS while the car is being driven. The SRS indicator light will show normal system operation by lighting for about 6 seconds when the ignition key is turned to position II.

The following components are monitored by the diagnostics.

- Right Dash Sensor
- Airbag Activator
- Left Dash Sensor
- All Related Wiring
- SRS Control Unit

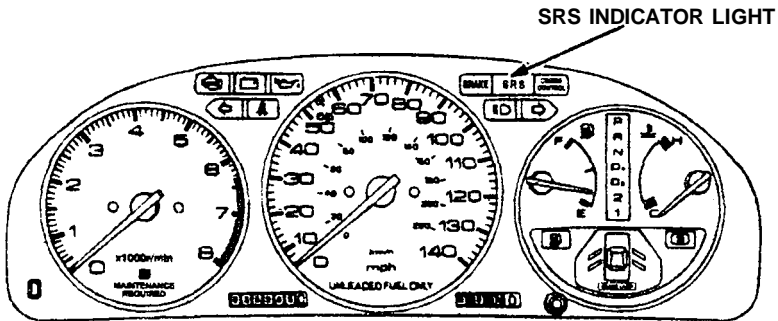

In the event of a malfunction, promptly take the car to your nearest Honda dealer to have the system checked. Unless checked and repaired, the SRS will not function reliably. A malfunction is shown by:

- The indicator light flashing or flickering.
- The SRS indicator light failing to illuminate when the ignition switch is first turned to the II position.
- The SRS indicator light continuously illuminated.
- The SRS indicator light illuminated while driving.

Supplemental Restraint System (cont'd)

Safety Guidelines for the Supplemental Restraint System

During a severe frontal impact, a sudden, fairly loud inflation noise will be heard and some smoke and powder will be released, neither of which is injurious. The smoke from the airbag deployment does not indicate a fire in the vehicle.

Although it is highly unlikely that the SRS would activate in a non-accident situation - should it occur, the bag will deflate quickly, not obscure vision and will not interfere with the driver's ability to maintain control of the automobile.

NOTE: When you sell your car, we urge you to explain to the buyer that it is equipped with a Supplemental Restraint System by alerting him to the applicable section in this owner's manual.

System Servicing

To ensure its long-term reliability, the Supplemental Restraint System must be inspected by a Honda dealer ten years after the date of manufacture, which is shown on the certification label attached to the left rear door jamb.

CAUTION: The impact sensors are located on the left and right sides of the bulkhead behind the engine. If you need service or repair in those areas or near the steering wheel and column, have an authorized Honda dealer do the work.

WARNING

- After a collision that requires the airbag unit or the entire car to be scrapped, it is mandatory that an authorized Honda dealer use the procedures and tools described in the Honda Service Manual.
- The SRS has no user-serviceable parts. Tampering with or disconnecting the SRS wiring could result in accidental firing of the inflator or could make the system inoperative, which may result in serious injury in an accident. For required servicing of the SRS, see your nearest Honda dealer.

Instrument Panel

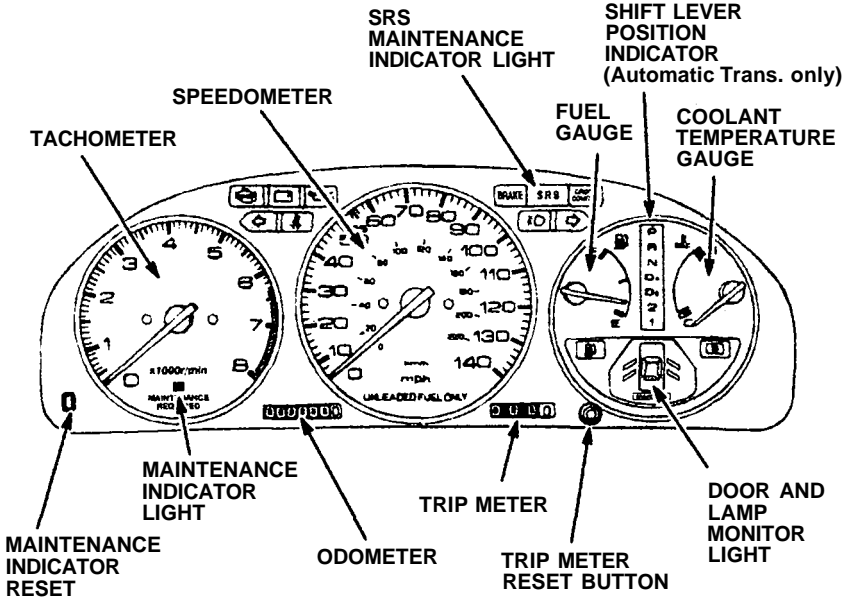
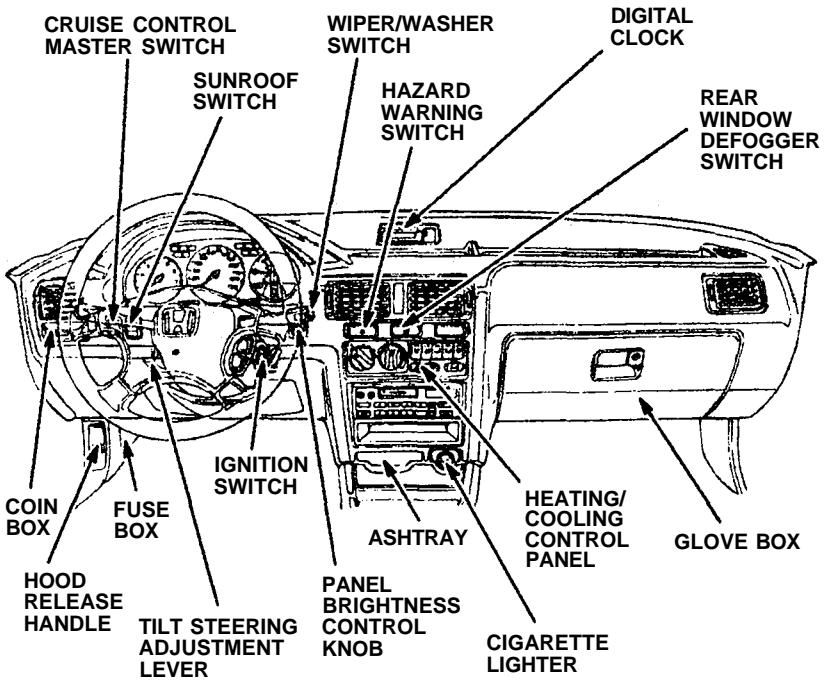

Gauges

Speedometer

US Cars: The speed is indicated in miles per hour (outer scale) and kilometers per hour (inner scale).

Canada Cars: The speed is indicated in kilometers per hour (outer scale) and miles per hour (inner scale).

Odometer

The numbers on the odometer indicate miles (US Cars) or kilometers (Canada Cars).

The odometer registers total distance traveled, and serves as your guide for determining when periodic maintenance is due.

US Cars: Federal law makes it illegal to alter the odometer of any motor vehicle with the intent to change the number of miles indicated.

Trip Meter

The numbers on the trip meter indicate miles (US Cars) or kilometers (Canada Cars).

The trip meter can be returned to zero by pushing in the reset button. Use the trip meter to check fuel consumption or distance traveled per trip.

Tachometer

The tachometer indicates engine speed in revolutions per minute. The beginning of the RED ZONE indicates the maximum allowable engine R.P.M. Do not run the engine with the tachometer indicator needle in the RED ZONE.

Fuel Gauge

FUEL TANK CAPACITY: Approx. 64.5 ℓ (14.1 Imp. gal, 17.0 US gal)

As a convenience, the gauge continues to show the same fuel level as when the ignition was last on. After refueling, the gauge will slowly change to the new fuel level when the ignition is switched on.

When the needle indicates E (empty), a usable reserve of about 4 ℓ (0.9 Imp gal, 1.1 US gal) remains in the tank.

Coolant Temperature Gauge

⚠️ WARNING Do not remove the radiator cap when the engine is hot. The coolant is under pressure and may blow out and scald you.

This gauge shows the temperature of the engine coolant. During normal operation, the needle should stay in the middle of the white range. Under severe driving conditions, such as hot weather or driving uphill for a long period, the needle may rise toward the upper section of the white range.

If the needle reaches the red line at "H" (Hot), pull safely off the road and stop the engine.

Wait until the engine is cool and check the coolant level in the reserve tank on the passenger side of the radiator under the hood. (See pages [97 - 98](#).)

Indicator Lights

US Car
Shown:

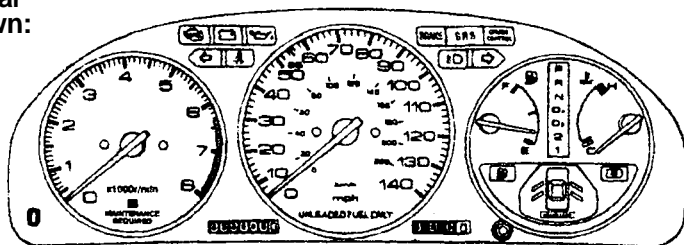

Shift Lever Position Indicator (Automatic transmission only)

A lighted indicator between the fuel and water temperature gauges shows which gear you have selected.

Indicator Light

The S (Sports) indicator light will come on when the "Sports" switch on the shift lever is pushed. See page 77.

NOTE: The S indicator light in the instrument panel also serves a second function. If the light flashes while driving (in any gear range) it indicates a possible malfunction in the transmission; avoid rapid acceleration and have the transmission checked by an authorized Honda dealer as soon as possible.

Turn Signal/Hazard Warning Indicator Lights

When the turn signal lever is pushed for left or right turns, the appropriate green indicator arrow on the instrument panel will blink along with the signal. Turning on the hazard warning switch makes all turn signals and both arrows blink (see page 39).

Headlight High Beam Indicator Light

This blue indicator light will go on whenever the high beams are switched on (see page 38).

Cruise Control Indicator Light

When the cruise control system is engaged, this indicator light is on (see page 41).



Fuel Reserve Light

If the light glows, it means you have about 10.0 ℓ (1.8 Imp gal, 2.6 US gal) or less fuel remaining and should refuel.

US



Canada

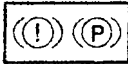

Parking Brake/Brake Failure Light

Check the brake light every time you start the car. With the parking brake set, the warning light should go on when the ignition switch is turned to II or III. With the parking brake released, the light should go on when the ignition switch is turned to III. If the light goes on at any other time, it means the brake fluid level in the master cylinder reservoir is too low; add fluid (see page 101) and have your dealer check for leaks immediately. Make sure the parking brake is released and the light is off before driving away.



Seat Belt Warning Light

The seat belt reminder light comes on for approximately six seconds when the ignition switch is turned on (see page 17).



Oil Pressure Light

A severe fluctuation in engine oil pressure will cause this light to flash on and off. You should get off the road as soon as possible and turn off the ignition. Check the oil level and add oil if necessary.

The oil pressure light will come on, and remain on, if there is insufficient oil pressure or when the ignition switch is turned on with the engine not running. If the light should come on while driving, get the car off the road as soon as you can, turn the engine off and check the engine oil level (see page 92).

Even if the oil level is correct, the engine should be checked by a Honda dealer before the car is driven again.

NOTE: The oil pressure light will only light as a result of low oil pressure. It is not directly an oil level indicator.

CAUTION: Running the engine while the oil pressure light is on constantly may cause immediate and severe engine damage.

Indicator Lights (cont'd)



Charging System Warning Light

The charging system warning light comes on when there is a problem with the electrical charging system or when the ignition switch is turned on with the engine not running. If the light comes on while driving, stop the car, turn off the engine and check the alternator belt for proper tension. With the engine turned off, push down on the middle of the belt as shown; it should have 10-12 mm (0.4 - 0.5 in) deflection under a force of 98 N.m (22 lb).

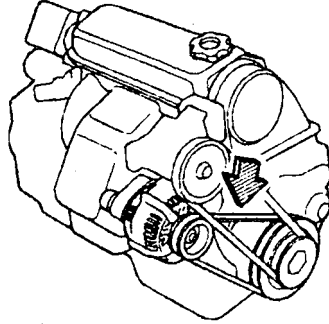

WARNING

- if the engine has been running, some engine components may be hot enough to burn you.
- **Keep hands away from the radiator fan. The fan may start automatically without warning and run for up to 15 minutes, even after the engine is turned off.**

NOTE: If necessary, have the charging system checked by an authorized Honda dealer.

US



Canada



Check Engine Warning Light

This light comes on for a couple of seconds each time the ignition is turned on. It will also come on, and remain on, if there is a malfunction in the emission control system. If the light comes on while driving, avoid driving at high speed, and have the system checked by a Honda dealer as soon as possible.

US

S R S Supplemental Restraint System

When the key is turned to the II position, the SRS indicator light will come on for about six seconds, to show normal system operation, and then turn off. See Supplemental Restraint System section on page [22 - 24](#).

Canada

D R L

Daytime Running Lights (DRL)

This light comes on when the ignition switch is ON (position II), the headlight switch OFF and the parking brake set. This indicates that the "Daytime Running Lights" are off. The indicator light goes off when the parking brake is released. If the parking brake is reapplied without switching the ignition off, the indicator light will remain off. See page [40](#).

Indicator Lights (cont'd)

Door and Lamp Monitor Lights

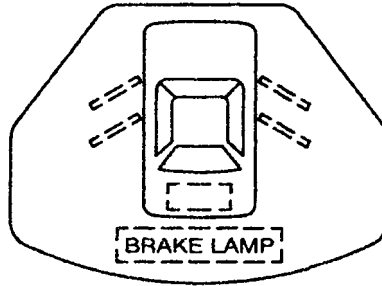

Door and Tailgate Warning Lights

If a door or the tailgate is open when the ignition is switched on, the appropriate indicator will light, and stay lit, until the door or tailgate is closed.

BRAKE LAMP

Brake Lamp Warning Light

If a brake light does not work, the BRAKE LAMP indicator will go on when you push the brake pedal while the ignition is ON; the indicator will stay on until you have the light repaired or replaced. Have the brake lights checked as soon as possible.

⚠️ WARNING It is dangerous to drive your car with a problem in either the brake electrical or hydraulic systems; have your dealer check both systems if you suspect brake trouble.

Checking the Door and Lamp Monitor Light

The door, tailgate and brake lamp warning lights should come on for about two seconds when the ignition switch is turned on. If they don't, have the system checked by a Honda dealer.

Maintenance indicator

When the total mileage of your car approaches the specified maintenance interval for engine oil and filter change or other required service, the indicator will change from green to yellow. The indicator will change to red if it is not reset before you reach the mileage interval. The indicator marked MAINTENANCE REQUIRED is to be used as a reminder that there are items in addition to the engine oil and filter that require service each 7,500 miles (12,000 km). See the maintenance schedule on page 87. After the maintenance is done, be sure to reset the indicator by inserting the ignition key in the slot. The color of the indicator will change to green and repeat its cycle.

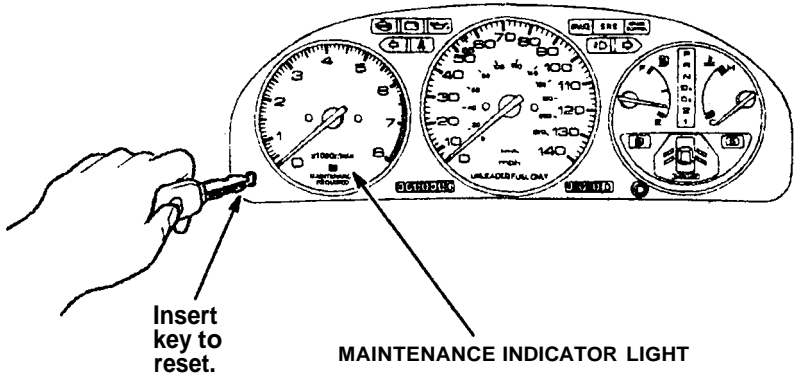

⚠ WARNING Do not reset the maintenance indicator while driving; your hand may impair steering which can result in an accident.

Tilt Steering

The steering wheel position can be adjusted to suit the driver's preference.

1. Push the lever located under the dash, on the left side of the steering column, all the way down and hold it while adjusting the steering wheel to the desired position.

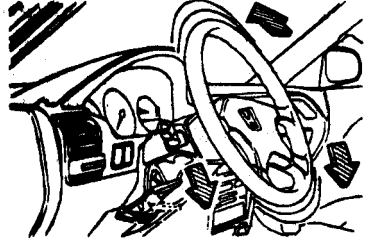

Push down

2. Hold the steering wheel in the desired position and pull the lever all the way up to lock it in place.

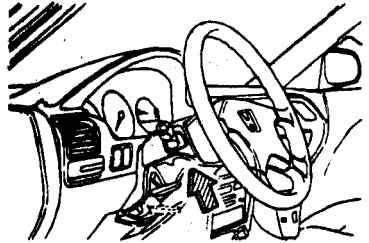

Pull up

WARNING

- Do not adjust the steering wheel position while driving.
- After adjusting the steering wheel position, make sure it is securely locked in place by "rocking" it up and down slightly.

Windshield Wipers/Washer

Windshield Wipers

Turn the switch to INT for intermittent operation; LO for low speed operation and HI for high speed operation.

In fog or very light rain, push the lever down to the MIST position for temporary high speed operation of the wipers. The wipers will return to the rest position and the motor will shut off as soon as you release the lever.

Windshield Washer

Pull the wiper switch lever toward you to turn on the washer. The windshield wipers will sweep when the washer is operated.

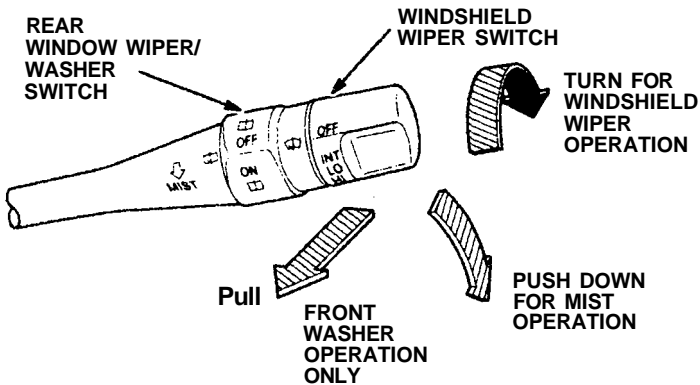

In freezing weather, warm the windshield with the defrosters before using the washer. This will help prevent icing which could seriously impair visibility.

Rear Window Wiper/Washer

Turn the switch "ON" to activate the rear windshield wiper. To use the wiper and washer, turn and hold the switch one position up from ON. To use only the washer, turn and hold the switch one position down from OFF. The rear window washer uses the same fluid reservoir as the front washer.

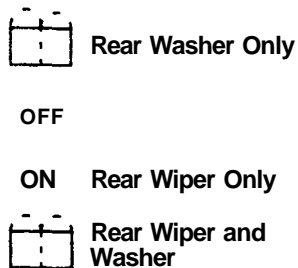

Windshield Washer Fluid/Defogger

Check the washer fluid regularly, especially during bad weather, or whenever the washer has been in frequent use. The float in the neck of the reservoir indicates the fluid level.

WINDSHIELD WASHER RESERVOIR CAPACITY:

4.2 ℓ (3.7 Imp qt, 4.4 US qt).

Use a good quality commercial washer fluid for all-weather cleaning.

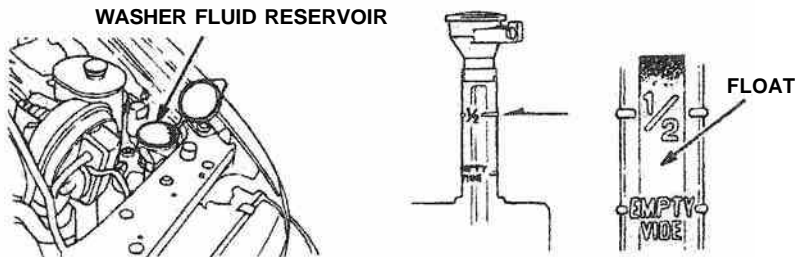

CAUTION:

- Do not use radiator antifreeze in the windshield washer; it will damage the paint.
- Do not use a vinegar/water combination in the windshield washer; it will damage the pump.
- Prolonged operation of the washer without fluid may damage the pump.

Rear Window Defogger

Push the switch to turn the defogger on or off. The indicator will light when the defogger is on.

The defogger will turn off automatically 25 minutes after it is turned on.

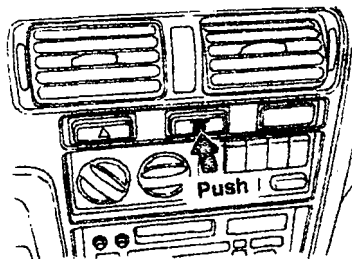

CAUTION:

- When cleaning the inside of the rear window, be careful not to damage the printed heater wires on the rear window. Wipe the window horizontally along the wires, not up and down.
- Load cargo so it does not contact the printed heater wires on the rear window. The wires may be damaged if cargo rubs against them.

Rearview Mirrors

Keep the inside and outside mirrors clean and adjusted for best visibility. Be sure to adjust mirror angles before you start driving.

The inside mirror has day and night positions. The night position reduces glare from the headlights of vehicles behind you. Flip the small tab on the bottom of the mirror forward or backward to select day or night position.

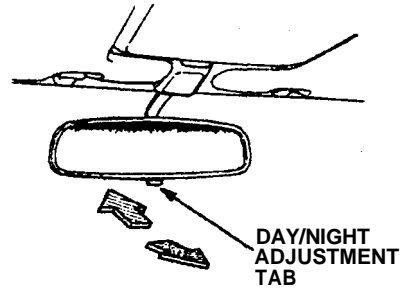

Power Mirrors

With the ignition switch in the I | I position, move the main switch to L (for driver's side) or R (for passenger's side), then use the adjustment switch to adjust the outside mirror to the correct angle.

After the mirrors have been adjusted, return the main switch to the center (OFF) position.

NOTE: Be sure to adjust mirror angles before you start driving.

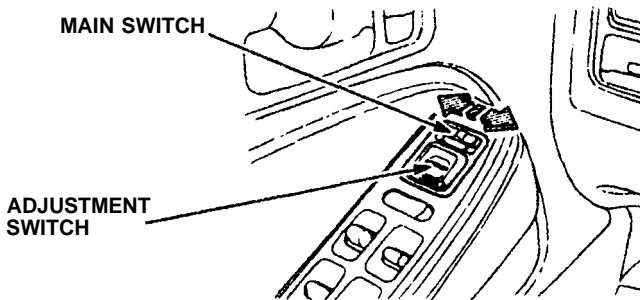

Lights

Turn Signals

Push the turn signal lever down to signal a left turn, and up for a right turn. The indicator and appropriate signal lights will blink. The lever will return automatically to its original position when the steering wheel is returned to straight ahead.

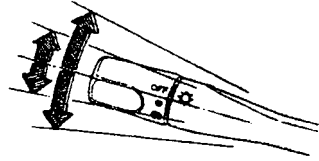

For lane changing you can signal by pushing the lever part way up or down (to the first stop) and holding it there; the lever will return to its original position when you release it.

If either turn signal indicator lights up but does not blink, blinks faster than usual or does not light up at all, check for a burned out bulb or fuse.

Headlights

Turn the light switch to the first position ● for taillights, side marker lights, parking lights, and instrument panel lights. Turn to the second position ● to illuminate the headlights.

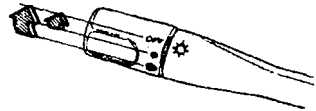

If the driver's door is opened when the light switch is turned to either "on" position, a chime will sound to remind you to turn off your lights.

High Beam/Low Beam Switch

The headlights may be switched between low beam and high beam by pulling the turn signal lever towards you. The blue high beam indicator light in the instrument panel will be on when the high beam is on.

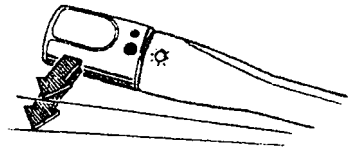

Headlight Flasher

To flash the headlights, pull lightly on the turn signal lever and release.

Hazard Warning System

This system should be used only when your car is stopped under emergency or hazardous conditions. To activate, push the hazard warning switch (▲). The front and rear turn signals will blink simultaneously and both indicator lights will flash. Push the switch (▲) again to turn the system off.

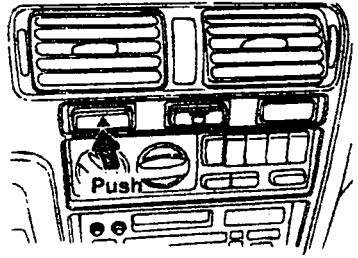

CAUTION: Be sure to push the switch all the way off when the hazard warning is no longer required, or the turn signals will not work properly.

Panel Brightness Control

The intensity of the instrument lights can be adjusted when the light switch is in either of the two "ON" positions. Push the button so it pops out, then turn the panel brightness control knob.

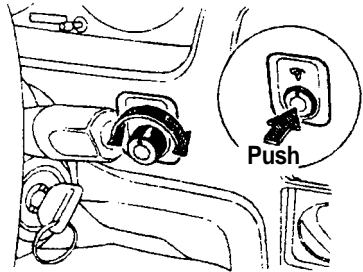

Ignition Switch Light

This light illuminates the switch when the driver's door is opened and remains on for several seconds after the driver's door is closed.

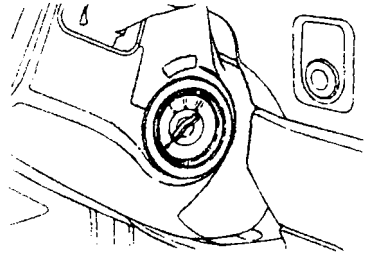

Lights (cont'd)

Interior Light

The interior light has a three position switch. The light is off all the time in the OFF position. In the middle position, it goes on only when a door is opened. In the ON position, it is on all the time.

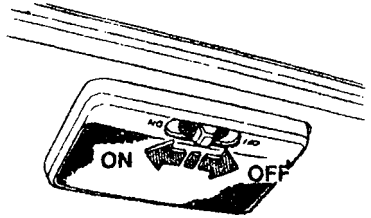

Cargo Area Light

The cargo area light has a three position switch. In the "ON" position the light remains on. In the middle position, it goes on only when the tailgate is opened. In the "OFF" position, the light will not come on.

Daytime Running Lights (Canadian Cars)

With the ignition ON (position II) and the headlight switch OFF, the high beam headlights will come on at one-half power when the parking brake is released. This type of lighting is called "Daytime Running Lights" or DRL. The DRL turns off when you turn the ignition switch off.

If the parking brake is reapplied without switching the ignition off, the "Daytime Running Lights" will remain on.

Cruise Control

The Cruise Control system allows you to set and automatically maintain any speed above 25 mph (40 km/h) without keeping your foot on the accelerator. As its name implies, it is meant for cruising on straight, uncongested highways or freeways. It is not recommended to be used in traffic, on winding roads or in bad weather conditions where the driver should have total control.

⚠ WARNING The Cruise Control automates the function of the accelerator pedal to maintain your car at a constant speed. This can be a convenience on long trips, but it can also be a danger if there are many other cars on the road or if the road is unfamiliar. Pay strict attention to the responsibility of driving whenever using the Cruise Control.

CAUTION: Because the Cruise Control directly activates the accelerator pedal, don't rest your foot under the pedal when the Cruise Control is on; it may pull the pedal down onto your foot.

NOTE:

- With Cruise Control on, your speed will still vary slightly, particularly when going up or down hills.
- Do not ride the brakes or clutch (5 speed transmission), as this will cause the Cruise Control to disengage.

To Set the Cruise Control:

Push the CRUISE CONTROL master switch on the dash; the indicator light will come on.

Accelerate to the desired speed, then push and release the SET switch on the steering wheel. The Cruise Control light on the instrument panel will come on.

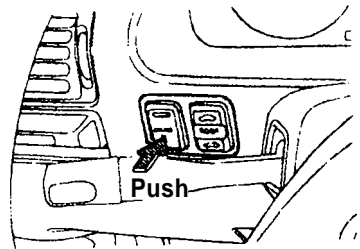

The speed you were going when you released the SET switch is the speed the Cruise Control will hold. You can then "fine tune" the set speed by briefly holding and releasing the SET switch to decrease it a few mph or pushing the RESUME switch to slightly increase it.

Cruise Control

To Change the Set Speed:

To a faster speed - for gradual acceleration with your foot off the accelerator, push and hold the RESUME switch until you reach the desired speed; release the switch and the system's memory will be re-programmed to the new speed. For faster acceleration, push the accelerator until you reach the desired speed, then push and release the SET switch to re-program the system.

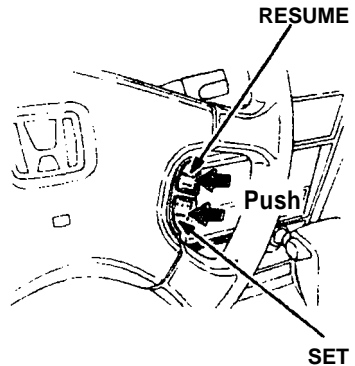

To a slower speed - push and hold the SET switch and the car will coast; when you reach the desired slower speed, release the switch and the system will be re-programmed.

For temporary acceleration above the set speed, such as for passing, use the accelerator pedal conventionally. When you want to return to the set speed, take your foot off the accelerator and coast without applying the brakes.

To Cancel the Cruise Control:

Simply push the CRUISE CONTROL master switch and the indicator light will go off (this also erases the memory of the set speed).

If you must temporarily disengage the system (but wish to retain the memory of the set speed): tap the brake pedal, or the clutch pedal (5 speed transmission). If you are still going above 25 mph (40 km/h), you can return to the set speed by simply pushing the RESUME switch. If the car has decelerated below approximately 25 mph (40 km/h), you can return to the set speed by using the accelerator conventionally until the speed is above 25 mph (40 km/h) and then pushing the RESUME switch.

Hood

To release the hood latch, pull back on the handle located under the dash on the driver's side.

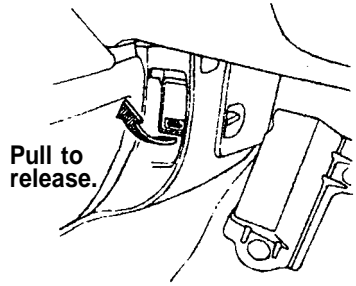

The hood latch is spring-loaded, so the hood will pop up slightly. Release the safety catch under the front center of the hood by pushing the rubber-tipped handle up. Lift the hood and prop it open with the support rod. To close, take the support rod down, place it back in its holder, lower the hood until it is approximately one foot (30 cm) from the closed position, then let it drop. Be sure the hood is securely latched before driving away.

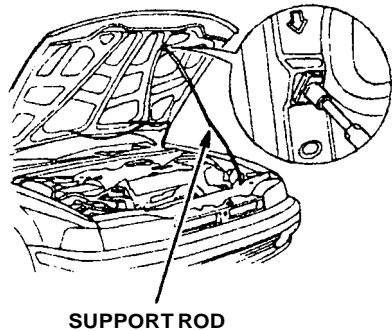
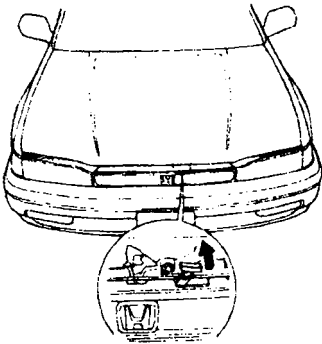

Parking Brake

To apply the parking brake, pull up on the lever. To release it, pull up slightly, push the button, and lower the lever; when fully released, the BRAKE (US cars), or ⓐ (Canadian cars) warning light will go out.

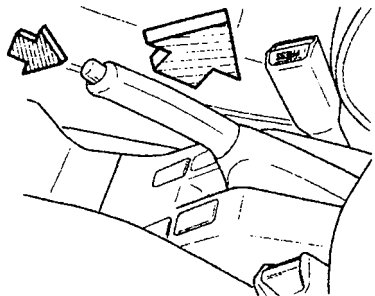

Power Windows

The power windows can be operated when the ignition switch is in the I I position.

The operation of the windows is controlled by the main switch located in the master control panel on the arm rest of the driver's door. When the main switch is off, only the driver's door window can be opened and closed. When the main switch is on, all door windows can be opened and closed by the driver, using the appropriate switch in the master control panel, and the passenger windows can be opened and closed by the passengers, using the switch located on each passenger door.

When opening or closing a window, push and hold either the "up" or "down" side of the switch until the window reaches the desired position, then release.

NOTE: The driver's window can be opened fully, without the driver having to hold the switch down, simply by pushing the switch past the first "stop."

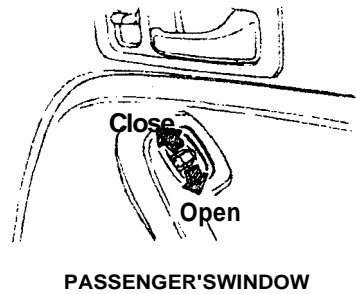
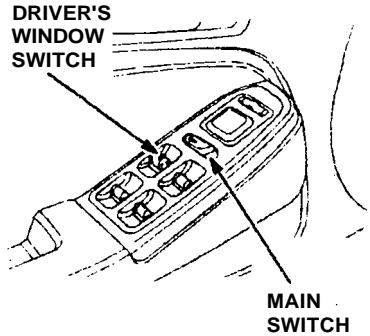

Power Window Key-off Operation

The power windows can still be operated for about 10 minutes after the ignition is turned from the I I to the I or 0 position as long as neither front door has been opened.

⚠ WARNING

- Be sure, before closing any window, that all hands, arms and other obstructions are clear of the window frame and glass; severe personal injury could result.
- Always keep the main switch in the off position when children are in the car; injury may result from unintentional window operation.

Glove Box

Open by pulling the handle. Close with a firm push.

The glove box door can be locked by using the master key or the remote access key (US: EX, Canada: EX-R). The glove box light will go on when the glove box door is opened and the headlights or parking lights are on.

⚠ WARNING Do not drive the car with the glove box door open; it could cause injury in an accident.

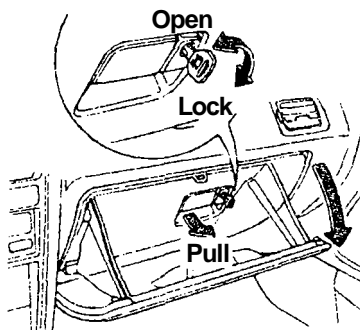

Digital Clock

The time is displayed continuously when the ignition is switched to I I or I I I. At all other times, push in on the lid to display the time.

To adjust the time with the key in the I I position:

1. Lower the lid.
2. Push the minute button (M) and hold it until the numbers advance to the desired minutes.
3. Push the hour (H) button and hold it until the numbers advance to the desired hour.
4. The RESET button allows you to synchronize your clock to the closest hour. If the time on the clock is before the half hour, pressing the RESET button will return the time to the previous hour. If the time is beyond the half hour, the RESET button will change the time to the next hour.

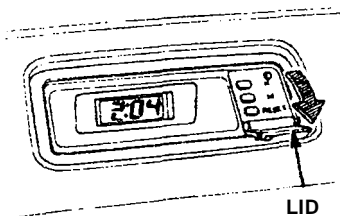

NOTE: Be careful not to push the H, M or RESET buttons accidentally. Pushing any of them will change the clock's time setting.

Beverage Holder

Your car is equipped with a beverage holder for use while the car is stopped. Drinking while driving or driving with a beverage in the holder may be hazardous. To open the beverage holder, push on the tray. Do not pull the tray, it will damage the mechanism,

NOTE: Use only lidded cups or containers that fit snugly in the beverage holder.

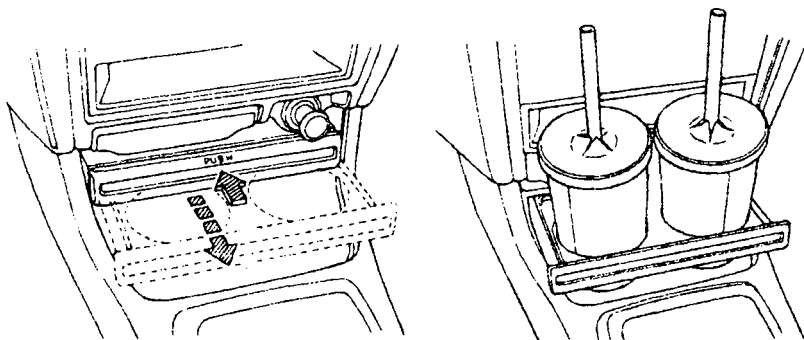

⚠ WARNING

- **Spilling even a small amount while driving, especially if the liquid is hot, may distract the driver's attention from the road and could result in a serious collision.**
- **Alcohol and driving don't mix. For your safety, and the safety of others, do not drink and drive.**

Cigarette Lighter

With the ignition in the I or I I position, push the lighter in to heat it up. The lighter will automatically release when the element is hot. DO NOT hold the lighter in while it is heating up, it may overheat and damage the lighter and the heating element.

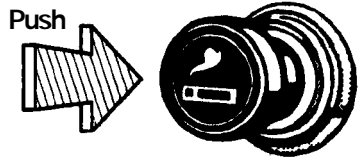

Front Ashtray

Open the ashtray by pulling its bottom edge toward you. To remove it, pull it out further while pushing down on the spring-loaded plate inside.

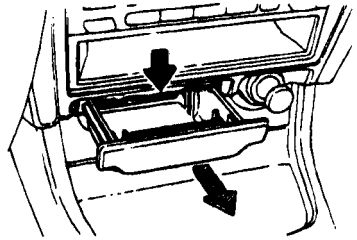

Rear Ashtray

The rear ashtray is located at the rear of the center console. It is opened by pulling out the top edge. To remove it, open the ashtray and release its bottom edge by pulling up, then out. To install, reverse the removal procedure.

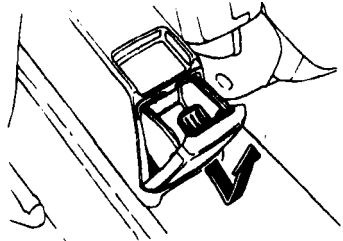

To remove, pull up and out.

CAUTION: Do not use the ashtrays as trash containers; use them only for extinguished cigarettes. Putting lit cigarettes or matches in an ashtray with other combustible materials may cause a fire.

Heating and Cooling

The vents, heater and air conditioner are combined in one system; adjusting four basic controls to different settings can provide a full range of interior temperatures for safe and comfortable driving.

Ventilation

The flow-through ventilation system provides fresh air to the interior when the car is moving even with the windows closed. When the car is stopped, turn on the fan to draw outside air into the car.

NOTE: For proper air flow, the flow-through vents must not be covered. Keep the air inlet at the base of the windshield free of leaves or other debris.

AIR INLET

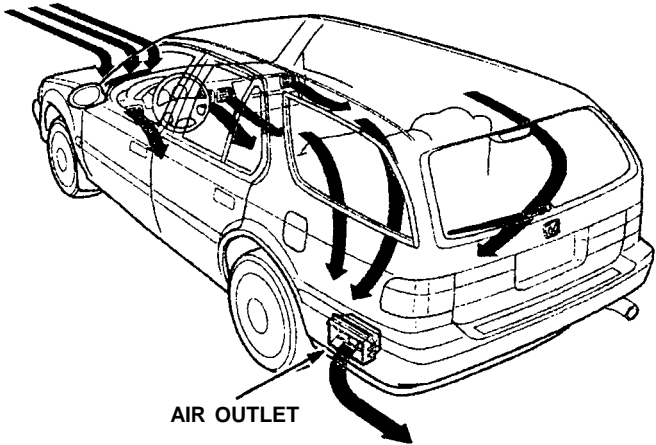

Adjust the panel controls to direct cool or warm outside air throughout the car.

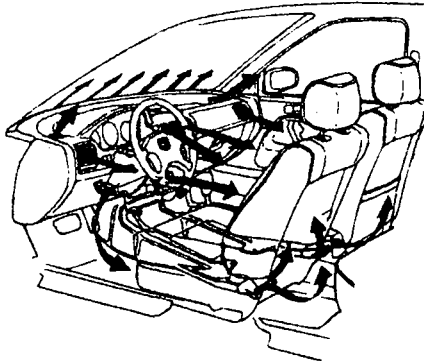

Dash Vents

The corner vents can be used for flow-through ventilation when the car is moving, or while the heater or air conditioner is turned on.

The corner and center vents can be tilted up or down, and their louvers turned right or left, to change the direction of air flow.

The amount of air flow from the corner and center vents can be controlled by the dial located beside each vent.

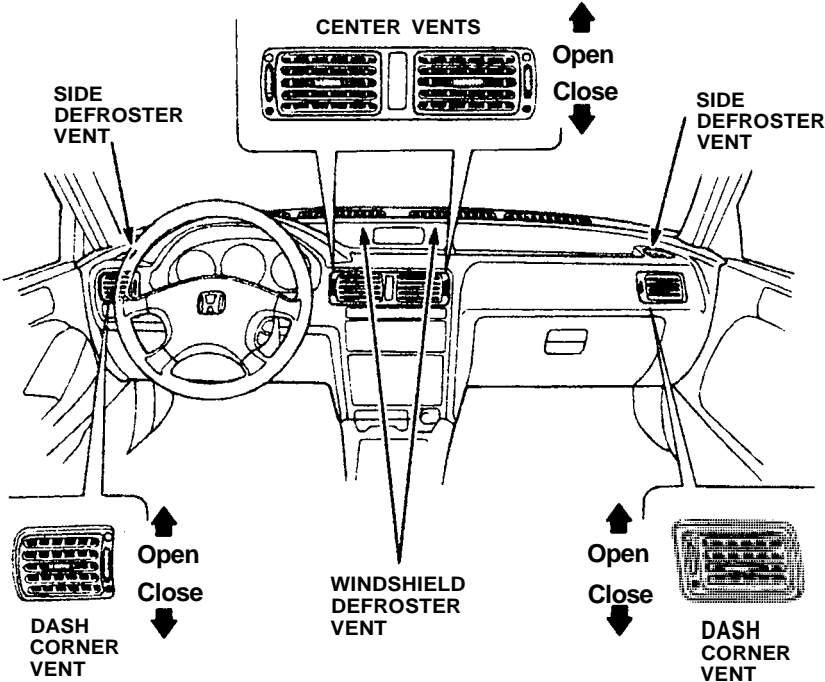

Heating and Cooling (cont'd)

What the Controls Do:

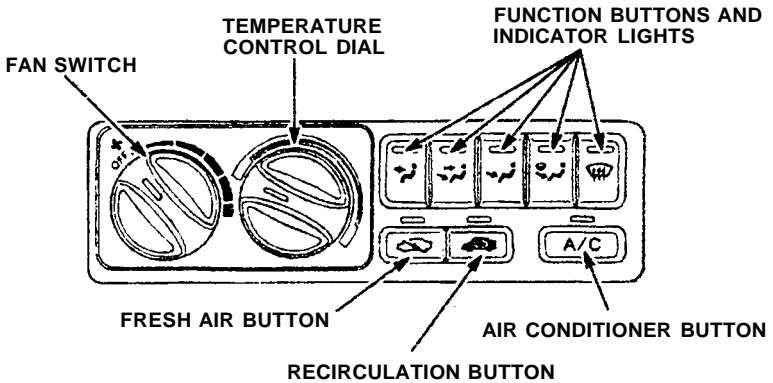

Fan Switch

Turning the dial clockwise increases the fan speed.

Whenever the fan is switched on, air flows from the dash corner vents regardless of the function button selected.

Function Buttons

Push the appropriate button to select air flow from the heater, defroster and dash vents.

There is an indicator light above each function button that comes on when the button is pushed.

Temperature Control Dial

Turn the dial clockwise to make air warmer.

Air Conditioner Switch

With the fan on, push the A/C button to operate the air conditioner. The indicator light will come on.

Push the button again to turn the air conditioner off.



Fresh Air () and Recirculation () Buttons

When the  button is pushed, the indicator light will go on and outside air will be circulated inside the car.

When the  button is pushed, the indicator light comes on, outside air is shut off and the air inside the car is recirculated.

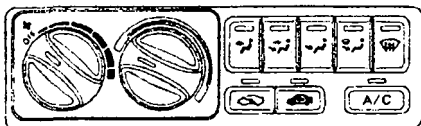

If the heater or air conditioner is on and you want to warm up or cool down the interior more quickly, or keep smoke or dust out of the car without losing the heat or cool function, simply push the  button.



NOTE: The windows may become fogged if the system is in the  setting for an extended period of time with the air conditioner off. As soon as the interior is warm, switch to the  setting.



How to Use the Controls

To Ventilate

Turn the temperature control dial counterclockwise and push the  and  buttons. Switch the fan on and outside air will flow through the corner and center vents. To change air distribution, switch to the  position and outside air will also flow from the heater ducts at the floor level.

Heating and Cooling (cont'd)

To Cool with A/C

To cool the car down quickly, start the engine, turn the fan to high, push the A/C button and open the windows briefly. Then close the windows, turn the temperature control dial counterclockwise all the way, select  the position and push the  button on, so inside air will recirculate to the air conditioner for maximum cooling.

When the interior has cooled sufficiently, switch the fan to the desired speed, then change to the  setting to direct fresh (outside) air to the air conditioner.

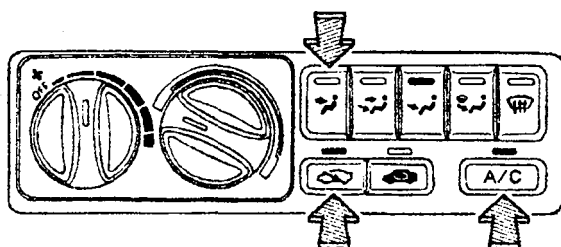



When using the air conditioner in heavy traffic, or while driving up long hills, watch the coolant temperature gauge: if the needle moves near the "H" end of the scale, turn the air conditioner off by pushing the A/C button; leave it off until the needle goes back into the middle of the scale.

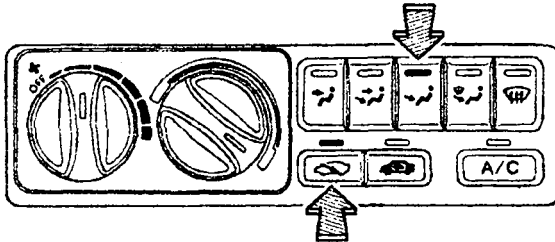

To Heat

Switch the fan on. Turn the temperature control dial clockwise, select the  position, and warmed air will begin flowing from the floor outlet.

A small amount of warmed air will also flow from the windshield defroster vent.



To warm up the interior quickly, push in the  button so the inside air will be recirculated to the heater.

If the windows begin to fog while heating in the  setting, switch to  to allow outside air to enter.

Heating and Cooling (cont'd)

To Dehumidify with A/C

Because an air conditioner dehumidifies as it works, you can use it in cool or cold weather to help defog the windows. Just switch the fan on, push the A/C button on, select the desired function and adjust the temperature control dial to a comfortable setting.

NOTE: This setting is desirable for most operating conditions in ambient temperatures above approximately 32°F (0°C).

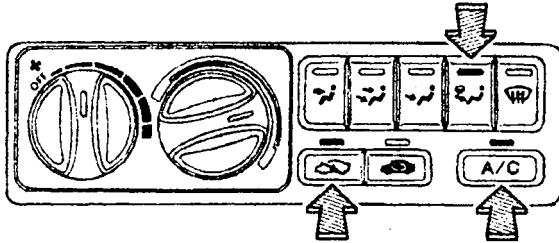





To Defrost

To defrost or defog the windshield and door windows, turn the temperature control dial clockwise, select  function and switch the fan on.

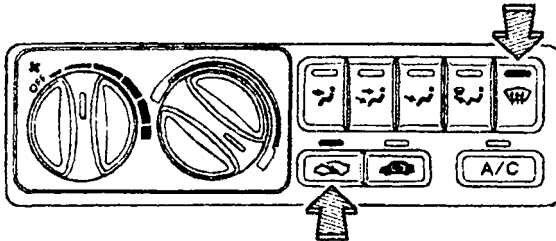
If there is actual frost on the windows, first select the  position.



If the windows are fogged, select the  setting. Warmed air will then flow from the windshield and side defroster vents.

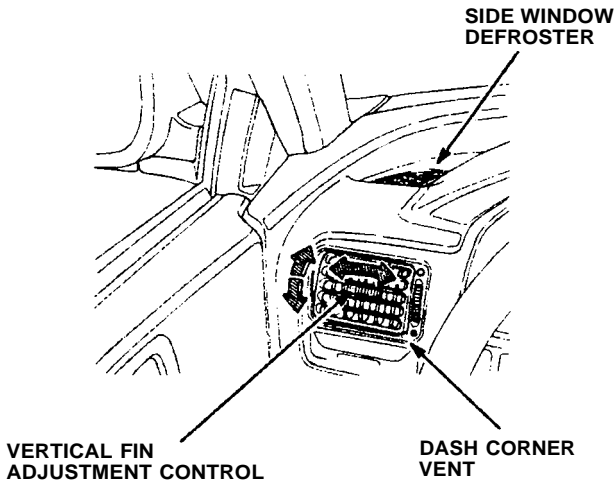

For extra door window defrosting or defogging, select either the , , or  function, switch to the  setting, and turn the fan on.

Air will flow to the side door windows from the vents at each end of the dash when the vertical fins of the dash corner vents are pointed toward the windows, and the horizontal fins are moved upward.



After the windows are defrosted, you may wish to retain the  or  mode for more comfort. Turning the temperature control dial counterclockwise will reduce the temperature of the air exiting the dash corner vents without appreciably affecting the heat to your leg and foot area. Continue to adjust the temperature and fan speed to find the most comfortable setting.

To Turn Everything OFF

Turn the temperature control dial counterclockwise all the way, turn the fan switch off and push the  button on.

NOTE: This setting should be used only for the first few minutes of driving in cold weather to prevent cold air from blowing into the cabin. Under normal operating conditions, the fan should always be kept ON to prevent the accumulation of stale air in the system.

Sunroof (Except US: LX)

The sunroof can be operated with the ignition switch in the II position. To open or close the sunroof, push and hold the switch. Release the switch when the sunroof reaches the desired position. Do not hold the switch on after the sunroof has fully opened or closed, or you may damage the sunroof motor.

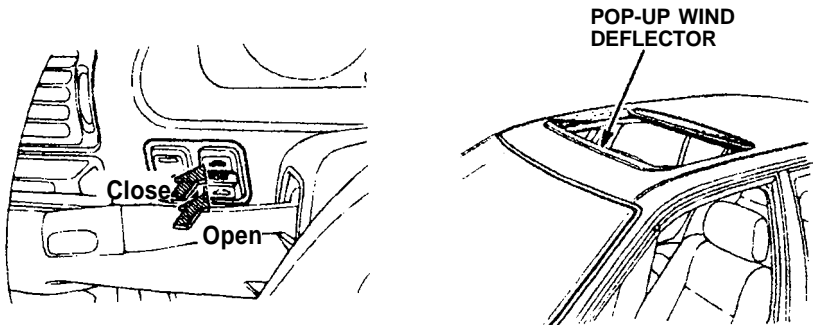

⚠ WARNING

- Do not allow any part of your body to extend through the sunroof while the vehicle is in motion. In the event of a collision or sudden application of the brakes, severe personal injury could result.
- To avoid the possibility of injury while closing the sunroof, never allow any part of your body to extend through the opening.

CAUTION: Operating the sunroof in severe cold or when it is covered with snow or ice may cause damage to the sunroof.

Sunshade

As well as the sunroof, there is a sliding sunshade which you can adjust to let in light with the roof closed, or to block out light entirely. The sunshade automatically opens as you open the sunroof.

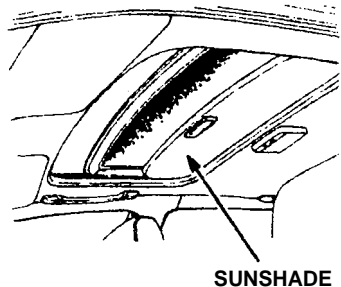

If the Sunroof Won't Close

The sunroof can be closed manually, if the control switch will not close it.

1. Remove the round plug near the rear center of the headliner.
2. Insert the sunroof wrench (from the tool kit) into the socket.
3. Turn the wrench until the sunroof seats in the closed position.
4. Replace the plug.

Remove plug.

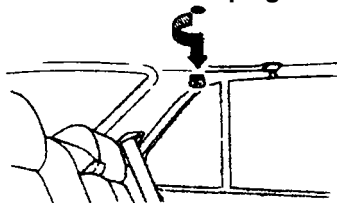

SOCKET

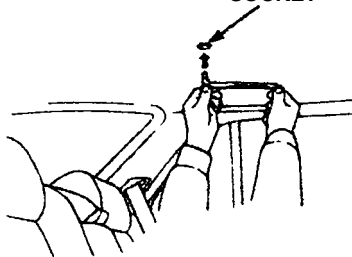

Maintenance

Periodically pour a little water down the drain holes to make sure they are not plugged. If they are free, water should drop on the ground behind each front wheel.

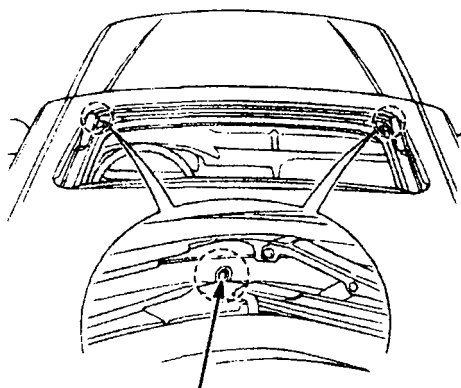

DRAIN HOLE

CAUTION: Do not put weight on the sunroof or force it open or closed, you may damage the mechanism.

Stereo Sound System

(US: LX)

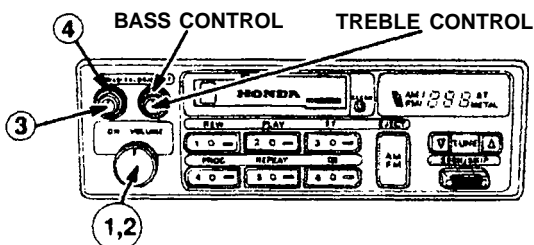

(US: EX)
(Canada: EX-R)

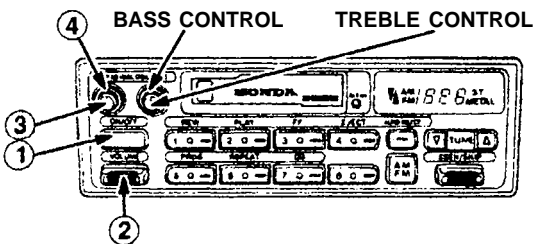

① ON/OFF Switch

Turn the switch clockwise on the LX model or push the button on the EX or EX-R models to switch the unit on. The radio antenna will rise automatically when the unit is turned on. Switch the unit off to retract the antenna. The antenna also retracts automatically if the ignition switch is turned off.

② Volume Control

On the LX model, turn the ON/OFF switch clockwise to increase volume and counterclockwise to decrease volume.

On the EX or EX-R model, push the switch up to increase volume and down to decrease volume.

③ Balance Control

Balances sound between left and right speakers.

NOTE: When the headlights are on, the radio panel illumination is on, even if the radio is turned off. The panel lighting can be turned off by first pushing the Balance Control button to its out position and then pulling it out slightly further.

④ Fader Control

Balances sound between front and rear speakers.

Radio Operation

(US: LX)

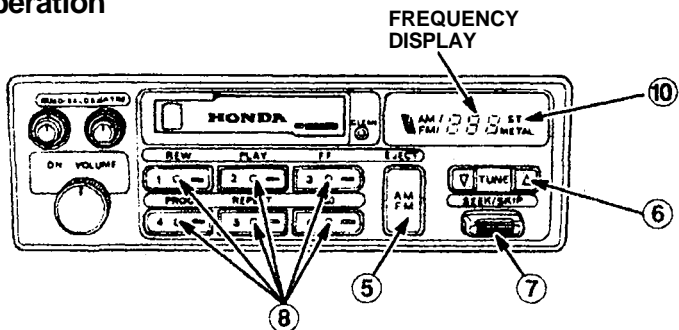

(US: EX)

(Canada: EX-R)

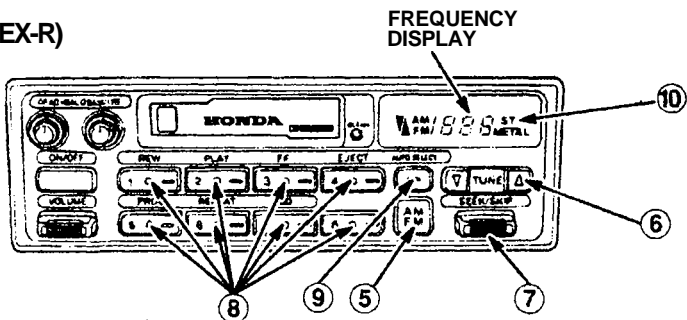

⑤ AM FM Band Selector

Push to select AM or FM band. The corresponding band indicator will light.

⑥ Manual Tuning

Push the ▼ button to tune to a lower frequency station.

Push the ▲ button to tune to a higher frequency station.

NOTE: If you hold either button, the frequency will count up or down rapidly.

⑦ Seek Tuning

Each time you push this button up or down, the tuner will automatically seek the next higher or lower frequency station.

⑧ Preset Station

1. Make sure the Band Selector is on the band you want. . . AM or FM. Then, find the station you want by Manual Tuning or Seek Tuning.
2. Press and hold one of the Preset Buttons.
3. In a few seconds, a beep will sound and the light in the button will come on. The station is now preset in the memory. You may preset 1 AM and 1 FM station per button (total, 6 of each on the LX model and 8 of each on the EX or EX-R model).
4. You can tune to a preset station by pushing its corresponding preset button.

NOTE: On the EX or EX-R model, the Auto Select Button must be off before the Preset Station Selection can be used.

⑨ Auto Select Button (EX or EX-R only)

If you are visiting a new broadcast area, you can quickly enter into memory the stronger stations in that area by simply pushing the Auto Select Button. The radio will then scan one band at a time, AM or FM, and temporarily memorize up to eight stations in the band selected. With the Auto Select Button on, the stations in memory can then be tuned to by pushing the preset buttons. If the band is changed and Auto Select on, the Auto Select feature will cancel.

Manually-preset stations remain memorized for use when you return to your normal broadcast area, but are only selectable with the Auto Select Button off.

⑩ Stereo Indicator

This lights up when an FM stereo broadcast is being received. It will flash when the signal strength diminishes. If it flashes, good stereo reception cannot be expected. Stereo reception is available only for FM stereo broadcasts, not for AM stereo broadcasts.

Tape Operation

(US: LX)

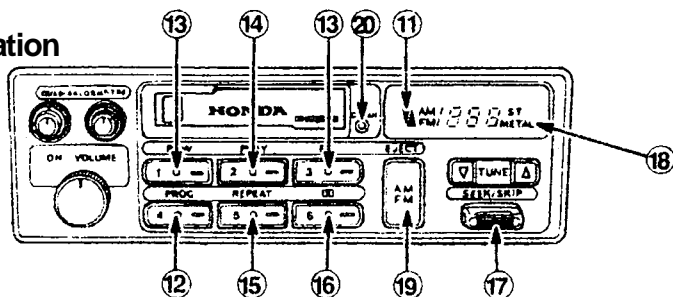

(US: EX)

(Canada: EX-R)

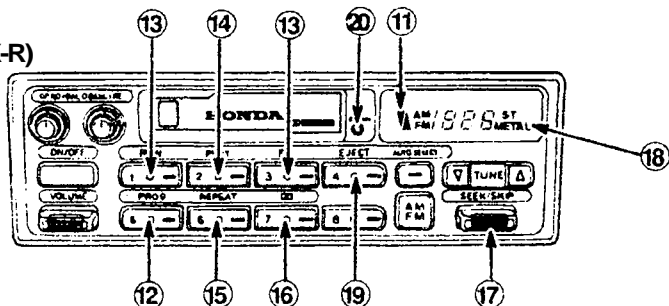

⑪ Tape Direction Indicator

With the cassette inserted "A" side up, the indicator (▲) will be displayed when the "A" side is playing; the indicator (▼) will be displayed when the "B" side is playing.

⑫ Program Selector (PROG)

Push to change the direction of tape play.

Auto Reverse Feature: The tape direction automatically reverses when the end of the tape is reached in play or FF mode and plays the other side.

⑬ Fast Forward/Rewind (FF/REW)

Note which Tape Direction Indicator is displayed, then push the appropriate button to rapidly wind the tape in the same direction of the tape in "PLAY" mode (FF) or opposite direction (REW).

⑭ Play (PLAY)

Push the PLAY button (indicator on) to resume tape play and stop rewind or fast forward operation.

Stereo Sound System (cont'd)

15 Repeat Button (REPEAT)

Push the REPEAT button (indicator on) to return to the beginning of a song or section of programming and repeat its play. Push the button again (indicator off) to cancel the repeat function and resume normal play.

16 DOLBY® Noise Reduction ()

Push when playing tapes recorded in Dolby NR (the Dolby NR Indicator will light). Push again when playing tapes not recorded in Dolby. Use of the wrong setting will affect the high frequency response.

NOTE:

- The Dolby NR circuit will not operate during radio reception.
- Dolby noise reduction system is manufactured under license from Dolby Laboratories Licensing Corporation. "Dolby" and the double-D symbol are trademarks of Dolby Laboratories Licensing Corporation.

17 Skip Button

The circuit senses silent passages between songs or programs on a tape. Push upward to automatically advance to the beginning of the next song, or downward to return to the beginning of the song just played.

NOTE: Tapes that contain short silent passages between songs, a high level of noise between songs, or silent passages within a song may not be suitable for this function.

18 Metal Indicator (METAL)

Most metal or CrO₂ cassettes are coded with slots on their back edge. If such a cassette is inserted, the player will detect the slots and automatically switch to the proper equalization for full enjoyment of metal/CrO₂ tapes. The indicator light will go on when coded cassettes are played.

19 Eject (EJECT)

Push this button to stop and eject the tape.

Ignition Key-OFF Eject: The cassette being played will automatically eject when the ignition or the unit is turned off.

NOTE: When one side of the tape ends, "Auto-Reverse" will automatically begin playing the other side, therefore, you must push the eject button to stop or remove the tape.

20 CLEAN Indicator Light

After 50 hours of cassette tape play, the light comes on as a reminder to clean the tape heads. If the light comes on and the tape heads were not cleaned at the recommended 30 hours of usage (see maintenance section below), they should be cleaned immediately. To reset, push and hold the indicator with a pointed instrument such as a ball-point pen until the light goes off (about 3 seconds).

Defective Tape Eject

The tape player includes a protection mechanism to automatically eject defective tapes (warped housing, loose label, faulty tape movement) immediately upon insertion. If a tape malfunctions while in play, the tape direction will change back and forth and then eject the cassette. Tapes ejected before play should be considered faulty and discarded; tapes ejected during play may only be unevenly wound and could be reusable if fully rewound, manually, outside the player.

NOTE: The tape player may repeat the loading and unloading motion several times in an effort to eject a faulty tape. During this process the tape will either eject fully or rise to the loading level and have to be pulled out manually. In either case, discard the tape; reuse may damage the tape player.

Stereo Sound System (cont'd)

Maintenance

The head in the cassette tape player can pick up dirt or tape deposits each time a cassette is played. The result is low or "muddy" sound from one or both channels, as if the treble tone control were turned all the way down. To prevent this, you should periodically clean the head with the Honda Tape Cleaning System, which is available from your Honda dealer, or a commercially available cleaning cassette.

As preventive maintenance, clean the head about every 30 hours of use. If you wait until the head becomes very dirty (noticeably poor sound), it may not be possible to remove all deposits with a simple cleaning cassette.

The use of 120 minute tapes is not recommended.

CAUTION: Storing cassettes out of their cases, or touching the magnetic tape with your fingers will increase the amount of dirt that gets to the tape head. Using low-quality "off-brand" tape will increase the amount of tape deposits that get on the head. Both of these practices may eventually lead to damage of the head and playing mechanism.

For proper operation of your car's emission controls, your engine is designed to use unleaded fuel only.

CAUTION: Using leaded or even low-lead gasoline could damage some of your emission controls, and also void their coverage under the emission controls warranty.

Use gasoline from pumps labeled unleaded, with a pump octane number of 86 or higher. Use of a lower octane gasoline can cause persistent, heavy "spark knock" (a metallic rapping noise), which can lead to engine damage if severe.

CAUTION: If you notice steady spark knock while holding a steady speed on a level road, try changing brands of gasoline. If the spark knock persists, consult your Honda dealer. Failure to do so is considered misuse, and misuse is not covered under the New Car Warranty.

Occasionally you may notice light spark knock while accelerating or driving up hills. This is no cause for concern, it simply means your engine is running most economically.

Gasolines Containing Alcohol

If you decide to use a gasoline containing alcohol "gasohol", be sure its octane rating is at least as high as that recommended for unleaded gasoline. There are two types of "gasohol": that containing ethanol, and that containing methanol. Do not use gasohol that contains more than 10% ethanol]. Do not use gasoline containing methanol (methyl or wood alcohol) that does not also contain cosolvents and corrosion inhibitors for methanol. Never use gasoline containing more than 5% methanol, even if it has cosolvents and corrosion inhibitors.

Gasoline (cont'd)

NOTE:

- Fuel system damage or vehicle performance problems resulting from the use of such fuels is not covered under the new car warranties. Honda cannot endorse the use of fuels containing methanol since evidence of their suitability is as yet incomplete.
- Before purchasing fuel from an unfamiliar station, try to confirm whether the fuel contains alcohol, of what kind, and how much. If you notice any undesirable operating symptoms after using a gasoline that contains alcohol; or one that you think contains alcohol, switch to an unleaded gasoline as recommended on page 65.

Operation in Foreign Countries

In order to comply with U.S. Federal Emissions Regulations, you must use unleaded fuels of the recommended octane rating. These fuels may not be available in other countries. If you intend taking your car outside the U.S. or Canada, write to Honda (stating the year and model of your car) at the address shown for information regarding modifications you may need to have done.

U. S. Owners:

American Honda Motor Co., Inc.
Consumer Affairs
1919 Torrance Blvd.
Torrance, CA 90501-2746

Canadian Owners:

Honda Canada
715 Milner Avenue
Scarborough, Ontario M1B 2K8

Fuel Filler Door and Cap

The fuel filler door is opened by pulling up on the lever at the left side of the driver's seat.

The door will lock automatically when closed; push it until it clicks.

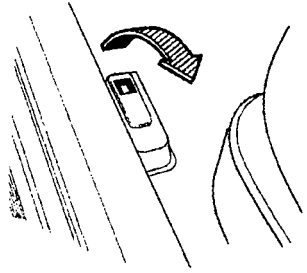

⚠ WARNING Gasoline is extremely flammable and is explosive under certain conditions. Always stop the engine before refueling and perform this operation in a well-ventilated area. Do not smoke or allow open flames or sparks in the area or where gasoline is stored.

CAUTION: You may hear a hiss when you open the filler cap. This sound is residual pressure escaping from the fuel tank. Open the cap slowly and remove the cap after the hissing stops. Fuel spray may cause injury. Do not overfill the tank; fill only until the gas pump clicks off automatically and never top off.

The removed filler cap can be placed on the inside of the fuel filler door.

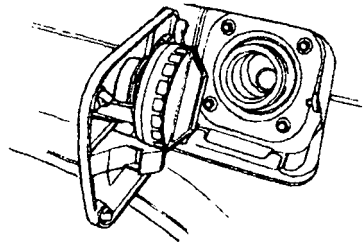

NOTE: The filler cap is a screw-on ratcheting type. When closing, tighten the cap clockwise until ratcheting clicks are heard.

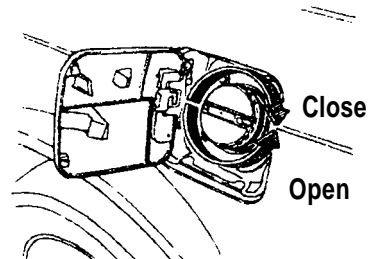

CAUTION: If you replace the cap, use only a genuine Honda replacement part or its equivalent. Failure to use the proper part could cause serious fuel system problems.

Gasoline (cont'd)

How To Improve Your Gas Mileage:

- Drive at a smooth, steady pace to avoid unnecessary deceleration and stops — accelerating back to speed uses more fuel.
- Plan trips to avoid rush hour traffic if possible.
- Make sure the parking brake is completely released.
- Consolidate trips whenever possible.
- Keep vehicle weight to a minimum by removing unnecessary items from the cargo area.
- Whenever possible, use fresh air from the dash vents to keep cool when driving; open windows, or use of the air conditioning affect fuel economy.
- Keep the tires adjusted to the recommended pressure.

	Front	Rear
Up to 475 lbs (215.5 kg)	32 psi, 220 kPa	32 psi, 220 kPa
Up to 950 lbs (430.9 kg)	32 psi, 220 kPa	38 psi, 260 kPa

Condition of Your Car

You can only get maximum fuel economy if your car is in top running condition. Have all required maintenance done at the proper intervals. Check tire pressures and tire wear frequently. If tire wear is uneven, have the alignment checked by your Honda dealer. Proper alignment saves gasoline and prolongs tire life.

The combined ignition switch/anti-theft lock is located on the right side of the steering column and has four positions:

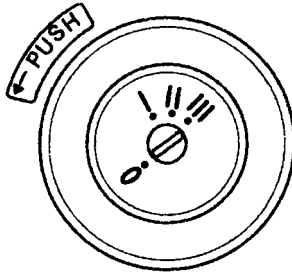

0 - LOCK position: The key can be removed or inserted in this position. To remove the key, push it in at position I, then turn it to 0 and pull it out. When the key is removed, the steering column will lock.

NOTE: On cars equipped with automatic transmissions, the transmission must be in Park before pushing and turning the key to the 0-LOCK position.

⚠ WARNING Never turn the ignition switch to the lock position or remove the key while the car is in motion; the steering wheel can lock causing a loss of directional control, and an accident could result.

I - ACCESSORY position: In this position, the accessory circuit is on, but the ignition circuit is off. If the key is difficult to turn from the 0 to the I position, turn the steering wheel slightly to relieve pressure on the lock.

II - ON position: This is the normal running position.

Canada Cars: The "Daytime Running Lights" will come on in this position, (see page 40).

III - START position: The starter will engage when the key is turned to this position.

To remind you to remove the ignition key when leaving your car, a beeper will sound if the key is still in the ignition when you open the driver's door. The beeper system is deactivated when you turn the ignition to 0 (Lock) and fully remove the key.

Starting the Engine

Before Starting

When starting in cold weather, keep all unnecessary electrical circuits off (lights, defogger, etc.) for the best battery output.

Manual Transmission:

1. Apply the parking brake.
2. Push the clutch pedal all the way in (see NOTE below).
3. Shift the transmission to neutral.

NOTE: On cars equipped with manual transmissions, the engine will not crank unless the clutch pedal is fully depressed.

Automatic Transmission:

1. Make sure the shift lever is in Park (P).
2. Apply the parking brake and foot brake.

Starting the Engine:

During the following starting procedures, do not crank the engine for more than 15 seconds at a time. If the engine won't start, wait 10 seconds before going to the next step.

1. With your foot off the accelerator, start the engine by turning the key to the III position.
2. If the engine won't start within 15 seconds or starts but fails to continue to run, push the accelerator pedal halfway, and hold it there while cranking the engine. If the engine starts, release the accelerator gradually.
3. If it doesn't start within 15 seconds, push the accelerator pedal down to the floor and hold it there while cranking. If the engine starts, release the accelerator gradually. If it doesn't start, repeat step 2.

Cold Weather at High Altitude Starting:

1. When starting in cold weather at high altitude (above 8,000 feet), push the accelerator pedal about halfway and hold it there while cranking the engine. If the engine starts, release the accelerator gradually.
2. If it doesn't start within 15 seconds, push the accelerator pedal down to the floor and hold it there while cranking. If the engine starts, release the accelerator gradually. If it doesn't start, repeat step 1.

NOTE: If the outside temperature is below freezing, or if your car has not been driven for several days, warm up the engine for a few minutes before driving.

Before driving away, check that:

- The doors are closed properly.
- The mirrors are properly adjusted, and the windows clean.
- The driver and passengers are wearing properly adjusted seat belts.
- The front seat head restraints are properly adjusted.
- The warning and indicator lights are operating properly.
- The brake pedal feels normal.
- All luggage and cargo is secured.
- Nothing is interfering with the driver's feet or blocking vision in any direction.

While driving remember to:

- Always drive defensively; expect the unexpected.
- Reduce your speed during night hours and bad weather.
- Follow at a safe distance; don't tailgate.
- Get off the highway when you are tired; stop and take a rest.

When stopping for repairs:

- Park the car well off the road.
- Turn on the hazard warning flasher.
- Use warning devices to warn other motorists.

After parking your car:

- Apply the parking brake and shift to first gear if equipped with manual transmission, or PARK on automatic transmission equipped cars.
- Make sure the sunroof (US: EX, Canada: EX-R), and all windows are closed and all doors are locked.
- If parked on a hill:
 - Turn the front wheels away from the curb if facing uphill.
 - Turn the front wheels toward the curb if facing downhill.
- Never leave children unattended in a parked car.
- Take your keys.





Engine Exhaust Gas Warning

A properly maintained car is your best protection against exhaust gas entering the passenger compartment.

The exhaust system should be thoroughly inspected by a competent mechanic whenever:

- The car is raised for an oil change.
- You notice a change in the sound of the exhaust.
- The exhaust system, or the rear or underside of the car is damaged.

WARNING

- **Avoid breathing engine exhaust gases. They contain carbon monoxide, which is a colorless, odorless gas that can cause loss of consciousness and eventual death. If you suspect that exhaust gas is entering the passenger compartment, have the cause determined and corrected as soon as possible.**
- **Do not run the engine in confined areas, such as garages, any longer than necessary to move the car in or out.**
- **If you must sit in a parked car with the engine running for more than a short time, adjust the heating/ventilation system as follows:**
 - Select the  function.
 - Set the temperature control dial for best comfort.
 - Select the  position.
 - Turn the fan to the highest speed.
- **The tailgate should remain closed when driving. An open tailgate may draw exhaust gases into the passenger compartment. If you must drive with the tailgate open, close all windows, open the vents, select the , and the  positions in the heating and cooling panel and turn the fan on to the highest speed.**
- **If you smell exhaust fumes in the vehicle, drive with the windows open and the tailgate closed. If you suspect a problem, have your authorized Honda dealer check the exhaust system for the cause of the smell.**

NOTE: To insure proper operation of the car's ventilation system, keep the front air inlet clear of snow, mud, leaves or other obstructions.

The fully-synchronized manual transmission is very easy to shift up or down. When you slow down for traffic, steep hills or corners, shift to a lower gear before the engine starts to labor. When descending steep grades, select a lower gear to help maintain a safe speed and to prevent the brakes from overheating. When shifting,

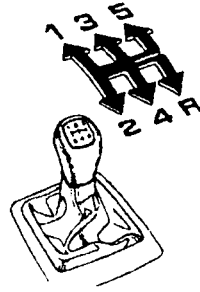

depress the clutch pedal fully, shift gears and then release the clutch gradually. Do not speed-shift; allow time for the gears to synchronize. To prevent grinding the gears when shifting into reverse, hold the clutch pedal depressed briefly before shifting, or shift the lever into one of the forward gears before selecting reverse. A safety lockout prevents accidental shifting straight from 5th to Reverse.

⚠ WARNING Avoid rapid acceleration or sudden deceleration when either or both driving wheels are on a slippery surface. Decreased traction could cause loss of directional control.

CAUTION:

- Do not drive with your foot on the clutch pedal as this will cause premature wear of clutch components.
- Do not shift into reverse while the car is moving.

Shifting the 5-Speed (cont'd)

Recommended Shift Speeds

For best fuel economy, and effective emission control, shift at the speeds shown:

Shift-up	Normal Acceleration
1st to 2nd	15 mph (24 km/h)
2nd to 3rd	28 mph (45 km/h)
3rd to 4th	41 mph (66 km/h)
4th to 5th	52 mph (83 km/h)

Shift-up	Cruise From Acceleration
1st to 2nd	7 mph (11 km/h)
2nd to 3rd	22 mph (35 km/h)
3rd to 4th	33 mph (53 km/h)
4th to 5th	48 mph (77 km/h)

Maximum Allowable Speeds

The speeds shown are the maximum at which the car can be driven or downshifted in each gear without over-revving the engine.



	LX	EX (US), EX-R (Canada)
1st	31 mph (50 km/h)	31 mph (50 km/h)
2nd	56 mph (90 km/h)	56 mph (90 km/h)
3rd	87 mph (140 km/h)	84 mph (135 km/h)

Shifting the Automatic

The automatic transmission shift lever has a locking mechanism to prevent accidental shifting into Reverse (R), Park (P), 2nd (2) or 1st (1). Also, an Automatic Shift Lock prevents you from shifting out of Park unless the brake pedal is already depressed and the ignition switch is in the II position.

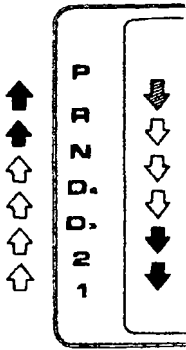
Push the button on the shift handle to shift into 2nd, 1st, Reverse or Park; depress the brake pedal and then push the button on the shift handle to shift out of Park.



-  Depress the brake pedal first and push the button, then shift.
-  Push the button, then shift.
-  Shift as desired.

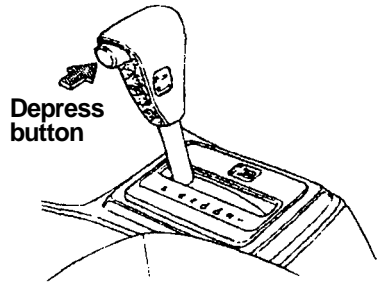

If you cannot shift out of Park with the brake pedal depressed and the ignition switch in the II position:

1. Turn the ignition switch off and remove the key.
2. Insert the key in the Shift Lock Release located to the right of the shift lever.
3. Press and hold the key down, then press the button on the shift handle and move the shift lever to Neutral.
4. Return the key to the ignition switch, depress the brake pedal and restart the engine.

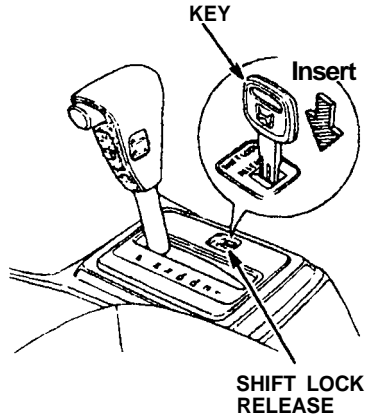

NOTE: If you encounter any problem shifting out of Park, have your authorized Honda dealer check the system as soon as possible.

Shifting the Automatic (cont'd)

Operating Tips

For smoother operation, apply the brakes when shifting from Neutral or Park into a gear.

When parking: bring the car to a stop with the foot-brake, hold the brake on and shift into Park, set the hand-brake and then turn off the engine.

NOTE: Your 4-speed automatic transmission is equipped with a torque converter lock-up clutch. Because of this, you may notice what feels like an extra shift as the clutch engages.

CAUTION:

- **Shift into P only after the car has come to a complete stop.**
- **Shift into or out of R only after the car has come to a complete stop.**
- **Do not "rev-up" the engine when the brake is on and the shift lever is in D4, D3, 2, 1 or R.**
- **When stopped on a hill, use the brakes, not the accelerator pedal to hold your position.**
- **Do not shift from N or P into D4, D3, 2, 1 or R when the engine is above idle speed. Before shifting into gear, make sure your foot is firmly on the brake pedal.**
- **Do not rest your hand on the shift lever or push the lock-out button while driving.**

Driving Technique

D4-4th

Use the D4 range for normal in-town and highway driving. The car will start off in 1st and shift automatically to 2nd, 3rd, and 4th. The further down you push the accelerator, the later the transmission shifts and the faster the car accelerates.

D3-3rd

D3 allows the transmission to start off in 1st and shift automatically to 2nd and 3rd. Use D3 when climbing grades to prevent the transmission from "hunting" between 3rd and 4th gear; or when increased engine braking is needed.

NOTE: If rapid acceleration is necessary, depress the accelerator to the floor; the transmission will automatically shift down according to load and engine speed. This applies to both D4 and D3 ranges.

S Mode

Pushing the Sports (**S**) switch while driving in the D4 or D3 range will change the shift points under part-throttle acceleration, allowing the transmission to stay in each lower gear for a longer period before automatically upshifting. With the Sports switch on, the "S" indicator light in the instrument panel will come on. To take the transmission out of the "S" mode, push the Sports switch again. The "S" indicator light will go out.

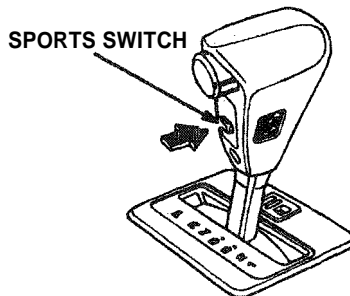

NOTE: Although the "S" indicator light in the instrument panel comes on in any gear range when the Sports switch is pushed, this mode functions only in the D3 and D4 ranges.

Shifting the Automatic (cont'd)

2-2nd

Use 2nd gear for increased engine braking when driving downhill, and increased power when driving uphill; also for driving on slippery roads, and freeing the car from mud or sand, where 1st gear could provide too much power and cause skidding or wheelspin.

The maximum recommended speed in 2nd gear is 69 mph (110 km/h).

1-1st

This position is to be used when stronger engine braking is needed.

The maximum recommended speed in 1st gear is 31 mph (50 km/h).

R-Reverse

CAUTION: Shift into or out of reverse only after the car has come to a complete stop; the transmission may be damaged if you shift while the car is moving.

P-Park

CAUTION: Use this position when starting the engine, or when parking. Shift into Park only when the car is COMPLETELY stopped.

N-Neutral

Use when starting the engine or during prolonged idling in traffic.

Your car is designed primarily to carry passengers and a normal amount of luggage. Although your car is capable of towing a trailer, there will be an effect on handling, performance, engine and automatic transmission fluid temperatures, braking, general vehicle and tire durability and fuel economy.

⚠ WARNING

- The weight of the trailer plus its cargo must not exceed a total of 1,000 lbs. (450kg).
- The gross vehicle weight must not exceed the Gross Vehicle Weight Rating (GVWR) indicated on the Certification label (see page 121). The gross vehicle weight is the total weight of the car, driver, passengers, luggage, hitch and trailer tongue load.
- The total weight supported by each axle must not exceed the Gross Axle Weight Rating (GAWR). The front and rear GAWR's are shown on the Certification label (page 131). The distribution of luggage and passengers in the car, as well as the tongue load and hitch weight should also be considered in terms of the GAWR, which is the maximum amount of weight that should be supported over the front and the rear axles. You should have your car and trailer weighed at a commercial weighing station to check both the GVWR and GAWR's to confirm that the total weight and weight distribution are within safe driving limits.
- The maximum trailer tongue load must not exceed 100 lbs. (45 kg). Cargo should be distributed so that the tongue load is approximately 10% of the total weight of the trailer and its cargo. This is done by distributing approximately 60% of cargo weight toward the front of the trailer and 40% toward the rear.

TRAILER WEIGHT

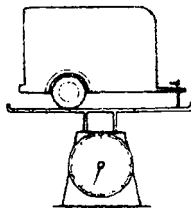

Maximum: 1,000 lbs (450 kg)

TONGUE LOAD

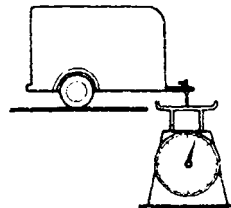

Maximum: 100 lbs (45 kg)

- Never load the trailer so that the back is heavier than the front. This will seriously affect vehicle handling. Be sure the cargo is secured so that it will not move during driving.

Towing a Trailer (cont'd)

Hitches

Use only a hitch recommended by your Honda dealer. The hitch should be bolted securely to the car and installed by a qualified technician. Do not use a hitch designed for temporary installation and never use one that attaches only to the bumper.

Trailer Brakes and Safety Chains

Honda recommends that trailers equipped with brakes should conform to any applicable federal and state regulations. When using a trailer equipped with electric brakes, a trailer brake controller that connects to the car's electrical system is recommended. Installing a brake controller that connects to the car's brake hydraulic system could result in brake fluid contamination or leaks. A safety chain must always be used between the car and the trailer. Leave sufficient slack in the chain so that it does not bind in sharp turns. The chain should cross under the trailer tongue to prevent the tongue from dropping to the ground.

Tires

Make sure your car's tires are properly inflated. Adjust tire pressure to the recommended tire pressure indicated on the label attached to the driver's door jamb. The trailer tires should be of the proper size, load rating and inflated to the pressure recommended by the trailer manufacturer.

Trailer Lights

Trailer lights must comply with federal, state/provinces and local regulations.

See your local recreational vehicle dealer or rental agency for the correct type of lighting and wiring for your trailer. Check for correct operation of the turn signals and stop lights each time you hitch up.

A trailer lighting connector is provided in the spare tire compartment, in the notched area, left of the spare tire. The wiring color codes are described on the next page.

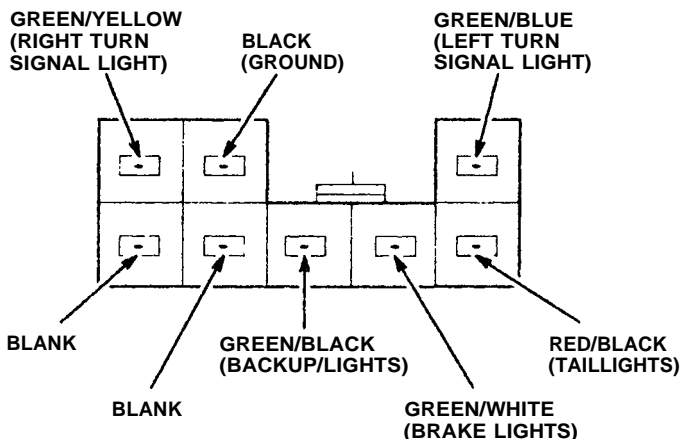

To connect your car's taillights to a trailer, an electrical converter must be installed. Your car has separate bulbs for brake (red) and turn signal lights (amber), while most trailers use the same bulb for brake and turn signal lights. A converter, available at most trailer supply stores, should be installed according to the instructions supplied by the converter manufacturer.

For information regarding trailer hitch and trailer electrical wiring availability, contact your Honda dealer, American Honda Motor Co., Inc. (for US cars), or Honda Canada (for Canada cars). See page 66 for American Honda and Honda Canada addresses.

CAUTION: Connections to your car's electrical system should be made by your Honda dealer or a qualified technician. Improper installation may damage your vehicle's electrical system and cause a malfunction of the lights.

Break-in Schedule

Do not tow a trailer during the 600 miles (1,000 km) break-in period: see page 2.

Maintenance

If you tow a trailer, your vehicle will require more frequent maintenance due to the additional load. Refer to the maintenance schedule under "Severe Driving Conditions" on page 89 for specific information.

Towing a Trailer (cont'd)

Before Towing

With the car and trailer completely loaded and parked on a level surface, confirm that the tongue loading is correct. If the car has an abnormal nose-up or nose-down attitude, check for improper cargo distribution. Check also for excessive cargo weight, worn suspension or other causes and correct the problem before driving.

Be sure the cargo is secured so it will not shift while driving. Check that your rearview mirrors conform to any federal, state or local regulations. If not, install rearview mirrors designed for towing.

Before towing a trailer, practice turning, stopping and reversing with a trailer in an area away from traffic until you learn the technique.

Towing Safety

WARNING

- **Stopping distance increases when towing a trailer. For each 10 mph (16 km/h) of speed, allow at least two car lengths between you and the vehicle ahead. Avoid sudden braking which may cause trailer jackknifing and loss of control.**
- **Avoid jerky starts and rapid acceleration. If your car has a manual transmission, always start out in first gear and release the clutch at moderate engine rpm.**
- **Avoid rapid lane changing and sharp turns. The trailer could hit your car in a tight turn. Slow down before making a turn. Remember, the total length of your car plus trailer requires a wider turning circle.**
- **Cross winds may adversely affect handling of your car and trailer. Use the rearview mirrors frequently to warn you of approaching large vehicles that may pass you causing your car and trailer to sway. When being passed, firmly grip the steering wheel and be prepared to reduce speed immediately but gradually. Never increase speed. Steer straight ahead.**
- **Towing a trailer in bad weather will magnify any difficulty in controlling the car caused by the weather itself. Avoid sudden maneuvers; slow down and use extra caution.**
- **Be careful when passing other vehicles. Passing requires considerable distance because of the added weight and length of your trailer.**

CAUTION:

- **Before starting out, check the operation of the lights and all car/trailer connections. After driving a short distance, stop and recheck the lights and connections.**
- **Reversing is difficult and requires practice. While backing-up, the trailer may pivot off-course. To correct for this, grip the bottom of the steering wheel and move your hand to the left to move the trailer to the left; or to the right to move the trailer to the right. Turn the steering wheel a little at a time, and keep the speed very low. Have someone guide you when backing.**
- **To help prevent overheating of the brakes, shift into a lower gear to make use of engine braking before descending steep or long grades; Do not make sudden downshifts.**
- **Pay strict attention to the coolant temperature gauge when going up hills. Because of the added load of the trailer, your car's engine may overheat on hot days. Turning off the air conditioner will reduce the load on the cooling system.**
- **On cars equipped with automatic transmission.**
 - **Do not hold the car stationary on an incline by using the accelerator pedal; this can cause the transmission fluid to overheat. Instead, use the hand brake or foot brake.**
 - **When towing a trailer, avoid high transmission fluid temperatures (caused by the transmission frequently shifting between 3rd and 4th gears) by driving in D3.**

NOTE: Be sure to check state and local laws concerning maximum speed or other driving restrictions for cars towing trailers. If you are driving across several states, check each state's requirements before leaving home, because restrictions may vary.

Towing a Trailer (cont'd)

Parking with a Trailer

Whenever parking your car on an incline with a trailer attached, place and seat chocks at each wheel of the car and trailer. This is in addition to the normal parking preparations of firmly applying the parking brake and placing the transmission in first or reverse (manual transmission) or P (automatic transmission).

CAUTION: Parking on an incline is not recommended and should be done only if it cannot be avoided. Follow all precautions mentioned above and turn the wheels to point towards a curb if facing downhill, away from a curb if facing uphill. When leaving an inclined parking place, move the car slightly to unseat the chocks. Then, while keeping the foot brake firmly applied, have an assistant remove the chocks.

Maintenance Schedule

Your Honda automobile must be properly maintained to ensure that it is in peak operating condition and the emission levels are within the standards set by the Federal Clean Air Act**.

The following instructions and maintenance procedures are based on the assumption that your car will be used exclusively for the purpose for which it was designed:

1. To carry passengers and cargo within the load limits shown on the label attached to the driver's door jamb.
2. To be driven on reasonable road surfaces within legal limits.
3. To generally be driven daily over a distance of several miles.
4. To use gasoline from pumps labeled unleaded, with a pump octane number of 86 or higher (Canada: minimum 91 research octane). The pump octane number is an average of the Research (R) octane and Motor (M) octane numbers.

NOTE: Failures which occur due to a lack of maintenance will not be covered under warranty.

The Required Maintenance Schedule* specifies all maintenance required to keep your car in peak operating condition. Work should be done by a Honda dealer but may be done by any qualified service facility or individual who is competent in this type of work.

US Cars:

Maintenance, replacement, or repair of emission control devices and systems may be done by any automotive repair establishment or individual using parts that are "certified" to EPA standards.

After the maintenance has been done, be sure to have your servicing dealer complete the Maintenance Record on pages 88 - 90. All required maintenance is considered normal owner operating cost and you will be charged for it by your dealer.

*For vehicles sold in California, maintenance operations indicated by *3 on page 87 are recommended by the manufacturer.

Other maintenance operations are required by California regulations and condition the emission warranty.

**In Canada, Schedule E (S1101, S1102, S1103, and S1105) of the Canada Motor Vehicle Safety Standard, legislated in 1971 and amended in 1980.

Maintenance Schedule (cont'd)

Check the following items at each fuel stop:

1. Engine oil level.
2. Radiator coolant level.

Check the following items periodically.

1. Brakes: for braking efficiency, brake pedal travel and hydraulic fluid level.
2. Lights: for operation of headlights, taillights, side marker lights, stoplights, turn signals and back-up lights.
3. Tires: for correct pressures (including spare); inspect for cuts and uneven or excessive wear. Rotate every 7,500 miles (12,000 km) in the pattern shown on page 115.
4. Steering: for excessive play or vibration while driving.
5. Exhaust system: for leaks or loose mounts.
6. Wipers: for operation of windshield wipers and washer, and condition of wiper blades.
7. Seat belts: for condition of fabric and buckles, and operation of restraint mechanism.
8. Battery condition.

The Supplemental Restraint System (SRS) must be inspected by an authorized Honda dealer ten years after its date of manufacture. The date of manufacture is printed on the certification label attached to the left rear door jamb. To serve as a reminder, note the date of manufacture and SRS inspection date here.

- Manufactured: _____
- SRS Inspection: _____
(add ten years to date of manufacture)

Service at the interval listed x 1,000 miles (or km) or after that number of months, whichever comes first.	R – Replace		*2 Thereafter, replace every 2 years or 30,000 miles (48,000 km), whichever comes first.				
	C – Clean						
	I – Inspect		*3 For cars sold in California, this service is recommended only; for other areas, it is required.				
	After inspection, clean, adjust, repair or replace if necessary.						
	*1 Tension adjustment only.						
x 1,000 mile	15	30	45	60	75	90	
x 1,000 km	24	48	72	96	120	144	
months	12	24	36	48	60	72	
Idle speed and idle CO				I			
Valve clearance	I	I	I	I	I	I	I
Alternator drive belt		I*1		I			I
Timing belt and timing balancer belt							R
Water pump							I
◆ Engine oil and oil filter *	Replace every 7,500 miles (12,000 km) or 6 months.						
◆ Transmission oil		R		R			R
Radiator coolant *			R		R*2		
Cooling system hoses and connections		I		I			I
E.G.R. system				I			
Air cleaner element		R		R			R
Fuel filter and hoses				R			
Fuel line connections		I*3		I			I
Evaporative emission control system				I			
Ignition timing and control system				I			
Spark plugs		R		R			R
Distributor cap and rotor				I			
Ignition wiring				I			
Positive crankcase ventilation valve				I			
Brake hoses and lines	I	I	I	I	I	I	I
Brake fluid		R		R			R
◆ Front brake discs and calipers	I	I	I	I	I	I	I
Front brake pads	Inspect every 7,500 miles (12,000 km) or 6 months.						
Rear brake drums, wheel cylinders and linings		I		I			I
Parking brake	I	I		I			I
Exhaust pipe and muffler	I	I	I	I			I
Suspension mounting bolts	I	I	I	I	I	I	I
Front wheel alignment	I	I	I	I	I	I	I
Steering operation, tie rod ends, steering gear box and boots	I	I		I			I
◆ Power steering system	I	I	I	I	I	I	I
Power steering pump belt		I*1		I			I
Catalytic converter heat shield				I			

- ◆ Check oil and coolant level at each fuel stop. Be sure to complete the Maintenance Record on page 88. All required maintenance is considered normal owner operating cost and you will be charged for it by your dealer.
- ◆ Under severe driving conditions service these items **twice as often** (see page 87).

Maintenance Schedule (cont'd)

Required Maintenance Record

- Have your servicing dealer record all Required Maintenance below.
- Keep receipts for all work done on your car.

7,500 Mi. 12,000 km (or 6 Mo.)	(Sign or Stamp)	Mileage
		Date
15,000 Mi. 24,000 km. (or 12 Mo.)	(Sign or Stamp)	Mileage
		Date
22,500 Mi. 36,000 km (or 18 Mo.)	(Sign or Stamp)	Mileage
		Date
30,000 Mi. 48,000 km (or 24 Mo.)	(Sign or Stamp)	Mileage
		Date
37,500 Mi. 60,000 km. (or 30 Mo.)	(Sign or Stamp)	Mileage
		Date
45,000 Mi. 72,000 Km. (or 36 Mo.)	(Sign or Stamp)	Mileage
		Date
52,500 Mi. 84,000 km (or 42 Mo.)	(Sign or Stamp)	Mileage
		Date
60,000 Mi. 96,000 km (or 48 Mo.)	(Sign or Stamp)	Mileage
		Date
67,500 Mi. 108,000 km. (or 54 Mo.)	(Sign or Stamp)	Mileage
		Date
75,000 Mi. 120,000 km. (or 60 Mo.)	(Sign or Stamp)	Mileage
		Date
82,500 Mi. 132,000 km. (or 66 Mo.)	(Sign or Stamp)	Mileage
		Date
90,000 Mi. 144,000 km. (or 72 Mo.)	(Sign or Stamp)	Mileage
		Date

Severe Driving Conditions

CAUTION: The following items must be serviced more frequently on cars normally used under severe driving conditions. Refer to the chart below for the appropriate maintenance intervals.

Severe driving conditions include:

- A: Repeated short distance driving
- B: Driving in dusty conditions
- C: Driving in severe cold weather
- D: Driving in areas using road salt or other corrosive materials
- E: Driving on rough and/or muddy roads
- F: Towing a trailer

Condition	Maintenance Item	Maintenance Operation	Interval
A, B, F	Engine oil and oil filter	R	Every 3,750 miles (6,000 km) or 3 months
F	Transmission oil	R	Every 15,000 miles (24,000 km) or 12 months
A, B, D, E, F	Front brake discs and calipers	I	Every 7,500 miles (12,000 km) or 6 months
B,C,E	Power steering system	I	Every 7,500 miles (12,000 km) or 6 months

R— Replace

I — Inspect

After inspection, clean, adjust, repair or replace if necessary.

Non-Scheduled Maintenance Record

Record additional maintenance for severe driving conditions or non-scheduled maintenance on this page (see page 85).

Maintenance Performed:	(Sign or Stamp)	Mileage
		Date
Maintenance Performed:	(Sign or Stamp)	Mileage
		Date
Maintenance Performed:	(Sign or Stamp)	Mileage
		Date
Maintenance Performed:	(Sign or Stamp)	Mileage
		Date

Maintenance Schedule (cont'd)

Maintenance Performed:	(Sign or Stamp)	Mileage
		Date
Maintenance Performed:	(Sign or Stamp)	Mileage
		Date
Maintenance Performed:	(Sign or Stamp)	Mileage
		Date
Maintenance Performed:	(Sign or Stamp)	Mileage
		Date
Maintenance Performed:	(Sign or Stamp)	Mileage
		Date
Maintenance Performed:	(Sign or Stamp)	Mileage
		Date
Maintenance Performed:	(Sign or Stamp)	Mileage
		Date
Maintenance Performed:	(Sign or Stamp)	Mileage
		Date
Maintenance Performed:	(Sign or Stamp)	Mileage
		Date
Maintenance Performed:	(Sign or Stamp)	Mileage
		Date
Maintenance Performed:	(Sign or Stamp)	Mileage
		Date
Maintenance Performed:	(Sign or Stamp)	Mileage
		Date
Maintenance Performed:	(Sign or Stamp)	Mileage
		Date
Maintenance Performed:	(Sign or Stamp)	Mileage
		Date

Fluid Locations

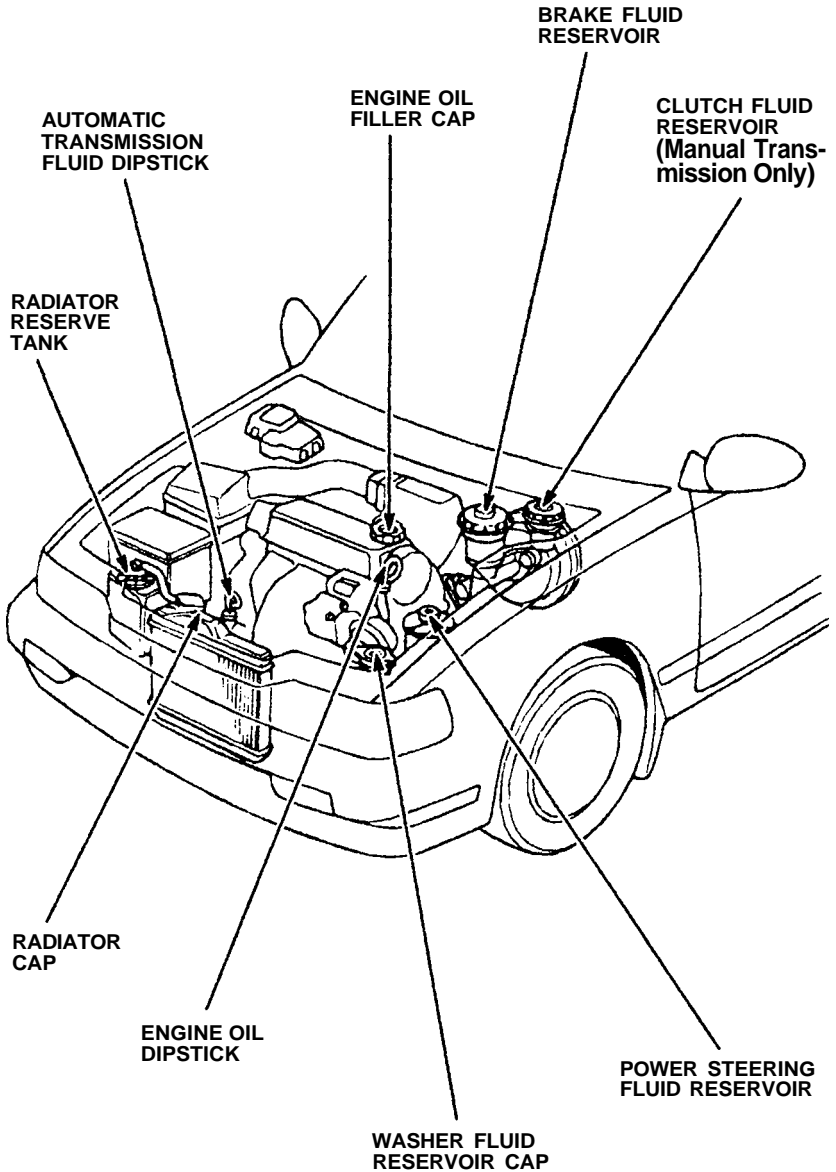

Engine Oil and Filter

Checking

Check the engine oil a couple of minutes after shutting the engine off, with the car parked on level ground. Remove the dipstick and wipe it clean. Reinsert it all the way down, then pull it out and read the level. The level should be between the upper and lower marks.

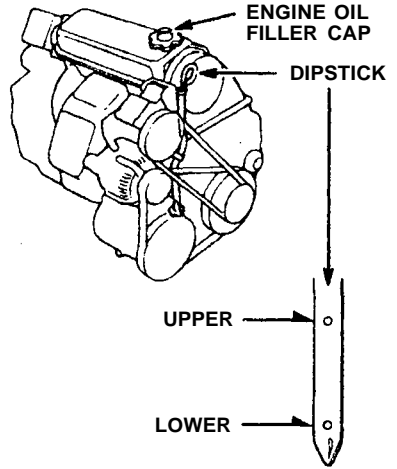

Adding

If the level has dropped close to the lower mark, add oil until it is even with the upper mark.

1. Turn the oil filler cap counterclockwise to remove. Add oil, then check the level again. Do not overfill.
2. Reinstall the cap and twist clockwise until it stops.

CAUTION:

- Be sure the oil filler cap is correctly replaced before starting the engine.
- Engine oil is a major factor affecting the performance and service life of the engine, you should use only a premium quality SG grade detergent oil labeled "Energy Conserving II".

Look for this label on the oil container.

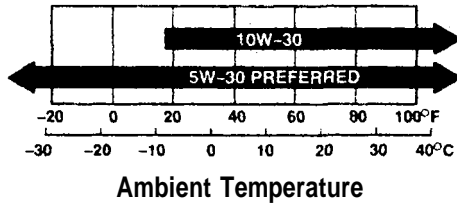
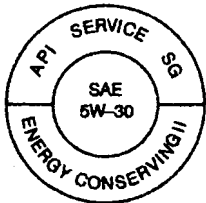

Use the proper viscosity oil for the climate in which you drive: Some oil labels may also include additional service classifications such as CC or CD. However, these are acceptable only when used together with SG.

NOTE: 5W-30 viscosity oil is recommended for improved fuel economy.

Fuel Efficient Oil

For the best fuel economy from your car, it is recommended that you use a fuel efficient "Energy Conserving II" SG grade oil.

Changing Oil and Filter

Engine oil and the filter should be changed together every 6 months or 7,500 miles (12,000 km), whichever comes first. The filter is located on the engine block, below the intake manifold.

CAUTION: The oil filter cannot easily be removed from above the engine. For this reason, it is recommended that the oil filter change be done by a skilled mechanic.

1. Start the car and run the engine until it reaches normal operating temperatures, then shut it off.
2. Remove the engine oil filler cap and drain bolt, and drain the oil.

⚠ WARNING A warmed-up engine and the oil in it are hot; be careful not to burn yourself.

3. Remove the oil filter and let the remaining oil drain out.
4. Install a new filter according to the instructions on or with the filter.
5. Reinstall the drain bolt with a new washer and tighten it securely. Refill the engine with the recommended oil to the upper mark on the dipstick.

ENGINE OIL CAPACITY:
3.8ℓ (3.3 Imp qt, 4.0 US qt including filter.)

6. Reinstall the filler cap securely.
7. Start the engine and make sure oil is not leaking from the drain bolt or the filter.
8. Shut off the engine and recheck the oil level.

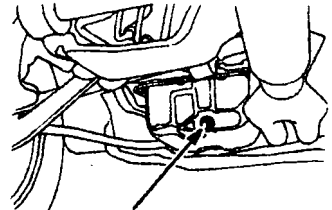

ENGINE OIL
DRAIN BOLT

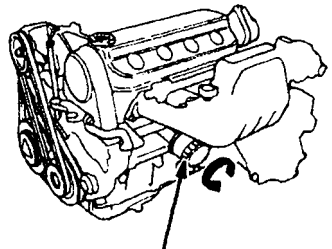

OIL FILTER

Engine Oil and Filter (cont'd)

CAUTION: Used motor oil may cause skin cancer if repeatedly left in contact with the skin for prolonged periods. Although this is unlikely unless you handle used oil on a daily basis, it is still advisable to thoroughly wash your hands with soap and water as soon as possible after handling used oil.

NOTE: Please dispose of used motor oil in a manner that is compatible with the environment. We suggest you take it in a sealed container to your local service station for reclamation. Do not throw it in the trash or pour it on the ground.

Transmission Oil/Fluid Check

Transmission oil/fluid must be checked with the engine off and the car on level ground.

⚠ WARNING

- If the engine has been running, some engine components may be hot enough to burn you.
- Keep hands away from the radiator fan. The fan may start automatically without warning and run for up to 15 minutes, even after the engine is turned off.

CAUTION: If the oil/fluid level is low, check for possible leaks before adding oil. Do not overfill.

Since the transmission and differential are in the same housing, you are actually checking both oil/fluid levels in one procedure. Change transmission oil/fluid according to the Maintenance Schedule on page 87.

5-Speed

Remove the oil filler bolt (beside the right axle). After the engine has cooled, feel inside the bolt hole with your finger. If the oil is up to the bottom edge of the hole, the oil level is correct. If it is not, slowly add oil until it runs out of the hole, then reinstall the bolt and tighten it securely with a wrench.

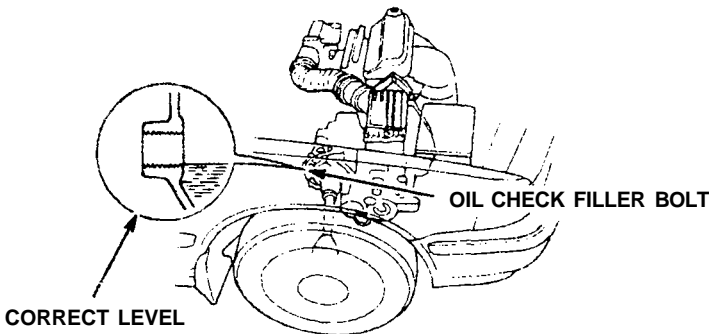

5-SPEED TRANSMISSION OIL CHANGE CAPACITY:
1.9 ℓ (1.7 Imp qt, 20 US qt).

Transmission Oil/Fluid Check (cont'd)

Use only SF or SG grade motor oil when adding or changing transmission oil.

Use the proper viscosity oil for the climate in which you drive:

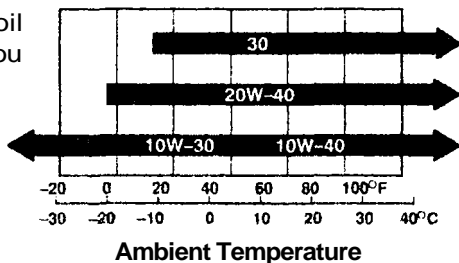

Automatic

Check the automatic transmission fluid level (with the engine off and the car on level ground) with the dipstick in the right end of the transmission housing. Remove the dipstick and wipe it off.

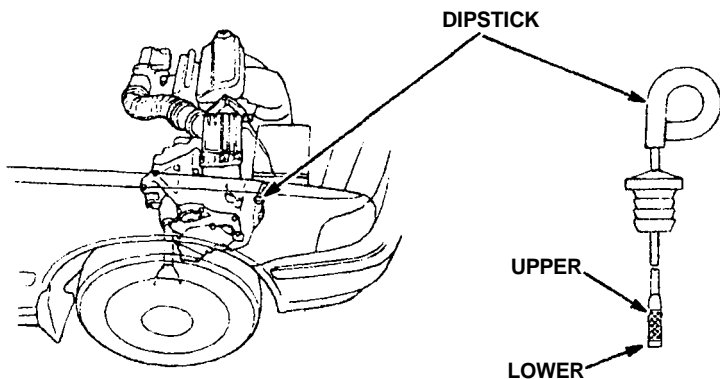

Insert the dipstick, remove it again, and read the fluid level. The fluid level should be between the upper and lower marks.

If necessary, add fluid and recheck. Use only Genuine Honda or DEXRON® II Automatic Transmission Fluid (A.T.F.) when adding or changing fluid.

After checking the fluid level, replace the dipstick securely.

AUTOMATIC TRANSMISSION FLUID CHANGE CAPACITY: 2.4 ℓ (2.1 Imp qt, 2.5 US qt).

The engine in your Honda contains a number of aluminum parts. Therefore, it requires an antifreeze/coolant specifically formulated to protect the aluminum parts from corrosion. Failure to use a suitable antifreeze/coolant may seriously shorten the life of the engine as the result of rapid corrosion damage. Some antifreeze/coolants, although labeled for use in engines containing aluminum, may not provide adequate protection for your engine.

Therefore, use only a Honda-recommended antifreeze/coolant.

CHECK WITH YOUR AUTHORIZED HONDA DEALER.

For best corrosion protection, the mixture of coolant and water must be maintained year-round at 50/50. Concentrations less than 50% coolant may not provide sufficient protection against corrosion and freezing. Concentrations of greater than 60% coolant will impair cooling efficiency and are not recommended. Low-mineral drinking water or distilled water should be mixed with the antifreeze/coolant. Coolant loss should be replenished by a mixture containing the proper concentration of antifreeze and water.

Do not mix different antifreeze/coolants.

Do not use additional rust inhibitors or anti-rust products, as they may not be compatible with the radiator coolant.

ENGINE DAMAGE CAUSED BY IMPROPER COOLANT USAGE IS NOT COVERED BY THE NEW CAR WARRANTY.

Checking Coolant

Check the coolant level in the reserve tank when the engine is at normal operating temperature.



- **Do not remove the radiator cap when the engine is hot; the coolant is under pressure and could severely scald you.**
- **Keep hands away from the radiator fan. The fan may start automatically without warning and run for up to 15 minutes, even after the engine is turned off.**

Cooling System (cont'd)

If the level is below the MAX mark, but still visible, add a 50/50 solution of antifreeze and water to bring it up to MAX.

If there is no coolant in the reserve tank, the cooling system should be checked for leaks and repaired if necessary. Coolant must then be added to the radiator.

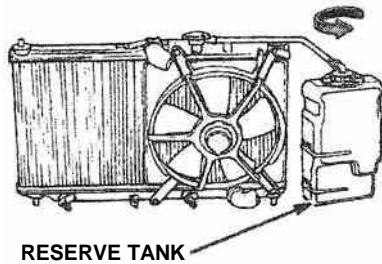

CAUTION: Radiator coolant will damage paint. Quickly rinse any spilled coolant from painted surfaces.

Wait until the engine is cool, then turn the radiator cap counterclockwise until it stops. **DO NOT PRESS DOWN WHILE TURNING THE CAP.** After any remaining pressure has been relieved, remove the cap by pressing down and again turning it counterclockwise. Add enough coolant to fill the radiator, and reinstall the cap. Be sure to tighten it securely. Fill the reserve tank up to the MAX mark with the engine cold.

Maintenance

1. Check the freeze protection level of the coolant with a hydrometer.
2. Keep the front of the radiator free of dirt and debris.
3. Check hoses and hose clamps regularly.

Replacing Coolant

Replace coolant at 36 months or 45,000 miles (72,000 km), whichever comes first. Thereafter, replace every 2 years or 30,000 miles (48,000 km), whichever comes first.

RADIATOR COOLANT REFILL CAPACITY:

including reserve tank	0.6 ℓ (0.5 Imp qt, 0.6 US qt)
5 speed transmission	3.0 ℓ (2.6 Imp qt, 3.2 US qt)
Automatic transmission	3.5 ℓ (3.1 Imp qt, 3.7 US qt)

1. Set the heater temperature control dial to maximum heat.
2. When the radiator is cold to the touch, remove the radiator cap and loosen the drain plug.

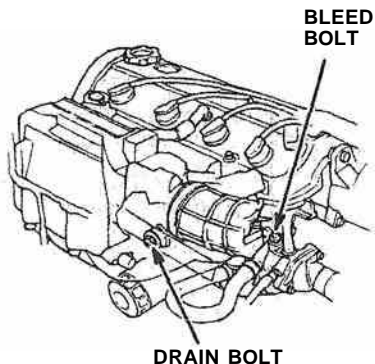
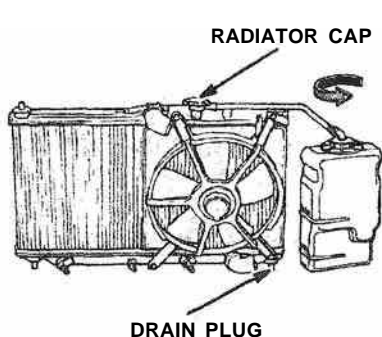

3. Remove the drain bolt from the rear side of the cylinder block, and drain the engine and heater.
4. Apply non-hardening sealant to the drain bolt threads, then reinstall the bolt and tighten it securely.
5. Tighten the radiator drain plug securely.
6. Mix the recommended antifreeze with an equal amount of low-mineral or distilled water and fill the reservoir to maximum, as illustrated.



7. Loosen the air bleed bolt in the water outlet, then fill the radiator to the filler neck with the coolant mixture. Tighten the bleed bolt as soon as coolant starts to run out in a steady stream without bubbles.

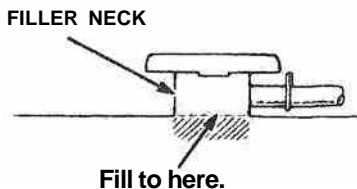

8. With the radiator cap off, start the engine and let it run until warmed up (fan goes on at least twice). Then, if necessary, add more coolant mix to bring the level back up to the filler neck.
9. Put the radiator cap on tightly, then run the engine again and check for leaks.

Brakes

Brake System Design

The diagonally-separated dual service brake system is designed so half the system will still provide braking action if the other half fails.

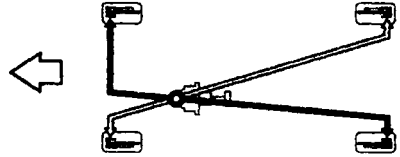

Stopping the car after losing the brake fluid from half the system will require more pedal pressure and pedal travel than normal. Also, the distance required to stop will be longer using only half the brake system. If the brakes fail suddenly, downshift to a lower gear for increased engine braking, and pull off the road as soon as possible.

WARNING

- It is hazardous to drive your car with a problem in either the brake electrical or hydraulic systems; have your dealer check both systems if you suspect brake trouble.
- Do not ride the brakes. In other words, don't put your foot on the brake pedal unless you intend to brake. This causes excessive brake wear and can lead to loss of braking effectiveness through overheating. Your brake lights may also confuse drivers behind you.
- Driving through deep water may affect the brakes. Check their effectiveness by pressing the brake pedal gently. If the car does not slow down at the normal rate, continue gently applying the brakes, while maintaining a safe speed, until they dry out and normal performance returns.

Brake Wear

Both front and rear brakes should be inspected for wear at the intervals shown in the Maintenance Schedule on page 87.

When the brakes require maintenance, use only Genuine Honda replacement parts or their equivalent.

Brake Wear Indicators

Your car is equipped with audible brake wear indicators. When the brake pads need to be replaced, the wear indicators will make a high-pitched chirp.

NOTE: Due to some driving habits or climates, brakes may "squeal" when you first apply them or have them partially applied; this is normal, and does not indicate excessive wear. The wear indicator makes a "screeching" sound while the brakes are applied.

Brake Fluid

Check the fluid level in the brake reservoir periodically; it should be between the MAX and MIN marks on the reservoir.

If the level is near the MIN mark, add fluid to raise it to the MAX mark. Do not overfill. Use only brake fluid manufactured to DOT 3 or DOT 4 specifications (see reservoir cap) from a sealed container. Follow the manufacturer's instructions printed on the can.

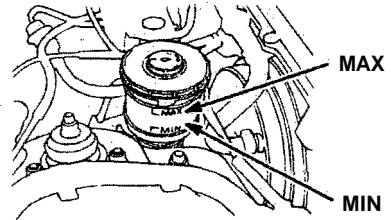

CAUTION: The arrow on the reservoir cap must be pointing forward after the cap is installed. Make sure the brake warning switch wiring doesn't get caught between the cap and top edge of the reservoir.

NOTE: A low brake fluid level may be an indication of brake wear or of brake fluid leakage. You should have your brakes checked if the brake fluid level in the reservoir is low before refilling it.

Clutch Fluid (Manual Transmission)

Check the fluid level in the clutch reservoir periodically; it should be between the MAX and MIN marks on the reservoir.

If the level is near the MIN mark, add fluid to raise it to the MAX mark. Do not overfill. Use brake fluid from a sealed container manufactured to DOT 3 or DOT 4 specifications only. Follow the manufacturer's instructions printed on the can.

NOTE: A low clutch fluid level may be an indication of clutch fluid leakage. You should have your clutch checked if the clutch fluid level in the reservoir is low.

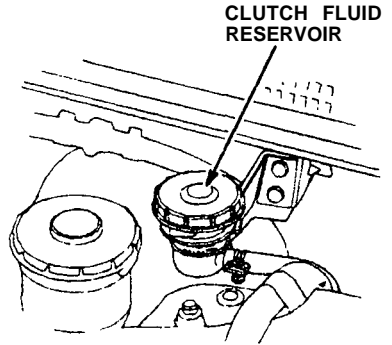

The power steering on your car provides easy handling while parking and maneuvering in traffic, without loss of road "feel" at highway speeds. An engine-driven hydraulic pump provides full power assist at low speeds and decreasing assist as the car goes faster.

CAUTION: If the power steering system should fall, or if the engine should stall, the car can still be steered. However, much greater effort will be required, particularly in sharp turns at low speed.

NOTE: You may feel a slight clunk or knock when turning the wheel with the engine off. This is a normal condition due to the design of the system.

Power Steering Fluid

Check the power steering fluid level with the engine cold and the car parked on level ground. Make sure the fluid level is between the upper and lower marks on the reservoir. If the level has dropped close to or below the lower mark, check for leaks before adding fluid to the upper mark. Do not overfill.

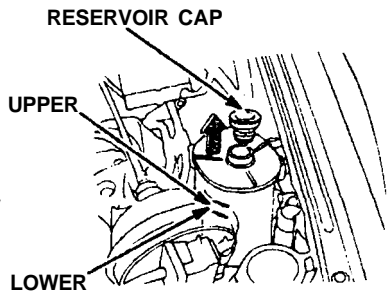

CAUTION: Use only genuine Honda power steering fluid. The use of other fluids such as A.T.F. or other manufacturer's power steering fluid will damage the system.

Air and Fuel Filters

Air Filter

Replace the air filter every 24 months or 30,000 miles (48,000 km), whichever comes first (more often in extremely dusty conditions).

Loosen the attaching bolts, then remove the cover.

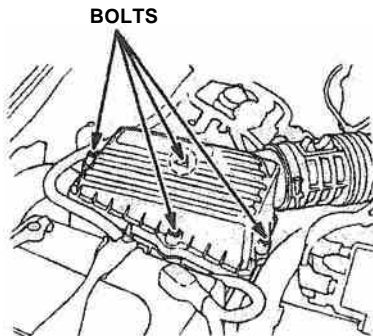

Remove the air filter and replace it with a new filter. Reinstall the cover and tighten the bolts.

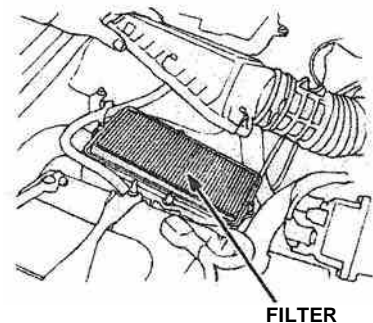

Fuel Filter

The fuel filter is located in the engine compartment, on the right center of the rear bulkhead. It should be replaced at 60,000 miles (96,000 km) or 48 months whichever comes first, or any time you suspect contaminated gas may have clogged it.

CAUTION: Because the fuel system is under pressure, the filter should be replaced only by a qualified Honda technician.

Spark plugs should be replaced every 24 months or 30,000 miles (48,000 km), whichever comes first.

Recommended spark plugs:

Normal driving conditions

ZFR5F-11 (NGK), KJ16CR-L11 (ND)

Hot climates, or continuous high speed driving

ZFR6F-11 (NGK), KJ20CR-L11 (ND)

⚠ WARNING Keep hands away from the radiator fan. The fan may start automatically without warning and run for up to 15 minutes, even after the engine is turned off.

Replace plugs one at a time so you don't get the wires mixed up.

1. Clean any dirt from around the spark plug base.
2. Disconnect the plug cap, then remove and discard the old plug.
3. Check the gap of the new spark plug before installation. Plug gap should be 1.1 mm (0.04 in).
4. Thread the new spark plug in by hand to prevent cross-threading.
5. After the plug seats against the cylinder head, tighten 1/2 turn with a spark plug wrench to compress the washer.
6. Reinstall the spark plug wire.

CAUTION: The spark plugs must be securely tightened, but not overtightened. A plug that's too loose can get very hot and possibly damage the engine; one that's too tight could damage the threads in the cylinder head.

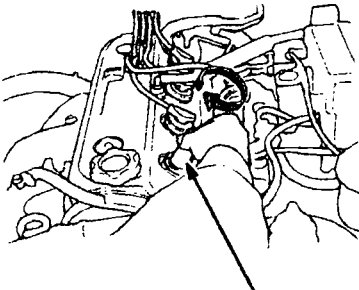

Thread in by hand

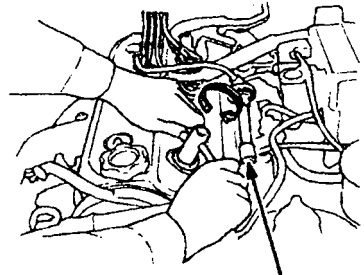

PLUG CAP

Wiper Blades

For maximum visibility, replace worn or cracked wiper blades when you notice they do not wipe the windshield cleanly or smoothly.

To Replace Worn-out Blades

1. Detach the blade assembly from the arm by pressing the lock tab in, then pushing the blade toward the base of the arm.

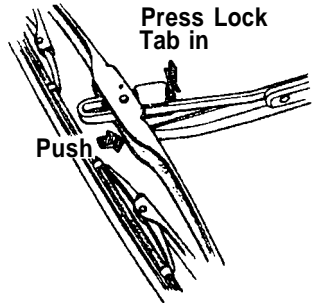

2. Firmly grasp the end of the blade rubber and pull until the tabs are free of the metal support.

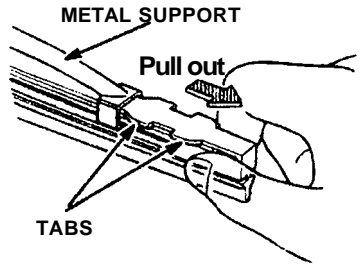

3. Remove the metal retainers from the worn-out blade and put them in a new blade.

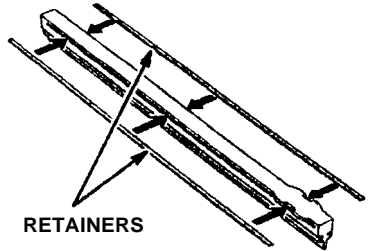

4. Insert the new blade rubber from the opposite side of the blade tabs and position the tabs in the metal support.
5. Reinstall the blade assembly on the wiper arm.

The condition of the battery can be determined by checking the test indicator. Service as required according to the label on the battery.

Any corrosion around the positive and negative terminals should be washed off with a solution of baking soda and warm water. Dry the terminals and then coat them with grease.

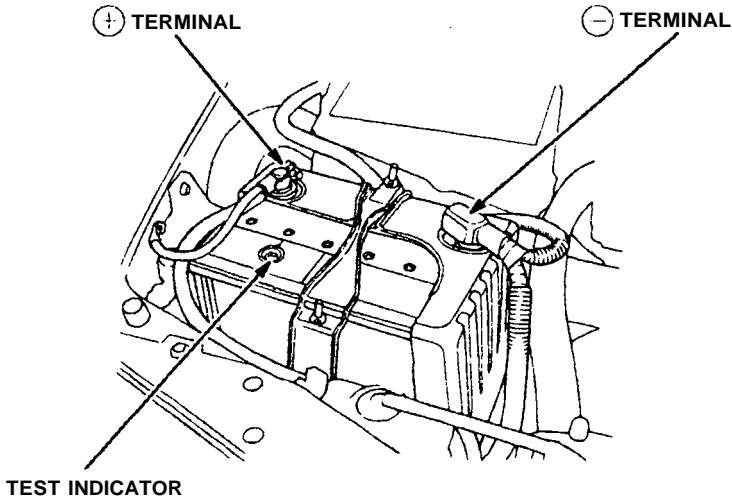

WARNING

- The battery gives off explosive gases; keep sparks, flames and cigarettes away. Provide adequate ventilation when charging or using the battery in an enclosed space.
- The battery contains sulfuric acid (electrolyte). Contact with skin or eyes may cause severe burns. Wear protective clothing and a face shield.
 - If electrolyte gets on your skin, flush with water.
 - If electrolyte gets in your eyes, flush with water for at least 15 minutes and call a physician immediately.
- Electrolyte is poisonous.
 - If swallowed, drink large quantities of water or milk and follow with milk of magnesia or vegetable oil and call a physician.

KEEP OUT OF REACH OF CHILDREN.

Fuse Replacement

Your car has two fuse boxes. One is located under the dashboard on the driver's side, the other is under the hood. The circuits protected by each fuse are listed inside the fuse box cover. To open the fuse box, turn the knob as shown.

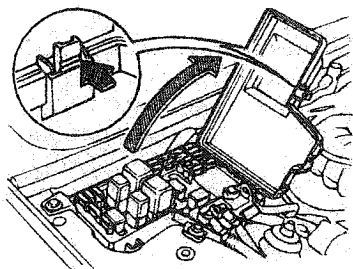
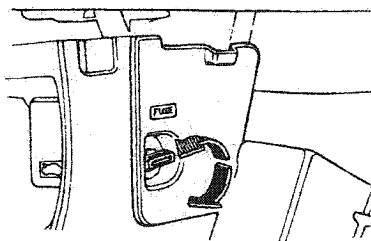

If any of your car's lights, accessories, or controls don't work, check their fuses. If a fuse has blown, the wire inside it will be burned through.

Checking the Fuses:

1. Turn off the ignition and all other switches.
2. If you find a blown or possibly faulty fuse, use the fuse remover (stored beside the spare fuse) to pull the blown fuse out of its clips.
3. Check all other fuses as well as the one you suspect.
4. Push in a new fuse of the same rating, and make sure it fits tightly in the clips. If it fits loosely, have your dealer fix it.

BLOWN

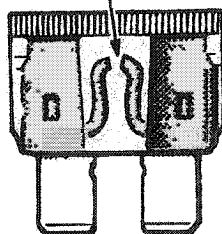

FUSE REMOVER

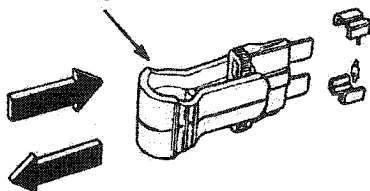

If you don't have a spare, take a fuse of the same rating (or lower) out of a circuit you may not need, like the radio or cigarette lighter. Remember to replace the borrowed fuse and the missing spares.

A blown fuse may be just a symptom of some other problem. If a new fuse blows right away, the cause should be diagnosed and corrected by a qualified Honda technician.

CAUTION: Never replace a fuse with anything but another fuse of the same or lower rating. A higher capacity fuse could cause damage and even start a fire.

The main fuses and some primary fuses are installed in the fuse box on the right front fender in the engine compartment.

If the circuits from the battery are ever overloaded (by a short in the system drawing too much current for example) a main fuse will blow, preventing damage to the entire wiring harness. If the main fuse blows, have a Honda dealer check the system, repair the cause, and replace the fuse.

CAUTION:

- **The electrical system is protected by fuses that are designed to fail and prevent damage to the wire harness. Always replace blown fuses with the same rating as specified to prevent wiring damage that can result in a possible fire.**
- **For proper electrical contact after replacing these fuses, make sure all screws are tight.**

Bulb Replacement

See page 131 for bulb specifications.

Front turn signal lights

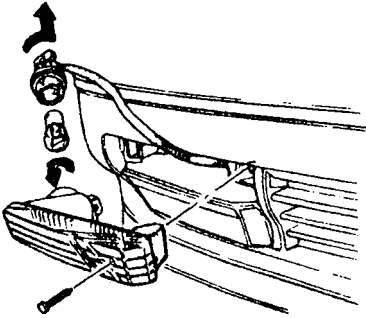

Front side marker and turn signal lights/position lights

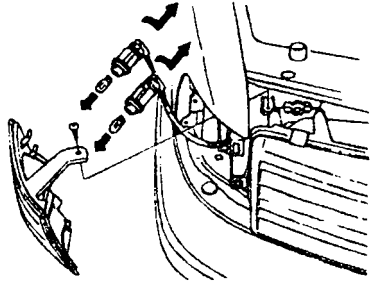

Rear turn signal/brake and taillights/back-up lights

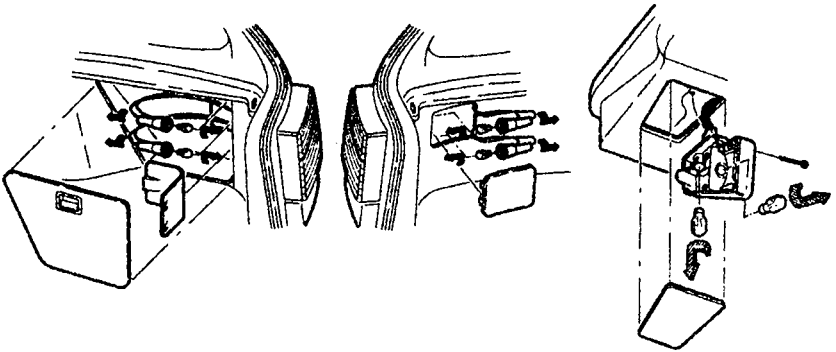

License plate lights

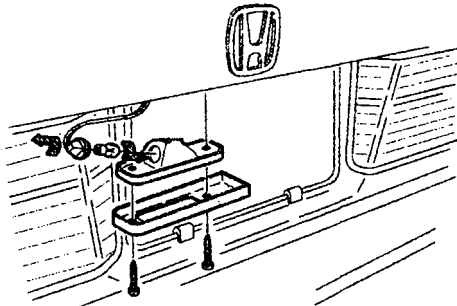

Interior/cargo area light

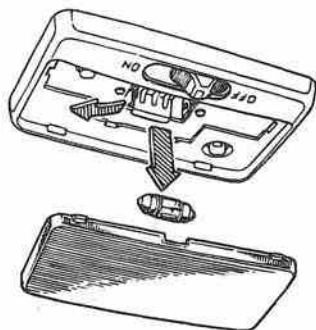

Sunvisor light

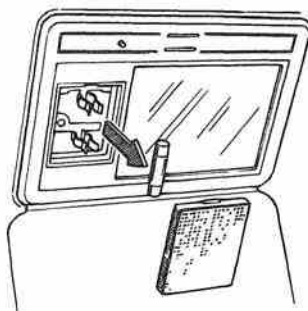

Door courtesy lights

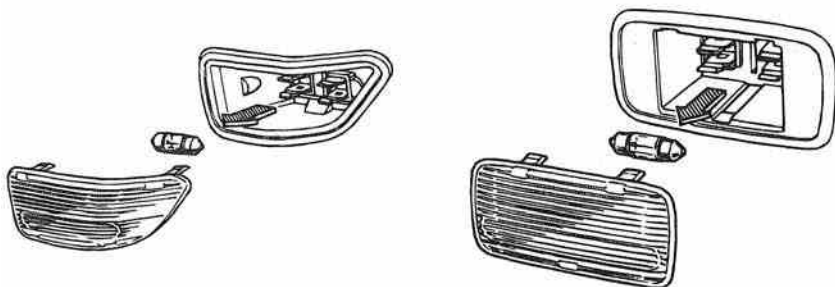

(Front)

(Rear)

High-mount brake light

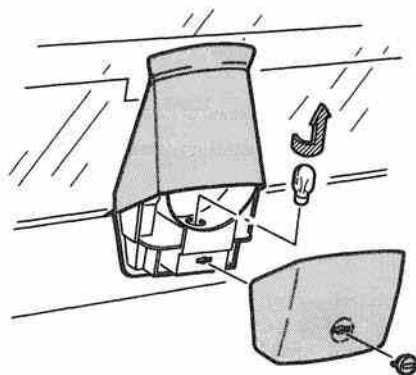

Tires

The factory-installed tires on your car were selected to match the car's performance capabilities and to provide the best combination of handling, ride comfort and tread wear. We recommend that you get the same size, type and grade of tires when replacement is necessary. If your tires have an "all-season" tread design, the model name will be followed by the marking "M + S" (mud and snow) or "all-season".

If you decide not to get the same brand of tires as those originally installed, you should make sure that the replacements are the radial type, of the same size, load range and speed rating as the original tires. If you have any questions about your car's tires, please contact your Honda dealer.

Inflation Pressures

The tire label on the driver's door jamb shows recommended tire pressures for carrying loads up to the limit shown.

These pressures were chosen to provide you with the best combination of tread life, riding comfort and stability under normal driving conditions.

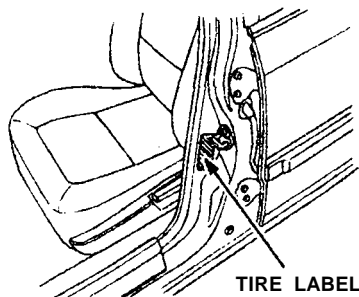

Improper inflation can reduce both tire life and load carrying capacity. Check the tire pressures at least once a month, including the spare.

Lower pressure than recommended lets the tread and sidewalls flex too much, causing increased tire temperatures, uneven wear, and poor handling. Pressure higher than recommended can make the tire too stiff, increasing the chance of damage from road hazards, and also causing uneven wear.

CAUTION:

- Check tire pressure when the tires are cold (after the car has been parked for more than 3 hours or driven less than 1 mile/1.6 km).
- Tire pressure may increase as much as 41 kPa (6 psi) when the tire is hot, so **NEVER ADJUST** tire pressure when the tires are hot.
- Never inflate load range B tires to more than 220 kPa (32 psi) cold.
- Cars with luggage racks or cartop carriers **DO NOT** have greater load limits than those on the label.

Winter Driving

Tires marked "M+S" or "all season" have an all-weather tread design and should be suitable for most driving conditions. However, snow tires and tire chains may be required under some conditions. If your tires do not have these markings, they may not be suitable for winter driving conditions. We recommend snow tires or tire chains for snow and icy conditions.

Snow Tires

If you use snow tires, they should be of the same size, construction and load capacity as the original tires on your car. Snow tires must be installed in sets of four, or they may cause poor handling. Driving with snow tires on dry roads can reduce your car's performance during acceleration, turning and stopping. If you need further information on snow tires, please contact your Honda dealer.

Tire Chains

Use chains only when you have to. Check with local authorities for requirements prior to installing tire chains. Make sure the chains are the right size for your tires. Install them only on the drive wheels of your car, and do so as tightly as possible, following the manufacturer's instructions. If metal chains are used, they must be SAE Class "S." Cable type traction devices can also be used. Drive slowly with chains installed. If you hear the chains contacting your car's body or chassis, stop and tighten them.

CAUTION:

- **If the contact continues, slow down until it stops or your car can be damaged.**
- **Chains that are the wrong size or improperly installed can damage your car's brake lines, suspension, body, and wheels.**

If you need further information on tire chains, please see your Honda dealer.

Remove the chains as soon as the road is clear of ice and snow.

Tires (cont'd)

Tire Replacement

Honda recommends that you replace tires in sets of four, or in pairs, front or rear. If you need to replace only one tire, mount the new tire opposite the tire showing the least amount of wear. For instance, if the left front tire shows the least amount of wear, mount the new tire on the front right side.

The original tires on your car have tread wear indicators to indicate when they should be replaced. The indicators appear as bands about 12.7 mm (1/2 in) wide when the tire tread depth is less than 1.6 mm (1/16 in). When indicators appear across two or more grooves in a row, you should replace the tire.

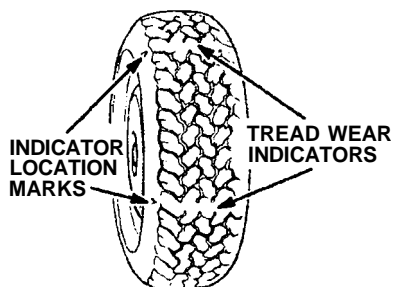

⚠️ WARNING Driving on worn-out tires is very hazardous, and will reduce braking effectiveness, steering accuracy and traction.

When replacing tires, use only the recommended tire size. Wheel rim widths and offsets must be those recommended by American Honda Motor Co., Inc. Contact the Zone Office nearest you as shown on the inside of the back cover.

⚠️ WARNING Tires and wheels other than those recommended may be unsafe. Do not mix radial and bias ply tires on the same car.

Spare Tire

The spare tire on your car is identical to those already mounted to your car. You can use it as a spare or regular tire. Check the pressure in the spare tire regularly so it will be ready to use when you need it.

Tire Balancing

Unbalanced tires may affect handling and tire wear. A tire should always be rebalanced after it has been dismantled from the wheel.

Your original tires were properly balanced before the car left the factory, but may need rebalancing at some time during the life of the tire.

CAUTION: If your car is equipped with aluminum wheels, use only genuine Honda wheel weights. Non-genuine wheel weights may corrode and damage the aluminum wheel.

Tire Rotation

Tires may wear unevenly when used for a long time in the same position on the car. To avoid this, rotate the tires every 7,500 miles (12,000 km). If abnormal or uneven wear develops between rotations, the cause should be found and corrected as soon as possible. The illustration shows how tires can be rotated.

NOTE: Brake pads should be inspected for wear whenever the tires are rotated.

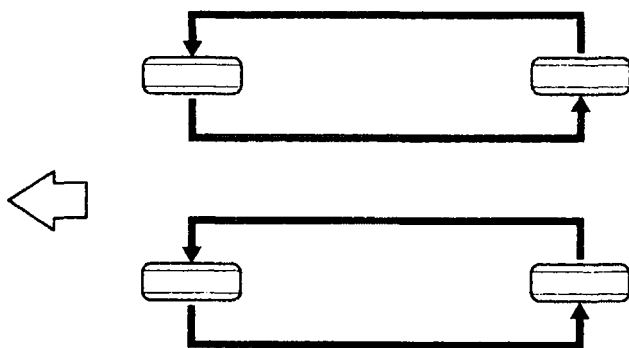

Tire Traction

⚠ WARNING Worn tires or slippery road surfaces can reduce driving, cornering and braking traction. To reduce the possibility of losing traction, slow down when the road gets slippery, replace tires when wear indicators are visible, and **KEEP TIRES PROPERLY INFLATED.**

Air Conditioner Care

Condenser and Radiator

Check the engine radiator and the air conditioner condenser (in front of the radiator) for accumulated dirt, insects or leaves. Carefully brush or hose them off to assure maximum cooling performance.

CAUTION: Radiator and condenser fins are very thin and easily damaged; do not bend them with high water pressure or brush.

Compressor Drive Belt

Check the compressor belt tension monthly during periods of high air conditioner usage.

If the engine has been running, some engine components may be hot enough to burn you.

When properly tensioned, the belt should have 10 to 12 mm (0.4 to 0.5 in) "play" or deflection when pushed with 98N (10 kg, 22 lb) of force midway between the alternator pulley and the engine crankshaft pulley. Have the belt adjusted whenever necessary.

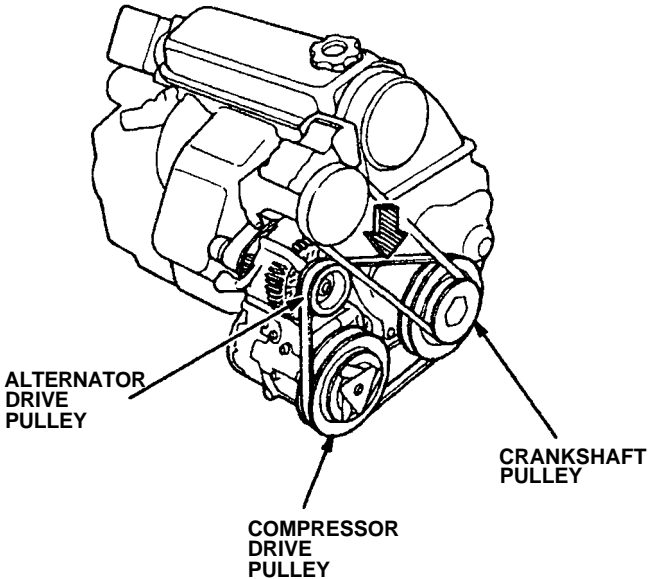

System Maintenance

Run your air conditioner for about ten minutes at least once a week, even during the off season. This lubricates the seals and the inside of the compressor and verifies that the system is functional.

If the air conditioner is not cooling properly, it may indicate an undercharged system. Have your dealer check the system for leaks, then evacuate and charge the system with 900-950 g (32-34 oz) of Refrigerant 12.

CAUTION: Prolonged use of an undercharged system may damage the compressor.

Whenever you have the air conditioning system serviced, make sure the service facility uses a refrigerant recycling system. This system captures the refrigerant for reuse. Releasing refrigerant into the atmosphere can damage the environment.

Appearance Care

Interior Trim

Remove dust and loose dirt with a vacuum cleaner.

Wipe the vinyl with a clean, damp cloth or sponge. Stains can be removed with a commercially available vinyl cleaner.

CAUTION: Do not use thinner, gasoline, kerosene, naphtha or other solvents on the interior. They are toxic, flammable and hazardous and could damage the material you're cleaning.

Windows

Use a commercially available glass cleaner to clean windows inside and out. A mixture of 1 part vinegar to 10 parts water works best to remove the dust or film sometimes caused by the ingredients used in interior vinyls and plastics.

NOTE:

- Do not put the vinegar-water solution in the windshield washer reservoir, it will damage the windshield washer pump.
- Use a commercially available windshield washer fluid in the windshield washer reservoir.

Be careful not to scratch or damage the defogger wires when cleaning the inside of the rear window; wipe the window horizontally along the wires, not up and down. Dry the windows with a lint-free cloth or paper towel. Keep all the windows clean for maximum visibility.

Exterior Care

Washing

- Rinse all loose dirt off the car by spraying it with lukewarm or cold water. Do not use hot water.
- Wash with water containing a mild detergent, such as a liquid dish-washing detergent, using a soft-bristle brush, sponge or cloth.
- Remove oil, tar, tree sap, etc., with tar remover or turpentine. Remove road salt, insects, etc., with mild detergent and lukewarm water. Any of these substances may damage the finish if left on painted surfaces.
- Rinse the car well. Promptly wipe with a chamois or soft towel to prevent water-spotting. Do not let water or soap air-dry on painted surfaces.

-
- During wiping, inspect the surface for stone chips and scratches; paint them with touch-up paint so they won't rust (touch-up paint is available through your Honda dealer).
 - For further instructions on corrosion protection, refer to the Rust Prevention section on page [120](#).

Waxing

Wax the car when water will no longer "bead" on the paint. Always wash and dry the car before you wax it. Use a good quality liquid or paste wax, and follow the manufacturer's instructions. Wax all the metal trim to keep its luster.

NOTE: Removing oil, tar, etc., with a spot remover will usually strip the wax from the surrounding finish. Be sure to re-wax these areas even if the rest of the car does not yet need waxing.

Aluminum Alloy Wheels (US: EX, Canada: EX-R)

Honda aluminum wheels are treated with a protective finish. Wash them with a low-phosphate detergent and sponge. Do not use abrasive cleaners or stiff brushes.

CAUTION:

- **Wash the wheels after driving on snowy or icy roads where salt has been applied.**
- **Avoid off-road driving. Brush, rocks, dirt and severe impact may damage the wheels.**
- **Install tire chains carefully. Improperly installed chains can cause damage to the wheels.**
- **Always install aluminum wheels in sets of four. If mixed with other types, the car's handling may be affected.**

Appearance Care (cont'd)

Rust Prevention

Rusting is likely to occur in parts of the car where water is trapped or where there is continual dampness.

- Water will collect inside doors and body panels if drain holes become clogged.
- Water which seeps under or soaks floor mats will subject floor sections to prolonged wetness or dampness.
- Road dirt or sand, which collects and fills recesses on the underside of the car, retains moisture long after the rest of the car has dried.

The removal of paint and undercoating by stones, gravel, and minor accidents immediately exposes metal to air and moisture.

Rusting is increased by high humidity and by the presence of corrosive substances in the air or on the roads.

- Salt used for road de-icing will coat the bottom of the car and hasten rusting.
- Localities with high humidity have greater potential for rust problems, especially where salt is also present on the road or in moist sea air.
- Industrial pollution will accelerate the deterioration of paint finishes and promote rusting.

Preventive Service

Check all drain holes in the doors and body panels for clogging and clear if necessary. When washing your car, also clean the underside of the car by using high pressure water; ① above subframe, ② inside front fender, ③ rear suspension, ④ inside rear wheel housing, and ⑤ under rear bumper.

After washing your car or after heavy rain, check for interior leaks. Dry all wet areas. Have leaks repaired as soon as possible.

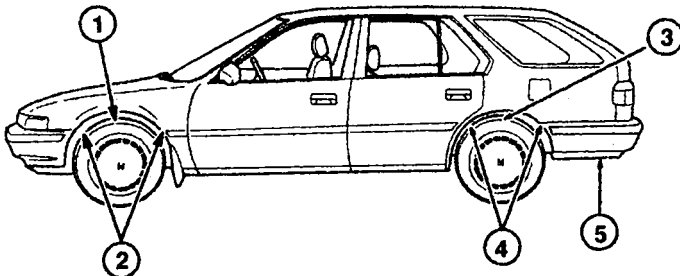

Replacement of Body and Fender Parts

If your vehicle incurs body damage and requires replacement parts, we encourage you to use only Genuine Honda sheet metal body and fender parts. Many insurance companies are specifying imitation sheet metal parts for collision repairs in an effort to reduce claim costs; however, if imitation parts are used:

- There is no assurance that imitation parts will equal the fit and finish of Genuine Honda sheet metal parts; and in our experience they often do not.
- There is no assurance that imitation parts will resist corrosion as well as Genuine Honda sheet metal parts.
- Imitation sheet metal parts are not covered by the Honda Limited Warranty.

To ensure your continued satisfaction with your Honda vehicle in the event of an accident, contact your insurance adjuster and insist on Genuine Honda parts in the repair of your vehicle.

Changing a Flat Tire



Do not attempt to change a tire unless the car is on firm, level ground and well out of the flow of traffic.

Park the car on a firm, level surface, apply the parking brake, turn on the hazard warning switch put the transmission in gear (Park for automatic) and turn the ignition off.

1. Lift the floor panel in the cargo area.
2. Remove the jack.

NOTE: Turn the connector on the end of the jack counterclockwise to loosen it from its mount.

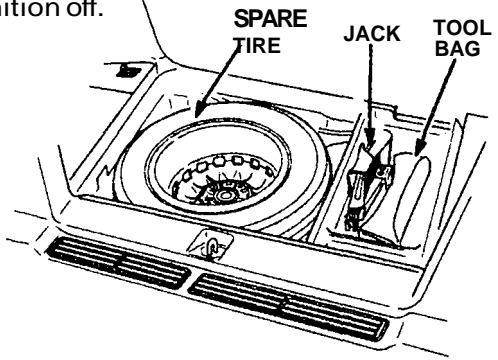

3. Remove the lug wrench/jack handle and jack handle extension from the tool bag.
4. Remove the spare tire.
5. Place blocks (not provided with the car) in front of and in back of the wheel diagonally opposite the tire you are changing.
6. Use the lug wrench to loosen the wheel lug nuts counterclockwise one-half turn.

— On the EX and EX-R models: First remove the center cap from the wheel by prying it out with a flat screwdriver (not provided in the tool bag), or coin.

CAUTION: Hold the center cap with your hand then pry it off using a cloth to protect the cap and the wheel.

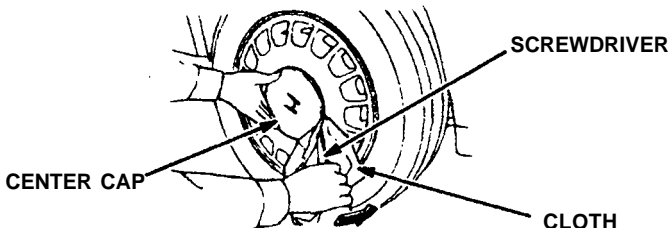

- On the LX model, remove the center cap by using a coin in the recess and turning the lock 90°.

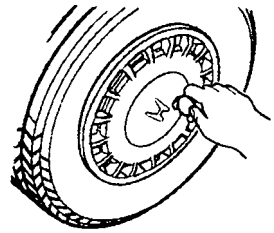

7. Remove the lug nuts and wheel.

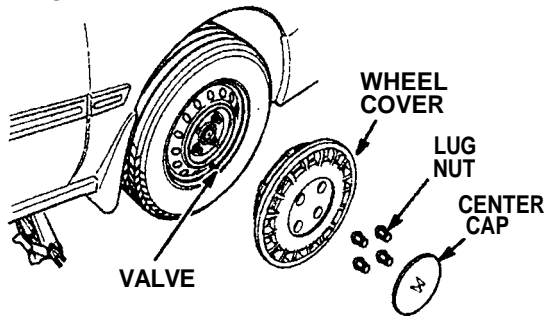

⚠ WARNING Follow tire changing preparations and procedures carefully to reduce the possibility of injury. The jack is designed for changing tires only. **STAND CLEAR, DO NOT** get under the car and **DO NOT** run the engine when the car is supported only by the jack.

8. Place the jack under the car as shown and raise the car by turning the handle clockwise until the tire is slightly off the ground.

⚠ WARNING To reduce the possibility of injury, be sure to use the jack provided with the car and the correct jacking points; never use any other part of the car for jack support.

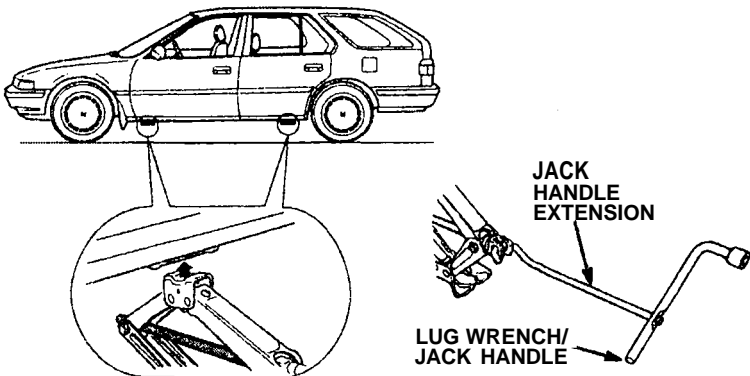

Changing a Flat Tire (cont'd)

9. Use a clean rag to wipe any dirt off the mounting surface of the hub and the wheel. This will assure a tight, even contact between the wheel and hub.

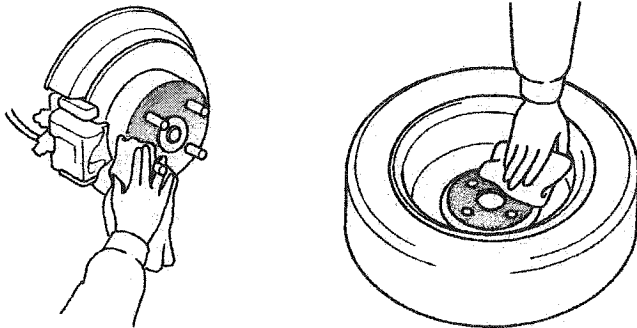

10. Install the spare. Install the lug nuts finger tight.
11. Lower the car, remove the jack, then tighten the lug nuts securely in an "X" pattern as shown.

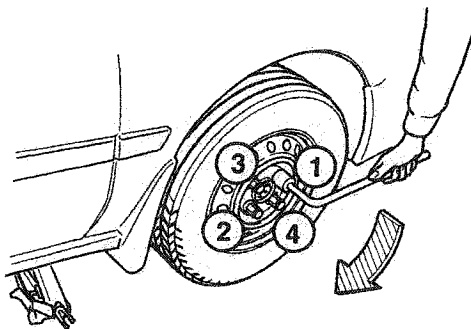

Tighten the lug nuts to the recommended torque:
110 N.m (11 kg.m, 80 lb.ft).

If a torque wrench was not used, ask an authorized Honda dealer to verify the torque as soon as possible.

12. Repair or replace the damaged tire as soon as you can, reinstall it in its original position, then put the spare back in the car.

CAUTION: Always stow the jack, tools and tire securely to prevent them from becoming dangerous projectiles in an accident.

13. Secure the tire and the spacer as shown in the illustration.

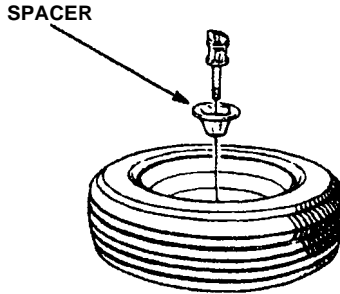

Jump Starting

To start a car with a dead battery, use another battery of the same voltage and the proper jumper cables.

- Procedures other than those below could cause injury or damage from battery acid spray, explosion or charging system overload.
- Never connect the jumper cable directly to the negative post of the "dead" battery.
- Never allow the two cars to touch each other.
- Never allow the jumper cable clamps to touch each other.
- Never lean over the battery when making connections.
- Never attempt to jump start a vehicle with a frozen battery. The battery could rupture and explode. If you suspect a frozen battery, do not attempt a jump start until the fluid thaws.

CAUTION: If jumper cables are connected backwards, the car's main fuse may blow.

1. Turn off all lights, heater and other electrical loads, set the parking brake, and shift the transmission to Neutral or Park.
2. Use one cable to connect the positive terminal of the booster battery to the positive terminal of the "dead" battery.

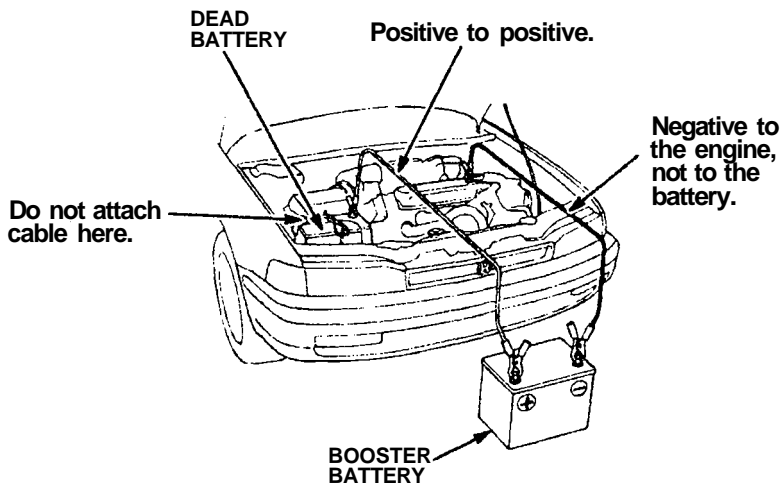

-
3. Use the other cable to connect the negative terminal of the booster battery to the engine at the ground cable as shown.
 4. To remove the cables, reverse the above procedures exactly.

 WARNING **DO NOT push or tow a car to start it. The forward surge when the engine starts could cause a collision. Also, under some conditions, the catalytic converter could be damaged. A car equipped with an automatic transmission cannot be started by pushing or towing.**

Towing

If towing is necessary, contact a professional towing service. Your authorized Honda dealer can assist you with detailed towing instructions.

⚠ WARNING Never use tow chains or rope to tow a car; your ability to safely control the car may be adversely affected.

We recommend the following:

Flat-Bed Equipment — Entire car is winched on to a flat-bed vehicle. This is the best way of transporting your Honda.

Wheel Lift Type — Tow with the front wheels off the ground.

If the car can only be towed with the front wheels on the ground: make sure the transmission is full of fluid (see page 95 - 96) and tow with the transmission in neutral (N) and the ignition key in the I position.

CAUTION: To avoid serious damage on automatic transmission cars, first start the engine and shift to D4, then to N and shut the engine off. If the engine does not run or the transmission cannot be shifted while the engine is running, the car must be transported on flat-bed equipment.

Check local regulations for towing.

CAUTION:

- Do not exceed 35 mph (55 km/h) or tow for distances of more than 50 miles (80 km).
- If a sling type tow is used, the tow truck driver should position wood spacer blocks between your car's frame and the chains and lift straps to avoid damaging the bumper and the body.
- Do not use the bumpers to lift the car or to support the car's weight while towing.

If Your Car Gets Stuck

If your car gets stuck in sand, mud, or snow, call a professional towing service for assistance in getting your car out.

CAUTION:

- **Do not rev up the engine and allow the wheels to spin freely at high speed. Severe transmission damage may result if the wheels are allowed to spin for more than a few seconds.**
- **DO NOT try to free a car with automatic transmission from snow etc., by rocking the car alternately between forward and reverse gears. Severe transmission damage may result from shifting into gear with the wheels moving.**

Specifications

Dimensions

Length		4,725 mm (186 in)
Width		1,725 mm (67.9 in)
Height		1,400 mm (55.1 in)
Wheelbase		2,720 mm (107.1 in)
Track	Front	1,475 mm (58.1 in)
	Rear	1,475 mm (58.1 in)

Weights

Gross vehicle weight rating	See the certification label attached to the left rear door jamb.
-----------------------------	--

Tires

Size/Pressure	See the tire label attached to the driver's door jamb.
---------------	--

Capacities

Fuel tank		Approx. 64.5ℓ (14.2 Imp gal, 17.0 US gal)
Radiator coolant		
	5-speed transmission	
	Change* ¹	3.0ℓ (2.6 Imp qt, 3.2 US qt)
	Total	6.6ℓ (5.8 Imp qt, 7.0 US qt)
Automatic transmission	Change* ¹	3.5ℓ (3.1 Imp qt, 3.7 US qt)
	Total	7.1ℓ (6.3 Imp qt, 7.5 US qt)
Engine Oil	Change* ²	3.8ℓ (3.3 Imp qt, 4.0 US qt)
	Total	4.9ℓ (4.3 Imp qt, 5.2 US qt)
5 speed transmission oil	Change	1.9ℓ (1.7 Imp qt, 2.0 US qt)
	Total	2.0ℓ (1.8 Imp qt, 2.1 US qt)
Automatic transmission fluid	Change	2.4ℓ (2.1 Imp qt, 2.5 US qt)
	Total	6.0ℓ (5.3 Imp qt, 6.4 US qt)
Windshield washer reservoir		4.2ℓ (3.7 Imp qt, 4.4 US qt)

* 1: Including the coolant in reserve tank 0.6 ℓ (0.5 Imp qt, 0.6 US qt) and that remaining in the engine.

*2: Excluding the oil remaining in the engine, but including that in the oil filter.

Engine

Type	Water cooled 4-stroke OHC gasoline engine
Bore x Stroke	85.0 x 95.0 mm (3.35 x 3.74 in)
Displacement	2.156 cm ³ (132 cu in)
Compression ratio	8.8
Spark plug	See spark plug maintenance section page 105

Alignment

Toe-in	Front	0 mm (0 in)
	Rear	4 mm (0.16 in)
Camber	Front	0°
	Rear	-0°30'
Caster	Front	3°

Battery

Capacity	12V – 52AH
----------	------------

Fuses

Under-hood	See the under-hood fuse box cover.
Under-dash	See the fuse label attached to the inside of the fuse compartment door under the dashboard.

Lights

Headlights	12V – 65/55W	
Front turn signal lights	12V – 45CP (SAE 3497)	
Front position lights	12V – 5W (6CP) (SAE 3652)	
Rear turn signal lights	12V – 45CP	
Stop/Tailights	12V – 43/3CP	
Side marker lights	Front	12V – 5W
	Rear	12V – 43/3CP
Back-up lights	12V – 32CP (SAE 1156)	
High-mount brake lamp	12V – 45CP (SAE 3497)	
License plate lights	12V – 8W (4CP)	
Interior light	12V – 8W	
Cargo area light	12V – 3.4W	
Vanity mirror light	12V – 1.8W	
Door courtesy lights	12V – 3.4W	

Identification Numbers

The Vehicle Identification Number (V.I.N.) is stamped on a plate attached to the top left side of the dashboard.

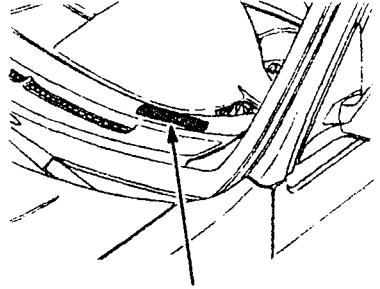

VEHICLE IDENTIFICATION NUMBER

It also appears on the Certification label attached to the left rear door jamb, as well as under the hood on the body, directly behind the engine.

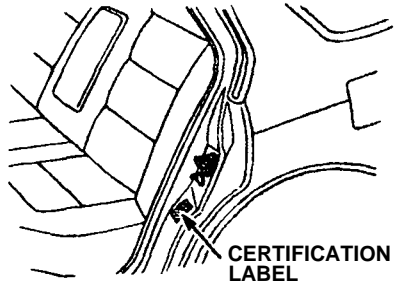

CERTIFICATION LABEL

NOTE: The V.I.N. is also provided in bar code on the Certification label.

The Engine Number is stamped on the right front side of the engine block.

The Transmission Number appears on a label on top of the transmission.

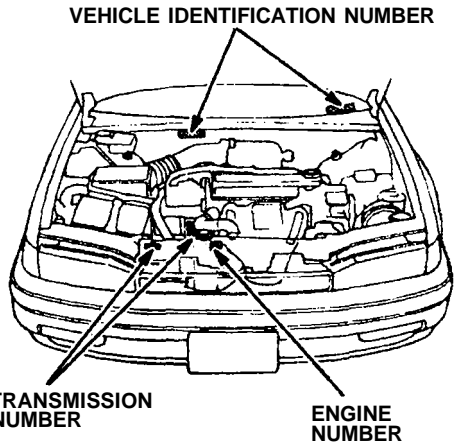

VEHICLE IDENTIFICATION NUMBER

TRANSMISSION NUMBER

ENGINE NUMBER

US Cars

The tires on all Honda cars meet Federal Safety Requirements. All tires on the Accord are also "graded" according to Department of Transportation (DOT) standards for tread wear, traction and temperature.

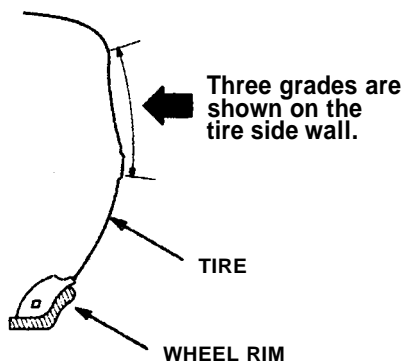

Tread Wear

The tread wear grade is a comparative rating based on the wear rate of the tire when tested under controlled conditions on a specified government test course. For example, a tire graded 150 would wear one and one half (1-1/2) times as well on the government course as a tire graded 100.

The relative performance of tires depends upon the actual conditions of their use, however, and may depart significantly from the norm due to variations in driving habits, service practices and differences in road characteristics and climate.

Traction

The traction grades, from highest to lowest, are A, B, and C, and they represent the tire's ability to stop on wet pavement as measured under controlled conditions on specified government test surfaces of asphalt and concrete. A tire marked C may have poor traction performance.

⚠ WARNING The traction grades assigned are based on braking (straight ahead) traction tests and do not include cornering (turning) traction.

DOT Tire Quality Grades (cont'd)

Temperature

The temperature grades are A (the highest), B and C representing the tire's resistance to the generation of heat and its ability to dissipate heat when tested under controlled conditions on a specified indoor laboratory test wheel. Sustained high temperature can cause the material of the tire to degenerate and reduce tire life, and excessive temperature can lead to sudden tire failure. The grade C corresponds to a level of performance which all passenger car tires must meet under the Federal Motor Vehicle Safety Standard No. 109. Grades B and A represent higher levels of performance on the laboratory test wheel than the minimum required by law.

 WARNING The tire temperature grade is established for a tire that is properly inflated and not overloaded. Excessive speed, under-inflation, or excessive loading, either separately or in combination, can cause heat buildup and possible tire failure.

Sources of Emissions

The combustion process produces carbon monoxide (CO), oxides of nitrogen (NO_x) and hydrocarbons. The evaporation of fuel in the fuel tank also produces hydrocarbons. Control of oxides of nitrogen and hydrocarbons is very important since, under certain conditions, when subjected to sunlight, they react to form photochemical smog. Carbon monoxide does not react to form smog, but it is toxic.

The Clean Air Act

The Clean Air Act* requires all vehicle manufacturers to explain in writing the operation and maintenance of their emission control systems.

Maintenance instructions are included on pages [85 - 89](#); the operation of each system is explained below and on the following page.

Replacement Parts

The emission control systems on your new Honda were designed, built and certified to conform with the Federal regulations implementing the Clean Air Act. Honda recommends only the use of new, genuine Honda parts or their equivalent. The use of other replacement parts which are not of equivalent quality may impair the effectiveness of your car's emission control systems.

Evaporative Emission Control System

The Evaporative Emission Control System is designed to prevent fuel vapors from escaping into the atmosphere.

Fuel vapors from the fuel tank are directed into the charcoal canister where they are adsorbed and stored while the engine is stopped or idling. When the coolant temperature rises to a certain value, the vapors are drawn into the engine through the throttle body and the intake manifold during normal engine operation.

*In Canada, Honda vehicles comply with the Canadian Motor Vehicle Safety Standards (CMVSS) on Emissions valid at the time they are manufactured.

Crankcase Emission Control System

To prevent crankcase emissions, your car is equipped with a Positive Crankcase Ventilation (PCV) System which routes blowby gases from the crankcase, through the PCV valve and intake manifold, into the combustion chamber.

Engine Exhaust Controls

The engine exhaust emission control systems are designed to control combustion during idle, acceleration, cruise, and deceleration. These systems are entirely separate from the crankcase and evaporative emission control systems described previously.

- **PGM-FI System**

The PGM-FI system consists of three independent sub-systems; Air Intake, Electronic Control and Fuel Control, thus allowing more accurate control of air/fuel ratios under all operating conditions. The Electronic Control Unit (ECU) detects the amount of air drawn into the cylinders and determines the amount of fuel to be injected to provide the optimum air/fuel ratio for all engine needs.

- **Ignition Timing Control System**

This system automatically controls the ignition timing to reduce the amount of HC and NO_x.

- **Catalytic Converter**

The catalyst is used to convert hydrocarbons (HC), carbon monoxide (CO) and oxides of nitrogen (NO_x) in the exhaust gas, to carbon dioxide (CO₂), dinitrogen (N₂) and water vapor.

- **Exhaust Gas Recirculation (EGR)**

The EGR system is designed to control the formation of oxides of nitrogen (NO_x) caused when fuel the mixture burns at high temperature. It works by recirculating exhaust gas through the EGR valve and intake manifold into the combustion chambers where it reduces peak temperature by diluting the air/fuel mixture.

Catalytic Converter

A catalytic converter is installed in the exhaust system to help clean up the harmful exhaust gases that can cause air pollution.

To be effective, the converter must work at high temperature, so don't park your car over dry grass, leaves or anything else that could burn easily.

To stay effective, the converter must not be contaminated by leaded gasoline; use only unleaded gas as explained on page 65.

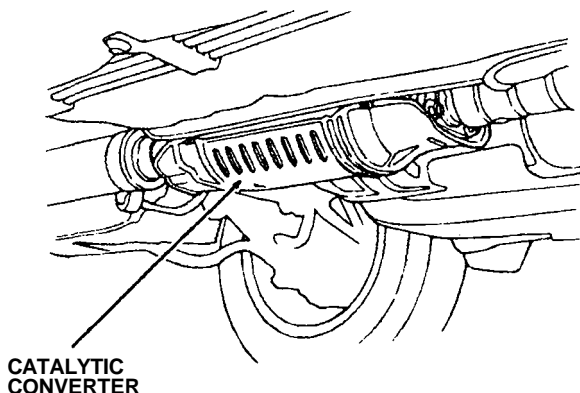

CAUTION: The converter can be overheated and damaged if it's fed too much unburned fuel mixture from the engine, so:

- Don't push or tow the car to start it; if the battery is dead, jump start the car as shown on page 126.
- Don't turn the key off while the engine is running above idle speed.
- Don't change the ignition timing, or remove any emission control parts.
- Use only the spark plugs specified in this manual.
- Don't keep driving your car if it isn't running properly, or if its CHARGE warning light or check engine light comes on; have it checked by your Honda dealer.

Warranty Service

Warranty (US Cars)

The following warranties are provided with every new vehicle.

1. New Car Limited Warranty
2. Emission Control Systems Defects Warranty
3. Emission Performance Warranty
4. Original Equipment Battery Limited Warranty
5. Rust Perforation Limited Warranty
6. Accessory Limited Warranty
7. Replacement Parts Limited Warranty
8. Replacement Muffler Lifetime Limited Warranty
9. Seat Belt Limited Warranty
10. Replacement Battery Limited Warranty

Your car's original tires are covered by their manufacturer. Tire warranty information is in a separate tire warranty booklet.

The details of all warranties pertaining to your car can be found in the Warranty booklet provided with your new car. The required maintenance schedule is contained in this Owner's Manual.

If you are unable to obtain warranty service or are dissatisfied with the warranty decision or service you received at an authorized Honda dealership, you should review the matter with that dealership's Service Manager. This will normally resolve your problem. If it does not, you should appeal the decision with the owner of the dealership. Please bear in mind that your problem will likely be resolved in the dealership, using the dealer's facilities, equipment and personnel. So it is very important that your initial contact be with the dealer or his management.

After following these steps, if you wish to have the matter reviewed by American Honda you should contact the Zone Office serving your area, as shown on the map on the inside of the back cover. When contacting American Honda, please provide the Zone Office with the following information:

- Vehicle Identification Number
- Servicing Dealer Name and Address
- Date of Purchase
- Mileage on your Car
- Your Name, Address, and Phone Number
- Nature of Problem
- Selling Dealer

After a review of the facts, you will be advised of what can be done.

(US Cars)

If you believe that your vehicle has a defect which could cause a crash or cause injury or death, you should immediately inform the National Highway Traffic Safety Administration (NHTSA) in addition to notifying American Honda Motor Co., Inc.

If NHTSA receives similar complaints, it may open an investigation, and if it finds that a safety defect exists in a group of vehicles, it may order a recall and remedy campaign. However, NHTSA cannot become involved in individual problems between you, your dealer, or American Honda Motor Co., Inc.

To contact NHTSA, you may either call the Auto Safety Hotline toll-free at 1-800-424-9393 (or 366-0123 in the Washington, D.C. area) or write to: NHTSA, U.S. Department of Transportation, Washington, D. C. 20590. You can also obtain other information about motor vehicle safety from the Hotline.

A

- Air Conditioner
 - Care, [116 - 117](#)
 - Operation, [51](#)
 - Recycled Refrigerant, [117](#)
- Air filter, [104](#)
- Air Pressure, Tires, [112](#)
- Aluminum Alloy Wheels, [119](#)
- Antenna, [58](#)
- Anti-theft Steering
 - Column Lock, [69](#)
- Antifreeze. See "[Radiator Coolant](#)"
- Appearance Care, [118](#)
- Ashtrays, [47](#)
- Audio System, [58](#)
- Automatic Shift Lock, [75](#)
- Automatic Transmission
 - Driving Technique, [77](#)
 - Fluid, [96](#)
 - Operation, [76](#)
 - Shift Lever
 - Position Indicator, [75](#)

B

- Battery
 - Charging System
 - Warning Light, [30](#)
 - Jump Starting, [126](#)
 - Maintenance, [107](#)
 - Specifications, [131](#)
- Beeper System
 - Fasten Seat Belt Beeper, [17](#)
 - Key Reminder, [69](#)
 - Light Reminder Chime, [38](#)
- Beverage Holder, [46](#)
- Body Repair, [121](#)
- Brake Lamp Warning Light, [32](#)

- Brakes
 - Brake Failure Light, [29](#)
 - Brake Fluid, [101](#)
 - Brake System Design, [100](#)
 - Brake Wear, [100](#)
 - Brake Wear Indicators, [101](#)
 - Lamp Warning Light, [32](#)
 - Parking Brake, [43](#)
 - Parking Brake Light, [29](#)
- Break-in Period, [2](#)
- Bulb
 - Replacements, [110 - 111](#)
 - Specifications, [131](#)

C

- Capacities, [130](#)
- Care and Cleaning, [118 - 120](#)
- Cargo Area, [13](#)
 - Storage Compartments, [13](#)
 - Tonneau Cover, [13](#)
- Cargo Area Light, [40](#)
- Catalytic Converter, [136](#), [137](#)
- Certification Label, [132](#)
- Chains, Tire, [113](#)
- Check Engine Warning Light, [30](#)
- Child Proof Door Locks, [7](#)
- Child Restraint, [18](#)
- Cigarette Lighter, [47](#)
- Clock, [45](#)
- Clutch Fluid, [102](#)
- Coolant Temperature Gauge, [27](#)
- Cooling (with A/C), [52](#)
- Cooling System, [97-99](#)
- Crankcase Emission
 - Control System, [136](#)
- Cruise Control
 - Indicator, [28](#)

To Cancel the Cruise Control, [42](#)
To Set the Cruise Control, [41](#)

Washing, [118](#)
Waxing, [119](#)

D

Daytime Running
 Lights (DRL), [31](#), [40](#)
Defrost/Defog, [54](#)
Dimensions, Specifications, [130](#)
Doors
 Child Proof Door Lock, [7](#)
 Locks, [6](#)
 Power Door Locks, [6](#)
 Warning Lights, [32](#)

E

Emergency
 Changing a Flat Tire, [122](#) - [125](#)
 Hazard Warning System, [39](#)
 If Your Car Gets Stuck, [129](#)
 Indicator Lights, [28](#) - [31](#)
 Jump Starting, [126](#)
 Towing, [128](#)
Emission Controls, [135](#) - [136](#)
Engine
 Coolant, [97](#)
 Coolant Temperature Gauge, [27](#)
 Exhaust Controls, [136](#)
 Identification Number, [132](#)
 Oil and Filter, [92](#) - [94](#)
 Oil Pressure Light, [29](#)
 Specifications, [131](#)
Engine Exhaust Gas Warning, [72](#)
Evaporative Emission
 Control System, [135](#)
Exhaust Gas
 Recirculation (EGR), [136](#)
Exterior Care, [118](#) - [119](#)
 Aluminum Alloy Wheels, [119](#)
 Preventive Service (Rust), [120](#)
 Rust Prevention, [120](#)

F

Filters
 Air, [104](#)
 Engine Oil, [93](#)
 Fuel, [104](#)
Fluid. See "Oil"
Foreign Countries,
 Operation in, [66](#)
Fuel
 Filter, [104](#)
 Fuel Filler Door
 and Cap, [67](#)
 Fuel Reserve Light, [29](#)
 Gasohol, [65](#)
 Gauge, [26](#)
 Requirement, [65](#)
Fuse
 Checking and
 Replacing, [108](#) - [109](#)
 Specifications, [131](#)

G

Gas Station Information, [142](#)
Gasoline, [65](#)-[68](#)
Gauges, [26](#)-[27](#)
Glove Box, [45](#)

H

Hazard Warning System, [39](#)
Head Restraints, [9](#)
Headlights
 Flasher, [38](#)
 High Beam
 Indicator Light, [28](#), [38](#)
 High/Low Beam Switch, [38](#)

Reminder Chime, [38](#)

Headlights (cont'd)

Switch, [38](#)

Heating, [53](#)

Hood, [43](#)

Hood Latch, [43](#)

I

Identification Numbers, [132](#)

Ignition Switch

Anti-theft Lock, [69](#)

Beeper Reminder (Key), [69](#)

Daytime Running

Lights (DRL), [40](#), [69](#)

Key, [69](#)

Light, [39](#)

Indicator Lights, [28 - 32](#)

Inflation Pressure, Tires, [112](#)

Instrument Panel, [25](#)

Interior Lights, [40](#)

Interior Trim Care, [118](#)

J

Jack, [122 - 125](#)

Jump Starting, [126 - 127](#)

K

Keyless Entry System, [4](#)

Keys

Automatic Shift Lock, [75](#)

Glove Box, [45](#)

Ignition, [69](#)

Keyless Entry System, [4](#)

Reminder Beeper, [69](#)

Remote Access Key, [4](#)

Using the, [5](#)

Tailgate, [3](#), [4](#), [5](#)

L

Lap/Shoulder Belts.

See "Seat Belts"

Lights

Bulb Replacement, [110 - 111](#)

Cargo Area Light, [40](#)

Daytime Running

Lights (DRL), [31](#), [40](#)

Fuse Replacement, [108](#)

Hazard Warning System, [39](#)

Headlight Switch, [38](#)

Ignition Switch, [39](#)

Indicator Lights, [28 - 32](#)

Interior Lights, [40](#)

Light Reminder Chime, [38](#)

Operation of, [38 - 40](#)

Turn Signals, [38](#)

Loading the Car, [12](#)

Lockout Prevention, [7](#)

Locks

Anti-theft Steering

Column Lock, [69](#)

Child Proof Door Locks, [7](#)

Door, [6](#)

Fuel Filler Door, [67](#)

Glove Box, [45](#)

Lockout Prevention, [7](#)

Power Door Locks, [6](#)

Tailgate, [4](#)

Plunger, [6](#)

Using Power Door Locks, [6](#)

Using Remote Access Key, [5](#)

Lumbar Support, [8](#)

M

Maintenance

Record, [88](#)

Schedule, [85 - 90](#)

Maintenance Indicator, [33](#)

Manual Transmission

Maximum Allowable Speed, [74](#)

Oil, [95-96](#)
Recommended Shift Speeds, [74](#)
Shifting, [73](#)

Meters, Gauges. See "[Gauges](#)"

Mirrors

Power Mirrors, [37](#)
Rearview Mirrors, [37](#)

N

Numbers

Vehicle Identification, [132](#)

O

Octane Rating, [65](#)

Odometer, [26](#)

Oil

Clutch Fluid, [102](#)
Engine Oil, [92 - 93](#)
Fluid Locations, [91](#)
Oil Pressure Light, [29](#)
Power Steering Fluid, [103](#)
Transmission Oil/Fluid, [96](#)

Operation in

Foreign Countries, [66](#)

P

Panel Brightness Control, [39](#)

Parking Brake, [43](#)

Parking Brake/

Brake Failure Light, [29](#)

Power

Door Locks, [6](#)
Mirrors, [37](#)
Steering, [103](#)
Windows, [44](#)

Pregnant Women, [20](#)

Pressures, Tire Inflation, [112](#)

Preventive Service, [120](#)

R

Radiator, Coolant, [97-99](#)

Radio Operation, [59](#)

Rear Seat Arm Rest, [9](#)

Rear Window Defogger, [36](#)

Remote Access Key, [4](#)

Using the, [5](#)

Glove Box, [45](#)

Tailgate, [5](#)

Replacement

Air Filter, [104](#)

Bulbs, [110-111](#)

Engine Oil, [93](#)

Fuel Filter, [104](#)

Oil Filter, [93](#)

Radiator Coolant, [98 - 99](#)

Spark Plugs, [105](#)

Tires, [114](#)

Wiper Blades, [106](#)

Review Mirrors, [37](#)

Rust Prevention, [120](#)

S

Safety Defects, Reporting, [139](#)

Safety Items, [71](#)

Seat Belts

Anchor Points, [19](#)

Buckling the

Front Seat Belts, [15](#)

Buckling the Rear Seat Belts, [16](#)

Child Restraint, [18](#)

Cleaning, [21](#)

Fasten Seat Belt Light
and Beeper, [17](#)

Inspection, [20](#)

Installation of Child Seat, [19](#)

Pregnant Women, [20](#)

- Rear Center Seat Belt, [16](#)
- Replacements, [21](#)
- Seat Belt Warning Light, [29](#)
- Shoulder Anchor Height
Adjusting Mechanism, [16](#)
- Seats
- Driver's Lumbar Support, [8](#)
- Seats (cont'd)
- Folding Rear Seat, [10](#)
- Front Seat, [8](#)
- Head Restraints, [9](#)
- Rear Seat Arm Rest, [9](#)
- Shift Lever Position Indicator, [28](#)
- Shifting
- 5-Speed, [73](#)
- Automatic Transmission, [75](#)
- Spare Tire, [114](#)
- Changing a Flat Tire, [122](#), [125](#)
- Specifications, [130](#)
- Spark Plugs, [105](#)
- Specifications, [130](#) - [131](#)
- Speedometer, [26](#)
- Sports Switch, [77](#)
- Starting the Engine, [70](#)
- Steering
- Anti-theft Column Lock, [69](#)
- Power Steering, [103](#)
- Tilt Steering, [34](#)
- Stereo Sound System
- Operation, [58](#)
- Storage Compartments, [13](#)
- Stuck Car, [129](#)
- Sunroof
- If the Sunroof Won't Close, [57](#)
- Maintenance, [57](#)
- Operation, [56](#)
- Sunshade, [56](#)
- Supplemental Restraint System
(SRS), [22-24](#), [31](#)

T

- Tachometer, [26](#)
- Tailgate, [3-7](#)
- Tape Operation, [61](#)
- Temperature Gauge
- Coolant, [27](#)
- Tilt Steering, [34](#)
- Tire
- Air Pressure, [112](#), [114](#)
- Balancing, [115](#)
- Chains, [113](#)
- Changing a Flat Tire, [122](#)
- DOT Tire
- Quality Grades, [133](#) - [134](#)
- Inflation Pressure, [112](#)
- Requirement, [133](#)
- Rotation, [115](#)
- Snow Tires, [113](#)
- Spare Tire, [114](#)
- Specifications, [130](#)
- Tonneau Cover, [13](#)
- Tools, [122](#)
- Towing, [128](#)
- Towing a Trailer, [79-84](#)
- Transmission
- Capacity, [130](#)
- Identification Number, [132](#)
- Oil/Fluid, [95](#)
- Shifting the Automatic, [75-78](#)
- Shifting the Manual, [73-74](#)
- Tread Wear, [133](#)
- Trip Meter, [26](#)
- Turn Signals, [28](#), [38](#)

V

Vehicle Identification Number,
132

Ventilation, 48

W

Warranty Service, 138

Washer

Rear Window Washer, 35

Reservoir Capacity, 36

Windshield Washer, 35

Washing, 118

Waxing, 119

Wheels, 119

Windows

Appearance Care, 118

Power Windows, 44

Windshield Defogger, 36

Windshield Washer, 35

Windshield Wipers, 35

Wipers

Blades, 106

Rear Window Wiper, 35

Windshield Wipers, 35

Authorized Manuals

A Factory-Authorized Manual is Available for Your Vehicle.

The following publications covering the operation and servicing of your vehicle can be obtained from Helm Incorporated either by filling out the reverse side of this form or, for credit card holders, calling the toll free phone number on the form. For manuals prior to the year shown below, contact Helm Incorporated, P.O. Box 07280, Detroit, Michigan 48207, or call (313) 883-1430.

Publications Form Number	Form Description	Price Each*
61SM403	1991 Accord Wagon Service Manual	\$48.00
61SM403-EL	1991 Accord Wagon Electrical Troubleshooting Manual	\$26.00
N/A	1991 Accord Wagon Body Repair Manual	
31SM5600	1991 Accord Wagon Owner's Manual	\$10.50
HON-R	Order Form for Previous Years – Indicate Year and Model Desired	FREE

*Prices are subject to change without notice and without incurring obligation. If order is to be placed after April 1993, contact Helm for current prices and availability.

Service Manual

This manual covers maintenance and recommended procedures for repair to engine and chassis components. It is written for the journeyman mechanic, but is simple enough for most mechanically-inclined owners to understand.

Electrical Troubleshooting Manual

This manual complements the Service Manual by providing in-depth troubleshooting information for each electrical circuit in your car.

Body Repair Manual

This manual describes the procedures involved in the replacement of damaged body parts.

ORDER TOLL FREE: 1-800-782-4356

(NOTE: For Credit Card Holder Orders Only)

Monday-Friday 8:30 A.M.-6:00 P.M. EST

(MINIMUM CREDIT CARD PURCHASE \$10.00)

(OR)

By completing this form you can order the materials desired. You can pay by check or money order, or charge to your credit card. Mail to Helm, Incorporated at the address shown below.

1 9 9 1 H O N	PUBLICATION FORM NUMBER	VEHICLE MODEL NAME	YEAR	QTY	PRICE EACH	TOTAL PRICE

*Prices are effective until April '93. After that date contact Helm, Incorporated for current prices and stock availability.

Orders are mailed within 10 days. Please allow adequate time for delivery.

Total Material	
Mich. Purchases Add 4% Sales Tax	
Handling Charge	\$3.50
Canadian Postage/ Handling (US Funds)	\$6.50
GRAND TOTAL	

NOTE: Dealers and Companies please provide dealer or company name, and also the name of the person to whose attention the shipment should be sent. For purchases outside U.S.A. please write to the above address for quotation.

S
H
I
P
T
O

(CUSTOMER NAME)

(ATTENTION)

(STREET ADDRESS - NO P.O. BOX NUMBERS)

(APT. NO.)

(CITY)

(STATE) (ZIP CODE)

DAYTIME TELEPHONE NO

AREA
CODE

P
A
Y
M
E
N
T

Check or money order enclosed payable to Helm, Inc. (U.S. funds only - do not send cash.)

Master Card

VISA

Check here if your billing address is different from the shipping address shown above.

Account
Number

--	--	--	--	--	--	--	--	--	--	--	--	--	--	--	--	--	--	--	--

Expiration
Mo-Yr

--	--	--	--

(CUSTOMER SIGNATURE)

(DATE)

These Publications cannot be returned for credit without receiving advance authorization within 14 days of delivery. On returns, a restocking fee may be applied against the original order.

HELM

P. O. BOX 072B0 • DETROIT, MICHIGAN 48207 • (313) 883-1430

Gas Station Information

Gasoline: UNLEADED only
Pump octane of 86 or higher

Gas Tank-Capacity: 64.5 ℓ (14.2 Imp gal, 17.0 US gal)
Reserve Capacity: 10.0 ℓ (1.8 Imp gal, 2.6 US gal)

Tire Information: See label on driver's door jamb.

Hood Release: Pull handle under left side of dash.

Engine Oil: Use "Energy Conserving II" SG grade oil.
5W-30 preferred (see page 92 for
viscosity recommendations).
Capacity (Including filter): 3.8 ℓ (3.3 Imp qt, 4.0 US qt)

Manual Transmission Oil:

Use SF or SG grade oil.
10W-30 or 10W-40 preferred (see page 96 for complete
viscosity recommendations).
Capacity (Including differential):
1.9 ℓ (1.7 Imp qt, 2.0 US qt)

Automatic Transmission Fluid:

Use DEXRON® II type Automatic Transmission Fluid (ATF).
Remove dipstick from right end of transmission, wipe off,
reinsert, remove, and read fluid level - do not force the
rubber plug in when reading fluid level or replacing dipstick.
Capacity (Including differential):
2.4 ℓ (2.1 Imp qt, 2.5 US qt)

Power Steering Fluid:

Use only Honda power steering fluid; do not use ATF or any
other brand of power steering fluid because it will damage
the system.

HONDA AMERICAN HONDA MOTOR CO., INC.
1919 Torrance Blvd., Torrance, CA 90501-2746

© 1990 American Honda Motor Co., Inc. - All Rights Reserved.