

1990 Civic Wagon 4WD Online Reference Owner's Manual

Use these links (and links throughout this manual) to navigate through this reference.

For a printed owner's manual, click on authorized manuals or go to www.helminc.com.

Contents

Owner's Identification

Features & Safety 2

What you should know before driving your car.

Starting & Driving..... 40

What gas to use, how to change gears, etc.

Maintenance..... 60

The Required Maintenance Schedule and some items you can service.

Emergency Service..... 99

Changing a flat, jump starting, towing.

Specifications..... 109

Dimensions, weights and capacities.

Consumer Information..... 111

Reporting Safety Detects, warranty service, vehicle identification numbers, etc.

Index 119

Gas Station Information



This Owner's Manual should be considered a permanent part of the vehicle, and must remain with the vehicle at time of resale.

OWNER'S I.D.

OWNER _____

ADDRESS _____

CITY _____ **STATE** _____ **ZIP CODE** _____

V.I.N. _____

DELIVERY DATE _____
(Date sold to original retail purchaser)

DEALER NAME _____ **DEALER NO.** _____

ADDRESS _____

CITY _____ **STATE** _____ **ZIP CODE** _____

OWNER'S SIGNATURE _____

DEALER'S SIGNATURE _____

The information and specifications included in this publication were in effect at the time of approval for printing. Honda Motor Co., Ltd. reserves the right however, to discontinue or change specifications or design at any time without notice and without incurring any obligation whatever.



Introduction

This manual contains important information about the safe operation and maintenance of your Honda CIVIC Wagon and CIVIC Wagon with Real Time® Four-Wheel Drive (4WD).

We urge you to read it carefully, become familiar with the controls it describes, and follow its recommendations, to help make your driving trouble-free and enjoyable.

Statements or labels on the product preceded by the following words are of special significance:

indicates severe personal injury or death will result if instructions are not followed.

indicates a strong possibility of severe personal injury or death if instructions are not followed.

CAUTION: means hazards or unsafe practices which could cause minor personal injury or product or property damage.

NOTE: gives helpful information.

Break-in Period

During the first 600 miles (1,000 km) of driving, avoid full throttle starts and cruising for extended periods at a constant speed.

NOTE:

- This break-in procedure also applies to exchanged or overhauled engines.
- During and after the break-in period, drive the car at moderate speeds until the engine is fully warmed up.

CAUTION:

(4WD:) Although 4WD provides better traction on poor road surfaces or when driving in snow or mud, this car is not designed for off-road use.

During the first 200 miles (300 km), try to avoid severe braking. Brake misuse during this period will reduce future braking efficiency.

Remember, your Honda Automobile Dealer knows your car best, and should be consulted for service assistance and advice.

Keys and Locks

Keys

Two identical keys come with your car. You should keep one of them in a safe place, away from the car, as a spare. Also write down the number stamped on the key and keep it in your wallet or purse in case you ever need to have a duplicate made. The key fits the ignition switch, door locks, and tailgate lock. The key can be inserted into the locks with either edge up.

Door Locks

You can lock the doors by pushing the tabs down.

The doors must be unlocked before you can open them from the inside. The passenger door can be locked when open, and will stay locked when you close it; the driver's door cannot be locked when open unless you hold the door handle open. Both doors can be locked and unlocked from the outside with the key.

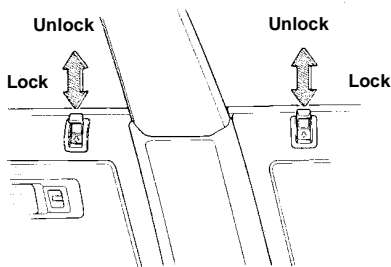

(cont'd)

Keys and Locks (cont'd)

Tailgate Lock

To open the tailgate from outside, put the ignition key in the lock and turn clockwise.

The tailgate can also be opened inside the car by pulling the tailgate release lever up at the left side of the driver's seat. It locks automatically when closed.

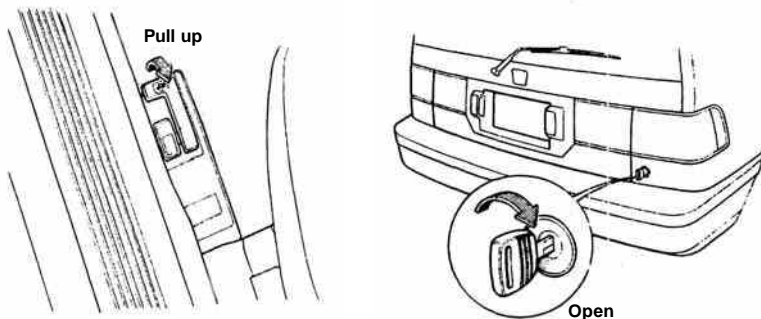

- **Keep the tailgate closed while driving, to keep poisonous carbon monoxide exhaust fumes out of the interior; prolonged exposure can cause unconsciousness that may lead to death.**
- **Weight limits shown on the label located in the glove box must be observed.**

The total weight of passengers and cargo must not exceed the total weight limit on the label.

Child Proof Door Locks

The child proof door locks are designed to prevent accidental opening of the rear doors. To activate the locks, push down the lock tabs located on each door, then close the doors. When the doors are locked in this way, they can only be opened from the outside.

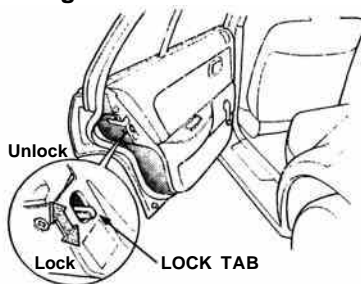

Seats

Front Seat

Adjust the seat position by pulling up on the adjustment lever under the front edge of the seat cushion, and sliding the seat to the desired position. Then release the lever and make sure the seat is locked in position by moving it back and forth.

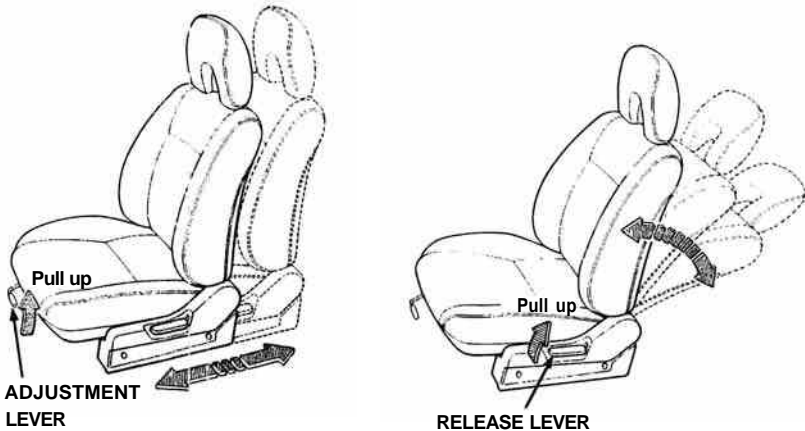

The angle of the seat-back can be changed by pulling up on the lever at the outside edge of the seat and leaning forward or back. Release the lever and let the seat lock into place when it reaches the desired angle.

Seat belts are most effective when the driver and passenger are sitting up straight and well back in each seat.

- Do not adjust the driver's seat while the car is moving; the seat could move suddenly, causing loss of vehicle control.
- To reduce the risk of sliding under the seat belts in a collision, the seat-backs should be reclined no more than is necessary for comfort.

(cont'd)

Seats (cont'd)

Head Restraints

The head restraints provided for the front and rear seats are designed to help reduce injuries due to whiplash. They are located at the top of the each seat-back and have several height positions. They can be adjusted by pulling up to the restraint's height bar, while pushing the restraint down.

Adjust so the top of the restraint is approximately level with the tops of your ears. That relative position may reduce injury due to whiplash in an accident.

If a head restraint must be removed (for cleaning, fabric repair, etc.) pull the restraint up to its highest position, then slide the button while pulling the restraint out.

To reinstall, reverse the above procedure.

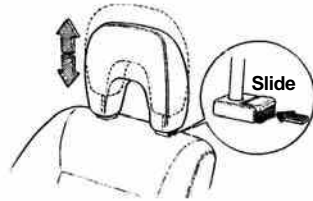

- Do not drive the car with head restraints removed.
- Do not try to adjust head restraints while driving.

Folding Rear Seat

The rear seat-back can be folded down to provide more luggage space.

Each of the rear seats can be folded separately.

1. Move the front seat-backs fully forward.

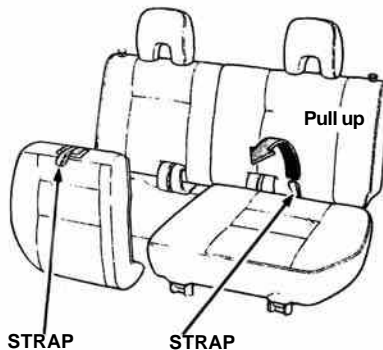

2. Pull up the strap at the center of the seat and lift the seat cushion up and forward.
3. Remove the head restraints while pushing the button next to the head restraint's height bar. Pull up the release knob on the upper edge of each seat-back, then fold the seat-backs forward.

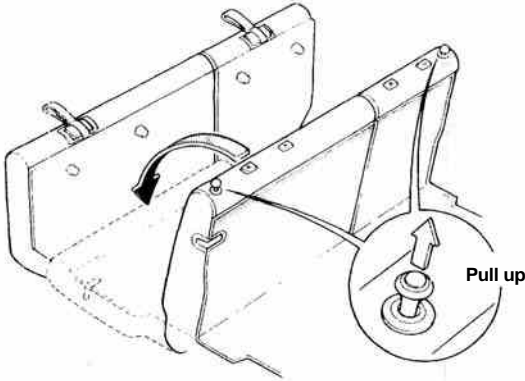
**CAUTION:**

Make sure to fold the front seat-back forward whenever you attempt to fold up or down the rear seat-back, or you may damage the release located on top of the rear seat-back.

- **Weight limits shown on the label located in the glove box must be observed.**
The total weight of passengers and cargo must not exceed the total weight limit on the label.
- **Make sure the seat-back latches engage securely when the seat-back is returned to its normal position.**
- **Always replace the head restraints when the seat-back is returned to upright position. (CIVIC WAGON and 4WO)**
- **When transporting luggage or other cargo, do not pile it higher than the front seats. This precaution will help prevent such items from becoming dangerous projectiles in an accident.**
- **Cargo weight should be distributed as far forward as possible for better vehicle handling.**

Seat Belts

Your Honda is provided with seat belts to minimize the chance of injury to yourself and your passengers in a sudden stop or accident. For precautions on using seat belts for children babies and pregnant women, see page 14 and 16.

Seat belts are most effective when the driver and passengers are sitting up straight and well back in the seat.

In the event of a collision, occupants not wearing seat belts could be seriously or fatally injured. Make sure you and all your passengers ALWAYS put on the seat belts before driving away.

CAUTION:

Be careful the seat belts are not damaged by catching or entangling in the door or seat mechanism.

Front Seat Belts

The front seats have an automatic ("passive") restraint system consisting of a shoulder belt, and a knee bolster, as well as a manual lap belt. The belts have emergency locking retractors designed to lock only during a sudden stop or impact. Otherwise, they allow you some freedom of movement in the seat.

Always wear the lap belt in addition to the shoulder belt for full protection. The shoulder belt portion should remain permanently latched.

Operation

1. Enter the car and close the door completely. Move the seat a comfortable distance from the steering wheel, sit as straight up as possible and well back in the seat.
2. Turn the ignition ON. The shoulder belt buckle will move to its rear locked position. The length of the shoulder belt will adjust automatically to your body and seating position.

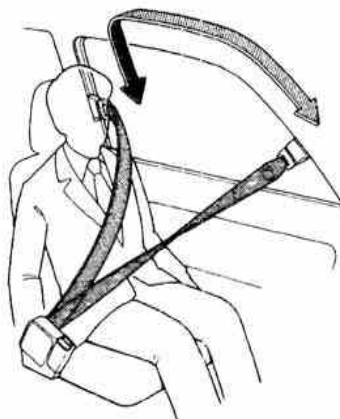

Normal movement of the shoulder belt buckle may cause injury. Be sure all parts of your body, especially fingers and hands, are clear of the shoulder buckle while it is moving.

NOTE:

- If the door is not closed completely, the shoulder belt buckle will not move and the door warning light will come on (see page 11).
- If the door is opened with the ignition on, the buckle will release itself from its locked position and move forward.
- If the shoulder belt buckle stops halfway or does not move at all, see page 107 for shoulder belt buckle operation.

3. Take hold of the tongue plate of the lap belt and pull it from its retractor. Be sure the belt is not twisted or caught on anything.

NOTE:

If pulled too fast, the belt will lock. If this happens, allow the belt to retract then pull it out more slowly.

4. Push the tongue plate into the buckle until it clicks locked. Position the belt across your lap, not your abdomen, as low on your hips as possible.

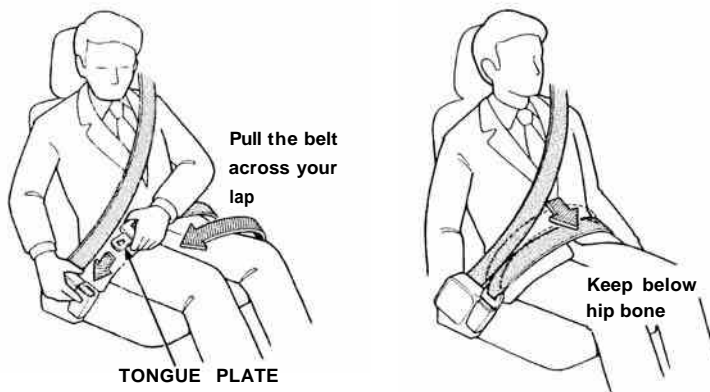

- **Avoid placing the lap belt across your abdomen. In the event of a collision, the pressure of the belt on the abdomen may increase the extent of injury.**
- **Never use one belt for more than one person, child or adult.**
- **Comfort clips sold on the open market are not recommended since they could impair the function and safety of the belts.**

(cont'd)

Seat Belts (cont'd)

- Make sure the strap of the shoulder belt and the lap belt are not crossed.
- Do not wear the shoulder portion of the belt under your arm or out of position. Such use could increase the chance and amount of injury in an accident.

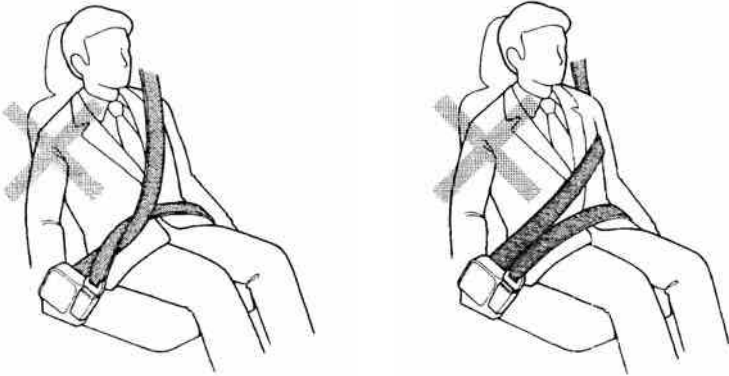

Releasing the Seat Belts

1. To release the manual lap belt, push the "PRESS" button in the buckle, the belt should retract automatically when released.
2. The driver's shoulder belt buckle will release and travel to its off position when the key is removed from the ignition.
3. The shoulder belt buckle will also release and travel to its off position when the door is opened.

Emergency Belt Release

The shoulder belt should always remain buckled. In case of an emergency, however, the shoulder belt can be released from the shoulder belt buckle by pushing the button.

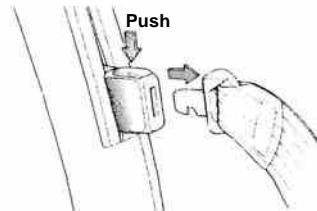

Relatch the shoulder belt before operating the car, making sure the belt is not twisted.

Driving with a twisted seat belt can increase your chance and extent of injury during a collision. Be sure the shoulder belt is not twisted before driving the car.

Fasten Seat Belt Warning Light and Warning Beeper

Lap Belt Warning Indicator:

Both the  light and the warning beeper will go on for about six seconds if the ignition switch is turned on when the driver's lap belt is not fastened. The beeper will not go on if the driver's lap belt is fastened, but the warning light will come on for about six seconds each time, to remind the driver to have passengers put their belts on.



Automatic Shoulder Belt Warning Indicator:

The warning light will come on if either of the automatic shoulder belts is unlatched with the ignition ON. The beeper will sound for approximately six seconds while the warning light is ON. Relatch the belt: the light should go off when the belt is latched.

The warning light will also come on while the shoulder belt buckle moves from its front off position to its rear locked position.

Automatic Shoulder Belt Malfunction Indicator:

The warning light will flash and the beeper will sound rapidly if either shoulder belt buckle stops before completing its full cycle (see page [107](#) for normal operation).

NOTE:

If the shoulder belt's tensioner mechanism locks and prevents the buckle from moving fully forward when you want to get out, recycle the system by closing the door and reopening it.

The buckle should move fully forward; if it does not, recline the seat — back and use Emergency Belt Release (see page [10](#)).

When the system does not function by either method, have the system checked by an authorized Honda dealer.

If the light and beeper do not function at all, or if they come on even with the belts latched and doors fully closed, it indicates a malfunction in the seat belt system. In the event of a collision, severe personal injury could result. The system should be checked immediately by an authorized Honda dealer.

(cont'd)

Seat Belts (cont'd)

Buckling the Rear Seat Belts

In the rear seat, there are two one-piece combination lap/shoulder belts and a center lap belt.

The seat-backs and seat belts provide best restraint when the occupants are sitting well back and straight up in the seat.

The right and left rear seat belts are one-piece combination lap/shoulder belts with an emergency locking retractor designed to lock only during a sudden stop or impact. Otherwise, they allow you some freedom of movement in the seat.

NOTE:

The emergency locking system of the rear seat belts will also be activated if you pull the belt too fast. If this happens, release the belt slightly then pull it out more slowly.

1. Take hold of the tongue plate and pull the belt across your lap. Be sure the belt is not twisted or caught on anything.

Pull the belt across your lap

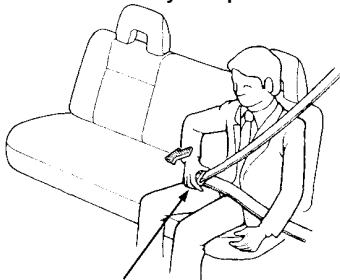

TONGUE PLATE

Take up slack

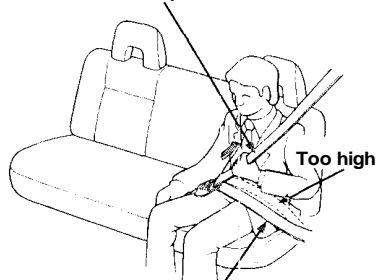

Keep below hipbone

2. Push the tongue plate into the buckle until it clicks locked. Position the belt across your lap, not your abdomen, as low on your hips as possible.

Avoid placing the lap belt across your abdomen. In the event of a collision, the pressure of the belt on the abdomen may increase the extent of injury.

3. To release the seat belt, push the "**PRESS**" button in the buckle; the belt should retract automatically when released. If the belt does not fully retract, pull it out and check for kinks or twists.

CAUTION:

Make sure both rear shoulder belts are positioned in front of the rear seat-backs whenever the seat-backs are in their upright position.

Rear Center Seat Belt

Adjust the center lap belt length to fit snugly but comfortably when buckled.

A slack belt will greatly reduce the protection afforded to the wearer. Hold the tongue plate perpendicular to the belt as shown.

* To shorten, pull the end of the belt away from the tongue plate.

* To lengthen, pull the tongue plate.

Push the tongue plate into the buckle until it clicks locked. Position the belt across your lap, not your abdomen, as low on your hips as possible.

Avoid placing the lap belt across your abdomen. In the event of a collision, the pressure of the belt on the abdomen may increase the extent of injury.

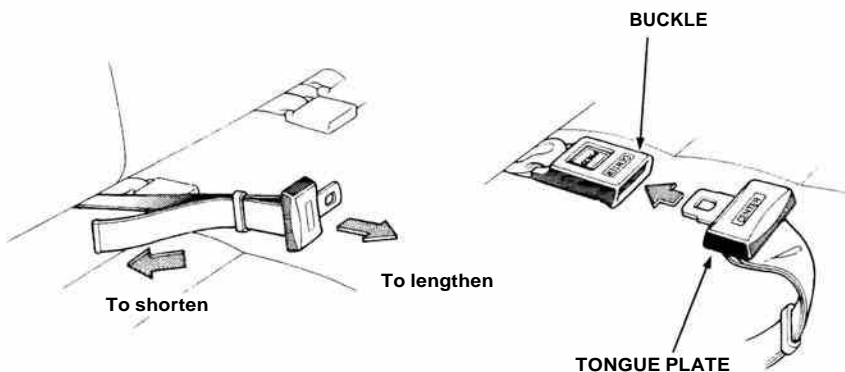

(cont'd)



Seat Belts (cont'd)

Child Restraint

Children riding in the car should be restrained to minimize the risk of injury in an accident, sudden stop or sudden maneuver.

According to accident statistics provided to the National Highway Traffic Safety Administration (NHTSA), children are safer when properly restrained in the rear seating positions than in the front seat. Larger children should use one of the seat belts provided.

For smaller children, we strongly recommend the use of a commercially available child restraint system that meets the Federal Motor Vehicle Safety Standard (FMVSS) because it offers the most protection against injury. All states now have laws which require that small children must be seated in a child passenger seat restraint system. Check local laws.

Before buying a particular child restraint system, make sure it fits your car seat and seat belts, and fits your child. Follow all the instructions that come with the system.

- **Children should never ride unrestrained in an automobile.**
- **Never use an infant carrier or child safety seat that "hooks" over a seat-back; it may not provide adequate security in an accident.**
- **Never allow a child to be held in a person's arms while they are in the moving vehicle. Holding a child in a moving vehicle does not provide the child with any means of protection during an accident, even if the person holding the child is wearing a seat belt.**

Installation of Child Seat

All child restraint systems are designed to be secured by lap belts or the lap belt portion of a lap-shoulder belt. The automatic shoulder belt system at the front passenger seat should not be used to secure the child restraint system. If a child seat must be installed on the front seat, place the shoulder portion of the belt behind the child seat and secure the child seat with the lap belt only.

Children could be endangered in a crash, if their child restraints are not properly secured. Follow the child seat manufacturer's instructions when installing the seat.

Your Honda automobile is equipped with attachment points specifically for a rear seat mounted child restraint system which uses a top tether.

The tether attachment points are located on the rear panel, below the tailgate.

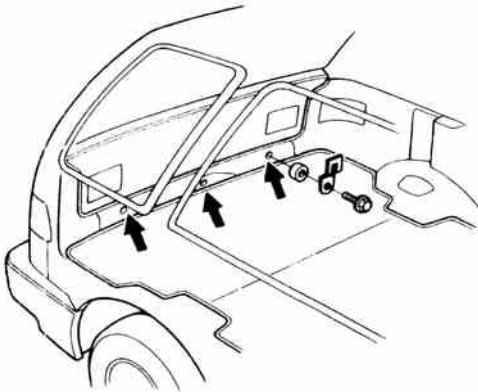

When the child restraint system is not in use, remove it from the car or secure it with the seat belt to keep it from becoming a projectile in the event of an accident.

NOTE:

See your Honda dealer for installation of the child restraint system.

(cont'd)

Seat Belts (cont'd)

Pregnant Women

A pregnant woman should use the shoulder and lap belts to help lessen the chance of injury and/or the amount of injury in an accident.

It is desirable that a pregnant woman ask her doctor at each medical check-up if she can drive, and also ask about the most appropriate way of wearing the lap/shoulder belt.

Lap belts should be worn as low and snugly as possible over the hips.

Inspection

All parts of the seat belts, including the belt fabric, should be regularly inspected for fraying, loosening, wear and other damage. Keep the belts in good condition at all times to reduce the chance of being injured in an accident, and to minimize any injuries that do occur. Make sure the buckles, retractors, tongue plates, guides and anchors all work properly.

Don't let anything get inside the buckle or the retractor; it could cause latch or retractor failure.

Cleaning

The belts should always be kept clean and dry; wet or damp belts can cause rewinding problems. To clean the belts, pull them all the way out of their retractors and use warm water and a mild soap; then let them air-dry fully extended, in the shade, with the car windows open.

- **Never bleach, dye or clean the belts with chemical solvents; it will weaken the fabric.**
- **Do not remove the seat belts from the car to wash them.**

Replacement

Replace the seat belt if:

1. The belting is cut, punctured, burned, etc.
2. The buckle or retractor does not work properly.
3. It was being worn at the time of a collision (also check for deformation damage at all seat belt anchor points).
4. Its condition is questionable.

Instrument Panel

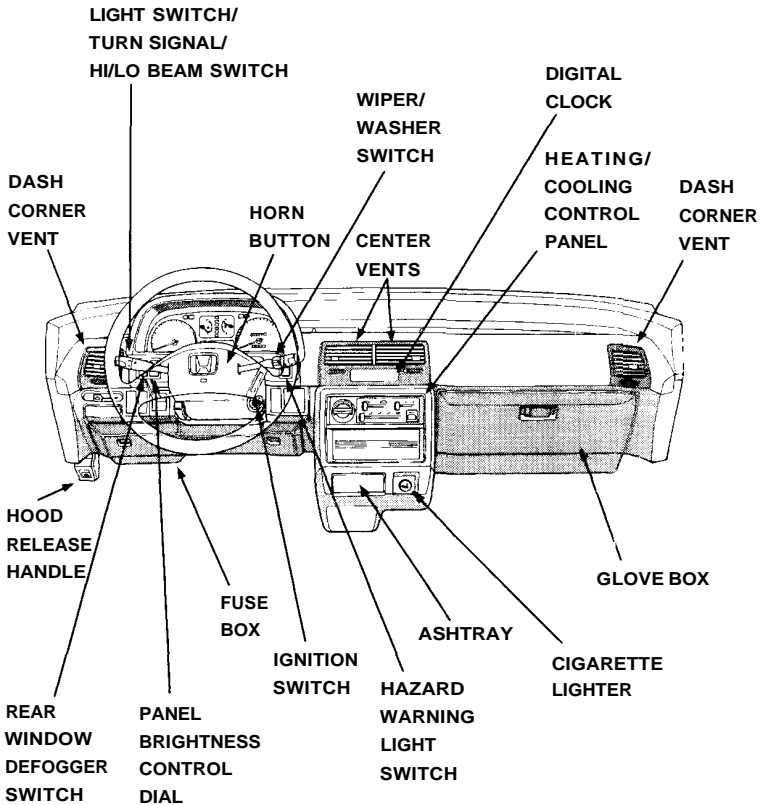

CIVIC WAGON

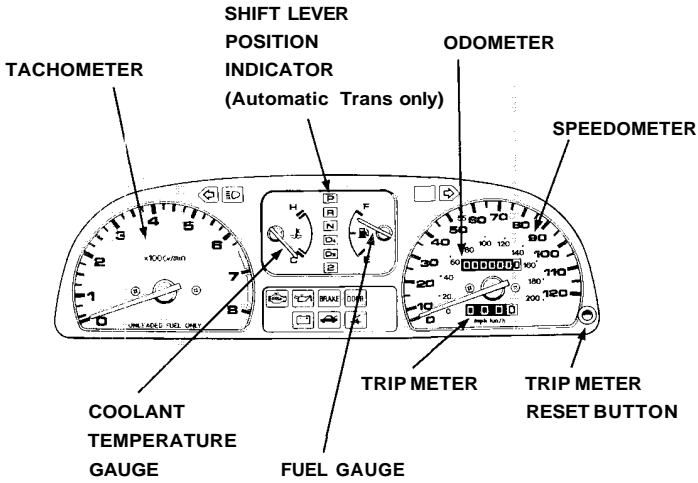

4WD

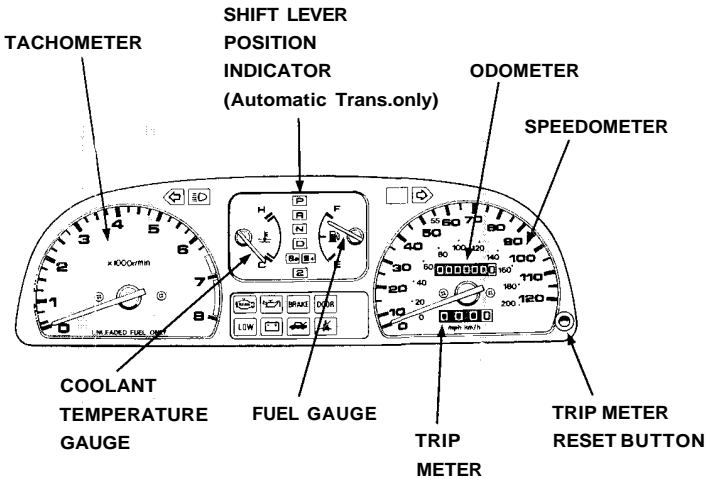



Gauges

Speedometer

The speed is indicated in miles per hour (outside scale) and kilometers per hour (inside).

Odometer

The numbers on the odometer indicate miles.

The odometer registers total distance traveled, and serves as your guide for determining when periodic maintenance is due. Federal law makes it illegal to alter the odometer of any motor vehicle with the intent to change the number of miles indicated.

Trip Meter

The numbers on the trip meter indicate miles.

The trip meter can be returned to zero by pushing in the reset button. Use it for checking fuel consumption or distance traveled per trip.

Tachometer

The tachometer indicates engine speed in revolutions per minute.

The beginning of the RED ZONE indicates the maximum allowable engine R.P.M. Do not run the engine with the tachometer indicator needle in the RED ZONE.

Fuel Gauge

FUEL TANK CAPACITY: 45 ℓ (11.9 US gal, 9.9 Imp gal)

As a convenience, the gauge continues to show the same fuel level as when the ignition was last on. After refueling, the gauge will slowly change to the new fuel level when the ignition is switched on. When the needle first indicates E (empty), you have a usable reserve left in the tank of about:

4 ℓ (1.1 US gal, 0.9 Imp gal)

Coolant Temperature Gauge

CAUTION:

The needle should stay within the white range. If the needle reaches the red line at "H" (Hot), pull safely off the road, stop the engine and check the coolant level in the reserve tank on the passenger side of the radiator under the hood.

Do not remove the radiator cap when the engine is hot. The coolant is under pressure and may blow out and scald you.

Warning and Indicator Lights

CIVIC WAGON

4WD

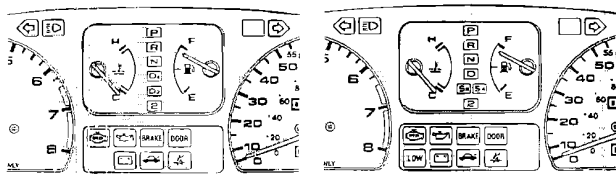

Shift Lever Position Indicator (Automatic Transmission only)

An indicator between the fuel and coolant temperature gauges shows which gear you have selected.

NOTE:

(4WD Automatic only)

The S₃ indicator light in the instrument panel also serves a second function. If the light flashes while driving (in any gear range) it indicates a possible malfunction in the transmission; avoid rapid acceleration and have the transmission checked by an authorized Honda dealer as soon as possible.



Turn Signal/Hazard Warning Indicator Lights

When the turn signal lever is pushed for left or right turns, the appropriate green indicator arrow on the instrument panel will blink along with the signal. Turning on the hazard warning switch, will make all 4 turn signals and both arrows blink (see pages 28 and 29).

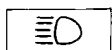

Headlight High Beam Indicator Light

This blue indicator light will go on whenever the high beams are switched on (see page 28).



Check Engine Warning Light

This light comes on for a couple of seconds each time the ignition is turned on. It will also come on, and remain on, if there is a malfunction in the emission control system. If the light comes on while driving, avoid driving at high speed, and have the system checked by a Honda dealer as soon as possible.

(cont'd)

Warning and Indicator Lights (cont'd)

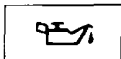

Oil Pressure Warning Light

The oil pressure warning light will come on, and remain on, if there is insufficient oil pressure or when the ignition switch is turned on with the engine not running. If the light should stay on while driving, get the car off the road as soon as you can, turn the engine off and check the engine oil level (see page 67).

Even if the oil level is correct, the engine should be checked by a Honda dealer before the car is driven again.

NOTE:

The oil pressure warning light will only light as a result of low oil pressure. It is not directly an oil level indicator.

CAUTION:

Running the engine while the oil pressure warning light is on constantly may cause immediate and severe engine damage.

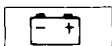

Charging System Warning Light

The charging system warning light comes on when there is a problem with the electrical charging system or when the ignition switch is turned on with the engine not running. If the light comes on while driving, stop the car and check to see if the alternator belt is loose or broken.

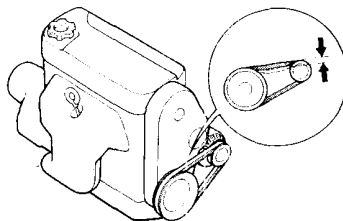

To check the belt tension, stop the engine and push with about 98N (22 lb) of force on the middle of the belt as shown. The belt should deflect about:

9 - 11 mm (0.3 - 0.4 in)

If the engine has been running, some engine components may be hot enough to burn you.

NOTE:

If necessary, have the charging system checked by an authorized Honda dealer.

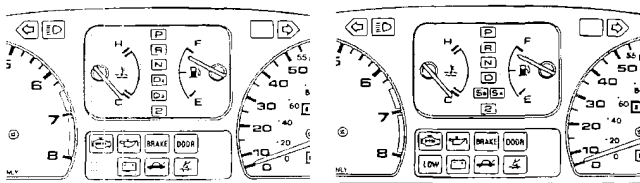
CIVIC WAGON**4WD****BRAKE****Parking Brake/Brake Failure Warning Light**

Check the brake warning light every time you start the car. With the parking brake set, the warning light should go on when the ignition switch is turned to II or III. With the parking brake released, the light should go on when the ignition switch is turned to III. If the light goes on at any other time, it means the brake fluid level in the master cylinder reservoir is too low; add fluid and have your dealer check for leaks and brake pad wear immediately. See page 78.

**Tailgate-open Indicator Light**

This light will go on when you turn on the ignition switch if the tailgate is not fully closed.

**Seat Belt Warning Light**

The seat belt warning light comes on for about six seconds when the ignition switch is turned on (see page 11).

LOW**LOW Indicator Light (4WD Automatic only)**

This indicator light is on while you are driving in the LOW mode (see page 56).

When the ignition switch is turned to the "II", this indicator light comes on for a couple of seconds; this is normal.

DOOR**Door Warning Light**

If a door is open when the ignition is switched on, this light will go on and stay on until the door is closed.

Tilt Steering

Tilt Steering

The steering wheel position can be adjusted to suit driver preference.

1. Push the lever located on the left side of the steering column all the way down and hold it while adjusting the steering wheel to the desired position.

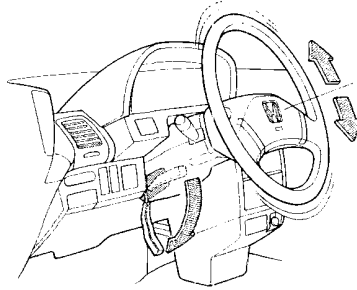

Push down

2. To lock the steering wheel, hold it in the desired position and pull the lever all the way up.

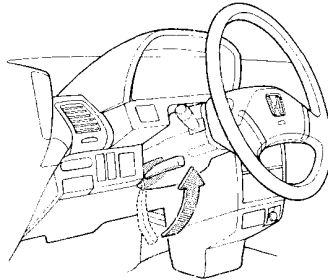

Pull up

- Do not adjust the steering wheel position while driving.
- After adjusting the steering wheel position, make sure it is securely locked in place by "rocking" it up and down slightly.

Windshield Wipers/Washer/Defogger

Windshield Wipers

Switch the wipers to INT for intermittent operation; LO for low speed operation; and HI for high speed operation.

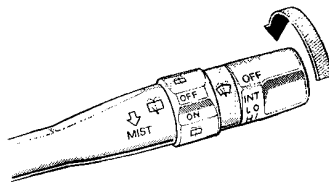

In fog or very light rain, push the lever down to the MIST position for temporary high speed operation of the wipers. The wipers will return to the "rest" position and the motor will shut off as soon as you release the lever.

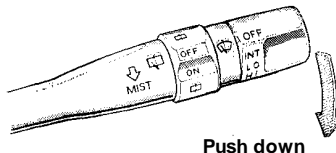

Push down

Windshield Washer

Pull the wiper switch lever toward you to turn on the washer. Check the washer fluid regularly, especially during bad weather or whenever the washer has been in frequent use.

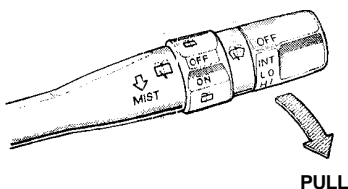

PULL

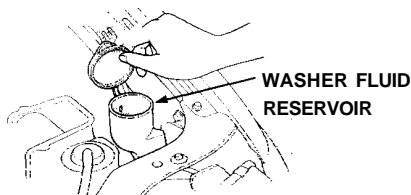

Use a good quality commercial washer fluid for all-weather cleaning.

CAUTION:

- Do not use radiator antifreeze in the windshield washer; it will damage the paint.
- Do not use a vinegar/water combination in the windshield washer; it will damage the pump.
- Prolonged operation of the washer without fluid may damage the pump.

In freezing weather, warm the windshield with the defrosters before using the washer. This will help prevent icing which could seriously impair visibility.

WINDSHIELD WASHER

RESERVOIR CAPACITY: 2.5 l (2.6 US qt, 2.2 Imp qt) (cont'd)

Windshield Wipers/Washer/Defogger (cont'd)

Rear Window Wiper/Washer

Switch to "ON" to activate the rear wiper. Turn and hold the switch one more step clockwise to "  " to activate the washer and wiper; or turn and hold the switch one step counterclockwise from "OFF" to activate to washer only. The rear washer uses the same fluid reservoir as the front washer.

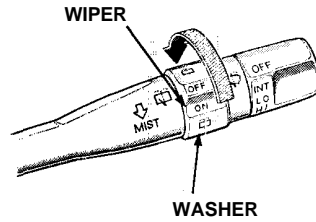

Rear Window Defogger

Push the switch to turn the defogger on or off. The indicator will light when the defogger is on. The defogger will turn off automatically 24 minutes after it is turned on.

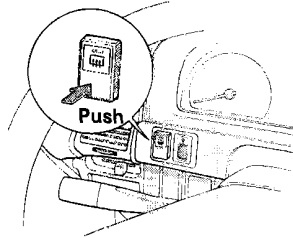

CAUTION:

When cleaning the inside of the rear window, be careful not to damage the printed heater wires on the rear window. Wipe the window horizontally along the wires, not up and down.

Parking Brake and Mirrors

Parking Brake

To apply the parking brake, pull up on the lever. To release it, pull up slightly, push the button, and lower the lever; when fully released, the BRAKE warning light will go out.

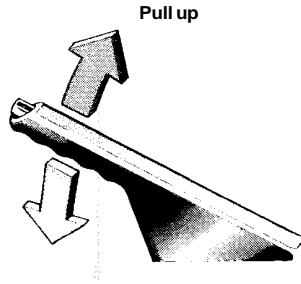

Rearview Mirrors

Keep the inside and outside mirrors clean and adjusted for best visibility. Be sure to adjust mirrors before you start.

The outside mirror can be adjusted by moving the knob on the inside of the driver's door.

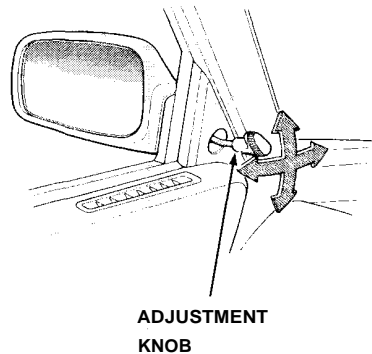
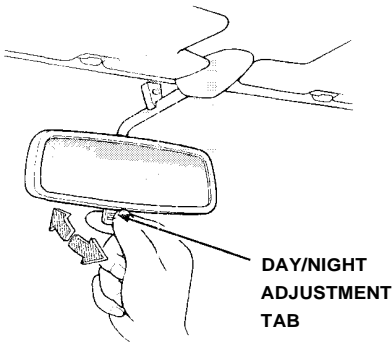

The inside mirror has day and night positions. The night position reduces glare from the headlights of vehicles behind you. Flip the small tab on the bottom of the mirror forward or backward to select day or night position.

Lights

Turn Signals

Push the turn signal lever down to signal a left turn, and up for a right turn. The indicator and appropriate signal lights will blink. The lever will return automatically to its original position when the steering wheel is returned to straight ahead.

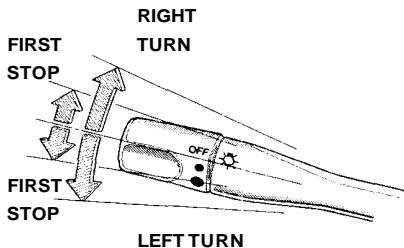

For lane changing, you can signal by pushing the lever part way up or down (to the first stop) and holding it there; the lever will return to its original position when you release it. If either turn signal indicator lights up but does not blink, blinks faster than usual, or does not light up at all, check for a burned out bulb or fuse.

Headlights

Turn the light switch to the first position (•) for taillights, side marker lights, position lights, license plate lights, and instrument panel lights. Turn to the second position (●) to add the headlights.

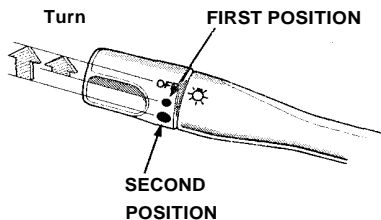

High Beam/Low Beam Switch

The headlights may be switched between low beam and high beam by pulling the turn signal lever towards you until a click is felt. The blue high beam indicator light will be on when the high beam is on.

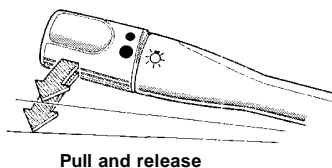

Headlight Flasher

To use the headlights as a passing signal, pull lightly on the turn signal lever and release.

Hazard Warning System

This system should be used only when your car is stopped under emergency or hazardous conditions. To activate push the hazard warning switch (▲). The front and rear turn signals will blink simultaneously and both indicator lights will flash. Push the switch (▲) again to turn the system off.

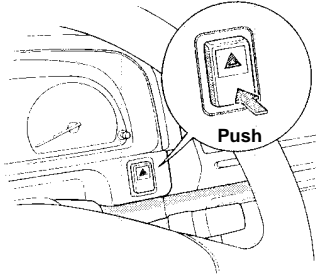

Panel Brightness Control

When the light switch is in either of the two "ON" positions, the intensity of the instrument lights can be adjusted by turning the panel brightness control dial.

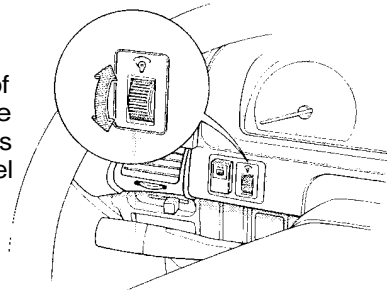

Interior Light

The interior light has a three position switch. The light is off all the time in the OFF position. In the middle position, it goes on only when a door is opened. In the ON position, it is on all the time.

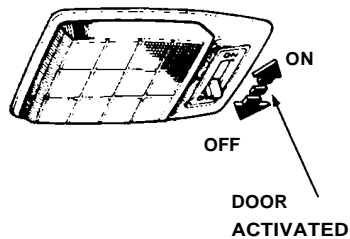

(cont'd)

Lights (cont'd)

Luggage Area Light

The luggage area light has a two-position switch. In the first position it is OFF all the time, in the second position it goes ON only when the tailgate is opened.

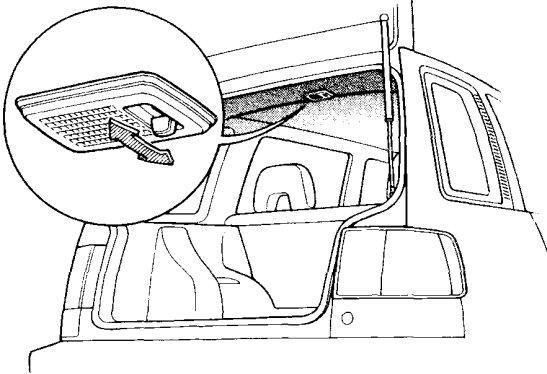

Hood and Glove Box

Hood

To open, pull back on the handle under the left side of the dash.

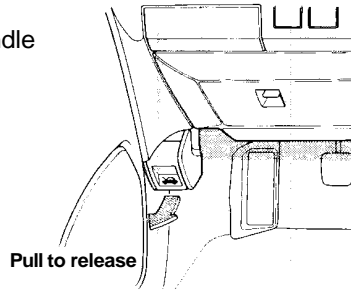

The hood latch is spring-loaded, so the hood will pop up slightly. Release the safety catch under the front center of the hood by pushing the rubber-tipped handle up.

Lift the hood and prop it open with the support rod.

To close, take the support rod down, and return it to its clip, then lower the hood until it is approximately one foot from the closed position, then let it drop. Be sure the hood is securely latched before driving away.

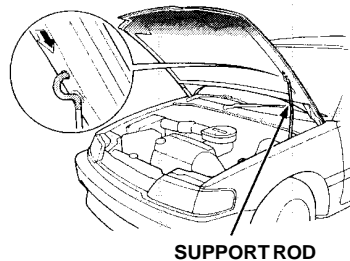
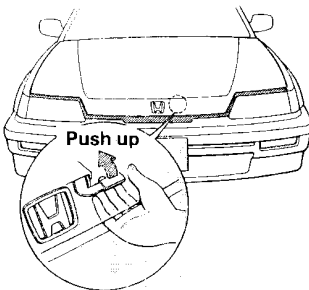

Glove Box

Open by pushing the knob as shown. Close with a firm push.

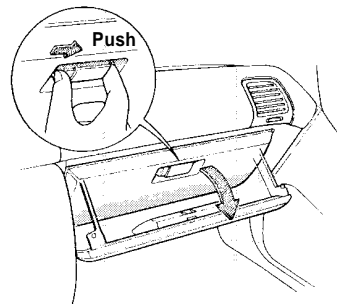

Do not drive the car with the glove box door open; it could cause injury in an accident.

Cigarette Lighter and Ashtrays

Cigarette Lighter

Push in to heat up. It will automatically release when the element is hot. **DO NOT** hold it in while it is heating up.

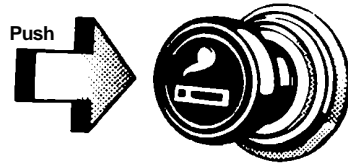

Front Ashtray

Open the ashtray by pulling its bottom edge toward you.

To remove it, pull it out further while pushing down on the spring loaded plate inside.

To install, reverse the removal procedure.

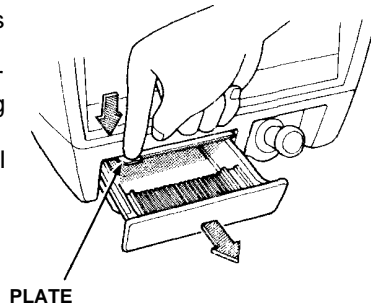

Rear Ashtray

Open the ashtray by pulling its top edge.

To remove it, open the ashtray and release its bottom edge by pulling up, then out. To install, reverse the removal procedure.

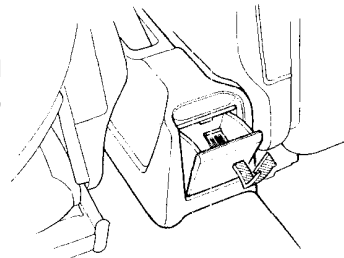

To remove, pull up and out

CAUTION:

Do not use the ashtrays as trash containers; use them only for extinguished cigarettes. Putting lit cigarettes or matches in an ashtray with other combustible materials may cause a fire.

Clock

Digital Clock

The time is displayed continuously when the ignition is on.

At all other times, push in on the lid to display the time.

To adjust the time:

1. Lower the lid.
2. Push the minute button (MIN) and hold it until the numbers advance to the desired minutes.
3. Push the hour button (HOUR) and hold it until the numbers advance to the desired hour.
4. The RESET button allows you to synchronize your clock to the closest hour. If the time on the clock is before the half hour, pressing the RESET button will return the time to the previous hour. If the time is beyond the half hour, the RESET button will change the time to the next hour.

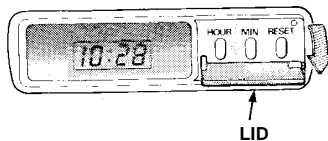

NOTE:

Be careful not to push the HOUR, MIN or RESET buttons accidentally. Pushing any of them will change the clock's time setting.

Heating and Cooling

The vents, heater and air conditioner are combined in one system; adjusting four basic controls to different settings can provide a full range of interior temperatures for safe and comfortable driving.

Airconditioner: optional

Ventilation

The flow-through ventilation system can provide fresh air to the interior when the car is moving or stopped, even with the windows closed.

NOTE:

For proper air flow, the flow-through vents must not be covered. Keep the air inlet at the base of the windshield free of leaves or other debris.

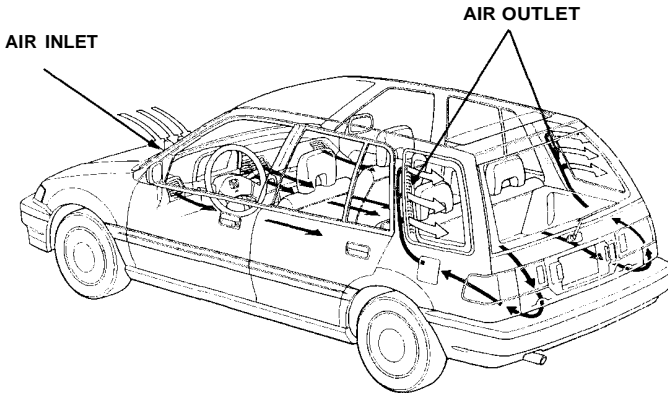

You can adjust the controls to direct cool or warm outside air throughout the car for defogging windows, heating, or cooling. When stopped or driving at low speeds, you can increase the air flow by turning on the fan.

Dash Vents

The corner vents can be used for flow-through ventilation, or for heating and air conditioning: When the car is moving, the driver's corner vent can also route fresh air directly from the outside by sliding the corner vent lever below it to the right and shutting it off from the heater and air conditioner system.

The louvers in the corner and center vents can be tilted up or down and right or left, to change the direction of air flow.

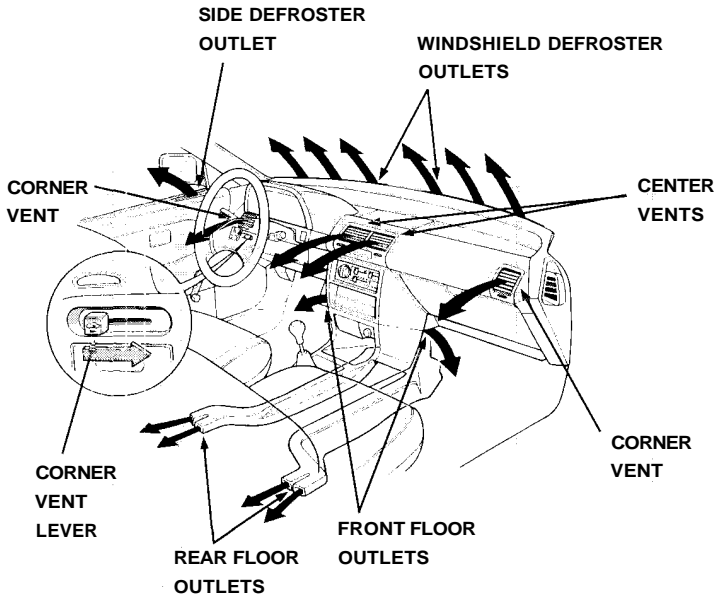

(cont'd)

Heating and Cooling (cont'd)

What the Controls Do:

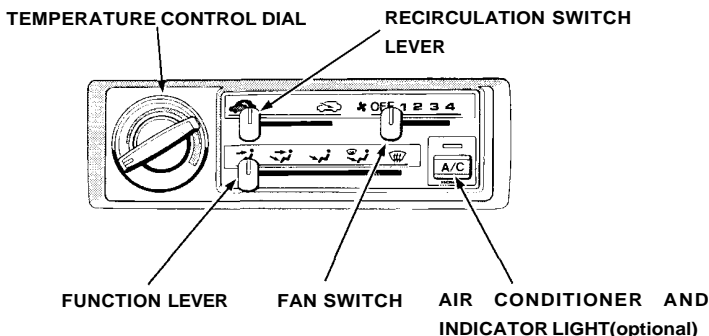

Fan Switch

Switch the fan to low (1), medium (2), medium high (3) or high (4) speed, to circulate warm, cool, or outside air, depending on where the temperature control dial and function lever are set.

Whenever the fan is switched on, air flows from the dash corner vents regardless of function selection.

Function Lever

Slide the lever right or left to direct outside air or recirculated (inside) air to and from the heater, air conditioner and vents.

Temperature Control Dial



Turn the dial clockwise to make air warmer when the appropriate function is selected.

Air Conditioner Switch (optional)

With the fan on, push the A/C switch to operate the air conditioner; the indicator light will come on.

Push the switch again to turn the air conditioner off.

Recirculation Lever

When the lever is set at the  position, outside air will be allowed to circulate inside the car. When the lever is set at  position, outside air is shut off and the air inside the car is recirculated. So when the heater or air conditioner is on and you want to warm up or cool down the interior more quickly, or keep smoke or dust out of the car without losing the heat or cool function, simply set the lever to the  position.

NOTE:

The windows may become fogged if the system is in the position for an extended period of time with the air conditioner off. As soon as the interior is warmed, slide the lever to the position.

How to Use the Controls**To Ventilate**

Turn the temperature control dial counterclockwise, slide the recirculation lever to the position and the function lever to the position. Switch the fan on and outside air will flow through the corner and center vents. To change air distribution, slide the function lever to the position, and outside air will also flow from the floor level outlet at the heater.

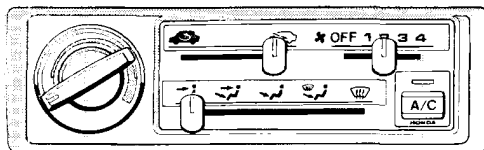
**To Cool (with optional air conditioner)**

To cool the car down quickly, slide the recirculation lever to the position, start the engine, turn the temperature control dial counterclockwise all the way, switch the fan to high (4), push the A/C button in, and open the window briefly.

Then close the windows and corner vents, slide the function lever to the position and the recirculation lever to the position so inside air will recirculate to the air conditioner for maximum cooling.

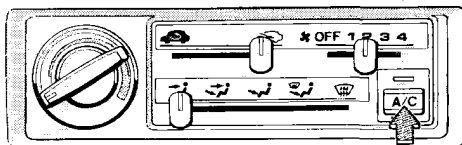



When the interior has cooled sufficiently, switch the fan to low (1), medium (2) or medium high (3), then slide the recirculation lever to the position to direct fresh (outside) air to the air conditioner.

(cont'd)

Heating and Cooling (cont'd)



When using the air conditioner in heavy traffic, or while driving up long hills, watch the coolant temperature gauge: if the needle moves near the "H" end of the scale, turn the air conditioner off by pushing the A/C button; leave it off until the needle goes back well into the middle of the scale.

To Heat

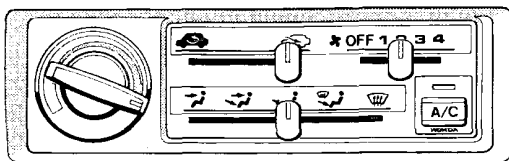

Switch the fan on, turn the temperature control dial clockwise, slide the function lever to the  position and the recirculation lever to the  position, and warmed (outside) air will begin flowing from the floor outlets.



To warm up the interior quickly, slide the recirculation lever to the  position so inside air will recirculate to the heater.

The windows may become fogged if the system is in the  position for an extended period of time. As soon as the interior is warmed, slide the lever to the  position.

To Dehumidify (with optional air conditioner)



Because an air conditioner dehumidifies as it works, you can use it in cool or cold weather in any function position to help defog the windows. Just switch the fan on, push the A/C button on, set either the  or  positions, and adjust the temperature control dial to a comfortable setting.

NOTE:

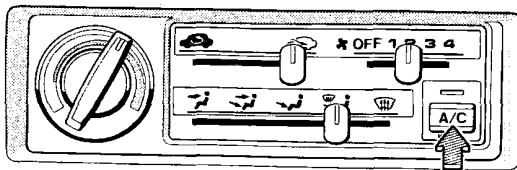
This setting is desirable for most operating conditions in ambient temperatures above approximately 32°F (0°C).



To Defrost

To defrost or defog the windshield and door windows, turn the temperature control dial clockwise, slide the function lever to the  (defrost) position, the recirculation lever to the  position, and switch the fan on. Warmed (outside) air will then flow from the windshield and side defroster vents. Use the  position only.



To Turn Everything OFF

Slide all levers to the left, turn the temperature control dial counterclockwise all the way, and push the A/C switch off.

NOTE:

This setting should only be used in cold weather for the first few minutes of driving to prevent cold air from blowing into the cabin. Under normal operating conditions, the fan should always be kept ON to prevent the accumulation of stale air in the system.

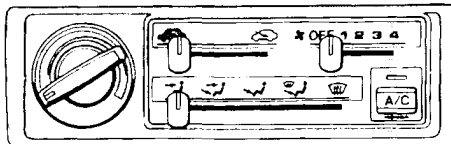



Gasoline

For proper operation of your car's emission controls, your engine is designed to use unleaded fuel only.

CAUTION:

Using leaded or even low-lead gasoline could damage some of your emission controls, and also void their coverage under the emission controls warranty.

Use gasoline from pumps labeled unleaded, with a pump octane number of 86 or higher. The pump octane number is an average of the Research (R) octane and Motor (M) octane numbers. Use of a lower octane gasoline can cause persistent, heavy "SPARK KNOCK" (a metallic rapping noise), which can lead to engine damage if severe.

CAUTION:

If you notice steady spark knock while holding a steady speed on a level road, try changing brands of gasoline. If the spark knock persists, consult your Honda dealer. Failure to do so is considered misuse, and misuse is not covered under the New Car Warranty.

Occasionally you may notice light spark knock while accelerating or driving up hills. This is no cause for concern, it simply means your engine is running at its most economical.

Gasoline Containing Alcohol

If you decide to use a gasoline containing alcohol ("gasohol"), be sure its octane rating is at least as high as that recommended for unleaded gasoline. There are two types of "gasohol": that containing ethanol, and that containing methanol. Do not use gasohol that contains more than 10% ethanol. Do not use gasoline containing methanol (methyl or wood alcohol) that does not also contain cosolvents and corrosion inhibitors for methanol. Never use gasoline containing more than 5% methanol, even if it has cosolvents and corrosion inhibitors.

**NOTE:**

- Fuel system damage or vehicle performance problems resulting from the use of such fuels is not covered under the new car warranties. Honda cannot endorse the use of fuels containing methanol since evidence of their suitability is as yet incomplete.
- Before purchasing fuel from an unfamiliar station, try to confirm whether the fuel contains alcohol; of what kind, and how much. If you notice any undesirable operating symptoms after using a gasoline that contains alcohol, or one that you think contains alcohol, switch to an unleaded gasoline, as recommended on page 40.

Operation In Foreign Countries

In order to comply with U.S. Federal Emissions Regulations, you must use unleaded fuels of the recommended octane rating. These fuels may not be available in other countries. If you intend taking your car outside the U.S. or Canada, write to American Honda Consumer Affairs (stating the year and model of your car) at the address below for information regarding modifications you may need to have done.

American Honda Motor Co., Inc.
Consumer Affairs
100 W. Alondra Blvd.,
Gardena, CA 90248

Fuel Filler Door and Cap

Gasoline is extremely flammable and is explosive under certain conditions. Perform this operation in a well-ventilated area with the engine stopped. Do not smoke or allow open flames or sparks in the area or where gasoline is stored.

The fuel filler door is opened by pulling up on the lever at the left side of the driver's seat.

The door will lock automatically when closed; push it until it clicks.

CAUTION:

You may hear a hiss when you open the filler cap. This sound is residual pressure escaping from the fuel tank. Open the cap slowly and remove the cap after the hissing stops. Fuel spray may cause injury. Do not overfill the tank; fill only until the gas pump clicks off automatically and never top off.

(cont'd)

Gasoline (cont'd)

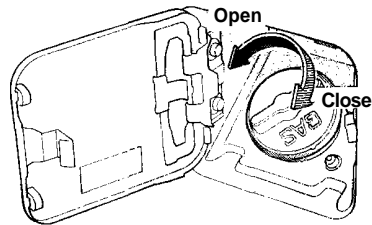
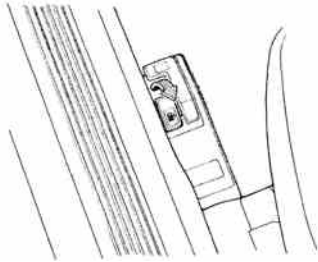

Fuel vapor is extremely hazardous under certain conditions. Always stop the engine before refueling, and never refuel near sparks or open flames.

CAUTION:

When reinstalling the fuel cap, be sure both tabs on the cap are engaged in the slots of the filler neck and turn the cap until it stops. If you replace the cap, use only a genuine Honda replacement part or its equivalent. Failure to use the proper part could cause serious fuel system problems.

How to Improve Your Gas Mileage:

- Drive at a smooth, steady pace to avoid unnecessary decelerations and stops — accelerating back to speed uses more fuel.
- Plan trips to avoid rush hour traffic if possible.
- Make sure the parking brake is completely released.
- Consolidate trips whenever possible.
- Keep vehicle weight to a minimum by removing unnecessary items from the luggage area.
- Whenever possible, use fresh air from the dash vents to keep cool when driving; open windows or use of the optional air conditioning both affect fuel economy.
- Keep the tires adjusted to the recommended pressure.

Tire Pressure (measured cold): Front/Rear

CIVIC WAGON

220/220 kPa (32/32 psi)

4WD

195/195 kPa (28/28 psi)

Condition of Your Car

You can only get maximum fuel economy if your car is in top running condition. Have all required maintenance done at the proper intervals. Check tire pressures and tire wear frequently. If tire wear is uneven, have the alignment checked by your Honda dealer. Proper alignment saves gasoline and prolongs tire life.

Ignition Switch

The combined ignition switch/anti-theft lock is located on the right side of the steering column and has four positions:

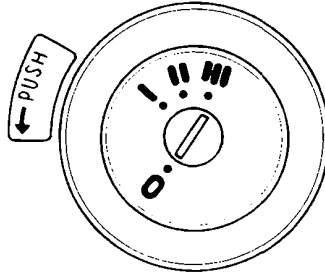

- **0-LOCK position:** The key can be removed or inserted in this position. To remove the key, push it in at position I, then turn it to 0 and pull it out. When the key is removed, the steering column will lock.

NOTE:

On cars equipped with automatic transmissions, the transmission must be in Park before pushing and turning the key to the 0-LOCK position.

Never turn the ignition switch to the lock position or remove the key while the car is in motion; the steering wheel can lock causing a loss of directional control, and an accident could result.

- **I-ACCESSORY position:** In this position, the accessory circuit is on, but the ignition circuit is off.
If the key is difficult to turn from the 0 to the I position, turn the steering wheel slightly to relieve pressure on the lock.
- **II-ON position:** This is the normal running position.
- **III-START position:** The starter will engage when the key is turned to this position.

To remind you to remove the ignition key when leaving your car, a beeper will sound if the key is still in the ignition when you open the driver's door. The beeper system is deactivated when you turn the ignition to 0 (Lock) and fully remove the key.



Starting the Engine

Before Starting

Manual Transmission:

1. Apply the parking brake.
2. Push the clutch pedal all the way in (see NOTE below).
3. Shift the transmission to neutral.

NOTE:

On cars equipped with manual transmissions, the engine will not crank unless the clutch pedal is fully depressed.

Automatic Transmission:

1. Make sure the shift lever is in Park (P).
2. Apply the parking brake and the foot brake.

NOTE:

- When starting in cold weather, keep all unnecessary electrical circuits off (lights, defogger, etc.) for the best battery output.
- Do not crank the engine for more than 15 seconds at a time. Wait 10 seconds before going to the next step.

Starting the Engine:

1. With YOUR FOOT OFF THE ACCELERATOR start the engine by turning the key to the III position.
2. If the engine won't start within 15 seconds or starts but fails to continue to run, push the accelerator pedal halfway, and hold it there while cranking the engine. Once the engine starts, release the accelerator gradually as the engine speeds up.
3. If it doesn't start within 15 seconds, push the accelerator pedal down to the floor and hold it there while cranking in order to clear flooding. Try step 2 again.

Cold Weather at High Altitude Starting:

1. When starting in cold weather at high altitude (above 8,000 feet), push the accelerator pedal about halfway and hold it there while cranking the engine. Once the engine starts, release the accelerator gradually as the engine speeds up.
2. If it doesn't start within 15 seconds, push the accelerator pedal down to the floor and hold it there while cranking in order to clear flooding. Try step 1 again.

NOTE:

If the outside temperature is below freezing, or if your car has not been driven for several days, warm up the engine for a few minutes before driving.

Safety Items

Before driving away, check that:

- The doors are closed properly.
- The mirrors are properly adjusted, and the windows clean.
- The driver and passengers are wearing properly adjusted seat belts.
- The head restraints are properly adjusted.
- The warning and indicator lights are operating properly.
- The brake pedal feels normal.
- All luggage and cargo is secured.
- Nothing is interfering with the driver's feet or blocking vision to the rear.

While driving remember to:

- Always drive defensively; expect the unexpected.
- Reduce your speed during night hours and bad weather.
- Follow at a safe distance; don't tailgate.
- Get off the highway when you are tired; stop and take a rest.

When stopping for repairs:

- Park the car well off the road.
- Turn on the hazard warning flasher.
- Use flares or other warning devices to warn other motorists.

After parking your car:

- Apply the parking brake and shift to first gear if equipped with manual transmission, or PARK on automatic transmission equipped cars.
- Take your keys.
- Make sure the windows are closed and all doors are locked.
- If parked on a hill:
 1. Turn the front wheels away from the curb if facing uphill.
 2. Turn the front wheels toward the curb if facing downhill.
- Never leave children unattended in a parked car.



Engine Exhaust Gas Warning

A properly maintained car is your best protection against exhaust gas entering the passenger compartment.

The exhaust system should be thoroughly inspected by a competent mechanic whenever:

- The car is raised for an oil change.
- You notice a change in the sound of the exhaust.
- The exhaust system or the rear or underside of the car is damaged.

- **Avoid breathing exhaust gases. They contain carbon monoxide, which is a colorless, odorless gas that can cause loss of consciousness and eventual death. If you suspect that exhaust gas is entering the passenger compartment, have the cause determined and corrected as soon as possible. If you must drive under these conditions, drive only with all windows fully open.**
- **Do not drive with the tailgate open. An open tailgate may draw exhaust gases into the passenger compartment. If you must drive with the tailgate open, drive only with all the windows wide open.**
- **Do not run the engine in confined areas, such as garages, any longer than necessary to move the car in or out.**
- **If you must sit in a parked car with the engine running for more than a short time, adjust the heating/ventilation system as follows:**

1. Set the function lever to the  position.
2. Set the temperature control dial for best comfort.
3. Set the recirculation lever to the  position.
4. Turn the fan to the highest speed.

NOTE:

To insure proper operation of the car's ventilation system, keep the front air inlet clear of snow, mud, leaves or other obstructions.

Shifting the 5 or 6 Speed

The fully synchronized manual transmission is very easy to shift up or down. When you slow down for traffic, steep hills, or corners, shift to a lower gear before the engine starts to labor. When descending steep grades, select a lower gear to help maintain a safe speed and to prevent the brakes from overheating.

When shifting, depress the clutch pedal fully, shift gears and then release the clutch gradually. Do not speed-shift; allow time for the gears to synchronize.

To prevent grinding the gears when shifting into reverse, hold the clutch pedal depressed briefly before shifting, or shift the lever into one of the forward gears before selecting reverse.

A safety lockout prevents accidental shifting straight from 5th to Reverse.

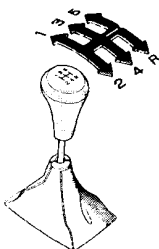

5 Speeds
(CIVIC WAGON)



6 Speeds
(4WD)

SL-Super Low Gear (4WD)

This super low ratio gear reduces the possibility of spinning the wheels when accelerating on roads covered with snow, sand or mud, or on steep hills.

Avoid rapid acceleration or sudden deceleration when either or both driving wheels are on a slippery surface. Decreased traction could cause loss of directional control.

CAUTION:

When downshifting to SL, do so only at speeds of 3 mph (5km/h) or less and release the clutch gradually to avoid any sudden engine over-revving.

(cont'd)



Shifting the 5 or 6 Speed (cont'd)

Clutch Pedal Adjustment

Clutch pedal free travel must be adjusted periodically to compensate for lining wear. There should be approximately 25 mm (1 in) of pedal free travel. If not, or if the clutch seems to slip or you have difficulty shifting, have your dealer check the clutch adjustment.

CAUTION:

- **Do not drive with your foot on the clutch pedal as this will cause premature wear of clutch components.**
- **Do not shift into reverse while the car is moving.**
- **Driving with the clutch pedal free travel improperly adjusted can cause premature wear of the clutch components.**

Maximum Allowable Speeds

The speeds shown below are the maximum at which the car can be driven or downshifted in each gear without over-revving the engine:

CIVIC WAGON

1st	33 mph (53 km/h)
2nd	55 mph (88 km/h)
3rd	82 mph (132 km/h)

4WD

SL	20 mph (32 km/h)
1st	28 mph (45 km/h)
2nd	47 mph (75 km/h)
3rd	72 mph (116 km/h)

Recommended Shift Speeds

For best fuel economy, and effective emission control, shift at the speeds shown for your car:

CIVIC WAGON

Shift up	Normal Acceleration	Cruise from Acceleration
1st to 2nd	15 mph (24 km/h)	9 mph (14 km/h)
2nd to 3rd	27 mph (43 km/h)	20 mph (32 km/h)
3rd to 4th	39 mph (62 km/h)	33 mph (53 km/h)
4th to 5th	53 mph (85 km/h)	48 mph (77 km/h)

4WD

Shift up	Normal Acceleration
1st to 2nd	15 mph (24 km/h)
2nd to 3rd	25 mph (40 km/h)
3rd to 4th	40 mph (64 km/h)
4th to 5th	47 mph (76 km/h)

Shifting the Automatic (CIVIC WAGON)

The automatic transmission shift lever has a locking mechanism to prevent accidental shifting into Reverse (R), Park (P) or 2nd (2). Also, the Automatic Shift Lock prevents you from shifting out of Park unless the brake pedal is already depressed and the ignition switch is in the II position.

Push the button on the shift handle to shift into 2nd, Reverse or Park; depress the brake pedal and then push the button on the shift handle to shift out of Park.

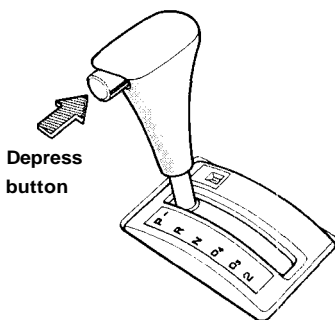
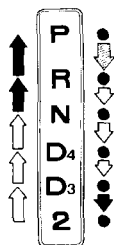

- ➡ : Depress the brake pedal first and push the button, then shift.
- ➡ : Push the button, then shift.
- ➡ : Shift as desired.

If you cannot shift out of Park with the brake pedal depressed and the ignition switch in the II position:

1. Turn the ignition switch off and remove the key.
2. Insert the key in the Shift Lock Release located to the right of the shift lever.
3. Press and hold the key down, then press the button on the shift handle and move the shift lever to Neutral.
4. Return the key to the ignition switch, depress the brake pedal and restart the engine.

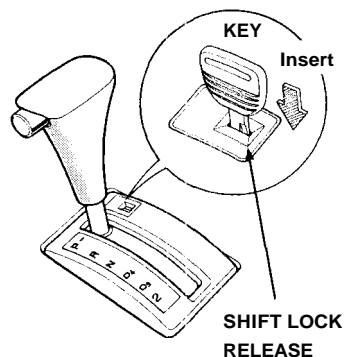

NOTE:

If you encounter any problem shifting out of Park, have your authorized Honda dealer check the system as soon as possible.



Operating Tips

For smoother operation, apply the brakes when shifting from Neutral or Park to a forward or reverse gear.

When parking: bring the car to a stop with the foot brake, hold the brake on and shift into Park, set the hand brake and then turn off the engine.

NOTE:

Your 4 speed automatic transmission is equipped with a torque converter lock-up clutch. Because of this, you may notice what feels like an extra shift as the clutch engages.

CAUTION:

- Shift into P only after the car has come to a complete stop.
- Shift into or out of R only after the car has come to a complete stop.
- Do not "rev-up" the engine when the brake is on and the shift lever is in D4, S3, 2 or R.
- When stopped on a hill, use the brakes to hold your position, not the accelerator pedal.
- Do not shift from N or P into D4, S3, 2 or R when the engine is above idle speed. Before shifting into gear, make sure your foot is firmly on the brake pedal.
- Do not rest your hand on the shift lever or push the shift button while driving.

(cont'd)



Shifting the Automatic (CIVIC WAGON) (cont'd)

Driving Technique

D4-4th

Use the D₄ range for normal in-town and highway driving. The car will start off in 1st and shift automatically to 2nd, 3rd, and 4th. The further down you push the accelerator, the later the transmission will shift and the faster the car will accelerate.

D3-3rd

Use of D₃ will allow the transmission to start off in 1st and shift automatically to 2nd and 3rd. Use D₃ when climbing grades to prevent the transmission from "hunting" between 3rd and 4th gear; or when increased braking is needed.

NOTE:

If rapid acceleration is necessary, depress the accelerator to the floor; the transmission will automatically shift down according to load and engine speed. This applies to both D₄ and D₃ ranges.

2-2nd

Use 2nd gear for increased engine braking when driving downhill, and increased power when driving uphill; also for driving on slippery roads, and freeing the car from mud or sand, where 1st gear could provide too much power and cause skidding or wheel-spin. The maximum recommended speed in 2nd gear is:
62 mph (100 km/h)

R-Reverse

CAUTION:

Shift into or out of reverse only after the car has come to a complete stop; the transmission may be damaged if you shift while the car is moving.

P-Park

CAUTION:

Use this position when starting the engine, or when parking. Shift into Park only when the car is COMPLETELY stopped.

N-Neutral

Use when starting the engine or during prolonged idling in traffic.

Shifting the Automatic (4WD)

The automatic transmission shift lever has a locking mechanism to prevent accidental shifting into Reverse (R), Park (P) or 2nd (2). Also, the Automatic Shift Lock prevents you from shifting out of Park unless the brake pedal is already depressed and the ignition switch is in the II position.

Push the button on the shift handle to shift into 2nd, Reverse or Park; depress the brake pedal and then push the button on the shift handle to shift out of Park.

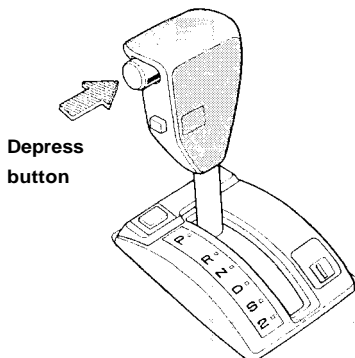
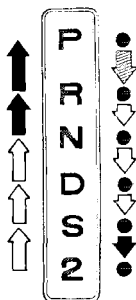

- ➡ : Depress the brake pedal first and push the button, then shift.
- ➡ : Push the button, then shift.
- ➡ : Shift as desired.

If you cannot shift out of Park with the brake pedal depressed and the ignition switch in the II position:

1. Turn the ignition switch off and remove the key.
2. Insert the key in the Shift Lock Release located to the right of the shift lever.
3. Press and hold the key down, then press the button on the shift handle and move the shift lever to Neutral.
4. Return the key to the ignition switch, depress the brake pedal and restart the engine.

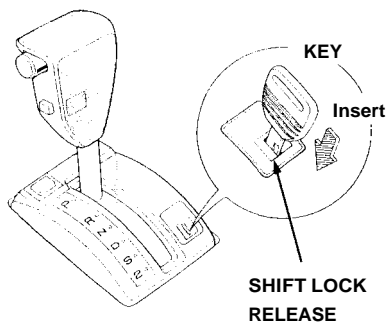

NOTE:

If you encounter any problem shifting out of Park, have your authorized Honda dealer check the system as soon as possible.



Shifting the Automatic (4WD) (cont'd)

Operating Tips

For smoother operation, apply the brakes when shifting from Neutral or Park to a forward or reverse gear.

When parking: bring the car to a stop with the foot brake, hold the brake on and shift into Park, set the hand brake and then turn off the engine.

NOTE:

Your 4 speed automatic transmission is equipped with a torque converter lock-up clutch. Because of this, you may notice what feels like an extra shift as the clutch engages.

CAUTION:

- **Shift into P only after the car has come to a complete stop.**
- **Shift into or out of R only after the car has come to a complete stop.**
- **Do not "rev-up" the engine when the brake is on and the shift lever is in D, S, 2 or R.**
- **When stopped on a hill, use the brakes to hold your position, not the accelerator pedal.**
- **Do not shift from N or P into D, S, 2 or R when the engine is above idle speed. Before shifting into gear, make sure your foot is firmly on the brake pedal.**
- **Do not rest your hand on the shift lever or push the shift button while driving.**

Driving Technique

D-4th

Use the D range for normal in-town and highway driving. The car will start off in 1st and shift automatically to 2nd, 3rd, and 4th. The further down you push the accelerator, the later the transmission will shift and the faster the car will accelerate.

S(S₃—3rd/S₄—4th)

The "S" shift selector range changes the shift points under part throttle acceleration, allowing the transmission to stay in each lower gear for a longer period before automatically upshifting. With the shift selector in the "S" range, the "S₃" indicator light in the dash pangil will come on and the transmission will shift from 1st to 2nd and 3rd but not 4th. This is especially useful when climbing or descending grades. While driving in the "S" range, the car's performance is improved but fuel economy is reduced. While driving in the "S" range, you can select 4th gear by pushing the "S₄" switch. Depending upon vehicle speed and throttle pedal position, the transmission will shift to 4th gear when the switch is pressed; the "S₄" indicator light in the instrument panel will come on. Pushing the "S₄" switch again will cause the transmission to downshift to 3rd gear in the "S₃" mode. The "S₄" indicator light in the instrument panel will go out, and the "S₃" light on the instrument panel will come on.

If the shift lever is moved to any other driving range, the "S₄" switch will be cancelled automatically.

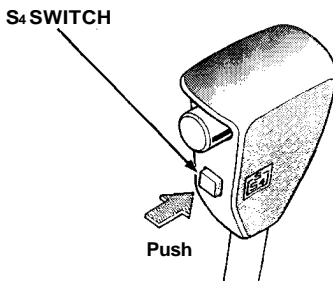

NOTE:

If rapid acceleration is necessary, depress the accelerator to the floor; the transmission will automatically shift down according to load and engine speed. This applies to both D and S ranges.

(cont'd)

Shifting the Automatic (4WD) (cont'd)

2-1st/2nd

Use "2" to increase engine braking when driving downhill and engine power when driving uphill.

Using "2" will allow the transmission to automatically shift up or down between the 1st gear and the 2nd gear. The maximum recommended speed for the "2" range is:

62mph (100km/h)

If you need more engine braking or engine power when using the "2" position, push the  switch to use the 1st gear only.

When the speed is more than 31 mph (50 km/h):

The indicator light in the instrument panel will come on but the transmission will remain in 2nd gear. However, when the speed goes below 31 mph (50 km/h), the transmission downshifts from 2nd to 1st and locks in 1st.

The maximum recommended speed when locked in 1st gear is:

37mph (60km/h)

To release the Low lock, push the  switch again or select any other driving range.

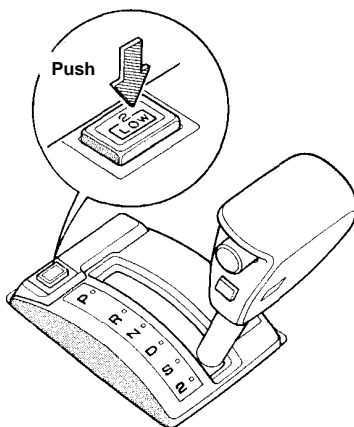

R-Reverse

CAUTION:

Shift into or out of reverse only after the car has come to a complete stop; the transmission may be damaged if you shift while the car is moving.

P-Park

CAUTION:

Use this position when starting the engine, or when parking. Shift into Park only when the car is COMPLETELY stopped.

N-Neutral

Use when starting the engine or during prolonged idling in traffic.

Real Time 4WD

The 4WD system automatically engages between the front and rear wheels.

Service

To prevent sudden movement of the car, which may result in personal injury, always disengage the 4WD system manually before performing service that requires either the front or rear wheels to be raised and turning.

Towing

CAUTION:

Before towing the car with either the front or rear wheels raised off the ground, place the transmission in neutral and manually disengage the 4WD system to prevent the raised wheels from turning.

4WD Disengagement (Manual Transmission)

1. Locate the orange disengagement lever at the rear of the engine compartment.



2. Loosen the lock bolt at the slotted end of the lever.

NOTE:

For better accessibility, use a socket and a long extension bar.

CAUTION:

Do not loosen the lock bolt more than 5—7 turns. Replacement is extremely difficult.

Unlocked
Position
(4WD off)

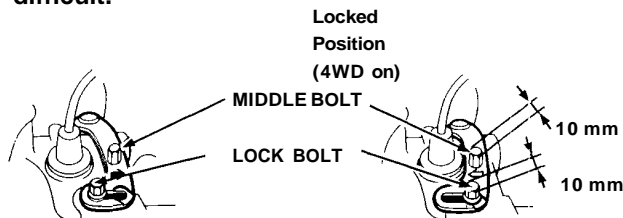

3. Move the lever by turning the middle bolt counterclockwise.
4. Tighten the lock bolt.

NOTE:

After service or towing is completed, return the lever to the normal (4WD on) position and tighten the lock bolt.

4WD Disengagement (Automatic Transmission)

1. Locate the disengagement plate at the rear of the transmission case behind the right front wheel.

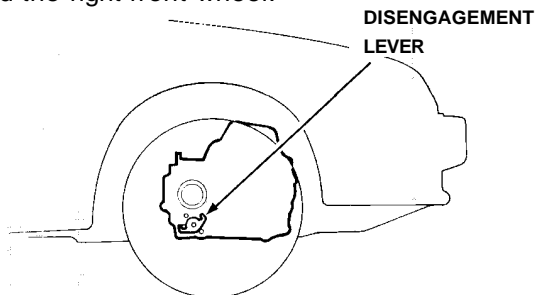

2. Loosen the lock bolt in the notch on the plate.

NOTE:

For better accessibility, use a socket and a long extension bar.

CAUTION:

Do not loosen the lock bolt more than 5—7 turns. Replacement is extremely difficult.

Unlocked
Position
(4WD off)

Locked
Position
(4WD on)

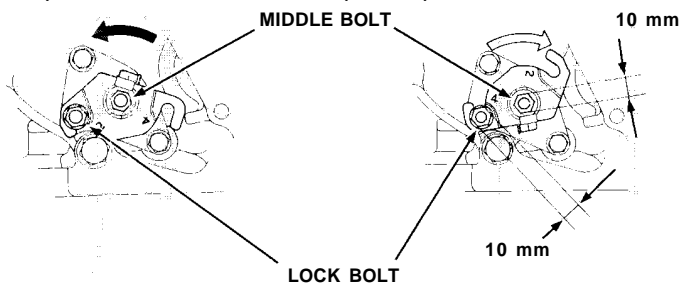

3. Turn the middle bolt counterclockwise until the plate rotates about 150° and is stopped by the lock bolt.
4. Tighten the lock bolt.

NOTE:

After service or towing is completed, return the plate to the normal (4WD on) position and tighten the lock bolt.



Maintenance Schedule and Records

Your Honda automobile must be properly maintained to ensure that it is in peak operating condition and the emission levels are within the standards set by the Federal Clean Air Act.

The following instructions and maintenance procedures are based on the assumption that your car will be used exclusively for the purpose for which it was designed:

1. To carry passengers and cargo within the load limits shown on the label in the glove box.
2. To be driven on reasonable road surfaces within legal limits.
3. To generally be driven daily over a distance of several miles.
4. Use gasoline from pumps labeled unleaded, with a pump octane number of 86 or higher. The pump octane number is an average of the Research (R) octane and Motor (M) octane numbers.

NOTE:

Failures which occur due to a lack of maintenance will not be covered under warranty.

The Required Maintenance Schedule * specifies all maintenance required to keep your car in peak operating condition. Work should be done by an authorized Honda dealer but may be done by any qualified service facility or individual who is competent in this type of work.

Maintenance, replacement, or repair of emission control devices and systems may be done by any automotive repair establishment or individual using parts that are "certified" to EPA standards.

After the maintenance has been done, be sure to complete the Maintenance Records on pages 63, 64 – 65. All required maintenance is considered normal owner operating cost and you will be charged for it by your dealer.

- * Maintenance operations indicated by * 4 are recommended by the manufacturer for vehicle sold in California, but not required. Other maintenance operations are required by California regulations and condition the emission warranty. All operations (including *4) are required for vehicles sold outside California.



Check the following items at each fuel stop:

1. Engine oil level.
2. Radiator coolant level.

Check the following items periodically:

1. Brakes: for braking efficiency, brake pedal travel and hydraulic fluid level.
2. Lights: for operation of headlights, taillights, side marker lights, stoplights, turn signals and back-up lights.
3. Tires: for correct pressures (including spare); inspect for cuts and uneven or excessive wear. Rotate every 7,500 miles (12,000 km) in the pattern shown on page [90](#).
4. Steering: for excessive play or vibration while driving.
5. Exhaust system: for leaks or loose mounts.
6. Wipers: for operation of windshield wipers and washer, and condition of wiper blades.
7. Seat belts: for condition of fabric and buckles, and operation of the restraint mechanism.
8. Battery condition.
9. Clutch adjustment (clutch release arm travel).

(cont'd)



Maintenance Schedule and Records (cont'd)

R—Replace C—Clean I—Inspect After inspection clean, adjust, repair or replace if necessary.
 *1 Tension adjustment only
 *2 4WD only
 *3 Thereafter, replace every 2 years or 30,000 miles (48,000km), whichever comes first.
 *4 For cars sold in California, this service is recommended only; for other areas, it is required.
 *5 Only 1.5 l cars with automatic transmission sold in California.

Service at the interval listed ×1,000 miles (or km) or after that number of months, whichever comes first.	x1,000 miles	15	30	45	60	75	90
	x1,000 km	24	48	72	96	120	144
	months	12	24	36	48	60	72
Idle speed and idle CO					I		
Valve clearance		I	I	I	I	I	I
Alternator drive belt			I*1		I		I
Timing belt							R
Water pump							I
◆ Engine oil and oil filter •		Replace every 7,500 miles (12,000 km) or 6 months					
Transmission oil			R		R		R
Rear differential Oil *2			R		R		R
Radiator coolant •				R		R*3	
Cooling system hoses and connections		I		I		I	I
E.G.R.system *5					I		
Air cleaner element			R		R		R
Fuel filter and hoses					R		
Fuel line connections			I*4		I		I
Evaporative emission control system					I		
Ignition timing and control system					I		
Spark plugs			R		R		R
Distributor cap and rotor					I		
Ignition wiring					I		
Positive crankcase ventilation valve					I		
Brake hoses and lines		I	I	I	I	I	I
Brake fluid			R		R		R
◆ Front brake discs and calipers		I	I	I	I	I	I
Front brake pads		Inspect every 7,500 miles (12,000 km) or 6 months					
Rear brake drums, wheel cylinders and linings			I		I		I
Parking brake		I	I		I		I
◆ Clutch release arm travel		Inspect every 7,500 miles (12,000 km) or 6 months					
Exhaust pipe and muffler		I	I	I	I	I	I
Suspension mounting bolts		I	I	I	I	I	I
Front wheel alignment		I	I	I	I	I	I
Steering operation, tie rod ends, steering gear box and boots		I	I		I		I
◆ Power steering system (if equipped)		I	I	I	I	I	I
Power steering pump belt (if equipped)			I*1		I		I
Catalytic converter heat shield					I		

● : Check oil and coolant level at each fuel stop.

◆ : Under severe driving conditions, service these items **twice as often**. (See page 64.)



Required Maintenance Record

- Have your servicing dealer record all Required Maintenance below.
- Keep receipts for all work done on your car.

7,500 Mi. 12,000 km. (or 6 Mo.)	(Sign or Stamp)	Mileage Date
15,000 Mi. 24,000 km. (or 12 Mo.)	(Sign or Stamp)	Mileage Date
22,500 Mi. 36,000 km. (or 18 Mo.)	(Sign or Stamp)	Mileage Date
30,000 Mi. 48,000 km. (or 24 Mo.)	(Sign or Stamp)	Mileage Date
37,500 Mi. 60,000 km. (or 30 Mo.)	(Sign or Stamp)	Mileage Date
45,000 Mi. 72,000 km. (or 36 Mo.)	(Sign or Stamp)	Mileage Date
52,500 Mi. 84,000 km. (or 42 Mo.)	(Sign or Stamp)	Mileage Date
60,000 Mi. 96,000 km. (or 48 Mo.)	(Sign or Stamp)	Mileage Date
67,500 Mi. 108,000 km. (or 54 Mo.)	(Sign or Stamp)	Mileage Date
75,000 Mi. 120,000 km. (or 60 Mo.)	(Sign or Stamp)	Mileage Date
82,500 Mi. 132,000 km. (or 66 Mo.)	(Sign or Stamp)	Mileage Date
90,000 Mi. 144,000 km. (or 72 Mo.)	(Sign or Stamp)	Mileage Date

(cont'd)



Maintenance Schedule and Records (cont'd)

Severe Driving Conditions

CAUTION: The following items must be serviced more frequently on cars normally used under severe driving conditions. Refer to the chart below for the appropriate maintenance intervals.

Severe driving conditions include:

A: Repeated short distance driving

B: Driving in dusty conditions

C: Driving in severe cold weather

D: Driving in areas using road salt or other corrosive materials

E: Driving on rough and/or muddy roads

Condition	Maintenance item	Maintenance operation	Interval
A B . . .	Engine oil and oil filter	R	Every 3,750 miles (6,000 km) or 3 months
A B . D E	Front brake discs and calipers	I	Every 7,500 miles (12,000 km) or 6 months
A B C . E	Clutch release arm travel	I	Every 3,750 miles (6,000 km) or 3 months
. B C . E	Power steering system	I	Every 7,500 miles (12,000 km) or 6 months

R—Replace

I—Inspect

After inspection, clean, adjust, repair or replace if necessary.

Non-Scheduled Maintenance Record

Record additional maintenance for severe driving conditions or non-scheduled maintenance on this page. (See page 78)

Maintenance Performed:	(Sign or Stamp)	Mileage Date
Maintenance Performed:	(Sign or Stamp)	Mileage Date
Maintenance Performed:	(Sign or Stamp)	Mileage Date
Maintenance Performed:	(Sign or Stamp)	Mileage Date
Maintenance Performed:	(Sign or Stamp)	Mileage Date



Maintenance Performed:	(Sign or Stamp)	Mileage Date
Maintenance Performed:	(Sign or Stamp)	Mileage Date
Maintenance Performed:	(Sign or Stamp)	Mileage Date
Maintenance Performed:	(Sign or Stamp)	Mileage Date
Maintenance Performed:	(Sign or Stamp)	Mileage Date
Maintenance Performed:	(Sign or Stamp)	Mileage Date
Maintenance Performed:	(Sign or Stamp)	Mileage Date
Maintenance Performed:	(Sign or Stamp)	Mileage Date
Maintenance Performed:	(Sign or Stamp)	Mileage Date
Maintenance Performed:	(Sign or Stamp)	Mileage Date
Maintenance Performed:	(Sign or Stamp)	Mileage Date
Maintenance Performed:	(Sign or Stamp)	Mileage Date
Maintenance Performed:	(Sign or Stamp)	Mileage Date
Maintenance Performed:	(Sign or Stamp)	Mileage Date
Maintenance Performed:	(Sign or Stamp)	Mileage Date
Maintenance Performed:	(Sign or Stamp)	Mileage Date

Fluid Locations

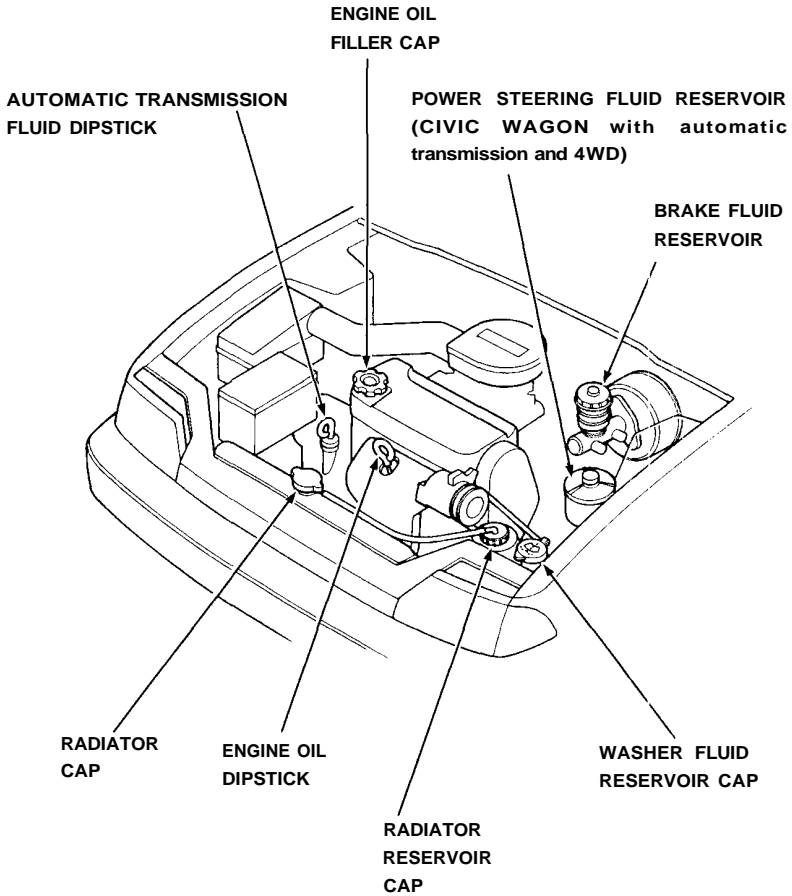

Engine Oil and Filter

Checking

Check the engine oil a couple of minutes after shutting the engine off, with the car parked on level ground. Remove the dipstick and wipe it clean. Reinsert it all the way down, then pull it out and read the level. The level should be between the upper and lower marks.

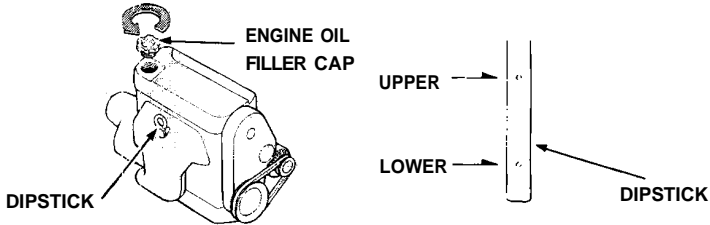

Adding

If the level has dropped close to the lower mark, add oil until it is even with the upper mark.

1. Turn the oil filler cap counterclockwise to remove. Add oil, then check the level again. Do not overfill.
2. Reinstall the cap and twist clockwise until it stops.

CAUTION:

- Be sure the oil filler cap is correctly replaced before starting the engine.
- Engine oil is a major factor affecting the performance and service life of the engine; you should use only a premium quality detergent oil labeled SG grade.

LOOK FOR THIS LABEL ON THE OIL CONTAINER Use the proper viscosity oil for the climate in which you drive:

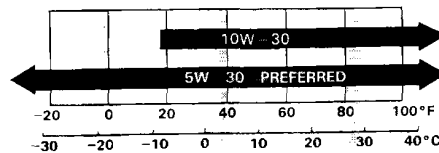
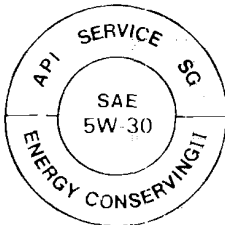

Ambient Temperature

Some oil labels may also include additional designations of quality such as CC or CD. However, these are acceptable only when used together with SG.

NOTE:

5W-30 viscosity oil is recommended for improved fuel economy.

(cont'd)

Engine Oil and Filter (cont'd)

Fuel Efficient Oil

For the best fuel economy from your car, it is recommended that you use a fuel efficient SG oil. This oil is usually identified by the words such as: "Energy Conserving II," "Gas Saving," and "Fuel Saving," etc.

Changing Oil and Filter

Engine oil and filter should be changed together every 6 months or 7,500 miles (12,000 km), whichever comes first. The filter is located on the engine block, below the intake manifold. A special "cap type" wrench is required (available from your Honda dealer). Use only a genuine Honda filter or its equivalent.

CAUTION:

The oil filter cannot easily be removed from above the engine. For this reason it is recommended that the oil filter change be done by a skilled mechanic.

1. Start the car to warm up the engine, then shut it off.
2. Remove the engine oil filler cap and drain bolt, and drain the oil.

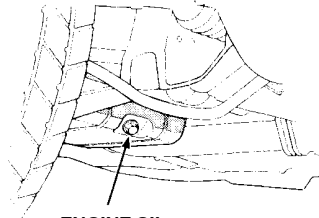

ENGINE OIL
DRAIN BOLT

A warmed-up engine and the oil in it are hot; be careful not to burn yourself.

3. Remove the oil filter and let the remaining oil drain out.
4. Install a new filter according to instructions on or with the filter.
5. Reinstall the drain bolt with a new washer and tighten it securely. Refill the engine with the recommended oil, to the upper mark on the dipstick.

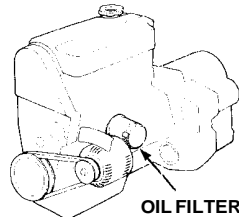

OIL FILTER

ENGINE OIL CAPACITY (including filter):

3.5 ℓ (3.7 US qt, 3.1 Imp qt)



-
6. Reinstall the filler cap securely.
 7. Start the engine and make sure oil is not leaking from the drain bolt or filter.
 8. Shut off the engine and recheck the oil level.

NOTE:

Please dispose of used motor oil in a manner that is compatible with the environment. We suggest you take it in a sealed container to your local service station for reclamation. Do not throw it in the trash or pour it on the ground.

CAUTION:

Used motor oil may cause skin cancer if repeatedly left in contact with the skin for prolonged periods. Although this is unlikely unless you handle used oil on a daily basis, it is still advisable to thoroughly wash your hands with soap and water as soon as possible after handling used oil.

Transmission Oil/Fluid Check

Transmission oil/fluid must be checked with the engine off and the car on level ground.

If the engine has been running, some engine components may be hot enough to burn you.

CAUTION:

If the oil/fluid level is low, check for possible leaks before adding oil. Do not overfill.

Since the transmission and differential are in the same housing, you are actually checking both oil/fluid levels in one procedure. Change transmission oil/fluid according to the Maintenance Schedule on page 62.

Manual

Remove the oil filler bolt (beside the right axle). Feel inside the bolt hole with your finger. If the oil is up to the bottom edge of the hole, the oil level is correct. If it is not, slowly add oil until it runs out of the hole, then reinstall the bolt and tighten it securely with a wrench.

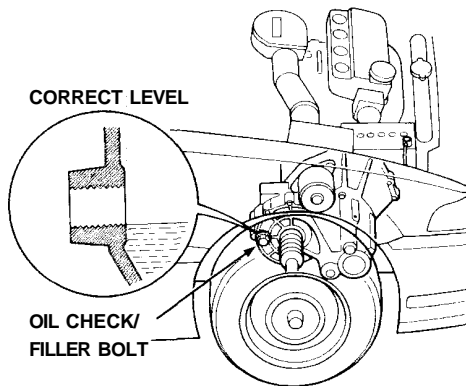

MANUAL TRANSMISSION

OIL CHANGE CAPACITY:

CIVIC WAGON: 1.8 l (1.9 US qt, 1.6 Imp qt)

4WD: 2.3 l (2.4 US qt, 2.0 Imp qt)

Use only SE or SF grade motor oil when adding or changing transmission oil.

Use the proper viscosity oil for the climate in which you drive:

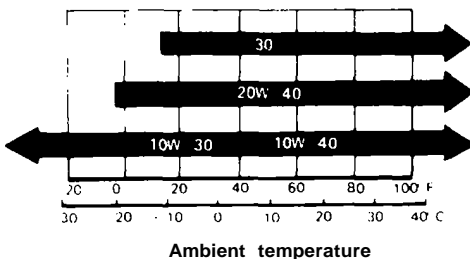

Automatic

The automatic: transmission fluid level is checked (with the engine off and the car on level ground) using the dipstick in the right end of the transmission housing. Remove the dipstick and wipe it off.

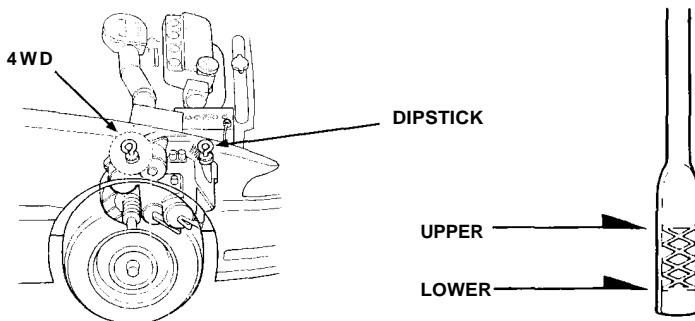

Insert the dipstick and remove it. The fluid level should be between the upper and lower marks.

If necessary, add fluid and recheck. Use only DEXRON® II Automatic Transmission Fluid (A.T.F.) when adding or changing fluid. After checking the fluid level, push the dipstick in securely.

AUTOMATIC TRANSMISSION FLUID CHANGE CAPACITY:

CIVIC WAGON: 2.4 ℓ (2.5 US qt, 2.1 Imp qt)
4WD: 3.2 ℓ (3.4 US qt, 2.8 Imp qt)

Rear Differential Oil (4WD)

Rear differential oil must be checked or filled with the engine off and the car on the level ground.

CAUTION:

- **When checking the rear differential oil level, remember that if the car has been running, the differential and exhaust pipe will be hot.**
- **If the oil level is low, check for possible leaks before adding oil. Do not overfill.**

Remove the oil filler bolt. Feel inside the bolt hole with your finger. If the oil is up to the bottom edge of the hole, the oil level is correct. If it is not, slowly add oil until it runs out of the hole, then reinstall the bolt and tighten it securely with a wrench.

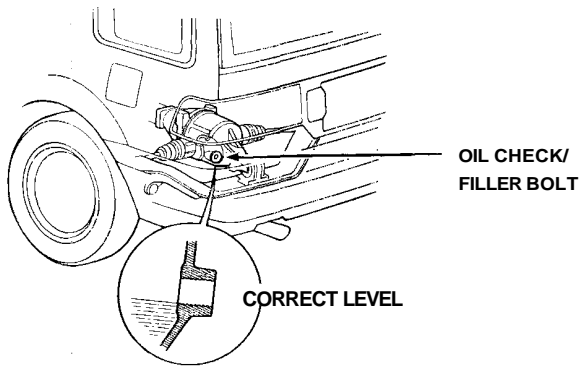

REAR DIFFERENTIAL OIL CHANGE CAPACITY:

0.65 ℓ (0.69 US qt, 0.57 Imp qt)

Recommended oil:

HYPOID GEAR OIL (API GL5) SAE90 above 5°C (41 °F)

HYPOID GEAR OIL (API GL5) SAE80 below 5°C (41 °F)



Cooling System

Your Honda engine contains a number of aluminum parts. Therefore, it requires an antifreeze/coolant specifically formulated to protect the aluminum parts from corrosion. Failure to use a suitable antifreeze/coolant may seriously shorten the life of the engine as the result of rapid corrosion damage. Some antifreeze/coolants, although labeled for use in engines containing aluminum, may not provide adequate protection for your engine.

Therefore, use only a Honda **RECOMMENDED** antifreeze/coolant. CHECK WITH YOUR AUTHORIZED HONDA DEALER.

For best corrosion protection, the mixture of coolant and water must be maintained year-round at 50/50. Concentrations less than 50% coolant may not provide sufficient protection against corrosion and freezing. Concentrations of greater than 60% coolant will impair cooling efficiency and are not recommended. Low-mineral drinking water or distilled water should be mixed with the antifreeze/coolant. Coolant loss should be replenished by a mixture containing the proper concentration of antifreeze and water.

Do not mix different antifreeze/coolants.

Do not use additional rust inhibitors or anti-rust products, as they may not be compatible with the radiator coolant.

ENGINE DAMAGE CAUSED BY IMPROPER COOLANT USAGE IS NOT COVERED BY THE NEW CAR WARRANTY.

(cont'd)

Cooling System (cont'd)

Checking Coolant

Check the coolant level in the reserve tank when the engine is at normal operating temperature.

- If the level is below the MAX mark, but still visible, add a 50/50 solution of antifreeze and water to bring it up to MAX.
- If there is no coolant in the reserve tank, the cooling system should be checked for leaks and repaired if necessary. Coolant must then be added to the radiator.

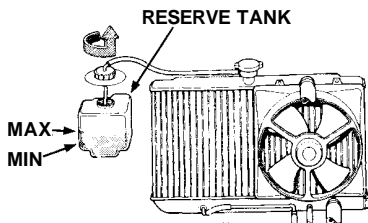

Do not remove the radiator cap when the engine is hot; the coolant is under pressure and could severely scald you.

CAUTION:

Radiator coolant will damage paint. Quickly rinse any spilled coolant from painted surfaces.

Wait until the engine is cool, then turn the radiator cap counterclockwise until it stops. **DO NOT PRESS DOWN WHILE TURNING THE CAP.** After any remaining pressure has been relieved, remove the cap by pressing down and again turning it counterclockwise. Add enough coolant to fill the radiator, and reinstall the cap. Be sure to tighten it securely. Fill the reserve tank up to the MAX mark with the engine cold.

Maintenance

1. Check the freeze protection level of the coolant with a hydrometer.
2. Keep the front of the radiator free of dirt and debris.
3. Check hoses and hose clamps regularly.

Replacing Coolant

Replace coolant at 36 months or 45,000 miles (72,000 km), whichever comes first. Thereafter, replace every 2 years or 30,000 miles (48,000 km), whichever comes first.

RADIATOR COOLANT

REFILL CAPACITY:

Manual Transmission

(CIVIC WAGON): 4.5 ℓ (1.19 US gal, 0.99 Imp gal)

(4WD): 4.4 ℓ (1.16 US gal, 0.97 Imp gal)

Automatic Transmission

(CIVIC WAGON): 4.4 ℓ (1.16 US gal, 0.97 Imp gal)

(4WD): 4.8 ℓ (1.27 US gal, 1.06 Imp gal)

Plus reserve tank 0.4 ℓ (0.11 US gal, 0.09 Imp gal)

1. Turn the heater temperature control dial to maximum heat.
2. Remove the radiator cap and drain plug when the radiator is cool, and drain the radiator.

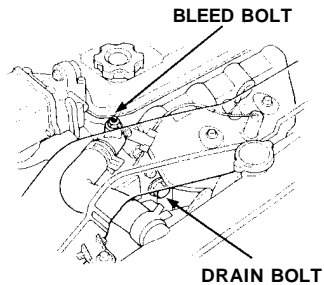
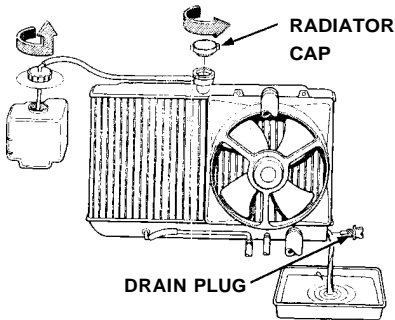

3. Remove the drain bolt from the front side of the cylinder block, and drain the engine and heater.
4. Apply non-hardening sealant to the drain bolt threads, then reinstall the bolt and tighten it securely.
5. Tighten the radiator drain plug securely.
6. Mix the recommended antifreeze with an equal amount of low-mineral or distilled water and fill the reservoir to maximum, as illustrated.

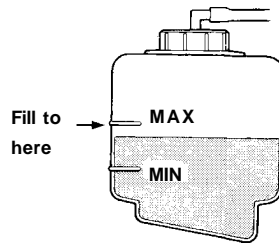

(cont'd)

Cooling System (cont'd)

7. Loosen the air bleed bolt in the thermostat housing, then fill the radiator to the filler neck with the coolant mixture. Tighten the bleed bolt as soon as coolant starts to run out in a steady stream without bubbles.

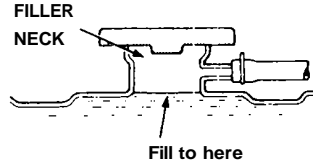

8. With the radiator cap off, start the engine and let it run until warmed up (fan goes on at least twice). Then, if necessary, add more coolant mixture to bring the level back up to the filler neck.
9. Put the radiator cap on, then run the engine again and check for leaks.

Brakes

Brake System Design

The diagonally-separated dual service brake system is designed so half the system will still provide braking action if the other half fails. However, stopping the car with only half the system will require more pedal pressure and pedal travel than normal. Also, the distance required to stop will be longer using only half the brake system. If the brakes fail suddenly, downshift to a lower gear for increased engine braking, and pull off the road as soon as possible.

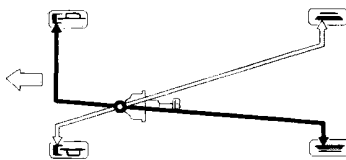

- It is dangerous to drive your car with a problem in either the brake electrical or hydraulic system; have your dealer check both systems if you suspect brake trouble.
- Do not ride the brakes. In other words, don't put your foot on the brake pedal unless you intend to brake. This causes excessive brake wear and can damage, or lead to loss of braking effectiveness through overheating. Your brake lights may also confuse drivers behind you.
- Driving through deep water may affect the brakes. Check their effectiveness by pressing the brake pedal gently. If the car does not slow down at the normal rate, continue gently applying the brakes, while maintaining a safe speed, until they dry out and normal performance returns.

Brake Wear

Both front and rear brakes should be inspected for wear at the intervals shown in the maintenance schedule on page 62. When the brakes require maintenance, use only genuine Honda replacement parts or their equivalent.

(cont'd)

Brakes (cont'd)

Front Brake Wear Indicators

Your car is equipped with audible front brake wear indicators. When the brake pads wear to point that they should be replaced, they will make a "screeching" sound when the wheels are rolling and when the brakes are applied.

NOTE:

Due to some driving habits or climates, brakes may "squeal" when you first apply them or when you have them partially applied; this is normal, and does not indicate excessive wear. The wear indicator makes a "screeching" sound while the brakes are applied.

Brake Fluid

Check the fluid level in the brake fluid reservoir periodically; it should be between the MAX and MIN marks on the reservoir.

If the level is near the MIN mark, add fluid to raise it to the MAX mark. Do not overfill. Use only brake fluid manufactured to DOT 3 or DOT 4 specifications (see reservoir cap) from a sealed container. Follow the manufacturer's instructions printed on the can.

NOTE:

A low brake fluid level may be an indication of brake pad wear or of brake fluid leakage. You should have your brakes checked if the brake fluid level in the reservoir is low before refilling it.

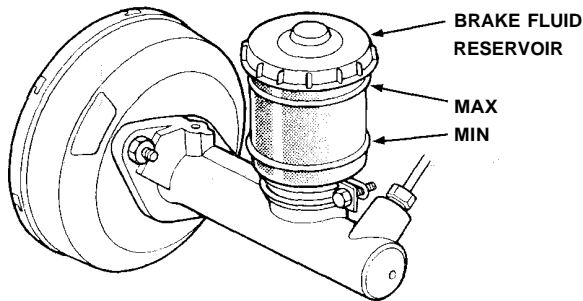

CAUTION:

The arrow on the reservoir cap must be pointing forward after the cap is installed. Make sure the brake warning switch wiring doesn't get caught between the cap and top edge of the reservoir.

Power Steering (4WD or CIVICWAGON with Automatic)

The power steering on your car provides easy handling while parking and maneuvering in traffic, without loss of road "feel" at highway speeds. An engine-driven hydraulic pump provides full power assist at low speeds and decreasing assist as the car goes faster.

CAUTION:

If the power steering system should fail, or if the engine should stall, the car can still be steered. However, much greater effort will be required, particularly in sharp turns at low speed.

NOTE:

You may feel a slight clunk or knock when turning the wheel with the engine off. This is a normal condition due to the design of the system.

Power Steering Fluid

Check the power steering fluid level with the engine cold and the car parked on level ground. Make sure the fluid level is between the upper and lower marks on the reservoir. If the level has dropped close to or below the lower mark, check for leaks before adding fluid to the upper mark. Do not overfill.

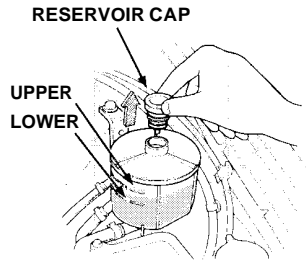

CAUTION:

Use only genuine Honda power steering fluid. The use of other fluids such as A.T.F. or other manufacturer's power steering fluid will damage the system.

Air and Fuel Filters

Air Filter

Replace the air filter every 24 months or 30,000 miles (48,000 km), whichever comes first (more often in extremely dusty conditions).

Replacement

Remove the four screws holding the air filter cover halves together. Remove the top half of the air filter cover. Replace the filter. Reinstall the cover and screws securely.

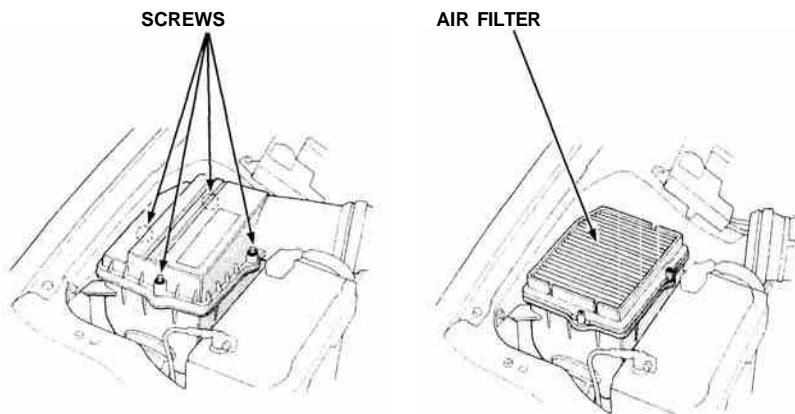

Fuel Filter

The fuel filter is located in the engine compartment, on the right center of the firewall. It should be replaced at 60,000 miles (96,000 km) or 48 months whichever comes first, or any time you suspect contaminated gas may have clogged it.

CAUTION:

Because the fuel system is under pressure, the filter should be replaced only by a qualified Honda technician.



Spark Plugs

Spark plugs should be replaced every 24 months or 30,000 miles (48,000 km), whichever comes first.

Recommended spark plugs:

For all normal driving	BCPR6E-11 (NGK) BCPR6EY-N11 (NGK) Q20PR-U11 (ND)
For hot climates or continuous high speed driving	BCPR7E-11 (NGK) BCPR7EY-11 (NGK) Q22PR-U11 (ND)

CAUTION:

Never use spark plugs with an improper heat range; they will adversely affect engine performance and durability.

(cont'd)

Spark Plugs (cont'd)

Spark Plug Replacement

Replace plugs one at a time, so you don't get the wires mixed up.

1. Clean any dirt from around the spark plug base.
2. Disconnect the spark plug cap, then remove and discard the old plug.
3. Check the gap of the new spark plugs before installation.
Plug gap should be: 1.1 mm (0.04in) .
4. Thread the new spark plug in by hand to prevent cross-threading.
5. After the plug seats against the cylinder head, tighten 1/2 turn with a spark plug wrench to compress the washer.
6. Reinstall the spark plug cap.

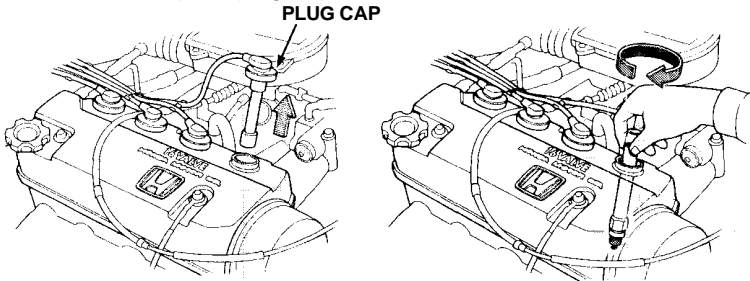

CAUTION:

The spark plugs must be securely tightened, but not overtightened. A plug that's too loose can get very hot and possibly damage the engine; one that's too tight could damage the threads in the cylinder head.

Wiper Blades

For maximum visibility, replace worn or cracked wiper blades when you notice they do not wipe the windshield cleanly or smoothly.

To Replace Worn-out Blades:

1. Detach the blade assembly from the arm by pressing the lock tab in, then pushing the blade toward the base of the arm.

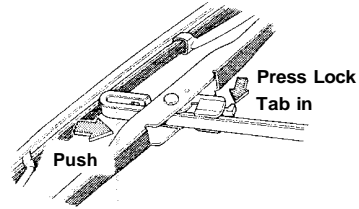

2. Firmly grasp the end of the blade rubber and pull until the tabs are free of the metal support.

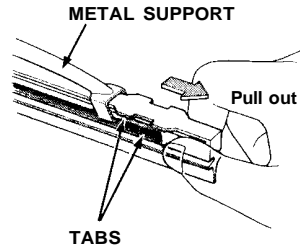

3. Remove the metal retainers from the worn-out blade rubber and put them in a new blade rubber.

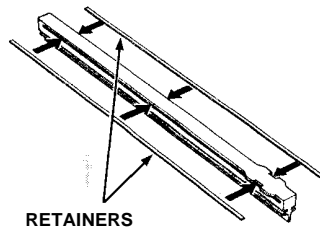

4. Insert the new blade rubber from the opposite side of the blade tabs and position the tabs in the metal support.

Battery

The condition of the battery can be determined by checking the test indicator. Service as required according to the label on the battery.

Any corrosion around the positive and negative terminals should be washed off with a solution of baking soda and warm water. Dry the terminals and then coat them with grease.

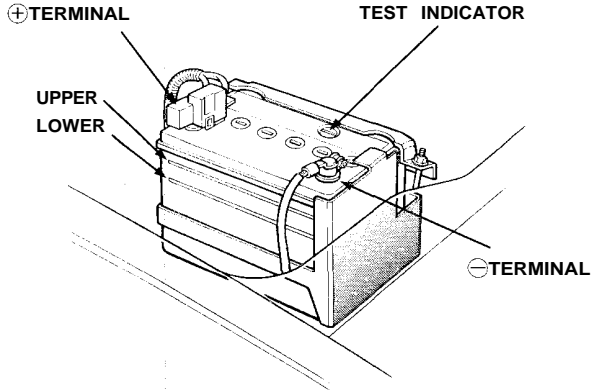

- The battery gives off explosive gases; keep sparks, flames and cigarettes away. Provide adequate ventilation when charging or using the battery in an enclosed space.
 - The battery contains sulfuric acid (electrolyte). Contact with skin or eyes may cause severe burns. Wear protective clothing and a face shield.
 - If electrolyte gets on your skin, flush with water.
 - If electrolyte gets in your eyes, flush with water for at least 15 minutes and call a physician immediately.
 - Electrolyte is poisonous.
 - If swallowed, drink large quantities of water or milk and follow with milk of magnesia or vegetable oil and call a physician.
- KEEP OUT OF REACH OF CHILDREN.**

Fuse Replacement

The fuse box is located under the dashboard on the driver's side. The circuits protected by each fuse are listed inside the box.

The fuses for automatic shoulder belt buckle motor are installed on the ⊕ terminal of the battery.

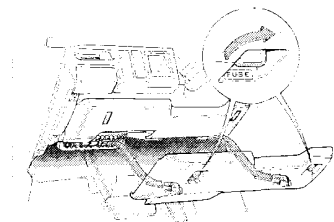

If any of your car's lights, accessories, or controls don't work, check their fuses. If a fuse has blown, the wire inside it will be burned through.

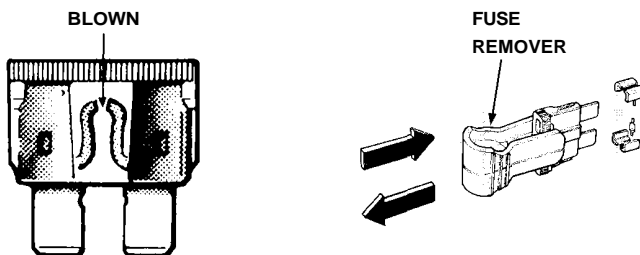

Checking the fuses:

1. Turn off the ignition and all other switches.
2. If you find a blown or possibly faulty fuse, use the fuse remover, stored beside the spare fuse to pull the blown fuse out of its clips.
3. Check all other fuses as well as the one you suspect.
4. Push in a new fuse of the same rating, and make sure it fits tightly in the clips. If it fits loosely, have your dealer fix it.

If you don't have a spare, take a fuse of the same rating (or lower) out of a circuit you may not need, like the radio or cigarette lighter. Remember to replace the borrowed fuse and the missing spares.

CAUTION:

A blown fuse may be just a symptom of some other problem. If a new fuse blows right away, the cause should be diagnosed and corrected by a qualified Honda technician. Never replace a fuse with anything but another fuse of the same or lower rating. A higher capacity fuse could cause damage and even start a fire.

(cont'd)

Fuse Replacement (cont'd)

The main fuse and some primary fuses are installed on the right front fender beside the battery.

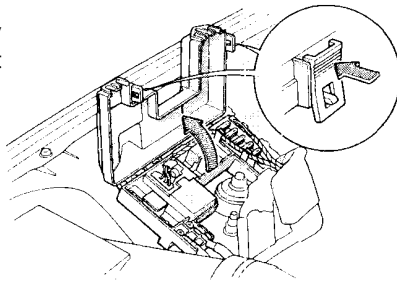

If the circuits from the battery are ever overloaded (by a short in the system drawing too much current for example) the main or a primary fuse will blow, preventing damage to the entire wiring harness. If the main fuse blows, have a Honda dealer check the system, repair the cause, and replace the fuse.

CAUTION:

- **The electrical system is protected by fuses that are designed to fail and prevent damage to the wire harness. Always replace blown fuses with the same rating as specified to prevent wiring damage that can result in a possible fire.**
- **For proper electrical contact after replacing these fuses, make sure all screws are tight.**

Bulb Replacement

NOTE:

See page 110 for bulb specifications.

Front turn signal lights

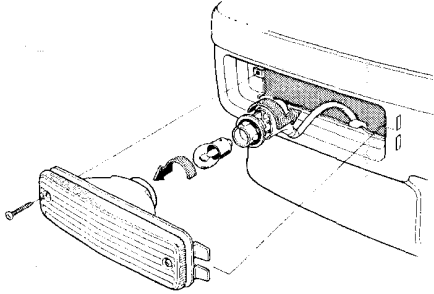

Front side marker and parking lights

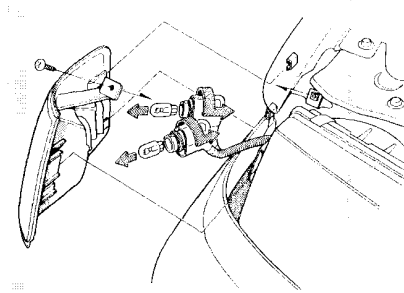

License plate lights

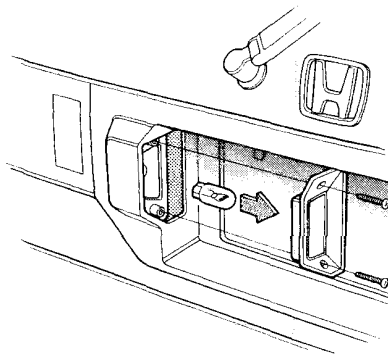

(cont'd)

Bulb Replacement (cont'd)

Rear side marker, turn signal, brake, taillights and back-up lights

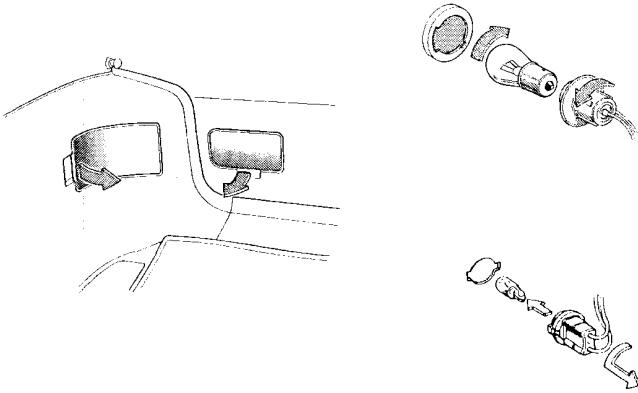

Interior light

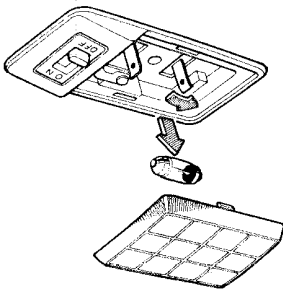

Luggage area light

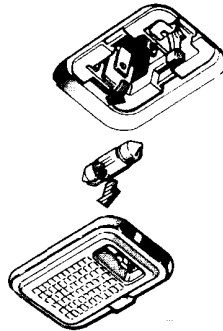

High mount brake lamp

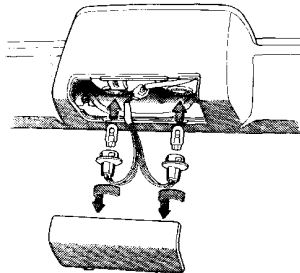

Tires

The factory-installed tires on your car were selected to provide the best performance for normal driving.

Inflation Pressures

The tire label in the glove box lists recommended tire pressures for carrying loads up to the limit shown. (Tire pressures are also listed on the back cover of this manual.)

These pressures were chosen to provide you with the best combination of tread life, riding comfort and stability under normal driving conditions.

Improper inflation can reduce both tire life and load carrying capacity. Check the tire pressures at least once a month, including the spare.

Lower pressure than recommended lets the tread and sidewalls flex too much, causing increased tire temperatures, uneven wear, and poor handling. Pressure higher than recommended can make the tire too stiff, increasing the chance of damage from road hazards, and also causing uneven wear.

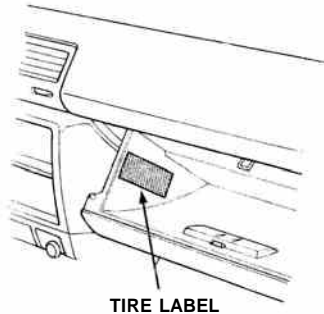

CAUTION:

- **Check tire pressure when the tires are cold.**
(After the car has been parked for more than 3 hours or driven less than 1 mile/1.6 km).
- **Tire pressure may increase as much as 41 kPa (6 psi) when the tire is hot, so NEVER ADJUST tire pressure when the tires are hot.**
- **Never inflate load range B tires to more than 220 kPa (32 psi) cold.**
- **Cars with luggage racks or cartop carriers DO NOT have greater load limits than those on the label.**

Snow Tires

If you use snow tires, they should have the same load capacity as the original equipment tires, and they must be installed in sets of four, or they may cause poor handling. They should be inflated to 28 kPa (4 psi) (cold) above the recommended pressure on the tire label in the glove box. Cars with snow tires should not be driven faster than 75 mph (120 km/h).

(cont'd)

Tires (cont'd)

Tire Chains

When required, tire chains should be installed on the front wheels. If you are using metal type chains, make sure they are designated SAE Class "S". You may also use plastic or cable type "chains". Use only the correct size chains recommended for your tire size and make sure they are installed following the chain manufacturer's instructions.

Once tire chains are installed, drive at less than 19 mph (30km/h) on roads covered with snow or ice. To minimize tire and chain wear, avoid driving on cleared roads with chains installed.

CAUTION:

Improper installation or loose tire chains may damage your car's chassis and fenders.

NOTE:

Keep the manufacturer's installation instructions in your glove box for future reference.

Tire Rotation

Tires may wear unevenly when used for a long time at the same position on the car. To avoid this, rotate the tires every 7,500 miles (12,000 km). If abnormal or uneven wear develops between rotations, the cause should be found and corrected as soon as possible. The illustration shows how the tires can be rotated. The COMPACT spare tire must not be included in tire rotation.

NOTE:

Front brake pads should be inspected for wear whenever the tires are rotated.

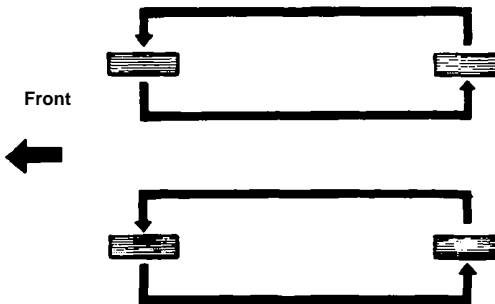

Tire Balancing

Unbalanced tires may affect handling and tire wear. A tire should always be rebalanced after it has been dismantled from the wheel. Your original tires were properly balanced before the car left the factory, but may need rebalancing at some time during the life of the tire. Tire balancing for the COMPACT spare is not necessary.

Tire Traction

Worn tires or slippery road surfaces can reduce driving, cornering and braking traction. To reduce the possibility of losing traction, slow down when the road gets slippery, replace tires when wear indicators are visible, and KEEP TIRES PROPERLY INFLATED.

Tire Replacement

The original tires on your car have tread wear indicators to indicate when they should be replaced. The indicators appear as bands about 12.7 mm (1/2 in) wide when the tire tread depth is less than 1.6 mm (1/16 in). When indicators appear across two or more grooves in a row, you should replace the tire.

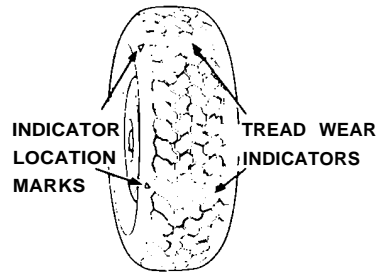

Driving on worn-out or under-inflated tires is very hazardous, and will reduce braking effectiveness, steering accuracy and traction.

When replacing tires, use only the recommended tire size. Wheel rim widths and offsets must be those recommended by American Honda Motor Co., Inc. Contact the Zone Office nearest you as shown on the inside of the back cover.

Tires and wheels other than those recommended may be unsafe. Do not mix radial and bias ply tires on the same car.

(cont'd)



Tires (cont'd)

Mixing radial and bias ply tires or different sized tires can adversely affect your car's handling, which could lead to loss of control and possible injury.

Additional 4WD Tire Information

Unevenly worn tires, or different sized tires, can cause the 4WD mechanism to engage abnormally, which may eventually damage the transmission. Therefore, observe the following precautions carefully:

- Rotate the tires at least every 7,500 miles (12,000 km).
- Replace worn tires in sets of four.
- If replacement of all four tires is not practical (because of damage to an individual tire, for example), always replace with the same size, brand and type as those currently on the car.

Air Conditioner Care

Condenser and Radiator

Check the engine radiator and the air conditioner condenser (in front of the radiator) for accumulated dirt, insects or leaves. Carefully brush or hose them off to assure maximum cooling performance.

CAUTION:

Radiator and condenser fins are very thin and easily damaged; do not bend them with the high water pressure or brush.

Compressor Drive Belt

Check the compressor belt tension monthly, during periods when you use the air conditioner a lot.

If the engine has been running, some engine components may be hot enough to burn you.

When pushed with 98 N (22 lb) of force midway between the compressor drive pulley and the engine crankshaft pulley, the belt should deflect about:

7.0- 9.0 mm (0.28- 0.35 in)

Have the belt adjusted whenever necessary.

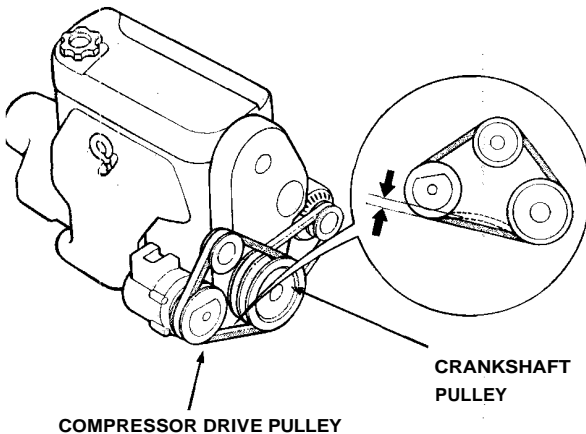



Air Conditioner Care (cont'd)

System Maintenance

Run your air conditioner at least once a week for about ten minutes, even during the off season, to lubricate the seals and the inside of the compressor and, to verify that the system is functional.

If the air conditioner is not cooling properly, it may indicate an undercharged system. Have your dealer check the system for leaks, then evacuate and charge the system with refrigerant 12.

Charging quantity:

850- 950 g (30.1- 33.6 oz)

CAUTION:

Prolonged use of an undercharged system may damage the compressor.



Appearance Care

Interior Trim

Remove dust and loose dirt with a vacuum cleaner.

Wipe the vinyl with a clean, damp cloth or sponge. Stains can be removed with a commercially available vinyl cleaner.

CAUTION:

Do not use thinner, gasoline, kerosene, naphtha or other solvents on the interior. They are toxic, flammable and hazardous and could damage the material you're cleaning.

Windows

A 10 to 1 mix of water and white vinegar, or a commercially available glass cleaner may be used to clean windows and to remove the dust film sometimes caused by the ingredients used in interior vinyls and plastics.

NOTE:

Do not put this solution in the windshield washer reservoir, it will damage the windshield washer pump.

Be careful not to scratch or damage the defogger wires when cleaning the inside of the rear window; wipe the window horizontally along the wires, not up and down. Dry the windows with a lint-free cloth or paper towel. Keep all the windows clean for maximum visibility.

Exterior Care

Washing

Rinse all loose dirt off the car by spraying it with lukewarm or cold water. Do not use hot water.

Wash using a soft bristle brush, sponge, or cloth with water containing a mild detergent, such as a liquid dishwashing detergent.

Remove oil, tar, tree sap, etc., with tar remover or turpentine. Remove road salt, insects, etc., with mild detergent and lukewarm water. Any of these substances may damage the finish if left on painted surfaces.

Rinse the car well. Promptly wipe with a chamois or soft towel to prevent water-spotting. Do not let water or soap air-dry on painted surfaces.

During wiping, inspect the surface for stone chips and scratches; paint them with touch-up paint so they won't rust (touch-up paint is available through your Honda dealer).

For further instructions on corrosion protection, refer to the Rust Prevention section on page [96](#).

(cont'd)



Appearance Care (cont'd)

Waxing

Wax the car when water will no longer "bead" on the paint.

Always wash and dry the car before you wax it.

Use a good quality liquid or paste wax, and follow the manufacturer's instructions. Wax all the metal trim to keep its luster.

NOTE:

Removing oil, tar, etc., with a spot remover will usually strip the wax from the surrounding finish. Be sure to re-wax these areas even if the rest of the car does not yet need waxing.

Rust Prevention

Rusting is likely to occur in parts of the car where water is trapped or where there is continual dampness.

- Water will collect inside doors and body panels if drain holes become clogged.
- Water which seeps under or soaks floor mats will subject floor sections to prolonged wetness or dampness.
- Road dirt or sand, which collects and fills recesses on the underside of the car, retains moisture long after the rest of the car has dried.

The removal of paint and undercoating by stones, gravel, and minor accidents immediately exposes metal to air and moisture.

Rusting is increased by high humidity and by the presence of corrosive substances in the air or on the roads.

- Salt used for road de-icing will coat the bottom of the car and hasten rusting.
- Localities with high humidity have greater potential for rust problems, especially where salt is also present on the road or in moist sea air.
- Industrial pollution will accelerate the deterioration of paint finishes and promote rusting.

Preventive Service

Check all drain holes in doors and body panels for clogging and clear if necessary. When washing your car, also clean the underside of the car by using high pressure water; ① above subframe, ② inside front fender, ③ rear suspension, ④ inside rear wheel housing, and ⑤ under rear bumper.

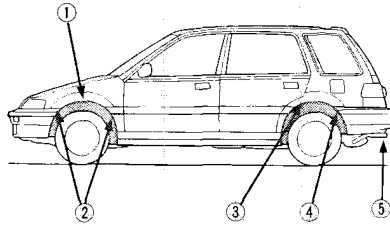

After washing your car or after heavy rain, check for leaks. While checking for leaks, lift the floor mats in the passenger, cargo and spare tire areas, and check beneath them. Water can collect in these areas and remain unseen for prolonged periods. Dry any wet areas of your car's interior. Remove and dry wet floor mats. Have leaks repaired as soon as possible.



Body Repair

Replacement Body and Fender Parts

If your vehicle incurs body damage and requires replacement parts, we encourage you to use only Genuine Honda sheet metal body and fender parts. Many insurance companies are specifying imitation sheet metal parts for collision repairs in an effort to reduce claim costs; however, if imitation parts are used the following conditions may apply:

- There is no assurance that imitation parts will equal the fit and finish of Genuine Honda sheet metal parts; and in our experience they often do not.
- There is no assurance that imitation parts will resist corrosion as well as Genuine Honda sheet metal parts.
- Imitation sheet metal parts are not covered by the Honda Limited Warranty.

To ensure your continued satisfaction with your Honda vehicle in the event of an accident, contact your insurance adjuster and insist on Genuine Honda parts in the repair of your vehicle.

Spare Tire

COMPACT Spare Tire

Your car is supplied with a COMPACT spare tire and wheel for temporary use only in the event of a flat tire. Use the COMPACT spare only when you have to, and only to go as far as the next garage or dealer to have the regular tire repaired and reinstalled.

Because you will rarely use the COMPACT spare, be sure to regularly check its condition and air pressure (415 kPa, 60 psi), so it will be ready when you need it. This type of tire holds less air at higher pressure than a regular tire, so it will inflate (or deflate if there is a leak) more rapidly; check its pressure often and add air gradually if it needs any.

- The COMPACT spare tire has a different tire size, air pressure requirement, tread life and maximum speed rating than the four regular tires on your car. Disregarding these warnings may result in tire failure, loss of vehicle control and possible injury to vehicle occupants.
- Do not exceed 50 mph (80 km/h) under any circumstances when using the COMPACT spare.
- Do not mount snow chains on the COMPACT spare. They will not fit properly and will damage the tire and possibly your car. If you must use the COMPACT spare when driving on roads covered with snow or ice, use it as one of the rear tires and mount chains only on the front two regular tires.

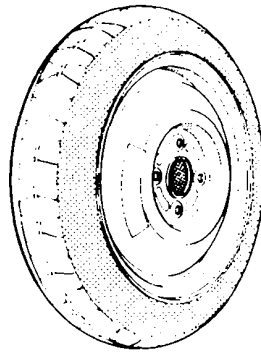

(cont'd)

Spare Tire (cont'd)

- The COMPACT spare tire has a much shorter tread life than regular tires. Replace the tire as soon as tread wear indicators appear as solid bands across the tread. Replace with a tire of exactly the same size and construction.

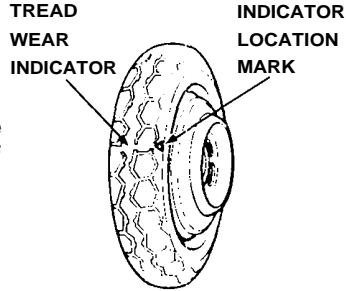

- The COMPACT spare tire and wheel set was designed especially for your car; do not use it on any other vehicle; do not install any other tire on this wheel which is not identical to the original in size and construction, and do not use the COMPACT spare tire on any other wheel.
- Because the COMPACT spare is smaller in size and higher in air pressure than a regular tire, it will ride more harshly with less ground clearance and may have less traction on some road surfaces. Drive cautiously.

Changing a Flat Tire

Do not attempt to change a tire unless the car is on firm, level ground and well out of the flow of traffic.

Park the car on a firm, level surface, apply the parking brake, turn on the hazard warning switch and put the transmission in gear (Park for automatic).

1. Remove the jack, lug wrench/jack handle and jack handle extension (in the tool bag) from the location shown.

NOTE:

To remove the jack, release its tension against the mount by turning the screw counterclockwise.

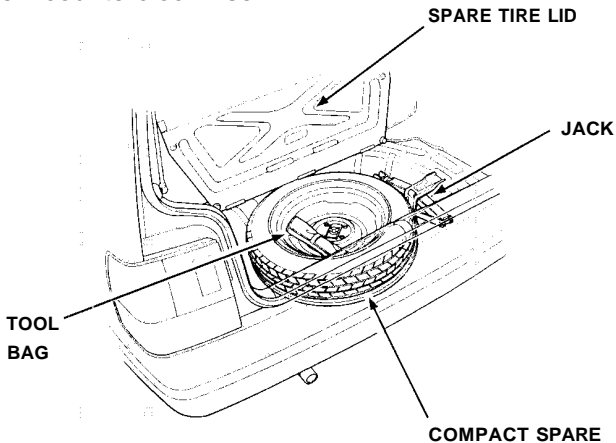

2. Remove the spare tire. (On the 4WD, remove the spare tire bucket before removing the spare tire.)
3. Place blocks in front and back of the wheel diagonally opposite the tire you are changing.
4. Use the lug wrench/jack handle to loosen the wheel lug nuts counterclockwise one-half turn.

Follow tire changing preparations and procedures carefully to reduce the possibility of injury. The jack is designed for changing tires only. STAND CLEAR, DO NOT get under the car and DO NOT run the engine when the car is supported only by the jack.

(cont'd)

Changing a Flat Tire (cont'd)

- Place the jack under the jack point nearest the wheel you are removing; align the jack head so the car frame will fit in the recess as you raise the jack.

To reduce the possibility of injury, be sure to use the jack provided with the car and the correct jacking points; never use any other part of the car for jack support.

- Set the jack handle extension in the connector on the end of the jack and install the lug wrench/jack handle. Turn the lug wrench/jack handle clockwise until the tire is slightly off the ground.

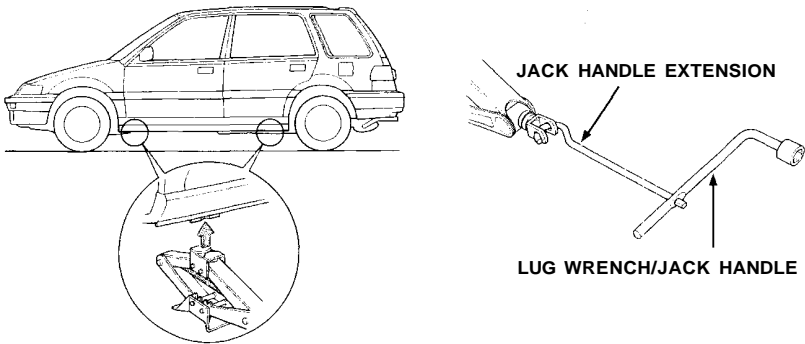

- Remove the lug nuts, semi-cap and wheel.
(Semi-cap:4WD)
- Install the spare tire; and install the lug nuts hand tight.

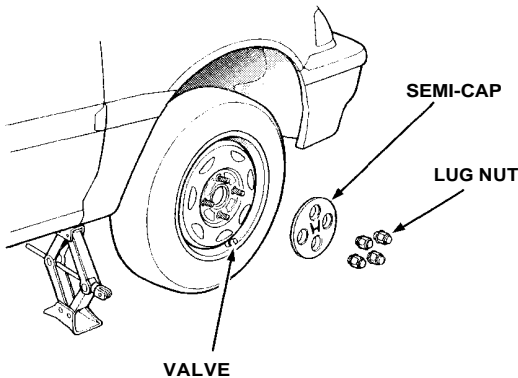

9. Lower the car, remove the jack, then tighten the lug nuts securely in an "X" pattern as shown.
10. Tighten the lug nuts securely. The recommended torque is:
 110 N·m (11 kg·m, 80 lb·ft)
 If a torque wrench was not used, ask an authorized Honda dealer to verify the torque as soon as possible.

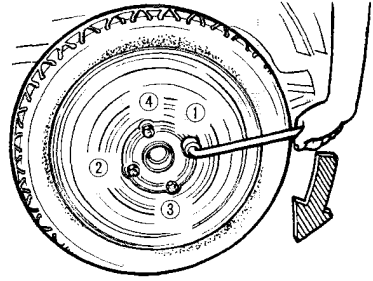

**TIGHTENING
 TORQUE:
 110 N·m (11 Kg·m, 80 lb·ft)**

11. Repair or replace the damaged tire as soon as you can, then reinstall it in its original position on the car, and put the spare back in the car.

Always stow the jack, tools and tire securely to prevent them from becoming dangerous projectiles in an accident.

12. Secure the tire and the spacer as shown in the illustration.

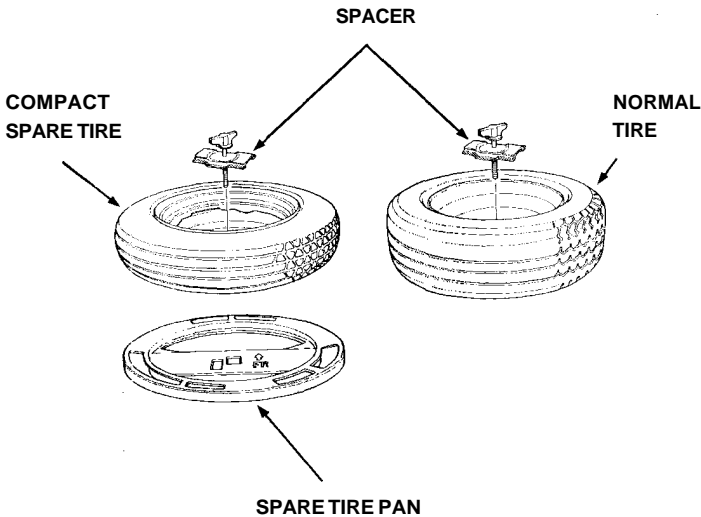

Jump Starting

To start a car with a dead battery, use another battery of the same voltage, and the proper jumper cables.

- Procedures other than those below could cause injury or damage from battery acid spray, explosion or charging system overload.
- Never connect the jumper cable directly to the negative post of the "dead" battery.
- Never allow the two cars to touch each other.
- Never allow the jumper cable clamps to touch each other.
- Never lean over the battery when making connections.
- Never attempt to jump start a vehicle with a frozen battery. The battery could rupture and explode. If you suspect a frozen battery, remove the vent caps and check the fluid. If there seems to be no fluid, or if you see ice, do not attempt a jump start until the fluid thaws.

CAUTION:

If jumper cables are connected backwards, the car's main fuse may blow.

1. Turn off all lights, heater and other electrical loads, set parking brake, and shift transmission to Neutral or Park.
2. Use one cable to connect the positive terminal of the booster battery to the positive terminal of the "dead" battery.

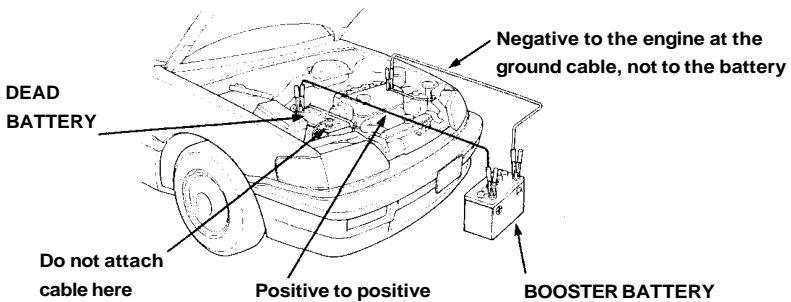

3. Use the other cable to connect the negative terminal of the booster battery to the engine at the ground cable as shown.
4. To remove the cables, reverse the above procedures exactly.

DO NOT push or tow a car to start it. The forward surge when the engine starts could cause a collision. Also, under some conditions, the catalytic converter could be damaged. A car equipped with an automatic transmission cannot be started by pushing or towing.

Towing

If towing is necessary, contact a professional towing service. Your authorized Honda dealer can assist you with detailed towing instructions.

Never use tow chains or rope to tow a car; your ability to safely control the car may be adversely affected.

We recommend the following:

Flat Bed Equipment—Entire car is winched on a flat bed vehicle. This is the best way of transporting your Honda.

Wheel Lift Type—Tow with the front wheels off the ground.

If the car can only be towed with the front wheels on the ground: make sure the transmission is full of fluid (see page 70 - 71) and tow with the transmission in neutral (N) and the ignition key in the I position.

CAUTION:

To avoid serious damage on automatic transmission cars, first start the engine and shift to D4 (D on 4WD) then to N and shut the engine off. If the engine does not run or the transmission cannot be shifted while the engine is running, the car must be transported on flat bed equipment.

Check local regulations for towing.

CAUTION:

- Do not exceed 35 mph (55 km/h) or tow for distances of more than 50 miles (80 km).
- If a Sling Type tow is used, the tow truck driver should position wood spacer blocks between your car's frame and the chains and lift straps to avoid damaging the bumper and the body.
- Do not use the bumpers to lift the car or to support the car's weight while towing.
- (4WD) Before towing the car with either the front or rear wheels raised off the ground, place the transmission in neutral and manually disengage the 4WD system to prevent the raised wheels from turning (see page 58).



If Your Car Gets Stuck

If your car gets stuck in sand, mud, or snow, call a professional towing service for assistance in getting your car out.

CAUTION:

- **Do not rev up the engine and allow the wheels to spin freely at high speed. Severe transmission damage may result if the wheels are allowed to spin for more than a few seconds.**
- **DO NOT try to free a car with automatic transmission from snow etc. by rocking the car alternately between forward and reverse gears. Severe transmission damage may result from shifting into gear with the wheels moving.**

Shoulder Belt Buckle

Proceed as follows if the shoulder belt buckle stalls.

1. Lift the hood and remove the cover from the fuse case (for the automatic shoulder belt buckle motor) located on the battery's \oplus terminal.
2. Remove the fuse for the automatic ("passive") shoulder belt buckle motor that does not work.

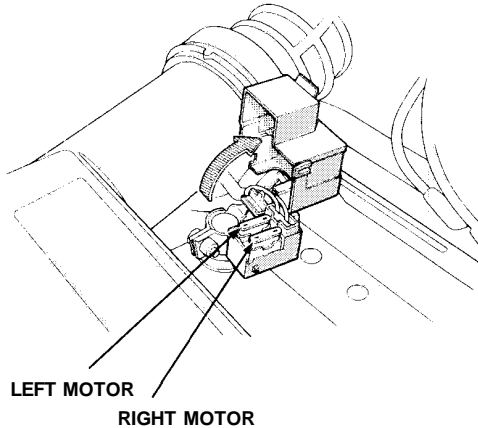

3. If the fuse has blown, replacing it with a new fuse of the same amperage should allow the shoulder belt buckle motor to work. However, if the fuse hasn't blown, or if a new fuse did not solve the problem, remove the fuse and operate the motor manually.

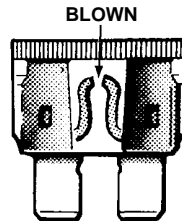

CAUTION:

Always remove the fuse before manually operating the shoulder belt buckle motor, otherwise the motor may suddenly activate.

(cont'd)

Shoulder Belt Buckle (cont'd)

4. Remove the cover located on the center pillar.

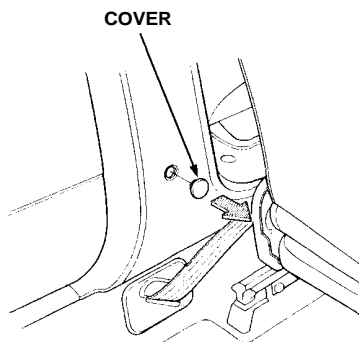

5. Set the wrench extension into the wrench grip (both provided in the tool bag) then insert the wrench into the socket and turn it counterclockwise until the shoulder belt buckle reaches its rear locked position.

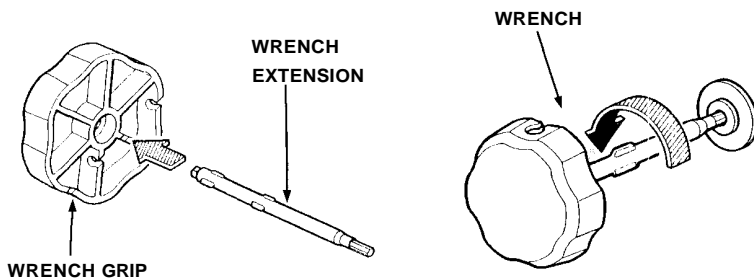

NOTE:

After the manual operation, make sure that the seat belt warning light is off and the shoulder belt buckle is seated properly in its locked position.

6. Replace the cover on the center pillar.
7. Reinstall the fuse, the fuse remover and both fuse box covers.



Specifications

Dimensions		CIVIC WAGON	4WD
Length		4,105 mm (161.6 in)	
Width		1,690 mm (66.5 in)	
Height		1,490 mm (58.7 in)	
Wheelbase		2,500 mm (98.4 in)	
Track	Front	1,440 mm (56.7 in)	
	Rear	1,450 mm (57.1 in)	

Weights

Gross vehicle weight rating	See the certification label attached to the left rear door jamb.
-----------------------------	------------------------------------------------------------------

Tires

Size/Pressure	See the tire label attached to the inside of the glove box.
---------------	-------------------------------------------------------------

Capacities

Fuel tank		45 ℓ (11.9 US gal, 9.9 Imp gal)	
Radiator Manual transmission	Change* 1	4.1 ℓ (1.08 US gal, 0.90 Imp gal)	4.0 ℓ (1.06 US gal, 0.88 Imp gal)
	Total	5.5 ℓ (1.45 US gal, 1.21 Imp gal)	5.4 ℓ (1.43 Imp gal, 1.19 Imp gal)
Radiator Automatic transmission	Change* 1	4.0 ℓ (1.06 US gal, 0.88 Imp gal)	4.5 ℓ (1.19 US gal, 0.99 Imp gal)
	Total	5.4 ℓ (1.43 US gal, 1.19 Imp gal)	5.9 ℓ (1.56 US gal, 1.30 Imp gal)
Engine Oil	Change* 2	3.5 ℓ (3.7 US qt, 3.1 Imp qt)	
	Total	4.0 ℓ (4.2 US qt, 3.5 Imp qt)	
Manual transmission oil	Change	1.8 ℓ (1.9 US qt, 1.6 Imp qt)	2.3 ℓ (2.4 US qt, 2.0 Imp qt)
	Total	1.9 ℓ (2.0 US qt, 1.7 Imp qt)	2.4 ℓ (2.5 US qt, 2.1 Imp qt)
Automatic transmission fluid	Change	2.4 ℓ (2.5 US qt, 2.1 Imp qt)	3.2 ℓ (3.4 US qt, 2.8 Imp qt)
	Total	5.4 ℓ (5.7 US qt, 4.8 Imp qt)	6.4 ℓ (6.8 US qt, 5.6 Imp qt)
Rear differential oil	Change	/	
	Total		
Rear differential oil	Change	/	
	Total		
Windshield washer fluid reservoir		2.5 ℓ (2.6 US qt, 2.2 Imp qt)	

* 1 Excluding the coolant in the reserve tank and that remaining in the engine:

0.4 ℓ (0.11 US gal, 0.09 Imp gal)

* 2 Excluding the oil remaining but including that remaining in the oil filter.

(cont'd)



Specifications (cont'd)

Engine	CIVIC WAGON	4WD
Type	Water cooled, 4-stroke OHC gasoline engine	
Bore x Stroke	75.0 x 84.5 mm (2.952 x 3.326 in)	75 x 90 mm (2.95 x 3.54 in)
Displacement	1,493 cm ³ (91.1 cu-in)	1,590 cm ³ (97.0 cu-in)
Compression ratio	9.2	9.1
Spark plug	See spark plug maintenance section page 81.	

Alignment

Toe-in	Front	0 mm (0.0 in)	
	Rear	2 mm (0.1 in)	
Camber	Front	0° 19'	0° 35' ± 1°
	Rear	-0° 23'	0° 00' ± 1°
Caster	Front	2° 58'	2° 56' ± 1°

Battery

Capacity	12V — 47AH
----------	------------

Lights

Headlights	12V — 65/55W (C6)	
Front turn signal lights	12V — 45CP (SAE 3497)	
Rear turn signal lights	12V — 32CP (SAE 1156)	
Stop/Taillights	12V — 32/2CP (SAE 2057)	
Side marker lights	Front	12V — 5W
	Rear	12V — 3CP (SAE 168)
Back-up lights	12V — 32CP (SAE 1156)	
High mount brake light	12V — 21CP	
License lights	12V — 8W	
Interior light	12V — 5W	
Luggage area light	12V — 3.4W	

Fuses

In the fuse box	See the fuse label attached to the inside of the fuse compartment door under the dashboard.
In the relay box	See the fuse label attached to the relay box cover under the hood.

Identification Numbers

The **Vehicle Identification Number (V.I.N.)** is stamped on a plate attached to the top left side of the dashboard.

It also appears on the Certification label attached to the left rear door jamb, as well as under the hood on the body, directly behind the engine.

NOTE:

The V.I.N. is also provided in bar code on the Certification label.

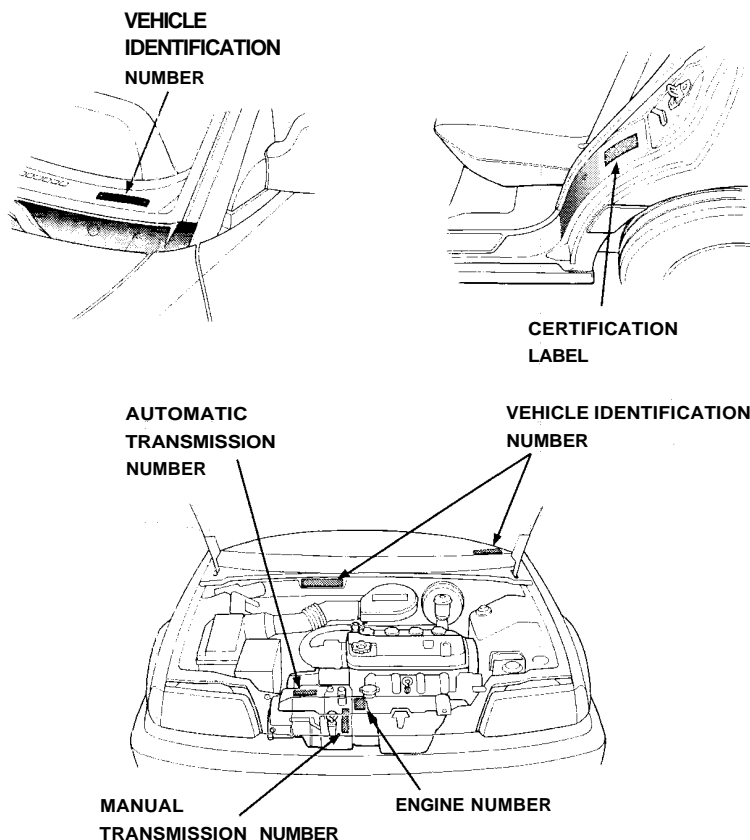

The **Engine Number** is stamped on the right front side of the engine block.

The **Transmission Number** appears on a label on the top edge of the transmission where it attaches to the engine.

DOT Tire Quality Grades

The tires on your car meet Federal Safety Requirements. All tires are also "graded" according to Department of Transportation (DOT) standards for tread wear, traction and temperature.

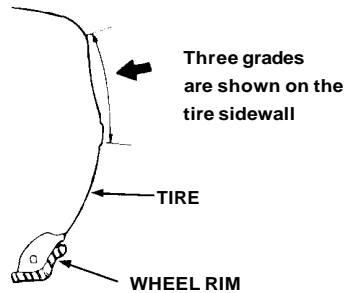

Tread Wear

The tread wear grade is a comparative rating based on the wear rate of the tire when tested under controlled conditions on a specified government test course. For example, a tire graded 150 would wear one and one half (1-1/2) times as well on the government course as a tire graded 100.

The relative performance of tires depends upon the actual conditions of their use, however, and may depart significantly from the norm due to variations in driving habits, service practices and differences in road characteristics and climate.

Traction

The traction grades, from highest to lowest, are A, B, and C, and they represent the tire's ability to stop on wet pavement as measured under controlled conditions on specified government test surfaces of asphalt and concrete. A tire marked C may have poor traction performance.

The traction grades assigned are based on braking (straight ahead) traction tests and do not include cornering (turning) traction.

Temperature

The temperature grades are A (the highest), B and C representing the tire's resistance to the generation of heat and its ability to dissipate heat when tested under controlled conditions on a specified indoor laboratory test wheel. Sustained high temperature can cause the material of the tire to degenerate and reduce tire life, and excessive temperature can lead to sudden tire failure. The grade C corresponds to a level of performance which all passenger car tires must meet under the Federal Motor Vehicle Safety Standard No. 109. Grades B and A represent higher levels of performance on the laboratory test wheel than the minimum required by law.

The tire temperature grade is established for a tire that is properly inflated and not overloaded. Excessive speed, underinflation, or excessive loading, either separately or in combination, can cause heat buildup and possible tire failure.



Emission Controls

Sources of Emissions

The combustion process produces carbon monoxide, oxides of nitrogen and hydrocarbons. The evaporation of fuel in the fuel tank also produces hydrocarbons. Control of oxides of nitrogen and hydrocarbons is very important since, under certain conditions, when subjected to sunlight, they react to form photochemical smog. Carbon monoxide does not react to form smog, but it is toxic.

Honda Motor Co., Ltd. has developed a number of systems which are highly effective in reducing carbon monoxide, oxides of nitrogen and hydrocarbons.

The Clean Air Act

The Clean Air Act requires all vehicle manufacturers to explain in writing, the operation and maintenance of their emission control systems.

Maintenance instructions are included on pages [60—65](#); the operation of each system is explained on the following pages.

Replacement Parts

The emission control systems on your new Honda were designed, built and certified to conform with the Federal regulations implementing the Clean Air Act. Honda recommends only the use of new, genuine Honda parts or their equivalent. The use of other replacement parts which are not of equivalent quality may impair the effectiveness of your car's emission control systems.

Crankcase Emission Control System

To prevent crankcase emissions, your car is equipped with a Positive Crankcase Ventilation (PCV) System which routes blowby gases from the crankcase, through the PCV valve and intake manifold, into the combustion chamber.

Evaporative Emission Control System

The Evaporative Emission Control System is designed to prevent fuel vapors from escaping into the atmosphere.

Fuel vapors from the fuel tank are directed into the charcoal canister where they are adsorbed and stored while the engine is stopped or idling. When the coolant temperature rises to a certain value, the vapors are drawn into the engine through the throttle body and the intake manifold during normal engine operation.

Engine Exhaust Emission Controls

The engine exhaust emission control systems are designed to control combustion during idle, acceleration, cruise, and deceleration. These systems are entirely separate from the crankcase and evaporative emission control systems described previously.

HONDA PGM-FI System

The PGM-FI system consists of three independent sub-systems; Air Intake, Electronic Control and Fuel Control, thus allowing more accurate control of air/fuel ratios under all operating conditions. The Electronic Control Unit (ECU) detects the amount of air drawn into the cylinders and determines the amount of fuel to be injected to provide the optimum air/fuel ratio for all engine needs.

Ignition Timing Control System

This system automatically controls the ignition timing to reduce the amount of HC and NOx.

Catalytic Converter

Three Way Catalyst

The catalyst is used to convert hydrocarbons (HC), carbon monoxide (CO) and oxides of nitrogen (NOx) in the exhaust gas, to carbon dioxide (CO₂), dinitrogen (N₂) and water vapor.

Exhaust Gas Recirculation (EGR)

[California automatic models with 1.5 l engine]

The EGR system is designed to control the formation of oxides of nitrogen (NOx) caused when fuel mixture burns at high temperature. It works by recirculating exhaust gas through the EGR valve and intake manifold into the combustion chambers where it reduces peak temperature by diluting the air/fuel mixture.

Catalytic Converter

A catalytic converter is installed in the exhaust system to help clean-up the exhaust gases that can cause air pollution.

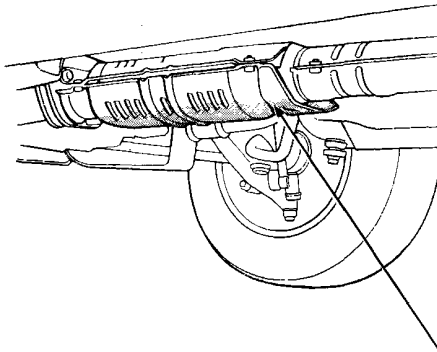

CATALYTIC CONVERTER

To be effective, the converter must work at high temperature, so don't park your car over dry grass, leaves or anything else that could burn easily.

To stay effective, the converter must not be contaminated by leaded gasoline, use only unleaded gas as explained on page 40.

CAUTION:

The converter can be overheated and damaged if it's fed too much unburned fuel mixture from the engine, so:

- Don't push or tow the car to start it; if the battery is dead, jump start the car as shown on page 104.
- Don't turn the key off while the engine is running above idl e speed.
- Don't change the ignition timing, or remove any emission control parts.
- Use only the spark plugs specified in this manual.
- Don't keep driving your car if it isn't running properly, or if its CHARGE warning light comes on; have it checked by your Honda dealer.

Warranty Service

Warranty

The following warranties are provided with every new vehicle:

1. New Car Limited Warranty
2. Emission Control Systems Warranty
3. Emission Controls Performance Warranty
4. Battery Limited Warranty
5. Rust Perforation Limited Warranty
6. Accessory Limited Warranty
7. Replacement Parts Limited Warranty
8. Replacement Muffler Lifetime Limited Warranty
9. Replacement Engine Limited Warranty
10. Seat Belt Limited Warranty.

All warranties pertaining to your car can be found in the Warranty booklet provided with your new car except the required maintenance schedule which is contained here in the Owner's Manual.

If you are unable to obtain warranty service or are dissatisfied with the warranty decision or service you received at an authorized Honda dealership, you should review the matter with that dealership's Service Manager. This will normally resolve your problem. If it does not resolve your problem you should appeal the decision with the owner of the dealership. Please bear in mind that your problem will likely be resolved at the dealership, using the dealer's facilities, equipment and personnel. So it is very important that your initial contact be with the dealer or his management.

After following these steps, if you wish to have the matter reviewed by American Honda you should contact the Automobile Zone Office serving your area, as shown on the map on the inside of the back cover. When contacting American Honda, please provide the Automobile Zone Office with the following information:

- Vehicle Identification Number
- Servicing Dealer Name and Address
- Date of Purchase
- Mileage on your Car
- Your Name, Address, and Phone Number
- Nature of Problem
- Selling Dealer

After a review of the facts, you will be advised of what can be done.



Index

A

Air Conditioner	
Care.....	93
Operation.....	36
Air Filter.....	80
Air Pressure,Tires.....	89
Antifreeze	
.....See "Radiator Coolant"	
Anti-theft Steering Column Lock	
System	43
Appearance Care.....	95
Ashtrays.....	32
Automatic Transmission	
Driving Technique	
(CIVIC WAGON).....	51
Driving Technique(4WD).....	54
Fluid.....	71
Operation	
(CIVIC WAGON).....	50
Operation(4WD)	53
Shift Lever Position Indicator	
.....	21

B

Battery	
Charging System Warning	
Light.....	22
Jump Starting	104
Maintenance.....	84
Specification.. ..	110
Beeper System	
Fasten Seat Belt Warning	
Bee per.....	11
Key Reminder	43
Belts, Seat.....See"Seat Belts"	
Body Repair	98
Brake Warning Light	23
Brakes	
Brake Failure Warning	
Light	23
Brake Fluid	78
Brake System Design	77
Brake Wear	77
Brake Wear Indicators.....	78
Parking Brake	27
Parking Brake Warning	
Light	23
Break-in Period.....	2
Bulb	

Replacement.....	87
Specification	110
Buzzer	See"Beeper System"

C

Capacities	109
Care and Cleaning	95
Catalytic Converter	116
Certification Label	111
Chains, Tires	90
Check Engine	
Warning Light	21
Child Proof Door Locks.....	4
Child Restraint System	14
Cigarette Lighter	32
Clock.....	33
Clutch Pedal Adjustment	48
COMPACT Spare Tire.....	99
Coolant Temperature Gauge	20
Cooling(with A/C)	37
Cooling System.....	73
Crankcase Emission Control	
System	114

D

Defogger	26
Defroster.....	39
Doors	
Child Proof Door Locks	4
Door Locks.....	3

E

Emergency	
Changing a Flat Tire.....	101
Hazard Warning System	27
If Your Car Gets Stuck	106
Jump Starting	104
Towing.....	105
Warning and Indicator	
Lights.....	21
Emission Controls.....	114
Engine	
Coolant	73
Coolant Temperature	
Gauge	20
Exhaust Controls	115
Identification Number.....	111

(cont'd)



Index (cont'd)

- Oil and Filter.....67
 - Oil Pressure Warning Light.....22
 - Specification110
 - Engine Exhaust Gas Warning46
 - Evaporative Emission Control System115
 - Exhaust Gas Recirculation.....115
 - Exterior Care.....95
- F**
- Filters
 - Air.....80
 - Engine Oil68
 - Fuel.....80
 - Fluid.....See"Oil"
 - Foreign Countries, Operation in.....41
 - Four-Wheel DriveSee"Real Time 4WD"
 - Front Seat Adjustment5
 - Fuel
 - Filler Door and Cap41
 - Filter80
 - Gasohol.....40
 - Gasoline40
 - Gauge20
 - Requirement.....40
 - Fuse
 - Checking and Replacing.....85
 - Specification110
- G**
- Gasoline.....See"Fuel"
 - Gas Station Informationback cover
 - Gauges20
 - Glove Box31
- H**
- Hazard Warning System29
 - Headlights
 - Flasher.....28
 - High Beam Indicator.....21
 - High Beam/Low Beam Switch.....28
 - Switch.....28
 - Headlight High Beam Indicator Light21
 - Head Restraints6
 - Heating.....38
 - High Beam Indicator Light21
 - Switch.....28
 - Hood Latch.....31
- I**
- Identification Numbers.....111
 - Ignition Keys.....3
 - Switch43
 - Indicator Lights21
 - Inflation Pressures, Tire89
 - Instrument Panel.....18
 - Instrument Panel Brightness Control.....29
 - Interior Light29
 - Interior Trim Care95
- J**
- Jack111
 - Jump Starting104
- K**
- Keys
 - Door Locks3
 - Ignition43
 - Key Reminder Buzzer.....43
 - Keys.....3
 - Tailgate Lock.....4
- L**
- Lap/Shoulder Belts,See"Seat Belts"
 - Light
 - Bulb Replacement87
 - Fuse Replacement85
 - Operation28
 - Warning and Indicator Light21



Locks	
Anti-theft Steering Column	
Lock	43
Child Proof Door Locks.....	4
Doors.....	3
Fuel Filler Door	41
Tailgate.....	4
Luggage Area Light.....	30

M

Maintenanse	
Non-Scheduled Maintenance	
Record	64
Required Maintenance Record	
.....	63
Schedule	60
Manual Transmission	
Clutch Pedal Adjustment	48
Maximum Allowable Speeds	
.....	48
Oil.....	70
Recommended Shift Speeds	
.....	49
Shifting	47
Meters, Gauges.....	See "Gauges"
Mirrors	
Rearview Mirrors	27

N

Numbers, Identification.....	111
------------------------------	-----

O

Octane Rating, Gasoline	
.....	See "Fuel"
Odometer.....	20
Oil	
Engine Oil	67
Fluid Locations.....	66
Oil Pressure Warning Light.....	22
Transmission Oil/Fluid	70
Operation In Foreign Countries	
.....	41

P

Panel Brightness Control.....	29
Parking Brake... ..	27
Power Steering.....	79
Passive belt.....	8

Pressures, Tire Inflation	89
Preventive Service	97

R

Radiator Coolant	73
Real Time 4WD	58
4WD Disengagement	58
Rear Seat	6
Rearview Mirrors	27
Rear Window Defogger.....	26
Rear Window Wiper/Washer	26
Reminder Lights	
.....	See "Warning Lights"
Replacement	
Air Filter	80
Body and Fender Parts	98
Bulb.....	87
Engine Oil	68
Fuel Filter	80
Fuse.....	85
Oil Filter	68
Radiator Coolant	74
Spark Plugs.....	81
Tire	91
Wiper Blades	83
Rust Prevention.....	96

S

Safety Items.....	45
Seat Belt Warning Light and	
Beeper.....	11
Seat Belts	
Anchor Points	15
Automatic Belt	8
Buckling the Rear	
Seat Combination Lap/	
Shoulder Belts	12
Child Restraint.....	14
Cleaning	16
Emergency Belt Release.....	10
Fasten Seat Belt Warning	
Light and Warning Beeper	
.....	11
Front Seat Belts	8
Inspection.....	16
Installation of Child Seat.....	15
Pregnant Women.....	16
Rear Center Seat Belts.....	13

(cont'd)



Automobile Zone Office Locations

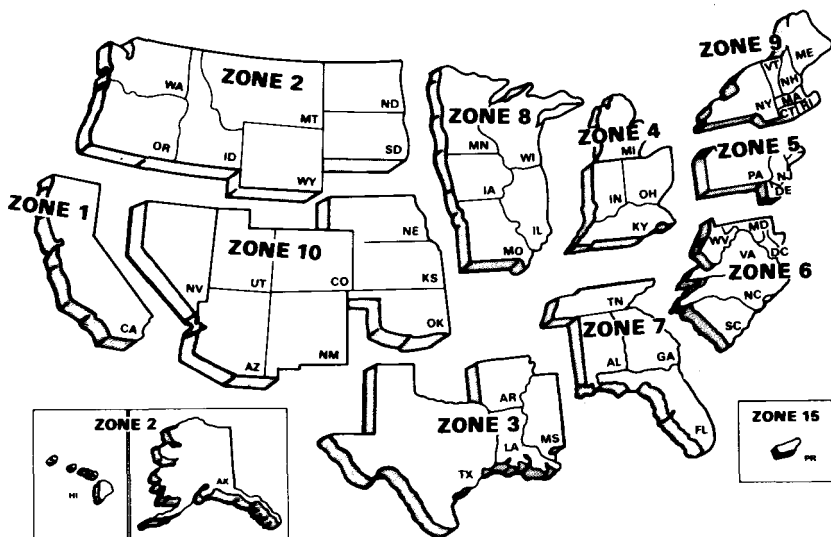

1 Western Zone
P.O. Box 2260
700 Van Ness Avenue
Torrance, California 90509-2260
(213) 781-4565

2 Northwestern Zone
P.O. Box 20186
12439 N.E. Airport Way
Portland, Oregon 97220
(503) 256-0943
(also includes Alaska and Hawaii)

3 South Central Zone
4529 Royal Lane
Irving, Texas 75063
(214) 929-5481

4 Central Zone
101 South Stanfield Road
Troy, Ohio 45373
(513) 332-6250

5 Northeastern Zone
P.O. Box 337
Eastgate Industrial Park
115 Gaither Drive
Moorestown, New Jersey 08057
(609) 235-5533

6 Mid-Atlantic Zone
209 Perry Parkway, Suite 10
Gaithersburg, Maryland 20877
(301) 990-2020

7 Southeastern Zone
1500 Morrison Parkway
Alpharetta, Georgia 30201
(404) 442-2045

8 North Central Zone
601 Campus Drive, Suite A-9
Arlington Heights, Illinois 60004
(312) 870-5600

9 New England Zone
555 Old County Road
Windsor Locks, Connecticut 06096
(203) 623-3310

10 West Central Zone
1600 South Abilene Street, Suite D
Aurora, Colorado 80012
(303) 696-3935

15 Puerto Rico and U.S. V.I.
Bella International
P.O. Box 816
Hato Rey, Puerto Rico 00919
(809) 765-8070

The above addresses and telephone numbers are subject to change. If you cannot reach your Zone office, ask your Honda dealer for the current information.



Gas Station Information

Gasoline: UNLEADED only
Pump octane of 86 or higher.

Gas Tank-Capacity : 45 l (11.9 gallons)

Tire Pressure (measured cold) front/rear

CIVIC WAGON : 220 kPa (32 psi)/220 kPa (32 psi)

4WD: 195 kPa (28 psi)/195 kPa (28 psi)

COMPACT spare: 415 kPa (60 psi)

Other Tire Information: See "Tires" pages 89 — 92.

Hood Release: Pull handle under left side of dash.

Engine Oil : An "Energy Conserving II" SG grade oil is recommended. See page 67 for viscosity recommendations.

Capacity (Including filter):

3.5 l (3.7 US qt, 3.1 Imp qt)

Rear Differential Oil (4WD):

Rear Differential Oil (4WD) :SAE 90 or 80

Hypoid GearOil: See page 70.

Manual Transmission Oil

Recommended type — SAE 10W — 30 or
10W-40 weight, grade SE or SF.

Capacity (Including differential):

CIVIC WAGON: 1.8 l (1.9 US qt, 1.6 Imp qt)

4WD: 2.3 l (2.4 US qt, 2.0 Imp qt)

Automatic Transmission Fluid:

Use DEXRON® II type Automatic Transmission Fluid (ATF). Unscrew dipstick in right end of transmission, wipe off, reinsert, remove and read fluid level — do not screw-in to check fluid level.

Capacity (Including differential):

CIVIC WAGON : 2.4 l (2.5 US qt, 2.1 Imp qt)

4WD: 3.2 l (3.4 US qt, 2.8 Imp qt)

Honda Motor Co., Ltd. 1989 All Rights Reserved

HONDA

AMERICAN HONDA MOTOR CO., INC.

P.O.Box 80, Gardena, CA., 90248

(213) 327-8280

