

# 1990 Accord Coupe Online Reference Owner's Manual

Use these links (and links throughout this manual) to navigate through this reference.  
For a printed owner's manual, click on authorized manuals or go to [www.helminc.com](http://www.helminc.com).

## Contents

---

### Owner's Identification Form

<b>Features &amp; Safety</b> .....	<b>2</b>
What you should know before driving your car.	
<b>Starting &amp; Driving</b> .....	<b>57</b>
What gas to use, how to change gears, etc.	
<b>Maintenance</b> .....	<b>78</b>
The Required Maintenance Schedule and some items you can service.	
<b>Emergency Service</b> .....	<b>113</b>
Changing a flat, jump starting, towing.	
<b>Specifications</b> .....	<b>124</b>
Dimensions, weights and capacities.	
<b>Consumer Information</b> .....	<b>126</b>
Reporting Safety Detects, warranty service, vehicle identification numbers, etc.	
<b>Index</b> .....	<b>135</b>

### Gas Station Information

---

This Owner's Manual should be considered a permanent part of the vehicle, and must remain with the vehicle at time of resale.

<b>OWNER'S I.D.</b>		
OWNER _____		
ADDRESS _____		
CITY _____	STATE _____	ZIP CODE _____
V.I.N. _____		
DELIVERY DATE _____		
(Date sold to original retail purchaser)		
DEALER NAME _____		DEALER NO. _____
ADDRESS _____		
CITY _____	STATE _____	ZIP CODE _____
OWNER'S SIGNATURE _____		
DEALER'S SIGNATURE _____		

The information and specifications included in this publication were in effect at the time of approval for printing. Honda Motor Co., Ltd. reserves the right however, to discontinue or change specifications or design at any time without notice and without incurring any obligation whatever.

# Introduction

---

This manual contains important information about the safe operation and maintenance of your car.

We urge you to read it carefully, become familiar with the controls it describes, and follow its recommendations, to help make your driving trouble-free and enjoyable.

Statements or labels on the product preceded by the following words are of special significance:

**▲ DANGER** indicates severe personal injury or death will result if instructions are not followed.

**▲ WARNING** indicates a strong possibility of severe personal injury or death if instructions are not followed.

**CAUTION:** means hazards or unsafe practices which could cause minor personal injury or product or property damage.

**NOTE:** gives helpful information.

## Break-in Period

During the first 600 miles (1,000 km) of driving, avoid full throttle starts and cruising for extended periods at a constant speed.

**NOTE:**

- This break-in procedure also applies to exchanged or overhauled engines.
- During and after the break-in period, drive the car at moderate speeds until the engine is fully warmed up.

During the first 200 miles (300 km), try to avoid severe braking.

Brake misuse during this period will reduce future braking efficiency.

Remember, your Honda Automobile dealer knows your car best, and should be consulted for service assistance and advice.

## Keys

Your car is supplied with a master key that fits the ignition and all locks, and a valet key that fits the ignition and doors but not the trunk, trunk remote release, rear seat trunk access or glove box. The valet key is provided for times when you must leave the key with a parking attendant or repair person, but still want to keep valuables safely locked-up.

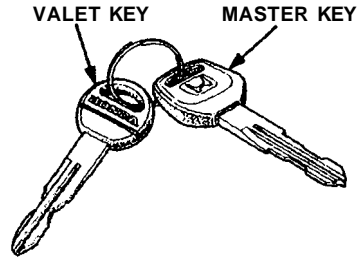

Write down the numbers stamped on both keys and keep the information in your wallet or purse in case you ever need to have duplicates made. Both the master and valet keys are double-edged, so you can insert them in the locks with either side up.

## Door Locks

You can lock the doors by pushing the tab forward. The doors must be unlocked before you can open them. The passenger door can be locked when open, and will stay locked when you close it; the driver's door cannot be locked when open unless you hold the door handle open. Both doors can be locked and unlocked from the outside with the key.

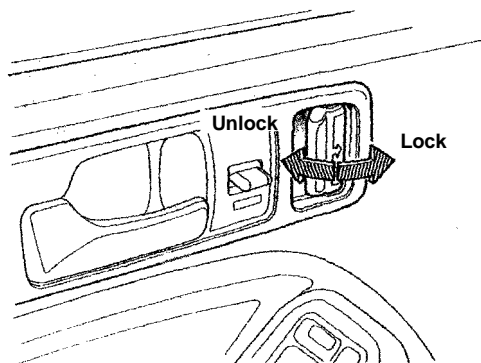

(cont'd)

# Keys and Locks (cont'd)

---

## Power Door Locks (LX, EX)

Both doors can be simultaneously locked and unlocked by operating the master door lock switch located on each door.

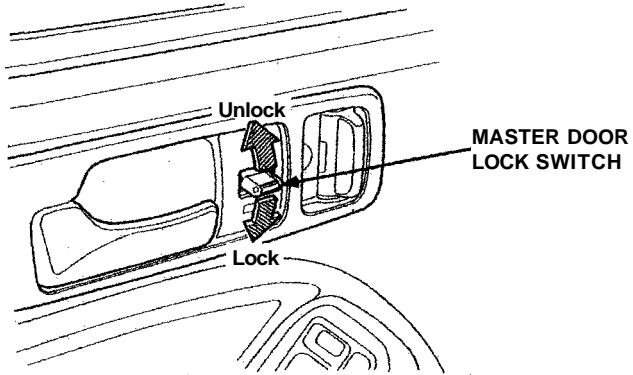

In addition, the passenger door will lock automatically when the tab on the driver's door is pushed forward, or when the driver's door is locked from the outside with the key.

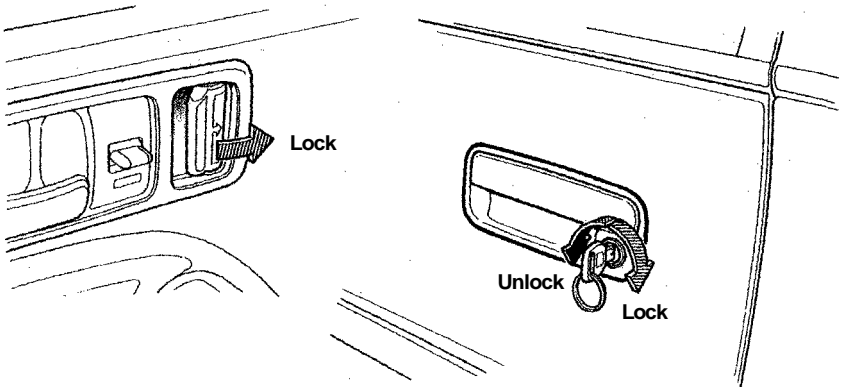

---

## Trunk

The trunk can be opened by pulling up the lever at the left side of the driver's seat. To open the trunk lid from outside, put the master key in the lock and turn clockwise. The trunk lid opener lever is lockable with the master key.

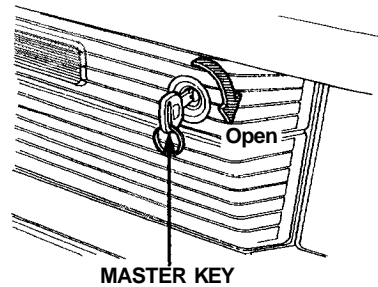
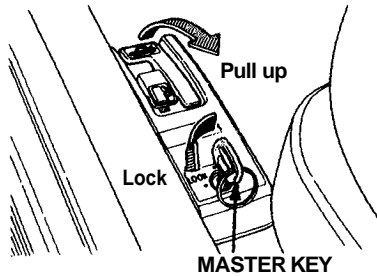

**⚠ WARNING** Keep the trunk lid closed while driving, to keep poisonous carbon monoxide exhaust fumes out of the interior; prolonged exposure can cause unconsciousness that may lead to death.

# Seats

---

## Front Seat

Adjust the seat position by pulling up on the adjustment lever under the front edge of the seat cushion, and sliding the seat to the desired position. Then release the lever and make sure the seat is locked in position by moving it back and forth.

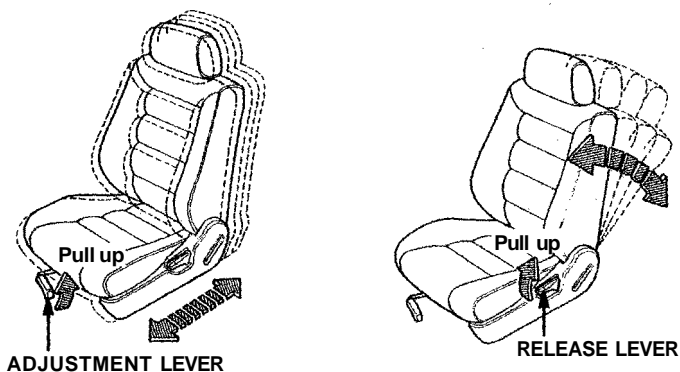

The angle of the seat-back can be changed by pulling up on the lever at the outside edge of the seat and leaning forward or back. Release the lever and let the seat lock into place when it reaches the desired angle.

Seat belts are most effective when the driver and passenger are sitting up straight and well back in each seat.

### **▲ WARNING**

- Do not adjust the driver's seat while the car is moving; the seat could move suddenly, causing loss of vehicle control.
- To reduce the risk of sliding under the seat belts in a collision, the seat-backs should be reclined no more than is necessary for comfort.

---

## Driver's Lumbar Support (EX)

Support of the lower back can be adjusted by turning the knob on the inner side of the seat-back to give more or less support.

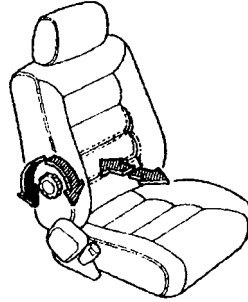

**▲ WARNING** Do not try to adjust lumbar support while driving. Make the adjustment while sitting in your normal driving position before driving away.

## To Get In/Out of Rear Seat

For easier access to or from the rear seat, pull up the angle adjustment lever on each front seat to swing the seat-back forward. The front passenger seat has an additional convenience: pulling up the lever on the inside of the passenger seat-back will swing the seat-back and slide the entire seat forward.

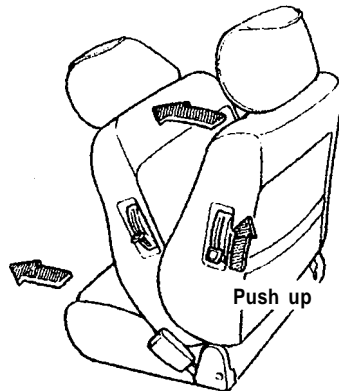

(cont'd)



## Seats (cont'd)

---

### Head Restraints

The head restraints are designed to help reduce injuries due to whiplash. They are located at the top of each front seat-back and have several height positions. They can be adjusted by pulling up to the recommended position. To lower them, slide the button next to the restraint's height bar, while pushing the restraint down. Adjust so the top of the restraint is approximately level with the tops of your ears. That position may reduce injury due to whiplash in an accident.

If a head restraint must be removed (for cleaning, fabric repair, etc.) pull the restraint up to its highest position, then slide the button while pulling the restraint out.

To reinstall, reverse the above procedure.

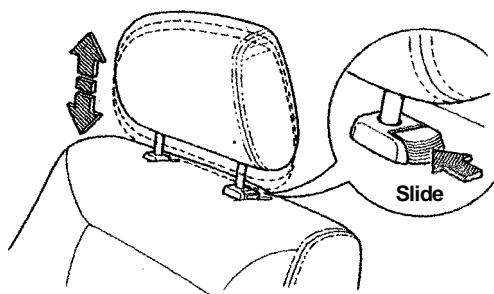

#### **▲ WARNING**

- Do not drive the car with head restraints removed.
- Do not try to adjust head restraints while driving.

---

## Trunk Access From Rear Seat

The rear seat-back can be opened by turning the lock on the rear shelf with the master key and pulling down the top of the seat-back. This allows access to the trunk and makes it possible to carry long objects inside the car.

The rear seat-back can also be released from inside the trunk by pulling the release.

When closing the rear seat trunk access, push the seat-back firmly into place, then pull on the top of the seat-back to make sure it is secure.

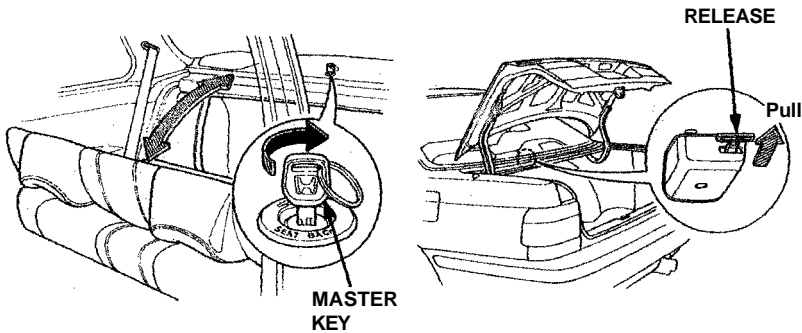

### **⚠ WARNING**

- **Passengers or pets must not sit on the folded portion of the rear seat.**
- **Make sure any luggage or cargo within the trunk, or extending through the rear seat trunk access is secured.**
- **Make sure the seat-back latches engage securely when the seat-back is returned to its normal position.**
- **Weight limits shown on the label on the driver's door jamb must be observed. The total weight of passengers and cargo must not exceed the total weight limit on the label.**
- **Do not store any items on the shelf behind the rear seat; they may become dangerous projectiles in a collision.**
- **Store any luggage or cargo in the trunk. If you are carrying more items than will fit in the trunk, use the floor space between the front and rear seats.**

# Seat Belts

---

Your Honda automobile is provided with seat belts to minimize the chance of injury to yourself and your passengers in a sudden stop or accident.

See pages 16 and 17 for precautions on using seat belts for children, babies, and pregnant women. Seat belts are most effective when the driver and passengers are sitting up straight and well back in their seats.

**⚠ WARNING** In the event of a collision, occupants not wearing seat belts could be seriously or fatally injured. Make sure you and all your passengers **ALWAYS** put on the seat belts before driving away.

**CAUTION:** Be careful the seat belts are not damaged by catching or entangling in the door or seat mechanism.

## Front Seat Belts

The front seats have an automatic ("passive") restraint system consisting of a shoulder belt and knee bolsters. To enhance the protection provided by the automatic system, you should also wear the manual lap belt. The shoulder belt should remain permanently latched. The manual lap belt must be put on for maximum protection in the event of a collision.

The automatic and manual belts have emergency locking retractors designed to lock only during a sudden stop or impact. Otherwise, they allow some freedom of movement in the seat.

## Operation

1. Enter the car and close the door completely. Move the seat a comfortable distance from the steering wheel, sit as straight up as possible and well back in the seat.

**⚠ WARNING** Never drive the car with the doors ajar. The front doors must be closed completely for the front seat belts to function properly.

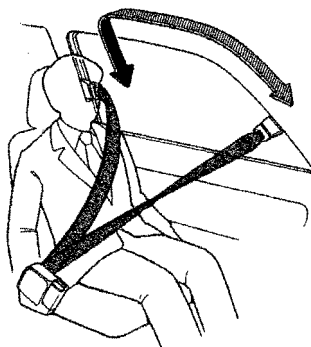

2. Turn the ignition ON. The shoulder belt buckle will move to its rear locked position. The length of the shoulder belt will adjust automatically to your body and seating position.

---

**⚠ WARNING** Normal movement of the shoulder belt buckle may cause injury. Be sure all parts of your body, especially fingers and hands, are clear of the shoulder buckle while it is moving.

NOTE:

- If the door is not closed completely, the shoulder belt buckle will not move and the door warning light will come on (see page 24).
  - If the door is opened with the ignition on, the buckle will release itself from its locked position and move forward.
  - If the shoulder belt buckle stops halfway or does not move at all, see page 122 for shoulder belt buckle operation.
3. Take hold of the tongue plate of the lap belt and pull it from its retractor. Be sure the belt is not twisted or caught on anything.

NOTE: If pulled too fast, the belt will lock. If this happens, allow the belt to retract then pull it out more slowly.

4. Push the tongue plate into the buckle until it clicks locked. Position the belt across your lap, not your abdomen, as low on your hips as possible.

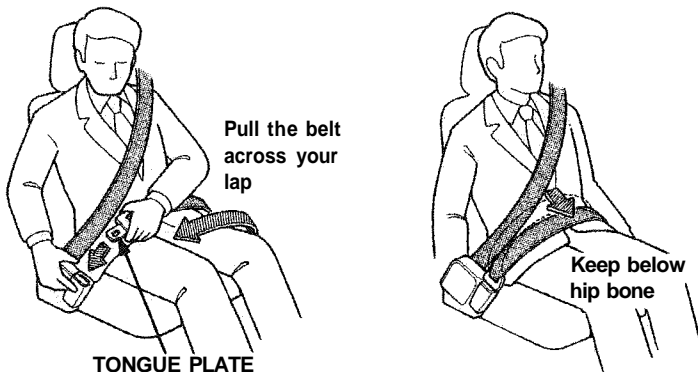

**⚠ WARNING**

- Avoid placing the lap belt across your abdomen. In the event of a collision, the pressure of the belt on the abdomen may increase the extent of injury.
- Never use one belt for more than one person, child or adult.
- Comfort clips sold on the open market are not recommended since they could impair the function and safety of the belts.

(cont'd)

## Seat Belts (cont'd)

---

- Make sure the strap of the shoulder belt and the lap belt are not crossed.
- Do not wear the shoulder portion of the belt under your arm or out of position. Such use could increase the chance and amount of injury in an accident.

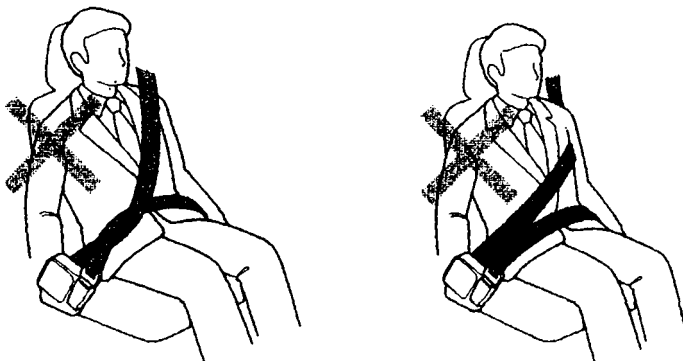

### Releasing the Seat Belts

1. To release the manual lap belt, push the "PRESS" button in the buckle, the belt should retract automatically when released.
2. The driver's shoulder belt buckle will release and travel to its off position when the key is removed from the ignition.
3. The shoulder belt buckle will also release and travel to its off position when the door is opened.

### Emergency Belt Release

The shoulder belt should always remain buckled. In case of an emergency, however, the shoulder belt can be released from the shoulder belt buckle by pushing the button.

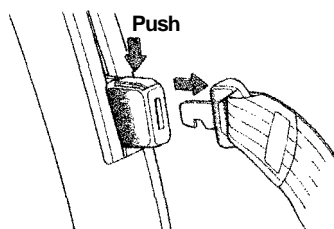

Relatch the shoulder belt before operating the car, making sure the belt is not twisted.

**▲ WARNING** Driving with a twisted seat belt can increase your chance and extent of injury during a collision. Be sure the shoulder belt is not twisted before driving the car.

---

## Buckling the Rear Seat Combination Lap/Shoulder Belts

In the rear seat, there are two one-piece combination lap/shoulder belts and a center lap belt. The seat-backs and seat belts provide best restraint when the occupant is sitting well back and straight up in the seat.

The combination lap/shoulder belts with emergency locking retractors are designed to lock only during a sudden stop or impact. Otherwise, they allow you some freedom of movement in the seat.

**NOTE:** The emergency locking system of the rear seat belts will also be activated if you pull the belt too fast. If this happens, release the belt slightly then pull it out more slowly.

1. Take hold of the tongue plate and pull the belt across your lap. Be sure the belt is not twisted or caught on anything.

**Pull the belt across your lap**

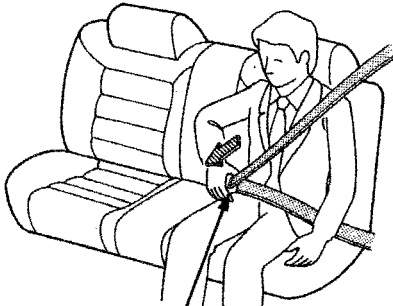

**TONGUE PLATE**

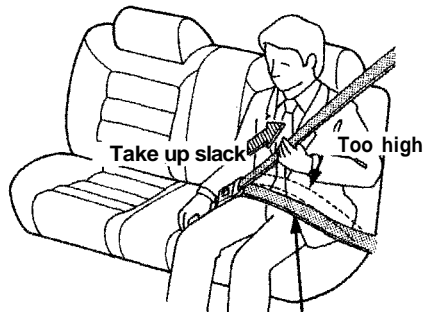

**Keep below hip bone**

2. Push the tongue plate into the buckle until it clicks locked. Position the belt across your lap, not your abdomen, as low on your hips as possible.



**WARNING** Avoid placing the lap belt across your abdomen.

**In the event of a collision, the pressure of the belt on the abdomen may increase the extent of injury.**

3. To release the seat belt, push the "**PRESS**" button in the buckle; the belt should retract automatically when released. If the belt does not fully retract, pull it out and check for kinks or twists.

**CAUTION:** Make sure both rear shoulder belts are positioned in front of the rear seat-backs whenever the seat-backs are in their upright position.

(cont'd)

## Seat Belts (cont'd)

---

### Rear Center Seat Belt

Adjust the center lap belt length to fit snugly but comfortably when buckled.

A slack belt will greatly reduce the protection afforded to the wearer. Hold the tongue plate perpendicular to the belt as shown.

\* To shorten, pull the end of the belt away from the tongue plate.

\* To lengthen, pull the tongue plate.

Push the tongue plate into the buckle until it clicks locked and position the belt across your lap, not your abdomen, as low on your hips as possible.

If worn across your abdomen, pressure of the seat belt on your abdomen may increase the extent of injury in the event of an accident.

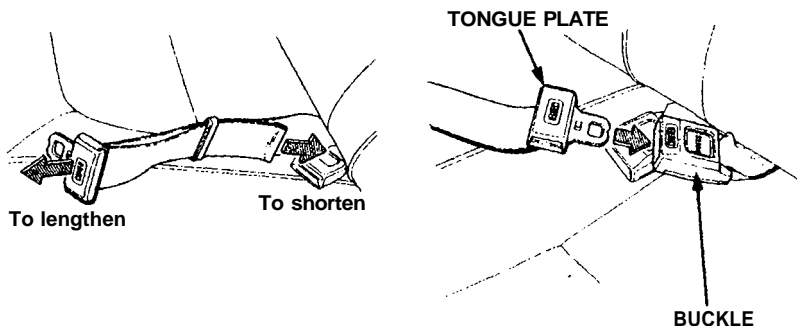

---

## Fasten Seat Belt Warning Light and Warning Beeper

Lap Belt Warning Indicator:

Both the  light and the warning beeper will go on for about six seconds if the ignition switch is turned on when the driver's lap belt is not fastened. The beeper will not go on if the driver's lap belt is fastened, but the warning light will come on for about six seconds each time, to remind the driver to have passengers put their belts on.

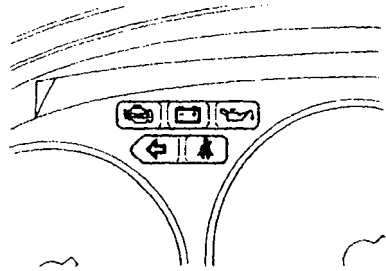

Automatic Shoulder Belt Warning Indicator:

The warning light will come on if either of the automatic shoulder belts is unlatched with the ignition ON. The beeper will sound for approximately six seconds while the warning light is ON. Relatch the belt: the light should go off when the belt is latched.

The warning light will also come on while the shoulder belt buckle moves from its front off position to its rear locked position.

Automatic Shoulder Belt Malfunction Indicator:

The warning light will flash and the beeper will sound rapidly if either shoulder belt buckle stops before completing its full cycle (see page 122 for manual operation).

NOTE: If the shoulder belt's tensioner mechanism locks and prevents the buckle from moving fully forward when you want to get out, recycle the system by closing the door and reopening it.

The buckle should move fully forward; if it does not, recline the seat-back and use Emergency Belt Release (see page 12).

When the system does not function by either method, have the system checked by an authorized Honda dealer.

**⚠ WARNING** If the light and beeper do not function at all, or if they come on even with the belts latched and doors fully closed, it indicates a malfunction in the seat belt system. In the event of a collision, severe personal injury could result. The system should be checked immediately by an authorized Honda dealer.

(cont'd)



# Seat Belts (cont'd)

---

## Child Restraint

Children riding in the car should be restrained to minimize the risk of injury in an accident, sudden stop or sudden maneuver. According to accident statistics provided to the National Highway Traffic Safety Administration (NHTSA), children are safer when properly restrained in the rear seating positions than in the front seat. Larger children should use one of the seat belts provided.

For smaller children, we strongly recommend the use of a commercially available child restraint system that meets the Federal Motor Vehicle Safety Standard (FMVSS) because it offers the most protection against injury. All states now have laws which require that small children must be seated in a child passenger seat restraint system. Check local laws.

Before buying a particular child restraint system, make sure it fits your car seat and seat belts, and fits your child. Follow all the instructions that come with the system.

### WARNING

- **Children should never ride unrestrained in an automobile.**
- **Never use an infant carrier or child safety seat that "hooks" over a seat-back; it may not provide adequate security in an accident.**
- **Never allow a child to be held in a person's arms while they are in the moving vehicle. Holding a child in a moving vehicle does not provide the child with any means of protection during an accident, even if the person holding the child is wearing a seat belt.**

## Installation of Child Seat

All child restraint systems are designed to be secured by lap belts or the lap belt portion of a lap-shoulder belt. The automatic shoulder belt system at the front passenger seat should not be used to secure the child restraint system. If a child seat must be installed on the front seat, do the following: If the seat is installed facing forward, place the shoulder belt behind the child seat and secure the child seat with the lap belt only.

If the seat is installed facing the rear of the car, place the shoulder belt between the car's seat-back and the base of the child seat and secure the child seat with the lap belt only.

Children could be endangered in a crash, if their child restraints are not properly secured. Follow the child seat manufacturer's instructions when installing the seat.

---

Your Honda automobile is equipped with attachment points specifically for a rear seat mounted child restraint system which uses a top tether.

The tether attachment points are located on the rear tray, just behind the rear seat-back.

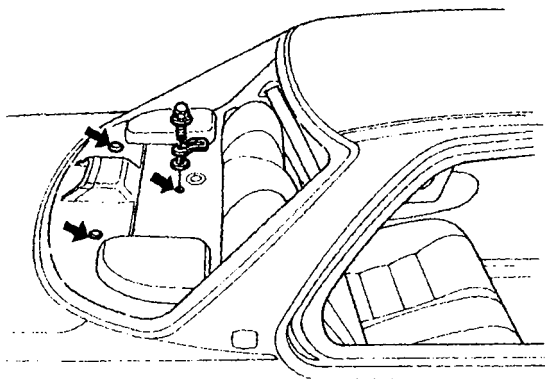

**⚠ WARNING** When the child restraint system is not in use, remove it from the car or secure it with the seat belt to keep it from becoming a projectile in the event of an accident.

NOTE: See your Honda dealer for installation of the child restraint system.

### **Pregnant Women**

A pregnant woman should use the shoulder and lap belts to help lessen the chance of injury and/or the amount of injury in an accident.

**⚠ WARNING** It is desirable that a pregnant woman ask her doctor at each medical check-up if she can drive, and also ask about the most appropriate way of wearing the lap/shoulder belt. If a rear seat lap belt is used, it should be worn as low and snugly as possible over the hips.

(cont'd)

# Seat Belts (cont'd)

---

## Inspection

All parts of the seat belts, including the belt fabric, should be regularly inspected for fraying, loosening, wear and other damage. Keep the belts in good condition at all times to reduce the chance of being injured in an accident, and to minimize any injuries that do occur. Make sure the buckles, retractors, tongue plates, guides and anchors all work properly.

Don't let anything get inside the buckle or the retractor; it could cause latch or retractor failure.

## Cleaning

The belts should always be kept clean and dry; wet or damp belts can cause rewinding problems. To clean the belts, pull them all the way out of their retractors and use warm water and a mild soap; then let them air-dry fully extended, in the shade, with the car windows open.

### WARNING

- **Never bleach, dye or clean the belts with chemical solvents; it will weaken the fabric.**
- **Do not remove the seat belts from the car to wash them.**

## Replacement

Replace the seat belt if:

1. The belting is cut, punctured, burned, etc.
2. The buckle or retractor does not work properly.
3. It was being worn at the time of a collision (also check for damage at the seat belt anchor points).
4. Its condition is questionable.

# Instrument Panel

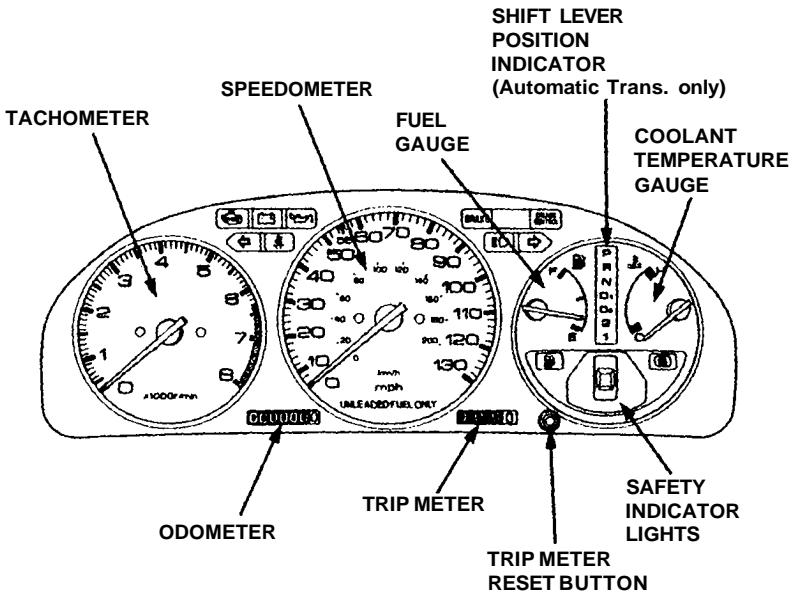
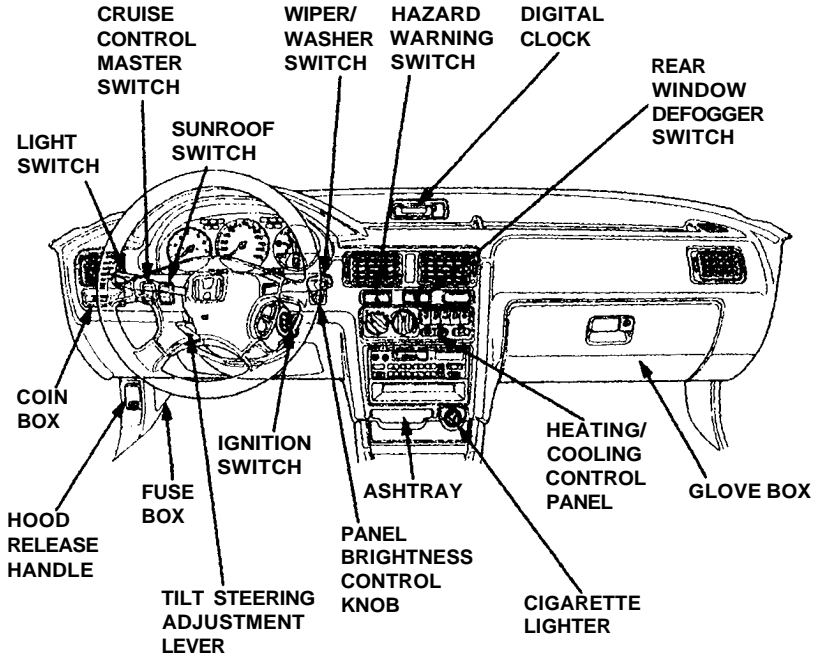

# Gauges

---

## Speedometer

The speed is indicated in miles per hour (outside scale) and kilometers per hour (inside).

## Odometer

The numbers on the odometer indicate miles. The odometer registers total distance traveled, and serves as your guide for determining when periodic maintenance is due. Federal law makes it illegal to alter the odometer of any motor vehicle with the intent to change the number of miles indicated.

## Trip Meter

The numbers on the trip meter indicate miles. The trip meter can be returned to zero by pushing in the reset button. Use it for checking fuel consumption or distance traveled per trip.

## Tachometer

The tachometer indicates engine speed in revolutions per minute. The beginning of the RED ZONE indicates the maximum allowable engine R.P.M. Do not run the engine with the tachometer indicator needle in the RED ZONE.

## Fuel Gauge

FUEL TANK CAPACITY: Approx. 64.5 ℓ (17.0 US gal)

As a convenience, the gauge continues to show the same fuel level as when the ignition was last on. After refueling, the gauge will slowly change to the new fuel level when the ignition is switched on.

When the needle indicates E (empty), a usable reserve of about 4 ℓ (1.1 US gal) remains in the tank.

## Coolant Temperature Gauge

**CAUTION:** The needle should stay within the white range. If the needle reaches the red line at "H" (Hot), pull safely off the road, stop the engine and check the coolant level in the reserve tank on the passenger side of the radiator under the hood.



Do not remove the radiator cap when the engine is hot. The coolant is under pressure and may blow out and scald you.

# Warning and Indicator Lights

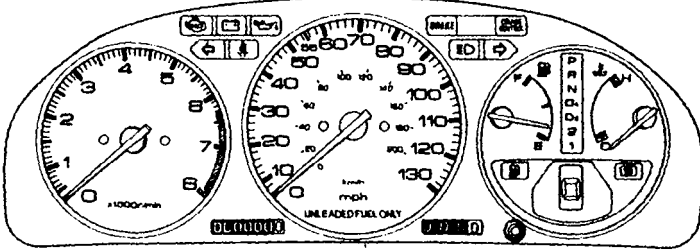

## Shift Lever Position Indicator (Automatic transmission only)

A lighted indicator between the fuel and coolant temperature gauges shows which gear you have selected.



### S Indicator Light

This indicator light will come on when the S switch is pushed. The S indicator light in the instrument panel also serves a second function. If the light flashes while driving (in any gear range) it indicates a possible malfunction in the transmission; avoid rapid acceleration and have the transmission checked by an authorized Honda dealer as soon as possible.



### Turn Signal/Hazard Warning Indicator Lights

When the turn signal lever is pushed for left or right turns, the appropriate green indicator arrow on the instrument panel will blink along with the signal. Turning on the hazard warning switch will make all turn signals and both arrows blink (see page 30).

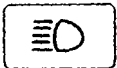

### Headlight High Beam Indicator Light

This blue indicator light will go on whenever the high beams are switched on (see page 29).



### Cruise Control Indicator Light (LX, EX)

When the cruise control system is on, this indicator light is on (see pages 32 and 33).



### Fuel Reserve Warning Light

If the warning light glows, it means you have about 8.0 l (2.1 US gal) or less fuel remaining and should refuel. (cont'd)

## Warning and Indicator Lights (cont'd)

---

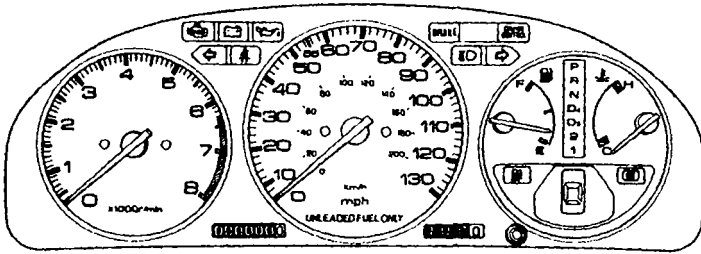

### **BRAKE**

#### **Parking Brake/Brake Failure Warning Light**

Check the brake warning light every time you start the car. With the parking brake set, the warning light should go on when the ignition switch is turned to II or III. With the parking brake released, the light should go on when the ignition switch is turned to III. If the light goes on at any other time, it means the brake fluid level in the master cylinder reservoir is too low; add fluid (see page 94) and have your dealer check for leaks immediately.



#### **Seat Belt Reminder Light**

The seat belt reminder light comes on for approximately six seconds when the ignition switch is turned on (see page 15).



#### **Oil Pressure Warning Light**

A severe fluctuation in engine oil pressure will cause this light to flash on and off. You should stop as soon as possible, check the oil level, and add oil if necessary.

The oil pressure warning light will come on, and remain on, if there is insufficient oil pressure or when the ignition switch is turned on with the engine not running. If the light should come on while driving, get the car off the road as soon as you can, turn the engine off and check the engine oil level (see page 85).

Even if the oil level is correct, the engine should be checked by a Honda dealer before the car is driven again.

**NOTE:** The oil pressure warning light will only light as a result of low oil pressure. It is not directly an oil level indicator.

**CAUTION:** Running the engine while the oil pressure warning light is on constantly may cause immediate and severe engine damage.



## Charging System Warning Light

The charging system warning light comes on when there is a problem with the electrical charging system or when the ignition switch is turned on with the engine not running. If the light comes on while driving, stop the car and check the alternator belt for proper tension. With the engine stopped, push down on the middle of the belt as shown; it should have 10 — 12 mm (0.4 — 0.5 in) deflection under a force of 98 N (22 lb).

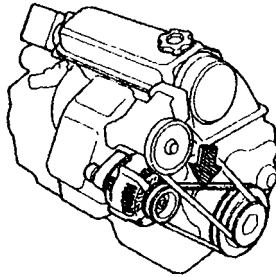

### WARNING

- If the engine has been running, some engine components may be hot enough to burn you.
- Keep hands away from the radiator fan. The fan may start automatically without warning and run for up to 15 minutes, even after the engine is turned off.

NOTE: If necessary, have the charging system checked by an authorized Honda dealer.



## Check Engine Warning Light

This light comes on for a couple of seconds each time the ignition is turned on. It will also come on, and remain on, if there is a malfunction in the emission control system. If the light comes on while driving, avoid driving at high speed, and have the system checked by a Honda dealer as soon as possible.

(cont'd)



## Warning and Indicator Lights (cont'd)

---

### Safety Indicator Lights:

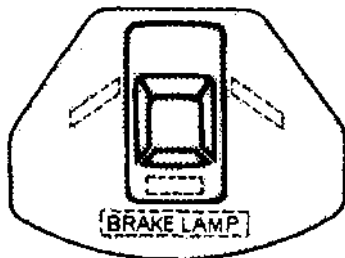

### Door and Trunk Lid Warning Lights

If a door or the trunk lid is open when the ignition is switched on, the appropriate indicator will light, and stay lit, until the door or trunk lid is closed.

**BRAKE LAMP**

### Brake Lamp Warning Light

If a brake light does not work, the BRAKE LAMP indicator will go on when you push the brake pedal with the ignition on; the indicator will stay on until you have the lamp repaired or replaced. Have the brake lights checked as soon as possible.

**▲ WARNING**

**It is dangerous to drive your car with a problem in either the brake electrical or hydraulic systems; have your dealer check both systems if you suspect brake trouble.**

### Checking the Safety Indicator Lights

The door, trunk lid and brake lamp warning lights should come on for about two seconds when the ignition switch is turned on. If they don't, have the system checked by a Honda dealer.

## Tilt Steering

The steering wheel position can be adjusted to suit driver preference.

1. Push the lever located under the dash, on the left side of the steering column, all the way down and hold it while adjusting the steering wheel to the desired position.

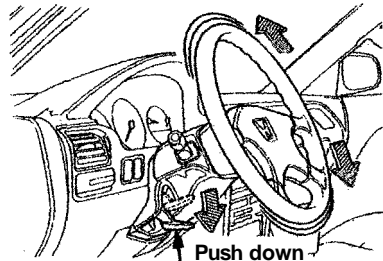

**TILT STEERING  
ADJUSTMENT  
LEVER**

2. To lock the steering wheel, hold it in the desired position and pull the lever all the way up.

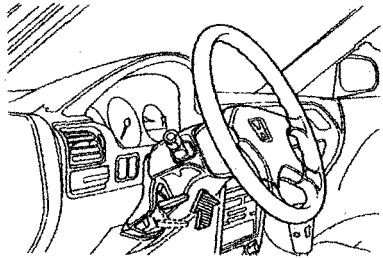

**Pull up**

### **⚠ WARNING**

- Do not adjust the steering wheel position while driving.
- After adjusting the steering wheel position, make sure it is securely locked in place by "rocking" it up and down slightly.

# Windshield Wipers/Washer/Defogger

## Windshield Wipers

Switch the wipers to INT for intermittent operation; LO for low speed operation; and HI for high speed operation.

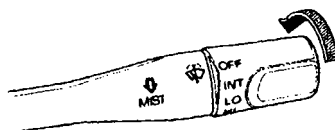

In fog or very light rain, push the lever down to the MIST position for temporary high speed operation of the wipers. The wipers will return to the rest position and the motor will shut off as soon as you release the lever.

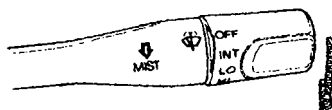

Push down

## Washer

Pull the wiper switch lever toward you to turn on the washer.

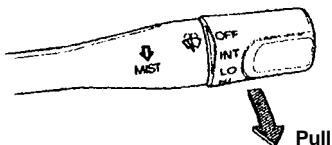

On the LX and EX, the windshield wipers will sweep when the washer is operated.

Check the washer fluid regularly, especially during bad weather, or whenever the washer has been in frequent use. The float in the neck of the reservoir indicates the fluid level.

## WINDSHIELD WASHER RESERVOIR CAPACITY:

2.5 l (2.6 US qt)

Use a good quality commercial washer fluid for all-weather cleaning.

### WASHER FLUID RESERVOIR

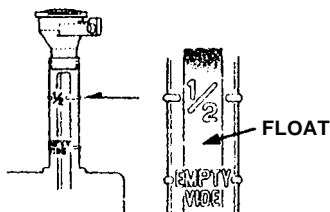
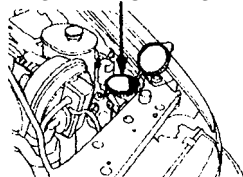

---

**CAUTION:**

- Do not use radiator antifreeze in the windshield washer; it will damage the paint.
- Do not use a vinegar/water combination in the windshield washer; it will damage the pump.
- Prolonged operation of the washer without fluid may damage the pump.

In freezing weather, warm the windshield with the defrosters before using the washer. This will help prevent icing which could seriously impair visibility.

**Rear Window Defogger**

Push the switch to turn the defogger on or off. The indicator will light when the defogger is on.

The switch will turn off automatically 25 minutes after it is turned on.

**CAUTION:** When cleaning the inside of the rear window, be careful not to damage the printed heater wires on the rear window. Wipe the window horizontally along the wires, not up and down.

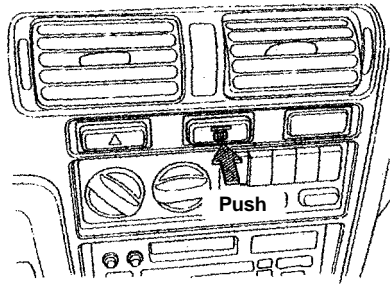

# Mirrors

---

## Rearview Mirrors

Keep the inside and outside mirrors clean and adjusted for best visibility. Be sure to adjust mirror angles before you start driving.

The inside mirror has day and night positions. The night position reduces glare from the headlights of vehicles behind you. Flip the small tab on the bottom of the mirror forward or backward to select day or night position.

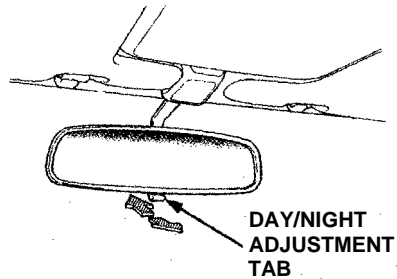

On the DX, the outside mirror can be adjusted by moving the knob on the inside of the driver's door.

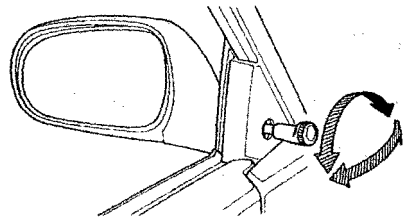

## Power Mirrors (LX, EX)

With the ignition switch in the "II" position, move the main switch to L (for driver's side) or R (for passenger's side), then use the adjustment switch to adjust the outside mirror to the correct angle.

After the mirrors have been adjusted, return the main switch to the center (off) position.

NOTE: Be sure to adjust mirror angles before you start driving.

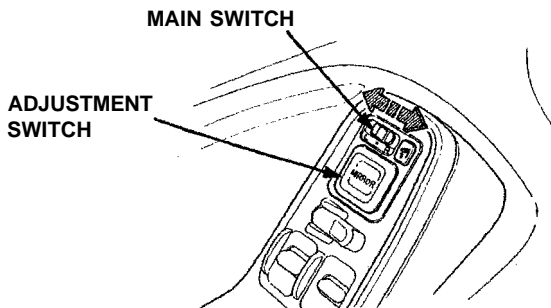

## Turn Signals

Push the turn signal lever down to signal a left turn, and up for a right turn. The indicator and appropriate signal lights will blink. The lever will return automatically to its original position when the steering wheel is returned to straight ahead.

For lane changing, you can signal by pushing the lever part way up or down (to the first stop) and holding it there; the lever will return to its original position when you release it. If either turn signal indicator lights up but does not blink, blinks faster than usual or does not light up at all, check for a burned out bulb or fuse.

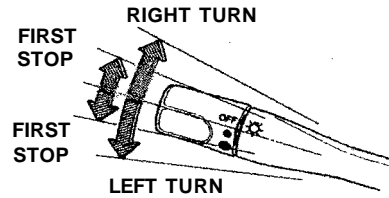

## Headlights

Turn the light switch to the first position (●) for taillights, side marker lights, parking lights, and instrument panel lights. Turn to the second position (●) to illuminate the headlights.

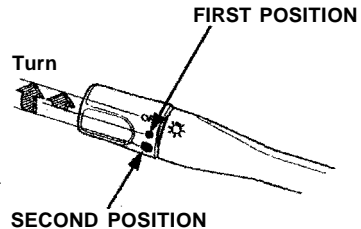

If the driver's door is opened when the light switch is turned to either "on" position, a chime will sound to remind you to turn off your lights.

## High Beam/Low Beam Switch

The headlights may be switched between low beam and high beam by pulling the turn signal lever towards you. The blue high beam indicator light will be on when the high beam is on.

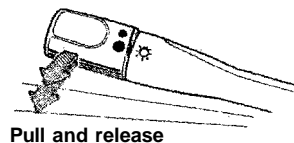

## Headlight Flasher

To use the headlights as a passing signal, pull lightly on the turn signal lever and release.

(cont'd)

## Lights (cont'd)

---

### Hazard Warning System

This system should be used only when your car is stopped under emergency or hazardous conditions. To activate, push the hazard warning switch (▲). The front and rear turn signals will blink simultaneously and both indicator lights will flash.

Push the switch (▲) again to turn the system off.

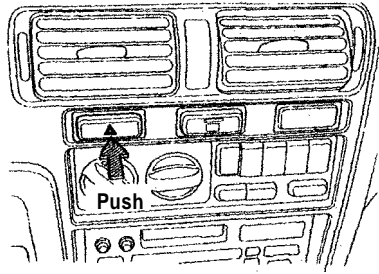

### Panel Brightness Control

When the light switch is in either of the two "on" positions, the intensity of the instrument lights can be adjusted. Push the button so it pops out, then turn the panel brightness control knob.

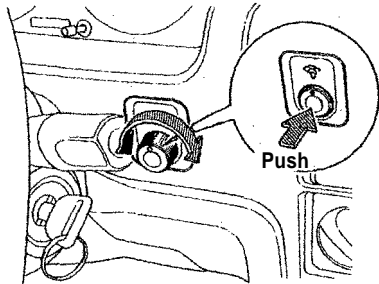

### Ignition Switch Light (LX, EX)

This light will illuminate the switch for several seconds after the driver's door is closed.

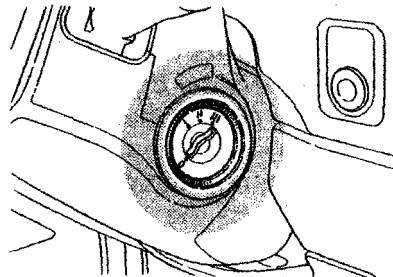

---

## Interior Light

The interior light has a three position switch. The light is off all the time in the OFF position. In the middle position, it goes on only when a door is opened. In the ON position, it is on all the time.

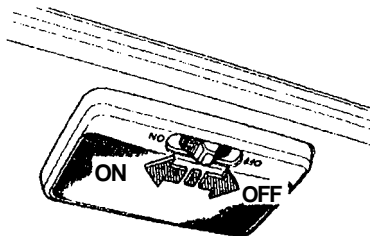



# Cruise Control (LX, EX)

---

## Cruise Control

The Cruise Control system allows you to set and automatically maintain any speed above 25 mph (40 km/h) without keeping your foot on the accelerator. As its name implies, it is meant for cruising on straight, uncongested highways or freeways. It is not recommended to be used in traffic, on winding roads or in bad weather conditions where the driver should have total control.

### To Set the Cruise Control:

Push the CRUISE CONTROL master switch on the dash; the indicator light will come on. Accelerate to the desired speed, then push and release the SET switch on the steering wheel. The Cruise Control light on the instrument panel will come on.

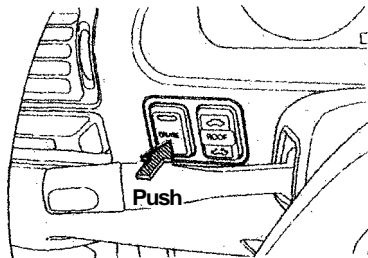

The speed you were going when you released the SET switch is the speed the Cruise Control will hold. You can then "fine tune" the set speed by briefly holding and releasing the SET switch to decrease it a few mph or pushing the RESUME switch to slightly increase it.

### To Cancel the Cruise Control:

Simply push the CRUISE CONTROL master switch and the indicator light will go off (this also erases the memory of the set speed).

If you must temporarily disengage the system (but you wish to retain the memory of the set speed): tap the brake pedal, or the clutch pedal (5 speed transmission) or move the automatic transmission shift lever to N (Neutral). If you are still going above 25 mph (40 km/h), you can return to the set speed by simply pushing the RESUME switch. If the car has decelerated below approximately 25 mph (40 km/h), you can return to the set speed by using the accelerator conventionally until the speed is above 25 mph (40 km/h) and then pushing the RESUME switch.

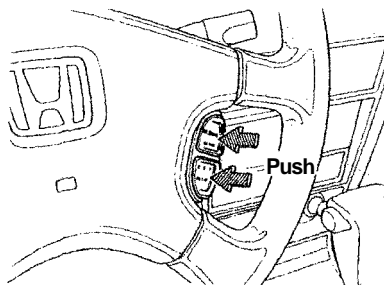

---

## To Change the Set Speed:

To a faster speed — For gradual acceleration with your foot off the accelerator, push and hold the RESUME switch until you reach the desired speed; release the switch and the system's memory will be re-programmed to the new speed. For faster acceleration, push the accelerator until you reach the desired speed, then push and release the SET switch to re-program the system.

To a slower speed — push and hold the SET switch and the car will coast; when you reach the desired slower speed, release the switch and the system will be re-programmed.

For temporary acceleration above the set speed, such as for passing, use the accelerator pedal conventionally. When you want to return to the set speed, take your foot off the accelerator and coast without applying the brakes.

**⚠ WARNING** The Cruise Control automates the function of the accelerator pedal to maintain your car at a constant speed. This can be a convenience on long trips, but it can also be a danger if there are many other cars on the road or if the road is unfamiliar. Pay strict attention to the responsibility of driving whenever using the Cruise Control.

**CAUTION:** Because the Cruise Control directly activates the accelerator pedal, don't rest your foot under the pedal when the Cruise Control is on; it may pull the pedal down onto your foot.

### NOTE:

- With Cruise Control on, your speed will still vary slightly, particularly when going up or down hills.
- Do not ride the brakes or clutch (5 speed transmission), as this will cause the Cruise Control to disengage.

# Hood and Parking Brake

---

## Hood

To open the hood, pull back on the handle located under the dash on the driver's side.

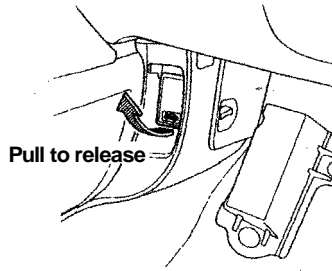

The hood latch is spring-loaded, so the hood will pop up slightly. Release the safety catch under the front center of the hood by pushing the rubber-tipped handle up. Lift the hood and prop it open with the support rod. To close, take the support rod down, place it back in its holder, lower the hood until it is approximately one foot from the closed position, then let it drop. Be sure the hood is securely latched before driving away.

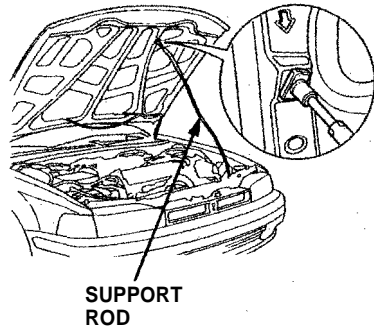
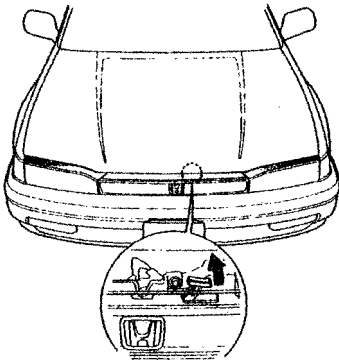

## Parking Brake

To apply the parking brake, pull up on the lever. To release it, pull up slightly, push the button, and lower the lever; when fully released, the BRAKE warning light will go out.

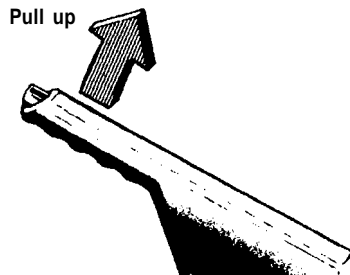

## Power Windows

The power windows can be operated only when the ignition switch is in the "II" position.

The operation of the windows is controlled by the main switch located in the master control panel on the armrest of the driver's door. When the main switch is off, only the driver's door window can be opened and closed. When the main switch is on, both door windows can be opened and closed by the driver, using the appropriate switch in the master control panel, and the passenger window can be opened and closed by the passenger, using the switch located on the armrest of the passenger door.

When opening or closing a window, push and hold either the "up" or "down" side of the switch until the window reaches the desired position, then release.

**NOTE:** The driver's window can be opened fully, without the driver having to hold the switch down, simply by pushing the switch past the first "stop".

## Power Window Key-off Operation

The power windows can still be operated for about 10 minutes after the ignition is turned from the "II" to the "I" or "0" position as long as neither front door has been opened.

### **▲ WARNING**

- **Be sure, before closing any window, that all hands, arms and other obstructions are clear of the window frame and glass; severe personal injury could result.**
- **Always keep the main switch in the off position when children are in the car; injury may result from unintentional window operation.**

**DRIVER'S  
WINDOW  
SWITCH**

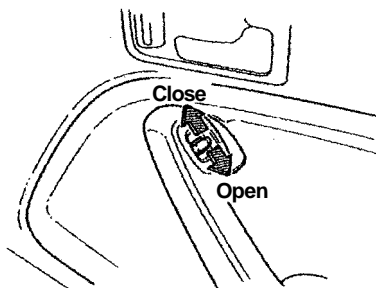
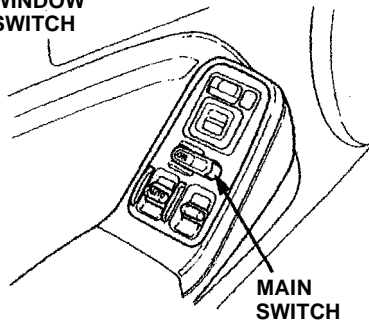

# Rear Quarter Windows and Clock

---

## Rear Quarter Windows

To open, pull the latch toward you, then push it outward and lock it in place.

To close and lock the window, pull the latch toward you, then push it backward until it snaps shut.

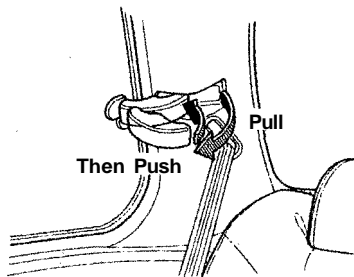

## Digital Clock

The time is displayed continuously when the ignition is switched to II or III. At all other times, push in on the lid to display the time.

To adjust the time:

1. Lower the lid.
2. Push the minute button (M) and hold it until the numbers advance to the desired minutes.
3. Push the hour button (H) and hold it until the numbers advance to the desired hour.
4. The RESET button allows you to synchronize your clock to the closest hour. If the time on the clock is before the half hour, pressing the RESET button will return the time to the previous hour. If the time is beyond the half hour, the RESET button will change the time to the next hour.

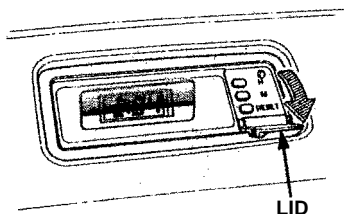

**NOTE:** Be careful not to push the "H", "M" or RESET buttons accidentally. Pushing any of them will change the clock's time setting.

# Glove Box and Beverage Holder (LX, EX)

## Glove Box

Open by pulling the handle.  
Close with a firm push.

The glove box door can be locked by using the master key. The glove box light will go on when the glove box door is opened and the headlights are on.

**⚠ WARNING** Do not drive the car with the glove box door open; it could cause injury in an accident.

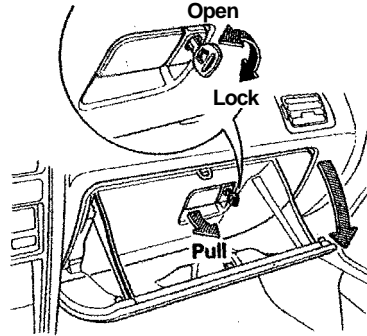

Your car is equipped with a beverage holder for use while the car is stopped. Drinking while driving or driving with a beverage in the holder may be hazardous. Open the holder by pushing it.

**NOTE:** Use only lidded cups or containers that fit snugly in the beverage holder.

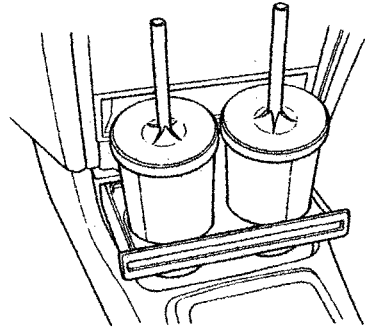
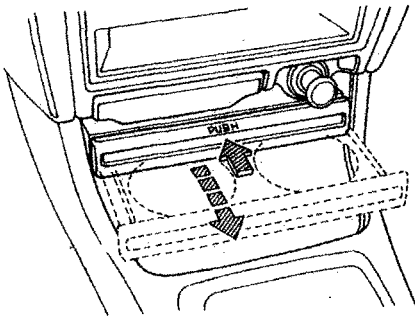

**⚠ WARNING**

- Spilling even a small amount while driving, especially if the liquid is hot, may distract the driver's attention from the road and could result in a serious collision.
- Alcohol and driving don't mix. For your safety, and the safety of others, please do not drink and drive.

# Cigarette Lighter and Ashtrays

---

## Cigarette Lighter

Push in to heat up. It will automatically release when the element is hot. DO NOT hold it in while it is heating up.

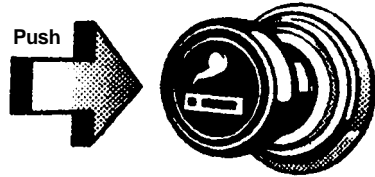

## Front Ashtray

Open the ashtray by pulling its bottom edge toward you. To remove it, pull it out further while pushing down on the spring loaded plate inside.

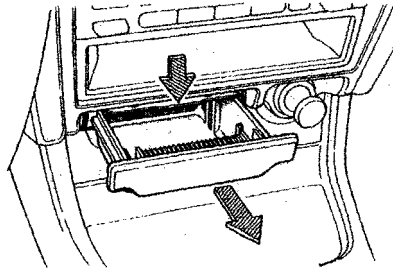

## Rear Ashtray

The rear ashtray is located at the rear of the center console. It is opened by pulling out the top edge. To remove it, open the ashtray and release its bottom edge by pulling up, then out. To install, reverse the removal procedure.

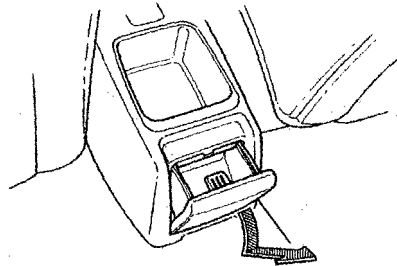

To remove, pull up and out

**CAUTION:** Do not use the ashtrays as trash containers; use them only for extinguished cigarettes. Putting lit cigarettes or matches in an ashtray with other combustible materials may cause a fire.

# Heating and Cooling

The vents, heater and air conditioner (optional on DX) are combined in one system; adjusting four basic controls to different settings can provide a full range of interior temperatures for safe and comfortable driving.

## Ventilation

The flow-through ventilation system can provide fresh air to the interior when the car is moving or stopped, even with the windows closed.

**NOTE:** For proper air flow, the flow-through vents must not be covered. Keep the air inlet at the base of the windshield free of leaves or other debris.

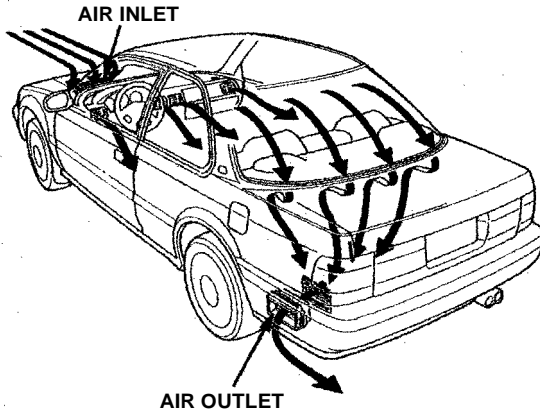

You can adjust the controls to direct cool or warm outside air throughout the car for defogging windows, heating, or cooling by turning on the fan.

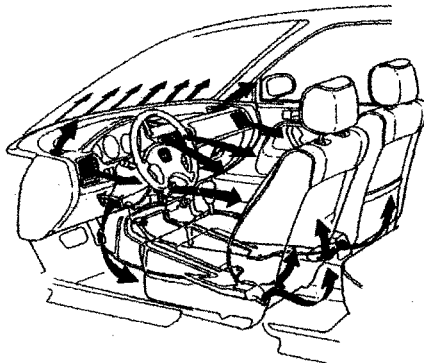

(cont'd)



# Heating and Cooling (cont'd)

## Dash Vents

The corner vents can be used for flow-through ventilation, or during the heating and air conditioning operation.

The corner and center vents can be tilted up or down, and their louvers turned right or left, to change the direction of air flow.

The amount of air flow from the corner and center vents can be regulated by the control located beside each vent.

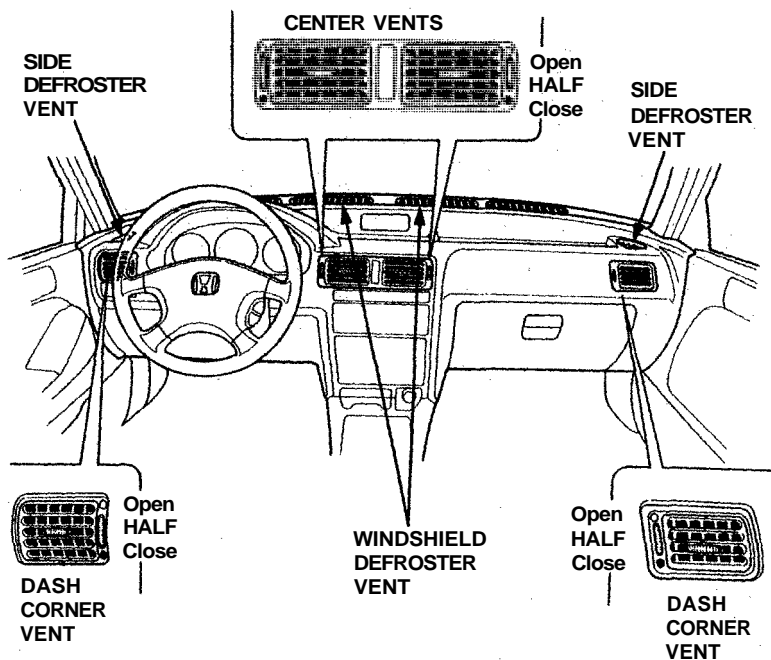

## What the Controls Do:

[DX]

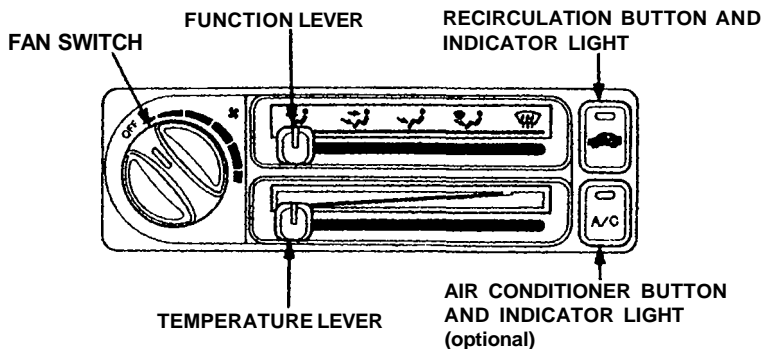

[LX/EX1]

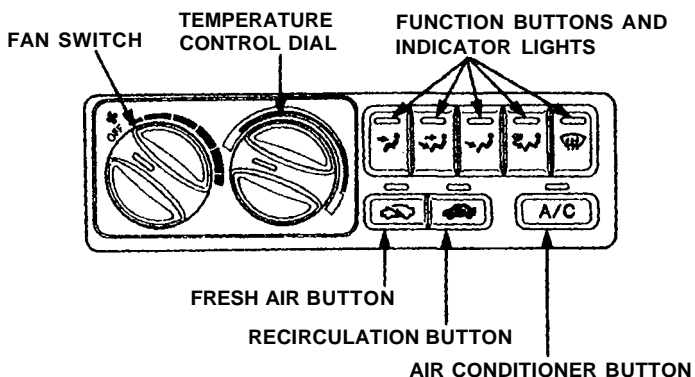

### Fan Switch

Turning the switch clockwise will increase the fan speed, and the fan will circulate warm, cool, or outside air, depending on where the temperature lever/control dial and function lever/buttons are set.

Whenever the fan is switched on, air flows from the dash corner vents regardless of function lever/button position.

### Function Lever/Buttons

Slide the lever on the DX model or push the appropriate button on the LX and EX models to direct air to and from the heater, defroster and vents.

There is an indicator light in each function button that comes on when the button is pushed.

(cont'd)

# Heating and Cooling (cont'd)

---

## Temperature Lever/Control Dial

Slide the lever from left to right on the DX model or turn the dial clockwise on the LX and EX models to make air warmer when the appropriate function is selected.

## Air Conditioner Switch (optional on DX)

With the fan on, push the A/C button to operate the air conditioner. The indicator light will come on.

Push the button again to turn the air conditioner off.

## Fresh Air (☁️) and Recirculation (🚗) Buttons

### [DX]

When the 🚗 button's indicator light is out, outside air will be allowed to circulate inside the car.

When the ☁️ button is pushed in and the indicator light comes on, outside air is shut off and the air inside the car is recirculated.

If the heater or air conditioner is on and you want to warm up or cool down the interior more quickly, or keep smoke or dust out of the car without losing the heat or cool function, simply push the 🚗 button.

### [LX/EX]

When the ☁️ button is pushed, the indicator light will go on and outside air will be allowed to circulate inside the car.

When the 🚗 button is pushed, the indicator light comes on, outside air is shut off and the air inside the car is recirculated.

If the heater or air conditioner is on and you want to warm up or cool down the interior more quickly, or keep smoke or dust out of the car without losing the heat or cool function, simply push the 🚗 button.

### [DX]

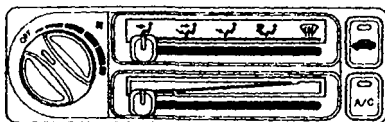

### [LX/EX]

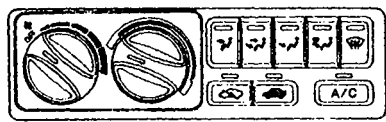



NOTE: The windows may become fogged if the system is in the 🚗 setting for an extended period of time with the air conditioner off. As soon as the interior is warmed, switch to ☁️ setting.

---

## How to Use the Controls To Ventilate



### [DX]

Move the temperature lever to the left, select the  position and push the  button off.

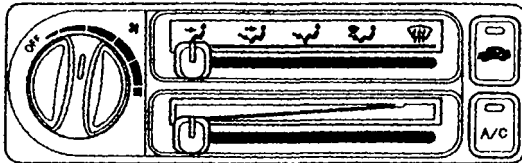
Switch the fan on and outside air will flow through the corner and center vents. To change air distribution, switch to the  position and outside air will also flow from the heater ducts at the floor level.



### [LX/EX]

Turn the temperature control dial counterclockwise, and push the  and  buttons. Switch the fan on and outside air will flow through the corner and center vents. To change air distribution, switch to the  position and outside air will also flow from the heater ducts at the floor level.

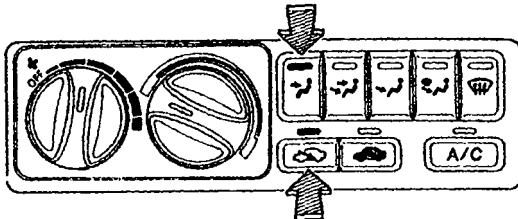



(cont'd)

## Heating and Cooling (cont'd)

---

### To Cool with A/C (optional on DX)

To cool the car down quickly, start the engine, turn the fan to high, push the A/C button and open the windows briefly. Then close the windows, slide the temperature lever all the way to the left on the DX model or turn the temperature control counterclockwise all the way on the LX and EX models. Select the  position and push the  button on, so inside air will recirculate to the air conditioner for maximum cooling. When the interior has cooled sufficiently, switch the fan to the desired speed, then change to the  setting to direct fresh (outside) air to the air conditioner.

[DX]

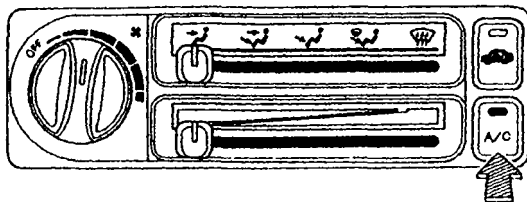

[LX/EX]

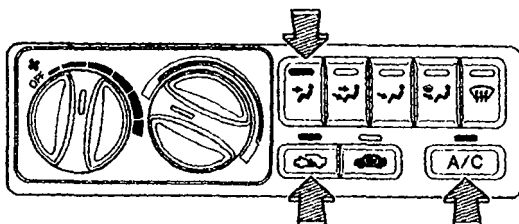

When using the air conditioner in heavy traffic, or while driving up long hills, watch the coolant temperature gauge: if the needle moves near the "H" end of the scale, turn the air conditioner off by pushing the A/C button; leave it off until the needle goes back into the middle of the scale.

---

## To Heat

Switch the fan on, slide the temperature lever to the right on the DX model or turn the temperature control dial clockwise on the LX and EX models; select the  position, and warmed air will begin flowing from the floor outlet.

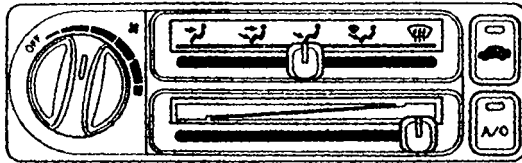

On the LX and EX models, a small amount of warmed air will also flow from the windshield defroster vent.

[DX]

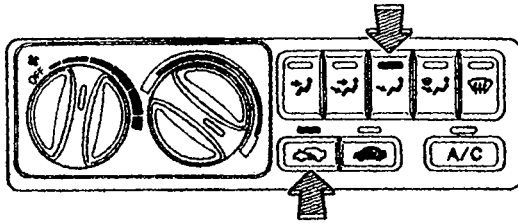

[LX/EX]



To warm up the interior quickly, push in the  button so the inside air will be recirculated to the heater. If the windows begin to fog while heating in the  setting, switch to  to allow outside air to enter.

(cont'd)

# Heating and Cooling (cont'd)

---

## To Dehumidify with A/C (optional on DX)

Because an air conditioner dehumidifies as it works, you can use it in cool or cold weather to help defog the windows. Just switch the fan on, push the A/C button on, select the desired function and adjust the temperature lever/control dial to a comfortable setting.

NOTE: This setting is desirable for most operating conditions in ambient temperatures above approximately 32°F (0°C).

[DX]

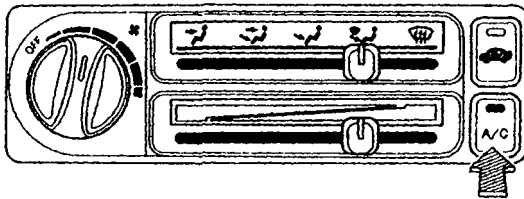

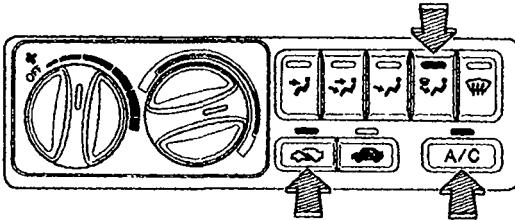

[LX/EX]



---

## To Defrost

To defrost or defog the windshield and door windows, slide the temperature lever to the right on the DX model or turn the temperature control dial clockwise on the LX and EX models; select  (defrost) function, switch to the  setting, and switch the fan on. Warmed (outside) air will then flow from the windshield and side defroster vents.

[DX]



[LX/EX]

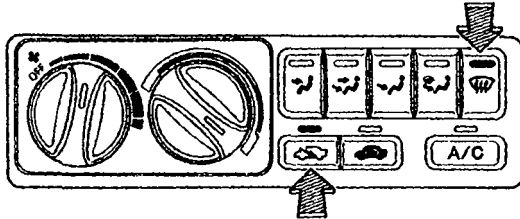





(cont'd)





## Heating and Cooling (cont'd)

---

For extra door window defrosting or defogging, select either the , , or  (defrost) function, switch to the  setting, and turn the fan on.

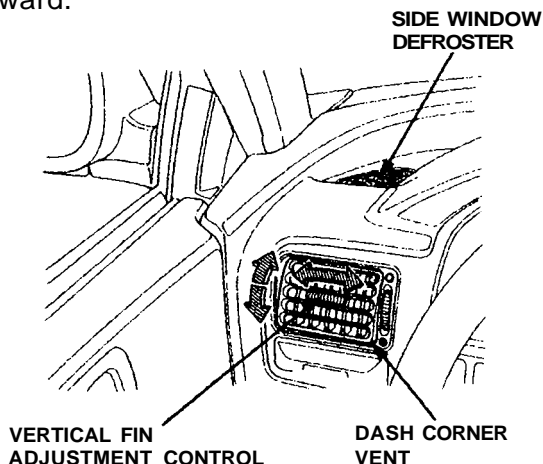
Air will flow to the side door windows from the vents at each end of the dash when the vertical fins of the dash corner vents are pointed toward the windows, and the horizontal fins are moved upward.



After the windows are sufficiently defrosted, you may wish to select the  or  mode for more comfort. Sliding the temperature lever to the left on the DX model or turning the temperature control dial counterclockwise on the LX and EX models will reduce the temperature of the air exiting the dash corner vents without appreciably affecting the heat to your leg and foot area. Continue to adjust the temperature and fan speed to find the most comfortable setting.

### To Turn Everything OFF

Slide the temperature lever to the left on the DX model or turn the temperature control dial counterclockwise all the way on the LX and EX models. Turn the fan switch off and push the  button on.

**NOTE:** This setting should only be used in cold weather for the first few minutes of driving to prevent cold air from blowing into the cabin. Under normal operating conditions, the fan should always be kept ON to prevent the accumulation of stale air in the system.

## Sunroof (EX)

To open or close the sunroof, push and hold the switch. Release the switch when the sunroof reaches the desired position. Do not hold the switch on after the sunroof has fully opened or closed, or you may damage the sunroof motor.

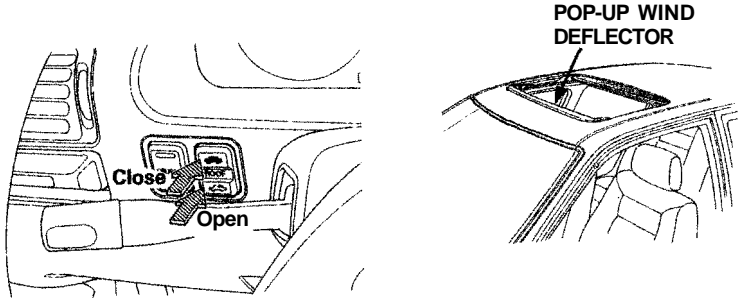

### **▲ WARNING**

- Do not allow any part of your body to extend through the sunroof while the vehicle is in motion. In the event of a collision or sudden application of the brakes, severe personal injury could result.
- To avoid the possibility of injury while closing the sunroof, never allow any part of your body to extend through the opening.

**CAUTION:** Operating the sunroof in severe cold or when it is covered with snow or ice may cause damage to the sunroof.

### Sunshade

As well as the sunroof, there is a sliding sunshade which you can adjust to let in light with the roof closed, or to block out light entirely. The sunshade automatically opens as you open the sunroof.

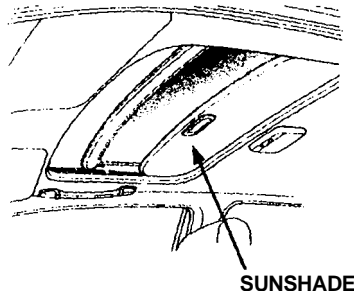

(cont'd)

# Sunroof (cont'd)

## If the Sunroof Won't Close

The sunroof can be closed manually, if the control switch will not close it.

1. Remove the round plug near the rear center of the headliner.
2. Insert the sunroof wrench (from the tool kit) into the socket.
3. Turn the wrench until the sunroof seats in the closed position.
4. Replace the plug.

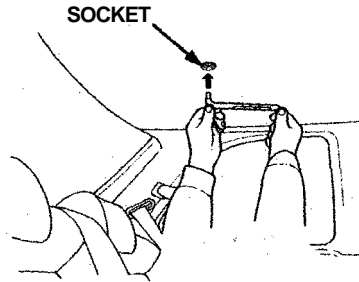
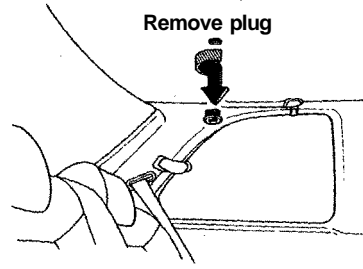

## Maintenance

Periodically pour a little water down the drain holes to make sure they are not plugged. If they are free, water should drop on the ground behind each front wheel.

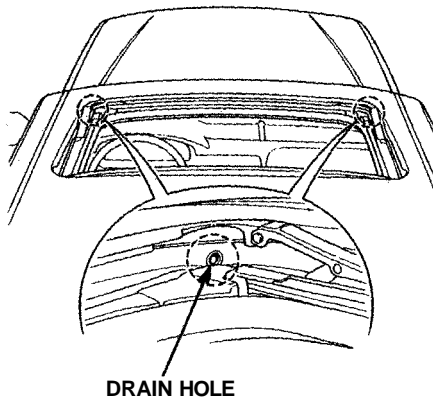

**CAUTION:** Do not put weight on the sunroof or force it open or closed, you may damage the mechanism.

# Stereo Sound System (LX, EX)

[LX]

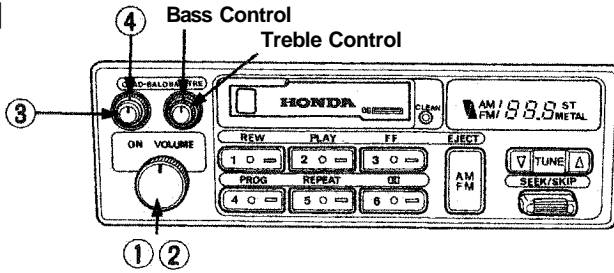

[EX]

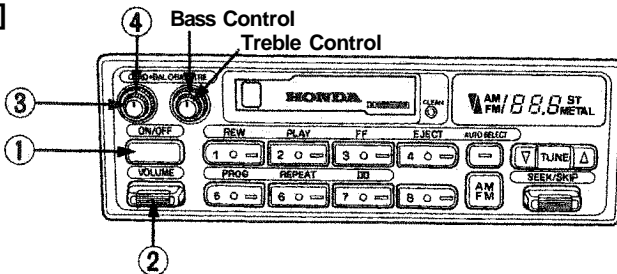

## ① ON/OFF Switch

Turn the switch clockwise on the LX model or push the button on the EX model to switch the unit on. The radio antenna will rise automatically when the unit is turned on. Switch the unit off to retract the antenna. The antenna will also retract automatically if the ignition switch is turned off.

## ② Volume Control

On the LX model, turn the ON/OFF switch clockwise to increase volume and counterclockwise to decrease volume. On the EX model, push the switch up to increase volume and down to decrease volume.

## ③ Balance Control

Balances sound between left and right speakers.

NOTE: When the headlights are on, the radio panel illumination is on, even if the radio is turned off. The panel lighting can be turned off by first pushing the Balance Control button to its out position and then pulling it out slightly further.

## ④ Fader Control

Balances sound between front and rear speakers.

(cont'd)

# Stereo Sound System (cont'd)

## Radio Operation

[LX]

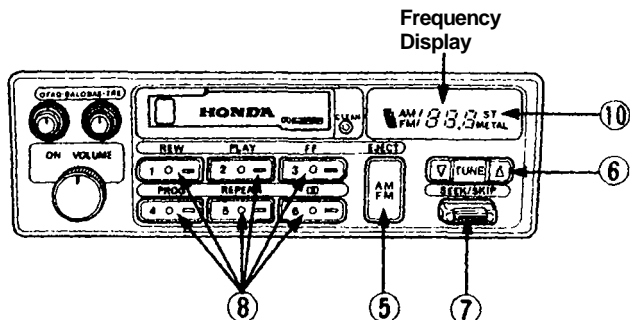

[EX]

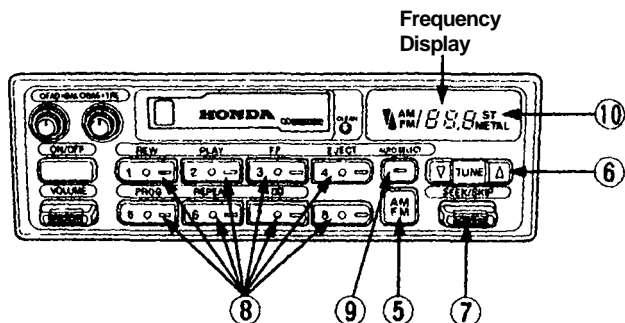

### ⑤ AM/FM Band Selector

Push to select AM or FM band. The corresponding band indicator will light.

### ⑥ Manual Tuning

Push the ▼ button to tune to a lower frequency station.

Push the ▲ button to tune to a higher frequency station.

NOTE: If you hold either button for more than half a second, the tuning frequency will count up or down rapidly.

### ⑦ Seek Tuning

Each time you push this button up or down, the tuner will automatically seek the next higher or lower frequency station.

---

## ⑧ **Preset Station**

1. Make sure the Band Selector is on the band you want...AM or FM. Then, find the station you want by Manual Tuning or Seek Tuning.
2. Press and hold one of the Preset Buttons.
3. In a few seconds, a beep will sound and the light in the button will come on. The station is now preset in the memory. You may preset 1 AM and 1 FM station per button (total, 6 of each on the LX model and 8 of each on the EX model).
4. You can tune to a preset station by pushing its corresponding preset button.

NOTE: On the EX model, the Auto Select Button must be off before the Preset Station Selection can be used.

## ⑨ **Auto Select Button (EX only)**

If you are visiting a new broadcast area, you can quickly enter into memory the stronger stations in that area by simply pushing the Auto Select Button. The radio will then automatically scan the AM or FM bands and temporarily memorize up to eight stations in each. With the Auto Select Button on, these stations can then be tuned by pushing the preset buttons. Manually-preset stations remain memorized for use when you return to your normal broadcast area, but are only selectable with the Auto Select Button off.

## ⑩ **Stereo Indicator**

This lights up when a FM broadcast in stereo is being received. It will flash when the signal strength diminishes. If it flashes, good stereo reception cannot be expected. Stereo reception is available only for FM stereo broadcasts, not for AM stereo broadcast.

(cont'd)

# Stereo Sound System (cont'd)

## Tape Operation

[LX]

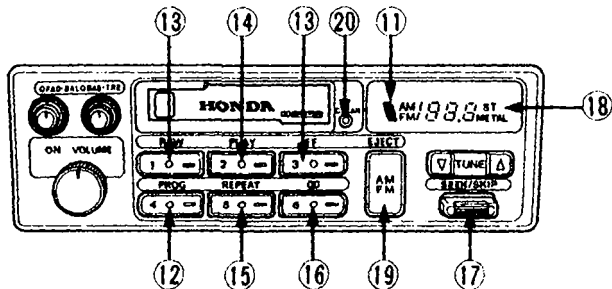

[EX]

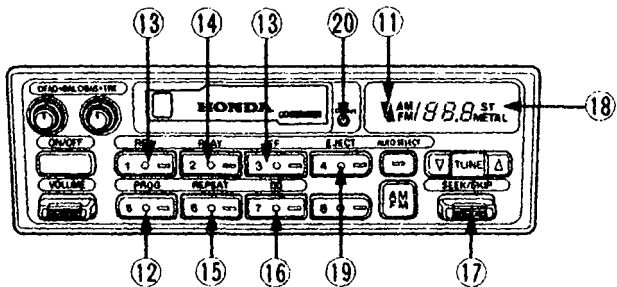

### ⑪ Tape Direction Indicator

With the cassette inserted "A" side up, the indicator (▲) will be displayed when the "A" side is playing; the indicator (▼) will be displayed when the "B" side is playing.

### ⑫ Program Selector (PROG)

Push to change the direction of tape play.

Auto Reverse Feature: The tape direction automatically reverses when the end of the tape is reached in play or FF mode and plays the other side.

### ⑬ Fast Forward/Rewind (FF/REW)

Note which Tape Direction Indicator is displayed, then push the appropriate button to rapidly wind the tape in the same direction (FF) or in the opposite direction (REW).

### ⑭ Play (PLAY)

Push the PLAY button (indicator on) to resume tape play and stop rewind or fast forward operation.

---

**⑮ Repeat Button (REPEAT)**

Push the REPEAT button (indicator on) to return to the beginning of a song or section of programming and repeat its play. Push the button again (indicator off) to cancel the repeat function and resume normal play.

**⑯ Dolby® Noise Reduction (Ⓝ)**

Push when playing tapes recorded in Dolby NR (the Dolby NR Indicator will light). Push again when playing tapes not recorded in Dolby NR. Use of the wrong setting will affect high frequency response.

NOTE:

- The Dolby NR circuit will not operate during radio reception.
- Dolby noise reduction system is manufactured under license from Dolby Laboratories Licensing Corporation. "Dolby" and the double-D symbol are trademarks of Dolby Laboratories Licensing Corporation.

**⑰ Skip Button**

The circuit senses silent passages between songs or programs on a tape. Push upward to automatically advance to the beginning of the next song, or downward to return to the beginning of the song just played.

NOTE: Tapes that contain short silent passages between songs, a high level of noise between songs, or silent passages within a song may not be suitable for this function.

**⑱ Metal Indicator (METAL)**

Most metal or CrO<sub>2</sub> cassettes are coded with slots on their back edge. If such a cassette is inserted, the player will detect the slots and automatically switch to the proper equalization for full enjoyment of metal/CrO<sub>2</sub> tapes. The indicator light will go on when coded cassettes are played.

**⑲ Eject (EJECT)**

Push this button to stop and eject the tape.

Ignition Key-OFF Eject: The cassette being played will be automatically ejected when the ignition or the unit is turned off.

NOTE: When one side of the tape ends, "Auto-Reverse" will automatically begin playing the other side, therefore, you must push the eject button to stop or remove the tape.

(cont'd)



# Stereo Sound System (cont'd)

---

## ⑳ CLEAN Indicator Light

After 50 hours of cassette tape play, the light will come on as a reminder to clean the tape heads. If the light comes on and the tape heads were not cleaned at the recommended 30 hours of usage (see maintenance section below), they should be cleaned immediately. To reset, push the indicator for a minimum of five seconds until the light goes off.

## Defective Tape Eject

The tape player includes a protection mechanism to automatically eject defective tapes (warped housing, loose label, faulty tape movement) immediately upon insertion. If a tape malfunctions while in play, the tape direction will change back and forth and then eject the cassette. Tapes ejected before play should be considered faulty and discarded; tapes ejected during play may only be unevenly wound and could be re-usable if fully rewound, manually, outside the player.

NOTE: The tape player may repeat cycle through the loading and unloading motion several times in an effort to eject a faulty tape. During this process the tape will either eject fully or rise to the loading level and have to be pulled out manually. In either case, discard the tape; re-use may damage the tape player.

## Maintenance

The head in the cassette tape player can pick up dirt or tape deposits each time a cassette is played. The result is low or "muddy" sound from one or both channels, as if the treble tone control were turned all the way down. To prevent this, you should periodically clean the head with a commercially available cleaning cassette.

As preventive maintenance, clean the head about every 30 hours of use. If you wait until the head becomes very dirty (noticeably poor sound), it may not be possible to remove all deposits with a simple cleaning cassette.

The use of 120 minutes tapes is not recommended.

**CAUTION: Storing cassettes out of their cases, or touching the magnetic tape with your fingers will increase the amount of dirt that gets to the tape head. Using low-quality "off-brand" tape will increase the amount of tape deposits that get on the head. Both of these practices may eventually lead to damage of the head and playing mechanism.**

For proper operation of your car's emission controls, your engine is designed to use unleaded fuel only.

**CAUTION: Using leaded or even low-lead gasoline could damage some of your emission controls, and also void their coverage under the emission controls warranty.**

Use gasoline from pumps labeled unleaded, with a pump octane number of 86 or higher. The pump octane number is an average of the Research (R) octane and Motor (M) octane numbers. Use of a lower octane gasoline can cause persistent, heavy "spark knock" (a metallic rapping noise), which can lead to engine damage if severe.

**CAUTION: If you notice steady spark knock while holding a steady speed on a level road, try changing brands of gasoline. If the spark knock persists, consult your Honda dealer. Failure to do so is considered misuse, and misuse is not covered under the New Car Warranty.**

Occasionally you may notice light spark knock while accelerating or driving up hills. This is no cause for concern, it simply means your engine is running at its most economical.

### **Gasoline Containing Alcohol**

If you decide to use a gasoline containing alcohol ("gasohol"), be sure its octane rating is at least as high as that recommended for unleaded gasoline. There are two types of "gasohol": that containing ethanol, and that containing methanol. Do not use gasohol that contains more than 10% ethanol. Do not use gasoline containing methanol (methyl or wood alcohol) that does not also contain cosolvents and corrosion inhibitors for methanol. Never use gasoline containing more than 5% methanol, even if it has cosolvents and corrosion inhibitors.

(cont'd)

## Gasoline (cont'd)

---

### NOTE:

- Fuel system damage or vehicle performance problems resulting from the use of such fuels is not covered under the new car warranties. Honda cannot endorse the use of fuels containing methanol since evidence of their suitability is as yet incomplete.
- Before purchasing fuel from an unfamiliar station, try to confirm whether the fuel contains alcohol, of what kind, and how much. If you notice any undesirable operating symptoms after using a gasoline that contains alcohol; or one that you think contains alcohol, switch to an unleaded gasoline as recommended on page [57](#).

### Operation In Foreign Countries

In order to comply with U.S. Federal Emissions Regulations, you must use unleaded fuels of the recommended octane rating. These fuels may not be available in other countries. If you intend taking your car outside the U.S. or Canada, write to American Honda Consumer Affairs (stating the year and model of your car) at the address below for information regarding modifications you may need to have done.

American Honda Motor Co., Inc.  
Consumer Affairs  
100 W. Alondra Blvd.,  
Gardena, CA 90248

## Fuel Filler Door and Cap

**⚠ WARNING** Gasoline is extremely flammable and is explosive under certain conditions. Perform this operation in a well-ventilated area with the engine stopped. Do not smoke or allow open flames or sparks in the area or where gasoline is stored.

The fuel filler door is opened by pulling up on the lever at the left side of the driver's seat. The door will lock automatically when closed; push it until it clicks.

**CAUTION:** You may hear a hiss when you open the filler cap. This sound is residual pressure escaping from the fuel tank. Open the cap slowly and remove the cap after the hissing stops. Fuel spray may cause injury. Do not overfill the tank; fill only until the gas pump clicks off automatically and never top off.

**NOTE:** The filler cap is a screw-in ratchetting type. Tighten the cap clockwise until ratchetting clicks are heard.

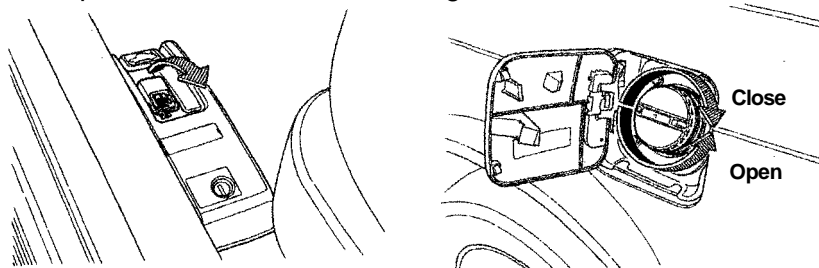

The removed filler cap can be placed on the inside of the door.

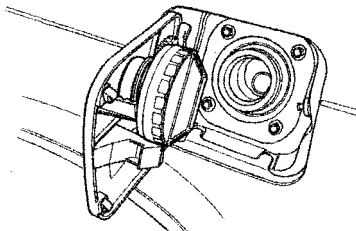

**⚠ WARNING** Fuel vapor is extremely hazardous under certain conditions. Always stop the engine before refueling, and never refuel near sparks or open flames.

**CAUTION:** If you replace the cap, use only a genuine Honda replacement part or its equivalent. Failure to use the proper part could cause serious fuel system problems.

(cont'd)

## Gasoline (cont'd)

---

### How To Improve Your Gas Mileage:

- Drive at a smooth, steady pace to avoid unnecessary decelerations and stops — accelerating back to speed uses more fuel.
- Plan trips to avoid rush hour traffic if possible.
- Make sure the parking brake is completely released.
- Consolidate trips whenever possible.
- Keep vehicle weight to a minimum by removing unnecessary items from the luggage area.
- Whenever possible, use fresh air from the dash vents to keep cool when driving; open windows, or use of the air conditioning (optional on DX) both affect fuel economy.
- Keep the tires adjusted to the recommended pressure.

Tire Pressure (measured cold):

Front/Rear:	DX, LX	200/200 kPa (29/29 psi)
	EX	195/195 kPa (28/28 psi)

### Condition of Your Car

You can only get maximum fuel economy if your car is in top running condition. Have all required maintenance done at the proper intervals. Check tire pressures and tire wear frequently. If tire wear is uneven, have the alignment checked by your Honda dealer. Proper alignment saves gasoline and prolongs tire life.

# Ignition Switch

The combined ignition switch/anti-theft lock is located on the right side of the steering column and has four positions:

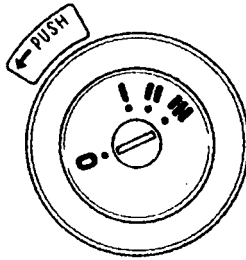

- **0-LOCK position:** The key can be removed or inserted in this position. To remove the key, push it in at position I, then turn it to 0 and pull it out. When the key is removed, the steering column will lock.

NOTE: On cars equipped with automatic transmissions, the transmission must be in Park before pushing and turning the key to the 0-LOCK position.

**▲ WARNING** Never turn the ignition switch to the lock position or remove the key while the car is in motion; the steering wheel can lock causing a loss of directional control, and an accident could result.

- **I-ACCESSORY position:** In this position, the accessory circuit is on, but the ignition circuit is off. If the key is difficult to turn from the 0 to the I position, turn the steering wheel slightly to relieve pressure on the lock.
- **II-ON position:** This is the normal running position.
- **III-START position:** The starter will engage when the key is turned to this position.

To remind you to remove the ignition key when leaving your car, a beeper will sound if the key is still in the ignition when you open the driver's door. The beeper system is deactivated when you turn the ignition to 0 (Lock) and fully remove the key.

# Starting the Engine

---

## Before Starting

### Manual Transmission:

1. Apply the parking brake.
2. Push the clutch pedal all the way in (see NOTE below).
3. Shift the transmission to neutral.

NOTE: On cars equipped with manual transmissions, the engine will not crank unless the clutch pedal is fully depressed.

### Automatic Transmission:

1. Make sure the shift lever is in Park (P).
2. Apply the parking brake and foot brake.

#### NOTE:

- When starting in cold weather, keep all unnecessary electrical circuits off (lights, defogger, etc.) for the best battery output.
- Do not crank the engine for more than 15 seconds at a time. Wait 10 seconds before going to the next step.

## Starting the Engine:

1. With your foot off the accelerator start the engine by turning the key to the III position.
2. If the engine won't start within 15 seconds or starts but fails to continue to run, push the accelerator pedal halfway, and hold it there while cranking the engine. Once the engine starts, release the accelerator gradually as the engine speeds up.
3. If it doesn't start within 15 seconds, push the accelerator pedal down to the floor and hold it there while cranking in order to clear flooding. Try step 2 again.

## Cold Weather at High Altitude Starting:

1. When starting in cold weather at high altitude (above 8,000 feet), push the accelerator pedal about halfway and hold it there while cranking the engine. Once the engine starts, release the accelerator gradually as the engine speeds up.
2. If it doesn't start within 15 seconds, push the accelerator pedal down to the floor and hold it there while cranking in order to clear flooding. Try step 1 again.

NOTE: If the outside temperature is below freezing, or if your car has not been driven for several days, warm up the engine for a few minutes before driving.

### **Before driving away, check that:**

- The doors are closed properly.
- The mirrors are properly adjusted, and the windows clean.
- The driver and passengers are wearing properly adjusted seat belts.
- The front seat head restraints are properly adjusted.
- The warning and indicator lights are operating properly.
- The brake pedal feels normal.
- All luggage and cargo is secured.
- Nothing is interfering with the driver's feet or blocking vision to the rear.

### **While driving remember to:**

- Always drive defensively; expect the unexpected.
- Reduce your speed during night hours and bad weather.
- Follow at a safe distance; don't tailgate.
- Get off the highway when you are tired; stop and take a rest.

### **When stopping for repairs:**

- Park the car well off the road.
- Turn on the hazard warning flasher.
- Use flares or other warning devices to warn other motorists.

### **After parking your car:**

- Apply the parking brake and shift to first gear if equipped with manual transmission, or PARK on automatic transmission equipped cars.
- Make sure the sunroof (EX) and all windows are closed and the doors are locked.
- If parked on a hill:
  1. Turn the front wheels away from the curb if facing uphill.
  2. Turn the front wheels toward the curb if facing downhill.
- Never leave children unattended in a parked car.
- Take your keys.



# Engine Exhaust Gas Warning

---

A properly maintained car is your best protection against exhaust gas entering the passenger compartment.

The exhaust system should be thoroughly inspected by a competent mechanic whenever:

- The car is raised for oil change.
- You notice a change in the sound of the exhaust.
- The exhaust system or the rear or underside of the car is damaged.

## WARNING

- **Avoid breathing exhaust gases.** They contain carbon monoxide, which is a colorless, odorless gas that can cause loss of consciousness and eventual death. If you suspect that exhaust gas is entering the passenger compartment, have the cause determined and corrected as soon as possible. If you must drive under these conditions, drive only with all windows fully open.
- **Do not drive with the trunk lid open.** An open trunk lid may draw exhaust gases into the passenger compartment. If you must drive with the trunk lid open, drive only with all the windows wide open.
- **Do not run the engine in confined areas, such as garages, any longer than necessary to move the car in or out.**
- **If you must sit in a parked car with the engine running for more than a short time, adjust the heating/ventilation system as follows:**

### 1.[DX]

Slide the function lever to  and push the  button off.

### [LX, EX]

Select the  and  positions.

2. Set the temperature lever/control dial for best comfort.
3. Turn the fan to the highest speed.

NOTE: To insure proper operation of the car's ventilation system, keep the front air inlet clear of snow, mud, leaves or other obstructions.

## Shifting the 5 Speed

---

The fully synchronized manual transmission is very easy to shift up or down. When you slow down for traffic, steep hills, or corners, shift to a lower gear before the engine starts to labor. When descending steep grades, select a lower gear to help maintain a safe speed and to prevent the brakes from overheating. When shifting, depress the clutch pedal fully, shift gears and then release the clutch gradually. Do not speed-shift; allow time for the gears to synchronize. To prevent grinding gears when shifting into reverse, hold the clutch pedal depressed briefly before shifting, or shift the lever into one of the forward gears before selecting reverse. A safety lockout prevents accidental shifting straight from 5th to Reverse.

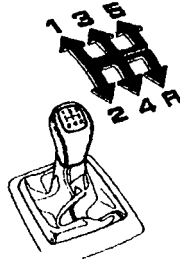

**⚠ WARNING** Avoid rapid acceleration or sudden deceleration when either or both driving wheels are on a slippery surface. Decreased traction could cause loss of directional control.

### CAUTION:

- Do not drive with your foot on the clutch pedal as this will cause premature wear of clutch components.
- Do not shift into reverse while the car is moving.

(cont'd)

# Shifting the 5 Speed (cont'd)

---

## Recommended Shift Speeds

For best fuel economy, and effective emission control, shift at the speeds shown:

Shift up	Normal Acceleration
1st to 2nd	15 mph (24 km/h)
2nd to 3rd	28 mph (45 km/h)
3rd to 4th	41 mph (66 km/h)
4th to 5th	52 mph (83 km/h)

Shift up	Cruise From Acceleration
1st to 2nd	7 mph (11 km/h)
2nd to 3rd	22 mph (35 km/h)
3rd to 4th	33 mph (53 km/h)
4th to 5th	48 mph (77 km/h)

## Maximum Allowable Speeds

The speeds shown are the maximum at which the car can be driven or downshifted in each gear without over-revving the engine.

	DX, LX	EX
1st	31 mph (50 km/h)	31 mph (50 km/h)
2nd	56 mph (90 km/h)	56 mph (90 km/h)
3rd	87 mph (140 km/h)	84 mph (135 km/h)

# Shifting the Automatic

The automatic transmission shift lever has a locking mechanism to prevent accidental shifting into Reverse (R), Park (P), 2nd (2) or 1st (1). Also, an Automatic Shift Lock prevents you from shifting out of Park unless the brake pedal is already depressed and the ignition switch is in the II position.

Push the button on the shift handle to shift into 2nd, 1st, Reverse or Park; depress the brake pedal and then push the button on the shift handle to shift out of Park.

- ⇨: Depress the brake pedal first and push the button, then shift.
- ➡: Push the button, then shift.
- ⇨: Shift as desired.

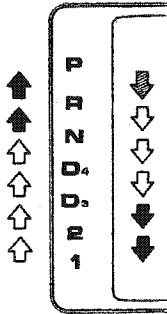

Depress button

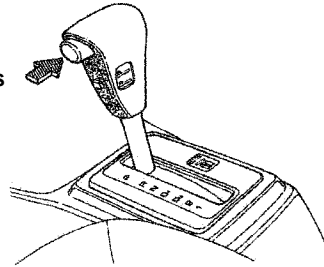

If you cannot shift out of Park with the brake pedal depressed and the ignition switch in the II position:

1. Turn the ignition switch off and remove the key.
2. Insert the key in the Shift Lock Release located to the right of the shift lever.
3. Press and hold the key down, then press the button on the shift handle and move the shift lever to Neutral.
4. Return the key to the ignition switch, depress the brake pedal and restart the engine.

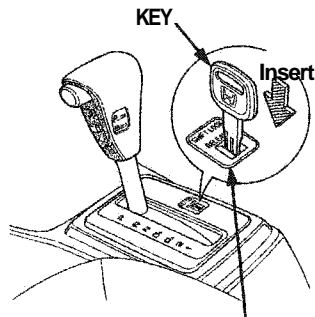

SHIFT LOCK RELEASE

NOTE: If you encounter any problem shifting out of Park, have your authorized Honda dealer check the system as soon as possible.

(cont'd)

# Shifting the Automatic (cont'd)

---

## Operating Tips

For smoother operation, apply the brakes when shifting from Neutral or Park to a forward or reverse gear.

When parking: bring the car to a stop with the foot brake, hold the brake on and shift into Park, set the hand brake and then turn off the engine.

NOTE: Your 4 speed automatic transmission is equipped with a torque converter lock-up clutch.

Because of this, you may notice what feels like an extra shift as the clutch engages.

## CAUTION:

- Shift into P only after the car has come to a complete stop.
- Shift into or out of R only after the car has come to a complete stop.
- Do not "rev-up" the engine when the brake is on and the shift lever is in D<sub>4</sub>, D<sub>3</sub>, 2, 1 or R.
- When stopped on a hill, use the brakes to hold your position, not the accelerator pedal.
- Do not shift from N or P into D<sub>4</sub>, D<sub>3</sub>, 2, 1 or R when the engine is above idle speed. Before shifting into gear, make sure your foot is firmly on the brake pedal.
- Do not rest your hand on the shift lever or push the lock-out button while driving.

---

## Driving Technique

### D4-4th

Use the D4 range for normal in-town and highway driving. The car will start off in 1st and shift automatically to 2nd, 3rd, and 4th. The further down you push the accelerator, the later the transmission will shift and the faster the car will accelerate.

### D3-3rd

Use of D3 will allow the transmission to start off in 1st and shift automatically to 2nd and 3rd. Use D3 when climbing grades to prevent the transmission from "hunting" between 3rd and 4th gear; or when increased braking is needed.

### NOTE:

If rapid acceleration is necessary, depress the accelerator to the floor; the transmission will automatically shift down according to load and engine speed. This applies to both D4 and D3 ranges.

### S Mode

Pushing the Sport (  ) switch while driving in the D4 or D3 range will change the shift points under part throttle acceleration, allowing the transmission to stay in each lower gear for a longer period before automatically upshifting. With the Sport switch on, the Sport indicator light in the instrument panel will come on. To take the transmission out of S mode, push the Sport switch again. The Sport indicator light will go out.

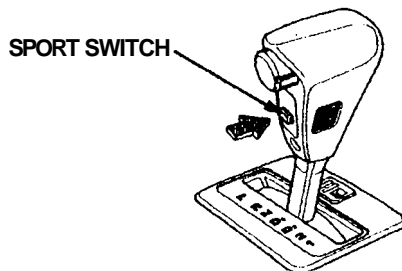

NOTE: Although the S indicator light in the instrument panel will come on in any gear range when the Sport switch is pushed, this mode is selectable only in the D3 and D4 range.

(cont'd)

## Shifting the Automatic (cont'd)

---

### **2-2nd**

Use 2nd gear for increased engine braking when driving downhill, and increased power when driving uphill; also for driving on slippery roads, and freeing the car from mud or sand, where 1st gear could provide too much power and cause skidding or wheelspin. The maximum recommended speed in 2nd gear is 69 mph (110 km/h).

### **1-1st**

This position is to be used when stronger engine braking is needed. The maximum recommended speed in 1st gear is 31 mph (50 km/h).

### **R-Reverse**

**CAUTION:** Shift into or out of reverse only after the car has come to a complete stop; the transmission may be damaged if you shift while the car is moving.

### **P-Park**

**CAUTION:** Use this position when starting the engine, or when parking. Shift into Park only when the car is COMPLETELY stopped.

### **N-Neutral**

Use when starting the engine or during prolonged idling in traffic.

## Towing a Trailer

Your car is designed primarily to carry passengers and a normal amount of luggage. Although your car is capable of towing a trailer, there will be an effect on handling, performance, braking, general vehicle and tire durability and fuel economy.

### ⚠ WARNING

- The weight of the trailer plus its cargo must not exceed a total of **1,000 lbs. (450 kg)**.
- The gross vehicle weight must not exceed the Gross Vehicle Weight Rating (GVWR) indicated on the Certification label (see page 126). The gross vehicle weight is the total weight of the car, driver, passengers, luggage, hitch and trailer tongue load.
- The total weight supported by each axle must not exceed the Gross Axle Weight Rating (GAWR). The front and rear GAWR's are shown on the Certification label (page 126). The distribution of luggage and passengers in the car, as well as the tongue load and hitch weight should also be considered in terms of the GAWR, which is the maximum amount of weight that should be supported over the front and the rear axles. You should have your car and trailer weighed at a commercial weighing station to check both the GVWR and GAWR's to confirm that the total weight and weight distribution are within safe driving limits.
- The maximum trailer tongue load must not exceed **100 lbs. (45 kg)**. Cargo should be distributed so that the tongue load is approximately 10% of the total weight of the trailer and its cargo. This is done by distributing approximately 60% of cargo weight toward the front of the trailer and 40% toward the rear.

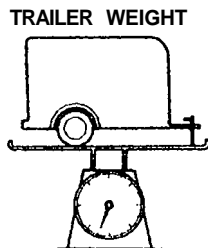

Maximum: 1,000 lbs (450 kg)

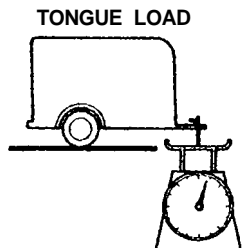

Maximum: 100 lbs (45 kg)

- Never load the trailer so that the back is heavier than the front. This will seriously affect vehicle handling. Be sure the cargo is secured so that it will not move during driving.

(cont'd)



## Towing a Trailer (cont'd)

---

### Hitches

Use only a hitch recommended by your Honda dealer. The hitch should be bolted securely to the car and installed by a qualified technician. Do not use a hitch designed for temporary installation and never use one that attaches only to the bumper.

### Trailer Brakes and Safety Chains

The Honda Automobile Division recommends that trailers equipped with brakes should conform to any applicable federal and state regulations. When using a trailer equipped with electric brakes, a trailer brake controller that connects to the car's electrical system is recommended. Installing a brake controller that connects to the car's brake hydraulic system could result in brake fluid contamination or leaks. A safety chain must always be used between the car and the trailer. Leave sufficient slack in the chain so that it does not bind in sharp turns. The chain should cross under the trailer tongue to prevent the tongue from dropping to the ground.

### Tires

Make sure your car's tires are properly inflated. Adjust tire pressure to the recommended tire pressure indicated on the label attached to the driver's door jamb. The trailer tires should be of the proper size, load rating and inflated to the pressure recommended by the trailer manufacturer.

### Trailer Lights

Trailer lights must comply with federal, state and local regulations.

See your local recreational vehicle dealer or rental agency for the correct type of lighting and wiring for your trailer. Check for correct operation of the turn signals and stop lights each time you hitch up.

**A trailer lighting connector is provided behind the left garnish by the taillight access door in the trunk. The wiring color codes are described on the next page.**

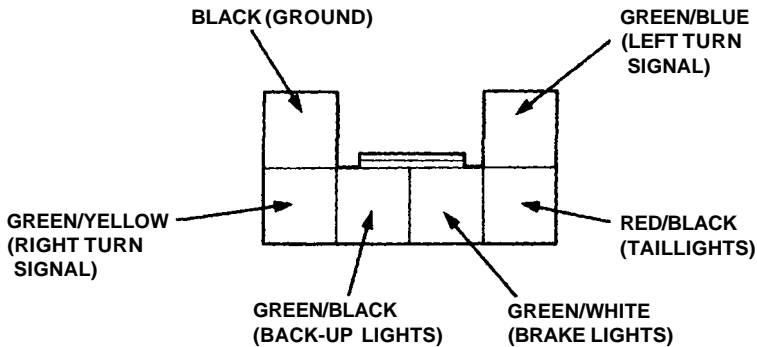

To connect your car's taillights to a trailer, an electrical converter must be installed in the car. Your car has separate bulbs for brake (red) and turn signal lights (amber), while most trailers use the same bulb for brake and turn signal lights. A converter, available at most trailer supply stores, should be installed according to the instructions supplied by the converter manufacturer.

For information regarding trailer hitch and trailer electrical wiring availability, contact your Honda dealer.

**CAUTION: Connections to your car's electrical system should be made by your Honda dealer or a qualified electrician. Improper installation may damage your vehicle's electrical system and cause a malfunction of the lights.**

### **Break-in Schedule**

Do not tow a trailer during the 600 miles (1,000 km) break-in period: see page 2.

### **Maintenance**

If you tow a trailer, your vehicle will require more frequent maintenance due to the additional load. Refer to the "Maintenance schedule under severe driving conditions" on page 82 for specific information.

(cont'd)

# Towing a Trailer (cont'd)

---

## Before Towing

With the car and trailer completely loaded and parked on a level surface, confirm that the tongue loading is correct. If the car has an abnormal nose-up or nose-down attitude, check for improper cargo distribution. Check also for excessive cargo weight, worn suspension or other causes and correct the problem before driving.

Be sure the cargo is secured so it will not shift while driving. Check that your rearview mirrors conform to any federal, state or local regulations. If not, install rearview mirrors designed for towing.

Before towing a trailer, practice turning, stopping and reversing with a trailer in an area away from traffic until you learn the technique.

## Towing Safety

### **⚠ WARNING**

- **Stopping distance will be increased when towing a trailer. For each 10 mph (16 km/h) of speed, allow at least two car lengths between you and the vehicle ahead. Avoid sudden braking which may cause trailer jackknifing and loss of control.**
- **Avoid jerky starts and rapid acceleration. If your car has a manual transmission, always start out in first gear and release the clutch at moderate engine rpm.**
- **Avoid rapid lane changing and sharp turns. The trailer could hit your car in a tight turn. Slow down before making a turn. Remember, the total length of your car plus trailer will require a wider turning circle.**
- **Crosswinds may adversely affect handling of your car and trailer. Use the rearview mirrors frequently to warn you of approaching large vehicles that may pass you causing your car and trailer to sway. When being passed, firmly grip the steering wheel and be prepared to reduce speed immediately but gradually. Never increase speed. Steer straight ahead.**
- **Towing a trailer in bad weather will magnify any difficulty in controlling the car caused by the weather itself. Avoid sudden maneuvers: slow down and use extra caution.**
- **Be careful when passing other vehicles. Passing requires considerable distance because of the added weight and length of your trailer.**

---

**CAUTION:**

- Before starting out, check the operation of the lights and all car/trailer connections. After driving a short distance, stop and recheck the lights and connections.
- Reversing is difficult and requires practice. While backing-up, the trailer may pivot off-course. To correct for this, grip the bottom of the steering wheel and move your hand to the left to move the trailer to the left; or to the right to move the trailer to the right. Turn the steering wheel a little at a time, and keep the speed very low. Have someone guide you when backing.
- To help prevent overheating of the brakes, shift into a lower gear to make use of engine braking before descending steep or long grades. Do not make sudden downshifts.
- Pay strict attention to the coolant temperature gauge when going up hills. Because of the added load of the trailer, your car's engine may overheat on hot days. Turning off the air conditioner will reduce the load on the cooling system.
- On cars equipped with automatic transmission.
  - Do not hold the car stationary on an incline by using the accelerator pedal; this can cause the transmission fluid to overheat. Instead, use the handbrake or footbrake.
  - When towing trailers, avoid high transmission fluid temperatures (caused by the transmission frequently shifting between 3rd and 4th gears) by driving in D3.

**NOTE:** Be sure to check state and local laws concerning maximum speed or other driving restrictions for cars towing trailers. If you are driving across several states, check each state's requirements before leaving home, because restrictions may vary.

(cont'd)

## Towing a Trailer (cont'd)

---

### **Parking with a Trailer**

Whenever parking your car on an incline with a trailer attached, place and seat chocks at each wheel of the car and trailer. This is in addition to the normal parking preparations of firmly applying the parking brake and placing the transmission in first or reverse (manual transmission) or P (automatic transmission).

**CAUTION: Parking on an incline is not recommended and should be done only if it cannot be avoided. Follow all precautions mentioned above and turn the wheels to point towards a curb if facing downhill, away from a curb if facing uphill. When leaving an inclined parking place, move the car slightly to unseat the chocks. Then while keeping the foot brakes firmly applied, have an assistant remove the chocks.**

# Maintenance Schedule and Records

---

Your Honda automobile must be properly maintained to ensure that it is in peak operating condition and the emission levels are within the standards set by the Federal Clean Air Act.

The following instructions and maintenance procedures are based on the assumption that your car will be used exclusively for the purpose for which it was designed:

1. To carry passengers and cargo within the load limits shown on the label on the driver's door jamb.
2. To be driven on reasonable road surfaces within legal limits.
3. To generally be driven daily over a distance of several miles.
4. Use gasoline from pumps labeled unleaded, with a pump octane number of 86 or higher. The pump octane number is an average of the Research (R) octane and Motor (M) octane numbers.

NOTE: Failures which occur due to a lack of maintenance will not be covered under the New Car Warranty.

The Required Maintenance Schedule \* specifies all maintenance required to keep your car in peak operating condition. Work should be done by a Honda dealer but may be done by any qualified service facility or individual who is competent in this type of work.

**Maintenance, replacement, or repair of emission control devices and systems may be done by any automotive repair establishment or individual using parts that are "certified" to EPA standards.**

After the maintenance has been done, be sure to have your servicing dealer complete the Maintenance Record on pages [81](#) — [83](#). All required maintenance is considered normal owner operating cost and you will be charged for it by your dealer.

\* For vehicles sold in California, maintenance operations indicated by \*3 on page [80](#) are recommended by the manufacturer.

Other maintenance operations are required by California regulations and condition the emission warranty.

---

Check the following items at each fuel stop:

1. Engine oil level.
2. Radiator coolant level.

Check the following items periodically:

1. Brakes: for braking efficiency, brake pedal travel and hydraulic fluid level.
2. Lights: for operation of headlights, taillights, side marker lights, stoplights, turn signals and back-up lights.
3. Tires: for correct pressures (including spare); inspect for cuts and uneven or excessive wear. Rotate every 7,500 miles (12,000 km) in the pattern shown on page 106.
4. Steering: for excessive play or vibration while driving.
5. Exhaust system: for leaks or loose mounts.
6. Wipers: for operation of windshield wipers and washer, and condition of wiper blades.
7. Seat belts: for condition of fabric and buckles, and operation of restraint mechanism.
8. Battery condition.

(cont'd)

# Maintenance Schedule and Records (cont'd)

R—Replace	* <sup>1</sup> Tension adjustment only						
C—Clean	* <sup>2</sup> Thereafter, replace every 2 years or 30,000 miles (48,000 km), whichever comes first.						
I—Inspect	* <sup>3</sup> For cars sold in California, this service is recommended only; for other areas, it is required.						
After inspection, clean, adjust, repair or replace if necessary.							
Service at the interval listed x 1,000 miles (or km) or after that number of months, whichever comes first.	x 1,000 mile	15	30	45	60	75	90
	x 1,000 km	24	48	72	96	120	144
	months	12	24	36	48	60	72
Idle speed and idle CO					I		
Valve clearance		I	I	I	I	I	I
Alternator drive belt			I* <sup>1</sup>		I		I
Timing belt and timing balancer belt							R
Water pump							I
◆ Engine oil and oil filter ●	Replace every 7,500 miles (12,000 km) or 6 months.						
◆ Transmission oil			R		R		R
Radiator coolant ●				R		R* <sup>2</sup>	
Cooling system hoses and connections		I			I		I
E.G.R. system					I		
Air cleaner element			R		R		R
Fuel filter and hoses					R		
Fuel line connections			I* <sup>3</sup>		I		I
Evaporative emission control system					I		
Ignition timing and control system					I		
Spark plugs			R		R		R
Distributor cap and rotor					I		
Ignition wiring					I		
Positive crankcase ventilation valve					I		
Brake hoses and lines	I	I	I	I	I	I	I
Brake fluid			R		R		R
◆ Front brake discs and calipers	I	I	I	I	I	I	I
Front brake pads	Inspect every 7,500 miles (12,000 km) or 6 months.						
Rear brake drums, wheel cylinders and linings		I			I		I
Parking brake	I	I			I		I
Exhaust pipe and muffler	I	I	I	I	I	I	I
Suspension mounting bolts	I	I	I	I	I	I	I
Front wheel alignment	I	I	I	I	I	I	I
Steering operation, tie rod ends, steering gear box and boots	I	I			I		I
◆ Power steering system	I	I	I		I	I	I
Power steering pump belt			I* <sup>1</sup>		I		I
Catalytic converter heat shield					I		

● Check oil and coolant level at each fuel stop.

◆ Under severe driving conditions, service these items **twice as often**. (See page 82)



## Required Maintenance Record

- Have your servicing dealer record all Required Maintenance below.
- Keep receipts for all work done on your car.

7,500 MI. 12,000 km. (or 6 Mo.)	(Sign or Stamp)	Mileage Date
15,000 MI. 24,000 km. (or 12 Mo.)	(Sign or Stamp)	Mileage Date
22,500 MI. 36,000 km. (or 18 Mo.)	(Sign or Stamp)	Mileage Date
30,000 MI. 48,000 km. (or 24 Mo.)	(Sign or Stamp)	Mileage Date
37,500 MI. 60,000 km. (or 30 Mo.)	(Sign or Stamp)	Mileage Date
45,000 MI. 72,000 km. (or 36 Mo.)	(Sign or Stamp)	Mileage Date
52,500 MI. 84,000 km. (or 42 Mo.)	(Sign or Stamp)	Mileage Date
60,000 MI. 96,000 km. (or 48 Mo.)	(Sign or Stamp)	Mileage Date
67,500 MI. 108,000 km. (or 54 Mo.)	(Sign or Stamp)	Mileage Date
75,000 MI. 120,000 km. (or 60 Mo.)	(Sign or Stamp)	Mileage Date
82,500 MI. 132,000 km. (or 66 Mo.)	(Sign or Stamp)	Mileage Date
90,000 MI. 144,000 km. (or 72 Mo.)	(Sign or Stamp)	Mileage Date

# Maintenance Schedule and Records (cont'd)

## Severe Driving Conditions

**CAUTION:** The following items must be serviced more frequently on cars normally used under severe driving conditions. Refer to the chart below for the appropriate maintenance intervals.

Severe driving conditions include:

A: Repeated short distance driving

B: Driving in dusty conditions

C: Driving in severe cold weather

D: Driving in areas using road salt or other corrosive materials

E: Driving on rough and/or muddy roads

F: Towing a trailer

Condition	Maintenance item	Maintenance operation	Interval
A B . . . F	Engine oil and oil filter	R	Every 3,750 miles (6,000 km) or 3 months
. . . . . F	Transmission oil	R	Every 15,000 miles (24,000 km) or 12 months
A B · D E F	Front brake discs and calipers	I	Every 7,500 miles (12,000 km) or 6 months
· B C · E ·	Power steering system	I	Every 7,500 miles (12,000 km) or 6 months

R—Replace

I—Inspect

After inspection, clean, adjust, repair or replace if necessary.

## Non-Scheduled Maintenance Record

Record additional maintenance for severe driving conditions or non-scheduled maintenance on this page. (See page 80)

Maintenance Performed:	(Sign or Stamp)	Mileage ..... Date
Maintenance Performed:	(Sign or Stamp)	Mileage ..... Date
Maintenance Performed:	(Sign or Stamp)	Mileage ..... Date
Maintenance Performed:	(Sign or Stamp)	Mileage ..... Date
Maintenance Performed:	(Sign or Stamp)	Mileage ..... Date

Maintenance Performed:	(Sign or Stamp)	Mileage Date
Maintenance Performed:	(Sign or Stamp)	Mileage Date
Maintenance Performed:	(Sign or Stamp)	Mileage Date
Maintenance Performed:	(Sign or Stamp)	Mileage Date
Maintenance Performed:	(Sign or Stamp)	Mileage Date
Maintenance Performed:	(Sign or Stamp)	Mileage Date
Maintenance Performed:	(Sign or Stamp)	Mileage Date
Maintenance Performed:	(Sign or Stamp)	Mileage Date
Maintenance Performed:	(Sign or Stamp)	Mileage Date
Maintenance Performed:	(Sign or Stamp)	Mileage Date
Maintenance Performed:	(Sign or Stamp)	Mileage Date
Maintenance Performed:	(Sign or Stamp)	Mileage Date
Maintenance Performed:	(Sign or Stamp)	Mileage Date
Maintenance Performed:	(Sign or Stamp)	Mileage Date
Maintenance Performed:	(Sign or Stamp)	Mileage Date
Maintenance Performed:	(Sign or Stamp)	Mileage Date

# Fluid Locations

---

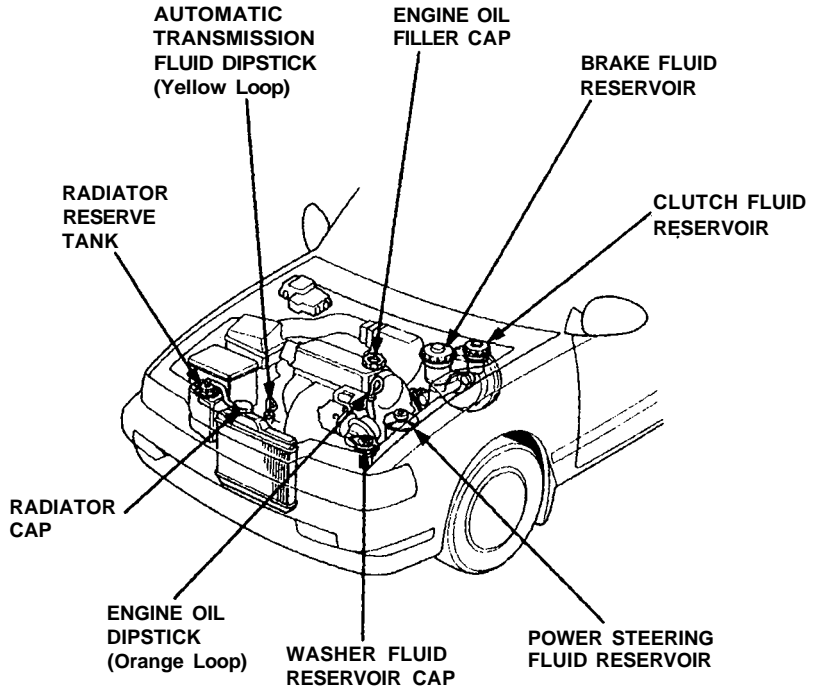

# Engine Oil and Filter

## Checking

Check the engine oil a couple of minutes after shutting the engine off, with the car parked on level ground. Remove the dipstick and wipe it clean. Re-insert it all the way down, then pull it out and read the level. The level should be between the upper and lower marks.

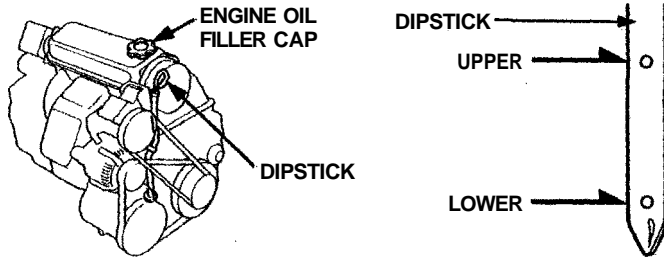

## Adding

If the level has dropped close to the lower mark, add oil until it is even with the upper mark.

1. Turn the oil filler cap counterclockwise to remove. Add oil, then check the level again. Do not overfill.
2. Reinstall the cap and twist clockwise until it stops.

## CAUTION:

- Be sure the oil filler cap is correctly replaced before starting the engine.
- Engine oil is a major factor affecting the performance and service life of the engine, you should use only a premium quality detergent oil labeled SG grade.

LOOK FOR THIS LABEL  
ON THE OIL CONTAINER

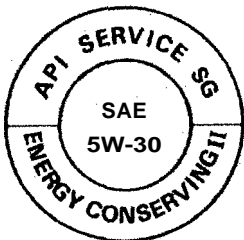

Use the proper viscosity oil for  
the climate in which you drive:

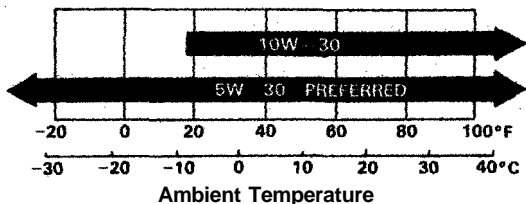

Some oil labels may also include additional designations of quality such as CC or CD. However, these are acceptable only when used together with SG.

NOTE: 5W-30 viscosity oil is recommended for improved fuel economy.

(cont'd)

# Engine Oil and Filter (cont'd)

---

## Fuel Efficient Oil

For the best fuel economy from your car, it is recommended that you use a fuel efficient SG oil. This oil is usually identified by the words such as: "Energy Conserving II," "Gas Saving," and "Fuel Saving," etc.

## Changing Oil and Filter

Engine oil and the filter should be changed together every 6 months or 7,500 miles (12,000 km), whichever comes first. The filter is located on the engine block, below the intake manifold.

**CAUTION: The oil filter cannot easily be removed from above the engine. For this reason it is recommended that the oil filter change be done by a skilled mechanic.**

1. Start the car to warm up the engine, then shut it off.
2. Remove the engine oil filler cap and drain bolt, and drain the oil.

**▲ WARNING** A warmed-up engine and the oil in it are hot; be careful not to burn yourself.

3. Remove the oil filter and let the remaining oil drain out.
4. Install a new filter according to the instructions on or with the filter.
5. Reinstall the drain bolt with a new washer and tighten it securely. Refill the engine with the recommended oil, to the upper mark on the dipstick.

**ENGINE OIL CAPACITY:**

3.8 ℓ (4.0 US qt) including filter.

6. Reinstall the filler cap securely.
7. Start the engine and make sure oil is not leaking from the drain bolt or the filter.
8. Shut off the engine and recheck the oil level.

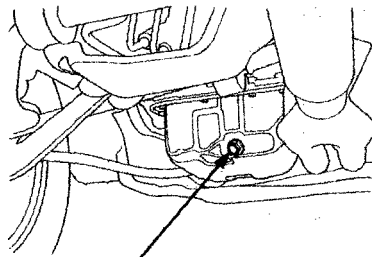

ENGINE OIL  
DRAIN BOLT

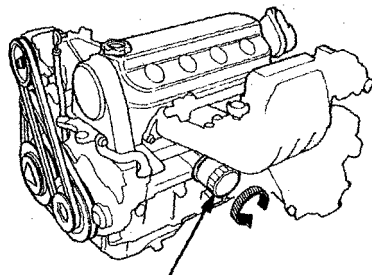

OIL FILTER

---

NOTE: Please dispose of used motor oil in a manner that is compatible with the environment. We suggest you take it in a sealed container to your local service station for reclamation. Do not throw it in the trash or pour it on the ground.

**CAUTION: Used motor oil may cause skin cancer if repeatedly left in contact with the skin for prolonged periods. Although this is unlikely unless you handle used oil on a daily basis, it is still advisable to thoroughly wash your hands with soap and water as soon as possible after handling used oil.**

# Transmission Oil/Fluid Check

---

Transmission oil/fluid must be checked with the engine off and the car on level ground.

## **⚠ WARNING**

- If the engine has been running, some engine components may be hot enough to burn you.
- Keep hands away from the radiator fan. The fan may start automatically without warning and run for up to 15 minutes, even after the engine is turned off.

**CAUTION:** If the oil/fluid level is low, check for possible leaks before adding oil. Do not overfill.

Since the transmission and differential are in the same housing, you are actually checking both oil/fluid levels in one procedure. Change transmission oil/fluid according to the Maintenance Schedule on page [80](#).

## 5-Speed

Remove the oil filler bolt (beside the right axle). Feel inside the bolt hole with your finger. If the oil is up to the bottom edge of the hole, the oil level is correct. If it is not, slowly add oil until it runs out of the hole, then reinstall the bolt and tighten it securely with a wrench.

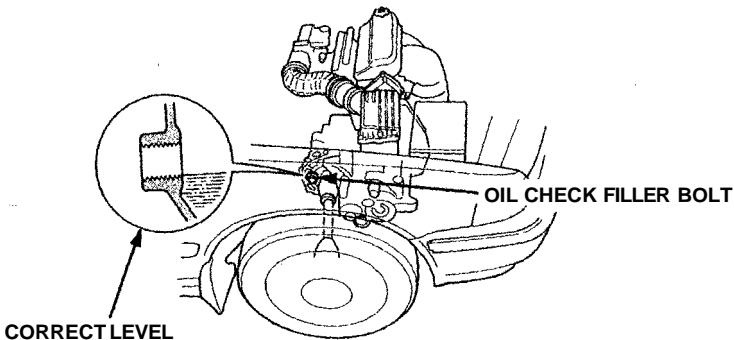

## 5-SPEED TRANSMISSION

OIL CHANGE CAPACITY: 1.9 ℓ (2.0 US qt).

Use only SE or SF grade motor oil when adding or changing transmission oil.



Use the proper viscosity oil for the climate in which you drive:

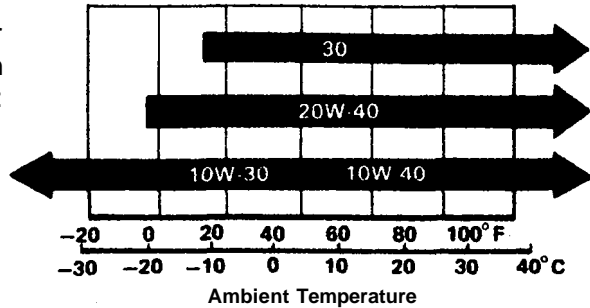

### Automatic

The automatic transmission fluid level is checked (with the engine off and the car on level ground) using the dipstick in the right end of the transmission housing. Remove the dipstick and wipe it off.

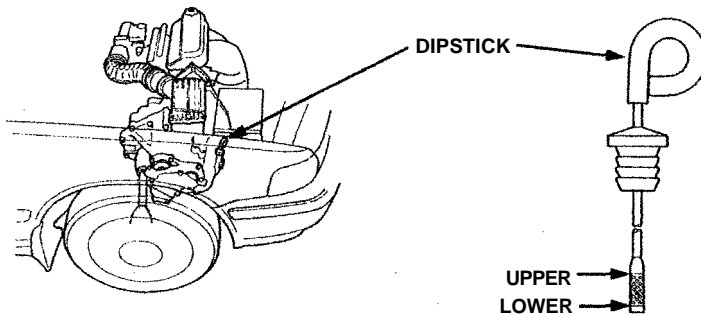

Insert the dipstick and remove it. The fluid level should be between the upper and lower marks.

If necessary, add fluid and recheck. Use only DEXRON® II Automatic Transmission Fluid (A.T.F.) when adding or changing fluid.

After checking the fluid level, push the dipstick in securely.

### AUTOMATIC TRANSMISSION

FLUID CHANGE CAPACITY: 2.4 ℓ (2.5 US qt).

# Cooling System

---

The engine in your Honda contains a number of aluminum parts. Therefore, it requires an antifreeze/coolant specifically formulated to protect the aluminum parts from corrosion. Failure to use a suitable antifreeze/coolant may seriously shorten the life of the engine as the result of rapid corrosion damage. Some antifreeze/coolants, although labeled for use in engines containing aluminum, may not provide adequate protection for your engine.

Therefore, use only a Honda **RECOMMENDED** antifreeze/coolant.

CHECK WITH YOUR AUTHORIZED HONDA DEALER.

For best corrosion protection, the mixture of coolant and water must be maintained year-round at 50/50. Concentrations less than 50% coolant may not provide sufficient protection against corrosion and freezing. Concentrations of greater than 60% coolant will impair cooling efficiency and are not recommended. Low-mineral drinking water or distilled water should be mixed with the antifreeze/coolant. Coolant loss should be replenished by a mixture containing the proper concentration of antifreeze and water.

Do not mix different antifreeze/coolants.

Do not use additional rust inhibitors or anti-rust products, as they may not be compatible with the radiator coolant.

ENGINE DAMAGE CAUSED BY IMPROPER COOLANT USAGE IS NOT COVERED BY THE NEW CAR WARRANTY.

## Checking Coolant

Check the coolant level in the reserve tank when the engine is at normal operating temperature.

- If the level is below the MAX mark, but still visible, add a 50/50 solution of antifreeze and water to bring it up to MAX.
- If there is no coolant in the reserve tank, the cooling system should be checked for leaks and repaired if necessary. Coolant must then be added to the radiator.

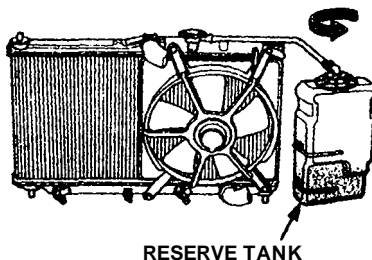

---

**⚠ WARNING**

- **Do not remove the radiator cap when the engine is hot; the coolant is under pressure and could severely scald you.**
- **Keep hands away from the radiator fan. The fan may start automatically without warning and run for up to 15 minutes, even after the engine is turned off.**

**CAUTION: Radiator coolant will damage paint. Quickly rinse any spilled coolant from painted surfaces.**

Wait until the engine is cool, then turn the radiator cap counterclockwise until it stops. **DO NOT PRESS DOWN WHILE TURNING THE CAP.** After any remaining pressure has been relieved, remove the cap by pressing down and again turning it counterclockwise. Add enough coolant to fill the radiator, and reinstall the cap. Be sure to tighten it securely. Fill the reserve tank up to the MAX mark with the engine cold.

### **Maintenance**

1. Check the freeze protection level of the coolant with a hydrometer.
2. Keep the front of the radiator free of dirt and debris.
3. Check hoses and hose clamps regularly.

### **Replacing Coolant**

Replace coolant at 36 months or 45,000 miles (72,000 km), whichever comes first. Thereafter, replace every 2 years or 30,000 miles (48,000 km), whichever comes first.

### **RADIATOR COOLANT**

**REFILL CAPACITY:** including reserve tank (0.6 ℓ/0.6 US qt)

5 speed transmission      3.0 ℓ (3.2 US qt)

Automatic transmission    3.5 ℓ (3.7 US qt)

**(cont'd)**

## Cooling System (cont'd)

1. Set the heater temperature control dial to maximum heat.
2. Remove the radiator cap and loosen the drain plug when the radiator is cool, and drain the radiator.

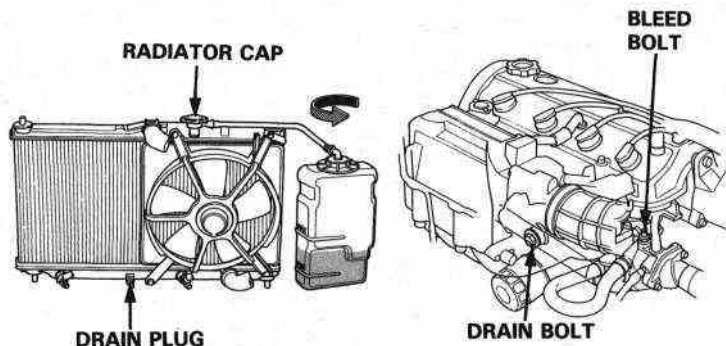

3. Remove the drain bolt from the rear side of the cylinder block, and drain the engine and heater.
4. Apply non-hardening sealant to the drain bolt threads, then reinstall the bolt and tighten it securely.
5. Tighten the radiator drain plug securely.
6. Mix the recommended antifreeze with an equal amount of low-mineral or distilled water and fill the reservoir to maximum, as illustrated.

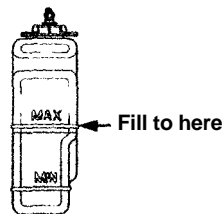

7. Loosen the air bleed bolt in the thermo case then fill the radiator to the filler neck with the coolant mixture. Tighten the bleed bolt as soon as coolant starts to run out in a steady stream without bubbles.

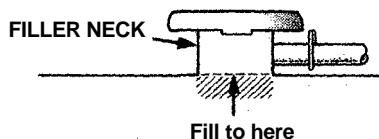

8. With the radiator cap off, start the engine and let it run until warmed up (fan goes on at least twice). Then, if necessary add more coolant mix to bring the level back up to the filler neck.
9. Put the radiator cap on, then run the engine again and check for leaks.

## Brake System Design

The diagonally-separated dual service brake system is designed so half the system will still provide braking action if the other half fails.

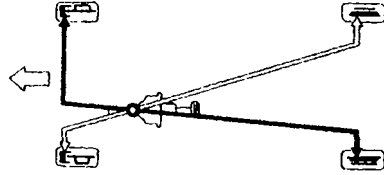

Stopping the car after losing the brake fluid from half the system will require more pedal pressure and pedal travel than normal. Also, the distance required to stop will be longer using only half the brake system. If the brakes fail suddenly, downshift to a lower gear for increased engine braking, and pull off the road as soon as possible.

### **▲ WARNING**

- It is dangerous to drive your car with a problem in either the brake electrical or hydraulic systems; have your dealer check both systems if you suspect brake trouble.
- Do not ride the brakes. In other words, don't put your foot on the brake pedal unless you intend to brake. This causes excessive brake wear and can damage, or lead to loss of braking effectiveness through overheating. Your brake lights may also confuse drivers behind you.
- Driving through deep water may affect the brakes. Check their effectiveness by pressing the brake pedal gently. If the car does not slow down at the normal rate, continue gently applying the brakes, while maintaining a safe speed, until they dry out and normal performance returns.

## Brake Wear

Both front and rear brakes should be inspected for wear at the intervals shown in the Maintenance Schedule on page 80. When the brakes require maintenance use only genuine Honda replacement parts or their equivalent.

## Front Brake Wear Indicators

Your car is equipped with audible front brake wear indicators. When the brake pads need to be replaced, the wear indicators will make a "screeching" sound or a high pitch chirp.

(cont'd)

# Brakes/Clutch Fluid (cont'd)

---

NOTE: Due to some driving habits or climates, brakes may "squeal" when you first apply them or when you have them partially applied; this is normal, and does not indicate excessive wear. The wear indicator makes a "screeching" sound while the brakes are applied.

## Brake Fluid

Check the fluid level in the brake reservoir periodically; it should be between the MAX and MIN marks on the reservoir.

If the level is near the MIN mark, add fluid to raise it to the MAX mark. Do not overfill. Use only brake fluid manufactured

to DOT 3 or DOT 4 specifications (see reservoir cap) from a sealed container. Follow the manufacturer's instructions printed on the can.

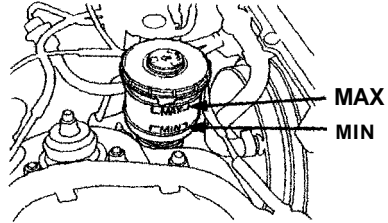

NOTE: A low brake fluid level may be an indication of brake pad wear or of brake fluid leakage. You should have your brakes checked if the brake fluid reservoir is low before re-filling it.

**CAUTION:** The arrow on the reservoir cap must be pointing forward after the cap is installed. Make sure the brake warning switch wiring doesn't get caught between the cap and top edge of the reservoir.

## Clutch Fluid

Check the fluid level in the clutch reservoir periodically; it should be between the MAX and MIN marks on the reservoir.

If the level is near the MIN mark, add fluid to raise it to the MAX mark. Do not overfill. Use only brake fluid manufactured

to DOT 3 or DOT 4 specifications from a sealed container. Follow the manufacturer's instructions printed on the can.

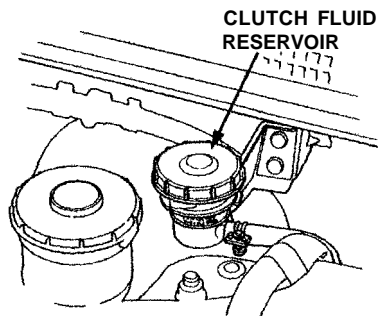

NOTE: A low clutch fluid level may be an indication of clutch fluid leakage. You should have your clutch checked if the clutch fluid level in the reservoir is low.

# Power Steering

---

The power steering on your car provides easy handling while parking and maneuvering in traffic, without loss of road "feel" at highway speeds. An engine-driven hydraulic pump provides full power assist at low speeds and decreasing assist as the car goes faster.

**CAUTION:** If the power steering system should fail, or if the engine should stall, the car can still be steered. However, much greater effort will be required, particularly in sharp turns at low speed.

**NOTE:** You may feel a slight clunk or knock when turning the wheel with the engine off. This is a normal condition due to the design of the system.

## Power Steering Fluid

Check the power steering fluid level with the engine cold and the car parked on level ground. Make sure the fluid level is between the upper and lower marks on the reservoir. If the level has dropped close to or below the lower mark, check for leaks before adding fluid to the upper mark. Do not overfill.

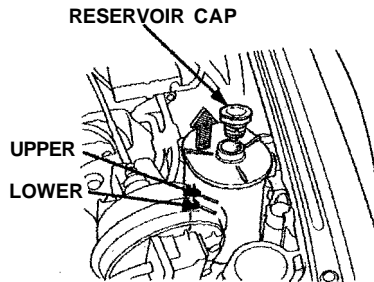

**CAUTION:** Use only genuine Honda power steering fluid. The use of other fluids such as A.T.F. or other manufacturer's power steering fluid will damage the system.

# Air and Fuel Filters

---

## Air Filter

Replace the air filter every 24 months or 30,000 miles (48,000 km), whichever comes first (more often in extremely dusty conditions).

Loosen the attaching bolts, then remove the cover.

Remove the air filter and replace it with a new filter. Reinstall the cover and tighten the bolts.

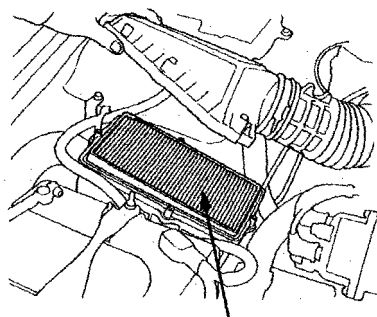
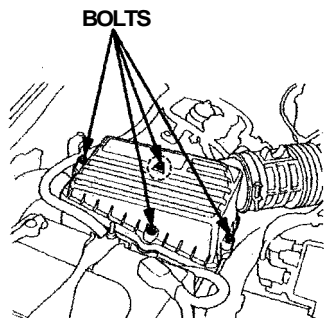

## Fuel Filter

The fuel filter is located in the engine compartment, on the right center of the firewall. It should be replaced at 60,000 miles (96,000 km) or 48 months whichever comes first, or any time you suspect contaminated gas may have clogged it.

**CAUTION:** Because the fuel system is under pressure, the filter should be replaced only by a qualified Honda technician.



Spark plugs should be replaced every 24 months or 30,000 miles (48,000 km), whichever comes first.

Recommended spark plugs:

ZFR5F-11 (NGK), KJ16CR-L11 (ND)  
(for all normal driving)

ZFR6F-11 (NGK), KJ20CR-L11 (ND)  
(for hot climates or continuous high speed driving)

**⚠ WARNING** Keep hands away from the radiator fan. The fan may start automatically without warning and run for up to 15 minutes, even after the engine is turned off.

**CAUTION:** Never use spark plugs with an improper heat range; they will adversely affect engine performance and durability.

Replace plugs one at a time, so you don't get the wires mixed up.

1. Clean any dirt from around the spark plug base.
2. Disconnect the plug cap, then remove and discard the old plug.
3. Check the gap of the new spark plug before installation. Plug gap should be 1.1 mm (0.04 in).
4. Thread the new spark plug in by hand to prevent cross-threading.
5. After the plug seats against the cylinder head, tighten 1/2 turn with a spark plug wrench to compress the washer.
6. Reinstall the spark plug cap.

**CAUTION:** The spark plugs must be securely tightened, but not overtightened. A plug that's too loose can get very hot and possibly damage the engine; one that's too tight could damage the threads in the cylinder head.

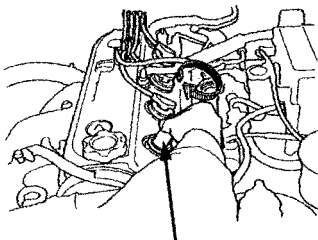

Thread in by hand

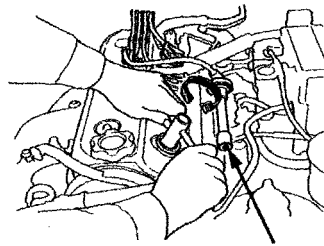

PLUG CAP

# Wiper Blades

---

For maximum visibility, replace worn or cracked wiper blades when you notice they do not wipe the windshield cleanly or smoothly.

## To Replace Worn-out Blades

1. Detach the blade assembly from the arm by pressing the lock tab in, then pushing the blade toward the base of the arm.

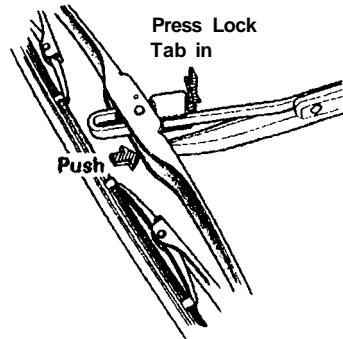

2. Firmly grasp the end of the blade rubber and pull until the tabs are free of the metal support.

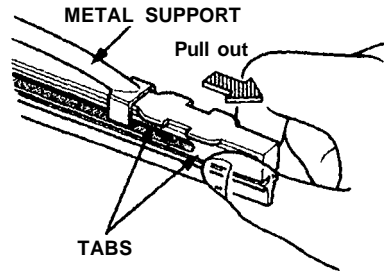

3. Remove the metal retainers from the worn-out blade rubber and put them in a new blade rubber.

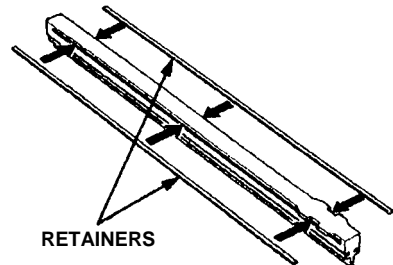

4. Insert the new blade rubber from the opposite side of the blade tabs and position the tabs in the metal support.

5. Reinstall the blade assembly on the wiper arm.

The condition of the battery can be determined by checking the test indicator. Service as required according to the label on the battery.

Any corrosion around the positive and negative terminals should be washed off with a solution of baking soda and warm water. Dry the terminals and then coat them with grease.

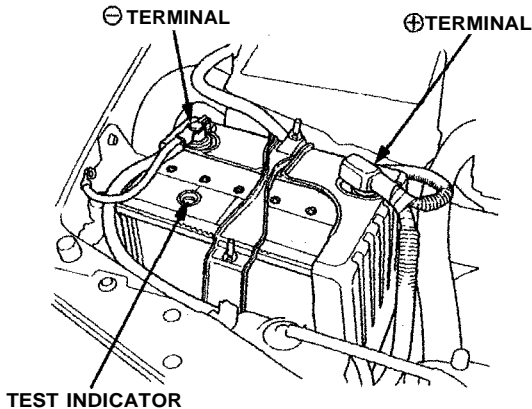

**⚠ WARNING**

- The battery gives off explosive gases; keep sparks, flames and cigarettes away. Provide adequate ventilation when charging or using the battery in an enclosed space.
- The battery contains sulfuric acid (electrolyte). Contact with skin or eyes may cause severe burns. Wear protective clothing and a face shield.
  - If electrolyte gets on your skin, flush with water.
  - If electrolyte gets in your eyes, flush with water for at least 15 minutes and call a physician immediately.
- Electrolyte is poisonous.
  - If swallowed, drink large quantities of water or milk and follow with milk of magnesia or vegetable oil and call a physician.

**KEEP OUT OF REACH OF CHILDREN.**

# Fuse Replacement

---

The fuse box is located under the dashboard on the driver's side. The circuits protected by each fuse are listed inside the fuse box cover. To open the fuse box, turn the knob as shown.

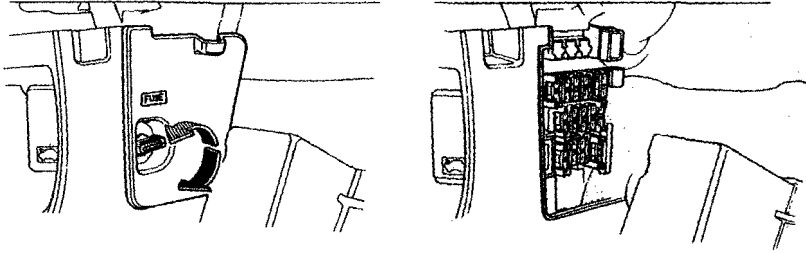

If any of your car's lights, accessories, or controls don't work, check their fuses. If a fuse has blown, the wire inside it will be burned through.

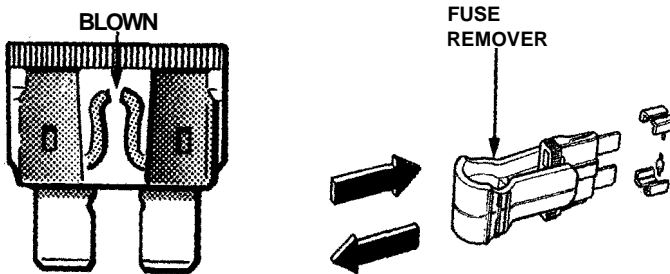

## Checking the fuses:

1. Turn off the ignition and all other switches.
2. If you find a blown or possibly faulty fuse, use the fuse remover, stored beside the spare fuse to pull the blown fuse out of its clips.
3. Check all other fuses as well as the one you suspect.
4. Push in a new fuse of the same rating, and make sure it fits tightly in the clips. If it fits loosely, have your dealer fix it. If you don't have a spare, take a fuse of the same rating (or lower) out of a circuit you may not need, like the radio or cigarette lighter. Remember to replace the borrowed fuse and the missing spares.

---

**CAUTION:** A blown fuse may be just a symptom of some other problem. If a new fuse blows right away, the cause should be diagnosed and corrected by a qualified Honda technician. Never replace a fuse with anything but another fuse of the same or lower rating. A higher capacity fuse could cause damage and even start a fire.

The main fuses and some primary fuses are installed in the fuse box on the right front fender in the engine compartment.

If the circuits from the battery are ever overloaded (by a short in the system drawing too much current for example) a main fuse will blow, preventing damage to the entire wiring harness. If the main fuse blows, have a Honda dealer check the system, repair the cause, and replace the fuse.

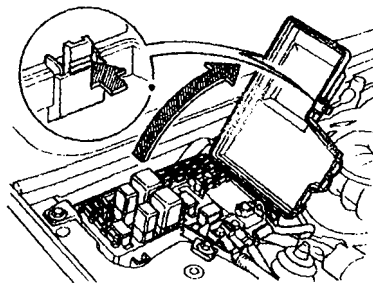

**CAUTION:**

- The electrical system is protected by fuses that are designed to fail and prevent damage to the wire harness. Always replace blown fuses with the same rating as specified to prevent wiring damage that can result in a possible fire.
- For proper electrical contact after replacing these fuses, make sure all screws are tight.

# Bulb Replacement

---

See page [125](#) for bulb specifications.

Front turn signal lights

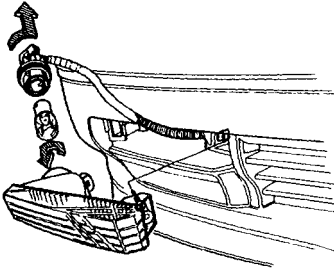

Front side marker and turn signal lights/position lights

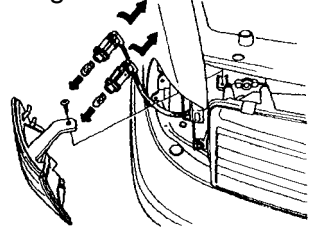

Rear turn signal/brake and taillights

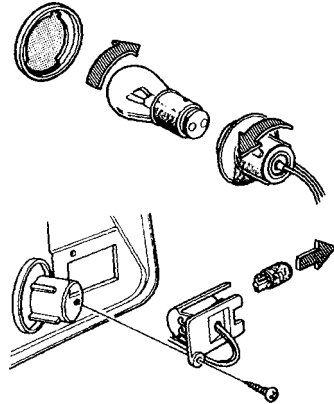
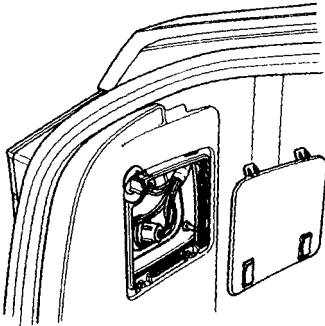

Brake and taillights/back-up lights

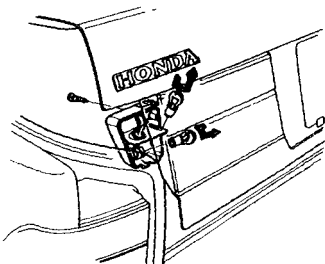

License plate lights

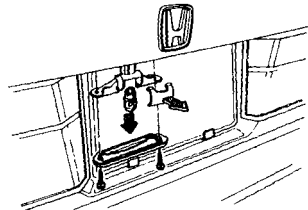

**Interior light**

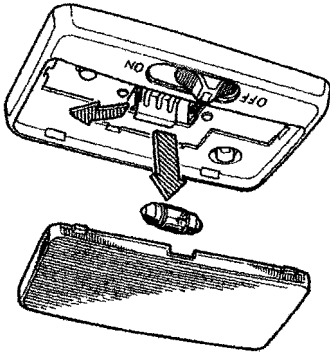

**Sunvisor light (LX, EX)**

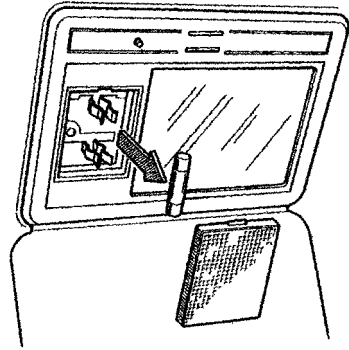

**Door courtesy lights (LX, EX)**

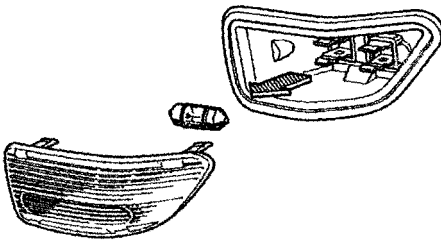

**Trunk light**

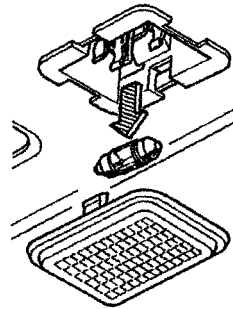

**High mount brake light**

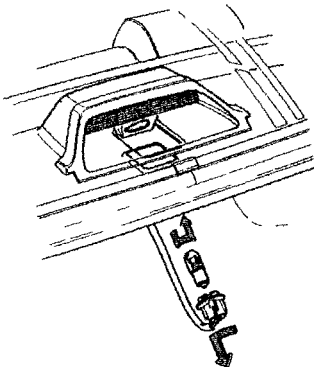

# Tires

---

The factory-installed tires on your car were selected to provide the best performance for normal driving.

## Inflation Pressures

The tire label on the driver's door jamb shows recommended tire pressures for carrying loads up to the limit shown.

These pressures were chosen to provide you with the best combination of tread life, riding comfort and stability under normal driving conditions.

Improper inflation can reduce both tire life and load carrying capacity. Check the tire pressures at least once a month, including the spare.

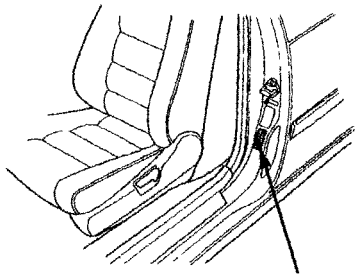

TIRE LABEL

Lower pressure than recommended lets the tread and sidewalls flex too much, causing increased tire temperatures, uneven wear, and poor handling. Pressure higher than recommended can make the tire too stiff, increasing the chance of damage from road hazards, and also causing uneven wear.

## CAUTION:

- Check tire pressure when the tires are cold.  
(After the car has been parked for more than 3 hours or driven less than 1 mile/1.6 km).
- Tire pressure may increase as much as 41 kPa (6 psi) when the tire is hot, so **NEVER ADJUST** tire pressure when the tires are hot.
- Never inflate load range B tires to more than 220 kPa (32 psi) cold.
- Cars with luggage racks or cartop carriers **DO NOT** have greater load limits than those on the label.

## Snow Tires

If you use snow tires, they should have the same load capacity as the original equipment tires, and they must be installed in sets of four, or they may cause poor handling. Cars with snow tires should not be driven faster than 75 mph (120 km/h).



---

## Tire Chains

When required, install tire chains on the front wheels of your car. If you are using metal type chains, make sure they are designated SAE Class "S". You may also use plastic or cable type "chains". Use only the correct size chains recommended for your tire size and make sure they are installed following the chain manufacturer's instructions.

Once tire chains are installed, drive at less than 19 mph (30 km/h) on roads covered with snow or ice. To minimize tire and chain wear, avoid driving on cleared roads with chains installed.

**CAUTION: Improper installation or loose tire chains may damage your car's chassis and fenders.**

NOTE: Keep the manufacturer's installation instructions in your glove box for future reference.

## Tire Balancing

**▲ WARNING** Unbalanced tires may affect handling and tire wear. A tire should always be rebalanced after it has been dismounted from the wheel.

Your original tires were properly balanced before the car left the factory, but may need rebalancing at some time during the life of the tire. Tire balancing for the COMPACT spare is not necessary.

**CAUTION: Use only genuine Honda aluminum wheel weights if your car is equipped with aluminum wheels. Non genuine Honda wheel weights may corrode and damage the aluminum wheel.**

## Tire Rotation

Tires may wear unevenly when used for a long time in the same position on the car. To avoid this, rotate the tires every 7,500 miles (12,000 km). If abnormal or uneven wear develops between rotations, the cause should be found and corrected as soon as possible. The illustration shows how tires can be rotated. The COMPACT spare tire must not be included in tire rotation.

(cont'd)

## Tires (cont'd)

---

NOTE: Brake pads should be inspected for wear whenever the tires are rotated.

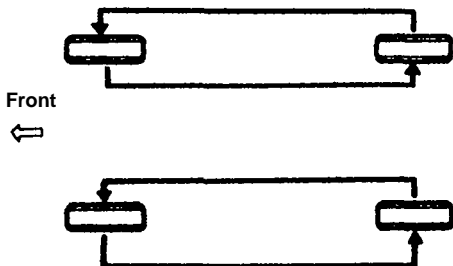

### Tire Traction

**▲ WARNING** Worn tires or slippery road surfaces can reduce driving, cornering and braking traction. To reduce the possibility of losing traction, slow down when the road gets slippery, replace tires when wear indicators are visible, and **KEEP TIRES PROPERLY INFLATED.**

### Tire Replacement

The original tires on your car have tread wear indicators to indicate when they should be replaced. The indicators appear as bands about 12.7 mm (1/2 in) wide when the tire tread depth is less than 1.6 mm (1/16 in). When indicators appear across two or more grooves in a row, you should replace the tire.

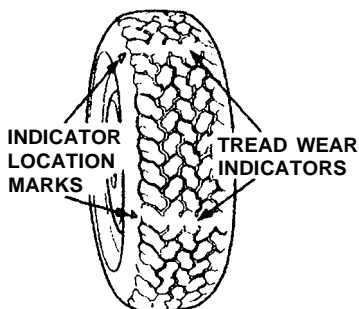

**▲ WARNING** Driving on worn-out tires is very hazardous, and will reduce braking effectiveness, steering accuracy and traction.

When replacing tires, use only the recommended tire size. Wheel rim widths and offsets must be those recommended by American Honda Motor Co., Inc. Contact the Zone Office nearest you as shown on the inside of the back cover.

**▲ WARNING** Tires and wheels other than those recommended may be unsafe. Do not mix radial and bias ply tires on the same car.

## Condenser and Radiator

Check the engine radiator and the air conditioner condenser (in front of the radiator) for accumulated dirt, insects or leaves. Carefully brush or hose them off to assure maximum cooling performance.

**CAUTION: Radiator and condenser fins are very thin and easily damaged; do not bend them with high water pressure or brush.**

## Compressor Drive Belt

Check the compressor belt tension monthly, during periods when you use the air conditioner a lot.

**▲ WARNING** If the engine has been running some engine components may be hot enough to burn you.

When properly tensioned, the belt should have 10 to 12 mm (0.4 to 0.5 in) "play" or deflection when pushed with 98N (22 lb) of force midway between the alternator pulley and the engine crankshaft pulley. Have the belt adjusted whenever necessary.

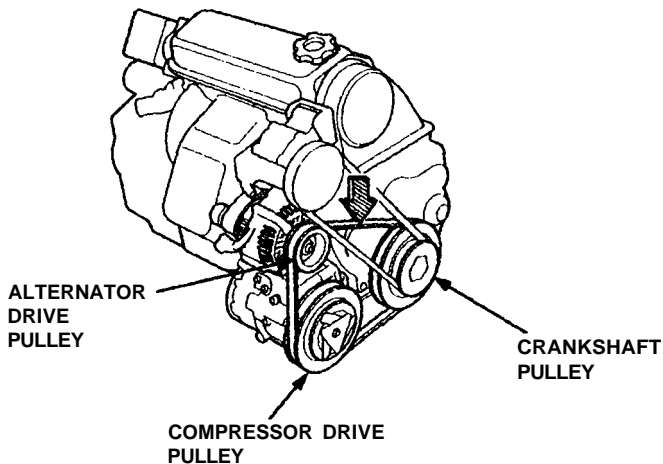

(cont'd)

## Air Conditioner Care (cont'd)

---

### System Maintenance

Run your air conditioner at least once a week for about ten minutes, even during the off season, to lubricate the seals and the inside of the compressor and, to verify that the system is functional.

If the air conditioner is not cooling properly, it may indicate an undercharged system. Have your dealer check the system for leaks, then evacuate and charge the system with 900—950 g (31 - 34 oz) of Refrigerant 12.

**CAUTION: Prolonged use of an undercharged system may damage the compressor.**

## Interior Trim

Remove dust and loose dirt with a vacuum cleaner. Wipe the vinyl with a clean, damp cloth or sponge. Stains can be removed with a commercially available vinyl cleaner.

**CAUTION: Do not use thinner, gasoline, kerosene, naphtha or other solvents on the interior. They are toxic, flammable and hazardous and could damage the material you're cleaning.**

## Windows

A 10 to 1 mix of water and white vinegar, or a commercially available glass cleaner may be used to clean windows and to remove the dust film sometimes caused by the ingredients used in interior vinyls and plastics.

**NOTE:** Do not put this solution in the windshield washer reservoir, it will damage the windshield washer pump.

Be careful not to scratch or damage the defogger wires when cleaning the inside of the rear window; wipe the window horizontally along the wires, not up and down. Dry the windows with a lint-free cloth or paper towel. Keep all the windows clean for maximum visibility.

## Exterior Care

### Washing

Rinse all loose dirt off the car by spraying it with lukewarm or cold water. Do not use hot water.

Wash using a soft-bristle brush, sponge or cloth with water containing a mild detergent such as a liquid dishwashing detergent.

Remove oil, tar, tree sap, etc., with tar remover or turpentine. Remove road salt, insects, etc., with mild detergent and lukewarm water. Any of these substances may damage the finish if left on painted surfaces.

Rinse the car well. Promptly wipe with a chamois or soft towel to prevent water-spotting. Do not let water or soap air-dry on painted surfaces.

During wiping, inspect the surface for stone chips and scratches; paint them with touch-up paint so they won't rust (touch-up paint is available through your Honda dealer).

For further instructions on corrosion protection, refer to the Rust Prevention section on the next pages.

(cont'd)

# Appearance Care (cont'd)

---

## Waxing

Wax the car when water will no longer "bead" on the paint. Always wash and dry the car before you wax it.

Use a good quality liquid or paste wax, and follow the manufacturer's instructions. Wax all the metal trim to keep its luster.

NOTE: Removing oil, tar, etc., with a spot remover will usually strip the wax from the surrounding finish. Be sure to re-wax these areas even if the rest of the car does not yet need waxing.

## Aluminum Alloy Wheels (EX)

### CAUTION:

- **Wash the wheels after driving on snowy or icy roads where salt has been applied.**
- **Avoid off-road driving. Brush, rocks, dirt and severe impact may damage the wheels.**
- **Install tire chains carefully. Improperly installed chains can cause damage to the wheels.**
- **Honda aluminum wheels are treated with a protective finish. Wash them with a low-phosphate detergent and sponge. Do not use abrasive cleaners or stiff brushes.**
- **Always install aluminum wheels in sets of four. If mixed with other types, the car's handling may be affected.**

## Rust Prevention

Rusting is likely to occur in parts of the car where water is trapped or where there is continual dampness.

- Water will collect inside doors and body panels if drain holes become clogged.
- Water which seeps under or soaks floor mats will subject floor sections to prolonged wetness or dampness.
- Road dirt or sand, which collects and fills recesses on the underside of the car, retains moisture long after the rest of the car has dried.

The removal of paint and undercoating by stones, gravel, and minor accidents immediately exposes metal to air and moisture.

Rusting is increased by high humidity and by the presence of corrosive substances in the air or on the roads.

- 
- Salt used for road de-icing will coat the bottom of the car and hasten rusting.
  - Localities with high humidity have greater potential for rust problems, especially where salt is also present on the road or in moist sea air.
  - Industrial pollution will accelerate the deterioration of paint finishes and promote rusting.

### Preventive Service

Check all drain holes in the doors and body panels for clogging and clear if necessary. When washing your car, also clean the underside of the car by using high pressure water; ① above subframe, ② inside front fender, ③ rear suspension, ④ inside rear wheel housing, and ⑤ under rear bumper.

After washing your car or after heavy rain, check for leaks. Dry any wet areas of your car's interior. Have leaks repaired as soon as possible.

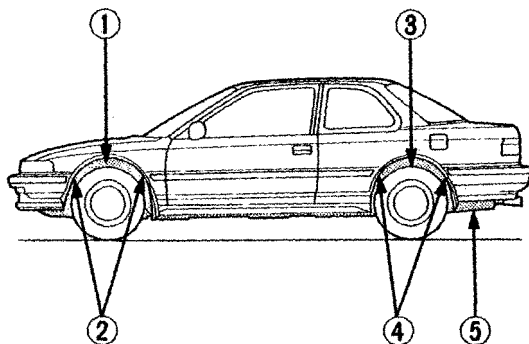

# Body Repair

---

## Replacement Body and Fender Parts

If your vehicle incurs body damage and requires replacement parts, we encourage you to use only Genuine Honda sheet metal body and fender parts. Many insurance companies are specifying imitation sheet metal parts for collision repairs in an effort to reduce claim costs; however, if imitation parts are used the following conditions may apply:

- There is no assurance that imitation parts will equal the fit and finish of Genuine Honda sheet metal parts; and in our experience they often do not.
- There is no assurance that imitation parts will resist corrosion as well as Genuine Honda sheet metal parts.
- Imitation sheet metal parts are not covered by the Honda Limited Warranty.

To ensure your continued satisfaction with your Honda vehicle in the event of an accident, contact your insurance adjuster and insist on Genuine Honda parts in the repair of your vehicle.



## COMPACT Spare Tire

Your car is supplied with a COMPACT spare tire and wheel for temporary use only in the event of a flat tire. Use the COMPACT spare only when you have to, and only to go as far as the next garage or dealer to have the regular tire repaired and reinstalled.

Because you will rarely use the COMPACT spare, be sure to regularly check its condition and air pressure (415 kPa, 60 psi), so it will be ready when you need it. This type of tire holds less air at higher pressure than a regular tire, so it will inflate (or deflate if there is a leak) more rapidly; check its pressure often and add air gradually if it needs any.

### WARNING

- **The COMPACT spare tire has a different tire size, air pressure requirement, tread life and maximum speed rating than the four regular tires on your car. Disregarding these warnings may result in tire failure, loss of vehicle control and possible injury to vehicle occupants:**
- **Do not exceed 50 mph (80 km/h) under any circumstances when using the COMPACT spare.**
- **Do not mount snow chains on the COMPACT spare. They will not fit properly and will damage the tire and possibly your car. If you must use the COMPACT spare when driving on roads covered with snow or ice, use it as one of the rear tires and mount chains only on the front two regular tires.**

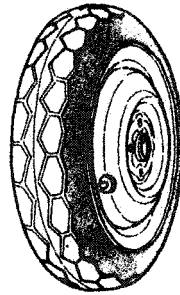

(cont'd)

## Spare Tire (cont'd)

---

### **▲ WARNING**

- The **COMPACT** spare tire has a much shorter tread life than regular tires. Replace the tire as soon as tread wear indicators appear as solid bands across the tread. Replace with a tire of exactly the same size and construction.
- The **COMPACT** spare tire and wheel set was designed especially for your car; do not use it on any other vehicle; do not install any other tire on this wheel which is not identical to the original in size and construction, and do not use the **COMPACT** spare tire on any other wheel.
- Because the **COMPACT** spare is smaller in size and higher in air pressure than a regular tire, it will ride more harshly with less ground clearance and may have less traction on some road surfaces. Drive cautiously.

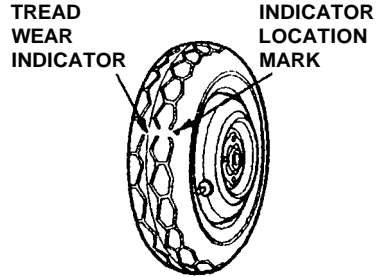

# Changing a Fiat Tire

**⚠ WARNING** Do not attempt to change a tire unless the car is on firm, level ground and well out of the flow of traffic.

Park the car on a firm, level surface, apply the parking brake, turn on the hazard warning switch and put the transmission in gear, (Park for automatic).

1. Remove the cover.
2. Remove the jack.

**NOTE:** Turn the connector on the end of the jack counter-clockwise to loosen it from its mount.

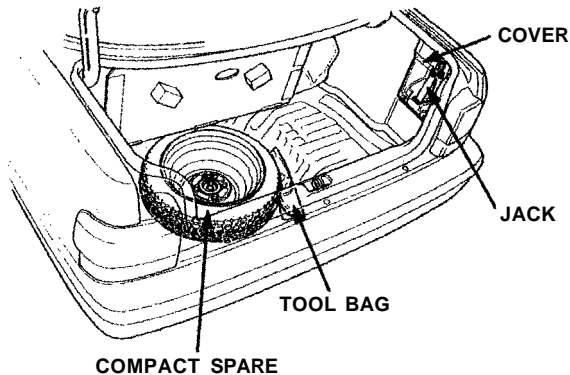

3. Remove the lug wrench/jack handle and jack handle extension from the tool bag.
4. Remove the spare tire.
5. Place blocks in front and back of the wheel diagonally opposite the tire you are changing.
6. Use the lug wrench to loosen the wheel lug nuts counter-clockwise one-half turn. On the EX model, first remove the center cap from the wheel by prying it out with the flat screwdriver (not provided in the tool bag).

**CAUTION:** Hold the center cap with your hand then pry it off using a rag to protect the cap and the wheel.

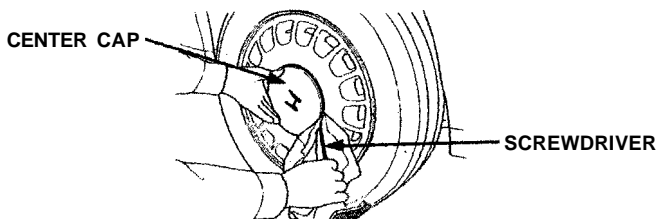

(cont'd)

## Changing a Flat Tire (cont'd)

**▲ WARNING** Follow tire changing preparations and procedures carefully to reduce the possibility of injury. The jack is designed for changing tires only. **STAND CLEAR, DO NOT** get under the car and **DO NOT** run the engine when the car is supported only by the jack.

7. Place the jack under the car as shown and raise the car by turning the handle clockwise until the tire is slightly off the ground.

**▲ WARNING** To reduce the possibility of injury, be sure to use the jack provided with the car and the correct jacking points; never use any other part of the car for jack support.

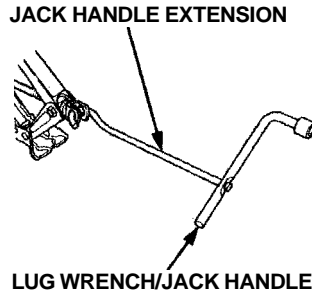
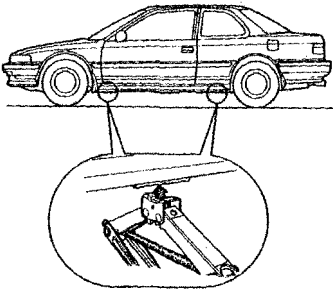

8. Remove the lug nuts, wheel cover (DX, LX) and wheel.  
9. Install the spare, and lug nuts hand tight.

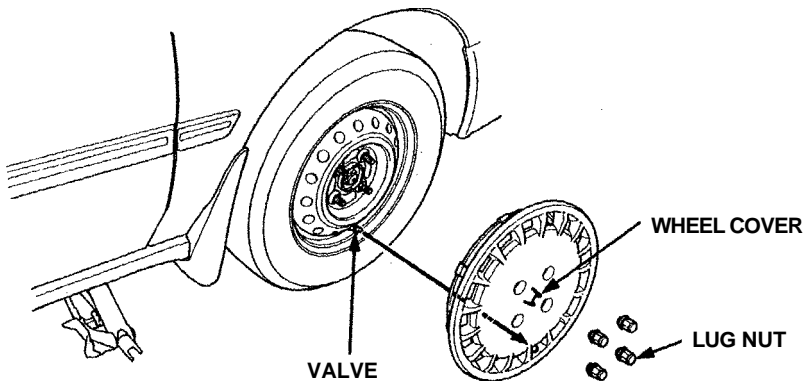

10. Lower the car, remove the jack, then tighten the lug nuts securely in an "X" pattern as shown.
11. Tighten the lug nuts securely. The recommended torque is: 110 N.m (80 lb. ft). If a torque wrench was not used, ask an authorized Honda dealer to verify the torque as soon as possible.
12. Repair or replace the damaged tire as soon as you can, reinstall it in its original position, then put the spare back in the car.

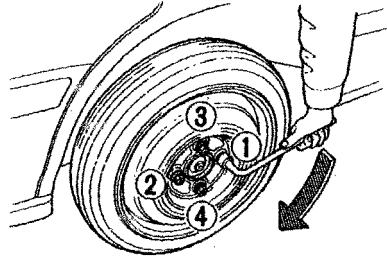

**TIGHTENING TORQUE**  
110 N.m (80 lb-ft)

**CAUTION:** Always stow the jack, tools and tire securely to prevent them from becoming dangerous projectiles in an accident.

13. Secure the tire as shown in the illustration.

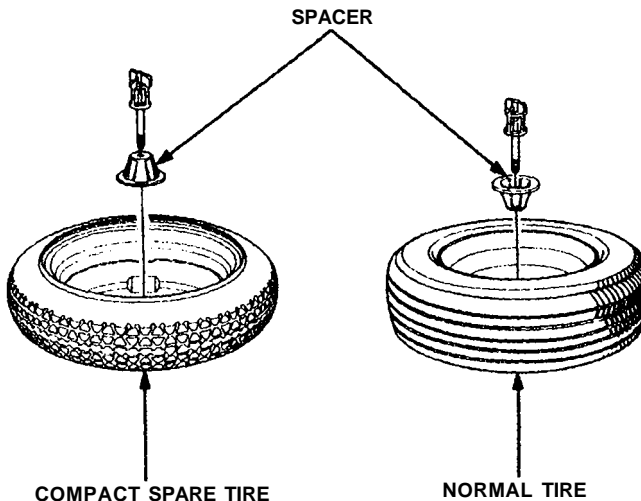

# Jump Starting

---

To start a car with a dead battery, use another battery of the same voltage, and the proper jumper cables.

## **⚠ WARNING**

- Procedures other than those below could cause injury or damage from battery acid spray, explosion or charging system overload.
- Never connect the jumper cable directly to the negative post of the "dead" battery.
- Never allow the two cars to touch each other.
- Never allow the jumper cable clamps to touch each other.
- Never lean over the battery when making connections.
- Never attempt to jump start a vehicle with a frozen battery. The battery could rupture and explode. If you suspect a frozen battery, remove the vent caps and check the fluid, if there seems to be no fluid, or if you see ice, do not attempt a jump start until the fluid thaws.

**CAUTION:** If jumper cables are connected backwards, the car's main fuse may blow.

1. Turn off all lights, heater and other electrical loads, set parking brake, and shift transmission to Neutral or Park.
2. Use one cable to connect the positive terminal of the booster battery to the positive terminal of the "dead" battery.

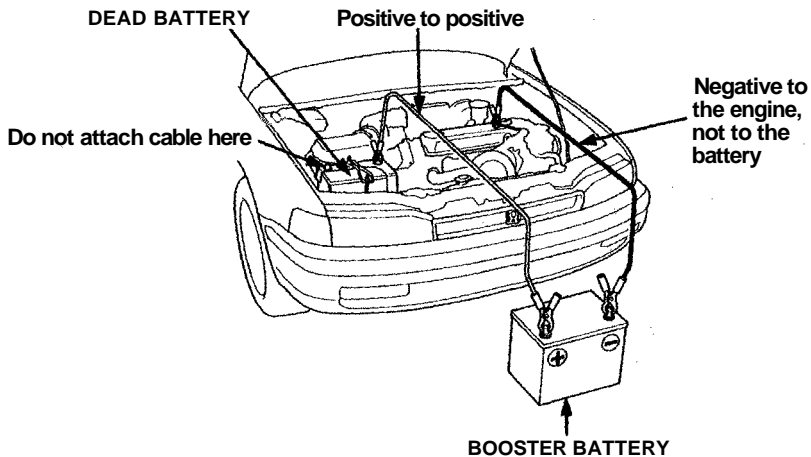

- 
3. Use the other cable to connect the negative terminal of the booster battery to the engine at the ground cable as shown.
  4. To remove the cables, reverse the above procedures exactly.

**⚠ WARNING** **DO NOT push or tow a car to start it. The forward surge when the engine starts could cause a collision. Also, under some conditions, the catalytic converter could be damaged. A car equipped with an automatic transmission cannot be started by pushing or towing.**

# Towing

---

If towing is necessary, contact a professional towing service. Your authorized Honda dealer can assist you with detailed towing instructions.

**⚠ WARNING** **Never use tow chains or rope to tow a car; your ability to safely control the car may be adversely affected.**

We recommend the following:

**Flat Bed Equipment** — **Entire** car is winched on a flat bed vehicle. This is the best way of transporting your Honda.

**Wheel Lift Type** — **Tow** with the front wheels off the ground.

If the car can only be towed with the front wheels on the ground: make sure the transmission is full of fluid (see pages 88 — 89) and tow with the transmission in neutral (N) and the ignition key in the I position.

**CAUTION:** To avoid serious damage on automatic transmission cars, first start the engine and shift to D4, then to N and shut the engine off. If the engine does not run or the transmission cannot be shifted while the engine is running, the car must be transported on flat bed equipment.

Check local regulations for towing.

**CAUTION:**

- Do not exceed 35 mph (55 km/h) or tow for distances of more than 50 miles (80 km).
- If a sling type tow is used, the tow truck driver should position wood spacer blocks between your car's frame and the chains and lift straps to avoid damaging the bumper and the body.
- Do not use the bumpers to lift the car or to support the car's weight while towing.



## If Your Car Gets Stuck

---

If your car gets stuck in sand, mud, or snow, call a professional towing service for assistance in getting your car out.

### **CAUTION:**

- **Do not rev up the engine and allow the wheels to spin freely at high speed. Severe transmission damage may result if the wheels are allowed to spin for more than a few seconds.**
- **DO NOT try to free a car with automatic transmission from snow etc. by rocking the car alternately between forward and reverse gears. Severe transmission damage may result from shifting into gear with the wheels moving.**

# Shoulder Belt Buckle

---

Proceed as follows if the shoulder belt buckle stalls.

1. Lift the hood and remove the cover from the engine compartment fuse box.
2. Remove the fuse for the automatic ("passive") shoulder belt buckle motor that does not work.

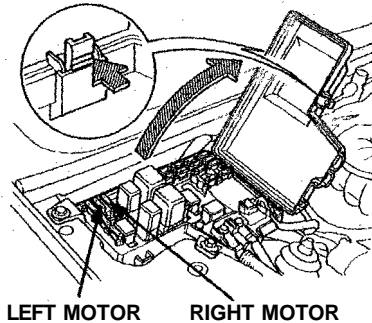

3. If the fuse has blown, replacing it with a new fuse of the same amperage should allow the shoulder belt buckle motor to work. However, if the fuse hasn't blown, or if a new fuse did not solve the problem, remove the fuse and operate the motor manually.

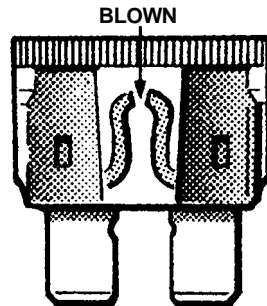

**CAUTION:** Always remove the fuse before manually operating the shoulder belt buckle motor, otherwise the motor may suddenly activate.

---

4. Remove the cover located on the side panel.

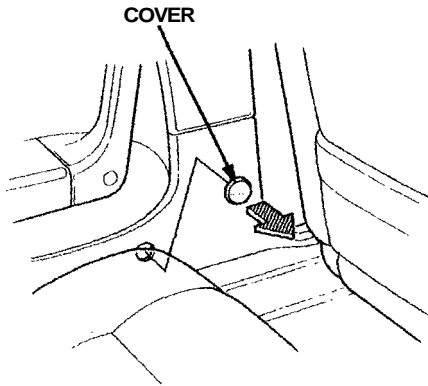

5. Set the wrench extension into the wrench grip (both provided in the tool bag) then insert the wrench into the socket and turn it counterclockwise until the shoulder belt buckle reaches its rear locked position.

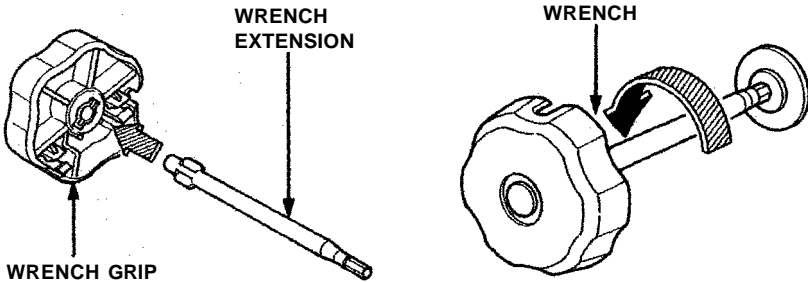

**NOTE:** After the manual operation, make sure that the seat belt warning light is off and the shoulder belt buckle is seated properly in its locked position.

6. Replace the cover on the side panel.

7. Reinstall the fuse, the fuse remover and both fuse box covers.

# Specifications

Dimensions		
Length		4,695 mm (184.8 in)
Width		1,725 mm (67.9 in)
Height		1,370 mm (53.9 in)
Wheelbase		2,720 mm (107.1 in)
Track	Front	1,475 mm (58.1 in)
	Rear	1,480 mm (58.3 in)

Weights	
Gross vehicle weight rating	See the certification label attached to the driver's door jamb.

Tires	
Size/Pressure	See the tire label attached to the driver's door jamb.

Capacities		
Fuel tank		Approx. 64.5 ℓ (17.0 US gal)
Radiator coolant 5 speed transmission	Change* <sup>1</sup>	3.0 ℓ (3.2 US qt)
	Total	6.6 ℓ (7.0 US qt)
Automatic transmission	Change* <sup>1</sup>	3.5 ℓ (3.7 US qt)
	Total	7.1 ℓ (7.5 US qt)
Engine oil	Change* <sup>2</sup>	3.8 ℓ (4.0 US qt)
	Total	4.9 ℓ (5.2 US qt)
5 speed transmission oil	Change	1.9 ℓ (2.0 US qt)
	Total	2.0 ℓ (2.1 US qt)
Automatic transmission fluid	Change	2.4 ℓ (2.5 US qt)
	Total	6.0 ℓ (6.4 US qt)
Windshield washer reservoir		2.5 ℓ (2.6 US qt)

\* 1: Including the coolant in reserve tank (0.6ℓ./0.6 US qt) and that remaining in the engine.

\* 2: Excluding the oil remaining in the engine, but including that in the oil filter.

Engine	
Type	Water cooled 4-stroke OHC gasoline engine
Bore x Stroke	85.0 x 95.0 mm (3.35 x 3.74 in)
Displacement	2,156 cm <sup>3</sup> (132 cu in)
Compression ratio	8.8
Spark plugs	See spark plug maintenance section page 97.

Alignment		
Toe-in	Front	0 mm (0 in)
	Rear	2 mm (0.08 in)
Camber	Front	0°
	Rear	-0°30'
Caster	Front	3°

Battery	
Capacity	12V-52AH/6HR

Fuses	
In the relay box	See the relay box cover under the hood.
In the fuse box	See the fuse label attached to the inside of the fuse compartment door under the dashboard.

Lights		
Headlights	12V-65/55W	
Front turn signal lights	12V-45CP (SAE 3497)	
Front position lights	12V-5W (6CP) (SAE 3652)	
Rear turn signal lights	12V-32CP (SAE1156)	
Stop/Taillights	12V-32/2CP (SAE2057)	
Side marker lights	Front	12V-5W
	Rear	12V-3.4W (3CP)
Back-up lights	12V-32CP (SAE1156)	
High mount brake lamp	12V-45CP (SAE 3497)	
License lights	12V-8W (4CP)	
Interior light	12V-8W	
Trunk light	12V-3.4W	
Vanity mirror light	12V-1.8W	
Door courtesy lights	12V-3.4W	

# Identification Numbers

---

**The Vehicle Identification Number (V.I.N.)** is stamped on a plate attached to the top left side of the dashboard.

It also appears on the Certification label attached to the door jamb, as well as under the hood on the body, directly behind the engine.

**NOTE:** The V.I.N. is also provided in bar code on the Certification label.

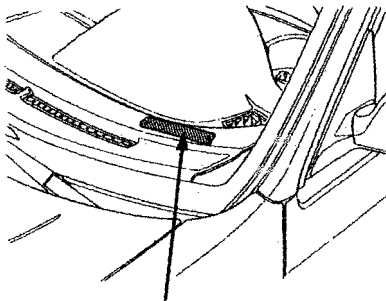

**VEHICLE  
IDENTIFICATION  
NUMBER**

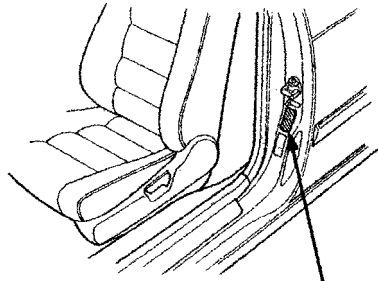

**CERTIFICATION  
LABEL**

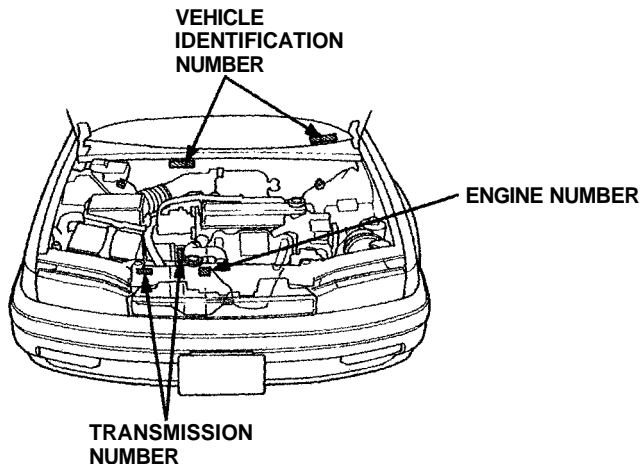

**VEHICLE  
IDENTIFICATION  
NUMBER**

**ENGINE NUMBER**

**TRANSMISSION  
NUMBER**

**The Engine Number** is stamped on the right front side of the engine block.

**The Transmission Number** appears on a label on top of the transmission.

# DOT Tire Quality Grades

---

The tires on all Honda cars meet Federal Safety Requirements. All tires on the ACCORD are also "graded" according to Department of Transportation (DOT) standards for tread wear, traction and temperature.

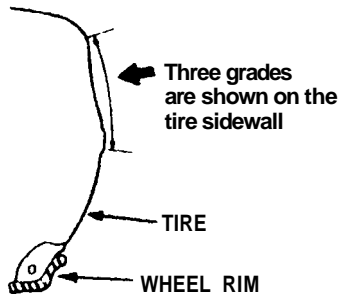

## Tread Wear

The tread wear grade is a comparative rating based on the wear rate of the tire when tested under controlled conditions on a specified government test course. For example, a tire graded 150 would wear one and one half (1-1/2) times as well on the government course as a tire graded 100.

The relative performance of tires depends upon the actual conditions of their use, however, and may depart significantly from the norm due to variations in driving habits, service practices and differences in road characteristics and climate.

## Traction

The traction grades, from highest to lowest, are A, B, and C, and they represent the tire's ability to stop on wet pavement as measured under controlled conditions on specified government test surfaces of asphalt and concrete. A tire marked C may have poor traction performance.

**▲ WARNING** The traction grades assigned are based on braking (straight ahead) traction tests and do not include cornering (turning) traction.

(cont'd)

## DOT Tire Quality Grades (cont'd)

---

### Temperature

The temperature grades are A (the highest), B, and C representing the tire's resistance to the generation of heat and its ability to dissipate heat when tested under controlled conditions on a specified indoor laboratory test wheel. Sustained high temperature can cause the material of the tire to degenerate and reduce tire life, and excessive temperature can lead to sudden tire failure. The grade C corresponds to a level of performance which all passenger car tires must meet under the Federal Motor Vehicle Safety Standard No. 109. Grades B and A represent higher levels of performance on the laboratory test wheel than the minimum required by law.

**▲ WARNING** The tire temperature grade is established for a tire that is properly inflated and not overloaded. Excessive speed, underinflation, or excessive loading, either separately or in combination, can cause heat buildup and possible tire failure.



## Sources of Emissions

The combustion process produces carbon monoxide, oxides of nitrogen and hydrocarbons. The evaporation of fuel in the fuel tank also produces hydrocarbons. Control of oxides of nitrogen and hydrocarbons is very important since, under certain conditions, when subjected to sunlight, they react to form photochemical smog. Carbon monoxide does not react to form smog, but it is toxic.

Honda Motor Co., Ltd. has developed a number of systems which are highly effective in reducing carbon monoxide, oxides of nitrogen and hydrocarbons.

## The Clean Air Act

The Clean Air Act requires all vehicle manufacturers to explain in writing, the operation and maintenance of their emission control systems.

Maintenance instructions are included on pages 78—80; the operation of each system is explained on the following.

## Replacement Parts

The emission control systems on your new Honda were designed, built and certified to conform with the Federal regulations implementing the Clean Air Act. Honda recommends only the use of new, genuine Honda parts or their equivalent. The use of other replacement parts which are not of equivalent quality may impair the effectiveness of your car's emission control systems.

## Crankcase Emission Control System

To prevent crankcase emissions, your car is equipped with a Positive Crankcase Ventilation (PCV) System which routes blowby gases from the crankcase, through the PCV valve and intake manifold, into the combustion chamber.

## Evaporative Emission Control System

The Evaporative Emission Control System is designed to prevent fuel vapors from escaping into the atmosphere.

Fuel vapors from the fuel tank are directed into the charcoal canister where they are adsorbed and stored while the engine is stopped or idling. When the coolant temperature rises to a certain value, the vapors are drawn into the engine through the throttle body and the intake manifold during normal engine operation.

(cont'd)

## Emission Controls (cont'd)

---

### Engine Exhaust Controls

The engine exhaust emission control systems are designed to control combustion during idle, acceleration, cruise, and deceleration. These systems are entirely separate from the crankcase and evaporative emission control systems described previously.

- **PGM-FI System**

The PGM-FI system consists of three independent sub-systems; Air Intake, Electronic Control and Fuel Control, thus allowing more accurate control of air/fuel ratios under all operating conditions. The Electronic Control Unit (ECU) detects the amount of air drawn into the cylinders and determines the amount of fuel to be injected to provide the optimum air/fuel ratio for all engine needs.

- **Ignition Timing Control System**

This system automatically controls the ignition timing to reduce the amount of HC and NOx.

- **Catalytic Converter**

The catalyst is used to convert hydrocarbons (HC), carbon monoxide (CO) and oxides of nitrogen (NOx) in the exhaust gas, to carbon dioxide (CO<sub>2</sub>), dinitrogen (N<sub>2</sub>) and water vapor.

- **Exhaust Gas Recirculation (EGR)**

The EGR system is designed to control the formation of oxides of nitrogen (NOx) caused when fuel mixture burns at high temperature. It works by recirculating exhaust gas through the EGR valve and intake manifold into the combustion chambers where it reduces peak temperature by diluting the air/fuel mixture.

## Catalytic Converter

---

A catalytic converter is installed in the exhaust system to help clean-up the harmful exhaust gases that can cause air pollution.

To be effective, the converter must work at high temperature, so don't park your car over dry grass, leaves or anything else that could burn easily.

To stay effective, the converter must not be contaminated by leaded gasoline; use only unleaded gas as explained on page 57.

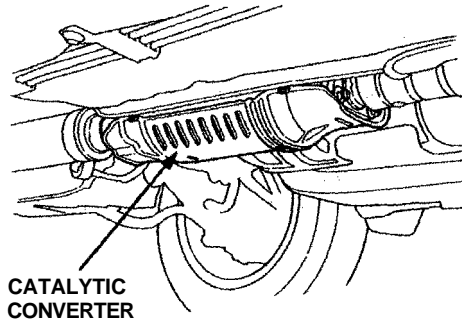

**CAUTION:** The converter can be overheated and damaged if it's fed too much unburned fuel mixture from the engine, so:

- Don't push or tow the car to start it; if the battery is dead, jump start the car as shown on page 118.
- Don't turn the key off while the engine is running above idle speed.
- Don't change the ignition timing, or remove any emission control parts.
- Use only the spark plugs specified in this manual.
- Don't keep driving your car if it isn't running properly, or if its CHARGE warning light comes on; have it checked by your Honda dealer.

# Warranty Service

---

## Warranty

The following warranties are provided with every new vehicle.

1. New Car Limited Warranty
2. Emission Control Systems Warranty
3. Emission Controls Performance Warranty
4. Battery Limited Warranty
5. Rust Perforation Limited Warranty
6. Accessory Limited Warranty
7. Replacement Parts Limited Warranty
8. Replacement Muffler Lifetime Limited Warranty
9. Replacement Engine Limited Warranty
10. Seat Belt Limited Warranty

All warranty details pertaining to your car can be found in the Warranty booklet provided with your new car except the required maintenance schedule which is contained here in the Owner's Manual.

If you are unable to obtain warranty service or are dissatisfied with the warranty decision or service you received at an authorized Honda dealership, you should review the matter with that dealership's Service Manager. This will normally resolve your problem. If it does not resolve your problem you should appeal the decision with the owner of the dealership. Please bear in mind that your problem will likely be resolved in the dealership, using the dealer's facilities, equipment and personnel. So it is very important that your initial contact be with the dealer or his management.

After following these steps, if you wish to have the matter reviewed by American Honda you should contact the Zone Office serving your area, as shown on the map on the inside of the back cover. When contacting American Honda, please provide the Zone Office with the following information:

- Vehicle Identification Number
- Servicing Dealer Name and Address
- Date of Purchase
- Mileage on your Car
- Your Name, Address, and Phone Number
- Nature of Problem
- Selling Dealer

After a review of the facts, you will be advised of what can be done.

## Reporting Safety Defects

---

If you believe that your vehicle has a defect which could cause a crash or could cause injury or death, you should immediately inform the National Highway Traffic Safety Administration (NHTSA) in addition to notifying American Honda Motor Co., Inc.

If NHTSA receives similar complaints, it may open an investigation, and if it finds that a safety defect exists in a group of vehicles, it may order a recall and remedy campaign.

However, NHTSA cannot become involved in individual problems between you, your dealer, or American Honda Motor Co., Inc.

To contact NHTSA, you may either call the Auto Safety Hotline toll-free at 1-800-424-9393 (or 366-0123 in Washington, D.C. area) or write to:

NHTSA, U.S. Department of Transportation  
Washington, D.C. 20590.

You can also obtain other information about motor vehicle safety from the Hotline.

# Service Manuals

A Honda Service Manual is available for your car. It is written for the Journeyman mechanic, but it is simple enough for most mechanically inclined owners to understand.

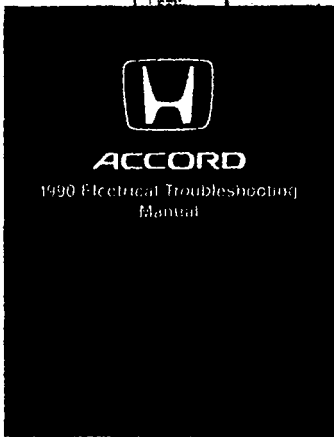
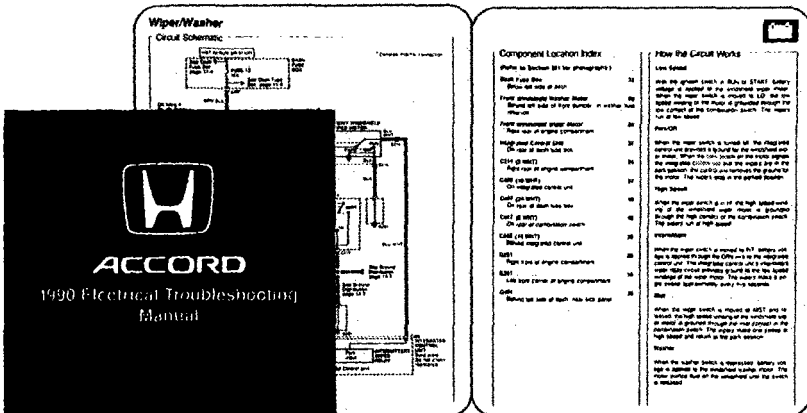
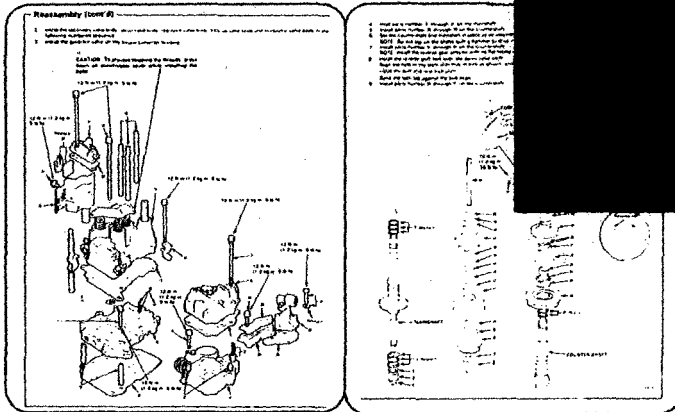
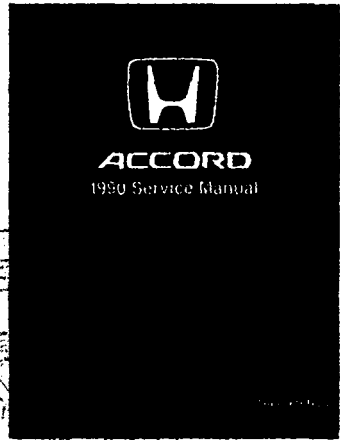

An Electrical Troubleshooting Manual is also available for your car. This manual complements the Service Manual by providing in-depth troubleshooting information for each electrical circuit in your car.

You can purchase these manuals through your Honda dealer's Parts Department.

## A

Air Conditioner	
Care .....	107
Operation .....	44
Air Filter .....	96
Air Pressure, Tires .....	104
Aluminum Alloy Wheels .....	110
Antenna .....	51
Antifreeze	
..... See "Radiator Coolant"	
Anti-theft Steering Column Lock	
System .....	61
Appearance Care .....	109
Ashtrays .....	38
Audio System .....	51
Automatic Seat Belt .....	10
Automatic Transmission	
Driving Technique .....	69
Fluid .....	89
Operation .....	68
Shift Lever Position	
Indicator .....	21

## B

Battery	
Charging System Warning	
Light .....	23
Jump Starting .....	118
Maintenance .....	99
Specification .....	125
Beeper System	
Fasten Seat Belt Beeper ....	15
Key Reminder .....	61
Light Reminder Chime .....	29
Belts, Seat .....	See "Seat Belts"
Beverage Holder .....	37
BodyRepair.....	112
Brake Warning Light .....	22
Brakes	
Brake Failure Warning	
Light .....	22
BrakeFluid .....	94
Brake System Design.....	93
BrakeWear .....	93
Brake Wear Indicators .....	93
Parking Brake .....	34
Parking Brake Warning	
Light .....	22
Break-in Period .....	2

## Bulb

Replacement .....	102
Specification .....	125
Buzzer .....	See "Beeper System"

## C

Capacities .....	124
Care and Cleaning .....	109
Catalytic Converter .....	131
Certification Label .....	126
Chains, Tires .....	105
Check Engine Warning	
Light .....	23
Child Restraint System .....	16
Cigarette Lighter .....	38
Clock .....	36
Clutch Fluid .....	94
COMPACT Spare Tire .....	113
Coolant Temperature	
Gauge .....	20
Cooling (with A/C) .....	44
Cooling System .....	90
Crankcase Emission Control	
System .....	129
Cruise Control	
Indicator .....	21
Operation .....	32

## D

Defogger .....	27
Defroster .....	47
Dimmer Switch,	
Headlights .....	29
Doors	
Locks .....	3
Power Door Locks .....	4
Warning Light .....	24

## E

Emergency	
Changing a Flat Tire .....	115
Hazard Warning System ...	30

(cont'd)

## Index (cont'd)

---

If Your Car Gets Stuck .....	121
Jump Starting .....	118
Shoulder Belt Buckle .....	122
Towing .....	120
Warning and Indicator Lights .....	21
Emission Controls .....	129
Engine	
Coolant .....	90
Coolant Temperature Gauge .....	20
Exhaust Controls .....	130
Identification Number .....	126
Oil and Filter .....	85
Oil Pressure Warning Light .....	22
Specification .....	125
Engine Exhaust Gas Warning .....	64
Evaporative Emission Control System .....	129
Exhaust Gas Recirculation .....	130
ExteriorCare .....	109
<b>F</b>	
Filters	
Air .....	96
Engine Oil .....	86
Fuel .....	96
Fluid .....	See "Oil"
Foreign Countries, Operation in .....	58
Front Seat Adjustment .....	6
Fuel	
Filler Door and Cap .....	59
Filter .....	96
Gasohol .....	57
Gasoline .....	57
Gauge .....	20
Requirement .....	57
Reserve Warning Light .....	21
Fuse	
Checking and Replacing ...	100
Specification .....	125

## G

Gasoline .....	See "Fuel"
Gas Station Information .....	Back cover
Gauges .....	20
Glove Box .....	37

## H

Hazard Warning System .....	30
Headlights	
Flasher .....	29
High Beam Indicator .....	21
High Beam/Low Beam Switch .....	29
Reminder Chime .....	29
Switch .....	29
Headlight High Beam Indicator Light .....	21
Head Restraints .....	8
Heating .....	45
High Beam Indicator Light .....	21
Switch .....	29
Hood Latch .....	34

## I

Identification Numbers .....	126
Ignition	
Keys .....	3
Switch .....	61
Ignition Switch Light .....	30
Indicator Lights .....	21
Inflation Pressures, Tire .....	104
Instrument Panel .....	19
Instrument Panel Brightness Control .....	30
Interior Light .....	31
Interior Trim Care .....	109

## J

Jack .....	115
Jump Starting .....	118



## K

Keys	
Door Locks .....	3
Glove Box .....	37
Ignition .....	61
Key Reminder Beeper .....	61
Keys .....	3
Trunk Lock .....	5

## L

Lap/Shoulder	
Belts .....	See "Seat Belts"
Lights	
Bulb Replacement .....	102
Fuse Replacement .....	100
Light Reminder Chime .....	29
Operation .....	29
Warning and Indicator	
Lights .....	21
Locks	
Anti-theft Steering Column	
Lock .....	61
Doors .....	3
Fuel Filler Door .....	59
Glove Box .....	37
Power Door Locks .....	4
Trunk .....	5
Lumbar Support .....	7

## M

Maintenance	
Record .....	81
Schedule .....	78
Manual Transmission	
Maximum Allowable	
Speeds .....	66
Oil .....	88
Recommended Shift	
Speeds .....	66
Shifting .....	65
Meters, Gauges ...	See "Gauges"
Mirrors	
Power Mirrors .....	28
Rearview Mirrors .....	28

## N

Numbers, Identification .....	126
-------------------------------	-----

## O

Octane Rating,	
Gasoline .....	See "Fuel"
Odometer .....	20
Oil	
Clutch Fluid .....	94
Engine Oil .....	85
Fluid Locations .....	84
Oil Pressure Warning	
Light .....	22
Power Steering Fluid .....	95
Transmission Oil/Fluid .....	88
Operation In Foreign	
Countries .....	58

## P

Panel Brightness Control .....	30
Parking Brake .....	34
Passive Belt .....	10
PGM-FI	
Check Engine Warning	
Light .....	23
System .....	130
Power	
Door Locks .....	4
Mirrors .....	28
Steering .....	95
Windows .....	35
Pregnant Women .....	17
Pressures, Tire Inflation .....	104
Preventive Service .....	111

## R

Radiator Coolant .....	90
Radio .....	51
Rear Quarter Windows .....	36
Rearview Mirrors .....	28
Rear Window Defogger .....	27
Reminder	
Lights ..	See "Warning Lights"

(cont'd)

# Index (cont'd)

---

Replacement	
Air Filter .....	96
Bulbs .....	102
Engine Oil .....	86
Fuel Filter .....	96
Fuses .....	100
Oil Filter .....	86
Radiator Coolant .....	91
Spark Plugs .....	97
Tires .....	106
Wiper Blades .....	98
Rust Prevention .....	110

## S

Safety Defects, Reporting ....	133
Safety Indicator Lights .....	24
Safety Items .....	63
Seat Belt Reminder Light and Beeper .....	15
Seat Belts	
Anchor Points .....	17
Automatic Belt .....	10
Buckling the Front	
Seat Belts .....	10
Buckling the Rear	
Seat Belts .....	13
Child Restraint .....	16
Cleaning .....	18
Fasten Seat Belt Reminder Light and Beeper .....	15
Inspection .....	18
Passive Belt .....	10
Pregnant Women .....	17
Rear Center Seat Belt .....	14
Replacement .....	18
Shoulder Belt Buckle .....	122
Seats	
Driver's Lumbar	
Support .....	7
Front Seat .....	6
Head Restraints .....	8
Trunk Access from	
Rear Seat .....	9
Shift Lever Position	
Indicator .....	21
Shifting	
Automatic .....	67
5-Speed .....	65

Spare Tire	
Changing a Flat Tire .....	115
COMPACT Spare Tire .....	113
Specifications .....	124
Spark Plugs .....	97
Specifications .....	124
Speedometer .....	20
Starting the Engine .....	62
Steering	
Anti-theft Column Lock ....	61
Power Steering .....	95
Tilt Steering .....	25
Stereo Sound System	
Operation .....	51
Stuck Car .....	121
Sunroof	
If the Sunroof Won't	
Close .....	50
Maintenance .....	50
Operation .....	49
Sunshade .....	49
<b>T</b>	
Tachometer .....	20
Temperature Gauge,	
Coolant .....	20
Tilt Steering .....	25
Tire	
Air Pressure .....	104
Balancing .....	105
Chains .....	105
Changing a Flat Tire .....	115
COMPACT Spare .....	113
DOT Tire Quality Grades ...	127
Inflation Pressures .....	104
Requirement .....	127
Rotation .....	105
Snow Tire .....	104
Spare Tire .....	113
Specification .....	124
Tools .....	115
Towing .....	120
Towing a Trailer .....	71
Trailer .....	71

---

Transmission	
Capacity .....	124
Identification Number .....	126
Oil/Fluid .....	88
Shifting the Automatic .....	67
Shifting the 5 Speed .....	65
Tread Wear .....	127
TripMeter .....	20
Trunk	
Access From Rear Seat ....	9
Lid .....	5
Lid Warning Light .....	24
Turn Signals .....	29

## V

Vehicle Identification Number .....	126
Ventilation .....	39

## W

Warning Lights .....	21
Warranty Service .....	132
Washer	
Reservoir Capacity .....	26
Windshield Washer .....	26
Washing .....	109
Waxing .....	110
Wheels .....	110
Windows	
Appearance Care .....	109
Power Windows .....	35
Rear Quarter Windows .....	36
Windshield Defogger .....	27
Windshield Washer .....	26
Windshield Wipers .....	26
Wiper Blades .....	98
Wipers .....	26

## Automobile Zone Office Locations

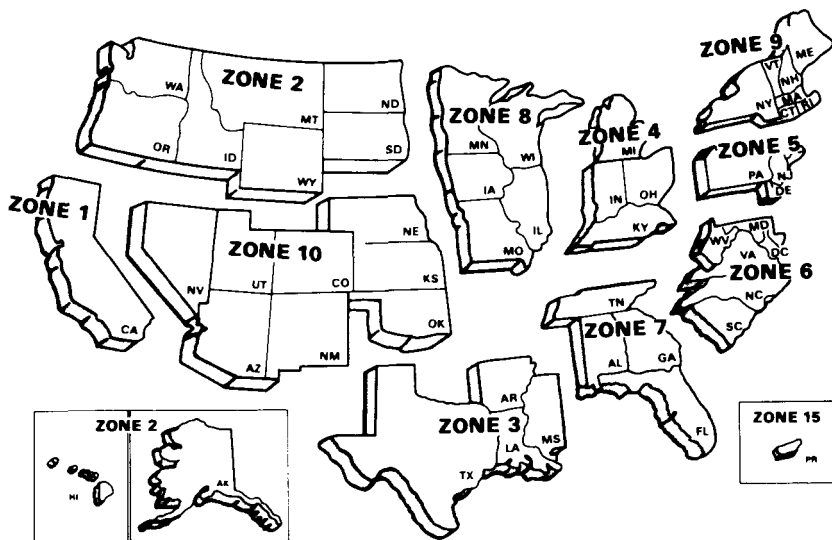

**1** Western Zone  
P.O. Box 2260  
700 Van Ness Avenue  
Torrance, California 90509-2260  
(213) 781-4565

**2** Northwestern Zone  
P.O. Box 20186  
12439 N.E. Airport Way  
Portland, Oregon 97220  
(503) 256-0943  
(also includes Alaska and Hawaii)

**3** South Central Zone  
4529 Royal Lane  
Irving, Texas 75063  
(214) 929-5481

**4** Central Zone  
101 South Stanfield Road  
Troy, Ohio 45373  
(513) 332-6250

**5** Northeastern Zone  
P.O. Box 337  
Eastgate Industrial Park  
115 Gaither Drive  
Moorestown, New Jersey 08057  
(609) 235-5533

**6** Mid-Atlantic Zone  
209 Perry Parkway, Suite 10  
Gaithersburg, Maryland 20877  
(301) 990-2020

**7** Southeastern Zone  
1500 Morrison Parkway  
Alpharetta, Georgia 30201  
(404) 442-2045

**8** North Central Zone  
601 Campus Drive, Suite A-9  
Arlington Heights, Illinois 60004  
(312) 870-5600

**9** New England Zone  
555 Old County Road  
Windsor Locks, Connecticut 06096  
(203) 623-3310

**10** West Central Zone  
1600 South Abilene Street, Suite D  
Aurora, Colorado 80012  
(303) 696-3935

**15** Puerto Rico and U.S. V.I.  
Bella International  
P.O. Box 816  
Hato Rey, Puerto Rico 00919  
(809) 765-8070

The above addresses and telephone numbers are subject to change. If you cannot reach your Zone office, ask your Honda dealer for the current information.

# Gas Station Information

**Gasoline:** UNLEADED only  
Pump octane of 86 or higher

**Gas Tank-Capacity:** 64.5 ℓ (17.0 US gal)

**Tire Pressure (measured cold):** front/rear  
**DX, LX: 200/200 kPa (29/29 psi)**  
**EX: 195/195 kPa (28/28 psi)**  
COMPACT spare tire, 415 kPa (60 psi)

**Other Tire Information:** Label on driver's door jamb

**Hood Release:** Pull handle under left side of dash.

**Engine Oil:** An "Energy Conserving II" SG grade oil is recommended.  
See page 85 for viscosity recommendations.  
Capacity (Including filter): 3.8 ℓ (4.0 US qt)

**5 Speed Transmission Oil:**  
Recommended type — SAE 10W — 30 or 10W — 40 weight,  
grade SE or SF.  
Capacity (Including differential): 1.9 ℓ (2.0 US qt)

**Automatic Transmission Fluid:**  
Use DEXRON® II type Automatic Transmission Fluid  
(ATF). Remove dipstick from right end of transmission,  
wipe off, reinsert, remove, and read fluid level - do not  
force the rubber plug in when reading fluid level or  
replacing dipstick.  
Capacity (Including differential): 2.4 ℓ (2.5 US qt)

**Power Steering Fluid:**  
Use only Honda power steering fluid: do not use ATF or  
any other brand of power steering fluid because it will  
damage the system.



AMERICAN HONDA MOTOR CO., INC.  
1919 Torrance Blvd., Torrance California 90501