



November 2015 | Second Printing
Owner's Manual | Mustang
Litho in U.S.A.



GR3J19A321 AA



owner.ford.com (U.S.)



ford.ca (Canada)

M U S T A N G 2 0 1 6 O W N E R ' S M A N U A L



2016

OWNER'S MANUAL



The information contained in this publication was correct at the time of going to print. In the interest of continuous development, we reserve the right to change specifications, design or equipment at any time without notice or obligation. No part of this publication may be reproduced, transmitted, stored in a retrieval system or translated into any language in any form by any means without our written permission. Errors and omissions excepted.

© Ford Motor Company 2015

All rights reserved.

Part Number: 10/2015 20151001205307

Table of Contents

Introduction

About This Manual.....	7
Symbols Glossary.....	7
Data Recording.....	9
California Proposition 65.....	11
Perchlorate.....	11
Ford Credit.....	11
Replacement Parts Recommendation.....	11
Special Notices.....	12
Mobile Communications Equipment.....	13
Export Unique Options.....	13

Environment

Protecting the Environment.....	14
---------------------------------	----

Child Safety

General Information.....	15
Installing Child Restraints.....	16
Booster Seats.....	22
Child Restraint Positioning.....	24

Seatbelts

Principle of Operation.....	26
Fastening the Seatbelts.....	27
Seatbelt Warning Lamp and Indicator Chime.....	30
Seatbelt Reminder.....	30
Child Restraint and Seatbelt Maintenance.....	32

Personal Safety System™

Personal Safety System™.....	33
------------------------------	----

Supplementary Restraints System

Principle of Operation.....	34
Driver and Passenger Airbags.....	35
Front Passenger Sensing System.....	36

Side Airbags.....	38
Driver and Passenger Knee Airbags.....	40
Safety Canopy™ - Coupe.....	40
Crash Sensors and Airbag Indicator.....	41
Airbag Disposal.....	42

Keys and Remote Controls

General Information on Radio Frequencies.....	43
Remote Control.....	44
Replacing a Lost Key or Remote Control.....	47

MyKey™

Principle of Operation.....	48
Creating a MyKey.....	49
Clearing All MyKeys.....	50
Checking MyKey System Status.....	51
Using MyKey With Remote Start Systems.....	52
MyKey Troubleshooting.....	52

Locks

Locking and Unlocking.....	53
Interior Luggage Compartment Release.....	57

Security

Passive Anti-Theft System.....	59
Anti-Theft Alarm.....	60

Steering Wheel

Adjusting the Steering Wheel.....	61
Audio Control.....	61
Voice Control.....	62
Cruise Control.....	62
Information Display Control.....	62

Wipers and Washers

Windshield Wipers.....	63
------------------------	----

Table of Contents

Autowipers.....	63
Windshield Washers.....	64

Lighting

General Information.....	65
Lighting Control.....	65
Autolamps.....	66
Instrument Lighting Dimmer.....	67
Headlamp Exit Delay.....	67
Daytime Running Lamps.....	68
Front Fog Lamps.....	68
Direction Indicators.....	69
Welcome Lighting.....	69
Interior Lamps.....	69
Ambient Lighting.....	69

Windows and Mirrors

Power Windows.....	70
Global Opening.....	70
Exterior Mirrors.....	71
Interior Mirror.....	72
Sun Visors.....	73

Instrument Cluster

Gauges.....	74
Warning Lamps and Indicators.....	76
Audible Warnings and Indicators.....	79

Information Displays

General Information.....	80
Information Messages.....	88

Climate Control

Manual Climate Control.....	99
Automatic Climate Control.....	101
Hints on Controlling the Interior Climate.....	102
Heated Windows and Mirrors.....	105
Cabin Air Filter.....	105

Remote Start.....	106
-------------------	-----

Seats

Sitting in the Correct Position.....	107
Head Restraints.....	107
Manual Seats.....	109
Power Seats.....	109
Memory Function.....	110
Rear Seats.....	111
Climate Controlled Seats.....	112

Universal Garage Door Opener

Universal Garage Door Opener.....	113
-----------------------------------	-----

Auxiliary Power Points

Auxiliary Power Points.....	117
-----------------------------	-----

Storage Compartments

Center Console.....	118
Glasses Holder.....	118

Starting and Stopping the Engine

General Information.....	119
Keyless Starting.....	119
Steering Wheel Lock.....	120
Starting a Gasoline Engine.....	120
Engine Block Heater.....	122

Fuel and Refueling

Safety Precautions.....	124
Fuel Quality.....	125
Running Out of Fuel.....	125
Refueling.....	126
Fuel Consumption.....	128
Emission Control System.....	129

Table of Contents

Transmission

Manual Transmission.....	132
Automatic Transmission.....	134

Rear Axle

Limited Slip Differential.....	138
--------------------------------	-----

Brakes

General Information.....	139
Hints on Driving With Anti-Lock Brakes.....	139
Parking Brake.....	139
Hill Start Assist.....	140

Traction Control

Principle of Operation.....	142
Using Traction Control.....	142

Stability Control

Principle of Operation.....	143
Using Stability Control.....	144

Parking Aids

Principle of Operation.....	147
Rear Parking Aid.....	147
Rear View Camera.....	148

Cruise Control

Principle of Operation.....	152
Using Cruise Control.....	152
Using Adaptive Cruise Control.....	153

Driving Aids

Blind Spot Information System.....	160
Cross Traffic Alert.....	162
Steering.....	165
Collision Warning System.....	166
Drive Control.....	168

Load Carrying

Load Limit.....	171
-----------------	-----

Towing

Towing a Trailer.....	178
Recommended Towing Weights.....	179
Essential Towing Checks.....	180
Transporting the Vehicle.....	182
Towing the Vehicle on Four Wheels.....	182

Convertible Top

Opening the Convertible Top.....	184
Closing the Convertible Top.....	185

Driving Hints

Breaking-In.....	187
Economical Driving.....	187
Driving Through Water.....	187
Floor Mats.....	188

Roadside Emergencies

Roadside Assistance.....	190
Hazard Warning Flashers.....	191
Fuel Shutoff.....	191
Jump Starting the Vehicle.....	192
Post-Crash Alert System.....	194

Customer Assistance

Getting the Services You Need.....	195
In California (U.S. Only).....	196
The Better Business Bureau (BBB) Auto Line Program (U.S. Only).....	197
Utilizing the Mediation/Arbitration Program (Canada Only).....	198
Getting Assistance Outside the U.S. and Canada.....	198
Ordering Additional Owner's Literature.....	199
Reporting Safety Defects (U.S. Only).....	200

Table of Contents

Reporting Safety Defects (Canada Only).....	200
---	-----

Fuses

Fuse Specification Chart.....	202
Changing a Fuse.....	209

Maintenance

General Information.....	211
Opening and Closing the Hood.....	211
Under Hood Overview - 2.3L EcoBoost™.....	213
Under Hood Overview - 3.7L.....	214
Under Hood Overview - 5.0L.....	215
Engine Oil Dipstick.....	216
Engine Oil Check.....	216
Engine Coolant Check.....	217
Manual Transmission Fluid Check.....	221
Automatic Transmission Fluid Check.....	221
Brake and Clutch Fluid Check.....	221
Power Steering Fluid Check.....	221
Washer Fluid Check.....	222
Fuel Filter.....	222
Changing the 12V Battery.....	222
Checking the Wiper Blades.....	224
Changing the Wiper Blades.....	224
Adjusting the Headlamps.....	224
Changing a Bulb.....	226
Bulb Specification Chart.....	228
Changing the Engine Air Filter.....	229

Vehicle Care

General Information.....	230
Cleaning Products.....	230
Cleaning the Exterior.....	230
Waxing.....	231
Cleaning the Engine.....	232
Cleaning the Windows and Wiper Blades.....	232

Cleaning the Interior.....	233
Cleaning the Instrument Panel and Instrument Cluster Lens.....	233
Cleaning Leather Seats.....	234
Repairing Minor Paint Damage.....	234
Cleaning the Alloy Wheels.....	234
Vehicle Storage.....	235
Cleaning the Convertible Top.....	237

Wheels and Tires

Tire Sealant and Inflator Kit.....	238
Tire Care.....	244
Using Summer Tires.....	259
Using Snow Chains.....	259
Tire Pressure Monitoring System.....	260
Changing a Road Wheel.....	264
Driving at High Speed.....	269
Technical Specifications.....	270

Capacities and Specifications

Engine Specifications - 2.3L EcoBoost™.....	271
Engine Specifications - 3.7L.....	271
Engine Specifications - 5.0L.....	272
Motorcraft Parts - 2.3L EcoBoost™.....	273
Motorcraft Parts - 3.7L.....	274
Motorcraft Parts - 5.0L.....	275
Vehicle Identification Number.....	276
Vehicle Certification Label.....	277
Transmission Code Designation.....	277
Capacities and Specifications - 2.3L EcoBoost™.....	278
Capacities and Specifications - 3.7L.....	282
Capacities and Specifications - 5.0L.....	286

Audio System

General Information.....	291
Audio Unit - Vehicles With: AM/FM/CD/SYNC/Satellite Radio.....	292

Table of Contents

Audio Unit - Vehicles With: Premium AM/ FM/CD.....	295
Digital Radio.....	296
Satellite Radio.....	298
USB Port.....	301
Media Hub.....	301

SYNC™

General Information.....	302
Using Voice Recognition.....	304
Using SYNC™ With Your Phone.....	306
SYNC™ Applications and Services.....	318
Using SYNC™ With Your Media Player.....	323
SYNC™ Troubleshooting.....	332

Accessories

Accessories.....	340
------------------	-----

Extended Service Plan (ESP)

Extended Service Plan (ESP).....	342
----------------------------------	-----

Scheduled Maintenance

General Maintenance Information.....	344
Normal Scheduled Maintenance.....	347
Special Operating Conditions Scheduled Maintenance.....	350
Scheduled Maintenance Record.....	352

Appendices

End User License Agreement.....	362
Type Approvals.....	383

Introduction

ABOUT THIS MANUAL

Thank you for choosing Ford. We recommend that you take some time to get to know your vehicle by reading this manual. The more that you know about your vehicle, the greater the safety and pleasure you will get from driving it.

WARNING



Driving while distracted can result in loss of vehicle control, crash and injury. We strongly recommend that you use extreme caution when using any device that may take your focus off the road. Your primary responsibility is the safe operation of your vehicle. We recommend against the use of any hand-held device while driving and encourage the use of voice-operated systems when possible. Make sure you are aware of all applicable local laws that may affect the use of electronic devices while driving.

Note: This manual describes product features and options available throughout the range of available models, sometimes even before they are generally available. It may describe options not fitted to the vehicle you have purchased.

Note: Some of the illustrations in this manual may show features as used in different models, so they may appear different to you on your vehicle.

Note: Always use and operate your vehicle in line with all applicable laws and regulations.

Note: Pass on this manual when selling your vehicle. It is an integral part of your vehicle.

This manual may qualify the location of a component as left-hand side or right-hand side. The side is determined when facing forward in the seat.



E154903

A Right-hand side.

B Left-hand side.

SYMBOLS GLOSSARY

These are some of the symbols you may see on your vehicle.



Safety alert



See Owner's Manual



Air conditioning system



Anti-lock braking system



Avoid smoking, flames or sparks



Battery



Battery acid



Brake fluid - non petroleum based

Introduction



Brake system



Cabin air filter



Check fuel cap



Child safety door lock or unlock



Child seat lower anchor



Child seat tether anchor



Cruise control



Do not open when hot



Engine air filter



Engine coolant



Engine coolant temperature



Engine oil



Explosive gas



Fan warning



Fasten seatbelt



Front airbag



Front fog lamps



Fuel pump reset



Fuse compartment



Hazard warning flashers



Heated rear window



Heated windshield



Interior luggage compartment release



Jack



Keep out of reach of children



Lighting control



Low tire pressure warning



Maintain correct fluid level



Note operating instructions



Panic alarm

Introduction



Parking aid



Parking brake



Power steering fluid



Power windows front/rear



Power window lockout



Service engine soon



Side airbag



Shield the eyes



Stability control



Windshield wash and wipe

DATA RECORDING

Service Data Recording

Service data recorders in your vehicle are capable of collecting and storing diagnostic information about your vehicle. This potentially includes information about the performance or status of various systems and modules in the vehicle, such as engine, throttle, steering or brake systems. In order to properly diagnose and service your vehicle, Ford Motor Company, Ford of Canada, and service and repair

facilities may access or share among them vehicle diagnostic information received through a direct connection to your vehicle when diagnosing or servicing your vehicle. Additionally, when your vehicle is in for service or repair, Ford Motor Company, Ford of Canada, and service and repair facilities may access or share among them data for vehicle improvement purposes. For U.S. only (if equipped), if you choose to use the SYNC Vehicle Health Report, you consent that certain diagnostic information may also be accessed electronically by Ford Motor Company and Ford authorized service facilities, and that the diagnostic information may be used for any purpose. See **SYNC™** (page 302).

Event Data Recording

This vehicle is equipped with an event data recorder. The main purpose of an event data recorder is to record, in certain crash or near crash-like situations, such as an airbag deployment or hitting a road obstacle; this data will assist in understanding how a vehicle's systems performed. The event data recorder is designed to record data related to vehicle dynamics and safety systems for a short period of time, typically 30 seconds or less.

The event data recorder in this vehicle is designed to record such data as:

- **How various systems in your vehicle were operating;**
- **Whether or not the driver and passenger safety belts were buckled/fastened;**
- **How far (if at all) the driver was depressing the accelerator and/or the brake pedal; and**
- **How fast the vehicle was traveling; and**
- **Where the driver was positioning the steering wheel.**

Introduction

This data can help provide a better understanding of the circumstances in which crashes and injuries occur.

Note: *Event data recorder data is recorded by your vehicle only if a non-trivial crash situation occurs; no data is recorded by the event data recorder under normal driving conditions and no personal data or information (e.g., name, gender, age, and crash location) is recorded (see limitations regarding 911 Assist and Traffic, directions and Information privacy below). However, parties, such as law enforcement, could combine the event data recorder data with the type of personally identifying data routinely acquired during a crash investigation.*

To read data recorded by an event data recorder, special equipment is required, and access to the vehicle or the event data recorder is needed. In addition to the vehicle manufacturer, other parties, such as law enforcement, that have such special equipment, can read the information if they have access to the vehicle or the event data recorder. Ford Motor Company and Ford of Canada do not access event data recorder information without obtaining consent, unless pursuant to court order or where required by law enforcement, other government authorities or other third parties acting with lawful authority. Other parties may seek to access the information independently of Ford Motor Company and Ford of Canada.

Note: *Including to the extent that any law pertaining to Event Data Recorders applies to SYNC or its features, please note the following: Once 911 Assist (if equipped) is enabled (set ON), 911 Assist may, through any paired and connected cell phone, disclose to emergency services that the vehicle has been in a crash involving the deployment of an airbag or, in certain vehicles, the activation of the fuel pump shut-off. Certain versions or updates to 911 Assist may also be capable of being used to electronically or verbally provide to 911 operators the vehicle location (such as latitude and longitude), and/or other details about the vehicle or crash or personal information about the occupants to assist 911 operators to provide the most appropriate emergency services. If you do not want to disclose this information, do not activate the 911 Assist feature. See SYNC™ (page 302).*

Additionally, when you connect to Traffic, Directions and Information (if equipped, U.S. only), the service uses GPS technology and advanced vehicle sensors to collect the vehicle's current location, travel direction, and speed ("vehicle travel information"), only to help provide you with the directions, traffic reports, or business searches that you request. If you do not want Ford or its vendors to receive this information, do not activate the service. For more information, see Traffic, Directions and Information, Terms and Conditions. See SYNC™ (page 302).

Introduction

CALIFORNIA PROPOSITION 65

WARNINGS



Some constituents of engine exhaust, certain vehicle components, certain fluids contained in vehicles and certain products of component wear contain or emit chemicals known to the State of California to cause cancer and birth defects or other reproductive harm.



Battery posts, terminals and related accessories contain lead and lead compounds, chemicals known to the State of California to cause cancer and reproductive harm. Batteries also contain other chemicals known to the State of California to cause cancer. Wash your hands after handling.

PERCHLORATE

Certain components in your vehicle such as airbag modules, safety belt pretensioners and remote control batteries may contain perchlorate material. Special handling may apply for service or vehicle end of life disposal.

For more information visit:

Web Address
www.dtsc.ca.gov/hazardouswaste/perchlorate

FORD CREDIT

(U.S. Only)

Ford Credit offers a full range of financing and lease plans to help you acquire your vehicle. If you have financed or leased your vehicle through Ford Credit, thank you for your business.

For your convenience we offer a number of ways to contact us, as well as to help manage your account.

Phone: 1-800-727-7000

For more information regarding Ford Credit, as well as to access Account Manager, please go to www.fordcredit.com.

REPLACEMENT PARTS RECOMMENDATION

Your vehicle has been built to the highest standards using quality parts. We recommend that you demand the use of genuine Ford and Motorcraft parts whenever your vehicle requires scheduled maintenance or repair. You can clearly identify genuine Ford and Motorcraft parts by looking for the Ford, FoMoCo or Motorcraft branding on the parts or their packaging.

Scheduled Maintenance and Mechanical Repairs

One of the best ways for you to make sure that your vehicle provides years of service is to have it maintained in line with our recommendations using parts that conform to the specifications detailed in this Owner's Manual. Genuine Ford and Motorcraft parts meet or exceed these specifications.

Collision Repairs

We hope that you never experience a collision, but accidents do happen. Genuine Ford replacement collision parts meet our stringent requirements for fit, finish, structural integrity, corrosion protection and dent resistance. During vehicle

Introduction

development we validate these parts deliver the intended level of protection as a whole system. A great way to know for sure you are getting this level of protection is to use genuine Ford replacement collision parts.

Warranty on Replacement Parts

Genuine Ford and Motorcraft replacement parts are the only replacement parts that benefit from a Ford Warranty. Damage caused to your vehicle as a result of the failure of non-Ford parts may not be covered by the Ford Warranty. For additional information, refer to the terms and conditions of the Ford Warranty.

SPECIAL NOTICES

New Vehicle Limited Warranty

For a detailed description of what your vehicle's New Vehicle Limited Warranty covers, see the Warranty Guide provided to you along with your Owner's Manual.

Additional Warranty Information

Your vehicle carries the same warranty as other Ford models. This information is covered in its entirety in the Ford Warranty Guide. You can obtain warranty service for your vehicle at any authorized dealer nationwide.

We design and build our vehicles for our customers to drive as delivered from the factory. The Ford Warranty Guide discusses vehicle use and the installation of aftermarket parts and their effect on warranty coverage. See the Ford Warranty Guide for complete information.

Using your vehicle on a dedicated road course may result in degraded function and failure of major systems such as the engine, transmission and rear axle due to the overheating of these systems. If you intend to use your vehicle on a dedicated road course, we suggest that you equip your vehicle with racing-type coolers to protect these three systems.

In addition, if the vehicle is subjected to dedicated road course use, we recommend the following vehicle durability maintenance:

- Change your axle lubricant and friction modifier after the initial (first) hour of high-speed operation; thereafter change the axle lubricant and friction modifier every 12 hours (under these conditions).
- Change your transmission oil after each event where your vehicle is subjected to individual on-track sessions exceeding 15 minutes.
- Change your engine oil and filter after each event.

Additionally, perform a multi-point inspection on items specified in the scheduled maintenance section of this owner guide before and after dedicated road course use. See **General Maintenance Information** (page 344). See the vehicle service manual for removal and installation procedures. Replace with Genuine Ford and Motorcraft™ service parts as needed.

These actions may not necessarily protect your powertrain from damage in dedicated road course use. Subjecting your vehicle to dedicated road course use even with these proposed precautions may render repairs non-reimbursable under the warranty.

Introduction

Special Instructions

WARNINGS



You risk death or serious injury to yourself and others if you do not follow the instruction highlighted by the warning symbol. Failure to follow the specific warnings and instructions could result in personal injury.



Front seat mounted rear-facing child or infant seats should never be placed in front of an active passenger airbag.

For your added safety, your vehicle is fitted with sophisticated electronic controls.

On-board Diagnostics (OBD-II)

Your vehicle's On-board Diagnostics (OBD-II) system has a data port for diagnostics, repair and reprogramming services with diagnostic scan tools. Installing a non-Ford-approved aftermarket OBD plug-in device that uses the port during normal driving, for example remote insurance company monitoring, remote vehicle diagnostics, telematics or engine reprogramming, may cause interference or damage to vehicle systems. We do not recommend or endorse the use of any non-Ford-approved aftermarket OBD plug-in devices. The vehicle Warranty may not cover damage caused by any non-Ford-approved aftermarket OBD plug-in device.

MOBILE COMMUNICATIONS EQUIPMENT

Using mobile communications equipment is becoming increasingly important in the conduct of business and personal affairs. However, you must not compromise your own or others' safety when using such equipment. Mobile communications can

enhance personal safety and security when appropriately used, particularly in emergency situations. Safety must be paramount when using mobile communications equipment to avoid negating these benefits. Mobile communication equipment includes, but is not limited to, cellular phones, pagers, portable email devices, text messaging devices and portable two-way radios.

WARNING



Driving while distracted can result in loss of vehicle control, crash and injury. We strongly recommend that you use extreme caution when using any device that may take your focus off the road. Your primary responsibility is the safe operation of your vehicle. We recommend against the use of any hand-held device while driving and encourage the use of voice-operated systems when possible. Make sure you are aware of all applicable local laws that may affect the use of electronic devices while driving.

EXPORT UNIQUE OPTIONS

For your particular global region, your vehicle may be equipped with features and options that are different from the features and options that are described in this Owner's Manual. A market unique supplement may be supplied that complements this book. By referring to the market unique supplement, if provided, you can properly identify those features, recommendations and specifications that are unique to your vehicle. This Owner's Manual is written primarily for the U.S. and Canadian Markets. Features or equipment listed as standard may be different on units built for Export. **Refer to this Owner's Manual for all other required information and warnings.**

Environment

PROTECTING THE ENVIRONMENT

You must play your part in protecting the environment. Correct vehicle usage and the authorized disposal of waste, cleaning and lubrication materials are significant steps toward this aim.

Child Safety

GENERAL INFORMATION

See the following sections for directions on how to properly use safety restraints for children.

WARNINGS



Always make sure your child is secured properly in a device that is appropriate for their height, age and weight. Child safety restraints must be bought separately from your vehicle. Failure to follow these instructions and guidelines may result in an increased risk of serious injury or death to your child.



All children are shaped differently. The recommendations for safety restraints are based on probable child height, age and weight thresholds from the National Highway Traffic Safety Administration and other safety organizations, or are the minimum requirements of law. We recommend checking with a NHTSA Certified Child Passenger Safety Technician (CPST) and

WARNINGS

consult your pediatrician to make sure your child seat is appropriate for your child, and is compatible with and properly installed in your vehicle. To locate a child seat fitting station and CPST, contact NHTSA toll free at 1-888-327-4236 or go to <http://www.nhtsa.dot.gov>. In Canada, contact Transport Canada toll free at 1-800-333-0371 or go to www.tc.gc.ca to find a Child Car Seat Clinic in your area. Failure to properly restrain children in safety seats made especially for their height, age, and weight may result in an increased risk of serious injury or death to your child.



Do not leave children or animals unattended in the vehicle. On hot days, the temperature in the trunk or vehicle interior can rise very quickly. Exposure of people or animals to these high temperatures for even a short time can cause death or serious heat-related injuries, including brain damage. Small children are particularly at risk.

Child Safety

Recommendations for Safety Restraints for Children

Child	Child size, height, weight, or age	Recommended restraint type
Infants or toddlers	Children weighing 40 lb (18 kg) or less (generally age four or younger).	Use a child safety seat (sometimes called an infant carrier, convertible seat, or toddler seat).
Small children	Children who have outgrown or no longer properly fit in a child safety seat (generally children who are less than 4 ft. 9 in. (1.45 m) tall, are greater than age four and less than age 12, and between 40 lb (18 kg) and 80 lb (36 kg) and upward to 100 lb (45 kg) if recommended by your child restraint manufacturer).	Use a belt-positioning booster seat.
Larger children	Children who have outgrown or no longer properly fit in a belt-positioning booster seat (generally children who are at least 4 ft. 9 in. (1.45 m) tall or greater than 80 lb (36 kg) or 100 lb (45 kg) if recommended by child restraint manufacturer).	Use a vehicle safety belt having the lap belt snug and low across the hips, shoulder belt centered across the shoulder and chest, and seat back upright.

- You are required by law to properly use safety seats for infants and toddlers in the United States and Canada.
- Many states and provinces require that small children use approved booster seats until they reach age eight, a height of 4 feet 9 inches (1.45 meters) tall, or 80 pounds (36 kilograms). Check your local and state or provincial laws for specific requirements about the safety of children in your vehicle.
- When possible, always properly restrain children 12 years of age and under in a rear seating position of your vehicle. Accident statistics suggest that children are safer when properly restrained in the rear seating positions than in a front seating position. See **Front Passenger Sensing System** (page 36).

INSTALLING CHILD RESTRAINTS

Child Seats



E142594

Child Safety

Use a child safety seat (sometimes called an infant carrier, convertible seat, or toddler seat) for infants, toddlers, or children weighing 40 pounds (18 kilograms) or less (generally age four or younger).

Using Lap and Shoulder Belts

WARNINGS



Airbags can kill or injure a child in a child seat. Never place a rear-facing child seat in front of an active airbag. If you must use a forward-facing child seat in the front seat, move the seat upon which the child seat is installed all the way back.



Airbags can kill or injure a child in a child seat. Children 12 and under should be properly restrained in the rear seat whenever possible.



Depending on where you secure a child restraint, and depending on the child restraint design, you may block access to certain seatbelt buckle assemblies and LATCH lower anchors, rendering those features potentially unusable. To avoid risk of injury, occupants should only use seating positions where they are able to be properly restrained.

When installing a child safety seat with combination lap and shoulder belts:

- Use the correct seatbelt buckle for that seating position.
- Insert the belt tongue into the proper buckle until you hear a snap and feel it latch. Make sure the tongue is securely fastened in the buckle.
- Keep the buckle release button pointing up and away from the safety seat, with the tongue between the child seat and the release button, to prevent accidental unbuckling.

- Place the vehicle seat upon which the child seat will be installed in the upright position.
- Put the seatbelt in the automatic locking mode. See Step 5. This vehicle does not require the use of a locking clip.

Perform the following steps when installing the child seat with combination lap and shoulder belts:

Note: *Although the child seat illustrated is a forward facing child seat, the steps are the same for installing a rear facing child seat.*



E142528

1. Position the child safety seat in a seat with a combination lap and shoulder belt.



E142529

Child Safety

2. Pull down on the shoulder belt and then grasp the shoulder belt and lap belt together.



E142530

3. While holding the shoulder and lap belt portions together, route the tongue through the child seat according to the child seat manufacturer's instructions. Be sure the belt webbing is not twisted.

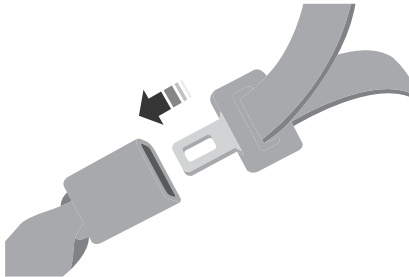

E142531

4. Insert the belt tongue into the proper buckle (the buckle closest to the direction the tongue is coming from) for that seating position until you hear a snap and feel the latch engage. Make sure the tongue is latched securely by pulling on it.



E142875

5. To put the retractor in the automatic locking mode, grasp the shoulder portion of the belt and pull downward until all of the belt is pulled out.

Note: *The automatic locking mode is available on the front passenger and rear seats. This vehicle does not require the use of a locking clip.*

6. Allow the belt to retract to remove slack. The belt will click as it retracts to indicate it is in the automatic locking mode.
7. Try to pull the belt out of the retractor to make sure the retractor is in the automatic locking mode (you should not be able to pull more belt out). If the retractor is not locked, unbuckle the belt and repeat Steps 5 and 6.



E142533

Child Safety

- Remove remaining slack from the belt. Force the seat down with extra weight, for example, by pressing down or kneeling on the child restraint while pulling up on the shoulder belt in order to force slack from the belt. This is necessary to remove the remaining slack that will exist once the extra weight of the child is added to the child restraint. It also helps to achieve the proper snugness of the child seat to your vehicle. Sometimes, a slight lean toward the buckle will additionally help to remove remaining slack from the belt.
- Attach the tether strap (if the child seat is equipped).

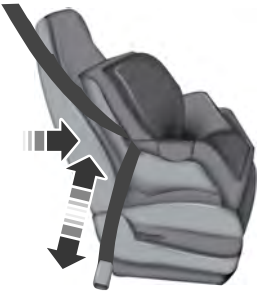

E142534

- Before placing the child in the seat, forcibly move the seat forward and back to make sure the seat is securely held in place. To check this, grab the seat at the belt path and attempt to move it side to side and forward and back. There should be no more than 1 inch (2.5 centimeters) of movement for proper installation.

We recommend checking with a NHTSA Certified Child Passenger Safety Technician to make certain the child restraint is properly installed. In Canada, check with Transport Canada for referral to a Child Car Seat Clinic.

Using Lower Anchors and Tethers for Children (LATCH)

WARNINGS

 Never attach two child safety seats to the same anchor. In a crash, one anchor may not be strong enough to hold two child safety seat attachments and may break, causing serious injury or death.

 Depending on where you secure a child restraint, and depending on the child restraint design, you may block access to certain seatbelt buckle assemblies or LATCH lower anchors, rendering those features potentially unusable. To avoid risk of injury, occupants should only use seating positions where they are able to be properly restrained.

 The center of the rear seat is not designed as a seating position and is not equipped with seatbelts. The LATCH anchors were not designed to be used with a child seat in the center position and there is no tether anchor available at the center. Attempted use of the center as a seating position will increase the risk of injury or death in the event of a crash.

The LATCH system is composed of three vehicle anchor points: two lower anchors located where seat back and seat cushion meet (called the seat bight) and one top tether anchor located behind that seating position.

LATCH compatible child safety seats have two rigid or webbing mounted attachments that connect to the two lower anchors at the LATCH equipped seating positions in your vehicle. This type of attachment method eliminates the need to use seatbelts to attach the child seat,

Child Safety

however the seatbelt can still be used to attach the child seat. For forward-facing child seats, the top tether strap must also be attached to the proper top tether anchor, if a top tether strap has been provided with your child seat.

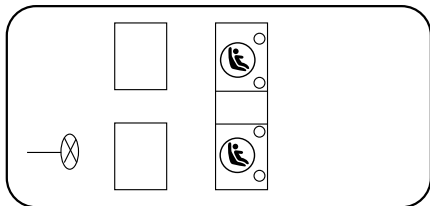

E174449

Your vehicle has LATCH lower anchors for child seat installation at the seating positions marked with the child seat symbol.

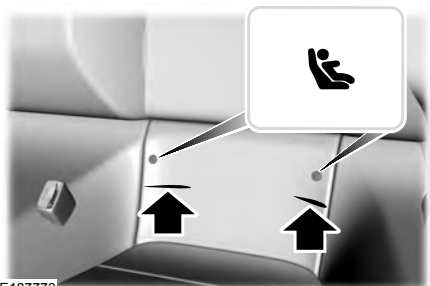

E187773

The LATCH anchors are located at the rear section of the rear seat between the cushion and seatback below the symbols as shown. Follow the child seat manufacturer's instructions to properly install a child seat with LATCH attachments. Follow the instructions on attaching child safety seats with tether straps.

Attach LATCH lower attachments of the child seat only to the anchors shown.

Combining Seatbelt and LATCH Lower Anchors for Attaching Child Safety Seats

When used in combination, either the seatbelt or the LATCH lower anchors may be attached first, provided a proper installation is achieved. Attach the tether strap afterward, if included with the child seat.

Using Tether Straps



Many forward-facing child safety seats include a tether strap which extends from the back of the child safety seat and hooks to an anchoring point called the top tether anchor. Tether straps are available as an accessory for many older safety seats.

Contact the manufacturer of your child seat for information about ordering a tether strap, or to obtain a longer tether strap if the tether strap on your safety seat does not reach the appropriate top tether anchor in your vehicle.

Once the child safety seat has been installed using either the seatbelt, the lower anchors of the LATCH system, or both, you can attach the top tether strap.

The tether strap anchors in your vehicle are in the following positions (shown from top view):

Child Safety

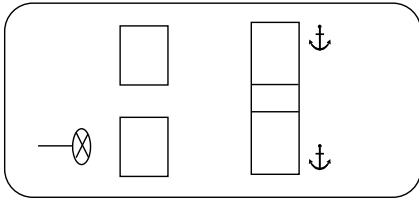

E174399

Perform the following steps to install a child safety seat with tether anchors:

For coupe:

Note: *If you install a child seat with rigid LATCH attachments, do not tighten the tether strap enough to lift the child seat off your vehicle seat cushion when the child is seated in it. Keep the tether strap just snug without lifting the front of the child seat. Keeping the child seat just touching your vehicle seat gives the best protection in a severe crash.*

1. Route the tether strap over the top of the seatback.



E174400

2. Locate the correct anchor for the selected seating position.
3. Open the tether anchor cover.



E174401

4. Clip the tether strap to the anchor as shown.
5. Tighten the child safety seat tether strap according to the manufacturer's instructions. If your child restraint system is equipped with a tether strap, and the child restraint manufacturer recommends its use, we also recommend its use.

If the safety seat is not anchored properly, the risk of a child being injured in a crash greatly increases.

For convertible:

Note: *For easier access, attach the tether with the convertible top up.*

1. Route the child safety seat tether strap over the top of the seatback.

Child Safety

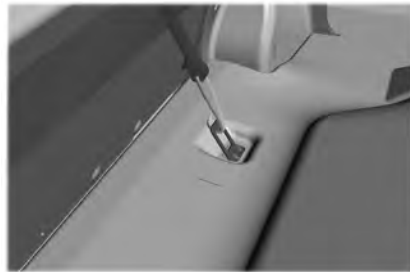
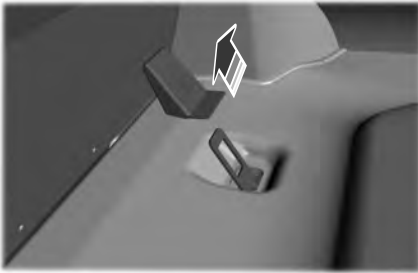

E185416

2. Access the tether anchors located behind the seatback.
3. Remove the tether anchor cap.
4. Clip the tether strap to the anchor.
5. Tighten the child safety seat tether strap according to the manufacturer's instructions.

If the safety seat is not anchored properly, the risk of a child being injured in a crash greatly increases.

If your child restraint system is equipped with a tether strap, and the child restraint manufacturer recommends its use, we also recommend its use.

BOOSTER SEATS

WARNING



Never place, or allow a child to place, the shoulder belt under a child's arm or behind the back because it reduces the protection for the upper part of the body and may increase the risk of injury or death in a crash.

Use a belt-positioning booster seat for children who have outgrown or no longer properly fit in a child safety seat (generally children who are less than 4 feet 9 inches (1.45 meters) tall, are greater than age four (4) and less than age twelve (12), and between 40 pounds (18 kilograms) and 80 pounds (36 kilograms) and upward to 100 pounds (45 kilograms) if recommended by your child restraint manufacturer). Many state and provincial laws require that children use approved booster seats until they reach age eight, a height of 4 feet 9 inches (1.45 meters) tall, or 80 pounds (36 kilograms).

Booster seats should be used until you can answer YES to ALL of these questions when seated without a booster seat:

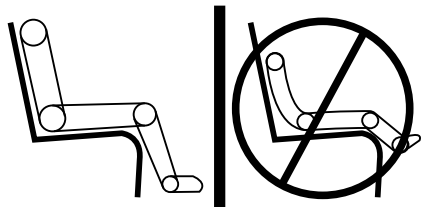

E142595

Child Safety

- Can the child sit all the way back against their vehicle seat back with knees bent comfortably at the edge of the seat cushion?
- Can the child sit without slouching?
- Does the lap belt rest low across the hips?
- Is the shoulder belt centered on the shoulder and chest?
- Can the child stay seated like this for the whole trip?

Always use booster seats in conjunction with your vehicle lap and shoulder belt.

Types of Booster Seats



E68924

- Backless booster seats

If your backless booster seat has a removable shield, remove the shield. If a vehicle seating position has a low seat back or no head restraint, a backless booster seat may place your child's head (as measured at the tops of the ears) above the top of the seat. In this case, move the backless booster to another seating position with a higher seat back or head restraint and lap and shoulder belts, or consider using a high back booster seat.



E70710

- High back booster seats

If, with a backless booster seat, you cannot find a seating position that adequately supports your child's head, a high back booster seat would be a better choice.

Children and booster seats vary in size and shape. Choose a booster that keeps the lap belt low and snug across the hips, never up across the stomach, and lets you adjust the shoulder belt to cross the chest and rest snugly near the center of the shoulder. The following drawings compare the ideal fit (center) to a shoulder belt uncomfortably close to the neck and a shoulder belt that could slip off the shoulder. The drawings also show how the lap belt should be low and snug across the child's hips.

Child Safety



E142596



E142597

If the booster seat slides on the vehicle seat upon which it is being used, placing a rubberized mesh sold as shelf or carpet liner under the booster seat may improve this condition. Do not introduce any item thicker than this under the booster seat. Check with the booster seat manufacturer's instructions.

CHILD RESTRAINT POSITIONING

WARNINGS



Airbags can kill or injure a child in a child seat. Never place a rear-facing child seat in front of an active airbag. If you must use a forward-facing child seat in the front seat, move the vehicle seat upon which the child seat is installed all

WARNINGS

the way back. When possible, all children age 12 and under should be properly restrained in a rear seating position. If all children cannot be seated and restrained properly in a rear seating position, properly restrain the largest child in the front seat.



Always carefully follow the instructions and warnings provided by the manufacturer of any child restraint to determine if the restraint device is appropriate for your child's size, height, weight, or age. Follow the child restraint manufacturer's instructions and warnings provided for installation and use in conjunction with the instructions and warnings provided by your vehicle

Child Safety

WARNINGS

manufacturer. A safety seat that is improperly installed or utilized, is inappropriate for your child's height, age, or weight or does not properly fit the child may increase the risk of serious injury or death.



Never let a passenger hold a child on his or her lap while your vehicle is moving. The passenger cannot protect the child from injury in a crash, which may result in serious injury or death.



Never use pillows, books, or towels to boost a child. They can slide around and increase the likelihood of injury or death in a crash.

WARNINGS



Always restrain an unoccupied child seat or booster seat. These objects may become projectiles in a crash or sudden stop, which may increase the risk of serious injury.



Never place, or allow a child to place, the shoulder belt under a child's arm or behind the back because it reduces the protection for the upper part of the body and may increase the risk of injury or death in a crash.



To avoid risk of injury, do not leave children or pets unattended in your vehicle.

Recommendations for attaching child safety restraints for children

Restraint Type	Combined weight of child and child seat	Use any attachment method as indicated below by X				
		LATCH (lower anchors and top tether anchor)	LATCH (lower anchors only)	Safety belt and top tether anchor	Safety belt and LATCH (lower anchors and top tether anchor)	Safety belt only
Rear facing child seat	Up to 65 lb (29.5 kg)		X			X
Rear facing child seat	Over 65 lb (29.5 kg)					X
Forward facing child seat	Up to 65 lb (29.5 kg)	X		X	X	
Forward facing child seat	Over 65 lb (29.5 kg)			X	X	

Note: The child seat must rest tightly against the vehicle seat upon which it is installed. It may be necessary to lift or remove the head restraint. See **Seats** (page 107).

Seatbelts

PRINCIPLE OF OPERATION

WARNINGS



Always drive and ride with your seatback upright and the lap belt snug and low across the hips.



To reduce the risk of injury, make sure children sit where they can be properly restrained.



Never let a passenger hold a child on his or her lap while your vehicle is moving. The passenger cannot protect the child from injury in a crash.



All occupants of your vehicle, including the driver, should always properly wear their safety belts, even when an airbag supplemental restraint system is provided. Failure to properly wear your safety belt could seriously increase the risk of injury or death.



It is extremely dangerous to ride in a cargo area, inside or outside of a vehicle. In a crash, people riding in these areas are more likely to be seriously injured or killed. Do not allow people to ride in any area of your vehicle that is not equipped with seats and safety belts. Be sure everyone in your vehicle is in a seat and using a safety belt properly.



In a rollover crash, an unbelted person is significantly more likely to die than a person wearing a safety belt.



Each seating position in your vehicle has a specific safety belt assembly which is made up of one buckle and one tongue that are designed to be used as a pair. 1) Use the shoulder belt on the outside shoulder only. Never wear the shoulder belt under the arm. 2) Never swing the safety belt around your neck over the inside shoulder. 3) Never use a single belt for more than one person.

WARNINGS



When possible, all children 12 years old and under should be properly restrained in a rear seating position. Failure to follow this could seriously increase the risk of injury or death.



Safety belts and seats can become hot in a vehicle that has been closed up in sunny weather; they could burn a small child. Check seat covers and buckles before you place a child anywhere near them.



Front and rear seat occupants, including pregnant women, should wear safety belts for optimum protection in an accident.



The center of the rear seat is not designed as a seating position and is not equipped with safety belts. The LATCH anchors were not designed to be used with a child seat in the center position and there is no tether anchor available at the center. Attempted use of the center as a seating position will increase the risk of injury or death in the event of a crash.

All seating positions in your vehicle have lap and shoulder safety belts. All occupants of the vehicle should always properly wear their safety belts, even when an airbag supplemental restraint system is provided.

The safety belt system consists of:

- Lap and shoulder safety belts.
- Safety belt pretensioner at the front outboard seating positions.
- Belt tension sensor at the front outboard passenger seating position.



• Safety belt warning light and chime.



• Crash sensors and monitoring system with readiness indicator.

Seatbelts

The safety belt pretensioners at the front seating positions are designed to tighten the safety belts when activated. In frontal and near-frontal crashes, the safety belt pretensioners may be activated alone or, if the crash is of sufficient severity, together with the front airbags. The pretensioners may also activate when a side curtain airbag is deployed.

FASTENING THE SEATBELTS

The front outboard and rear safety restraints in the vehicle are combination lap and shoulder belts.

A web guide is included on the outboard side of the front seats. Depending on occupant size and seating position, you may need to route the belt through the guide for a proper fit. If the seatbelt does not route across the middle of the shoulder, route the belt through the web guide.

Convertible



E175860

Coupe

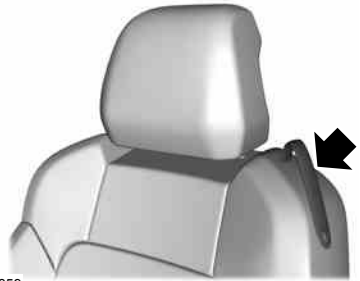

E175859

Recaro

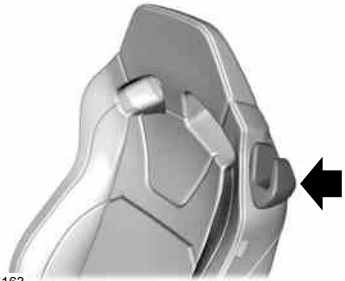

E175163

Recaro SVT

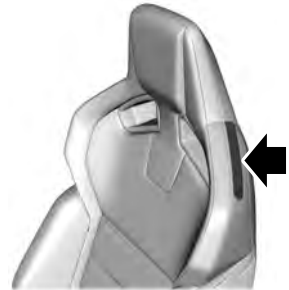

E216814

Seatbelts

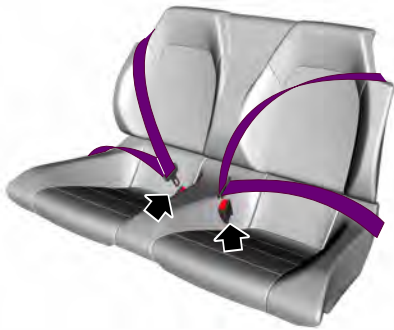

E204921

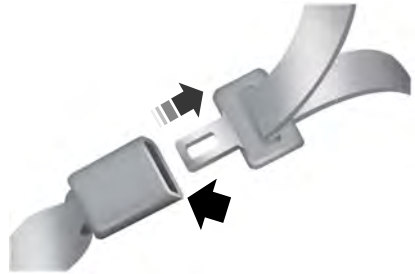

E142588

2. To unfasten, press the release button and remove the tongue from the buckle.

Using Seatbelts During Pregnancy

WARNING

 Always ride and drive with your seatback upright and the seatbelt properly fastened. The lap portion of the seatbelt should fit snug and be positioned low across the hips. The shoulder portion of the seatbelt should be positioned across the chest. Pregnant women should also follow this practice. See the following figure.



E142587

1. Insert the belt tongue into the proper buckle (the buckle closest to the direction the tongue is coming from) until you hear a snap and feel it latch. Make sure you securely fasten the tongue in the buckle.

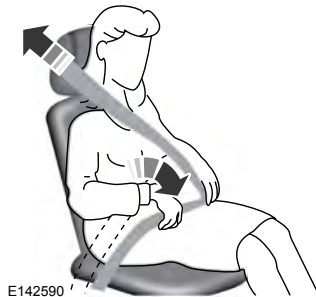

E142590

Seatbelts

Pregnant women should always wear their seatbelt. The lap belt portion of a combination lap and shoulder belt should be positioned low across the hips below the belly and worn as tight as comfort will allow. The shoulder belt should be positioned to cross the middle of the shoulder and the center of the chest.

Seatbelt Locking Modes

WARNINGS



After any vehicle crash, the seatbelt system at all passenger seating positions must be checked by an authorized dealer to verify that the automatic locking retractor feature for child seats is still functioning properly. In addition, all seatbelts should be checked for proper function.



The belt and retractor assembly must be replaced if the seatbelt assembly automatic locking retractor feature or any other seatbelt function is not operating properly when checked by an authorized dealer. Failure to replace the belt and retractor assembly could increase the risk of injury in crashes.

All safety restraints in the vehicle are combination lap and shoulder belts and have vehicle sensitive locking mode. In addition, the front outboard passenger and rear seat seatbelts have the automatic locking mode.

Vehicle Sensitive Mode

This is the normal retractor mode, which allows free shoulder belt length adjustment to your movements and locking in response to vehicle movement. For example, if the driver brakes suddenly or turns a corner sharply, or the vehicle receives an impact of about 5 mph (8 km/h) or more, the combination seatbelts will lock to help reduce forward movement of the driver and passengers.

In addition, the retractor is designed to lock if the webbing is pulled out too quickly. If this occurs, let the belt retract slightly and pull webbing out again in a slow and controlled manner.

Automatic Locking Mode

In this mode, the shoulder belt is automatically pre-locked. The belt will still retract to remove any slack in the shoulder belt. The automatic locking mode is not available on the driver seatbelt.

When to Use the Automatic Locking Mode

This mode should be used any time a child safety seat, except a booster, is installed in passenger front or rear seating positions. Children 12 years old and under should be properly restrained in a rear seating position whenever possible. See **Child Safety** (page 15).

How to Disengage the Automatic Locking Mode

Unbuckle the combination lap and shoulder belt and allow it to retract completely to disengage the automatic locking mode and activate the vehicle sensitive (emergency) locking mode.

Seatbelt Extension Assembly

WARNINGS



Do not use extensions to change the fit of the shoulder belt across the torso.



Do not use extensions with an inflatable seatbelt.

If the seatbelt is too short when fully extended, a seatbelt extension assembly can be obtained from an authorized dealer.

Seatbelts

Use only extensions manufactured by the same supplier as the seatbelt. Manufacturer identification is on a label located either at the end of the webbing or on the retractor behind the trim. Also, use the seatbelt extension only if the seatbelt is too short for you when fully extended.

SEATBELT WARNING LAMP AND INDICATOR CHIME



This lamp illuminates and an audible warning will sound if the driver's safety belt has not been fastened when the vehicle's ignition is turned on.

Conditions of operation

If...	Then...
The driver's safety belt is not buckled before the ignition switch is turned to the on position...	The safety belt warning light illuminates 1-2 minutes and the warning chime sounds 4-8 seconds.
The driver's safety belt is buckled while the indicator light is illuminated and the warning chime is sounding...	The safety belt warning light and warning chime turn off.
The driver's safety belt is buckled before the ignition switch is turned to the on position...	The safety belt warning light and indicator chime remain off.

SEATBELT REMINDER

Belt-Minder™

This feature supplements the safety belt warning function by providing additional reminders that intermittently sound a tone and illuminate the safety belt warning light when you are in the driver seat or you have a front seat passenger and a safety belt is unbuckled.

The system uses information from the front passenger sensing system to determine if a front seat passenger is present and therefore potentially in need of a warning. To avoid activating the Belt-Minder feature for objects you place in the front passenger seat, only the front seat passengers receive warnings as determined by the front passenger sensing system.

If the Belt-Minder warnings expire (warnings for about five minutes) for one passenger (driver or front passenger), the other passenger can still cause the Belt-Minder feature to turn on.

Seatbelts

If...	Then...
You and the front seat passenger buckle your safety belts before you switch the ignition on or less than 1-2 minutes elapse after you switch the ignition on...	The Belt-Minder feature will not activate.
You or the front seat passenger do not buckle your safety belts before your vehicle reaches at least 6 mph (9.7 km/h) and 1-2 minutes elapse after you switch the ignition on...	The Belt-Minder feature activates, the safety belt warning light illuminates and a warning tone sounds for 6 seconds every 25 seconds, repeating for about 5 minutes or until you and the front seat passenger buckle your safety belts.
The safety belt for the driver or front passenger is unbuckled for about 1 minute while the vehicle is traveling at least 6 mph (9.7 km/h) and more than 1-2 minutes elapse after you switch the ignition on...	The Belt-Minder feature activates, the safety belt warning light illuminates and a warning tone sounds for 6 seconds every 25 seconds, repeating for about 5 minutes or until you and the front seat passenger buckle your safety belts.

Deactivating and Activating the Belt-Minder Feature

WARNING



While the system allows you to deactivate it, this system is designed to improve your chances of being safely belted and surviving an accident. We recommend you leave the system activated for yourself and others who may use the vehicle.

Note: *The driver and front passenger warnings switch on and off independently. When you perform this procedure for one seating position, do not buckle the other position as this will terminate the process.*

Note: *If you are using MyKey, you cannot disable the Belt-Minder. Also, if you have previously disabled the Belt-Minder, it will be re-enabled during the use of MyKey.*

Read Steps 1 - 4 thoroughly before proceeding with the programming procedure.

Before following the procedure, make sure that:

- The parking brake is set.
 - The transmission is in park (P) (automatic transmission) or neutral (N) (manual transmission).
 - The ignition is off.
 - The driver and front passenger safety belts are unbuckled.
1. Switch the ignition on. Do not start the vehicle.
 2. Wait until the safety belt warning light turns off (about one minute). After Step 2, wait an additional 5 seconds before proceeding with Step 3. Once you start Step 3, you must complete the procedure within 30 seconds.
 3. For the seating position you are switching off, buckle then unbuckle the safety belt three times at a moderate speed, ending in the unbuckled state. After Step 3, the safety belt warning light turns on.

Seatbelts

4. While the safety belt warning light is on, buckle and then unbuckle the safety belt. After Step 4, the safety belt warning light flashes for confirmation.
 - This will switch the feature off for that seating position if it is currently on.
 - This will switch the feature on for that seating position if it is currently off.

CHILD RESTRAINT AND SEATBELT MAINTENANCE

Inspect the vehicle safety belts and child safety seat systems periodically to make sure they work properly and are not damaged. Inspect the vehicle and child seat safety belts to make sure there are no nicks, tears or cuts. Replace if necessary. All vehicle safety belt assemblies, including retractors, buckles, front safety belt buckle assemblies, buckle support assemblies (slide bar-if equipped), shoulder belt height adjusters (if equipped), shoulder belt guide on seat back (if equipped), child safety seat LATCH and tether anchors, and attaching hardware, should be inspected after a crash. Read the child restraint manufacturer's instructions for additional inspection and maintenance information specific to the child restraint.

Ford Motor Company recommends that all safety belt assemblies in use in vehicles involved in a crash be replaced. However, if the crash was minor and an authorized dealer finds that the belts do not show damage and continue to operate properly, they do not need to be replaced. Safety belt assemblies not in use during a crash should also be inspected and replaced if either damage or improper operation is noted.

Properly care for safety belts. See **Vehicle Care** (page 230).

Personal Safety System™

The Personal Safety System provides an improved overall level of frontal crash protection to front seat occupants and is designed to help further reduce the risk of airbag-related injuries. The system is able to analyze different occupant conditions and crash severity before activating the appropriate safety devices to help better protect a range of occupants in a variety of frontal crash situations.

The Vehicle Personal Safety System consists of:

- Driver and passenger dual-stage airbag supplemental restraints.
- Front seat outboard safety belts with pretensioners, energy management retractors and safety belt usage sensors.
- Driver seat position sensor.
- Front passenger sensing system.
- Passenger airbag off and on indicator lamp.
- Front crash severity sensors.
- Restraints control module with impact and safing sensors.
- Restraint system warning light and backup tone.
- The electrical wiring for the airbags, crash sensors, safety belt pretensioners, front safety belt usage sensors, driver seat position sensor, front passenger sensing system and indicator lights.

How Does the Personal Safety System Work?

The Personal Safety System can adapt the deployment strategy of the safety devices according to crash severity and occupant conditions. A collection of crash and occupant sensors provides information to the restraints control module. During a crash, the restraints control module may deploy the safety belt pretensioners, one or both stages of the dual-stage airbags based on crash severity and occupant conditions.

Supplementary Restraints System

PRINCIPLE OF OPERATION

WARNINGS

 Airbags do not inflate slowly or gently, and the risk of injury from a deploying airbag is the greatest close to the trim covering the airbag module.

 All occupants of your vehicle, including the driver, should always properly wear their safety belts, even when an airbag supplemental restraint system is provided. Failure to properly wear your safety belt could seriously increase the risk of injury or death.

 Always transport children 12 years old and under in the back seat and always properly use appropriate child restraints. Failure to follow this could seriously increase the risk of injury or death.

 Never place your arm over the airbag module as a deploying airbag can result in serious arm fractures or other injuries.

 Airbags can kill or injure a child in a child seat. Never place a rear-facing child seat in front of an active airbag. If you must use a forward-facing child seat in the front seat, move the seat upon which the child seat is installed all the way back.

 Do not attempt to service, repair, or modify the airbag supplemental restraint systems or its fuses as you could be seriously injured or killed. Contact your authorized dealer as soon as possible.

 Several airbag system components get hot after inflation. To reduce the risk of injury, do not touch them after inflation.

 If the airbag has deployed, the airbag will not function again and must be replaced immediately. If the airbag is not replaced, the unrepaired area will increase the risk of injury in a crash.

The airbags are a supplemental restraint system and are designed to work with the safety belts to help protect the driver and right front passenger from certain upper body injuries. Airbags do not inflate slowly; there is a risk of injury from a deploying airbag.

Note: *You will hear a loud bang and see a cloud of harmless powdery residue if an airbag deploys. This is normal.*

The airbags inflate and deflate rapidly upon activation. After airbag deployment, it is normal to notice a smoke-like, powdery residue or smell the burnt propellant. This may consist of cornstarch, talcum powder (to lubricate the bag) or sodium compounds (for example, baking soda) that result from the combustion process that inflates the airbag. Small amounts of sodium hydroxide may be present which may irritate the skin and eyes, but none of the residue is toxic.

While the system is designed to help reduce serious injuries, contact with a deploying airbag may also cause abrasions or swelling. Temporary hearing loss is also a possibility as a result of the noise associated with a deploying airbag. Because airbags must inflate rapidly and with considerable force, there is the risk of death or serious injuries such as fractures, facial and eye injuries or internal injuries, particularly to occupants who are not properly restrained or are otherwise out of position at the time of airbag deployment. Thus, it is extremely important that occupants be properly restrained as far away from the airbag module as possible while maintaining vehicle control.

Routine maintenance of the airbags is not required.

Supplementary Restraints System

DRIVER AND PASSENGER AIRBAGS

WARNINGS



Never place your arm or any objects over an airbag module. Placing your arm over a deploying airbag can result in serious arm fractures or other injuries. Objects placed on or over the airbag inflation area may cause those objects to be propelled by the airbag into your face and torso causing serious injury.



Airbags can kill or injure a child in a child seat. Never place a rear-facing child seat in front of an active airbag. If you must use a forward-facing child seat in the front seat, move the seat upon which the child seat is installed all the way back.

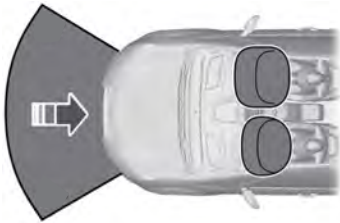

E151127

The driver and front passenger airbags will deploy during significant frontal and near frontal crashes.

The driver and passenger front airbag system consists of:

- Driver and passenger airbag modules.
- Front passenger sensing system.



• Crash sensors and monitoring system with readiness indicator. See **Crash Sensors and Airbag**

Indicator (page 41).

Proper Driver and Front Passenger Seating Adjustment

WARNING



National Highway Traffic Safety Administration (NHTSA) recommends a minimum distance of at least 10 inches (25 centimeters) between an occupant's chest and the driver airbag module.

To properly position yourself away from the airbag:

- Move your seat to the rear as far as you can while still reaching the pedals comfortably.
- Recline the seat slightly (one or two degrees) from the upright position.

After all occupants have adjusted their seats and put on safety belts, it is very important that they continue to sit properly. A properly seated occupant sits upright, leaning against the seat back, and centered on the seat cushion, with their feet comfortably extended on the floor. Sitting improperly can increase the chance of injury in a crash event. For example, if an occupant slouches, lies down, turns sideways, sits forward, leans forward or sideways, or puts one or both feet up, the chance of injury during a crash is greatly increased.

Children and Airbags

WARNING



Airbags can kill or injure a child in a child seat. Never place a rear-facing child seat in front of an active airbag. If you must use a forward-facing child seat in the front seat, move the seat upon which the child seat is installed all the way back.

Supplementary Restraints System



E142846

Children must always be properly restrained. Accident statistics suggest that children are safer when properly restrained in the rear seating positions than in the front seating position. Failure to follow these instructions may increase the risk of injury in a crash.

FRONT PASSENGER SENSING SYSTEM

WARNINGS



Even with Advanced Restraints Systems, children 12 and under should be properly restrained in a rear seating position. Failure to follow this could seriously increase the risk of injury or death.



Sitting improperly out of position or with the seat back reclined too far can take off weight from the seat cushion and affect the decision of the front passenger sensing system, resulting in serious injury or death in a crash. Always sit upright against your seatback, with your feet on the floor.

WARNINGS



To reduce the risk of possible serious injury: Do not stow objects in seatback map pocket or hang objects off seatback if a child is in the front passenger seat. Do not place objects underneath the front passenger seat or between the seat and the center console. Check the passenger airbag off indicator lamp for proper airbag status. Failure to follow these instructions may interfere with the front passenger sensing system.



Any alteration or modification to the front passenger seat may affect the performance of the front passenger sensing system.

This system works with sensors that are part of the front passenger seat and safety belt to detect the presence of a properly-seated occupant and determine if the front passenger frontal airbag should be enabled (may inflate) or not.



E179527

The front passenger sensing system uses a passenger airbag off indicator which will illuminate and stay lit to remind you that the front passenger frontal airbag is disabled.

The indicator lamp is located on the overhead console.

Supplementary Restraints System

Note: When the ignition is first turned on, the indicator lamp will illuminate for a short period of time to confirm it is functional.

The front passenger sensing system is designed to disable (will not inflate) the front passenger frontal airbag when a rear facing infant seat, a forward-facing child restraint, or a booster seat is detected. Even with this technology, parents are **strongly** encouraged to always properly restrain children in the rear seat. The sensor also turns off the passenger front airbag and seat-mounted side airbag when the passenger seat is empty.

- When the front passenger sensing system disables (will not inflate) the front passenger frontal airbag, the indicator lamp will illuminate and stay lit to remind you that the front passenger frontal airbag is disabled.
- If the child restraint has been installed and the indicator lamp is not lit, then turn the vehicle off, remove the child restraint from the vehicle and reinstall the restraint following the child restraint manufacturer's instructions.

The front passenger sensing system is designed to enable (may inflate) the front passenger frontal airbag anytime the system senses that a person of adult size is sitting properly in the front passenger seat.

- When the front passenger sensing system enables the front passenger frontal airbag (may inflate), the indicator lamp will be unlit and stay unlit.

If a person of adult size is sitting in the front passenger seat, but the airbag off indicator lamp is lit, it is possible that the person is not sitting properly in the seat. If this happens:

- Turn the vehicle off and ask the person to place the seat back in the full upright position.
- Have the person sit upright in the seat, centered on the seat cushion, with the person's legs comfortably extended.
- Restart the vehicle and have the person remain in this position for about two minutes. This will allow the system to detect that person and enable the passenger's frontal airbag.
- If the indicator lamp remains lit even after this, the person should be advised to ride in the rear seat.

Occupant	Passenger airbag OFF indicator	Passenger airbag
Empty	Unlit	Disabled
Child	Lit	Disabled
Adult	Unlit	Enabled

Note: When the front passenger airbag off light is illuminated, the passenger (seat mounted) side airbag may be disabled to avoid the risk of airbag deployment injuries.

After all occupants have adjusted their seats and put on safety belts, it is very important that they continue to sit properly. A properly seated occupant sits upright, leaning against the seat back, and centered on the seat cushion, with their

Supplementary Restraints System

feet comfortably extended on the floor. Sitting improperly can increase the chance of injury in a crash event. For example, if an occupant slouches, lies down, turns sideways, sits forward, leans forward or sideways, or puts one or both feet up, the chance of injury during a crash is greatly increased.

If you think that the status of the passenger airbag off indicator lamp is incorrect, check for the following:

- Objects lodged underneath the seat.
- Objects between the seat cushion and the center console.
- Objects hanging off the seatback.
- Objects stowed in the seatback map pocket.
- Objects placed on the occupant's lap.
- Cargo interference with the seat.
- Other passengers pushing or pulling on the seat.
- Rear passenger feet and knees resting or pushing on the seat.

The conditions listed above may cause the weight of a properly seated occupant to be incorrectly interpreted by the front passenger sensing system. The person in the front passenger seat may appear heavier or lighter due to the conditions described in the list above.



Make sure the front passenger sensing system is operating properly. See **Crash Sensors and Airbag Indicator** (page 41).

If the airbag readiness light is lit, do the following:

The driver and adult passengers should check for objects lodged underneath the front passenger seat, or cargo interfering with the seat.

If there are lodged objects, or cargo is interfering with the seat, take the following steps to remove the obstruction:

- Pull the vehicle over.
- Turn the vehicle off.
- Driver and adult passengers should check for any objects lodged underneath the front passenger seat or cargo interfering with the seat.
- Remove the obstruction(s) (if found).
- Restart the vehicle.
- Wait at least two minutes and verify that the airbag readiness light is no longer illuminated.
- If the airbag readiness light remains illuminated, this may or may not be a problem due to the front passenger sensing system.

Do not attempt to repair or service the system. Take your vehicle immediately to an authorized dealer.

If it is necessary to modify an advanced front airbag system to accommodate a person with disabilities, contact the Ford Customer Relationship Center. See **Getting the Services You Need** (page 195).

SIDE AIRBAGS

WARNINGS





Do not place objects or mount equipment on or near the airbag cover, on the side of the seatbacks (of the front seats), or in front seat areas that may come into contact with a deploying airbag. Failure to follow these instructions may increase the risk of personal injury in the event of a crash.

Supplementary Restraints System

WARNINGS

 Do not use accessory seat covers. The use of accessory seat covers may prevent the deployment of the side airbags and increase the risk of injury in an accident.

 Do not lean your head on the door. The side airbag could injure you as it deploys from the side of the seatback.

 Do not attempt to service, repair, or modify the airbag, its fuses or the seat cover on a seat containing an airbag as you could be seriously injured or killed. Contact your authorized dealer as soon as possible.

 If the side airbag has deployed, the airbag will not function again. The side airbag system (including the seat) must be inspected and serviced by an authorized dealer. If the airbag is not replaced, the unrepaired area will increase the risk of injury in a crash.

The side airbags are located on the outboard side of the seatbacks of the front seats. In certain sideways crashes, the airbag on the side affected by the crash will be inflated. The airbag was designed to inflate between the door panel and occupant to further enhance the protection provided occupants in side impact crashes.

Coupe



E162533

Convertible



E174777

The system consists of the following:

- A label or embossed side panel indicating that side airbags are fitted to your vehicle.
- Side airbags located inside the driver and front passenger seatbacks.
- Front passenger sensing system.



• Crash sensors and monitoring system with readiness indicator. See **Crash Sensors and Airbag Indicator** (page 41).

Note: *The passenger sensing system will deactivate the passenger seat-mounted side airbag if it detects an empty passenger seat.*

Supplementary Restraints System

The design and development of the side airbag system included recommended testing procedures that were developed by a group of automotive safety experts known as the Side Airbag Technical Working Group. These recommended testing procedures help reduce the risk of injuries related to the deployment of side airbags.

DRIVER AND PASSENGER KNEE AIRBAGS

WARNINGS



Keep the glove box door closed while driving for optimal performance of the passenger knee airbag during a crash.



To reduce risk of injury, do not obstruct or place objects in the deployment path of the knee airbag.

A driver knee airbag is located under or within the instrument panel. A passenger knee airbag is located within the glove box door. During a crash, the restraints control module may activate the driver and passenger knee airbags based on crash severity and occupant conditions. Under certain crash and occupant conditions, the driver and passenger knee airbag may deploy but the driver front airbag may not activate. As with front and side airbags, it is important to be properly seated and restrained to reduce the risk of death or serious injury.



Make sure the knee airbags are operating properly. See **Crash Sensors and Airbag Indicator**

(page 41).

SAFETY CANOPY™ - COUPE

WARNINGS



Do not place objects or mount equipment on or near the headliner at the siderail that may come into contact with a deploying curtain airbag. Failure to follow these instructions may increase the risk of personal injury in the event of a crash.



Do not lean your head on the door. The curtain airbag could injure you as it deploys from the headliner.



Do not attempt to service, repair, or modify the curtain airbags, its fuses, the A, B, or C pillar trim, or the headliner on a vehicle containing curtain airbags as you could be seriously injured or killed. Contact your authorized dealer as soon as possible.



All occupants of your vehicle including the driver should always wear their safety belts even when an airbag supplemental restraint system and curtain airbag is provided. Failure to properly wear your safety belt could seriously increase the risk of injury or death.



To reduce risk of injury, do not obstruct or place objects in the deployment path of the curtain airbag.



If the curtain airbags have deployed, the curtain airbags will not function again. The curtain airbags (including the A, B and C pillar trim and headliner) must be inspected and serviced by an authorized dealer. If the curtain airbag is not replaced, the unrepaired area will increase the risk of injury in a crash.

Supplementary Restraints System

The Safety Canopy will deploy during significant side crashes or when a certain likelihood of a rollover event is detected by the rollover sensor. The Safety Canopy is mounted to the roof side-rail sheet metal, behind the headliner, above each row of seats. In certain sideways crashes or rollover events, the Safety Canopy will be activated, regardless of which seats are occupied. The Safety Canopy is designed to inflate between the side window area and occupants to further enhance protection provided in side impact crashes and rollover events.

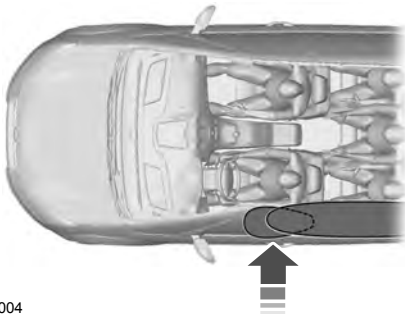

E75004

The system consists of the following:

- Safety canopy curtain airbags located above the trim panels over the front and rear side windows identified by a label or wording on the headliner or roof-pillar trim.
- A flexible headliner which opens above the side doors to allow air curtain deployment



• Crash sensors and monitoring system with a readiness indicator. See **Crash Sensors and Airbag Indicator** (page 41).

Children 12 years old and under should always be properly restrained in the rear seats. The Safety Canopy will not interfere with children restrained using a properly installed child or booster seat because it is designed to inflate downward from the headliner above the doors along the side window opening.

The design and development of the Safety Canopy included recommended testing procedures that were developed by a group of automotive safety experts known as the Side Airbag Technical Working Group. These recommended testing procedures help reduce the risk of injuries related to the deployment of side airbags (including the Safety Canopy).

CRASH SENSORS AND AIRBAG INDICATOR

WARNING



Modifying or adding equipment to the front end of the vehicle (including frame, bumper, front end body structure and tow hooks) may affect the performance of the airbag system, increasing the risk of injury. Do not modify the front end of the vehicle.

Your vehicle has a collection of crash and occupant sensors which provide information to the restraints control module. The restraints control module deploys (activates) the front safety belt pretensioners, driver airbag, passenger airbag, knee airbag(s), seat mounted side airbags and Safety Canopy airbags. Based on the type of crash (frontal impact or side impact), the restraints control module will deploy the appropriate safety devices.

Supplementary Restraints System

The restraints control module also monitors the readiness of the above safety devices plus the crash and occupant sensors. The readiness of the safety system is indicated by a warning indicator light in the instrument cluster or by a backup tone if the warning light is not working. Routine maintenance of the airbag is not required.

A difficulty with the system is indicated by one or more of the following:



The readiness light will not illuminate immediately after the ignition is turned on.

- The readiness light will either flash or stay lit.
- A series of five beeps will be heard. The tone pattern will repeat periodically until the problem, the light or both are repaired.

If any of these things happen, even intermittently, have the supplemental restraint system serviced at an authorized dealer immediately. Unless serviced, the system may not function properly in the event of a crash.

The safety belt pretensioners and the front airbag supplemental restraint system are designed to activate when the vehicle sustains frontal deceleration sufficient to cause the restraints control module to deploy a safety device.

The fact that the safety belt pretensioners or front airbags did not activate for both front seat occupants in a crash does not mean that something is wrong with the system. Rather, it means the restraints control module determined the accident conditions (crash severity, belt usage) were not appropriate to activate these safety devices.

- The design of the front airbags is to activate only in frontal and near-frontal crashes (not rollovers, side impacts or rear impacts unless the crash causes sufficient frontal deceleration).
- The safety belt pretensioners are designed to activate in frontal, near-frontal and side crashes.
- The knee airbag(s) may deploy based on crash severity and occupant conditions.
- The design of the side airbags is to inflate in certain side crashes. The design of the Safety Canopy is to inflate in certain side impact crashes and when a certain likelihood of rollover is detected by the rollover sensor. Side airbags and Safety Canopy airbags may activate in other types of crashes if the vehicle experiences sufficient sideways motion or deformation.

AIRBAG DISPOSAL

Contact your authorized dealer as soon as possible. Airbags must be disposed of by qualified personnel.

Keys and Remote Controls

GENERAL INFORMATION ON RADIO FREQUENCIES

This device complies with Part 15 of the FCC Rules and with Industry Canada license-exempt RSS standard(s).

Operation is subject to the following two conditions: (1) This device may not cause harmful interference, and (2) This device must accept any interference received, including interference that may cause undesired operation.

Note: *Changes or modifications not expressly approved by the party responsible for compliance could void the user's authority to operate the equipment. The term **IC** before the radio certification number only signifies that Industry Canada technical specifications were met.*

The typical operating range for your transmitter is approximately 33 feet (10 meters). Vehicles with the remote start feature will have a greater range. One of the following could cause a decrease in operating range:

- weather conditions
- nearby radio towers
- structures around the vehicle
- other vehicles parked next to your vehicle

Other short-distance radio transmitters, such as amateur radios, medical equipment, wireless headphones, remote controls and alarm systems may operate on the same frequency as your remote control. If other transmitters are operating on those frequencies, you may not be able to use your remote control. Using your remote control near some types of electronic equipment, such as USB devices,

computers or cell phones can interfere with remote operation. Operating your remote control near metal or metallic-finished purses, bags or clothing can interfere with remote operation. You can lock and unlock the doors with the key.

Note: *Make sure to lock your vehicle before leaving it unattended.*

Note: *If you are in range, the remote control will operate if you press any button unintentionally.*

Intelligent Access

The system uses a radio frequency signal to communicate with your vehicle and authorize your vehicle to unlock when one of the following conditions are met:

- You touch the inside of any exterior door handle within 3 ft (1 m) proximity of an intelligent access key.
- You press the luggage compartment button.
- You press a button on the transmitter.

If excessive radio frequency interference is present in the area or if the transmitter battery is low, you may need to mechanically unlock your door. You can use the mechanical key blade in your intelligent access key to open the driver door in this situation. See **Remote Control** (page 44).

Keys and Remote Controls

REMOTE CONTROL

Intelligent Access Key



E144506

Your intelligent access keys operate the power locks and the remote start system. The key must be in your vehicle to activate the push-button start system.

Removable Key Blade

The intelligent access key also contains a removable mechanical key blade that you can use to unlock the driver door.



E176269

Slide the release on the back of the remote control and pivot the cover off to access the key blade.



E151795

Note: Your vehicle's backup keys came with a security tag that provides important vehicle key cut information. Keep the tag in a safe place for future reference.

Using the Key Blade

The key cylinder is under a cap on the driver door handle.

To remove the cap:

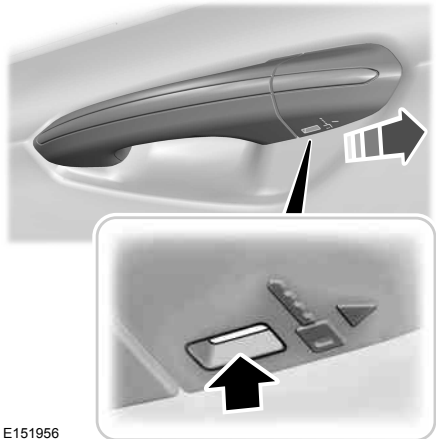

E151956

1. Insert the key blade into the slot on the bottom of the handle and press up.
2. While maintaining upward pressure, move the cap rearward to release it. Gently remove the key while doing so.

To install the cap:

Keys and Remote Controls



E151957

1. Place the cap just forward of the key cylinder.
2. While applying pressure to the cap, move it forward until it is in place. You may hear a snap as it engages.

Make sure you have properly installed the cap by trying to move it rearward.

Replacing the Battery

Note: Refer to local regulations when disposing of transmitter batteries.

Note: Do not wipe off any grease on the battery terminals or on the back surface of the circuit board.

Note: Replacing the battery will not delete the transmitter from the vehicle. The transmitter should operate normally.

A message will appear in the information display when the remote control battery is low. See **Information Messages** (page 88).

Intelligent Access Transmitter

The remote control uses two coin-type three-volt lithium batteries CR2025 or equivalent.



E151796

1. Slide the release on the back of the remote control and pivot the cover off.



E153890

2. Insert a coin into the slot and twist to separate the housing.

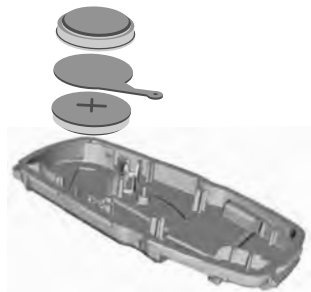

E176226

3. Remove the batteries.
4. Install new batteries with the + facing each other.

Keys and Remote Controls

Note: Make sure to replace the label between the two batteries.

5. Reinstall the housing and cover.

Car Finder



Press the button twice within three seconds. The horn will sound and the turn signals will flash. We recommend you use this method to locate your vehicle, rather than using the panic alarm.

Sounding a Panic Alarm

Note: The panic alarm will only operate when the ignition is off.



Press the button to activate the alarm. Press the button again or switch the ignition on to deactivate.

Remote Start

WARNING



To avoid exhaust fumes, do not use remote start if your vehicle is parked indoors or in areas that are not well ventilated.

Note: Do not use remote start if your vehicle is low on fuel.



The remote start button is on the transmitter.

This feature allows you to start your vehicle from outside the vehicle. The transmitter has an extended operating range.

Vehicles with automatic climate control can be configured to operate when the vehicle is remote started. See **Climate Control** (page 99). A manual climate control system will run at the setting it was set to when you switched the vehicle off.

Many states and provinces have restrictions for the use of remote start. Check your local and state or provincial laws for specific requirements regarding remote start systems.

The remote start system will not work if:

- the ignition is on
- the alarm system is triggered
- you disable the feature
- the hood is open
- the transmission is not in **P**
- the vehicle battery voltage is too low
- the service engine soon light is on.

Remote Control Feedback

An LED on the remote control provides status feedback of remote start or stop commands.

LED	Status
Solid green	Remote start or extension successful
Solid red	Remote stop successful; engine off
Blinking red	Remote start or stop failed
Blinking green	Waiting for status update

Remote Starting the Vehicle

Note: You must press each button within three seconds of each other. Your vehicle will not remote start if you do not follow this sequence.

Keys and Remote Controls

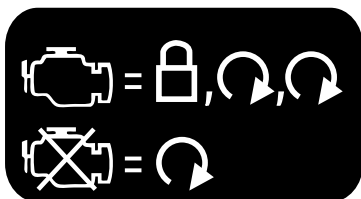

E138626

The tag with your transmitter details the starting procedure.

To remote start your vehicle:

1. Press the lock button to lock all the doors.
2. Press the remote start button twice. The exterior lamps will flash twice.

The horn will sound if the system fails to start, unless quiet start is on. Quiet start will run the blower fan at a slower speed to reduce noise. It can be switched on or off in the information display. See **General Information** (page 80).

Note: You must press the **START/STOP** button on the instrument panel once while applying the brake pedal before driving your vehicle.

The power windows will not work during the remote start and the radio will not turn on automatically.

The parking lamps will remain on and the vehicle will run for 5, 10, or 15 minutes, depending on the setting.

Extending the Vehicle Run Time

Repeat Steps 1 and 2 with the vehicle still running to extend the run time for another remote start duration. If you programmed the duration to last 10 minutes, the second 10 minutes will begin after what is left of the first activation time. For example, if the vehicle had been running from the first remote start for five minutes, the vehicle will continue to run now for a total of 15 minutes. You can extend the remote start up to a maximum of 35 minutes.

Wait at least five seconds before remote starting after a vehicle shutdown.

Turning the Vehicle Off After Remote Starting



Press the button once. The parking lamps will turn off.

You may have to be closer to the vehicle than when starting due to ground reflection and the added noise of the running vehicle.

You can disable or enable the remote start system through the information display. See **General Information** (page 80).

Memory Feature (If Equipped)

You can use the remote control to recall memory positions. If programmed to a pre-set position, the remote control recalls memory positions when you unlock your vehicle. See **Memory Function** (page 110).

REPLACING A LOST KEY OR REMOTE CONTROL

Replacement keys or remote controls can be purchased from an authorized dealer. Authorized dealers can program remote controls for your vehicle. See **Passive Anti-Theft System** (page 59).

PRINCIPLE OF OPERATION

MyKey allows you to program keys with restricted driving modes to promote good driving habits. All but one of the keys programmed to the vehicle can be activated with these restricted modes.

Any keys that have not been programmed are referred to as administrator keys or admin keys. These can be used to:

- Create a MyKey.
- Program configurable MyKey settings.
- Clear all MyKey features.

When you have programmed a MyKey, you can access the following information using the information display:

- How many admin keys and MyKeys are programmed to your vehicle.
- The total distance your vehicle has traveled using a MyKey.

Note: All MyKeys are programmed to the same settings. You cannot program them individually.

Note: For vehicles with intelligent access with push-button start, when both a MyKey and an admin intelligent access key fob are present, the admin fob will be recognized by the vehicle while switching the ignition on to start the vehicle.

Non-configurable Settings

The following settings cannot be changed by an admin key user:

- Belt-Minder or safety belt reminder. You cannot disable this feature. The audio system will mute when the front seat occupants' safety belts are not fastened.
- Early low fuel. The low-fuel warning activates earlier, giving the MyKey user more time to refuel.

- Driver assist features, if equipped on your vehicle, are forced on: parking aid, blind spot information system (BLIS) with cross traffic alert, lane departure warning and forward collision warning system.
- Track Mode, if your vehicle is equipped with this feature, is restricted.
- Satellite radio adult content restrictions (available only in some markets).

Configurable Settings

With an admin key, you can configure certain MyKey settings when you first create a MyKey and before you recycle the key or restart the vehicle. You can also change the settings afterward with an admin key.

- A vehicle speed limit can be set. Warnings will be shown in the display followed by an audible tone when your vehicle reaches the set speed. You cannot override the set speed by fully depressing the accelerator pedal or by setting cruise control.

WARNING



Do not set MyKey maximum speed limit to a limit that will prevent the driver from maintaining a safe speed considering posted speed limits and prevailing road conditions. The driver is always responsible to drive in accordance with local laws and prevailing conditions. Failure to do so could result in accident or injury.

- Various vehicle speed minders can be set. Once you select a speed, it will be shown in the display, followed by an audible tone when the preselected vehicle speed is exceeded.
- Audio system maximum volume of 45%. A message will be shown in the display when you attempt to exceed the limited volume. Also, the speed-sensitive or compensated automatic volume control will be disabled.
- Always on setting. When this is selected, you will not be able to turn off traction control, Emergency Assistance and Do Not Disturb (if your vehicle is equipped with these features), and Sport Mode will not be available to MyKey drivers.

CREATING A MYKEY

Use the information display to create a MyKey:

1. Insert the key you want to program into the ignition. If your vehicle is equipped with a push-button start, place the remote control into the backup position. The location of your backup position is in another chapter. See **Starting a Gasoline Engine** (page 120).
2. Switch the ignition on.
3. Access the main menu on the information display controls. Use the arrow keys to get to the following menu selections:

Message	Action and Description
Settings	Press the OK button or the right arrow key.
MyKey	Press the OK button or the right arrow key.
Create MyKey	Press the OK button or the right arrow key.

When prompted, hold the **OK** button until you see a message informing you to label this key as a MyKey. The key will be restricted at the next start.

MyKey is successfully created. Make sure you label it so you can distinguish it from the admin keys.

You can also program configurable settings for the key(s). See **Programming/Changing Configurable Settings**.

Programming/Changing Configurable Settings

Use the information display to access your configurable MyKey settings.

1. Switch the ignition on using an admin key or remote control.
2. Access the main menu on the information display controls. Use the arrow keys to get to the following menu selections:

Message	Action and Description
Settings	Press the OK button or the right arrow key.
MyKey	Press the OK button or the right arrow key.

MyKey™

Note: You can clear or change your MyKey settings at any time during the same key cycle as you created the MyKey. Once you have switched the vehicle off, however, you will need an admin key to change or clear your MyKey settings.

CLEARING ALL MYKEYS

You can clear or change your MyKey settings using the information display control on the steering wheel. See **Information Displays** (page 80).

Switch the ignition on using an admin key or remote control.

To clear all MyKeys of all MyKey settings, press the left arrow button to access the main menu and scroll to:

Message	Action and Description
Settings	Press the OK button.
MyKey	Press the OK button.
Clear MyKey	Press and hold the OK button until the following message displays.
All MyKeys Cleared	

Note: When you clear your MyKeys, you remove all restrictions and return all MyKeys to their original admin key status.

CHECKING MYKEY SYSTEM STATUS

You can find information on programmed MyKey(s) using the information display control on the steering wheel. See **Information Displays** (page 80).

To find information on programmed MyKey(s), press the left arrow button to access the main menu and scroll to:

Message	Description
Settings	Press the OK button.
MyKey	Press the OK button.
Select one of the following:	
MyKey Dist.	Tracks the distance when drivers use a MyKey. The only way to delete the accumulated distance is by using an admin key to clear your MyKeys. If the distance does not accumulate as expected, then the intended user is not using the MyKey, or an admin key user recently cleared and then recreated a MyKey.
{0} MyKeys	Indicates the number of MyKeys programmed to your vehicle. Use this feature to detect how many MyKeys you have for your vehicle and determine when a MyKey has been deleted.
{0} Admin Keys	Indicates how many admin keys are programmed to your vehicle. Use this feature to determine how many unrestricted keys you have for your vehicle, and detect if an additional MyKey has been programmed.

USING MYKEY WITH REMOTE START SYSTEMS

MyKey is not compatible with non

Ford-approved, aftermarket remote start systems. If you choose to install a remote start system, see an authorized dealer for a Ford-approved remote start system.

MYKEY TROUBLESHOOTING

Condition	Potential Causes
I cannot create a MyKey.	<ul style="list-style-type: none"> • The key or transmitter used to start the vehicle does not have admin privileges. • The key or transmitter used to start the vehicle is the only admin key (there always has to be at least one admin key). • Vehicles with keyless start: The keyless start transmitter is not placed in the backup position. See Keyless Starting (page 119). • SecuriLock passive anti-theft system is disabled or in unlimited mode.
I cannot program the configurable settings.	<ul style="list-style-type: none"> • The key or transmitter used to start your vehicle does not have admin privileges. • No MyKeys are created. See Creating a MyKey (page 49).
I cannot clear the MyKeys.	<ul style="list-style-type: none"> • The key or transmitter used to start your vehicle does not have admin privileges. • No MyKeys are created. See Creating a MyKey (page 49).
I lost the only admin key.	Purchase a new key from an authorized dealer.
I lost a key.	Program a spare key. See Passive Anti-Theft System (page 59).
MyKey distances do not accumulate.	<ul style="list-style-type: none"> • The MyKey user is not using the MyKey. • An admin key holder cleared the MyKeys and created new MyKeys. • The key system has been reset.
No MyKey functions with the keyless entry transmitter.	<ul style="list-style-type: none"> • An admin transmitter is present at vehicle start. • No MyKeys are created. See Creating a MyKey (page 49).

Locks

LOCKING AND UNLOCKING

You can use the power door lock control or the remote control to lock and unlock your vehicle.

Power Door Locks

The power door lock control is on the driver and front passenger door panels.



E180791

- A Unlock.
- B Lock.

Door Lock Indicator

An LED on each door window trim lights when you lock the door. It remains lit for up to 10 minutes after you switch off the ignition.

Switch Inhibitor

When you electronically lock your vehicle, the power door lock button and interior luggage compartment release button, after 20 seconds, no longer operate. You must unlock your vehicle with the remote control, or switch on the ignition, to restore function to these buttons. You can switch this feature on or off in the information display. See **General Information** (page 80).

Remote Control

You can use the remote control at any time. The luggage compartment release button only works when your vehicle speed is less than 5 mph (8 km/h).

You can link your remote control to memory seat and mirror positions, if equipped. See **Memory Function** (page 110).

Unlocking the Doors (Two-Stage Unlock)



Press the button to unlock the driver door.

Press the button again within three seconds to unlock all doors. The directional indicators flash.

Press and hold both the lock and unlock buttons on the remote control for three seconds to change between driver-door or all-door unlock mode. The direction indicators flash twice to indicate a change to the unlocking mode. Driver-door unlock mode only unlocks the driver door when you press the unlock button once. All-door unlock mode unlocks all doors with one press of the unlock button. The unlocking mode applies to the remote control and intelligent access. You can also change the mode in the information display. See **General Information** (page 80).

Locking the Doors



Press the button to lock all the doors. The direction indicators flash.

Press the button again within three seconds to confirm that all the doors are closed. The doors lock again, the horn sounds and the direction indicators flash if all the doors and the luggage compartment are closed.

Locks

Mislock

If any door or the luggage compartment is open, or if the hood is open on vehicles with an anti-theft alarm or remote start, the horn sounds twice and the directional indicators do not flash. You can enable or disable this feature in the information display. See **General Information** (page 80).

Opening the Luggage Compartment



Press twice within three seconds to open the luggage compartment.

Make sure to close and latch the luggage compartment before driving your vehicle. Objects may fall from an unlatched luggage compartment. An unlatched luggage compartment may block your rear view.

Activating Intelligent Access

You must have the intelligent access key within 3 ft (1 m) of your vehicle.

At a Door

Pull an exterior door handle to unlock and open the door. Make sure not to touch the lock sensor on top of the handle.

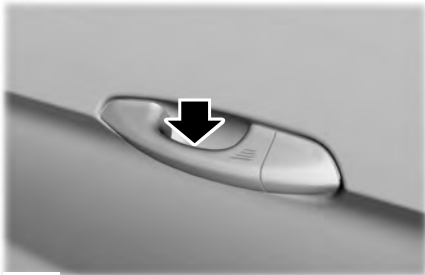

E180792

Touch the top of the door handle to lock your vehicle. There is a brief delay before you can unlock your vehicle again.

Note: *Keep the door handle surface clean to avoid issues with operation.*

At the Luggage Compartment

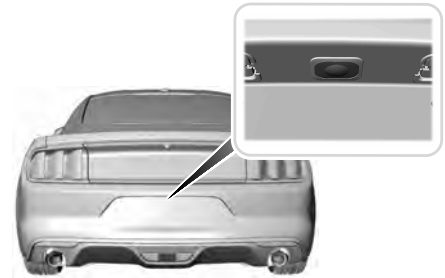

E175208

Press the exterior release button hidden above the license plate.

Smart Unlocks

This feature helps to prevent you from unintentionally locking your intelligent access key inside your vehicle's passenger compartment or luggage compartment.

When you electronically lock your vehicle (with any door open, vehicle in park and ignition off), your vehicle searches for an intelligent access key in the passenger compartment after you close the last door. If your vehicle finds a key, all of the doors immediately unlock and the horn sounds twice, indicating that a key is inside.

Locks

You can override the smart unlock feature and intentionally lock the intelligent access key inside your vehicle. To do this, lock your vehicle after you have closed all the doors by:

- Pressing the lock button on another intelligent access key.
- Touching the locking area on the handle with another intelligent access key in your hand.

When you open one of the front doors and lock your vehicle using the power door lock control, all doors lock then unlock if:

- The ignition is on.
- The ignition is off and your vehicle is not in **P**.

Auto Relock

If you press the unlock button on the remote control and do not open a door within 45 seconds, your vehicle locks and arms your alarm. You can enable or disable this feature in the information display. See **General Information** (page 80).

Autolock Feature (If Equipped)

The autolock feature locks all the doors when:

- All doors are closed.
- The ignition is on.
- You shift into any gear putting your vehicle in motion.
- And your vehicle attains a speed greater than 12 mph (20 km/h).

The autolock feature repeats when:

- You open, and then close, any door while the ignition is on and your vehicle speed is 9 mph (15 km/h).
- And your vehicle then attains a speed greater than 12 mph (20 km/h).

Enabling or Disabling

To enable or disable the autolock feature, contact an authorized dealer.

Autounlock Feature

The autounlock feature unlocks all the doors when:

- The ignition is on, all the doors are closed, and your vehicle has been in motion at a speed greater than 12 mph (20 km/h).
- The vehicle comes to a stop and you switch the ignition off or to accessory.
- And you open the driver door within 10 minutes of switching the ignition off or to accessory.

Note: *The doors do not autounlock if you electronically lock your vehicle after you switch the ignition off and before you open the driver door.*

Enabling or Disabling

You can enable or disable the autounlock feature in the information display or an authorized dealer can do it for you. See **General Information** (page 80).

Key Blade

Turn the top of the key toward the front of your vehicle once to lock all doors.

Turn the top of the key toward the rear of your vehicle once to unlock the driver door only. See **Remote Control** (page 44).

Locking the Doors Individually

If the power locks do not operate because of a discharged battery, lock the doors individually using the mechanical key blade in the position shown.

Locks



E180643

Left-Hand Side

Turn clockwise to lock.

Right-Hand Side

Turn counterclockwise to lock.

Unlocking the Luggage Compartment (Convertible Only)

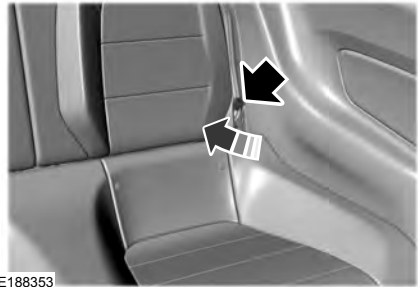

E188353

If the power decklid release does not operate because of a discharged battery, pull the rear seat left-hand side seatback cushion aside, insert the mechanical key blade into the key slot and turn the key to release the decklid latch.

Illuminated Entry

The interior lamps and select exterior lamps illuminate when you unlock the doors with the remote entry system.

The illuminated entry system turns off the lights if:

- The ignition is on.
- You press the remote control lock button.
- After 25 seconds of illumination.

The lights do not turn off if:

- You switch them on with the lamp control.
- Any door is open.

Illuminated Exit

The interior lamps and select exterior lamps illuminate when all doors are closed and you switch the ignition off.

Locks

The lamps turn off if all the doors remain closed and:

- 25 seconds elapse.
- You press the **START/STOP** button.

Battery Saver

If you leave on the courtesy lamps, dome lamps or headlamps, the battery saver turns them off 10 minutes after you switch off the ignition.

Accessory Mode Battery Saver for Intelligent Access Keys

If you leave your vehicle in the run ignition state, it turns off once it detects a certain amount of battery drain or after 45 minutes.

Luggage Compartment

From Inside Your Vehicle



E188015

Press the button on the instrument panel to unlatch the luggage compartment.

With the Remote Control



Press twice within three seconds to unlatch the luggage compartment.

From Outside Your Vehicle

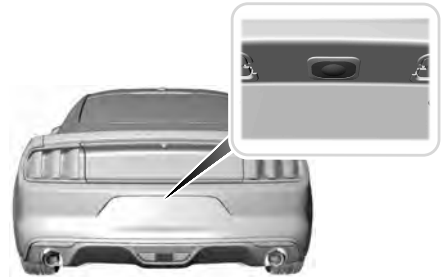

E175208

Press the release button above the license plate to unlatch the luggage compartment. Your vehicle must be unlocked or have an intelligent access transmitter within 3 ft (1 m) of the luggage compartment.

INTERIOR LUGGAGE COMPARTMENT RELEASE

WARNINGS



Keep vehicle doors and luggage compartment locked and keep keys and remote transmitters out of a child's reach. Unsupervised children could lock themselves in the trunk and risk injury. Children should be taught not to play in vehicles.



Do not leave children or animals unattended in the vehicle. On hot days, the temperature in the trunk or vehicle interior can rise very quickly. Exposure of people or animals to these high temperatures for even a short time can cause death or serious heat-related injuries, including brain damage. Small children are particularly at risk.

Your vehicle is equipped with a release handle that provides a means of escape for children and adults if they become locked inside the luggage compartment.

Locks

Adults should familiarize themselves with the operation and location of the release handle.

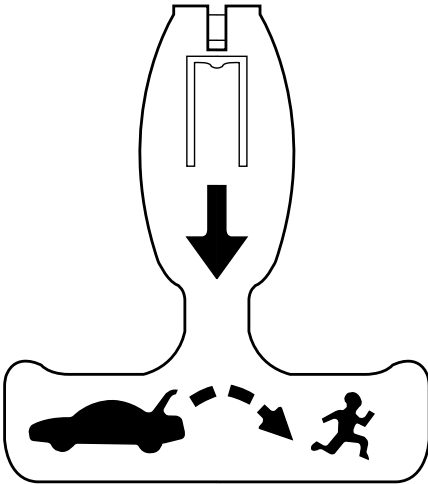

E144403

The handle is located inside the luggage compartment either on the luggage compartment door (lid) or near the tail lamps. It is composed of a material that will glow for hours in darkness following brief exposure to ambient light.

Pull the handle and push up on the luggage compartment door (lid) to open from within the luggage compartment.

Security

PASSIVE ANTI-THEFT SYSTEM

Note: *The system is not compatible with non-Ford aftermarket remote start systems. Use of these systems may result in vehicle starting problems and a loss of security protection.*

Note: *Metallic objects, electronic devices or a second coded key on the same key chain may cause vehicle starting problems if they are too close to the key when starting your vehicle. Prevent these objects from touching the coded key while starting your vehicle. Switch the ignition off, move all objects on the key chain away from the coded key and restart your vehicle if a problem occurs.*

Note: *Do not leave a duplicate coded key in your vehicle. Always take your keys and lock all doors when leaving your vehicle.*

SecuriLock

The system helps prevent your vehicle from starting unless you use a coded key programmed to your vehicle. Using the wrong key may prevent your vehicle from starting. A message may appear in the information display.

If you are unable to start your vehicle with a correctly coded key, it is not operating properly. A message may appear in the information display.

Automatic Arming

Your vehicle arms immediately after switching the ignition off.

Automatic Disarming

Switching the ignition on with a coded key disarms your vehicle.

Replacement Keys

Note: *Your vehicle comes equipped with two intelligent access keys.*

The intelligent access key functions as a programmed key that operates the driver door lock and activates the intelligent access with push button start system, as well as a remote control.

If your programmed transmitters are lost or stolen and you do not have an extra coded key, you need to have your vehicle towed to an authorized dealer. You need to erase the key codes from your vehicle and program new coded keys.

Store an extra programmed key away from your vehicle in a safe place to help prevent any inconveniences. See your authorized dealer to purchase additional spare or replacement keys.

Programming a Spare Intelligent Access Key

Note: *You can program a maximum of four intelligent access keys to your vehicle.*

You must have two previously programmed intelligent access keys inside your vehicle and the new unprogrammed intelligent access keys readily accessible. See an authorized dealer to have the spare key programmed if two previously programmed keys are not available.

Make sure that your vehicle is off before beginning this procedure. Make sure that you close all the doors before beginning and that they remain closed throughout the procedure. Perform all steps within 30 seconds of starting the sequence. Stop and wait for at least one minute before starting again if you perform any steps out of sequence.

Read and understand the entire procedure before you begin.

Security



E174956

1. Remove the rubber covering (A) from the cupholder. Place the first programmed key in the backup slot (B) at the bottom of the cupholder, then press the push button ignition switch.
2. Wait five seconds and then press the push button ignition switch again.
3. Remove the intelligent access key.
4. Within 10 seconds, place a second programmed intelligent access key in the backup slot. Press the push button ignition switch.
5. Wait five seconds and then press the push button ignition switch again.
6. Remove the intelligent access key.
7. Place the unprogrammed intelligent access key in the backup slot and press the push button ignition switch.

Programming is now complete. Verify the remote control functions operate and your vehicle starts with the new intelligent access key.

If programming was not successful, wait 10 seconds and repeat Steps 1 through 7. If you are still unsuccessful, take your vehicle to your authorized dealer.

ANTI-THEFT ALARM (If Equipped)

The system will warn you of an unauthorized entry to your vehicle. It will be triggered if any door, the luggage compartment or the hood is opened without using the key, remote control or keyless entry keypad.

The direction indicators will flash and the horn will sound if unauthorized entry is attempted while the alarm is armed.

Take all remote controls to an authorized dealer if there is any potential alarm problem with your vehicle.

Arming the Alarm

The alarm is ready to arm when there is not a key in your vehicle. Electronically lock your vehicle to arm the alarm.

Disarming the Alarm

Disarm the alarm by any of the following actions:

- Unlock the doors or luggage compartment with the remote control or keyless entry keypad.
- Switch your vehicle on or start your vehicle.
- Use a key in the driver door to unlock your vehicle, then switch your vehicle on within 12 seconds.

Note: *Pressing the panic button on the remote control will stop the horn and signal indicators, but will not disarm the system.*

Steering Wheel

ADJUSTING THE STEERING WHEEL

WARNING



Do not adjust the steering wheel when your vehicle is moving.

Note: Make sure that you sit in the correct position. See **Sitting in the Correct Position** (page 107).



E176634

1. Unlock the steering column.
2. Adjust the steering wheel to the desired position.



E176635

3. Lock the steering column.

AUDIO CONTROL (If Equipped)

You can operate the following functions with the control:

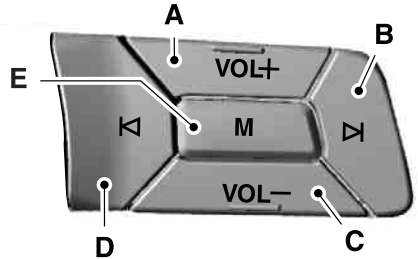

E174583

- A Volume up.
- B Seek up or next.
- C Volume down.
- D Seek down or previous.
- E Media.

MEDIA

Press repeatedly to scroll through available audio sources.

Seek, Next or Previous

Press the seek button to:

- Tune the radio to the next or previous stored preset.
- Play the next or the previous track.

Press and hold the seek button to:

- Tune the radio to the next station up or down the frequency band.
- Seek or fast forward through a track.

Steering Wheel

VOICE CONTROL (If Equipped)

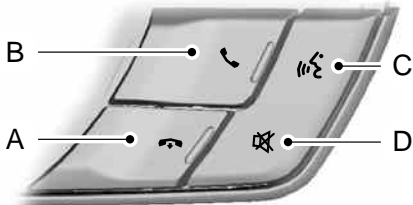

E174584

- A End a call.
- B Answer a call.
- C Voice recognition.
- D Mute.

See your SYNC information.

INFORMATION DISPLAY CONTROL

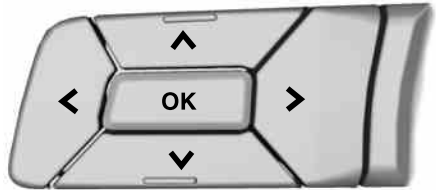

E174595

See **Information Displays** (page 80).

CRUISE CONTROL

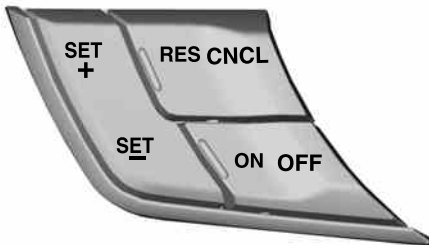

E174594

See **Cruise Control** (page 152).

Wipers and Washers

WINDSHIELD WIPERS

Note: Fully defrost the windshield before switching on the windshield wipers.

Note: Make sure you switch off the windshield wipers before entering a car wash.

Note: Clean the windshield and wiper blades if they begin to leave streaks or smears. If that does not resolve the issue, install new wiper blades.

Note: Do not operate the wipers on a dry windshield. This may scratch the glass, damage the wiper blades or cause the wiper motor to burn out. Always use the windshield washers before wiping a dry windshield.

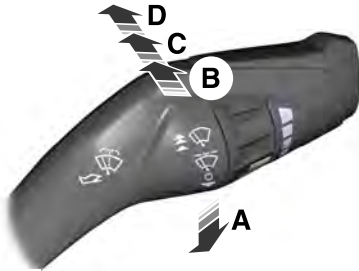

E173728

- A Single wipe
- B Intermittent wipe
- C Normal wipe
- D High speed wipe

Intermittent Wipe

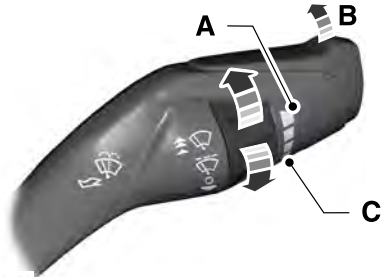

E173729

- A Shortest wipe interval
- B Intermittent wipe
- C Longest wipe interval

Use the rotary control to adjust the intermittent wipe interval.

Speed Dependent Wipers

When your vehicle speed increases, the interval between wipes will decrease.

AUTOWIPERS (If Equipped)

The feature uses a rain sensor. You will find it in the area around the interior mirror. The rain sensor monitors the amount of moisture on the windshield and automatically turns on the wipers. It adjusts the wiper speed by the amount of moisture that the sensor detects on the windshield. You can switch this feature on and off in the information display. See **General Information** (page 80).

Wipers and Washers

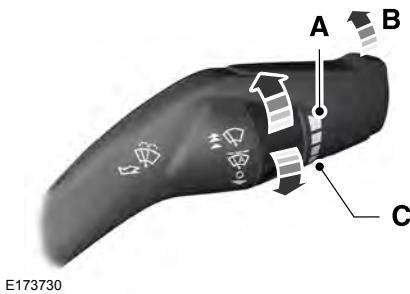

E173730

- A Highest sensitivity
- B On
- C Lowest sensitivity

Use the rotary control to adjust the sensitivity of the rain sensor. There are six sensitivity settings. When you set the control to low sensitivity (the first position), the wipers turn on when there is a large amount of moisture on the windshield. When you set the control to high sensitivity (the sixth position), the wipers will turn on when there is a small amount of moisture on the windshield.

Keep the outside of the windshield clean. The rain sensor is very sensitive. If the area around the mirror is dirty, then the wipers may operate if dirt, mist or insects hit the windshield.

Wet or winter driving conditions with ice, snow or salty road mist can cause inconsistent and unexpected wiping or smearing. You can do the following to help keep your windshield clear:

- Lower the sensitivity of the autowipers to reduce the amount of smearing.
- Switch to normal or high-speed wipe.
- Switch off the autowipers.

Note: Fully defrost the windshield before switching on the windshield wipers.

Note: Make sure you switch off the windshield wipers before entering a car wash.

Note: Clean the windshield and wiper blades if they begin to leave streaks or smears. If that does not resolve the issue, install new wiper blades.

Note: If you switch on the autolamps feature in conjunction with autowipers, your low beam headlamps will turn on automatically when the rain sensor turns on the windshield wipers to a normal wipe speed.

WINDSHIELD WASHERS

Note: Do not operate the washers when the washer reservoir is empty. This may cause the washer pump to overheat.



E173731

To operate the washers and spray the windshield, pull the lever toward you.

Lighting

GENERAL INFORMATION

Condensation in Lamp Assemblies

Exterior lamps have vents to accommodate normal changes in air pressure.

Condensation can be a natural by-product of this design. When moist air enters the lamp assembly through the vents, there is a possibility that condensation can occur when the temperature is cold. When normal condensation occurs, a fine mist can form on the interior of the lens. The fine mist eventually clears and exits through the vents during normal operation.

Clearing time may take as long as 48 hours under dry weather conditions.

Examples of acceptable condensation are:

- The presence of a fine mist (no streaks, drip marks or large droplets).
- A fine mist covers less than 50% of the lens.

Examples of unacceptable condensation are:

- A water puddle inside the lamp.
- Streaks, drip marks or large droplets present on the interior of the lens.

If you see any unacceptable condensation, have your vehicle checked by an authorized dealer.

LIGHTING CONTROL

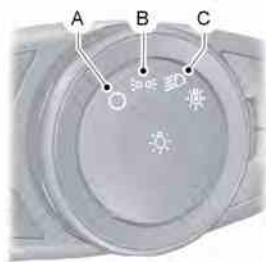

E142449

- A Off
- B Parking lamps, instrument panel lamps, license plate lamps and tail lamps
- C Headlamps

High Beams



E162679

Push the lever forward to switch the high beams on.

Push the lever forward again or pull the lever toward you to switch the high beams off.

Lighting

Headlamp Flasher



E162680

Pull the lever toward you slightly and release it to flash the headlamps.

AUTOLAMPS (If Equipped)

WARNING



The autolamps switch position may not activate the headlamps in all low visibility conditions, such as daytime fog. Always ensure that your headlamps are switched to auto or on, as appropriate, during all low visibility conditions. Failure to do so may result in a collision.

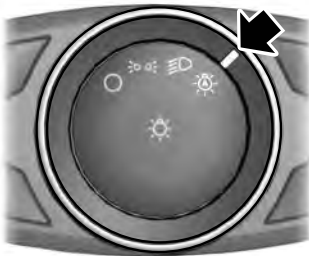

E142451

When the lighting control is in the autolamps position, the headlamps automatically turn on in low light situations or when the wipers activate.

If equipped, the following also activate when the lighting control is in the autolamps position and you switch them on in the information display:

- Configurable daytime running lamps.
- Automatic high beam control.
- Adaptive headlamp control.

The headlamps remain on for a period of time after you switch the ignition off. Use the information display controls to adjust the period of time that the headlamps remain on. See **Information Displays** (page 80).

Note: *With the headlamps in the autolamps position, you cannot switch the high beam headlamps on until the autolamps system turns the low beam headlamps on.*

Windshield Wiper Activated Headlamps

The windshield wiper activated headlamps turn on within 10 seconds when you switch the windshield wipers on and the lighting control is in the autolamps position. They turn off approximately 60 seconds after you switch the windshield wipers off.

The headlamps will not turn on by wiper activation:

- During a mist wipe.
- When the wipers are on to clear washer fluid during a wash condition.
- If the wipers are in intermittent mode.

Note: *If you switch autolamps and autowipers on, the headlamps will automatically turn on when the windshield wipers continuously operate.*

Lighting

INSTRUMENT LIGHTING DIMMER

Note: If you disconnect the battery or it becomes discharged, the illuminated components will switch to the maximum setting.

Vehicles With Front Fog Lamps



E132712

Press repeatedly or press and hold until you reach the desired level.

Vehicles Without Front Fog Lamps



E165366

- A Press repeatedly or press and hold to dim.
- B Press repeatedly or press and hold to brighten.

HEADLAMP EXIT DELAY

After you switch the ignition off, you can switch the headlamps on by pulling the direction indicator lever toward you. You will hear a short tone. The headlamps will switch off automatically after three minutes with any door open or 30 seconds after the last door has been closed. You can cancel this feature by pulling the direction indicator toward you again or switching the ignition on.

Lighting

DAYTIME RUNNING LAMPS (If Equipped)

WARNING



The daytime running lamps system does not activate the rear lamps and may not provide adequate lighting during low visibility driving conditions. Also, the autolamps switch position may not activate the headlamps in all low visibility conditions, such as daytime fog. Make sure the headlamps are switched to auto or on, as appropriate, during all low visibility conditions. Failure to do so may result in a crash.

Type 1 - Conventional (Non-Configurable)

The daytime running lamps turn on when:

1. The ignition is switched to the on position.
2. The transmission is not in park (P) for vehicles with automatic transmissions or the parking brake is released for vehicles with manual transmissions.
3. The lighting control is in the off, parking lamp or autolamps positions.
4. The headlamps are off.

Type 2 - Configurable

Switch the daytime running lamps on or off using the information display controls.

The daytime running lamps turn on when:

1. They are switched on in the information display.
2. The ignition is switched to the on position.
3. The transmission is not in park (P) for vehicles with automatic transmissions or the parking brake is released for vehicles with manual transmissions.

4. The lighting control is in the autolamps position.
5. The headlamps are off.

The other lighting control switch positions do not activate the daytime running lamps, and you can use them to temporarily override autolamp control.

When switched off in the information display, the daytime running lamps are off in all lighting control switch positions.

FRONT FOG LAMPS (If Equipped)



E142453

Press the control to switch the fog lamps on or off.

You can switch the fog lamps on when the lighting control is in any position except Off and the high beams are not on.

Lighting

DIRECTION INDICATORS



E162681

Push the lever up or down to use the direction indicators.

Note: Tap the lever up or down to make the direction indicators flash three times to indicate a lane change.

WELCOME LIGHTING (If Equipped)

Pony Projection Lights

The pony projection lights are on the bottom of the exterior mirror housings. They will project an image onto the ground a short distance from your vehicle when welcome lighting or lighted entry turns on.

Note: Moisture, frost and ice build-up or other types of contamination on the surface of the light lens can cause non-permanent distortion or reduced brightness of the image. Do not use abrasive materials to clean the lens.

INTERIOR LAMPS

The lamps turn on when:

- You open any door.
- You press a button on the remote control.
- You press a map lamp button.

Map Lamps



E175199

- A Left-hand side map lamp.
- B Right-hand side map lamp.

You can switch the lamps on individually by pressing the buttons.

AMBIENT LIGHTING (If Equipped)

You can adjust the ambient lighting system in your information display. See **Information Displays** (page 80).

Windows and Mirrors

POWER WINDOWS

WARNINGS



Do not leave children unattended in your vehicle and do not let them play with the power windows. They may seriously injure themselves.



When closing the power windows, you should verify they are free of obstructions and make sure that children and pets are not in the proximity of the window openings.



E180087

Note: You may hear a pulsing noise when just one of the windows is open. Lower the opposite window slightly to reduce this noise.

Note: Use the singular control (if equipped) to open both rear windows.

Press the switch to open the window.

Lift the switch to close the window.

One-Touch Down

Press the switch fully and release it. Press again or lift it to stop the window.

One-Touch Up (Coupe Only)

Lift the switch fully and release it. Press or lift it again to stop the window.

Bounce-Back (Coupe Only)

The window will stop automatically while closing. It will reverse some distance if there is an obstacle in the way.

Overriding the Bounce-Back Feature

WARNING



When you override the bounce-back feature the window will not reverse if it detects an obstacle. Take care when closing the windows to avoid personal injury or damage to your vehicle.

Pull up the window switch and hold within two seconds of the window reaching the bounce-back position. The window will travel up with no bounce-back protection. The window will stop if you release the switch before the window is fully closed.

Accessory Delay

You can use the window switches for several minutes after you switch the ignition off or until you open either front door.

GLOBAL OPENING (If Equipped)

You can use the remote control to operate the windows with the ignition off.

Note: You can enable or disable this feature in the information display, or see an authorized dealer. See **General Information** (page 80).

Note: To operate this feature, accessory delay must not be active.

Windows and Mirrors

Opening the Windows

You can open the windows for a short time after you unlock your vehicle with the remote control. After you unlock your vehicle, press and hold the remote control unlock button to open the windows. Release the button once movement starts. Press the lock or unlock button to stop movement.

EXTERIOR MIRRORS

Power Exterior Mirrors

WARNING



Do not adjust the mirrors when your vehicle is moving.

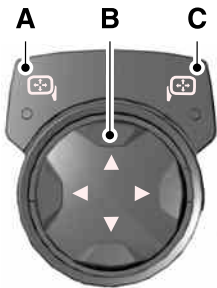

E176804

- A Left-hand mirror
- B Adjustment control
- C Right-hand mirror

To adjust a mirror:

1. Select the mirror you want to adjust. The control will illuminate.
2. Adjust the position of the mirror.
3. Press the mirror switch again.

Fold-Away Exterior Mirrors

Push the mirror toward the door window glass. Make sure that you fully engage the mirror in its support when returning it to its original position.

Heated Exterior Mirrors (If Equipped)

See **Heated Windows and Mirrors** (page 105).

Memory Mirrors (If Equipped)

You can save and recall the mirror positions through the memory function. See **Power Seats** (page 109).

Signal Indicator Mirrors (If Equipped)

The outer portion of the appropriate mirror housing will blink when you switch on the turn signal.

Pony Projection Lights (If Equipped)

The lights are on the bottom of the mirror housings.

This feature projects an image onto the ground a short distance from the vehicle with the illuminated entry and exit feature.

Note: *Moisture, frost and ice build-up (or other types of contamination) on the surface of the light lens can cause some non-permanent distortion or reduced brightness of the image. Do not use abrasive materials to clean the lens.*

Integrated Blind Spot Mirrors (If Equipped)

WARNING



Objects in the blind spot mirror are closer than they appear.

Windows and Mirrors

Blind spot mirrors have an integrated convex mirror built into the upper outboard corner of the exterior mirrors. They can increase your visibility along the side of your vehicle.

Check the main mirror first before a lane change, then check the blind spot mirror. If the blind spot mirror does not show any vehicles in its viewing area and the traffic in the adjacent lane is at a safe distance, signal that you intend to change lanes. Glance over your shoulder to verify traffic is clear and carefully change lanes.

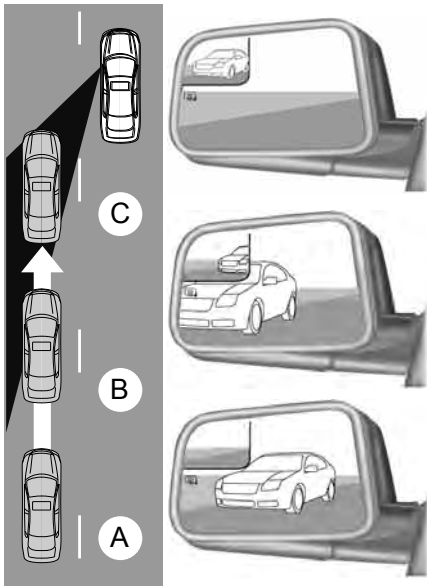

E138665

The image of the approaching vehicle is small and near the inboard edge of the main mirror when it is at a distance. The image becomes larger and begins to move outboard across the main mirror as the vehicle approaches (A). The image will transition from the main mirror and begin to appear in the blind spot mirror as the vehicle approaches (B). The vehicle will transition to your peripheral field of view as it leaves the blind spot mirror (C).

Blind Spot Monitor (If Equipped)

See **Blind Spot Information System** (page 160).

INTERIOR MIRROR

WARNING



Do not adjust the mirror when your vehicle is moving.

Note: Do not clean the housing or glass of any mirror with harsh abrasives, fuel or other petroleum or ammonia-based cleaning products.

You can adjust the interior mirror to your preference. In addition to the standard pivot point, this mirror also includes a second pivot point, letting you move the mirror head up or down and from side to side.

Auto-Dimming Mirror

Note: Do not block the sensors on the front and back of the mirror. Mirror performance may be affected. A rear center passenger or raised rear center head restraint may also block light from reaching the sensor.

Windows and Mirrors

To reduce glare, the mirror dims automatically when it detects bright lights from behind your vehicle. It automatically returns to normal reflection when you select reverse (R) gear to make sure you have a clear view when backing up.

SUN VISORS

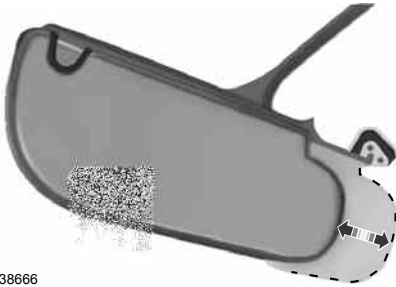

E138666

Rotate the sun visor toward the side window and extend it rearward for extra shade.

Illuminated Vanity Mirror

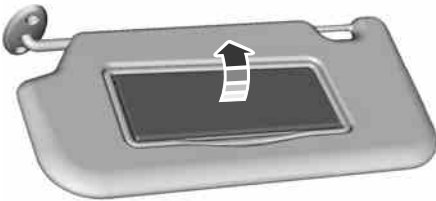

E162197

Lift the cover to switch the lamp on.

Instrument Cluster

GAUGES

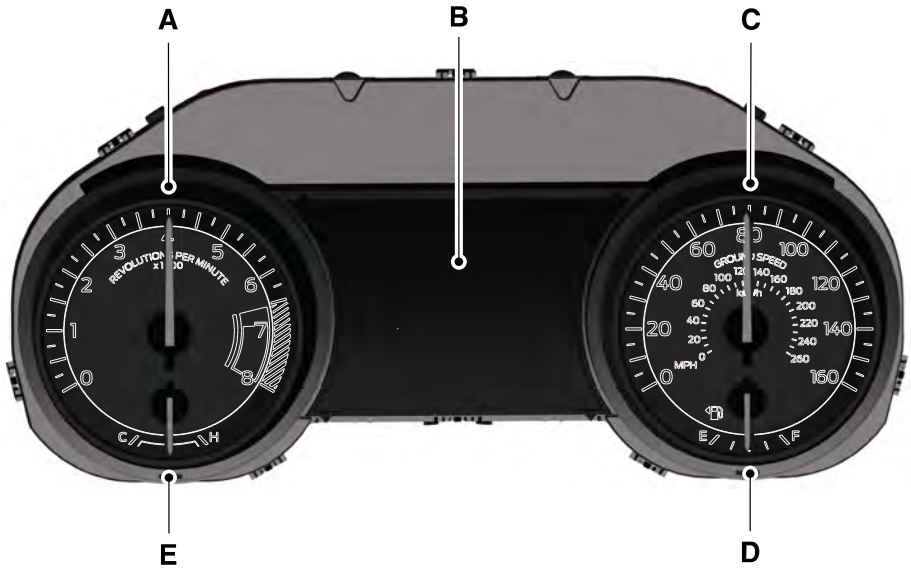

E174486

- A Tachometer (Revolutions per minute)
- B Information display
- C Speedometer (Ground speed)
- D Fuel gauge
- E Engine coolant temperature gauge

Information Display

Odometer

Located in the bottom of the information display. Registers the accumulated distance your vehicle has traveled.

Trip Computer

See **General Information** (page 80).

Vehicle Settings and Personalization

See **General Information** (page 80).

Instrument Cluster

Fuel Gauge

Note: *The fuel gauge may vary slightly when your vehicle is moving or on a gradient.*

Switch the ignition on. The fuel gauge will indicate approximately how much fuel is left in the fuel tank. The arrow adjacent to the fuel pump symbol indicates on which side of your vehicle the fuel filler door is located.

The needle should move toward F when you refuel your vehicle. If the needle points to E after adding fuel, this indicates your vehicle needs service soon.

After refueling some variability in needle position is normal:

- It may take a short time for the needle to reach F after leaving the gas station. This is normal and depends upon the slope of pavement at the gas station.
- The fuel amount dispensed into the tank is a little less or more than the gauge indicated. This is normal and depends upon the slope of pavement at the gas station.
- If the gas station nozzle shuts off before the tank is full, try a different gas pump nozzle.

Low Fuel Reminder

A low fuel reminder triggers when the distance to empty value reaches 50 mi (80 km) to empty, with additional warnings at 25 mi (40 km), 10 mi (20 km) and 0 mi (0 km) to empty, provided the message is cleared each time. An additional warning at 75 mi (120 km) to empty is provided when the MyKey is being used.

Variations:

Note: *The low fuel warning and distance-to-empty warning can appear at different fuel gauge positions depending on fuel economy conditions. This variation is normal.*

Driving type (fuel economy conditions)	Distance-to-empty	Fuel gauge position
Highway driving	50 mi (80 km)	1/8th tank
Severe duty driving (trailer towing, extended idle)	50 mi (80 km)	1/4 tank

Engine Coolant Temperature Gauge

WARNING



Never remove the coolant reservoir cap while the engine is running or hot.

Indicates engine coolant temperature. At normal operating temperature, the level indicator will be in the normal range. If the engine coolant temperature exceeds the normal range, stop your vehicle as soon as safely possible, switch off the engine and let it cool.

Instrument Cluster

Gauge Package (If Equipped)



Oil Pressure Gauge

Indicates the engine oil pressure.

Vacuum/Boost Gauge

Indicates the vacuum and boost pressure in the intake.

WARNING LAMPS AND INDICATORS

The following warning lamps and indicators will alert you to a vehicle condition that may become serious. Some lamps will illuminate when you start your vehicle to make sure they work. If any lamps remain on after starting your vehicle, refer to the respective system warning lamp for further information.

Note: Some warning indicators appear in the information display and function the same as a warning lamp but do not display when you start your vehicle.

Adaptive Cruise Control (If Equipped)



The speed control system indicator light changes color to indicate what mode the system is in: See **Using Adaptive Cruise Control** (page 153).

On (white light): Illuminates when the adaptive cruise control system is turned on. Turns off when the speed control system is turned off.

Engaged (green light): Illuminates when the adaptive cruise control system is engaged. Turns off when the speed control system is disengaged.

Anti-Lock Braking System



If it illuminates when you are driving, this indicates a malfunction. You will continue to have the normal braking system (without ABS) unless the brake system warning lamp is also illuminated. Have the system checked by your authorized dealer.

Battery



If it illuminates while driving, it indicates a malfunction. Switch off all unnecessary electrical equipment and have the system checked by your authorized dealer immediately.

Blind Spot Monitor (If Equipped)



It will illuminate when you switch this feature off or in conjunction with a message. See **Blind Spot Information System** (page 160). See **Information Messages** (page 88).

Brake System



It will illuminate when you engage the parking brake with the ignition on.

If it illuminates when you are driving, check that the parking brake is not engaged. If the parking brake is not engaged, this indicates low brake fluid level or a brake system malfunction. Have the system checked immediately by your authorized dealer.

Instrument Cluster

WARNING



Driving your vehicle with the warning lamp on is dangerous. A significant decrease in braking performance may occur. It will take you longer to stop your vehicle. Have your vehicle checked by your authorized dealer immediately. Driving extended distances with the parking brake engaged can cause brake failure and the risk of personal injury.

Cruise Control (If Equipped)



It will illuminate when you switch this feature on.

Direction Indicator



Illuminates when the left or right turn signal or the hazard warning flasher is turned on. If the indicators stay on or flash faster, check for a burned out bulb. See **Changing a Bulb** (page 226).

Door Ajar



Displays when the ignition is on and any door is not completely closed.

Engine Coolant Temperature



Illuminates when the engine coolant temperature is high. Stop the vehicle as soon as possible, switch off the engine and let cool. See **Engine Coolant Check** (page 217).

Engine Oil



If it illuminates with the engine running or when you are driving, this indicates a malfunction. Stop your vehicle as soon as it is safe to do so and switch the engine off. Check the engine oil level. See **Engine Oil Check** (page 216).

Note: Do not resume your journey if it illuminates despite the level being correct. Have the system checked by your authorized dealer immediately.

Fasten Safety Belt



It will illuminate and a chime will sound to remind you to fasten your safety belt. See **Seatbelt Reminder** (page 30).

Front Airbag



If it fails to illuminate when you start your vehicle, continues to flash or remains on, it indicates a malfunction. Have the system checked by your authorized dealer.

Front Fog Lamps (If Equipped)



Lights when you switch the front fog lamps on.

Heads Up Display (If Equipped)



A red beam of lights will illuminate on the windshield in certain instances when using adaptive cruise control or the collision warning system. It will also illuminate momentarily when you start your vehicle to make sure the display works.

Instrument Cluster

High Beam



It will illuminate when you switch the high beam headlamps on. It will flash when you use the headlamp flasher.

Low Fuel Level



It will illuminate when the fuel level is low or the fuel tank is nearly empty. Refuel as soon as possible.

Low Tire Pressure Warning



It will illuminate when your tire pressure is low. If the lamp remains on with the engine running or when driving, check your tire pressures as soon as possible.

It will also illuminate momentarily when you switch the ignition on to confirm the lamp is functional. If it does not illuminate when you switch the ignition on, or begins to flash at any time, have the system checked by your authorized dealer.

Parking Lamps



It will illuminate when you switch the parking lamps on.

Service Engine Soon



If the service engine soon indicator light stays illuminated after the engine is started, it indicates that the On Board Diagnostics system (OBD) has detected a malfunction of the vehicle emissions control system. Refer to On board diagnostics (OBD) in the Fuel and Refueling chapter for more information about having your vehicle serviced. See **Emission Control System** (page 129).

If the light is blinking, engine misfire is occurring which could damage your catalytic converter. Drive in a moderate fashion (avoid heavy acceleration and deceleration) and have your vehicle serviced immediately.

WARNING



Under engine misfire conditions, excessive exhaust temperatures could damage the catalytic converter, the fuel system, interior floor coverings or other vehicle components, possibly causing a fire. Have an authorized dealer service your vehicle immediately.

The service engine soon indicator light illuminates when the ignition is first turned on prior to engine start to check the bulb and to indicate whether the vehicle is ready for Inspection/Maintenance (I/M) testing.

Normally, the service engine soon light will stay on until the engine is cranked, then turn itself off if no malfunctions are present. However, if after 15 seconds the service engine soon light blinks eight times, it means that the vehicle is not ready for I/M testing. See **Emission Control System** (page 129).

Stability Control



It will flash when the system is active. If it remains illuminated or does not illuminate when you switch the ignition on, this indicates a malfunction. During a malfunction the system will switch off. Have the system checked by your authorized dealer immediately. See **Using Stability Control** (page 144).

Instrument Cluster

Stability Control Off



It will illuminate when you switch the system off. It will go out when you switch the system back on or when you switch the ignition off. See **Using Stability Control** (page 144).

AUDIBLE WARNINGS AND INDICATORS

Keyless Warning Alert

The horn will sound twice when you exit your vehicle with the intelligent access key and your vehicle is in ON, indicating your vehicle is still on. The horn will also sound twice when you exit your vehicle and attempt to lock the doors manually while the intelligent access key is still in the vehicle. The doors will not lock if the intelligent access key remains in the vehicle.

Headlamps On Warning Chime

Sounds when you remove the key from the vehicle and you have left the headlamps or parking lamps on.

Parking Brake On Warning Chime

Sounds when you have left the parking brake on and drive your vehicle. If the warning chime remains on after you have released the parking brake, have the system checked by your authorized dealer immediately.

Information Displays

GENERAL INFORMATION

WARNING



Driving while distracted can result in loss of vehicle control, crash and injury. We strongly recommend that you use extreme caution when using any device that may take your focus off the road. Your primary responsibility is the safe operation of your vehicle. We recommend against the use of any handheld device while driving and encourage the use of voice-operated systems when possible. Make sure you are aware of all applicable local laws that may affect the use of electronic devices while driving.

Various systems on your vehicle can be controlled using the information display controls on the steering wheel. Corresponding information is displayed in the information display.

Information Display Controls

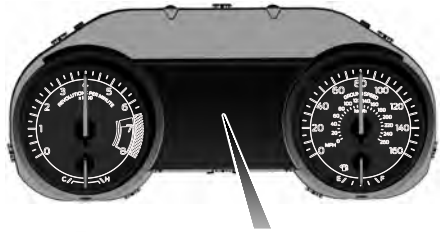

E174488

- Press the up and down arrow buttons to scroll through and highlight the options within a menu.
- Press the right arrow button to enter a sub-menu.
- Press the left arrow button to exit a menu.
- Press and hold the left arrow button at any time to return to the main menu display (escape button).
- Press the **OK** button to choose and confirm settings or messages.

Main menu

- Gauge Mode
- Trip/Fuel
- Track Apps

Information Displays

- Driver Assist
- Settings

Note: Some options may appear slightly different or not at all if the items are optional.

Gauge Mode

Use the arrow buttons to choose between the following gauge options.

Gauge Mode		
Distance to Empty - XXX miles		
Tire Pressure – Tire Pressure on Demand Screen		
Gauge Detail	Air/Fuel Ratio	Virtual gauge shown
	Boost/Vac	
	Cyl Head	
	Inlet Air	
Oil Pressure		
	Oil Temp	Virtual gauge shown
	Trans Temp	
	Voltage	

Note: In order to provide real-time values, some gauges may display more value fluctuation than other gauges during normal operation.

Some gauges shown in standard measure. Metric similar.

Tire Pressure



E182200

Displays your current vehicle tire pressures.

Air/Fuel Ratio

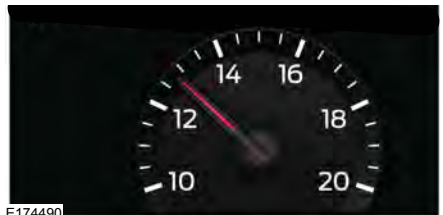

E174490

Displays the current air to fuel mixture in the engine.

Information Displays

Boost/Vac (If Equipped)



E213874

Displays the vacuum or boost pressure.

Cyl Head



E174491

Displays the engine's cylinder head temperature.

Inlet Air



E174492

Displays the temperature of the air in the cold air inlet tube.

Oil Temp



E174493

Displays the engine oil temperature. If the temperature rises to the red area, stop in a safe place and let your vehicle cool. If the problem persists, see an authorized dealer.

Trans Temp (Automatic Transmission only)



E174494

Displays the transmission fluid operating temperature. If the temperature rises to the red area, stop in a safe place and let the transmission cool. If the problem persists, see an authorized dealer.

Voltage



E174495

Information Displays

Displays your vehicle's battery voltage. If the voltage is consistently too high or very low, see an authorized dealer.

Trip/Fuel

Use the arrow buttons to choose between the following trip options.

Trip/Fuel	
Trip 1 or Trip 2 - Trip timer, Trip distance, mi to E and avg mpg	
Fuel Economy	Instant fuel economy
	AVG MPG
	mi to E
Fuel History	Last 30 minutes
	AVG MPG
	mi to E
Average Speed	

Note: Press and hold **OK** to reset the currently displayed information.

Trip timer

Registers the time of individual journeys.

Trip distance

Registers the mileage of individual journeys.

Mi to E

Shows the approximate distance your vehicle can travel before running out of fuel.

Avg mpg

Shows the average fuel usage based on time.

Instant fuel economy

Shows your instantaneous fuel usage.

Fuel history

Shows fuel usage as a bar graph based on time. The graph is updated each minute with the fuel economy that you achieved during 30 minutes of driving.

Track Apps

WARNING



Track Apps is for track use only. Remember that even advanced technology cannot defy the laws of physics. It is always possible to lose control of a vehicle due to inappropriate driver input for the conditions. Aggressive driving on any road condition can cause you to lose control of your vehicle increasing the risk of personal injury or property damage.

Note: Track Apps are for track use only. They are not to be used under any other driving conditions.

Information Displays

Note: Viewed or cleared results cannot be used unless your vehicle is at a complete stop. The right arrow on the display menu will be inactive. If your vehicle does not reach 100 mph (160 km/h) during the track run, your display may not display your 1/4 mile results.

Note: The system will disable the collision warning system while using track apps or when you switch off advancetrac.

Track Apps		
Accelerometer	Virtual gauge shown	
Acceleration Timer	0-30 MPH (50 km/h)	Automatic Start or Countdown Start
	0-60 MPH (100 km/h)	
	0-100 MPH (200 km/h)	
	0-1/8 Mile (200m)	
	0-1/4 Mile (400m)	
Brake Performance	60-0 MPH (100km/h)	
	100-0 MPH (200km/h)	
Lap Timer	Track (XXX)	
Launch Control	Launch Control - check enabled or uncheck disabled	
	RPM	RPM set value
Line Lock		
VIEW/CLEAR Results	Acceleration Timer	
	Brake Perform	
	All Time Best	
	Clear Saved Data	
	Clear All Time Best	

Information Displays

Accelerometer



Displays your vehicle's rate of acceleration or deceleration.

The red dot will move toward the area of acceleration or deceleration.

- LEFT acceleration or deceleration - When accelerating or decelerating left, the red dot will move to the right on the accelerometer.
- RIGHT acceleration/deceleration - When accelerating or decelerating right, the red dot will move to the left on the accelerometer.

Acceleration Timer

Displays your vehicle's rate of acceleration.

1. Choose desired speed or distance.
2. Choose Automatic Start or Countdown Start.

3. Follow the on-screen prompts.

Brake Performance

Displays your vehicle's rate of deceleration.

1. Choose desired speed to start recording data.
2. Follow the on-screen prompts.

Lap Timer

Gives the driver the ability to record three separate lap times.

Launch Control (if equipped)

Maximize traction from a standing start.

Line Lock (if equipped)

Locks front brakes while allowing rear wheels to turn freely.

VIEW/CLEAR Results

View and clear the last and saved results of the acceleration timer, brake performance and all time best.

Driver Assist

Use the arrow buttons to configure different driver setting choices.

Note: Some items are optional and may not appear.

Driver Assist	
Advancetrac - check enabled or uncheck disabled	
Auto Engine Off – check enabled or uncheck disabled	
Blindspot - check enabled or uncheck disabled	
Collision Warning	On - check enabled or uncheck disabled
	Sensitivity High, Normal or Low
Cross Traffic Alert - check enabled or uncheck disabled	
Cruise Control	Adaptive or Normal

Information Displays

Driver Assist

Hill Start Assist - check enabled or uncheck disabled

Rear Park Aid - check enabled or uncheck disabled

Seatbelt Monitor On Demand screen pops up

Note: *Some items are optional and may not appear.*

Settings

Use the arrow buttons to configure different driver setting choices.

Settings

Settings			
Vehicle	Easy Entry/Exit - check enabled or uncheck disabled		
	Lighting	Autolamp Delay	Off or XXX seconds
		Daytime Lights - check enabled or uncheck disabled	
	Locks	Autounlock - check enabled or uncheck disabled	
		Mislock - check enabled or uncheck disabled	
		Relock - check enabled or uncheck disabled	
		Remote Unlock	All Doors or Driver First
		Switch Inhibit - check enabled or uncheck disabled	
	Oil Life Reset	Hold OK to reset	
	Park Lock Control - check enabled or uncheck disabled		
	Remote Start	Climate Control	Auto or Last Setting
		Seats	Auto or Off
		Duration	5, 10 or 15 minutes
		System - check enabled or uncheck disabled	
	Windows	Remote Open or Close - check enabled or uncheck disabled	
	Wipers	Courtesy Wipe or Rain Sensing - check enabled or uncheck disabled	

Information Displays

Settings				
MyColor	Gauge Color	Ice blue, White, Green, Purple, Blue, Orange, Red or MyColor 1 - 3		
	Ambient Light	Ambient Light - check enabled or uncheck disabled		
		Ambient Dim	High or Low	
	Ambient Color	Ice blue, White, Green, Purple, Blue, Orange, Red or MyColor 1 - 3		
Set MyColor	Set MyColor 1 - 3	R, G or B		
MyKey	MyKey Status	X MyKeys, XXX MyKey miles and X Admin Keys		
	Create MyKey	Hold OK to Create MyKey		
	911 Assist	Always On or User Selectable		
	AdvanceTrac	Always On or User Selectable		
	Do Not Disturb	Always On or User Selectable		
	MAX Speed	65, 70, 75, 80 MPH or Off		
	Speed Minder	45, 55 or 65 MPH or Off		
	Volume Limiter - check enabled or uncheck disabled			
	Clear MyKey	Hold OK to Clear MyKeys		
Display Setup	Distance	Miles & Gallons, L/100km or km/L		
	Temperature	°Fahrenheit or °Celsius		
	Tire Pressure	psi or kPa		
	Language	Language 1 - 4 - Hold OK to Set		

Information Displays

INFORMATION MESSAGES

Note: Depending on your vehicle options and instrument cluster type, not all of the messages display or are available. The information display may abbreviate or shorten certain messages.

Press the **OK** button to acknowledge and remove some messages from the information display. The information display automatically removes other messages after a short time.

You need to confirm certain messages before you can access the menus.

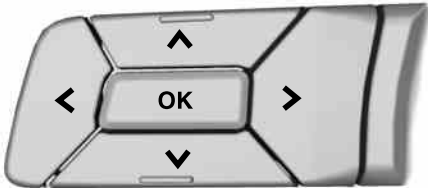

E174595

Adaptive Cruise Control

Message	Action
Adaptive Cruise Malfunction	A radar malfunction is preventing the adaptive cruise control from engaging. See Using Adaptive Cruise Control (page 153).
Adaptive Cruise Not Available	A condition exists such that the adaptive cruise cannot function properly. See Using Adaptive Cruise Control (page 153).
Adaptive Cruise Not Available Sensor Blocked See Manual	You have a blocked sensor due to bad weather, ice, mud or water in front of the radar sensor. You can typically clean the sensor to resolve. See Using Adaptive Cruise Control (page 153).
Normal Cruise Active Automatic Braking Turned Off	The system has disabled the automatic braking.
Front Sensor Not Aligned	A radar malfunction is preventing the adaptive cruise control from engaging.

Information Displays

Message	Action
Adaptive Cruise - Driver Resume Control	The adaptive cruise has reinstated controls to the driver.
Adaptive Cruise Speed Too Low to Activate	Your vehicle speed is too slow to activate the adaptive cruise.
Adaptive Cruise Shift Down	The adaptive cruise is automatically adjusting the gap distance and the driver needs to shift the transmission into a lower gear.

AdvanceTrac™

Message	Action
Service AdvanceTrac	The system detects a malfunction due to a blocked sensor.
AdvanceTrac Off On	The driver has disabled or enabled the traction control.
AdvanceTrac SPORT MODE	The system is in sport mode.

Airbag

Message	Action
Occupant Sensor BLOCKED Remove Objects Near Passenger Seat	The system detects a malfunction due to a blocked sensor. Remove blockage.

Alarm

Message	Action
Vehicle Alarm to Stop Alarm, Start Vehicle	Alarm triggered due to unauthorized entry. See Anti-Theft Alarm (page 60).
Alarm All Sensors Perimeter Sensing	All perimeter sensors are active. See Anti-Theft Alarm (page 60).

Information Displays

Battery and Charging System

Message	Action
Check Charging System	The charging system needs servicing. If the warning stays on or continues to come on, contact an authorized dealer as soon as possible.
Charging System Service Soon	The charging system needs servicing. If the warning stays on or continues to come on, contact an authorized dealer as soon as possible.
Charging System Service Now	The charging system needs servicing. Contact an authorized dealer as soon as possible.
Battery State of Charge Low	The battery management system determines that the battery is at a low state of charge. Turn your ignition off as soon as possible to protect the battery. This message clears once you restart your vehicle and the battery state of charge has recovered.
Low Battery Features Temporarily Turned Off	The battery management system detects an extended low-voltage condition. Your vehicle disables various features to help preserve the battery. Turn off as many of the electrical loads as soon as possible to improve system voltage. If the system voltage has recovered, the disabled features operate again as normal.
Turn Power Off to Save Battery	The battery management system determines that the battery is at a low state of charge. Turn your ignition off as soon as possible to protect the battery. This message clears once you restart your vehicle and the battery state of charge has recovered. Turning off unnecessary electrical loads allow faster battery state-of-charge recovery.

Information Displays

Blind Spot Information and Cross Traffic Alert System

Message	Action
Blindspot System Fault	A fault with the system has occurred. Contact an authorized dealer as soon as possible.
Blindspot Not Available Sensor Blocked See Manual	The system sensors are blocked.
Cross Traffic Not Available Sensor Blocked See Manual	The blind spot information system and cross traffic alert system sensors are blocked.
Cross Traffic System Fault	A fault with the system has occurred. Contact an authorized dealer as soon as possible.

Collision Warning System

Message	Action
Collision Warning Malfunction	A fault with the system has occurred. Contact an authorized dealer as soon as possible.
Collision Warning Not Available Sensor Blocked See Manual	You have a blocked sensor due to bad weather, ice, mud or water in front of the radar sensor. You can typically clean the sensor to resolve.
Collision Warning Not Available	A fault with the system has occurred. Contact an authorized dealer as soon as possible.

Doors and Locks

Message	Action
X Door Ajar	The door(s) listed is not completely closed.
Trunk ajar	The trunk is not completely closed.
Hood Ajar	The hood is not completely closed.
Switches Inhibited Security Mode	The system has disabled the door switches.

Information Displays

Engine

Message	Action
Power Reduced to Lower Engine Temp.	The engine is overheating and the power has been reduced to assist in lowering the temperature. Stop in a safe place as soon as it is possible.

Fuel

Message	Action
Fuel Level Low	An early reminder of a low fuel condition.
Check Fuel Fill Inlet	The fuel fill inlet may not be properly closed.

Hill Start Assist

Message	Action
Hill Start Assist Not Available	Hill start assist is not available. Contact an authorized dealer. See Hill Start Assist (page 140).

Keys and Intelligent Access

Message	Action
Press Brake to START	A reminder to press the brake while starting the vehicle.
Press Clutch to Start	A reminder to depress the clutch pedal on manual transmission while starting the vehicle.
No Key Detected	The system does not detect a key in your vehicle. See Keyless Starting (page 119).
Restart Now or Key is Needed	You pressed the start/stop button to switch off the engine and your vehicle does not detect your intelligent access key inside your vehicle.
Accessory Power Active	Your vehicle is in the accessory ignition state.
Starting System Fault	There is a problem with your vehicle's starting system. See an authorized dealer for service.
Key Program Successful	You have successfully programmed an intelligent access key to the system.

Information Displays

Message	Action
Key Program Failure	You have failed to program an intelligent access key to the system.
Max Number of Keys Learned	You have programmed the maximum number of keys to the system.
Not Enough Keys Learned	You have not programmed enough keys to the system.
Key Battery Low Replace Soon	The key battery is low. Change the battery as soon as possible.
Engine On	Inform the driver that they are exiting the vehicle and the engine is on.

Maintenance

Message	Action
LOW Engine Oil Pressure	Stop your vehicle as soon as safely possible and turn off the engine. Check the oil level. If the warning stays on or continues to come on with your engine running, contact an authorized dealer as soon as possible.
Change Engine Oil Soon	The engine oil life remaining is 10% or less. See Engine Oil Check (page 216).
Oil Change Required	The oil life left is at 0%. See Engine Oil Check (page 216).
Brake Fluid Level LOW	The brake fluid level is low, inspected the brake system immediately. See Brake and Clutch Fluid Check (page 221).
Check Brake System	The brake system needs servicing. Stop your vehicle in a safe place. Contact an authorized dealer.
Transport / Factory Mode	Your vehicle is still in Transport or Factory mode. This may not allow some features to operate properly. See an authorized dealer.
See Manual	The powertrain needs service due to a powertrain malfunction.

Information Displays

MyKey

Message	Action
MyKey Not Created	You cannot program a MyKey.
MyKey Active Drive Safely	MyKey is active.
Speed Limited to XX MPH/km/h	When switching on your vehicle and MyKey is in use, displays that the MyKey speed limit is on.
Near Vehicle Top Speed	MyKey is in use and the MyKey speed limit is on and the vehicle speed is approaching 80 mph (130 km/h).
Vehicle at Top Speed of MyKey Setting	You have reached the speed limit set for your MyKey.
Check Speed Drive Safely	You have an active MyKey with a programmed set speed limit.
Buckle Up to Unmute Audio	Belt-Minder turns on with a MyKey in use.
AdvanceTrac On - MyKey Setting	With a MyKey in use, AdvanceTrac turns on.
Traction Control On - MyKey Setting	With a MyKey in use, traction control turns on.
MyKey Park Aid Cannot be Deactivated	With a MyKey in use, park aid is always on.

Park Aid

Message	Action
Check Rear Park Aid	The system has detected a condition that requires service. Contact an authorized dealer. See Rear Parking Aid (page 147).
Rear Park Aid On Off	Displays the park aid status.

Information Displays

Park Brake

Message	Action
Park Brake Engaged	You have set the parking brake and you have driven the vehicle more than 3 mph (5 km/h). If the warning stays on after you have released the parking brake, contact an authorized dealer.

Rear Axle

Message	Action
Axle Over Temperature Reduce Speed	This warning message may display during extended high-speed or road course usage. It indicates that your axle fluid temperature is at a high temperature. Operation under those conditions could cause damage to your car's axle assembly. Reduce the vehicle speed or bring the vehicle to a stop safely, to allow the axle fluid to cool. If the warning message displays again upon restarting the engine, the axle fluid has not sufficiently cooled and further high-speed operation could cause damage to your axle assembly. If you choose to continue driving the car at a reduced speed (and less aggressively) to cool the axle fluid, the warning message will automatically clear when the axle fluid temperature has cooled to a sufficient level. Contact your authorized dealer if message continues.

Remote Start

Message	Action
To Drive: Press Brake and Start Button	A reminder to apply the brake and push the start button to drive your vehicle after a remote start.

Seats

Message	Action
Memory Recall Not Permitted While Driving	A reminder that memory seats are not available while driving.
Memory X Saved	Shows where you have saved your memory setting.

Information Displays

Starting System

Message	Action
Press Brake to Start	A reminder to apply the brake when starting your vehicle.
Press Clutch to Start	A reminder to apply the clutch when starting your vehicle.
Cranking Time Exceeded	The starter has exceeded its cranking time in attempting to start your vehicle.
Engine Start Pending Please Wait	The starter is attempting to start your vehicle.
Pending Start Cancelled	The system has cancelled the pending start.

Steering System

Message	Action
Steering Fault Service Now	The power steering system has detected a condition that requires service. See an authorized dealer.
Steering Loss Stop Safely	The power steering system is not working. Stop your vehicle in a safe place. Contact an authorized dealer.
Steering Assist Fault Service Required	The power steering system has detected a condition within the power steering system or passive entry or passive start system requires service. Contact an authorized dealer.
Steering Lock Malfunction Service Now	The steering lock system has detected a condition that requires service. See an authorized dealer.
Steering Col. Lock Turn Wheel while Starting vehicle	You need to turn your steering wheel while start your vehicle to unlock your steering column.

Information Displays

Tire Pressure Monitoring System

Message	Action
Tire Pressure LOW	One or more tires on your vehicle has low tire pressure. See Tire Pressure Monitoring System (page 260).
Tire Pressure Monitor Fault	The tire pressure monitoring system is malfunctioning. If the warning stays on or continues to come on, contact an authorized dealer. See Tire Pressure Monitoring System (page 260).
Tire Pressure Sensor Fault	A tire pressure sensor is malfunctioning or your spare tire is in use. See Tire Pressure Monitoring System (page 260). If the warning stays on or continues to come on, contact an authorized dealer as soon as possible.

Traction Control

Message	Action
Traction Control Off / Traction Control On	The status of the traction control system after you switched it off or on. See Using Traction Control (page 142).
Spinout Detected Hazards Activated	A spinout has occurred and the hazards are on.

Transmission

Message	Action
Transmission Malfunction Service Now	See your authorized dealer.
Transmission Overheating Stop Safely	The transmission is overheating and needs to cool. Stop in a safe place as soon as it is possible.
Transmission Overtemperature Stop Safely	The transmission has overheated and needs to cool. Stop in a safe place as soon as it is possible.
Transmission Service Required	See your authorized dealer.
Transmission Too Hot Press Brake	Transmission is getting hot. Stop to let it cool.

Information Displays

Message	Action
Transmission Limited Function See Manual	Displays when the transmission has overheated and has limited functionality. See Automatic Transmission (page 134).
Transmission Warming Up Please Wait	Transmission is too cold. Wait for it to warm up before you drive.
Transmission Not in Park	Displays as a reminder to shift into park.
Press Brake Pedal	Displays as a reminder to press the brake pedal in order to select a gear.
Transmission Adjusted	Displays when the transmission has adjusted the shift strategy.
Transmission Adapt Mode	Displays when the transmission is adjusting the shift strategy.
Transmission Indicate Mode Lockup On	Displays when the transmission shift lever is locked and unable to select gears.
Transmission Indicate Mode Lockup Off	Displays when the transmission shift lever is unlocked and free to select gears.

Climate Control

MANUAL CLIMATE CONTROL (If Equipped)

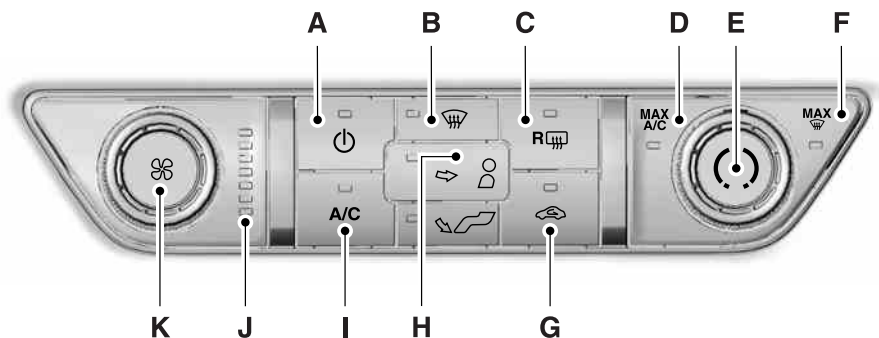

E174095

- A **Power:** Press the button to switch the system on and off. When the system is off, it prevents outside air from entering the vehicle.
 - B **Defrost:** Select to distribute air through the windshield air vents. Air distribution to the instrument panel and footwell vents turns off. You can also use this setting to defrost and clear the windshield of a thin covering of ice.
 - C **Heated rear window:** Press the button to switch the heated rear window on and off. See **Heated Windows and Mirrors** (page 105).
 - D **MAX A/C:** Adjust the control to the full cool position to maximize cooling. Recirculated air flows through the instrument panel vents, air conditioning automatically turns on, and the fan automatically adjusts to the highest speed.
 - E **Temperature control:** Controls the temperature of the air circulated in your vehicle.
 - F **MAX Defrost:** Adjust the control to the full heat position to switch on defrost. Outside air flows through the windshield vents, air conditioning automatically turns on, and fan automatically adjusts to the highest speed. You can also use this setting to defrost and clear the windshield of a thin covering of ice. The heated rear window also automatically turns on when you select maximum defrost.
- Note:** To prevent window fogging, you cannot select recirculated air when maximum defrost is on.

Climate Control

- G **Recirculated air:** Press the button to switch between outside air and recirculated air. When you select recirculated air, the air currently in the passenger compartment recirculates. This may reduce the time needed to cool the interior (when used with **A/C**) and may reduce unwanted odors from entering your vehicle.
- Note:** Recirculated air may turn off automatically (or be prevented from turning on) in all airflow modes except **MAX A/C** to reduce risk of fogging. Recirculated air may also turn on and off automatically in **Panel** or **Panel and Floor** airflow modes during hot weather in order to improve cooling efficiency.
- H **Air distribution control:** Adjust the control to turn airflow from the windshield, instrument panel, or footwell vents on or off. You can distribute air through any combination of these vents.
- I **A/C:** Press the button to switch the air conditioning on or off. Air conditioning cools your vehicle using outside air. To improve the time to reach a comfortable temperature in hot weather, drive with the windows open until you feel cold air through the air vents.
- Note:** In certain conditions (for example, maximum defrost), the air conditioning compressor may continue to operate even though the air conditioning is switched off.
- J **Fan speed indicators:** Illuminates to indicate fan speed.
- K **Fan speed control:** Adjusts the volume of air circulated in the vehicle.

Climate Control

AUTOMATIC CLIMATE CONTROL (If Equipped)

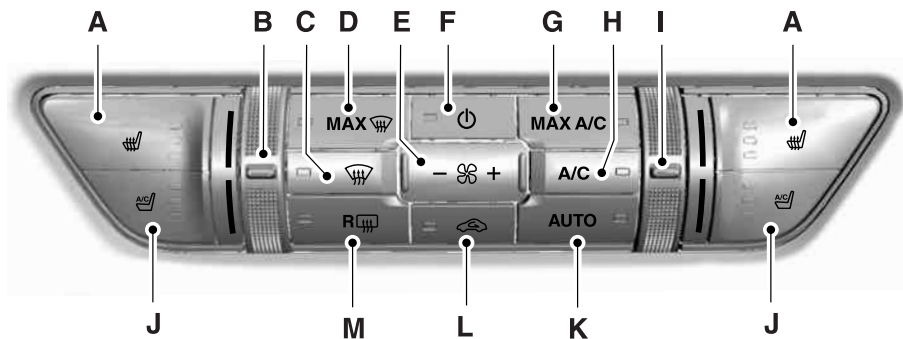

E174096

- A **Heated seats (if equipped):** Press the button to switch the heated seats on and off. See **Climate Controlled Seats** (page 112).
- B **Driver temperature control:** Adjusts the temperature setting using the control on the driver side.
- C **Defrost:** Select to distribute air through the windshield air vents. Air distribution to the instrument panel and footwell vents turns off. You can also use this setting to defrost and clear the windshield of a thin covering of ice.
- D **MAX Defrost:** Press the button to switch on defrost. Outside air flows through the windshield vents, air conditioning automatically turns on, and fan automatically adjusts to the highest speed. You can also use this setting to defrost and clear the windshield of a thin covering of ice. The heated rear window also automatically turns on when you select maximum defrost.
Note: To prevent window fogging, you cannot select recirculated air when maximum defrost is on.
- E **Fan speed control:** Adjusts the volume of air circulated in the vehicle.
- F **Power:** Press the button to switch the system on and off. When the system is off, it prevents outside air from entering the vehicle.
- G **MAX A/C:** Press the button to maximize cooling. Recirculated air flows through the instrument panel vents, air conditioning automatically turns on, and the fan automatically adjusts to the highest speed.

Climate Control

- H **A/C:** Press the button to turn air conditioning compressor on or off. Use air conditioning with recirculated air to improve cooling performance and efficiency.
Note: In certain conditions (for example, maximum defrost), the air conditioning compressor may continue to operate even though the air conditioning is switched off.
- I **Passenger temperature control:** Adjusts the temperature on the passenger side.
- J **Climate controlled seats (if equipped):** Press the button to switch the climate controlled seats on and off. See **Climate Controlled Seats** (page 112).
- K **AUTO:** Press the button to turn on automatic operation. Select the desired temperature using the temperature control. The system adjusts fan speed, air distribution, air conditioning operation, and selects outside air or recirculated air to heat or cool the vehicle in order to maintain the desired temperature. You can also use the **AUTO** button to turn off dual zone operation by pressing and holding the button for more than two seconds.
- L **Recirculated air:** Press the button to switch between outside air and recirculated air. When you select recirculated air, the air currently in the passenger compartment recirculates. This may reduce the time needed to cool the interior (when used with **A/C**) and may reduce unwanted odors from entering your vehicle.
Note: Recirculated air may turn off automatically (or be prevented from turning on) in all airflow modes except **MAX A/C** to reduce risk of fogging. Recirculated air may also turn on and off automatically in **Panel** or **Panel and Floor** airflow modes during hot weather in order to improve cooling efficiency.
- M **Heated rear window:** Press the button to switch the heated rear window on and off. See **Heated Windows and Mirrors** (page 105).

HINTS ON CONTROLLING THE INTERIOR CLIMATE

General Hints

WARNING



Prolonged use of recirculated air may cause the windows to fog up. If the windows fog up, follow the settings for demisting the windshield.

Note: You may feel a small amount of air from the footwell air vents regardless of the air distribution setting.

Note: To reduce humidity build-up inside your vehicle, do not drive with the system switched off or with recirculated air always switched on.

Note: Do not place objects under the front seats as this may interfere with the airflow to the rear seats.

Note: Remove any snow, ice or leaves from the air intake area at the base of the windshield.

Climate Control

Note: To improve the time to reach a comfortable temperature in hot weather, drive with the windows open until you feel cold air through the air vents.

Manual Climate Control

Note: To reduce fogging of the windshield during humid weather, adjust the air distribution control to the windshield air vents position.

Automatic Climate Control

Note: Adjusting the settings when your vehicle interior is extremely hot or cold is not necessary. The system automatically adjusts to heat or cool the interior to your selected temperature as quickly as possible. For the system to function efficiently, the instrument panel and side air vents should be fully open.

Note: If you select **AUTO** during cold outside temperatures, the system directs airflow to the windshield and side window vents. In addition, the fan may run at a slower speed until the engine warms up.

Note: If you select **AUTO** during hot outside temperatures, or when the inside of the vehicle is hot, the system automatically uses recirculated air to maximize interior cooling. When the interior reaches the selected temperature, the system automatically switches to using outside air.

Heating the Interior Quickly

	Vehicle with manual climate control	Vehicle with automatic climate control
1	Adjust the fan speed to a high speed setting.	Press the AUTO button.
2	Adjust the temperature control to the full heat setting.	Adjust the temperature control to the desired setting.
3	Select the footwell air vents using the air distribution buttons.	

Climate Control

Recommended Settings for Heating

	Vehicle with manual climate control	Vehicle with automatic climate control
1	Adjust the fan speed to the center setting.	Press the AUTO button.
2	Adjust the temperature control to the midway point of the hot settings.	Adjust the temperature control to the desired setting. Use 72°F (22°C) as a starting point, then adjust the setting as necessary.
3	Select the footwell air vents using the air distribution buttons.	

Cooling the Interior Quickly

	Vehicle with manual climate control	Vehicle with automatic climate control
1	Adjust the temperature control to the MAX A/C position.	Press the MAX A/C button.
2	Drive with the windows fully open until you feel cold air through the air vents.	

Recommended Settings for Cooling

	Vehicle with manual climate control	Vehicle with automatic climate control
1	Adjust the fan speed to the center setting.	Press the AUTO button.
2	Adjust the temperature control to the midway point of the cold settings.	Adjust the temperature control to the desired setting. Use 72°F (22°C) as a starting point, then adjust the setting as necessary.
3	Select the instrument panel air vents using the air distribution buttons.	

Climate Control

Side Window Defogging in Cold Weather

	Vehicle with manual climate control	Vehicle with automatic climate control
1	Select the windshield air vents using the air distribution buttons.	Press the defrost button.
2	Press the A/C button if the indicator is off.	Adjust the temperature control to the desired setting. Use 72°F (22°C) as a starting point, then adjust the setting as necessary.
3	Adjust the temperature control to the desired setting.	
4	Adjust the fan speed to a high speed setting.	

HEATED WINDOWS AND MIRRORS (If Equipped)

Heated Rear Window

Note: Make sure the engine is running before operating the heated windows.



Press the button to clear the heated rear window of thin ice and fog. The heated rear window will automatically turn off after a short period of time. Start the engine before you switch the heated rear window on.

Note: Do not use razor blades or other sharp objects to clean or remove decals from the inside of the heated rear window. The vehicle warranty does not cover damage caused to the heated rear window grid lines.

Heated Exterior Mirror (If Equipped)

When you switch the heated rear window on, the heated exterior mirrors will automatically turn on.

Note: Do not remove ice from the mirrors with a scraper or adjust the mirror glass when it is frozen in place.

Note: Do not clean the mirror housing or glass with harsh abrasives, fuel or other petroleum-based cleaning products.

CABIN AIR FILTER

Your vehicle is equipped with a cabin air filter, which gives you and your passengers the following benefits:

- It improves your driving comfort by reducing particle concentration.
- It improves the interior compartment cleanliness.
- It protects the climate control components from particle deposits.

You can locate the cabin air filter behind the glove box.

Note: Make sure you have a cabin air filter installed at all times. This prevents foreign objects from entering the system. Running the system without a filter in place could result in degradation or damage to the system.

Replace the filter at regular intervals. See **Scheduled Maintenance** (page 344).

Climate Control

For additional cabin air filter information, or to replace the filter, see an authorized dealer.

REMOTE START (If Equipped)

The remote start feature allows you to pre-condition the interior of your vehicle. The climate control system works to achieve comfort according to your previous settings.

Note: *You cannot adjust the system during remote start operation.*

Turn the ignition on to return the system to its previous settings. You can now make adjustments normally, but you need to turn certain vehicle-dependent features back on, such as:

- Heated seats.
- Cooled seats.
- Heated steering wheel.
- Heated mirrors.
- Heated rear window.

You can adjust the default remote start settings using the information display controls. See **Information Displays** (page 80).

Automatic Settings

In hot weather, the system is set to 72°F (22°C). The cooled seats are set to high (if available, and selected to AUTO in the information display).

In moderate weather, the system either heats or cools (based on previous settings). The rear defroster, heated mirrors and heated seats do not automatically turn on.

In cold weather, the system is set to 72°F (22°C). The heated seats are set to high (if available, and selected to AUTO in the information display). The rear defroster and heated mirrors automatically turn on.

Seats

SITTING IN THE CORRECT POSITION

WARNINGS

 Sitting improperly, out of position or with the seatback reclined too far can take weight off the seat cushion and affect the decision of the passenger sensing system, resulting in serious injury or death in the event of a crash. Always sit upright against your seat back, with your feet on the floor.

 Do not recline the seatback as this can cause the occupant to slide under the safety belt, resulting in serious injury in the event of a crash.

 Do not place objects higher than the seatback to reduce the risk of serious injury in the event of a crash or during heavy braking.

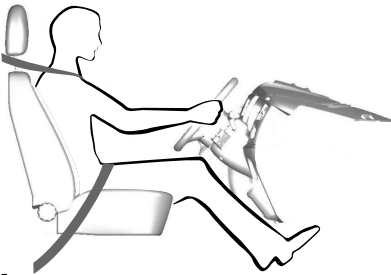

E68595

When you use them properly, the seat, head restraint, safety belt and airbags will provide optimum protection in the event of a crash.

We recommend that you follow these guidelines:

- Sit in an upright position with the base of your spine as far back as possible.
- Do not recline the seatback more than 30 degrees.
- Adjust the head restraint so that the top of it is level with the top of your head and as far forward as possible. Make sure that you remain comfortable.
- Keep sufficient distance between yourself and the steering wheel. We recommend a minimum of 10 in (25 cm) between your breastbone and the airbag cover.
- Hold the steering wheel with your arms slightly bent.
- Bend your legs slightly so that you can press the pedals fully.
- Position the shoulder strap of the safety belt over the center of your shoulder and position the lap strap tightly across your hips.

Make sure that your driving position is comfortable and that you can maintain full control of your vehicle.

HEAD RESTRAINTS

WARNINGS

 Fully adjust the head restraint before you operate your vehicle. This will help minimize the risk of neck injury in the event of a crash. Do not adjust the head restraint when your vehicle is moving.

 The adjustable head restraint is a safety device. Whenever possible it should be installed and properly adjusted when the seat is occupied. Failure to adjust the head restraint properly could reduce its effectiveness during certain impacts.

Seats

WARNINGS



Install the head restraint properly to help minimize the risk of neck injury in the event of a crash.

Note: Adjust the seatback to an upright driving position before adjusting the head restraint. Adjust the head restraint so that the top of it is level with the top of your head and as far forward as possible. Make sure that you remain comfortable. If you are extremely tall, adjust the head restraint to its highest position.

Front seat head restraints (if equipped)

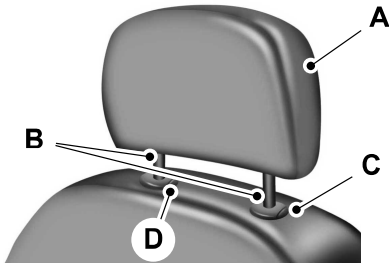

E138642

The head restraints consist of:

- A An energy absorbing head restraint.
- B Two steel stems.
- C Guide sleeve adjust and release button.
- D Guide sleeve unlock and remove button.

Adjusting the Head Restraint

Raising the Head Restraint

Pull the head restraint up.

Lowering the Head Restraint

1. Press and hold button C.
2. Push the head restraint down.

Removing the Head Restraint

1. Pull the head restraint up until it reaches its highest position.
2. Press and hold buttons C and D.
3. Pull the head restraint up.

Installing the Head Restraint

Align the steel stems into the guide sleeves and push the head restraint down until in locks.

Front Seat Non-Adjustable Head Restraints (If Equipped)



E174407

The non-adjustable head restraints consist of a trimmed foam covering over the upper structure of the seatback.

Properly adjust the seatback to an upright driving or riding position, so that the head restraint is positioned as close as possible to the back of your head.

Tilting Head Restraints (If Equipped)

The front head restraints tilt for extra comfort. To tilt the head restraint, do the following:

Seats



E144727

1. Adjust the seatback to an upright driving or riding position.
2. Pivot the head restraint forward toward your head to the desired position.

After the head restraint reaches the forward-most tilt position, pivoting it forward again will then release it to the rearward, un-tilted position.

MANUAL SEATS

WARNINGS



Do not adjust the driver's seat or seatback when your vehicle is moving.



Rock the seat backward and forward after releasing the lever to make sure that it is fully engaged.



Reclining the seatback can cause an occupant to slide under the seat's safety belt, resulting in severe personal injuries in the event of a crash.

The manual front seats may consist of:



E174553

- A A bar to move the seat backward and forward.
- B A lever to adjust the height of the seat.
- C A lever to adjust the angle of the seatback.

POWER SEATS (If Equipped)

WARNINGS



Do not adjust the driver seat or seatback when your vehicle is moving.



Do not place cargo or any objects behind the seatback before returning it to the original position.

Seats

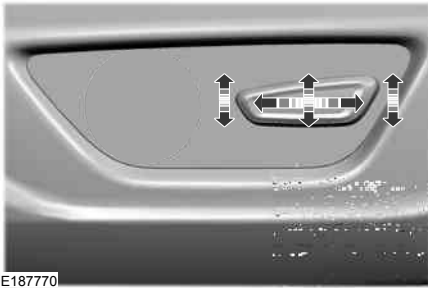

E187770

The power seat control is located on the outboard side of the seat. Move the control in the direction of the arrows to raise or lower the seat cushion or to move the seat forward, backward, up or down.

Power Lumbar (If Equipped)

The power lumbar control is located on the side of the driver seat.

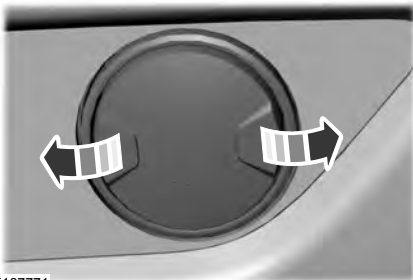



E187771

Press one side of the control to increase lower back firmness. Press the other side of the control to decrease lower back firmness.

MEMORY FUNCTION (If Equipped)

WARNINGS

 Before activating the seat memory, make sure that the area immediately surrounding the seat is clear of obstructions and that all occupants are clear of moving parts.

 Do not use the memory function when your vehicle is moving.

This feature will automatically recall the position of the driver seat and power mirrors. The memory control is located on the driver door.



E142554

Saving a PreSet Position

1. Switch the ignition on.
2. Adjust the seat and exterior mirrors to your desired position.
3. Press and hold the desired preset button until you hear a single tone.

You can save up to three preset memory positions. You can save a memory preset at any time.

Recalling a PreSet Position

Press and release the preset button associated with your desired driving position. The seat and mirrors will move to the position stored for that preset.

Seats

Note: A preset memory position can only be recalled when the ignition is off, or when the transmission is in park (P) or neutral (N) if the ignition is on.

You can also recall a preset memory position by:

- Pressing the unlock button on your intelligent access key fob if it is linked to a preset position.
- Unlocking the intelligent driver door handle if a linked key fob is present.
- Entering a personal entry code on the Securicode keypad. See **Locks** (page 53).

Note: Using a linked key fob to recall your memory position when the ignition is off will move the seat to the Easy Entry position.

Note: Pressing any seat or mirror adjustment control (or any memory button) during a memory recall cancels the operation.

Seat recall movement will also stop if you drive your vehicle.

Linking a PreSet Position to your Remote Control or Intelligent Access Key Fob

Your vehicle can save the preset memory positions for up to three remote controls or intelligent access (IA) keys.

1. With the ignition on, move the memory positions to the desired positions.
2. Press and hold the desired preset button for about five seconds. A tone will sound after about two seconds. Continue holding until a second tone is heard.
3. Within three seconds, press the lock button on the remote control you are linking.

To unlink a remote control, follow the same procedure – except in step 3, press the unlock button on the remote control.

Note: If more than one linked remote control or intelligent access key is in range, the memory function will move to the settings of the first key stored.

Easy Entry and Exit Feature

If you enable the easy entry and exit feature, it automatically moves the driver seat position rearward up to two inches (five centimeters) when you switch the ignition off.

The driver seat will return to the previous position when you switch the ignition on.

You can enable or disable this feature in the information display. See **Information Displays** (page 80).

REAR SEATS

Note: Your vehicle may have split seatbacks that you must fold individually.



E175692

Use the seatback release to fold the back of the front seat forward for rear seat access. This release handle is located on the upper back of the front seat. The seatback has memory and locks automatically in the original position.

Seats

Second Row Split-Folding Rear Seat (If Equipped)



E175611

To lower the seatback(s):

1. Pull the strap to release the seatback.
2. Fold the seatback down.

When raising the seatback(s), make sure you hear the seat latch into place. Pull down on the seatback to make sure that it has latched.

CLIMATE CONTROLLED SEATS

(If Equipped)

Heated Seats

WARNING



Persons who are unable to feel pain to the skin because of advanced age, chronic illness, diabetes, spinal cord injury, medication, alcohol use, exhaustion, or other physical conditions, must exercise care when using the seat heater. The seat heater may cause burns even at low temperatures, especially if used for long periods of time. Do not place anything on the seat that insulates against heat, such as a blanket or cushion, because this may cause the seat heater to overheat.

Note: Do not do the following:

- Place heavy objects on the seat.
- Operate the seat heater if water or any other liquid is spilled on the seat. Allow the seat to dry thoroughly.
- Operate the heated seats unless the engine is running. Doing so can cause the battery to lose charge.



E146322

Touch the heated seat symbol to cycle through the various heat settings and off. Warmer settings are indicated by more indicator lights.

Cooled Seats (If Equipped)

The cooled seats will only function when the engine is running.



E146309

To operate the cooled seats:

Press the cooled seat symbol to cycle through the various cooling settings and off. Cooler settings are indicated by more indicator lights.

If the engine falls below 350 RPM while the cooled seats are on, the feature will turn itself off. You will need to reactivate it.

Universal Garage Door Opener (If Equipped)

HomeLink Wireless Control System

WARNINGS



Make sure that the garage door and security device are free from obstruction when you are programming. Do not program the system with the vehicle in the garage.



Do not use the system with any garage door opener that does not have the safety stop and reverse feature as required by U.S. Federal Safety Standards (this includes any garage door opener manufactured before April 1, 1982). A garage door opener which cannot detect an object, signaling the door to stop and reverse, does not meet current federal safety standards. Using a garage door opener without these features increases the risk of serious injury or death.

Note: Make sure you keep the original remote control transmitter for use in other vehicles as well as for future system programming.

Note: We recommend that upon the sale or lease termination of your vehicle, you erase the programmed function buttons for security reasons. See **Erasing the Function Button Codes** later in this section.

Note: You can program a maximum of three devices. To change or replace any of the three devices after it has been initially programmed, you must first erase the current settings. See **Erasing the Function Button Codes**.



E188211

The universal garage door opener replaces the common hand-held garage door opener with a three-button transmitter integrated into the driver's sun visor.

The system includes two primary features, a garage door opener and a platform for remote activation of devices within the home. You can program garage doors as well as entry gate operators, security systems, entry door locks and home or office lighting.

Additional system information can be found online at www.homelink.com, www.youtube.com/user/HomeLinkGentex or by calling the toll-free help line at 1-800-355-3515.

In-Vehicle Programming

This process is to program your in-vehicle HomeLink function button with your hand-held transmitter.

Note: The programming steps below assume you will be programming HomeLink that was not previously programmed. If your HomeLink was previously programmed, you may need to erase your HomeLink buttons. See **Erasing the Function Button Codes**.

Note: Put a new battery in the hand-held transmitter. This helps ensure quicker training and accurate transmission of the radio-frequency signal.

Universal Garage Door Opener (If Equipped)



E188212

1. With your vehicle parked outside of the garage, switch your ignition to the **on** position, but do not start your vehicle.
2. Press and release the function button that you would like to program.
3. Hold your hand-held garage door transmitter 1–3 in (2–8 cm) away from the HomeLink button you want to program.
4. Press and hold the hand-held transmitter button you want to program while watching the indicator light on HomeLink. Continue to hold the hand-held button until the HomeLink indicator light flashes rapidly or is continuously on.

Note: You may need to use a different method if you live in Canada or have difficulties programming your gate operator or garage door opener. See **Gate Operator / Canadian Programming**.

5. Press and hold the HomeLink button you programmed for two seconds, then release. You may need to do this twice to activate the door. If your garage door does not operate, watch the HomeLink indicator light.

If the indicator light stays on, the programming is complete. Your device should activate when the HomeLink button is pressed and released.

If the indicator light flashes rapidly, press and hold for two seconds and release the programmed HomeLink button. Repeat the "press/hold/release" sequence up to three times to complete the programming process. If your device still does not operate, you must program your garage door. See **Programming Your Garage Door Opener Motor**.

To program additional buttons, repeat Steps 1 – 4.

For questions or comments, please contact HomeLink at www.homelink.com, www.youtube.com/user/HomeLinkGentex or by calling the toll-free help line at 1-800-355-3515.

Programming Your Garage Door Opener Motor

Note: You may need a ladder to reach the unit and you may need to remove the cover or lamp lens on your garage door opener.



E142659

1. Press the learn button on the garage door opener motor and then you have 30 seconds to complete the next two steps.
2. Return to your vehicle.

Universal Garage Door Opener (If Equipped)

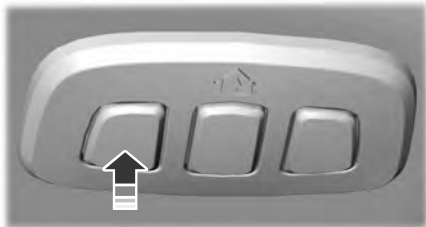

E188212

3. Press and hold the function button you want to program for 2 seconds, then release. Repeat this step. Depending on your brand of garage door opener, you may need to repeat this sequence a third time.

Gate Operator / Canadian Programming

Canadian radio-frequency laws require transmitter signals to “time-out” (or quit) after several seconds of transmission – which may not be long enough for HomeLink to pick up the signal during programming. Similar to this Canadian law, some U.S. gate operators are designed to “time-out” in the same manner.

Note: *If programming a garage door opener or gate operator, it is advised to unplug the device during the “cycling” process to prevent possible overheating.*

1. Press and release, **every two seconds**, your hand-held transmitter until the HomeLink indicator light changes to a rapidly blinking or continuously on light.
2. Release the hand-held transmitter button.
3. Continue programming HomeLink. See **In-Vehicle Programming, Step 4.**

Erasing the Function Button Codes

Note: *You cannot erase individual buttons.*

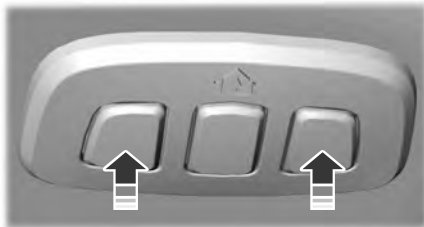

E188213

1. Press and hold the outer two function buttons simultaneously for approximately 10 seconds until the indicator light above the buttons flashes rapidly.
2. When the indicator light flashes, release the buttons. You erased the codes for all buttons.

Reprogramming a Single Button

To program a device to a previously trained button, follow these steps:

1. Press and hold the desired button. Do NOT release the button.
2. The indicator light begins to flash after 20 seconds. Without releasing the button, follow Step 1 in the Programming section.

For questions or comments, contact HomeLink at www.homelink.com, www.youtube.com/user/HomeLinkGentex or by calling the toll-free help line at 1-800-355-3515.

Universal Garage Door Opener (If Equipped)

FCC and RSS-210 Industry Canada Compliance

This device complies with Part 15 of the FCC Rules and with RSS-210 of Industry Canada. Operation is subject to the following two conditions: (1) this device may not cause harmful interference, and (2) this device must accept any interference received, including interference that may cause undesired operation.

Note: *Changes or modifications to your device not expressly approved by the party responsible for compliance can void the user's authority to operate the equipment.*

This equipment complies with FCC radiation exposure limits set forth for an uncontrolled environment. End Users must follow the specific operating instructions for satisfying RF exposure compliance. This transmitter must be at least 8 in (20 cm) from the user and must not be co-located or operating in conjunction with any other antenna or transmitter.

The term "IC:" before the certification/registration number only signifies that Industry Canada technical specifications were met.

Auxiliary Power Points

12 Volt DC Power Point

WARNING



Do not plug optional electrical accessories into the cigar lighter socket (if equipped). Improper use of the lighter can cause damage not covered by your warranty, and can result in fire or serious injury.

Run the vehicle for full capacity use of the power point. To prevent the battery from discharging accidentally:

- Do not use the power point longer than necessary when the vehicle is not running.
- Do not leave devices plugged in overnight or when you park your vehicle for extended periods.

Note: *If used when the vehicle is not running, the battery will discharge. There may be insufficient power to restart your vehicle.*

Note: *Do not insert objects other than an accessory plug into the power point. This will damage the outlet and blow the fuse.*

Note: *Do not hang any type of accessory or accessory bracket from the plug.*

Note: *Do not use the power point over the vehicle capacity of 12 volt DC 180 watts or a fuse may blow.*

Note: *Always keep the power point caps closed when not in use.*

Locations

Power points may be in the following locations:

- On the instrument panel.
- In the center console storage compartment.

Storage Compartments

CENTER CONSOLE

Stow items in the cupholder carefully as items may become loose during hard braking, acceleration or collisions, including hot drinks which may spill.

The console includes:

- Cupholder.
- Storage compartment.



E209039

Lift the latch to open the storage compartment and use the following features:

- Auxiliary power point.
- Auxiliary audio input jack.
- USB port.
- Media hub.

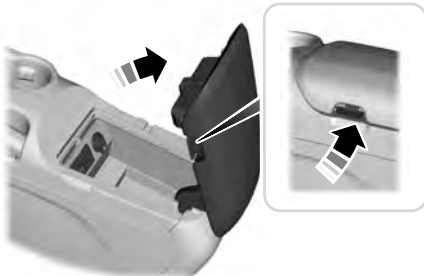

E175706

Locking Storage Bin (If Equipped)

The storage bin locks when the doors are electronically locked. The bin will unlock when the driver door is electronically unlocked with the remote control.

Note: *You cannot lock the storage bin when the vehicle is on.*

GLASSES HOLDER

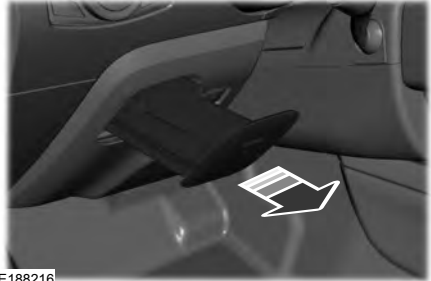

E188216

Press near the center of the door to open it. Pull out the tray.

Starting and Stopping the Engine

GENERAL INFORMATION

WARNINGS



Extended idling at high engine speeds can produce very high temperatures in the engine and exhaust system, creating the risk of fire or other damage.



Do not park, idle or drive your vehicle on dry grass or other dry ground cover. The emission system heats up the engine compartment and exhaust system, creating the risk of fire.



Do not start the engine in a closed garage or in other enclosed areas. Exhaust fumes can be toxic. Always open the garage door before you start the engine.



If you smell exhaust fumes inside your vehicle, have your vehicle checked by an authorized dealer immediately. Do not drive your vehicle if you smell exhaust fumes.

If you disconnect the battery, your vehicle may exhibit some unusual driving characteristics for approximately 5 miles (8 kilometers) after you reconnect it. This is because the engine management system must realign itself with the engine. You can disregard any unusual driving characteristics during this period.

The powertrain control system meets all Canadian interference-causing equipment standard requirements regulating the impulse electrical field or radio noise.

When you start the engine, avoid pressing the accelerator pedal before and during operation. Only use the accelerator pedal when you have difficulty starting the engine.

KEYLESS STARTING

Note: The keyless starting system may not function if the key is close to metal objects or electronic devices such as cellular phones.

Note: A valid key must be located inside your vehicle to switch the ignition on and start the engine.

Ignition Modes

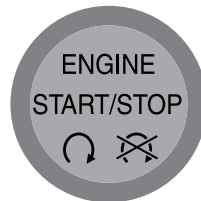

E146431

The keyless starting system has three modes:

Off: Turns the ignition off.

- Without applying the brake pedal, press and release the button once when the ignition is in the on mode, or when the engine is running but the vehicle is not moving.

On: All electrical circuits are operational and the warning lamps and indicators illuminate.

- Without applying the brake pedal, press and release the button once.

Start: Starts the engine.

- Press the brake pedal (automatic transmission) or clutch pedal (manual transmission), and then press the button for any length of time. An indicator light on the button illuminates when the ignition is on and when the engine starts.

Starting and Stopping the Engine

STEERING WHEEL LOCK (If

Equipped)

The steering wheel locks automatically when you leave your vehicle and take the intelligent access key with you. The steering wheel unlocks automatically when you enter your vehicle with the intelligent access key.

Note: You may need to turn the steering wheel left or right if the wheel does not unlock completely. This may happen in certain situations, such as parking your vehicle on a steep grade.

STARTING A GASOLINE ENGINE

When you start the engine, the idle speed increases, this helps to warm up the engine. If the engine idle speed does not slow down automatically, have your vehicle checked by an authorized dealer.

Note: You can crank the engine for a total of 60 seconds (without the engine starting) before the starting system temporarily disables. The 60 seconds does not have to be all at once. For example, if you crank the engine three times for 20 seconds each time, without the engine starting, you reached the 60-second time limit. A message appears in the information display alerting you that you exceeded the cranking time. You cannot attempt to start the engine for at least 15 minutes. After 15 minutes, you are limited to a 15-second engine cranking time. You need to wait 60 minutes before you can crank the engine for 60 seconds again.

Before starting the engine, check the following:

- Make sure all occupants have fastened their seatbelts.
- Make sure the headlamps and electrical accessories are off.
- Make sure the parking brake is on.
- Move the transmission selector lever to park (P) (automatic transmission) or neutral (manual transmission)

Note: Do not touch the accelerator pedal.

Note: You must have your intelligent access key in the vehicle in order to shift the transmission out of position **P**.

1. Fully press the brake pedal.
2. Press the button.

The system does not function if:

- The key frequencies are jammed.
- The key battery has no charge.

If you are unable to start the engine, do the following:



E174956

1. Remove the rubber covering (A) in the cupholder.
2. Place the remote in the backup slot (B) with the buttons facing up and the keyring toward the front of the vehicle.

Starting and Stopping the Engine

3. With the key in this position, press the brake pedal (automatic transmission) or clutch pedal (manual transmission), then the START button to switch the ignition on and start your vehicle.

Fast Restart

The fast restart feature allows you to restart the engine within 20 seconds of switching it off, even if a valid key is not present.

Within 20 seconds of switching the engine off, press the brake pedal (automatic transmission) or clutch pedal (manual transmission) and press the button. After 20 seconds have expired, you can no longer restart the engine without the key present inside your vehicle.

Once the engine has started, it remains running until you press the button, even if the system does not detect a valid key. If you open and close a door while the engine is running, the system searches for a valid key. You cannot restart the engine if the system does not detect a valid key within 20 seconds.

Failure to Start

If you cannot start the engine after three attempts, wait 10 seconds and follow this procedure:

1. If your vehicle is equipped with an automatic transmission, fully press the brake pedal. If your vehicle is equipped with a manual transmission, fully press the clutch pedal and apply the handbrake.
2. Move the transmission selector lever to park (P) (automatic transmission) or neutral (manual transmission).
3. Fully press the accelerator pedal and hold it there.
4. Start the engine.

Automatic Engine Shutdown

Your vehicle is equipped with a feature that automatically shuts down the engine if it has been idling for an extended period. The ignition also turns off in order to save battery power. Before the engine shuts down, a message appears in the information display showing a timer counting down from 30 seconds. If you do not intervene within 30 seconds, the engine shuts down. Another message appears in the information display to inform you that the engine has shut down in order to save fuel. Start your vehicle as you normally do.

Automatic Engine Shutdown Override

Note: *You cannot permanently switch off the automatic engine shutdown feature. When you switch it off temporarily, it turns on at the next ignition cycle.*

You can stop the engine shutdown, or reset the timer, at any point before the 30-second countdown has expired by doing any of the following:

- You can reset the timer by interacting with your vehicle (such as pressing the brake pedal or accelerator pedal).
- You can temporarily switch off the shutdown feature any time the ignition is on (for the current ignition cycle only). Use the information display to do so. See **Information Displays** (page 80).
- During the countdown before engine shutdown, you are prompted to press OK or RESET (depending on your type of information display) to temporarily switch the feature off (for the current ignition cycle only).

Stopping the Engine When Your Vehicle is Stationary

1. Move the transmission selector lever to park (P) (automatic transmission) or neutral (manual transmission).

Starting and Stopping the Engine

2. Press the button once.
3. Apply the parking brake.

Note: This switches off the ignition, all electrical circuits, warning lamps and indicators.

Note: If the engine is idling for 30 minutes, the ignition and engine automatically shut down.

Stopping the Engine When Your Vehicle is Moving

WARNING



Switching off the engine when the vehicle is still moving will result in a loss of brake and steering assistance. The steering will not lock, but higher effort will be required. When the ignition is switched off, some electrical circuits, including air bags, warning lamps and indicators may also be off. If the ignition was turned off accidentally, you can shift into neutral (N) and re-start the engine.

1. Move the transmission selector lever to the neutral position and use the brakes to bring your vehicle to a safe stop.
2. When your vehicle has stopped, move the transmission selector lever to park (P) (automatic transmission) or neutral (manual transmission).
3. Press and hold the button for one second, or press it three times within two seconds.
4. Apply the parking brake.

Guarding Against Exhaust Fumes

WARNING



If you smell exhaust fumes inside your vehicle, have your vehicle checked by your authorized dealer immediately. Do not drive your vehicle if you smell exhaust fumes. Carbon monoxide is present in exhaust fumes. Take precautions to avoid its dangerous effects.

Important Ventilating Information

If you stop your vehicle and leave the engine idling for long periods, we recommend that you do one of the following:

- Open the windows at least 1 in (2.5 cm).
- Set your climate control to outside air.

ENGINE BLOCK HEATER (if

Equipped)

WARNINGS



Failure to follow engine block heater instructions could result in property damage or serious personal injury.



Do not use your heater with ungrounded electrical systems or two-pronged adapters. There is a risk of electrical shock.



Do not fully close the hood, or allow it to drop under its own weight when using the engine block heater. This could damage the power cable and may cause an electrical short resulting in fire, injury and property damage.

Note: The heater is most effective when outdoor temperatures are below 0°F (-18°C).

Starting and Stopping the Engine

The heater acts as a starting aid by warming the engine coolant. This allows the climate control system to respond quickly. The equipment includes a heater element (installed in the engine block) and a wire harness. You can connect the system to a grounded 120-volt AC electrical source.

We recommend that you do the following for a safe and correct operation:

- Use a 16-gauge outdoor extension cord that is product certified by Underwriter's Laboratory (UL) or Canadian Standards Association (CSA). This extension cord must be suitable for use outdoors, in cold temperatures, and be clearly marked Suitable for Use with Outdoor Appliances. Do not use an indoor extension cord outdoors. This could result in an electric shock or become a fire hazard.
- Use as short an extension cord as possible.
- Do not use multiple extension cords.
- Make sure that when in operation, the extension cord plug and heater cord plug connections are free and clear of water. This could cause an electric shock or fire.
- Make sure your vehicle is parked in a clean area, clear of combustibles.
- Make sure the heater, heater cord and extension cord are firmly connected.
- Check for heat anywhere in the electrical hookup once the system has been operating for approximately 30 minutes.

- Make sure the system is unplugged and properly stowed before starting and driving your vehicle. Make sure the protective cover seals the prongs of the block heater cord plug when not in use.
- Make sure the heater system is checked for proper operation before winter.

Using the Engine Block Heater

Make sure the receptacle terminals are clean and dry prior to use. Clean them with a dry cloth if necessary.

The heater uses 0.4 to 1.0 kilowatt-hours of energy per hour of use. The system does not have a thermostat. It achieves maximum temperature after approximately three hours of operation. Using the heater longer than three hours does not improve system performance and unnecessarily uses electricity.

Fuel and Refueling

SAFETY PRECAUTIONS

WARNINGS



Do not overfill the fuel tank. The pressure in an overfilled tank may cause leakage and lead to fuel spray and fire.



The fuel system may be under pressure. If you hear a hissing sound near the fuel filler inlet, do not refuel until the sound stops. Otherwise, fuel may spray out, which could cause serious personal injury.



Automotive fuels can cause serious injury or death if misused or mishandled.



Flow of fuel through a fuel pump nozzle can produce static electricity. This can cause a fire if you are filling an ungrounded fuel container.



Gasoline may contain benzene, which is a cancer-causing agent.



When refueling always shut the engine off and never allow sparks or open flames near the fuel tank filler valve. Never smoke or use a cell phone while refueling. Fuel vapor is extremely hazardous under certain conditions. Avoid inhaling excess fumes.

Observe the following guidelines when handling automotive fuel:

- Extinguish all smoking materials and any open flames before refueling your vehicle.
- Always turn off the vehicle before refueling.
- Automotive fuels can be harmful or fatal if swallowed. Fuel such as gasoline is highly toxic and if swallowed can cause death or permanent injury. If fuel is swallowed, call a physician immediately, even if no symptoms are immediately apparent. The toxic effects of fuel may not be visible for hours.
- Avoid inhaling fuel vapors. Inhaling too much fuel vapor of any kind can lead to eye and respiratory tract irritation. In severe cases, excessive or prolonged breathing of fuel vapor can cause serious illness and permanent injury.
- Avoid getting fuel liquid in your eyes. If fuel is splashed in the eyes, remove contact lenses (if worn), flush with water for 15 minutes and seek medical attention. Failure to seek proper medical attention could lead to permanent injury.
- Fuels can also be harmful if absorbed through the skin. If fuel is splashed on the skin, clothing or both, promptly remove contaminated clothing and wash skin thoroughly with soap and water. Repeated or prolonged skin contact with fuel liquid or vapor causes skin irritation.
- Be particularly careful if you are taking Antabuse or other forms of Disulfiram for the treatment of alcoholism. Breathing gasoline vapors could cause an adverse reaction, serious personal injury or sickness. If fuel is splashed on the skin, wash the affected areas immediately with plenty of soap and water. Consult a physician immediately if you experience any adverse reactions.

Fuel and Refueling

FUEL QUALITY

Choosing the Right Fuel

Use only UNLEADED gasoline or UNLEADED gasoline blended with a maximum of 15% ethanol in your gasoline vehicle. Flex fuel vehicles have a yellow fuel fill cap or the fuel fill inlet will have a yellow housing or bezel.

Do not use:

- Fuel containing more than 15% ethanol or E-85 fuel.
- Fuel with methanol.
- Fuels containing metallic based additives, including manganese-based compounds.
- Fuels containing the octane booster additive, methylcyclopentadienyl manganese tricarbonyl (MMT).
- Leaded fuel (The use of leaded fuel is prohibited by law).

Note: *Use of any fuel other than recommended fuel can cause powertrain damage, impair the emission control system or cause loss of vehicle performance. Any damage to vehicle that is caused by use of fuel not recommended will not be covered under warranty.*

Octane Recommendations

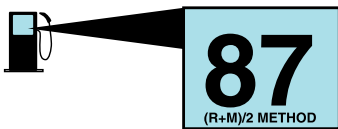

E161513

Do not be concerned if your engine sometimes knocks lightly. However, if it knocks heavily under most driving conditions while you are using fuel with the recommended octane rating, see your authorized dealer to prevent any engine damage.

2.3L EcoBoost and 5.0L V8 Engines

We recommend regular unleaded gasoline with a pump (R+M)/2 octane rating of 87. Some stations offer fuels posted as regular with an octane rating below 87, particularly in high altitude areas. We do not recommend fuels with an octane rating below 87.

To provide improved performance, we recommend premium fuel for severe duty usage, such as trailer tow.

3.7L V6 Engines

We recommend regular unleaded gasoline with a pump (R+M)/2 octane rating of 87. Some stations offer fuels posted as regular with an octane rating below 87, particularly in high altitude areas. We do not recommend fuels with an octane rating below 87.

RUNNING OUT OF FUEL

Avoid running out of fuel. This situation may have an adverse effect on powertrain components.

If you have run out of fuel:

Fuel and Refueling

- You may need to cycle the ignition from off to on several times after refueling to allow the fuel system to pump the fuel from the fuel tank to the engine. On restarting, cranking time will take a few seconds longer than normal.
- Normally, adding 1.0 gal (3.8 L) of fuel is enough to restart the engine. If the vehicle is out of fuel and on a steep grade, more than 1.0 gal (3.8 L) may be required.
- The service engine soon indicator may come on. For more information on the service engine soon indicator, See **Warning Lamps and Indicators** (page 76).
- For information on calculating DTE (Distance to empty), See **Instrument Cluster** (page 74).

Refilling With a Portable Fuel Container

WARNINGS

 Do not insert the nozzle of portable fuel containers or aftermarket funnels into the Easy Fuel “no cap” fuel system. This could damage the fuel system and its seal, and may cause fuel to run onto the ground instead of filling the tank, which could result in serious personal injury.

 Do not try to pry open or push open the Easy Fuel “no cap” fuel system with foreign objects. This could damage the fuel system and its seal and cause injury to you or others.

Note: When filling the vehicle’s fuel tank from a portable fuel container, use the funnel included with the vehicle.

With the Easy Fuel capless fuel system, use the following directions when filling from a portable fuel container:



E142668

1. Locate the white plastic funnel in the spare tire compartment.
2. Slowly insert the portable fuel container into the fuel filler opening.
3. Fill the vehicle with fuel from the portable fuel container.
4. When done, clean the funnel or properly dispose of it. You can purchase extra funnels from your authorized dealer if you choose to dispose of the funnel. Do not use aftermarket funnels. They will not work with the Easy Fuel system and can damage it. We have specially designed the included funnel to work safely with your vehicle.

REFUELING

WARNINGS





 Fuel vapor burns violently and a fuel fire can cause severe injuries.

 Read and follow all the instructions on the pump island.

 When refueling always shut the engine off and never allow sparks or open flames near the fuel tank filler valve. Never smoke or use a cell phone while refueling. Fuel vapor is extremely hazardous under certain conditions. Avoid inhaling excess fumes.

Fuel and Refueling

WARNINGS

-  Stay outside your vehicle and do not leave the fuel pump unattended when refueling your vehicle. This is against the law in some places.
-  Keep children away from the fuel pump; never let children pump fuel.
-  Wait at least 10 seconds before removing the fuel pump nozzle to allow any residual fuel to drain into the fuel tank.
-  Stop refueling when the fuel pump nozzle automatically shuts off for the first time. Failure to follow this will fill the expansion space in the fuel tank and could lead to fuel overflowing.
-  Do not remove the fuel pump nozzle from its fully inserted position when refueling.

Use the following guidelines to avoid electrostatic charge build-up, which can produce a spark, when filling an ungrounded fuel container:

- Place approved fuel container on the ground.
- Do not fill a fuel container while it is in the vehicle (including the cargo area).
- Keep the fuel pump nozzle in contact with the fuel container while filling.
- Do not use a device that would hold the fuel pump handle in the fill position.

Easy Fuel™ Capless Fuel System

WARNING

-  The fuel system may be under pressure. If you hear a hissing sound near the fuel filler door, do not refuel until the sound stops. Otherwise, fuel may spray out, which could cause serious personal injury.

When fueling your vehicle:

1. When your vehicle has stopped, shift into park (P) and switch the ignition off.
2. Fully open the fuel tank filler door until it engages.

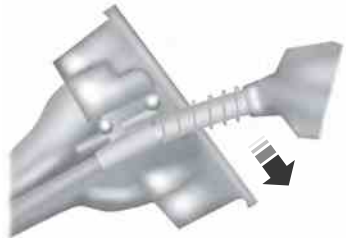

E156032

3. Insert the fuel pump nozzle up to the first notch on the nozzle. Hold handle higher during insertion for easier access. Leave the fuel pump nozzle fully inserted until you are done pumping.

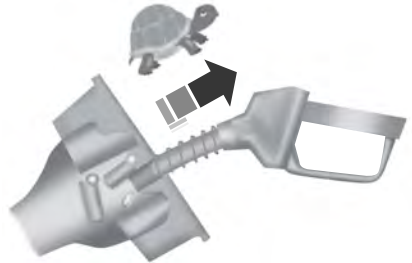

E154765

4. Remove the fuel filler nozzle and fully close the fuel tank filler door.

Fuel and Refueling

Note: A fuel spillage concern may occur if overfilling the fuel tank. Do not overfill the tank. The fill pipe is equipped with a drain hole. Excess fuel due to overfill may drain through the drain hole and drip onto the ground.

If the fuel fill inlet was not properly closed, a service engine warning lamp may appear on the instrument cluster.

At the next opportunity, do the following:

1. Stop your vehicle as soon as safely possible and shift the transmission into park (P).
2. Switch the ignition off.
3. Open the fuel filler door and remove any visible debris from the fuel fill opening.
4. Insert either the fuel fill nozzle or the fuel fill funnel provided with the vehicle several times to allow the inlet to close properly. This will dislodge any debris preventing the inlet from sealing.

If this action corrects the problem, the message may not reset immediately. It may take several driving cycles for the message to turn off. A driving cycle consists of an engine start-up (after 4 or more hours with the engine off) followed by city or highway driving. Continuing to drive with the message on may cause the service engine soon lamp to turn on as well.

FUEL CONSUMPTION

The advertised capacity is the indicated capacity and the empty reserve combined. Indicated capacity is the difference in the amount of fuel in the fuel tank and when the fuel gauge indicates empty.

See **Capacities and Specifications** (page 271).

Note: The amount of fuel in the empty reserve varies and should not be relied upon to increase driving range.

Note: When refueling your vehicle after the fuel gauge indicates empty, you might not be able to refuel the full amount of the advertised capacity due to the empty reserve still present in the fuel tank.

Filling the Fuel Tank

For consistent results when refueling:

- Always switch the ignition off before refueling. If you leave the engine running, you will get an inaccurate reading.
- Use the same fill rate (low-medium-high) each time you fill the tank.
- Allow no more than two automatic shut-offs when refueling.

Results are most accurate when the filling method is consistent.

Calculating Fuel Economy

Do not measure fuel economy during the first 1,000 mi (1,600 km) of driving (this is your engine's break-in period). A more accurate measurement is obtained after 2,000 mi (3,200 km) to 3,000 mi (4,800 km). Also, fuel expense, frequency of fill ups or fuel gauge readings are not accurate ways to measure fuel economy.

1. Fill the fuel tank completely and record the initial odometer reading.
2. Each time you fill the fuel tank, record the amount of fuel added.
3. After at least three fill ups, fill the fuel tank and record the current odometer reading.
4. Subtract your initial odometer reading from the current odometer reading.

Fuel and Refueling

5. To calculate L/100 km (liters per 100 kilometers) fuel consumption, multiply the liters used by 100, then divide by kilometers traveled. To calculate MPG (miles per gallon) fuel consumption, divide miles traveled by gallons used.

Keep a record for at least one month and record the type of driving (city or highway). This provides an accurate estimate of your vehicle's fuel economy under current driving conditions. Keeping records during summer and winter will show how temperature impacts fuel economy.

Conditions

- Heavily loading your vehicle reduces fuel economy.
- Carrying unnecessary weight in your vehicle may reduce fuel economy.
- Adding certain accessories to your vehicle such as bug deflectors, rollbars or light bars, running boards and ski racks may reduce fuel economy.
- Using fuel blended with alcohol may lower fuel economy.
- Fuel economy may decrease with lower temperatures.
- Fuel economy may decrease when driving short distances.
- You will get better fuel economy when driving on flat terrain than when driving on hilly terrain.

EMISSION CONTROL SYSTEM

WARNINGS



Do not park, idle, or drive your vehicle in dry grass or other dry ground cover. The emission system heats up the engine compartment and exhaust system, which can start a fire.

WARNINGS



Exhaust leaks may result in entry of harmful and potentially lethal fumes into the passenger compartment. If you smell exhaust fumes inside your vehicle, have your dealer inspect your vehicle immediately. Do not drive if you smell exhaust fumes.

Your vehicle is equipped with various emission control components and a catalytic converter that will enable your vehicle to comply with applicable exhaust emission standards. To make sure that the catalytic converter and other emission control components continue to work properly:

- Use only the specified fuel listed.
- Avoid running out of fuel.
- Do not turn off the ignition while your vehicle is moving, especially at high speeds.
- Have the items listed in scheduled maintenance information performed according to the specified schedule.

The scheduled maintenance items listed in scheduled maintenance information are essential to the life and performance of your vehicle and to its emissions system. See **Scheduled Maintenance** (page 344).

If you use parts other than Ford, Motorcraft or Ford-authorized parts for maintenance replacements, or for service of components affecting emission control, such non-Ford parts should be the equivalent to genuine Ford Motor Company parts in performance and durability.

Illumination of the service engine soon indicator, charging system warning light or the temperature warning light, fluid leaks, strange odors, smoke or loss of engine power could indicate that the emission control system is not working properly.

Fuel and Refueling

An improperly operating or damaged exhaust system may allow exhaust to enter the vehicle. Have a damaged or improperly operating exhaust system inspected and repaired immediately.

Do not make any unauthorized changes to your vehicle or engine. By law, vehicle owners and anyone who manufactures, repairs, services, sells, leases, trades vehicles, or supervises a fleet of vehicles are not permitted to intentionally remove an emission control device or prevent it from working. Information about your vehicle's emission system is on the Vehicle Emission Control Information Decal located on or near the engine. This decal also lists engine displacement

Please consult your warranty information for complete details.

On-Board Diagnostics (OBD-II)

Your vehicle has a computer known as the on-board diagnostics system (OBD-II) that monitors the engine's emission control system. The system protects the environment by making sure that your vehicle continues to meet government emission standards. The OBD-II system also assists a service technician in properly servicing your vehicle.



When the service engine soon indicator illuminates, the OBD-II system has detected a malfunction. Temporary malfunctions may cause the service engine soon indicator to illuminate.

Examples of temporary malfunctions are:

- the vehicle has run out of fuel—the engine may misfire or run poorly
- poor fuel quality or water in the fuel—the engine may misfire or run poorly

- the fuel fill inlet may not have closed properly. See **Refueling** (page 126).
- driving through deep water—the electrical system may be wet.

You can correct these temporary malfunctions by filling the fuel tank with good quality fuel, properly closing the fuel fill inlet or letting the electrical system dry out. After three driving cycles without these or any other temporary malfunctions present, the service engine soon indicator should stay off the next time you start the engine. A driving cycle consists of a cold engine startup followed by mixed city/highway driving. No additional vehicle service is required.

If the service engine soon indicator remains on, have your vehicle serviced at the first available opportunity. Although some malfunctions detected by the OBD-II may not have symptoms that are apparent, continued driving with the service engine soon indicator on can result in increased emissions, lower fuel economy, reduced engine and transmission smoothness, and lead to more costly repairs.

Readiness for Inspection/Maintenance (I/M) Testing

Some state/provincial and local governments may have Inspection/Maintenance (I/M) programs to inspect the emission control equipment on your vehicle. Failure to pass this inspection could prevent you from getting a vehicle registration.



If the service engine soon indicator is on or the bulb does not work, you may need to have the vehicle serviced. See On-Board Diagnostics (OBD-II).

Fuel and Refueling

Your vehicle may not pass the I/M test if the service engine soon indicator is on or not working properly (bulb is burned out), or if the OBD-II system has determined that some of the emission control systems have not been properly checked. In this case, your vehicle is not ready for I/M testing.

If the vehicle's engine or transmission has just been serviced, or the battery has recently run down or been replaced, the OBD-II system may indicate that the vehicle is not ready for I/M testing. To determine if the vehicle is ready for I/M testing, turn the ignition key to the on position for 15 seconds without cranking the engine. If the service engine soon indicator blinks eight times, it means that the vehicle is not ready for I/M testing; if the service engine soon indicator stays on solid, it means that the vehicle is ready for I/M testing.

The OBD-II system monitors the emission control system during normal driving. A complete check may take several days. If the vehicle is not ready for I/M testing, you may need to perform the following driving cycle consisting of mixed city and highway driving:

Drive on an expressway or highway for a steady 15 minutes, followed by 20 minutes of stop-and-go driving with at least four 30-second idle periods.

Allow the vehicle to sit for at least eight hours without starting the engine. Then, start the engine and complete the above driving cycle. The engine must warm up to its normal operating temperature. Once started, do not turn off the engine until the above driving cycle is complete. If the vehicle is still not ready for I/M testing, you will have to repeat the above driving cycle.

Transmission

MANUAL TRANSMISSION

Using the Clutch

Note: Failure to fully press the clutch pedal to the floor may cause increased shift efforts, prematurely wear transmission components or damage the transmission.

Note: Do not drive with your foot resting on the clutch pedal or use the clutch pedal to hold your vehicle at a standstill while waiting on a hill. These actions will reduce the life of the clutch and could nullify a clutch warranty claim.

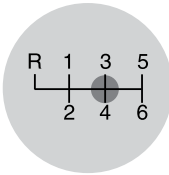

E144954

Manual transmission vehicles have a starter interlock that prevents cranking the engine unless the clutch pedal is fully pressed.

To start the vehicle:

1. Make sure the parking brake is fully set.
2. Press the clutch pedal to the floor, then put the gearshift lever in the neutral position.
3. Start the engine.
4. Press the brake pedal and move the gearshift lever to the desired gear; first (1) or reverse (R).
5. Release the parking brake, then slowly release the clutch pedal while slowly pressing on the accelerator.

During each shift, the clutch pedal must be fully pressed to the floor. Make sure the floor mat is properly positioned so it doesn't interfere with the full extension of the clutch pedal.

Recommended Shift Speeds

Note: Do not downshift into first (1) when your vehicle is moving faster than 15 mph (24 km/h). This will damage the clutch.

2.3L

Recommended upshifts (for best fuel economy) when accelerating	
Shift from:	
1 - 2	15 mph (24 km/h)
2 - 3	24 mph (39 km/h)
3 - 4	35 mph (56 km/h)
4 - 5	41 mph (66 km/h)
5 - 6	50 mph (80 km/h)

3.7L with 3.15 Axle Ratio

Recommended upshifts (for best fuel economy) when accelerating	
Shift from:	
1 - 2	13 mph (21 km/h)
2 - 3	26 mph (42 km/h)
3 - 4	37 mph (60 km/h)
4 - 5	43 mph (69 km/h)
5 - 6	59 mph (95 km/h)

Transmission

3.7L with 3.55 Axle Ratio

Recommended upshifts (for best fuel economy) when accelerating	
Shift from:	
1 - 2	13 mph (21 km/h)
2 - 3	24 mph (39 km/h)
3 - 4	33 mph (53 km/h)
4 - 5	39 mph (63 km/h)
5 - 6	43 mph (69 km/h)

5.0L

Recommended upshifts (for best fuel economy) when accelerating	
Shift from:	
1 - 2	13 mph (21 km/h)
2 - 3	24 mph (39 km/h)
3 - 4	31 mph (50 km/h)
4 - 5	39 mph (63 km/h)
5 - 6	43 mph (69 km/h)

Reverse

Note: Make sure that your vehicle is at a complete stop before you shift into reverse (R). Failure to do so may damage the transmission.

1. Press the clutch pedal to the floor to disengage clutch.
2. Shift into reverse (R) by raising the collar below the gearshift knob up, then moving the lever fully to the left, then forward.

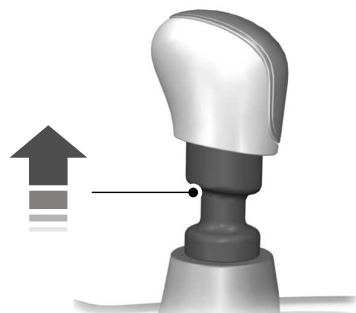

E99067

Note: The gearshift lever can only be moved to reverse (R) by raising the collar below the gearshift knob up before shifting to reverse. This is a lockout feature which protects the transmission from accidentally engaging reverse (R) when intending to select first (1).

If reverse (R) is not fully engaged, press the clutch pedal down and return the gearshift to the neutral position. Release the clutch pedal for a moment, then raise the collar and shift to reverse (R) again.

Parking Your Vehicle

WARNING



Do not park your vehicle in neutral (N), it may move unexpectedly and injure someone. Use first (1) gear and set the parking brake fully.

To park your vehicle:

1. Apply the brake and shift into the neutral position.
2. Fully apply the parking brake, hold the clutch pedal down, then shift into first (1).
3. Turn the ignition off.

Transmission

AUTOMATIC TRANSMISSION

(If Equipped)

WARNINGS



Always set the parking brake fully and make sure the gearshift is latched in park (P). Turn the ignition to the off position and remove the key whenever you leave your vehicle.



Do not apply the brake pedal and accelerator pedal simultaneously. Applying both pedals simultaneously for more than three seconds will limit engine rpm, which may result in difficulty maintaining speed in traffic and could lead to serious injury.

Understanding the Positions of Your Automatic Transmission

Putting your vehicle in gear:

1. Fully press down the brake pedal.
2. Press and hold the button on the top of the gearshift lever.
3. Move the gearshift lever into the desired gear.
4. Release the button and your transmission remains in the selected gear.



E174572

Park (P)

This position locks the transmission and prevents the rear wheels from turning. Come to a complete stop before putting your vehicle into and out of park (P).

Reverse (R)

With the selector in reverse (R), your vehicle moves backward. Always come to a complete stop before shifting into and out of reverse (R).

Neutral (N)

With the selector in neutral (N), you can start your vehicle and it is free to roll. Hold the brake pedal down while in this position.

Drive (D)

Drive (D) is the normal driving position for the best fuel economy. The overdrive function allows automatic upshifts and downshifts through all gears.

Sport (S)

Putting your vehicle in sport (S):

- Provides additional engine braking and extends lower gear operation to enhance performance for uphill climbs, hilly terrain or mountainous areas. This will increase engine RPM during engine braking.
- Provides additional lower gear operation through the automatic transmission shift strategy.
- Provides gear selection more quickly and at higher engine speeds.

SelectShift Automatic™ Transmission

Your vehicle has a SelectShift Automatic transmission. The SelectShift Automatic transmission gives you the ability to change gears up or down (without a clutch) as desired.

Transmission

In order to prevent the engine from running at too low an RPM, which may cause it to stall, SelectShift still automatically makes some downshifts if it has determined that you have not downshifted in time. Although SelectShift makes some downshifts for you, it still allows you to downshift at any time as long as the SelectShift determines that damage will not be caused to the engine from over-revving.

Note: *Engine damage may occur if you maintain excessive engine revving without shifting.*

SelectShift does not automatically upshift, even if the engine is approaching the RPM limit. It must be shifted manually by pressing the + button. Notice should be taken of the shift indicator lamp, which alerts you when to shift to make sure you achieve the highest level of efficiency and fuel economy.

Pull the + paddle on the steering wheel to activate SelectShift.

- Pull the right paddle (+) to upshift.
- Pull the left paddle (-) to downshift.



E144821

SelectShift in drive (D):

- Provides a temporary manual mode for performing more demanding maneuvers where extra control of gear selection is required (for example, when towing or overtaking). This mode will hold a selected gear for a temporary period of time dependent on driver inputs (for example, steering or accelerator pedal input).

SelectShift in sport (S):

- Provides a permanent manual gear selection where full control of gear selection is required.

To exit SelectShift mode shift the transmission into another gear (for example, drive [D]).

The instrument cluster displays your currently selected gear. If a gear is requested but not available due to vehicle conditions (low speed, too high engine speed for requested gear selection), the current gear flashes three times.

Note: *At full accelerator pedal travel, the transmission automatically downshifts for maximum performance.*

Note: *In low traction conditions, you can pull away in second gear using SelectShift. To perform this operation, select drive (D) or sport (S) mode and press the + toggle (if equipped) or pull the + paddle (if equipped) until 2 is displayed on the cluster. Your vehicle is now ready to move in 2nd gear.*

Brake-Shift Interlock

WARNINGS



Do not drive your vehicle until you verify that the brake lamps are working.

Transmission

WARNINGS



When doing this procedure, you will be taking your vehicle out of park which means your vehicle can roll freely. To avoid unwanted vehicle movement, always fully set the parking brake prior to doing this procedure. Use wheel chocks if appropriate.



If the parking brake is fully released, but the brake warning lamp remains illuminated, the brakes may not be working properly. See your authorized dealer.

Note: Contact an authorized dealer as soon as possible if this procedure is used.

Note: For some markets, this feature will be disabled.

Use the brake shift interlock lever to move the gearshift lever from the park position in the event of an electrical malfunction or if your vehicle has a dead battery.

Apply the parking brake and switch the ignition off before performing this procedure.



E184747

1. Using a flat head screwdriver or similar tool, remove the chrome bezel and gearshift bracket at the base of the gearshift lever.



E174501

2. Locate the white release lever and slide the lever forward while pulling the gearshift lever out of the park (P) position and into the neutral (N) position.
3. Reinstall the console.
4. Start your vehicle and release the parking brake.

Automatic Transmission Adaptive Learning

This feature is designed to increase durability and provide consistent shift feel over the life of your vehicle. A new vehicle or transmission may have firm or soft shifts. This operation is normal and does not affect function or durability of the transmission. Over time, the adaptive learning process will fully update transmission operation. Additionally, whenever you disconnect the battery is or install a new battery, the system must relearn the strategy.

If Your Vehicle Gets Stuck In Mud or Snow

Note: Do not rock your vehicle if the engine is not at normal operating temperature or damage to the transmission may occur.

Transmission

Note: *Do not rock your vehicle for more than a minute or damage to the transmission and tires may occur, or the engine may overheat.*

If your vehicle gets stuck in mud or snow, you may rock it out by shifting between forward and reverse gears, stopping between shifts in a steady pattern. Press lightly on the accelerator in each gear.

Rear Axle

LIMITED SLIP DIFFERENTIAL

(If Equipped)

This axle provides added traction on slippery surfaces, particularly when one wheel is on a poor traction surface. Under normal conditions, the limited-slip axle functions like a standard rear axle. The axle may exhibit a slight noise or vibration during tight turns with low vehicle speed. This is normal behavior and indicates the axle is working.

Traction-Lok™ and TORSEN™ Axles (If Equipped)

These axles provide improved traction on slippery and loose surfaces, particularly when one wheel is on a poor traction surface. Under normal conditions, these axles function like a standard rear axle.

Extended use of tire sizes other than the manufacturer's specified tire size on these axles could result in a permanent reduction in effectiveness. This loss does not affect your normal driving and should not be noticeable.

Brakes

GENERAL INFORMATION

Note: Occasional brake noise is normal. If a metal-to-metal, continuous grinding or continuous squeal sound is present, the brake linings may be worn-out. Have the system checked by an authorized dealer. If your vehicle has continuous vibration or shudder in the steering wheel while braking, have it checked by an authorized dealer.

Note: Brake dust may accumulate on the wheels, even under normal driving conditions. Some dust is inevitable as the brakes wear and does not contribute to brake noise. See **Cleaning the Alloy Wheels** (page 234).



See **Warning Lamps and Indicators** (page 76).

Wet brakes result in reduced braking efficiency. Gently press the brake pedal a few times when driving from a car wash or standing water to dry the brakes.

Brake Over Accelerator

In the event the accelerator pedal becomes stuck or entrapped, apply steady and firm pressure to the brake pedal to slow the vehicle and reduce engine power. If you experience this condition, apply the brakes and bring your vehicle to a safe stop. Move the transmission to park (P), switch the engine off and apply the parking brake. Inspect the accelerator pedal for any interference. If none are found and the condition persists, have your vehicle towed to the nearest authorized dealer.

Brake Assist

Brake assist detects when you brake rapidly by measuring the rate at which you press the brake pedal. It provides maximum braking efficiency as long as you press the pedal, and can reduce stopping distances in critical situations.

Anti-lock Brake System

This system helps you maintain steering control during emergency stops by keeping the brakes from locking.



This lamp momentarily illuminates when you turn the ignition on. If the light does not illuminate during start up, remains on or flashes, the system may be disabled. Have the system checked by an authorized dealer. If the anti-lock brake system is disabled, normal braking is still effective.



If the brake warning lamp remains illuminated after you release the parking brake, have the system checked by an authorized dealer.

HINTS ON DRIVING WITH ANTI-LOCK BRAKES

Note: When the system is operating, the brake pedal may pulse and may travel further. Maintain pressure on the brake pedal. You may also hear a noise from the system. This is normal.

The anti-lock braking system will not eliminate the risks when:

- You drive too closely to the vehicle in front of you.
- Your vehicle is hydroplaning.
- You take corners too fast.
- The road surface is poor.

PARKING BRAKE

WARNINGS



If the parking brake is fully released, but the brake warning lamp remains illuminated, the brakes may not be working properly. See your authorized dealer as soon as possible.

Brakes

WARNINGS

-  Always set the parking brake fully and make sure that the transmission is securely latched in park (P) (automatic transmission) or first gear (1) (manual transmission).



E223664

To set the parking brake, pull the parking brake handle up as far as possible.

To release the parking brake:

1. Press and hold the button located at the end of the parking brake handle.
2. Pull the handle up slightly, then push the handle down.

HILL START ASSIST

WARNINGS

 The system does not replace the parking brake. When you leave your vehicle, always apply the parking brake and shift the transmission into park (P) for automatic transmission or first gear for manual transmission.

 You must remain in your vehicle once you have activated the system.

 During all times, you are responsible for controlling your vehicle, supervising the system and intervening, if required.

WARNINGS

 If the engine is revved excessively, or if a malfunction is detected, the system will be deactivated.

The system makes it easier to pull away when your vehicle is on a slope without the need to use the parking brake.

When the system is active, your vehicle will remain stationary on the slope for two to three seconds after you release the brake pedal. This allows you time to move your foot from the brake to the accelerator pedal. The brakes are released automatically once the engine has developed sufficient torque to prevent your vehicle from rolling down the slope. This is an advantage when pulling away on a slope, for example from a car park ramp, traffic lights or when reversing uphill into a parking space.

The system will activate automatically on any slope that will cause significant vehicle rollback. For vehicles with a manual transmission, you can switch this feature off using the information display. See **Information Displays** (page 80). The system will remain on or off depending on how it was last set.

Note: *There is no warning lamp to indicate the system is either on or off.*

Using Hill Start Assist

1. Press the brake pedal to bring your vehicle to a complete standstill. Keep the brake pedal pressed and select an uphill gear (for example, first (1) when facing uphill or reverse (R) when facing downhill).
2. If the sensors detect that your vehicle is on a slope, the system will activate automatically.

Brakes

3. When you remove your foot from the brake pedal, your vehicle will remain on the slope without rolling away for about two or three seconds. This hold time will automatically be extended if you are in the process of driving off.
4. Drive off in the normal manner. The brakes will release automatically.

Switching the System On and Off

Vehicles with Manual Transmission

You can switch this feature on or off in the information display. The system remembers the last setting when you start your vehicle.

Vehicles with Automatic Transmission

You cannot turn the system on or off. When you switch the ignition on, the system automatically turns on.

Traction Control

PRINCIPLE OF OPERATION

The traction control system helps avoid drive wheel spin and loss of traction.

If your vehicle begins to slide, the system applies the brakes to individual wheels and, when needed, reduces engine power at the same time. If the wheels spin when accelerating on slippery or loose surfaces, the system reduces engine power in order to increase traction.

USING TRACTION CONTROL

WARNING



The stability and traction control light illuminates steadily if the system detects a failure. Make sure you did not manually disable the traction control system using the switch. If the stability control and traction control light is still illuminating steadily, have the system serviced by an authorized dealer immediately. Operating your vehicle with traction control disabled could lead to an increased risk of loss of vehicle control, vehicle rollover, personal injury and death.

The system automatically turns on each time you switch the ignition on.

If your vehicle is stuck in mud or snow, switching traction control off may be beneficial as this allows the wheels to spin.

Note: When you switch traction control off, stability control remains fully active.

Switching the System Off

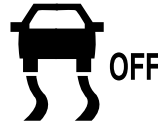

E166706

The switch for the stability and traction control system is on the instrument panel.

When you switch the system off, a message and an illuminated icon appear on the instrument cluster.

Use the switch again to return the traction control system to normal operation.

Your vehicle may have MyKey restrictions regarding this feature. See **Principle of Operation** (page 48).

System Indicator Lights and Messages



The stability and traction control light temporarily illuminates on engine start-up and flashes:

- When a driving condition activates either of the systems.
- If a problem occurs in either of the systems.



The stability and traction control off light temporarily illuminates on engine start-up and stays on:

- When you switch the traction control system off.
- When you select an alternative stability control mode.

Stability Control

PRINCIPLE OF OPERATION

WARNINGS



Vehicle modifications involving braking system, aftermarket roof racks, suspension, steering system, tire construction and wheel and tire size may change the handling characteristics of the vehicle and may adversely affect the performance of the AdvanceTrac system. In addition, installing any stereo loudspeakers may interfere with and adversely affect the AdvanceTrac system. Install any aftermarket stereo loudspeaker as far as possible from the front center console, the tunnel, and the front seats in order to minimize the risk of interfering with the AdvanceTrac sensors. Reducing the effectiveness of the AdvanceTrac system could lead to an increased risk of loss of vehicle control, vehicle rollover, personal injury and death.



Remember that even advanced technology cannot defy the laws of physics. It's always possible to lose control of a vehicle due to inappropriate driver input for the conditions. Aggressive driving on any road condition can cause you to lose control of your vehicle increasing the risk of personal injury or property damage. Activation of the AdvanceTrac system is an indication that at least some of the tires have exceeded their ability to grip the road; this could reduce the operator's ability to control the vehicle potentially resulting in a loss of vehicle control, vehicle rollover, personal injury and death. If your AdvanceTrac system activates, SLOW DOWN.



If a failure has been detected within the traction control system, the stability control light will illuminate steadily. Verify that the traction control system was not manually disabled using the stability control button. If the stability control light still illuminates steadily, have

WARNINGS

the system serviced by an authorized dealer immediately. Operating your vehicle with traction control disabled could lead to an increased risk of loss of vehicle control, vehicle rollover, personal injury and death.



The stability and traction control light temporarily lights on engine start-up and flashes when a driving condition activates either of the systems.



The stability and traction control off light temporarily lights on engine start-up and stays on:

- When you switch the traction control system off.
- When you select an alternative stability control mode.
- If a problem occurs in either of the systems.

The AdvanceTrac Control system helps you keep control of your vehicle when on a slippery surface. The electronic stability control portion of the system helps avoid skids and lateral slides. The traction control system helps avoid drive wheel spin and loss of traction. See **Using Traction Control** (page 142).

Stability Control

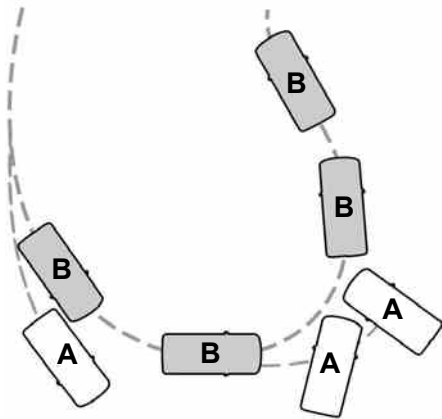

E72903

A Vehicle without AdvanceTrac

- B Vehicle with AdvanceTrac maintaining control on a slippery surface.

USING STABILITY CONTROL

AdvanceTrac™

The system automatically activates when you start your engine. The electronic stability control portion of the system is disabled when the transmission is in reverse (R) or, on some models, if you press and hold the stability control button for more than five seconds when you apply the brakes and the vehicle is at a stop. You can switch off the traction control portion of the system independently. See **Using Traction Control** (page 142).

AdvanceTrac features					
Button functions	Mode	Stability control off light	Electronic stability control	Traction control system	Collision warning with brake support
Default at start-up	Stability and traction control fully enabled	On during bulb check	Enabled	Enabled	Enabled
Button pressed momentarily	Traction control off	On	Enabled	Disabled	Enabled

Stability Control

AdvanceTrac features					
Button pressed twice rapidly	Sport mode (if equipped)	On	Enabled	Enabled	Disabled
Button pressed and held more than five seconds	AdvanceTrac disabled	On	Disabled	Disabled	Disabled
Button pressed again after deactivation	AdvanceTrac fully enabled	Off	Enabled	Enabled	Enabled

Note: Do not use Sport mode on public roadways.

Some models may also come equipped with a sport mode which allows the driver to reduce normal AdvanceTrac system intervention and provide a more spirited driving experience. To enter sport mode, toggle the stability control button twice rapidly. The message appears in the information display that the system is now in sport mode.

For vehicles equipped with the selectable drive mode feature, AdvanceTrac sport mode is not available. You can utilize the performance oriented AdvanceTrac mode by selecting track drive mode. In this mode, AdvanceTrac intervention is reduced and tuned specifically for track use only and is not for use on public roads. In all of the selectable drive modes, you can disable traction control and AdvanceTrac with the AdvanceTrac switch.

Line Lock (If Equipped)

Line Lock is a feature intended for use at tracks only and should not be used on public roadways. Use of this feature will result in significantly increased rear tire wear. It is intended to condition the rear tires to maximize traction prior to track use. Line Lock maintains brake force at the front wheels, allowing the rear wheels to spin with minimal vehicle movement.

This feature is located in the Track Apps menu. Make selections through the 5-way information display control and OK button located on the steering wheel.

Using Line Lock

There are three Line Lock stages:

- Initiated.
- Engaged.
- Off.

Initiating Line Lock

The initiation stage verifies that the vehicle is ready for Line Lock function, and confirms driver intent. Follow the prompts in the information display in to initiate Line Lock.

Stability Control

The following conditions must be met to initialize Line Lock:

- The vehicle is on a level surface.
- The engine is running.
- The vehicle is traveling less than 25 mph (40 km/h).
- Selectable Drive Mode is not in wet mode (if equipped).
- There are no AdvanceTrac faults.

If you want to cancel Line Lock once it is initialized, press the left information display control. Once initiated, Line Lock is prepared for activation and will remain initiated up to 25 mph (40 km/h). If vehicle speed exceeds 25 mph (40 km/h), Line Lock will be automatically canceled.

Engaging Line Lock

Follow the prompts in the information display to engage Line Lock after it is initialized. To engage, firmly apply the brakes. Then press the OK button. Once engaged, release the brake pedal. The front brakes will remain applied and the rear brakes will release. At this point, the engagement timer is initiated and shown on the driver information display.

The following conditions must be met to engage Line Lock:

- The vehicle is on a level surface.
- The engine is running.
- The vehicle is stopped.
- The parking brake is not applied.
- The driver door is closed.
- The transmission is in a forward gear.
- Selectable Drive Mode is not in wet mode (if equipped).
- There are no AdvanceTrac faults.
- The steering wheel must be in the straight ahead position.

Releasing Line Lock

While Line Lock is engaged, you can exit (release) the feature using the OK button. When you press the OK button, Line Lock releases immediately and normal vehicle function will resume. When Line Lock is engaged, a countdown timer shows the remaining time before Line Lock is released automatically. If you exceed the time limit, or another vehicle condition requires Line Lock to release, the system will safely disengage and normal vehicle function will resume.

Note: *If the brake pedal is applied while Line Lock is engaged, Line Lock automatically cancels and normal brake function resumes.*

Parking Aids

PRINCIPLE OF OPERATION

WARNINGS



To help avoid personal injury, please read and understand the limitations of the system as contained in this section. Sensing is only an aid for some (generally large and fixed) objects when moving on a flat surface at parking speeds. Certain objects with surfaces that absorb ultrasonic waves, surrounding vehicle's parking aid systems, traffic control systems, fluorescent lamps, inclement weather, air brakes, and external motors and fans may also affect the function of the sensing system; this may include reduced performance or a false activation.



To help avoid personal injury, always use caution when in reverse (R) and when using the sensing system.



This system is not designed to prevent contact with small or moving objects. The system is designed to provide a warning to assist the driver in detecting large stationary objects to avoid damaging your vehicle. The system may not detect smaller objects, particularly those close to the ground.



Certain add-on devices such as large trailer hitches, bike or surfboard racks and any device that may block the normal detection zone of the system, may create false beeps.

Note: *Keep the sensors, located on the bumper or fascia, free from snow, ice and large accumulations of dirt. If the sensors are covered, the system's accuracy can be affected. Do not clean the sensors with sharp objects.*

Note: *If your vehicle sustains damage to the bumper or fascia, leaving it misaligned or bent, the sensing zone may be altered causing inaccurate measurement of obstacles or false alarms.*

Note: *The sensing system cannot be turned off when a MyKey is present. See **Principle of Operation** (page 48).*

Note: *If you attach certain add-on devices such as a trailer or bike rack, the rear sensing system may detect that add-on device and therefore provide warnings. It is suggested that you disable the rear sensing system when you attach an add-on device to your vehicle to prevent these warnings.*

The sensing system warns the driver of obstacles within a certain range of your vehicle. The system turns on automatically whenever you switch the ignition on.

The system can be switched off through the information display menu or from the pop-up message that appears once you shift the transmission into reverse (R). See **General Information** (page 80).

If a fault is present in the system, a warning message appears in the information display. See **Information Messages** (page 88).

REAR PARKING AID (If Equipped)

The rear sensors are only active when the transmission is in reverse (R). As your vehicle moves closer to the obstacle, the rate of the audible warning increases. When the obstacle is less than 12 in (30 cm) away, the warning sounds continuously. If the system detects a stationary or receding object farther than 12 in (30 cm) from the corners of the bumper, the tone sounds for only three seconds. Once the system detects an object approaching, the warning sounds again.

Parking Aids



E130178

Coverage area of up to 6 ft (1.8 m) from the rear bumper. There may be decreased coverage area at the outer corners of the bumper.

The system detects certain objects while the transmission is in reverse (R) :

- Your vehicle is moving toward a stationary object at a speed of 3 mph (5 km/h) or less.
- Your vehicle is not moving, but a moving object is approaching the rear of your vehicle at a speed of 3 mph (5 km/h) or less.
- Your vehicle is moving at a speed of less than 3 mph (5 km/h) and a moving object is approaching the rear of your vehicle at a speed of less than 3 mph (5 km/h).

The system provides audio warnings only when your vehicle is moving or when your vehicle is stationary and the detected obstacle is less than 12 in (30 cm) away from the bumper.

Obstacle Distance Indicator (If

Equipped)

The system provides obstacle distance indication through the information display. The distance indicator displays when the transmission is in reverse (R).

The indicator displays:

- As the distance to the obstacle decreases the indicator blocks illuminate and move towards the vehicle icon.
- If there is no obstacle detected, the distance indicator blocks are grayed out.

REAR VIEW CAMERA

WARNINGS



The rear view camera system is a reverse aid supplement device that still requires the driver to use it in conjunction with the interior and exterior mirrors for maximum coverage.



You may not see objects that are close to either corner of the bumper or under the bumper due to the limited coverage of the camera system.



Back up as slow as possible since higher speeds might limit your reaction time to stop your vehicle.



Use caution when using the rear video camera and the luggage compartment is ajar. If the luggage compartment is ajar, the camera will be out of position and the video image may be incorrect. All guidelines are removed when the luggage compartment is ajar.



Use caution when turning camera features on or off. Make sure your vehicle is not moving.

Parking Aids

The rear view camera system provides a video image of the area behind your vehicle.

During operation, lines appear in the display which represent your vehicle's path and proximity to objects behind your vehicle.

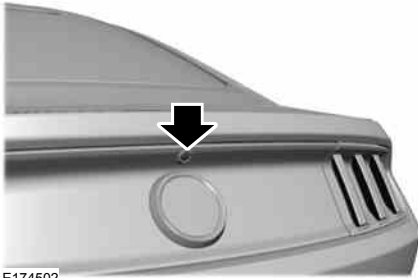

E174502

The camera is located on the luggage compartment door.

Using the Rear View Camera System

The rear view camera system displays what is behind your vehicle when you place the transmission in reverse (R).

Note: *The reverse sensing system is not effective at speeds above 3 mph (5 km/h) and may not detect certain angular or moving objects.*

The system uses two types of guides to help you see what is behind your vehicle:

- Fixed guidelines: Show the actual path your vehicle is moving in while reversing in a straight line. This can be helpful when backing into a parking space or aligning your vehicle with another object behind you.
- Centerline: Helps align the center of your vehicle with an object.

Note: *If the transmission is in reverse (R) and the luggage compartment is open, no camera features will display.*

The camera may not operate correctly under the following conditions:

- Nighttime or dark areas if the reverse lamps are not operating.
- Mud, water or debris obstructs the camera's view. Clean the lens with a soft, lint-free cloth and non-abrasive cleaner.
- The camera is misaligned due to damage to the rear of your vehicle.

Camera Guidelines

Note: *Active guidelines are only available when the transmission is in reverse (R).*

Note: *Upon a battery disconnect, the active guidelines may not be functional until your vehicle has been driven a short distance and exceeds a speed of 12 mph (20 km/h).*

Parking Aids

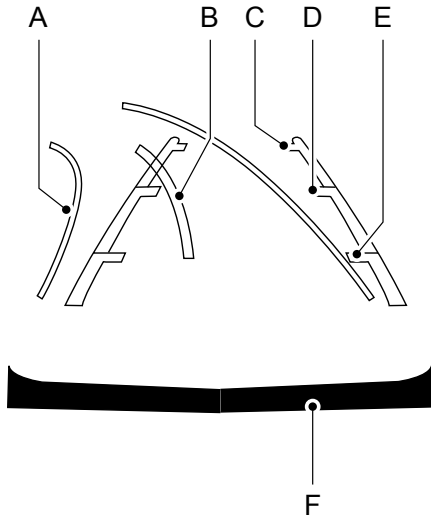

E142436

- A Active guidelines
- B Centerline
- C Fixed guideline: Green zone
- D Fixed guideline: Yellow zone
- E Fixed guideline: Red zone
- F Rear bumper

Active guidelines only show with fixed guidelines. To use active guidelines, turn the steering wheel to point the guidelines toward an intended path. If the steering wheel position changes while reversing, your vehicle might deviate from the original intended path.

The fixed and active guidelines fade in and out depending on the steering wheel position. The active guidelines do not show when the steering wheel position is straight.

Always use caution while reversing. Objects in the red zone are closest to your vehicle and objects in the green zone are farther away. Objects are getting closer to your vehicle as they move from the green zone to the yellow or red zones. Use the side view mirrors and rear view mirror to get better coverage on both sides and rear of your vehicle.

Manual Zoom

WARNING



When manual zoom is on, the full area behind your vehicle does not show. Be aware of your surroundings when using the manual zoom feature.

Note: Manual zoom is only available when the transmission is in reverse (R).

Note: When manual zoom is enabled, only the centerline is shown.

Selectable settings for this feature are Zoom in (+) and Zoom out (-). Press the symbol in the camera screen to change the view. The default setting is Zoom OFF.

This feature allows you to get a closer view of an object behind your vehicle. The zoomed image keeps the bumper in the image to provide a reference. The zoom is only active while the transmission is in reverse (R). When the transmission shifts out of reverse (R), the feature automatically turns off and must be reset when it is used again.

Parking Aids

Camera System Settings

To access any of the rear view camera system settings, make the following selections in the multifunctional display when the transmission is not in reverse (R):

Main Menu
Settings
Vehicle
Camera Settings

Enhanced Park Aids or Park Pilot

Selectable settings for this feature are ON and OFF.

The system uses red, yellow and green highlights that appear on top of the video image when any of the sensing systems detect an object.

Vehicles equipped with touchscreen

The system will provide an image of your vehicle and the sensor zones. The zones will highlight green, yellow and red when the parking aid sensors detect an object in the coverage area.

The coverage area is up to 6 ft (1.8 m) from the rear bumper. There is decreased coverage area at the outer corners of the bumper.



E130178

For additional information of the zone coverage and the rear sensing system. See **Principle of Operation** (page 147).

Rear Camera Delay

Selectable settings for this feature are ON and OFF.

The default setting for the rear camera delay is OFF.

When shifting the transmission out of reverse (R) and into any gear other than park (P), the camera image remains in the display until:

- Your vehicle speed sufficiently increases.
- You shift your vehicle into park (P).
- You pull the hand brake on vehicles with a manual transmission.

Cruise Control

PRINCIPLE OF OPERATION

Cruise control lets you maintain a set speed without keeping your foot on the accelerator pedal. You can use cruise control when your vehicle speed is greater than 20 mph (30 km/h).

USING CRUISE CONTROL

WARNINGS



Do not use cruise control on winding roads, in heavy traffic or when the road surface is slippery. This could result in loss of vehicle control, serious injury or death.



When you are going downhill, your vehicle speed may increase above the set speed. The system will not apply the brakes but a warning displays.

Note: Cruise control will disengage if the vehicle speed decreases more than 10 mph (16 km/h) below the set speed while driving uphill.

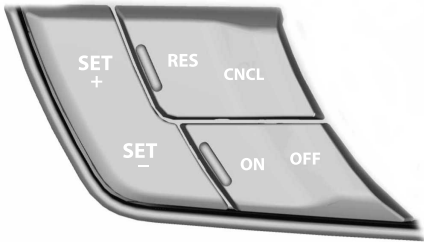

E176993

The cruise controls are on the steering wheel.

Switching Cruise Control On

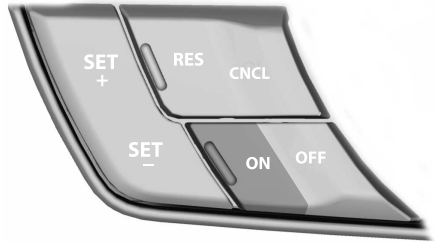

E176994

Press and release **ON**.



The indicator appears in the instrument cluster.

Setting the Cruise Speed

1. Drive to desired speed.
2. Press and release **SET+**.
3. Take your foot off the accelerator pedal.

Changing the Set Speed

- Press and release **SET+** or **SET-**. When you select km/h as the display measurement in the information display the set speed changes in approximately 2 km/h increments. When you select mph as the display measurement in the information display the set speed changes in approximately 1 mph increments.
- Press the accelerator or brake pedal until you reach the desired speed. Press and release **SET+**.
- Press and hold **SET+** or **SET-**. Release the control when you reach the desired speed.

Cruise Control

Canceling the Set Speed

Press and release **CNCL** or tap the brake pedal. The set speed does not erase.

Resuming the Set Speed

Press and release **RES**.

Switching Cruise Control Off

Press and release **OFF** when the system is in stand by mode or switch the ignition off.

Note: *You erase the set speed when you switch the system off.*

USING ADAPTIVE CRUISE CONTROL (If Equipped)

WARNINGS

 Always pay close attention to changing road conditions when using adaptive cruise control. The system does not replace attentive driving. Failing to pay attention to the road may result in a crash, serious injury or death.

 Adaptive cruise control is not a crash warning or avoidance system.

 Adaptive cruise control does not detect pedestrians or objects in the road.

 Adaptive cruise control only warns of vehicles detected by the radar sensor. In some cases there may be no warning or a delayed warning. You should always apply the brakes when necessary. Failure to do so may result in a crash, serious injury or death.

 Adaptive cruise control does not detect oncoming vehicles in the same lane.

WARNINGS

 Do not use adaptive cruise control on winding roads, in heavy traffic or when the road surface is slippery.

This could result in loss of vehicle control, serious injury or death.

 Adaptive cruise control does not detect stationary or slow moving vehicles below 6 mph (10 km/h).

 Do not use the system in poor visibility, for example fog, heavy rain, spray or snow.

Note: *It is your responsibility to stay alert, drive safely and be in control of the vehicle at all times.*

The system adjusts your vehicle speed to maintain the set gap between you and the vehicle in front of you in the same lane.

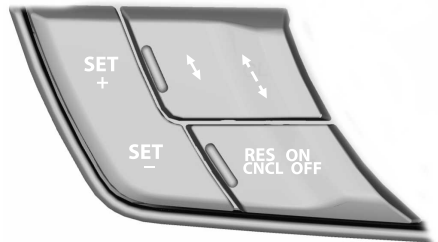

E177068

The adaptive cruise controls are on the steering wheel.

Cruise Control

Switching Adaptive Cruise Control On

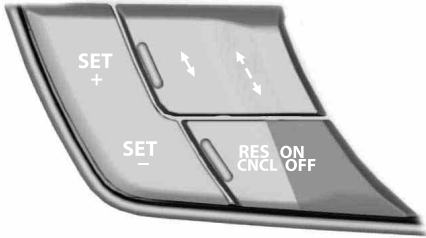

E177069

Press and release **ON**.



The indicator appears in the instrument cluster.

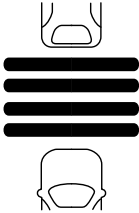

E164805

The indicator, current gap setting and set speed appears in the instrument cluster.

Setting the Adaptive Cruise Speed

1. Drive to desired speed.
2. Press and release **SET+**.
3. A green indicator light, current gap setting and your desired set speed appear in the instrument cluster.
4. Take your foot off the accelerator pedal.

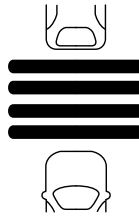

E164805

5. A vehicle graphic illuminates if there is a vehicle detected in front of you.

Note: When adaptive cruise control is active, the speedometer may vary slightly from the set speed displayed in the information display.

Following a Vehicle

WARNINGS

 When following a vehicle, your vehicle does not decelerate automatically to a stop, nor does your vehicle always decelerate quickly enough to avoid a crash without driver intervention. Always apply the brakes when necessary. Failing to do so may result in a crash, serious injury or death.

 Adaptive cruise control only warns of vehicles detected by the radar sensor. In some cases there may be no warning or a delayed warning. You should always apply the brakes when necessary. Failure to do so may result in a crash, serious injury or death.

Note: The brakes may emit noise when applied by the system.

When a vehicle ahead of you enters the same lane or a slower vehicle is ahead in the same lane, the vehicle speed adjusts to maintain a preset gap distance.

Note: When you are following a vehicle and you switch on a direction indicator, adaptive cruise control may provide a small temporary acceleration to help you pass.

Cruise Control

Your vehicle maintains a consistent gap from the vehicle ahead until:

- The vehicle in front of you accelerates to a speed above the set speed.
- The vehicle in front of you moves out of your lane or out of view.
- The vehicle speed falls below 12 mph (20 km/h).
- A new gap distance is set.

The system applies the brakes to slow your vehicle to maintain a safe gap distance from the vehicle in front. You can override the system by applying the brakes.

If the system determines that its maximum braking level will not be sufficient, an audible warning sounds when the system continues to brake. A red warning bar displays on the windshield and you must take immediate action.

Setting the Gap Distance

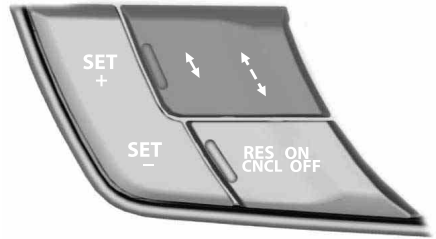

E177070

You can decrease or increase the distance between your vehicle and the vehicle in front by pressing the gap control.

Note: *It is your responsibility to select a gap appropriate to the driving conditions.*

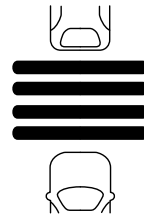

E164805

The selected gap appears in the information display as shown by the bars in the image. You can select four gap settings.

Cruise Control

Distance between vehicle settings

Set speed mph (km/h)	Graphic display, bars indicated between vehicles	Time gap, seconds	Distance gap yd (m)	Dynamic beha- vior
62 (100)	1	1	31 (28)	Sport
62 (100)	2	1.4	43 (39)	Normal
62 (100)	3	1.8	55 (50)	Normal
62 (100)	4	2.2	67 (61)	Comfort

When you switch the ignition on, the system automatically selects the last chosen gap setting.

Canceling the Set Speed

Press and release **CNCL** or tap the brake pedal. The set speed does not erase.

Overriding the Set Speed

WARNING



If you override the system by pressing the accelerator pedal, it does not automatically apply the brakes to maintain a gap from any vehicle ahead.

You can override the set speed and gap distance by pressing the accelerator pedal.



When you override the system, the green indicator light illuminates. The vehicle graphic does not appear in the information display.

The system resumes operation when you release the accelerator pedal. The vehicle speed decreases to the set speed, or a lower speed if following a slower vehicle.

Changing the Set Speed

- Press and release **SET+** or **SET-**. When you select km/h as the display measurement in the information display the set speed changes in approximately 2 km/h increments. When you select mph as the display measurement in the information display the set speed changes in approximately 1 mph increments.
- Accelerate or brake to the desired speed, then press and release **SET+**.
- Press and hold **SET+** or **SET-** until the desired set speed shows on the information display. The vehicle speed gradually changes to the set speed.

The system may apply the brakes to slow the vehicle to the new set speed. The set speed displays continuously in the information display when the system is active.

Resuming the Set Speed

Press and release **RES**. The vehicle returns to the previously set speed. The set speed continuously displays while the system is active.

Cruise Control

Note: Only use resume if you are aware of the set speed and intend to return to it.

Automatic Cancellation

The system is not functional at vehicle speeds below 12 mph (20 km/h). An audible alarm sounds and the automatic braking releases if your vehicle drops below this speed. The system cancels at low speeds if you switch off electronic stability control.

Hilly Condition Usage

You should select a lower gear position when the system is active in situations such as prolonged downhill driving on steep grades, for example in mountainous areas. The system needs additional engine braking in these situations to reduce the load on the vehicle's regular brake system to prevent them from overheating.

Note: An audible alarm sounds and the system shuts down if it is applying brakes for an extended period of time. This allows the brakes to cool down. The system functions normally again when the brakes have cooled down.

Switching the System Off

Press and release **OFF** when the system is in stand by mode or switch off the ignition.

Note: You erase the set speed when you switch the system off.

Detection Issues

WARNING



On rare occasions, detection issues can occur due to the road infrastructures, for example bridges, tunnels and safety barriers. In these cases, the system may brake late or unexpectedly. At all times, you are responsible for controlling your vehicle, supervising the system and intervening, if required.

The radar sensor has a limited field of vision. It may not detect vehicles at all or detect a vehicle later than expected in some situations. The vehicle graphic does not appear in the information display if the system does not detect a vehicle in front of you.

A

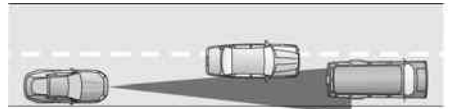

B



C

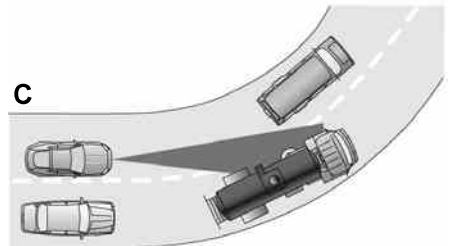

E71621

Cruise Control

Detection issues can occur:

- A With vehicles that edge into your lane that can only be detected once they have moved fully into your lane.
- B Motorcyclists may be detected late, or not at all.
- C With vehicles in front of you when going into and coming out of a bend. The detection beam does not follow sharp curves in the road.

In these cases the system may brake late or unexpectedly. You should stay alert and intervene if necessary.

If something hits the front end of your vehicle or damage occurs, the radar-sensing zone may change. This could cause missed or false vehicle detections. See an authorized dealer to have the radar checked for proper coverage and operation.

System Not Available

Conditions that can cause the system to deactivate or prevent the system from activating when requested include:

- A blocked sensor.
- High brake temperature.
- A failure in the system or a related system.

Blocked Sensor

WARNING



Do not use tire sizes other than those recommended because this can affect the normal operation of the system. Failing to do so may result in a loss of vehicle control, which could result in serious injury.



E145632

A message displays if something obstructs the radar signals from the sensor. The sensor is located on the lower grille. The system cannot detect a vehicle ahead and does not function when something obstructs the sensor.

Cruise Control

The following table lists possible causes and actions for this message displaying.

Cause	Action
The surface of the radar in the grille is dirty or obstructed in some way.	Clean the grille surface in front of the radar or remove the object causing the obstruction.
The surface of the radar in the grille is clean but the message remains in the display.	Wait a short time. It may take several minutes for the radar to detect that it is free from obstruction.
Heavy rain or snow is interfering with the radar signals.	Do not use the system in these conditions because it may not detect any vehicles ahead.
Swirling water, or snow or ice on the surface of the road may interfere with the radar signals.	Do not use the system in these conditions because it may not detect any vehicles ahead.

It is possible to get a blockage warning and not be blocked. A false blocked condition self clears or clears after a key cycle.

Switching to Normal Cruise Control

WARNING



Normal cruise control does not brake due to slower vehicles. Always be aware of which mode you have selected and apply the brakes when necessary.

You can manually change from adaptive cruise control to normal cruise control through the information display.



The cruise control indicator light replaces the adaptive cruise control indicator light if you select normal cruise control. The gap setting does not display, the system does not automatically respond to lead vehicles and automatic braking does not activate. The system remembers the last setting when you start your vehicle.

Driving Aids

BLIND SPOT INFORMATION SYSTEM

WARNING



To help avoid injuries, NEVER use the Blind Spot Information System as a replacement for using the interior and exterior mirrors or looking over your shoulder before changing lanes. The Blind Spot Information System is not a replacement for careful driving.

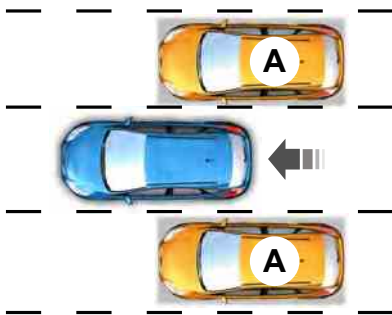

E124788

The Blind Spot Information System is designed to aid you in detecting vehicles that may have entered the blind spot zone (A). The detection area is on both sides of your vehicle, extending rearward from the exterior mirrors to approximately 13 ft (4 m) beyond the bumper. The system is designed to alert you if certain vehicles enter the blind spot zone while driving.

Note: *The Blind Spot Information System does not prevent contact with other vehicles or objects; nor detect parked vehicles, people, animals or infrastructure (fences, guardrails, trees). It's only designed to alert you to vehicles in the blind spot zones.*

Note: *When a vehicle passes quickly through the blind spot zone, typically fewer than two seconds, the system does not trigger.*

Using the System

The Blind Spot Information System turns on when you start the engine and you drive your vehicle forward above 5 mph (8 km/h).

For automatic transmissions, the Blind Spot Information System remains on while the transmission is in drive (D). If shifted into reverse (R) or park (P) the Blind Spot Information System turns off. Once shifted back into drive (D), the Blind Spot Information System turns back on when you drive your vehicle above 5 mph (8 km/h).

For manual transmissions, the Blind Spot Information System is on for all gears except the reverse (R).

Note: *The Blind Spot Information System does not function in reverse (R) or park (P).*

System Lights and Messages



E142442

Driving Aids

The Blind Spot Information System illuminates an amber alert indicator in the outside mirror on the side of your vehicle the approaching vehicle is coming from. When the Blind Spot Information System is alerting on a vehicle and the corresponding turn signal is ON, the Blind Spot Information System alert indicator flashes as an increased warning level.

The alert indicator dims when the system detects nighttime darkness.

Note: *The alert indicator flashes in case of an alert and the turn signal is set to that side at the same time.*

System Sensor Blockage

WARNING



To help avoid injuries, NEVER use the Blind Spot Information System as a replacement for using the interior and exterior mirrors or looking over your shoulder before changing lanes. The Blind Spot Information System is not a replacement for careful driving.

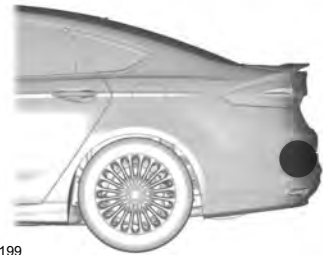

E205199

The system uses radar sensors that are located behind the bumper fascia on each side of your vehicle. Any dirt, mud and snow in front of the sensors and/or driving in heavy rain can cause system degradation. Also, other types of obstructions in front of the sensor can cause system degradation. This is referred to as a 'blocked' condition.

Note: *Do not apply bumper stickers and/or repair compound to these areas, this can cause degraded system performance.*

Driving Aids

If the system detects a degraded performance condition, a message warning of a blocked sensor will appear in the information display. Also the BLIS alert indicators will remain ON and BLIS will no longer provide any vehicle warnings. You can clear the information display warning but the alert indicators will remain illuminated.

A "blocked" condition can be cleared in two ways:

- After the blockage in front of the sensors is removed or the rainfall/snowfall rate decreases or stops, drive for a few minutes in traffic to allow the sensors to detect passing vehicles.
- By cycling the ignition from ON to OFF and then back ON.

Note: *If your vehicle has a tow bar with a factory equipped trailer tow module and it is towing a trailer, the sensors will automatically turn the Blind Spot Information System off. If your vehicle has a tow bar but no factory equipped trailer tow module, it is recommended to turn the Blind Spot Information System off manually. Operating the Blind Spot Information System with a trailer attached will cause poor system performance.*

System Errors

If the system senses a problem with the left or right sensor, the telltale will illuminate and a message will appear in the information display. See **Information Messages** (page 88).

Switching the System Off and On

You can temporarily switch the Blind Spot Information System off in the information display. See **General Information** (page 80). When the Blind Spot Information System switches off, you will not receive alerts and the information display shows a system off message. The telltale in the cluster also illuminates. When you switch the Blind Spot Information System on or off, the alert indicators flash twice.

Note: *The Blind Spot Information System remembers the last selected on or off setting.*

You can also have the Blind Spot Information System switched off permanently at an authorized dealer. Once switched off permanently, the system can only be switched back on at an authorized dealer.

CROSS TRAFFIC ALERT

WARNING



To help avoid personal injury, NEVER use the Cross Traffic Alert system as a replacement for using the interior and exterior mirrors and looking over your shoulder before backing out of a parking space. Cross Traffic Alert is not a replacement for careful driving.

Cross Traffic Alert is designed to warn you of vehicles approaching from the sides when the transmission is in reverse (R).

Using the System

Cross Traffic Alert turns on when you start the engine and you shift into reverse (R). Once shifted out of reverse (R), Cross Traffic Alert turns off.

Note: *Cross Traffic Alert only functions while your transmission is in reverse (R).*

Driving Aids

Cross Traffic Alert is designed to detect vehicles that approach with a speed up to 37 mph (60 km/h). Coverage decreases when the sensors are partially, mostly or

fully obstructed. Reversing slowly helps increase the coverage area and effectiveness.

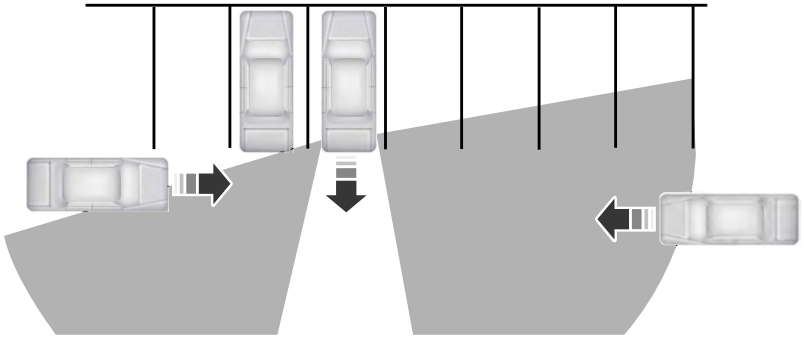

E142440

In this first example, the left sensor is only partially obstructed; zone coverage to the right is nearly maximized.

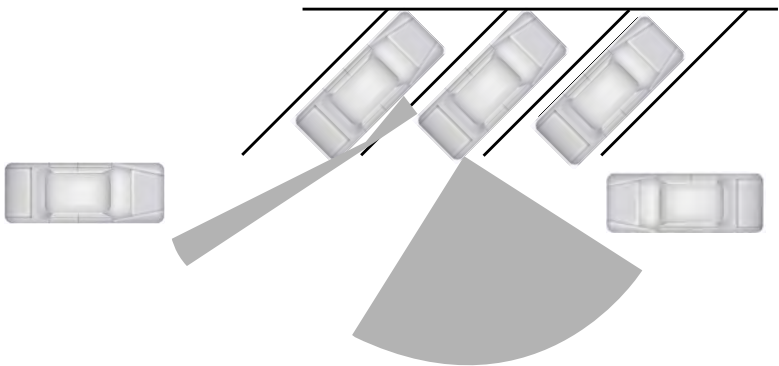

E142441

Driving Aids

Zone coverage also decreases when parking at shallow angles. Here, the left sensor is mostly obstructed; zone coverage on that side is severely limited.

System Lights, Messages and Audible Alerts



E142442

The Cross Traffic Alert illuminates an amber alert indicator in the outside mirror on the side of your vehicle the approaching vehicle is coming from. Cross Traffic Alert also sounds an audible alert and a message appears in the information display indicating a vehicle is coming from the right or left. Cross Traffic Alert works with the reverse sensing system that sounds its own series of tones. See **Rear Parking Aid** (page 147).

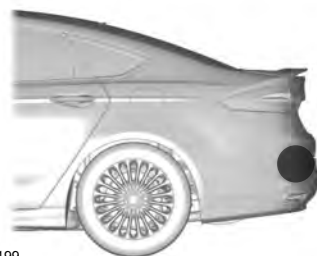

E205199

The system uses radar sensors that are located behind the bumper fascia on each side of your vehicle. Do not allow mud, snow or bumper stickers to obstruct these areas, this can cause degraded system performance. See **Blind Spot Information System** (page 160). If the Blind Spot Information System is blocked, Cross Traffic Alert is also blocked. A corresponding message appears in the information display as soon as you shift the transmission into reverse (R).

System Limitations

Cross Traffic Alert has its limitations; situations such as severe weather conditions or debris build-up on the sensor area may limit vehicle detection.

Driving Aids

The following are other situations that may limit the Cross Traffic Alert performance:

- Adjacently parked vehicles or objects obstructing the sensors.
- Approaching vehicles passing at speeds greater than 37 mph (60 km/h).
- Driving in reverse faster than 7 mph (12 km/h).
- Backing out of an angled parking spot.

False Alerts

Note: *If your vehicle has a tow bar with a factory equipped trailer tow module and it is towing a trailer, the sensors will automatically turn the Cross Traffic Alert off. If your vehicle has a tow bar but no factory equipped trailer tow module, it is recommended to turn the Cross Traffic Alert off manually. Operating Cross Traffic Alert with a trailer attached will cause poor Cross Traffic Alert performance.*

There may be certain instances when there is a false alert by the Cross Traffic Alert system that illuminates the alert indicator with no vehicle in the coverage zone. Some amount of false alerts are normal; they are temporary and self-correct.

System Errors

If Cross Traffic Alert senses a problem with the left or right sensor a message will appear in the information display. See (page 80).

Switching the System Off and On

You can temporarily switch Cross Traffic Alert off in the information display. See **General Information** (page 80). When you switch Cross Traffic Alert off, you will not receive alerts and the information display will display a system off message.

Note: *The Cross Traffic Alert switches on whenever the ignition is switched on and ready to provide appropriate alerts when the transmission is in reverse (R). Cross Traffic Alert will not remember the last selected on or off setting.*

You can also have Cross Traffic Alert switched off permanently at an authorized dealer. Once switched off permanently, the system can only be switched back on at an authorized dealer.

STEERING

Electric Power Steering

WARNINGS



The electric power steering system has diagnostic checks that continuously monitor the system. If a fault is detected, a message displays in the information display. Stop your vehicle as soon as it is safe to do so. Switch the ignition off. After at least 10 seconds, switch the ignition on and watch the information display for a steering system warning message. If a steering system warning message returns, have the system checked by an authorized dealer.



If the system detects an error, you may not feel a difference in the steering, however a serious condition may exist. Obtain immediate service from an authorized dealer, failure to do so may result in loss of steering control.

Your vehicle has an electric power steering system. There is no fluid reservoir. No maintenance is required.

If your vehicle loses electrical power while you are driving, electric power steering assistance is lost. The steering system still operates and you can steer your vehicle manually. Manually steering your vehicle requires more effort.

Driving Aids

Extreme continuous steering may increase the effort required for you to steer your vehicle. This increased effort prevents overheating and permanent damage to the steering system. You do not lose the ability to steer your vehicle manually. Typical steering and driving maneuvers allow the system to cool and return to normal operation.

Steering Tips

If the steering wanders or pulls, check for:

- Correct tire pressures.
- Uneven tire wear.
- Loose or worn suspension components.
- Loose or worn steering components.
- Improper vehicle alignment.

Note: A high crown in the road or high crosswinds may also make the steering seem to wander or pull.

Adaptive Learning

The electronic power steering system adaptive learning helps correct road irregularities and improves overall handling and steering feel. It communicates with the brake system to help operate advanced stability control and accident avoidance systems. Additionally, whenever the battery is disconnected or a new battery installed, you must drive your vehicle a short distance before the system relearns the strategy and reactivates all systems.

COLLISION WARNING SYSTEM

(If Equipped)

PRINCIPLE OF OPERATION

WARNINGS



This system is designed to be a supplementary driving aid. It is not intended to replace the driver's attention, and judgment, or the need to apply the brakes. This system does NOT activate the brakes automatically. Failure to press the brake pedal to activate the brakes may result in a collision.



The collision warning system with brake support cannot help prevent all collisions. Do not rely on this system to replace driver judgment and the need to maintain distance and speed.

Note: The system does not detect, warn or respond to potential collisions with vehicles to the rear or sides of the vehicle.

Note: The collision warning system is active at speeds above approximately 5 mph (8 km/h).



E156130

This system is designed to alert the driver of certain collision risks. A radar detects if your vehicle is rapidly approaching another vehicle traveling in the same direction as yours.

Driving Aids

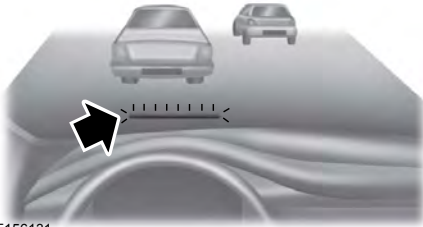

E156131

If it is, a red warning light illuminates and an audible warning chime sounds.

The brake support system assists the driver in reducing the collision speed by charging the brakes. If the risk of collision further increases after the warning light illuminates, the brake support prepares the brake system for rapid braking. This may be apparent to the driver. The system does not automatically activate the brakes but, if the brake pedal is pressed, full force braking is applied even if the brake pedal is lightly pressed.

Using the Collision Warning System

WARNING



The collision warning system's brake support can only help reduce the speed at which a collision occurs if the driver applies the vehicle's brakes. The brake pedal must be pressed just like any typical braking situation.

The warning system sensitivity can be adjusted to one of three possible settings by using the information display control. See **General Information** (page 80).

Note: *If collision warnings are perceived as being too frequent or disturbing then the warning sensitivity can be reduced, though the manufacturer recommends using the highest sensitivity setting where possible. Setting lower sensitivity would lead to fewer and later system warnings. See **General Information** (page 80).*

Blocked Sensors



E145632

If a message regarding a blocked sensor appears in the information display, the radar signals from the sensor have been obstructed. The sensors are located behind a fascia cover near the driver side of the lower grille. When the sensors are obstructed, a vehicle ahead cannot be detected and the collision warning system does not function. The following table lists possible causes and actions for this message being displayed.

Driving Aids

Cause	Action
The surface of the radar in the grille is dirty or obstructed in some way	Clean the grille surface in front of the radar or remove the object causing the obstruction
The surface of the radar in the grille is clean but the message remains in the display	Wait a short time. It may take several minutes for the radar to detect that it is no longer obstructed
Heavy rain, spray, snow, or fog is interfering with the radar signals	The collision warning system is temporarily disabled. Collision warning should automatically reactivate a short time after the weather conditions improve
Swirling water, or snow or ice on the surface of the road may interfere with the radar signals	The collision warning system is temporarily disabled. Collision warning should automatically reactivate a short time after the weather conditions improve

System Limitations

WARNING



The collision warning system's brake support can only help reduce the speed at which a collision occurs if the driver applies the vehicle's brakes. The brake pedal must be pressed just like any typical braking situation.

Due to the nature of radar technology, there may be certain instances where vehicles do not provide a collision warning. These include:

- Stationary vehicles or vehicles moving below 6 mph (10 km/h).
- Pedestrians or objects in the roadway.
- Oncoming vehicles in the same lane.
- Severe weather conditions (see blocked sensor section).
- Debris build-up on the grille near the headlamps (see blocked sensor section).

- Small distance to vehicle ahead.
- Steering wheel and pedal movements are large (very active driving style).

If the front end of the vehicle is hit or damaged, the radar sensing zone may be altered causing missed or false collision warnings. See your authorized dealer to have your collision warning radar checked for proper coverage and operation.

DRIVE CONTROL

Selectable Drive Modes

Selectable drive modes delivers a driving experience through a suite of sophisticated electronic vehicle systems. These systems optimize steering, handling and powertrain response. This provides a single location to control multiple systems performance settings.

Selectable drive modes consists of the following systems:

Driving Aids

- Electronically power-assisted steering adjusts steering effort and feel based on your selected mode.
- Electronic stability control and traction control maintain your vehicle control in adverse conditions or high performance driving. See **Stability Control** (page 143).
- Electronic throttle control enhances the powertrain response to your inputs.
- Sport+ – Provides a sportier steering feel and throttle response. Sport+ mode is ideal for use during more spirited driving.
- Track – Provides a performance driving experience. The engine responds directly to your inputs and takes on a more powerful tone. Track mode is for use when pure performance is desired. A performance oriented traction control mode is automatically utilized when Track drive mode is selected. In this mode, traction control intervention is reduced and tuned specifically for track usage only and is not intended for public roads. See **Using Stability Control** (page 144).
- Snow/Wet - Provides a confident handling driving experience during poor weather. This mode provides a confident drive experience and a direct connection to the road without sacrificing any of the composure demanded from your vehicle.

Using Selectable Drive Modes

Selectable drive modes automatically tailors your vehicle configuration for each mode selected.

MODE To change the drive mode setting, toggle the mode button or switch on the instrument panel under the display. The first press of the mode button or switch illuminates the selected mode, subsequent presses will change the selected mode.

Note: *Mode changes are not available when the vehicle ignition is off or reverse (R) gear is selected. In gear position drive (D), the available modes are Normal, Sport+, Track and Snow/Wet. In gear position sport (S) Snow/Wet and Normal mode are unavailable.*

Modes:

- Normal – Delivers a balanced combination of comfort and handling. This mode provides an engaging drive experience and a direct connection to the road without sacrificing any of the composure demanded from your vehicle.
- Sport – Engages when you shift your automatic transmission into sport (S). Sport mode increases throttle response and helps your vehicle accelerate faster, but does not change the feel of the steering or stability system.

Note: *Selectable driving modes has diagnostic checks that continuously monitor the system to ensure proper operation. Certain selectable drive modes will not be available based on gear shifter position (for example, Snow/Wet is not available while in sport (S) position). If a selected mode is unavailable due to a system fault or change in gear shifter position, the selected mode will default to Normal.*

Note: *Collision warning with brake support is automatically disabled when Track mode is selected.*

Selectable Steering

Note: *The steering setting defaults to Normal if the battery is disconnected or removed.*

Driving Aids



To change the steering feel, toggle the switch on the instrument panel. The first press illuminates the selected mode, subsequent presses will change the selected mode.

Modes:

- Normal - Default factory setting.
- Sport - Slightly higher effort required for steering with more road force felt through the steering wheel.
- Comfort - Slightly less effort required for steering with less road force felt through the steering wheel.

After selecting the desired setting, you may feel a soft feedback bump in the steering wheel when the changeover occurs.

Note: *If your vehicle is equipped with the selectable drive modes feature, the steering feel will change when you select a new drive mode. You can override this automatic selection by pressing the steering button or switch.*

Load Carrying

LOAD LIMIT

Vehicle Loading - with and without a Trailer

This section will guide you in the proper loading of your vehicle, trailer or both, to keep your loaded vehicle weight within its design rating capability, with or without a trailer. Properly loading your vehicle will provide maximum return of vehicle design performance. Before loading your vehicle, familiarize yourself with

the following terms for determining your vehicle's weight ratings, with or without a trailer, from the vehicle's Tire Label or Safety Compliance Certification Label:

Base Curb Weight - is the weight of the vehicle including full fluids and all standard equipment. It does not include passengers, cargo, or optional equipment.

Vehicle Curb Weight - is the weight of your new vehicle when you picked it up from your authorized dealer plus any aftermarket equipment.

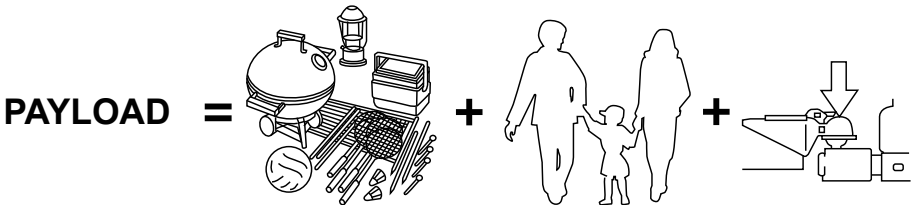

E143816

Payload - is the combined weight of cargo and passengers that the vehicle is carrying. The maximum payload for your vehicle can be found on the Tire Label on the B-Pillar or the edge of the driver door (vehicles exported outside the US and Canada may not have a Tire Label). Look for **“THE COMBINED WEIGHT OF OCCUPANTS AND CARGO SHOULD NEVER EXCEED XXX kg OR XXX lb.”** for maximum

payload. The payload listed on the Tire Label is the maximum payload for the vehicle as built by the assembly plant. If you install any aftermarket or authorized-dealer installed equipment on the vehicle, you must subtract the weight of the equipment from the payload listed on the Tire Label in order to determine the new payload.

Load Carrying

WARNING



The appropriate loading capacity of your vehicle can be limited either by volume capacity (how much space is available) or by payload capacity (how much weight the vehicle should carry). Once you have reached the maximum payload of your vehicle, do not add more cargo, even if there is space available. Overloading or improperly loading your vehicle can contribute to loss of vehicle control and vehicle rollover.

Example only:

TIRE AND LOADING INFORMATION			
SEATING CAPACITY		TOTAL 5	FRONT 2 REAR 3
The combined weight of occupants and cargo should never exceed : XXX kg or XXX lbs.			
TIRE	SIZE	COLD TIRE PRESSURE	SEE OWNERS MANUAL FOR ADDITIONAL INFORMATION
FRONT	LT225/75R16.5E	200 KPA, 29 PSI	
REAR	LT225/75R16.5E	200 KPA, 29 PSI	
SPARE	T145/80D16 P225/60R17	420 KPA, 60 PSI 200 KPA, 29 PSI	

E210944

TIRE AND LOADING INFORMATION			
RENSEIGNEMENTS SUR LES PNEUS ET LE CHARGEMENT			
SEATING CAPACITY		TOTAL 5	FRONT 2 REAR 3
NOMBRE DE PLACES		5	2 AVANT 3 ARRIERE
The combined weight of occupants and cargo should never exceed 492 kg or 1085 lbs.			
Le poids total des occupants et du chargement ne doit jamais dépasser 492 kg ou 1085 lbs.			
TIRE PNEU	SIZE DIMENSIONS	COLD TIRE PRESSURE PRESSION DES PNEUS A FROID	SEE OWNERS MANUAL FOR ADDITIONAL INFORMATION VOIR LE MANUEL DE L'USAGER POUR PLUS DE RENSEIGNEMENTS
FRONT AVANT	P235/70R16	240 KPA, 35 PSI	
REAR ARRIERE	P235/70R16	240 KPA, 35 PSI	
SPARE DE SECOURS	T145/90R17	415 KPA, 60 PSI	

E210945

CARGO

=



+

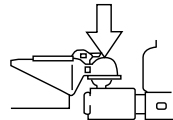

E143817

Load Carrying

Cargo Weight - includes all weight added to the Base Curb Weight, including cargo and optional equipment. When towing, trailer tongue load or king pin weight is also part of cargo weight.

GAW (Gross Axle Weight) - is the total weight placed on each axle (front and rear) including vehicle curb weight and all payload.

GAWR (Gross Axle Weight Rating) - is the maximum allowable weight that can be carried by a single axle (front or rear). These numbers are shown on the Safety Compliance

Certification Label. The label shall be affixed to either the door hinge pillar, door-latch post, or the door edge that meets the door-latch post, next to the driver's seating position. **The total load on each axle must never exceed its Gross Axle Weight Rating.**

Note: For trailer towing information refer to the *RV and Trailer Towing Guide* available at an authorized dealer.

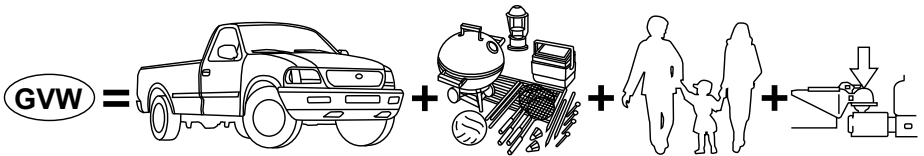

E143818

GVW (Gross Vehicle Weight) - is the Vehicle Curb Weight, plus cargo, plus passengers.

GVWR (Gross Vehicle Weight Rating) - is the maximum allowable weight of the fully loaded vehicle (including all options, equipment, passengers and cargo). It is shown on the

Safety Compliance Certification Label. The label shall be affixed to either the door hinge pillar, door-latch post, or the door edge that meets the door-latch post, next to the driver's seating position. **The Gross Vehicle Weight must never exceed the Gross Vehicle Weight Rating.**

Load Carrying

Example only:

MFD. BY FORD MOTOR CO.

DATE: XX/XX GVWR: XXXX KG (XXXX LB)
 FRONT GAWR: REAR GAWR:
 XXXX KG (XXXX LB) WITH XXXX KG (XXXX LB) WITH
 TIRES XXXXXXXXXXXXXXXX TIRES
 XXXXXXXX RIMS XXXXXXXX RIMS
 AT XXXX kPa/ XXX PSI COLD AT XXXX kPa/ XXX PSI COLD

THIS VEHICLE CONFORMS TO ALL APPLICABLE FEDERAL MOTOR VEHICLE SAFETY AND THEFT PREVENTION STANDARDS IN EFFECT ON THE DATE OF MANUFACTURE SHOWN ABOVE.

VIN: XXXXXXXXXXXXXXXXXXXX XXXXX
 TYPE: XXXX XXXXX



EXT PNT: XX XXXXXX RC: XX DSO: XXXX
 WB INT TR TP/PS R AXLE TR SPR XXXX
 XXX XX XXX X XX X XXXX XXXX
 XXXXXXXXXXXXXXXX XXXX XXXX-XXXXXXXX-XX

MFD. BY FORD MOTOR CO.

DATE: xx/xx GVWR/PNBV: xxxxx LB/xxxxx KG
 FRONT GAWR/PNBE AV / REAR GAWR/ PNBE AR
 xxxxx /xxxxx B / xxxxx KG/xxxxx B
 WITH/AVEC TIRES/PNEUS
 xxxxx /xxxxxx
 xxxxx /xxxxxx
 xxxxx

EC

AT/A kPa/PSI/LPC xxx/xx COLD/A FROID xxx/xx
 /JUMEELES

VIN: xxxxxxxxxxxxxxxxxxxx xxxxxx
 TYPE: xxx/xxxxx COMPLETES: xxxxx/xxxx -xxxx xxxxxx



EXT PNT: 01
 WB INT TR TP/PS R AXLE TR SPR xxxxxx
 xxx xx x xx x xxxxx xxx
 xxxxxxxxxxxxxxxx xxx xxxxx-xxxxxxxx-xx

E198828

WARNING

 Exceeding the Safety Compliance Certification Label vehicle weight rating limits could result in substandard vehicle handling or performance, engine, transmission and/or structural damage, serious damage to the vehicle, loss of control and personal injury.

GCW
=
GVW
+

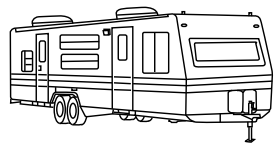

E143819

Load Carrying

GCW (Gross Combined Weight)

- is the Gross Vehicle Weight plus the weight of the fully loaded trailer.

GCWR (Gross Combined Weight Rating)

- is the maximum allowable weight of the vehicle and the loaded trailer, including all cargo and passengers, that the vehicle can handle without risking damage. (Important: The towing vehicle's braking system is rated for operation at Gross Vehicle Weight Rating, not at Gross Combined Weight Rating.)

Separate functional brakes should be used for safe control of towed vehicles and for trailers where the Gross Combined Weight of the towing vehicle plus the trailer exceed the Gross Vehicle Weight Rating of the towing vehicle. **The Gross Combined Weight must never exceed the Gross Combined Weight Rating.**

Maximum Loaded Trailer Weight

- is the highest possible weight of a fully loaded trailer the vehicle can tow. It assumes a vehicle with mandatory options, driver and front passenger weight (150 pounds [68 kilograms] each), no cargo weight (internal or external) and a tongue load of 10–15% (conventional trailer) or king pin weight of 15–25% (fifth wheel trailer). Consult an authorized dealer (or the RV and Trailer Towing Guide available at an authorized dealer) for more detailed information.

Tongue Load or Fifth Wheel King Pin Weight

- refers to the amount of the weight that a trailer pushes down on a trailer hitch.

Examples: For a 5000 pound (2268 kilogram) conventional trailer, multiply 5000 by 0.10 and 0.15 to obtain a proper tongue load range of 500 to 750 pounds (227 to 340 kilograms). For an 11500 pound (5216 kilogram) fifth wheel trailer, multiply by 0.15 and 0.25 to obtain a proper king pin load range of 1725 to 2875 pounds (782 to 1304 kilograms).

WARNINGS



Do not exceed the GVWR or the GAWR specified on the Safety Compliance Certification Label.



Do not use replacement tires with lower load carrying capacities than the original tires because they may lower the vehicle's GVWR and GAWR limitations. Replacement tires with a higher limit than the original tires do not increase the GVWR and GAWR limitations.



Exceeding any vehicle weight rating limitation could result in serious damage to the vehicle and/or personal injury.

Steps for determining the correct load limit:

Load Carrying

1. Locate the statement "The combined weight of occupants and cargo should never exceed XXX kg or XXX lb." on your vehicle's placard.
2. Determine the combined weight of the driver and passengers that will be riding in your vehicle.
3. Subtract the combined weight of the driver and passengers from XXX kg or XXX lb.
4. The resulting figure equals the available amount of cargo and luggage load capacity. For example, if the "XXX" amount equals 1,400 lb. and there will be five 150 lb. passengers in your vehicle, the amount of available cargo and luggage load capacity is 650 lb. $(1400 - 750 (5 \times 150) = 650 \text{ lb.})$
5. Determine the combined weight of luggage and cargo being loaded on the vehicle. That weight may not safely exceed the available cargo and luggage load capacity calculated in Step 4.
6. If your vehicle will be towing a trailer, load from your trailer will be transferred to your vehicle. Consult this manual to determine how this reduces the available cargo and luggage load capacity of your vehicle.

The following gives you a few examples on how to calculate the available amount of cargo and luggage load capacity:

*Suppose your vehicle has a 1400-pound (635-kilogram) cargo and luggage capacity. You decide to go golfing. Is there enough load capacity to carry you, four of your friends and all the golf bags? You and four friends average 220 pounds (99 kilograms) each and the golf bags weigh approximately 30 pounds (13.5 kilograms) each. The calculation would be: $1400 - (5 \times 220) - (5 \times 30) = 1400 - 1100 - 150 = 150$ pounds. Yes, you have enough load capacity in your vehicle to transport four friends and your golf bags. In metric units, the calculation would be: $635 \text{ kilograms} - (5 \times 99 \text{ kilograms}) - (5 \times 13.5 \text{ kilograms}) = 635 - 495 - 67.5 = 72.5$ kilograms.

*Suppose your vehicle has a 1400-pound (635-kilogram) cargo and luggage capacity. You and one of your friends decide to pick up cement from the local home improvement store to finish that patio you have been planning for the past two years. Measuring the inside of the vehicle with the rear seat folded down, you have room for twelve 100-pound (45-kilogram) bags of cement. Do you have enough load capacity to transport the cement to your home? If you and your friend each weigh 220 pounds (99 kilograms), the calculation would be: $1400 - (2 \times 220) - (12 \times 100) = 1400 - 440 - 1200 = -240$ pounds. No, you do not have enough cargo capacity to carry that much weight. In metric units, the calculation would

Load Carrying

be: 635 kilograms - (2 x 99 kilograms) - (12 x 45 kilograms) = 635 - 198 - 540 = -103 kilograms. You will need to reduce the load weight by at least 240 pounds (104 kilograms). If you remove three 100-pound (45-kilogram) cement bags, then the load calculation would be: 1400 - (2 x 220) - (9 x 100) = 1400 - 440 - 900 = 60 pounds. Now you have the load capacity to transport the cement and your friend home. In metric units, the calculation would be: 635 kilograms - (2 x 99 kilograms) - (9 x 45 kilograms) = 635 - 198 - 405 = 32 kilograms.

The above calculations also assume that the loads are positioned in your vehicle in a manner that does not overload the Front or the Rear Gross Axle Weight Rating specified for your vehicle on the Safety Compliance Certification Label. The label shall be affixed to either the door hinge pillar, door-latch post, or the door edge that meets the door-latch post, next to the driver's seating position.

Towing

TOWING A TRAILER

WARNINGS



Do not exceed the GVWR or the GAWR specified on the certification label.



Towing trailers beyond the maximum recommended gross trailer weight exceeds the limit of your vehicle and could result in engine damage, transmission damage, structural damage, loss of vehicle control, vehicle rollover and personal injury.

Note: *There may be electrical items such as fuses or relays that can affect trailer towing operation. See **Fuses** (page 202).*

The load capacity of your vehicle is designated by weight not volume. You may not necessarily be able to use all available space when loading your vehicle or trailer.

Towing a trailer places extra load on the engine, transmission, axle, brakes, tires, and suspension. Inspect these components before, during and after towing.

Load Placement

To help minimize how trailer movement affects the vehicle when driving:

- Load the heaviest items closest to the trailer floor.
- Load the heaviest items in the center of the left and right side trailer tires.
- Load the heaviest items above the trailer axles or just slightly forward toward the trailer tongue. Do not allow the final trailer tongue weight to go above or below 10-15% of the loaded trailer weight.
- Select a ball mount with the correct rise or drop. When both the loaded vehicle and trailer are connected, the trailer frame should be level, or slightly angled down toward the vehicle, when viewed from the side.

When driving with a trailer or payload, a slight takeoff vibration or shudder may be present due to the increased payload weight. Additional information regarding proper trailer loading and setting your vehicle up for towing is located in the Load Carrying chapter. See **Load Limit** (page 171).

You can also find information in the **RV & Trailer Towing Guide** available at your authorized dealer, or online.

Towing

RV & Trailer Towing Guide Online

Website | <http://www.fleet.ford.com/towing-guides/>

RECOMMENDED TOWING WEIGHTS

Note: Do not exceed the trailer weight for your vehicle configuration listed in the chart below.

Note: Be sure to take into consideration trailer frontal area. Do not exceed 20 feet² (1.86 meters²).

Note: For high altitude operation, reduce the gross combined weight by 2% per 1000 feet (300 meters) starting at the 1000 foot (300 meter) elevation point.

Note: Certain states require separate trailer brakes for trailers over a specified weight. Be sure to check state regulations for this specified weight. The maximum trailer weights listed may be limited to this specified weight, as the vehicle's electrical system may not include the wiring connector needed to activate electric trailer brakes.

Your vehicle may tow a trailer provided the maximum trailer weight is less than or equal to the maximum trailer weight listed for your vehicle configuration on the following chart.

Powertrain	Maximum trailer weight
2.3L GTDI	1000 lb (454 kg)
3.7L TiVCT	1000 lb (454 kg)
5.0L TiVCT	1000 lb (454 kg)

Towing

ESSENTIAL TOWING CHECKS

Follow these guidelines for safe towing:

- Do not tow a trailer until you drive your vehicle at least 1000 miles (1600 kilometers).
- Consult your local motor vehicle laws for towing a trailer.
- See the instructions included with towing accessories for the proper installation and adjustment specifications.
- Service your vehicle more frequently if you tow a trailer. See your scheduled maintenance information.
- If you use a rental trailer, follow the instructions the rental agency gives you.

You can find information on load specification terms found on the tire label and Safety Compliance label as well as instructions on calculating your vehicle's load in the Load Carrying chapter. See **Load Limit** (page 171).

Remember to account for the trailer tongue weight as part of your vehicle load when calculating the total vehicle weight.

Hitches

Do not use a hitch that either clamps onto the bumper or attaches to the axle.

Distribute the trailer load so 10-15% of the total trailer weight is on the tongue.

Safety Chains

Note: *Never attach safety chains to the bumper.*

Always connect the safety chains to the hook retainers of your vehicle hitch.

To connect the safety chains, cross them under the trailer tongue and allow enough slack for turning tight corners. Do not allow the chains to drag on the ground.

Trailer Brakes

WARNING



Do not connect a trailer's hydraulic brake system directly to your vehicle's brake system. Your vehicle may not have enough braking power and your chances of having a collision greatly increase.

Electric brakes and manual, automatic or surge-type trailer brakes are safe if you install them properly and adjust them to the manufacturer's specifications. The trailer brakes must meet local and federal regulations.

The rating for the tow vehicle's braking system operation is at the gross vehicle weight rating, not the gross combined weight rating.

Trailer Lamps

WARNING



Never connect any trailer lamp wiring to the vehicle's tail lamp wiring; this may damage the electrical system resulting in fire. Contact your authorized dealer as soon as possible for assistance in proper trailer tow wiring installation. Additional electrical equipment may be required.

Trailer lamps are required on most towed vehicles. Make sure all running lights, brake lights, direction indicators and hazard lights are working.

Before Towing a Trailer

Practice turning, stopping and backing up to get the feel of your vehicle-trailer combination before starting on a trip. When turning, make wider turns so the trailer wheels clear curbs and other obstacles.

Towing

When Towing a Trailer

- Do not drive faster than 70 mph (113 km/h) during the first 500 miles (800 kilometers).
- Do not make full-throttle starts.
- Check your hitch, electrical connections and trailer wheel lug nuts thoroughly after you have traveled 50 miles (80 kilometers).
- When stopped in congested or heavy traffic during hot weather, place the gearshift in park (P) (automatic transmission) or neutral (manual transmission) to aid engine and transmission cooling and to help air conditioning performance.
- Switch off the speed control with heavy loads or in hilly terrain. The speed control may turn off automatically when you are towing on long, steep grades.
- Shift to a lower gear when driving down a long or steep hill. Do not apply the brakes continuously, as they may overheat and become less effective.
- If your transmission is equipped with a Grade Assist or Tow/Haul feature, use this feature when towing. This provides engine braking and helps eliminate excessive transmission shifting for optimum fuel economy and transmission cooling.
- Allow more distance for stopping with a trailer attached. Anticipate stops and brake gradually.
- Avoid parking on a grade. However, if you must park on a grade:
 1. Turn the steering wheel to point your vehicle tires away from traffic flow.
 2. Set your vehicle parking brake.
 3. Place the automatic transmission in park (P) or manual transmission in a low gear.

4. Place wheel chocks in front and back of the trailer wheels. (Chocks not included with vehicle.)

Launching or Retrieving a Boat or Personal Watercraft (PWC)

Note: *Disconnect the wiring to the trailer before backing the trailer into the water.*

Note: *Reconnect the wiring to the trailer after removing the trailer from the water.*

When backing down a ramp during boat launching or retrieval:

- Do not allow the static water level to rise above the bottom edge of the rear bumper.
- Do not allow waves to break higher than 6 inches (15 centimeters) above the bottom edge of the rear bumper.

Exceeding these limits may allow water to enter vehicle components:

- Causing internal damage to the components.
- Affecting driveability, emissions, and reliability.

Any time the rear axle submerges in water, replace the rear axle lubricant. Water may contaminate the rear axle lubricant, which is not a normal maintenance inspection item unless there is a possibility of a leak or other axle repair is required.

Towing

TRANSPORTING THE VEHICLE

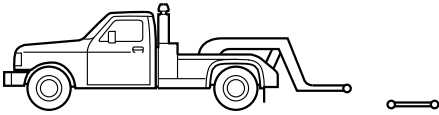

The rear wheels (drive wheels) must be on a tow dolly when towing your vehicle from the front using wheel lift equipment. This prevents damage to the transmission.

The front wheels should be on a tow dolly when towing your vehicle from the rear using wheel lift equipment. This prevents damage to the front fascia.

TOWING THE VEHICLE ON FOUR WHEELS

Emergency Towing

WARNING

 If your vehicle has a steering wheel lock make sure the ignition is in the accessory or on position when being towed.

You can flat-tow (all wheels on the ground, regardless of the powertrain or transmission configuration) your disabled vehicle (without access to wheel dollies or vehicle transport trailer) under the following conditions:

- Your vehicle is facing forward so you tow it in a forward direction.
- You shift into Neutral (N). If you cannot shift into Neutral (N), you may need to override the transmission. See **Transmission** (page 132).
- Maximum speed is 35 mph (56 km/h).
- Maximum distance is 50 mi (80 km).

Recreational Towing

Note: Put your climate control system in recirculated air mode to prevent exhaust fumes from entering the vehicle. See **Climate Control** (page 99).

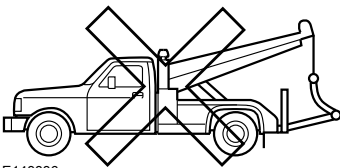
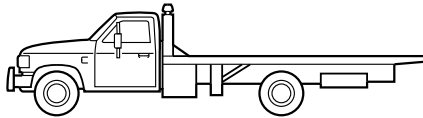

E143886

If you need to have your vehicle towed, contact a professional towing service or, if you are a member of a roadside assistance program, your roadside assistance service provider.

We recommend the use of a wheel lift and dollies or flatbed equipment to tow your vehicle. Do not tow with a slingbelt. Ford Motor Company has not approved a slingbelt towing procedure. Vehicle damage may occur if towed incorrectly, or by any other means.

Ford Motor Company produces a towing manual for all authorized tow truck operators. Have your tow truck operator refer to this manual for proper hook-up and towing procedures for your vehicle.

Towing

Follow these guidelines if you have a need for recreational (RV) towing. An example of recreational towing would be towing your vehicle behind a motorhome. These guidelines are to make sure you do not damage the transmission during towing.

Do not tow your vehicle with any wheels on the ground, as vehicle or transmission damage may occur. It is recommended to tow your vehicle with all four wheels off the ground, for example when using a vehicle transport trailer. Otherwise, you cannot tow your vehicle.

Convertible Top (If Equipped)

OPENING THE CONVERTIBLE TOP

When you use the top, you must first unlatch it from the windshield and then use the convertible top control.

Note: *The convertible top does not operate unless the vehicle is stationary or traveling under 3 mph (5 km/h). A chime sounds and a warning message appears in the instrument panel when you slow down, the top operates.*

Note: *When you latch or unlatch the convertible top, the audio system mutes briefly. This allows the vehicle to optimize the cabin's sound quality depending on the position of the convertible top.*

To unlatch the convertible top:

1. Bring the vehicle to a complete stop. The ignition must be on. We recommend that the vehicle remains running when you open the top to prevent draining the battery.
2. Check the convertible top stowage compartment behind the rear seat to be sure it is empty. Make sure the convertible top outer surface is free of debris.
3. Move the latch handle, located above the interior mirror, down toward the windshield and rotate the handle clockwise to release the convertible top.



E174571

The windows open automatically when you press the convertible top control.

To open the convertible top:

1. Press and hold the convertible top control, located on the overhead console, until the windows are completely down and the top stores completely.
2. Release the convertible top control.



E174568

Note: *Do not store articles behind the rear seat. Articles stored in the convertible top stowage compartment may break the rear glass window when you open the top.*

Note: *Opening the convertible top when the top material is wet may cause mold or mildew.*

Convertible Top (If Equipped)

Using the Tonneau Caps

Your convertible top also includes two tonneau caps, one for each side of the vehicle. These caps stow inside the trunk.

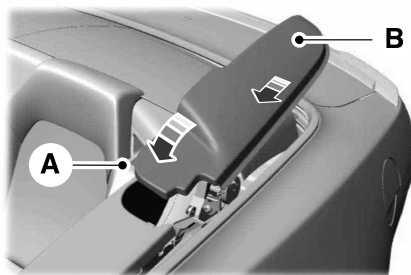

E205441

A.	Leading edge.
B.	Side edge.

After opening your convertible top, place the tonneau caps between the top and your vehicle trim moulding:

1. Insert tab A under the trim.
2. When tab A is under the trim slot, angle B down so the edges slide under the surrounding moulding and secure into place between the trim edges.
3. Repeat Steps 1 and 2 on the opposite side of the vehicle to install the second tonneau cap.

CLOSING THE CONVERTIBLE TOP

Closing the convertible top is a three-step process: Remove both of the tonneau caps, press the convertible top control to close the top, and then close the latch.

To remove the tonneau caps:

1. Slide B toward the center of the vehicle to release the edges from the surrounding trim.
2. Lift up on B, and then pull the piece back to release tab A from the trim.
3. Repeat Steps 1 and 2 on the opposite side of the vehicle.
4. Make sure you stow both pieces in the trunk.

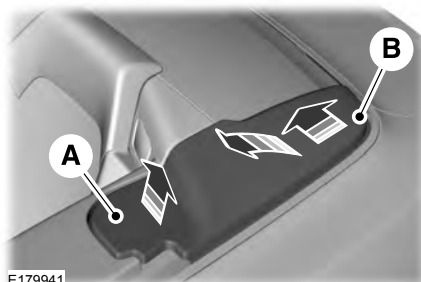

E179941

Note: The convertible top does not operate unless the vehicle is stationary or traveling under 3 mph (5 km/h). A chime sounds and a warning message appears in the instrument panel. When you slow down, the top operates.

Note: You must remove the tonneau caps before you are able to close the top or a chime sounds and a warning message appears in the instrument panel. Remove and stow the caps in the trunk, and then press the convertible top control again.

Note: When you latch or unlatch the convertible top, the audio system mutes briefly. This allows the vehicle to optimize the cabin's sound quality depending on the position of the convertible top.

Convertible Top (If Equipped)

To close the convertible top:

1. Bring the vehicle to a complete stop and make sure you switch the ignition on. We recommend that the vehicle remains running when you open the top to prevent draining the battery.
2. Press and hold the convertible top control. When the convertible latch handle is within reach, make sure it is down and that you rotate it clockwise so the latch is in the fully opened position. Continue pressing the convertible top control until the windows raise completely, and the top unfolds and moves forward toward the windshield header.
3. When the top lines up evenly with the windshield header, release the convertible top control.



E178453

Note: If you keep the top open for an extended period of time or if the temperature is low, the top material may shrink slightly. If this happens, pull on the latch handle to secure the top.



E174568

The final step when closing the convertible top is to lock the latch.

To lock the latch on the convertible top:

1. Pull down on the latch handle and rotate it counter-clockwise to secure the convertible top.
2. After securing the convertible top fully, push the latch handle up into the stowed position to secure the latch.

Driving Hints

BREAKING-IN

You need to break in new tires for approximately 300 miles (480 kilometers). During this time, your vehicle may exhibit some unusual driving characteristics.

Avoid driving too fast during the first 1000 miles (1600 kilometers). Vary your speed frequently and change up through the gears early. Do not labor the engine.

Do not tow during the first 1000 miles (1600 kilometers).

ECONOMICAL DRIVING

Fuel economy is affected by several things such as how you drive, the conditions you drive under and how you maintain your vehicle.

There are some things to keep in mind that may improve your fuel economy:

- Accelerate and slow down in a smooth, moderate fashion.
- Drive at steady speeds.
- Anticipate stops; slowing down may eliminate the need to stop.
- Combine errands and minimize stop-and-go driving (When running errands, go to the furthest destination first and then work your way back home).
- Close the windows for high-speed driving.
- Drive at reasonable speeds.
- Keep the tires properly inflated and use only the recommended size.
- Use the recommended engine oil.
- Perform all regularly scheduled maintenance.

There are also some things you may want to avoid doing because they reduce your fuel economy:

- Avoid sudden or hard accelerations.
- Avoid revving the engine before turning off the car.
- Avoid long idle periods.
- Do not warm up your vehicle on cold mornings.
- Reduce the use of air conditioning and heat.
- Avoid using speed control in hilly terrain.
- Do not rest your foot on the brake pedal while driving.
- Avoid carrying unnecessary weight.
- Avoid adding particular accessories to your vehicle (e.g. bug deflectors, rollbars/light bars, running boards, ski racks).
- Avoid driving with the wheels out of alignment.

DRIVING THROUGH WATER

WARNING



Do not drive through flowing or deep water as you may lose control of your vehicle.

Note: *Driving through standing water can cause vehicle damage.*

Note: *Engine damage can occur if water enters the air filter.*

Before driving through standing water, check the depth. Never drive through water that is higher than the bottom of the front rocker area of your vehicle.

Driving Hints



E176360

When driving through standing water, drive very slowly and do not stop your vehicle. Your brake performance and traction may be limited. After driving through water and as soon as it is safe to do so:

- Lightly press the brake pedal to dry the brakes and to check that they work.
- Check that the horn works.
- Check that the exterior lights work.
- Turn the steering wheel to check that the steering power assist works.

FLOOR MATS

WARNINGS

 Always use floor mats that are designed to fit the foot well of your vehicle. Only use floor mats that leave the pedal area unobstructed. Only use floor mats that are firmly secured to retention posts so that they cannot slip out of position and interfere with the pedals or impair safe operation of your vehicle in other ways.

 Pedals that cannot move freely can cause loss of vehicle control and increase the risk of serious personal injury.

WARNINGS

 Always make sure that the floor mats are properly attached to the retention posts in the carpet that are supplied with your vehicle. Floor mats must be properly secured to both retention posts to make sure mats do not shift out of position.

 Never place floor mats or any other covering in the vehicle foot well that cannot be properly secured to prevent them from moving and interfering with the pedals or the ability to control the vehicle.

 Never place floor mats or any other covering on top of already installed floor mats. Floor mats should always rest on top of vehicle carpeting surface and not another floor mat or other covering. Additional floor mats or any other covering will reduce the pedal clearance and potentially interfere with pedal operation.

 Check attachment of floor mats on a regular basis. Always properly reinstall and secure floor mats that have been removed for cleaning or replacement.

 Always make sure that objects cannot fall into the driver foot well while the vehicle is moving. Objects that are loose can become trapped under the pedals causing a loss of vehicle control.

 Failure to properly follow floor mat installation or attachment instructions can potentially cause interference with pedal operation causing a loss of vehicle control.

Driving Hints



E142666

To install floor mats, position the floor mat so that the eyelet is over the retention post and press down to lock in.

To remove the floor mat, reverse the installation procedure.

Roadside Emergencies

ROADSIDE ASSISTANCE

Vehicles Sold in the United States: Getting Roadside Assistance

To fully assist you should you have a vehicle concern, Ford Motor Company offers a complimentary roadside assistance program. This program is separate from the New Vehicle Limited Warranty. The service is available:

- 24 hours a day, seven days a week.
- For the coverage period listed on the Roadside Assistance Card included in your Owner's Manual portfolio.

Roadside Assistance covers:

- A flat tire change with a good spare, if provided with the vehicle (except vehicles supplied with a tire inflation kit).
- Battery jump start.
- Lock-out assistance (key replacement cost is the customer's responsibility).
- Fuel delivery — independent service contractors, if not prohibited by state, local or municipal law, shall deliver up to 2 gal (7.6 L) of gasoline or 5 gal (18.9 L) of diesel fuel to a disabled vehicle. Roadside Assistance limits fuel delivery service to two no-charge occurrences within a 12-month period.
- Winch out — available within 100 ft (30.5 m) of a paved or county maintained road, no recoveries.
- Towing — independent service contractors, if not prohibited by state, local or municipal law, shall tow Ford eligible vehicles to an authorized dealer within 35 mi (56 km) of the disablement location or to the nearest

authorized dealer. If a member requests a tow to an authorized dealer that is more than 35 mi (56 km) from the disablement location, the member shall be responsible for any mileage costs in excess of 35 mi (56 km).

Roadside Assistance includes up to \$200 for a towed trailer if the disabled eligible vehicle requires service at the nearest authorized dealer. If the towing vehicle is operational but the trailer is not, then the trailer does not qualify for any roadside services.

Vehicles Sold in the United States: Using Roadside Assistance

Complete the roadside assistance identification card and place it in your wallet for quick reference. This card is in the owner's information portfolio in the glove compartment.

United States Ford vehicle customers who require Roadside Assistance, call 1-800-241-3673.

If you need to arrange roadside assistance for yourself, Ford Motor Company reimburses a reasonable amount for towing to the nearest dealership within 35 mi (56 km). To obtain reimbursement information, United States Ford vehicle customers call 1-800-241-3673. Customers need to submit their original receipts.

Vehicles Sold in Canada: Getting Roadside Assistance

To fully assist you should you have a vehicle concern, Ford Motor Company of Canada, Limited offers a complimentary roadside assistance program. This program is eligible within Canada or the continental United States.

Roadside Emergencies

This program is separate from the New Vehicle Limited Warranty, but the coverage is concurrent with the powertrain coverage period of your vehicle.

Canadian customers who require roadside assistance, call 1-800-665-2006.

Vehicles Sold in Canada: Using Roadside Assistance

Complete the roadside assistance identification card and place it in your wallet for quick reference.

In Canada, this card is found in the Warranty Guide in the glove compartment of your vehicle.

Vehicles Sold in Canada: Roadside Assistance Program Coverage

The service is available 24 hours a day, seven days a week.

Canadian roadside coverage and benefits may differ from the U.S. coverage.

For complete program coverage details you may contact your dealer, you can call us in Canada at 1-800-665-2006, or visit our website at www.ford.ca.

HAZARD WARNING FLASHERS

Note: *The hazard warning flashers will operate when the ignition is in any position or if the key is not in the ignition. If used when the engine is not running, the battery will lose charge. As a result, there may be insufficient power to restart your engine.*



The hazard flasher control is located on the instrument panel by the radio. Use it when your vehicle is disabled and is creating a safety hazard for other motorists.

- Press the flasher control and all front and rear direction indicators flash.
- Press the flasher control again to turn them off.

FUEL SHUTOFF

WARNING



Failure to inspect and, if necessary, repair fuel leaks after a collision may increase the risk of fire and serious injury. Ford Motor Company recommends that the fuel system be inspected by an authorized dealer after any collision.

In the event of a moderate to severe collision, this vehicle includes a fuel pump shut-off feature that stops the flow of fuel to the engine. Not every impact will cause a shut-off.

Should your vehicle shut off after a collision, you may restart your vehicle. For vehicles equipped with a push button start system:

1. Press the **START/STOP** button to switch off the ignition.
2. Press the brake pedal (automatic transmission) or the clutch pedal (manual transmission) and press the **START/STOP** button to switch on the ignition.
3. Remove your foot from the brake or clutch pedal and press the **START/STOP** button to switch off the ignition.
4. Press the brake or clutch pedal and the **START/STOP** button, or switch on the ignition only by pressing the **START/STOP** button without pressing the brake or clutch pedal. Both ways re-enable the fuel system.

Roadside Emergencies

Note: When you try to restart your vehicle after a fuel shutoff, the vehicle makes sure that various systems are safe to restart. Once your vehicle determines that the systems are safe, then the vehicle will allow you to restart.

Note: In the event that your vehicle does not restart after your third attempt, contact an authorized dealer.

JUMP STARTING THE VEHICLE

WARNINGS



Batteries normally produce explosive gases which can cause personal injury. Therefore, do not allow flames, sparks or lighted substances to come near the battery. When working near the battery, always shield your face and protect your eyes. Always provide correct ventilation.



Keep batteries out of reach of children. Batteries contain sulfuric acid. Avoid contact with skin, eyes or clothing. Shield your eyes when working near the battery to protect against possible splashing of acid solution. In case of acid contact with skin or eyes, flush immediately with water for a minimum of 15 minutes and get prompt medical attention. If acid is swallowed, call a physician immediately.



Use only adequately sized cables with insulated clamps.

Preparing Your Vehicle

Note: Do not attempt to push-start your automatic transmission vehicle. Attempting to push-start a vehicle with an automatic transmission may cause transmission damage.

Note: Use only a 12-volt supply to start your vehicle.

Note: Do not disconnect the battery of the disabled vehicle as this could damage the vehicles electrical system.

Park the booster vehicle close to the hood of the disabled vehicle, making sure the two vehicles do not touch. Switch off all accessories.

Connecting the Jumper Cables

WARNING



Do not attach the cables to fuel lines, engine rocker covers, the intake manifold or electrical components as grounding points. Stay clear of moving parts. To avoid reverse polarity connections, make sure that you correctly identify the positive (+) and negative (-) terminals on both the disabled and booster vehicles before connecting the cables.

Note: In the illustration, the bottom vehicle represents the booster vehicle.

Roadside Emergencies

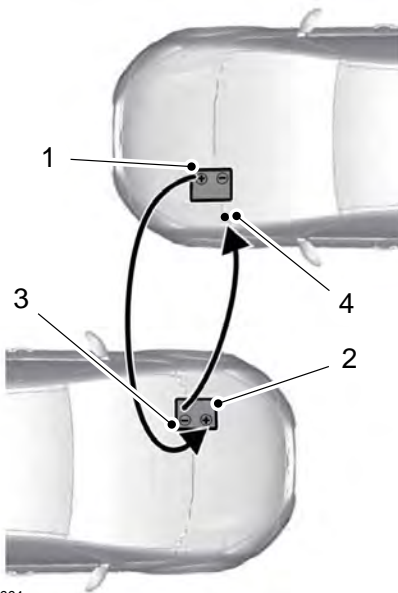

E142664

1. Connect the positive (+) jumper cable to the positive (+) terminal of the discharged battery.
2. Connect the other end of the positive (+) cable to the positive (+) terminal of the booster vehicle battery.
3. Connect the negative (-) cable to the negative (-) terminal of the booster vehicle battery.
4. Make the final connection of the negative (-) cable to an exposed metal part of the stalled vehicle's engine, away from the battery and the fuel injection system, or connect the negative (-) cable to a ground connection point if available.

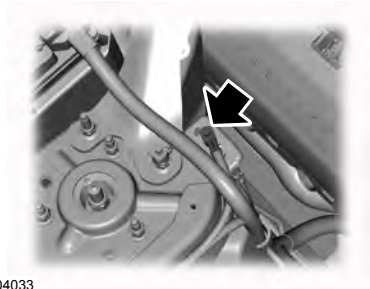

E204033

Note: You can use the optional connection point location shown above to ground your vehicle.

WARNING



Do not connect the end of the second cable to the negative (-) terminal of the battery to be jumped. A spark may cause an explosion of the gases that surround the battery.

Jump Starting

1. Start the engine of the booster vehicle and rev the engine moderately, or press the accelerator gently to keep your engine speed between 2000 and 3000 RPM as shown in your tachometer.
2. Start the engine of the disabled vehicle.
3. Once the disabled vehicle has been started, run both vehicle engines for an additional three minutes before disconnecting the jumper cables.

Removing the Jumper Cables

Remove the jumper cables in the reverse order that they were connected.

Roadside Emergencies

POST-CRASH ALERT SYSTEM

The system flashes the direction indicators and sounds the horn (intermittently) in the event of a serious impact that deploys an airbag (front, side, side curtain or Safety Canopy) or the safety belt pretensioners.

The horn and indicators will turn off when:

- You press the hazard control button.
- You press the panic button on the remote entry transmitter (if equipped).
- Your vehicle runs out of power.

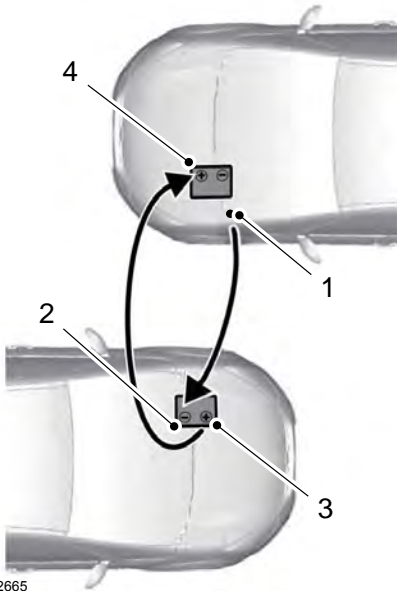

E142665

1. Remove the jumper cable from the ground metal surface or connecting point, if available.
2. Remove the negative (-) jumper cable from the disabled vehicle.
3. Remove the jumper cable on the negative (-) terminal of the booster vehicle battery.
4. Remove the jumper cable from the positive (+) terminal of the booster vehicle battery.
5. Remove the jumper cable from the positive (+) terminal of the disabled vehicle battery.

Allow the engine to idle for at least one minute.

Customer Assistance

GETTING THE SERVICES YOU NEED

Warranty repairs to your vehicle must be performed by an authorized dealer. While any authorized dealer handling your vehicle line will provide warranty service, we recommend you return to your selling authorized dealer who wants to ensure your continued satisfaction.

Please note that certain warranty repairs require special training and equipment, so not all authorized dealers are authorized to perform all warranty repairs. This means that, depending on the warranty repair needed, you may have to take your vehicle to another authorized dealer.

A reasonable time must be allowed to perform a repair after taking your vehicle to the authorized dealer. Repairs will be made using Ford or Motorcraft® parts, or remanufactured or other parts that are authorized by Ford.

Away From Home

If you are away from home when your vehicle needs service, contact the Ford Customer Relationship Center or use the online resources listed below to find the nearest authorized dealer.

In the United States:

Mailing address

Ford Motor Company
Customer Relationship Center
P.O. Box 6248
Dearborn, MI 48126

Telephone

1-800-392-3673 (FORD)
(TDD for the hearing impaired:
1-800-232-5952)

Additional information and resources are available online:

Website
www.owner.ford.com

These are some of the items that can be found online:

- U.S. dealer locator by Dealer Name, City/State or Zip Code.
- Owner Manuals.
- Maintenance Schedules.
- Recalls.
- Ford Extended Service Plans.
- Ford Genuine Accessories.
- Service specials and promotions.

In Canada:

Mailing address

Customer Relationship Centre
Ford Motor Company of Canada, Limited
P.O. Box 2000
Oakville, Ontario L6K 0C8

Telephone

1-800-565-3673 (FORD)

Website
www.ford.ca

Twitter

@FordServiceCA (English Canada)
@FordServiceQC (Quebec)

Additional Assistance

If you have questions or concerns, or are unsatisfied with the service you are receiving, follow these steps:

1. Contact your Sales Representative or Service Advisor at your selling or servicing authorized dealer.

Customer Assistance

2. If your inquiry or concern remains unresolved, contact the Sales Manager, Service Manager or Customer Relations Manager.
3. If you require assistance or clarification on Ford Motor Company policies, please contact the Ford Customer Relationship Center.

In order to help us serve you better, please have the following information available when contacting a Customer Relationship Center:

- Vehicle Identification Number.
- Your telephone number (home and business).
- The name of the authorized dealer and city where located.
- The vehicle's current odometer reading.

In some states within the United States, you must directly notify Ford in writing before pursuing remedies under your state's warranty laws, and Ford is also allowed a final repair attempt.

Additionally, in some states within the United States, a consumer has the option of submitting a warranty dispute to the BBB Auto Line before taking action under the Magnuson-Moss Warranty Act, or to the extent allowed by state law, before pursuing replacement or repurchase remedies provided by certain state laws. This dispute handling procedure is not required prior to enforcing state created rights or other rights which are independent of the Magnuson-Moss Warranty Act or state replacement or repurchase laws.

IN CALIFORNIA (U.S. ONLY)

California Civil Code Section 1793.2(d) requires that, if a manufacturer or its representative is unable to repair a motor vehicle to conform to the vehicle's applicable express warranty after a reasonable number of attempts, the manufacturer shall be required to either replace the vehicle with one substantially identical or repurchase the vehicle and reimburse the buyer in an amount equal to the actual price paid or payable by the consumer (less a reasonable allowance for consumer use). The consumer has the right to choose whether to receive a refund or replacement vehicle.

California Civil Code Section 1793.22(b) presumes that the manufacturer has had a reasonable number of attempts to conform the vehicle to its applicable express warranties if, within the first 18 months of ownership of a new vehicle or the first 18000 miles (29 000 km), whichever occurs first:

1. Two or more repair attempts are made on the same non-conformity likely to cause death or serious bodily injury OR
2. Four or more repair attempts are made on the same nonconformity (a defect or condition that substantially impairs the use, value or safety of the vehicle) OR
3. The vehicle is out of service for repair of nonconformities for a total of more than 30 calendar days (not necessarily all at one time).

In the case of 1 or 2 above, the consumer must also notify the manufacturer of the need for the repair of the nonconformity at the following address:

Ford Motor Company
16800 Executive Plaza Drive
Mail Drop 3NE-B
Dearborn, MI 48126

Customer Assistance

You are required to submit your warranty dispute to BBB AUTO LINE before asserting in court any rights or remedies conferred by California Civil Code Section 1793.22(b). You are also required to use BBB AUTO LINE before exercising rights or seeking remedies created by the Federal Magnuson-Moss Warranty Act, 15 U.S.C. sec. 2301 et seq. If you choose to seek redress by pursuing rights and remedies not created by California Civil Code Section 1793.22(b) or the Magnuson-Moss Warranty Act, resort to BBB AUTO LINE is not required by those statutes.

THE BETTER BUSINESS BUREAU (BBB) AUTO LINE PROGRAM (U.S. ONLY)

Your satisfaction is important to Ford Motor Company and to your dealer. If a warranty concern has not been resolved using the three-step procedure outlined earlier in this chapter in the Getting the Services you need section, you may be eligible to participate in the BBB AUTO LINE program.

The BBB AUTO LINE program consists of two parts – mediation and arbitration. During mediation, a representative of the BBB will contact both you and Ford Motor Company to explore options for settlement of the claim. If an agreement is not reached during mediation or you do not want to participate in mediation, and if your claim is eligible, you may participate in the arbitration process. An arbitration hearing will be scheduled so that you can present your case in an informal setting before an impartial person. The arbitrator will consider the testimony provided and make a decision after the hearing.

Disputes submitted to the BBB AUTO LINE program are usually decided within forty days after you file your claim with the BBB. You are not bound by the decision, and may reject the decision and proceed to court where all findings of the BBB Auto Line dispute, and decision, are admissible in the court action. Should you choose to accept the BBB AUTO LINE decision, Ford is then bound by the decision, and must comply with the decision within 30 days of receipt of your acceptance letter.

BBB AUTO LINE Application: Using the information provided below, please call or write to request a program application. You will be asked for your name and address, general information about your new vehicle, information about your warranty concerns, and any steps you have already taken to try to resolve them. A Customer Claim Form will be mailed that will need to be completed, signed and returned to the BBB along with proof of ownership. Upon receipt, the BBB will review the claim for eligibility under the Program Summary Guidelines.

You can get more information by calling BBB AUTO LINE at 1-800-955-5100, or writing to:

**BBB AUTO LINE
3033 Wilson Boulevard, Suite 600
Arlington, Virginia 22201**

BBB AUTO LINE applications can also be requested by calling the Ford Motor Company Customer Relationship Center at 1-800-392-3673.

Note: *Ford Motor Company reserves the right to change eligibility limitations, modify procedures, or to discontinue this process at any time without notice and without obligation.*

Customer Assistance

UTILIZING THE MEDIATION/ARBITRATION PROGRAM (CANADA ONLY)

For vehicles delivered to authorized Canadian dealers. In those cases where you continue to feel that the efforts by Ford of Canada and the authorized dealer to resolve a factory-related vehicle service concern have been unsatisfactory, Ford of Canada participates in an impartial third party mediation/arbitration program administered by the Canadian Motor Vehicle Arbitration Plan (CAMVAP).

The CAMVAP program is a straight forward and relatively speedy alternative to resolve a disagreement when all other efforts to produce a settlement have failed. This procedure is without cost to you and is designed to eliminate the need for lengthy and expensive legal proceedings.

In the CAMVAP program, impartial third-party arbitrators conduct hearings at mutually convenient times and places in an informal environment. These impartial arbitrators review the positions of the parties, make decisions and, when appropriate, render awards to resolve disputes. CAMVAP decisions are fast, fair, and final as the arbitrator's award is binding on both you and Ford of Canada.

CAMVAP services are available in all Canadian territories and provinces. For more information, without charge or obligation, call your CAMVAP Provincial Administrator directly at 1-800-207-0685 or visit www.camvap.ca.

GETTING ASSISTANCE OUTSIDE THE U.S. AND CANADA

Before exporting your vehicle to a foreign country, contact the appropriate foreign embassy or consulate. These officials can inform you of local vehicle registration regulations and where to find unleaded fuel.

If you cannot find unleaded fuel or can only get fuel with an anti-knock index lower than is recommended for your vehicle, contact our Customer Relationship Center.

The use of leaded fuel in your vehicle without proper conversion may damage the effectiveness of your emission control system and may cause engine knocking or serious engine damage. Ford Motor Company or Ford of Canada is not responsible for any damage caused by use of improper fuel. Using leaded fuel may also result in difficulty importing your vehicle back into the United States.

If your vehicle must be serviced while you are traveling or living in Asia-Pacific Region, Sub-Saharan Africa, U.S. Virgin Islands, Central America, the Caribbean, and Israel, contact the nearest authorized dealer. If the authorized dealer cannot help you, contact:

FORD MOTOR COMPANY
Customer Relationship Center
1555 Fairlane Drive
Fairlane Business Park #3
Allen Park, Michigan 48101
U.S.A.
Telephone: (313) 594-4857
Fax: (313) 390-0804
Email: expcac@ford.com

Customer Assistance

For customers in Guam, the Commonwealth of the Northern Mariana Islands (CNMI), America Samoa, and the U.S. Virgin Islands, please feel free to call our Toll-Free Number: (800) 841-FORD (3673).

If your vehicle must be serviced while you are traveling or living in Puerto Rico, contact the nearest authorized dealer. If the authorized dealer cannot help you, contact:

FORD MOTOR COMPANY
Customer Relationship Center
1555 Fairlane Drive
Fairlane Business Park #3
Allen Park, Michigan 48101
U.S.A.
Telephone: (800) 841-FORD (3673)
FAX: (313) 390-0804
Email: prcac@ford.com
www.ford.com.pr

If your vehicle must be serviced while you are traveling or living in the Middle East, contact the nearest authorized dealer. If the authorized dealer cannot help you, contact:

FORD MOTOR COMPANY
Customer Relationship Center
1555 Fairlane Drive
Fairlane Business Park #3
Allen Park, Michigan 48101
U.S.A.

Ford: 80004443673
Lincoln: 80004441067
If calling from the UAE: 80004441066
If calling from the Kingdom of Saudi Arabia: 8008443673
If calling from Kuwait: 22280384

FAX: +971 4 3327266
Email: menacac@ford.com
www.me.ford.com

If you buy your vehicle in North America and then relocate to any of the above locations, register your vehicle identification number (VIN) and new address with Ford Motor Company Export Operations & Global Growth Initiatives by emailing **expcac@ford.com**.

If you are in another foreign country, contact the nearest authorized dealer. In the event your inquiry is unresolved, communicate your concern with the dealership's Sales Manager, Service Manager or Customer Relations Manager. If you require additional assistance or clarification, please contact the respective Customer Relationship Center as previously listed.

Customers in the U.S. should call 1-800-392-3673.

ORDERING ADDITIONAL OWNER'S LITERATURE

To order the publications in this portfolio, contact Helm, Incorporated at:

HELM, INCORPORATED
47911 Halyard Drive
Plymouth, Michigan 48170
Attention: Customer Service

Or to order a free publication catalog, call toll free: 1-800-782-4356

Monday-Friday 8:00 a.m. - 6:00 p.m. EST

Helm, Incorporated can also be reached by their website:

www.helminc.com

(Items in this catalog may be purchased by credit card, check or money order.)

Customer Assistance

Obtaining a French Owner's Manual

French Owner's Manual can be obtained from your authorized dealer or by contacting Helm, Incorporated using the contact information listed previously in this section.

REPORTING SAFETY DEFECTS (U.S. ONLY)



E142557

If you believe that your vehicle has a defect which could cause a crash or could cause injury or death, you should immediately inform the National Highway Traffic Safety Administration (NHTSA) in addition to notifying Ford Motor Company.

If NHTSA receives similar complaints, it may open an investigation, and if it finds that a safety defect exists in a group of vehicles, it may order a recall and remedy campaign. However, NHTSA cannot become involved in individual problems between you, your dealer, or Ford Motor Company.

To contact NHTSA, you may call the Vehicle Safety Hotline toll-free at 1-888-327-4236 (TTY: 1-800-424-9153); go to <http://www.safercar.gov>; or write to:

Administrator

1200 New Jersey Avenue,
Southeast

Washington, D.C. 20590

You can also obtain other information about motor vehicle safety from <http://www.safercar.gov>.

REPORTING SAFETY DEFECTS (CANADA ONLY)

If you believe that your vehicle has a defect which could cause a crash or could cause injury or death, you should immediately inform Transport Canada and Ford of Canada.

Customer Assistance

Transport Canada Contact Information

Website	www.tc.gc.ca/eng/motorvehiclesafety/safevehicles-defectinvestigations-index-76.htm (English)
Website	www.tc.gc.ca/fra/securiteautomobile/VehiculesSecuritaires-Enquetes-index-76.htm (French)
Phone	1-800-333-0510

Ford of Canada Contact Information

Website	www.ford.ca
Phone	1-800-565-3673

Fuses

FUSE SPECIFICATION CHART

Power Distribution Box

WARNINGS



Always disconnect the battery before servicing high current fuses.



To reduce risk of electrical shock, always replace the cover to the power distribution box before reconnecting the battery or refilling fluid reservoirs.

The power distribution box is located in the engine compartment. It has high-current fuses that protect your vehicle's main electrical systems from overloads.

If you disconnect and reconnect the battery, you will need to reset some features. See **Changing the 12V Battery** (page 222).

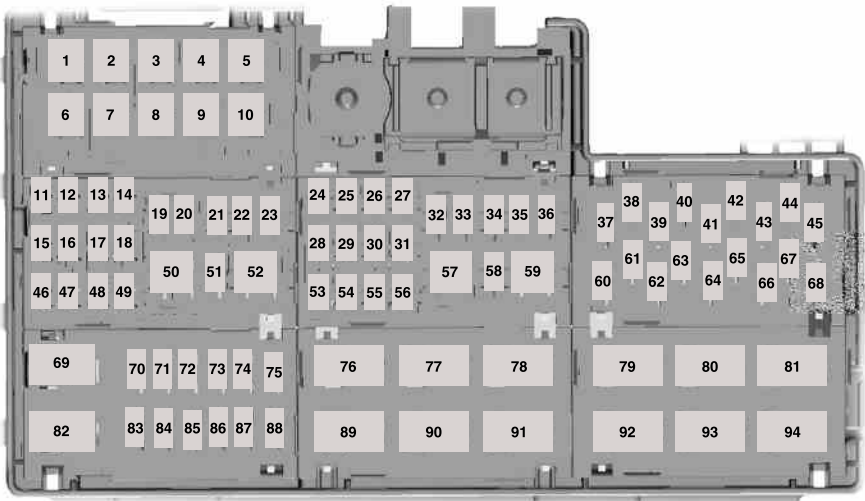

E174563

Fuse or relay number	Fuse amp rating	Protected components
1	—	Not used.
2	—	Not used.
3	—	Not used.

Fuses

Fuse or relay number	Fuse amp rating	Protected components
4	—	Not used.
5	50A*	Automatic brake system pump.
6	50A*	Body control module.
7	60A*	Body control module.
8	50A*	Body control module.
9	40A*	Rear window defroster.
10	40A*	Blower motor.
11	30A**	Left-hand front window.
12	30A**	Driver seat.
13	30A**	Passenger seat.
14	30A**	Climate-controlled seat module.
15	20A**	Convertible top motor.
16	—	Not used.
17	20A**	Convertible top motor.
18	—	Not used.
19	20A***	Steering column lock relay.
20	10A***	Brake on-off switch.
21	20A***	Horn.
22	10A***	Powertrain control module relay.
23	10A***	Air conditioning clutch.
24	30A**	Voltage quality module.
25	—	Not used.
26	25A**	Windshield wiper motor.
27	—	Not used.
28	30A**	Automatic brake system valve.
29	30A**	Electronic fan 1.
30	30A**	Starter motor solenoid.

Fuses

Fuse or relay number	Fuse amp rating	Protected components
31	40A**	Electronic fan 3.
32	10A***	Latch relay coil.
33	20A***	Left-hand high-intensity discharge head-lamps.
34	15A***	Exhaust valves.
35	20A***	Right-hand high-intensity discharge head-lamps.
36	10A***	Alt sense.
37	—	Not used.
38	20A***	Vehicle power 1.
39	—	Not used.
40	20A***	Vehicle power 2.
41	15A***	Fuel injectors.
42	15A***	Vehicle power 3.
43	—	Not used.
44	15A***	Vehicle power 4.
	30A***	Ignition coils (GT350 only).
45	—	Not used.
46	20A**	Differential pump.
47	—	Not used.
48	30A**	Fuel pump #2.
49	30A**	Fuel pump.
50	—	Steering column lock relay.
51	—	Not used.
52	—	Horn relay.
53	20A**	Cigar lighter.
54	20A**	Auxiliary power point.
55	25A**	Electronic fan 2.

Fuses

Fuse or relay number	Fuse amp rating	Protected components
56	—	Not used.
57	—	Air conditioning clutch relay.
58	—	Not used.
59	—	Exhaust valves.
60	5A***	Powertrain control module.
61	—	Not used.
62	5A***	Anti-lock brakes run-start switch.
63	—	Not used.
64	5A***	Electronic power assist steering.
65	—	Not used.
66	5A***	Blind spot information system. Rear view camera. Air conditioning compressor relay coils.
67	—	Not used.
68	10A***	Headlamp leveling switch.
69	—	Auxiliary power point relay.
70	10A***	Heated exterior mirrors.
71	—	Not used.
72	5A***	Rain sensor module.
73	—	Not used.
74	5A***	Mass air flow sensor.
75	—	Not used.
76	—	Rear window defroster.
77	—	Electronic cooling fan 2.
78	—	Left-hand high-intensity discharge headlamp relay (export).
79	—	Right-hand high-intensity-discharge headlamp relay (export).

Fuses

Fuse or relay number	Fuse amp rating	Protected components
80	—	Windshield wiper relay.
81	—	Starter motor solenoid.
82	—	Powertrain control module relay.
83	—	Not used.
84	—	Not used.
85	—	Not used.
86	—	Not used.
87	—	Not used.
88	—	Not used.
89	—	Electronic fan 1 relay.
90	—	Differential pump.
91	—	Electronic fan 3 relay.
92	—	Blower motor relay.
93	—	Fuel pump #2.
94	—	Fuel pump relay.

*J-case fuses.

**M-case fuses.

***Micro fuses.

Passenger Compartment Fuse Panel

The fuse panel is in the right-hand side of the passenger footwell behind a trim panel and plastic key code card.

To remove the trim panel, lift it from the rear retaining hooks, while pulling it toward you and swinging it away from the side. To reinstall it, line up the tabs with the grooves on the panel, drop the panel back into place, and then push it shut.

To reach the fuse panel, first remove the key code card.

After replacing a fuse, return the key code card to the original position. To reinstall the trim panel, lineup the tabs with the grooves on the panel, drop the panel back into place, and then push it shut to reinstall the trim panel.

Fuses

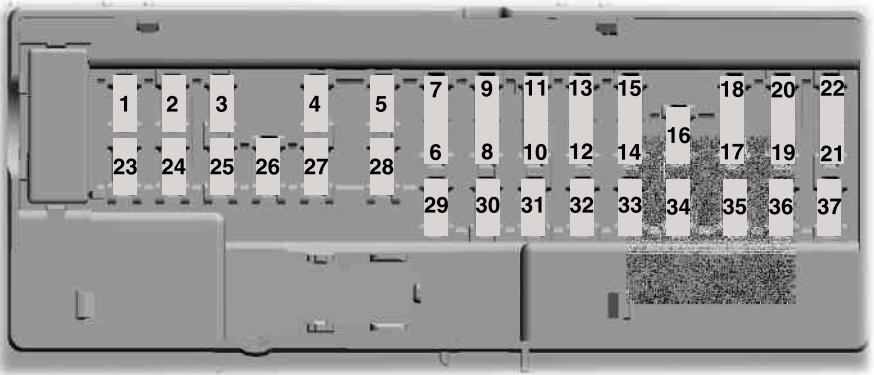

E174564

Fuse or relay number	Fuse amp rating	Protected components
1	10A	Demand lamps.
2	7.5A	Power mirror memory module.
3	20A	Driver console unlock.
4	—	Not used.
5	20A	Subwoofer amplifier.
6	—	Not used.
7	—	Not used.
8	—	Not used.
9	—	Not used.
10	—	Not used.
11	—	Not used.

Fuses

Fuse or relay number	Fuse amp rating	Protected components
12	7.5A	Climate control module.
13	7.5A	Gateway module. Steering column control module. Instrument cluster.
14	—	Not used.
15	10A	Gateway module.
16	15A	Decklid release.
17	5A	Not used (spare).
18	5A	Intrusion sensor module.
19	7.5A	Passenger airbag deactivation indicator.
20	—	Not used.
21	5A	In-vehicle temperature and humidity sensor.
22	5A	Occupant classification system module.
23	10A	Switches. Power windows. Rear-view mirror.
24	20A	Central lock unlock.
25	30A	Magneride.
26	30A	Right-hand front-window motor.
27	30A	Amplifier.
28	20A	Auxiliary body module.
29	30A	Left-hand rear-window power.
30	30A	Right-hand rear-window power.
31	—	Not used.
32	10A	Remote keyless entry. Multi-function display. SYNC. Global positioning system module. Gauges.
33	20A	Audio head unit.

Fuses

Fuse or relay number	Fuse amp rating	Protected components
34	30A	Run-start bus.
35	5A	Restraints control module.
36	15A	Auxiliary body module.
37	20A	Power distribution box run-start bus.
—	30A	Not used (spare).

CHANGING A FUSE

Fuses

WARNING



Always replace a fuse with one that has the specified amperage rating. Using a fuse with a higher amperage rating can cause severe wire damage and could start a fire.



E217331

If electrical components in the vehicle are not working, a fuse may have blown. Blown fuses are identified by a broken wire within the fuse. Check the appropriate fuses before replacing any electrical components.

Fuses

Fuse Types

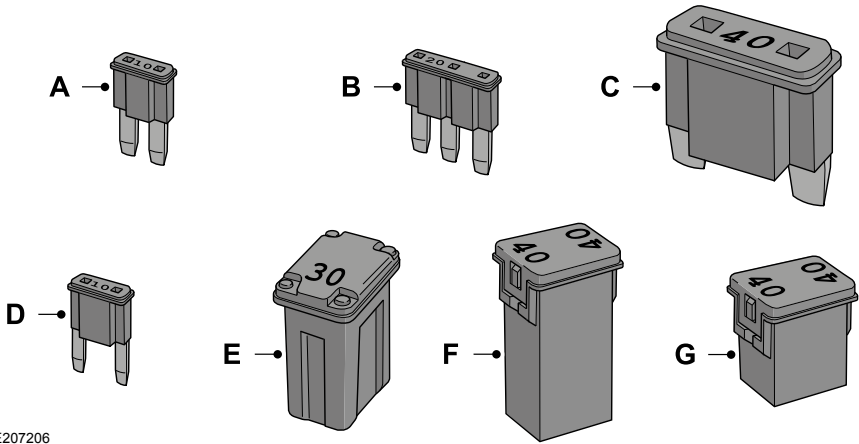

E207206

Callout	Fuse Type
A	Micro 2
B	Micro 3
C	Maxi
D	Mini
E	M Case
F	J Case
G	J Case Low Profile

Maintenance

GENERAL INFORMATION

Have your vehicle serviced regularly to help maintain its roadworthiness and resale value. There is a large network of authorized dealers that are there to help you with their professional servicing expertise. We believe that their specially trained technicians are best qualified to service your vehicle properly and expertly. They are supported by a wide range of highly specialized tools developed specifically for servicing your vehicle.

If your vehicle requires professional service, an authorized dealer can provide the necessary parts and service. Check your warranty information to find out which parts and services are covered.

Use only recommended fuels, lubricants, fluids and service parts conforming to specifications. Motorcraft® parts are designed and built to provide the best performance in your vehicle.

Precautions

- Do not work on a hot engine.
- Make sure that nothing gets caught in moving parts.
- Do not work on a vehicle with the engine running in an enclosed space, unless you are sure you have enough ventilation.
- Keep all open flames and other burning material (such as cigarettes) away from the battery and all fuel related parts.

Working with the Engine Off

1. Set the parking brake and shift to park (P).
2. Switch off the engine.
3. Block the wheels.

Working with the Engine On

WARNING



To reduce the risk of vehicle damage and/or personal burn injuries, do not start your engine with the air cleaner removed and do not remove it while the engine is running.

1. Set the parking brake and shift to park (P).
2. Block the wheels.

OPENING AND CLOSING THE HOOD

Opening the Hood



E142457

1. Inside the vehicle, pull the hood release handle located under the left-hand side of the instrument panel.
2. Slightly lift the hood.

Maintenance

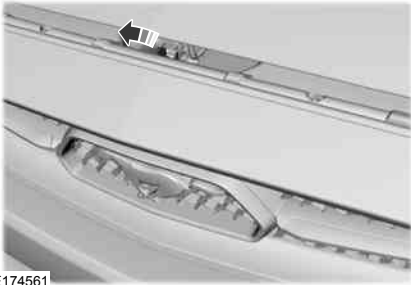

E174561

3. Release the hood latch by pushing the secondary release lever to your left-hand side.



E87786

4. Open the hood. Support the hood with the strut.

Closing the Hood

1. Remove the hood strut from the catch and secure it correctly after use.
2. Lower the hood and allow it to drop under its own weight for the last 8–12 in (20–30 cm).

Note: *Make sure that the hood is correctly closed.*

Maintenance

UNDER HOOD OVERVIEW - 2.3L ECOBOOST™

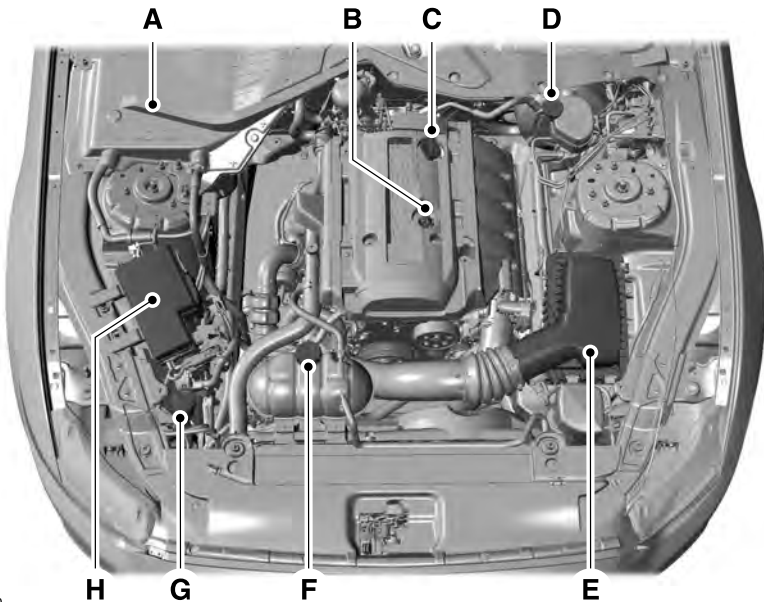

E174450

- A Battery (out of view). See **Changing the 12V Battery** (page 222).
- B Engine oil dipstick. See **Engine Oil Dipstick** (page 216).
- C Engine oil filler cap. See **Engine Oil Check** (page 216).
- D Brake fluid reservoir. See **Brake and Clutch Fluid Check** (page 221).
- E Air filter assembly. See **Changing the Engine Air Filter** (page 229).
- F Engine coolant reservoir. See **Engine Coolant Check** (page 217).
- G Windshield washer fluid reservoir. See **Washer Fluid Check** (page 222).
- H Power distribution box. See **Fuses** (page 202).

Maintenance

UNDER HOOD OVERVIEW - 3.7L

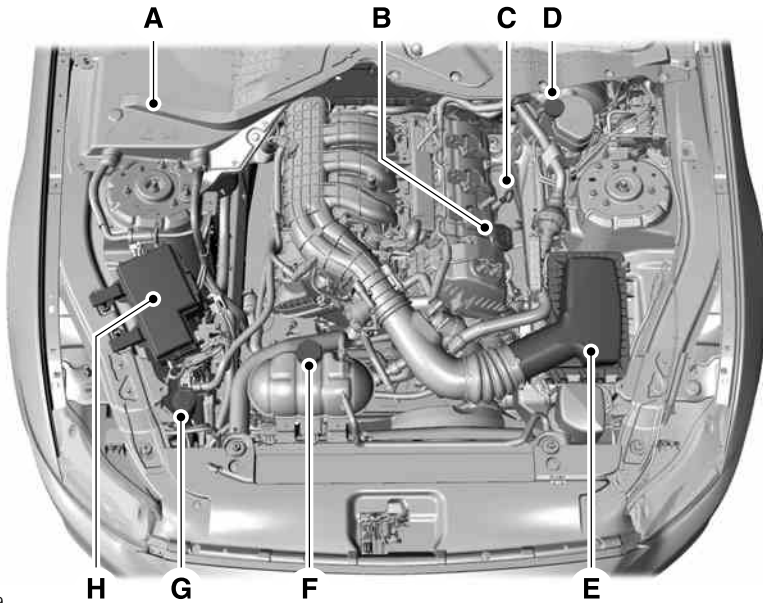

E174559

- A. Battery (out of view). See **Changing the 12V Battery** (page 222).
- B. Engine oil filler cap. See **Engine Oil Check** (page 216).
- C. Engine oil dipstick. See **Engine Oil Dipstick** (page 216).
- D. Brake fluid reservoir. See **Brake and Clutch Fluid Check** (page 221).
- E. Air filter assembly. See **Changing the Engine Air Filter** (page 229).
- F. Engine coolant reservoir. See **Engine Coolant Check** (page 217).
- G. Windshield washer fluid reservoir. See **Washer Fluid Check** (page 222).
- H. Power distribution box. See **Fuses** (page 202).

Maintenance

UNDER HOOD OVERVIEW - 5.0L

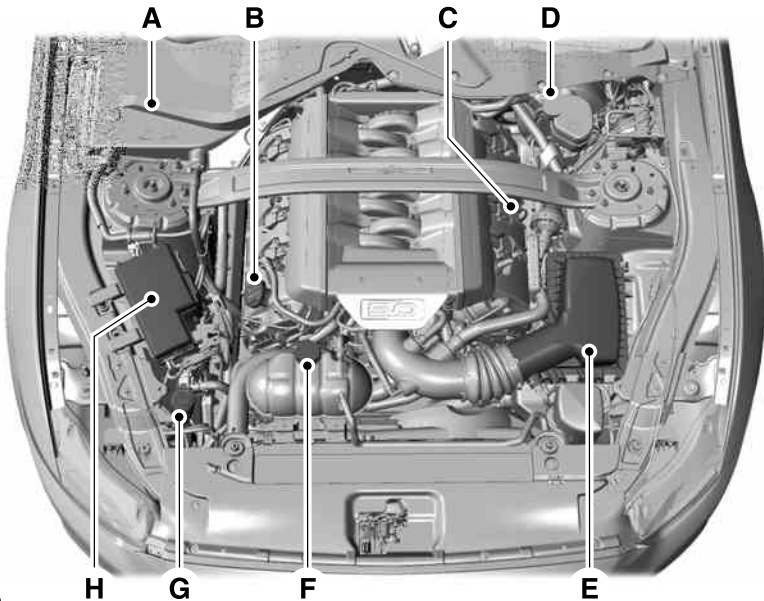

E174560

- A. Battery (out of view). See **Changing the 12V Battery** (page 222).
- B. Engine oil filler cap. See **Engine Oil Check** (page 216).
- C. Engine oil dipstick. See **Engine Oil Dipstick** (page 216).
- D. Brake fluid reservoir. See **Brake and Clutch Fluid Check** (page 221).
- E. Air filter assembly. See **Changing the Engine Air Filter** (page 229).
- F. Engine coolant reservoir. See **Engine Coolant Check** (page 217).
- G. Windshield washer fluid reservoir. See **Washer Fluid Check** (page 222).
- H. Power distribution box. See **Fuses** (page 202).

Maintenance

ENGINE OIL DIPSTICK



E161560

- A MIN
B MAX

ENGINE OIL CHECK

1. Make sure that your vehicle is on level ground.
2. Switch the engine off and wait 15 minutes for the oil to drain into the oil pan.
3. Set the parking brake and ensure the gearshift is in park (P).
4. Open the hood. Protect yourself from engine heat.
5. Locate and carefully remove the engine oil level dipstick.
6. Wipe the dipstick clean. Insert the dipstick fully, then remove it again.
 - If the oil level is between the lower and upper holes, the oil level is acceptable. **DO NOT ADD OIL.**
 - If the oil level is below the lower hole, add enough oil to raise the level within the lower and upper holes.
 - Oil levels above the upper hole may cause engine damage. Some oil must be removed from the engine by an authorized dealer.
7. Put the oil level dipstick back into the oil dipstick tube and ensure it is fully seated.

Adding Engine Oil

Note: Do not remove the filler cap when the engine is running.

Note: Do not remove the engine oil level dipstick when the engine is running.

Note: Do not add oil further than the MAX mark. Oil levels above the MAX mark may cause engine damage.



E142732

Maintenance

Only use oils certified for gasoline engines by the American Petroleum Institute (API). An oil with this trademark symbol conforms to the current engine and emission system protection standards and fuel economy requirements of the International Lubricants Specification Advisory Council (ILSAC), comprised of U.S. and Japanese automobile manufacturers.

1. Check the engine oil level.
2. If the engine oil level is not within the normal range, add engine oil that meets Ford specifications. See **Capacities and Specifications** (page 271).
3. Remove the engine oil filler cap and use a funnel to pour the engine oil into the opening.
4. Wipe off any spilled oil.
5. Recheck the engine oil level. Make sure the oil level is not above the normal operating range on the engine oil level dipstick.
6. Install the engine oil level dipstick and ensure it is fully seated.
7. Fully install the engine oil filler cap by turning the filler cap clockwise until three clicks are heard or until the cap is fully seated.

ENGINE COOLANT CHECK

WARNINGS



Do not add engine coolant when the engine is hot. Steam and scalding liquids released from a hot cooling system can burn you badly. Also, spilling coolant on hot engine parts can burn you.



Do not put engine coolant in the windshield washer fluid container. If sprayed on the windshield, engine coolant could make it difficult to see through the windshield.

WARNINGS



To reduce the risk of personal injury, make sure the engine is cool before unscrewing the coolant pressure relief cap. The cooling system is under pressure. Steam and hot liquid can come out forcefully when you loosen the cap slightly.



Do not add coolant further than the **MAX** mark.

Checking the Engine Coolant

When the engine is cold, check the concentration and level of the engine coolant at the intervals listed in the scheduled maintenance information. See **Scheduled Maintenance** (page 344).

Note: Make sure that the coolant level is between the **MIN** and **MAX** marks on the coolant reservoir.

Note: Coolant expands when it is hot. The level may extend beyond the **MAX** mark.

Note: If the level is at the **MIN** mark, below the **MIN** mark, or empty, add coolant immediately.

Maintain coolant concentration within 48% to 50%, which equates to a freeze point between -30°F (-34°C) and -34°F (-37°C).

Note: For best results, coolant concentration should be tested with a refractometer such as Robinair® Coolant and Battery Refractometer 75240. We do not recommend the use of hydrometers or coolant test strips for measuring coolant concentrations.

Note: Automotive fluids are not interchangeable. Do not use engine coolant, antifreeze or windshield washer fluid outside of its specified function and vehicle location.

Maintenance

Adding Engine Coolant

Note: Do not use stop leak pellets, cooling system sealants or additives as they can cause damage to the engine cooling or heating systems. Your warranty may not cover these damages.

Note: During normal vehicle operation, the coolant may change color from orange to pink or light red. As long as the coolant is clear and uncontaminated, this color change does not indicate the coolant has degraded nor does it require the coolant to be drained, the system to be flushed, or the coolant to be replaced.

Do not mix different colors or types of coolant in your vehicle. Mixing of engine coolants may harm your engine's cooling system. Use prediluted engine coolant meeting the correct specification. See **Capacities and Specifications** (page 271). The use of an incorrect coolant may harm the engine or cooling system components and may not be covered by the vehicle Warranty.

In case of emergency, you can add a large amount of water without engine coolant in order to reach a vehicle service location. In this instance, qualified personnel:

1. Must drain the cooling system.
2. Chemically clean the cooling system with Motorcraft Premium Cooling System Flush.
3. Refill with engine coolant as soon as possible.

Water alone, without engine coolant, can cause engine damage from corrosion, overheating or freezing.

Do not use the following as a coolant substitute:

- Alcohol.
- Methanol.

- Brine.
- Any engine coolant mixed with alcohol or methanol antifreeze or coolant.

Alcohol and other liquids can cause engine damage from overheating or freezing.

Do not add extra inhibitors or additives to the coolant. These can be harmful and compromise the corrosion protection of the engine coolant.

When adding coolant:

1. Unscrew the cap slowly. Any pressure will escape as you unscrew the cap.
2. Add prediluted engine coolant meeting the correct specification. See **Capacities and Specifications** (page 271).
3. Check the coolant level in the coolant reservoir the next few times you drive your vehicle.
4. If necessary, add enough prediluted engine coolant to bring the coolant level to the proper level.

Recycled Engine Coolant

We do not recommend the use of recycled engine coolant as an approved recycling process is not yet available.

Used engine coolant should be disposed of in an appropriate manner. Follow your community's regulations and standards for recycling and disposing of automotive fluids.

Maintenance

Severe Climates

If you drive in extremely cold climates:

- It may be necessary to have an authorized dealer increase the coolant concentration above 50%.
- A coolant concentration of 60% provides improved freeze point protection. Engine coolant concentrations above 60% decrease the overheat protection characteristics of the engine coolant and may cause engine damage.

If you drive in extremely hot climates:

- It may be necessary to have an authorized dealer decrease the coolant concentration to 40%.
- A coolant concentration of 40% provides improved overheat protection. Engine coolant concentrations below 40% decrease the freeze and corrosion protection characteristics of the engine coolant and may cause engine damage.

Vehicles driven year-round in non-extreme climates should use prediluted engine coolant for optimum cooling system and engine protection.

What You Should Know About Fail-Safe Cooling

If you deplete the engine coolant supply, fail-safe cooling allows you to temporarily drive your vehicle before you incur incremental component damage. The fail-safe distance depends on ambient temperatures, vehicle load and terrain.

How Fail-Safe Cooling Works

If the engine begins to overheat, the engine coolant temperature gauge will move to the red (hot) area and:



the coolant temperature warning light will illuminate



the service engine soon indicator will illuminate.

If the engine reaches a preset over-temperature condition, the engine automatically switches to alternating cylinder operation. Each disabled cylinder acts as an air pump and cools the engine.

When this occurs, your vehicle will still operate. However:

- The engine power will be limited.
- This will disable the air conditioning system.

Continued operation increases the engine temperature, causing the engine to completely shut down. Your steering and braking effort increases in this situation.

When the engine temperature cools, you can re-start your engine. Take your vehicle to an authorized dealer as soon as possible to minimize engine damage.

When Fail-Safe Mode Is Activated

WARNINGS



Fail-safe mode is for use during emergencies only. Operate your vehicle in fail-safe mode only as long as necessary to bring your vehicle to rest in a safe location and seek immediate repairs. When in fail-safe mode, your vehicle will have limited power, will not be able to maintain high-speed operation, and may completely shut down without warning, potentially losing engine power, power steering assist, and power brake assist, which may increase the possibility of a crash resulting in serious injury.



Never remove the coolant reservoir cap while the engine is running or hot.

Maintenance

You have limited engine power when in the fail-safe mode, so drive your vehicle with caution. Your vehicle will not maintain high-speed operation and the engine will operate poorly.

Remember that the engine is capable of automatically shutting down to prevent engine damage. In this situation:

1. Pull off the road as soon as safely possible and switch off the engine.
2. Tow your vehicle to an authorized dealer.
3. If this is not possible, wait a short period for the engine to cool.
4. Check the coolant level and add if low.
5. Re-start the engine and drive your vehicle to an authorized dealer.

Note: *Driving your vehicle without repair increases the chance of engine damage. Contact an authorized dealer as soon as possible.*

Engine Fluid Temperature Management (If Equipped)

WARNINGS



To reduce the risk of crash and injury, be prepared that the vehicle speed may reduce and the vehicle may not be able to accelerate with full power until the fluid temperatures reduce.



Never remove the coolant reservoir cap while the engine is running or hot.

Your vehicle can pull a trailer, but because of the added load, your vehicle's engine may temporarily reach higher temperatures during severe operating conditions such as ascending a long or steep grade while pulling a trailer in high temperatures.

At this time, you may notice your engine coolant temperature gauge needle move toward the **H** and the **POWER REDUCED TO LOWER TEMP** message may appear in the information display.

You may notice a reduction in vehicle speed caused by reduced engine power. In order to manage the engine fluid temperatures, your vehicle may enter this mode if certain high-temperature and high-load conditions take place. The amount of speed reduction depends on many factors such as vehicle loading, towing, grade and ambient temperature. If this occurs, there is no need to pull off the road. You can continue to drive your vehicle while this message is active.

The air conditioning may also cycle on and off during severe operating conditions to protect overheating of the engine. When the engine coolant temperature decreases to a normal operating temperature, the air conditioning will turn on once again.

If the engine coolant temperature gauge moves fully into the red (hot) area, or if the coolant temperature warning or service engine soon messages appear in your information display:

1. Pull off the road as soon as safely possible and shift the transmission into **P**.
2. Leave the engine running until the coolant temperature gauge needle moves away from the red (hot) area. After several minutes, if the temperature does not drop, follow the remaining steps.
3. Switch the engine off and wait for it to cool before checking the coolant level.
4. If the coolant level is normal, restart your engine and continue.

Maintenance

5. If the coolant is low, add coolant, and restart the engine. See **Adding Engine Coolant** or **How Fail-Safe Cooling Works** in this chapter for more information.

MANUAL TRANSMISSION FLUID CHECK

1. Clean the filler plug. The filler plug is on the right-hand side of the transmission.

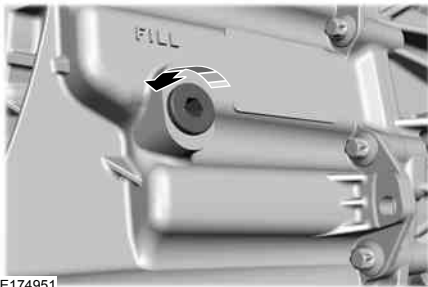

E174951

2. Remove the filler plug.
3. The correct fluid fill level is 0.0–0.1 in (0–3 mm) below the bottom edge of the filler hole.
4. Add fluid through the filler hole.
5. Install the filler plug.
6. Tighten the filler plug until you feel a strong resistance.

Only use fluid that meets Ford specifications. See **Capacities and Specifications** (page 271).

AUTOMATIC TRANSMISSION FLUID CHECK

If required, have an authorized dealer check and change the transmission fluid at the correct service interval. See **Scheduled Maintenance** (page 344).

The automatic transmission does not have a transmission fluid dipstick.

Refer to your scheduled maintenance information for scheduled intervals for fluid checks and changes. Your transmission does not consume fluid. However, if the transmission slips, shifts slowly or if you notice a sign of leaking fluid, contact an authorized dealer.

Do not use supplemental transmission fluid additives, treatments or cleaning agents. The use of these materials may affect transmission operation and result in damage to internal transmission components.

BRAKE AND CLUTCH FLUID CHECK

Fluid levels between the MIN and MAX lines are within the normal operating range; there is no need to add fluid. If the fluid levels are outside of the normal operating range, the performance of the system could be compromised; seek service from your authorized dealer immediately.

POWER STEERING FLUID CHECK

Your vehicle is equipped with an electric power steering (EPS) system. There is no fluid reservoir to check or fill.

Maintenance

WASHER FLUID CHECK

WARNING



If you operate your vehicle in temperatures below 40°F (5°C), use washer fluid with antifreeze protection. Failure to use washer fluid with antifreeze protection in cold weather could result in impaired windshield vision and increase the risk of injury or accident.

Add fluid to fill the reservoir if the level is low. Only use a washer fluid that meets Ford specifications. See **Capacities and Specifications** (page 271).

State or local regulations on volatile organic compounds may restrict the use of methanol, a common windshield washer antifreeze additive. Washer fluids containing non-methanol antifreeze agents should be used only if they provide cold weather protection without damaging the vehicle's paint finish, wiper blades or washer system.

FUEL FILTER

Your vehicle is equipped with a lifetime fuel filter that is integrated with the fuel tank. Regular maintenance or replacement is not needed.

CHANGING THE 12V BATTERY

WARNINGS



Batteries normally produce explosive gases which can cause personal injury. Therefore, do not allow flames, sparks or lighted substances to come near the battery. When working near the battery, always shield your face and protect your eyes. Always provide correct ventilation.

WARNINGS



When lifting a plastic-cased battery, excessive pressure on the end walls could cause acid to flow through the vent caps, resulting in personal injury and damage to the vehicle or battery. Lift the battery with a battery carrier or with your hands on opposite corners.



Keep batteries out of reach of children. Batteries contain sulfuric acid. Avoid contact with skin, eyes or clothing. Shield your eyes when working near the battery to protect against possible splashing of acid solution. In case of acid contact with skin or eyes, flush immediately with water for a minimum of 15 minutes and get prompt medical attention. If acid is swallowed, call a physician immediately.



Battery posts, terminals and related accessories contain lead and lead compounds. Wash hands after handling.



This vehicle may be fitted with more than one battery. Removing the battery cables from only one battery does not disconnect your vehicle electrical system. Make sure you disconnect the battery cables from all batteries when disconnecting power. Failure to do so may cause serious personal injury or property damage.

Your vehicle is fitted with a Motorcraft maintenance-free battery which normally does not require additional water.

When a battery replacement is required, you must use a recommended replacement battery that matches the electrical requirements of the vehicle.

Note: After cleaning or replacing the battery, make sure you reinstall the battery cover or shield.

Maintenance

Note: *If you add electrical accessories or components to the vehicle, it may adversely affect the low voltage battery performance and durability. This may also affect the performance of other electrical systems in the vehicle.*

For longer, trouble-free operation, keep the top of the battery clean and dry.

If you see any corrosion on the battery or terminals, remove the cables from the terminals and clean with a wire brush. You can neutralize the acid with a solution of baking soda and water.

Because your vehicle's engine is electronically controlled by a computer, some control conditions are maintained by power from the battery. When the battery is disconnected or a new battery is installed, the engine must relearn its idle and fuel trim strategy for optimum driveability and performance. Flexible fuel vehicles (FFV) must also relearn the ethanol content of the fuel for optimum driveability and performance.

To restore the settings, do the following:

1. Apply the parking brake.
2. Shift into park (P) or neutral (N).
3. Switch off all accessories.
4. Press the brake pedal and start your vehicle.
5. Run the engine until it reaches normal operating temperature. While the engine is warming up, complete the following: Reset the clock. See **Audio System** (page 291). Reset the power windows bounce-back feature. See **Windows and Mirrors** (page 70). Reset the radio station presets. See **Audio System** (page 291).
6. Allow the engine to idle for at least one minute.

7. Drive the vehicle at least 10 mi (16 km) to completely relearn the idle trim and fuel trim strategy.

Note: *If you do not allow the engine to relearn the idle and fuel trim strategy, the idle quality of your vehicle may be adversely affected until the engine computer eventually relearns the idle trim and fuel trim strategy.*

Note: *For flexible fuel vehicles, if you are operating on E85, you may experience poor starts or an inability to start the engine and driveability problems until the fuel trim and ethanol content have been relearned.*

Make sure that you dispose of old batteries in an environmentally friendly way. Seek advice from your local authority about recycling old batteries.

If storing your vehicle for more than 30 days without recharging the battery, we recommend that you disconnect the battery cables to maintain battery charge for quick starting.

Battery Management System (if Equipped)

The battery management system monitors battery conditions and takes actions to extend battery life. If excessive battery drain is detected, the system temporarily disables some electrical systems to protect the battery.

Systems included are:

- Heated rear window.
- Heated seats.
- Climate control.
- Heated steering wheel.
- Audio unit.
- Navigation system.

Maintenance

A message may appear in the information displays to alert you that battery protection actions are active. These messages are only for notification that an action is taking place, and not intended to indicate an electrical problem or that the battery requires replacement.

After battery replacement, or in some cases after charging the battery with an external charger, the battery management system requires eight hours of vehicle sleep time to relearn the battery state of charge. During this time your vehicle must remain fully locked with the ignition switched off.

Note: *Prior to relearning the battery state of charge, the battery management system may temporarily disable some electrical systems.*

Electrical Accessory Installation

To make sure the battery management system works correctly, do not connect an electrical device ground connection directly to the battery negative post. This can cause inaccurate measurements of the battery condition and potential incorrect system operation.

Note: *If you add electrical accessories or components to the vehicle, it may adversely affect battery performance and durability. This may also affect the performance of other electrical systems in the vehicle.*

CHECKING THE WIPER BLADES



E142463

Run the tip of your fingers over the edge of the blade to check for roughness.

Clean the wiper blades with washer fluid or water applied with a soft sponge or cloth.

CHANGING THE WIPER BLADES

1. Pull the wiper blade and arm away from the glass and press the locking buttons together.

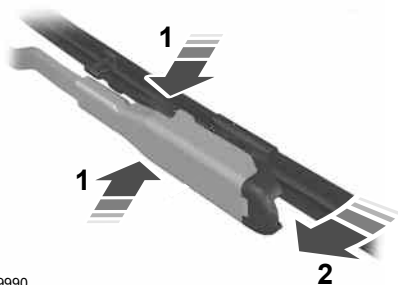

E129990

2. Rotate and remove the wiper blade.
3. Attach the new blade to the arm and snap it into place.

Replace wiper blades at least once per year for optimum performance.

Poor wiper quality can be improved by cleaning the wiper blades and the windshield. See **Cleaning the Windows and Wiper Blades** (page 232).

ADJUSTING THE HEADLAMPS

Vertical Aim Adjustment

The headlamps on your vehicle are properly aimed at the assembly plant. If your vehicle has been in an accident, have the alignment of your headlamps checked by an authorized dealer.

Maintenance

Headlamp Aiming Target

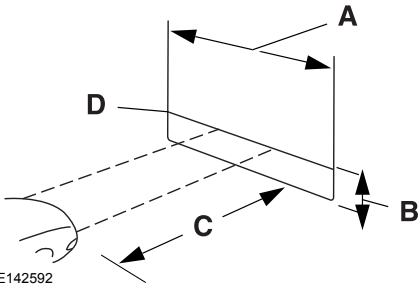

E142592

- A 8 feet (2.4 meters)
- B Center height of lamp to ground
- C 25 feet (7.6 meters)
- D Horizontal reference line

Vertical Aim Adjustment

1. Park the vehicle directly in front of a wall or screen on a level surface, approximately 25 feet (7.6 meters) away.
2. Measure the height from the center of your headlamp (indicated by a 3.0 millimeter circle on the lens) to the ground and mark an 8 foot (2.4 meter) horizontal reference line on the vertical wall or screen at this height (a piece of masking tape works well).

Note: To see a clearer light pattern for adjusting, you may want to block the light from one headlamp while adjusting the other.

3. Turn on the low beam headlamps to illuminate the wall or screen and open the hood. Cover one of the headlamps so no light hits the wall.



E142465

4. There is a distinct cut-off (change from light to dark) in the left portion of the beam pattern. Position the top edge of this cut-off 3 inches (7.5 centimeters) below the horizontal reference line.

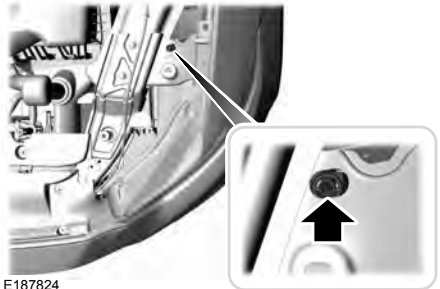

E187824

5. Locate the vertical adjuster on each headlamp. Use a Phillips #2 screwdriver to turn the adjuster either clockwise or counterclockwise to adjust the vertical aim of the headlamp.
6. Repeat Steps 3 through 7 to adjust the other headlamp.
7. Close the hood and turn off the lamps.

Horizontal Aim Adjustment

The horizontal aim does not require any adjustment for this vehicle. If a fault occurs, have the system checked by an authorized dealer.

Maintenance

CHANGING A BULB

Lamp Assembly Condensation

Exterior lamps have vents to accommodate normal changes in pressure. Condensation can be a natural occurrence of this design. When moist air enters the lamp assembly through the vents, there is a possibility that condensation can occur in cold temperatures. When normal condensation occurs, a thin film of mist can form on the interior of the lens. The mist eventually clears and exits through the vents during normal operation. Clearing time may take as long as 48 hours under dry weather conditions.

Examples of acceptable condensation are:

- Thin mist without streaks, drip marks or droplets.
- Fine mist that covers less than 50% of the lens.

Examples of unacceptable moisture are:

- Water puddle inside the lamp.
- Large water droplets, drip marks or streaks on the interior of the lens.

If any of the above conditions of unacceptable moisture are present, contact an authorized.

Replacing HID Headlamp Bulbs

Your vehicle has high intensity discharge lamps. These lamps operate at a high voltage. Contact an authorized dealer.

Accessing the Direction Indicator and Fog Lamp Bulbs

1. Rotate the steering wheel to the opposite side of the bulb needing replacement.

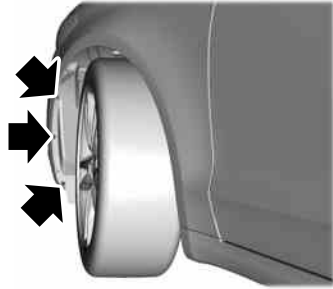

E159695

2. Remove the three wheel liner fasteners.



E176616

3. Locate the most outside fastener attaching the front fascia to the wheel liner and remove it.
4. Pull the wheel liner back toward the tire to gain access to the bulbs.

Maintenance

Replacing the Direction Indicator Bulbs



E180889

1. Remove the bulb holder from the lamp assembly by turning it counterclockwise.
2. Disconnect the electrical connector.
3. Remove the bulb from the bulb holder by pulling it straight out.

Replacing Fog Lamp Bulbs (If Equipped)

1. Make sure the lighting control is in the off position.
2. Disconnect the electrical connector from the bulb by pulling it straight off.



E174588

3. Rotate the bulb counterclockwise and remove from the fog lamp assembly.
4. Install the bulb in reverse order.

Replacing LED Fog Lamp Bulbs (If Equipped)

These lamps have LED bulbs. Contact an authorized dealer.

Replacing Reverse Lamp Bulbs

1. Make sure the lighting control is in the off position.
2. Locate the reverse lamp bulb under the rear bumper of your vehicle. To access the bulb, reach behind the bumper.
3. Disconnect the electrical sensor from the bulb by pulling it straight off.

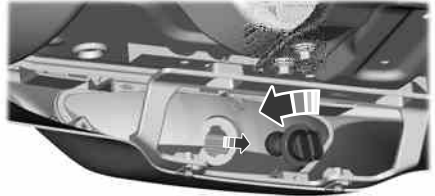

E177487

4. Rotate the bulb counterclockwise and remove it from the reverse lamp assembly.

Replacing rear, Brake, High-Mount Brake, Rear Direction Indicator and License Plate Lamp Bulbs

These lamps have LED bulbs. Contact an authorized dealer.

Maintenance

BULB SPECIFICATION CHART

Replacement bulbs are specified in the chart below. Headlamp bulbs must be marked with an authorized "D.O.T." for North America and an "E" for Europe to

make sure lamp performance, light brightness and pattern and safe visibility. The correct bulbs do not damage the lamp assembly or void the lamp assembly warranty and provide quality bulb illumination time.

Function	Trade name
Headlamps - high intensity discharge (HID)*	D3S
Front park and Direction indicators	7444NA (amber)
Sidemarkers	WY5W (amber)
Fog lamp	LED
	H11
Rear lamp, brake lamp and direction indicator lamp*	LED
High-mount brake lamp*	LED
Backup lamp	3156 or 3157
License plate lamp*	LED
Dome and Map lamp	W5W
Glove box and Cargo lamp	W5W
To replace all instrument panel lights, contact an authorized dealer	
* Contact an authorized dealer to replace the bulb.	

Maintenance

CHANGING THE ENGINE AIR FILTER

WARNING



To reduce the risk of vehicle damage and personal burn injuries, do not start your engine with the air cleaner removed and do not remove it while the engine is running.

Note: Failure to use the correct air filter element may result in severe engine damage. Your warranty may not cover these damages.

Use only the air filter element listed when changing the air filter element. See **Motorcraft Parts** (page 273).

Change the air filter element at the proper intervals. See **Scheduled Maintenance** (page 344).

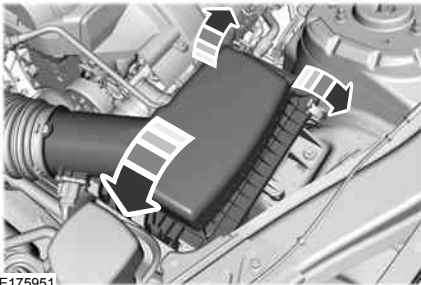

1. Release the two clamps that secure the air filter housing cover.
2. Carefully lift the air filter housing cover.
3. Remove the air filter element from the air filter housing.
4. Wipe any dirt or debris from the air filter housing and cover to make sure no dirt gets in the engine and that you have a good seal.

5. Install a new air filter element. Be careful not to crimp the filter element edges between the air filter housing and cover. This could cause filter damage and allow unfiltered air to enter the engine if it is not properly seated.
6. Replace the air filter housing cover.
7. Engage the clamps to secure the air filter housing cover to the air filter housing.

Vehicle Care

GENERAL INFORMATION

Your Ford or Lincoln authorized dealer has many quality products available to clean your vehicle and protect its finishes.

Materials

Name	Specification
Motorcraft Bug and Tar Remover ZC-42	-
Motorcraft Custom Bright Metal Cleaner ZC-15	-
Motorcraft® Detail Wash ZC-3-A	ESR-M14P4-A
Motorcraft Engine Shampoo and Degreaser (U.S.) ZC-20 (U.S.)	-
Engine Shampoo	-
Motorcraft Leather and Vinyl Cleaner ZC-56	-
Multi-Purpose Cleaner	-
Motorcraft® Premium Windshield Wash Concentrate with Bitterant (U.S.) ZC-32-B2 (U.S.)	WSS-M14P19-A
Professional Strength Carpet and Upholstery Cleaner ZC-54	-
Motorcraft Spot and Stain Remover (U.S.) ZC-14 (U.S.)	-
Motorcraft® Ultra-Clear Spray Glass Cleaner (U.S.) ZC-23 (U.S.)	ESR-M14P5-A
Motorcraft® Wheel and Tire Cleaner ZC-37-A	-

CLEANING PRODUCTS

For best results, use the following products or products of equivalent quality:

CLEANING THE EXTERIOR

Wash your vehicle regularly with cool or lukewarm water and a neutral pH shampoo, we recommend Motorcraft Detail Wash.

- Never use strong household detergents or soap, for example dish washing or laundry liquid. These products can discolor and spot painted surfaces.
- Never wash your vehicle when it is hot to the touch, or during strong or direct sunlight.
- Dry your vehicle with a chamois or soft terry cloth towel to eliminate water spotting.

Vehicle Care

- Immediately remove fuel spillages, bird droppings, insect deposits and road tar. These may cause damage to your vehicle's paintwork or trim over time. We recommend Motorcraft Bug and Tar Remover.
- Remove any exterior accessories, for example antennas, before entering a car wash.
- Do not use water pressure higher than 2,000 psi (14,000 kPa).
- Do not use water hotter than 179°F (82°C).
- Use a spray with a 40° wide spray angle pattern.
- Keep the nozzle at a 12 in (305 mm) distance and 90° angle to your vehicle's surface.

Note: *Suntan lotions and insect repellents can damage painted surfaces. If these substances come in contact with your vehicle, wash the affected area as soon as possible.*

Exterior Chrome Parts

- Apply a high quality-cleaning product to bumpers and other chrome parts. Follow the manufacturer's instructions. We recommend Motorcraft Custom Bright Metal Cleaner.
- Do not apply the cleaning product to hot surfaces. Do not leave the cleaning product on chrome surfaces longer than the time recommended.
- Using other non-recommended cleaners can result in severe and permanent cosmetic damage.

Note: *Never use abrasive materials, for example steel wool or plastic pads as they can scratch the chrome surface.*

Note: *Do not use chrome cleaner, metal cleaner or polish on wheels or wheel covers.*

Exterior Plastic Parts

For routine cleaning we recommend Motorcraft Detail Wash. If tar or grease spots are present, we recommend Motorcraft Bug and Tar Remover.

Stripes or Graphics (If Equipped)

Hand washing your vehicle is preferred however, pressure washing may be used under the following conditions:

Note: *Holding the pressure washer nozzle at an angle to the vehicle's surface may damage graphics and cause the edges to peel away from the vehicle's surface.*

Underbody

Flush the complete underside of your vehicle frequently. Keep body and door drain holes free of debris or foreign material.

WAXING

Regular waxing is necessary to protect your car's paint from the elements. We recommend that you wash and wax the painted surface once or twice a year.

When washing and waxing, park your vehicle in a shaded area out of direct sunlight. Always wash your vehicle before applying wax.

- Use a quality wax that does not contain abrasives.
- Follow the manufacturer's instructions to apply and remove the wax.
- Apply a small amount of wax in a back-and-forth motion, not in circles.

Vehicle Care

- Do not allow wax to come in contact with any non-body (low-gloss black) colored trim. The wax will discolor or stain the parts over time.
 - Roof racks.
 - Bumpers.
 - Grained door handles.
 - Side moldings.
 - Mirror housings.
 - Windshield cowl area.
- Do not apply wax to glass areas.
- After waxing, your car's paint should feel smooth, and be free of streaks and smudges.

CLEANING THE ENGINE

Engines are more efficient when they are clean because grease and dirt buildup keep the engine warmer than normal.

When washing:

- Take care when using a power washer to clean the engine. The high-pressure fluid could penetrate the sealed parts and cause damage.
- Do not spray a hot engine with cold water to avoid cracking the engine block or other engine components.
- Spray Motorcraft Engine Shampoo and Degreaser on all parts that require cleaning and pressure rinse clean. In Canada, use Motorcraft Engine Shampoo.
- Never wash or rinse the engine while it is hot or running; water in the running engine may cause internal damage.

- Never wash or rinse any ignition coil, spark plug wire or spark plug well, or the area in and around these locations.
- Cover the battery, power distribution box, and air filter assembly to prevent water damage when cleaning the engine.

CLEANING THE WINDOWS AND WIPER BLADES

Car wash chemicals and environmental fallout can result in windshield and wiper blade contamination. Dirty windshield and wipers will result in poor windshield wiper operation. Keep the windshield and wiper blades clean to maintain windshield wiper performance.

To clean the windshield and wiper blades:

- Clean the windshield with a non-abrasive glass cleaner. When cleaning the interior of the windshield, avoid getting any glass cleaner on the instrument panel or door panels. Wipe any glass cleaner off these surfaces immediately.
- For windshields contaminated with tree sap, chemicals, wax or bugs, clean the entire windshield using steel wool (no greater than 0000 grade) in a circular motion and rinse with water.
- Clean the wiper blades with isopropyl rubbing alcohol or windshield washer concentrate.

Note: *Do not use razor blades or other sharp objects to clean or remove decals from the inside of the heated rear window. The vehicle warranty does not cover damage caused to the heated rear window grid lines.*

Vehicle Care

CLEANING THE INTERIOR

WARNINGS



Do not use cleaning solvents, bleach or dye on the vehicle's safety belts, as these actions may weaken the belt webbing.



On vehicles equipped with seat-mounted airbags, do not use chemical solvents or strong detergents. Such products could contaminate the side airbag system and affect performance of the side airbag in a collision.

For fabric, carpets, cloth seats, safety belts and seats equipped with side airbags:

- Remove dust and loose dirt with a vacuum cleaner.
- Remove light stains and soil with Motorcraft Professional Strength Carpet & Upholstery Cleaner.
- If grease or tar is present on the material, spot-clean the area first with Motorcraft Spot and Stain Remover. In Canada, use Motorcraft Multi-Purpose Cleaner.
- If a ring forms on the fabric after spot cleaning, clean the entire area immediately (but do not oversaturate) or the ring will set.
- Do not use household cleaning products or glass cleaners, which can stain and discolor the fabric and affect the flame retardant abilities of the seat materials.

CLEANING THE INSTRUMENT PANEL AND INSTRUMENT CLUSTER LENS

WARNING



Do not use chemical solvents or strong detergents when cleaning the steering wheel or instrument panel to avoid contamination of the airbag system.

Note: Follow the same procedure as cleaning leather seats for cleaning leather instrument panels and leather interior trim surfaces. See **Cleaning Leather Seats** (page 234).

Clean the instrument panel and cluster lens with a clean, damp and soft cloth, then use a clean, dry and soft cloth to dry these areas.

- Avoid cleaners or polishes that increase the gloss of the upper portion of the instrument panel. The dull finish in this area helps protect you from undesirable windshield reflection.
- Do not use any household cleaning products or glass cleaners as these may damage the finish of the instrument panel, interior trim and cluster lens.
- Wash or wipe your hands clean if you have been in contact with certain products such as insect repellent and suntan lotion to avoid possible damage to the interior painted surfaces.
- Do not allow air fresheners and hand sanitizers to spill onto interior surfaces. If a spill occurs, wipe off immediately. Your warranty may not cover these damages.

If a staining liquid like coffee or juice has been spilled on the instrument panel or on interior trim surfaces:

Vehicle Care

1. Wipe up spilled liquid using a clean, soft cloth as quickly as possible.
2. Use Motorcraft Premium Leather and Vinyl Cleaner or a commercially available leather cleaning product for automotive interiors. Test any cleaner or stain remover on an inconspicuous area.
3. Alternatively, wipe the surface with a clean, soft cloth and a mild soap and water solution. Dry the area with a clean, soft cloth.
4. If necessary, apply more soap and water solution or cleaning product to a clean, soft cloth and press it onto the soiled area. Allow this to set at room temperature for 30 minutes.
5. Remove the soaked cloth, then with a clean, damp cloth, use a rubbing motion for 60 seconds on the soiled area.
6. Dry the area with a clean, soft cloth.

CLEANING LEATHER SEATS (If Equipped)

Note: Follow the same procedure as cleaning leather seats for cleaning leather instrument panels and leather interior trim surfaces.

For routine cleaning, wipe the surface with a soft, damp cloth and a mild soap and water solution. Dry the area with a clean, soft cloth.

For cleaning and removing stains such as dye transfer, use Motorcraft Premium Leather and Vinyl Cleaner or a commercially available leather cleaning product for automotive interiors.

Note: Test any cleaner or stain remover on an inconspicuous area.

You should:

- Remove dust and loose dirt with a vacuum cleaner.
- Clean and treat spills and stains as soon as possible.

Do not use the following products as these may damage the leather:

- Oil and petroleum or silicone-based leather conditioners.
- Household cleaners.
- Alcohol solutions.
- Solvents or cleaners intended specifically for rubber, vinyl and plastics.

REPAIRING MINOR PAINT DAMAGE

Authorized dealers have touch-up paint to match your vehicle's color. Your vehicle color code is printed on a sticker on the front, left-hand side door jamb. Take your color code to your authorized dealer to make sure you get the correct color.

Before repairing minor paint damage, use a cleaner such as Motorcraft Bug and Tar Remover to remove particles such as bird droppings, tree sap, insect deposits, tar spots, road salt and industrial fallout.

Always read the instructions before using cleaning products.

CLEANING THE ALLOY WHEELS (If Equipped)

Note: Do not apply a cleaning chemical to warm or hot wheel rims and covers.

Note: Some automatic car washes may cause damage to the finish on your wheel rims and covers.

Vehicle Care

Note: *Industrial-strength or heavy-duty cleaners in combination with brush agitation to remove brake dust and dirt, could wear away the clear coat finish over a period time.*

Note: *Do not use hydrofluoric acid-based or high caustic-based wheel cleaners, steel wool, fuels or strong household detergents.*

Note: *If you intend parking your vehicle for an extended period after cleaning the wheels with a wheel cleaner, drive your vehicle for a few minutes before doing so. This will reduce the risk of increased corrosion of the brake discs.*

Alloy wheels and wheel covers are coated with a clear coat paint finish. To maintain their condition we recommend that you:

- Clean the wheels weekly using Motorcraft Wheel and Tire Cleaner. Apply using manufacturer's instructions.
- Use a sponge to remove heavy deposits of dirt and brake dust accumulation.
- Rinse thoroughly with a strong stream of water when you have completed the cleaning process.
- To remove tar and grease, use Motorcraft Bug and Tar Remover.

VEHICLE STORAGE

If you plan on storing your vehicle for 30 days or more, read the following maintenance recommendations to make sure your vehicle stays in good operating condition.

We engineer and test all motor vehicles and their components for reliable, regular driving. Under various conditions, long-term storage may lead to degraded engine performance or failure unless you use specific precautions to preserve engine components.

General

- Store all vehicles in a dry, ventilated place.
- Protect from sunlight, if possible.
- If vehicles are stored outside, they require regular maintenance to protect against rust and damage.

Body

- Wash your vehicle thoroughly to remove dirt, grease, oil, tar or mud from exterior surfaces, rear-wheel housing and the underside of front fenders.
- Periodically wash your vehicle if it is stored in exposed locations.
- Touch-up exposed or primed metal to prevent rust.
- Cover chrome and stainless steel parts with a thick coat of auto wax to prevent discoloration. Re-wax as necessary when you wash your vehicle.
- Lubricate all hood, door and luggage compartment hinges and latches with a light grade oil.
- Cover interior trim to prevent fading.
- Keep all rubber parts free from oil and solvents.

Engine

- Change the engine oil and filter prior to storage because used engine oil contains contaminants which may cause engine damage.
- Start the engine every 15 days for a minimum of 15 minutes. Run at fast idle with the climate controls set to defrost until the engine reaches normal operating temperature.

Vehicle Care

- With your foot on the brake, shift through all the gears while the engine is running.
- We recommend that you change the engine oil before you use your vehicle again.

Fuel system

- Fill the fuel tank with high-quality fuel until the first automatic shutoff of the fuel pump nozzle.

Cooling system

- Protect against freezing temperatures.
- When removing your vehicle from storage, check coolant fluid level. Confirm that there are no cooling system leaks and that fluid is at the recommended level.

Battery

- Check and recharge as necessary. Keep connections clean.
- If storing your vehicle for more than 30 days without recharging the battery, we recommend that you disconnect the battery cables to maintain battery charge for quick starting.

Note: *It is necessary to reset memory features if battery cables are disconnected.*

Brakes

- Make sure the brakes and parking brake release fully.

Tires

- Maintain recommended air pressure.

Miscellaneous

- Make sure all linkages, cables, levers and pins under your vehicle are covered with grease to prevent rust.
- Move vehicles at least 25 ft (7.5 m) every 15 days to lubricate working parts and prevent corrosion.

Removing Vehicle From Storage

When your vehicle is ready to come out of storage, do the following:

- Wash your vehicle to remove any dirt or grease film build-up on window surfaces.
- Check windshield wipers for any deterioration.
- Check under the hood for any foreign material that may have collected during storage such as mice or squirrel nests.
- Check the exhaust for any foreign material that may have collected during storage.
- Check tire pressures and set tire inflation per the Tire Label.
- Check brake pedal operation. Drive your vehicle 15 ft (4.5 m) back and forth to remove rust build-up.
- Check fluid levels (including coolant, oil and gas) to make sure there are no leaks, and fluids are at recommended levels.
- If you remove the battery, clean the battery cable ends and check for damage.

Contact an authorized dealer if you have any concerns or issues.

Vehicle Care

CLEANING THE CONVERTIBLE TOP

Remove lint with a lint roller or a vacuum with a soft bristle brush.

For cloth and vinyl tops, wash with an approved high-quality convertible top cleaner and protectant.

Note: *Do not use stiff bristle brushes, abrasive materials or household cleaning products.*

Note: *High-pressure water may cause water leaks and possible seal damage to the convertible top.*

Note: *Do not fold the convertible top when it is wet.*

Note: *Avoid hot wax on vinyl materials during car washes.*

Wheels and Tires

TIRE SEALANT AND INFLATOR KIT (If Equipped)

Note: The temporary mobility kit contains enough sealant compound in the canister for one tire repair only. See an authorized Ford dealer for replacement sealant canisters.

The kit is located under the load floor in the trunk. The kit consists of an air compressor to re-inflate the tire and a canister of sealing compound that will effectively seal most punctures caused by nails or similar objects. This kit provides a temporary tire repair, allowing you to drive your vehicle up to 120 mi (200 km) at a maximum speed of 50 mph (80 km/h) to reach a tire service location.

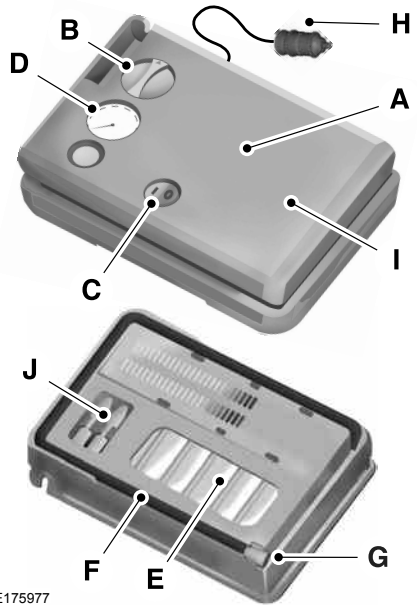

- A Air compressor (inside).
- B Selector switch.
- C On and off button.
- D Air pressure gauge.
- E Sealant bottle and canister.
- F Dual purpose hose: air and repair.
- G Tire valve connector.
- H Accessory power plug.
- I Casing/housing.
- J Bike/raft/sports ball adapters.

Wheels and Tires

General Information

WARNING



Failure to follow these guidelines could result in an increased risk of loss of vehicle control, injury or death.

Note: Do not use the kit if you have severely damaged a tire. Only seal punctures located within the tire tread with the kit.

Do not attempt to repair punctures larger than ¼ inch (6 millimeters) or damage to the tire's sidewall. The tire may not completely seal.

Loss of air pressure may adversely affect tire performance. For this reason:

Note: Do not drive the vehicle above 50 mph (80 km/h).

Note: Do not drive further than 120 mi (200 km). Drive only to the closest authorized Ford dealer or tire repair shop to have your tire inspected.

- Drive carefully and avoid abrupt steering maneuvers.
- Periodically monitor tire inflation pressure in the affected tire; if the tire is losing pressure, have the vehicle towed.
- Read the information in the Tips for Use of the Kit section to make sure safe operation of the kit and your vehicle.

Tips for Use of the Kit

To ensure safe operation of the kit:

- Read all instructions and cautions fully.
- Before operating the kit, make sure your vehicle is safely off the road and away from moving traffic. Switch on the hazard lights.
- Always set the parking brake to ensure the vehicle does not move unexpectedly.

- Do not remove any foreign objects, such as nails or screws, from the tire.
- When using the kit, leave the engine running (only if the vehicle is outdoors or in a well-ventilated area) so the compressor does not drain the vehicle's battery.
- Do not allow the compressor to operate continuously for more than 15 minutes. This will help prevent the compressor from overheating.
- Never leave the kit unattended during operation.
- Sealant compound contains latex. Those with latex sensitivities should use appropriate precautions to avoid an allergic reaction.
- Keep the kit away from children.
- Only use the kit when the ambient temperature is between -22°F (-30°C) and 158°F (70°C).
- Only use the sealing compound before the use-by date. The use-by date is on a label on the sealant canister, which you can see through the rectangular viewing window on the bottom of the compressor. Check the use-by date regularly and replace the canister after four years of non-use.
- Do not store the kit unsecured inside the passenger compartment of the vehicle as it may cause injury during a sudden stop or crash. Always store the kit in its original location.
- After sealant use, an authorized Ford dealer must replace the tire pressure monitoring system sensor and valve stem on the wheel.
- Operating the kit could cause an electrical disturbance in radio, CD and DVD player operation.

Wheels and Tires



* When inflation only is required for a tire or other objects, the selector must be in the Air position.



What to do When a Tire Is Punctured

You can repair a tire puncture within the tire's tread area in two stages with the kit.

- In the first stage, inflate the tire with a sealing compound and air. After you inflate the tire, you will need to drive the vehicle a short distance (about 4 miles [6 kilometers]) to distribute the sealant in the tire.
- In the second stage, check the tire pressure and adjust, if necessary, to the vehicle's specified tire inflation pressure.

First Stage: Inflating the Tire with Sealing Compound and Air

WARNINGS

-  Do not stand directly over the kit while inflating the tire. If you notice any unusual bulges or deformations in the tire's sidewall during inflation, stop and call roadside assistance.
-  If the tire does not inflate to the recommended tire pressure within 15 minutes, stop and call roadside assistance.
-  Do not run the engine during kit operation unless the vehicle is outdoors or in a well-ventilated area.

Preparation: Park the vehicle in a safe, level and secure area, away from moving traffic.

Switch the hazard lights on. Apply the parking brake and switch the engine off. Inspect the flat tire for visible damage.

Sealant compound contains latex. Use appropriate precautions to avoid any allergic reactions.

Do not remove any foreign object that has pierced the tire. If a puncture is located in the tire sidewall, stop and call roadside assistance.

1. Remove the valve cap from the tire valve.
2. Unwrap the dual purpose hose (black tube) from the back of the compressor housing.
3. Fasten the hose to the tire valve by turning the connector clockwise. Tighten the connection securely.



E200523

4. Plug the power cable into the 12-volt power point in the vehicle.
5. Remove the warning sticker found on the casing/housing and place it on the top of the instrument panel or the center of the dash.
6. Start the vehicle and leave the engine running so the compressor does not drain the vehicle's battery.

Wheels and Tires



E175981

7. Turn dial (A) clockwise to the sealant position. Switch the kit on by pressing the on/off button (B).
8. Inflate the tire to the pressure listed on the tire label located on the driver's door or the door jamb area. The initial air pressure gauge reading may indicate a value higher than the label pressure while you pump the sealing compound into the tire. This is normal and should be no reason for concern. The pressure gauge reading will indicate the tire inflation pressure after about 30 seconds of operation. You should check the final tire pressure with the compressor turned OFF in order to get an accurate pressure reading.

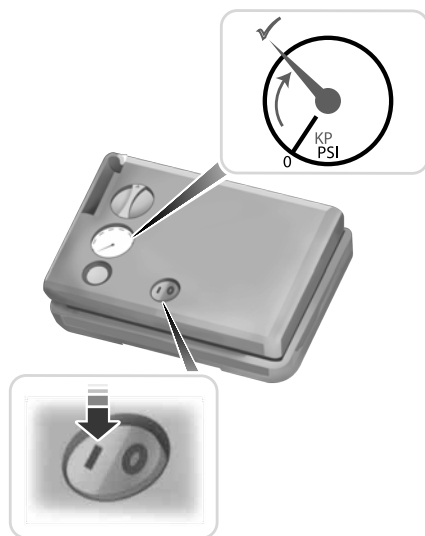

E175982

9. When the tire reaches the recommended tire pressure, switch off the kit, unplug the power cable, and disconnect the hose from the tire valve. Re-install the valve cap on the tire valve and return the kit to the stowage area.
10. Immediately and cautiously, drive the vehicle 4 miles (6 kilometers) to distribute the sealant evenly inside the tire. Do not exceed 50 mph (80 km/h).
11. After 4 miles (6 kilometers), stop and check the tire pressure. See Second Stage: Checking Tire Pressure.

Wheels and Tires

Note: *If you experience any unusual vibration, ride disturbance or noise while driving, reduce your speed until you can safely pull off to the side of the road to call for roadside assistance. Note: Do not proceed to the second stage of this operation.*

Second Stage: Checking Tire Pressure

WARNINGS



If you are proceeding from the First Stage: Re-inflating the Tire with Sealing Compound and Air section and have injected sealant in the tire and the pressure is below 20 psi (1.4 bar), continue to the next step.



The power plug may get hot after use and should be handled carefully while unplugging.

Check the air pressure of your tires as follows:



1. Remove the valve cap from the tire valve.
2. Firmly screw the air compressor hose onto the valve stem by turning clockwise.
3. Push and turn the dial clockwise to the air position.

4. If required, switch on the compressor and adjust the tire to the recommended inflation pressure shown on the tire label located on the driver's door or door jamb area. You should check the tire pressure with the compressor turned OFF in order to get an accurate pressure reading.
5. Unplug the hoses, re-install the valve cap on the tire and return the kit to the stowage area.

What to Do After the Tire has Been Sealed

After using the kit to seal your tire, you will need to replace the sealant canister. You can obtain sealant canisters and spare parts at an authorized Ford dealer. You can dispose of empty sealant canisters at home. However, you should dispose of canisters still containing liquid sealant through your local authorized Ford dealer or tire dealer, or in accordance with local waste disposal regulation.

Note: *After you use the sealing compound, the maximum vehicle speed is 50 mph (80 km/h) and the maximum driving distance is 120 mi (200 km). You should inspect the sealed tire immediately.*

You can check the tire pressure any time within the 120 mi (200 km) by performing the steps listed previously in the Second Stage: Checking Tire Pressure procedure.

Wheels and Tires

Removal of the sealant canister from the kit

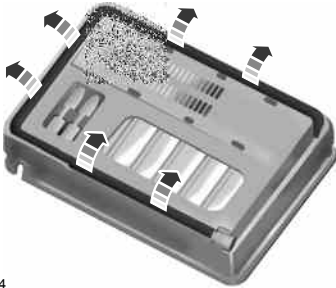

E175984

1. Unwrap the dual purpose hose (black tube) from the compressor housing.



E175985

2. Unwrap the power cord.



E175986

3. Remove the back cover.



E175987

4. Rotate the sealant canister up 90 degrees and pull away from casing/housing to remove.

Installation of the sealant canister to the kit

1. With the canister held perpendicular to the housing, insert the canister nozzle into the connector and push until seated.
2. Rotate the canister 90 degrees down into the housing/casing.



E175988

3. Snap the back cover back into place.

Wheels and Tires

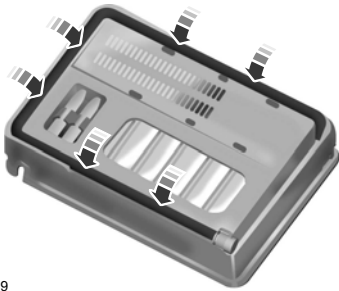

E175989

4. Wrap the dual purpose hose (black tube) around the channel on the bottom of the housing/casing.



E175990

5. Wrap the power cord around the housing and stow the accessory power plug into its storage area.

Note: *If you experience any difficulties with the removal or installation of the sealant canister, consult an authorized Ford dealer for assistance.*

Make sure you check the sealant compound's use-by date regularly. The use-by date is on a label located on the sealant canister, which you can see through the rectangular viewing window on the bottom of the kit. You should replace the sealant canister after four years of non-use.

TIRE CARE

Information About Uniform Tire Quality Grading



E142542

Tire Quality Grades apply to new pneumatic passenger car tires. The Quality grades can be found where applicable on the tire sidewall between tread shoulder and maximum section width. For example: **Treadwear 200 Traction AA Temperature A.**

These Tire Quality Grades are determined by standards that the United States Department of Transportation has set.

Tire Quality Grades apply to new pneumatic passenger car tires. They do not apply to deep tread, winter-type snow tires, space-saver or temporary use spare tires, light truck or LT type tires, tires with nominal rim diameters of 10 to 12 inches or limited production tires as defined in Title 49 Code of Federal Regulations Part 575.104 (c)(2).

Wheels and Tires

U.S. Department of Transportation Tire quality grades: The U.S. Department of Transportation requires Ford Motor Company to give you the following information about tire grades exactly as the government has written it.

Treadwear

The treadwear grade is a comparative rating based on the wear rate of the tire when tested under controlled conditions on a specified government test course. For example, a tire graded 150 would wear 1 ½ times as well on the government course as a tire graded 100. The relative performance of tires depends upon the actual conditions of their use, however, and may depart significantly from the norm due to variations in driving habits, service practices, and differences in road characteristics and climate.

Traction AA A B C

WARNING

 The traction grade assigned to this tire is based on straight-ahead braking traction tests, and does not include acceleration, cornering, hydroplaning or peak traction characteristics.

The traction grades, from highest to lowest are AA, A, B, and C. The grades represent the tire's ability to stop on wet pavement as measured under controlled conditions on specified government test surfaces of asphalt and concrete. A tire marked C may have poor traction performance.

Temperature A B C

WARNING

 The temperature grade for this tire is established for a tire that is properly inflated and not overloaded. Excessive speed, underinflation, or excessive loading, either separately or in combination, can cause heat buildup and possible tire failure.

The temperature grades are A (the highest), B and C, representing the tire's resistance to the generation of heat and its ability to dissipate heat when tested under controlled conditions on a specified indoor laboratory test wheel. Sustained high temperature can cause the material of the tire to degenerate and reduce tire life, and excessive temperature can lead to sudden tire failure. The grade C corresponds to a level of performance which all passenger car tires must meet under the

Wheels and Tires

Federal Motor Vehicle Safety Standard No. 139. Grades B and A represent higher levels of performance on the laboratory test wheel than the minimum required by law.

Glossary of Tire Terminology

***Tire label:** A label showing the original equipment tire sizes, recommended inflation pressure and the maximum weight the vehicle can carry.

***Tire Identification Number (TIN):** A number on the sidewall of each tire providing information about the tire brand and manufacturing plant, tire size and date of manufacture. Also referred to as DOT code.

***Inflation pressure:** A measure of the amount of air in a tire.

***Standard load:** A class of P-metric or Metric tires designed to carry a maximum load at set pressure. For example: For P-metric tires 35 psi (2.4 bar) or 36 (2.5 bar) depending on tire size and for Metric tires 36 psi (2.5 bar). Increasing the inflation pressure beyond this pressure will not increase the tire capability.

***Extra load:** A class of P-metric or Metric tires designed to carry a heavier maximum load at 42 psi (2.9 bar). Increasing the inflation pressure beyond this pressure will not increase the tire's load carrying capability.

***kPa:** Kilopascal, a metric unit of air pressure.

***PSI:** Pounds per square inch, a standard unit of air pressure.

***Cold tire pressure:** The tire pressure when the vehicle has been stationary and out of direct sunlight for an hour or more and prior to the vehicle being driven for 1 mile (1.6 km).

***Recommended inflation pressure:** The cold inflation pressure found on the Safety Compliance Certification Label (affixed to either the door hinge pillar, door-latch post, or the door edge that meets the door-latch post, next to the driver's seating position), or Tire Label located on the B-Pillar or the edge of the driver's door.

***B-pillar:** The structural member at the side of the vehicle behind the front door.

***Bead area of the tire:** Area of the tire next to the rim.

***Sidewall of the tire:** Area between the bead area and the tread.

***Tread area of the tire:** Area of the perimeter of the tire that contacts the road when mounted on the vehicle.

***Rim:** The metal support (wheel) for a tire or a tire and tube assembly upon which the tire beads are seated.

Wheels and Tires

Information Contained on the Tire Sidewall

Both United States and Canada Federal regulations require tire manufacturers to place standardized information on the sidewall of all tires. This information identifies and describes the fundamental characteristics of the tire and also provides a U.S. DOT Tire Identification Number for safety standard certification and in case of a recall.

Information on P Type Tires

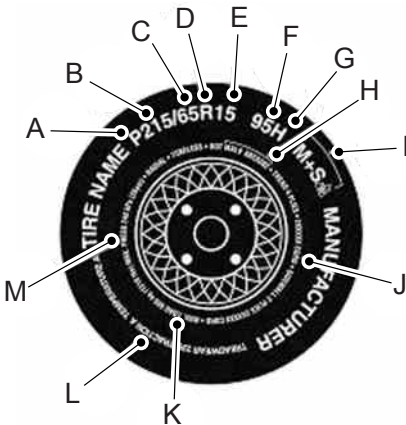

E142543

P215/65R15 95H is an example of a tire size, load index and speed rating. The definitions of these items are listed below. (Note that the tire size, load index and speed rating for your vehicle may be different from this example.)

A. P: Indicates a tire, designated by the Tire and Rim Association, that may be used for service on cars, sport utility vehicles, minivans and light trucks. **Note:** If your tire size does not begin with a letter this may mean it is designated by either the European Tire and Rim Technical Organization or the Japan Tire Manufacturing Association.

B. 215: Indicates the nominal width of the tire in millimeters from sidewall edge to sidewall edge. In general, the larger the number, the wider the tire.

C. 65: Indicates the aspect ratio which gives the tire's ratio of height to width.

D. R: Indicates a radial type tire.

E. 15: Indicates the wheel or rim diameter in inches. If you change your wheel size, you will have to purchase new tires to match the new wheel diameter.

F. 95: Indicates the tire's load index. It is an index that relates to how much weight a tire can carry. You may find this information in your owner's manual. If not, contact a local tire dealer.

Note: You may not find this information on all tires because it is not required by federal law.

Wheels and Tires

G. H: Indicates the tire's speed rating. The speed rating denotes the speed at which a tire is designed to be driven for extended periods of time under a standard condition of load and inflation pressure. The tires on your vehicle may operate at different conditions for load and inflation pressure. These speed ratings may need to be adjusted for the difference in conditions. The ratings range from 81 mph (130 km/h) to 186 mph (299 km/h). These ratings are listed in the following chart.

Note: *You may not find this information on all tires because it is not required by federal law.*

Letter rating	Speed rating - mph (km/h)
M	81 (130)
N	87 (140)
Q	99 (159)
R	106 (171)
S	112 (180)
T	118 (190)
U	124 (200)
H	130 (210)
V	149 (240)

Letter rating	Speed rating - mph (km/h)
W	168 (270)
Y	186 (299)

Note: *For tires with a maximum speed capability over 149 mph (240 km/h), tire manufacturers sometimes use the letters ZR. For those with a maximum speed capability over 186 mph (299 km/h), tire manufacturers always use the letters ZR.*

H. U.S. DOT Tire Identification Number (TIN): This begins with the letters DOT and indicates that the tire meets all federal standards. The next two numbers or letters are the plant code designating where it was manufactured, the next two are the tire size code and the last four numbers represent the week and year the tire was built. For example, the numbers 317 mean the 31st week of 1997. After 2000 the numbers go to four digits. For example, 2501 means the 25th week of 2001. The numbers in between are identification codes used for traceability. This information is used to contact customers if a tire defect requires a recall.

I. M+S or M/S: Mud and Snow, or

AT: All Terrain, or

AS: All Season.

Wheels and Tires

J. Tire Ply Composition and Material Used: Indicates the number of plies or the number of layers of rubber-coated fabric in the tire tread and sidewall. Tire manufacturers also must indicate the ply materials in the tire and the sidewall, which include steel, nylon, polyester, and others.

K. Maximum Load: Indicates the maximum load in kilograms and pounds that can be carried by the tire. See the Safety Compliance Certification Label (affixed to either the door hinge pillar, door-latch post, or the door edge that meets the door-latch post, next to the driver's seating position), for the correct tire pressure for your vehicle.

L. Treadwear, Traction and Temperature Grades:

***Treadwear** The treadwear grade is a comparative rating based on the wear rate of the tire when tested under controlled conditions on a specified government test course. For example, a tire graded 150 would wear one and one-half times as well on the government test course as a tire graded 100.

***Traction:** The traction grades, from highest to lowest are AA, A, B, and C. The grades represent the tire's ability to stop on wet pavement as measured under controlled conditions on specified government test surfaces of asphalt and concrete. A tire marked C may have poor traction performance.

***Temperature:** The temperature grades are A (the highest), B and C, representing the tire's resistance to the generation of heat and its ability to dissipate heat when tested under controlled conditions on a specified indoor laboratory test wheel.

M. Maximum Inflation Pressure: Indicates the tire manufacturers' maximum permissible pressure or the pressure at which the maximum load can be carried by the tire. This pressure is normally higher than the vehicle manufacturer's recommended cold inflation pressure which can be found on the Safety Compliance Certification Label (affixed to either the door hinge pillar, door-latch post, or the door edge that meets the door-latch post, next to the driver's seating position), or Tire Label which is located on the B-Pillar or the edge of the driver's door. The cold inflation pressure should never be set lower than the recommended pressure on the vehicle label.

Wheels and Tires

The tire suppliers may have additional markings, notes or warnings such as standard load or radial tubeless.

Additional Information Contained on the Tire Sidewall for LT Type Tires

Note: *Tire Quality Grades do not apply to this type of tire.*

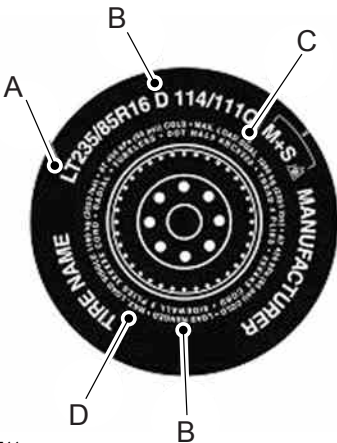

E142544

LT type tires have some additional information beyond those of P type tires; these differences are described below.

A. LT: Indicates a tire, designated by the Tire and Rim Association, that is intended for service on light trucks.

B. Load Range and Load Inflation Limits: Indicates the tire's load-carrying capabilities and its inflation limits.

C. Maximum Load Dual lb (kg) at psi (kPa) cold: Indicates the maximum load and tire pressure when the tire is used as a dual, defined as four tires on the rear axle (a total of six or more tires on the vehicle).

D. Maximum Load Single lb (kg) at psi (kPa) cold: Indicates the maximum load and tire pressure when the tire is used as a single, defined as two tires (total) on the rear axle.

Information on T Type Tires

T145/80D16 is an example of a tire size.

Note: *The temporary tire size for your vehicle may be different from this example. Tire Quality Grades do not apply to this type of tire.*

Wheels and Tires

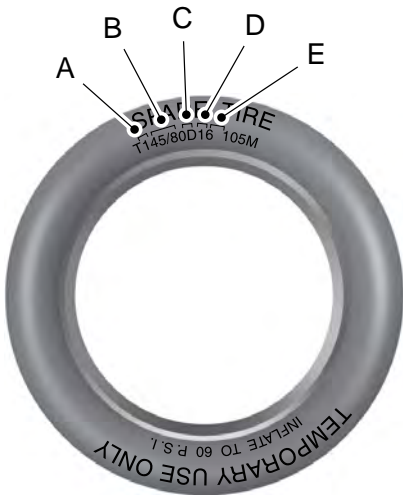

E142545

T type tires have some additional information beyond those of P type tires; these differences are described below:

A. T: Indicates a type of tire, designated by the Tire and Rim Association, that is intended for temporary service on cars, sport utility vehicles, minivans and light trucks.

B. 145: Indicates the nominal width of the tire in millimeters from sidewall edge to sidewall edge. In general, the larger the number, the wider the tire.

C. 80: Indicates the aspect ratio which gives the tire's ratio of height to width. Numbers of 70 or lower indicate a short sidewall.

D. D: Indicates a diagonal type tire.

R: Indicates a radial type tire.

E. 16: Indicates the wheel or rim diameter in inches. If you change your wheel size, you will have to purchase new tires to match the new wheel diameter.

Location of the Tire Label

You will find a Tire Label containing tire inflation pressure by tire size and other important information located on the B-Pillar or the edge of the driver's door.

Inflating Your Tires

Safe operation of your vehicle requires that your tires are properly inflated. Remember that a tire can lose up to half of its air pressure without appearing flat.

Every day before you drive, check your tires. If one looks lower than the others, use a tire gauge to check pressure of all tires and adjust if required.

At least once a month and before long trips, inspect each tire and check the tire pressure with a tire gauge (including spare, if equipped). Inflate all tires to the inflation pressure recommended by Ford Motor Company.

Wheels and Tires

You are strongly urged to buy a reliable tire pressure gauge, as automatic service station gauges may be inaccurate. Ford recommends the use of a digital or dial-type tire pressure gauge rather than a stick-type tire pressure gauge.

Use the recommended cold inflation pressure for optimum tire performance and wear. Under-inflation or over-inflation may cause uneven treadwear patterns.

WARNING



Under-inflation is the most common cause of tire failures and may result in severe tire cracking, tread separation or blowout, with unexpected loss of vehicle control and increased risk of injury. Under-inflation increases sidewall flexing and rolling resistance, resulting in heat buildup and internal damage to the tire. It also may result in unnecessary tire stress, irregular wear, loss of vehicle control and accidents. A tire can lose up to half of its air pressure and not appear to be flat!

Always inflate your tires to the Ford recommended inflation pressure even if it is less than the maximum inflation pressure information found on the tire. The Ford recommended tire inflation pressure is found on the Safety Compliance Certification Label

(affixed to either the door hinge pillar, door-latch post, or the door edge that meets the door-latch post, next to the driver's seating position), or Tire Label which is located on the B-Pillar or the edge of the driver's door. Failure to follow the tire pressure recommendations can cause uneven treadwear patterns and adversely affect the way your vehicle handles.

Maximum Inflation Pressure is the tire manufacturer's maximum permissible pressure and the pressure at which the maximum load can be carried by the tire. This pressure is normally higher than the manufacturer's recommended cold inflation pressure which can be found on the Safety Compliance Certification Label (affixed to either the door hinge pillar, door-latch post, or the door edge that meets the door-latch post, next to the driver's seating position), or Tire Label which is located on the B-Pillar or the edge of the driver's door. The cold inflation pressure should never be set lower than the recommended pressure on the Safety Compliance Certification Label or Tire Label.

Wheels and Tires

When weather temperature changes occur, tire inflation pressures also change. A 43°F (6°C) temperature drop can cause a corresponding drop of 1 psi (7 kPa) in inflation pressure. Check your tire pressures frequently and adjust them to the proper pressure which can be found on the Safety Compliance Certification Label or Tire Label.

To check the pressure in your tire(s):

1. Make sure the tires are cool, meaning they are not hot from driving even a mile.

Note: *If you are checking tire pressure when the tire is hot, (for example, driven more than 1 mile [1.6 kilometers]), never bleed or reduce air pressure. The tires are hot from driving and it is normal for pressures to increase above recommended cold pressures. A hot tire at or below recommended cold inflation pressure could be significantly under-inflated.*

Note: *If you have to drive a distance to get air for your tire(s), check and record the tire pressure first and add the appropriate air pressure when you get to the pump. It is normal for tires to heat up and the air pressure inside to go up as you drive.*

2. Remove the cap from the valve on one tire, then firmly press the tire gauge onto the valve and measure the pressure.

3. Add enough air to reach the recommended air pressure.

Note: *If you overfill the tire, release air by pressing on the metal stem in the center of the valve. Then recheck the pressure with your tire gauge.*

4. Replace the valve cap.
5. Repeat this procedure for each tire, including the spare.

Note: *Some spare tires operate at a higher inflation pressure than the other tires. For T type mini-spare tires, see the Dissimilar spare wheel and tire assembly information for a description. Store and maintain at 60 psi (4.15 bar). For full-size and dissimilar spare tires, see the Dissimilar spare wheel and tire assembly information for a description. Store and maintain at the higher of the front and rear inflation pressure as shown on the Tire Label.*

6. Visually inspect the tires to make sure there are no nails or other objects embedded that could poke a hole in the tire and cause an air leak.
7. Check the sidewalls to make sure there are no gouges, cuts or bulges.

Wheels and Tires

Inspecting Your Tires and Wheel Valve Stems

Periodically inspect the tire treads for uneven or excessive wear and remove objects such as stones, nails or glass that may be wedged in the tread grooves. Check the tire and valve stems for holes, cracks, or cuts that may permit air leakage and repair or replace the tire and replace the valve stem. Inspect the tire sidewalls for cracking, cuts, bruises and other signs of damage or excessive wear. If internal damage to the tire is suspected, have the tire demounted and inspected in case it needs to be repaired or replaced. For your safety, tires that are damaged or show signs of excessive wear should not be used because they are more likely to blow out or fail.

Improper or inadequate vehicle maintenance can cause tires to wear abnormally. Inspect all your tires, including the spare, frequently, and replace them if one or more of the following conditions exist:

Tire Wear

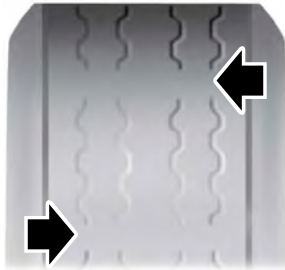

E142546

When the tread is worn down to one sixteenth of an inch (2 mm), tires must be replaced to help prevent your vehicle from skidding and hydroplaning. Built-in treadwear indicators, or wear bars, which look like narrow strips of smooth rubber across the tread will appear on the tire when the tread is worn down to one sixteenth of an inch (2 mm).

When the tire tread wears down to the same height as these wear bars, the tire is worn out and must be replaced.

Damage

Periodically inspect the tire treads and sidewalls for damage (such as bulges in the tread or sidewalls, cracks in the tread groove and separation in the tread or sidewall). If damage is observed

Wheels and Tires

or suspected have the tire inspected by a tire professional. Tires can be damaged during off-road use, so inspection after off-road use is also recommended.

Age

WARNING



Tires degrade over time depending on many factors such as weather, storage conditions, and conditions of use (load, speed, inflation pressure) the tires experience throughout their lives.

In general, tires should be replaced after six years regardless of tread wear. However, heat caused by hot climates or frequent high loading conditions can accelerate the aging process and may require tires to be replaced more frequently.

You should replace your spare tire when you replace the road tires or after six years due to aging even if it has not been used.

U.S. DOT Tire Identification Number

Both United States and Canada Federal regulations require tire manufacturers to place standardized information on the sidewall of all tires. This information identifies and

describes the fundamental characteristics of the tire and also provides a U.S. DOT Tire Identification Number for safety standard certification and in case of a recall.

This begins with the letters DOT and indicates that the tire meets all federal standards. The next two numbers or letters are the plant code designating where it was manufactured, the next two are the tire size code and the last four numbers represent the week and year the tire was built. For example, the numbers 317 mean the 31st week of 1997. After 2000 the numbers go to four digits. For example, 2501 means the 25th week of 2001. The numbers in between are identification codes used for traceability. This information is used to contact customers if a tire defect requires a recall.

Tire Replacement Requirements

Your vehicle is equipped with tires designed to provide a safe ride and handling capability.

WARNINGS



Only use replacement tires and wheels that are the same size, load index, speed rating and type (such as P-metric versus LT-metric or all-season versus all-terrain) as those originally provided by Ford. The recommended tire and wheel size

Wheels and Tires

WARNINGS

may be found on either the Safety Compliance Certification Label (affixed to either the door hinge pillar, door-latch post, or the door edge that meets the door-latch post, next to the driver seating position), or the Tire Label which is located on the B-Pillar or edge of the driver's door. If this information is not found on these labels then you should contact your authorized dealer as soon as possible. Use of any tire or wheel not recommended by Ford can affect the safety and performance of your vehicle, which could result in an increased risk of loss of vehicle control, vehicle rollover, personal injury and death. Additionally the use of non-recommended tires and wheels could cause steering, suspension, axle, transfer case or power transfer unit failure. If you have questions regarding tire replacement, contact your authorized dealer as soon as possible.



To reduce the risk of serious injury, when mounting replacement tires and wheels, you should not exceed the maximum pressure indicated on the sidewall of the tire to set the beads without additional precautions listed below. If the beads do not seat at the maximum pressure indicated, re-lubricate and try again.

WARNINGS

When inflating the tire for mounting pressures up to 20 psi (1.38 bar) greater than the maximum pressure on the tire sidewall, the following precautions must be taken to protect the person mounting the tire:

1. Make sure that you have the correct tire and wheel size.
2. Lubricate the tire bead and wheel bead seat area again.
3. Stand at a minimum of 12.0 ft (3.66 m) away from the wheel and tire assembly.
4. Use both eye and ear protection.

For a mounting pressure more than 20 psi (1.38 bar) greater than the maximum pressure, a Ford dealer or other tire service professional should do the mounting.

Always inflate steel carcass tires with a remote air fill with the person inflating standing at a minimum of 12.0 ft (3.66 m) away from the wheel and tire assembly.

Important: Remember to replace the wheel valve stems when the road tires are replaced on your vehicle.

Wheels and Tires

It is recommended that the two front tires or two rear tires generally be replaced as a pair.

The tire pressure sensors mounted in the wheels (originally installed on your vehicle) are not designed to be used in aftermarket wheels.

The use of wheels or tires not recommended by Ford Motor Company may affect the operation of your tire pressure monitoring system.

If the tire pressure monitoring system indicator is flashing, your system is malfunctioning. Your replacement tire might be incompatible with your tire pressure monitoring system, or some component of the system may be damaged.

Safety Practices

WARNINGS



If your vehicle is stuck in snow, mud, or sand, do not rapidly spin the tires. Spinning the tires can tear the tire and cause an explosion. A tire can explode in as little as three to five seconds.



Do not spin the wheels at over 35 mph (56 km/h). The tires may fail and injure a passenger or bystander.

Driving habits have a great deal to do with your tire mileage and safety.

- *Observe posted speed limits.
- *Avoid fast starts, stops and turns.
- *Avoid potholes and objects on the road.
- *Do not run over curbs or hit the tire against a curb when parking.

Highway Hazards

No matter how carefully you drive there's always the possibility that you may eventually have a flat tire on the highway. Drive slowly to the closest safe area out of traffic. This may further damage the flat tire, but your safety is more important.

If you feel a sudden vibration or ride disturbance while driving, or you suspect your tire or vehicle has been damaged, immediately reduce your speed. Drive with caution until you can safely pull off the road. Stop and inspect the tires for damage. If a tire is under-inflated or damaged, deflate it, remove wheel and replace it with your spare tire and wheel. If you cannot detect a cause, have the vehicle towed to the nearest repair facility or tire dealer to have the vehicle inspected.

Wheels and Tires

Tire and Wheel Alignment

A bad jolt from hitting a curb or pothole can cause the front end of your vehicle to become misaligned or cause damage to your tires. If your vehicle seems to pull to one side when you're driving, the wheels may be out of alignment. Have an authorized dealer check the wheel alignment periodically.

Wheel misalignment in the front or the rear can cause uneven and rapid treadwear of your tires and should be corrected by an authorized dealer. Front-wheel drive vehicles and those with an independent rear suspension (if equipped) may require alignment of all four wheels.

The tires should also be balanced periodically. An unbalanced tire and wheel assembly may result in irregular tire wear.

Tire Rotation

Note: *If your tires show uneven wear ask an authorized dealer to check for and correct any wheel misalignment, tire imbalance or mechanical problem involved before tire rotation.*

Note: *Your vehicle may be equipped with a dissimilar spare wheel and tire assembly. A dissimilar spare wheel and tire assembly is defined as a spare wheel and tire assembly that is different in brand, size or appearance from the road tires and wheels. If you have a dissimilar spare wheel and tire assembly it is intended for temporary use only and should not be used in a tire rotation.*

Note: *After having your tires rotated, inflation pressure must be checked and adjusted to the vehicle requirements.*

Rotating your tires at the recommended interval (as indicated in the Scheduled Maintenance chapter) will help your tires wear more evenly, providing better tire performance and longer tire life. Sometimes irregular tire wear can be corrected by rotating the tires.

Rear-wheel drive vehicles (front tires on the left side of the diagram).

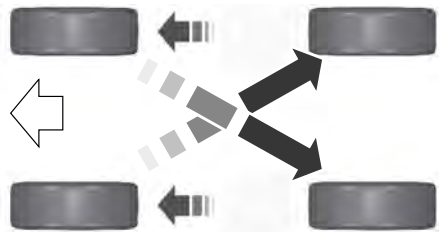

E142548

Wheels and Tires

Non-directional tires

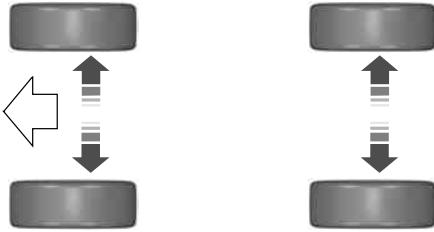

E209823

Vehicles equipped with different size tires on the front and rear axle

USING SUMMER TIRES (If Equipped)

Summer tires provide superior performance on wet and dry roads. Summer tires do not have the Mud and Snow (M+S or M/S) tire traction rating on the tire side wall. Since summer tires do not have the same traction performance as All-season or Snow tires, we do not recommend using summer tires when temperatures drop to about 45°F (7°C) or below (depending on tire wear and environmental conditions) or in snow and ice conditions. Like any tire, summer tire performance is affected by tire wear and environmental conditions. If you must drive in those conditions, we recommend using Mud and Snow (M+S, M/S), All-season or Snow tires.

Always store your summer tires indoors at temperatures above 19°F (-7°C). The rubber compounds used in these tires lose flexibility and may develop surface cracks in the tread area at temperatures below 19°F (-7°C). If the tires have been subjected to 19°F (-7°C) or less, warm them in a heated space to at least 41°F

(5°C) for at least 24 hours before installing them on a vehicle, or moving the vehicle with the tires installed, or checking tire inflation. Do not place tires near heaters or heating devices used to warm the room where the tires are stored. Do not apply heat or blow heated air directly on the tires. Always inspect the tires after storage periods and before use.

USING SNOW CHAINS

WARNINGS

 Driving too fast for conditions creates the possibility of loss of vehicle control. Driving at very high speeds for extended periods of time may result in damage to vehicle components.

 Snow tires must be the same size, load index, speed rating as those originally provided by Ford. Use of any tire or wheel not recommended by Ford can affect the safety and performance of your vehicle, which could result in an increased risk of loss of vehicle control, vehicle rollover, personal injury and death. Additionally, the use of non-recommended tires and wheels could cause steering, suspension, axle, transfer case or power transfer unit failure.

The tires on your vehicle may have all-weather treads to provide traction in rain and snow. However, in some climates, you may need to use snow tires and chains. Use chains on the tires only in an emergency or if the law requires them.

Note: *The suspension insulation and bumpers will help prevent vehicle damage. Do not remove these components from your vehicle when using snow tires and chains.*

Follow these guidelines when using snow tires and chains:

Wheels and Tires

- If possible, avoid fully loading your vehicle.
- Chains may damage aluminum wheels.
- Use ultra low profile cables, 10 mm or less in dimension as measured on the sidewall of your tire, with 235/55R 17, 235/50R18 and 255/40R19 on the rear axle only.
- Do not use snow chains or cables with 275/40R19 and 265/35R20 tires.
- Not all S-class snow chains or cables meet these restrictions. Chains of this size restriction will include a tensioning device.
- Purchase chains or cables from a manufacturer that clearly labels body to tire dimension restrictions. The snow chains or cables must be mounted in pairs on the front or the rear tires only.
- Do not exceed 30 mph (50 km/h) if recommended by the chain manufacturer while using snow chains.
- Install cables securely, verifying that the cables do not touch any wiring, brake lines or fuel lines.
- Drive cautiously. If you hear the cables rub or bang against the vehicle, stop and retighten them. If this does not work, remove the cables to prevent vehicle damage.
- Remove the tire chains when they are no longer needed. Do not use tire chains on dry roads.

If you have any questions regarding snow chains or cables, please contact your authorized dealer.

TIRE PRESSURE MONITORING SYSTEM

WARNING



The tire pressure monitoring system is not a substitute for manually checking tire pressure. The tire pressure should be checked periodically (at least monthly) using a tire gauge, see Inflating your tires in this chapter. Failure to properly maintain your tire pressure could increase the risk of tire failure, loss of control, vehicle rollover and personal injury.



Each tire, including the spare (if provided), should be checked monthly when cold and inflated to the inflation pressure recommended by the vehicle manufacturer on the vehicle placard or tire inflation pressure label. (If your vehicle has tires of a different size than the size indicated on the vehicle placard or tire inflation pressure label, you should determine the proper tire inflation pressure for those tires.)

As an added safety feature, your vehicle has been equipped with a Tire Pressure Monitoring System (TPMS) that illuminates a low tire pressure telltale when one or more of your tires is significantly under-inflated. Accordingly, when the low tire pressure telltale illuminates, you should stop and check your tires as soon as possible, and inflate them to the proper pressure. Driving on a significantly under-inflated tire causes the tire to overheat and can lead to tire failure. Under-inflation also reduces fuel efficiency and tire tread life, and may affect the vehicle's handling and stopping ability.

Wheels and Tires

Please note that the TPMS is not a substitute for proper tire maintenance, and it is the driver's responsibility to maintain correct tire pressure, even if under-inflation has not reached the level to trigger illumination of the TPMS low tire pressure telltale.

Your vehicle has also been equipped with a TPMS malfunction indicator to indicate when the system is not operating properly. The TPMS malfunction indicator is combined with the low tire pressure telltale. When the system detects a malfunction, the telltale will flash for approximately one minute and then remain continuously illuminated. This sequence will continue upon subsequent vehicle start-ups as long as the malfunction exists.

When the malfunction indicator is illuminated, the system may not be able to detect or signal low tire pressure as intended. TPMS malfunctions may occur for a variety of reasons, including the installation of replacement or alternate tires or wheels on the vehicle that prevent the TPMS from functioning properly. Always check the TPMS malfunction telltale after replacing one or more tires or wheels on your vehicle to ensure that the replacement or alternate tires and wheels allow the TPMS to continue to function properly.

The tire pressure monitoring system complies with part 15 of the FCC rules and with RSS-210 of Industry Canada. Operation is subject to the following two conditions: (1) This device may not cause harmful interference, and (2) This device must accept any interference received, including interference that may cause undesired operation.

Changing Tires With a Tire Pressure Monitoring System



E142549

Note: Each road tire is equipped with a tire pressure sensor located inside the wheel and tire assembly cavity. The pressure sensor is attached to the valve stem. The pressure sensor is covered by the tire and is not visible unless the tire is removed. Take care when changing the tire to avoid damaging the sensor.

You should always have your tires serviced by an authorized dealer.

Check the tire pressure periodically (at least monthly) using an accurate tire gauge. See *Inflating Your Tires* in this chapter.

Understanding Your Tire Pressure Monitoring System

The tire pressure monitoring system measures pressure in your four road tires and sends the tire pressure readings to your vehicle. See **General Information** (page 80). The low tire pressure warning light will turn on if the tire pressure is significantly low. Once the light is illuminated, your tires are under-inflated and need to be inflated to the manufacturer's recommended tire pressure. Even if the light turns on and a short time later turns off, your tire pressure still needs to be checked.

Wheels and Tires

When Your Temporary Spare Tire is Installed

When one of your road tires needs to be replaced with the temporary spare, the system will continue to identify an issue to remind you that the damaged road wheel and tire assembly needs to be repaired and put back on your vehicle.

To restore the full function of the tire pressure monitoring system, have the damaged road wheel and tire assembly repaired and remounted on your vehicle.

When You Believe Your System is Not Operating Properly

The main function of the tire pressure monitoring system is to warn you when your tires need air. It can also warn you in the event the system is no longer capable of functioning as intended. See the following chart for information concerning your tire pressure monitoring system:

Wheels and Tires

Low tire pressure warning light	Possible cause	Customer action required
Solid warning light	Tire(s) under-inflated	Make sure tires are at the proper pressure. See Inflating your tires in this chapter. After inflating your tires to the manufacturer's recommended pressure as shown on the Tire Label (located on the edge of driver's door or the B-Pillar), the vehicle must be driven for at least two minutes over 20 mph (32 km/h) before the light turns off.
	Spare tire in use	Repair the damaged road wheel and tire assembly and reinstall it on the vehicle to restore system function. For a description on how the system functions, see When your temporary spare tire is installed in this section.
	TPMS malfunction	If the tires are properly inflated and the spare tire is not in use but the light remains on, contact your authorized dealer as soon as possible.
Flashing warning light	Spare tire in use	Repair the damaged road wheel and tire assembly and reinstall it on the vehicle to restore system function. For a description on how the system functions, see When your temporary spare tire is installed in this section.
	TPMS malfunction	If the tires are properly inflated and the spare tire is not in use but the light remains on, contact your authorized dealer as soon as possible.

When Inflating Your Tires

When putting air into your tires (such as at a gas station or in your garage), the tire pressure monitoring system may not respond immediately to the air added to your tires.

It may take up to two minutes of driving over 20 mph (32 km/h) for the light to turn off after you have filled your tires to the recommended inflation pressure

Wheels and Tires

How Temperature Affects Your Tire Pressure

The tire pressure monitoring system monitors tire pressure in each pneumatic tire. While driving in a normal manner, a typical passenger tire inflation pressure may increase about 2 to 4 psi (14 to 28 kPa) from a cold start situation. If the vehicle is stationary overnight with the outside temperature significantly lower than the daytime temperature, the tire pressure may decrease about 3 psi (21 kPa) for a drop of 30°F (17°C) in ambient temperature. This lower pressure value may be detected by the tire pressure monitoring system as being significantly lower than the recommended inflation pressure and activate the system warning light for low tire pressure. If the low tire pressure warning light is on, visually check each tire to verify that no tire is flat. If one or more tires are flat, repair as necessary. Check the air pressure in the road tires. If any tire is under-inflated, carefully drive the vehicle to the nearest location where air can be added to the tires. Inflate all the tires to the recommended inflation pressure.

CHANGING A ROAD WHEEL

WARNINGS



The use of tire sealant may damage your tire pressure monitoring system and should only be used in roadside emergencies. If you must use a sealant, the Ford Tire Mobility Kit sealant should be used. The tire pressure monitoring system sensor and valve stem on the wheel must be replaced by an authorized dealer after use of the sealant.



See **Tire Pressure Monitoring System** (page 260). If the tire pressure monitor sensor becomes damaged, it will no longer function.

Note: *The tire pressure monitoring system indicator light will illuminate when the spare tire is in use. To restore the full function of the monitoring system, all road wheels equipped with tire pressure monitoring sensors must be mounted on the vehicle.*

If you get a flat tire while driving, do not apply the brake heavily. Instead, gradually decrease your speed. Hold the steering wheel firmly and slowly move to a safe place on the side of the road.

Have a flat serviced by an authorized dealer in order to prevent damage to the tire pressure monitoring system sensors. See **Tire Pressure Monitoring System** (page 260). Replace the spare tire with a road tire as soon as possible. During repairing or replacing of the flat tire, have the authorized dealer inspect the tire pressure monitoring system sensor for damage.

Dissimilar Spare Wheel and Tire Assembly Information

WARNING



Failure to follow these guidelines could result in an increased risk of loss of vehicle control, injury or death.

If you have a dissimilar spare wheel and tire, then it is intended for temporary use only. This means that if you need to use it, you should replace it as soon as possible with a road wheel and tire assembly that is the same size and type as the road tires and wheels that were originally provided by Ford. If the dissimilar spare tire or wheel is damaged, it should be replaced rather than repaired.

A dissimilar spare wheel and tire assembly is defined as a spare wheel and tire assembly that is different in brand, size or appearance from the road tires and wheels and can be one of three types:

Wheels and Tires

1. T-type mini-spare: This spare tire begins with the letter T for tire size and may have Temporary Use Only molded in the sidewall.

2. Full-size dissimilar spare with label on wheel: This spare tire has a label on the wheel that states: THIS WHEEL AND TIRE ASSEMBLY FOR TEMPORARY USE ONLY.

When driving with one of the dissimilar spare tires listed above, do not:

- Exceed 50 mph (80 km/h).
- Load the vehicle beyond maximum vehicle load rating listed on the Safety Compliance Label.
- Use snow chains on the end of the vehicle with the dissimilar spare tire.
- Use more than one dissimilar spare tire at a time.
- Use commercial car washing equipment.
- Try to repair the dissimilar spare tire.

Use of one of the dissimilar spare tires listed above at any one wheel location can lead to impairment of the following:

- Handling, stability and braking performance.
- Comfort and noise.
- Ground clearance and parking at curbs.
- Winter weather driving capability.
- Wet weather driving capability.
- All-wheel driving capability.

3. Full-size dissimilar spare without label on wheel

When driving with the full-size dissimilar spare wheel and tire assembly, do not:

- Exceed 70 mph (113 km/h).
- Use more than one dissimilar spare wheel and tire assembly at a time.

- Use commercial car washing equipment.
- Use snow chains on the end of the vehicle with the dissimilar spare wheel and tire assembly.

The usage of a full-size dissimilar spare wheel and tire assembly can lead to impairment of the following:

- Handling, stability and braking performance.
- Comfort and noise.
- Ground clearance and parking at curbs.
- Winter weather driving capability.
- Wet weather driving capability.
- All-wheel driving capability.

When driving with the full-size dissimilar spare wheel and tire assembly additional caution should be given to:

- Driving vehicles with a load on the cargo rack.

Drive cautiously when using a full-size dissimilar spare wheel and tire assembly and seek service as soon as possible.

Tire Change Procedure

WARNINGS



When one of the front wheels is off the ground, the transmission alone will not prevent your vehicle from moving or slipping off the jack, even if the transmission is in park (P) or reverse (R) for manual transmissions.



To help prevent your vehicle from moving when you change a tire, be sure to place the transmission in park (P) or reverse (R) for manual transmissions, set the parking brake and block (in both directions) the wheel that is diagonally opposite (other side and end of the vehicle) to the tire being changed.

Wheels and Tires

WARNINGS



Never get underneath a vehicle that is supported only by a jack. If your vehicle slips off the jack, you or someone else could be seriously injured.



Do not attempt to change a tire on the side of the vehicle close to moving traffic. Pull far enough off the road to avoid the danger of being hit when operating the jack or changing the wheel.



Always use the jack provided as original equipment with your vehicle. If using a jack other than the one provided as original equipment with your vehicle, make sure the jack capacity is adequate for the vehicle weight, including any vehicle cargo or modifications.



Check that the vehicle jack is not damaged or deformed and the thread is lubricated and clean.



Passengers should not remain in your vehicle when the vehicle is being jacked.

1. Park on a surface, set the parking brake and activate the hazard flashers.
2. Place the transmission in park (P) and turn the engine off. For vehicles with a manual transmission, place the transmission in reverse (R) after the engine is turned off.

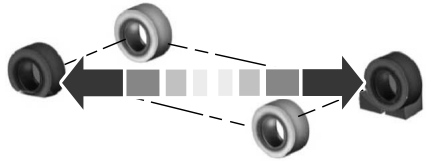

E175447

3. Block both the front and rear of the wheel diagonally opposite the flat tire. For example, if the left front tire is flat, block the right rear wheel.

Wheels and Tires

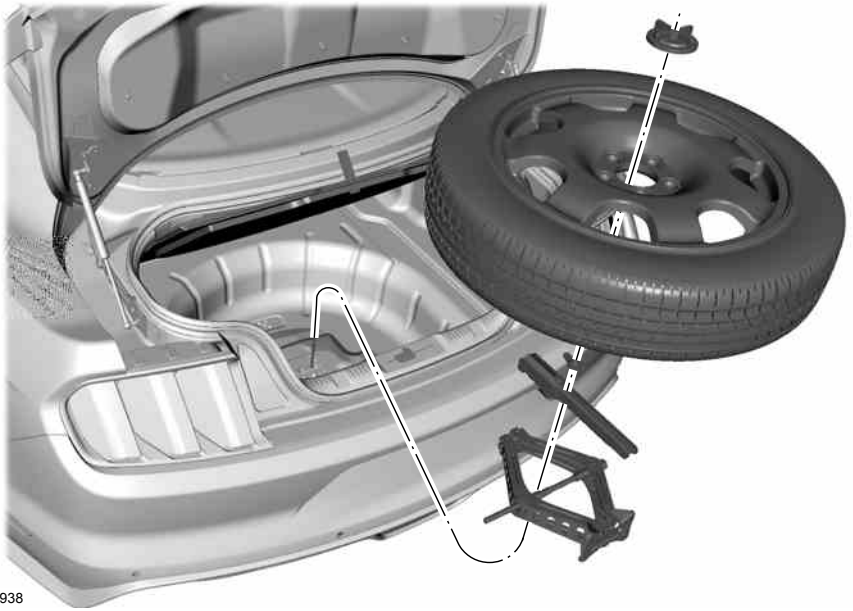

E174938

4. Remove the lug wrench, spare tire and jack.
5. Remove the center ornament from the wheel if required to access the lug nuts.
6. To remove the wrench from the jack, turn the hex nut on the jack counterclockwise. This will lower the jack and loosen the mechanical lock.
7. Loosen each wheel lug nut one-half turn counterclockwise but do not remove them until the wheel is raised off the ground.

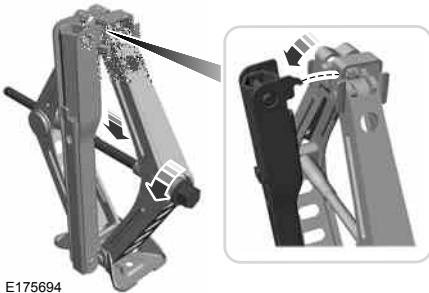

E175694

Wheels and Tires

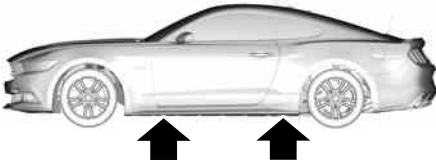

E176084

Note: Jack at the specified locations to avoid damage to the vehicle.

8. The vehicle jacking points are shown here, and can be identified by the triangle markings on the vehicle. Details are depicted on the warning label on the jack.



E174939

9. Place the jack at the jacking point next to the tire you are changing. Turn the jack handle clockwise until the wheel is completely off the ground.
10. Remove the lug nuts with the lug wrench.

11. Replace the flat tire with the spare tire, making sure the valve stem is facing outward. Reinstall lug nuts until the wheel is snug against the hub. Do not fully tighten the lug nuts until the wheel has been lowered. If you are using the temporary tire, the lug nut washers will not appear to be flush with the rim. This is normal only when using the temporary spare tire.
12. Lower the wheel by turning the jack handle counterclockwise.

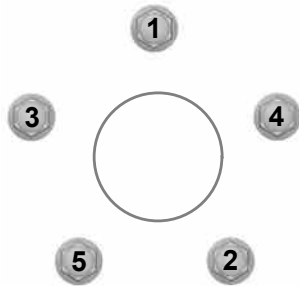

E75442

13. Remove the jack and fully tighten the lug nuts in the order shown. See **Technical Specifications** (page 270).
14. To store the folded wrench on the jack, engage the bracket of the jack base on the wrench feature as shown. Swing the wrench upwards and adjust the height of the jack until the pin engages the hole. Tighten the hex nut clockwise by hand until secure.

Wheels and Tires



E176165

15. Put the flat tire, wheel ornament, jack and lug wrench away. Make sure the jack is fastened so it does not rattle when you drive.
16. Unblock the wheel.

DRIVING AT HIGH SPEED

Tire pressure - Speeds greater than 100 mph (160 km/h)

WARNING



To reduce the risk of potential tire failure that could lead to serious injury or death, increase the front and rear tire placard pressures by the amount shown on the warning label, located on either the driver side B-pillar or door, when driving over 100 mph (160 km/h). Only travel at speeds over 100 mph (160 km/h) where it is legal and conditions allow. The tire placard pressure can be found on the tire placard located on either the driver side B-pillar or door of your vehicle.



Warning: Failure to follow these instructions can result in a loss of vehicle stability due to tire failure that could lead to serious injury or death. If you are not sure about the proper tire inflation pressures, contact an authorized dealer or service center.

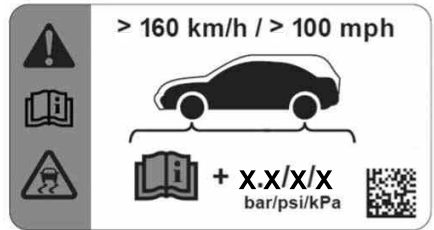

E184089

Your tires may require additional inflation pressure for operation at speeds greater than 100 mph (160 km/h). If this label is present on your vehicle, you must adjust the tire pressure accordingly.

Wheels and Tires

TECHNICAL SPECIFICATIONS

Wheel Lug Nut Torque Specifications

WARNING

 When a wheel is installed, always remove any corrosion, dirt or foreign materials present on the mounting surfaces of the wheel or the surface of the wheel hub, brake drum or brake disc that contacts the wheel. Make sure that any fasteners that attach the rotor to the hub are secured so they do not interfere with the mounting surfaces of the wheel. Installing wheels without correct metal-to-metal contact at the wheel mounting surfaces can cause the wheel nuts to loosen and the wheel to come off while your vehicle is in motion, resulting in a loss of control.

Bolt size	lb-ft (Nm)*
M14 X 1.5	150 lb.ft (204 Nm)

*Torque specifications are for nut and bolt threads free of dirt and rust. Use only Ford recommended replacement fasteners.

Retighten the lug nuts to the specified torque within 100 miles (160 kilometers) after any wheel disturbance (such as tire rotation, changing a flat tire, wheel removal).



E145950

A Wheel pilot bore

Inspect the wheel pilot bore and mounting surface prior to installation. Remove any visible corrosion or loose particles.

Capacities and Specifications

ENGINE SPECIFICATIONS - 2.3L ECOBOOST™

Engine	2.3L EcoBoost
Cubic inches	138
Firing order	1-3-4-2
Ignition system	Coil on plug
Spark plug gap	0.028 in (0.7 mm) - 0.031 in (0.8 mm)
Compression ratio	9.5:1

Drivebelt Routing

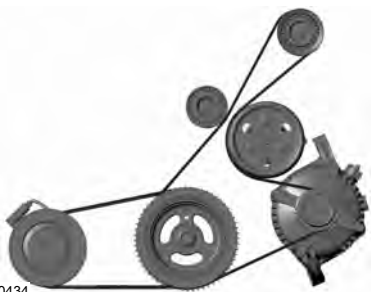

E170434

ENGINE SPECIFICATIONS - 3.7L

Engine	3.7L
Cubic inches	226
Firing order	1-4-2-5-3-6
Ignition system	Coil on plug
Spark plug gap	0.049 in (1.25 mm) - 0.053 in (1.35 mm)
Compression ratio	10.5:1

Capacities and Specifications

Drivebelt Routing

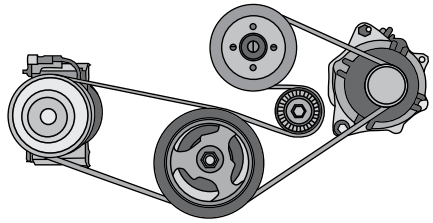

E167464

ENGINE SPECIFICATIONS - 5.0L

Engine	5.0L
Cubic inches	302
Firing order	1-5-4-8-6-3-7-2
Ignition system	Coil on plug
Spark plug gap	0.049 in (1.25 mm) - 0.053 in (1.35 mm)
Compression ratio	11.0:1

Drivebelt Routing

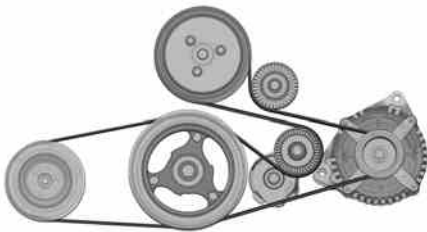

E198573

Capacities and Specifications

MOTORCRAFT PARTS - 2.3L ECOBOOST™

Component	Part Number
Air filter element	FA-1918
Oil filter	FL-910-S
Battery	BXT-96R-590
Spark plugs	SP-537
Cabin air filter	FP-78
Windshield wiper blade	WW-1964 (driver side) WW-2160 (passenger side)

We recommend Motorcraft replacement parts available at your Ford dealer or at fordparts.com for scheduled maintenance. These parts meet or exceed Ford Motor Company's specifications and are engineered for your vehicle. Use of other parts may impact vehicle performance, emissions and durability. Your warranty may be void for any damage related to use of other parts.

If a Motorcraft oil filter is not available, use an oil filter that meets industry performance specification SAE/USCAR-36.

For spark plug replacement, contact an authorized dealer. Replace the spark plugs at the appropriate intervals. See **Scheduled Maintenance** (page 344).

Capacities and Specifications

MOTORCRAFT PARTS - 3.7L

Component	Part Number
Air filter element	FA-1918
Oil filter	FL-500-S
Battery	BXT-96R-590
Spark plugs	SP-520
Cabin air filter	FP-78
Windshield wiper blade	WW-1964 (driver side) WW-2160 (passenger side)

We recommend Motorcraft replacement parts available at your Ford dealer or at fordparts.com for scheduled maintenance. These parts meet or exceed Ford Motor Company's specifications and are engineered for your vehicle. Use of other parts may impact vehicle performance, emissions and durability. Your warranty may be void for any damage related to use of other parts.

If a Motorcraft oil filter is not available, use an oil filter that meets industry performance specification SAE/USCAR-36.

For spark plug replacement, contact an authorized dealer. Replace the spark plugs at the appropriate intervals. See **Scheduled Maintenance** (page 344).

Capacities and Specifications

MOTORCRAFT PARTS - 5.0L

Component	Part Number
Air filter element	FA-1918
Oil filter	FL-500-S
Battery	BXT-96R-590
Spark plugs	SP-519
Cabin air filter	FP-78
Windshield wiper blade	WW-1964 (driver side) WW-2160 (passenger side)

We recommend Motorcraft replacement parts available at your Ford dealer or at fordparts.com for scheduled maintenance. These parts meet or exceed Ford Motor Company's specifications and are engineered for your vehicle. Use of other parts may impact vehicle performance, emissions and durability. Your warranty may be void for any damage related to use of other parts.

If a Motorcraft oil filter is not available, use an oil filter that meets industry performance specification SAE/USCAR-36.

For spark plug replacement, contact an authorized dealer. Replace the spark plugs at the appropriate intervals. See **Scheduled Maintenance** (page 344).

Capacities and Specifications

VEHICLE IDENTIFICATION NUMBER

The vehicle identification number is located on the left-hand side of the instrument panel.

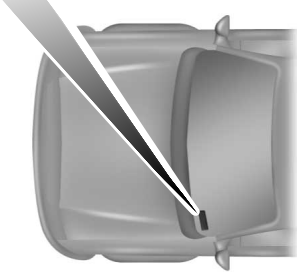

E142476

Please note that in the graphic, XXXX is representative of your vehicle identification number.

The Vehicle Identification Number contains the following information:

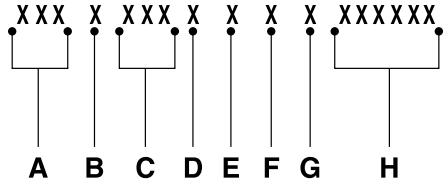

E142477

- A World manufacturer identifier
- B Brake system, Gross Vehicle Weight Rating, Restraint Devices and their locations
- C Make, vehicle line, series, body type
- D Engine type
- E Check digit
- F Model year
- G Assembly plant
- H Production sequence number

Capacities and Specifications

VEHICLE CERTIFICATION LABEL

MFD. BY FORD MOTOR CO.

DATE: XX/XX GVWR: XXXX KG (XXXX LB)
 FRONT GAWR: REAR GAWR:
 XXXX KG (XXXX LB) WITH XXXX KG (XXXX LB) WITH
 TIRES TIRES
 XXXXXXXXXXXXXXXX TIRES XXXXXXXXXXXXXXXX TIRES
 XXXXXXX RIMS XXXXXXX RIMS
 AT XXXX kPa/ XXX PSI COLD AT XXXX kPa/ XXX PSI COLD

THIS VEHICLE CONFORMS TO ALL APPLICABLE FEDERAL MOTOR VEHICLE SAFETY AND THEFT PREVENTION STANDARDS IN EFFECT ON THE DATE OF MANUFACTURE SHOWN ABOVE.

VIN: XXXXXXXXXXXXXXXX XXXXX
 TYPE: XXXX XXXXX



EXT PNT: XX XXXXXX RC: XX DSO: XXXX
 WB INT TR TP/PS R AXLE TR SPR XXXX
 XXX XX XXX X XX X XXXX XXXX
 XXXXXXXXXXXXXXX XXX XXXX-XXXXXXXX-XX

E167469

The National Highway Traffic Safety Administration Regulations require that a Safety Compliance Certification Label be affixed to a vehicle and prescribe where the Safety Compliance Certification Label may be located. The Safety Compliance Certification Label shall be affixed to either the door hinge pillar, the door latch post, or the edge of the door near the door latch, next to the driver's seating position.

TRANSMISSION CODE DESIGNATION

MFD. BY FORD MOTOR CO.

DATE: XX/XX GVWR: XXXX KG (XXXX LB)
 FRONT GAWR: REAR GAWR:
 XXXX KG (XXXX LB) WITH XXXX KG (XXXX LB) WITH
 TIRES TIRES
 XXXXXXXXXXXXXXXX TIRES XXXXXXXXXXXXXXXX TIRES
 XXXXXXX RIMS XXXXXXX RIMS
 AT XXXX kPa/ XXX PSI COLD AT XXXX kPa/ XXX PSI COLD

THIS VEHICLE CONFORMS TO ALL APPLICABLE FEDERAL MOTOR VEHICLE SAFETY AND THEFT PREVENTION STANDARDS IN EFFECT ON THE DATE OF MANUFACTURE SHOWN ABOVE.

VIN: XXXXXXXXXXXXXXXX XXXXX
 TYPE: XXXX XXXXX



EXT PNT: XX XXXXXX RC: XX DSO: XXXX
 WB INT TR TP/PS R AXLE TR SPR XXXX
 XXX XX XXX X XX X XXXX XXXX
 XXXXXXXXXXXXXXX XXX XXXX-XXXXXXXX-XX

↑

E167814

The transmission code is on the Safety Compliance Certification Label. The following table shows the transmission code along with the transmission description.

Description	Code
Six-speed automatic transmission 6R80E	3
Six-speed manual transmission MT82	X

Capacities and Specifications

CAPACITIES AND SPECIFICATIONS - 2.3L ECOBOOST™

Capacities

WARNING



The air conditioning refrigerant system contains refrigerant R-134a under high pressure. Opening the air conditioning refrigerant system can cause personal injury. Have the air conditioning refrigerant system serviced only by qualified personnel.

Item	Capacity
Engine oil	5.7 qt (5.4 L)
Engine coolant	9.5 qt (8.96 L)
Brake fluid	Between MIN/MAX on brake fluid reservoir
Rear axle fluid	3.2 pt (1.5L)
Rear axle friction modifier	3.28 fl oz (97 ml)
Automatic transmission fluid*	11.6 qt (10.98 L)
Manual transmission fluid*	2.7 qt (2.6 L)
Windshield washer fluid	Fill as required
Fuel tank	15.5 gal (58.8 L)
A/C Refrigerant	21 oz (0.6 kg)
A/C Refrigerant Compressor Oil	3.4 fl oz (100.5 ml)

*Approximate dry fill capacity. Actual amount may vary during fluid changes.

Capacities and Specifications

Specifications

Materials

Name	Specification
Recommended motor oil (U.S.): Motorcraft SAE 5W-30 Premium Synthetic Blend Motor Oil XO-5W30-QSP	WSS-M2C946-A
Recommended motor oil (Canada): Motorcraft® SAE 5W-30 Super Premium Motor Oil CXO-5W30-LSP12	WSS-M2C946-A
Recommended motor oil (Mexico): Motorcraft SAE 5W-30 Premium Synthetic Blend Motor Oil MXO-5W30-QSP	WSS-M2C946-A
Optional motor oil (U.S. and Mexico): Motorcraft SAE 5W-30 Full Synthetic Motor Oil XO-5W30-QFS	WSS-M2C946-A
Optional motor oil (Canada): Motorcraft SAE 5W-30 Synthetic Motor Oil CXO-5W30-LFS12	WSS-M2C946-A
Engine coolant (U.S. and Mexico): Motorcraft Orange Antifreeze/Coolant Prediluted VC-3DIL-B	WSS-M97B44-D2
Engine coolant (Canada): Motorcraft Orange Antifreeze/Coolant Prediluted CVC-3DIL-B	WSS-M97B44-D2
Brake fluid: Motorcraft DOT 4 Low Viscosity (LV) High Performance Motor Vehicle Brake Fluid PM-20	WSS-M6C65-A2
Rear axle fluid: Motorcraft SAE 75W-85 Premium Synthetic Hypoid Gear Lubricant XY-75W85-QL	WSS-M2C942-A
Rear axle friction modifier (U.S. and Mexico):* Motorcraft Additive Friction Modifier XL-3	EST-M2C118-A

Capacities and Specifications

Name	Specification
Rear axle friction modifier (Canada): Motorcraft Additive Friction Modifier CXL-3	EST-M2C118-A
Automatic transmission fluid (U.S. and Mexico): Motorcraft MERCON LV Automatic Transmission Fluid XT-10-QLVC	WSS-M2C938-A MERCON LV
Automatic transmission fluid (Canada): Motorcraft MERCON LV Automatic Transmission Fluid CXT-10-LV12	WSS-M2C938-A MERCON LV
Manual transmission fluid : Motorcraft Dual Clutch Transmission Fluid XT-11-QDC	WSS-M2C200-D2
Windshield washer fluid (U.S. and Mexico): Motorcraft Premium Windshield Wash Concentrate with Bitterant ZC-32-B2	WSS-M14P19-A
Windshield washer fluid (Canada): Motorcraft Premium Quality Windshield Washer Fluid CXC-37-(A, B, D, F)	WSS-M14P19-A
A/C refrigerant (U.S.): Motorcraft R-134a Refrigerant YN-19	WSH-M17B19-A
A/C refrigerant (Canada): Motorcraft R-134a Refrigerant CYN-16-R	WSH-M17B19-A
A/C refrigerant (Mexico): Motorcraft R-134a Refrigerant MYN-19	WSH-M17B19-A
A/C refrigerant compressor oil: Motorcraft PAG Refrigerant Compressor Oil YN-12-D	WSH-M1C231-B
Multi-purpose grease: Motorcraft Multi-Purpose Grease Spray XL-5	ESB-M1C93-B
Lock cylinders (U.S.): Penetrating and Lock Lubricant XL-1	--

Capacities and Specifications

Name	Specification
Lock cylinders (Canada): Penetrating Fluid CXC-51-A	--
Lock cylinders (Mexico): Penetrating and Lock Lubricant MXL-1	--

*For complete refill of limited slip Ford axles, add 3.28 oz. (97 ml) of Additive Friction Modifier XL-3 or equivalent meeting Ford Specification EST-M2C118-A. Ford rear axles contain a synthetic lubricant that does not require changing unless you submerge the axle in water.

If you use oil and fluids that do not meet the defined specification and viscosity grade, this may lead to:

- Component damage which is not covered by the vehicle warranty.
- Longer engine cranking periods.
- Increased emission levels.
- Reduced engine performance.
- Reduced fuel economy.
- Degraded brake performance.

We recommend Motorcraft motor oil for your vehicle. If Motorcraft oil is not available, use motor oils of the recommended viscosity grade that meet API SN requirements and display the API Certification Mark for gasoline engines. Do not use oil labeled with API SN service category unless the label also displays the API certification mark.



E142732

An oil with this trademark symbol conforms to current engine, emission system protection standards and fuel economy requirements of the International Lubricant Standardization and Approval Council (ILSAC), comprised of U.S. and Japanese automobile manufacturers.

Do not use supplemental engine oil additives because they are unnecessary and could lead to engine damage that may not be covered by your vehicle warranty.

Capacities and Specifications

Note: Ford recommends using DOT 4 Low Viscosity (LV) High Performance Brake Fluid or equivalent meeting WSS-M6C65-A2. Use of any fluid other than the recommended fluid may cause degraded brake performance and not meet the Ford performance standards. Keep brake fluid clean and dry. Contamination with dirt, water, petroleum products or other materials may result in brake system damage and possible failure.

Note: Automatic transmissions that require MERCON LV transmission fluid should only use MERCON LV transmission fluid. The use of any other fluid may cause transmission damage.

CAPACITIES AND SPECIFICATIONS - 3.7L

Capacities

WARNING



The air conditioning refrigerant system contains refrigerant R-134a under high pressure. Opening the air conditioning refrigerant system can cause personal injury. Have the air conditioning refrigerant system serviced only by qualified personnel.

Item	Capacity
Engine oil	6.0 qt (5.7 L)
Engine coolant	12.4 qt (11.7 L)
Brake fluid	Between MIN/MAX on brake fluid reservoir
Rear axle fluid	3.2 pt (1.5L)
Rear axle friction modifier	3.28 fl oz (97 ml)
Automatic transmission fluid*	12.0 qt (11.4 L)
Manual transmission fluid*	2.7 qt (2.6 L)
Windshield washer fluid	Fill as required
Fuel tank	16.0 gal (60.6 L)
A/C refrigerant	21 oz (0.6 kg)
A/C refrigerant compressor oil	3.4 fl oz (100.5 ml)

*Approximate dry fill capacity. Actual amount may vary during fluid changes.

Capacities and Specifications

Specifications

Materials

Name	Specification
Recommended motor oil (U.S.): Motorcraft SAE 5W-20 Premium Synthetic Blend Motor Oil XO-5W20-QSP	WSS-M2C945-A
Recommended motor oil (Canada): Motorcraft® SAE 5W-20 Super Premium Motor Oil CXO-5W20-LSP12	WSS-M2C945-A
Recommended motor oil (Mexico): Motorcraft SAE 5W-20 Premium Synthetic Blend Motor Oil MXO-5W20-QSP	WSS-M2C945-A
Optional motor oil (U.S. and Mexico): Motorcraft SAE 5W-20 Full Synthetic Motor Oil XO-5W20-QFS	WSS-M2C945-A
Optional motor oil (Canada): Motorcraft SAE 5W-20 Synthetic Motor Oil CXO-5W20-LFS12	WSS-M2C945-A
Engine coolant (U.S. and Mexico): Motorcraft Orange Antifreeze/Coolant Prediluted VC-3DIL-B	WSS-M97B44-D2
Engine coolant (Canada): Motorcraft Orange Antifreeze/Coolant Prediluted CVC-3DIL-B	WSS-M97B44-D2
Brake fluid: Motorcraft DOT 4 Low Viscosity (LV) High Performance Motor Vehicle Brake Fluid PM-20	WSS-M6C65-A2
Rear axle fluid: Motorcraft SAE 75W-85 Premium Synthetic Hypoid Gear Lubricant XY-75W85-QL	WSS-M2C942-A
Rear axle friction modifier (U.S. and Mexico):* Motorcraft Additive Friction Modifier XL-3	EST-M2C118-A

Capacities and Specifications

Name	Specification
Rear axle friction modifier (Canada): Motorcraft Additive Friction Modifier CXL-3	EST-M2C118-A
Automatic transmission fluid (U.S. and Mexico): Motorcraft MERCON LV Automatic Transmission Fluid XT-10-QLVC	WSS-M2C938-A MERCON LV
Automatic transmission fluid (Canada): Motorcraft MERCON LV Automatic Transmission Fluid CXT-10-LV12	WSS-M2C938-A MERCON LV
Manual transmission fluid : Motorcraft Dual Clutch Transmission Fluid XT-11-QDC	WSS-M2C200-D2
Windshield washer fluid (U.S. and Mexico): Motorcraft Premium Windshield Wash Concentrate with Bitterant ZC-32-B2	WSS-M14P19-A
Windshield washer fluid (Canada): Motorcraft Premium Quality Windshield Washer Fluid CXC-37-(A, B, D, F)	WSS-M14P19-A
A/C refrigerant (U.S.): Motorcraft R-134a Refrigerant YN-19	WSH-M17B19-A
A/C refrigerant (Canada): Motorcraft R-134a Refrigerant CYN-16-R	WSH-M17B19-A
A/C refrigerant (Mexico): Motorcraft R-134a Refrigerant MYN-19	WSH-M17B19-A
A/C refrigerant compressor oil: Motorcraft PAG Refrigerant Compressor Oil YN-12-D	WSH-M1C231-B
Multi-purpose grease: Motorcraft Multi-Purpose Grease Spray XL-5	ESB-M1C93-B
Lock cylinders (U.S.): Penetrating and Lock Lubricant XL-1	--

Capacities and Specifications

Name	Specification
Lock cylinders (Canada): Penetrating Fluid CXC-51-A	--
Lock cylinders (Mexico): Penetrating and Lock Lubricant MXL-1	--

*For complete refill of limited slip Ford axles, add 3.28 fl oz. (97 ml) of Additive Friction Modifier XL-3 or equivalent meeting Ford Specification EST-M2C118-A. Ford rear axles contain a synthetic lubricant that does not require changing unless you submerge the axle in water.

If you use oil and fluids that do not meet the defined specification and viscosity grade, this may lead to:

- Component damage, which the vehicle warranty does not cover.
- Longer engine cranking periods.
- Increased emission levels.
- Reduced engine performance.
- Reduced fuel economy.
- Degraded brake performance.

Only use fluid that meets Ford specifications.

We recommend Motorcraft motor oil for your vehicle. If Motorcraft oil is not available, use motor oils of the recommended viscosity grade that meet API SN requirements and display the API Certification Mark for gasoline engines. Do not use oil labeled with API SN service category unless the label also displays the API certification mark.



E142732

An oil with this trademark symbol conforms to current engine, emission system protection standards and fuel economy requirements of the International Lubricant Standardization and Approval Council (ILSAC), comprised of U.S. and Japanese automobile manufacturers.

Do not use supplemental engine oil additives because they are unnecessary and could lead to engine damage that may not be covered by your vehicle warranty.

Capacities and Specifications

Note: Ford recommends using DOT 4 Low Viscosity (LV) High Performance Brake Fluid or equivalent meeting WSS-M6C65-A2. Use of any fluid other than the recommended fluid may cause degraded brake performance and not meet the Ford performance standards. Keep brake fluid clean and dry. Contamination with dirt, water, petroleum products or other materials may result in brake system damage and possible failure.

Note: Automatic transmissions that require MERCON LV transmission fluid should only use MERCON LV transmission fluid. The use of any other fluid may cause transmission damage.

CAPACITIES AND SPECIFICATIONS - 5.0L

Capacities

WARNING



The air conditioning refrigerant system contains refrigerant R-134a under high pressure. Only qualified personnel should service the air conditioning refrigerant system. Opening the air conditioning refrigerant system can cause personal injury.

Item	Capacity
Engine oil	8.0 qt (7.6 L)
Engine coolant	13.6 qt (12.88 L)
Engine coolant with Track Pack (If equipped)	15.2 qt (14.4 L)
Brake fluid	Between MIN/MAX on brake fluid reservoir
Rear axle fluid	3.2 pt (1.5L)
Rear axle friction modifier	3.28 fl oz (97 ml)
Automatic transmission fluid*	11.8 qt (11.17 L)
Manual transmission fluid*	2.7 qt (2.6 L)
Windshield washer fluid	Fill as required
Fuel tank	16.0 gal (60.6 L)
A/C Refrigerant	24.0 oz (0.68 kg)
A/C Refrigerant Compressor Oil	4.1 fl oz (120 ml)

*Approximate dry fill capacity. Actual amount may vary during fluid changes.

Capacities and Specifications

Specifications

Materials

Name	Specification
Recommended motor oil (U.S.): Motorcraft SAE 5W-20 Premium Synthetic Blend Motor Oil XO-5W20-QSP	WSS-M2C945-A
Recommended motor oil (Canada): Motorcraft® SAE 5W-20 Premium Synthetic Blend Motor Oil CXO-5W20-LSP12	WSS-M2C945-A
Recommended motor oil (Mexico): Motorcraft SAE 5W-20 Premium Synthetic Blend Motor Oil MXO-5W20-QSP	WSS-M2C945-A
Optional motor oil (U.S. and Mexico): Motorcraft SAE 5W-20 Full Synthetic Motor Oil XO-5W20-QFS	WSS-M2C945-A
Optional motor oil (Canada): Motorcraft SAE 5W-20 Synthetic Motor Oil CXO-5W20-LFS12	WSS-M2C945-A
Engine coolant (U.S. and Mexico): Motorcraft Orange Antifreeze/Coolant Prediluted VC-3DIL-B	WSS-M97B44-D2
Engine coolant (Canada): Motorcraft Orange Antifreeze/Coolant Prediluted CVC-3DIL-B	WSS-M97B44-D2
Brake fluid: Motorcraft DOT 4 Low Viscosity (LV) High Performance Motor Vehicle Brake Fluid PM-20	WSS-M6C65-A2
Rear axle fluid: Motorcraft SAE 75W-85 Premium Synthetic Hypoid Gear Lubricant XY-75W85-QL	WSS-M2C942-A
Rear axle friction modifier (U.S. and Mexico):* Motorcraft Additive Friction Modifier XL-3	EST-M2C118-A

Capacities and Specifications

Name	Specification
Rear axle friction modifier (Canada): Motorcraft Additive Friction Modifier CXL-3	EST-M2C118-A
Automatic transmission fluid (U.S. and Mexico): Motorcraft MERCON LV Automatic Transmission Fluid XT-10-QLVC	WSS-M2C938-A MERCON LV
Automatic transmission fluid (Canada): Motorcraft MERCON LV Automatic Transmission Fluid CXT-10-LV12	WSS-M2C938-A MERCON LV
Manual transmission fluid: Motorcraft Dual Clutch Transmission Fluid XT-11-QDC	WSS-M2C200-D2
Windshield washer fluid (U.S. and Mexico): Motorcraft Premium Windshield Wash Concentrate with Bitterant ZC-32-B2	WSS-M14P19-A
Windshield washer fluid (Canada): Motorcraft Premium Quality Windshield Washer Fluid CXC-37-(A, B, D, F)	WSS-M14P19-A
A/C refrigerant (U.S.): Motorcraft R-134a Refrigerant YN-19	WSH-M17B19-A
A/C refrigerant (Canada): Motorcraft R-134a Refrigerant CYN-16-R	WSH-M17B19-A
A/C refrigerant (Mexico): Motorcraft R-134a Refrigerant MYN-19	WSH-M17B19-A
A/C refrigerant compressor oil: Motorcraft PAG Refrigerant Compressor Oil YN-12-D	WSH-M1C231-B
Multi-purpose grease: Motorcraft Multi-Purpose Grease Spray XL-5	ESB-M1C93-B
Lock cylinders (U.S.): Penetrating and Lock Lubricant XL-1	--

Capacities and Specifications

Name	Specification
Lock cylinders (Canada): Penetrating Fluid CXC-51-A	--
Lock cylinders (Mexico): Penetrating and Lock Lubricant MXL-1	--

*For complete refill of limited slip Ford axles, add 3.28 oz. (97 ml) of Additive Friction Modifier XL-3 or equivalent meeting Ford Specification EST-M2C118-A. Ford rear axles contain a synthetic lubricant that does not require changing unless you submerge the axle in water.

If you use oil and fluids that do not meet the defined specification and viscosity grade, this may lead to:

- Component damage which is not covered by the vehicle warranty.
- Longer engine cranking periods.
- Increased emission levels.
- Reduced engine performance.
- Reduced fuel economy.
- Degraded brake performance.

Only use fluid that meets Ford specifications.

We recommend Motorcraft motor oil for your vehicle. If Motorcraft oil is not available, use motor oils of the recommended viscosity grade that meet API SN requirements and display the API Certification Mark for gasoline engines. Do not use oil labeled with API SN service category unless the label also displays the API certification mark.



E142732

An oil with this trademark symbol conforms to current engine, emission system protection standards and fuel economy requirements of the International Lubricant Standardization and Approval Council (ILSAC), comprised of U.S. and Japanese automobile manufacturers.

Do not use supplemental engine oil additives because they are unnecessary and could lead to engine damage that may not be covered by your vehicle warranty.

Capacities and Specifications

Note: *Ford recommends using DOT 4 LV High Performance Brake Fluid or equivalent meeting WSS-M6C65-A2. Use of any fluid other than the recommended fluid may cause degraded brake performance and not meet the Ford performance standards. Keep brake fluid clean and dry. Contamination with dirt, water, petroleum products or other materials may result in brake system damage and possible failure.*

Note: *Automatic transmissions that require MERCON LV transmission fluid should only use MERCON LV transmission fluid. The use of any other fluid may cause transmission damage.*

Audio System

GENERAL INFORMATION

Radio Frequencies and Reception Factors

AM and FM frequencies are established by the Federal Communications Commission (FCC) and the Canadian Radio and Telecommunications Commission (CRTC). Those frequencies are:

- AM: 530, 540-1700, 1710 kHz
- FM: 87.9-107.7, 107.9 MHz

Radio Reception Factors	
Distance and strength	The further you travel from an AM or FM station, the weaker the signal and the weaker the reception.
Terrain	Hills, mountains, tall buildings, bridges, tunnels, freeway overpasses, parking garages, dense tree foliage and thunderstorms can interfere with the reception.
Station overload	When you pass a ground-based broadcast repeating tower, a stronger signal may overtake a weaker one and result in the audio system muting.

CD and CD Player Information

Note: *CD units play commercially pressed 4.75-inch (12 centimeter) audio compact discs only. Due to technical incompatibility, certain recordable and re-recordable compact discs may not function correctly when used in Ford CD players.*

Note: *Do not insert CDs with homemade paper (adhesive) labels into the CD player as the label may peel and cause the CD to become jammed. You should use a permanent felt tip marker rather than adhesive labels on your homemade CDs. Ballpoint pens may damage CDs. Please contact an authorized dealer for further information.*

Note: *Do not use any irregularly shaped discs or discs with a scratch protection film attached.*

Always handle discs by their edges only. Clean the disc with an approved CD cleaner only. Wipe it from the center of the disc toward the edge. Do not clean in a circular motion.

Do not expose discs to direct sunlight or heat sources for extended periods.

MP3 and WMA Track and Folder Structure

Audio systems capable of recognizing and playing MP3 and WMA individual tracks and folder structures work as follows:

- There are two different modes for MP3 and WMA disc playback: MP3 and WMA track mode (system default) and MP3 and WMA folder mode.
- MP3 and WMA track mode ignores any folder structure on the MP3 and WMA disc. The player numbers each MP3 and WMA track on the disc (noted by the MP3 or WMA file extension) from T001 to a maximum of T255. The maximum number of playable MP3 and WMA files may be less depending on the structure of the CD and exact model of radio present.

Audio System

- MP3 and WMA folder mode represents a folder structure consisting of one level of folders. The CD player numbers all MP3 and WMA tracks on the disc (noted by the MP3 or WMA file extension) and all folders containing MP3 and WMA files, from F001 (folder) T001 (track) to F253 T255.
- Creating discs with only one level of folders helps with navigation through the disc files.

If you are burning your own MP3 and WMA discs, it is important to understand how the system reads the structures you create. While various files may be present (files with extensions other than MP3 and WMA), only files with the MP3 and WMA extension are played; other files are ignored by the system. This enables you to use the same MP3 and WMA disc for a variety of tasks on your work computer, home computer and your in-vehicle system.

In track mode, the system displays and plays the structure as if it were only one level deep (all MP3 and WMA files play, regardless of being in a specific folder). In folder mode, the system only plays the MP3 and WMA files in the current folder.

AUDIO UNIT - VEHICLES WITH: AM/FM/CD/SYNC/SATELLITE RADIO

WARNING



Driving while distracted can result in loss of vehicle control, crash and injury. We strongly recommend that you use extreme caution when using any device that may take your focus off the road. Your primary responsibility is the safe operation of your vehicle. We recommend against the use of any hand-held device while driving and encourage the use of voice-operated systems when possible. Make sure you are aware of all applicable local laws that may affect the use of electronic devices while driving.

Note: Depending on your vehicle option package, your system may look different from what you see here.

Note: Some features, such as Sirius satellite radio, may not be available in your location. Check with an authorized dealer.

Audio System

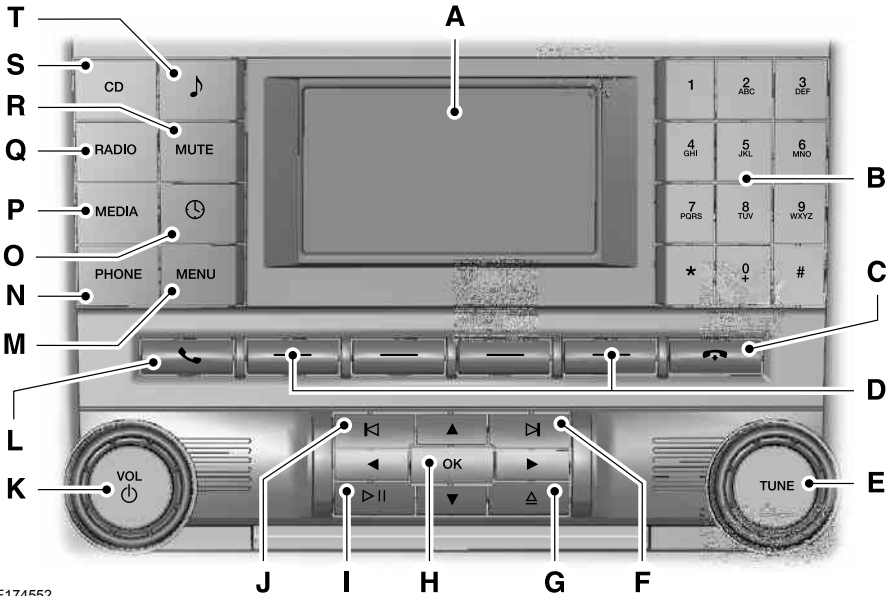

E174552

- A **Display screen:** Shows audio and SYNC information.
- B **Number block:** In radio mode, store your favorite stations for later access. When tuned to any station, press and hold a preset button until sound returns. In CD mode, press a button to select a track. In phone mode, press the buttons to enter a phone number.
- C **End phone call:** Press this button to end a phone call.
- D **Function buttons:** Select different functions of the audio system depending on which mode you are in (such as Radio mode or CD mode).
- E **TUNE:** Turn to search the frequency band in individual increments.
- F **Seek:** In radio mode, select a frequency band and press this button. The system stops at the first station up the band. Press and hold the button to move quickly to the next strong radio station or memory preset. In CD mode, press this button to select the next track. Press and hold the button to move quickly forward through the current track.
- G **Eject:** Press this button to eject a CD.

Audio System

- H **Cursor arrows and OK:** Use the up and down arrow buttons to select the various settings. When you make your selection, press the left and right arrow buttons to change the settings. Press **OK** to set or press **MENU** to exit.
- I **Play/Pause:** Press to either play or pause a track when listening to a CD.
- J **Seek:** In radio mode, select a frequency band and press this button. The system stops at the first station down the band. Press and hold the button to move quickly to the previous strong radio station or memory preset. In CD mode, press this button to select the previous track. Press and hold the button to move quickly backward through the current track.
- K **VOL and Power:** Press this button to turn the system off and on. Turn it to adjust the volume.
- L **Pick-up or Make phone call:** Press this button to either pick-up an incoming phone call or to make a phone call.
- M **MENU:** Press this button to access different audio system features.
- N **PHONE:** Press this button to access the phone features of the SYNC® system. See **SYNC™** (page 302).
- O **Clock:** Press this button to access the clock setting. Use the center arrow controls to change the hours and minutes. You can also set the clock by pressing the **MENU** button and scrolling to Clock Settings.
- P **MEDIA:** Press this button to access your auxiliary input jack or switch between devices you plug into the input jack or USB port.
- Q **RADIO:** Press this button to listen to the radio or change radio frequencies bands. Press the function buttons below the radio screen to select different radio functions.
- R **MUTE or SIRIUS:** Press this button to mute the playing audio, or if equipped, listen to Sirius satellite radio.
- S **CD:** Press this button to listen to a CD. Press the function buttons below the radio screen to select on-screen options of Repeat or Shuffle.
- T **Sound:** Press this button to access settings for Treble, Midrange, Bass, Fade and Balance. Use the up and down arrow buttons to select the various settings. When you make your selection, press the left and right arrow buttons to change the settings. Press **OK** to set or press **MENU** to exit. Sound settings can be set for each audio source independently.

Audio System

AUDIO UNIT - VEHICLES WITH: PREMIUM AM/FM/CD

Note: The touchscreen system controls most of the audio features. See your SYNC information.

WARNING



Driving while distracted can result in loss of vehicle control, crash and injury. We strongly recommend that you use extreme caution when using any device that may take your focus off the road. Your primary responsibility is the safe operation of your vehicle. We recommend against the use of any hand-held device while driving and encourage the use of voice-operated systems when possible. Make sure you are aware of all applicable local laws that may affect the use of electronic devices while driving.

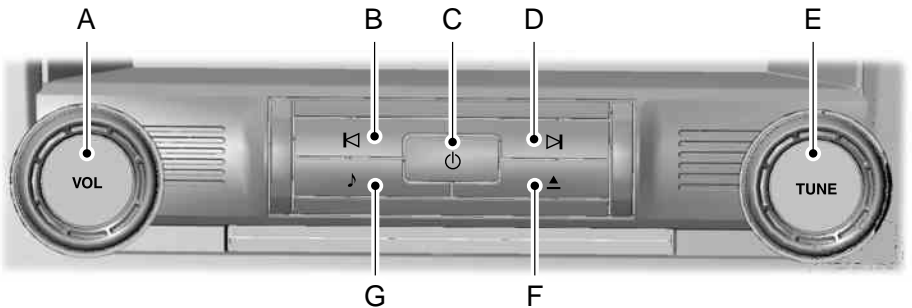

E174101

- A **VOL:** Turn the dial to adjust the system volume.
- B **Seek and Reverse:** In radio mode, select a frequency band and press this button. The system stops at the first station down the band. Press and hold the button to move quickly to the previous strong radio station or memory preset. In CD mode, press this button to select the previous track. Press and hold the button to move quickly backward through the current track.
- C **Power:** Press this button to turn the system off and on.

Audio System

- D **Seek and Fast Forward:** In radio mode, select a frequency band and press this button. The system stops at the first station up the band. Press and hold the button to move quickly to the next strong radio station or memory preset. In CD mode, press this button to select the next track. Press and hold the button to move quickly forward through the current track.
- E **TUNE:** Once you select a frequency band, turn the dial to find the desired station.
- F **Eject:** Press this button to eject a CD.
- G **Sound:** Press this button to access settings for Treble, Midrange, Bass, Fade and Balance.

DIGITAL RADIO

Note: *HD Radio broadcasts are not available in all markets.*

HD Radio technology is the digital evolution of analog AM/FM radio. Your system has a special receiver that allows it to receive digital broadcasts (where available) in addition to the analog broadcasts, it already receives. Digital broadcasts provide a better sound quality than analog broadcasts with free, crystal-clear audio and no static or distortion. For more information, and a guide to available stations and programming, please visit www.hdradio.com.

When HD Radio is on and you tune to a station broadcasting HD Radio technology, you may notice the HD Radio logo on your screen. When this logo is available, you may also see Title and Artist fields on-screen.

The multicast indicator appears in FM mode (only) if the current station is broadcasting multiple digital broadcasts. The highlighted numbers signify available digital channels where new or different content is available. HD1 signifies the main programming status and is available in analog and digital broadcasts. Other multicast stations (HD2 through HD7) are only available digitally.

When HD Radio broadcasts are active, you can access the following functions:

- **Scan** allows you to hear a brief sampling of all available stations. This feature still works when HD Radio reception is on, although it does not scan for HD2-HD7 channels. You may see the HD logo appear if the station has a digital broadcast.
- **Memory presets** allow you to save an active channel as a memory preset. Touch and hold a memory preset slot until the sound returns. There is a brief mute while the radio saves the station. Sound returns when finished. When switching to an HD2 or HD3 memory preset, the sound mutes before the digital audio plays, because the system has to reacquire the digital signal.

Note: *As with any saved radio station, you cannot access the saved station if your vehicle is outside the station's reception area.*

Audio System

HD Radio Reception and Station Troubleshooting

Potential reception issues	
Reception area	If you are listening to a multicast station and you are on the fringe of the reception area, the station may mute due to weak signal strength.
	If you are listening to HD1, the system switches back to the analog broadcast until the digital broadcast is available again. However, if you are listening to any of the possible HD2-HD7 multicast channels, the station mutes and stays muted unless it is able to connect to the digital signal again.
Station blending	When the system first receives a station (aside from HD2-HD7 multicast stations), it first plays the station in the analog version. Once the receiver verifies the station is an HD Radio station, it shifts to the digital version. Depending on the station quality, you may hear a slight sound change when the station changes from analog to digital. Blending is the shift from analog to digital sound or digital back to analog sound.

In order to provide the best possible experience, use the contact form to report any station issues found while listening to a station broadcasting with HD Radio technology. Independent entities own and operate each station. These stations are responsible for ensuring all audio streams and data fields are accurate.

Audio System

Potential station issues		
Issues	Cause	Action
Echo, stutter, skip or repeat in audio. Increase or decrease in audio volume.	This is poor time alignment by the radio broadcaster.	No action required. This is a broadcast issue.
Sound fading or blending in and out.	The radio is shifting between analog and digital audio.	No action required. The reception issue may clear up as you continue to drive.
There is an audio mute delay when selecting HD2 or HD3, multicast preset or Direct Tune .	The digital multicast is not available until the HD Radio broadcast is decoded. Once decoded, the audio is available.	No action required. This is normal behavior. Wait until the audio is available.
Cannot access HD2 or HD3 multicast channel when recalling a preset or from a direct tune.	The previously stored multicast preset or direct tune is not available in your current reception area.	No action required. The station is not available in your current location.
Text information does not match currently playing audio.	Data service issue by the radio broadcaster.	Fill out the station issue form at website listed below.*
There is no text information shown for currently selected frequency.	Data service issue by the radio broadcaster.	Fill out the station issue form at website listed below.*
HD2-HD7 stations not found when Scan is pressed.	Pressing Scan disables HD2-HD7 channel search.	No action required. This is normal behavior.

* http://www.ibiquity.com/automotive/report_radio_station_experiences

HD Radio Technology manufactured under license from iBiquity Digital Corp. U.S. and foreign patents. HD Radio and the HD and HD Radio logos are proprietary trademarks of iBiquity Digital Corp. Ford Motor Company and iBiquity Digital Corp. are not responsible for the content sent using HD Radio technology. Content may be changed, added or deleted at any time at the station owner's discretion.

SATELLITE RADIO (If Equipped)

SIRIUS® broadcasts a variety of music, news, sports, weather, traffic and entertainment satellite radio channels. For more information and a complete list of SIRIUS satellite radio channels, visit www.siriusxm.com in the United States, www.siriusxm.ca in Canada, or call SIRIUS at 1-888-539-7474.

Audio System

Note: This receiver includes the eCos real-time operating system. eCos is published under the eCos License.

Satellite Radio Reception Factors

Potential satellite radio reception issues	
Antenna obstructions	For optimal reception performance, keep the antenna clear of snow and ice build-up and keep luggage and other material as far away from the antenna as possible.
Terrain	Hills, mountains, tall buildings, bridges, tunnels, freeway overpasses, parking garages, dense tree foliage and thunderstorms can interfere with your reception.
Station overload	When you pass a ground-based broadcast-repeating tower, a stronger signal may overtake a weaker one and the audio system may mute.
Satellite radio signal interference	Your display may show ACQUIRING . . . to indicate the interference and the audio system may mute.

SIRIUS® Satellite Radio Service

Note: SIRIUS reserves the unrestricted right to change, rearrange, add or delete programming including canceling, moving or adding particular channels, and its prices, at any time, with or without notice to you. Ford Motor Company shall not be responsible for any such programming changes.



E142593

SIRIUS satellite radio is a subscription-based satellite radio service that broadcasts a variety of music, sports, news, weather, traffic and entertainment programming. Your factory-installed SIRIUS satellite radio system includes hardware and a limited subscription term, which begins on the date of sale or lease of your vehicle. See an authorized dealer for availability.

For more information on extended subscription terms (a service fee is required), the online media player and a complete list of SIRIUS satellite radio channels, and other features, please visit www.siriusxm.com in the United States, www.siriusxm.ca in Canada, or call SIRIUS at 1-888-539-7474.

Satellite Radio Electronic Serial Number (ESN)

You need your ESN to activate, modify or track your satellite radio account. When in satellite radio mode, tune to channel 0.

Audio System

Troubleshooting

Message	Condition	Action
Acquiring...	Radio requires more than two seconds to produce audio for the selected channel.	No action required. This message should disappear shortly.
Satellite antenna fault SIRIUS system failure	There is an internal module or system failure present.	If this message does not clear shortly, or with an ignition key cycle, your receiver may have a fault. See an authorized dealer for service.
Invalid Channel	The channel is no longer available.	Tune to another channel or choose another preset.
Unsubscribed Channel	Your subscription does not include this channel.	Contact SIRIUS at 1-888-539-7474 to subscribe to the channel, or tune to another channel.
No Signal	The signal is lost from the SIRIUS satellite or SIRIUS tower to your vehicle antenna.	The signal is blocked. When you move into an open area, the signal should return.
Updating...	Update of channel programming in progress.	No action required. The process may take up to three minutes.
Questions? Call 1-888-539-7474	Your satellite service is no longer available.	Contact SIRIUS at 1-888-539-7474 to resolve subscription issues.
None found Check Channel Guide	All the channels in the selected category are either skipped or locked.	Use the channel guide to turn off the Lock or Skip function on that station.
Subscription Updated	SIRIUS has updated the channels available for your vehicle.	No action required.

Audio System

USB PORT (If Equipped)



E176344

The USB port allows you to plug in media playing devices, memory sticks and charge devices (if supported). See your SYNC information.

MEDIA HUB (If Equipped)

The media hub is located in the center console and has the following features:



E201595

See your SYNC information.

GENERAL INFORMATION

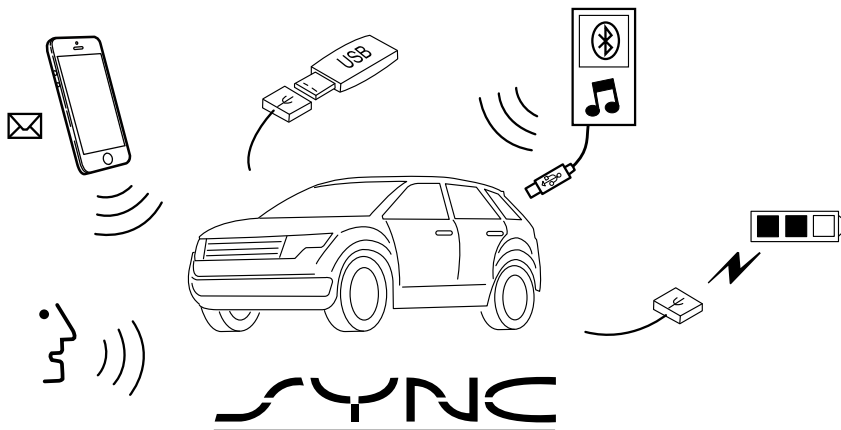

E198355

SYNC is an in-vehicle communications system that works with your Bluetooth-enabled cellular phone and portable media player. This allows you to:

- Make and receive calls.
- Access and play music from your portable music player.
- Use 911 Assist and applications, such as Spotify and Glympse, via SYNC AppLink.*
- Access phonebook contacts and music using voice commands.
- Stream music from your connected phone.
- Text message.

- Use the advanced voice recognition system.
- Charge your USB device (if your device supports this).

*These features are not available in all markets and may require activation. Available AppLink enabled apps vary by market.

Make sure that you review your device's manual before using it with SYNC.

Support

The SYNC support team is available to help you with any questions you cannot answer on your own.

Monday-Saturday, 8:30am-9:00pm EST.

Sunday, 10:30am-7:30pm EST.

In the United States, call 1-800-392-3673.

In Canada, call 1-800-565-3673.

Times are subject to change due to holidays.

SYNC Owner Account

Why do I need a SYNC owner account?

- Essential for keeping up with the latest software downloads available for SYNC.
- Access to customer support for any questions you may have.

Driving Restrictions

For your safety, certain features are speed-dependent and restricted when your vehicle is traveling over 3 mi (5 km).

Safety Information

WARNING



Driving while distracted can result in loss of vehicle control, crash and injury. We strongly recommend that you use extreme caution when using any device that may take your focus off the road. Your primary responsibility is the safe operation of your vehicle. We recommend against the use of any hand-held device while driving and encourage the use of voice-operated systems when possible. Make sure you are aware of all applicable local laws that may affect the use of electronic devices while driving.

When using SYNC:

- Do not operate playing devices if the power cords or cables are broken, split or damaged. Place cords and cables out of the way, so they do not interfere with the operation of pedals, seats, compartments or safe driving abilities.
- Do not leave playing devices in your vehicle during extreme conditions as it could cause them damage. See your device's manual for further information.
- Do not attempt to service or repair the system. See an authorized dealer.

Privacy Information

When a cellular phone is connected to SYNC, the system creates a profile within your vehicle that is linked to that cellular phone. This profile is created in order to offer you more cellular features and to operate more efficiently. Among other things, this profile may contain data about your cellular phone book, text messages (read and unread), and call history, including history of calls when your cellular phone was not connected to the system. In addition, if you connect a media device, the system creates and retains an index of supported media content. The system also records a short development log of approximately 10 minutes of all recent system activity. The log profile and other system data may be used to improve the system and help diagnose any problems that may occur.

The cellular profile, media device index, and development log will remain in the vehicle unless you delete them and are generally accessible only in the vehicle when the cellular phone or media player is connected. If you no longer plan to use the system or the vehicle, we recommend you perform a Master Reset to erase all stored information.

System data cannot be accessed without special equipment and access to the vehicle's SYNC module. Ford Motor Company and Ford of Canada will not access the system data for any purpose other than as described absent consent, a court order, or where required by law enforcement, other government authorities, or other third parties acting with lawful authority. Other parties may seek to access the information independently of Ford Motor Company and Ford of Canada. For further privacy information, see the section on 911 Assist. See **SYNC™ Applications and Services** (page 318).

USING VOICE RECOGNITION

This system helps you control many features using voice commands. This allows you to keep your hands on the wheel and focus on what is around you.

Initiating a Voice Session



Press the voice button. A list of available voice commands appears in the display.

Global Voice Commands

These voice commands are always available. You can say them at any time.

Global voice commands	
(cancel exit)	This command ends the voice session. You can also cancel a session by holding the voice button for two or more seconds.
help	This command provides you with hints, examples and instructions.
(main menu start again)	This command restarts the voice session from the initial starting point.

You can say any of the voice commands that appear within open and close brackets that are separated by |. For example, where; (cancel | exit) appears you say; cancel or exit.

Helpful Hints

- Make sure the interior of your vehicle is as quiet as possible. Wind noise from open windows and road vibrations may prevent the system from correctly recognizing spoken commands.
- Before giving a voice command, wait for the system announcement to finish, followed by a single tone. Any command spoken before this does not register with the system.
- Speak naturally, without long pauses between words.
- You can interrupt the system at any time while it is speaking by pressing the voice button. You can cancel a voice session by pressing and holding the voice button.

System Interaction and Feedback

The system provides feedback through audible tones, prompts, questions and spoken confirmations depending on the situation and the chosen level of interaction. You can customize the voice recognition system to provide more or less instruction and feedback.

The default setting is to a higher level of interaction in order to help you learn to use the system. You can change these settings at any time.

Adjusting the Interaction Level



Press the voice button. When prompted, say:

Voice Command	Action and Description
voice settings	
Then either of the following:	
interaction mode novice	Provides more detailed interaction and guidance. (Recommended for first time users.)
interaction mode advanced	Provides less audible interaction and guidance.

Confirmation Prompts

Confirmation prompts are short questions the system asks when it is not sure of your request or when there is more than one possible response to your request.

To adjust this setting press the voice button, when prompted say:

Voice Command	Action and Description
voice settings	
Then either of the following:	
confirmation prompts off	Make a best guess from the command; you may still occasionally be asked to confirm settings.
confirmation prompts on	Clarify your voice command with a short question.

Phone Confirmation

Using phone confirmations the system asks you to verify before placing any calls.

SYNC™ (If Equipped)

To adjust this setting press the voice button, when prompted say:

Voice Command	Action and Description
voice settings	
Then any of the following:	
phone confirmation on	When enabled, this feature will prompt you to confirm any voice initiated call command prior to the call being placed.
phone confirmation off	The system will make a best guess; you may still occasionally be asked to confirm settings.

Changing the Voice Settings

In addition to using voice commands to change the voice settings, you can also use the menu in the audio display.

To change the voice settings press the Menu button then select:

Menu Item
SYNC-Settings
Voice settings

USING SYNC™ WITH YOUR PHONE

Hands-free calling is one of the main features of SYNC. While the system supports a variety of features, many are dependent on your cellular phone's functionality. At a minimum, most cellular phones with Bluetooth wireless technology support the following functions:

- Answering an incoming call.
- Ending a call.
- Using privacy mode.
- Dialing a number.
- Redialing.

- Call waiting notification.
- Caller ID.

Other features, such as text messaging using Bluetooth and automatic phonebook download, are phone-dependent features. To check your phone's compatibility, see your phone's manual and visit www.SYNCMYride.com, www.SYNCMYride.ca or www.syncmaroute.ca.

Pairing a Phone for the First Time

Wirelessly pairing your phone with SYNC allows you to make and receive hands-free calls.

Note: SYNC can support downloading up to approximately 4000 entries per Bluetooth-enabled cellular phone.

Note: Make sure to switch on the ignition and the radio. Shift the transmission into park (P) for automatic transmission or first gear for manual transmission.

Using the Audio System

Note: To scroll through the menus, press the up and down arrows on your audio system.

SYNC™ (If Equipped)

1. Make sure to switch on your phone's Bluetooth feature before starting the search. See your device's manual if necessary.
2. Press the **PHONE** button. When the audio display indicates there is no paired phone, select the option to add.
3. When a message to begin pairing appears in the audio display, search for SYNC on your phone to start the pairing process.
4. When prompted on your cell phone's display, confirm that the PIN provided by SYNC matches the PIN displayed on your cell phone. Your phone is now paired and the display indicates that the pairing was successful. If you are prompted to enter a PIN on your device, enter the PIN displayed on the screen. The display indicates when the pairing is successful.

Depending on your phone's capability and your market, the system may prompt you with questions, such as setting the current phone as the primary phone (the phone SYNC automatically tries to connect with first upon vehicle start-up) and downloading your phonebook.

Using Voice Commands



Make sure to switch on your phone's Bluetooth feature before starting the search. See your device's manual if necessary.

Press the voice and when prompted say:

Voice Command	Action and Description
(pair ([Bluetooth] device phone Bluetooth audio) add phone)	Follow the instructions on the audio display.

You can say any of the voice commands that appear within open and close brackets that are separated by |. For example, where; (what's | what is) appears you say; what's or what is.

The commands that have [] around the word means that the word is optional.

Depending on your phone's capability and your market, the system may prompt you with questions, such as setting the current phone as the primary phone (the phone SYNC automatically tries to connect with first upon vehicle start-up) and downloading your phonebook.

Pairing Subsequent Phones

Note: Make sure to switch on the ignition and the radio. Shift the transmission into park (P) for automatic transmission or first gear for manual transmission.

Note: To scroll through the menus, press the up and down arrows on your audio system.

1. Make sure to switch on your phone's Bluetooth feature before starting the search. See your device's manual if necessary.
2. Press the **PHONE** button.
3. Select the option for Bluetooth Devices.
4. Press the **OK** button.

SYNC™ (If Equipped)

5. Select the option to add. This starts the pairing process.
6. When a message to begin pairing appears in the audio display, search for SYNC on your device.
7. When prompted on your cell phone's display, confirm that the PIN provided by SYNC matches the PIN displayed on your cell phone. Your phone is now paired and the display indicates that the pairing was successful. If you are prompted to enter a PIN on your device, enter the PIN displayed on the screen. The display indicates when the pairing is successful.

SYNC may prompt you with more cell phone options. Your cell phone may also prompt you to give SYNC permission to access information. For more information on your cell phone's capability, see your cell phone's manual and visit the website.

Phone Voice Commands



Press the voice button. When prompted, say any of the following:

Voice Command
(phone Blackberry iPhone)
Then say any of the following:
call (___)
call ___ at home
call ___ ((in at) [the] office at work)
call ___ on (cell mobile)
call ___ on other
dial [[a] number] ¹
([go to] privacy transfer to phone privacy on) ²

Voice Command
(hold call [on] place call on hold) ²
join (calls call) ²
mute call [on] ²
(mute call off un-mute call) ²
(turn ringer on silent mode off)
(turn ringer off silent mode [on])
[text] (messages message) ³
help

___ is a dynamic listing that should be the name of a contact in your phonebook. For example you could say "Call Home".

¹ See **Dial** table below.

² These commands are only valid while in a phone call.

³ See the text message table below.

Dial Commands

Press the voice button and when prompted say any of the following commands:

Voice Commands
411 (four-one-one), 911 (nine-one-one)
700 (seven hundred)
800 (eight hundred)
900 (nine hundred)
Clear (deletes all entered digits)
Delete (deletes last set of digits entered)
Number <0-9>

SYNC™ (If Equipped)

Voice Commands
Plus
Pound (#)
Star (*)

Note: To exit dial mode, press and hold the phone button or press any button on the audio system.

To access text messages say:

Voice Command
[text] (messages message)
Then say any of the following:
(listen to read) ([text] message)
forward (text [text] message)
reply to (text [text] message)
call [sender]

Phonebook Hints

To hear how the SYNC system speaks a name browse phonebook, select a contact and press:

Menu Item
Hear it

Changing Devices Using Voice Commands

Using SYNC, you can easily access multiple phones, ipods, or USB devices. to switch devices say:

Voice Command	
(connect device) ____	You can state the name of the desired device, such as "My iPhone"; "My Galaxy" or "My iPod". SYNC may ask you to confirm the type of device (Phone, USB, or Bluetooth Audio).

Making Calls



Press the voice button. When prompted, say:

Voice Command	
call [[a] name]	
dial [[a] number]	SYNC prompts you to say the numbers that you wish to dial. After you say the numbers, the system confirms it. You can then say:

When the system has stated the number, you say any of the following:

Voice Command	
(dial send)	This initiates the call.
(delete correct)	This erases the spoken digits.

To end the call, press the end call button on the steering wheel or select the end call option in the audio display.

Receiving Calls

Accepting calls

When receiving a call, you can answer the call by pressing the accept call button on the steering wheel or use the screen.

To use the screen to accept a call select:

Menu Item
Accept

Rejecting Calls

When receiving a call, you can reject the call by pressing the reject call button on the steering wheel or use the screen.

To use the screen to reject a call select:

Menu Item
Reject

Ignore the call by doing nothing.

Phone Options during an Active Call

During an active call, you have more menu features that become available, such as putting a call on hold or joining calls.

To access this menu, choose one of the options available at the bottom of the audio display or select **More** to choose from the following options:

Menu Item	Description and action
Mic. off	Switch your vehicle's microphone off. To switch the microphone on, select the option again.
Privacy	Switch a call from an active hands-free environment to your cellular phone for a more private conversation. When selected, the audio display indicates the call is private.
Hold	Put an active call on hold. When selected, the audio display indicates the call is on hold.
Dial a number	Enter numbers using the audio system's numeric keypad (for example, numbers for passwords).
Join calls	Join two separate calls. The system supports a maximum of three callers on a multiparty or conference call. 1. Select the More option. 2. Access the desired contact through the system or use voice commands to place the second call. Once actively in the second call, select the More option. 3. Scroll to the option to join calls and press the OK button.
Phonebook	Access your phonebook contacts. 1. Select the More option. 2. Scroll to the option for phonebook and press the OK button. 3. Scroll through your phonebook contacts.

SYNC™ (If Equipped)

Menu Item	Description and action
	<ol style="list-style-type: none"> 4. Press the OK button again when the desired contact appears in the audio display. 5. Press the OK button or dial button to call the selection.
Call History	<p>Access your call history log.</p> <ol style="list-style-type: none"> 1. Select the More option. 2. Scroll to the option for call history and press the OK button. 3. Scroll through your call history options (incoming, outgoing or missed). 4. Press the OK button again when the desired selection appears in the audio display. 5. Press the OK button or dial button to call the selection.

Accessing Features through the Phone Menu

You can access your call history, phonebook, sent text messages, as well as access phone and system settings.

1. Press the **PHONE** button to enter the phone menu.
2. Select one of the options available.

Display	Description and action
Dial a number	Enter numbers using the audio system's numeric keypad.
Phonebook	<p>Access your downloaded phonebook.</p> <ol style="list-style-type: none"> 1. Press the OK button to confirm and enter. You can use the options at the bottom of the screen to access an alphabetical category quickly. You can also use the letters on the audio system's numeric keypad to jump in the list. 2. Scroll through your phonebook contacts. 3. Press the OK button again when the desired selection appears in the audio display. 4. Press the OK button or dial button to call the selection.
Call History	<p>Access any previously dialed, received or missed calls.</p> <ol style="list-style-type: none"> 1. Press the OK button to select. 2. Scroll to select incoming, outgoing or missed calls. Press the OK button to make your selection. 3. Press the OK button or dial button to call the selection.
Speed Dial	Select 1 of 10 speed dial entries. To set a speed dial entry, go to the phonebook and then press and hold one of the numbers on the audio system's numeric keypad.

SYNC™ (If Equipped)

Display	Description and action
Text messaging	Send, download and delete text messages.
BT Devices	Access the option for Bluetooth Device menu listings (add, connect, set as primary, on or off, delete).
Phone settings	View various settings and features on your phone.

Text Messaging

Note: *This is a phone-dependent feature.*

SYNC allows you to receive, send, download and delete text messages. The system can also read incoming text messages to you so that you do not have to take your eyes off the road.

Receiving a Text Message

Note: *This is a phone-dependent feature. Your phone must support downloading text messages using Bluetooth to receive incoming text messages.*

Note: *This is a speed-dependent feature and is only available when your vehicle is traveling at 3.1 mph (5 km/h) or less.*

When a new message arrives, an audible tone sounds and the audio display indicates you have a new message.

To hear the message you can say:

Voice command	Description and action
(listen to read) ([text] message)	Select this option to have the system read the message to you.

Using the screen you also have the following options:

Menu Item	Description and action
Ignore	Select this option, or do nothing, and the message goes into your text message inbox.
View	Select the view option to open the text message. Once selected, you have the ability to have the message read to you, to view other messages. For additional options select:
More...	If you select this option, use the arrow button to scroll through the following options:

SYNC™ (If Equipped)

Menu Item	Description and action	
	Reply to sender	Press the OK button to access, and then scroll through a list of pre-defined messages to send.
	Call sender	Press the OK button to call the sender of the message.
	Forward msg.	Press the OK button to forward the message to anyone in your phonebook or call history. You can also choose to enter a number.

Sending, Downloading and Deleting Your Text Messages

1. Press the **PHONE** button.

2. Select the text messaging option, and then press the **OK** button.

Choose from the following options:

Menu Item	Description and action
New	Allows you to send a new text message based on a pre-defined set of 15 messages.
View	Allows you to read the full message and, in addition, provides the option to have the system read the message to you. To go to the next message, select the More option. This allows you to reply to the sender, call the sender or forward the message.
Delete	Allows you to delete current text messages from the system (not your cellular phone). The audio display indicates when the system has deleted all your text messages.
More...	Allows you to delete all messages or manually trigger a download of all unread messages from your cellular phone.

Sending a Text Message

Note: You can only send a text message to one recipient at a time.

1. Select the send option when the desired selection highlights in the audio display.
2. Select the confirmation option when the contact appears.

3. Press the OK button again to confirm when the system asks if you want to send the message. A pre-defined signature appears on each text message.

Note: You can send text messages either by choosing a contact from the phonebook and selecting the text option from the audio display or by replying to a received message in the inbox.

SYNC™ (If Equipped)

Accessing Your Phone Settings

These are phone-dependent features. Your phone settings allow you to access and adjust features such as your ring tone and text message notification, modify your

phonebook, and set up automatic download.

1. Press the **PHONE** button.
2. Scroll until the phone settings option appears, and then press the **OK** button.

Scroll to select from the following options:

Menu Item	Description and action
Set as master	If this option is checked, the system uses the cellular phone as the master when there is more than one cellular phone paired to the system. This option can be changed for all cellular phones (not only the active phone) using the Bluetooth Devices menu.
Phone status	See the cellular phone name, provider name, cellular phone number, and signal level. When done, press the left arrow buttons to return to the phone status menu.
Set ringtone	Select which ringtone sounds during an incoming call (one of the system's tones or your cellular phone's). If your phone supports in-band ringing, your phone's ringtone sounds when you choose the cellular phone ringtone option. 1. Press the OK button to select and scroll to hear each ringtone. 2. Press the OK button to select a ringtone.
Text msg notify	Have the option of hearing an audible tone to notify you when a text message arrives. Press the OK button to switch the audible tone off or on.
Phonebook pref.	Modify the contents of your phonebook (such as add, delete or download). Press the OK button to select and scroll between the choices in the phonebook preferences table below.

SYNC™ (If Equipped)

Menu Item	Phonebook preferences	
Add contacts	Push the desired contacts on your cellular phone. See your device's manual on how to push contacts. Press the OK button to add more contacts from your phonebook.	
Delete	When a message asking you to delete appears, select the option to confirm. Press the OK button to delete the current phonebook and call history. The system takes you back to the menu for phone settings.	
Download now	Press the OK button to select and download your phonebook to the system.	
Auto-download	When automatic download is on, the system deletes any changes (additions or deletions) saved in the system since your last download.	
	When automatic download is off, the system does not download your phonebook when your cellular phone connects to SYNC.	
	You can only access your phonebook, call history and text messages when your paired cellular phone connects to the system. Check or uncheck this option to download your phonebook automatically each time your phone connects to the system. Download times are phone-dependent and quantity-dependent.	
Sorting Pref.	Enabling this feature allows you to select how your contacts are displayed. You can select:	
	<table border="1"> <tr> <td>First/Last name</td> <td>Last/First name</td> </tr> </table>	First/Last name
First/Last name	Last/First name	

Bluetooth Devices

The Bluetooth Devices menu allows you to add, connect and delete devices as well as set a phone as primary.

1. Press the **PHONE** button.
2. Scroll until Bluetooth Devices appears, and then press the **OK** button.

Select from the following options:

Menu Item	Description and action
Add	Pair additional phones to the system. 1. Select the option to add to start the pairing process.

SYNC™ (If Equipped)

Menu Item	Description and action
	<p>2. When a message to begin pairing appears in the audio display, search for SYNC on your phone. See your phone's manual if necessary.</p> <p>3. When prompted on your cell phone's display, confirm that the PIN provided by SYNC matches the PIN displayed on your cell phone. Skip the next step. If you are prompted to enter a PIN on your device, it does not support Secure Simple Pairing. To pair, enter the PIN displayed on the screen. The display indicates when the pairing is successful.</p> <p>4. When the option to set the phone as primary appears, select either yes or no.</p> <p>5. SYNC may prompt you with more cell phone options. Your cell phone may also prompt you to give SYNC permission to access information. For more information on your cell phone's capability, see your cell phone's manual and visit the website.</p>
Delete	<p>Select the delete option and confirm when the system asks to delete the selected device. After deleting a phone from the list, you have to repeat the pairing process to pair it again.</p>
Master	<p>The system attempts to connect with the primary cellular phone each time you switch on the ignition. When you select a cellular phone as primary, it appears first in the list, marked with an asterisk. Set a previously paired phone as master by selecting the master option and confirming it as the primary.</p>
Conn.	<p>Connect a previously connected phone. You can only have one phone connected at a time to use the phone's functionality. When you connect another phone, the previous phone disconnects from the telephone services. The system allows you to use different Bluetooth devices for the cellular phone functionality and the Bluetooth audio music playback feature at the same time.</p>
Discon.	<p>Disconnects the selected cellular phone. Select this option and confirm when asked. After disconnecting a phone, you can reconnect it again without repeating the full pairing process.</p>

System Settings

1. Press the **MENU** button.

2. Select the SYNC settings option, and then press the **OK** button.

Scroll to select from the following options:

Display	Description and action
Bluetooth on	Check or uncheck this option to switch the system's Bluetooth interface off or on. Select this option, and then press the OK button to change the option's status.
Set defaults	Return to the factory default settings without erasing your indexed information (such as phonebook, call history, text messages and paired devices). Select this option and confirm when prompted in the audio display.
Master reset	Completely erase all information stored in the system (such as phonebook, call history, text messages and paired devices) and return to factory default settings.
Install on SYNC	Install downloaded applications or software updates. Select this option and confirm when prompted in the audio display. There must be a valid SYNC application or update available on the USB drive in order to finish an installation successfully.
System info	Display the system's version numbers as well as its serial number. Press the OK button to select.
Voice settings	The voice settings submenu contains various options. See Using Voice Recognition (page 304).
Browse USB	Browse the actual menu structure of the connected USB device. Press the OK button and use the up and down arrow buttons to scroll through the folders and files. Use the left or right arrow buttons to enter or leave a folder. You can select media content for playback from this menu.

SYNC™ APPLICATIONS AND SERVICES (If Equipped)

In order for the following features to work, your cellular phone must be compatible with SYNC. To check your phone's compatibility, visit www.SYNCMYRide.com, www.SYNCMYRide.ca or www.syncmaroute.ca.

- 911 Assist: Can alert 911 in the event of an emergency.
- SYNC AppLink: Allows you to connect to and use certain applications such as Spotify and Glmpse (if your phone is compatible).

These features may require activation. Available AppLink enabled apps vary by market.

911 Assist

WARNINGS



Unless the 911 Assist setting is set on before a crash, the system will not dial for help which could delay response time, potentially increasing the risk of serious injury or death after a crash.



Do not wait for 911 Assist to make an emergency call if you can do it yourself. Dial emergency services immediately to avoid delayed response time which could increase the risk of serious injury or death after a crash. If you do not hear 911 Assist within five seconds of the crash, the system or phone may be damaged or non-functional.



Always place your phone in a secure location in your vehicle so it does not become a projectile or get damaged in a crash. Failure to do so may cause serious injury to someone or damage the phone which could prevent 911 Assist from working properly.

Note: The SYNC 911 Assist feature must be set on before the incident.

Note: The SYNC 911 Assist feature only operates in the U.S., Canada or in a territory in which 911 is the emergency number.

Note: Before setting this feature on, make sure that you read the 911 Assist Privacy Notice later in this section for important information.

Note: If any user switches 911 Assist to on or off, that setting applies for all paired phones. If 911 Assist is switched off, either a voice message plays or a display message or an icon comes on when your vehicle is started and after a previously paired phone connects.

Note: Every phone operates differently. While SYNC 911 Assist works with most cellular phones, some may have trouble using this feature.

If a crash deploys an airbag (excluding knee airbags and rear inflatable safety belts [if equipped]) or activates the fuel pump shut-off, your SYNC-equipped vehicle may be able to contact emergency services by dialing 911 through a paired and connected Bluetooth-enabled phone. You can learn more about the 911 Assist feature, visit www.SYNCMYRide.com, www.SYNCMYRide.ca or www.syncmaroute.ca.

See **Supplementary Restraints System** (page 34). Important information about airbag deployment is in this chapter.

See **Roadside Emergencies** (page 190). Important information about the fuel pump shut-off is in this chapter.

Setting 911 Assist On or Off

Press menu then select:

Menu Item	Action and Description
SYNC-Applications	
911 Assist	Select desired option, on or off.

If you choose not to activate this feature you will have the following options:

Menu Item	Action and Description
Voice Reminder ON	Provides a display and voice reminder at phone connection at vehicle start.
Voice Reminder OFF	Provides a display reminder only without a voice reminder at phone connection.

To make sure that 911 Assist works properly:

- SYNC must be powered and working properly at the time of the incident and throughout feature activation and use.
- The 911 Assist feature must be set on before the incident.
- You must pair and connect a Bluetooth-enabled and compatible cell phone to SYNC.
- A connected Bluetooth-enabled phone must have the ability to make and maintain an outgoing call at the time of the incident.

- A connected Bluetooth-enabled phone must have adequate network coverage, battery power and signal strength.
- The vehicle must have battery power and be located in the U.S., Canada or in a territory in which 911 is the emergency number.

In the Event of a Crash

Not all crashes deploy an airbag or activate the fuel pump shut-off (the triggers for 911 Assist). If a connected cell phone sustains damage or loses its connection to SYNC during a crash, SYNC searches for and tries to connect to a previously paired cell phone; SYNC then attempts to call the emergency services.

Before making the call:

- SYNC provides a short window of time (about 10 seconds) to cancel the call. If you fail to cancel the call, SYNC attempts to dial 911.
- SYNC says the following, or a similar message: "SYNC will attempt to call 911, to cancel the call, press Cancel on your screen or press and hold the phone button on your steering wheel".

If you do not cancel the call, and SYNC makes a successful call, a pre-recorded message plays for the 911 operator, and then the occupant(s) in your vehicle is able to talk with the operator. Be prepared to provide your name, phone number and location immediately, because not all 911 systems are capable of receiving this information electronically.

911 Assist May Not Work If

- Your cellular phone or 911 Assist hardware sustains damage in a crash.
- The vehicle's battery or the SYNC system has no power.
- The phone(s) thrown from your vehicle are the ones paired and connected to the system.

911 Assist Privacy Notice

When you switch on 911 Assist, it may disclose to emergency services that your vehicle has been in a crash involving the deployment of an airbag or activation of the fuel pump shut-off. Certain versions or updates to 911 Assist may also be capable of electronically or verbally disclosing to 911 operators your vehicle location or other details about your vehicle or crash to assist 911 operators to provide the most appropriate emergency services. If you do not want to disclose this information, do not switch the feature on.

SYNC Mobile Apps

The system enables voice and steering wheel control of SYNC AppLink enabled smartphone apps. When an app is running through AppLink, you can control main features of the app through voice commands and steering wheel controls.

Note: You must pair and connect your smartphone to SYNC to access AppLink.

Note: iPhone users need to connect the phone to the USB port.

Note: Android users need to connect the phone to SYNC using Bluetooth.

Note: For information on available apps, supported smartphone devices and troubleshooting tips please visit the Ford website.

Availability of SYNC AppLink enabled Apps will vary by region.

Note: Make sure you have an active account for the app that you have downloaded. Some apps work automatically with no setup. Other apps want you to configure your personal settings and personalize your experience by creating stations or favorites. We recommend you do this at home or outside of your vehicle.

Note: AppLink is not available if your vehicle is equipped with the MyFordTouch system.

To Access Using the SYNC Menu

Press the MENU button to access the menu on-screen. Then select:

Menu Item	Action and Description
SYNC-Apps	
Mobile Apps	Scroll through the list of available applications and select a particular app or select:
	Find New Apps

Note: If you cannot find a compatible SYNC AppLink app, make sure the required app is running on the mobile device.

Accessing an App's Menu

When an app is running through SYNC, press the right arrow button on the steering wheel control to access the app menu.

You can access various app features from here, for example thumbs up and thumbs down.

Press the left arrow button on the steering wheel control to exit the app menu.

To Access Using Voice Commands

Press the voice button then when prompted say:

Menu Item	Action and Description
mobile (apps applications)	Say the name of the application after the tone. The app should start. When an app is running through SYNC, you can press the voice button and speak commands specific to the app, for example "Play Playlist Road Trip".
help	Use this command to discover the available voice commands.

SYNC Mobile App Voice Commands

The following voice commands are always available:

Menu Item	Action and Description
mobile (apps applications)	SYNC prompts you to say the name of an app to start it on SYNC.
list [mobile] (apps applications)	SYNC lists all of the currently available mobile apps.
find [new] [mobile] (apps applications)	Searches your connected mobile device for SYNC-compatible mobile apps.
help	
You can say the name of a mobile app at any time to start the mobile app on SYNC.	

App Permissions

App permissions are organized by groups. You can grant these group permissions individually. You can change a permission group status any time when not driving, by using the settings menu.

When you launch an app using SYNC, the system may ask you to grant certain permissions, for example:

- To allow your vehicle to provide vehicle information to the app such as, but not limited to: Fuel level, fuel economy, fuel consumption, engine speed, rain sensor, odometer, VIN, external temperature, gear position, tire pressure, and head lamp status.
- To allow your vehicle to provide driving characteristic information such as, but not limited to: MyKey, seat belt status, engine revolutions per minute, gear position, braking events, steering wheel angle, and accelerator pedal position.

SYNC™ (If Equipped)

- To allow your vehicle to provide location information, including: GPS and speed.
- To allow the app to send push notifications using the vehicle display and voice capabilities while running in a background state. Push notifications may be particularly useful for news or

location based apps.

Note: *You only need to grant permissions the first time you use an app with SYNC.*

Note: *Ford is not responsible or liable for any damages or loss of privacy relating to usage of an app, or dissemination of any vehicle data that you approve Ford to provide to an app.*

Enabling and Disabling App Permissions Using the SYNC Menu

Press the MENU button to access the SYNC menu then select:

Menu Item	Action and Description
SYNC-Apps	
Mobile Apps	
All Apps	You can also select a specific app. If the app supports push notifications, this setting is listed. Select to enable or disable the feature as required.

Enabling SYNC Mobile Apps

In order to enable mobile apps, SYNC requires user consent to send and receive app authorization information and updates using the data plan associated with the connected device.

Data is sent to Ford in the United States through the connected device. The information is encrypted and includes your VIN, SYNC module number, anonymous usage statistics and debugging information. Updates may take place automatically.

Note: *You must enable mobile apps for each connected device the first time you select a mobile app using the system.*

Note: *Standard data rates apply. Ford is not responsible for any additional charges you may receive from your service provider, when your vehicle sends or receives data through the connected device. This includes any additional charges incurred due to driving in areas when roaming out of a home network.*

App Status

You can view the current status of an app in the settings menu.

SYNC™ (If Equipped)

There are three possible statuses:

Menu Item	Action and Description
Update Needed	The system has detected a new app requiring authorization or a general permissions update is required.
Up-To-Date	No update is required.
Updating...	The system is trying to receive an update.

Update settings

Menu Item	Action and Description
Request Update	Select this option from the settings menu to manually preform a needed update.
Disable Updates	Select this option from the settings menu to disable automatic updates. Doing so also disables the use of Mobile Apps on SYNC.

USING SYNC™ WITH YOUR MEDIA PLAYER

You can access and play music from your digital music player over your vehicle's speaker system using the system's media menu or voice commands. You can also sort and play your music by specific categories, such as artist and album.

Note: *The system is capable of indexing up to 15,000 songs.*

SYNC is capable of hosting nearly any digital media player including: iPod, Zune, plays from device players, and most USB drives. SYNC also supports audio formats, such as MP3, WMA, WAV and ACC.

Confirm that the USB device has been formatted correctly and has the following specifications:

- USB 2.0.
- File format must be FAT16/32.

The format of the audio files on the USB device must be:

- MP3.
- Non DRM protected WMA.
- WAV.
- AAC.

Connecting Your Digital Media Player to the USB Port

Note: *If your digital media player has a power switch, make sure you switch it on before plugging it in.*

To Connect Using Voice Commands

Plug the device into one of the vehicle's USB ports.

Press the voice button and when prompted, say:

Voice Command	Action and Description
(USB [stick] iPod MP3 [player])	You can now play music by saying any of the appropriate voice commands. See the media voice commands.

Words in brackets [] are optional and do not have to be spoken for the system to understand the command. For example, for where (USB [stick] | IPOD | MP3 [player]) appears, you can say USB or USB stick.

To view USB content select:

Message	Description and Action
Browse USB	Depending on how many media files are on your connected device, an indexing message may appear in the display. When indexing is complete, the selected source starts to playback audio automatically.

You can browse the files on the USB device in categories. Select BROWSE from the buttons at the bottom of the audio display and choose from the following:

Message
Play all
Playlists
Songs
Artists

To Connect Using the System Menu

1. Plug the device into one of the vehicle's USB ports.
2. Press the **MEDIA** button and select either USB 1 or USB 2 from the media source list in the audio display.

Message
Albums
Genres
Browse USB
Reset USB

Media Voice Commands



Press the voice button and when prompted say:

SYNC™ (If Equipped)

Voice Command	Description and Action
(USB [stick] iPod MP3 [player])	You can now play music by saying any of the appropriate voice commands.

You can say any of the voice commands that appear within open and close brackets that are separated by |. For example, where; (what's | what is) appears you say; what's or what is.

You must say any of the voice commands that appear outside of open and close brackets. For example, where; (what's | what is) playing, you must say either "what's playing" or "what is playing".

Command	Description and Action
pause	Pauses device playback.
play	Resumes device playback.
play [album] ___	
play all	Play all media on the device from the first track to the last.
play [artist] ___	
play [genre] ___	
play [playlist] ___	
next [track title song file podcast chapter episode]	Plays the next track on the current media.
previous [track title song file podcast chapter episode]	Plays the previous track on current media.
[play] (similar music more like this)	Creates a playlist with a similar genre to the one currently playing.
play [song track title file] ___	
repeat off	
repeat (one track) [on]	Repeats the current track.

SYNCTM (If Equipped)

Command	Description and Action
shuffle [all] [on]	Plays the current playlist in a random order. (Not all devices support this command.)
shuffle off	
((who's who is) this who plays this (what's what is) playing [now] (what which) (song track artist) is this (who's who is) playing (what's what is) this)	At any time during playback, you can press the voice button and ask the system what is playing. The system reads the metadata tags (if populated) of the current track.

___ is a dynamic listing, meaning that it could be the name of anything, such as a group, artist or song. For example you could say "Play artist The Beatles".

Examples of USB Commands

SYNCTM provides the user with many intuitive ways to find and play a song using voice. For example, if we have a song called "Penny Lane" from the album "Magical Mystery Tour" we can say the following to play this song:

- Play song "Penny Lane".
- Play "Penny Lane".

If we wanted to play the entire album, we can say:

- Play album "Magical Mystery Tour".
- Play "Magical Mystery Tour".

Bluetooth Audio

The system is also capable of playing music from your cellular phone through Bluetooth.

To switch the Bluetooth audio on, use the **MEDIA** button (next to the audio display) or **Source** button, or press the voice button and when prompted say:

Voice Command
Bluetooth audio

Then any of the following:

Voice Command
pause
play
next [track title song file podcast chapter episode]
previous [track title song file podcast chapter episode]

SYNC™ (If Equipped)

Media Menu Features

The media menu allows you to select how to play your music (such as by artist, genre, shuffle or repeat), find similar music or

reset the index of your USB devices.

Press the **MEDIA** button and select either USB 1 or USB 2 from the media source list in the audio display to start USB playback.

Message	Description and Action
Options	This will enter the media menu.

Then any of the following:

Message	Description and Action
Shuffle	Choose to shuffle or repeat your music. Once you make your choice, it remains on until you switch it off.
Repeat track	Choose to shuffle or repeat your music. Once you make your choice, it remains on until you switch it off.
Similar music	You can play similar types of music to the current playlist from the USB port. The system uses the metadata information of each track to compile a playlist. The system then creates a new list of similar tracks and then begins playing. Each track must have the metadata tags populated for this feature. With certain playing devices, if your metadata tags are not populated, the tracks will not be available in voice recognition, the play menu or this option. However, if you place these tracks onto your playing device in mass storage device mode they are available in voice recognition, the play menu or this option. The system places unknowns into any unpopulated metadata tag.
Reset USB	Resets the USB index. After the new indexing is complete you can choose what to play from the USB song library.

Accessing Your USB Song Library

1. Plug the device into your vehicle's USB port.

2. Press the **MEDIA** button (next to the audio display) to select USB playback.

Message	Description and Action
Browse USB	This menu allows you to select and play your media files by artist, album, genre, playlist or track.

SYNC™ (If Equipped)

If there are no media files to access, the **NO MEDIA** display indicates there is no media.

If there are media files, you have the following options:

Display	Description and Action
Play all	Play all indexed media files from your device one at a time in numerical order.* Press the OK button to select. The first track title appears in the display.
Playlists	Access your playlists (from formats like ASX, M3U, WPL, or MTP).* 1. Press the OK button to select. 2. Scroll to select the desired playlist, and then press the OK button.
Songs	Search for and play a specific indexed track.* 1. Press the OK button to select. 2. Scroll to select the desired track, and then press the OK button.
Artists	Sort all indexed media files by artist. The system then lists and plays all artists and tracks alphabetically.* 1. Press the OK button to select. 2. Scroll to select the desired artist, and then press the OK button.
Albums	Sort all indexed media files by album.* 1. Press the OK button to select. 2. Scroll to select the desired album, and then press the OK button.
Genres	Sort all indexed media files by genre (category) type.* 1. Press the OK button to select. 2. Scroll to select the desired genre, and then press the OK button.
Browse USB	Browse all supported media files on your media player connected to the USB port. You can only view media files that are compatible with SYNC. (Other files are not visible.) 1. Press the OK button to select.

SYNC™ (If Equipped)

Display	Description and Action
	2. Scroll to browse indexed media files on the device, and then press the OK button.
Reset USB	Resets the USB index. After the new indexing is complete, you can choose what to play from the USB song library.

*You can use the buttons at the bottom of the audio display to jump to a certain alphabetical category quickly. You can also use the letters on the audio system's numeric keypad to jump in the list.

Using Voice Commands

You can access and view your USB songs using voice commands.

Plug the device into your vehicle's USB port.

Press the voice button and when prompted, say any of the following commands:

Accessing and Viewing USB Media
(browse search show) all (album albums)
(browse search show) all (artist artists)
(browse search show) all (genre genres)
(browse search show) all (playlist playlists)
(browse search show) all (song songs title titles file files track tracks)
(browse search show) album ____
(browse search show) artist ____
(browse search show) genre ____
(browse search show) playlist ____

USB 2 (If Equipped)

Your vehicle may come equipped with an additional USB port. If so, USB 1 is located at the front of the vehicle at the bottom of the instrument panel. USB 2 is located inside the storage compartment of the vehicle's center console.

You can plug in an additional USB device into the second USB port.

You can access both USB devices by using voice commands.

To access a USB device press the voice button and when prompted say:

Voice command
USB 1
USB 2

Note: SYNC only supports one connected iOS (Apple) devices at a time (whichever one you plug in first). When you connect a second iOS device, the systems charges it, but does not support playback from it.

Bluetooth Devices and System Settings

You can access these menus using the audio display. See **Using SYNC™ With Your Phone** (page 306).

Voice Commands for Audio Sources

Your voice system allows you to change audio sources with a simple voice command.



Press the voice button and when prompted say:

Voice Command
(music audio entertainment) [system]
Below are a few examples of voice commands you can use.
[tune [to]] AM
[tune [to]] AM1
[tune [to]] AM (autostore AST autose)
[tune [to]] AM 2
Bluetooth (audio stereo)
(disc CD [player]) play
[tune [to]] FM
[tune [to]] FM1
[tune [to]] FM (autostore AST autose)
[tune [to]] FM 2
Radio
tune [to] SAT *
Sirius *
(USB [stick] iPod MP3 [player])

Voice Command

((who's | who is) this | who plays this | (what's | what is) playing [now] | (what | which) (song | track | artist) is this | (who's | who is) playing | (what's | what is) this)

help

* If equipped.

Radio Voice Commands



If you are listening to the radio, press the voice button, and then say any of the commands in the following table.

If you are not listening to the radio, press the voice button and, after the tone, say:

Voice Command
Radio
You can then say any of the following commands.
[tune [to]] AM
[tune [to]] AM1
[tune [to]] AM (autostore AST autose)
[tune [to]] AM 2
[tune [to]] (AM ___ ___ [AM])
[tune [to]] AM preset ___
[tune [to]] AM1 preset ___
[tune [to]] FM
[tune [to]] FM1
[tune [to]] FM (autostore AST autose) preset ___

SYNC™ (If Equipped)

Voice Command
[tune [to]] FM 2
[tune [to]] (FM ___ ___ [FM])
[tune [to]] FM preset ___
FM ___ HD ___ *
[tune [to]] FM 2 preset ___
HD ___ *
[tune [to]] preset ___
Tune
help

* If equipped.

Sirius Satellite Radio Voice Commands (If equipped)



To listen to Sirius satellite radio, press the voice button and, after the tone, say:

Voice Commands
Sirius

When you are listening to Sirius satellite radio, you can press the voice button, and say any of the commands in the following table.

Voice Commands
tune [to] SAT
[tune [to]] SAT 1
[tune [to]] SAT 2
[tune [to]] SAT 3
[tune [to]] preset ___
[tune [to]] SAT 1 preset ___

Voice Commands	
[tune [to]] SAT 2 preset ___	
[tune [to]] SAT 3 preset ___	
tune [to] [Sirius]	
Help	
[tune [to]] Sirius [channel] ___	You can say the channel number (0-233) to listen to that Sirius station.

CD Voice Commands



If you are listening to a CD, press the voice button, and then say any of the commands in the following table.

If you are not listening to a CD, press the voice button and, after the tone, say:

Voice Command
(disc CD [player]) play
You can then say any of the following commands.
pause
play
[play] next track
[play] previous track
[play change to] track [number] ___
repeat (track song) [on]
repeat folder [on]
repeat off
(shuffle random mix) [on (tracks songs) [on]]

SYNC™ (If Equipped)

Voice Command
(shuffle random mix) (CD [player] disc) [on]
(shuffle random mix) folder [on]
shuffle off

Use the website at any time to check your phone's compatibility, register your account and set preferences as well as access a customer representative via an online chat (during certain hours). Visit www.SYNCMyRide.com, www.SYNCMyRide.ca or www.syncmaroute.ca for more information.

SYNC™ TROUBLESHOOTING

Your SYNC system is easy to use. However, should questions arise, see the tables below.

Phone issues		
Issue	Possible cause(s)	Possible solution(s)
There is excessive background noise during a phone call.	The audio control settings on your phone may be affecting SYNC performance.	Review your phone's manual about audio adjustments.
During a call, I can hear the other person but they cannot hear me.	This may be a possible phone malfunction.	Try turning off the device, resetting the device, removing the device's battery, then trying again.
SYNC is not able to download my phonebook.	This is a phone-dependent feature. This may be a possible phone malfunction.	Go to the website to review your phone's compatibility. Try turning off the device, resetting the device or removing the device's battery, then trying again. Try pushing your phonebook contacts to SYNC by using the Add Contacts feature. Use the SYNCmyphone feature available on the website.
The system says Phonebook Downloaded but the phonebook in SYNC is empty or missing contacts.	This may be a limitation on your phone's capability.	Try pushing your phonebook contacts to SYNC by using the Add Contacts feature.

SYNC™ (If Equipped)

Phone issues		
Issue	Possible cause(s)	Possible solution(s)
		Turn off the Auto phone-book download setting.
Text messaging is not working on SYNC.	<p>This is a phone-dependent feature.</p> <p>This may be a possible phone malfunction.</p>	<p>Go to the website to review your phone's compatibility.</p> <p>Try turning off the device, resetting the device or removing the device's battery, then trying again.</p>

USB and media issues		
Issue	Possible cause(s)	Possible solution(s)
I am having trouble connecting my device.	This may be a possible device malfunction.	<p>Try turning off the device, resetting the device, removing the device's battery, then trying again.</p> <p>Make sure you are using the manufacturer's cable.</p> <p>Make sure you insert the USB cable correctly into the device and the USB port.</p> <p>Make sure that the device does not have an auto-install program or active security settings.</p>
SYNC does not recognize my device when I turn on the car.	This is a device limitation.	Make sure you are not leaving the device in your vehicle during very hot or cold temperatures.
Bluetooth audio does not stream.	This is a phone-dependent feature.	Review the device compatibility chart on the SYNC website to confirm your phone supports the Bluetooth audio streaming function.

SYNC™ (If Equipped)

USB and media issues		
Issue	Possible cause(s)	Possible solution(s)
	The device is not connected.	Make sure you correctly connect the device to SYNC, and that you have pressed play on your device.
SYNC does not recognize music that is on my device.	<p>Your music files may not contain the correct artist, song title, album or genre information.</p> <p>The file may be corrupted.</p> <p>The song may have copyright protection, which does not allow it to play.</p>	<p>Make sure that all song details are populated.</p> <p>Some devices require you to change the USB settings from mass storage to MTP class.</p>

Voice command issues		
Issue	Possible cause(s)	Possible solution(s)
SYNC does not understand what I am saying.	<p>You may be using the wrong voice commands.</p> <p>You may be speaking too soon or at the wrong time.</p>	<p>Review the phone voice commands and the media voice commands at the beginning of their respective sections.</p> <p>After pressing the voice icon, wait until after the tone sounds and Listening appears before saying a command. Any command spoken before this does not register with the system.</p>
SYNC does not understand the name of a song or artist.	You may be using the wrong voice commands.	Review the media voice commands at the beginning of the media section.

SYNC™ (If Equipped)

Voice command issues		
Issue	Possible cause(s)	Possible solution(s)
	<p>You may be saying the name differently than the way you saved it.</p> <p>The system may not be reading the name the same way you are saying it.</p>	<p>Say the song or artist exactly as listed. If you say "Play Artist Prince", the system does not play music by Prince and the Revolution or Prince and the New Power Generation.</p> <p>Make sure you are saying the complete title, such as "California remix featuring Jennifer Nettles".</p> <p>If the song titles are in all CAPS, you have to spell them. LOLA requires you to say "L-O-L-A".</p> <p>Do not use special characters in the title. The system does not recognize them.</p>
<p>SYNC does not understand or is calling the wrong contact when I want to make a call.</p>	<p>You may be using the wrong voice commands.</p> <p>You may be saying the name differently than the way you saved it.</p>	<p>Review the Phone voice commands at the beginning of the phone section.</p> <p>Make sure you are saying the contacts exactly as they are listed. For example, if you save a contact as Joe Wilson, say "Call Joe Wilson".</p> <p>Using the SYNC phone menu, open the phonebook and scroll to the name SYNC is having trouble understanding. SYNC will read the name to you, giving you some idea of the pronunciation SYNC is expecting.</p>

SYNC™ (If Equipped)

Voice command issues		
Issue	Possible cause(s)	Possible solution(s)
	<p>The system may not be reading the name the same way you are saying it.</p> <p>Contacts in your phonebook may be very short and similar, or they may contain special characters.</p> <p>Your phonebook contacts may be in CAPS.</p>	<p>The system works better if you list full names, such as "Joe Wilson" rather than "Joe".</p> <p>Do not use special characters, such as 123 or ICE, as the system does not recognize them.</p> <p>If a contact is in CAPS, you have to spell it. JAKE requires you to say "Call J-A-K-E".</p>

AppLink issues		
Issue	Possible cause(s)	Possible solution(s)
<p>AppLink Mobile Applications: When I select "Find New Apps," SYNC does not find any applications.</p>	<p>An AppLink capable phone is not connected to SYNC.</p>	<p>Ensure you have a compatible smartphone; an Android with OS 2.3 or higher or an iPhone 3GS or newer with iOS 5.0 or higher. Additionally, ensure your phone is paired and connected to SYNC in order to find AppLink-capable apps on your device. iPhone users must also connect to SYNC's USB port with an Apple USB cable.</p>
<p>My phone is connected, but I still cannot find any apps.</p>	<p>AppLink-enabled apps are not installed and running on your mobile device.</p>	<p>Ensure you have downloaded and installed the latest version of the app from your phone's app store. Ensure the app is running on your phone. Some apps require you to register or</p>

SYNC™ (If Equipped)

AppLink issues		
Issue	Possible cause(s)	Possible solution(s)
		login on the app on the phone before using them with AppLink. Also, some may have a "Ford SYNC" setting, so check the app's settings menu on the phone.
My phone is connected, my app(s) are running, but I still cannot find any apps.	Sometime apps do not properly close and re-open their connection to SYNC, over ignition cycles, for example.	<p>Closing and restarting apps may help SYNC find the application if you cannot discover it inside the vehicle.</p> <p>On an Android device, if apps have an "Exit" or 'Quit' option, select that then restart the app. If the app does not have that option, you can also manually "Force Close" the app by going to the phone's settings menu, selecting 'Apps.' then finding the particular app and choosing 'Force stop.' Don't forget to restart the app afterwards, then select "Find New Apps" on SYNC.</p> <p>On an iPhone with iOS7+, to force close an app, double tap the home button then swipe up on the app to close it. Tab the home button again, then select the app again to restart it. After a few seconds, the app should then appear in SYNC's Mobile App's Menu.</p>
My Android phone is connected, my app(s) are running, I restarted them, but I still cannot find any apps.	There is a Bluetooth bug on some order versions of the Android operating system that may cause apps that were found on your previous vehicle drive to not be found again if you have not turned off Bluetooth.	Reset the Bluetooth on your phone by turning it off and then turning Bluetooth back on. If you are in your vehicle, SYNC should be able to automatically re-connect to your phone if you press the "Phone" button.

SYNC™ (If Equipped)

AppLink issues		
Issue	Possible cause(s)	Possible solution(s)
My iPhone phone is connected, my app is running, I restarted the app but I still cannot find it on SYNC.	The USB connection to SYNC may need to be reset.	Unplug the USB cable from the phone, wait a moment, and plug the USB cable back in to the phone. After a few seconds, the app should appear in SYNC's Mobile Apps Menu. If not, "Force Close" the application and restart it.
I have an Android phone. I found and started my media app on SYNC, but there is no sound or the sound is very low.	The bluetooth volume on the phone may be low.	Try increasing the Bluetooth volume of the device by using the device's volume control buttons which are most often found on the side of the device.
I can only see some of the AppLink apps running on my phone listed in SYNC's Mobile Apps Menu.	Some Android devices have a limited number of bluetooth ports apps can use to connect. If you have more AppLink apps on your phone than the number of available Bluetooth ports, you will not see all of your apps listed in SYNC's mobile apps menu.	Force close or uninstall the apps you do not want SYNC to find. If the app has a "Ford SYNC" setting, disable that setting in the app's settings menu on the phone.

SYNC System Reset

The SYNC system in your vehicle has System Reset feature that can be performed if the function of a SYNC feature is lost. This reset is intended to restore functionality and will not erase any information previously stored in the system (Such as paired devices, phonebook, call history, text messages, or user settings). To perform a System Reset, press and hold the Seek Up (>>) button while pressing and holding the Radio Power button. Release both buttons after 2-3 seconds. Please allow a few minutes for the reset to complete. After a few minutes has passed you can resume using the SYNC system.

Accessories

For a complete listing of the accessories that are available for your vehicle, please contact your authorized dealer or visit the online store web site:

Web Address (United States)

www.Accessories.Ford.com
--

Web Address (Canada)

www.Accessories.Ford.ca
--

Ford Motor Company will repair or replace any properly authorized dealer-installed Ford Original Accessory found to be defective in factory-supplied materials or workmanship during the warranty period, as well as any component damaged by the defective accessories.

Ford Motor Company warrants your Ford Original Accessory through the warranty that provides the greatest benefit:

- 24 months, unlimited mileage.
- The remainder of your new vehicle limited warranty.

Contact an authorized dealer for details and a copy of the warranty.

Exterior style

- Custom graphics*.
- Hood deflector.
- Rear spoilers.
- Wheel center caps.
- Wheels.

Interior style

- Ambient lighting.
- Floor mats.
- Illuminated sill plates.
- Rear seat entertainment system*.

- Shift knobs.
- Sport pedals.

Lifestyle

- Ash cup (smoker's packages).
- Cargo area protector.
- Cargo net.
- Soft cargo organizers.

Peace of mind

- Bumper-mounted parking assist system*.
- Full vehicle covers.
- Remote start.
- Temporary spare tire kit.
- Vehicle security systems.
- Wheel locks.

*Ford Licensed Accessory. The accessory manufacturer designs, develops and therefore warrants Ford Licensed Accessories, and does not design or test these accessories to Ford Motor Company engineering requirements. Contact an authorized Ford dealer for the manufacturer's limited warranty details and request a copy of the Ford Licensed Accessories product limited warranty from the accessory manufacturer.

Accessories

For maximum vehicle performance, keep the following information in mind when adding accessories, equipment, passengers and luggage to your vehicle:

- Do not exceed the total weight capacity of the vehicle or of the front or rear axle (GVWR or GAWR as indicated on the Safety Compliance Certification label). Consult an authorized dealer for specific weight information.
- The Federal Communications Commission (FCC) and Canadian Radio Telecommunications Commission (CRTC) regulate the use of radio transmitter-equipped mobile communications systems, for example, two-way radios, telephones and theft alarms. Any such equipment should comply with the Federal Communications Commission (FCC) and Canadian Radio Telecommunications Commission (CRTC) regulations, and an authorized dealer should install this equipment.
- An authorized dealer should install mobile communications systems. Improper installation may harm the operation of your vehicle, particularly if their manufacturer did not design the mobile communication system specifically for automotive use.
- If you or an authorized dealer add any non-Ford electrical or electronic accessories or components to your vehicle, you may adversely affect battery performance and durability. In addition, you may also adversely affect the performance of other electrical systems in the vehicle.

Extended Service Plan (ESP)

PROTECT YOURSELF FROM THE RISING COST OF VEHICLE REPAIRS WITH A FORD EXTENDED SERVICE PLAN.

EXTENDED SERVICE PLAN (U.S. Only)

More than 32 million Ford owners have discovered the powerful protection of Ford Extended Service Plan. It is the extended service plan backed by Ford Motor Company, and provides peace of mind protection beyond the New Vehicle Limited Warranty coverage.

Ford ESP Can Quickly Pay for Itself

One service bill – the cost of parts and labor – can easily exceed the price of your Ford Extended Service Plan. With Ford ESP you minimize your risk for unexpected repair bills and rising repair costs.

Up to 1,000+ Covered Vehicle Components

There are four core Extended Service Plans with different levels of coverage. Ask your authorized dealer for details.

1. PremiumCARE - Our most comprehensive coverage. With over 1,000 covered components, this plan is so complete that we generally only discuss what's not covered.
2. ExtraCARE - Covers 113 components, and includes many high-tech items.
3. BaseCARE - Covers 84 components.
4. PowertrainCARE - Covers 29 critical components.

Ford Extended Service Plan is honored by all authorized Ford dealers in the U.S., Canada and Mexico. It is the extended service plan authorized and backed by Ford Motor Company.

That means you get:

- Reliable, quality service at any Ford or Lincoln dealership
- Repairs performed by factory trained technicians, using genuine parts

Rental Car Reimbursement

1st day Rental Benefit

You take advantage of replacement transportation if your vehicle is at your authorized dealer for same day covered repairs.

Extended Rental Benefits

If your vehicle is kept overnight for covered repairs, you are eligible for rental car coverage, including bumper to bumper warranty repairs, and Field Service Actions.

Roadside Assistance

Exclusive 24/7 roadside assistance, including:

- Towing, flat-tire change and battery jump starts
- Out of fuel and lock-out assistance.
- Travel expense reimbursement for lodging, meals and rental car.
- Destination assistance for taxi, shuttle, rental car coverage and emergency transportation.

Transferable Coverage

If you sell your vehicle before your Ford Extended Service Plan coverage expires, you can transfer any remaining coverage to the new owner. Whenever you sell your vehicle, prospective buyers may have a higher degree of confidence that vehicle was properly maintained with Ford ESP, thereby improving resale value.

Extended Service Plan (ESP)

Avoid the Rising Cost of Properly Maintaining Your Vehicle!

Ford Extended Service Plan also offers a Premium Maintenance Plan that covers all scheduled maintenance, and selected wear items. The coverage is prepaid, so you never have to worry about affording your vehicle's maintenance. It covers regular checkups, routine inspections, preventive care and replacement of select items that require periodic attention for normal wear:

- Windshield wiper blades.
- Spark plugs.
- The clutch disc.
- Brake pads and linings.
- Shock absorbers.
- Struts.
- Engine Belts.
- Engine coolant hoses, clamps and o-rings.
- Diesel exhaust fluid replenishment.

Interest Free Finance Options Available

Take advantage of our interest free installment payment plan. Just a 10% down payment will provide you with an affordable, no interest, no fee payment program allowing you all the security and benefits Ford ESP has to offer while paying over time. You are pre-approved with no credit checks, no hassles! To learn more, call our Ford ESP specialists at 800-367-3377.

Ford ESP
P.O. Box 321067
Detroit, MI 48232

EXTENDED SERVICE PLAN (CANADA ONLY)

You can get more protection for your vehicle by purchasing a Ford Extended Service Plan. Ford Extended Service Plan is the only service contract backed by Ford Motor Company of Canada, Limited. Depending on the plan you purchase, Ford Extended Service Plan provides benefits such as:

- Rental reimbursement.
- Coverage for certain maintenance and wear items.
- Protection against repair costs after your New Vehicle Limited Warranty Coverage expires.
- Roadside Assistance benefits.

There are several Ford Extended Service Plans available in various time, distance and deductible combinations. Each plan is tailored to fit your own driving needs, including reimbursement for towing and rental. When you purchase Ford Extended Service Plan, you receive added peace-of-mind protection throughout Canada, the United States and Mexico, provided by a network of participating authorized Ford Motor Company dealers.

Note: *Repairs performed outside of Canada, the United States and Mexico are not eligible for Ford Extended Service Plan coverage.*

This information is subject to change. For more information, visit your local Ford of Canada dealer or www.ford.ca to find the Ford Extended Service Plan that is right for you.

Scheduled Maintenance

GENERAL MAINTENANCE INFORMATION

Why Maintain Your Vehicle?

Carefully following the maintenance schedule helps protect against major repair expenses resulting from neglect or inadequate maintenance and may help to increase the value of your vehicle when you sell or trade it. Keep all receipts for completed maintenance with your vehicle.

We have established regular maintenance intervals for your vehicle based upon rigorous testing. It is important that you have your vehicle serviced at the proper times. These intervals serve two purposes; one is to maintain the reliability of your vehicle and the second is to keep your cost of owning your vehicle down.

It is your responsibility to have all scheduled maintenance performed and to make sure that the materials used meet the specifications identified in this owner's manual. See **Capacities and Specifications** (page 271).

Failure to perform scheduled maintenance invalidates warranty coverage on parts affected by the lack of maintenance.

Why Maintain Your Vehicle at Your Dealership?

Factory-Trained Technicians

Service technicians participate in extensive factory-sponsored certification training to help them become experts on the operation of your vehicle. Ask your dealership about the training and certification their technicians have received.

Genuine Ford and Motorcraft® Replacement Parts

Dealerships stock Ford, Motorcraft and Ford-authorized branded re-manufactured replacement parts. These parts meet or exceed our specifications. Parts installed at your dealership carry a nationwide 24-month or unlimited mile (kilometer) parts and labor limited warranty.

If you do not use Ford authorized parts they may not meet our specifications and depending on the part, it could affect emissions compliance.

Convenience

Many dealerships have extended evening and Saturday hours to make your service visit more convenient and they offer one stop shopping. They can perform any services that are required on your vehicle, from general maintenance to collision repairs.

Note: *Not all dealers have extended hours or body shops. Please contact your dealer for details.*

Protecting Your Investment

Maintenance is an investment that pays dividends in the form of improved reliability, durability and resale value. To maintain the proper performance of your vehicle and its emission control systems, make sure you have scheduled maintenance performed at the designated intervals.

Your vehicle is equipped with the Intelligent Oil-Life Monitor system, which displays a message in the information display at the proper oil change interval. This interval may be up to one year or 10000 miles (16000 kilometers).

Scheduled Maintenance

When the oil change message appears in the information display, it is time for an oil change. Make sure you perform the oil change within two weeks or 500 miles (800 kilometers) of the message appearing. Make sure you reset the Intelligent Oil-Life Monitor after each oil change. See (page 80).

If your information display resets prematurely or becomes inoperative, you should perform the oil change interval at six months or 5000 miles (8000 kilometers) from your last oil change. Never exceed one year or 10000 miles (16000 kilometers) between oil change intervals.

Your vehicle is very sophisticated and built with multiple, complex, performance systems. Every manufacturer develops these systems using different specifications and performance features. That is why it is important to rely upon your dealership to properly diagnose and repair your vehicle.

Ford Motor Company has recommended maintenance intervals for various parts and component systems based upon engineering testing. Ford Motor Company relies upon this testing to determine the most appropriate mileage for replacement of oils and fluids to protect your vehicle at the lowest overall cost to you and recommends against maintenance schedules that deviate from the scheduled maintenance information.

We strongly recommend the use of only genuine Ford, Motorcraft or Ford-authorized re-manufactured replacement parts engineered for your vehicle.

Additives and Chemicals

This owner's manual and the Ford Workshop Manual list the recommended additives and chemicals for your vehicle. We do not recommend using chemicals or additives not approved by us as part of your vehicle's normal maintenance. Please consult your warranty information.

Oils, Fluids and Flushing

In many cases, fluid discoloration is a normal operating characteristic and, by itself, does not necessarily indicate a concern or that the fluid needs to be changed. However, a qualified expert, such as the factory-trained technicians at your dealership, should inspect discolored fluids that also show signs of overheating or foreign material contamination immediately.

Make sure to change your vehicle's oils and fluids at the specified intervals or in conjunction with a repair. Flushing is a viable way to change fluid for many vehicle sub-systems during scheduled maintenance. It is critical that systems are flushed only with new fluid that is the same as that required to fill and operate the system or using a Ford-approved flushing chemical.

Owner Checks and Services

Make sure you perform the following basic maintenance checks and inspections every month or at six-month intervals.

Scheduled Maintenance

Check every month
Engine oil level.
Function of all interior and exterior lights.
Tires (including spare) for wear and proper pressure.
Windshield washer fluid level.

Check every six months
Battery connections. Clean if necessary.
Body and door drain holes for obstructions. Clean if necessary.
Cooling system fluid level and coolant strength.
Door weatherstrips for wear. Lubricate if necessary.
Hinges, latches and outside locks for proper operation. Lubricate if necessary.
Parking brake for proper operation.
Safety belts and seat latches for wear and function.
Safety warning lamps (brake, ABS, airbag and safety belt) for operation.
Washer spray and wiper operation. Clean or replace blades as necessary.

Multi-Point Inspection

In order to keep your vehicle running right, it is important to have the systems on your vehicle checked regularly. This can help identify potential issues and prevent major problems. We recommend having the following multi-point inspection performed at every scheduled maintenance interval to help make sure your vehicle keeps running great.

Scheduled Maintenance

Multi-Point inspection	
Accessory drive belt(s)	Hazard warning system operation
Battery performance	Horn operation
Engine air filter	Radiator, cooler, heater and air conditioning hoses
Exhaust system	Suspension components for leaks or damage
Exterior lamps operation	Steering and linkage
Fluid levels*; fill if necessary	Tires (including spare) for wear and proper pressure**
For oil and fluid leaks	Windshield for cracks, chips or pits
Half-shaft dust boots	Washer spray and wiper operation

* Brake, coolant recovery reservoir, automatic transmission and window washer

**If your vehicle is equipped with a temporary mobility kit, check the tire sealant expiration Use By date on the canister. Replace as needed.

Be sure to ask your dealership service advisor or technician about the multi-point vehicle inspection. It is a comprehensive way to perform a thorough inspection of your vehicle. Your checklist gives you immediate feedback on the overall condition of your vehicle.

NORMAL SCHEDULED MAINTENANCE

Intelligent Oil-Life Monitor™

Your vehicle is equipped with an Intelligent Oil-Life Monitor that determines when you should change the engine oil based on how your vehicle is used. By using several important factors in its calculations, the monitor helps reduce the cost of owning your vehicle and reduces environmental waste at the same time.

This means you do not have to remember to change the oil on a mileage-based schedule. Your vehicle lets you know when an oil change is due by displaying a message in the information display.

The following table provides examples of vehicle use and its impact on oil change intervals. It is a guideline only. Actual oil change intervals depend on several factors and generally decrease with severity of use.

Scheduled Maintenance

When to expect the message prompting you to change your oil	
Interval	Vehicle use and example
7,000–10,000 mi (12,000–16,000 km)	Normal
	Normal commuting with highway driving No, or moderate, load or towing Flat to moderately hilly roads No extended idling
5,000–7,000 mi (8,000–11,999 km)	Severe
	Moderate to heavy load or towing Mountainous or off-road conditions Extended idling Extended hot or cold operation
3,000–5,000 mi (4,800–7,999 km)	Extreme
	Maximum load or towing Extreme hot or cold operation

Normal Maintenance Intervals

At every oil change interval as indicated by the information display*
Change engine oil and filter.**
Rotate tires, inspect tire wear and measure tread depth.
Perform a multi-point inspection (recommended).
Inspect the automatic transmission fluid level (if equipped with dipstick). Consult your dealer for requirements.
Inspect the brake pads, rotors, hoses and parking brake.
Inspect the engine cooling system strength and hoses.
Inspect the exhaust system and heat shields.
Inspect rear axle and U-joints. Lubricate if equipped with grease fittings.

Scheduled Maintenance

At every oil change interval as indicated by the information display*
Inspect the half-shaft boots.
Inspect the steering linkage, ball joints, suspension, tie-rod ends, driveshaft and U-joints. Lubricate any areas with grease fittings.
Inspect the wheels and related components for abnormal noise, wear, looseness or drag.

* Do not exceed one year or 10,000 mi (16,000 km) between service intervals.

** Reset the Intelligent Oil-Life Monitor after engine oil and filter changes.

Other maintenance items¹	
Every 20,000 mi (32,000 km)	Replace cabin air filter.
Every 30,000 mi (48,000 km)	Replace engine air filter.
At 100,000 mi (160,000 km)	Change engine coolant. ²
Every 100,000 mi (160,000 km)	Replace spark plugs.
	Inspect accessory drive belt(s). ³
Every 150,000 mi (240,000 km)	Change automatic transmission fluid and filter.
	Change manual transmission fluid.
	Replace accessory drive belt(s).

¹ Perform these maintenance items within 3,000 mi (4,800 km) of the last engine oil and filter change. Do not exceed the designated distance for the interval.

² Initial replacement at six years or 100,000 mi (160,000 km), then every three years or 50,000 mi (80,000 km).

³ After initial inspection, inspect every other oil change until replaced.

Scheduled Maintenance

SPECIAL OPERATING CONDITIONS SCHEDULED MAINTENANCE

If you operate your vehicle **primarily** in any of the following conditions, you need to perform extra maintenance, as indicated. If you operate your vehicle **occasionally** under any of these conditions, it is not necessary to perform the extra maintenance. For specific recommendations, see your dealership service advisor or technician.

Perform the services shown in the following tables when specified or within 3,000 mi (4,800 km) of a message appearing in the information display prompting you to change your oil.

- **Example 1:** The message comes on at 28,751 mi (46,270 km). Perform the 30,000 mi (48,000 km) automatic transmission fluid replacement.
- **Example 2:** The message has **not** come on, but the odometer reads 30,000 mi (48,000 km) (for example, the Intelligent Oil-Life Monitor was reset at 25,000 mi (40,000 km)). Perform the engine air filter replacement.

Towing a trailer or using a car-top carrier	
As required	Change engine oil and filter as indicated by the information display and perform services listed in the Normal Scheduled Maintenance chart.
Inspect frequently, service as required	Inspect rear axle and U-joints. Lubricate if equipped with grease fittings.
	See axle maintenance items under Exceptions .
Every 60,000 mi (96,000 km)	Change manual transmission fluid.
	Replace spark plugs.

Extensive idling or low-speed driving for long distances, as in heavy commercial use (such as delivery, taxi, patrol car or livery)	
As required	Change engine oil and filter as indicated by the information display and perform services listed in the Normal Scheduled Maintenance chart.
Inspect frequently, service as required	Replace cabin air filter.
Every 15,000 mi (24,000 km)	Inspect engine air filter. Replace as required.
Every 60,000 mi (96,000 km)	Replace spark plugs.

Scheduled Maintenance

Operating in dusty or sandy conditions (such as unpaved or dusty roads)	
Inspect frequently, service as required	Replace cabin air filter.
Every 15,000 mi (24,000 km)	Inspect engine air filter. Replace as required.
Every 5,000 mi (8,000 km)	Inspect the wheels and related components for abnormal noise, wear, looseness or drag.
	Rotate tires, inspect tires for wear and measure tread depth.
Every 5,000 mi (8,000 km) or six months	Change engine oil and filter.*
Every 50,000 mi (80,000 km)	Change manual transmission fluid.

*Reset your Intelligent Oil-Life Monitor after each engine oil and filter change.

Exclusive use of E85 (Flex fuel vehicles only)	
Every oil change interval	If ran exclusively on E85, fill the fuel tank full with regular unleaded fuel.

Exceptions

There are several exceptions to the Normal Schedule:

Axle Maintenance

Change the axle fluid anytime an axle is submerged in water.

California Fuel Filter Replacement

If you register your vehicle in California, the California Air Resources Board has determined that the failure to perform this maintenance item does not nullify the emission warranty or limit recall liability before the completion of your vehicle's useful life. Ford Motor Company, however, urges you to have all recommended maintenance services performed at the specified intervals and to record all vehicle service.

Scheduled Maintenance

Hot Climate Oil Change Intervals

Vehicles operating in the Middle East, North Africa, Sub-Saharan Africa or locations with similar climates using an American Petroleum Institute (API) Certified for Gasoline Engines (Certification mark) oil of SM or SN quality, the normal oil change interval is 3,000 mi (4,800 km).

If the available API SM or SN oils are not available, then the oil change interval is 1,800 mi (2,900 km).

Engine Air Filter and Cabin Air Filter Replacement

The life of the engine air filter and cabin air filter is dependent on exposure to dusty and dirty conditions. Vehicles operated in these conditions require frequent inspection and replacement of the engine air filter and cabin air filter.

SCHEDULED MAINTENANCE RECORD

<input type="radio"/> Repair Order #:	Dealer stamp
<input type="radio"/> Distance:	
<input type="radio"/> Engine hours (optional):	
<input type="radio"/> Multi-point inspection (recommended): <input type="checkbox"/>	
<input type="radio"/> Signature:	

<input type="radio"/> Repair Order #:	Dealer stamp
<input type="radio"/> Distance:	
<input type="radio"/> Engine hours (optional):	
<input type="radio"/> Multi-point inspection (recommended): <input type="checkbox"/>	
<input type="radio"/> Signature:	

Scheduled Maintenance

<input type="radio"/> Repair Order #:	Dealer stamp
<input type="radio"/> Distance:	
<input type="radio"/> Engine hours (optional):	
<input type="radio"/> Multi-point inspection (recommended): <input type="checkbox"/>	
<input type="radio"/> Signature:	

<input type="radio"/> Repair Order #:	Dealer stamp
<input type="radio"/> Distance:	
<input type="radio"/> Engine hours (optional):	
<input type="radio"/> Multi-point inspection (recommended): <input type="checkbox"/>	
<input type="radio"/> Signature:	

Scheduled Maintenance

<input type="radio"/> Repair Order #:	Dealer stamp
<input type="radio"/> Distance:	
<input type="radio"/> Engine hours (optional):	
<input type="radio"/> Multi-point inspection (recommended): <input type="checkbox"/>	
<input type="radio"/> Signature:	

<input type="radio"/> Repair Order #:	Dealer stamp
<input type="radio"/> Distance:	
<input type="radio"/> Engine hours (optional):	
<input type="radio"/> Multi-point inspection (recommended): <input type="checkbox"/>	
<input type="radio"/> Signature:	

Scheduled Maintenance

<input type="radio"/> Repair Order #:	<p>Dealer stamp</p>
<input type="radio"/> Distance:	
<input type="radio"/> Engine hours (optional):	
<input type="radio"/> Multi-point inspection (recommended): <input type="checkbox"/>	
<input type="radio"/> Signature:	

<input type="radio"/> Repair Order #:	<p>Dealer stamp</p>
<input type="radio"/> Distance:	
<input type="radio"/> Engine hours (optional):	
<input type="radio"/> Multi-point inspection (recommended): <input type="checkbox"/>	
<input type="radio"/> Signature:	

Scheduled Maintenance

<input type="radio"/> Repair Order #:	Dealer stamp
<input type="radio"/> Distance:	
<input type="radio"/> Engine hours (optional):	
<input type="radio"/> Multi-point inspection (recommended): <input type="checkbox"/>	
<input type="radio"/> Signature:	

<input type="radio"/> Repair Order #:	Dealer stamp
<input type="radio"/> Distance:	
<input type="radio"/> Engine hours (optional):	
<input type="radio"/> Multi-point inspection (recommended): <input type="checkbox"/>	
<input type="radio"/> Signature:	

Scheduled Maintenance

<input type="radio"/> Repair Order #:	Dealer stamp
<input type="radio"/> Distance:	
<input type="radio"/> Engine hours (optional):	
<input type="radio"/> Multi-point inspection (recommended): <input type="checkbox"/>	
<input type="radio"/> Signature:	

<input type="radio"/> Repair Order #:	Dealer stamp
<input type="radio"/> Distance:	
<input type="radio"/> Engine hours (optional):	
<input type="radio"/> Multi-point inspection (recommended): <input type="checkbox"/>	
<input type="radio"/> Signature:	

Scheduled Maintenance

<input type="radio"/> Repair Order #:	Dealer stamp
<input type="radio"/> Distance:	
<input type="radio"/> Engine hours (optional):	
<input type="radio"/> Multi-point inspection (recommended): <input type="checkbox"/>	
<input type="radio"/> Signature:	

<input type="radio"/> Repair Order #:	Dealer stamp
<input type="radio"/> Distance:	
<input type="radio"/> Engine hours (optional):	
<input type="radio"/> Multi-point inspection (recommended): <input type="checkbox"/>	
<input type="radio"/> Signature:	

Scheduled Maintenance

<input type="radio"/> Repair Order #:	<p>Dealer stamp</p>
<input type="radio"/> Distance:	
<input type="radio"/> Engine hours (optional):	
<input type="radio"/> Multi-point inspection (recommended): <input type="checkbox"/>	
<input type="radio"/> Signature:	

<input type="radio"/> Repair Order #:	<p>Dealer stamp</p>
<input type="radio"/> Distance:	
<input type="radio"/> Engine hours (optional):	
<input type="radio"/> Multi-point inspection (recommended): <input type="checkbox"/>	
<input type="radio"/> Signature:	

Scheduled Maintenance

<input type="radio"/> Repair Order #:	Dealer stamp
<input type="radio"/> Distance:	
<input type="radio"/> Engine hours (optional):	
<input type="radio"/> Multi-point inspection (recommended): <input type="checkbox"/>	
<input type="radio"/> Signature:	

<input type="radio"/> Repair Order #:	Dealer stamp
<input type="radio"/> Distance:	
<input type="radio"/> Engine hours (optional):	
<input type="radio"/> Multi-point inspection (recommended): <input type="checkbox"/>	
<input type="radio"/> Signature:	

Scheduled Maintenance

<input type="radio"/> Repair Order #:	Dealer stamp
<input type="radio"/> Distance:	
<input type="radio"/> Engine hours (optional):	
<input type="radio"/> Multi-point inspection (recommended): <input type="checkbox"/>	
<input type="radio"/> Signature:	

<input type="radio"/> Repair Order #:	Dealer stamp
<input type="radio"/> Distance:	
<input type="radio"/> Engine hours (optional):	
<input type="radio"/> Multi-point inspection (recommended): <input type="checkbox"/>	
<input type="radio"/> Signature:	

Appendices

END USER LICENSE AGREEMENT

SYNC End User License Agreement (EULA)

- You have acquired a device ("DEVICE") that includes software licensed by Ford Motor Company and its affiliates ("FORD MOTOR COMPANY") from an affiliate of Microsoft Corporation ("MS"). Those installed software products of MS origin, as well as associated media, printed materials, and "online" or electronic documentation ("MS SOFTWARE") are protected by international intellectual property laws and treaties. The MS SOFTWARE is licensed, not sold. All rights reserved.
- The MS SOFTWARE may interface with and/or communicate with, or may be later upgraded to interface with and/or communicate with additional software and/or systems provided by FORD MOTOR COMPANY. The additional software and systems of FORD MOTOR COMPANY origin, as well as associated media, printed materials, and "online" or electronic documentation ("FORD SOFTWARE") are protected by international intellectual property laws and treaties. The FORD SOFTWARE is licensed, not sold. All rights reserved.

- The MS SOFTWARE and/or FORD SOFTWARE may interface with and/or communicate with, or may be later upgraded to interface with and/or communicate with additional software and/or systems provided by third party software and service suppliers. The additional software and services of third party origin, as well as associated media, printed materials, and "online" or electronic documentation ("THIRD PARTY SOFTWARE") are protected by international intellectual property laws and treaties. The THIRD PARTY SOFTWARE is licensed, not sold. All rights reserved.
- The MS SOFTWARE, FORD SOFTWARE and THIRD PARTY SOFTWARE hereinafter collectively and individually will be referred to as "SOFTWARE".

IF YOU DO NOT AGREE TO THIS END USER LICENSE AGREEMENT ("EULA") DO NOT USE THE DEVICE OR COPY THE SOFTWARE. ANY USE OF THE SOFTWARE, INCLUDING BUT NOT LIMITED TO USE ON THE DEVICE, WILL CONSTITUTE YOUR AGREEMENT TO THIS EULA (OR RATIFICATION OF ANY PREVIOUS CONSENT).

GRANT OF SOFTWARE LICENSE: This EULA grants you the following license:

- You may use the SOFTWARE as installed on the DEVICE and as otherwise interfacing with systems and/or services provide by or through FORD MOTOR COMPANY or its third party software and service providers.

Appendices

Description of Other Rights and Limitations

- **Speech Recognition:** If the SOFTWARE includes speech recognition component(s), you should understand that speech recognition is an inherently statistical process and that recognition errors are inherent in the process. Neither FORD MOTOR COMPANY nor its suppliers shall be liable for any damages arising out of errors in the speech recognition process.
- **Limitations on Reverse Engineering, Decompilation and Disassembly:** You may not reverse engineer, decompile, or disassemble nor permit others to reverse engineer, decompile or disassemble the SOFTWARE, except and only to the extent that such activity is expressly permitted by applicable law notwithstanding this limitation.
- **Limitations on Distributing, Copying, Modifying and Creating Derivative Works:** You may not distribute, copy, make modifications to or create derivative works based on the SOFTWARE, except and only to the extent that such activity is expressly permitted by applicable law notwithstanding this limitation.
- **Single EULA:** The end user documentation for the DEVICE and related systems and services may contain multiple EULAs, such as multiple translations and/or multiple media versions (e.g., in the user documentation and in the software). Even if you receive multiple EULAs, you are licensed to use only one (1) copy of the SOFTWARE.
- **SOFTWARE Transfer:** You may permanently transfer your rights under this EULA only as part of a sale or transfer of the DEVICE, provided you retain no copies, you transfer all of the SOFTWARE (including all component parts, the media and printed materials, any upgrades, and, if applicable, the Certificate(s) of Authenticity), and the recipient agrees to the terms of this EULA. If the SOFTWARE is an upgrade, any transfer must include all prior versions of the SOFTWARE.
- **Termination:** Without prejudice to any other rights, FORD MOTOR COMPANY or MS may terminate this EULA if you fail to comply with the terms and conditions of this EULA.
- **Security Updates/Digital Rights Management:** Content owners use the WMDRM technology included in your DEVICE to protect their intellectual property, included copyrighted content. Portions of the SOFTWARE on your DEVICE use WMDRM software to access WMDRM-protected content. If the WMDRM software fails to protect the content, content owners may ask Microsoft to revoke the SOFTWARE's ability to use WMDRM to play or copy protected content. This action does not affect unprotected content. When your DEVICE downloads licenses for protected content, you agree that Microsoft may include a revocation list with the licenses. Content owners may require you to upgrade the SOFTWARE on your DEVICE to access their content. If you decline an upgrade, you will not be able to access content that requires the upgrade.

Appendices

- **Consent to Use of Data:** You agree that MS, Microsoft Corporation, FORD MOTOR COMPANY, third party software and systems suppliers, their affiliates and/or their designated agent may collect and use technical information gathered in any manner as part of product support services related to the SOFTWARE or related services. MS, Microsoft Corporation, FORD MOTOR COMPANY, third party software and services suppliers, their affiliates and/or their designated agent may use this information solely to improve their products or to provide customized services or technologies to you. MS, Microsoft Corporation, FORD MOTOR COMPANY, third party software and systems suppliers, their affiliates and/or their designated agent may disclose this information to others, but not in a form that personally identifies you.

- **Internet-Based Services Components:** The SOFTWARE may contain components that enable and facilitate the use of certain Internet-based services. You acknowledge and agree that MS, Microsoft Corporation, FORD MOTOR COMPANY, third party software and service suppliers, their affiliates and/or their designated agent may automatically check the version of the SOFTWARE and/or its components that you are utilizing and may provide upgrades or supplements to the SOFTWARE that may be automatically downloaded to your DEVICE.

- **Additional Software/Services:** The SOFTWARE may permit FORD MOTOR COMPANY, third party software and service suppliers, MS, Microsoft Corporation, their affiliates and/or their designated agent to provide or make available to you SOFTWARE updates,

supplements, add-on components, or Internet-based services components of the SOFTWARE after the date you obtain your initial copy of the SOFTWARE ("Supplemental Components").

If FORD MOTOR COMPANY or third party software and services suppliers provide or make available to you Supplemental Components and no other EULA terms are provided along with the Supplemental Components, then the terms of this EULA shall apply.

If MS, Microsoft Corporation, their affiliates and/or their designated agent make available Supplemental Components, and no other EULA terms are provided, then the terms of this EULA shall apply, except that the MS, Microsoft Corporation or affiliate entity providing the Supplemental Component(s) shall be the licensor of the Supplemental Component(s).

FORD MOTOR COMPANY, MS, Microsoft Corporation, their affiliates and/or their designated agent reserve the right to discontinue without liability any Internet-based services provided to you or made available to you through the use of the SOFTWARE.

Appendices

- **Links to Third Party Sites:** The MS SOFTWARE may provide you with the ability to link to third party sites through the use of the SOFTWARE. The third party sites are not under the control of MS, Microsoft Corporation, their affiliates and/or their designated agent. Neither MS nor Microsoft Corporation nor their affiliates nor their designated agent are responsible for (i) the contents of any third party sites, any links contained in third party sites, or any changes or updates to third party sites, or (ii) webcasting or any other form of transmission received from any third party sites. If the SOFTWARE provides links to third party sites, those links are provided to you only as a convenience, and the inclusion of any link does not imply an endorsement of the third party site by MS, Microsoft Corporation, their affiliates and/or their designated agent.
- **Obligation to Drive Responsibly:** You recognize your obligation to drive responsibly and keep attention on the road. You will read and abide with the DEVICE operating instructions particularly as they pertain to safety and assumes any risk associated with the use of the DEVICE.

UPGRADES AND RECOVERY MEDIA:

If the SOFTWARE is provided by FORD MOTOR COMPANY separate from the DEVICE on media such as a ROM chip, CD ROM disk(s) or via web download or other means, and is labeled "For Upgrade Purposes Only" or "For Recovery Purposes Only" you may install one (1) copy of such SOFTWARE onto the DEVICE as a replacement copy for the existing SOFTWARE, and use it in accordance with this EULA, including any additional EULA terms accompanying the upgrade SOFTWARE.

INTELLECTUAL PROPERTY RIGHTS:

All title and intellectual property rights in and to the SOFTWARE (including but not limited to any images, photographs, animations, video, audio, music, text and "applets" incorporated into the SOFTWARE), the accompanying printed materials, and any copies of the SOFTWARE, are owned by MS, Microsoft Corporation, FORD MOTOR COMPANY, or their affiliates or suppliers. The SOFTWARE is licensed, not sold. You may not copy the printed materials accompanying the SOFTWARE. All title and intellectual property rights in and to the content which may be accessed through use of the SOFTWARE is the property of the respective content owner and may be protected by applicable copyright or other intellectual property laws and treaties. This EULA grants you no rights to use such content. All rights not specifically granted under this EULA are reserved by MS, Microsoft Corporation, FORD MOTOR COMPANY, third party software and service providers, their affiliates and suppliers. Use of any on-line services which may be accessed through the SOFTWARE may be governed by the respective terms of use relating to such services. If this SOFTWARE contains documentation that is provided only in electronic form, you may print one copy of such electronic documentation.

EXPORT RESTRICTIONS: You acknowledge that the SOFTWARE is subject to U.S. and European Union export jurisdiction. You agree to comply with all applicable international and national laws that apply to the SOFTWARE, including the U.S. Export Administration Regulations, as well as end-user, end-use and destination restrictions issued by U.S. and other governments. For additional information, see:

Appendices

Website
http://www.microsoft.com/exporting/

TRADEMARKS: This EULA does not grant you any rights in connection with any trademarks or service marks of FORD MOTOR COMPANY, MS, Microsoft Corporation, third party software or service providers, their affiliates or suppliers.

PRODUCT SUPPORT: Product support for the SOFTWARE is not provided by MS, its parent corporation Microsoft Corporation, or their affiliates or subsidiaries. For product support, please refer to FORD MOTOR COMPANY instructions provided in the documentation for the DEVICE. Should you have any questions concerning this EULA, or if you desire to contact FORD MOTOR COMPANY for any other reason, please refer to the address provided in the documentation for the DEVICE.

No Liability for Certain Damages: EXCEPT AS PROHIBITED BY LAW, FORD MOTOR COMPANY, ANY THIRD PARTY SOFTWARE OR SERVICES SUPPLIERS, MS, MICROSOFT CORPORATION AND THEIR AFFILIATES SHALL HAVE NO LIABILITY FOR ANY INDIRECT, SPECIAL, CONSEQUENTIAL OR INCIDENTAL DAMAGES ARISING FROM OR IN CONNECTION WITH THE USE OR PERFORMANCE OF THE SOFTWARE. THIS LIMITATION SHALL APPLY EVEN IF ANY REMEDY FAILS OF ITS ESSENTIAL PURPOSE. IN NO EVENT SHALL MS, MICROSOFT CORPORATION AND/OR THEIR AFFILIATES BE LIABLE FOR ANY AMOUNT IN EXCESS OF U.S. TWO HUNDRED FIFTY DOLLARS (U.S. \$250.00).

- THERE ARE NO WARRANTIES OTHER THAN THOSE THAT MAY EXPRESSLY BE PROVIDED FOR YOUR NEW VEHICLE.

Adobe

Contains Adobe® [Flash® Player] or [AIR®] technology by Adobe Systems Incorporated. This [Licensee Product] contains [Adobe® Flash® Player] [Adobe® AIR®] software under license from Adobe Systems Incorporated, Copyright ©1995-2009 Adobe Macromedia Software LLC. All rights reserved. Adobe, Flash and AIR are trademarks of Adobe Systems Incorporated.

End User Notice

Microsoft® Windows® Mobile for Automotive Important Safety Information

This system Ford SYNC contains software that is licensed to Manufacturer FORD MOTOR COMPANY by an affiliate of Microsoft Corporation pursuant to a license agreement. Any removal, reproduction, reverse engineering or other unauthorized use of the software from this system in violation of the license agreement is strictly prohibited and may subject you to legal action.

Read and follow instructions: Before using your Windows Automotive- based system, read and follow all instructions and safety information provided in this end user manual ("User's Guide"). Not following precautions found in this User's Guide can lead to an accident or other serious consequences.

Appendices

Keep User's Guide in vehicle: When kept in the vehicle, the User's Guide will be a ready reference for you and other users unfamiliar with the Windows Automotive-based system. Please make certain that before using the system for the first time, all persons have access to the User's Guide and read its instructions and safety information carefully.

WARNING



Operating certain parts of this system while driving can distract your attention away from the road, and possibly cause an accident or other serious consequences. Do not change system settings or enter data non-verbally (using your hands) while driving. Stop the vehicle in a safe and legal manner before attempting these operations. This is important since while setting up or changing some functions you might be required to distract your attention away from the road and remove your hands from the wheel.

General Operation

Voice Command Control: Functions within the Windows Automotive-based system may be accomplished using only voice commands. Using voice commands while driving allows you to operate the system without removing your hands from the wheel.

Prolonged Views of Screen: Do not access any function requiring a prolonged view of the screen while you are driving. Pull over in a safe and legal manner before attempting to access a function of the system requiring prolonged attention. Even occasional short scans to the screen may be hazardous if your attention has been diverted away from your driving task at a critical time.

Volume Setting: Do not raise the volume excessively. Keep the volume at a level where you can still hear outside traffic and emergency signals while driving. Driving while unable to hear these sounds could cause an accident.

Use of Speech Recognition Functions: Speech recognition software is inherently a statistical process which is subject to errors. It is your responsibility to monitor any speech recognition functions included in the system and address any errors.

Navigation Features: Any navigation features included in the system are intended to provide turn by turn instructions to get you to a desired destination. Please make certain all persons using this system carefully read and follow instructions and safety information fully.

Distraction Hazard: Any navigation features may require manual (non-verbal) setup. Attempting to perform such set-up or insert data while driving can seriously distract your attention and could cause an accident or other serious consequences. Stop the vehicle in a safe and legal manner before attempting these operations.

Let Your Judgment Prevail: Any navigation features are provided only as an aid. Make your driving decisions based on your observations of local conditions and existing traffic regulations. Any such feature is not a substitute for your personal judgment. Any route suggestions made by this system should never replace any local traffic regulations or your personal judgment or knowledge of safe driving practices.

Appendices

Route Safety: Do not follow the route suggestions if doing so would result in an unsafe or illegal maneuver, if you would be placed in an unsafe situation, or if you would be directed into an area that you consider unsafe. The driver is ultimately responsible for the safe operation of the vehicle and therefore, must evaluate whether it is safe to follow the suggested directions.

Potential Map Inaccuracy: Maps used by this system may be inaccurate because of changes in roads, traffic controls or driving conditions. Always use good judgment and common sense when following the suggested routes.

Emergency Services: Do not rely on any navigation features included in the system to route you to emergency services. Ask local authorities or an emergency services operator for these locations. Not all emergency services such as police, fire stations, hospitals and clinics are likely to be contained in the map database for such navigation features.

Telenav Software End User License Agreement

Please read these terms and conditions carefully before you use the Telenav Software. Your use of the Telenav Software indicates that you accept these terms and conditions. If you do not accept these terms and conditions, do not break the seal of the package, launch, or otherwise use the Telenav Software.

These terms and conditions represent the agreement (“Agreement”) between you and Telenav, Inc. (“Telenav”) with respect to the Telenav Software (including upgrades, modifications, or additions thereto) (collectively “Telenav Software”). All references herein to “you” and “your” means you, your employees, agents, and contractors, and any other entity on whose behalf you accept these terms and

conditions, all of whom shall also be bound by this Agreement. Additionally, all of your account information, as well as other payment and personal information provided by you to Telenav (directly or through the use of the Telenav Software, is subject to Telenav’s privacy policy located at <http://www.telenav.com>.

Telenav may revise this Agreement and the privacy policy at any time, with or without notice to you. You agree to visit <http://www.telenav.com> from time to time to review the then current version of this Agreement and of the privacy policy.

1. Safe and Lawful Use

You acknowledge that devoting attention to the Telenav Software may pose a risk of injury or death to you and others in situations that otherwise require your undivided attention, and you therefore agree to comply with the following when using the Telenav Software: (a) observe all traffic laws and otherwise drive safely; (b) use your own personal judgment while driving. If you feel that a route suggested by the Telenav Software instructs you to perform an unsafe or illegal maneuver, places you in an unsafe situation, or directs you into an area that you consider to be unsafe, do not follow such instructions; (c) do not input destinations, or otherwise manipulate the Telenav Software, unless your vehicle is stationary and parked; (d) do not use the Telenav Software for any illegal, unauthorized, unintended, unsafe, hazardous, or unlawful purposes, or in any manner inconsistent with this Agreement; (e) arrange all GPS and wireless devices and cables necessary for use of the Telenav Software in a secure manner in your vehicle so that they will not interfere with your driving and will not prevent the operation of any safety device (such as an airbag).

Appendices

You agree to indemnify and hold Telenav harmless against all claims resulting from any dangerous or otherwise inappropriate use of the Telenav Software in any moving vehicle, including as a result of your failure to comply with the directions above.

2. Account Information

You agree: (a) when registering the Telenav Software, to provide Telenav with true, accurate, current, and complete information about yourself, and (b) to inform Telenav promptly of any changes to such information, and to keep it true, accurate, current and complete.

3. Software License

Subject to your compliance with the terms of this Agreement, Telenav hereby grants to you a personal, non-exclusive, non-transferable license (except as expressly permitted below in connection with your permanent transfer of the Telenav Software license), without the right to sublicense, to use the Telenav Software (in object code form only) in order to access and use the Telenav Software. This license shall terminate upon any termination or expiration of this Agreement. You agree that you will use the Telenav Software only for your personal business or leisure purposes, and not to provide commercial navigation services to other parties.

3.1 License Limitations

You agree not to do any of the following: (a) reverse engineer, decompile, disassemble, translate, modify, alter or otherwise change the Telenav Software or any part thereof; (b) attempt to derive the source code, audio library or structure of the Telenav Software without the prior express written consent of Telenav; (c) remove from the Telenav Software, or alter, any of Telenav's or its suppliers' trademarks, trade names, logos, patent or

copyright notices, or other notices or markings; (d) distribute, sublicense or otherwise transfer the Telenav Software to others, except as part of your permanent transfer of the Telenav Software; or (e) use the Telenav Software in any manner that (i) infringes the intellectual property or proprietary rights, rights of publicity or privacy or other rights of any party, (ii) violates any law, statute, ordinance or regulation, including but not limited to laws and regulations related to spamming, privacy, consumer and child protection, obscenity or defamation, or (iii) is harmful, threatening, abusive, harassing, tortuous, defamatory, vulgar, obscene, libelous, or otherwise objectionable; and (f) lease, rent out, or otherwise permit unauthorized access by third parties to the Telenav Software without advanced written permission of Telenav.

4. Disclaimers

To the fullest extent permissible pursuant to applicable law, in no event will Telenav, its licensors and suppliers, or agents or employees of any of the foregoing, be liable for any decision made or action taken by you or anyone else in reliance on the information provided by the Telenav Software. Telenav also does not warrant the accuracy of the map or other data used for the Telenav Software. Such data may not always reflect reality due to, among other things, road closures, construction, weather, new roads and other changing conditions. You are responsible for the entire risk arising out of your use of the Telenav Software. For example but without limitation, you agree not to rely on the Telenav Software for critical navigation in areas where the well-being or survival of you or others is dependent on the accuracy of navigation, as the maps or functionality of the Telenav Software are not intended to support such high risk applications, especially in more remote geographical areas.

Appendices

TELENAV EXPRESSLY DISCLAIMS AND EXCLUDES ALL WARRANTIES IN CONNECTION WITH THE TELENAV SOFTWARE, WHETHER STATUTORY, EXPRESS OR IMPLIED, INCLUDING ALL WARRANTIES WHICH MAY ARISE FROM COURSE OF DEALING, CUSTOM OR TRADE AND INCLUDING, BUT NOT LIMITED TO, THE IMPLIED WARRANTIES OF MERCHANTABILITY, FITNESS FOR A PARTICULAR PURPOSE AND NON-INFRINGEMENT OF THIRD PARTY RIGHTS WITH RESPECT TO THE TELENAV SOFTWARE. Certain jurisdictions do not permit the disclaimer of certain warranties, so this limitation may not apply to you.

5. Limitation of Liability

TO THE EXTENT PERMITTED UNDER APPLICABLE LAW, UNDER NO CIRCUMSTANCES SHALL TELENAV OR ITS LICENSORS AND SUPPLIERS BE LIABLE TO YOU OR TO ANY THIRD PARTY FOR ANY INDIRECT, INCIDENTAL, CONSEQUENTIAL, SPECIAL OR EXEMPLARY DAMAGES (INCLUDING IN EACH CASE, BUT NOT LIMITED TO, DAMAGES FOR THE INABILITY TO USE THE EQUIPMENT OR ACCESS DATA, LOSS OF DATA, LOSS OF BUSINESS, LOSS OF PROFITS, BUSINESS INTERRUPTION OR THE LIKE) ARISING OUT OF THE USE OF OR INABILITY TO USE THE TELENAV SOFTWARE, EVEN IF TELENAV HAS BEEN ADVISED OF THE POSSIBILITY OF SUCH DAMAGES.

NOTWITHSTANDING ANY DAMAGES THAT YOU MIGHT INCUR FOR ANY REASON WHATSOEVER (INCLUDING, WITHOUT LIMITATION, ALL DAMAGES REFERENCED HEREIN AND ALL DIRECT OR GENERAL DAMAGES IN CONTRACT, TORT (INCLUDING NEGLIGENCE) OR OTHERWISE), THE ENTIRE LIABILITY OF TELENAV AND OF ALL OF TELENAV'S SUPPLIERS SHALL BE LIMITED TO THE AMOUNT ACTUALLY PAID BY YOU FOR

THE TELENAV SOFTWARE. SOME STATES AND/OR JURISDICTIONS DO NOT ALLOW THE EXCLUSION OR LIMITATION OF INCIDENTAL OR CONSEQUENTIAL DAMAGES, SO THE ABOVE LIMITATIONS OR EXCLUSIONS MAY NOT APPLY TO YOU.

6. Arbitration and Governing Law

You agree that any dispute, claim or controversy arising out of or relating to this Agreement or the Telenav Software shall be settled by independent arbitration involving a neutral arbitrator and administered by the American Arbitration Association in the County of Santa Clara, California. The arbitrator shall apply the Commercial Arbitration Rules of the American Arbitration Association, and the judgment upon the award rendered by the arbitrator may be entered by any court having jurisdiction. Note that there is no judge or jury in an arbitration proceeding and the decision of the arbitrator shall be binding upon both parties. You expressly agree to waive your right to a jury trial.

This Agreement and performance hereunder will be governed by and construed in accordance with the laws of the State of California, without giving effect to its conflict of laws provisions. To the extent judicial action is necessary in connection with the binding arbitration, both Telenav and you agree to submit to the exclusive jurisdiction of the courts of the County of Santa Clara, California. The United Nations Convention on Contracts for the International Sale of Goods shall not apply.

7. Assignment

You may not resell, assign, or transfer this Agreement or any of your rights or obligations, except in totality, in connection with your permanent transfer of the Telenav Software, and expressly conditioned upon the new user of the

Appendices

Telenav Software agreeing to be bound by the terms and conditions of this Agreement. Any such sale, assignment or transfer that is not expressly permitted under this paragraph will result in immediate termination of this Agreement, without liability to Telenav, in which case you and all other parties shall immediately cease all use of the Telenav Software. Notwithstanding the foregoing, Telenav may assign this Agreement to any other party at any time without notice, provided the assignee remains bound by this Agreement.

8. Miscellaneous

8.1

This Agreement constitutes the entire agreement between Telenav and you with respect to the subject matter hereof.

8.2

Except for the limited licenses expressly granted in this Agreement, Telenav retains all right, title and interest in and to the Telenav Software, including without limitation all related intellectual property rights. No licenses or other rights which are not expressly granted in this Agreement are intended to, or shall be, granted or conferred by implication, statute, inducement, estoppel or otherwise, and Telenav and its suppliers and licensors hereby reserve all of their respective rights other than the licenses explicitly granted in this Agreement.

8.3

By using the Telenav Software, you consent to receive from Telenav all communications, including notices, agreements, legally required disclosures or other information in connection with the Telenav Software (collectively, "Notices") electronically. Telenav may provide such

Notices by posting them on Telenav's Website or by downloading such Notices to your wireless device. If you desire to withdraw your consent to receive Notices electronically, you must discontinue your use of the Telenav Software.

8.4

Telenav's or your failure to require performance of any provision shall not affect that party's right to require performance at any time thereafter, nor shall a waiver of any breach or default of this Agreement constitute a waiver of any subsequent breach or default or a waiver of the provision itself.

8.5

If any provision herein is held unenforceable, then such provision will be modified to reflect the intention of the parties, and the remaining provisions of this Agreement will remain in full force and effect.

8.6

The headings in this Agreement are for convenience of reference only, will not be deemed to be a part of this Agreement, and will not be referred to in connection with the construction or interpretation of this Agreement. As used in this Agreement, the words "include" and "including," and variations thereof, will not be deemed to be terms of limitation, but rather will be deemed to be followed by the words "without limitation."

9. Other Vendors Terms and Conditions

The Telenav Software utilizes map and other data licensed to Telenav by third party vendors for the benefit of you and other end users. This Agreement includes end-user terms applicable to these companies (included at the end of this

Appendices

Agreement), and thus your use of the Telenav Software is also subject to such terms. You agree to comply with the following additional terms and conditions, which are applicable to Telenav's third party vendor licensors:

9.1 End User Terms Required by HERE North America, LLC

The data ("Data") is provided for your personal, internal use only and not for resale. It is protected by copyright, and is subject to the following terms and conditions which are agreed to by you, on the one hand, and Telenav ("Telenav") and its licensors (including their licensors and suppliers) on the other hand.

© 2013 HERE. All rights reserved.

The Data for areas of Canada includes information taken with permission from Canadian authorities, including: © Her Majesty the Queen in Right of Canada, © Queen's Printer for Ontario, © Canada Post Corporation, GeoBase®, © Department of Natural Resources Canada.

HERE holds a non-exclusive license from the United States Postal Service® to publish and sell ZIP+4® information.

©United States Postal Service® 2014. Prices are not established, controlled or approved by the United States Postal Service®. The following trademarks and registrations are owned by the USPS: United States Postal Service, USPS, and ZIP+4.

The Data for Mexico includes certain data from Instituto Nacional de Estadística y Geografía.

TERMS AND CONDITIONS

9.2 End User Terms Required by NAV2 (Shanghai) Co., Ltd

The data ("Data") is provided for your personal, internal use only and not for resale. It is protected by copyright, and is subject to the following terms and conditions which are agreed to by you, on the one hand, and NAV2 (Shanghai) Co., Ltd ("NAV2") and its licensors (including their licensors and suppliers) on the other hand.

© 20xx. All rights reserved.

Permitted Use.

You agree to use this Data together with the Telenav Software solely for the internal business and personal purposes for which you were licensed, and not for service bureau, time-sharing or other similar purposes. Accordingly, but subject to the restrictions set forth in the following paragraphs, you agree not to otherwise reproduce, copy, modify, decompile, disassemble, create any derivative works of, or reverse engineer any portion of this Data, and may not transfer or distribute it in any form, for any purpose, except to the extent permitted by mandatory laws.

Restrictions.

Except where you have been specifically licensed to do so by Telenav, and without limiting the preceding paragraph, you may not use this Data (a) with any products, systems, or applications installed or otherwise connected to or in communication with vehicles, capable of vehicle navigation, positioning, dispatch, real time route guidance, fleet management or similar applications; or (b) with or in communication with any

Appendices

positioning devices or any mobile or wireless-connected electronic or computer devices, including without limitation cellular phones, palmtop and handheld computers, pagers, and personal digital assistants or PDAs.

Warning.

The Data may contain inaccurate or incomplete information due to the passage of time, changing circumstances, sources used and the nature of collecting comprehensive geographic data, any of which may lead to incorrect results.

No Warranty.

This Data is provided to you "as is," and you agree to use it at your own risk. Telenav and its licensors (and their licensors and suppliers) make no guarantees, representations or warranties of any kind, express or implied, arising by law or otherwise, including but not limited to, content, quality, accuracy, completeness, effectiveness, reliability, fitness for a particular purpose, usefulness, use or results to be obtained from this Data, or that the Data or server will be uninterrupted or error-free.

Disclaimer of Warranty:

TELENAV AND ITS LICENSORS (INCLUDING THEIR LICENSORS AND SUPPLIERS) DISCLAIM ANY WARRANTIES, EXPRESS OR IMPLIED, OF QUALITY, PERFORMANCE, MERCHANTABILITY, FITNESS FOR A PARTICULAR PURPOSE OR NON-INFRINGEMENT. Some States, Territories and Countries do not allow certain warranty exclusions, so to that extent the above exclusion may not apply to you.

Disclaimer of Liability:

TELENAV AND ITS LICENSORS (INCLUDING THEIR LICENSORS AND SUPPLIERS) SHALL NOT BE LIABLE TO YOU: IN RESPECT OF ANY CLAIM, DEMAND OR ACTION, IRRESPECTIVE OF THE NATURE OF THE CAUSE OF THE CLAIM, DEMAND OR ACTION ALLEGING ANY LOSS, INJURY OR DAMAGES, DIRECT OR INDIRECT, WHICH MAY RESULT FROM THE USE OR POSSESSION OF THE INFORMATION; OR FOR ANY LOSS OF PROFIT, REVENUE, CONTRACTS OR SAVINGS, OR ANY OTHER DIRECT, INDIRECT, INCIDENTAL, SPECIAL OR CONSEQUENTIAL DAMAGES ARISING OUT OF YOUR USE OF OR INABILITY TO USE THIS INFORMATION, ANY DEFECT IN THE INFORMATION, OR THE BREACH OF THESE TERMS OR CONDITIONS, WHETHER IN AN ACTION IN CONTRACT OR TORT OR BASED ON A WARRANTY, EVEN IF TELENAV OR ITS LICENSORS HAVE BEEN ADVISED OF THE POSSIBILITY OF SUCH DAMAGES. Some States, Territories and Countries do not allow certain liability exclusions or damages limitations, so to that extent the above may not apply to you.

Export Control.

You shall not export from anywhere any part of the Data or any direct product thereof except in compliance with, and with all licenses and approvals required under, applicable export laws, rules and regulations, including but not limited to the laws, rules and regulations administered by the Office of Foreign Assets Control of the U.S. Department of Commerce and the Bureau of Industry and Security of the U.S. Department of Commerce. To the extent

Appendices

that any such export laws, rules or regulations prohibit HERE from complying with any of its obligations hereunder to deliver or distribute Data, such failure shall be excused and shall not constitute a breach of this Agreement.

Entire Agreement.

These terms and conditions constitute the entire agreement between Telenav (and its licensors, including their licensors and suppliers) and you pertaining to the subject matter hereof, and supersedes in their entirety any and all written or oral agreements previously existing between us with respect to such subject matter.

Governing Law.

The above terms and conditions shall be governed by the laws of the State of Illinois [insert "Netherlands" where European HERE Data is used], without giving effect to (i) its conflict of laws provisions, or (ii) the United Nations Convention for Contracts for the International Sale of Goods, which is explicitly excluded. You agree to submit to the jurisdiction of the State of Illinois [insert "The Netherlands" where European HERE Data is used] for any and all disputes, claims and actions arising from or in connection with the Data provided to you hereunder.

Government End Users.

If the Data is being acquired by or on behalf of the United States government or any other entity seeking or applying rights similar to those customarily claimed by the United States government, this Data is a "commercial item" as that term is defined at 48 C.F.R. ("FAR") 2.101, is licensed in accordance with these End-User Terms, and each copy of Data delivered or otherwise furnished shall be marked and embedded as appropriate with the following "Notice of Use," and shall be treated in accordance with such Notice:

NOTICE OF USE

CONTRACTOR (MANUFACTURER/
SUPPLIER) NAME: HERE

CONTRACTOR (MANUFACTURER/
SUPPLIER) ADDRESS: c/o Nokia, 425
West Randolph Street, Chicago, Illinois
60606

This Data is a commercial item as defined in FAR 2.101 and is subject to these End-User Terms under which this Data was provided.

© 1987 – 2014 HERE – All rights reserved.

If the Contracting Officer, federal government agency, or any federal official refuses to use the legend provided herein, the Contracting Officer, federal government agency, or any federal official must notify HERE prior to seeking additional or alternative rights in the Data.

I. US/Canada Territory

A. United States Data. The End-User Terms for any Application containing Data for the United States shall contain the following notices:

"HERE holds a non-exclusive license from the United States Postal Service® to publish and sell ZIP+4® information."

"©United States Postal Service® 20XX. Prices are not established, controlled or approved by the United States Postal Service®. The following trademarks and registrations are owned by the USPS: United States Postal Service, USPS, and ZIP+4."

Appendices

B. Canada Data. The following provisions apply to the Data for Canada, which may include or reflect data from third party licensors (“Third Party Data”), including Her Majesty the Queen in Right of Canada (“Her Majesty”), Canada Post Corporation (“Canada Post”) and the Department of Natural Resources of Canada (“NRCan”):

1. Disclaimer and Limitation: Client agrees that its use of the Third Party Data is subject to the following provisions:

a. Disclaimer: The Third Party Data is licensed on an “as is” basis. The licensors of such data, including Her Majesty, Canada Post and NRCan, make no guarantees, representations or warranties respecting such data, either express or implied, arising by law or otherwise, including but not limited to, effectiveness, completeness, accuracy or fitness for a particular purpose.

b. Limitation on Liability: The Third Party Data licensors, including Her Majesty, Canada Post and NRCan, shall not be liable: (i) in respect of any claim, demand or action, irrespective of the nature of the cause of the claim, demand or action alleging any loss, injury or damages, direct or indirect, which may result from the use or possession of such Data; or (ii) in any way for loss of revenues or contracts, or any other consequential loss of any kind resulting from any defect in the Data.

2. Copyright Notice: In connection with each copy of all or any portion of the Data for the Territory of Canada, Client shall affix in a conspicuous manner the following copyright notice on at least one of: (i) the label for the storage media of the copy; (ii) the packaging for the copy; or (iii) other materials packaged with the copy, such as user manuals or end user license agreements: “This data includes information taken with permission from Canadian authorities, including © Her Majesty the Queen in Right of Canada, © Queen’s Printer for Ontario, © Canada Post Corporation, GeoBase®, © The Department of Natural Resources Canada. All rights reserved.”

3. End-User Terms: Except as otherwise agreed by the parties, in connection with the provision of any portion of the Data for the Territory of Canada to End-Users as may be authorized under the Agreement, Client shall provide such End-Users, in a reasonably conspicuous manner, with terms (set forth with other end user terms required to be provided under the Agreement, or as otherwise may be provided, by Client) which shall include the following provisions on behalf of the Third Party Data licensors, including Her Majesty, Canada Post and NRCan:

The Data may include or reflect data of licensors, including Her Majesty the Queen in the Right of Canada (“Her Majesty”), Canada Post Corporation (“Canada Post”) and the Department of Natural Resources Canada (“NRCan”). Such data is licensed on an “as is” basis. The licensors, including Her Majesty, Canada Post and NRCan, make no guarantees, representations or warranties respecting such data,

Appendices

either express or implied, arising by law or otherwise, including but not limited to, effectiveness, completeness, accuracy or fitness for a particular purpose. The licensors, including Her Majesty, Canada Post and NRCan, shall not be liable in respect of any claim, demand or action, irrespective of the nature of the cause of the claim, demand or action alleging any loss, injury or damages, direct or indirect, which may result from the use or possession of the data or the Data. The licensors, including Her Majesty, Canada Post and NRCan, shall not be liable in any way for loss of revenues or contracts, or any other consequential loss of any kind resulting from any defect in the data or the Data.

End User shall indemnify and save harmless the licensors, including Her Majesty, Canada Post and NRCan, and their officers, employees and agents from and against any claim, demand or action, irrespective of the nature of the cause of the claim, demand or action, alleging loss, costs, expenses, damages or injuries (including injuries resulting in death) arising out of the use or possession of the data or the Data.

4. Additional Provisions: The terms contained in this Section are in addition to all of the rights and obligations of the parties under the Agreement. To the extent that any of the provisions of this Section are inconsistent with, or conflict with, any other provisions of the Agreement, the provisions of this Section shall prevail.

II. Mexico. The following provision applies to the Data for Mexico, which includes certain data from the Instituto Nacional de Estadística y Geografía (“INEGI”):

A. Any and all copies of the Data and/or packaging containing Data for Mexico shall contain the following notice: “Fuente: INEGI (Instituto Nacional de Estadística y Geografía)”

III. Latin America Territory

A. Third Party Notices. Any and all copies of the Data and/or packaging relating thereto shall include the respective Third Party Notices set forth below and used as described below corresponding to the Territory (or portion thereof) included in such copy:

Territory	Notice
Ecuador	“INSTITUTO GEOGRAFICO MILITAR DEL ECUADOR AUTORIZACION N° IGM-2011-01- PCO-01 DEL 25 DE ENERO DE 2011” “source: © IGN 2009 - BD TOPO ®”
Guadeloupe, French Guiana and Martinique Mexico	“Fuente: INEGI (Instituto Nacional de Estadística y Geografía)”

IV. Middle East Territory

Appendices

A. Third Party Notices. Any and all copies of the Data and/or packaging relating thereto shall include the respective Third Party Notices set forth below and used as described below corresponding to the Territory (or portion thereof) included in such copy:

Country	Notice
Jordan	“© Royal Jordanian Geographic Centre”. The foregoing notice requirement for Jordan Data is a material term of the Agreement. If Client or any of its permitted sublicensees (if any) fail to meet such requirement, HERE shall have the right to terminate Client’s license with respect to the Jordan Data.

B. Jordan Data. Client and its permitted sublicensees (if any) are restricted from licensing and/or otherwise distributing HERE’s database for the country of Jordan (“Jordan Data”) for use in Enterprise Applications to (i) non-Jordanian entities for use of the Jordan Data solely in Jordan or (ii) Jordan-based customers. In addition, Client, its permitted sublicensees (if any) and End-Users are restricted from using the Jordan Data in Enterprise Applications if such party is (i) a non-Jordanian entity using the Jordan Data solely in Jordan or (ii) a Jordan-based customer. For purposes of the foregoing, “Enterprise Applications” shall mean Geomarketing applications, GIS applications, mobile business asset management applications, call center applications, telematics applications, public organization Internet applications or for providing geocoding services.

V. Europe Territory

A. Use of Certain Traffic Codes in Europe

1. General Restrictions Applicable to Traffic Codes. Client acknowledges and agrees that in certain countries of the Europe Territory, Client will need to obtain rights directly from third party RDS-TMC code providers to receive and use the Traffic Codes in the Data and to deliver to End-Users Transactions in any way derived from or based on such Traffic Codes. For such countries, HERE shall deliver the Data incorporating Traffic Codes to Client only after receiving certification from Client of its having obtained such rights.

2. Display of Third Party Rights Legends for Belgium. Client shall, for each Transaction that uses Traffic Codes for Belgium, provide the following notice to the End-User: “Traffic Codes for Belgium are provided by the Ministerie van de Vlaamse Gemeenschap and the Ministère de l’Equipement et des Transports.”

B. Paper Maps. With respect to any license granted to Client relating to making, selling or distributing paper maps (i.e., a map fixed on a paper or paper-like medium): (a) such license with respect to Data for the Territory of Great Britain is conditioned on Client’s entering into and complying with a separate written agreement with the Ordnance Survey (“OS”) to create and sell paper maps, Client’s paying to the OS any and all applicable paper map royalties, and Client’s complying with the OS copyright notice requirements; (b) such license for selling or otherwise distributing for charge with respect to Data for the Territory of Czech Republic

Appendices

is conditioned on Client's obtaining prior written consent from Kartografie a.s.; (c) such license for selling or distributing with respect to Data for the Territory of Switzerland is conditioned on Client's obtaining a permit from Bundesamt für Landestopografie of Switzerland; (d) Client is restricted from using Data for the Territory of France to create paper maps with a scale between 1:5,000 and 1:250,000; and (e) Client is restricted from using any Data to create, sell or distribute paper maps that are the same or substantially similar, in terms of data content and specific use of color, symbols and scale, to paper maps published by the European national mapping agencies, including without limitation, Landervermessungämter of Germany, Topografische Dienst of the Netherlands, Nationaal Geografisch Instituut of Belgium, Bundesamt für Landestopografie of Switzerland, Bundesamt für Eich- und Vermessungswesen of Austria, and the National Land Survey of Sweden.

C. OS Enforcement. Without limiting Section IV(B) above, with respect to Data for the Territory of Great Britain, Client acknowledges and agrees that the Ordnance Survey ("OS") may bring a direct action against Client to enforce compliance with the OS copyright notice (see Section IV(D) below) and paper map requirements (see Section IV(B) above) contained in this Agreement.

D. Third Party Notices. Any and all copies of the Data and/or packaging relating thereto shall include the respective Third Party Notices set forth below and used as described below corresponding to the Territory (or portion thereof) included in such copy:

Country(ies) Notice

Austria	"© Bundesamt für Eich- und Vermessungswesen"
Croatia Cyprus, Estonia, Latvia, Lithuania, Moldova, Poland, Slovenia and/or Ukraine	"© EuroGeographics"
France	"source: © IGN 2009 – BD TOPO ®"
Germany	"Die Grundlegendaten wurden mit Genehmigung der zuständigen Behörden entnommen"
Great Britain	"Contains Ordnance Survey data © Crown copyright and database right 2010 Contains Royal Mail data © Royal Mail copyright and database right 2010"
Greece	"Copyright Geomatics Ltd."
Hungary	"Copyright © 2003; Top-Map Ltd."
Italy	"La Banca Dati Italiana è stata prodotta usando quale riferimento anche cartografia numerica ed al tratto prodotta e fornita dalla Regione Toscana."
Norway	"Copyright © 2000; Norwegian Mapping Authority"
Portugal	"Source: IgeoE – Portugal"

Appendices

Spain	“Información geográfica propiedad del CNIG”
Sweden	“Based upon electronic data © National Land Survey Sweden.”
Switzerland	“Topografische Grundlage: © Bundesamt für Landestopographie.

E. Respective Country Distribution. Client acknowledges that HERE has not received approvals to distribute map data for the following countries in such respective countries: Albania, Belarus, Kyrgyzstan, Moldova and Uzbekistan. HERE may update such list from time to time. The license rights granted to Client under this TL with respect to the Data for such countries are contingent upon Client's compliance with all applicable laws and regulations, including, without limitation, any required licenses or approvals to distribute the Application incorporating such Data in such respective countries.

VI. Australia Territory

A. Third Party Notices. Any and all copies of the Data and/or packaging relating thereto shall include the respective Third Party Notices set forth below and used as described below corresponding to the Territory (or portion thereof) included in such copy:

Copyright. Based on data provided under license from PSMA Australia Limited (www.pasma.com.au).

Product incorporates data which is © 20XX Telstra Corporation Limited, GM Holden Limited, Intelomatics Australia Pty Ltd and Continental Pty Ltd.

B. Third Party Notices for Australia. In addition to the foregoing, the End-User Terms for any Application containing RDS-TMC Traffic Codes for Australia shall contain the following notice: “Product incorporates traffic location codes which is © 20XX Telstra Corporation Limited and its licensors.”

VII. China Territory

Personal Use Only

You agree to use this Data together with [insert name of Client Application] for the solely personal, non-commercial purposes for which you were licensed, and not for service bureau, time-sharing or other similar purposes. Accordingly, but subject to the restrictions set forth in the following paragraphs, you may copy this Data only as necessary for your personal use to (i) view it, and (ii) save it, provided that you do not remove any copyright notices that appear and do not modify the Data in any way. You agree not to otherwise reproduce, copy, modify, decompile, disassemble or reverse engineer any portion of this Data, and may not transfer or distribute it in any form, for any purpose, except to the extent permitted by mandatory laws.

Restrictions

Except where you have been specifically licensed to do so by NAV2 , and without limiting the preceding paragraph, you may not (a) use this Data with any products, systems, or applications installed or otherwise connected to or in communication with vehicles, capable of vehicle navigation, positioning, dispatch, real time route guidance, fleet management or similar applications; or (b)

Appendices

with or in communication with any positioning devices or any mobile or wireless-connected electronic or computer devices, including without limitation cellular phones, palmtop and handheld computers, pagers, and personal digital assistants or PDAs. You agree to cease using this Data if you fail to comply with these terms and conditions.

Limited Warranty

NAV2 warrants that (a) the Data will perform substantially in accordance with the accompanying written materials for a period of ninety (90) days from the date of receipt, and (b) any support services provided by NAV2 shall be substantially as described in applicable written materials provided to you by NAV2, and NAV2's support engineers will make commercially reasonable efforts to solve any problem issues.

rigCustomer Remedies

NAV2 and its suppliers' entire liability and your exclusive remedy shall be, at NAV2's sole discretion, either (a) return of the price paid, if any, or (b) repair or replacement of the Data that do not meet NAV2's Limited Warranty and that are returned to NAV2 with a copy of your receipt. This Limited Warranty is void if failure of the Data has resulted from accident, abuse, or misapplication. Any replacement Data will be warranted for the remainder of the original warranty period or thirty (30) days, whichever is longer. Neither these remedies nor any product support services offered by NAV2 are available without proof of purchase from an authorized international source.

No Other Warranty:

EXCEPT FOR THE LIMITED WARRANTY SET FORTH ABOVE AND TO THE EXTENT PERMITTED BY APPLICABLE LAW, NAV2 AND ITS LICENSORS (INCLUDING THEIR LICENSORS AND SUPPLIERS) DISCLAIM ANY WARRANTIES, EXPRESS OR IMPLIED, OF QUALITY, PERFORMANCE, MERCHANTABILITY, FITNESS FOR A PARTICULAR PURPOSE, OWNERSHIP OR NON-INFRINGEMENT. Certain warranty exclusions may not be permitted under applicable law, so to that extent the above exclusion may not apply to you.

Limited Liability:

TO THE EXTENT PERMITTED BY APPLICABLE LAW, NAV2 AND ITS LICENSORS (INCLUDING THEIR LICENSORS AND SUPPLIERS) SHALL NOT BE LIABLE TO YOU: IN RESPECT OF ANY CLAIM, DEMAND OR ACTION, IRRESPECTIVE OF THE NATURE OF THE CAUSE OF THE CLAIM, DEMAND OR ACTION ALLEGING ANY LOSS, INJURY OR DAMAGES, DIRECT OR INDIRECT, WHICH MAY RESULT FROM THE USE OR POSSESSION OF THE INFORMATION; OR FOR ANY LOSS OF PROFIT, REVENUE, CONTRACTS OR SAVINGS, OR ANY OTHER DIRECT, INDIRECT, INCIDENTAL, SPECIAL OR CONSEQUENTIAL DAMAGES ARISING OUT OF YOUR USE OF OR INABILITY TO USE THIS INFORMATION, ANY DEFECT IN THE INFORMATION, OR THE BREACH OF THESE TERMS OR CONDITIONS, WHETHER IN AN ACTION IN CONTRACT OR TORT OR BASED ON A WARRANTY, EVEN IF NAV2 OR ITS LICENSORS HAVE BEEN ADVISED OF THE POSSIBILITY OF SUCH DAMAGES. UNDER NO CIRCUMSTANCES SHALL NAV2'S OR ITS SUPPLIERS' LIABILITY HEREUNDER EXCEED THE PRICE PAID. Certain liability exclusions may not be permitted under applicable law, so to that extent the above exclusion may not apply to you.

Appendices

Export Control

You agree not to export to anywhere any part of the Data provided to you or any direct product thereof except in compliance with, and with all licenses and approvals required under, applicable export laws, rules and regulations.

IP Protection

The Data are owned by NAV2 or its suppliers and are protected by applicable copyright and other intellectual property law and treaties. The Data are provided solely on the basis of a license to use, not sale.

Entire Agreement

These terms and conditions constitute the entire agreement between NAV2 (and its licensors, including their licensors and suppliers) and you pertaining to the subject matter hereof, and supersedes in their entirety any and all written or oral agreements previously existing between us with respect to such subject matter.

Governing Law.

The above terms and conditions shall be governed by the laws of the People's Republic of China, without giving effect to (i) its conflict of laws provisions, or (ii) the United Nations Convention for Contracts for the International Sale of Goods, which is explicitly excluded. Any dispute arising from or in connection with the Data provided to you hereunder shall be submitted to the Shanghai International Economic and Trade Arbitration Commission for arbitration.

Gracenote® Copyright

CD and music-related data from Gracenote, Inc., copyright© 2000-2007 Gracenote. Gracenote Software, copyright © 2000-2007 Gracenote. This product and service may practice one or more of the following U.S. Patents #5,987,525, #6,061,680, #6,154,773, #6,161,132, #6,230,192, #6,230,207, #6,240,459, #6,330,593 and other patents issued or pending. Some services supplied under license from Open Globe, Inc. for U.S. Patent: #6,304,523.

Gracenote and CDDB are registered trademarks of Gracenote. The Gracenote logo and logotype, and the "Powered by Gracenote™" logo are trademarks of Gracenote.

Gracenote® End User License Agreement (EULA)

This device contains software from Gracenote, Inc. of 2000 Powell Street Emeryville, California 94608 ("Gracenote").

The software from Gracenote (the "Gracenote Software") enables this device to do disc and music file identification and obtain music-related information, including name, artist, track, and title information ("Gracenote Data") from online servers ("Gracenote Servers"), and to perform other functions. You may use Gracenote Data only by means of the intended End User functions of this device.

This device may contain content belonging to Gracenote's providers. If so, all of the restrictions set forth herein with respect to Gracenote Data shall also apply to such content and such content providers shall be entitled to all of the benefits and protections set forth herein that are available to Gracenote.

Appendices

You agree that you will use the content from Gracenote ("Gracenote Content"), Gracenote Data, the Gracenote Software, and Gracenote Servers for your own personal, non-commercial use only. You agree not to assign, copy, transfer or transmit the Gracenote Content, Gracenote Software or any Gracenote Data (except in a Tag associated with a music file) to any third party. YOU AGREE NOT TO USE OR EXPLOIT GRACENOTE CONTENT, GRACENOTE DATA, THE GRACENOTE SOFTWARE, OR GRACENOTE SERVERS, EXCEPT AS EXPRESSLY PERMITTED HEREIN.

You agree that your non-exclusive licenses to use the Gracenote Content, Gracenote Data, the Gracenote Software, and Gracenote Servers will terminate if you violate these restrictions. If your licenses terminate, you agree to cease any and all use of the Gracenote Content, Gracenote Data, the Gracenote Software, and Gracenote Servers. Gracenote, respectively, reserve all rights in Gracenote Data, the Gracenote Software, and the Gracenote Servers and Gracenote Content, including all ownership rights. Under no circumstances will either Gracenote become liable for any payment to you for any information that you provide, including any copyrighted material or music file information. You agree that Gracenote may enforce its respective rights, collectively or separately, under this agreement against you, directly in each company's own name.

Gracenote uses a unique identifier to track queries for statistical purposes. The purpose of a randomly assigned numeric identifier is to allow Gracenote to count queries without knowing anything about who you are. For more information, see the web page at www.gracenote.com for the Gracenote Privacy Policy.

THE GRACENOTE SOFTWARE, EACH ITEM OF GRACENOTE DATA AND THE GRACENOTE CONTENT ARE LICENSED TO YOU "AS IS". NEITHER GRACENOTE MAKES ANY REPRESENTATIONS OR WARRANTIES, EXPRESS OR IMPLIED, REGARDING THE ACCURACY OF ANY GRACENOTE DATA FROM THE GRACENOTE SERVERS OR GRACENOTE CONTENT. GRACENOTE COLLECTIVELY AND SEPARATELY RESERVE THE RIGHT TO DELETE DATA AND/OR CONTENT FROM THE COMPANIES' RESPECTIVE SERVERS OR, IN THE CASE OF GRACENOTE, CHANGE DATA CATEGORIES FOR ANY CAUSE THAT GRACENOTE DEEMS SUFFICIENT. NO WARRANTY IS MADE THAT EITHER GRACENOTE CONTENT OR THE GRACENOTE SOFTWARE OR GRACENOTE SERVERS ARE ERROR-FREE OR THAT THE FUNCTIONING OF THE GRACENOTE SOFTWARE OR GRACENOTE SERVERS WILL BE UNINTERRUPTED. GRACENOTE IS NOT OBLIGATED TO PROVIDE YOU WITH ANY ENHANCED OR ADDITIONAL DATA TYPES THAT GRACENOTE MAY CHOOSE TO PROVIDE IN THE FUTURE AND IS FREE TO DISCONTINUE ITS ONLINE SERVICES AT ANY TIME. GRACENOTE DISCLAIM ALL WARRANTIES EXPRESS OR IMPLIED, INCLUDING, BUT NOT LIMITED TO, IMPLIED WARRANTIES OF MERCHANTABILITY, FITNESS FOR A PARTICULAR PURPOSE, TITLE, AND NON-INFRINGEMENT. NEITHER GRACENOTE WARRANTS THE RESULTS THAT WILL BE OBTAINED BY YOUR USE OF THE GRACENOTE SOFTWARE OR ANY GRACENOTE SERVER. IN NO CASE WILL GRACENOTE BE LIABLE FOR ANY CONSEQUENTIAL OR INCIDENTAL DAMAGES OR FOR ANY LOST PROFITS OR LOST REVENUES FOR ANY REASON WHATSOEVER.

© Gracenote 2007.

Appendices

Vehicle with SYNC only United States and Mexico

FCC ID: KMHSG1G1

IC: 1422A-SG1G1

Mexico

Model: KMHSG1P1

NOM-121-SCT1-2009

The operation of this equipment is subject to the following two conditions: (1) This equipment or device may not cause harmful interference, and (2) this equipment or device must accept any interference, including interference that may cause undesired operation.

Vehicle with SYNC with Touchscreen/My Touch

FCC ID: KMHSYNGG2

IC: 1422A-SYNGG2

This device complies with Part 15 of the FCC Rules and with RSS-210 of Industry Canada. Operation is subject to the following two conditions: (1) This device may not cause harmful interference, and (2) this device must accept any interference received, including interference that may cause undesired operation.

WARNING



Changes or modifications not expressly approved by the party responsible for compliance could void the user's authority to operate the equipment. The term "IC" before the radio certification number only signifies that Industry Canada technical specifications were met.

The antenna used for this transmitter must not be co-located or operating in conjunction with any other antenna or transmitter.

TYPE APPROVALS

RF Certification Logos for Tire Pressure Monitoring Sensor(s)

Schrader AG2SZ4 Numero de Registro
CNC: H-13498

E207816

Argentina

TRA
REGISTERED NO:ER0130238/14
DEALER NO:DA0047074/10

E207817

Abu Dhabi, Dubai

MODELO AG2SZ3
2109-14-8001
ANATEL
(01)0789895330292

E197509

Appendices



E202555

Brazil



E197811

Moldova

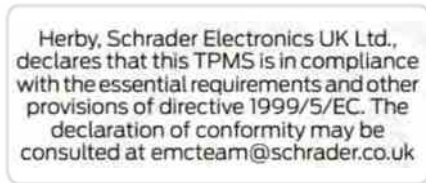

E207818

European Union EU



E207821

Morocco

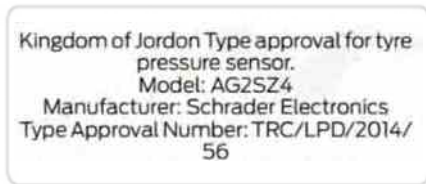

E207819

Jordan



E198001

Philippines



E207820

Malaysia



E197844

Serbia

Appendices

Complies with
IDA Standards
DA 00461

E207822

Singapore



TA-2014/064

Approved

E198002

South Africa



E203899



CCAM14LP0090T3

E203679

Taiwan



Schrader Electronics цім стверджує, що обладнання Радіопередавач моделі AG2S24 системи контролю тиску в шині автомобіля відповідає вимогам Технічного регламенту радіообладнання і телекомунікаційного кінцевого (термінального) обладнання (Постанова КМУ № 679 від 24 червня 2009 р.) Декларация відповідності знаходиться на сайті Schrader

Electronics та надається за запитом на електронну адресу doc.request@schrader.co.uk

E198009

Ukraine

Index

A

A/C	
See: Climate Control.....	99
About This Manual.....	7
ABS	
See: Brakes.....	139
ABS driving hints	
See: Hints on Driving With Anti-Lock Brakes.....	139
Accessories.....	340
Exterior style.....	340
Interior style.....	340
Lifestyle.....	340
Peace of mind.....	340
Accessories	
See: Replacement Parts Recommendation.....	11
ACC	
See: Using Adaptive Cruise Control.....	153
Adjusting the Headlamps.....	224
Horizontal Aim Adjustment.....	225
Vertical Aim Adjustment.....	224
Adjusting the Steering Wheel.....	61
Airbag Disposal.....	42
Air Conditioning	
See: Climate Control.....	99
Air Filter	
See: Changing the Engine Air Filter.....	229
Alarm	
See: Anti-Theft Alarm.....	60
Ambient Lighting.....	69
Anti-Theft Alarm.....	60
Arming the Alarm.....	60
Disarming the Alarm.....	60
Appendices.....	362
Audible Warnings and Indicators.....	79
Headlamps On Warning Chime.....	79
Keyless Warning Alert.....	79
Parking Brake On Warning Chime.....	79
Audio Control.....	61
MEDIA.....	61
Seek, Next or Previous.....	61
Audio System.....	291
General Information.....	291
Audio Unit - Vehicles With: AM/FM/CD/ SYNC/Satellite Radio.....	292

Audio Unit - Vehicles With: Premium AM/FM/CD.....	295
Autolamps.....	66
Windshield Wiper Activated Headlamps.....	66
Automatic Climate Control.....	101
Automatic Transmission.....	134
Automatic Transmission Adaptive Learning.....	136
Brake-Shift Interlock.....	135
If Your Vehicle Gets Stuck In Mud or Snow.....	136
SelectShift Automatic™ Transmission.....	134
Understanding the Positions of Your Automatic Transmission.....	134
Automatic Transmission Fluid Check.....	221
Autowipers.....	63
Auxiliary Power Points.....	117
12 Volt DC Power Point.....	117
Locations.....	117

B

Battery	
See: Changing the 12V Battery.....	222
Blind Spot Information System.....	160
Switching the System Off and On.....	162
System Errors.....	162
Using the System.....	160
Bonnet Lock	
See: Opening and Closing the Hood.....	211
Booster Seats.....	22
Types of Booster Seats.....	23
Brake and Clutch Fluid Check.....	221
Brakes.....	139
General Information.....	139
Breaking-In.....	187
Bulb Specification Chart.....	228

C

Cabin Air Filter.....	105
California Proposition 65.....	11
Capacities and Specifications - 2.3L EcoBoost™.....	278
Specifications.....	279

Index

Capacities and Specifications - 3.7L.....	282
Specifications.....	283
Capacities and Specifications - 5.0L.....	286
Specifications.....	287
Capacities and Specifications.....	271
Car Wash See: Cleaning the Exterior.....	230
Center Console.....	118
Locking Storage Bin.....	118
Changing a Bulb.....	226
Accessing the Direction Indicator and Fog Lamp Bulbs.....	226
Lamp Assembly Condensation.....	226
Replacing Fog Lamp Bulbs (If Equipped).....	227
Replacing HID Headlamp Bulbs.....	226
Replacing LED Fog Lamp Bulbs (If Equipped).....	227
Replacing rear, Brake, High-Mount Brake, Rear Direction Indicator and License Plate Lamp Bulbs.....	227
Replacing Reverse Lamp Bulbs.....	227
Replacing the Direction Indicator Bulbs.....	227
Changing a Fuse.....	209
Fuses.....	209
Changing a Road Wheel.....	264
Dissimilar Spare Wheel and Tire Assembly Information.....	264
Tire Change Procedure.....	265
Changing the 12V Battery.....	222
Battery Management System.....	223
Changing the Engine Air Filter.....	229
Changing the Wiper Blades.....	224
Checking MyKey System Status.....	51
Checking the Wiper Blades.....	224
Child Restraint and Seatbelt Maintenance.....	32
Child Restraint Positioning.....	24
Child Safety.....	15
General Information.....	15
Cleaning Leather Seats.....	234
Cleaning Products.....	230
Cleaning the Alloy Wheels.....	234
Cleaning the Convertible Top.....	237
Cleaning the Engine.....	232
Cleaning the Exterior.....	230
Exterior Chrome Parts.....	231
Exterior Plastic Parts.....	231
Stripes or Graphics.....	231
Underbody.....	231
Cleaning the Instrument Panel and Instrument Cluster Lens.....	233
Cleaning the Interior.....	233
Cleaning the Windows and Wiper Blades.....	232
Clearing All MyKeys.....	50
Climate Control.....	99
Climate Controlled Seats.....	112
Cooled Seats.....	112
Closing the Convertible Top.....	185
Collision Warning System.....	166
PRINCIPLE OF OPERATION.....	166
Convertible Top.....	184
Coolant Check See: Engine Coolant Check.....	217
Crash Sensors and Airbag Indicator.....	41
Creating a MyKey.....	49
Programming/Changing Configurable Settings.....	49
Cross Traffic Alert.....	162
False Alerts.....	165
Switching the System Off and On.....	165
System Errors.....	165
System Lights, Messages and Audible Alerts.....	164
System Limitations.....	164
Using the System.....	162
Cruise Control.....	62
Principle of Operation.....	152
Cruise control See: Using Cruise Control.....	152
Customer Assistance.....	195

D

Data Recording.....	9
Event Data Recording.....	9
Service Data Recording.....	9
Daytime Running Lamps.....	68
Type 1 - Conventional (Non-Configurable).....	68
Type 2 - Configurable.....	68

Index

Digital Radio.....	296	Engine Specifications - 5.0L.....	272
HD Radio Reception and Station Troubleshooting.....	297	Drivebelt Routing.....	272
Direction Indicators.....	69	Environment.....	14
Drive Control.....	168	Essential Towing Checks.....	180
Selectable Drive Modes.....	168	Before Towing a Trailer.....	180
Selectable Steering.....	169	Hitches.....	180
Driver and Passenger Airbags.....	35	Launching or Retrieving a Boat or Personal Watercraft (PWC).....	181
Children and Airbags.....	35	Safety Chains.....	180
Proper Driver and Front Passenger Seating Adjustment.....	35	Trailer Brakes.....	180
Driver and Passenger Knee Airbags.....	40	Trailer Lamps.....	180
Driving Aids.....	160	When Towing a Trailer.....	181
Driving at High Speed.....	269	Event Data Recording See: Data Recording.....	9
Driving Hints.....	187	Export Unique Options.....	13
Driving Through Water.....	187	Extended Service Plan (ESP).....	342
DRL See: Daytime Running Lamps.....	68	EXTENDED SERVICE PLAN (CANADA ONLY).....	343
E		EXTENDED SERVICE PLAN (U.S. Only).....	342
Economical Driving.....	187	Exterior Mirrors.....	71
Emission Control System.....	129	Blind Spot Monitor.....	72
On-Board Diagnostics (OBD-II).....	130	Fold-Away Exterior Mirrors.....	71
Readiness for Inspection/Maintenance (I/M) Testing.....	130	Heated Exterior Mirrors.....	71
End User License Agreement.....	362	Integrated Blind Spot Mirrors.....	71
SYNC End User License Agreement (EULA).....	362	Memory Mirrors.....	71
Engine Block Heater.....	122	Pony Projection Lights.....	71
Using the Engine Block Heater.....	123	Power Exterior Mirrors.....	71
Engine Coolant Check.....	217	Signal Indicator Mirrors.....	71
Adding Engine Coolant.....	218	F	
Checking the Engine Coolant.....	217	Fastening the Seatbelts.....	27
Recycled Engine Coolant.....	218	Seatbelt Extension Assembly.....	29
Severe Climates.....	219	Seatbelt Locking Modes.....	29
What You Should Know About Fail-Safe Cooling.....	219	Using Seatbelts During Pregnancy.....	28
Engine Immobilizer See: Passive Anti-Theft System.....	59	Flat Tire Inflation See: Tire Sealant and Inflator Kit.....	238
Engine Oil Check.....	216	Floor Mats.....	188
Adding Engine Oil.....	216	Fog Lamps - Front See: Front Fog Lamps.....	68
Engine Oil Dipstick.....	216	Ford Credit.....	11
Engine Specifications - 2.3L EcoBoost™.....	271	(U.S. Only).....	11
Drivebelt Routing.....	271	Front Fog Lamps.....	68
Engine Specifications - 3.7L.....	271	Front Passenger Sensing System.....	36
Drivebelt Routing.....	272	Fuel and Refueling.....	124

Index

Fuel Consumption.....	128	Headlamp Exit Delay.....	67
Calculating Fuel Economy.....	128	Head Restraints.....	107
Filling the Fuel Tank.....	128	Adjusting the Head Restraint.....	108
Fuel Filter.....	222	Front Seat Non-Adjustable Head Restraints	
Fuel Quality.....	125	108
Choosing the Right Fuel.....	125	Tilting Head Restraints.....	108
Octane Recommendations.....	125	Heated Windows and Mirrors.....	105
Fuel Shutoff.....	191	Heated Exterior Mirror.....	105
Fuses.....	202	Heated Rear Window.....	105
Fuse Specification Chart.....	202	Heating	
Passenger Compartment Fuse		See: Climate Control.....	99
Panel.....	206	Hill Start Assist.....	140
Power Distribution Box.....	202	Switching the System On and Off.....	141
G		Using Hill Start Assist.....	140
Garage Door Opener		Hints on Controlling the Interior	
See: Universal Garage Door Opener.....	113	Climate.....	102
Gauges.....	74	Cooling the Interior Quickly.....	104
Engine Coolant Temperature Gauge.....	75	General Hints.....	102
Fuel Gauge.....	75	Heating the Interior Quickly.....	103
Gauge Package.....	76	Recommended Settings for Cooling.....	104
Information Display.....	74	Recommended Settings for Heating.....	104
General Information on Radio		Side Window Defogging in Cold	
Frequencies.....	43	Weather.....	105
Intelligent Access.....	43	Hints on Driving With Anti-Lock	
General Maintenance Information.....	344	Brakes.....	139
Multi-Point Inspection.....	346	Hood Lock	
Owner Checks and Services.....	345	See: Opening and Closing the Hood.....	211
Protecting Your Investment.....	344	I	
Why Maintain Your Vehicle?.....	344	In California (U.S. Only).....	196
Why Maintain Your Vehicle at Your		Information Display Control.....	62
Dealership?.....	344	Information Displays.....	80
Getting Assistance Outside the U.S. and		General Information.....	80
Canada.....	198		
Getting the Services You Need.....	195		
Away From Home.....	195		
Glasses Holder.....	118		
Global Opening.....	70		
Opening the Windows.....	71		
H			
Handbrake			
See: Parking Brake.....	139		
Hazard Warning Flashers.....	191		
Headlamp Adjusting			
See: Adjusting the Headlamps.....	224		

Index

Information Messages.....	88
Adaptive Cruise Control.....	88
AdvanceTrac™.....	89
Airbag.....	89
Alarm.....	89
Battery and Charging System.....	90
Blind Spot Information and Cross Traffic Alert System.....	91
Collision Warning System.....	91
Doors and Locks.....	91
Engine.....	92
Fuel.....	92
Hill Start Assist.....	92
Keys and Intelligent Access.....	92
Maintenance.....	93
MyKey.....	94
Park Aid.....	94
Park Brake.....	95
Rear Axle.....	95
Remote Start.....	95
Seats.....	95
Starting System.....	96
Steering System.....	96
Tire Pressure Monitoring System.....	97
Traction Control.....	97
Transmission.....	97
Installing Child Restraints.....	16
Child Seats.....	16
Using Lap and Shoulder Belts.....	17
Using Lower Anchors and Tethers for Children (LATCH).....	19
Using Tether Straps.....	20
Instrument Cluster.....	74
Instrument Lighting Dimmer.....	67
Vehicles With Front Fog Lamps.....	67
Vehicles Without Front Fog Lamps.....	67
Interior Lamps.....	69
Map Lamps.....	69
Interior Luggage Compartment Release.....	57
Interior Mirror.....	72
Auto-Dimming Mirror.....	72
Introduction.....	7

J

Jump Starting the Vehicle.....	192
Connecting the Jumper Cables.....	192
Jump Starting.....	193
Preparing Your Vehicle.....	192
Removing the Jumper Cables.....	193

K

Keyless Starting.....	119
Ignition Modes.....	119
Keys and Remote Controls.....	43

L

Lighting Control.....	65
Headlamp Flasher.....	66
High Beams.....	65
Lighting.....	65
General Information.....	65
Limited Slip Differential.....	138
Traction-Lok™ and TORSEN™ Axles.....	138
Load Carrying.....	171
Load Limit.....	171
Vehicle Loading - with and without a Trailer.....	171
Locking and Unlocking.....	53
Activating Intelligent Access.....	54
Autolock Feature.....	55
Auto Relock.....	55
Battery Saver.....	57
Illuminated Entry.....	56
Illuminated Exit.....	56
Key Blade.....	55
Luggage Compartment.....	57
Power Door Locks.....	53
Remote Control.....	53
Smart Unlocks.....	54
Locks.....	53
Lug Nuts See: Changing a Road Wheel.....	264

M

Maintenance.....	211
General Information.....	211
Manual Climate Control.....	99

Index

Manual Seats.....	109
Manual Transmission Fluid Check.....	221
Manual Transmission.....	132
Parking Your Vehicle.....	133
Recommended Shift Speeds.....	132
Reverse.....	133
Using the Clutch.....	132
Media Hub.....	301
Memory Function.....	110
Easy Entry and Exit Feature.....	111
Linking a PreSet Position to your Remote Control or Intelligent Access Key Fob.....	111
Saving a PreSet Position.....	110
Message Center	
See: Information Displays.....	80
Mirrors	
See: Heated Windows and Mirrors.....	105
See: Windows and Mirrors.....	70
Mobile Communications Equipment.....	13
Motorcraft Parts - 2.3L EcoBoost™.....	273
Motorcraft Parts - 3.7L.....	274
Motorcraft Parts - 5.0L.....	275
MyKey Troubleshooting.....	52
MyKey™.....	48
Principle of Operation.....	48
N	
Normal Scheduled Maintenance.....	347
Intelligent Oil-Life Monitor™.....	347
Normal Maintenance Intervals.....	348
O	
Oil Check	
See: Engine Oil Check.....	216
Opening and Closing the Hood.....	211
Closing the Hood.....	212
Opening the Hood.....	211
Opening the Convertible Top.....	184
Using the Tonneau Caps.....	185
Ordering Additional Owner's Literature.....	199
Obtaining a French Owner's Manual.....	200

P

Parking Aids.....	147
Principle of Operation.....	147
Parking Brake.....	139
Passive Anti-Theft System.....	59
SecuriLock.....	59
PATS	
See: Passive Anti-Theft System.....	59
Perchlorate.....	11
Personal Safety System™.....	33
How Does the Personal Safety System Work?.....	33
Post-Crash Alert System.....	194
Power Door Locks	
See: Locking and Unlocking.....	53
Power Seats.....	109
Power Lumbar.....	110
Power Steering Fluid Check.....	221
Power Windows.....	70
Accessory Delay.....	70
Bounce-Back (Coupe Only).....	70
One-Touch Down.....	70
One-Touch Up (Coupe Only).....	70
Protecting the Environment.....	14

R

Rear Axle.....	138
Rear Parking Aid.....	147
Obstacle Distance Indicator.....	148
Rear Seats.....	111
Second Row Split-Folding Rear Seat.....	112
Rear View Camera.....	148
Using the Rear View Camera System.....	149
Rear View Camera	
See: Rear View Camera.....	148
Recommended Towing Weights.....	179
Refueling.....	126
Easy Fuel™ Capless Fuel System.....	127
Remote Control.....	44
Car Finder.....	46
Intelligent Access Key.....	44
Memory Feature.....	47
Remote Start.....	46
Replacing the Battery.....	45
Sounding a Panic Alarm.....	46
Using the Key Blade.....	44

Index

Remote Start.....	106	Seatbelts.....	26
Automatic Settings.....	106	Principle of Operation.....	26
Repairing Minor Paint Damage.....	234	Seatbelt Warning Lamp and Indicator	
Replacement Parts		Chime.....	30
Recommendation.....	11	Conditions of operation.....	30
Collision Repairs.....	11	Seats.....	107
Scheduled Maintenance and Mechanical		Security.....	59
Repairs.....	11	Side Airbags.....	38
Warranty on Replacement Parts.....	12	Sitting in the Correct Position.....	107
Replacing a Lost Key or Remote		Snow Chains	
Control.....	47	See: Using Snow Chains.....	259
Reporting Safety Defects (Canada		Special Notices.....	12
Only).....	200	Additional Warranty Information.....	12
Reporting Safety Defects (U.S.		New Vehicle Limited Warranty.....	12
Only).....	200	On-board Diagnostics (OBD-II).....	13
Roadside Assistance.....	190	Special Instructions.....	13
Vehicles Sold in Canada: Getting Roadside		Special Operating Conditions Scheduled	
Assistance.....	190	Maintenance.....	350
Vehicles Sold in Canada: Roadside		Exceptions.....	351
Assistance Program Coverage.....	191	Speed Control	
Vehicles Sold in Canada: Using Roadside		See: Cruise Control.....	152
Assistance.....	191	Stability Control.....	143
Vehicles Sold in the United States: Getting		Principle of Operation.....	143
Roadside Assistance.....	190	Starting a Gasoline Engine.....	120
Vehicles Sold in the United States: Using		Automatic Engine Shutdown.....	121
Roadside Assistance.....	190	Failure to Start.....	121
Roadside Emergencies.....	190	Fast Restart.....	121
Running-In		Guarding Against Exhaust Fumes.....	122
See: Breaking-In.....	187	Important Ventilating Information.....	122
Running Out of Fuel.....	125	Stopping the Engine When Your Vehicle is	
Refilling With a Portable Fuel		Moving.....	122
Container.....	126	Stopping the Engine When Your Vehicle is	
		Stationary.....	121
S		Starting and Stopping the Engine.....	119
Safety Canopy™ - Coupe.....	40	General Information.....	119
Safety Precautions.....	124	Steering.....	165
Satellite Radio.....	298	Electric Power Steering.....	165
Satellite Radio Electronic Serial Number		Steering Wheel Lock.....	120
(ESN).....	299	Steering Wheel.....	61
Satellite Radio Reception Factors.....	299	Storage Compartments.....	118
SIRIUS® Satellite Radio Service.....	299	Sun Visors.....	73
Troubleshooting.....	300	Illuminated Vanity Mirror.....	73
Scheduled Maintenance Record.....	352	Supplementary Restraints System.....	34
Scheduled Maintenance.....	344	Principle of Operation.....	34
Seatbelt Reminder.....	30	Symbols Glossary.....	7
Belt-Minder™.....	30	SYNC™ Applications and Services.....	318
		911 Assist.....	318
		SYNC Mobile Apps.....	320

Index

SYNC™	302
General Information.....	302
SYNC™ Troubleshooting.....	332

T

Technical Specifications	
See: Capacities and Specifications.....	271
The Better Business Bureau (BBB) Auto Line Program (U.S. Only).....	197
Tire Care.....	244
Glossary of Tire Terminology.....	246
Information About Uniform Tire Quality Grading.....	244
Information Contained on the Tire Sidewall.....	247
Temperature A B C.....	245
Traction AA A B C.....	245
Treadwear.....	245
Tire Inflation When Punctured	
See: Tire Sealant and Inflator Kit.....	238
Tire Pressure Monitoring System.....	260
Changing Tires With a Tire Pressure Monitoring System.....	261
Understanding Your Tire Pressure Monitoring System	261
Tire Repair Kit	
See: Tire Sealant and Inflator Kit.....	238
Tire Sealant and Inflator Kit.....	238
First Stage: Inflating the Tire with Sealing Compound and Air.....	240
General Information.....	239
Second Stage: Checking Tire Pressure.....	242
Tips for Use of the Kit.....	239
What to Do After the Tire has Been Sealed.....	242
What to do When a Tire Is Punctured.....	240
Tires	
See: Wheels and Tires.....	238
Towing a Trailer.....	178
Load Placement.....	178
Towing the Vehicle on Four Wheels.....	182
Emergency Towing.....	182
Recreational Towing.....	182
Towing.....	178

Traction Control.....	142
Principle of Operation.....	142
Transmission Code Designation.....	277
Transmission.....	132
Transmission	
See: Transmission.....	132
Transporting the Vehicle.....	182
Type Approvals.....	383
RF Certification Logos for Tire Pressure Monitoring Sensor(s).....	383

U

Under Hood Overview - 2.3L EcoBoost™.....	213
Under Hood Overview - 3.7L.....	214
Under Hood Overview - 5.0L.....	215
Universal Garage Door Opener.....	113
HomeLink Wireless Control System.....	113
USB Port.....	301
Using Adaptive Cruise Control.....	153
Automatic Cancellation.....	157
Blocked Sensor.....	158
Canceling the Set Speed.....	156
Changing the Set Speed.....	156
Detection Issues.....	157
Following a Vehicle.....	154
Hilly Condition Usage.....	157
Overriding the Set Speed.....	156
Resuming the Set Speed.....	156
Setting the Adaptive Cruise Speed.....	154
Setting the Gap Distance.....	155
Switching Adaptive Cruise Control On.....	154
Switching the System Off.....	157
Switching to Normal Cruise Control.....	159
System Not Available.....	158
Using Cruise Control.....	152
Switching Cruise Control Off.....	153
Switching Cruise Control On.....	152
Using MyKey With Remote Start Systems.....	52
Using Snow Chains.....	259
Using Stability Control.....	144
AdvanceTrac™	144
Line Lock.....	145
Using Summer Tires.....	259

Index

Using SYNC™ With Your Media Player.....	323
Accessing Your USB Song Library.....	327
Bluetooth Devices and System Settings.....	329
Connecting Your Digital Media Player to the USB Port.....	323
Media Menu Features.....	327
Media Voice Commands.....	324
USB 2.....	329
Voice Commands for Audio Sources.....	330
Using SYNC™ With Your Phone.....	306
Accessing Features through the Phone Menu.....	311
Accessing Your Phone Settings.....	314
Bluetooth Devices.....	315
Making Calls.....	309
Pairing a Phone for the First Time.....	306
Pairing Subsequent Phones.....	307
Phone Options during an Active Call.....	310
Phone Voice Commands.....	308
Receiving Calls.....	310
System Settings.....	316
Text Messaging.....	312
Using Traction Control.....	142
Switching the System Off	142
System Indicator Lights and Messages.....	142
Using Voice Recognition.....	304
Initiating a Voice Session.....	304
System Interaction and Feedback.....	305
Utilizing the Mediation/Arbitration Program (Canada Only).....	198
V	
Vehicle Care.....	230
General Information.....	230
Vehicle Certification Label.....	277
Vehicle Identification Number.....	276
Vehicle Storage.....	235
Battery.....	236
Body.....	235
Brakes.....	236
Cooling system.....	236
Engine.....	235
Fuel system.....	236
General.....	235
Miscellaneous.....	236
Removing Vehicle From Storage.....	236
Tires.....	236
Ventilation	
See: Climate Control.....	99
VIN	
See: Vehicle Identification Number.....	276
Voice Control.....	62
W	
Warning Lamps and Indicators.....	76
Adaptive Cruise Control.....	76
Anti-Lock Braking System.....	76
Battery.....	76
Blind Spot Monitor.....	76
Brake System.....	76
Cruise Control.....	77
Direction Indicator.....	77
Door Ajar.....	77
Engine Coolant Temperature.....	77
Engine Oil.....	77
Fasten Safety Belt.....	77
Front Airbag.....	77
Front Fog Lamps.....	77
Heads Up Display.....	77
High Beam.....	78
Low Fuel Level.....	78
Low Tire Pressure Warning.....	78
Parking Lamps.....	78
Service Engine Soon.....	78
Stability Control.....	78
Stability Control Off.....	79
Washer Fluid Check.....	222
Washers	
See: Cleaning the Exterior.....	230
See: Wipers and Washers.....	63
Waxing.....	231
Welcome Lighting.....	69
Pony Projection Lights.....	69

Index

Wheel Nuts	
See: Changing a Road Wheel.....	264
Wheels and Tires.....	238
Technical Specifications.....	270
Windows and Mirrors.....	70
Windshield Washers.....	64
Windshield Wipers.....	63
Intermittent Wipe.....	63
Speed Dependent Wipers.....	63
Wiper Blades	
See: Checking the Wiper Blades.....	224
Wipers and Washers.....	63
Wrecker Towing	
See: Transporting the Vehicle.....	182