

## Table of Contents

<b>Introduction</b>	<b>4</b>
<b>Instrument Cluster</b>	<b>14</b>
Warning lights and chimes	14
Gauges	19
<b>Entertainment Systems</b>	<b>22</b>
AM/FM stereo	22
AM/FM stereo with CD	23
Auxiliary input jack (Line in)	25
Bluetooth system	27
<b>Climate Controls</b>	<b>38</b>
Manual heating and air conditioning	38
Rear window defroster	41
<b>Lights</b>	<b>43</b>
Headlamps	43
Turn signal control	46
Bulb replacement	47
<b>Driver Controls</b>	<b>56</b>
Windshield wiper/washer control	56
Steering wheel adjustment	57
Power windows	59
Mirrors	59
Speed control	61
<b>Locks and Security</b>	<b>68</b>
Keys	68
Anti-theft system	74

## Table of Contents

### **Seating and Safety Restraints 77**

Seating	77
Safety restraints	87
Airbags	100
Child restraints	111

### **Tires, Wheels and Loading 131**

Tire information	133
Tire inflation	135
Tire Pressure Monitoring System (TPMS)	148
Vehicle loading	156
Trailer towing	162
Recreational towing	162

### **Driving 163**

Starting	163
Brakes	168
AdvanceTrac®	170
Transmission operation	177
Reverse sensing system	179
Rear-view camera system	181

### **Roadside Emergencies 185**

Getting roadside assistance	185
Hazard flasher control	186
Fuel pump shut-off switch	186
Fuses and relays	187
Changing tires	195
Wheel lug nut torque	202
Jump starting	203
Wrecker towing	207

### **Customer Assistance 209**

Reporting safety defects (U.S. only)	215
Reporting safety defects (Canada only)	216

### **Cleaning 217**

## Table of Contents

<b>Maintenance and Specifications</b>	<b>225</b>
Engine compartment	227
Engine oil	229
Battery	231
Engine coolant	233
Fuel information	239
Air filter(s)	253
Part numbers	256
Maintenance product specifications and capacities	257
Engine data	259
<b>Accessories</b>	<b>263</b>
<b>Ford Extended Service Plan</b>	<b>265</b>
<b>Scheduled Maintenance</b>	<b>269</b>
Normal scheduled maintenance and log	274
<b>Index</b>	<b>290</b>

All rights reserved. Reproduction by any means, electronic or mechanical including photocopying, recording or by any information storage and retrieval system or translation in whole or part is not permitted without written authorization from Ford Motor Company. Ford may change the contents without notice and without incurring obligation.

Copyright © 2010 Ford Motor Company

## Introduction

### CONGRATULATIONS

Congratulations on acquiring your new Ford. Please take the time to get well acquainted with your vehicle by reading this handbook. The more you know and understand about your vehicle, the greater the safety and pleasure you will derive from driving it.

For more information on Ford Motor Company and its products visit the following website:

- In the United States: [www.ford.com](http://www.ford.com)
- In Canada: [www.ford.ca](http://www.ford.ca)
- In Australia: [www.ford.com.au](http://www.ford.com.au)
- In Mexico: [www.ford.com.mx](http://www.ford.com.mx)

Additional owner information is given in separate publications.

This Owner's Guide describes every option and model variant available and therefore some of the items covered may not apply to your particular vehicle. Furthermore, due to printing cycles it may describe options before they are generally available.

Remember to pass on this Owner's Guide when reselling the vehicle. It is an integral part of the vehicle.



**WARNING: Fuel pump shut-off:** In the event of an accident this feature will automatically cut off the fuel supply to the engine. It can also be activated through sudden vibration (e.g. collision when parking). To restart your vehicle, refer to *Fuel pump shut-off* in the *Roadside Emergencies* chapter.

## Introduction

### SAFETY AND ENVIRONMENT PROTECTION

#### **Warning symbols in this guide**

How can you reduce the risk of personal injury to yourself or others? In this guide, answers to such questions are contained in comments highlighted by the warning triangle symbol. These comments should be read and observed.

#### **Warning symbols on your vehicle**

When you see this symbol, it is imperative that you consult the relevant section of this guide before touching or attempting adjustment of any kind.



#### **Protecting the environment**

We must all play our part in protecting the environment. Correct vehicle usage and the authorized disposal of waste, cleaning and lubrication materials are significant steps towards this aim. Information in this respect is highlighted in this guide with the tree symbol.



#### **CALIFORNIA Proposition 65 Warning**

 **WARNING:** Engine exhaust, some of its constituents, and certain vehicle components contain or emit chemicals known to the State of California to cause cancer and birth defects or other reproductive harm. In addition, certain fluids contained in vehicles and certain products of component wear contain or emit chemicals known to the State of California to cause cancer and birth defects or other reproductive harm.

## Introduction

### PERCHLORATE MATERIAL

Certain components of this vehicle such as airbag modules, seat belt pretensioners, and button cell batteries may contain Perchlorate Material – Special handling may apply for service or vehicle end of life disposal. See [www.dtsc.ca.gov/hazardouswaste/perchlorate](http://www.dtsc.ca.gov/hazardouswaste/perchlorate).

### BREAKING-IN YOUR VEHICLE

Your vehicle does not need an extensive break-in. Try not to drive continuously at the same speed for the first 1,000 miles (1,600 km) of new vehicle operation. Vary your speed frequently in order to give the moving parts a chance to break in.

Drive your new vehicle at least 1,000 miles (1,600 km) before towing a trailer. For more detailed information about towing a trailer, refer to *Trailer towing* in the *Tires, Wheels and Loading* chapter.

Do not add friction modifier compounds or special break-in oils since these additives may prevent piston ring seating. See *Engine oil* in the *Maintenance and Specifications* chapter for more information on oil usage.

### SPECIAL NOTICES

#### New Vehicle Limited Warranty

For a detailed description of what is covered and what is not covered by your vehicle's New Vehicle Limited Warranty, refer to the *Warranty Guide* that is provided to you along with your Owner's Guide.

#### Special instructions

For your added safety, your vehicle is fitted with sophisticated electronic controls.



**WARNING:** Please read the section *Airbag Supplemental Restraint System (SRS)* in the *Seating and Safety Restraints* chapter. Failure to follow the specific warnings and instructions could result in personal injury.



**WARNING:** Front seat mounted rear-facing child or infant seats should **NEVER** be placed in front of an active passenger airbag.

## Introduction

### Transit Connect Electric vehicles

All references in this publication to engine, engine coolant, fuel system, transmission and related specifications should be disregarded for the Transit Connect Electric. Please see the Transit Connect Electric supplement for specific references to unique systems.

### Notice to owners of pickup trucks and utility type vehicles



**WARNING:** Utility vehicles have a significantly higher rollover rate than other types of vehicles.

Before you drive your vehicle, please read this Owner's Guide carefully. Your vehicle is not a passenger car. As with other vehicles of this type, failure to operate this vehicle correctly may result in loss of vehicle control, vehicle rollover, personal injury or death.

### Using your vehicle as an ambulance

#### **Do not use this vehicle as an ambulance.**

Your vehicle is not equipped with the Ford Ambulance Preparation Package.

## DATA RECORDING

### Service Data Recording

Service data recorders in your vehicle are capable of collecting and storing diagnostic information about your vehicle. This potentially includes information about the performance or status of various systems and modules in the vehicle, such as engine, throttle, steering or brake systems. In order to properly diagnose and service your vehicle, Ford Motor Company, Ford of Canada, and service and repair facilities may access or share among them vehicle diagnostic information received through a direct connection to your vehicle when diagnosing or servicing your vehicle. For U.S. only (if equipped), if you choose to use the SYNC® Vehicle Health Report, you consent that certain diagnostic information may also be accessed electronically by Ford Motor Company and Ford authorized service facilities, and that the diagnostic information may be used for any purpose. See your *SYNC*® supplement for more information.

## Introduction

### Event Data Recording

This vehicle is equipped with an event data recorder (EDR). The main purpose of an EDR is to record, in certain crash or near crash-like situations, such as an airbag deployment or hitting a road obstacle; this data will assist in understanding how a vehicle's systems performed. The EDR is designed to record data related to vehicle dynamics and safety systems for a short period of time, typically 30 seconds or less. The EDR in this vehicle is designed to record such data as:

- How various systems in your vehicle were operating;
- Whether or not the driver and passenger seatbelts were buckled/fastened;
- How far (if at all) the driver was depressing the accelerator and/or the brake pedal; and
- How fast the vehicle was travelling; and
- Where the driver was positioning the steering wheel.

This data can help provide a better understanding of the circumstances in which crashes and injuries occur.

**Note:** EDR data is recorded by your vehicle only if a non-trivial crash situation occurs; no data is recorded by the EDR under normal driving conditions and no personal data or information (e.g., name, gender, age, and crash location) is recorded (see limitations regarding 911 Assist and Traffic, directions and Information privacy below). However, parties, such as law enforcement, could combine the EDR data with the type of personally identifying data routinely acquired during a crash investigation.

To read data recorded by an EDR, special equipment is required, and access to the vehicle or the EDR is needed. In addition to the vehicle manufacturer, other parties, such as law enforcement, that have such special equipment, can read the information if they have access to the vehicle or the EDR. Ford Motor Company and Ford of Canada do not access event data recorder information without obtaining consent, unless pursuant to court order or where required by law enforcement, other government authorities or other third parties acting with lawful authority. Other parties may seek to access the information independently of Ford Motor Company and Ford of Canada.



## Introduction

**Note: Including to the extent that any law pertaining to Event Data Recorders applies to SYNC® or its features, please note the following: Once 911 Assist (if equipped) is enabled (set ON), 911 Assist may, through any paired and connected cell phone, disclose to emergency services that the vehicle has been in a crash involving the deployment of an airbag or, in certain vehicles, the activation of the fuel pump shut-off. Certain versions or updates to 911 Assist may also be capable of being used to electronically or verbally provide to 911 operators the vehicle location (such as latitude and longitude), and/or other details about the vehicle or crash or personal information about the occupants to assist 911 operators to provide the most appropriate emergency services. If you do not want to disclose this information, do not activate the 911 Assist feature. See your SYNC® supplement for more information.**

**Additionally, when you connect to Traffic, Directions and Information (if equipped, U.S. only) the service uses GPS technology and advanced vehicle sensors to collect the vehicle's current location, travel direction, and speed ("vehicle travel information") only to help provide you with the directions, traffic reports, or business searches your request. If you do not want Ford or its vendors to receive this information, do not activate the service. Ford Motor Company and the vendors it uses to provide you with this information do not store your vehicle travel information. For more information, see Traffic, Directions and Information, Terms and Conditions. See your SYNC® supplement for more information.**

### **Vehicle Modification Data Recording**

Some aftermarket products may cause severe engine and/or transmission damage; refer to the *What is not covered* section in *The new vehicle limited warranty for your vehicle* chapter of your vehicle's *Warranty Guide* for more information. Some vehicles are equipped with Powertrain Control Systems that can detect and store information about vehicle modifications that, for example, increase horsepower and torque output; this information cannot be erased and will stay in the system's memory even if the modification is removed. When a dealer or repair facility works on your vehicle, it may be necessary for them to access the information in the Powertrain Control System. This information will likely identify if any unauthorized modifications have been made to the system, which may be used to determine if the warranty has been violated and if repairs will be covered by warranty.

## Introduction

### CELL PHONE USE

The use of Mobile Communications Equipment has become increasingly important in the conduct of business and personal affairs. However, drivers must not compromise their own or others' safety when using such equipment. Mobile Communications can enhance personal safety and security when appropriately used, particularly in emergency situations. Safety must be paramount when using mobile communications equipment to avoid negating these benefits.

Mobile Communication Equipment includes, but is not limited to, cellular phones, pagers, portable email devices, text messaging devices and portable two-way radios.



**WARNING:** Driving while distracted can result in loss of vehicle control, accident and injury. Ford strongly recommends that you use extreme caution when using any device or feature that may take your focus off the road. Your primary responsibility is the safe operation of your vehicle. We recommend against the use of any handheld device while driving and that you comply with all applicable laws.

## Introduction



















### **EXPORT UNIQUE (NON-UNITED STATES/CANADA) VEHICLE SPECIFIC INFORMATION**

For your particular global region, your vehicle may be equipped with features and options that are different from the features and options that are described in this Owner's Guide. A market unique supplement may be supplied that complements this book. By referring to the market unique supplement, if provided, you can properly identify those features, recommendations and specifications that are unique to your vehicle. This Owner's Guide is written primarily for the U.S. and Canadian Markets. Features or equipment listed as standard may be different on units built for Export. **Refer to this Owner's Guide for all other required information and warnings.**

## Introduction













These are some of the symbols you may see on your vehicle.

### Vehicle Symbol Glossary

Safety Alert		See Owner's Guide	
Fasten Safety Belt		Airbag - Front	
Airbag - Side		Child Seat Lower Anchor	
Child Seat Tether Anchor		Brake System	
Anti-Lock Brake System		Parking Brake System	
Brake Fluid - Non-Petroleum Based		Parking Aid System	
Stability Control System		Speed Control	
Master Lighting Switch		Hazard Warning Flasher	
Fog Lamps-Front		Fuse Compartment	
Fuel Pump Reset		Windshield Wash/Wipe	
Windshield Defrost/Demist		Rear Window Defrost/Demist	

## Introduction

### Vehicle Symbol Glossary

Power Windows Front/Rear		Power Window Lockout	
Child Safety Door Lock/Unlock		Interior Luggage Compartment Release	
Panic Alarm		Engine Oil	
Engine Coolant		Engine Coolant Temperature	
Do Not Open When Hot		Battery	
Avoid Smoking, Flames, or Sparks		Battery Acid	
Explosive Gas		Fan Warning	
Power Steering Fluid		Maintain Correct Fluid Level	
Service Engine Soon		Engine Air Filter	
Passenger Compartment Air Filter		Jack	
Check Fuel Cap		Low Tire Pressure Warning	

## Instrument Cluster

### WARNING LIGHTS AND CHIMES

Standard instrument cluster shown; metric clusters similar

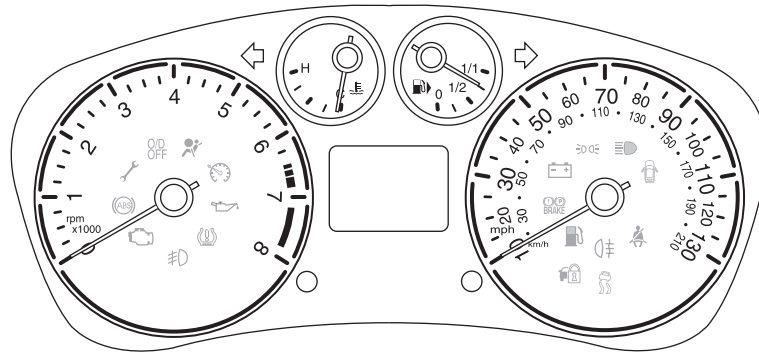

Warning lights and gauges can alert you to a vehicle condition that may become serious enough to cause expensive repairs. A warning light may illuminate when a problem exists with one of your vehicle's functions. Many lights will illuminate when you start your vehicle to make sure the bulb works. If any light remains on after starting the vehicle, refer to the respective system warning light for additional information.

**Service engine soon:** The *service engine soon* indicator light illuminates when the ignition is first turned to the on position to check the bulb and to indicate whether the vehicle is ready for Inspection/Maintenance (I/M) testing. Normally, the “service engine soon” light will stay on until the engine is cranked, then turn itself off if no malfunctions are present. However, if after 15 seconds the “service engine soon” light blinks eight times, it means that the vehicle is not ready for I/M testing. See the *Readiness for Inspection/Maintenance (I/M) testing* in the *Maintenance and Specifications* chapter.

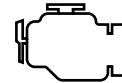

Solid illumination after the engine is started indicates the on-board diagnostics system (OBD-II) has detected a malfunction. Refer to *On-board diagnostics (OBD-II)* in the *Maintenance and Specifications* chapter. If the light is blinking, engine misfire is occurring which could damage your catalytic converter. Drive in a moderate fashion (avoid heavy acceleration and deceleration) and have your vehicle serviced immediately by your authorized dealer.

## Instrument Cluster



**WARNING:** Under engine misfire conditions, excessive exhaust temperatures could damage the catalytic converter, the fuel system, interior floor coverings or other vehicle components, possibly causing a fire.

**Brake system warning light:** To confirm the brake system warning light is functional, it will momentarily illuminate when the ignition is turned to the on position



when the engine is not running, or in a position between on and start, or by applying the parking brake when the ignition is turned to the on position. If the brake system warning light does not illuminate at this time, seek service immediately from your authorized dealer. Illumination after releasing the parking brake indicates low brake fluid level and the brake system should be inspected immediately by your authorized dealer.



**WARNING:** Driving a vehicle with the brake system warning light on is dangerous. A significant decrease in braking performance may occur. It will take you longer to stop the vehicle. Have the vehicle checked by your authorized dealer. Driving extended distances with the parking brake engaged can cause brake failure and the risk of personal injury.

**Anti-lock brake system:** If the ABS light stays illuminated or continues to flash, a malfunction has been detected, have the system serviced immediately by your authorized dealer. Normal braking is still functional unless the brake warning light also is illuminated.

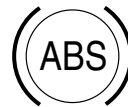

**Airbag readiness:** If this light fails to illuminate when the ignition is turned to on, continues to flash or remains on, have the system serviced immediately by your authorized dealer. A chime will sound when there is a malfunction in the indicator light.



## Instrument Cluster

**Safety belt:** Reminds you to fasten your front driver and passenger safety belt. A Belt-Minder® chime will also sound to remind you to fasten your safety belt. Refer to the *Seating and Safety Restraints* chapter to activate/deactivate the Belt-Minder® chime feature.



**Charging system:** Illuminates when the battery is not charging properly. If it stays on while the engine is running, there may be a malfunction with the charging system. Contact your authorized dealer as soon as possible. This indicates a problem with the electrical system or a related component.



**Engine oil pressure:** Illuminates when the oil pressure falls below the normal range, refer to *Engine oil* in the *Maintenance and Specifications* chapter.

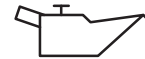

**Anti-theft system:** Flashes when the SecuriLock® Passive Anti-theft system has been activated.



**Overdrive off (if equipped):** Illuminates when the overdrive function of the transaxle has been turned off, refer to the *Driving* chapter. If the light flashes steadily or does not illuminate, have the transmission serviced soon, or damage may occur.



**Speed control (if equipped):** Illuminates when the speed control is activated. Turns off when the speed control system is deactivated, refer to the *Driver Controls* chapter for more information.

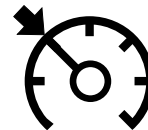



## Instrument Cluster

**Low tire pressure warning:**

Illuminates when your tire pressure is low. If the light remains on at start up or while driving, the tire pressure should be checked. Refer

to *Inflating your tires* in the *Tires, Wheels and Loading* chapter. When the ignition is first turned to on, the light will illuminate for three seconds to ensure the bulb is working. If the light does not turn on or begins to flash, have the system inspected by your authorized dealer. For more information on this system, refer to *Tire pressure monitoring system (TPMS)* in the *Tires, Wheels and Loading* chapter.

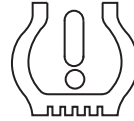

**AdvanceTrac®:** Illuminates when the AdvanceTrac® is active. If the light remains on, contact your authorized dealer as soon as possible. Refer to the *Driving* chapter for more information.



**Throttle control/transmission:**

Illuminates when a powertrain fault has been detected. Contact your authorized dealer as soon as possible.



**Low fuel:** Illuminates when the fuel level in the fuel tank is at or near empty (refer to *Fuel gauge* in this chapter).



**Door ajar:** Illuminates when the ignition is in the on position and any door is not completely closed.



**Turn signal:** Illuminates when the left or right turn signal or the hazard lights are turned on. If the indicators stay on or flash faster, check for a burned out bulb.



**High beams:** Illuminates when the high-beam headlamps are turned on.



## Instrument Cluster

**Park lamps:** Illuminates when the park lamps are turned on.



**Front fog lamps (if equipped):** Illuminates when the front fog lamps are turned on.



**Rear fog lamps:** Illuminates when the rear fog lamps are turned on.



**Key-in-ignition warning chime:** Sounds when the key is left in the ignition in the off or accessory position and the driver's door is opened.

**Park warning chime:** Sounds when the transmission is not in park, the driver's door is opened and the ignition is off or in accessory position.

**Headlamps on warning chime:** Sounds when the headlamps or parking lamps are on and the driver's door is opened.

**Seatbelt warning chime:** The seatbelt chime sounds when the driver's seatbelt is not fastened. When the ignition is in run and the seatbelt is not fastened, the chime will chime for six seconds. The chime will turn off if the driver's seatbelt is fastened or if the ignition returns to off or accessory position.

**Belt-Minder® warning chime:** This chime periodically sounds to remind the driver and/or passenger that their seatbelt is unbuckled. The seatbelt warning lamp in the cluster will also illuminate once vehicle speed has exceeded 6 mph (10 km/h).

**Airbag secondary warning chime:** This chime sounds to indicate a fault with the supplemental restraint system in the event that the airbag readiness warning light is not operating.

**Door ajar warning chime:** The door ajar reminder chime informs the driver that one or more doors are open while the ignition is in the run position.

### Electric vehicles

For specific information on the Transit Connect Electric, refer to the *Azure Dynamics TC-E Owner's Guide Supplement*.

## Instrument Cluster

### GAUGES

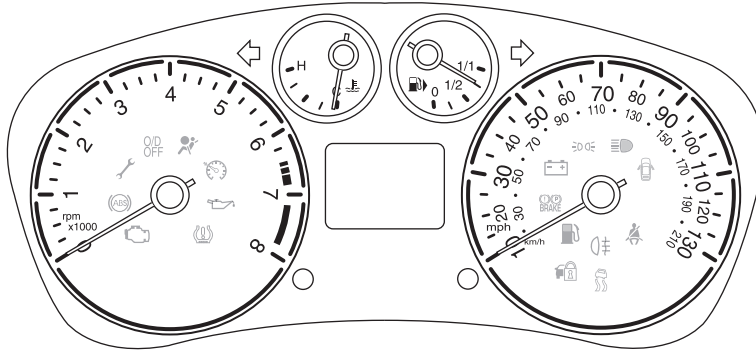

**Speedometer:** Indicates the current vehicle speed.

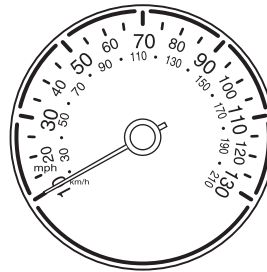

**Tachometer:** Indicates the engine speed in revolutions per minute. Driving with your tachometer pointer continuously at the top of the scale may damage the engine.

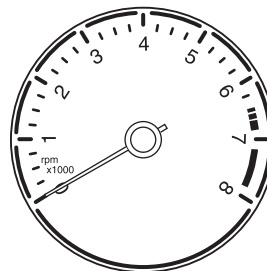

## Instrument Cluster

**Engine coolant temperature gauge:** Indicates engine coolant temperature. At normal operating temperature, the needle will be in the normal range. **If it enters the red section, the engine is overheating. Stop the vehicle as soon as safely possible, switch off the engine and let the engine cool.** If it enters the red section

and the service engine soon indicator light illuminates, refer to *How fail safe cooling works* in the *Maintenance and Specifications* chapter.

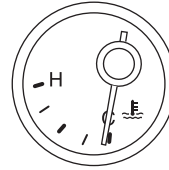

**WARNING:** Never remove the coolant reservoir cap while the engine is running or hot.

**Fuel gauge:** Indicates approximately how much fuel is left in the fuel tank (when the ignition is in the on position). The fuel gauge may vary slightly when the vehicle is in motion or on a grade.

The symbol of the fuel pump with the arrow points to the side of the vehicle that the fuel filler inlet is located.

Refer to *Filling the tank* in the *Maintenance and Specifications* chapter for more information.

**Information display type 1**

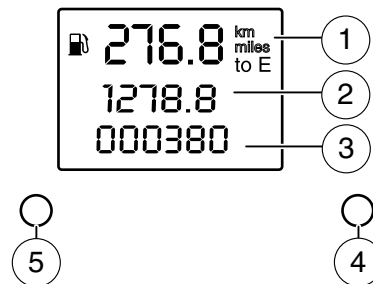

## Instrument Cluster

### Information display type 2

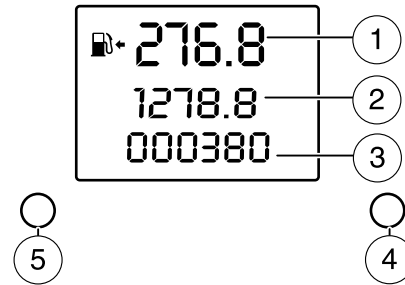

1. **Distance to empty / clock:** Registers the approximate distance the vehicle can travel before refueling is necessary. Clock shows the current set time.

#### Switching the display between “clock” and “distance to empty”:

- Vehicles with AM/FM radio: Press and release the Select button (4) to switch between the “distance to empty” display and the clock display.
- Vehicles with AM/FM radio/CD player: “Distance to empty” information is displayed normally. Press and hold the Select button (4) to switch to the “clock” display. After releasing the button, “distance to empty” will display again.

#### Setting the clock:

*Vehicles with AM/FM radio:* Press and hold the Select button (4) until the time flashes in the display. Press the Select button (4) to set the time.

*Vehicles with AM/FM radio / CD player:* Use the radio to set the time. See *Setting the clock* in the *Entertainment* chapter.

2. **Trip odometer:** Registers the distance of individual journeys. Press the Reset button (5) until the trip odometer resets.

3. **Odometer:** Registers the miles (kilometers) of the vehicle.

4. **Select button:** Press to switch between clock and distance to empty. Also used to set the clock for vehicles equipped with AM/FM radio.

5. **Reset button:** Press until the trip odometer resets.

**Note:** The information display will remain on for several minutes after you switch off the ignition.

If SHON or SHIP ON is displayed, the vehicle shipping mode is switched on. Have your dealer switch off the vehicle shipping mode.

## Entertainment Systems

### AUDIO SYSTEMS

#### AM/FM stereo (if equipped)

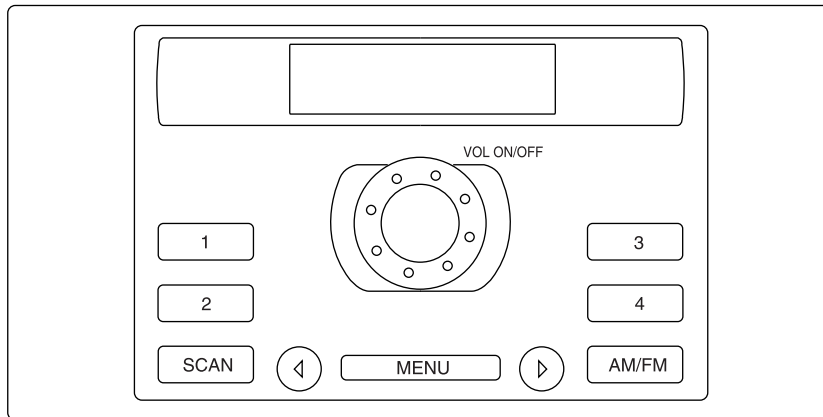

**WARNING:** Driving while distracted can result in loss of vehicle control, accident and injury. Ford strongly recommends that drivers use extreme caution when using any device or feature that may take their focus off the road. Your primary responsibility is the safe operation of the vehicle. We recommend against the use of any handheld device while driving, encourage the use of voice-operated systems when possible and that you become aware of applicable state and local laws that may affect the use of electronic devices while driving.

**One hour mode:** Press the ON/OFF control to operate the system with the ignition turned off; the system will automatically turn off after one hour.

**VOL ON/OFF:** Press to turn ON/OFF. Turn to increase/decrease volume.

#### **AM/FM Radio**

**AM/FM:** Press repeatedly to select AM/FM frequency band.

**◀▶** (Seek): Press to access the next strong station on the frequency band.

**SCAN:** Press for a brief sampling of all strong radio stations.

**(1-4):** (Memory Presets): When tuned to any station, press and hold a preset button until sound returns.

22

## Entertainment Systems

**MENU:** Press once to access MAN (Manual tuning). Press ◀/▶ to go up/down the frequency band in individual increments. Press MENU twice to access SCAN. Press ◀/▶ for a brief sampling of stations up or down the frequency band. Press and hold MENU and then press MENU again to access NO VID. This allows you to enter up to 17 alpha numeric characters (such as your VIN or other identifier). Press ▶ repeatedly to access the desired entry and then turn the volume knob to increase/decrease the number.

### AM/FM stereo with single CD (if equipped)

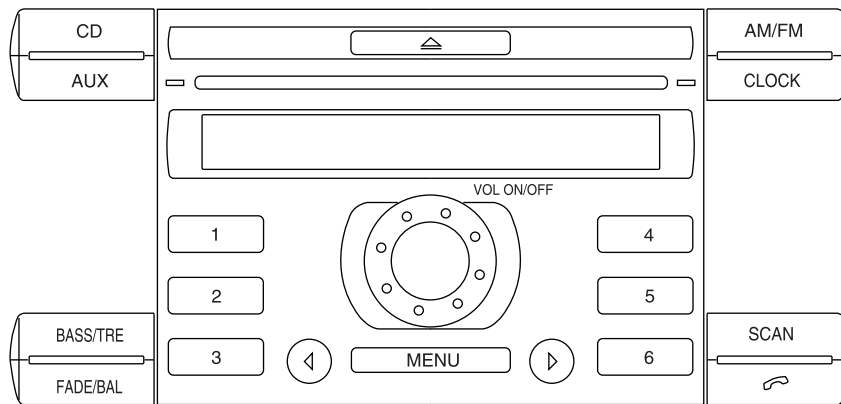

**!** **WARNING:** Driving while distracted can result in loss of vehicle control, accident and injury. Ford strongly recommends that drivers use extreme caution when using any device or feature that may take their focus off the road. Your primary responsibility is the safe operation of the vehicle. We recommend against the use of any handheld device while driving, encourage the use of voice-operated systems when possible and that you become aware of applicable state and local laws that may affect the use of electronic devices while driving.

**One hour mode:** Press the ON/OFF control to operate the system with the ignition turned off; the system will automatically turn off after one hour.

**VOL ON/OFF:** Press to turn ON/OFF. Turn to increase/decrease volume.

## Entertainment Systems

### **Setting the clock**

To set the time or date, turn the radio on and press CLOCK until the time begins to flash. Press ◀ or ▶ to access the desired selection (date or time). Once the desired selection is flashing, turn the VOL (Volume) control to adjust the time or date forward/backward. Press CLOCK again.

### **AM/FM radio**

**AM/FM:** Press repeatedly to select AM/FM1/FM2 frequency bands.

◀▶ (Seek): Press to access the next strong station on the frequency band.

**SCAN:** Press for a brief sampling of all strong radio stations.

**(1-6):** (Memory Presets): When tuned to any station, press and hold a preset button until sound returns.

**Autostore feature:** The autostore feature allows you to store the six strongest stations available from the FM frequency band. To use, press and hold the AM/FM button. The sound will mute and AST will appear in the display indicating the feature is active. When the search is complete, the sound will return and the six strongest stations will be stored in the memory presets (and overwrite any stations previously stored in the AST band).

**Note:** You can also manually store stations in the AST band. When the AST band is active, simply tune to the desired station and press and hold a memory preset. The new station will be saved and will override the previously saved station.

### **CD player**

To load a CD, simply insert the disc, label side up, into the CD slot.

▲ (Eject): Press to eject the CD.

◀▶ (Seek): Press ◀▶ to access the previous/next track.

**SCAN:** Press for a brief sampling of all tracks on the current disc.

### **Sound Adjustments**

**BASS/TRE:** Press to toggle between bass and treble adjustments. Once the desired selection appears in the display, press ◀▶ to adjust the levels.

24



## Entertainment Systems

**FADE/BAL:** Press to toggle between fade and balance adjustments. Once the desired selection appears in the display, press ◀▶ to adjust the audio between front (F) and back (B) and left (L) and right (R) speakers.

### **Extra Features**

**AUX:** Press to access auxiliary input jack mode and play music from a portable player over the vehicle speakers.

 (Phone): If your vehicle is equipped with the *Bluetooth*® system, refer to *Bluetooth hands free system* later in this chapter for more information. If your vehicle is not equipped with *Bluetooth*, this control will not be operational.

**MENU:** Press repeatedly to access the following features:

**SCAN:** Press ◀ or ▶ for a brief sampling of radio stations or CD tracks.

**SHUFFLE CD:** Select to shuffle the tracks on the current CD.

**REPEAT CD/TRK:** Select to repeat the current CD or track.

**COMP** (Compression): Select to bring soft and loud CD passages together for a more consistent listening level.

**CLOCK 24H:** Press to toggle between a 12 and 24 hour clock display.

**AVC:** Press ◀ or ▶ to decrease/increase the level of automatic volume control.

**ADV MENU:** When ADV MENU (Advanced menu) appears in the display, press and hold MENU to access the following features:

- **CLIP ON/OFF:** Press to turn nominal volume levels on/off.
- **VEHICLE ID:** Press to view the vehicle's VIN number.
- **BT ON/OFF:** Press to turn Bluetooth ON/OFF (if equipped). Refer to *Bluetooth hands free system* later in this chapter for more information

### **Auxiliary input jack (Line in)**



**WARNING:** Driving while distracted can result in loss of vehicle control, accident and injury. Ford strongly recommends that drivers use extreme caution when using any device or feature that may take their focus off the road. Your primary responsibility is the safe operation of the vehicle. We recommend against the use of any handheld device while driving, encourage the use of voice-operated systems when possible and that you become aware of applicable state and local laws that may affect use of electronic devices while driving.

## Entertainment Systems

The auxiliary input jack allows you to connect your portable music player and play music through the vehicle speakers with high fidelity.

### Required equipment:

1. Any portable music player designed to be used with headphones
2. An audio extension cable with stereo male 1/8 in. (3.5 mm) connectors at each end.

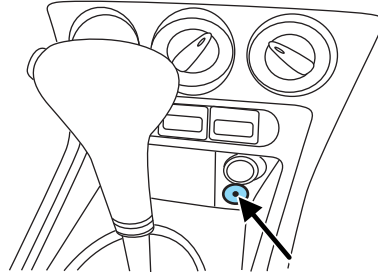

### To play your portable music player using the auxiliary input jack:

1. Begin with the vehicle parked and the radio turned off.
2. Ensure that the battery in your portable music player is new or fully charged and that the device is turned off.
3. Attach one end of the audio extension cable to the headphone output of your player and the other end of the audio extension cable to the auxiliary input jack.
4. Turn the radio on, using either a tuned FM station or a CD loaded into the system. Adjust the volume to a comfortable listening level.
5. Turn the portable music player on and adjust the volume to 1/2 the volume.
6. Press AUX on the vehicle radio repeatedly until AUX appears in the display. You should hear audio from your portable music player although it may be low.
7. Adjust the sound on your portable music player until it reaches the level of the FM station or CD by switching back and forth between the AUX and FM or CD controls.

### Troubleshooting:

1. Do not connect the audio input jack to a line level output. Line level outputs are intended for connection to a home stereo and are not compatible with the AIJ. The AIJ will only work correctly with devices that have a headphone output with a volume control.
2. Do not set the portable music player's volume level higher than is necessary to match the volume of the CD or FM radio in your audio system as this will cause distortion and will reduce sound quality. Many

## Entertainment Systems

portable music players have different output levels, so not all players should be set at the same levels. Some players will sound best at full volume and others will need to be set at a lower volume.

3. If the music sounds distorted at lower listening levels, turn the portable music player volume down. If the problems persists, replace or recharge the batteries in the portable music player.

4. The portable music player must be controlled in the same manner when it is used with headphones as the AIJ does not provide control (play, pause, etc.) over the attached portable music player.

5. For safety reasons, connecting or adjusting the settings on your portable music player should not be attempted while the vehicle is moving. Also, the portable music player should be stored in a secure location, such as the center console or the glove box, when the vehicle is in motion. The audio extension cable must be long enough to allow the portable music player to be safely stored while the vehicle is in motion.

### **BLUETOOTH® HANDS-FREE SYSTEM (IF EQUIPPED)**

Your vehicle may be equipped with *Bluetooth*®, a wireless technology which works with your cellular phone to allow you to send and receive calls in a hands-free manner. Your cellular phone must be *Bluetooth* enabled and also be connected (bonded or paired) to the vehicle's system. These features allow you to have hands-free conversations while enabling you to focus your attention on the road.

**For additional information on using voice commands with your Bluetooth system**, please visit the [www.fordvehicles.com/transitconnect](http://www.fordvehicles.com/transitconnect) website and click on "How-to Bluetooth".



**WARNING:** Driving while distracted can result in loss of vehicle control, accident and injury. Ford strongly recommends that drivers use extreme caution when using any device or feature that may take their focus off the road. Your primary responsibility is the safe operation of the vehicle. We recommend against the use of any handheld device while driving, encourage the use of voice-operated systems when possible and that you become aware of applicable state and local laws that may affect the use of electronic devices while driving.

## Entertainment Systems

### PHONE COMPATIBILITY

While your *Bluetooth* system supports a variety of features, many are dependent upon the functionality of your cellular phone with *Bluetooth* wireless technology. If there is an incompatibility, the performance of your system may be significantly degraded.

**To see if your phone is compatible with your Bluetooth system,** please visit the [www.fordvehicles.com/transitconnect](http://www.fordvehicles.com/transitconnect) website and click on "Check Bluetooth Compatibility".

### Getting started

#### ***Pairing (bonding) your phone***

The first thing you must do to use the system is to pair (bond) your *Bluetooth* enabled cellular phone with your vehicle's *Bluetooth* system. This process allows your phone to communicate with the hands-free system and ensures that other phones cannot inadvertently do so. You may pair/bond up to six phones with your *Bluetooth* system.

To pair/connect your phone:

1. Ensure that your *Bluetooth* enabled cellular phone and audio system are on and your vehicle is in Park (P).
2. Press MENU repeatedly until ADV MENU appears in the display.
3. Press and hold MENU to enter into the Advanced menu selections.
4. Press MENU repeatedly until BT ON/OFF appears in the display. If the feature is set to OFF, press > so BT ON appears in the display.
5. Ensure that your phone is not in privacy mode. Then, follow the instructions in your cellular phone's user guide to put your phone into *Bluetooth* discovery mode.
6. Select FORD AUDIO when it appears in your phone's display.
7. Enter the code number shown on the vehicle display using the phone keypad. If no code number is shown on the display, enter the Bluetooth PIN number 0000 or any number using the phone keypad. Now enter the Bluetooth PIN number shown on the vehicle display.

The phone you have just paired/bonded is now considered the 'active' phone. When the vehicle ignition is turned on, the *Bluetooth* system will automatically begin to search for paired phones, and will attempt to re-connect to the phone last paired/bonded with the system. If this phone is not available, the system will then automatically search for the next most recently connected phone.

**To pair/bond subsequent phones to the system,** simply follow the previous procedure.

28

## Entertainment Systems

**Phonebook entries:** Once the *Bluetooth* system connects to your phone, it will attempt to automatically download your Phonebook entries so that you can easily access them later. The maximum number of entries vary depending on the information attached to the number.

### Voice recognition

Your *Bluetooth* system is equipped with a voice recognition system which allows you to perform some operations by speaking certain commands to the system. The system will respond with a series of beeps, confirmations or questions when necessary. At any time, you can say, “Cancel” if you do not wish to continue, or “Help” for a list of possible voice commands in your current mode. Speak the command clearly to ensure that the system is able to recognize and perform the desired function.

#### For best system performance:

- After pressing VOICE on the stalk, wait until the beep is heard before speaking a command. Any command spoken prior to this will not register with the system.
- Speak naturally without large pauses in between words.
- Ensure that the interior of the vehicle is as quiet as possible. Wind noise from open windows and road vibrations may prevent the system from correctly recognizing spoken voice commands.

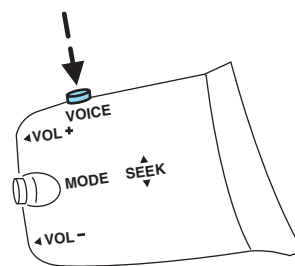

#### At any time, you can say these commands:

- Phone
- CD player
- External device
- Radio
- Cancel
- Help

**External device:** Auxiliary input jack

**Note:** This system is language specific. If you would like the system to operate in another language, please contact your authorized dealer.

## Entertainment Systems

### **Microphone**

Your vehicle has a microphone located in the A-pillar for the hands-free phone features and voice commands.

**To mute the microphone:** During an active call, press < or > on the audio system. Press again to un-mute and return to normal function.

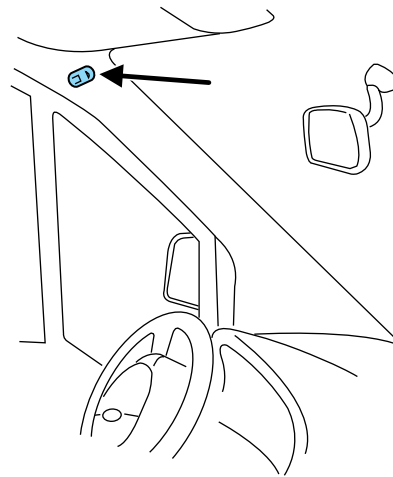

### **Voice commands**

Voice commands allow you to speak commands to the system while enabling you to keep your focus on the road. As you work through a voice session, the system will prompt you with a tone each time the system is ready to proceed.

**Name tag feature:** This system has a name tag feature which allows you assign name tags to items such as a favorite radio station or personal phone contact. You can store up to 20 name tags per function.

**Note:** There are some voice command 'short cuts' available which allow you to speak those commands directly without having to follow the complete command menu.

## Entertainment Systems

### CD player voice commands

Press the VOICE button on the stalk. After the tone, say, “CD player” and then any of the following commands:

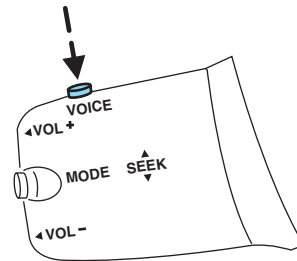

- Play
- Shuffle all
- Shuffle off
- Repeat track
- Help
- Track<sup>1</sup>
- Shuffle folder<sup>2</sup>
- Repeat folder<sup>2</sup>
- Repeat off

<sup>1</sup> Can be used as a shortcut.

<sup>2</sup> Only available as a voice command if the CD contains audio data files such as .mp3 or .wma.

**Note:** You can select any track number between 1–99. You can also list numbers individually, such as, “two, four, five” for track 245.

### Radio voice commands

Press the VOICE button on the stalk. After the tone, say, “Radio” and then any of the following commands:

- AM
- Tune name<sup>1</sup>
- Delete directory
- Store name
- Help
- FM
- Delete name
- Play directory
- Play

<sup>1</sup> Can be used as a shortcut. This allows you to call up a stored radio station.

**Store name:** When you say, “Store name”, the system will ask you for the name. Say the name when prompted.

**Delete name:** Allows you to delete a stored station.

**Delete directory:** Allows you to delete all stored stations at once.

## Entertainment Systems

**Play directory:** Allows you to let the system tell you of all the stored radio stations.

**Note:** Using the system with the engine off will drain the battery.

### Phone voice commands

Press the VOICE button on the stalk. After the tone, say, “Phone” and then any of the following commands:

- Mobile name<sup>1</sup>
- Dial number<sup>1</sup>
- Delete directory
- Store name
- Accept calls
- Help
- Dial name<sup>1</sup>
- Delete name
- Play directory
- Redial<sup>1</sup>
- Reject calls

<sup>1</sup> Can be used as a shortcut.

**Store name:** When you say, “Store name”, the system will ask you for the name. Say the name. The system will then ask you for the number associated with that name. Say the number.

**Delete name:** Allows you to delete a stored name.

**Delete directory:** Allows you to delete all stored names at once.

**Play directory:** Allows you to let the system tell you of all the stored names.

**Note:** Using the system with the engine off will drain the battery.

### External device commands (if equipped)

Press the VOICE button on the stalk. After the tone, say, “External device” and then any of the following commands:



- Help
- Play
- Line in

### Phone features

#### Phonebook



If your *Bluetooth* enabled cellular phone supports the feature, you can download your cell phone’s phone book to the *Bluetooth* system.

Depending on your phone book entry, different categories may be displayed in the audio display, such as:

-  or Phone
-  or Mobile or M



## Entertainment Systems

-  or Home or H
-  or Office or O
-  or Fax or F



### ***Making a call using voice commands***

To make a hands-free call using your system:

1. Press the VOICE button on the stalk.
2. When the tone sounds, say, "Phone". The system will confirm you are in phone mode.
3. Say, "Dial name" or "Dial number".
4. When prompted, say the desired name or phone number. The system will ask you to confirm. If you confirm, the call will be placed. Otherwise, the call will be cancelled.

### ***Making a call using your phone book entries***

To access your phone book entries via *Bluetooth*:

1. Press the  button on your audio system.
2. Press MENU repeatedly until PHONEBOOK appears in the display.
3. Press the SEEK switch on the back of the stalk to scroll through all possible listings.  
**Note:** Press and hold SEEK to advance to the next letter in the alphabet.
4. When the desired contact appears in the display, press  to initiate the call.

### ***Ending a call***

At any time, you can end an active call by pressing  on the audio system.

**To exit phone mode** (and end an active call if present), CD, AM/FM, VOL ON/OFF, or  on the audio system.

### ***Answering an incoming call***

**Accept the call** by pressing the  button on the audio system. The call will be transferred to hands-free mode.

**Ignore the call** by doing nothing.

**Reject the call** by pressing CD, AM/FM or VOL ON/OFF on the audio system.

## Entertainment Systems

### **Answering a second incoming call**



If another call comes in while you are already on an active call, you will hear a beep. You have the choice to end your current call and accept the incoming call.

**To accept the incoming call**, press the  button on the audio system.

**To reject the incoming call**, by pressing CD or AM/FM on the audio system.

### **Redialing a number**

To redial a number:

1. Press  on the audio system to enter the phone menu.
2. Press MENU repeatedly to cycle through CALL OUT, CALL IN, MISSED, INCOMING or OUTGOING appears in the display.
3. When the desired selection appears in the display, press < or > to access the desired number.
4. When the desired number appears in the display, press  for the system to initiate the call.

To redial a number using voice commands:

1. Press VOICE on the stalk.
2. After the tone, say, "Phone".
3. When prompted, say, "Redial". The system will attempt to redial the last number.

### **Changing the active phone**

With your *Bluetooth system*, you can pair (bond) and save up to six phones. At any time, you can choose to make another one of your saved phones the 'active' phone with which the system will connect. To select a another paired (bonded) phone as your active phone:

1. Press  on the audio system to enter the phone menu.
2. Press MENU repeatedly until ACTIVE appears in the display.
3. Press < or > on the audio system to scroll through the list of paired (bonded) phones.
4. When the desired selection appears in the display, press MENU.

## Entertainment Systems

### ***Deleting a phone***

A paired (bonded) phone can be deleted from the system at any time as long as the phone is not involved in an active call. To delete a phone from the system:

1. Press  on the audio system to enter the phone menu.
2. Press MENU repeatedly until DEBOND appears in the display.
3. Press < or > on the audio system to scroll through the list of paired (bonded) phones.
4. When the desired selection appears in the display that you would like to delete, press MENU.

### **GENERAL AUDIO INFORMATION**

#### **Radio frequencies:**

AM and FM frequencies are established by the Federal Communications Commission (FCC) and the Canadian Radio and Telecommunications Commission (CRTC). Those frequencies are:

AM: 530, 540–1700, 1710 kHz

FM: 87.7, 87.9–107.7, 107.9 MHz

#### **Radio reception factors:**

There are three factors that can affect radio reception:

- Distance/strength: The further you travel from an FM station, the weaker the signal and the weaker the reception.
- Terrain: Hills, mountains, tall buildings, power lines, electric fences, traffic lights and thunderstorms can interfere with your reception.
- Station overload: When you pass a broadcast tower, a stronger signal may overtake a weaker one and play while the weak station frequency is displayed.

## Entertainment Systems

### CD/CD player care

Do:

- Handle discs by their edges only. (Never touch the playing surface).
- Inspect discs before playing.
- Clean only with an approved CD cleaner.
- Wipe discs from the center out.

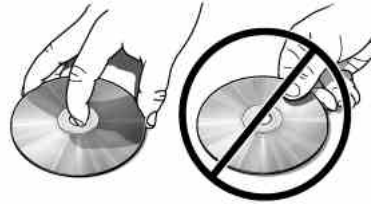

Don't:

- Expose discs to direct sunlight or heat sources for extended periods of time.
- Clean using a circular motion.

**CD units are designed to play commercially pressed 4.75 in (12 cm) audio compact discs only. Due to technical incompatibility, certain recordable and re-recordable compact discs may not function correctly when used in Ford CD players.**

**Do not use any irregular shaped CDs or discs with a scratch protection film attached.**



## Entertainment Systems

CDs with homemade paper (adhesive) labels should not be inserted into the CD player as the label may peel and cause the CD to become jammed. It is recommended that homemade CDs be identified with permanent felt tip marker rather than adhesive labels. Ballpoint pens may damage CDs. Please contact your authorized dealer for further information.

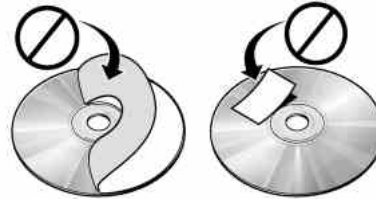



### Audio system warranty and service

Refer to the *Warranty Guide/Customer Information Guide* for audio system warranty information. If service is necessary, see your dealer or qualified technician.

## Climate Controls

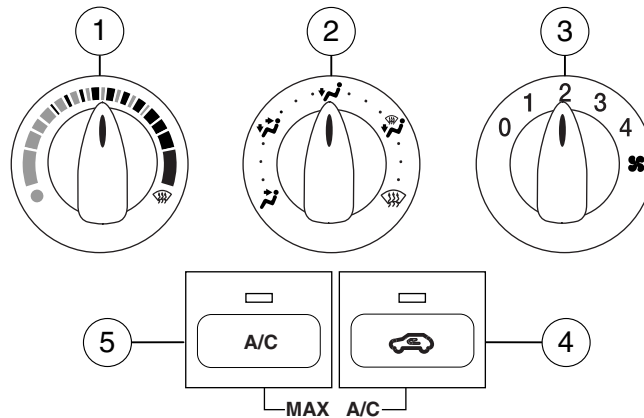
### MANUAL HEATING AND AIR CONDITIONING SYSTEM





1. **Temperature control:** Controls the temperature of the airflow in the vehicle. For optimum defrosting performance, set the dial to the defrost symbol .



2. **Air flow selections:** Controls the direction of the airflow in the vehicle. See the following for a brief description on each control setting:

 : Distributes air through the instrument panel vents.

 : Distributes air through the instrument panel vents and floor vents.



 : Distributes air through the floor vents. **Note:** You may notice a small amount of air flowing from the demister and defroster vents.

 : Distributes air through the windshield defroster vents, demisters and floor vents.





 : Distributes outside air through the windshield defroster and demister vents. Can be used to clear thin ice or fog from the windshield. To exit  select another mode.

3.  **Fan speed adjustment:** Controls the volume of air circulated in the vehicle. For optimum defrosting performance, set the dial to at least the 3 or 4 position.

## Climate Controls

4.  **Recirculated air:** Press to activate/deactivate air recirculation in the vehicle cabin. Recirculated air may reduce the amount of time required to cool down the interior of the vehicle and may also help reduce undesired odors from reaching the interior of the vehicle. Recirculated air will not function in  (defrost).
5. **A/C:** Press to activate/deactivate air conditioning. Use with recirculated air to improve cooling performance and efficiency. Engages automatically in  (defrost).

### Operating tips

- To reduce fog build-up on the windshield during humid weather, select  (defrost) and set the fan speed dial to the 3 or 4 position near the  (defrost) symbol. Also, set the temperature setting to the  (defrost) symbol during cooler weather.
- To reduce humidity build-up inside the vehicle, do not drive with the system off or with  (recirculated air) engaged and A/C off.
- Do not put objects under the front seats that will interfere with the airflow to the back seats.
- Remove any snow, ice or leaves from the air intake area at the base of the windshield.
- To improve the time to reach comfort in hot weather, drive with the windows slightly open for 2-3 minutes after start up or until the vehicle has been “aired out.”
- A small amount of air may be felt from the floor vent regardless of the air distribution setting that is selected.

During extreme high ambient temperatures when idling stationary for extended periods of time in gear, it is recommended to run the A/C in the max A/C mode, reduce blower fan speed from the highest setting and put the vehicle's transmission into the P (Park) gear position to continue to receive cool air from your A/C system.

## Climate Controls

**For maximum cooling performance, select MAX A/C by doing the following:**

1. Select the coolest temperature setting.
2. Select both the  (recirculated air) and A/C controls.
3. Set the fan to the highest speed initially. As the interior starts to cool down, adjust the fan speed to maintain comfort and/or switch from recirculated air to outside air mode.

**To aid in side window defogging/demisting in cold weather:**

1. Select .
2. Select A/C.
3. Adjust the temperature control to maintain comfort.
4. Set the fan speed to the highest setting.
5. Direct the outer instrument panel vents towards the side windows.

To increase airflow to the outer instrument panel vents, close the vents located in the middle of the instrument panel.

### Electric vehicles

For specific information on the Transit Connect Electric, refer to the *Azure Dynamics TC-E Owner's Guide Supplement*.

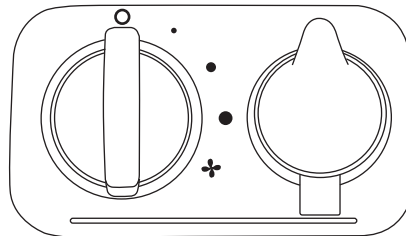

### AUXILIARY CLIMATE CONTROL (IF EQUIPPED)

Your auxiliary climate controls are located on the rear of the center console and can be used when the front climate control system is on. The temperature will be set by the front controls. Use the rear control to adjust the fan speed or turn the auxiliary controls off (O).





## Climate Controls

**Note:** In order to supply heat or cool air to this rear auxiliary climate unit, the front airflow control must be set in one of these three positions:  (Floor/vent),  (Floor) or  (Defrost/floor).



### REAR WINDOW DEFROSTER (IF EQUIPPED) / HEATED MIRRORS (IF EQUIPPED)

The rear defroster control is located on the instrument panel above the radio and works to clear the rear windows of fog and thin ice.

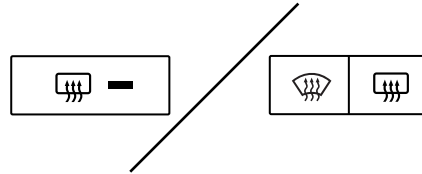

The ignition must be on to operate the rear window defroster.

Press  to turn the rear window defroster on. An indicator light on the button will illuminate when active. The rear window defroster turns off automatically after a predetermined amount of time, if a low battery condition is detected or when the ignition is turned off. To manually turn off the rear window defroster at any time, press the control again.

If your vehicle is equipped with heated mirrors, this button will activate them. Refer to *Exterior mirrors* in the *Driver Controls* chapter.

**Do not use razor blades or other sharp objects to clean the inside of the rear window or to remove decals from the inside or the rear window. This may cause damage to the heated grid lines and will not be covered by your warranty.**

## Climate Controls

### Heated Windshield Control (if equipped)

The heated windshield control is located on the instrument panel.

To activate the heated windshield, the engine must be running while the heated windshield control is pushed.

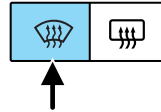

**Note:** During initial start-up, the windshield may have a shimmering appearance. This is normal operation and will only last for approximately 1 minute.

The heated windshield will turn off automatically after the engine is turned off.

To manually turn off the heated windshield before the specified time has passed, push the control switch again.

## Lights

### HEADLAMP CONTROL ☼

- Turns the lamps off.
- ☼ Turns on the parking lamps, instrument panel lamps, license plate lamps and tail lamps.
- ☼☼ Turns the headlamps on.

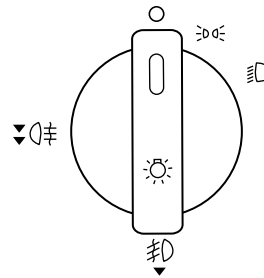

### Front fog lamps (if equipped)

The headlamp control operates the front fog lamps. The front fog lamps can only be turned on when the headlamp control is in the ☼☼ or ☼☼☼ position.

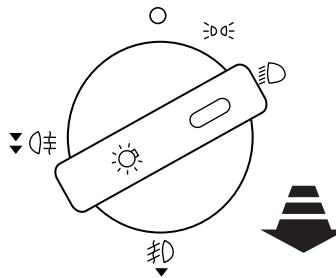

Pull the headlamp control towards you until the first detent is felt to turn the front fog lamps on. The front fog lamp indicator light ☼☼ will illuminate.

### Rear fog lamp

The headlamp control also operates the rear fog lamp. The rear fog lamp can only be turned on when the headlamp control is in the ☼☼☼ or ☼☼☼☼ position.

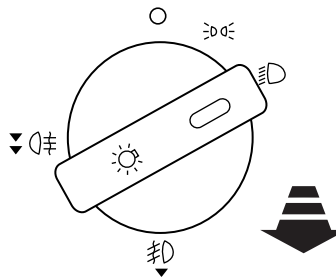

## Lights

Pull the headlamp control towards you until the second detent is felt to turn the rear fog lamp on. The rear fog lamp indicator light  will illuminate.

**Note:** Do not use the rear fog lamp when it is raining or snowing and visibility is more than 165 feet (50 m).

### High beams

Pull the lever fully past the detent to activate. Pull the lever fully again to deactivate.

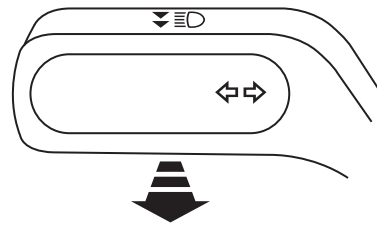

### Flash-to-pass

Pull the lever toward you to the first detent to activate flash-to-pass, and release to deactivate.

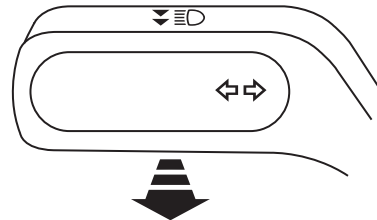

### Daytime running lamps (DRL) (if equipped)

Turns the headlamps on with a reduced output.

To activate:

- the ignition must be in the on position and
- the headlamp control must be in the off position.

## Lights

 **WARNING:** Always remember to turn on your headlamps at dusk or during inclement weather. The Daytime Running Lamp (DRL) system does not activate the tail lamps and generally may not provide adequate lighting during these conditions. Failure to activate your headlamps under these conditions may result in a collision.

### PANEL DIMMER CONTROL

Use to adjust the brightness of the instrument panel and all applicable switches in the vehicle during headlamp and parking lamp operation.

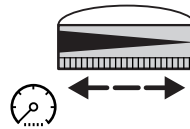

Move the control from left to right to increase the brightness. Move the control from right to left to reduce the brightness.

### AIMING THE HEADLAMPS

The headlamps on your vehicle are properly aimed at the assembly plant. If your vehicle has been in an accident, the alignment of your headlamps should be checked by your authorized dealer.

#### Vertical aim adjustment

1. Park the vehicle directly in front of a wall or screen on a level surface, approximately 25 feet (7.6 meters) away.

- (1) 8 feet (2.4 meters)
- (2) Center height of lamp to ground
- (3) 25 feet (7.6 meters)
- (4) Horizontal reference line

2. Measure the height from the center of your headlamp to the ground and mark an 8 foot (2.4 meter) horizontal reference line on the vertical wall or screen at this height (a piece of masking tape works well).

3. Turn on the low beam headlamps to illuminate the wall or screen and open the hood.

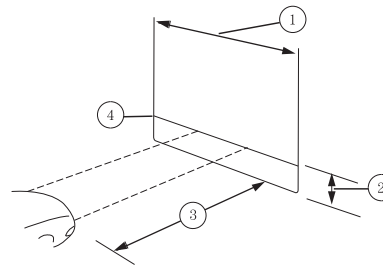

## Lights

4. On the wall or screen you will observe an area of high intensity light. The top of the high intensity area should touch the horizontal reference line. If not, the beam will need to be adjusted.

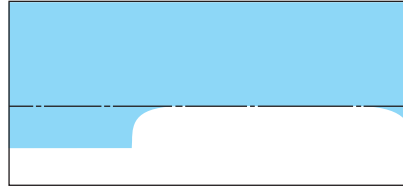

5. Locate the vertical adjuster on each headlamp, then use a Phillips #2 screwdriver or 10 mm wrench/socket to adjust the headlamp up or down.

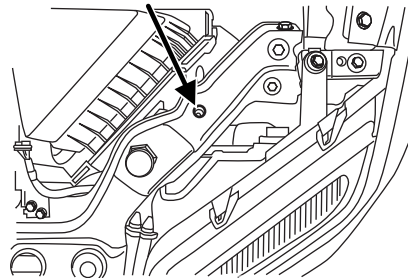

6. Close the hood and turn off the lamps.

HORIZONTAL AIM IS NOT REQUIRED FOR THIS VEHICLE AND IS NON-ADJUSTABLE.

### TURN SIGNAL CONTROL

- Push down and release to activate the left turn signal.
- Push up and release to activate the right turn signal.

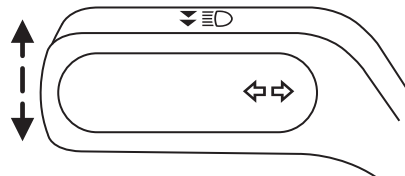

Tap the stalk up or down to make the turn signal indicator flash three times.

### INTERIOR LAMPS

#### Dome lamp

The dome lamp is equipped with a control switch that will illuminate when:

- the doors are closed and the switch is in the right position.
- the switch is in the middle position and any door is open.

When the dome lamp switch is in the left position, it will not illuminate when you open the doors.

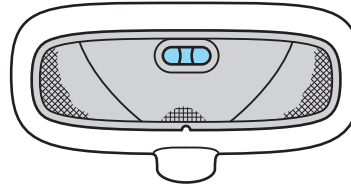

#### Reading lamps (if equipped)

The reading lamps are operated by separate on/off controls.

Theater dimming: The dome lamp dims about 20 seconds after the doors are closed.

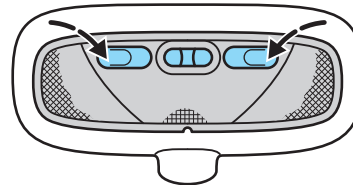

#### Approach lamps (if equipped)

The approach lamps will turn on and off automatically when you open and close the doors. If you unlock the doors with the remote control, they will come on. They will go off automatically after a short time.

### BULB REPLACEMENT

#### Lamp assembly condensation

Exterior lamps are vented to accommodate normal changes in pressure. Condensation can be a natural by-product of this design. When moist air enters the lamp assembly through the vents, there is a possibility that condensation can occur when the temperature is cold. When normal condensation occurs, a thin film of mist can form on the interior of the lens. The thin mist eventually clears and exits through the vents during normal operation. Clearing time may take as long as 48 hours under dry weather conditions.

## Lights

Examples of acceptable condensation are:

- Presence of thin mist (no streaks, drip marks or droplets)
- Fine mist covers less than 50% of the lens

Examples of unacceptable moisture (usually caused by a lamp water leak) are:

- Water puddle inside the lamp
- Large water droplets, drip marks or streaks present on the interior of the lens

Take your vehicle to a dealer for service if any of the above conditions of unacceptable moisture are present.

### Using the right bulbs

Replacement bulbs are specified in the chart below. Headlamp bulbs must be marked with an authorized "D.O.T." for North America to ensure lamp performance, light brightness and pattern and safe visibility. The correct bulbs will not damage the lamp assembly or void the lamp assembly warranty and will provide quality bulb burn time.

Function	Trade number
Headlamps	H13
Turn lamp indicator (front)	3457NAK
Turn lamp indicator (rear)	WY21W
Side marker lamp	W5W LL
Side repeater lamp	194NA
Front fog lamp	H11
Brake and tail lamps	W21/5W
Backup lamp	W21W
Rear fog lamp	W21W
License plate lamp	W5W LL
High-mount brake lamp	LED
Dome lamps (front and rear)	211
Reading lamps	W5W
To replace all instrument panel lights - see your authorized dealer	

### Replacing interior bulbs

Check the operation of all bulbs frequently.



## Lights

### **Replacing front dome lamps**

1. Make sure the headlamp switch is in the off position.
2. Switch off the interior lamps.

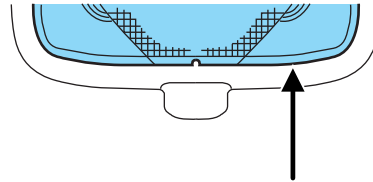

3. Pry out the light assembly with a flat screwdriver.

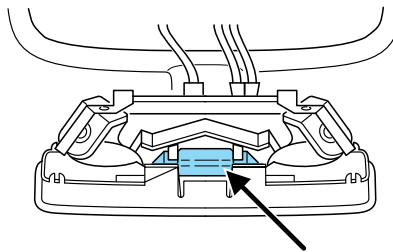

Install in reverse order.

### **Replacing rear dome lamps**

1. Make sure the headlamp switch is in the off position.
2. Switch off the interior lamps.
3. Pry out the light assembly with a flat screwdriver.

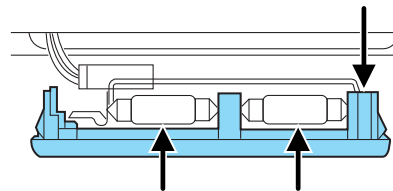

Install in reverse order.

## Lights

### Replacing reading bulbs

1. Open the reading lamp assembly.
  2. Pull the bulb straight out and replace it.
  3. After the bulb has been replaced, close the lamp assembly.
- Install in reverse order.

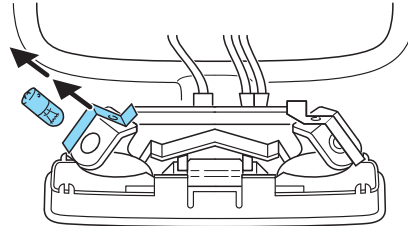

### Replacing exterior bulbs

Check the operation of all bulbs frequently.

### Replacing headlamp bulbs

1. Make sure the headlamp control is in the off position and open the hood.
2. Pull off the bulb cap.

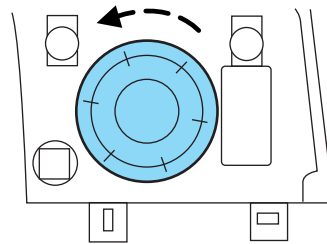

3. Disconnect electrical connector from the bulb.
4. Twist off the bulb retainer ring by turning it counterclockwise.

Install in reverse order.

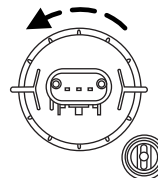

**WARNING:** Handle a halogen headlamp bulb carefully and keep out of children's reach. Grasp the bulb by only its plastic base and do not touch the glass. The oil from your hand could cause the bulb to break the next time the headlamps are operated.

**Note:** If the bulb is accidentally touched, it should be cleaned with rubbing alcohol before being used.

50

## Lights

### **Replacing front parking lamp bulbs**

1. Make sure the headlamp control is in the off position.
2. Turn the cover counterclockwise and remove it.

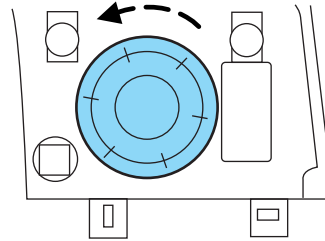

3. Remove the bulb and the bulb socket.
4. Pull the bulb straight out.

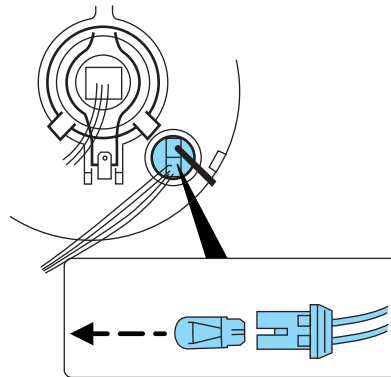

Install in reverse order.

### **Replacing front turn signal bulbs**

1. Make sure the headlamp control is in the off position and open the hood.
2. Remove the bulb socket from the lamp assembly by turning it counterclockwise.

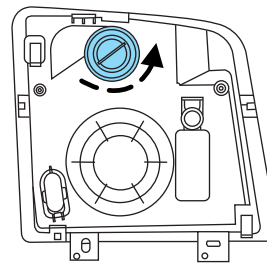

## Lights

3. Pull the bulb straight out of the socket.

Install in reverse order.

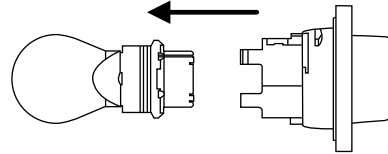

### **Replacing front fog lamp bulbs (if equipped)**

1. Make sure the headlamp switch is in the off position.

2. Reach under the front fender and remove the aeroshield. Then remove the harness/bulb assembly from the fog lamp by turning it counterclockwise.

3. Disconnect the harness from the bulb by pulling it straight out.

Install the new bulb in reverse order.

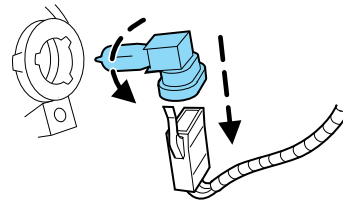

### **Replacing tail/brake/rear fog/backup lamps and turn signal bulbs**

1. Make sure the headlamp control is in the off position and then open the cargo door.

2. Remove the two wing nuts and gently pull the lamp assembly away from the vehicle.

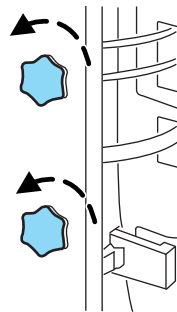

## Lights

3. Remove the bulb socket from the lamp assembly by turning it counterclockwise.

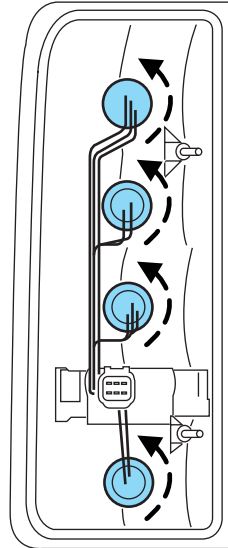

4. Pull the bulb straight out of the socket.  
Install in reverse order.

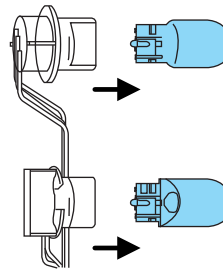

## Lights

### **Replacing front and rear side marker bulbs**

1. Make sure the headlamp control is in the off position and then open the cargo door.
2. Remove the side marker by gently prying the lamp assembly away from the vehicle.

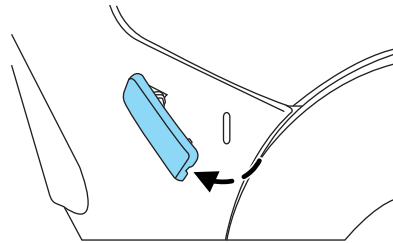

3. Remove the bulb socket from the lamp assembly by turning it counterclockwise.

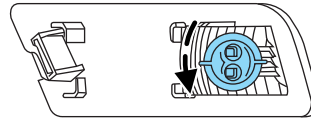

4. Pull the bulb straight out of the socket.

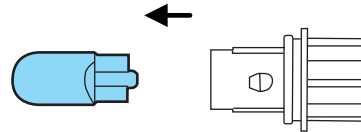

Install in reverse order.

### **Replacing side repeater bulbs**

1. Make sure the headlamp control is in the off position.
2. Remove the side repeater by prying it out from the bottom.
3. Hold the bulb holder and turn it counterclockwise to remove it.
4. Pull the bulb straight out.

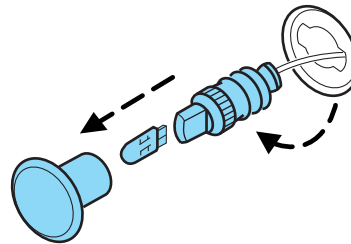

Install in reverse order.

## Lights

### **Replacing high-mount brake lamp bulbs**

See your authorized dealer for replacement.

### **Replacing license plate lamp bulbs**

1. Make sure the headlamp control is in the off position.
  2. Remove the lens assembly.
  3. Pull the bulb straight out.
- Install in reverse order.

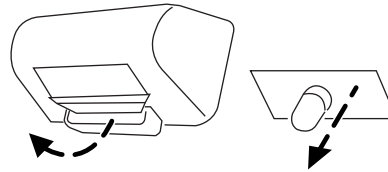

## Driver Controls

### WINDSHIELD WIPERS

Move the lever down for a single wipe.

 For intermittent operation, move control up one position and adjust the rotary control to the desired speed.

 For normal operation, move control up two positions and up three positions for high-speed wiping.

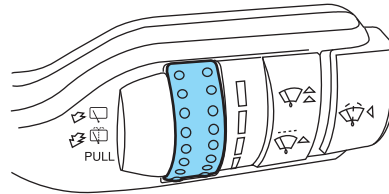

### Windshield washer

 To activate the windshield washer, press the windshield washer control in. Release control to stop washer fluid spray. The wipers will operate for a short time after the wash is turned off.

**Note:** Do not operate the washer when the washer reservoir is empty. This may cause the washer pump to overheat. Check the washer fluid level frequently. Do not operate the wipers when the windshield is dry. This may scratch the glass, damage the wiper blades and cause the wiper motor to burn out. Before operating the wiper on a dry windshield, always use the windshield washer. In freezing weather, be sure the wiper blades are not frozen to the windshield before operating the wipers.

### Rear window wiper/washer (if equipped)

#### Wiper

 Pull the lever towards you for intermittent wiping.

#### Washer

 Pull the lever farther to operate the washer. The wiper will operate for a short time and will activate once more after pausing to clear the windshield.

#### Reverse gear wipe

The rear wiper will be activated automatically when shifting into R (Reverse) if the front wiper is activated.



## Driver Controls

### TILT AND TELESCOPE STEERING COLUMN

Release the locking lever to adjust the height of the steering wheel and its distance from the driver.

Return the lever to its original position to secure the wheel.

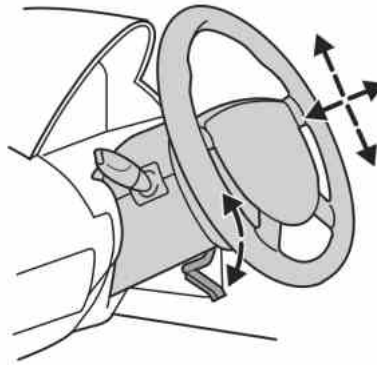

**WARNING:** Never adjust the steering wheel when the vehicle is moving.

### CENTER CONSOLE

Your vehicle has a variety of console features. These include:

- Cupholders
- Storage area
- Power window switches (if equipped)



**WARNING:** Use only soft cups in the cupholder. Hard objects can injure you in a collision.

## Driver Controls

### OVERHEAD STORAGE SHELF

The storage shelf above the windshield can be used for storing light objects such as safety jackets, coats, etc.

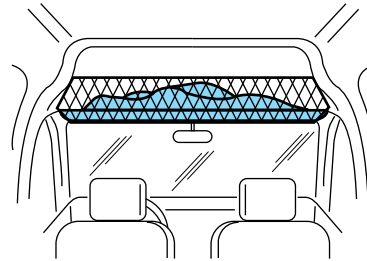

**WARNING:** Do not place heavy or hard objects in the overhead storage, which may fall while driving, and could cause serious injury.

### AUXILIARY POWER POINTS (12V DC)

**Power outlets are designed for accessory plugs only. Do not insert any other object in the power outlet as this will damage the outlet and blow the fuse. Do not hang any type of accessory or accessory bracket from the plug. Improper use of the power outlet can cause damage not covered by your warranty.**

Auxiliary power points can be found in the following locations:

- Near the transmission shift lever
- In the rear cargo area (if equipped)
- On the rear of the center console (if equipped)

Do not use the power point for operating a cigarette lighter element.

**Note:** Do not plug optional electrical accessories into the cigarette lighter socket (if equipped). Improper use of the lighter can cause damage not covered by your warranty, and can result in fire or serious injury.

To prevent the fuse from being blown, do not use the power point(s) over the vehicle capacity of 12V DC/135W. If the power point or cigar lighter socket is not working, a fuse may have blown. Refer to *Fuses and relays* in the *Roadside Emergencies* chapter for information on checking and replacing fuses.

To have full capacity usage of your power point, the engine is required to be running to avoid unintentional discharge of the battery. To prevent the battery from being discharged:

58

## Driver Controls

- do not use the power point longer than necessary when the engine is not running,
- do not leave battery chargers, video game adapters, computers and other devices plugged in overnight or when the vehicle is parked for extended periods.

Always keep the power point caps closed when not being used.

### POWER WINDOWS (IF EQUIPPED)

 **WARNING:** Do not leave children unattended in the vehicle and do not let children play with the power windows. They may seriously injure themselves.

 **WARNING:** When closing the power windows, you should verify they are free of obstructions and ensure that children and/or pets are not in the proximity of the window openings.

Press/pull the window switches, located on the center console near the cupholders, to open/close the windows.

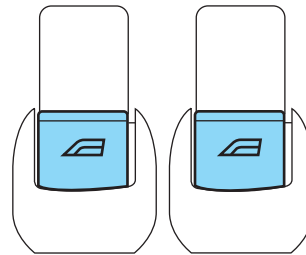

### One-touch down

Allows the driver's window to open fully without holding the control down. Press the switch down and release quickly. The window will open fully. Press it again to stop the window.

### INTERIOR MIRROR

The interior rear view mirror has two pivot points on the support arm which lets you adjust the mirror up or down and from side to side.

 **WARNING:** Do not adjust the mirror while the vehicle is in motion.

## Driver Controls

### Automatic dimming interior rear view mirror (if equipped)

The interior rear view mirror has an auto-dimming function. The electronic day/night mirror will change from the normal (high reflective) state to the non-glare (darkened) state when bright lights (glare) reach the mirror. When the mirror detects bright light from behind the vehicle, it will automatically adjust (darken) to minimize glare.

The mirror will automatically return to the normal state whenever the vehicle is placed in R (Reverse) to ensure a bright clear view when backing up.

**Do not block the sensors on the front and back of the interior rear view mirror since this may impair proper mirror performance.**

**Note:** A rear center passenger and/or raised rear center headrest (if equipped) may also block the light from reaching the sensor.

**Do not clean the housing or glass of any mirror with harsh abrasives, fuel or other petroleum-based cleaning products.**

**Note:** If equipped with a rearview camera system, a video image will display in the mirror when the vehicle is put in R (Reverse). As you shift into any other gear from R (Reverse), the image will remain for a few seconds and then turn off. Refer to *Rearview camera system* in the *Driving* chapter.

## EXTERIOR MIRRORS

### Power side view mirrors (if equipped)



**WARNING:** Do not adjust the mirror while the vehicle is in motion.

To adjust your mirrors:

1. Rotate the control clockwise to adjust the right mirror or counterclockwise to adjust the left mirror.
2. Move the control in the direction you wish to tilt the mirror.
3. Return the control to the center position to lock mirrors in place.

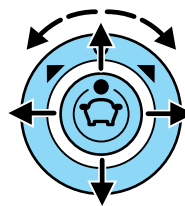

### Heated side view mirrors (if equipped)

Both mirrors are heated automatically to remove ice, mist and fog when the rear window defroster is activated.

60

## Driver Controls

**Do not remove ice from the mirrors with a scraper or attempt to readjust the mirror glass if it is frozen in place. These actions could cause damage to the glass and mirrors.**

### Fold-away mirrors

Pull/push the mirrors in to fold/unfold them.

### Blind spot mirrors

Your vehicle is equipped with blind spot mirrors. Refer to *Blind spot mirrors* in the *Driving* chapter.

### SPEED CONTROL (IF EQUIPPED)

With speed control set, you can maintain a set speed without keeping your foot on the accelerator pedal.



**WARNING:** Do not use the speed control in heavy traffic or on roads that are winding, slippery or unpaved.

### Using speed control

The speed controls are located on the steering wheel. The following buttons work with speed control:

 **ON:** Press to turn speed control on.

**OFF:** Press to turn speed control off.

**RES (Resume):** Press to resume a set speed.

**SET + :** Press to increase the set speed.

**- :** Press to decrease the set speed.

#### Setting speed control

1. Press and release ON.
2. Accelerate to the desired speed.
3. Press and release SET +.
4. Take your foot off the accelerator pedal.
5. The indicator  light on the instrument cluster will turn on.

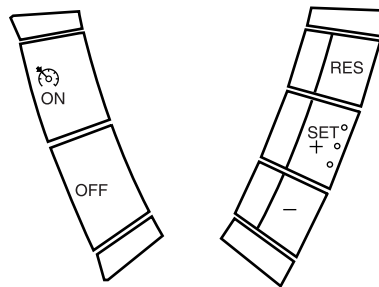

## Driver Controls

### **Note:**

- Vehicle speed may vary momentarily when driving up and down a steep hill.
- If the vehicle speed increases above the set speed on a downhill, you may want to apply the brakes to reduce the speed.
- If the vehicle speed decreases more than 10 mph (16 km/h) below your set speed on an uphill, your speed control will disengage.

### ***Disengaging speed control***

Press the brake pedal to disengage the speed control. Disengaging the speed control will not erase the previous set speed.

### ***Resuming a set speed***

Press and release RES. This will automatically return the vehicle to the previously set speed.

### ***Increasing speed while using speed control***

To set a higher speed:

- Press and hold SET + until you get to the desired speed, then release. You can also use SET + to operate the tap-up function. Press and release SET + to increase the vehicle set speed in 1 mph (1.6 km/h) increments.
- Use the accelerator pedal to get to the desired speed then press and release SET +.

### ***Reducing speed while using speed control***

To reduce a set speed:

- Press and hold – until you get to the desired speed, then release. You can also use – to operate the tap-down function. Press and release – to decrease the vehicle set speed in 1 mph (1.6 km/h) increments.
- Press the brake pedal until the desired vehicle speed is reached, then press SET +.

### ***Turning off speed control***

To turn off the speed control, press OFF or turn off the ignition.

**Note:** When you turn off the speed control or the ignition, your speed control set speed memory is erased.

## Driver Controls

### STEERING WHEEL CONTROLS (IF EQUIPPED)

The following functions can be operated with the steering wheel controls:

#### Volume

- Press the top button on the back of the remote control to increase the volume.
- Press the bottom button on the back of the remote control to decrease the volume.

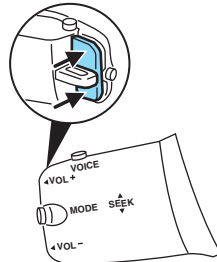

#### Seek

Move the SEEK switch up or down:

- In radio mode, this will locate the next radio station up or down the frequency band.
- In CD mode, it will select the next or previous track.

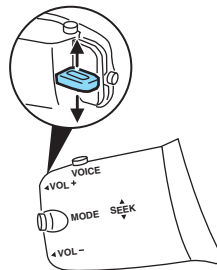

#### Mode

Briefly press the button on the side:

- In radio mode, this will locate the next preset radio station; or press and hold to change the band (AM, FM).
- In CD mode, this will select the next CD when equipped with a CD changer.
- In all modes to abort a traffic message during broadcasting

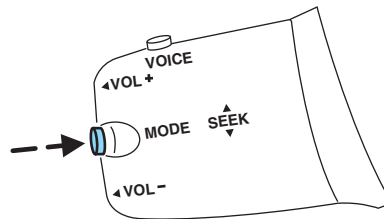

## Driver Controls

### Voice

Press the button on the top to select or deselect voice control. For further information see the supplemental information on the Bluetooth® feature.

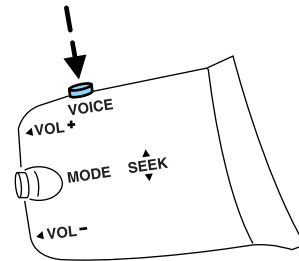

### POSITIVE RETENTION FLOOR MAT

 **WARNING:** Do not install additional floor mats on top of the factory installed floor mats as they may interfere with the accelerator or the brake pedals.

Position the floor mat so that the eyelet is over the end of the retention screw and rotate forward so the screw fits through the eyelet. Turn the screw one-quarter turn to lock in. Make sure that the mat does not interfere with the operation of the accelerator or the brake pedal. To remove the floor mat, reverse the installation procedure.

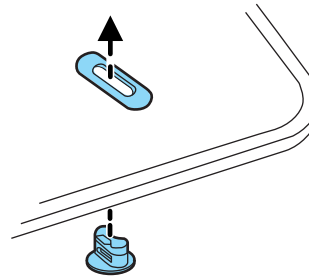



## Driver Controls

### DUAL REAR DOORS

Open the right hand door first from either the outside (1) or inside (2) the vehicle.

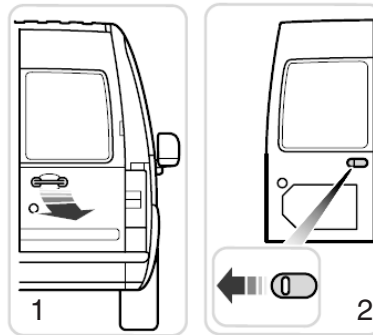

## Driver Controls

Open the left hand door second by squeezing the handle to unlatch the door and pulling it open.

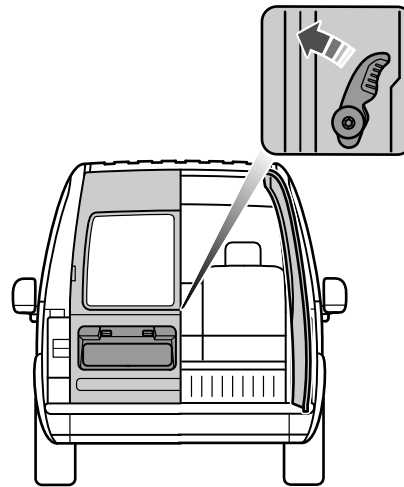

**Note:** The dual rear doors should be closed before driving your vehicle. Leaving the doors open could cause serious damage to them and their components. The left door must be closed first.

## Driver Controls

### Opening the doors fully

Push the yellow button located on the door and swing it open. The check arms will automatically re-engage when the doors are closed.

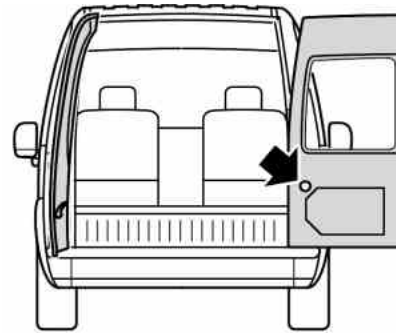

## Locks and Security

### KEYS

The key operates all locks on your vehicle. You should always carry a second key with you in a safe place in case you require it in an emergency.

If your vehicle is equipped with the SecuriLock® passive anti-theft system, your keys are electronically coded to your vehicle; using a non-coded key will not permit your vehicle to start. If you lose your dealer supplied keys, replacement keys are available through your authorized dealer.

### Central unlocking/locking

- To unlock the front and sliding doors, turn the key towards the front of the vehicle.
- To lock all doors, turn the key towards the rear of the vehicle.

**Note:** Your vehicle can be configured to unlock only the front doors, see your authorized dealer for more details.

### CHILDPROOF DOOR LOCKS

- When these locks are set, the sliding doors cannot be opened from the inside.
- The sliding doors can be opened from the outside when the childproof door locks are set, but the doors are unlocked.

The childproof locks are located on the rear edge of each sliding door and must be set separately for each door. Setting the lock for one door will not automatically set the lock for both doors.

- Insert the key and turn to the lock position to engage the childproof locks.
- Insert the key and turn to the unlock position to disengage the childproof locks.

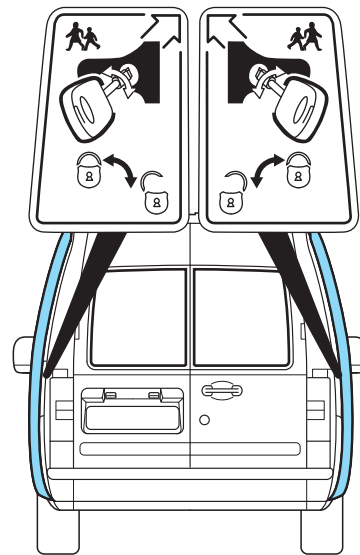

## Locks and Security

### OPENING THE SLIDING DOOR

**Note:** the right-hand sliding door is inhibited from opening fully when the fuel filler flap is unlocked and open.

### REMOTE ENTRY SYSTEM (IF EQUIPPED)

This device complies with part 15 of the FCC rules and with RSS-210 of Industry Canada. Operation is subject to the following two conditions:

(1) This device may not cause harmful interference, and (2) This device must accept any interference received, including interference that may cause undesired operation.

Remote entry receiver certification numbers	
Country	Part Label/Type Approval
Canada	<b>SIEMENS</b> VDO 5WK4 7899 IC: 267T - 5WK47899
USA	<b>SIEMENS</b> VDO 5WK4 7899 FCC ID: KR55WK47899

**Changes or modifications not expressly approved by the party responsible for compliance could void the user's authority to operate the equipment.**

## Locks and Security

The typical operating range for your remote entry transmitter is approximately 33 feet (10 meters). A decrease in operating range could be caused by:

- weather conditions,
- nearby radio towers,
- structures around the vehicle, or
- other vehicles parked next to your vehicle.

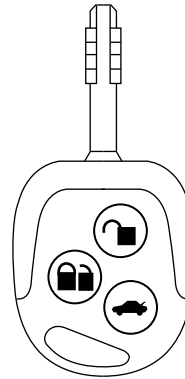

The remote entry system allows you to lock or unlock all vehicle doors and cargo door without a key.

**Note:** The lock and unlock buttons work only when the ignition is the off position. The cargo door button works when the ignition is any position.



If there are problems with the remote entry system, make sure to take **ALL remote entry transmitters** with you to the authorized dealer in order to aid in troubleshooting the problem.

### Two-step door unlocking



- Press  and release to unlock the front and sliding doors.
- Within three seconds, press  and release again to unlock all the doors.

**Note:** The interior lamps will illuminate if the control on the overhead lamp is **not** set to the **off** position.

### One-step door unlocking

If the one-step door unlocking feature is activated, press  and release once to unlock all the doors. **Note:** The interior lamps will illuminate (refer to the *Illuminated entry* feature later in this section), if the control on the overhead lamp is **not** set to the **off** position.

### Switching from two-step to one-step door unlocking



Your vehicle comes with two-step unlocking enabled. With the vehicle locked, unlocking can be switched between two-step and one-step door unlocking by pressing and holding both the  and  buttons

70

## Locks and Security

simultaneously on the remote entry transmitter for approximately four seconds and release. The turn signal lamps will flash twice to indicate that the vehicle has switched to one-step unlocking. Repeat the procedure to switch back to two-step unlocking.

### Unlocking cargo doors

- Press  to unlock the cargo doors.
- Within three seconds, press  again to unlock all the vehicle doors.

Ensure that the cargo doors are closed and latched before driving your vehicle. Failure to properly latch the cargo doors may cause objects to fall out.

### Locking the doors

- Press  and release to lock all the doors. If all doors are closed the turn signal lamps will flash twice.

### Replacing the battery

The remote entry transmitter uses one coin type three-volt lithium battery CR2032 or equivalent.

To replace the battery:

1. Carefully separate the transmitter unit from the key using a flat object (e.g. a screwdriver) at the recess on the back.

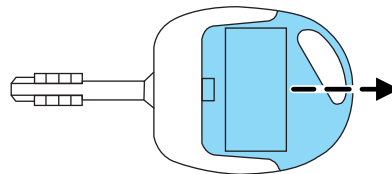

## Locks and Security

2. Open the transmitter unit by separating the retaining clips on the sides with the flat object.

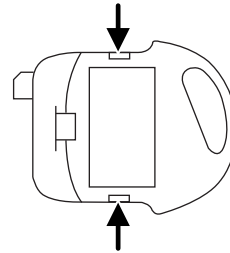

3. Remove the old battery.

**Note:** Please refer to local regulations when disposing of transmitter batteries.

4. DO NOT TAKE THE PLASTIC COVER AND CIRCUIT BOARD OFF THE FRONT HOUSING OF THE REMOTE ENTRY TRANSMITTER.

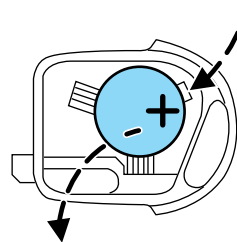

5. Do not wipe off any grease on the battery terminals or the back surface of the circuit board.

6. Insert the new battery. The positive + terminal should face upwards. Press the battery down to ensure that the battery is fully seated in the battery housing cavity.

7. Snap the two halves back together.

**Note:** Replacement of the battery will **not** cause the remote transmitter to become deprogrammed from your vehicle. The remote transmitter should operate normally after battery replacement.

### Replacing lost remote entry transmitters

If you would like to have your remote entry transmitter reprogrammed because you lost one, or would like to buy additional remote entry transmitters, you can either reprogram them yourself, or take **all remote entry transmitters** to your authorized dealer for reprogramming.

### How to reprogram your remote entry transmitters

You must have **all remote entry transmitters** (maximum of four) available before beginning this procedure. If all remote entry transmitters

72



## Locks and Security

are not present during the programming procedure, the transmitters that are not present during programming will no longer operate the vehicle.

**Note:** Ensure the brake pedal is not depressed during this sequence.

To reprogram the remote entry transmitters:

1. Ensure the vehicle is unlocked.
2. Put the key in the ignition in the 0 (off) position.
3. Cycle four times rapidly (within six seconds) between the 0 (off) and II (on) position.

**Note:** The fourth turn must end in the II (on) position.

4. Turn the key to the 0 (off) position within 10 seconds.
5. A chime will sound to confirm that the programming mode has been activated.
6. Within 10 seconds press any button on the remote entry transmitter.  
**Note:** If more than 10 seconds have passed you will need to start the procedure over again.
7. A chime will sound to confirm that this remote entry transmitter has been programmed.
8. Repeat Step 6 to program each additional remote entry transmitter.
9. The programming mode will exit automatically after 10 seconds of inactivity, or by turning the ignition to position II.

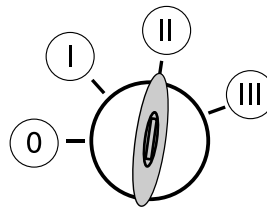

### Illuminated entry

The interior lamps illuminate when the remote entry system is used to unlock the door(s).

The illuminated entry system will turn off the interior lights if:

- the ignition switch is turned to the on position, or
- the remote transmitter lock control is pressed, or
- after 25 seconds of illumination.

The dome lamp control (if equipped) must **not** be set to the off position for the illuminated entry system to operate.

The inside lights will not turn off if:

- they have been turned on with the dome lamp control, or
- any door is open.

## Locks and Security

### SECURILOCK® PASSIVE ANTI-THEFT SYSTEM (IF EQUIPPED)

SecuriLock® passive anti-theft system is an engine immobilization system. This system is designed to help prevent the engine from being started unless a **coded key programmed to your vehicle** is used. The use of the wrong type of coded key may lead to a “no-start” condition.

Your vehicle comes with two coded keys; additional coded keys may be purchased from your authorized dealer. The authorized dealer can program your spare keys to your vehicle or you can program the keys yourself. Refer to *Programming spare keys* for instructions on how to program the coded key.

**Note:** The SecuriLock® passive anti-theft system is not compatible with non-Ford aftermarket remote start systems. Use of these systems may result in vehicle starting problems and a loss of security protection.

**Note:** Large metallic objects, electronic devices that are used to purchase gasoline or similar items, or a second coded key on the same key chain may cause vehicle starting issues. You need to prevent these objects from touching the coded key while starting the engine. These objects will not cause damage to the coded key, but may cause a momentary issue if they are too close to the key when starting the engine. If a problem occurs, turn the ignition off, remove all objects on the key chain away from the coded key and restart the engine.

**Note: Do not leave a duplicate coded key in the vehicle. Always take your keys and lock all doors when leaving the vehicle.**

### Anti-theft indicator

The anti-theft indicator is located in the instrument cluster.

- When the ignition is in the off position, the indicator will flash briefly to indicate the SecuriLock® system is functioning as a theft deterrent. The indicator light will stop flashing after approximately 10 seconds.
- When the ignition is in the on position, the indicator will glow for three seconds, then turn off, to indicate normal system functionality.



If a problem occurs with the SecuriLock® system, the indicator will flash rapidly or glow steadily when the ignition is in the on position. If this occurs, turn the ignition off then back to on to make sure there was no electronic interference with the programmed key. If the vehicle doesn't start, try to start it with the 2nd programmed key and if successful

74

## Locks and Security

contact your authorized dealership for key replacement. If the indicator still flashes rapidly or glows steadily, and the vehicle will not start, contact your authorized dealer as soon as possible for service.

### **Automatic arming**

The vehicle is armed immediately after switching the ignition to the off position.

### **Automatic disarming**

Switching the ignition to the on position with a **coded key** disarms the vehicle.

### **Replacement keys**

If your keys are lost or stolen and you don't have an extra coded key, you will need to have your vehicle towed to an authorized dealer. The key codes need to be erased from your vehicle and new coded keys will need to be programmed.

Replacing coded keys can be very costly. Store an extra programmed key away from the vehicle in a safe place to help prevent any inconveniences. Please visit an authorized dealer to purchase additional spare or replacement keys.

### **Programming spare keys**

You can program your own coded keys to your vehicle. Please read and understand the entire procedure before you begin.

The process for programming SecuriLock® keys is independent of the process for programming remote entry transmitters. If your vehicle is equipped with SecuriLock® and remote entry, you must perform both learning procedures in order to program both the immobilizer and remote locking functions of the key fob.

#### **Tips:**

- A maximum of eight keys can be coded to your vehicle.
- Only use SecuriLock® keys.
- You must have two previously programmed coded keys (keys that already operate your vehicle's engine) and the new unprogrammed key(s) readily accessible.
- If two previously programmed coded keys are not available, you must take your vehicle to your authorized dealer to have the spare key(s) programmed.

## Locks and Security

1. Insert a previously programmed coded key into the ignition.
2. Turn the ignition from the 0 (off) position to the II (on) position. Keep the ignition in the II (on) position for at least one second, but no more than 10 seconds.
3. Turn the ignition to the 0 (off) position.
4. Remove the previously programmed coded key from the ignition.
5. After three seconds but within 10 seconds of removing the previously programmed coded key, insert the other previously programmed coded key into the ignition.
6. Turn the ignition from the 0 (off) position to the II (on) position. Keep the ignition in the II (on) position for at least one second but not more than 10 seconds.
7. Turn the ignition to the 0 (off) position.
8. Remove the previously programmed coded key from the ignition.
9. After three seconds but within twenty seconds of removing the previously programmed coded key, insert the unprogrammed key (new/valet key) into the ignition.
10. Turn the ignition from the 0 (off) position to the II (on) position. Keep the ignition in the II (on) position for at least one second, but not more than 10 seconds.
11. Your new, unprogrammed key is now programmed.

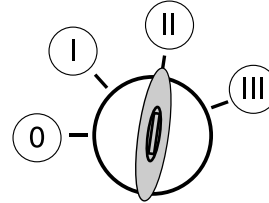

If the key has been successfully programmed it will start the vehicle's engine and the theft indicator light will illuminate for three seconds and then go out.

If the key was not successfully programmed, it will not start your vehicle's engine and the theft indicator light will flash on and off, or stay on for more than three seconds. If failure repeats, bring your vehicle to your authorized dealer to have the new key(s) programmed.

To program additional new unprogrammed key(s), repeat this procedure from Step 1 for each additional key.

## Seating and Safety Restraints

### FRONT SEATS

 **WARNING:** Reclining the seatback can cause an occupant to slide under the seat's safety belt, resulting in severe personal injuries in the event of a collision.

 **WARNING:** Do not pile cargo higher than the seatbacks to reduce the risk of injury in a collision or sudden stop.

 **WARNING:** Before returning the seatback to its original position, make sure that cargo or any objects are not trapped behind the seatback. After returning the seatback to its original position, pull on the seatback to ensure that it has fully latched. An unlatched seat may become dangerous in the event of a sudden stop or collision.

 **WARNING:** Never adjust the driver's seat or seatback when the vehicle is moving.

 **WARNING:** Always drive and ride with your seatback upright and the lap belt snug and low across the hips.

### Adjustable head restraints

Your vehicle is equipped with front row outboard head restraints that are vertically adjustable.

 **WARNING:** To minimize the risk of neck injury in the event of a crash, the driver and passenger occupants should not sit in and/or operate the vehicle, until the head restraint is placed in its proper position. The driver should never adjust the head restraint while the vehicle is in motion.

## Seating and Safety Restraints

The adjustable head restraints consist of:

- a trimmed energy absorbing foam and structure (1),
- two steel stems (2),
- a guide sleeve adjust/release button (3),
- and a guide sleeve unlock/remove button (4).

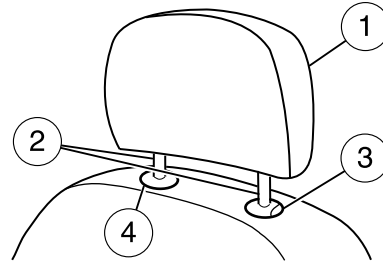

To adjust the head restraint, do the following:

1. Adjust the seatback to an upright driving/riding position.
2. Raise the head restraint by pulling up on the head restraint.

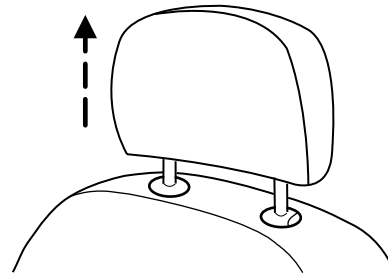

3. Lower the head restraint by pressing and holding the guide sleeve adjust/release button and pushing down on the head restraint.

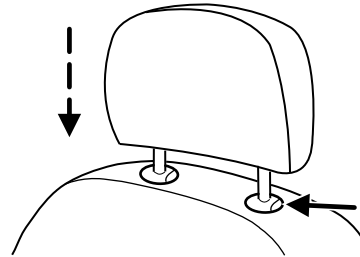

Properly adjust the head restraint so that the top of the head restraint is even with the top of your head and positioned as close as possible to the back of your head. For occupants of extremely tall stature, adjust the head restraint to its full up position.

## Seating and Safety Restraints



**WARNING:** The adjustable head restraint is a safety device. Whenever possible it should be installed and properly adjusted when the seat is occupied.

To remove the adjustable head restraint, do the following:

1. Pull up the head restraint until it reaches the highest adjustment position.

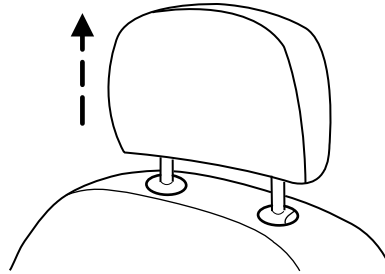

2. Use a push tool, such as a key, to press the unlock/remove button located on the side of the guide sleeve and, at the same time, press the adjust/release button, then pull the head restraint upward.

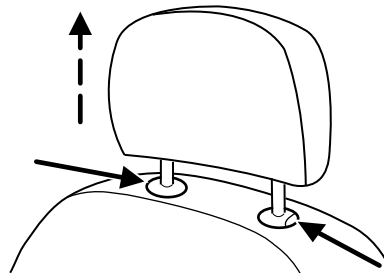

To reinstall the adjustable head restraint, do the following:

1. Insert the two stems into the guide sleeve collars.
2. Push the head restraint down until it locks.

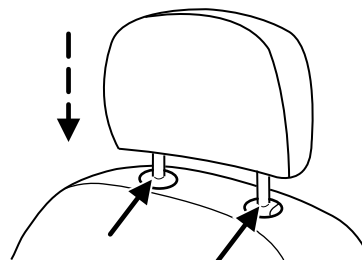

## Seating and Safety Restraints

Properly adjust the head restraint so that the top of the head restraint is even with the top of your head and positioned as close as possible to the back of your head. For occupants of extremely tall stature, adjust the head restraint to its full up position.



**WARNING:** To minimize the risk of neck injury in the event of a crash, head restraints must be installed properly.

### Adjusting the front manual seat



**WARNING:** Never adjust the driver's seat or seatback when the vehicle is moving.



**WARNING:** Always drive and ride with your seatback upright and the lap belt snug and low across the hips.

Lift handle to move seat forward or backward.

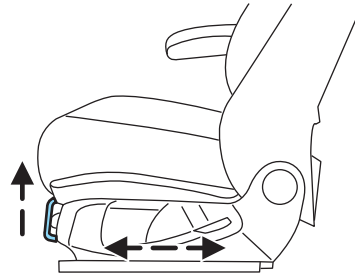

Rotate the control to adjust seatback.

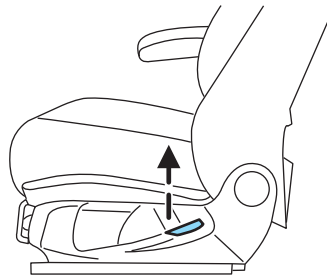



## Seating and Safety Restraints

Move the front control to raise or lower the seat cushion.

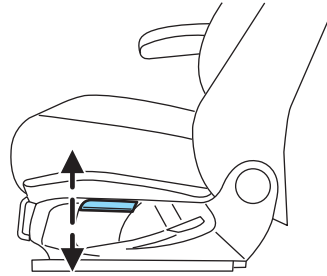

### Using the manual lumbar support

The lumbar support control is located on the in-board side of the seatback.

Turn the lumbar support control clockwise for more support.

Turn the lumbar support counter-clockwise for less support.

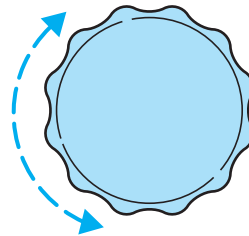

### Using the armrest (if equipped)

Move the armrest up or down. You can also move it all the way up to stow it on the side of the seatback.

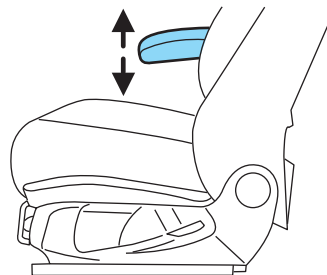

## REAR SEATS

### Second row adjustable head restraints

Your vehicle is equipped with second row outboard head restraints that are vertically adjustable.

## Seating and Safety Restraints

**⚠ WARNING:** To minimize the risk of neck injury in the event of a crash, the driver and passenger occupants should not sit in and/or operate the vehicle, until the head restraint is placed in its proper position. The driver should never adjust the head restraint while the vehicle is in motion.

The adjustable head restraints consist of :

- a trimmed energy absorbing foam and structure (1),
- two steel stems (2),
- a guide sleeve adjust/release button (3),
- and a red guide sleeve unlock/remove button (4).

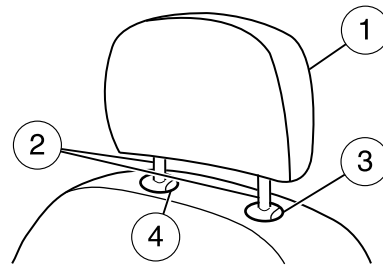

To adjust the head restraint, do the following:

1. Adjust the seatback to an upright driving/riding position.
2. Raise the head restraint by pulling up on the head restraint.

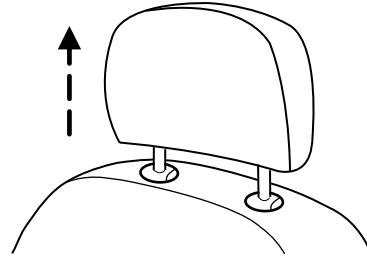

3. Lower the head restraint by pressing and holding the guide sleeve adjust/release button and pushing down on the head restraint.

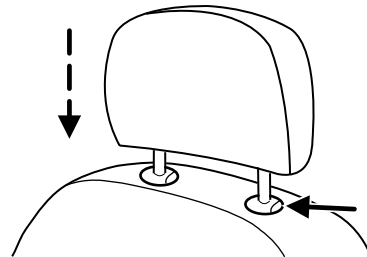

## Seating and Safety Restraints

Properly adjust the head restraint so that the top of the head restraint is even with the top of your head and positioned as close as possible to the back of your head. For occupants of extremely tall stature, adjust the head restraint to its full up position.



**WARNING:** The adjustable head restraint is a safety device. Whenever possible it should be installed and properly adjusted when the seat is occupied.

To remove the adjustable head restraint, do the following:

1. Pull up the head restraint until it reaches the highest adjustment position.

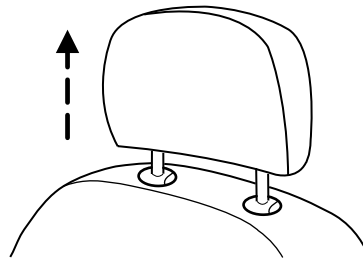

2. Simultaneously press and hold both the adjust/release button and the unlock/remove button, then pull up on the head restraint.

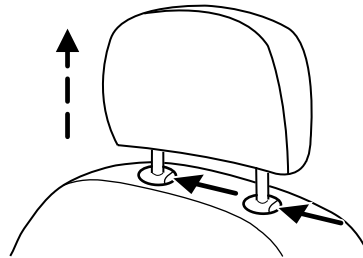

## Seating and Safety Restraints

To reinstall the adjustable head restraint, do the following:

1. Insert the two stems into the guide sleeve collars.
2. Push the head restraint down until it locks.

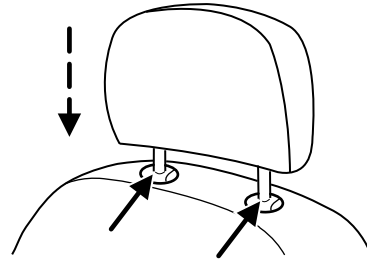

Properly adjust the head restraint so that the top of the head restraint is even with the top of your head and positioned as close as possible to the back of your head. For occupants of extremely tall stature, adjust the head restraint to its full up position.



**WARNING:** To minimize the risk of neck injury in the event of a crash, head restraints must be installed properly.

### Folding down the rear seat

One or both rear seatbacks can be folded down to provide additional cargo space.

To lower a single seatback:

1. Remove the head restraint(s). Refer to *Second row adjustable head restraints* earlier in this chapter.

**Note:** Place the head restraint underneath the back of the front seat for storage.

2. Pull down the lever on the side of the seat back.
3. Push the seatback forward.

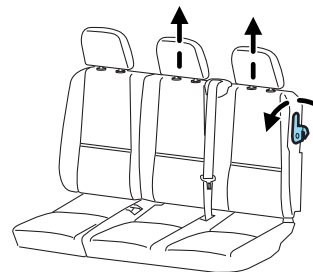

## Seating and Safety Restraints

To lower both seatbacks:

1. Remove all head restraints. Refer to *Adjustable rear head restraints* in this chapter.

**Note:** Place the head restraint underneath the back of the front seat for storage.

2. Pull the levers on the side of the seatback.

3. Fold the seatback forward.

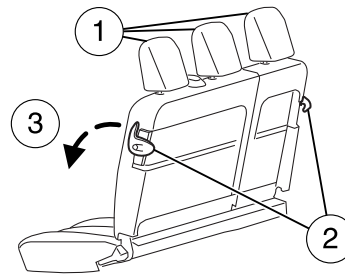

To place the seat in the tumble position:

4. Pull the release straps up.

5. Fold the seat forwards until the lever is automatically locked and you hear a click.

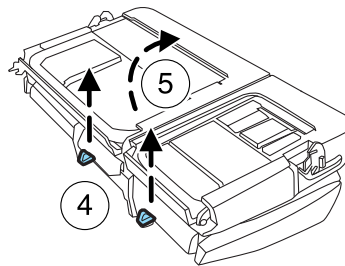

When raising the seatback(s), make sure the lever is locked and you hear the seat latch into place.

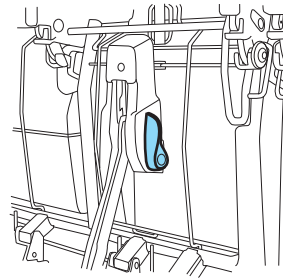

## Seating and Safety Restraints

### *Returning the seat to the upright position*

 **WARNING:** Before returning the seatback to its original position, make sure that cargo or any objects are not trapped behind the seatback. After returning the seatback to its original position, pull on the seatback to ensure that it has fully latched. An unlatched seat may become dangerous in the event of a sudden stop or collision.

1. Pull down on the locking lever.
2. Fold the seat down.
3. Raise the seatback.
4. Install all head restraints.

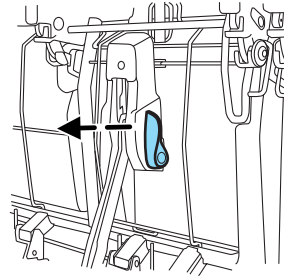

5. Ensure that the red indicator is in the locked position.

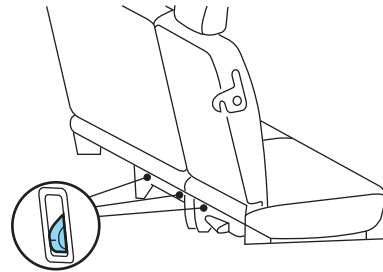

- Locked

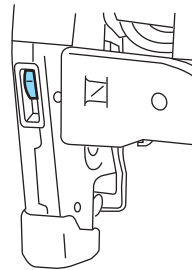

## Seating and Safety Restraints

- Unlocked

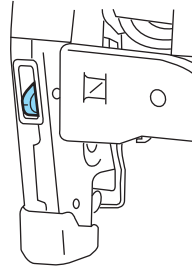

### SAFETY RESTRAINTS

#### Personal Safety System™

The Personal Safety System provides an improved overall level of frontal crash protection to front seat occupants and is designed to help further reduce the risk of airbag-related injuries. The system is able to analyze different occupant conditions and crash severity before activating the appropriate safety devices to help better protect a range of occupants in a variety of frontal crash situations.

Your vehicle's Personal Safety System consists of:

- Driver and passenger dual-stage airbag supplemental restraints.
- Front safety belts with pretensioners, energy management retractors, and safety belt usage sensors.
- Driver's seat position sensor.
- Two front crash severity sensors.
- Front passenger sensing system
- "Passenger airbag off" or "pass airbag off" indicator lamp
- Restraints Control Module (RCM) with impact and safing sensors.
- Restraint system warning light and backup tone.
- The electrical wiring for the airbags, crash sensor(s), safety belt pretensioners, front safety belt usage sensors, driver seat position sensor, and indicator lights.

#### ***How does the Personal Safety System work?***

The Personal Safety System can adapt the deployment strategy of your vehicle's safety devices according to crash severity and conditions. A collection of crash sensors provides information to the Restraints Control

## Seating and Safety Restraints

Module (RCM). During a crash, the RCM may activate the safety belt pretensioners and/or either none, one, or both stages of the dual-stage airbag supplemental restraints based on crash severity and conditions.

The fact that the pretensioners or airbags did not activate for both front seat occupants in a collision does not mean that something is wrong with the system. Rather, it means the Personal Safety System determined the accident conditions (crash severity, belt usage, etc.) were not appropriate to activate these safety devices. Front airbags are designed to activate only in frontal and near-frontal collisions, not rollovers, side-impacts, or rear-impacts unless the collision causes sufficient longitudinal deceleration.

### ***Driver and passenger dual-stage airbag supplemental restraints***

The dual-stage airbags offer the capability to tailor the level of airbag inflation energy. A lower, less forceful energy level is provided for more common, moderate-severity impacts. A higher energy level is used for the most severe impacts. Refer to *Airbag supplemental restraint system (SRS)* section in this chapter.

### ***Front crash severity sensors***

The front crash severity sensors enhance the ability to detect the severity of an impact. Positioned up front, they provide valuable information early in the crash event on the severity of the impact. This allows your Personal Safety System to distinguish between different levels of crash severity and modify the deployment strategy of the dual-stage airbags and safety belt pretensioners.

### ***Driver's seat position sensor***

The driver's seat position sensor allows your Personal Safety System to tailor the deployment level of the driver dual-stage airbag based on seat position. The system is designed to help protect smaller drivers sitting close to the driver airbag by providing a lower airbag output level.

### ***Front passenger sensing system***

For airbags to do their job they must inflate with great force, and this force can pose a potentially deadly risk to occupants that are very close to the airbag when it begins to inflate. For some occupants, like infants in rear-facing child seats, this occurs because they are initially sitting very close to the airbag. For other occupants, this occurs when the occupant is not properly restrained by safety belts or child safety seats and they move forward during pre-crash braking. The most effective way to reduce the risk of unnecessary injuries is to make sure all occupants

88



## Seating and Safety Restraints

are properly restrained. Accident statistics suggest that children are much safer when properly restrained in the rear seating positions than in the front.



**WARNING:** Air bags can kill or injure a child in a child seat. **NEVER** place a rear-facing child seat in front of an active air bag. If you must use a forward-facing child seat in the front seat, move the seat all the way back.



**WARNING:** Always transport children 12 years old and under in the back seat and always properly use appropriate child restraints.

The front passenger sensing system can automatically turn off the passenger front airbag. The system is designed to help protect small (child size) occupants from airbag deployments when they are improperly seated or restrained in the front passenger seat contrary to proper child-seating or restraint usage recommendations. Even with this technology, parents are **STRONGLY** encouraged to always properly restrain children in the rear seat. The sensor also turns off the airbag when the passenger seat is empty to prevent unnecessary replacement of the airbag(s) after a collision.

When the front passenger seat is occupied and the sensing system has turned off the passenger's frontal airbag, the "pass airbag off" indicator will light and stay lit to remind you that the front passenger frontal airbag is off. See *Front passenger sensing system* in the *Airbag supplemental restraint system (SRS)* section of this chapter.

### **Front safety belt usage sensors**

The front safety belt usage sensors detect whether or not the driver and front outboard passenger safety belts are fastened. This information allows your Personal Safety System to tailor the airbag deployment and safety belt pretensioner activation depending upon safety belt usage.

### **Front outboard safety belt pretensioners**

The safety belt pretensioners at the front outboard seating positions are designed to tighten the safety belts firmly against the occupant's body during frontal collisions, and in side collisions and rollovers. This helps increase the effectiveness of the safety belts. In frontal collisions, the safety belt pretensioners can be activated alone or, if the collision is of sufficient severity, together with the front airbags.

## Seating and Safety Restraints

### **Front outboard safety belt energy management retractors**

The front safety belt energy management retractors allow webbing to be pulled out of the retractor in a gradual and controlled manner in response to the occupant's forward momentum. This helps reduce the risk of force-related injuries to the occupant's chest by limiting the load on the occupant. Refer to the *Energy management feature* section in this chapter.

### **Determining if the Personal Safety System is operational**

The Personal Safety System uses a warning light in the instrument cluster or a backup tone to indicate the condition of the system. Refer to the *Warning lights and chimes* section in the *Instrument Cluster* chapter. Routine maintenance of the Personal Safety System is not required.

The Restraints Control Module (RCM) monitors its own internal circuits and the circuits for the airbag supplemental restraints, crash sensor(s), safety belt pretensioners, front safety belt buckle sensors, front passenger sensing system, and the driver seat position sensor. In addition, the RCM also monitors the restraints warning light in the instrument cluster. A difficulty with the system is indicated by one or more of the following.

- The warning light will either flash or stay lit.
- The warning light will not illuminate immediately after ignition is turned on.
- A series of five beeps will be heard. The tone pattern will repeat periodically until the problem and warning light are repaired.

If any of these things happen, even intermittently, have the Personal Safety System serviced at an authorized dealer immediately. Unless serviced, the system may not function properly in the event of a collision.

### **Safety restraints precautions**





**WARNING:** Always drive and ride with your seatback upright and the lap belt snug and low across the hips.





**WARNING:** To reduce the risk of injury, make sure children sit where they can be properly restrained.

## Seating and Safety Restraints

 **WARNING:** Never let a passenger hold a child on his or her lap while the vehicle is moving. The passenger cannot protect the child from injury in a collision.

 **WARNING:** All occupants of the vehicle, including the driver, should always properly wear their safety belts, even when an air bag supplemental restraint system (SRS) is provided.

 **WARNING:** It is extremely dangerous to ride in a cargo area, inside or outside of a vehicle. In a collision, people riding in these areas are more likely to be seriously injured or killed. Do not allow people to ride in any area of your vehicle that is not equipped with seats and safety belts. Be sure everyone in your vehicle is in a seat and using a safety belt properly.

 **WARNING:** In a rollover crash, an unbelted person is significantly more likely to die than a person wearing a seat belt.

 **WARNING:** Each seating position in your vehicle has a specific safety belt assembly which is made up of one buckle and one tongue that are designed to be used as a pair. 1) Use the shoulder belt on the outside shoulder only. Never wear the shoulder belt under the arm. 2) Never swing the safety belt around your neck over the inside shoulder. 3) Never use a single belt for more than one person.

 **WARNING:** When possible, all children 12 years old and under should be properly restrained in a rear seating position.

 **WARNING:** Safety belts and seats can become hot in a vehicle that has been closed up in sunny weather; they could burn a small child. Check seat covers and buckles before you place a child anywhere near them.

 **WARNING:** Front and rear seat occupants, including pregnant women, should wear safety belts for optimum protection in an accident.

## Seating and Safety Restraints

### Combination lap and shoulder belts

1. Insert the belt tongue into the proper buckle (the buckle closest to the direction the tongue is coming from) until you hear a snap and feel it latch. Make sure the tongue is securely fastened in the buckle.

- Front and rear seats

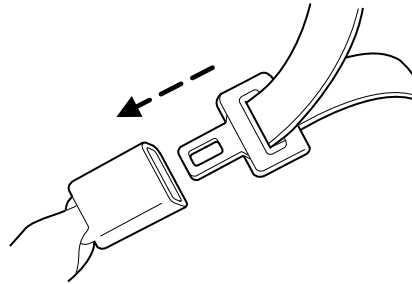

2. To unfasten, push the release button and remove the tongue from the buckle.

- Front and rear seats

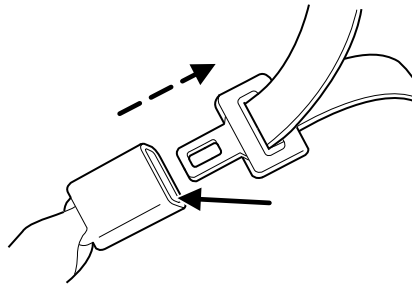

### ***Restraint of pregnant women***



**WARNING:** Always ride and drive with your seatback upright and the safety belt properly fastened. The lap portion of the safety belt should fit snug and be positioned low across the hips. The shoulder portion of the safety belt should be positioned across the chest. Pregnant women should also follow this practice. See figure below.

## Seating and Safety Restraints

Pregnant women should always wear their safety belt. The lap belt portion of a combination lap and shoulder belt should be positioned low across the hips below the belly and worn as tight as comfort will allow. The shoulder belt should be positioned to cross the middle of the shoulder and the center of the chest.

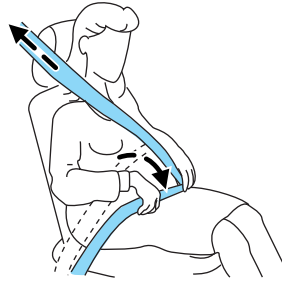

### Safety belt locking modes

All safety restraints in the vehicle are combination lap and shoulder belts. The driver safety belt has the first locking mode and the passenger safety belts have both types of locking modes described as follows:

#### Vehicle sensitive mode

This is the normal retractor mode, which allows free shoulder belt length adjustment to your movements and locking in response to vehicle movement. For example, if the driver brakes suddenly or turns a corner sharply, or the vehicle receives an impact of approximately 5 mph (8 km/h) or more, the combination safety belts will lock to help reduce forward movement of the driver and passengers.

In addition, the retractor is designed to lock if the webbing is pulled out too quickly. If this occurs, let the belt retract slightly and pull webbing out again in a slow and controlled manner.

#### Automatic locking mode

In this mode, the shoulder belt is automatically pre-locked. The belt will still retract to remove any slack in the shoulder belt. The automatic locking mode is not available on the driver safety belt.

#### *When to use the automatic locking mode*

This mode should be used **any time** a child safety seat, except a booster, is installed in passenger front or rear seating positions. Children 12 years old and under should be properly restrained in a rear seating position whenever possible. Refer to *Safety restraints for children* or *Safety seats for children* later in this chapter.

## Seating and Safety Restraints

### *How to use the automatic locking mode*

1. Buckle the combination lap and shoulder belt.
2. Grasp the shoulder portion and pull downward until the entire belt is pulled out.

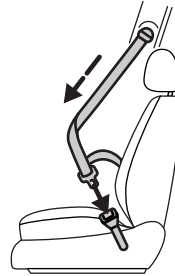

- Allow the belt to retract. As the belt retracts, you will hear a clicking sound. This indicates the safety belt is now in the automatic locking mode.

### **How to disengage the automatic locking mode**

Disconnect the combination lap/shoulder belt and allow it to retract completely to disengage the automatic locking mode and activate the vehicle sensitive (emergency) locking mode.



**WARNING:** After any vehicle collision, the safety belt system at all passenger seating positions must be checked by an authorized dealer to verify that the “automatic locking retractor” feature for child seats is still functioning properly. In addition, all safety belts should be checked for proper function.



**WARNING:** BELT AND RETRACTOR ASSEMBLY MUST BE REPLACED if the safety belt assembly “automatic locking retractor” feature or any other safety belt function is not operating properly when checked by an authorized dealer. Failure to replace the belt and retractor assembly could increase the risk of injury in collisions.

### **Safety belt pretensioner**

Your vehicle is equipped with safety belt pretensioners at the driver and front outboard passenger seating positions.

The safety belt pretensioner tightens the safety belts firmly against the occupant's body at the start of the crash.

94

## Seating and Safety Restraints

 **WARNING:** The driver and front passenger safety belt system (including retractors, buckles and height adjusters) must be replaced if the vehicle is involved in a collision that results in deployment of front airbags, side airbags, and safety belt pretensioners.

### Safety belt extension assembly

If the safety belt is too short when fully extended, there is a 12 inch (31 cm) (part number YL84 78611C22 ABW) or a 9 inch (23 cm) (part number YL84 78611C22 BBW ) safety belt extension assembly that can be added. This assembly can be obtained from an authorized dealer.

Use only extensions manufactured by the same supplier as the safety belt. Manufacturer identification is located at the end of the webbing on the label. Also, use the safety belt extension only if the safety belt is too short for you when fully extended.

 **WARNING:** Do not use extensions to change the fit of the shoulder belt across the torso.

### Front safety belt height adjustment

The front seat and outboard positions are equipped with a height adjuster. Adjust the height of the shoulder belt so the belt rests across the middle of your shoulder.

To adjust the shoulder belt height downward, push the button (1) and slide the height adjuster (2) upwards slightly and then down. Release the button (1) and pull down on the height adjuster (2) to make sure it is locked in place.

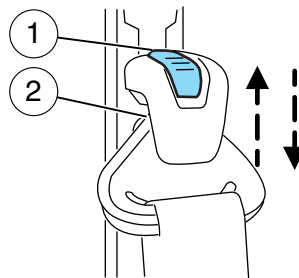

To adjust the belt upward, slide the adjuster up. You do not need to push the button to slide the adjuster upwards. Pull down on the height adjuster to make sure it is locked in place.

## Seating and Safety Restraints



**WARNING:** Position the safety belt height adjusters so that the belt rests across the middle of your shoulder. Failure to adjust the safety belt properly could reduce the effectiveness of the safety belt and increase the risk of injury in a collision.

### Safety belt warning light and indicator chime

The safety belt warning light illuminates in the instrument cluster and a chime sounds to remind the occupants to fasten their safety belts.

#### **Conditions of operation**

If...	Then...
The driver's safety belt is not buckled before the ignition switch is turned to the on position...	The safety belt warning light illuminates 1-2 minutes and the warning chime sounds 4-8 seconds.
The driver's safety belt is buckled while the indicator light is illuminated and the warning chime is sounding...	The safety belt warning light and warning chime turn off.
The driver's safety belt is buckled before the ignition switch is turned to the on position...	The safety belt warning light and indicator chime remain off.

#### **Belt-Minder®**

The Belt-Minder® feature is a supplemental warning to the safety belt warning function. This feature provides additional reminders by intermittently sounding a chime and illuminating the safety belt warning light in the instrument cluster when the driver's and front passenger's safety belt is unbuckled.

The Belt-Minder® feature uses information from the front passenger sensing system to determine if a front seat passenger is present and therefore potentially in need of a warning. To avoid activating the Belt-Minder® feature for objects placed in the front passenger seat, warnings will only be given to large front seat occupants as determined by the front passenger sensing system.

Both the driver's and passenger's safety belt usages are monitored and either may activate the Belt-Minder® feature. The warnings are the same for the driver and the front passenger. If the Belt-Minder® warnings have expired (warnings for approximately five minutes) for one occupant (driver or front passenger), the other occupant can still activate the Belt-Minder® feature.

96



## Seating and Safety Restraints

If...	Then...
The driver's and front passenger's safety belts are buckled before the ignition switch is turned to the on position or less than 1-2 minutes have elapsed since the ignition switch has been turned to on...	The Belt-Minder® feature will not activate.
The driver's or front passenger's safety belt is not buckled when the vehicle has reached at least 6 mph (10 km/h) and 1-2 minutes have elapsed since the ignition switch has been turned to on...	The Belt-Minder® feature is activated - the safety belt warning light illuminates and the warning chime sounds for six seconds every 16 seconds, repeating for approximately five minutes or until the safety belts are buckled.
The driver's or front passenger's safety belt becomes unbuckled while the vehicle is traveling at least 6 mph (10 km/h) and more than 1-2 minutes have elapsed since the ignition switch has been turned to on...	The Belt-Minder® feature is activated - the safety belt warning light illuminates and the warning chime sounds for six seconds every 16 seconds, repeating for approximately five minutes or until the safety belts are buckled.

The following are reasons most often given for not wearing safety belts (All statistics based on U.S. data):

Reasons given...	Consider...
"Crashes are rare events"	<b>36700 crashes occur every day.</b> The more we drive, the more we are exposed to "rare" events, even for good drivers. <i>1 in 4 of us will be seriously injured in a crash during our lifetime.</i>
"I'm not going far"	<b>3 of 4</b> fatal crashes occur within <b>25</b> miles (40 km) of home.

## Seating and Safety Restraints

Reasons given...	Consider..
“Belts are uncomfortable”	We design our safety belts to enhance comfort. If you are uncomfortable - try different positions for the safety belt upper anchorage and seatback which should be as upright as possible; this can improve comfort.
“I was in a hurry”	<b>Prime time for an accident.</b> Belt-Minder® reminds us to take a few seconds to buckle up.
“Safety belts don’t work”	<b>Safety belts</b> , when used properly, <b>reduce risk of death</b> to front seat occupants by <b>45% in cars</b> , and by <b>60% in light trucks</b> .
“Traffic is light”	<b>Nearly 1 of 2 deaths occur in single-vehicle crashes</b> , many when no other vehicles are around.
“Belts wrinkle my clothes”	Possibly, but a serious crash can do much more than wrinkle your clothes, particularly if you are unbelted.
“The people I’m with don’t wear belts”	Set the example, teen deaths occur 4 times more often in vehicles with TWO or MORE people. Children and younger brothers/sisters imitate behavior they see.
“I have an airbag”	Airbags offer greater protection when used with safety belts. Frontal airbags are not designed to inflate in rear and side crashes or rollovers.
“I’d rather be thrown clear”	Not a good idea. <b>People</b> who are <b>ejected are 40 times more likely to DIE</b> . Safety belts help prevent ejection, WE CAN’T “PICK OUR CRASH”.

## Seating and Safety Restraints



**WARNING:** Do not sit on top of a buckled safety belt or insert a latchplate into the buckle to avoid the Belt-Minder® chime. To do so may adversely affect the performance of the vehicle's airbag system.

### ***Deactivating/activating the Belt-Minder® feature***

*Read Steps 1 - 3 thoroughly before proceeding with the deactivation/activation programming procedure.*

The Belt-Minder® feature can be deactivated/activated by performing the following procedure:

Before following the procedure, make sure that:

- The parking brake is set.
- The gearshift is in P (Park).
- The ignition is off.
- The driver and front passenger safety belts are unbuckled.



**WARNING:** While the design allows you to deactivate your Belt-Minder®, this system is designed to improve your chances of being safely belted and surviving an accident. We recommend you leave the Belt-Minder® system activated for yourself and others who may use the vehicle. To reduce the risk of injury, do not deactivate/activate the Belt-Minder® feature while driving the vehicle.

1. Turn the ignition switch to the on position. **DO NOT START THE ENGINE.**
2. Wait until the safety belt warning light turns off (approximately 1-2 minutes).
  - Step 3 must be completed within 50 seconds after the safety belt warning light turns off.
3. Buckle then unbuckle the driver's safety belt nine times at a moderate speed, ending in the unbuckled state.
  - This will disable the Belt-Minder® feature if it is currently enabled or enable the Belt-Minder® feature if it is currently disabled. As confirmation, the safety belt warning light will flash three times.

## Seating and Safety Restraints

### AIRBAG SUPPLEMENTAL RESTRAINT SYSTEM (SRS)

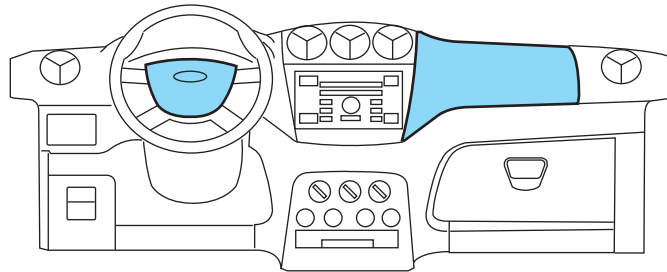

#### Important SRS precautions

The SRS is designed to work with the safety belt to help protect the driver and right front passenger from certain upper body injuries. Airbags DO NOT inflate slowly; there is a risk of injury from a deploying airbag.

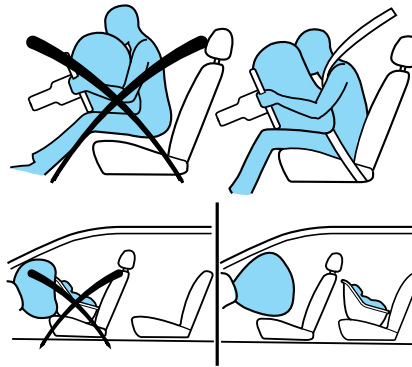

**!** **WARNING:** All occupants of the vehicle, including the driver, should always properly wear their safety belts, even when an air bag supplemental restraint system (SRS) is provided.

**!** **WARNING:** Always transport children 12 years old and under in a rear seating position, and always properly use appropriate child restraints. Never place a rear-facing child seat in front of an active airbag. If you must transport a forward-facing child in the front seat, move the seat all the way back and use appropriate restraints.

## Seating and Safety Restraints

 **WARNING:** National Highway Traffic Safety Administration (NHTSA) recommends a minimum distance of at least 10 inches (25 cm) between an occupant's chest and the driver airbag module.

 **WARNING:** Never place your arm over the air bag module as a deploying air bag can result in serious arm fractures or other injuries.

To properly position yourself away from the airbag:

- Move your seat to the rear as far as you can while still reaching the pedals comfortably.
- Recline the seat slightly one or two degrees from the upright position.

 **WARNING:** Do not put anything on or over the air bag module. Placing objects on or over the air bag inflation area may cause those objects to be propelled by the air bag into your face and torso causing serious injury.

 **WARNING:** Do not attempt to service, repair, or modify the airbag supplemental restraint systems or its fuses. Contact your authorized dealer as soon as possible.

 **WARNING:** Modifying or adding equipment to the front end of the vehicle (including frame, bumper, front end body structure and tow hooks) may affect the performance of the airbag system, increasing the risk of injury. Do not modify the front end of the vehicle.

 **WARNING:** Additional equipment may affect the performance of the airbag sensors increasing the risk of injury. Please refer to the *Body Builders Layout Book* for instructions about the appropriate installation of additional equipment.

## Seating and Safety Restraints

### Children and airbags

Children must always be properly restrained. Accident statistics suggest that children are safer when properly restrained in the rear seating positions than in the front seating position. Failure to follow these instructions may increase the risk of injury in a collision.

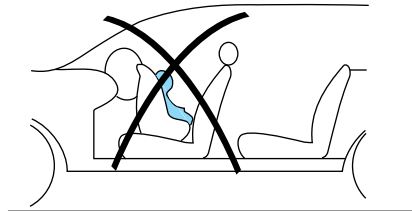

**WARNING:** Airbags can kill or injure a child in a child seat. **NEVER** place a rear-facing child seat in front of an active airbag. If you must use a forward-facing child seat in the front seat, move the seat all the way back.

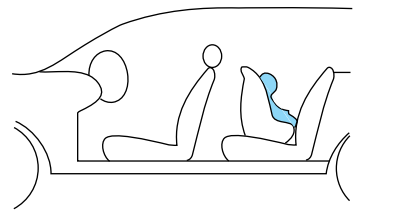

### How does the airbag supplemental restraint system work?

The airbag SRS is designed to activate when the vehicle sustains a longitudinal deceleration sufficient to cause the airbag sensors to close an electrical circuit that initiates airbag inflation. The fact that the airbags did not inflate in a collision does not mean that something is wrong with the system. Rather, it means the forces were not sufficient enough to cause activation. Airbags are designed to inflate in frontal and near-frontal collisions, not rollover, side-impact, or rear-impacts unless the collision causes sufficient longitudinal deceleration.

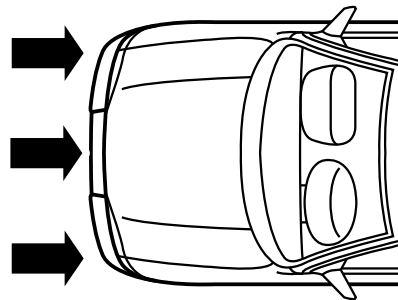

## Seating and Safety Restraints

The airbags inflate and deflate rapidly upon activation. After airbag deployment, it is normal to notice a smoke-like, powdery residue or smell the burnt propellant. This may consist of cornstarch, talcum powder or sodium compounds which may irritate the skin and eyes, but none of the residue is toxic.

While the SRS is designed to help reduce serious injuries, contact with a deploying airbag may also cause abrasions, swelling or temporary hearing loss. Because airbags must inflate rapidly and with considerable force, there is the risk of death or serious injuries such as fractures, facial and eye injuries or internal injuries, particularly to occupants who are not properly restrained or are otherwise out of position at the time of airbag deployment. It is extremely important that occupants be properly restrained as far away from the airbag module as possible while maintaining vehicle control.



The SRS consists of:

- driver and passenger airbag modules (which include the inflators and airbags)
- seat-mounted side airbags
- one or more impact and safing sensors
- a readiness light and tone
- a diagnostic module
- and the electrical wiring which connects the components

The diagnostic module monitors its own internal circuits and the supplemental airbag electrical system wiring (including the impact sensors), the system wiring, the airbag system readiness light, the airbag backup power and the airbag ignitors.



**WARNING:** Several air bag system components get hot after inflation. Do not touch them after inflation.

## Seating and Safety Restraints



**WARNING:** If the air bag has deployed, **the air bag will not function again and must be replaced immediately.** If the air bag is not replaced, the unrepaired area will increase the risk of injury in a collision.

### Front passenger sensing system

The front passenger sensing system is designed to meet the regulatory requirements of Federal Motor Vehicle Safety Standard (FMVSS) 208 and is designed to disable (will not inflate) the front passenger's frontal airbag under certain conditions.

The front passenger sensing system works with sensors that are part of the front passenger's seat and safety belt. The sensors are designed to detect the presence of a properly seated occupant and determine if the front passenger's frontal airbag should be enabled (may inflate) or disabled (will not inflate).

The front passenger sensing system will disable (will not inflate) the front passenger's frontal airbag if:

- the front passenger seat is unoccupied, or has small/medium objects in the front seat,
- the system determines that an infant is present in a rear-facing infant seat that is installed according to the manufacturer's instructions,
- the system determines that a small child is present in a forward-facing child restraint that is installed according to the manufacturer's instructions,
- the system determines that a small child is present in a booster seat,
- a front passenger takes his/her weight off of the seat for a period of time,
- a child or a small person occupies the front passenger seat.

**Note:** When the passenger airbag off light is illuminated, the passenger (seat mounted) side airbag may be disabled to avoid the risk of airbag deployment injuries.

The front passenger sensing system uses a "passenger airbag off" or "pass airbag off" indicator which will illuminate and stay lit to remind you

that the front passenger frontal airbag is disabled. The indicator lamp is located at the top of the instrument panel center stack area above the radio and next to the hazard warning indicator.

PASS AIRBAG OFF 



## Seating and Safety Restraints

**Note:** The indicator lamp will illuminate for a short period of time when the ignition is turned to the on position to confirm it is functional.

When the front passenger seat is not occupied (empty seat) or in the event that the front passenger frontal airbag is enabled (may inflate), the indicator lamp will be unlit.

The front passenger sensing system is designed to disable (will not inflate) the front passenger's frontal airbag when a rear facing infant seat, a forward-facing child restraint, or a booster seat is detected.

- When the front passenger sensing system disables (will not inflate) the front passenger frontal airbag, the indicator lamp will illuminate and stay lit to remind you that the front passenger frontal airbag is disabled.
- If the child restraint has been installed and the indicator lamp is not lit, then turn the vehicle off, remove the child restraint from the vehicle and reinstall the restraint following the child restraint manufacturer's instructions.

The front passenger sensing system is designed to enable (may inflate) the front passenger's frontal airbag anytime the system senses that a person of adult size is sitting properly in the front passenger seat.

- When the front passenger sensing system enables the front passenger frontal airbag (may inflate), the indicator will be unlit and stay unlit.

If a person of adult size is sitting in the front passenger's seat, but the "passenger airbag off" or "pass airbag off" indicator lamp is lit, it is possible that the person isn't sitting properly in the seat. If this happens:

- Turn the vehicle off and ask the person to place the seatback in the full upright position.
- Have the person sit upright in the seat, centered on the seat cushion, with the person's legs comfortably extended.
- Restart the vehicle and have the person remain in this position for about two minutes. This will allow the system to detect that person and enable the passenger's frontal airbag.
- If the indicator lamp remains lit even after this, the person should be advised to ride in the rear seat.

## Seating and Safety Restraints

Occupant	Pass Airbag Off Indicator Lamp	Passenger Airbag
Empty seat	Unlit	Disabled
Small child in child safety seat or booster	Lit	Disabled
Small child with safety belt buckled or unbuckled	Lit	Disabled
Adult	Unlit	Enabled

 **WARNING:** Even with Advanced Restraints Systems, children 12 and under should be properly restrained in a rear seating position.

After all occupants have adjusted their seats and put on safety belts, it's very important that they continue to sit properly. A properly seated occupant sits upright, leaning against the seat back, and centered on the seat cushion, with their feet comfortably extended on the floor. Sitting improperly can increase the chance of injury in a crash event. For example, if an occupant slouches, lies down, turns sideways, sits forward, leans forward or sideways, or puts one or both feet up, the chance of injury during a crash is greatly increased.

 **WARNING:** Sitting improperly out of position or with the seat back reclined too far can take off weight from the seat cushion and affect the decision of the front passenger sensing system, resulting in serious injury or death in a crash. Always sit upright against your seatback, with your feet on the floor.

The front passenger sensing system may detect small or medium objects placed on the seat cushion. For most objects that are in the front passenger seat, the passenger airbag will be disabled. Even though the passenger airbag is disabled, the "pass airbag off" lamp may or may not be illuminated according to the table below.

## Seating and Safety Restraints

Objects	Pass Airbag Off Indicator Lamp	Passenger Airbag
Small (i.e. three-ring binder, small purse, bottled water)	Unlit	Disabled
Medium (i.e. heavy briefcase, fully packed luggage)	Lit	Disabled
Empty seat, or small to medium object with safety belt buckled	Lit	Disabled

If you think that the status of the passenger airbag off indicator lamp is incorrect, check for the following:

- Objects lodged underneath the seat
- Objects between the seat cushion and the center console (if equipped)
- Objects hanging off the seat back
- Objects stowed in the seatback map pocket (if equipped)
- Objects placed on the occupant's lap
- Cargo interference with the seat
- Other passengers pushing or pulling on the seat
- Rear passenger feet and knees resting or pushing on the seat

The conditions listed above may cause the weight of a properly seated occupant to be incorrectly interpreted by the passenger sensing system. The person in the front passenger seat may appear heavier or lighter due to the conditions described in the list above.



**WARNING:** To reduce the risk of possible serious injury: Do not stow objects in seat back map pocket (if equipped) or hang objects off seat back if a child is in the front passenger seat. Do not place large objects (unless storing rear seat headrests) underneath the front passenger seat, or between the seat and the center console (if equipped). Check the “passenger airbag off” or “pass airbag off” indicator lamp for proper airbag Status. Failure to follow these instructions may interfere with the passenger seat sensing system.

## Seating and Safety Restraints

In case there is a problem with the front passenger sensing system, the airbag readiness lamp in the instrument cluster will stay lit.



### **If the airbag readiness lamp is lit, do the following:**

The driver and/or adult passengers should check for any objects that may be lodged underneath the front passenger seat or cargo interfering with the seat.

If objects are lodged and/or cargo is interfering with the seat; please take the following steps to remove the obstruction:

- Pull the vehicle over.
- Turn the vehicle off.
- Driver and/or adult passengers should check for any objects lodged underneath the front passenger seat or cargo interfering with the seat.
- Remove the obstruction(s) (if found).
- Restart the vehicle.
- Wait at least two minutes and verify that the airbag readiness lamp is no longer illuminated
- If the airbag readiness lamp remains illuminated, this may or may/not be a problem due to the front passenger sensing system.

DO NOT attempt to repair or service the system; take your vehicle immediately to an authorized dealer.

If it is necessary to modify an advanced front airbag system to accommodate a person with disabilities, contact the Ford Customer Relationship Center at the phone number shown in the *Customer Assistance* section of this Owner's Guide.



**WARNING:** Any alteration/modification to the front passenger seat may affect the performance of the front passenger sensing system.

### **Determining if the system is operational**

The SRS uses a readiness light in the instrument cluster or a tone to indicate the condition of the system. Refer to the *Warning lights and chimes* section in the *Instrument Cluster* chapter. Routine maintenance of the airbag is not required.

## Seating and Safety Restraints

A difficulty with the system is indicated by one or more of the following:

- The readiness light will either flash or stay lit.
- The readiness light will not illuminate immediately after ignition is turned on.
- A series of five beeps will be heard. The tone pattern will repeat periodically until the problem and/or light are repaired.





If any of these things happen, even intermittently, contact your authorized dealer as soon as possible. Unless serviced, the system may not function properly in the event of a collision.

### Seat-mounted side airbag system

 **WARNING:** Do not place objects or mount equipment on or near the airbag cover on the side of the seatbacks of the front seats or in front seat areas that may come into contact with a deploying airbag. Failure to follow these instructions may increase the risk of personal injury in the event of a collision.

 **WARNING:** Do not use accessory seat covers. The use of accessory seat covers may prevent the deployment of the side airbags and increase the risk of injury in an accident.

 **WARNING:** Do not lean your head on the door. The side airbag could injure you as it deploys from the side of the seatback.

 **WARNING:** Do not attempt to service, repair, or modify the airbag SRS, its fuses or the seat cover on a seat containing an airbag. Contact your authorized dealer as soon as possible.

 **WARNING:** All occupants of the vehicle should always wear their safety belts even when an airbag SRS is provided.

## Seating and Safety Restraints

### ***How does the side airbag system work?***

The design and development of the side airbag system included recommended testing procedures that were developed by a group of automotive safety experts known as the Side Airbag Technical Working Group. These recommended testing procedures help reduce the risk of injuries related to the deployment of side airbags.

The side airbag system consists of the following:

- An inflatable bag (airbag) with a gas generator concealed behind the outboard bolster of the driver and front passenger seatbacks.
- A special seat cover designed to allow airbag deployment.
- The same warning light, electronic control and diagnostic unit as used for the front airbags.
- Two side crash sensors located at the “B” pillars (one on each side).

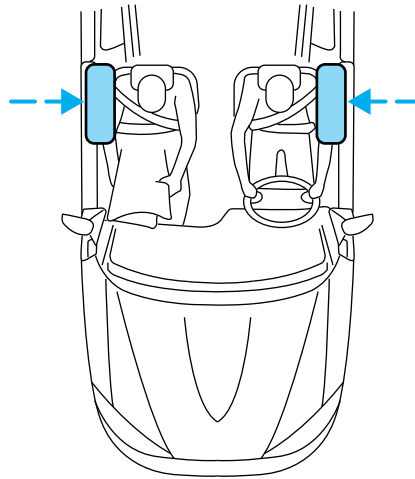

Side airbags, in combination with safety belts, can help reduce the risk of severe injuries in the event of a significant side impact collision.

The side airbags are fitted on the outboard side of the seatbacks of the front seats. In certain lateral collisions, the airbag on the side affected by the collision will be inflated. The airbag was designed to inflate between the door panel and occupant to further enhance the protection provided occupants in side impact collisions.

The airbag SRS is designed to activate when the vehicle sustains lateral deceleration sufficient to cause the sensors to close an electrical circuit that initiates airbag inflation.

The fact that the airbags did not inflate in a collision does not mean that something is wrong with the system. Rather, it means the forces were not of the type sufficient to cause activation. Side airbags are designed to inflate in side-impact collisions, not roll-over, rear-impact, frontal or near-frontal collisions, unless the collision causes sufficient lateral deceleration.

110

## Seating and Safety Restraints



**WARNING:** Several air bag system components get hot after inflation. Do not touch them after inflation.



**WARNING:** If the side airbag has deployed, **the airbag will not function again. The side airbag system (including the seat) must be inspected and serviced by an authorized dealer.** If the airbag is not replaced, the unrepaired area will increase the risk of injury in a collision.

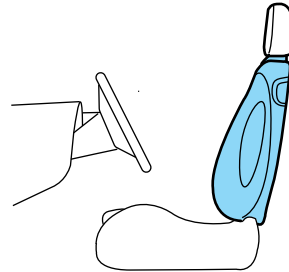

### ***Determining if the system is operational***

The SRS uses a readiness light in the instrument cluster or a tone to indicate the condition of the system. Refer to *Warning lights and chimes* in the *Instrument Cluster* chapter. Routine maintenance of the side airbag is not required.

A difficulty with the system is indicated by one or more of the following:

- The readiness light (same light as for front airbag system) will either flash or stay lit.
- The readiness light will not illuminate immediately after ignition is turned on.
- A series of five beeps will be heard. The tone pattern will repeat periodically until the problem and/or light are repaired.

If any of these things happen, even intermittently, have the SRS serviced at your authorized dealer immediately. Unless serviced, the system may not function properly in the event of a collision.

### **Disposal of airbags and airbag equipped vehicles (including pretensioners)**

Contact your authorized dealer as soon as possible. Airbags **MUST BE** disposed of by qualified personnel.

### **SAFETY RESTRAINTS FOR CHILDREN**

See the following sections for directions on how to properly use safety restraints for children. Also see *Airbag supplemental restraint system (SRS)* in this chapter for special instructions about using airbags.

## Seating and Safety Restraints

### Important child restraint precautions

 **WARNING:** Always make sure your child is secured properly in a device that is appropriate for their height, age and weight. Child safety restraints must be purchased separately from the vehicle. Failure to follow these instructions and guidelines may result in an increased risk of serious injury or death to your child.

 **WARNING:** All children are shaped differently. The Recommendations for Safety Restraints are based on probable child height, age and weight thresholds from NHTSA and other safety organizations or are the minimum requirements of law. Ford recommends checking with a NHTSA Certified Child Passenger Safety Technician (CPST) and consult your pediatrician to make sure your child seat is appropriate for your child, and is compatible with and properly installed in the vehicle. To locate a child seat fitting station and CPST contact the NHTSA toll free at 1-888-327-4236 or on the internet at <http://www.nhtsa.dot.gov>. In Canada, check with your local St. John Ambulance office for referral to a CPST or for further information, contact your provincial ministry of transportation, your local St. John Ambulance office at <http://www.sfa.ca>, or Transport Canada at 1-800-333-0371 (<http://www.tc.gc.ca>). Failure to properly restrain children in safety seats made especially for their height, age, and weight may result in an increased risk of serious injury or death to your child.

Recommendations for Safety Restraints for Children		
	Child size, height, weight, or age	Recommended restraint type
Infants or toddlers	Children weighing 40 lb (18 kg) or less (generally age four or younger)	Use a child safety seat (sometimes called an infant carrier, convertible seat, or toddler seat).



## Seating and Safety Restraints

<b>Recommendations for Safety Restraints for Children</b>		
	<b>Child size, height, weight, or age</b>	<b>Recommended restraint type</b>
Small children	Children who have outgrown or no longer properly fit in a child safety seat (generally children who are less than 4 feet 9 inches (1.45 meters) tall, are greater than age four (4) and less than age twelve (12), and between 40 lb (18 kg) and 80 lb (36 kg) and upward to 100 lb (45 kg) if recommended by your child restraint manufacturer)	Use a belt-positioning booster seat.
Larger children	Children who have outgrown or no longer properly fit in a belt-positioning booster seat (generally children who are at least 4 feet 9 inches (1.45 meters) tall or greater than 80 lb (36 kg) or 100 lb (45 kg) if recommended by child restraint manufacturer)	Use a vehicle safety belt having the lap belt snug and low across the hips, shoulder belt centered across the shoulder and chest, and seatback upright.

- You are required by law to properly use safety seats for infants and toddlers in the U.S. and Canada.
- Many states and provinces require that small children use approved booster seats until they reach age eight, a height of 4 ft 9 in. (1.45 meters) tall, or 80 lb (36 kg). Check your local and state or provincial laws for specific requirements regarding the safety of children in your vehicle.
- When possible, always properly restrain children twelve (12) years of age and under in a rear seating position of your vehicle. Accident statistics suggest that children are safer when properly restrained in the rear seating positions than in a front seating position.

## Seating and Safety Restraints

### Recommendations for attaching child safety restraints for children

Restraint Type	Child Weight	Use any attachment method as indicated below by "X"				
		LATCH (lower anchors and top tether anchor)	LATCH (lower anchors only)	Safety belt and top tether anchor	Safety belt and LATCH (lower anchors and top tether anchor)	Safety belt only
Rear facing child seat	Up to 48 lb (21 kg)		X			X
Forward facing child seat	Up to 48 lb (21 kg)	X		X	X	
Forward facing child seat	Over 48 lb (21 kg)			X	X	





**WARNING:** Airbags can kill or injure a child in a child seat. NEVER place a rear-facing child seat in front of an active airbag. If you must use a forward-facing child seat in the front seat, move the vehicle seat all the way back. When possible, all children age 12 and under should be properly restrained in a rear seating position. If all children cannot be seated and restrained properly in a rear seating position, properly restrain the largest child in the front seat.

## Seating and Safety Restraints

 **WARNING:** Always carefully follow the instructions and warnings provided by the manufacturer of any child restraint to determine if the restraint device is appropriate for your child's size, height, weight, or age. Follow the child restraint manufacturer's instructions and warnings provided for installation and use in conjunction with the instructions and warnings provided by the vehicle manufacturer. A safety seat that is improperly installed or utilized, is inappropriate for your child's height, age, or weight or does not properly fit the child may increase the risk of serious injury or death.

 **WARNING:** Never let a passenger hold a child on his or her lap while the vehicle is moving. The passenger cannot protect the child from injury in a collision, which may result in serious injury or death.

 **WARNING:** Never use pillows, books, or towels to boost a child. They can slide around and increase the likelihood of injury or death in a collision.

 **WARNING:** Always restrain an unoccupied child seat or booster seat. These objects may become projectiles in a collision or sudden stop, which may increase the risk of serious injury.

 **WARNING:** Never place, or allow a child to place, the shoulder belt under a child's arm or behind the back because it reduces the protection for the upper part of the body and may increase the risk of injury or death in a collision.

 **WARNING:** Do not leave children, unreliable adults, or pets unattended in your vehicle.

### Transporting children

Always make sure your child is secured properly in a device that is appropriate for their age, height and weight. All children are shaped differently. The child height, age and weight thresholds provided are recommendations or the minimum requirements of law. The National Highway Traffic Safety Administration (NHTSA) provides education and

## Seating and Safety Restraints

training to ensure that all children ages 0 to 16 are properly restrained in the correct restraint system. Ford recommends checking with a NHTSA Certified Child Passenger Safety Technician (CPST) and your pediatrician to make sure your seat is appropriate for your child and properly installed in the vehicle. To locate a child seat fitting station and CPST contact the NHTSA toll free at **1-888-327-4236** or on the internet at <http://www.nhtsa.dot.gov>. In Canada, check with your local St. John Ambulance office for referral to a CPST or for further information, contact your provincial ministry of transportation, your local St. John Ambulance office at <http://www.sfa.ca>, or Transport Canada at 1-800-333-0371 (<http://www.tc.gc.ca>).

Follow all the safety restraint and airbag precautions that apply to adult passengers in your vehicle.

If the child is the proper height, age, and weight (as specified by your child safety seat or booster manufacturer), fits the restraint and can be restrained properly, then restrain the child in the child safety seat or with the belt-positioning booster. Remember that child seats and belt-positioning boosters vary and may be designed to fit children of different heights, ages and weights. Children who are too large for child safety seats or belt-positioning boosters (as specified by your child safety seat manufacturer) should always properly wear safety belts.

### SAFETY SEATS FOR CHILDREN

#### Infant and/or toddler seats

Use a safety seat that is recommended for the size and weight of the child.

When installing a child safety seat:

- Review and follow the information presented in the *Airbag supplemental restraint system (SRS)* section in this chapter.
- Carefully follow all of the manufacturer's instructions included with the safety seat you put in your vehicle. If you do not install and use the safety seat properly, the child may be injured in a sudden stop or collision.

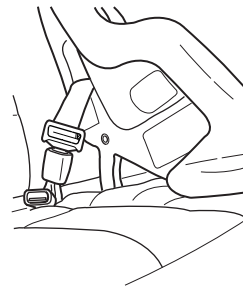

## Seating and Safety Restraints

Airbags can kill or injure a child in a child seat. NEVER place a rear-facing child seat in front of an active airbag. If you must use a forward-facing child seat in the front seat, move the vehicle seat all the way back.

Children 12 and under should be properly restrained in a rear seating position whenever possible. If all children cannot be seated and restrained properly in a rear seating position, properly restrain the largest child in the front seat.

### Installing child safety seats with combination lap and shoulder belts

Check to make sure the child seat is properly secured before each use. Children 12 and under should be properly restrained in a rear seating position whenever possible. If all children cannot be seated and restrained properly in a rear seating position, properly restrain the largest child in the front seat.

When installing a child safety seat with combination lap/shoulder belts:

- Use the correct safety belt buckle for that seating position.
- Insert the belt tongue into the proper buckle until you hear a snap and feel it latch. Make sure the tongue is securely fastened in the buckle.
- Keep the buckle release button pointing up and away from the safety seat, with the tongue between the child seat and the release button, to help prevent accidental unbuckling.
- Place vehicle seat back in upright position.
- Put the safety belt in the automatic locking mode. Refer to Step 5 below. This vehicle does not require the use of a locking clip.



**WARNING:** Depending on where you secure a child restraint, and depending on the child restraint design, you may block access to certain safety belt buckle assemblies and/or LATCH lower anchors, rendering those features potentially unusable. To avoid risk of injury, occupants should only use seating positions where they are able to be properly restrained.

Perform the following steps when installing the child seat with combination lap/shoulder belts:

**Note:** Although the child seat illustrated is a forward facing child seat, the steps are the same for installing a rear facing child seat.

## Seating and Safety Restraints

1. Position the child safety seat in a seat with a combination lap and shoulder belt.

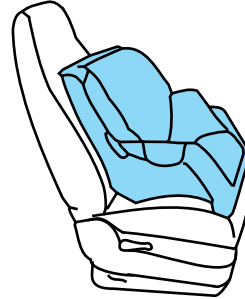

2. Pull down on the shoulder belt and then grasp the shoulder belt and lap belt together.

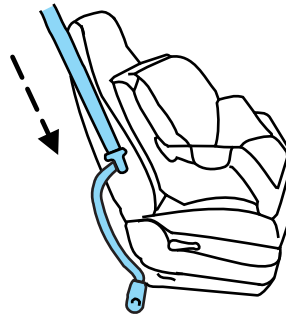

3. While holding the shoulder and lap belt portions together, route the tongue through the child seat according to the child seat manufacturer's instructions. Be sure the belt webbing is not twisted.

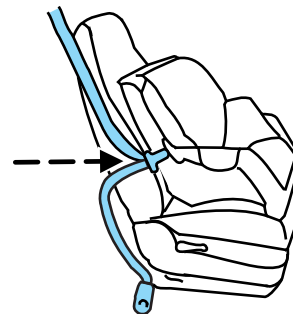

## Seating and Safety Restraints

4. Insert the belt tongue into the proper buckle (the buckle closest to the direction the tongue is coming from) for that seating position until you hear a snap and feel the latch engage. Make sure the tongue is latched securely by pulling on it.

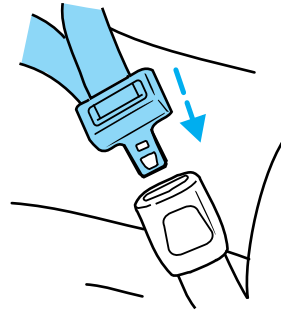

5. To put the retractor in the automatic locking mode, grasp the shoulder portion of the belt and pull downward until all of the belt is pulled out.

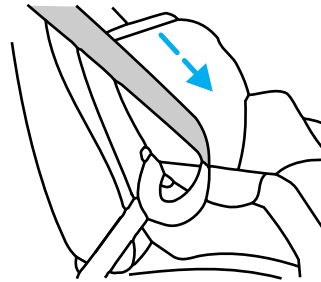

6. Allow the belt to retract to remove slack. The belt will click as it retracts to indicate it is in the automatic locking mode.

7. Try to pull the belt out of the retractor to make sure the retractor is in the automatic locking mode (you should not be able to pull more belt out). If the retractor is not locked, repeat Steps 5 and 6.

8. Remove remaining slack from the belt. Force the seat down with extra weight, e.g., by pressing down or kneeling on the child restraint while pulling up on the shoulder belt in order to force slack from the belt. This is necessary to remove the remaining slack that will exist once the additional weight of the child is added to the child restraint. It also helps to achieve the proper snugness of the child seat to the vehicle. Sometimes, a slight lean

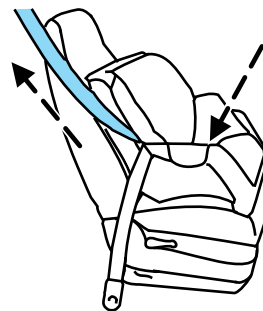

## Seating and Safety Restraints

towards the buckle will additionally help to remove remaining slack from the belt.

9. Attach the tether strap (if the child seat is equipped). Refer to *Attaching child safety seats with tether straps* later in this chapter.

10. Before placing the child in the seat, forcibly move the seat forward and back to make sure the seat is securely held in place. To check this, grab the seat at the belt path and attempt to move it side to side and forward and back. There should be no more than 1 inch (2.5 cm) of movement for proper installation.

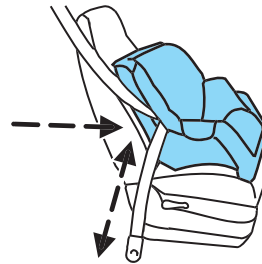

Ford recommends checking with a NHTSA Certified Child Passenger Safety Technician (CPST) to make certain the child restraint is properly installed. In Canada, check with your local St. John Ambulance office for referral to a CPST.

### **Attaching child safety seats with LATCH (Lower Anchors and Tethers for Children) attachments**

The LATCH system is composed of three vehicle anchor points: two (2) lower anchors located where the vehicle seat back and seat cushion meet (called the “seat bight”) and one (1) top tether anchor located behind that seating position.

LATCH compatible child safety seats have two rigid or webbing mounted attachments that connect to the two lower anchors at the LATCH equipped seating positions in your vehicle. This type of attachment method eliminates the need to use safety belts to attach the child seat, however the safety belt can still be used to attach the child seat. For forward-facing child seats, the top tether strap must also be attached to the proper top tether anchor, if a top tether strap has been provided with your child seat. Ford Motor Company recommends the use of a child safety seat having a top tether strap. See *Attaching child safety seats with tether straps* and *Recommendations for attaching safety restraints for children* in this chapter for more information.

Your vehicle has LATCH lower anchors for child seat installation at the seating positions marked with the child seat symbol.

120



## Seating and Safety Restraints

- Taxi version

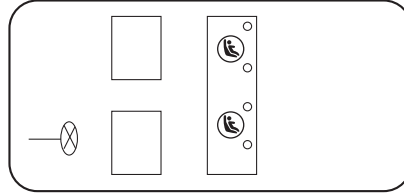

- All others

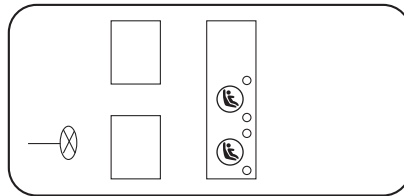

The LATCH lower anchors are located at the rear section of the rear seat between the cushion and seatback, below the locator symbols on the seat back. Follow the child seat manufacturer's instructions to properly install a child seat with LATCH attachments.

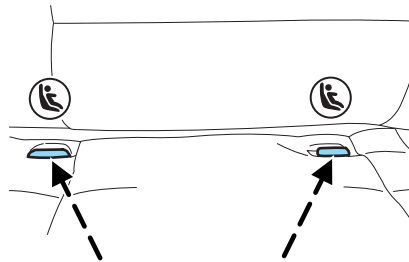

Follow the instructions on attaching child safety seats with tether straps. Refer to *Attaching child safety seats with tether straps* later in this chapter.

Attach LATCH lower attachments of the child seat only to the anchors shown.



**WARNING:** Never attach two child safety seats to the same anchor. In a crash, one anchor may not be strong enough to hold two child safety seat attachments and may break, causing serious injury or death.

## Seating and Safety Restraints

**⚠ WARNING:** Depending on where you secure a child restraint, and depending on the child restraint design, you may block access to certain safety belt buckle assemblies and/or LATCH lower anchors, rendering those features potentially unusable. To avoid risk of injury, occupants should only use seating positions where they are able to be properly restrained.

Each time you use the safety seat, check that the seat is properly attached to the lower anchors and tether anchor, if applicable. Tug the child seat from side to side and forward and back where it is secured to the vehicle. The seat should move less than one inch when you do this for a proper installation.

If the safety seat is not anchored properly, the risk of a child being injured in a crash greatly increases.

### **Combining safety belt and LATCH lower anchors for attaching child safety seats**

When used in combination, either the safety belt or the LATCH lower anchors may be attached first, provided a proper installation is achieved. Attach the tether strap afterward, if included with the child seat. Refer to *Recommendations for attaching child safety restraints for children* in this chapter.

### **Combining LATCH lower anchors with tethers for attaching child safety seats (5-Passenger Taxi only)**

When the LATCH lower anchors and tethers are used together, use the following attachment combinations only:

- Use LATCH lower anchor 1 with tether 1 as depicted in the graphic.
- Use LATCH lower anchor 2 with tether 2 as depicted in the graphic.
- **DO NOT** use the LATCH lower anchors in combination with tether 3.

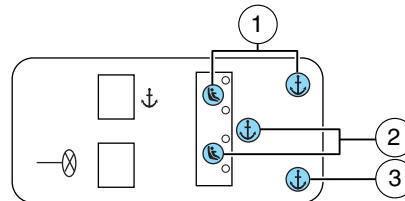

## Seating and Safety Restraints

### Attaching child safety seats with tether straps

Many forward-facing child safety seats include a tether strap which extends from the back of the child safety seat and hooks to an anchoring point called the top tether anchor. Tether straps are available as an accessory for many older safety seats. Contact the manufacturer of your child seat for information about ordering a tether strap, or to obtain a longer tether strap if the tether strap on your safety seat does not reach the appropriate top tether anchor in the vehicle.

The rear seating positions of your vehicle are equipped with built-in tether strap anchors located behind the seats on the d-pillar in the cargo area as described below.

The tether strap anchors in your vehicle are in the following positions (shown from top view):

- Four-passenger vehicle

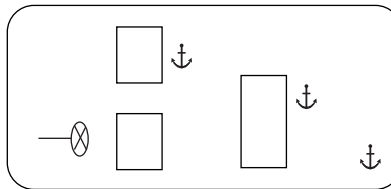

- Five-passenger vehicle

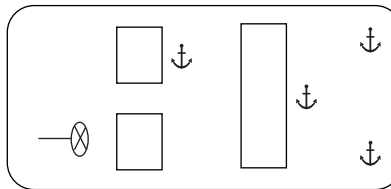

Attach the tether strap only to the appropriate tether anchor as shown. The tether strap may not work properly if attached somewhere other than the correct tether anchor.

Once the child safety seat has been installed, using either the safety belt or the lower anchors of the LATCH system, you can attach the top tether strap.

If you install a child seat with rigid LATCH attachments, and have attached the top tether strap to the proper top tether anchor, do not tighten the tether strap enough to lift the child seat off the vehicle seat cushion when the child is seated in it. Keep the tether strap just snug without lifting the front of the child seat. Keeping the child seat just touching the vehicle seat gives the best protection in a severe crash.

## Seating and Safety Restraints

Perform the following steps to install a child safety seat with tether anchors:

### Front passenger seating position

The tether can be attached directly to the rear of the front seat.

1. Route the tether strap under the head restraint and between the head restraint posts.
2. Clip the tether strap to the anchor as shown.

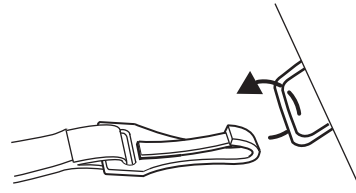

### Second row center seating position

The tether can be attached directly to the rear of the second row center seat.

1. Route the tether strap under the head restraint and between the head restraint posts.
2. Locate the anchor for the center seating position.

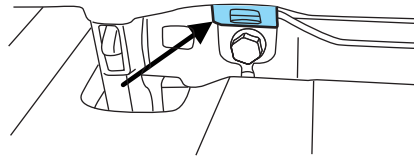

## Seating and Safety Restraints

3. Clip the tether strap to the anchor as shown.

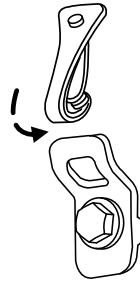

### Second-row outboard seating positions

1. Remove the head restraint. For instructions on how to remove the head restraint, refer to *Second row adjustable head restraints* earlier in this chapter.

**Note:** Place the head restraint underneath the back of the front seat for storage.

2. Locate the correct anchor for the selected seating position.

- On five-passenger vehicles, anchors are located on the passenger-side and driver-side upper rear door frame area close to the roof.

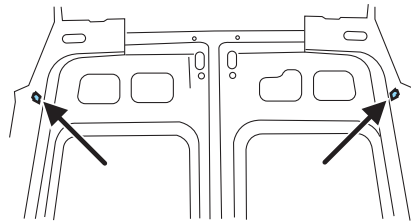

- On four-passenger vehicles the anchor is located on the driver-side upper rear door frame area close to the roof.

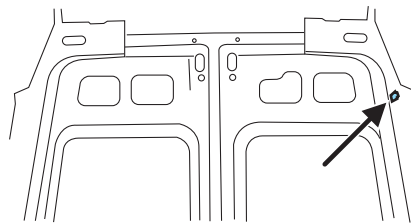

## Seating and Safety Restraints

3. Clip the tether strap to the anchor as shown.

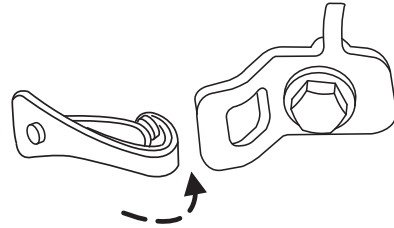

If the tether strap is clipped incorrectly, the child safety seat may not be retained properly in the event of a collision.

4. Tighten the child safety seat tether strap according to the manufacturer's instructions.

If the safety seat is not anchored properly, the risk of a child being injured in a collision greatly increases.

If your child restraint system is equipped with a tether strap, and the child restraint manufacturer recommends its use, Ford also recommends its use.

### Child booster seats

The belt-positioning booster (booster seat) is used to improve the fit of the vehicle safety belt. Children outgrow a typical child seat (e.g., convertible or toddler seat) when they weigh about 40 lb (18 kg) and are around four (4) years of age. Consult your child safety seat owner guide for the weight, height, and age limits specific to your child safety seat. Keep your child in the child safety seat if it properly fits the child, remains appropriate for their weight, height and age AND if properly secured to the vehicle.

Although the lap/shoulder belt will provide some protection, children who have outgrown a typical child seat are still too small for lap/shoulder belts to fit properly, and wearing an improperly fitted vehicle safety belt could increase the risk of serious injury in a crash. To improve the fit of both the lap and shoulder belt on children who have outgrown child safety seats, Ford Motor Company recommends use of a belt-positioning booster.

## Seating and Safety Restraints

Booster seats position a child so that vehicle lap/shoulder safety belts fit better. They lift the child up so that the lap belt rests low across the hips and the knees bend comfortably at the edge of the cushion, while minimizing slouching. Booster seats may also make the shoulder belt fit better and more comfortably. Try to keep the belt near the middle of the shoulder and across the center of the chest. Moving the child closer (a few centimeters or inches) to the center of the vehicle, but remaining in the same seating position, may help provide a good shoulder belt fit.

### **When children should use booster seats**

Children need to use booster seats from the time they outgrow the toddler seat until they are big enough for the vehicle seat and lap/shoulder belt to fit properly. Generally this is when they reach a height of at least 4 feet 9 inches (1.45 meters) tall (around age eight to age twelve and between 40 lb (18 kg) and 80 lb (36 kg) or upward to 100 lb (45 kg) if recommended by your child restraint manufacturer). Many state and provincial laws require that children use approved booster seats until they reach age eight, a height of 4 feet 9 inches (1.45 meters) tall, or 80 lb (36 kg).

Booster seats should be used until you can answer YES to ALL of these questions when seated without a booster seat:

- Can the child sit all the way back against the vehicle seat back with knees bent comfortably at the edge of the seat cushion?
- Can the child sit without slouching?

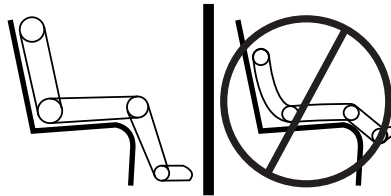

- Does the lap belt rest low across the hips?
- Is the shoulder belt centered on the shoulder and chest?
- Can the child stay seated like this for the whole trip?

## Seating and Safety Restraints

### **Types of booster seats**

There are generally two types of belt-positioning booster seats: backless and high back. Always use booster seats in conjunction with the vehicle lap/shoulder belt.

- **Backless booster seats**

If your backless booster seat has a removable shield, remove the shield. If a vehicle seating position has a low seat back or no head restraint, a backless booster seat may place your child's head (as measured at the tops of the ears) above the top of the seat. In this case, move the backless booster to another seating position with a higher seat back or head restraint and lap/shoulder belts, or consider using a high back booster seat.



- **High back booster seats**

If, with a backless booster seat, you cannot find a seating position that adequately supports your child's head, a high back booster seat would be a better choice.





## Seating and Safety Restraints

Children and booster seats vary in size and shape. Choose a booster that keeps the lap belt low and snug across the hips, never up across the stomach, and lets you adjust the shoulder belt to cross the chest and rest snugly near the center of the shoulder. The drawings below compare the ideal fit (center) to a shoulder belt uncomfortably close to the neck and a shoulder belt that could slip off the shoulder. The drawings below also show how the lap belt should be low and snug across the child's hips.

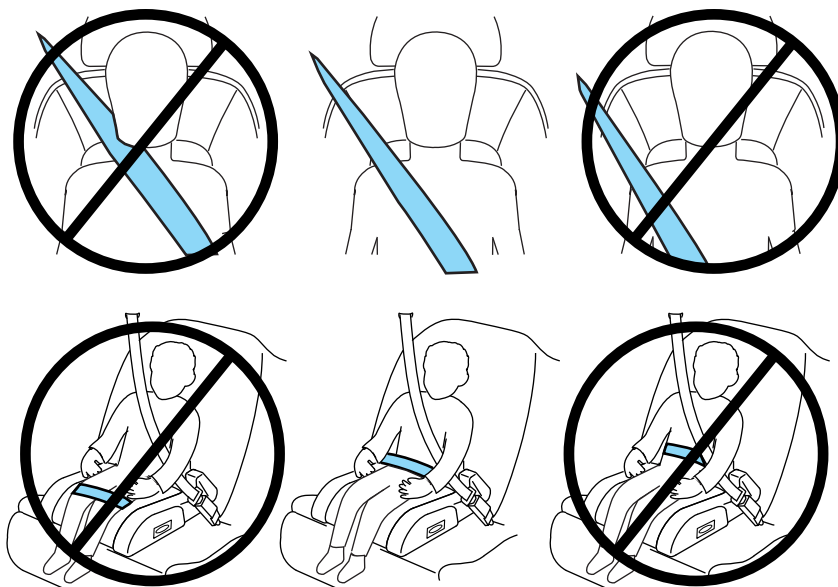

If the booster seat slides on the vehicle seat, placing a rubberized mesh sold as shelf or carpet liner under the booster seat may improve this condition. Do not introduce any item thicker than this under the booster seat. Check with the booster seat manufacturer's instructions.

### ***The importance of shoulder belts***

Using a booster without a shoulder belt increases the risk of a child's head hitting a hard surface in a collision. For this reason, you should never use a booster seat with a lap belt only. It is generally best to use a booster seat with lap/shoulder belts in the back seat.

Move a child to a different seating location if the shoulder belt does not stay positioned on the shoulder during use.

## Seating and Safety Restraints

Follow all instructions provided by the manufacturer of the booster seat.



**WARNING:** Never place, or allow a child to place, the shoulder belt under a child's arm or behind the back because it reduces the protection for the upper part of the body and may increase the risk of injury or death in a collision.

### Child restraint and safety belt maintenance

Inspect the vehicle safety belts and child safety seat systems periodically to make sure they work properly and are not damaged. Inspect the vehicle and child seat safety belts to make sure there are no nicks, tears or cuts. Replace if necessary. All vehicle safety belt assemblies, including retractors, buckles, front safety belt buckle assemblies, buckle support assemblies (slide bar-if equipped), shoulder belt height adjusters (if equipped), shoulder belt guide on seatback (if equipped), child safety seat LATCH and tether anchors, and attaching hardware, should be inspected after a collision. Refer to the child restraint manufacturer's instructions for additional inspection and maintenance information specific to the child restraint. Ford Motor Company recommends that all safety belt assemblies in use in vehicles involved in a collision be replaced. However, if the collision was minor and an authorized dealer finds that the belts do not show damage and continue to operate properly, they do not need to be replaced. Safety belt assemblies not in use during a collision should also be inspected and replaced if either damage or improper operation is noted.

For proper care of soiled safety belts, refer to *Interior* in the *Cleaning* chapter.





**WARNING:** Failure to inspect and if necessary replace the safety belt assembly or child restraint system under the above conditions could result in severe personal injuries in the event of a collision.

## Tires, Wheels and Loading

### NOTICE TO UTILITY VEHICLE AND TRUCK OWNERS

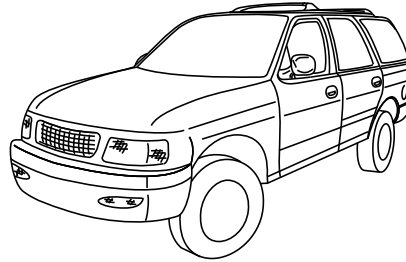
Utility vehicles and trucks handle differently than passenger cars in the various driving conditions that are encountered on streets, highways and off-road. Utility vehicles and trucks are not designed for cornering at speeds as high as passenger cars any more than low-slung sports cars are designed to perform satisfactorily under off-road conditions.



 **WARNING:** Utility vehicles have a significantly higher rollover rate than other types of vehicles. To reduce the risk of serious injury or death from a rollover or other crash you must:

- Avoid sharp turns and abrupt maneuvers;
- Drive at safe speeds for the conditions;
- Keep tires properly inflated;
- Never overload or improperly load your vehicle; and
- Make sure every passenger is properly restrained.

 **WARNING:** In a rollover crash, an unbelted person is significantly more likely to die than a person wearing a seat belt. All occupants must wear seat belts and children/infants must use appropriate restraints to minimize the risk of injury or ejection.

Study your owner's guide and any supplements for specific information about equipment features, instructions for safe driving and additional precautions to reduce the risk of an accident or serious injury.

## Tires, Wheels and Loading

### VEHICLE CHARACTERISTICS

#### How your vehicle differs from other vehicles

SUVs and trucks can differ from some other vehicles in a few noticeable ways. Your vehicle may be:

- Higher – to allow higher load carrying capacity and to allow it to travel over rough terrain without getting hung up or damaging underbody components.
- Shorter – to give it the capability to approach inclines and drive over the crest of a hill without getting hung up or damaging underbody components. All other things held equal, a shorter wheelbase may make your vehicle quicker to respond to steering inputs than a vehicle with a longer wheelbase.
- Narrower – to provide greater maneuverability in tight spaces, particularly in off-road use.

As a result of the above dimensional differences, SUVs and trucks often will have a higher center of gravity and a greater difference in center of gravity between the loaded and unloaded condition.

These differences that make your vehicle so versatile also make it handle differently than an ordinary passenger car.

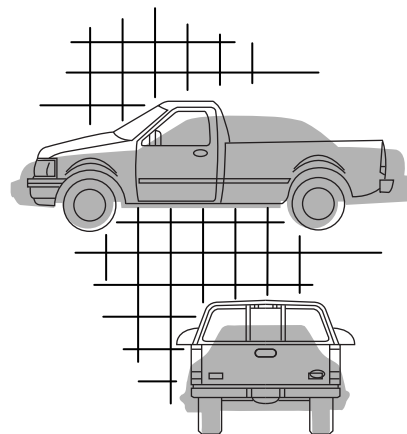
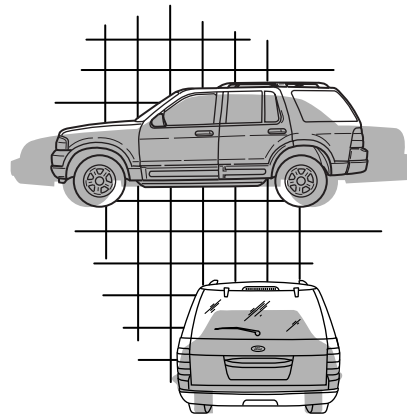

## Tires, Wheels and Loading

### INFORMATION ABOUT UNIFORM TIRE QUALITY GRADING

Tire Quality Grades apply to new pneumatic passenger car tires. The Quality grades can be found where applicable on the tire sidewall between tread shoulder and maximum section width. For example:

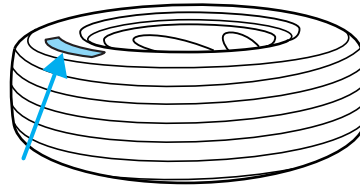

- **Treadwear 200 Traction AA Temperature A**

These Tire Quality Grades are determined by standards that the United States Department of Transportation has set.

Tire Quality Grades apply to new pneumatic passenger car tires. They do not apply to deep tread, winter-type snow tires, space-saver or temporary use spare tires, light truck or "LT" type tires, tires with nominal rim diameters of 10 to 12 inches or limited production tires as defined in Title 49 Code of Federal Regulations Part 575.104(c)(2).

**U.S. Department of Transportation-Tire quality grades:** The U.S. Department of Transportation requires Ford Motor Company to give you the following information about tire grades exactly as the government has written it.

#### **Treadwear**

The treadwear grade is a comparative rating based on the wear rate of the tire when tested under controlled conditions on a specified government test course. For example, a tire graded 150 would wear one and one-half (1½) times as well on the government course as a tire graded 100. The relative performance of tires depends upon the actual conditions of their use, however, and may depart significantly from the norm due to variations in driving habits, service practices, and differences in road characteristics and climate.

#### **Traction AA A B C**

The traction grades, from highest to lowest are AA, A, B, and C. The grades represent the tire's ability to stop on wet pavement as measured under controlled conditions on specified government test surfaces of asphalt and concrete. A tire marked C may have poor traction performance.

## Tires, Wheels and Loading



**WARNING:** The traction grade assigned to this tire is based on straight-ahead braking traction tests, and does not include acceleration, cornering, hydroplaning or peak traction characteristics.

### Temperature A B C

The temperature grades are A (the highest), B and C, representing the tire's resistance to the generation of heat and its ability to dissipate heat when tested under controlled conditions on a specified indoor laboratory test wheel. Sustained high temperature can cause the material of the tire to degenerate and reduce tire life, and excessive temperature can lead to sudden tire failure. The grade C corresponds to a level of performance which all passenger car tires must meet under the Federal Motor Vehicle Safety Standard No. 139. Grades B and A represent higher levels of performance on the laboratory test wheel than the minimum required by law.



**WARNING:** The temperature grade for this tire is established for a tire that is properly inflated and not overloaded. Excessive speed, underinflation, or excessive loading, either separately or in combination, can cause heat buildup and possible tire failure.

### TIRES

Tires are designed to give many thousands of miles of service, but they must be maintained in order to get the maximum benefit from them.

#### Glossary of tire terminology

- **Tire label:** A label showing the OE (Original Equipment) tire sizes, recommended inflation pressure and the maximum weight the vehicle can carry.
- **Tire Identification Number (TIN):** A number on the sidewall of each tire providing information about the tire brand and manufacturing plant, tire size and date of manufacture. Also referred to as DOT code.
- **Inflation pressure:** A measure of the amount of air in a tire.
- **Standard load:** A class of P-metric or Metric tires designed to carry a maximum load at 35 psi [37 psi (2.5 bar) for Metric tires]. Increasing the inflation pressure beyond this pressure will not increase the tire's load carrying capability.
- **Extra load:** A class of P-metric or Metric tires designed to carry a heavier maximum load. Increasing the inflation pressure will not increase the tire's load carrying capability.

134

## Tires, Wheels and Loading

- **kPa:** Kilopascal, a metric unit of air pressure.
- **PSI:** Pounds per square inch, a standard unit of air pressure.
- **Cold inflation pressure:** The tire pressure when the vehicle has been stationary and out of direct sunlight for an hour or more and prior to the vehicle being driven for 1 mile (1.6 km).
- **Recommended inflation pressure:** The cold inflation pressure found on the Safety Compliance Certification Label or Tire Label located on the B-Pillar or the edge of the driver's door.
- **B-pillar:** The structural member at the side of the vehicle behind the front door.
- **Bead area of the tire:** Area of the tire next to the rim.
- **Sidewall of the tire:** Area between the bead area and the tread.
- **Tread area of the tire:** Area of the perimeter of the tire that contacts the road when mounted on the vehicle.
- **Rim:** The metal support (wheel) for a tire or a tire and tube assembly upon which the tire beads are seated.

### INFLATING YOUR TIRES

Safe operation of your vehicle requires that your tires are properly inflated. Remember that a tire can lose up to half of its air pressure without appearing flat.

Every day before you drive, check your tires. If one looks lower than the others, use a tire gauge to check pressure of all tires and adjust if required.

At least once a month and before long trips, inspect each tire and check the tire pressure with a tire gauge (including spare, if equipped). Inflate all tires to the inflation pressure recommended by Ford Motor Company. You are strongly urged to buy a reliable tire pressure gauge, as automatic service station gauges may be inaccurate. Ford recommends the use of a digital or dial-type tire pressure gauge rather than a stick-type tire pressure gauge.

Use the recommended cold inflation pressure for optimum tire performance and wear. Under-inflation or over-inflation may cause uneven treadwear patterns.



**WARNING:** Under-inflation is the most common cause of tire failures and may result in severe tire cracking, tread separation or “blowout”, with unexpected loss of vehicle control and increased risk of injury. Under-inflation increases sidewall flexing and rolling resistance, resulting in heat buildup and internal damage to the tire. It also may result in unnecessary tire stress, irregular wear, loss of vehicle control and accidents. A tire can lose up to half of its air pressure and not appear to be flat!

## Tires, Wheels and Loading

Always inflate your tires to the Ford recommended inflation pressure even if it is less than the maximum inflation pressure information found on the tire. The Ford recommended tire inflation pressure is found on the Safety Compliance Certification Label or Tire Label which is located on the B-Pillar or the edge of the driver's door. Failure to follow the tire pressure recommendations can cause uneven treadwear patterns and adversely affect the way your vehicle handles.

**Maximum Permissible Inflation Pressure** is the tire manufacturer's maximum permissible pressure and/or the pressure at which the maximum load can be carried by the tire. This pressure is normally higher than the manufacturer's recommended cold inflation pressure which can be found on the Safety Compliance Certification Label or Tire Label which is located on the B-Pillar or the edge of the driver's door. The cold inflation pressure should never be set lower than the recommended pressure on the Safety Compliance Certification Label or Tire Label.

When weather temperature changes occur, tire inflation pressures also change. A 10°F (6°C) temperature drop can cause a corresponding drop of 1 psi (7 kPa) in inflation pressure. Check your tire pressures frequently and adjust them to the proper pressure which can be found on the Safety Compliance Certification Label or Tire Label.

To check the pressure in your tire(s):

1. Make sure the tires are cool, meaning they are not hot from driving even a mile.

If you are checking tire pressure when the tire is hot, (i.e. driven more than 1 mile [1.6 km]), never "bleed" or reduce air pressure. The tires are hot from driving and it is normal for pressures to increase above recommended cold pressures. A hot tire at or below recommended cold inflation pressure could be significantly under-inflated.

**Note:** If you have to drive a distance to get air for your tire(s), check and record the tire pressure first and add the appropriate air pressure when you get to the pump. It is normal for tires to heat up and the air pressure inside to go up as you drive.

2. Remove the cap from the valve on one tire, then firmly press the tire gauge onto the valve and measure the pressure.
3. Add enough air to reach the recommended air pressure.

**Note:** If you overfill the tire, release air by pressing on the metal stem in the center of the valve. Then recheck the pressure with your tire gauge.



## Tires, Wheels and Loading

4. Replace the valve cap.
5. Repeat this procedure for each tire, including the spare.

**Note:** Some spare tires operate at a higher inflation pressure than the other tires. For T-type/mini-spare tires (see the *Dissimilar spare tire/wheel information* section for description): Store and maintain at 60 psi (4.15 bar). For full-size and dissimilar spare tires (see the *Dissimilar spare tire/wheel information* section for description): Store and maintain at the higher of the front and rear inflation pressure as shown on the Tire Label.

6. Visually inspect the tires to make sure there are no nails or other objects embedded that could poke a hole in the tire and cause an air leak.
7. Check the sidewalls to make sure there are no gouges, cuts or bulges.

### Electric vehicles

For specific information on the Transit Connect Electric, refer to the *Azure Dynamics TC-E Owner's Guide* Supplement.

### TIRE CARE

#### Inspecting your tires and wheel valve stems

Periodically inspect the tire treads for uneven or excessive wear and remove objects such as stones, nails or glass that may be wedged in the tread grooves. Check the tire and valve stems for holes, cracks, or cuts that may permit air leakage and repair or replace the tire and replace the valve stem. Inspect the tire sidewalls for cracking, cuts, bruises and other signs of damage or excessive wear. If internal damage to the tire is suspected, have the tire demounted and inspected in case it needs to be repaired or replaced. For your safety, tires that are damaged or show signs of excessive wear should not be used because they are more likely to blow out or fail.

## Tires, Wheels and Loading

Improper or inadequate vehicle maintenance can cause tires to wear abnormally. Inspect all your tires, including the spare, frequently, and replace them if one or more of the following conditions exist:

### Tire wear

When the tread is worn down to 1/16th of an inch (2 mm), tires must be replaced to help prevent your vehicle from skidding and hydroplaning. Built-in treadwear indicators, or “wear bars”, which look like narrow strips of smooth rubber across the tread will appear on the tire when the tread is worn down to 1/16th of an inch (2 mm).

When the tire tread wears down to the same height as these “wear bars”, the tire is worn out and must be replaced.

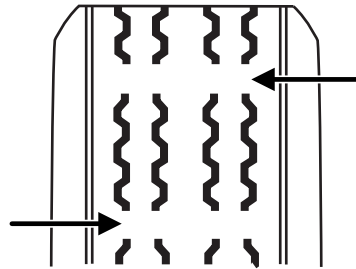

### Damage

Periodically inspect the tire treads and sidewalls for damage (such as bulges in the tread or sidewalls, cracks in the tread groove and separation in the tread or sidewall). If damage is observed or suspected have the tire inspected by a tire professional. Tires can be damaged during off-road use, so inspection after off-road use is also recommended.



### **WARNING: Age**

Tires degrade over time depending on many factors such as weather, storage conditions, and conditions of use (load, speed, inflation pressure, etc.) the tires experience throughout their lives. In general, tires should be replaced after six years regardless of tread wear. However, heat caused by hot climates or frequent high loading conditions can accelerate the aging process and may require tires to be replaced more frequently.

You should replace your spare tire when you replace the road tires or after six years due to aging even if it has not been used.

## Tires, Wheels and Loading

### U.S. DOT Tire Identification Number (TIN)

Both U.S. and Canada Federal regulations require tire manufacturers to place standardized information on the sidewall of all tires. This information identifies and describes the fundamental characteristics of the tire and also provides a U.S. DOT Tire Identification Number for safety standard certification and in case of a recall.

This begins with the letters “DOT” and indicates that the tire meets all federal standards. The next two numbers or letters are the plant code designating where it was manufactured, the next two are the tire size code and the last four numbers represent the week and year the tire was built. For example, the numbers 317 mean the 31st week of 1997. After 2000 the numbers go to four digits. For example, 2501 means the 25th week of 2001. The numbers in between are identification codes used for traceability. This information is used to contact customers if a tire defect requires a recall.

### Tire replacement requirements

Your vehicle is equipped with tires designed to provide a safe ride and handling capability.



**WARNING:** Only use replacement tires and wheels that are the same size, load index, speed rating and type (such as P-metric versus LT-metric or all-season versus all-terrain) as those originally provided by Ford. The recommended tire and wheel size may be found on either the Safety Compliance Certification Label or the Tire Label which is located on the B-Pillar or edge of the driver's door. If this information is not found on these labels then you should contact your authorized dealer as soon as possible. Use of any tire or wheel not recommended by Ford can affect the safety and performance of your vehicle, which could result in an increased risk of loss of vehicle control, vehicle rollover, personal injury and death. Additionally the use of non-recommended tires and wheels could cause steering, suspension, axle or transfer case/power transfer unit failure. If you have questions regarding tire replacement, contact your authorized dealer as soon as possible.

## Tires, Wheels and Loading



**WARNING:** When mounting replacement tires and wheels, you should not exceed the maximum pressure indicated on the sidewall of the tire to set the beads without additional precautions listed below. If the beads do not seat at the maximum pressure indicated, re-lubricate and try again.

When inflating the tire for mounting pressures up to 20 psi (1.38 bar) greater than the maximum pressure on the tire sidewall, the following precautions must be taken to protect the person mounting the tire:

1. Make sure that you have the correct tire and wheel size.
2. Lubricate the tire bead and wheel bead seat area again.
3. Stand at a minimum of 12 ft (3.66 m) away from the tire wheel assembly.
4. Use both eye and ear protection.

For a mounting pressure more than 20 psi (1.38 bar) greater than the maximum pressure, a Ford dealer or other tire service professional should do the mounting.

Always inflate steel carcass tires with a remote air fill with the person inflating standing at a minimum of 12 ft (3.66 m) away from the tire wheel assembly.

**Important:** Remember to replace the wheel valve stems when the road tires are replaced on your vehicle.

It is recommended that the two front tires or two rear tires generally be replaced as a pair.

The tire pressure sensors mounted in the wheels (originally installed on your vehicle) are not designed to be used in aftermarket wheels.

The use of wheels or tires not recommended by Ford Motor Company may affect the operation of your tire pressure monitoring system.

If the TPMS indicator is flashing, your TPMS is malfunctioning. Your replacement tire might be incompatible with your TPMS, or some component of the TPMS may be damaged.

## Tires, Wheels and Loading

### Safety practices

Driving habits have a great deal to do with your tire mileage and safety.

- Observe posted speed limits
- Avoid fast starts, stops and turns
- Avoid potholes and objects on the road
- Do not run over curbs or hit the tire against a curb when parking



**WARNING:** If your vehicle is stuck in snow, mud, sand, etc., **do not** rapidly spin the tires; spinning the tires can tear the tire and cause an explosion. A tire can explode in as little as three to five seconds.



**WARNING:** Do not spin the wheels at over 35 mph (56 km/h). The tires may fail and injure a passenger or bystander.

### Highway hazards

No matter how carefully you drive there's always the possibility that you may eventually have a flat tire on the highway. Drive slowly to the closest safe area out of traffic. This may further damage the flat tire, but your safety is more important.

If you feel a sudden vibration or ride disturbance while driving, or you suspect your tire or vehicle has been damaged, immediately reduce your speed. Drive with caution until you can safely pull off the road. Stop and inspect the tires for damage. If a tire is under-inflated or damaged, deflate it, remove wheel and replace it with your spare tire and wheel. If you cannot detect a cause, have the vehicle towed to the nearest repair facility or tire dealer to have the vehicle inspected.

### Tire and wheel alignment

A bad jolt from hitting a curb or pothole can cause the front end of your vehicle to become misaligned or cause damage to your tires. If your vehicle seems to pull to one side when you're driving, the wheels may be out of alignment. Have an authorized dealer check the wheel alignment periodically.

Wheel misalignment in the front or the rear can cause uneven and rapid treadwear of your tires and should be corrected by an authorized dealer. Front-wheel drive (FWD) vehicles and those with an independent rear suspension (if equipped) may require alignment of all four wheels.

## Tires, Wheels and Loading

The tires should also be balanced periodically. An unbalanced tire and wheel assembly may result in irregular tire wear.

### Tire rotation

Rotating your tires at the recommended interval (as indicated in the *Scheduled Maintenance* chapter) will help your tires wear more evenly, providing better tire performance and longer tire life.

- Front-wheel drive (FWD) vehicles  
(front tires at top of diagram)

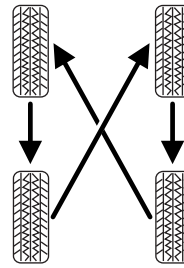

Sometimes irregular tire wear can be corrected by rotating the tires.

**Note:** If your tires show uneven wear ask an authorized dealer to check for and correct any wheel misalignment, tire imbalance or mechanical problem involved before tire rotation.

**Note:** Your vehicle may be equipped with a dissimilar spare tire/wheel. A dissimilar spare tire/wheel is defined as a spare tire and/or wheel that is different in brand, size or appearance from the road tires and wheels. If you have a dissimilar spare tire/wheel it is intended for temporary use only and should not be used in a tire rotation.

**Note:** After having your tires rotated, inflation pressure must be checked and adjusted to the vehicle requirements.

### INFORMATION CONTAINED ON THE TIRE SIDEWALL

Both U.S. and Canada Federal regulations require tire manufacturers to place standardized information on the sidewall of all tires. This information identifies and describes the fundamental characteristics of the tire and also provides a U.S. DOT Tire Identification Number for safety standard certification and in case of a recall.

## Tires, Wheels and Loading

### Information on “P” type tires

P215/65R15 95H is an example of a tire size, load index and speed rating. The definitions of these items are listed below. (Note that the tire size, load index and speed rating for your vehicle may be different from this example.)

1. **P:** Indicates a tire, designated by the Tire and Rim Association (T&RA), that may be used for service on cars, SUVs, minivans and light trucks.

**Note:** If your tire size does not begin with a letter this may mean it is designated by either ETRTO (European Tire and Rim Technical Organization) or JATMA (Japan Tire Manufacturing Association).

2. **215:** Indicates the nominal width of the tire in millimeters from sidewall edge to sidewall edge. In general, the larger the number, the wider the tire.

3. **65:** Indicates the aspect ratio which gives the tire’s ratio of height to width.

4. **R:** Indicates a “radial” type tire.

5. **15:** Indicates the wheel or rim diameter in inches. If you change your wheel size, you will have to purchase new tires to match the new wheel diameter.

6. **95:** Indicates the tire’s load index. It is an index that relates to how much weight a tire can carry. You may find this information in your owner’s guide. If not, contact a local tire dealer.

**Note:** You may not find this information on all tires because it is not required by federal law.

7. **H:** Indicates the tire’s speed rating. The speed rating denotes the speed at which a tire is designed to be driven for extended periods of time under a standard condition of load and inflation pressure. The tires on your vehicle may operate at different conditions for load and inflation pressure. These speed ratings may need to be adjusted for the difference in conditions. The ratings range from 81 mph (130 km/h) to 186 mph (299 km/h). These ratings are listed in the following chart.

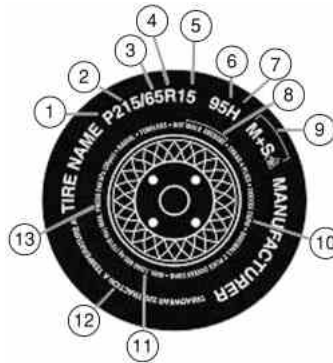

## Tires, Wheels and Loading

**Note:** You may not find this information on all tires because it is not required by federal law.

Letter rating	Speed rating - mph (km/h)
M	81 mph (130 km/h)
N	87 mph (140 km/h)
Q	99 mph (159 km/h)
R	106 mph (171 km/h)
S	112 mph (180 km/h)
T	118 mph (190 km/h)
U	124 mph (200 km/h)
H	130 mph (210 km/h)
V	149 mph (240 km/h)
W	168 mph (270 km/h)
Y	186 mph (299 km/h)

**Note:** For tires with a maximum speed capability over 149 mph (240 km/h), tire manufacturers sometimes use the letters ZR. For those with a maximum speed capability over 186 mph (299 km/h), tire manufacturers always use the letters ZR.

8. **U.S. DOT Tire Identification Number (TIN):** This begins with the letters "DOT" and indicates that the tire meets all federal standards. The next two numbers or letters are the plant code designating where it was manufactured, the next two are the tire size code and the last four numbers represent the week and year the tire was built. For example, the numbers 317 mean the 31st week of 1997. After 2000 the numbers go to four digits. For example, 2501 means the 25th week of 2001. The numbers in between are identification codes used for traceability. This information is used to contact customers if a tire defect requires a recall.

9. **M+S or M/S:** Mud and Snow, or

**AT:** All Terrain, or

**AS:** All Season.

10. **Tire Ply Composition and Material Used:** Indicates the number of plies or the number of layers of rubber-coated fabric in the tire tread and sidewall. Tire manufacturers also must indicate the ply materials in the tire and the sidewall, which include steel, nylon, polyester, and others.

11. **Maximum Load:** Indicates the maximum load in kilograms and pounds that can be carried by the tire. Refer to the Safety Compliance Certification Label, which is located on the B-Pillar or the edge of the driver's door, for the correct tire pressure for your vehicle.

144



## Tires, Wheels and Loading

### 12. Treadwear, Traction and Temperature Grades

- **Treadwear:** The treadwear grade is a comparative rating based on the wear rate of the tire when tested under controlled conditions on a specified government test course. For example, a tire graded 150 would wear one and one-half (1½) times as well on the government course as a tire graded 100.
- **Traction:** The traction grades, from highest to lowest are AA, A, B, and C. The grades represent the tire's ability to stop on wet pavement as measured under controlled conditions on specified government test surfaces of asphalt and concrete. A tire marked C may have poor traction performance.
- **Temperature:** The temperature grades are A (the highest), B and C, representing the tire's resistance to the generation of heat and its ability to dissipate heat when tested under controlled conditions on a specified indoor laboratory test wheel.

13. **Maximum Permissible Inflation Pressure:** Indicates the tire manufacturers' maximum permissible pressure and/or the pressure at which the maximum load can be carried by the tire. This pressure is normally higher than the manufacturer's recommended cold inflation pressure which can be found on the Safety Compliance Certification Label or Tire Label which is located on the B-Pillar or the edge of the driver's door. The cold inflation pressure should never be set lower than the recommended pressure on the vehicle label.

The tire suppliers may have additional markings, notes or warnings such as standard load, radial tubeless, etc.

## Tires, Wheels and Loading

### Additional information contained on the tire sidewall for “LT” type tires

“LT” type tires have some additional information beyond those of “P” type tires; these differences are described below.

**Note:** Tire Quality Grades do not apply to this type of tire.

1. **LT:** Indicates a tire, designated by the Tire and Rim Association (T&RA), that is intended for service on light trucks.

#### 2. **Load Range/Load Inflation**

**Limits:** Indicates the tire’s load-carrying capabilities and its inflation limits.

3. **Maximum Load Dual lb (kg) at psi (kPa) cold:** Indicates the maximum load and tire pressure when the tire is used as a dual; defined as four tires on the rear axle (a total of six or more tires on the vehicle).

4. **Maximum Load Single lb (kg) at psi (kPa) cold:** Indicates the maximum load and tire pressure when the tire is used as a single; defined as two tires (total) on the rear axle.

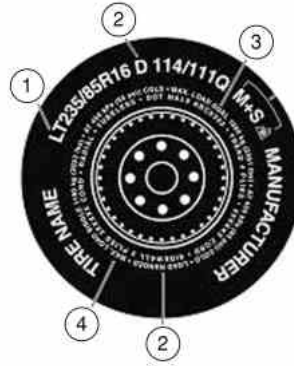

## Tires, Wheels and Loading

### Information on “T” type tires

“T” type tires have some additional information beyond those of “P” type tires; these differences are described below:

T145/80D16 is an example of a tire size.

**Note:** The temporary tire size for your vehicle may be different from this example. Tire Quality Grades do not apply to this type of tire.

1. **T:** Indicates a type of tire, designated by the Tire and Rim Association (T&RA), that is intended for temporary service on cars, SUVs, minivans and light trucks.

2. **145:** Indicates the nominal width of the tire in millimeters from sidewall edge to sidewall edge. In general, the larger the number, the wider the tire.

3. **80:** Indicates the aspect ratio which gives the tire’s ratio of height to width. Numbers of 70 or lower indicate a short sidewall.

4. **D:** Indicates a “diagonal” type tire.

**R:** Indicates a “radial” type tire.

5. **16:** Indicates the wheel or rim diameter in inches. If you change your wheel size, you will have to purchase new tires to match the new wheel diameter.

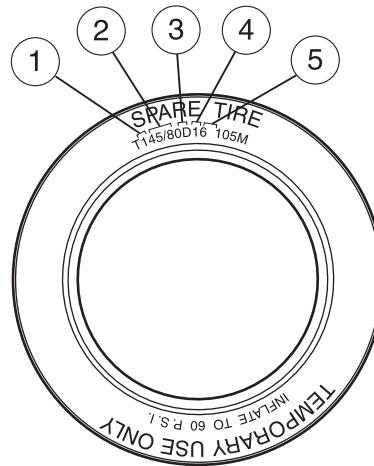

### Location of the tire label

You will find a Tire Label containing tire inflation pressure by tire size and other important information located on the B-Pillar or the edge of the driver’s door. Refer to the payload description and graphic in the *Vehicle loading* section.

## Tires, Wheels and Loading

### TIRE PRESSURE MONITORING SYSTEM (TPMS)

Each tire, including the spare (if provided), should be checked monthly when cold and inflated to the inflation pressure recommended by the vehicle manufacturer on the vehicle placard or tire inflation pressure label. (If your vehicle has tires of a different size than the size indicated on the vehicle placard or tire inflation pressure label, you should determine the proper tire inflation pressure for those tires.)

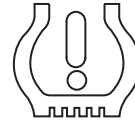

As an added safety feature, your vehicle has been equipped with a tire pressure monitoring system (TPMS) that illuminates a low tire pressure telltale when one or more of your tires is significantly under-inflated. Accordingly, when the low tire pressure telltale illuminates, you should stop and check your tires as soon as possible, and inflate them to the proper pressure. Driving on a significantly under-inflated tire causes the tire to overheat and can lead to tire failure. Under-inflation also reduces fuel efficiency and tire tread life, and may affect the vehicle's handling and stopping ability.

Please note that the TPMS is not a substitute for proper tire maintenance, and it is the driver's responsibility to maintain correct tire pressure, even if under-inflation has not reached the level to trigger illumination of the TPMS low tire pressure telltale.

Your vehicle has also been equipped with a TPMS malfunction indicator to indicate when the system is not operating properly. The TPMS malfunction indicator is combined with the low tire pressure telltale. When the system detects a malfunction, the telltale will flash for approximately one minute and then remain continuously illuminated. This sequence will continue upon subsequent vehicle start-ups as long as the malfunction exists.

When the malfunction indicator is illuminated, the system may not be able to detect or signal low tire pressure as intended. TPMS malfunctions may occur for a variety of reasons, including the installation of replacement or alternate tires or wheels on the vehicle that prevent the TPMS from functioning properly. Always check the TPMS malfunction telltale after replacing one or more tires or wheels on your vehicle to ensure that the replacement or alternate tires and wheels allow the TPMS to continue to function properly.

## Tires, Wheels and Loading

The tire pressure monitoring system complies with part 15 of the FCC rules and with RSS-210 of Industry Canada. Operation is subject to the following two conditions: (1) This device may not cause harmful interference, and (2) This device must accept any interference received, including interference that may cause undesired operation.



**WARNING:** The tire pressure monitoring system is NOT a substitute for manually checking tire pressure. The tire pressure should be checked periodically (at least monthly) using a tire gauge, see *Inflating your tires* in this chapter. Failure to properly maintain your tire pressure could increase the risk of tire failure, loss of control, vehicle rollover and personal injury.

### Changing tires with a TPMS

**Each road tire is equipped with a tire pressure sensor located inside the tire/wheel cavity. The pressure sensor is attached to the valve stem. The pressure sensor is covered by the tire and is not visible unless the tire is removed. Care must be taken when changing the tire to avoid damaging the sensor.** It is

recommended that you always have your tires serviced by an authorized dealer.

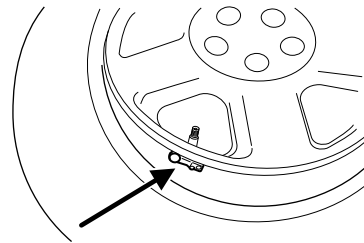

The tire pressure should be checked periodically (at least monthly) using an accurate tire gauge, refer to *Inflating your tires* in this chapter.

### Understanding your tire pressure monitoring system (TPMS)

The tire pressure monitoring system measures pressure in your four road tires and sends the tire pressure readings to your vehicle. The low tire pressure warning light will turn on if the tire pressure is significantly low. Once the light is illuminated, your tires are under-inflated and need to be inflated to the manufacturer's recommended tire pressure. Even if the light turns on and a short time later turns off, your tire pressure still needs to be checked. Visit [www.checkmytires.org](http://www.checkmytires.org) for additional information.

## **Tires, Wheels and Loading**

### ***When your temporary spare tire is installed***

When one of your road tires needs to be replaced with the temporary spare, the TPMS will continue to identify an issue to remind you that the damaged road wheel/tire needs to be repaired and put back on your vehicle.

To restore the full functionality of the tire pressure monitoring system, have the damaged road wheel/tire repaired and remounted on your vehicle. For additional information, refer to *Changing tires with a TPMS* in this section.

### ***When you believe your system is not operating properly***

The main function of the tire pressure monitoring system is to warn you when your tires need air. It can also warn you in the event the system is no longer capable of functioning as intended. Please refer to the following chart for information concerning your tire pressure monitoring system:

## Tires, Wheels and Loading

Low tire pressure warning light	Possible cause	Customer action required
Solid warning light	Tire(s) under-inflated	1. Check your tire pressure to ensure tires are properly inflated; refer to <i>Inflating your tires</i> in this chapter. 2. After inflating your tires to the manufacturer's recommended inflation pressure as shown on the Tire Label (located on the edge of driver's door or the B-Pillar), the vehicle must be driven for at least two minutes over 20 mph (32 km/h) before the light will turn off.
	Spare tire in use	Your temporary spare tire is in use. Repair the damaged road wheel/tire and reinstall it on the vehicle to restore system functionality. For a description on how the system functions, refer to <i>When your temporary spare tire is installed</i> in this section.
	TPMS malfunction	If your tires are properly inflated and your spare tire is not in use and the light remains on, have the system inspected by your authorized dealer.
	Tire rotation without sensor training	On vehicles with different front and rear tire pressures, the TPMS system must be retrained following every tire rotation. Refer to <i>Tire rotation</i> in this chapter.

## Tires, Wheels and Loading

Low tire pressure warning light	Possible cause	Customer action required
Flashing warning light	Spare tire in use	Your temporary spare tire is in use. Repair the damaged road wheel and re-mount it on the vehicle to restore system functionality. For a description of how the system functions under these conditions, refer to <i>When your temporary spare tire is installed</i> in this section.
	TPMS malfunction	If your tires are properly inflated and your spare tire is not in use and the TPMS warning light still flashes, have the system inspected by your authorized dealer.

### **When inflating your tires**

When putting air into your tires (such as at a gas station or in your garage), the tire pressure monitoring system may not respond immediately to the air added to your tires.

It may take up to two minutes of driving over 20 mph (32 km/h) for the light to turn off after you have filled your tires to the recommended inflation pressure.

### **How temperature affects your tire pressure**

The tire pressure monitoring system (TPMS) monitors tire pressure in each pneumatic tire. While driving in a normal manner, a typical passenger tire inflation pressure may increase approximately 2 to 4 psi (14 to 28 kPa) from a cold start situation. If the vehicle is stationary overnight with the outside temperature significantly lower than the daytime temperature, the tire pressure may decrease approximately 3 psi (21 kPa) for a drop of 30°F (17°C) in ambient temperature. This lower pressure value may be detected by the TPMS as being significantly lower than the recommended inflation pressure and activate the TPMS warning light for low tire pressure. If the low tire pressure warning light is on, visually check each tire to verify that no tire is flat. (If one or more tires are flat, repair as necessary.) Check air pressure in the road tires. If any tire is under-inflated, carefully drive the vehicle to the nearest location where air can be added to the tires. Inflate all the tires to the recommended inflation pressure.

152



## Tires, Wheels and Loading

### TPMS reset procedure

**The TPMS reset procedure needs to be performed after each tire rotation.**



**WARNING:** To determine the required pressure for your vehicle, refer to the Safety Compliance Certification Label or Tire Label located on the B-Pillar or the edge of the driver's door. See *Vehicle loading* in this chapter for more information.

### Overview

To provide the vehicle's load carrying capability, this vehicle requires different recommended tire pressures in the front tires as compared to the rear tires. The tire pressure monitoring system (TPMS) equipped on these vehicles is designed to illuminate the low tire pressure warning light at two different pressures; one for the front tires and one for the rear tires.

Since tires need to be rotated to provide consistent performance and maximum tire life, the tire pressure monitoring system needs to know when the tires are rotated to determine which set of tires are on the front and which are on the rear. With this information, the system can detect and properly warn of low tire pressures.

### TPMS reset tips:

- To reduce the chances of interference from another vehicle, the TPMS reset procedure should be performed at least three feet (one meter) away from another Ford Motor Company vehicle undergoing the TPMS reset procedure at the same time.
- Do not wait more than two minutes between resetting each tire sensor or the system will time-out and the entire procedure will have to be repeated on all four wheels.
- A double horn chirp indicates the need to repeat the procedure.

### Performing the TPMS reset procedure

It is recommended that you read the entire procedure before attempting.

1. Drive the vehicle above 20 mph (32 km/h) for at least two minutes and then park in a safe location where you can easily get to all four tires and have access to an air pump.
2. Place the ignition in the off position and keep the key in the ignition.

153

## Tires, Wheels and Loading

3. Cycle the ignition to the on position with the engine off.

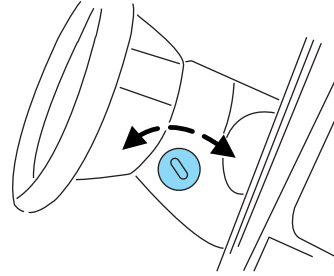

4. Turn the hazard flashers on then off three times. This must be accomplished within 10 seconds.



If the reset mode has been entered successfully, the horn will sound once and the TPMS indicator  will flash. If this does not occur, please try again starting at step 2.

If after repeated attempts to enter the reset mode, the horn does not sound and the TPMS indicator  does not flash, seek service from your authorized dealer.

5. Train the TPMS sensors in the tires using the following TPMS reset sequence starting with the **left front tire** in the following clockwise order:

- Left front (Driver's side front tire)
- Right front (Passenger's side front tire)
- Right rear (Passenger's side rear tire)
- Left rear (Driver's side rear tire)

6. Remove the valve cap from the valve stem on the left front tire; decrease the air pressure until the horn sounds.

**Note:** The single horn chirp confirms that the sensor identification code has been learned by the module for this position. If a double horn is heard, the reset procedure was unsuccessful, and must be repeated.

7. Remove the valve cap from the valve stem on the right front tire; decrease the air pressure until the horn sounds.

8. Remove the valve cap from the valve stem on the right rear tire; decrease the air pressure until the horn sounds.

154

## Tires, Wheels and Loading

9. Remove the valve cap from the valve stem on the left rear tire; decrease the air pressure until the horn sounds.

Training is complete after the horn sounds for the last tire trained (driver's side rear tire) and the TPMS indicator  stops flashing.

10. Turn the ignition off. If two short horn beeps are heard, the reset procedure was unsuccessful and must be repeated.

If after repeating the procedure and two short beeps are heard when the ignition is turned to off, seek assistance from your authorized dealer.

11. Set all four tires to the recommended air pressure as indicated on the Safety Compliance Certification Label or Tire Label located on the B-Pillar or the edge of the driver's door. See *Vehicle loading* in this chapter for more information.

### SNOW TIRES AND CHAINS



**WARNING:** Snow tires must be the same size, load index, speed rating as those originally provided by Ford. Use of any tire or wheel not recommended by Ford can affect the safety and performance of your vehicle, which could result in an increased risk of loss of vehicle control, vehicle rollover, personal injury and death. Additionally, the use of non-recommended tires and wheels could cause steering, suspension, axle or transfer case/power transfer unit failure.

The original equipment tires on your vehicle have an all-weather tread design to provide traction, handling and braking performance in year-round driving. You may install snow tires for improved traction when driving in areas with sustained periods of snow or icy driving conditions.

If you choose to install snow tires on your vehicle, they must be the same size, construction, and load range as the original tires listed on the tire placard, and they must be installed on all four wheels. Mixing tires of different size or construction on your vehicle can adversely affect your vehicle's handling and braking, and may lead to loss of vehicle control.



**WARNING:** Do not use snow chains or cables on this vehicle as they may cause damage to your vehicle which may lead to loss of vehicle control.

## Tires, Wheels and Loading

### VEHICLE LOADING

This section will guide you in the proper loading of your vehicle to keep your loaded vehicle weight within its design rating capability. Properly loading your vehicle will provide maximum return of vehicle design performance. Before loading your vehicle, familiarize yourself with the following terms for determining your vehicle's weight ratings from the vehicle's Tire Label or Safety Compliance Certification Label:

**Base Curb Weight** – is the weight of the vehicle including a full tank of fuel and all standard equipment. It does not include passengers, cargo, or optional equipment.

**Vehicle Curb Weight** – is the weight of your new vehicle when you picked it up from your authorized dealer plus any aftermarket equipment.



**Payload** – is the combined weight of cargo and passengers that the vehicle is carrying. The maximum payload for your vehicle can be found on the Tire Label on the B-Pillar or the edge of the driver's door (vehicles exported outside the US and Canada may not have a Tire Label). Look for **“THE COMBINED WEIGHT OF OCCUPANTS AND CARGO SHOULD NEVER EXCEED XXX kg OR XXX lb.”** for maximum payload. The payload listed on the Tire Label is the maximum payload for the vehicle as built by the assembly plant. If any aftermarket or authorized-dealer installed equipment has been installed on the vehicle, the weight of the equipment must be subtracted from the payload listed on the Tire Label in order to determine the new payload.

**⚠ WARNING:** The appropriate loading capacity of your vehicle can be limited either by volume capacity (how much space is available) or by payload capacity (how much weight the vehicle should carry). Once you have reached the maximum payload of your vehicle, do not add more cargo, even if there is space available. Overloading or improperly loading your vehicle can contribute to loss of vehicle control and vehicle rollover.

## Tires, Wheels and Loading

Example only:





### TIRE AND LOADING INFORMATION

SEATING CAPACITY	TOTAL 5	FRONT 2	REAR 3
------------------	---------	---------	--------

The combined weight of occupants and cargo should never exceed : **XXX kg or XXX lbs.**

TIRE	SIZE	COLD TIRE PRESSURE	SEE OWNERS MANUAL FOR ADDITIONAL INFORMATION
FRONT	LT225/75R 16.5E	200 KPA, 29 PSI	
REAR	LT225/75R 16.5E	200 KPA, 29 PSI	
SPARE	T145/80D16 P225/60R17	420 KPA, 60 PSI 200 KPA, 29 PSI	





### TIRE AND LOADING INFORMATION RENSEIGNEMENTS SUR LES PNEUS ET LE CHARGEMENT

SEATING CAPACITY NOMBRE DE PLACES	TOTAL 5	FRONT AVANT 2	REAR ARRIERE 3
--------------------------------------	---------	------------------	-------------------

The combined weight of occupants and cargo should never exceed 492 kg or 1085 lbs.  
Le poids total des occupants et du chargement ne doit jamais dépasser 492 kg ou 1085 lb.

TIRE PNEU	SIZE DIMENSIONS	COLD TIRE PRESSURE PRESSION DES PNEUS A FROID	SEE OWNER'S MANUAL FOR ADDITIONAL INFORMATION  VOIR LE MANUEL DE L'USAGER POUR PLUS DE RENSEIGNEMENTS
FRONT AVANT	P235/70R16	240 KPA, 35 PSI	
REAR ARRIERE	P235/70R16	240 KPA, 35 PSI	
SPARE DE SECOURS	T145/90R17	415 KPA, 60 PSI	



**CARGO =**



**Cargo Weight** – includes all weight added to the Base Curb Weight, including cargo and optional equipment.

**GAW (Gross Axle Weight)** – is the total weight placed on each axle (front and rear) – including vehicle curb weight and all payload.

## Tires, Wheels and Loading

**GAWR (Gross Axle Weight Rating)** – is the maximum allowable weight that can be carried by a single axle (front or rear). **These numbers are shown on the Safety Compliance Certification Label located on the B-Pillar or the edge of the driver's door. The total load on each axle must never exceed its GAWR.**

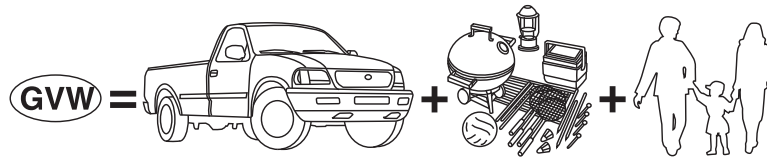

**GVW (Gross Vehicle Weight)** – is the Vehicle Curb Weight + cargo + passengers.

**GVWR (Gross Vehicle Weight Rating)** – is the maximum allowable weight of the fully loaded vehicle (including all options, equipment, passengers and cargo). **The GVWR is shown on the Safety Compliance Certification Label located on the B-Pillar or the edge of the driver's door. The GVW must never exceed the GVWR.**

## Tires, Wheels and Loading

- Example only:

**MFD. BY FORD MOTOR CO.**

DATE: XX/XX GVWR: XXXXXLB/ XXXXXKG  
 FRONT GAWR: XXXXL REAR GAWR: XXXXLB  
 XXXXKG WITH XXXXKG WITH  
 XXXX/XXXXXXXXX TIRES: XXXX/XXXXXXXXX TIRES  
 XXXX.XX RIMS: XXXX.XX RIMS  
 AT XXX kPa/XX PSI COLD AT XXX kPa/XX PSI COLD

THIS VEHICLE CONFORMS TO ALL APPLICABLE FEDERAL MOTOR VEHICLE SAFETY STANDARDS IN EFFECT ON THE DATE OF MANUFACTURE SHOWN ABOVE.

VIN: XXXXXXXXXXXXXXXXXXXX XXXXX  
 TYPE: XXX XXXXX



EXT PNT: XX RC: XX DSO:  
 WB INT TR TP/PS R AXLE TR SPR XXXXX  
 XXX XX X XX X XX XXX  
 XXXXXXXXXXXXXXX XXX XXXX-XXXXXX-XX

**MFD. BY FORD MOTOR CO.**

DATE: XX/XX GVWR/PNBV: XXXX LB/XXXXKG  
 FRONT GAWR/PNBE AV / REAR GAWR/ PNBE AR  
 XXXX/XXXXB / XXXXKG/XXXXLB  
 WITH/AVEC TIRES/PNEUS  
 XXXX/XXXXX  
 XXXX/XXXXX  
 XXXXXX RIMS/JANTES XXXXXX

AT/A kPa/PSI/LPC XXX/XX COLD/A FROID XXX/XX  
 /JUMEELES

VIN: XXXXXXXXXXXXXXXXXXXX XXXXX  
 TYPE: XXX/XXXX COMPLIES: XXXX/XXX - XXX XXXXX  
 XXXXXX



EXT PNT: XX RC: XX DSO:  
 WB INT TR TP/PS R AXLE TR SPR XXXXX  
 XXX XX X XX X XXXX XXX  
 XXXXXXXXXXXXXXX XXX XXXX-XXXXXX-XX

**!** **WARNING:** Exceeding the Safety Compliance Certification Label vehicle weight rating limits could result in substandard vehicle handling or performance, engine, transmission and/or structural damage, serious damage to the vehicle, loss of control and personal injury.

**!** **WARNING:** Do not exceed the GVWR or the GAWR specified on the Safety Compliance Certification Label.

## Tires, Wheels and Loading



**WARNING:** Do not use replacement tires with lower load carrying capacities than the original tires because they may lower the vehicle's GVWR and GAWR limitations. Replacement tires with a higher limit than the original tires do not increase the GVWR and GAWR limitations.



**WARNING:** Exceeding any vehicle weight rating limitation could result in serious damage to the vehicle and/or personal injury.

### Steps for determining the correct load limit:

1. Locate the statement "The combined weight of occupants and cargo should never exceed XXX kg or XXX lbs." on your vehicle's placard.
2. Determine the combined weight of the driver and passengers that will be riding in your vehicle.
3. Subtract the combined weight of the driver and passengers from XXX kg or XXX lbs.
4. The resulting figure equals the available amount of cargo and luggage load capacity. For example, if the "XXX" amount equals 1,400 lbs. and there will be five 150 lb. passengers in your vehicle, the amount of available cargo and luggage load capacity is 650 lbs. ( $1400 - 750 (5 \times 150) = 650$  lb.). In metric units ( $635 - 340 (5 \times 68) = 295$  kg.)
5. Determine the combined weight of luggage and cargo being loaded on the vehicle. That weight may not safely exceed the available cargo and luggage load capacity calculated in Step 4.

The following gives you a few examples on how to calculate the available amount of cargo and luggage load capacity:

- Another example for your vehicle with 1400 lb. (635 kg) of cargo and luggage capacity. You decide to go golfing. Is there enough load capacity to carry you, 4 of your friends and all the golf bags? You and four friends average 220 lb. (99 kg) each and the golf bags weigh approximately 30 lb. (13.5 kg) each. The calculation would be:  $1400 - (5 \times 220) - (5 \times 30) = 1400 - 1100 - 150 = 150$  lb. Yes, you have enough load capacity in your vehicle to transport four friends and your golf bags. In metric units, the calculation would be:  $635 \text{ kg} - (5 \times 99 \text{ kg}) - (5 \times 13.5 \text{ kg}) = 635 - 495 - 67.5 = 72.5$  kg.



## Tires, Wheels and Loading

- A final example for your vehicle with 1400 lb. (635 kg) of cargo and luggage capacity. You and one of your friends decide to pick up cement from the local home improvement store to finish that patio you have been planning for the past 2 years. Measuring the inside of the vehicle with the rear seat folded down, you have room for 12-100 lb. (45 kg) bags of cement. Do you have enough load capacity to transport the cement to your home? If you and your friend each weigh 220 lb. (99 kg), the calculation would be:  $1400 - (2 \times 220) - (12 \times 100) = 1400 - 440 - 1200 = -240$  lb. No, you do not have enough cargo capacity to carry that much weight. In metric units, the calculation would be:  $635 \text{ kg} - (2 \times 99 \text{ kg}) - (12 \times 45 \text{ kg}) = 635 - 198 - 540 = -103$  kg. You will need to reduce the load weight by at least 240 lb. (104 kg). If you remove 3-100 lb. (45 kg) cement bags, then the load calculation would be:

$1400 - (2 \times 220) - (9 \times 100) = 1400 - 440 - 900 = 60$  lb. Now you have the load capacity to transport the cement and your friend home. In metric units, the calculation would be:  $635 \text{ kg} - (2 \times 99 \text{ kg}) - (9 \times 45 \text{ kg}) = 635 - 198 - 405 = 32$  kg.

The above calculations also assume that the loads are positioned in your vehicle in a manner that does not overload the Front or the Rear Gross Axle Weight Rating specified for your vehicle on the Safety Compliance Certification Label found on the edge of the driver's door.

### Special loading instructions for owners of pick-up trucks and utility-type vehicles



**WARNING:** For important information regarding safe operation of this type of vehicle, see the *Preparing to drive your vehicle* section in the *Driving* chapter of this owner's guide.



**WARNING:** Loaded vehicles may handle differently than unloaded vehicles. Extra precautions, such as slower speeds and increased stopping distance, should be taken when driving a heavily loaded vehicle.

Your vehicle can haul more cargo and people than most passenger cars. Depending upon the type and placement of the load, hauling cargo and people may raise the center of gravity of the vehicle.

## Tires, Wheels and Loading

### TRAILER TOWING



**WARNING:** Never tow a trailer with this vehicle. Your vehicle is not equipped to tow. No towing packages are available through an authorized dealer.

### RECREATIONAL TOWING

Follow these guidelines if you have a need for recreational (RV) towing. An example of recreational towing would be towing your vehicle behind a motor home.

**Note:** Put your climate control system in recirculated air mode to prevent exhaust fumes from entering the vehicle. Refer to the *Climate Controls* chapter for more information.

In case of a roadside emergency with a disabled vehicle, see *Wrecker towing* in the *Roadside Emergencies* chapter.

These guidelines are designed to ensure that your transmission is not damaged after it is hooked-up to the RV or tow dolly.

Do not tow the vehicle with the front drive wheels on the ground. It is recommended to tow your vehicle with the front drive wheels on a dolly with the transmission in N (Neutral) or with all four (4) wheels off the ground on a car-hauling trailer.

### STARTING

#### Electric vehicles

For specific information on the Transit Connect Electric, refer to the *Azure Dynamics TC-E Owner's Guide Supplement*.

#### Positions of the ignition

- 0 (off) — locks the steering wheel, automatic transmission gearshift lever and allows key removal. This position also shuts the engine and all electrical accessories off.
- I (accessory) — allows the electrical accessories such as the radio to operate while the engine is not running.
- II (on) — all electrical circuits operational. Warning lights illuminated. Key position when driving.
- III (start) — cranks the engine. Release the key as soon as the engine starts.

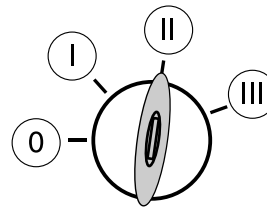

#### Preparing to start your vehicle

Engine starting is controlled by the powertrain control system.

This system meets all Canadian interference-causing equipment standard requirements regulating the impulse electrical field strength of radio noise.

When starting a fuel-injected engine, don't press the accelerator before or during starting. Only use the accelerator when you have difficulty starting the engine. For more information on starting the vehicle, refer to *Starting the engine* in this chapter.





**WARNING:** Extended idling at high engine speeds can produce very high temperatures in the engine and exhaust system, creating the risk of fire or other damage.



**WARNING:** Do not park, idle, or drive your vehicle in dry grass or other dry ground cover. The emission system heats up the engine compartment and exhaust system, which can start a fire.

## Driving

 **WARNING:** Do not start your vehicle in a closed garage or in other enclosed areas. Exhaust fumes can be toxic. Always open the garage door before you start the engine. See *Guarding against exhaust fumes* in this chapter for more instructions.

 **WARNING:** If you smell exhaust fumes inside your vehicle, have your dealer inspect your vehicle immediately. Do not drive if you smell exhaust fumes.

### ***Important safety precautions***

When the engine starts, the idle RPM runs faster to warm the engine. If the engine idle speed does not slow down automatically, have the vehicle checked.

Before starting the vehicle:

1. Make sure all occupants buckle their safety belts. For more information on safety belts and their proper usage, refer to the *Seating and Safety Restraints* chapter.
2. Make sure the headlamps and electrical accessories are off.
  - Make sure the parking brake is set.

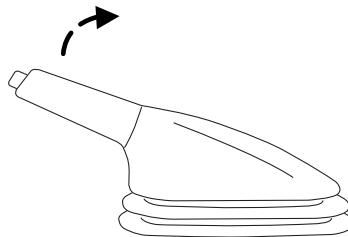

- Make sure the gearshift is in P (Park).

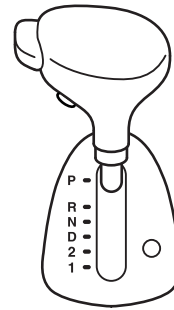

3. Turn the key to II (on) without turning the key to III (start).

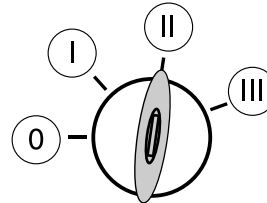

Some warning lights will briefly illuminate. See *Warning lights and chimes* in the *Instrument Cluster* chapter for more information regarding the warning lights.

### Starting the engine

1. Turn the key to II (on) without turning the key to III (start).
2. Turn the key to III (start), then release the key as soon as the engine begins cranking. Your vehicle has a computer assisted cranking system that assists in starting the engine. After releasing the key from the III (start) position, the engine may continue cranking for up to 10 seconds or until the vehicle starts.

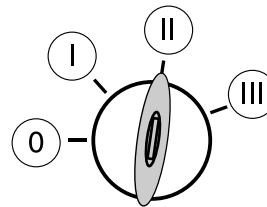

**Note:** Cranking may be stopped at any time by turning the key to the off position.

3. After idling for a few seconds, release the parking brake, apply the brake, shift into gear and drive.

## Driving

**Note:** If the engine does not start on the first try, turn the key to the O (off) position, wait 10 seconds and try Step 2 again. If the engine still fails to start, press the accelerator to the floor and try Step 2 again, keeping the accelerator on the floor until the engine begins to accelerate above cranking speeds; this will allow the engine to crank with the fuel shut off in case the engine is flooded with fuel.

### Guarding against exhaust fumes

Carbon monoxide is present in exhaust fumes. Take precautions to avoid its dangerous effects.



**WARNING:** If you smell exhaust fumes inside your vehicle, have your dealer inspect your vehicle immediately. Do not drive if you smell exhaust fumes.

### Important ventilating information

If the engine is idling while the vehicle is stopped for a long period of time, open the windows at least 1 inch (2.5 cm) or adjust the heating or air conditioning to bring in fresh air.

### ENGINE BLOCK HEATER (IF EQUIPPED)

An engine block heater warms the engine coolant which aids in starting and allows the heater/defroster system to respond quickly. If your vehicle is equipped with this system, your equipment includes a heater element which is installed in your engine block and a wire harness which allows the user to connect the system to a grounded 120 volt A/C electrical source. The block heater system is most effective when outdoor temperatures reach below 0°F (-18°C).



**WARNING:** Failure to follow engine block heater instructions could result in property damage or physical injury.



**WARNING:** To reduce the risk of electrical shock, do not use your heater with ungrounded electrical systems or two-pronged (cheater) adapters.

## Driving

Prior to using the engine block heater, follow these recommendations for proper and safe operation:

- For your safety, use an outdoor extension cord that is product certified by Underwriter's Laboratory (UL) or Canadian Standards Association (CSA). Use only an extension cord that can be used outdoors, in cold temperatures, and is clearly marked "Suitable for Use with Outdoor Appliances." Never use an indoor extension cord outdoors; it could result in an electric shock or fire hazard.
- Use a 16-gauge outdoor extension cord, minimum.
- Use as short an extension cord as possible.
- Do not use multiple extension cords. Instead, use one extension cord which is long enough to reach from the engine block heater cord to the outlet without stretching.
- Make certain that the extension cord is in excellent condition (not patched or spliced). Store your extension cord indoors at temperatures above 32°F (0°C). Outdoor conditions can deteriorate extension cords over a period of time.
- To reduce the risk of electrical shock, do not use your heater with ungrounded electrical systems or two pronged (cheater) adapters. Also ensure that the block heater, especially the cord, is in good condition before use.
- Make sure that when in operation, the extension cord plug/engine block heater cord plug connection is free and clear of water in order to prevent possible shock or fire.
- Be sure that areas where the vehicle is parked are clean and clear of all combustibles such as petroleum products, dust, rags, paper and similar items.
- Be sure that the engine block heater, heater cord and extension cord are solidly connected. A poor connection can cause the cord to become very hot and may result in an electrical shock or fire. Be sure to check for heat anywhere in the electrical hookup once the system has been operating for approximately a half hour.
- Finally, have the engine block heater system checked during your fall tune-up to be sure it's in good working order.

## Driving

### How to use the engine block heater

Ensure the receptacle terminals are clean and dry prior to use. To clean them, use a dry cloth.

Depending on the type of factory installed equipment, your engine block heater will use .4 to 1.0 kilowatt-hours of energy per hour of use. Your factory installed block heater system does not have a thermostat; however, maximum temperature is attained after approximately three hours of operation. Block heater operation longer than three hours will not improve system performance and will unnecessarily use additional electricity.

Make sure system is unplugged and properly stowed before driving the vehicle. While not in use, make sure the protective cover seals the prongs of the engine block heater cord plug.

### BRAKES

Occasional brake noise is normal. If a metal-to-metal, continuous grinding or continuous squeal sound is present, the brake linings may be worn-out and should be inspected by an authorized dealer. If the vehicle has continuous vibration or shudder in the steering wheel while braking, the vehicle should be inspected by an authorized dealer.

Refer to *Warning lights and chimes* in the *Instrument Cluster* chapter for information on the brake system warning light.

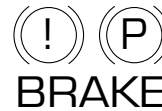

### Four-wheel anti-lock brake system (ABS)

Your vehicle is equipped with an anti-lock braking system (ABS). This system helps you maintain steering control during emergency stops by keeping the brakes from locking. Noise from the ABS pump motor and brake pedal pulsation may be observed during ABS braking and the brake pedal may suddenly travel a little farther as soon as ABS braking is done and normal brake operation resumes. These are normal characteristics of the ABS and should be no reason for concern.

### Using ABS

When hard braking is required, apply continuous force on the brake pedal. Do not pump the brake pedal since this will reduce the effectiveness of the ABS and will increase your vehicle's stopping distance. The ABS will be activated immediately, allowing you to retain steering control during hard braking and on slippery surfaces. However, the ABS does not decrease stopping distance.

168



**ABS warning lamp**

The ABS lamp in the instrument cluster momentarily illuminates when the ignition is turned on. If the light does not illuminate during start up, remains on or flashes, the ABS may be disabled and may need to be serviced.

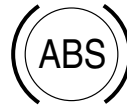

Even when the ABS is disabled, normal braking is still effective. If your BRAKE warning lamp illuminates with the parking brake released, have your brake system serviced immediately by an authorized dealer.



**Parking brake**

To set the parking brake (1), pull the parking brake handle up as far as possible.

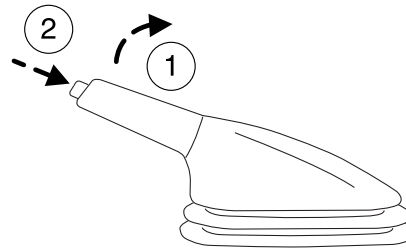

The BRAKE warning lamp will illuminate and will remain illuminated until the parking brake is released.



To release, press and hold the button (2), pull the handle up slightly, then push the handle down.



**WARNING:** Always set the parking brake fully and make sure that the gearshift is securely latched in P (Park).



**WARNING:** If the parking brake is fully released, but the brake warning lamp remains illuminated, the brakes may not be working properly. See your authorized dealer as soon as possible.

## Driving

### **ADVANCETRAC® WITH ROLL STABILITY CONTROL™ (RSC®) STABILITY ENHANCEMENT SYSTEM**

The AdvanceTrac® with RSC® system provides the following stability enhancement features for certain driving situations:

- Traction control system (TCS), which functions to help avoid drive-wheel spin and loss of traction.
- Electronic stability control (ESC), which functions to help avoid skids or lateral slides
- Roll Stability Control™ (RSC®), which functions to help avoid a vehicle roll-over.



**WARNING:** Vehicle modifications involving braking system, aftermarket roof racks, suspension, steering system, tire construction and/or wheel/tire size may change the handling characteristics of the vehicle and may adversely affect the performance of the AdvanceTrac® with RSC® system. In addition, installing any stereo loudspeakers may interfere with and adversely affect the AdvanceTrac® with RSC® system. Install any aftermarket stereo loudspeaker as far as possible from the front center console, the tunnel, and the front seats in order to minimize the risk of interfering with the AdvanceTrac® with RSC® sensors. Reducing the effectiveness of the AdvanceTrac® with RSC® system could lead to an increased risk of loss of vehicle control, vehicle rollover, personal injury and death.



**WARNING:** Remember that even advanced technology cannot defy the laws of physics. It's always possible to lose control of a vehicle due to inappropriate driver input for the conditions. Aggressive driving on any road condition can cause you to lose control of your vehicle increasing the risk of personal injury or property damage. Activation of the AdvanceTrac® with RSC® system is an indication that at least some of the tires have exceeded their ability to grip the road; this could reduce the operator's ability to control the vehicle, potentially resulting in a loss of vehicle control, vehicle rollover, personal injury and death. If your AdvanceTrac® with RSC® system activates, SLOW DOWN.

## Driving



**WARNING:** If a failure has been detected within the AdvanceTrac® with RSC® system, the stability control light will illuminate steadily. If the stability control light illuminates steadily, have the system serviced by an authorized dealer immediately. Operating your vehicle with the stability control light illuminated could lead to an increased risk of loss of vehicle control, vehicle rollover, personal injury and death.

The AdvanceTrac® with RSC® system automatically enables each time the engine is started. All features of the AdvanceTrac® with RSC® system (TCS, ESC, and RSC®) are active and monitor the vehicle from start-up. However, the system will only intervene if the driving situation requires it.

The stability control light in the instrument cluster will illuminate temporarily during start-up as part of a normal system self-check, or during driving if a driving situation causes the AdvanceTrac® with RSC® system to operate. If the stability control light remains steadily illuminated, have the system serviced by an authorized dealer immediately.

When AdvanceTrac® with RSC® performs a normal system self-check, some drivers may notice a slight movement of the brake, and/or a rumble, grunting, or grinding noise after startup and when driving off.

When an event occurs that activates AdvanceTrac® with RSC® you may experience the following:

- A slight deceleration of the vehicle
- The stability control light will flash.
- A vibration in the pedal when your foot is on the brake pedal
- If the driving condition is severe and your foot is not on the brake, the brake pedal may move as the systems applies higher brake forces. You may also hear a whoosh of air from under the instrument panel during this severe condition.
- The brake pedal may feel stiffer than usual.

### **Traction control system (TCS)**

Traction control is a driver aid feature that helps your vehicle maintain traction of the wheels, typically when driving on slippery and/or hilly road surfaces, by detecting and controlling wheel spin.

Excessive wheel spin is controlled in two ways, which may work separately or in tandem: engine traction control and brake traction

## Driving

control. Engine traction control works to limit drive-wheel spin by momentarily reducing engine power. Brake traction control works to limit wheel spin by momentarily applying the brakes to the wheel that is slipping. Traction control prevents the driven wheels from loss of traction due to excessive throttle or low road friction level.

During traction control events, the stability control light in the instrument cluster will flash.

If the traction control system is activated excessively in a short period of time, the braking portion of the system may become temporarily disabled to allow the brakes to cool down. In this situation, traction control will use only engine power reduction or transfer to help control the wheels from over-spinning. When the brakes have cooled down, the system will regain all features. Anti-lock braking, RSC®, and ESC are not affected by this condition and will continue to function during the cool-down period.

### **Electronic stability control (ESC)**

Electronic stability control (ESC) may enhance your vehicle's directional stability during adverse maneuvers, for example when cornering severely or avoiding objects in the roadway. ESC operates by applying brakes to one or more of the wheels individually and, if necessary, reducing engine power if the system detects that the vehicle is about to skid or slide laterally.

During electronic stability control events, the stability control light in the instrument cluster will flash.

Certain adverse driving maneuvers may activate the electronic stability control system, which include but are not limited to:

- Taking a turn too fast
- Maneuvering quickly to avoid an accident, pedestrian or obstacle
- Driving over a patch of ice or other slippery surfaces
- Changing lanes on a snow-rutted road
- Entering a snow-free road from a snow-covered side street, or vice versa
- Entering a paved road from a gravel road, or vice versa

### **Roll Stability Control™ (RSC®)**

Roll Stability Control™ (RSC®) may help to maintain roll stability of the vehicle during adverse maneuvers. RSC® operates by detecting the vehicle's roll motion and the rate at which it changes and by applying the brakes to one or more wheels individually.

172

## Driving

During an event that activates the Roll Stability Control™ (RSC®), the stability control light in the instrument cluster will flash.

Certain adverse driving maneuvers may activate the Roll Stability Control system, which include:

- Emergency lane-change
- Taking a turn too fast
- Quick maneuvering to avoid an accident, pedestrian or obstacle

### STEERING

To help prevent damage to the power steering system:

- Never hold the steering wheel at its furthest turning points (until it stops) for more than a few seconds when the engine is running.
- Do not operate the vehicle with a low power steering pump fluid level (below the MIN mark on the reservoir).
- Some noise is normal during operation. If the noise is excessive, check for low power steering pump fluid level before seeking service by your authorized dealer.
- Heavy or uneven steering efforts may be caused by low power steering pump fluid level. Check for low power steering pump fluid level before seeking service by your authorized dealer.
- Do not fill the power steering pump reservoir above the MAX mark on the reservoir, as this may result in leaks from the reservoir.

If the power steering system breaks down (or if the engine is turned off), you can steer the vehicle manually, but it takes more effort. If the steering wanders or pulls, check for:

- an improperly inflated tire
- uneven tire wear
- loose or worn suspension components
- loose or worn steering components
- improper steering alignment

A high crown in the road or high crosswinds may also make the steering seem to wander/pull.

If the steering wheel vibrates check for:

- improper wheel balance

## Driving

### PREPARING TO DRIVE



**WARNING:** Utility vehicles have a significantly higher rollover rate than other types of vehicles.



**WARNING:** In a rollover crash, an unbelted person is significantly more likely to die than a person wearing a seat belt.

Utility vehicles and trucks have larger tires and increased ground clearance, giving the vehicle a higher center of gravity than a passenger car.



**WARNING:** Vehicles with a higher center of gravity such as utility vehicles and trucks handle differently than vehicles with a lower center of gravity. Utility vehicles and trucks are **not** designed for cornering at speeds as high as passenger cars any more than low-slung sports cars are designed to perform satisfactorily under off-road conditions. Avoid sharp turns, excessive speed or abrupt maneuvers in these vehicles. Failure to drive cautiously could result in an increased risk of loss of vehicle control, vehicle rollover, personal injury and death.



**WARNING:** Loaded vehicles, with a higher center of gravity, may handle differently than unloaded vehicles. Do not overload your vehicle and use extra precautions, such as driving at slower speeds, avoiding abrupt steering changes and allowing for increased stopping distance, when driving a heavily loaded vehicle. Over-loading or loading the vehicle improperly can deteriorate handling capability and contribute to loss of vehicle control and vehicle rollover.

### Vehicle stability and handling

The risk of a rollover crash increases as the number of people and load in the vehicle increase. This increased risk occurs because the passenger weight and load raises the vehicle's center of gravity and causes it to shift rearward. As a result, the van has less resistance to rollover and handles differently from other commonly driven passenger vehicles, making it more difficult to control in an emergency situation. Placing any load on the roof also raises the center of gravity and increases the potential for rollover.

The van should be operated by an experienced driver. An organization that owns a van should select one or two experienced drivers to drive

174

## Driving

the van on a regular basis. These drivers will gain valuable experience handling the van. This experience will help make each trip safer.

The van should be operated at a safe speed which, in some conditions, may be less than the posted speed limit.

Further, all occupants should be properly restrained. Most people killed in rollover crashes were unbelted. Occupants can dramatically reduce their risk of being killed or seriously injured in a rollover crash by simply using their seat belts. Organizations that own vans should have a written seat belt use policy. Drivers should be responsible for enforcing the policy.

### **Emergency maneuvers**

- In an unavoidable emergency situation where a sudden sharp turn must be made, remember to avoid “over-driving” your vehicle, i.e., turn the steering wheel only as rapidly and as far as required to avoid the emergency. Excessive steering will result in less vehicle control, not more. Additionally, smooth variations of the accelerator and/or brake pedal pressure should be utilized if changes in vehicle speed are called for. Avoid abrupt steering, acceleration or braking which could result in an increased risk of loss of vehicle control, vehicle rollover and/or personal injury. Use all available road surface to return the vehicle to a safe direction of travel.
- In the event of an emergency stop, avoid skidding the tires and do not attempt any sharp steering wheel movements.



**WARNING:** Vehicles with a higher center of gravity such as utility and four-wheel drive vehicles handle differently than vehicles with a lower center of gravity. Utility and four-wheel drive vehicles are **not** designed for cornering at speeds as high as passenger cars any more than low-slung sports cars are designed to perform satisfactorily under off-road conditions. Avoid sharp turns, excessive speed and abrupt maneuvers in these vehicles. Failure to drive cautiously could result in an increased risk of loss of vehicle control, vehicle rollover, personal injury and death.

- If the vehicle goes from one type of surface to another (i.e., from concrete to gravel) there will be a change in the way the vehicle responds to a maneuver (steering, acceleration or braking). Again, avoid these abrupt inputs.

## Driving

### BRAKE-SHIFT INTERLOCK

This vehicle is equipped with a brake-shift interlock feature that prevents the gearshift lever from being moved from P (Park) when the ignition is in the on position unless the brake pedal is pressed.

If you cannot move the gearshift lever out of P (Park) with ignition in the on position and the brake pedal pressed, it is possible that a fuse has blown or the vehicle's brake lamps are not operating properly. Refer to *Fuses and relays* in the *Roadside Emergencies* chapter.

If the fuse is not blown and the brake lamps are working properly, the following procedure will allow you to move the gearshift lever from P (Park):

1. Apply the parking brake, turn ignition key to off, then remove the key.
2. Using a flat head screwdriver, remove the plastic cover.
3. Insert the ignition key and push it straight down to release the interlock.
4. Apply the parking brake, then shift to N (Neutral).
5. Start the vehicle. **Note:** Starting the vehicle in N (Neutral) still requires following the steps in the *Preparing to start your vehicle* section.
6. To drive, with the brake pedal still pressed, release the parking brake and shift to D (Drive) or R (Reverse).

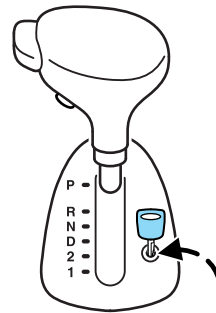

**See your authorized dealer as soon as possible if this procedure is used.**



**WARNING:** Do not drive your vehicle until you verify that the brake lamps are working.



**WARNING:** Always set the parking brake fully and make sure the gearshift is latched in P (Park). Turn the ignition to the off position and remove the key whenever you leave your vehicle.



## Driving



**WARNING:** If the parking brake is fully released, but the brake warning lamp remains illuminated, the brakes may not be working properly. See your authorized dealer.

### AUTOMATIC TRANSMISSION OPERATION

#### Electric vehicles

For specific information on the Transit Connect Electric, refer to the *Azure Dynamics TC-E Owner's Guide Supplement*.

#### Understanding the gearshift positions of the 4-speed automatic transmission

This vehicle is equipped with an adaptive transmission shift strategy. Adaptive Shift Strategy offers the optimal transmission operation and shift quality. When the vehicle's battery has been disconnected for any type of service or repair, the transmission will need to relearn the normal shift strategy parameters, much like having to reset your radio stations when your vehicle battery has been disconnected. The Adaptive Transmission Strategy allows the transmission to relearn these operating parameters. This learning process could take several transmission upshifts and downshifts; during this learning process, slightly firmer shifts may occur. After this learning process, normal shift feel and shift scheduling will resume.

#### P (Park)

This position locks the transmission and prevents the front wheels from turning.

To put your vehicle in gear:

- Start the engine
- Press the brake pedal
- Press the shifter button and move the gearshift lever into the desired gear

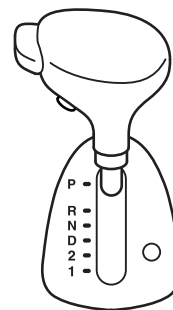

To put your vehicle in P (Park):

- Come to a complete stop
- Move the gearshift lever and securely latch it in P (Park)

## Driving



**WARNING:** Always set the parking brake fully and make sure the gearshift is latched in P (Park). Turn the ignition to the off position and remove the key whenever you leave your vehicle.

### R (Reverse)

With the gearshift lever in R (Reverse), the vehicle will move backward. Always come to a complete stop before shifting into and out of R (Reverse).

### N (Neutral)

With the gearshift lever in N (Neutral), the vehicle can be started and is free to roll. Hold the brake pedal down while in this position.

### D (Drive) with Overdrive

The normal driving position for the best fuel economy. Transmission operates in gears one through four.

### D (Drive) without Overdrive

Overdrive can be deactivated by pressing the transmission control switch on the side of the gearshift lever.

- This position allows for all forward gears (1–3) except overdrive.
- Provides engine braking.
- Use when driving conditions cause excessive shifting from O/D to other gears. Examples: hilly terrain, heavy loads, and when engine braking is required.
- O/D OFF lamp in the instrument cluster is illuminated.
- To return to O/D (overdrive mode), press the transmission control switch. The O/D OFF lamp in the instrument cluster will not be illuminated.
- O/D (overdrive) is automatically returned each time the key is turned off.

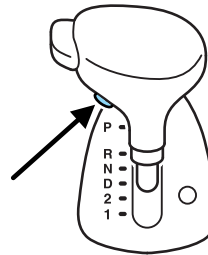

**O/D  
OFF**

### 2 (Second)

This position allows for second gear only.

- Provides engine braking.
- Use to start-up on slippery roads.
- To return to D (Overdrive), move the gearshift lever into the D (Overdrive) position.
- Selecting 2 (Second) at higher speeds will cause the transmission to downshift to second gear once the vehicle has slowed down to the appropriate speed.

### 1 (First)

This position allows for first gear only.

- Provides maximum engine braking.
- Selecting 1 (First) at higher speeds will cause the transmission to downshift to first gear once the vehicle has slowed down to the appropriate speed.

**Note:** 2 (Second) and 1 (First) are not intended for use under extended or normal driving conditions and results in lower fuel economy.

### REVERSE SENSING SYSTEM (IF EQUIPPED)

The reverse sensing system (RSS) sounds a tone to warn the driver of obstacles near the rear bumper when the R (Reverse) is selected and the vehicle is moving at low speeds. The system is not effective at high speeds and may not detect certain angular or moving objects.





**WARNING:** To help avoid personal injury, please read and understand the limitations of the reverse sensing system as contained in this section. Reverse sensing is only an aid for some (generally large and fixed) objects when moving in reverse on a flat surface at “parking speeds”. Inclement weather may also affect the function of the RSS; this may include reduced performance or a false activation.



**WARNING:** To help avoid personal injury, always use caution when in reverse and when using the RSS.

## Driving

 **WARNING:** This system is not designed to prevent contact with small or moving objects. The system is designed to provide a warning to assist the driver in detecting large stationary objects to avoid damaging the vehicle. The system may not detect smaller objects, particularly those close to the ground.

 **WARNING:** Certain add-on devices such as large trailer hitches, bike or surfboard racks and any device that may block the normal detection zone of the RSS system may create false beeps.

The RSS detects obstacles up to 6 feet (1.8 meters) from the rear bumper with a decreased coverage area at the outer corners of the bumper, (refer to the figures for approximate zone coverage areas). As you move closer to the obstacle, the rate of the tone increases. When the obstacle is less than 10 inches (25.0 cm) away, the tone will sound continuously.

The RSS automatically turns on when the gearshift lever is placed in R (Reverse) and the ignition is on. **Note:** The RSS will be disabled when the two trailer tow connectors are plugged in prior to towing.

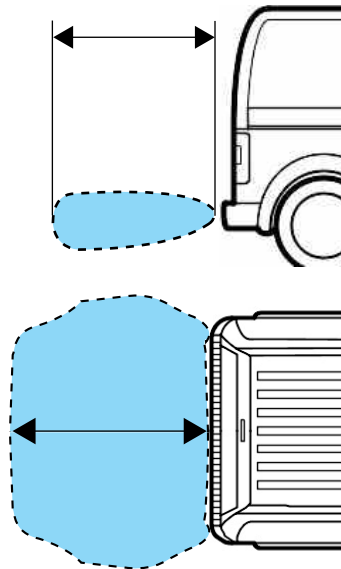

**Keep the RSS sensors (located on the rear bumper/fascia) free from snow, ice and large accumulations of dirt (do not clean the sensors with sharp objects). If the sensors are covered, it will affect the accuracy of the RSS.**

**If your vehicle sustains damage to the rear bumper/fascia, leaving it misaligned or bent, the sensing zone may be altered causing inaccurate measurement of obstacles or false alarms.**

### REARVIEW CAMERA SYSTEM (IF EQUIPPED)

The rearview camera is located on the rear doors. The camera system provides a video image which appears in the rear view mirror of the area behind the vehicle. It adds assistance to the driver while reversing or reverse parking the vehicle.

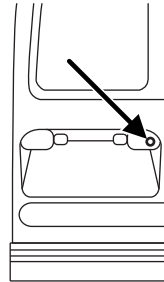

To use the camera system, place the transmission in R (Reverse); an image will display in the rear view mirror. The area displayed on the screen may vary according to the vehicle orientation and/or road condition.

- (1) Rear bumper
- (2) Red zone
- (3) Yellow zone
- (4) Green zone

Always use caution while backing.

Objects in the red zone are closest to your vehicle and objects in the green zone are further away. Objects are getting closer to your vehicle as they move from the green zone to the yellow or red zones.

Use the side mirrors and rear view mirror to get better coverage on both sides and rear of the vehicle.

The camera lens for the camera is located on the rear doors. Keep the lens clean so that the video image remains clear and undistorted. Clean the lens with a soft, lint-free cloth and non-abrasive cleaner.

**Note:** If the camera system image is not clear or seems distorted, it may be covered with water droplets, snow, mud or any other substance. If this occurs, clean the camera lens before using the rear view camera system.

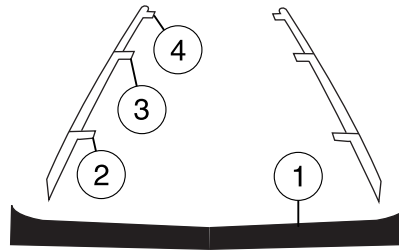

**WARNING:** The camera system is a reverse aid supplement device that still requires the driver to use it in conjunction with the rear view mirror and the side mirrors for maximum coverage.

## Driving



**WARNING:** Objects that are close to either corner of the bumper or under the bumper, might not be seen on the screen due to the limited coverage of the camera system.



**WARNING:** Back up as slow as possible since higher speeds might limit your reaction time to stop the vehicle.



**WARNING:** Do not use the camera system with the rear doors open.

If the back end of the vehicle is hit or damaged, then check with your authorized dealer to have your rear view camera checked for proper coverage and operation.

### Night time and dark area use

At night time or in dark areas, the camera system relies on the reverse lamp lighting to produce an image. Therefore, it is necessary that both reverse lamps are operating in order to get a clear image in the dark. If either of the lamps are not operating, stop using the camera system, at least in the dark, until the lamp(s) are replaced and functioning.

### Servicing

- If the image comes on while the vehicle is not in R (Reverse), have the system inspected by your authorized dealer.
- If the image is not clear, then check if there is anything covering the lens such as dirt, mud, ice, snow, etc. If the image is still not clear after cleaning, have your system inspected by your authorized dealer.

### BLIND SPOT MIRRORS

Blind spot mirrors have an integrated convex spotter mirror built into the upper outboard corner of the outside mirrors. They are designed to assist the driver by increasing visibility along the side of the vehicle. For more information on your side view mirrors, refer to *Exterior mirrors* in the *Driver Controls* chapter.

**Driving with blind spot mirrors**

Before a lane change, check the main mirror first, then check the blind spot mirror. If no vehicles are present in the blind spot mirror and the traffic in the adjacent lane is at a safe distance, signal that you are going to change lanes. Glance over your shoulder to verify traffic is clear, and carefully change lanes.

When the approaching vehicle is at a distance, its image is small and near the inboard edge of the main mirror. As the vehicle approaches, the image becomes larger and begins to move outboard across the main mirror (1). As the vehicle approaches its image will transition from the main mirror and begin to appear in the blind spot mirror (2). As the vehicle leaves the blind spot mirror it will transition to the driver's peripheral field of view (3).

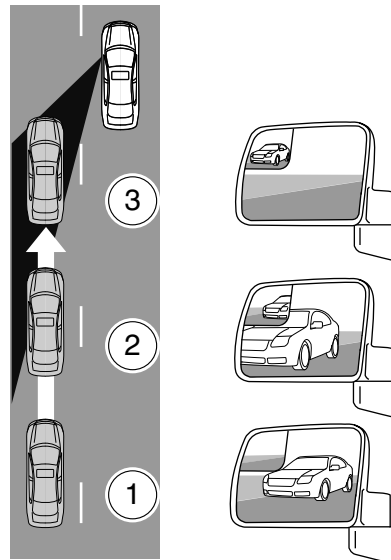

**WARNING:** Objects in the blind spot mirror are closer than they appear.

**DRIVING THROUGH WATER**

If driving through deep or standing water is unavoidable, proceed very slowly especially when the depth is not known. Never drive through water that is higher than the bottom of the wheel rims (for cars) or the bottom of the hubs (for trucks).

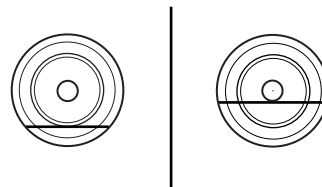

When driving through water, traction or brake capability may be limited. Also, water may enter your engine's air intake and severely damage your engine or your vehicle may stall. **Driving through deep water where the transmission vent tube is submerged may allow water into the transmission and cause internal transmission damage.**

## Driving

**Once through the water, always dry the brakes by moving your vehicle slowly while applying light pressure on the brake pedal.**

Wet brakes do not stop the vehicle as quickly as dry brakes.

### **Electric vehicles**

For specific information on the Transit Connect Electric, refer to the *Azure Dynamics TC-E Owner's Guide* Supplement.



## Roadside Emergencies

### ROADSIDE ASSISTANCE

#### Vehicles sold in the U.S. : Getting roadside assistance

To fully assist you should you have a vehicle concern, Ford Motor Company offers a complimentary roadside assistance program. This program is separate from the New Vehicle Limited Warranty. The service is available:

- 24-hours, seven days a week
- for the coverage period listed on the Roadside Assistance Card included in your Owner Guide portfolio.

Roadside assistance will cover:

- a flat tire change with a good spare (except vehicles that have been supplied with a tire inflation kit)
- battery jump start
- lock-out assistance (key replacement cost is the customer's responsibility)
- fuel delivery – Independent Service Contractors, if not prohibited by state, local or municipal law shall deliver up to 2.0 gallons (7.5L) of gasoline or 5.0 gallons (18.9L) of diesel fuel to a disabled vehicle. Fuel delivery service is limited to two no-charge occurrences within a 12-month period.
- winch out – available within 100 feet (30.5 meters) of a paved or county maintained road, no recoveries.
- towing – Ford and Lincoln eligible vehicles towed to an authorized dealer within 35 miles (56 km) of the disablement location or to the nearest authorized dealer. If a member requests to be towed to an authorized dealer more than 35 miles (56 km) from the disablement location, the member shall be responsible for any mileage costs in excess of 35 miles (56 km).

Trailers shall be covered up to \$200 if the disabled eligible vehicle requires service at the nearest authorized dealer. If the trailer is disabled, but the towing vehicle is operational, the trailer does not qualify for any roadside services.

#### Vehicles sold in the U.S. : Using roadside assistance

Complete the roadside assistance identification card and place it in your wallet for quick reference. In the United States, this card is found in the Owner Guide portfolio in the glove compartment. In Canada, the card is found in the *Warranty Guide* in the glove compartment.

## Roadside Emergencies

U.S. Ford and Lincoln vehicle customers who require Roadside Assistance, call 1-800-241-3673.

If you need to arrange roadside assistance for yourself, Ford Motor Company will reimburse a reasonable amount for towing to the nearest dealership within 35 miles (56 km). To obtain reimbursement information, U.S. Ford and Lincoln vehicle customers call 1-800-241-3673. Customers will be asked to submit their original receipts.

### **Vehicles sold in Canada : Getting roadside assistance**

Canadian customers who require roadside assistance, call 1-800-665-2006.

### **Vehicles sold in Canada : Using roadside assistance**

Complete the roadside assistance identification card and place it in your wallet for quick reference. In Canada, the card is found in the Warranty Guide in the glove box.

Canadian Roadside coverage and benefits may differ from the U.S. coverage. Please refer to your Warranty Guide or visit our website at [www.ford.ca](http://www.ford.ca) for information on Canadian services and benefits.

Canadian customers who need to obtain roadside information, call 1-800-665-2006 or visit our website at [www.ford.ca](http://www.ford.ca).

### **HAZARD FLASHER CONTROL**

The hazard flasher control is located on the instrument panel above the radio. The hazard flashers will operate when the ignition is in any position or if the key is not in the ignition.



Press the flasher control and all front and rear direction signals will flash. Press the flasher control again to turn them off. Use it when your vehicle is disabled and is creating a safety hazard for other motorists.

**Note:** With extended use, the flasher may run down your battery.

### **FUEL PUMP SHUT-OFF SWITCH**

This device stops the electric fuel pump from sending fuel to the engine when your vehicle has had a substantial jolt.

After an accident, if the engine cranks but does not start, this switch may have been activated.

186

## Roadside Emergencies

The fuel pump shut-off switch is accessible from behind the glove box. The button will be raised when the switch is activated.

To reset the switch:

1. Turn the ignition off.
2. Check the fuel system for leaks.
3. If no leaks are apparent, open the glove box then push in the sides and swing the glove box down.
4. Reset the switch by pushing in the reset button.
5. Turn the ignition on.
6. Wait a few seconds and return the key to off.
7. Make another check for leaks.

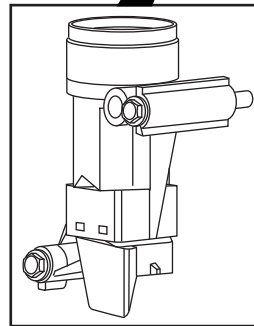
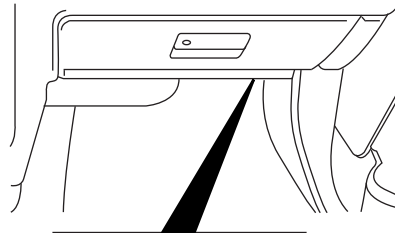

### Electric vehicles

For specific information on the Transit Connect Electric, refer to the *Azure Dynamics TC-E Owner's Guide Supplement*.

### FUSES AND RELAYS

#### Electric vehicles

For specific information on the Transit Connect Electric, refer to the *Azure Dynamics TC-E Owner's Guide Supplement*.

#### Fuses

If electrical components in the vehicle are not working, a fuse may have blown. Blown fuses are identified by a broken wire within the fuse. Check the appropriate fuses before replacing any electrical components.

**Note:** Always replace a fuse with one that has the specified amperage rating. Using a fuse with a higher amperage rating can cause severe wire damage and could start a fire.

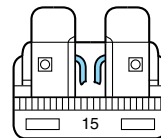

## Roadside Emergencies

### *Standard fuse amperage rating and color*

COLOR					
Fuse rating	Mini fuses	Standard fuses	Maxi fuses	Cartridge maxi fuses	Fuse link cartridge
2A	Grey	Grey	—	—	—
3A	Violet	Violet	—	—	—
4A	Pink	Pink	—	—	—
5A	Tan	Tan	—	—	—
7.5A	Brown	Brown	—	—	—
10A	Red	Red	—	—	—
15A	Blue	Blue	—	—	—
20A	Yellow	Yellow	Yellow	Blue	Blue
25A	Natural	Natural	—	Natural	Natural
30A	Green	Green	Green	Pink	Pink
40A	—	—	Orange	Green	Green
50A	—	—	Red	Red	Red
60A	—	—	Blue	Yellow	Yellow
70A	—	—	Tan	—	Brown
80A	—	—	Natural	Black	Black



## Roadside Emergencies

Fuse/Relay Location	Fuse Amp Rating	Protected Circuits
126	—	Rear unlock relay
127	—	Ignition overload relay
128	—	Battery saver relay (modified vehicle)
130	15A	Hazard flashers
131	5A	Power mirrors
132	10A	Light switch, Exterior lighting
133	—	Not used
134	—	Not used
135	—	Not used
136	15A	Horn
137	7.5A	Tire pressure monitoring system (TPMS), Radio, Instrument cluster
138	10A	Reverse lamp
139	20A	Ignition supply (modified vehicle)
140	—	Not used
141	7.5A	Front/rear fog lamps
142	15A	Brake lamps
143	20A	Cigar lighter, Front power point
144	10A	Ignition supply (modified vehicle)
145	—	Not used
146	20A	Windshield wipers, Wiper switch
147	15A	Front fog lamps
148	7.5A	Recirculation, Instrument cluster
149	10A	Ignition supply/Battery supply (modified vehicle)
150	—	Not used
151	15A	Radio, Bluetooth®/Voice command module
152	7.5A	A/C switch, Park aid module
153	7.5A	Interior lamps, Battery saver

## Roadside Emergencies

Fuse/Relay Location	Fuse Amp Rating	Protected Circuits
154	15A	Roof lamp (modified vehicle)
155	10A	Battery saver (modified vehicle)
156	7.5A	Right parking lamp/tail lamps
157	7.5A	License plate lamps
158	10A	Light switch
159	20A	Rear heater blower fan (modified vehicle)
160	—	Not used
161	7.5A	Anti-lock brake system (ABS)/RSC, Steering angle sensor
162	7.5A	Airbag module, Passenger airbag off indicator
163	20A	Locks
164	20A	TPMS module
165	—	Not used
166	25A	Front power windows
167	7.5A	Rear window defroster/heated mirror switch
168	—	Not used
169	20A	Second power point
170	—	Not used
171	—	Not used
172	10A	Right rear turn signal (modified vehicle)
173	10A	Left rear turn signal (modified vehicle)
174	20A	Rear power point, Rear center console power point (modified vehicle)
175	7.5A	Left park lamps/tail lamps
176	—	Not used
177	—	Not used

## Roadside Emergencies

Fuse/Relay Location	Fuse Amp Rating	Protected Circuits
178	25A	Rear window defroster
179	7.5A	Instrument cluster, Passive anti-theft system (PATS), Accelerator pedal sensor, TPMS, Rearview camera
180	20A	Front and rear window washer
181	—	Not used
182	—	Not used

### Power distribution box

The power distribution box is located in the engine compartment. The power distribution box contains high-current fuses that protect your vehicle's main electrical systems from overloads.



**WARNING:** Always disconnect the battery before servicing high current fuses.



**WARNING:** To reduce risk of electrical shock, always replace the cover to the power distribution box before reconnecting the battery or refilling fluid reservoirs.

If the battery has been disconnected and reconnected, refer to the *Battery* section of the *Maintenance and Specifications* chapter.

**Note:** To remove the power distribution box cover, the battery negative cable clip needs to be removed first. Pull up on the clip to detach it from the battery tray.



## Roadside Emergencies

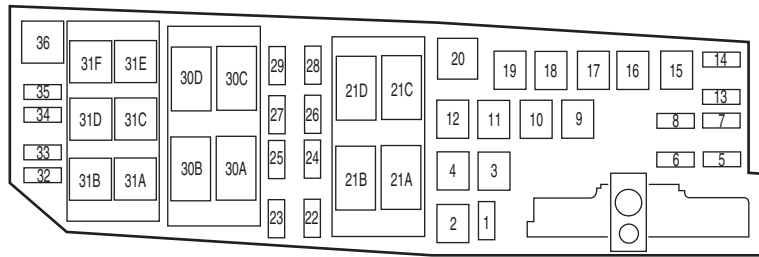

The high-current fuses are coded as follows:

Fuse/Relay Location	Fuse Amp Rating	Protected circuits
1	7.5A*	Heated windshield telltale
2	40A**	Right heated windshield, Modified vehicle — Rear heater blower fan, Ignition supply
3	50A**	Left heated windshield, Modified vehicle — Battery supply
4	20A**	Fuel pump
5	10A*	Powertrain control module (PCM) keep alive power, Canister solenoid
6	15A*	PCM, Data link connector
7	20A*	Ignition switch
8	15A*	Headlamps
9	40A**	Passenger compartment fuse panel II
10	25A**	Rear turn signal, Modified vehicle — Battery supply
11	40A**	Ignition overload, Passenger compartment fuse panel
12	30A**	Anti-lock brake system (ABS)/Roll stability control (RSC) pump motor

## Roadside Emergencies

Fuse/Relay Location	Fuse Amp Rating	Protected circuits
13	30A*	Heater blower motor
14	10A*	PCM relay
15	20A**	ABS/RSC valves
16	30A**	Cooling fan – low
17	50A**	Cooling fan – high
18	25A**	Daytime running lamps (DRL), Low beam interrupt relay
19	50A**	Passenger compartment fuse panel III
20	—	A/C clutch relay
21A	—	Right heated windshield relay, Modified vehicle — Rear fan relay
21B	—	Starter lock relay
21C	—	High beam headlamp relay
21D	—	PCM relay
22	10A*	PCM, Auxiliary connector, Fuel injectors
23	10A*	Right low beam headlamp
24	10A*	A/C clutch solenoid
25	10A*	Left low beam headlamp
26	10A*	Mass air flow sensor, Brake switch, Backup lamps relay, EGR stepper motor, EVAP canister purge valve, Heated oxygen sensors, Floor shifter, Transmission range sensor
27	—	Not used
28	15A*	PCM vehicle power 1
29	15A*	Auxiliary connector, Coil on plugs
30A	70A Relay	Cooling fan high relay
30B		
30C	—	Cooling fan low relay

## Roadside Emergencies

Fuse/Relay Location	Fuse Amp Rating	Protected circuits
30D	—	Left heated windshield relay
31A	—	Backup lamp relay
31B	—	Fuel pump relay
31C	—	DRL relay
31D	—	Low beam headlamps relay
31E	—	Modified vehicle — Right rear turn signal relay
31F	—	Front fog lamps
32	—	Cooling fan diode
33	—	Fuel pump relay diode
34	—	Gear shifter diode
35	30A*	Start lock relay
36	—	Modified vehicle — Left rear turn signal relay

\*Mini fuse \*\*Cartridge fuse

### CHANGING THE TIRES

If you get a flat tire while driving, do not apply the brake heavily. Instead, gradually decrease your speed. Hold the steering wheel firmly and slowly move to a safe place on the side of the road.

**Note:** The tire pressure monitoring system (TPMS) indicator light will illuminate when the spare tire is in use. To restore the full functionality of the monitoring system, all road wheels equipped with tire pressure monitoring sensors must be mounted on the vehicle.

Have a flat serviced by an authorized dealer in order to prevent damage to the TPMS sensors, refer to *Tire pressure monitoring system (TPMS)* in the *Tires, Wheels and Loading* chapter. Replace the spare tire with a road tire as soon as possible. During repairing or replacing of the flat tire, have the authorized dealer inspect the TPMS sensor for damage.



**WARNING:** The use of tire sealants may damage your tire pressure monitoring system (TPMS) and should not be used. However, if you must use a sealant, the TPMS sensor and valve stem on the wheel must be replaced by an authorized Ford dealer.

## Roadside Emergencies

 **WARNING:** Refer to *Tire pressure monitoring system (TPMS)* in the *Tires, Wheels and Loading* chapter for important information. If the tire pressure monitor sensor becomes damaged, it will no longer function.

### Dissimilar spare tire/wheel information

 **WARNING:** Failure to follow these guidelines could result in an increased risk of loss of vehicle control, injury or death.

If you have a dissimilar spare tire/wheel, then it is intended for temporary use only. This means that if you need to use it, you should replace it as soon as possible with a road tire/wheel that is the same size and type as the road tires and wheels that were originally provided by Ford. If the dissimilar spare tire or wheel is damaged, it should be replaced rather than repaired.

A dissimilar spare tire/wheel is defined as a spare tire and/or wheel that is different in brand, size or appearance from the road tires and wheels and can be one of three types:

1. **T-type mini-spare:** This spare tire begins with the letter “T” for tire size and may have “Temporary Use Only” molded in the sidewall
2. **Full-size dissimilar spare with label on wheel:** This spare tire has a label on the wheel that states: “THIS TIRE AND WHEEL FOR TEMPORARY USE ONLY”

When driving with one of the dissimilar spare tires listed above, **do not:**

- Exceed 50 mph (80 km/h)
- Load the vehicle beyond maximum vehicle load rating listed on the Safety Compliance Label
- Tow a trailer
- Use snow chains on the end of the vehicle with the dissimilar spare tire
- Use more than one dissimilar spare tire at a time
- Use commercial car washing equipment
- Try to repair the dissimilar spare tire

## Roadside Emergencies

Use of one of the dissimilar spare tires listed above at any one wheel location can lead to impairment of the following:

- Handling, stability and braking performance
- Comfort and noise
- Ground clearance and parking at curbs
- Winter weather driving capability
- Wet weather driving capability
- All-wheel driving capability (if applicable)

### 3. Full-size dissimilar spare without label on wheel

When driving with the full-size dissimilar spare tire/wheel, **do not:**

- Exceed 70 mph (113 km/h)
- Use more than one dissimilar spare tire/wheel at a time
- Use commercial car washing equipment
- Use snow chains on the end of the vehicle with the dissimilar spare tire/wheel

The usage of a full-size dissimilar spare tire/wheel can lead to impairment of the following:

- Handling, stability and braking performance
- Comfort and noise
- Ground clearance and parking at curbs
- Winter weather driving capability
- Wet weather driving capability
- All-wheel driving capability (if applicable)
- Load leveling adjustment (if applicable)

When driving with the full-size dissimilar spare tire/wheel additional caution should be given to:

- Towing a trailer
- Driving vehicles equipped with a camper body
- Driving vehicles with a load on the cargo rack

Drive cautiously when using a full-size dissimilar spare tire/wheel and seek service as soon as possible.

## Roadside Emergencies

### Stopping and securing the vehicle

1. Park on a level surface, set the parking brake and activate hazard flashers.
2. Place gearshift lever in P (Park) and turn engine off.

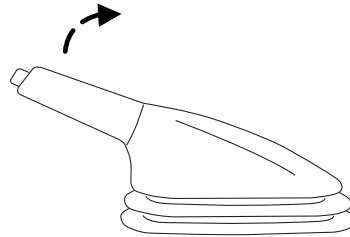

### Removing the spare tire

The jack and tools are located behind a cover in the sidewall at the left rear of the cargo area. The retention straps and wing nut need to be removed before removing the jack.

1. Open the cap in the rear of the vehicle and insert the end of the lug wrench into the guide hole.
2. Turn the handle counterclockwise and lower the spare tire until it rests on the ground and the cable is slack.

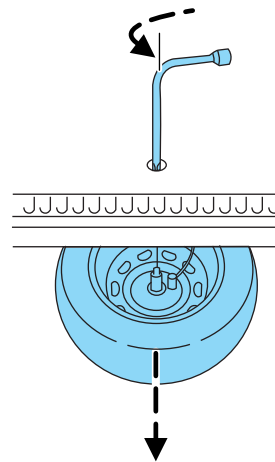

## Roadside Emergencies

3. Detach the first cable by pulling the cap up and sliding it away from the wheel. Then turn the end of the cable so it fits through the slot and remove the cable and bracket.

4. Detach the second cable by unscrewing the bolt.

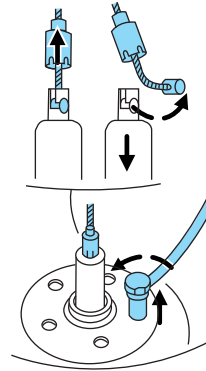

### Electric vehicles

For specific information on the Transit Connect Electric, refer to the *Azure Dynamics TC-E Owner's Guide Supplement*.

### Tire change procedure



**WARNING:** When one of the front wheels is off the ground, the transmission alone will not prevent the vehicle from moving or slipping off the jack, even if the vehicle is in P (Park).



**WARNING:** To help prevent the vehicle from moving when you change a tire, be sure the parking brake is set, then block (in both directions) the wheel that is diagonally opposite (other side and end of the vehicle) to the tire being changed.



**WARNING:** If the vehicle slips off the jack, you or someone else could be seriously injured.



**WARNING:** Do not attempt to change a tire on the side of the vehicle close to moving traffic. Pull far enough off the road to avoid the danger of being hit when operating the jack or changing the wheel.

**Note:** Passengers should not remain in the vehicle when the vehicle is being jacked.

## Roadside Emergencies

1. Block the diagonally opposite wheel.

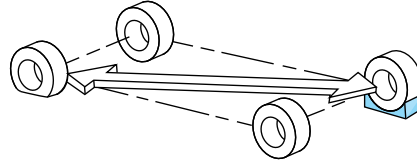

2. Insert the wrench end between the rim and the wheel cover through the gaps and carefully remove the cover.

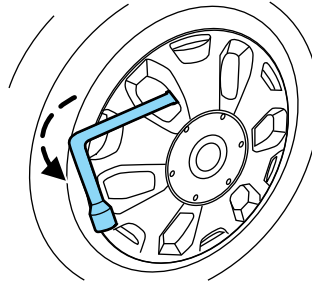

3. Loosen each wheel lug nut one-half turn counterclockwise but do not remove them until the wheel is raised off the ground.

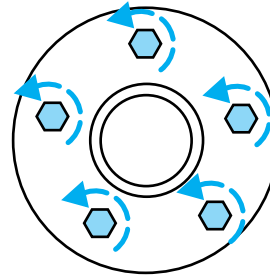



## Roadside Emergencies

4. Align the slot on top of the jack with the sheet metal flange indicated by the jack locator triangle next to the tire you are changing. Turn the jack handle clockwise until the wheel is completely off the ground.



**WARNING:** To lessen the risk of personal injury, do not put any part of your body under the vehicle while changing a tire. Do not start the engine when your vehicle is on the jack. The jack is only meant for changing the tire.

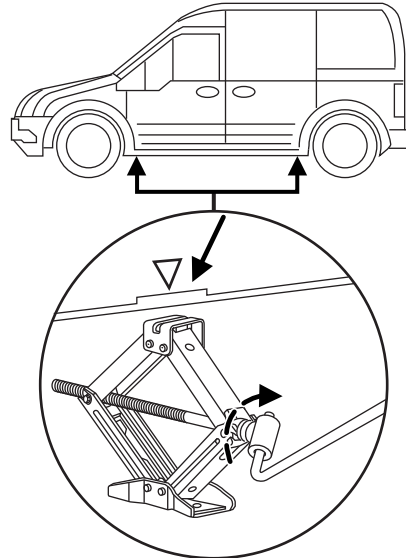

5. Remove the lug nuts with the lug nut wrench.

6. Replace the flat tire with the spare tire, making sure the valve stem is facing outward. Reinstall the lug nuts until the wheel is snug against the hub. Do not fully tighten the lug nuts until the wheel has been lowered.

7. Lower the wheel by turning the jack handle counterclockwise.

8. Remove the jack and fully tighten the lug nuts in the order shown. Refer to *Wheel lug nut torque specifications* later in this chapter for the proper lug nut torque specification.

9. Fit the wheel cover onto the rim making sure the valve stem aligns with the indent in the ring on the back of the cover. Tap it with the palm of your hand to lock it into place.

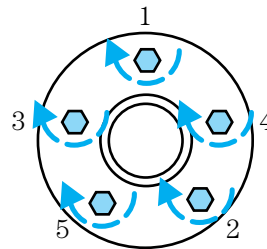

### **Electric vehicles**

For specific information on the Transit Connect Electric, refer to the *Azure Dynamics TC-E Owner's Guide Supplement*.

## Roadside Emergencies

### Stowing the flat/spare tire

**Note:** Failure to follow spare tire stowage instructions may result in failure of cable or loss of spare tire.

1. Lay the tire on the ground with the valve stem facing up toward the vehicle.
2. Slide the wheel partially under the vehicle and install the retainer through the wheel center. Pull on the cables to align the components at the end of the cables.
3. Attach the second cable by screwing the bolt into one of the holes in the wheel.
4. Turn the end of the first cable so it fits through the slot and install the cable. Then slide the cap over the retainer.
5. Turn the lug wrench clockwise until the tire is raised to its stowed position underneath the vehicle. The effort to turn the jack handle increases significantly and the spare tire carrier ratchets or slips when the tire is raised to the maximum tightness. Tighten to the best of your ability, to the point where the ratchet/slip occurs, if possible. The spare tire carrier will not allow you to overtighten. If the spare tire carrier ratchets or slips with little effort, take the vehicle to your authorized dealer for assistance at your earliest convenience.
6. Check that the tire lies flat against the frame and is properly tightened. Try to push or pull, then turn the tire to be sure it will not move. Loosen and retighten, if necessary. Failure to properly stow the spare tire may result in failure of the winch cable and loss of the tire.
7. Repeat this tightness check procedure when servicing the spare tire pressure (every six months, per *scheduled maintenance information*), or at any time that the spare tire is disturbed through service of other components.

Return the jack and tools to the storage position in the cargo area.

### WHEEL LUG NUT TORQUE SPECIFICATIONS

Retighten the lug nuts to the specified torque within 100 miles (160 km) after any wheel disturbance (rotation, flat tire, wheel removal, etc.).

Bolt size	Wheel lug nut torque*	
	ft-lb	N•m
M12 x 1.5	100	135

\* Torque specifications are for nut and bolt threads free of dirt and rust. Use only Ford recommended replacement fasteners.

202

## Roadside Emergencies

**!** **WARNING:** When a wheel is installed, always remove any corrosion, dirt or foreign materials present on the mounting surfaces of the wheel or the surface of the wheel hub, brake drum or brake disc that contacts the wheel. Ensure that any fasteners that attach the rotor to the hub are secured so they do not interfere with the mounting surfaces of the wheel. Installing wheels without correct metal-to-metal contact at the wheel mounting surfaces can cause the wheel nuts to loosen and the wheel to come off while the vehicle is in motion, resulting in loss of control.

**Note:** Inspect the wheel pilot hole prior to installation. If there is visible corrosion in wheel pilot hole, remove loose particles by wiping with clean rag and apply grease. Apply grease only to the wheel pilot hole surface by smearing a “dime” (1 square cm) sized glob of grease around the wheel pilot surface (1) with end of finger. **DO NOT** apply grease to lugnut/stud holes or wheel-to-brake surfaces.

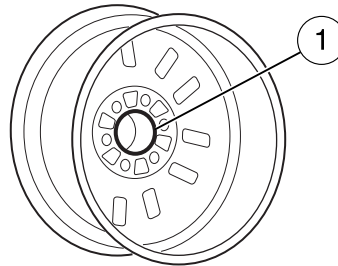

### JUMP STARTING

**!** **WARNING:** The gases around the battery can explode if exposed to flames, sparks, or lit cigarettes. An explosion could result in injury or vehicle damage.

**!** **WARNING:** Batteries contain sulfuric acid which can burn skin, eyes and clothing, if contacted.

**Do not attempt to push-start your automatic transmission vehicle. Automatic transmissions do not have push-start capability. Attempting to push-start a vehicle with an automatic transmission may cause transmission damage.**

### Electric vehicles

For specific information on the Transit Connect Electric, refer to the *Azure Dynamics TC-E Owner's Guide Supplement*.

## Roadside Emergencies

### Preparing your vehicle

When the battery is disconnected or a new battery is installed, the automatic transmission must relearn its shift strategy. As a result, the transmission may have firm and/or soft shifts. This operation is considered normal and will not affect function or durability of the transmission. Over time, the adaptive learning process will fully update transmission operation.

1. **Use only a 12-volt supply to start your vehicle.**
2. Do not disconnect the battery of the disabled vehicle as this could damage the vehicle's electrical system.
3. Park the booster vehicle close to the hood of the disabled vehicle making sure the two vehicles **do not** touch. Set the parking brake on both vehicles and stay clear of the engine cooling fan and other moving parts.
4. Check all battery terminals and remove any excessive corrosion before you attach the battery cables. Ensure that vent caps are tight and level.
5. Turn the heater fan on in both vehicles to protect from any electrical surges. Turn all other accessories off.

### Connecting the jumper cables

**Note:** In the illustration, the vehicle on the bottom is used to designate the assisting (boosting) battery.

## Roadside Emergencies

1. Connect the positive (+) jumper cable to the positive (+) terminal of the discharged battery.
2. Connect the other end of the positive (+) cable to the positive (+) terminal of the assisting battery.
3. Connect the negative (-) cable to the negative (-) terminal of the assisting battery.
4. Make the final connection of the negative (-) cable to an exposed metal part of the stalled vehicle's engine, away from the battery and the carburetor/fuel injection system.

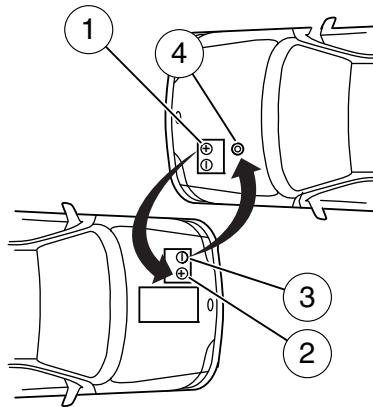

**Note:** Do not attach the negative (-) cable to fuel lines, engine rocker covers, the intake manifold or electrical components as grounding points.



**WARNING:** Do not connect the end of the second cable to the negative (-) terminal of the battery to be jumped. A spark may cause an explosion of the gases that surround the battery.

Ensure that the cables are clear of fan blades, belts, moving parts of both engines, or any fuel delivery system parts.

### Jump starting

1. Start the engine of the booster vehicle and run the engine at moderately increased speed.
2. Start the engine of the disabled vehicle.
3. Once the disabled vehicle has been started, run both engines for an additional three minutes before disconnecting the jumper cables.

## Roadside Emergencies

### Removing the jumper cables

Remove the jumper cables in the reverse order that they were connected.

**Note:** In the illustration, the vehicle on the bottom is used to designate the assisting (boosting) battery.

1. Remove the jumper cable from the ground metal surface.
2. Remove the jumper cable on the negative (-) terminal of the booster vehicle's battery.
3. Remove the jumper cable from the positive (+) terminal of the booster vehicle's battery.
4. Remove the jumper cable from the positive (+) terminal of the disabled vehicle's battery.

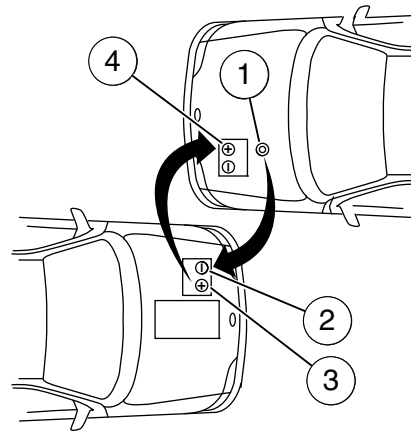

After the disabled vehicle has been started and the jumper cables removed, allow it to idle for several minutes so the engine computer can relearn its idle conditions.

## Roadside Emergencies

### WRECKER TOWING

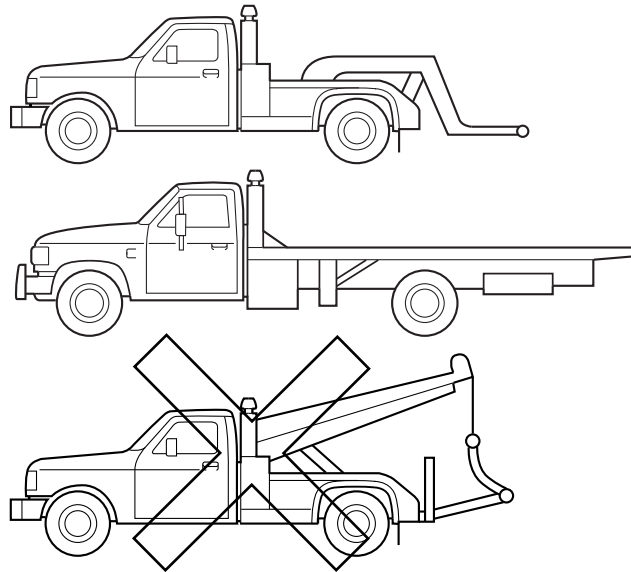

If you need to have your vehicle towed, contact a professional towing service or, if you are a member of a roadside assistance program, your roadside assistance service provider.

It is recommended that your vehicle be towed with a wheel lift or flatbed equipment. Do not tow with a slingbelt. Ford Motor Company has not approved a slingbelt towing procedure.

If your vehicle is to be towed from the rear using wheel lift equipment, the front wheels (drive wheels) must be placed on a dolly to prevent damage to the transmission.

**If the vehicle is towed by other means or incorrectly, vehicle damage may occur.**

Ford Motor Company produces a towing manual for all authorized tow truck operators. Have your tow truck operator refer to this manual for proper hook-up and towing procedures for your vehicle.

#### **Electric vehicles**

For specific information on the Transit Connect Electric, refer to the *Azure Dynamics TC-E Owner's Guide Supplement*.

## Roadside Emergencies

### Emergency towing

In case of a roadside emergency with a disabled vehicle (without access to wheel dollies, car hauling trailer, or flatbed transport vehicle) your vehicle (regardless of transmission powertrain configuration) can be flat towed (all wheels on the ground) under the following conditions:

- Vehicle is facing forward so that it is being towed in a forward direction.
- Place the transmission in N (Neutral). Refer to *Brake-shift interlock* in the *Driving* chapter for specific instructions if you cannot move the gear shift lever into N (Neutral).
- Maximum speed is not to exceed 35 mph (56 km/h).
- Maximum distance is 50 miles (80 km).



## Customer Assistance

### GETTING THE SERVICES YOU NEED

Warranty repairs to your vehicle must be performed by an authorized dealer. While any authorized dealer handling your vehicle line will provide warranty service, we recommend you return to your selling authorized dealer who wants to ensure your continued satisfaction.

Please note that certain warranty repairs require special training and/or equipment, so not all authorized dealers are authorized to perform all warranty repairs. This means that, depending on the warranty repair needed, you may have to take your vehicle to another authorized dealer.

A reasonable time must be allowed to perform a repair after taking your vehicle to the authorized dealer. Repairs will be made using Ford or Motorcraft® parts, or remanufactured or other parts that are authorized by Ford.

### Away from home

If you are away from home when your vehicle needs service, contact the Ford Customer Relationship Center or use the online resources listed below to find the nearest authorized dealer.

In the United States:

#### Mailing address

Ford Motor Company  
Customer Relationship Center  
P.O. Box 6248  
Dearborn, MI 48121

#### Telephone

1-800-392-3673 (FORD)  
(TDD for the hearing impaired: 1-800-232-5952)

#### Online

Additional information and resources are available online at [www.genuineservice.com](http://www.genuineservice.com).

- U.S. dealer locator by Dealer Name, City/State, or Zip Code
- Owner Guides
- Maintenance Schedules
- Recalls
- Ford Extended Service Plans
- Ford Genuine Accessories
- Service specials and promotions.

## Customer Assistance

In Canada:

**Mailing address (Ford vehicles)**

Customer Relationship Centre  
Ford Motor Company of Canada, Limited  
P.O. Box 2000  
Oakville, Ontario L6J 5E4

**Telephone**

1-800-565-3673 (FORD)

**Online**

[www.ford.ca](http://www.ford.ca)

**Mailing address (Lincoln vehicles)**

Lincoln Centre  
Ford Motor Company of Canada, Limited  
P.O. Box 2000  
Oakville, Ontario L6J 5E4

**Telephone**

1-800-387-9333

**Online**

[www.lincolncanada.com](http://www.lincolncanada.com)

**Additional assistance**

If you have questions or concerns, or are unsatisfied with the service you are receiving, follow these steps:

1. Contact your Sales Representative or Service Advisor at your selling/servicing authorized dealer.
2. If your inquiry or concern remains unresolved, contact the Sales Manager, Service Manager or Customer Relations Manager.
3. If you require assistance or clarification on Ford Motor Company policies, please contact the Ford Customer Relationship Center

In order to help you serve you better, please have the following information available when contacting a Customer Relationship Center:

- Vehicle Identification Number (VIN)
- Your telephone number (home and business)
- The name of the authorized dealer and city where located
- The vehicle's current odometer reading

In some states, you must directly notify Ford in writing before pursuing remedies under your state's warranty laws. Ford is also allowed a final repair attempt in some states.

210

## Customer Assistance

In the United States, a warranty dispute must be submitted to the BBB AUTO LINE before taking action under the Magnuson-Moss Warranty Act, or to the extent allowed by state law, before pursuing replacement or repurchase remedies provided by certain state laws. This dispute handling procedure is not required prior to enforcing state created rights or other rights which are independent of the Magnuson-Moss Warranty Act or state replacement or repurchase laws.

### **IN CALIFORNIA (U.S. ONLY)**

California Civil Code Section 1793.2(d) requires that, if a manufacturer or its representative is unable to repair a motor vehicle to conform to the vehicle's applicable express warranty after a reasonable number of attempts, the manufacturer shall be required to either replace the vehicle with one substantially identical or repurchase the vehicle and reimburse the buyer in an amount equal to the actual price paid or payable by the consumer (less a reasonable allowance for consumer use). The consumer has the right to choose whether to receive a refund or replacement vehicle.

California Civil Code Section 1793.22(b) presumes that the manufacturer has had a reasonable number of attempts to conform the vehicle to its applicable express warranties if, within the first 18 months of ownership of a new vehicle or the first 18,000 miles (29,000 km), whichever occurs first:

1. Two or more repair attempts are made on the same non-conformity likely to cause death or serious bodily injury OR
2. Four or more repair attempts are made on the same nonconformity (a defect or condition that substantially impairs the use, value or safety of the vehicle) OR
3. The vehicle is out of service for repair of nonconformities for a total of more than 30 calendar days (not necessarily all at one time)

In the case of 1 or 2 above, the consumer must also notify the manufacturer of the need for the repair of the nonconformity at the following address:

Ford Motor Company  
16800 Executive Plaza Drive  
Mail Drop 3NE-B  
Dearborn, MI 48126

You are required to submit your warranty dispute to BBB AUTO LINE before asserting in court any rights or remedies conferred by California Civil Code Section 1793.22(b). You are also required to use BBB AUTO

## Customer Assistance

LINE before exercising rights or seeking remedies created by the Federal Magnuson-Moss Warranty Act, 15 U.S.C. sec. 2301 et seq. If you choose to seek redress by pursuing rights and remedies not created by California Civil Code Section 1793.22(b) or the Magnuson-Moss Warranty Act, resort to BBB AUTO LINE is not required by those statutes.

### **THE BETTER BUSINESS BUREAU (BBB) AUTO LINE PROGRAM (U.S. ONLY)**

Your satisfaction is important to Ford Motor Company and to your dealer. If a warranty concern has not been resolved using the three-step procedure outlined earlier in this chapter in the *Getting the services you need* section, you may be eligible to participate in the BBB AUTO LINE program.

The BBB AUTO LINE program consists of two parts – mediation and arbitration. During mediation, a representative of the BBB will contact both you and Ford Motor Company to explore options for settlement of the claim. If an agreement is not reached during mediation or you do not want to participate in mediation, and if your claim is eligible, you may participate in the arbitration process. An arbitration hearing will be scheduled so that you can present your case in an informal setting before an impartial person. The arbitrator will consider the testimony provided and make a decision after the hearing.

Disputes submitted to the BBB AUTO LINE program are usually decided within forty days after you file your claim with the BBB. You are not bound by the decision, and may reject the decision and proceed to court where all findings of the BBB Auto Line dispute, and decision, are admissible in the court action. Should you choose to accept the BBB AUTO LINE decision, Ford is then bound by the decision, and must comply with the decision within 30 days of receipt of your acceptance letter.

BBB AUTO LINE Application: Using the information provided below, please call or write to request a program application. You will be asked for your name and address, general information about your new vehicle, information about your warranty concerns, and any steps you have already taken to try to resolve them. A Customer Claim Form will be mailed that will need to be completed, signed and returned to the BBB along with proof of ownership. Upon receipt, the BBB will review the claim for eligibility under the Program Summary Guidelines.

**You can get more information by calling BBB AUTO LINE at 1-800-955-5100, or writing to:**

**BBB AUTO LINE  
4200 Wilson Boulevard, Suite 800  
Arlington, Virginia 22203-1833**

212

## Customer Assistance

BBB AUTO LINE applications can also be requested by calling the Ford Motor Company Customer Relationship Center at 1-800-392-3673.

**Note:** Ford Motor Company reserves the right to change eligibility limitations, modify procedures, or to discontinue this process at any time without notice and without obligation.

### **UTILIZING THE MEDIATION/ARBITRATION PROGRAM (CANADA ONLY)**

For vehicles delivered to authorized Canadian dealers. In those cases where you continue to feel that the efforts by Ford of Canada and the authorized dealer to resolve a factory-related vehicle service concern have been unsatisfactory, Ford of Canada participates in an impartial third party mediation/arbitration program administered by the Canadian Motor Vehicle Arbitration Plan (CAMVAP).

The CAMVAP program is a straight forward and relatively speedy alternative to resolve a disagreement when all other efforts to produce a settlement have failed. This procedure is without cost to you and is designed to eliminate the need for lengthy and expensive legal proceedings.

In the CAMVAP program, impartial third-party arbitrators conduct hearings at mutually convenient times and places in an informal environment. These impartial arbitrators review the positions of the parties, make decisions and, when appropriate, render awards to resolve disputes. CAMVAP decisions are fast, fair, and final as the arbitrator's award is binding on both you and Ford of Canada.

CAMVAP services are available in all Canadian territories and provinces. For more information, without charge or obligation, call your CAMVAP Provincial Administrator directly at 1-800-207-0685 or visit [www.camvap.ca](http://www.camvap.ca).

### **GETTING ASSISTANCE OUTSIDE THE U.S. AND CANADA**

Before exporting your vehicle to a foreign country, contact the appropriate foreign embassy or consulate. These officials can inform you of local vehicle registration regulations and where to find unleaded fuel.

If you cannot find unleaded fuel or can only get fuel with an anti-knock index lower than is recommended for your vehicle, contact a regional office or owner relations/customer relationship office.

The use of leaded fuel in your vehicle without proper conversion may damage the effectiveness of your emission control system and may cause engine knocking or serious engine damage. Ford Motor Company/Ford of

213

## Customer Assistance

Canada is not responsible for any damage caused by use of improper fuel. Using leaded fuel may also result in difficulty importing your vehicle back into the U.S.

If your vehicle must be serviced while you are traveling or living in Asia-Pacific Region, Sub-Saharan Africa, U.S. Virgin Islands, Central America, the Caribbean, and Israel, contact the nearest authorized dealer. If the authorized dealer cannot help you, contact:

FORD MOTOR COMPANY  
FORD EXPORT OPERATIONS & GLOBAL INITIATIVES  
1555 Fairlane Drive  
Fairlane Business Park #3  
Allen Park, Michigan 48101  
U.S.A.

Telephone: (313) 594-4857

For customers in Guam, the Commonwealth of the Northern Mariana Islands (CNMI), American Samoa, and the U.S. Virgin Islands, please feel free to call our Toll-Free Number: (800) 841-FORD (3673).

FAX: (313) 390-0804

Email: [expcac@ford.com](mailto:expcac@ford.com)

If your vehicle must be serviced while you are traveling or living in Puerto Rico, contact the nearest authorized dealer. If the authorized dealer cannot help you, contact:

Ford International Business Development Inc.

Customer Relationship Center

P.O. Box 11957

Caparra Heights Station

San Juan, Puerto Rico 00922-1957

Telephone: (800) 841-FORD (3673)

FAX: (313) 390-0804

Email: [prcac@ford.com](mailto:prcac@ford.com)

[www.ford.com.pr](http://www.ford.com.pr)

If your vehicle must be serviced while you are traveling or living in the Middle East, contact the nearest authorized dealer. If the authorized dealer cannot help you, contact:

Ford Middle East

Customer Relationship Center

P.O. Box 21470

Dubai, United Arab Emirates

Telephone: +971 4 3326084

Toll-Free Number for the Kingdom of Saudi Arabia: 800 8971409

214

## Customer Assistance

Local Telephone Number for Kuwait: 24810575  
FAX: +971 4 3327299  
Email: [menacac@ford.com](mailto:menacac@ford.com)  
[www.me.ford.com](http://www.me.ford.com)

If you buy your vehicle in North America and then relocate to any of the above locations, register your vehicle identification number (VIN) and new address with Ford Motor Company Export Operations & Global Growth Initiatives by emailing [expcac@ford.com](mailto:expcac@ford.com).

If you are in another foreign country, contact the nearest authorized dealer. If the authorized dealer employees cannot help you, they can direct you to the nearest Ford affiliate office.

**Customers in the U.S. should call 1-800-392-3673.**

### ORDERING ADDITIONAL OWNER'S LITERATURE

To order the publications in this portfolio, contact Helm, Incorporated at:

HELM, INCORPORATED  
P.O. Box 07150  
Detroit, Michigan 48207

Or to order a free publication catalog, call toll free: 1-800-782-4356

Monday-Friday 8:00 a.m. - 6:00 p.m. EST

Helm, Incorporated can also be reached by their website:  
[www.helminc.com](http://www.helminc.com).

*(Items in this catalog may be purchased by credit card, check or money order.)*

### Obtaining a French Owner's Guide

French Owner's Guides can be obtained from your authorized dealer or by contacting Helm, Incorporated using the contact information listed previously in this section.

### REPORTING SAFETY DEFECTS (U.S. ONLY)

If you believe that your vehicle has a defect which could cause a crash or could cause injury or death, you should immediately inform the National Highway Traffic Safety Administration (NHTSA) in addition to notifying Ford Motor Company.



If NHTSA receives similar complaints, it may open an investigation, and if it finds that a safety defect exists in a group of vehicles, it may order a

215

## Customer Assistance

recall and remedy campaign. However, NHTSA cannot become involved in individual problems between you, your dealer, or Ford Motor Company.

To contact NHTSA, you may call the Vehicle Safety Hotline toll-free at 1-888-327-4236 (TTY: 1-800-424-9153); go to <http://www.safercar.gov>; or write to:

Administrator  
1200 New Jersey Avenue, Southeast  
Washington, D.C. 20590

You can also obtain other information about motor vehicle safety from <http://www.safercar.gov>.

### **REPORTING SAFETY DEFECTS (CANADA ONLY)**

If you believe that your vehicle has a defect which could cause a crash or could cause injury or death, you should immediately inform Transport Canada, using their toll-free number: 1-800-333-0510, or online at: <https://www.wapps.tc.gc.ca/Saf-Sec-Sur/7/PCDB-BDPP/Index.aspx>.



### WASHING THE EXTERIOR

Wash your vehicle regularly with cool or lukewarm water and a neutral pH shampoo, such as Motorcraft® Detail Wash (ZC-3-A), which is available from your authorized dealer.

- Never use strong household detergents or soap, such as dish washing or laundry liquid. These products can discolor and spot painted surfaces.
- Never wash a vehicle that is “hot to the touch” or during exposure to strong, direct sunlight.
- Always use a clean sponge or car wash mitt with plenty of water for best results.
- Dry the vehicle with a chamois or soft terry cloth towel in order to eliminate water spotting.
- It is especially important to wash the vehicle regularly during the winter months, as dirt and road salt are difficult to remove and cause damage to the vehicle.
- Immediately remove items such as gasoline, diesel fuel, bird droppings and insect deposits because they can cause damage to the vehicle's paintwork and trim over time. Use Motorcraft® Bug and Tar Remover (ZC-42), which is available from your authorized dealer.
- Remove any exterior accessories, such as antennas, before entering a car wash.
- Turn the heater fan off to prevent contamination of the cabin air filter.
- **Suntan lotions and insect repellents can damage any painted surface; if these substances come in contact with your vehicle, wash off as soon as possible.**
- **If your vehicle is equipped with running boards, do not use rubber, plastic and vinyl protectant products on the running board surface, as the area may become slippery.**

### Exterior chrome

- Wash the vehicle first, using cool or lukewarm water and a neutral pH shampoo, such as Motorcraft® Detail Wash (ZC-3-A).
- Use Motorcraft® Custom Bright Metal Cleaner (ZC-15), available from your authorized dealer. Apply the product as you would a wax to clean bumpers and other chrome parts; allow the cleaner to dry for a few minutes, then wipe off the haze with a clean, dry rag.
- **Never use abrasive materials such as steel wool or plastic pads as they can scratch the chrome surface.**

## Cleaning

### WAXING

- Wash the vehicle first.
- Use a quality wax that does not contain abrasives.
- Do not allow paint sealant to come in contact with any non-body (low-gloss black) colored trim, such as grained door handles, roof racks, bumpers, side moldings, mirror housings or the windshield cowl area. The paint sealant will “gray” or stain the parts over time.
- Do not allow paint sealant to come in contact with the sliding door electrical contact switches. Paint sealant or other contaminants could interfere with the proper operation of the power locks or radio speakers. If necessary, clean the contacts with Motorcraft® Bug and Tar Remover (ZC-42) to remove any sealant. Do not use any abrasives on the contact surfaces.

### PAINT CHIPS

Your authorized dealer has touch-up paint to match your vehicle's color. Take your color code (printed on a sticker in the driver's door jamb) to your authorized dealer to ensure you get the correct color.

- Remove particles such as bird droppings, tree sap, insect deposits, tar spots, road salt and industrial fallout before repairing paint chips.
- Always read the instructions before using the products.

### ALUMINUM WHEELS AND WHEEL COVERS

Aluminum wheels and wheel covers are coated with a clearcoat paint finish. In order to maintain their shine:

- Clean weekly with Motorcraft® Wheel and Tire Cleaner, which is available from your authorized dealer. Heavy dirt and brake dust accumulation may require agitation with a sponge. Rinse thoroughly with a strong stream of water.
- Never apply any cleaning chemical to hot or warm wheel rims or covers.
- Some automatic car washes may cause damage to the finish on your wheel rims or covers. Industrial-strength (heavy-duty) cleaners, or cleaning chemicals, in combination with brush agitation to remove brake dust and dirt, could wear away the clearcoat finish over time.
- Do not use hydrofluoric acid-based or high caustic-based wheel cleaners, steel wool, fuels or strong household detergent.
- To remove tar and grease, use Motorcraft® Bug and Tar Remover , available from your authorized dealer.

218

## Cleaning

### ENGINE

Engines are more efficient when they are clean because grease and dirt buildup keep the engine warmer than normal. When washing:

- Take care when using a power washer to clean the engine. The high-pressure fluid could penetrate the sealed parts and cause damage.
- Do not spray a hot engine with cold water to avoid cracking the engine block or other engine components.
- Spray Motorcraft® Engine Shampoo and Degreaser (ZC-20) on all parts that require cleaning and pressure rinse clean. In Canada, use Motorcraft® Engine Shampoo (CXC-66-A).
- Cover the highlighted areas to prevent water damage when cleaning the engine.

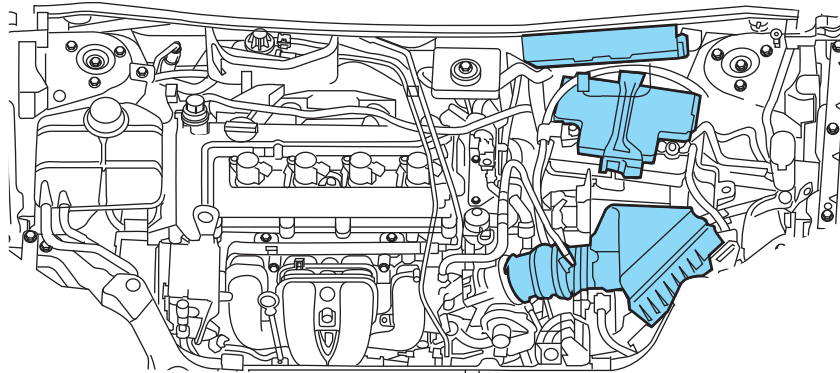

- Never wash or rinse the engine while it is hot or running; water in the running engine may cause internal damage.
- Never wash or rinse any ignition coil, spark plug wire or spark plug well, or the area in and around these locations.

### Electric vehicles

For specific information on the Transit Connect Electric, refer to the *Azure Dynamics TC-E Owner's Guide Supplement*.

### PLASTIC (NON-PAINTED) EXTERIOR PARTS

Use only approved products to clean plastic parts. These products are available from your authorized dealer.

## Cleaning

- For routine cleaning, use Motorcraft® Detail Wash (ZC-3-A).
- If tar or grease spots are present, use Motorcraft® Bug and Tar Remover (ZC-42).

### WINDOWS AND WIPER BLADES

The windshield, rear and side windows and the wiper blades should be cleaned regularly. If the wipers do not wipe properly, substances on the vehicle's glass or the wiper blades may be the cause. These may include hot wax treatments used by commercial car washes, water repellent coatings, tree sap, or other organic contamination; these contaminants may cause squeaking or chatter noise from the blades, and streaking and smearing of the windshield. To clean these items, follow these tips:

- The windshield, rear windows and side windows may be cleaned with a non-abrasive cleaner such as Motorcraft® Ultra-Clear Spray Glass Cleaner (ZC-23), available from your authorized dealer.
- The wiper blades can be cleaned with isopropyl (rubbing) alcohol or Motorcraft® Premium Windshield Washer Concentrate (ZC-32-A) in the U.S., or Premium Quality Windshield Washer Fluid [CXC-37-(A, B, D, or F)] in Canada, available from your authorized dealer. This washer fluid contains special solution in addition to alcohol which helps to remove the hot wax deposited on the wiper blade and windshield from automated car wash facilities. Be sure to replace wiper blades when they appear worn or do not function properly.
- Do not use abrasives, as they may cause scratches.
- Do not use fuel, kerosene, or paint thinner to clean any parts.

If you cannot remove those streaks after cleaning with the glass cleaner or if the wipers chatter and move in a jerky motion, clean the outer surface of the windshield and the wiper blades using a sponge or soft cloth with a neutral detergent or mild-abrasive cleaning solution. After cleaning, rinse the windshield and wiper blades with clean water. The windshield is clean if beads do not form when you rinse the windshield with water.

### INSTRUMENT PANEL/INTERIOR TRIM AND CLUSTER LENS

Clean the instrument panel, interior trim areas and cluster lens with a clean, damp, white cotton cloth, then use a clean and dry white cotton cloth to dry these areas.

- Avoid cleaners or polishes that increase the gloss of the upper portion of the instrument panel. The dull finish in this area helps protect the driver from undesirable windshield reflection.

220

## Cleaning

- Be certain to wash or wipe your hands clean if you have been in contact with certain products such as insect repellent and suntan lotion in order to avoid possible damage to the interior painted surfaces.
- Do not use household or glass cleaners as these may damage the finish of the instrument panel, interior trim and cluster lens.
- Do not allow air fresheners and hand sanitizers to spill on interior surfaces. If a spill occurs, **wipe off immediately**. Damage may not be covered by your warranty.



**WARNING:** Do not use chemical solvents or strong detergents when cleaning the steering wheel or instrument panel to avoid contamination of the airbag system.

If a staining liquid like coffee/juice has been spilled on the instrument panel or on interior trim surfaces, clean as follows:

1. Wipe up spilled liquid using a clean, white, cotton cloth.
2. Wipe the surface with a damp, clean, white cotton cloth. For more thorough cleaning, use a mild soap and water solution. If the spot cannot be completely cleaned by this method, the area may be cleaned using a commercially available cleaning product designed for automotive interiors.
3. If necessary, apply more soap and water solution or cleaning product to a clean, white, cotton cloth and press the cloth onto the soiled area—allow this to set at room temperature for 30 minutes.
4. Remove the soaked cloth, and if it is not soiled badly, use this cloth to clean the area by using a rubbing motion for 60 seconds.
5. Following this, wipe area dry with a clean, white, cotton cloth.

### INTERIOR

For fabric, carpets, cloth seats and safety belts:

- Remove dust and loose dirt with a vacuum cleaner.
- Remove light stains and soil with Motorcraft® Professional Strength Carpet & Upholstery Cleaner (ZC-54).
- If grease or tar is present on the material, spot-clean the area first with Motorcraft® Spot and Stain Remover (ZC-14). In Canada, use Motorcraft® Multi-Purpose Cleaner (CXC-101).
- If a ring forms on the fabric after spot cleaning, clean the entire area immediately (but do not oversaturate) or the ring will set.

## Cleaning

- Do not use household cleaning products or glass cleaners, which can stain and discolor the fabric and affect the flame retardant abilities of the seat materials.



**WARNING:** Do not use cleaning solvents, bleach or dye on the vehicle's seatbelts, as these actions may weaken the belt webbing.

### **LEATHER SEATS (IF EQUIPPED, EXCEPT FOR THE KING RANCH® EDITION)**

**For King Ranch® leather seats, refer to a separate section in this chapter.**

- Clean spills and stains as quickly as possible.
- For routine cleaning, wipe the surface with a soft, damp cloth. For more thorough cleaning, wipe the surface with a mild soap and water solution. In Canada, use Motorcraft® Vinyl Cleaner (CXC-93). Dry the area with a soft cloth.
- If the leather cannot be completely cleaned using a mild soap and water solution, the leather may be cleaned using a commercially available leather cleaning product designed for automotive interiors.
- To check for compatibility, first test any cleaner or stain remover on an inconspicuous part of the leather.
- Do not use household cleaning products, alcohol solutions, solvents or cleaners intended for rubber, vinyl and plastics, or oil/petroleum-based leather conditioners. These products may cause premature wearing or damage to the leather.

### **LEATHER SEATS FOR THE KING RANCH® EDITION ONLY (IF EQUIPPED)**

Your vehicle is equipped with seating covered in premium, top-grain leather which is extremely durable, but still requires special care and maintenance in order to ensure longevity and comfort.

Regular cleaning and conditioning will maintain the appearance of the leather.

#### **Cleaning**

For dirt, use a vacuum cleaner then use a clean, damp cloth or soft brush.

For routine cleaning, wipe the surface with a soft, damp cloth. For more thorough cleaning, wipe the surface with a mild soap and water solution.

222

## Cleaning

- Clean spills as quickly as possible.
- Test any cleaner or stain remover on an inconspicuous part of the leather as cleaners may darken the leather.
- Do not spill coffee, ketchup, mustard, orange juice or oil-based products on the leather as they may permanently stain the leather.
- Do not use household cleaning products, alcohol solutions, solvents or cleaners intended for rubber, vinyl or plastics.

### Scratches

Natural Markings - Because the leather in the seat comes from genuine steer hides, there will be evidence of naturally occurring markings, such as small scars. These markings give character to the seating covers and should be considered as proof of a genuine leather product.

In order to lessen the appearance of certain scratches and other wear marks, apply conditioner on the affected area following the same instructions as in the *Conditioning* section.

### Conditioning

Bottles of King Ranch® Leather Conditioner are available at the King Ranch® Saddle Shop. Visit the website at [www.krsaddleshop.com](http://www.krsaddleshop.com), or telephone (in the United States) 1-800-282-KING (5464). If you are unable to obtain King Ranch® Leather Conditioner, use another premium leather conditioner.

- Clean the surfaces using the steps outlined in the *Cleaning* section.
- Ensure the leather is dry then apply a nickel-sized amount of conditioner to a clean, dry cloth.
- Rub the conditioner into leather until it disappears. Allow the conditioner to dry and repeat the process for the entire interior. If a film appears, wipe off film with a dry, clean cloth.

### UNDERBODY

Flush the complete underside of your vehicle frequently. Keep body and door drain holes free from packed dirt.

### Electric vehicles

For specific information on the Transit Connect Electric, refer to the *Azure Dynamics TC-E Owner's Guide Supplement*.

## Cleaning

### FORD AND LINCOLN CAR CARE PRODUCTS

Your Ford or Lincoln authorized dealer has many quality products available to clean your vehicle and protect its finishes. These quality products have been specifically engineered to fulfill your automotive needs; they are custom designed to complement the style and appearance of your vehicle. Each product is made from high quality materials that meet or exceed rigid specifications. For best results, use the following products or products of equivalent quality:

- Motorcraft® Bug and Tar Remover (ZC-42)
- Motorcraft® Custom Bright Metal Cleaner (ZC-15)
- Motorcraft® Detail Wash (ZC-3-A)
- Motorcraft® Dusting Cloth (ZC-24)
- Motorcraft® Engine Shampoo and Degreaser (U.S. only) (ZC-20)
- Motorcraft® Engine Shampoo (Canada only) (CXC-66-A)
- Motorcraft® Multi-Purpose Cleaner (Canada only) (CXC-101)
- Motorcraft® Premium Glass Cleaner (Canada only) (CXC-100)
- Motorcraft® Premium Quality Windshield Washer Fluid (Canada only) [CXC-37-(A, B, D or F)]
- Motorcraft® Premium Windshield Washer Concentrate (U.S. only) (ZC-32-A)
- Motorcraft® Professional Strength Carpet & Upholstery Cleaner (ZC-54)
- Motorcraft® Spot and Stain Remover (U.S. only) (ZC-14)
- Motorcraft® Ultra-Clear Spray Glass Cleaner (ZC-23)
- Motorcraft® Vinyl Cleaner (Canada only) (CXC-93)
- Motorcraft® Wheel and Tire Cleaner (ZC-37-A)



## Maintenance and Specifications

### SERVICE RECOMMENDATIONS

To help you service your vehicle, we provide *scheduled maintenance information* which makes tracking routine service easy.

If your vehicle requires professional service, your authorized dealer can provide the necessary parts and service. Check your *Warranty Guide* to find out which parts and services are covered.

Use only recommended fuels, lubricants, fluids and service parts conforming to specifications. Motorcraft® parts are designed and built to provide the best performance in your vehicle.

### Electric vehicles

For specific information on the Transit Connect Electric, refer to the *Azure Dynamics TC-E Owner's Guide* Supplement.

### PRECAUTIONS WHEN SERVICING YOUR VEHICLE

- Do not work on a hot engine.
- Make sure that nothing gets caught in moving parts.
- Do not work on a vehicle with the engine running in an enclosed space, unless you are sure you have enough ventilation.
- Keep all open flames and other burning material (such as cigarettes) away from the battery and all fuel related parts.

### Working with the engine off

1. Set the parking brake and ensure the gearshift is securely latched in P (Park).
2. Turn off the engine and remove the key.
3. Block the wheels to prevent the vehicle from moving unexpectedly.

### Working with the engine on

1. Set the parking brake and shift to P (Park).
2. Block the wheels.



**WARNING:** To reduce the risk of vehicle damage and/or personal burn injuries, do not start your engine with the air cleaner removed and do not remove it while the engine is running.

## Maintenance and Specifications

### OPENING THE HOOD

1. Lift and swivel the hood badge back.

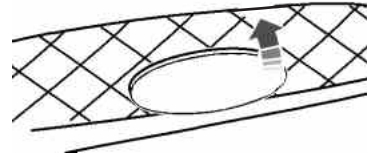

2. Insert the key and turn it to the left to release the primary latch. Then, turn the key to the right to release the secondary latch and lift the hood.

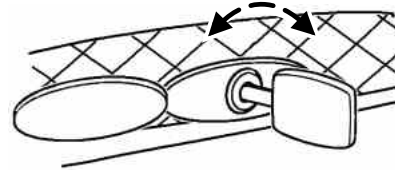

**Note:** To prevent damage to, or loss of the key, remove the key immediately after opening the hood and swivel the badge back.

3. Lift the hood and support it with the prop rod.

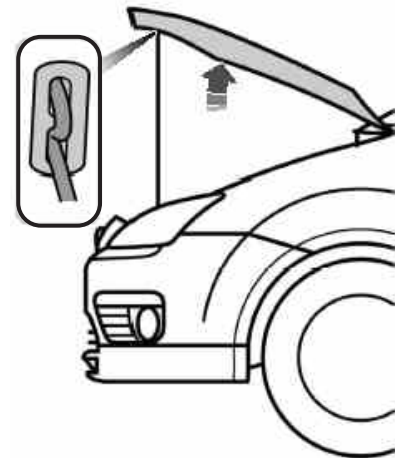

## Maintenance and Specifications

### IDENTIFYING COMPONENTS IN THE ENGINE COMPARTMENT

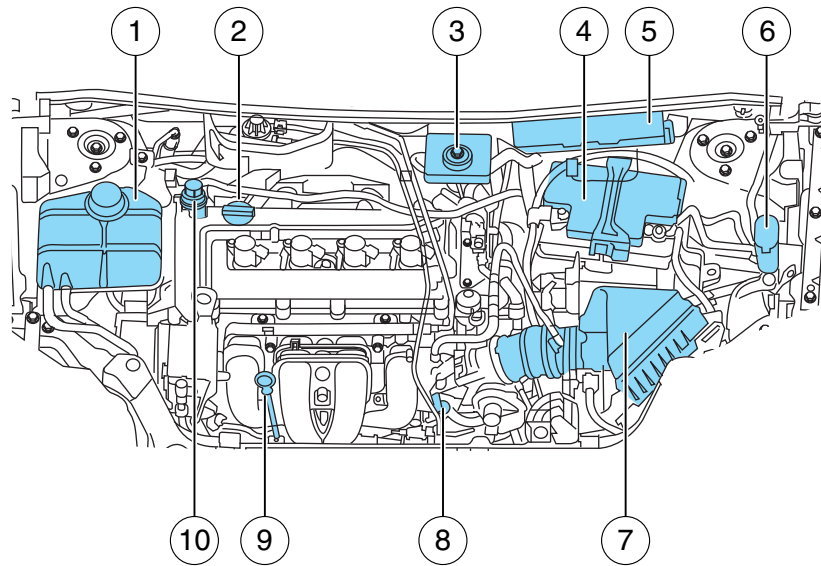

1. Engine coolant reservoir
2. Engine oil filler cap
3. Brake fluid reservoir
4. Battery
5. Power distribution box
6. Windshield washer fluid reservoir
7. Air filter assembly
8. Automatic transmission fluid dipstick
9. Engine oil dipstick
10. Power steering fluid reservoir

## Maintenance and Specifications

### WINDSHIELD WASHER FLUID

Add fluid to fill the reservoir if the level is low. In very cold weather, do not fill the reservoir completely.

Only use a washer fluid that meets Ford specifications. Do not use any special washer fluid such as windshield water repellent type fluid or bug wash. They may cause squeaking, chatter noise, streaking and smearing. Refer to *Maintenance product specifications and capacities* in this chapter.

State or local regulations on volatile organic compounds may restrict the use of methanol, a common windshield washer antifreeze additive. Washer fluids containing non-methanol antifreeze agents should be used only if they provide cold weather protection without damaging the vehicle's paint finish, wiper blades or washer system.



**WARNING:** If you operate your vehicle in temperatures below 40°F (5°C), use washer fluid with antifreeze protection. Failure to use washer fluid with antifreeze protection in cold weather could result in impaired windshield vision and increase the risk of injury or accident.

### CHANGING THE WIPER BLADES

1. Pull the wiper arm away from the vehicle. Turn the blade at an angle from the wiper arm. Press the lock tab to release the blade and pull the wiper blade down toward the windshield to remove it from the arm.

2. Attach the new wiper to the wiper arm and press it into place until a click is heard.

Replace wiper blades at least once per year for optimum performance. Poor wiper quality can be improved by cleaning the wiper blades and the windshield. Refer to *Windows and wiper blades* in the *Cleaning* chapter.

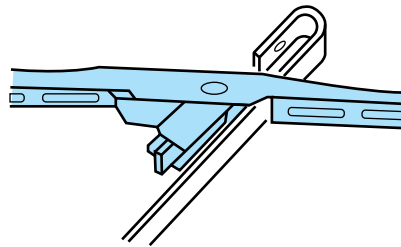

228

## Maintenance and Specifications

To prolong the life of the wiper blades, it is highly recommended to scrape off the ice on the windshield before turning on the wipers. The layer of ice has many sharp edges and can damage the micro edge of the wiper rubber element.

### Rear window wiper blades (if equipped)

Refer to *Changing the wiper blades* in this section and follow the same procedure given for checking and changing the wiper blades.

### ENGINE OIL

#### Checking the engine oil

Refer to the *scheduled maintenance information* for the appropriate intervals for checking the engine oil.

1. Make sure the vehicle is on level ground.
2. Turn the engine off and wait 15 minutes for the oil to drain into the oil pan.
3. Set the parking brake and ensure the gearshift is securely latched in P (Park)
4. Open the hood. Protect yourself from engine heat.
5. Locate and carefully remove the engine oil level dipstick.
6. Wipe the dipstick clean. Insert the dipstick fully, then remove it again.

- If the oil level is **between the MIN and MAX marks**, the oil level is acceptable. **DO NOT ADD OIL.**

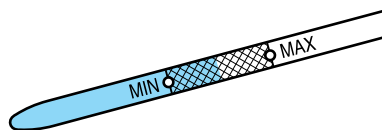

- If the oil level is below the MIN mark, add enough engine oil to raise the level within the MIN and MAX range. Refer to *Adding engine oil* in this chapter.
- **Oil levels above MAX mark may cause engine damage.** If the engine is overfilled, some oil must be removed from the engine by an authorized dealer.

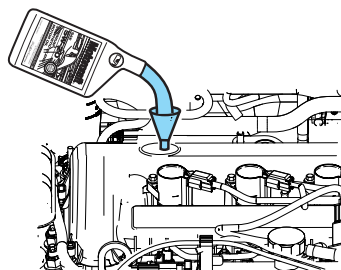

7. Put the dipstick back in and ensure it is fully seated.

## Maintenance and Specifications

### Adding engine oil

1. Check the engine oil. For instructions, refer to *Checking the engine oil* in this chapter.
2. If the engine oil level is not within the normal range, add only certified engine oil of the recommended viscosity. Remove the engine oil filler cap and use a funnel to pour the engine oil into the opening.
3. Recheck the engine oil level. Make sure the oil level is not above the normal operating range on the engine oil level dipstick.
4. Install the dipstick and ensure it is fully seated.
5. Fully install the engine oil filler cap by turning the filler cap clockwise 1/4 of a turn until three clicks are heard or until the cap is fully seated.

**To avoid possible oil loss, DO NOT operate the vehicle with the engine oil level dipstick and/or the engine oil filler cap removed.**

### Engine oil and filter recommendations

Look for this certification trademark.

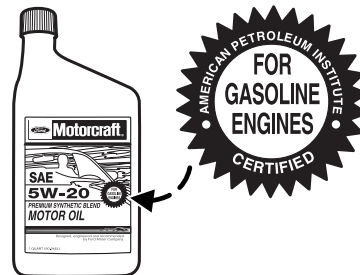

### Use SAE 5W-20 engine oil

Only use oils certified for gasoline engines by the American Petroleum Institute (API). An oil with this trademark symbol conforms to the current engine and emission system protection standards and fuel economy requirements of the International Lubricant Standardization and Approval Committee (ILSAC), comprised of U.S. and Japanese automobile manufacturers.

To protect your engine and engine's warranty, use Motorcraft® SAE 5W-20 or an equivalent SAE 5W-20 oil meeting Ford specification WSS-M2C930-A. **SAE 5W-20 oil provides optimum fuel economy and durability performance meeting all requirements for your vehicle's engine.** Refer to *Maintenance product specifications and capacities* later in this chapter for more information.

230

## Maintenance and Specifications

Do not use supplemental engine oil additives, cleaners or other engine treatments. They are unnecessary and could lead to engine damage that is not covered by Ford warranty.

Change your engine oil and filter according to the appropriate schedule listed in the *scheduled maintenance information*.

Ford production and Motorcraft® replacement oil filters are designed for added engine protection and long life. If a replacement oil filter is used that does not meet Ford material and design specifications, start-up engine noises or knock may be experienced.

It is recommended you use the appropriate Motorcraft® oil filter or another with equivalent performance for your engine application.

### BATTERY

Your vehicle is equipped with a Motorcraft® maintenance-free battery which normally does not require additional water during its life of service.

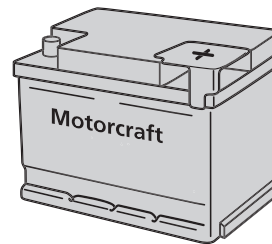

**If your battery has a cover/shield, make sure it is reinstalled after the battery has been cleaned or replaced.**

For longer, trouble-free operation, keep the top of the battery clean and dry. Also, make certain the battery cables are always tightly fastened to the battery terminals.

If you see any corrosion on the battery or terminals, remove the cables from the terminals and clean with a wire brush. You can neutralize the acid with a solution of baking soda and water.

It is recommended that the negative battery cable terminal be disconnected from the battery if you plan to store your vehicle for an extended period of time. This will minimize the discharge of your battery during storage.

**Note:** Electrical or electronic accessories or components added to the vehicle by the dealer or the owner may adversely affect battery performance and durability.

## Maintenance and Specifications

 **WARNING:** Batteries normally produce explosive gases which can cause personal injury. Therefore, do not allow flames, sparks or lighted substances to come near the battery. When working near the battery, always shield your face and protect your eyes. Always provide proper ventilation.

 **WARNING:** When lifting a plastic-cased battery, excessive pressure on the end walls could cause acid to flow through the vent caps, resulting in personal injury and/or damage to the vehicle or battery. Lift the battery with a battery carrier or with your hands on opposite corners.

 **WARNING:** Keep batteries out of reach of children. Batteries contain sulfuric acid. Avoid contact with skin, eyes or clothing. Shield your eyes when working near the battery to protect against possible splashing of acid solution. In case of acid contact with skin or eyes, flush immediately with water for a minimum of 15 minutes and get prompt medical attention. If acid is swallowed, call a physician immediately.

 **WARNING:** Battery posts, terminals and related accessories contain lead and lead compounds. **Wash hands after handling.**

Because your vehicle's engine is electronically controlled by a computer, some control conditions are maintained by power from the battery. When the battery is disconnected or a new battery is installed, the engine must relearn its idle and fuel trim strategy for optimum driveability and performance. To begin this process:

1. With the vehicle at a complete stop, set the parking brake.
2. Put the gearshift in P (Park), turn off all accessories and start the engine.
3. Run the engine until it reaches normal operating temperature.
4. Allow the engine to idle for at least one minute.
5. Turn the A/C on and allow the engine to idle for at least one minute.
6. Release the parking brake. With your foot on the brake pedal and with the A/C on, put the vehicle in D (Drive) and allow the engine to idle for at least one minute.

232



## Maintenance and Specifications

7. Drive the vehicle to complete the relearning process.
  - The vehicle may need to be driven 10 miles (16 km) or more to relearn the idle and fuel trim strategy.
  - **If you do not allow the engine to relearn its idle trim, the idle quality of your vehicle may be adversely affected until the idle trim is eventually relearned.**

If the battery has been disconnected or a new battery has been installed, the clock and radio settings must be reset once the battery is reconnected.

- Always dispose of automotive batteries in a responsible manner. Follow your local authorized standards for disposal. Call your local authorized recycling center to find out more about recycling automotive batteries.

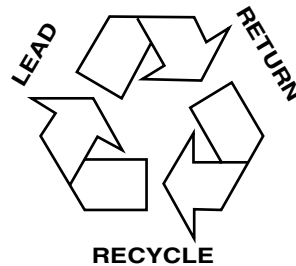

### ENGINE COOLANT

#### Electric vehicles

For specific information on the Transit Connect Electric, refer to the *Azure Dynamics TC-E Owner's Guide Supplement*.

#### Checking engine coolant

The concentration and level of engine coolant should be checked at the intervals listed in *scheduled maintenance information*. The coolant concentration should be maintained at 50/50 coolant and distilled water. Coolant concentration testing is possible with a hydrometer or antifreeze tester. The level of coolant should be maintained at the MAX level in the coolant reservoir. If the level falls below, add coolant per the instructions in the *Adding engine coolant* section.

Your vehicle was factory-filled with a 50/50 engine coolant and water concentration. If the concentration of coolant falls below 40% or above 60%, the engine parts could become damaged or not work properly. **A 50/50 mixture of coolant and water provides the following:**

- **Improved freeze protection.**
- **Improved boiling protection.**

## Maintenance and Specifications

- **Protection against rust and other forms of corrosion.**
- **Proper function of calibrated gauges.**

When the engine is cold, check the level of the engine coolant in the reservoir.

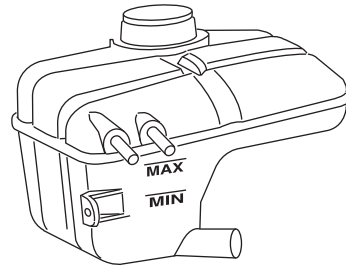

- The engine coolant should be at the MAX level as listed on the engine coolant reservoir.
- Refer to *scheduled maintenance information* for service interval schedules.

If the engine coolant has not been checked at the recommended interval, the engine coolant reservoir may become low or empty. If the reservoir is low or empty, add engine coolant to the reservoir. Refer to *Adding engine coolant* in this chapter.

**Note:** Automotive fluids are not interchangeable; do not use engine coolant/antifreeze or windshield washer fluid outside of its specified function and vehicle location.

### Adding engine coolant

When adding coolant, make sure it is a 50/50 mixture of engine coolant and distilled water. Add the mixture to the coolant reservoir, **when the engine is cool**, until the appropriate fill level is obtained.



**WARNING:** Do not add engine coolant when the engine is hot. Steam and scalding liquids released from a hot cooling system can burn you badly. Also, you can be burned if you spill coolant on hot engine parts.



**WARNING:** Do not put engine coolant in the windshield washer fluid container. If sprayed on the windshield, engine coolant could make it difficult to see through the windshield.

- **DO NOT MIX** different colors or types of coolant in your vehicle. Make sure the correct coolant is used. Mixing of engine coolants may

234

## Maintenance and Specifications

harm your engine's cooling system. The use of an improper coolant may harm engine and cooling system components and may void the warranty. Refer to *Maintenance product specifications and capacities* in this chapter.

- A large amount of water without engine coolant may be added, in case of emergency, to reach a vehicle service location. In this instance, the cooling system must be drained and refilled with a 50/50 mixture of engine coolant and distilled water as soon as possible. Water alone (without engine coolant) can cause engine damage from corrosion, overheating or freezing.
- **Do not use alcohol, methanol, brine or any engine coolants mixed with alcohol or methanol antifreeze (coolant).** Alcohol and other liquids can cause engine damage from overheating or freezing.
- **Do not add extra inhibitors or additives to the coolant.** These can be harmful and compromise the corrosion protection of the engine coolant.

For vehicles with overflow coolant systems with a non-pressurized cap on the coolant recovery system, add coolant to the coolant recovery reservoir when the engine is cool. Add the proper mixture of coolant and distilled water to the FULL COLD level. For all other vehicles which have a coolant degas system with a pressurized cap, or if it is necessary to remove the coolant pressure relief cap on the radiator of a vehicle with an overflow system, follow these steps to add engine coolant.



**WARNING:** To reduce the risk of personal injury, make sure the engine is cool before unscrewing the coolant pressure relief cap. The cooling system is under pressure; steam and hot liquid can come out forcefully when the cap is loosened slightly.

Add the proper mixture of coolant and water to the cooling system by following these steps:

1. Before you begin, turn the engine off and let it cool.
2. When the engine is cool, wrap a thick cloth around the coolant pressure relief cap on the coolant reservoir (a translucent plastic bottle). Slowly turn cap counterclockwise (left) until pressure begins to release.
3. Step back while the pressure releases.
4. When you are sure that all the pressure has been released, use the cloth to turn it counterclockwise and remove the cap.

## Maintenance and Specifications

5. Fill the coolant reservoir slowly with the proper coolant mixture to the MAX level on the reservoir. If you removed the radiator cap in an overflow system, fill the radiator until the coolant is visible and radiator is almost full.

6. Replace the cap. Turn until tightly installed. Cap must be tightly installed to prevent coolant loss.

After any coolant has been added, check the coolant concentration (refer to *Checking engine coolant*). If the concentration is not 50/50, drain some coolant and adjust the concentration. It may take several drains and additions to obtain a 50/50 coolant concentration.

Whenever coolant has been added, the coolant level in the coolant reservoir should be checked the next few times you drive the vehicle. If necessary, add enough 50/50 concentration of engine coolant and distilled water to bring the liquid level to the proper level.

If you have to add more than 1.0 quart (1.0 liter) of engine coolant per month, have your authorized dealer check the engine cooling system. Your cooling system may have a leak. Operating an engine with a low level of coolant can result in engine overheating and possible engine damage.

### Recycled engine coolant

Ford Motor Company does NOT recommend the use of recycled engine coolant since a Ford-approved recycling process is not yet available.



Used engine coolant should be disposed of in an appropriate manner. Follow your community's regulations and standards for recycling and disposing of automotive fluids.

### Coolant refill capacity

To find out how much fluid your vehicle's cooling system can hold, refer to *Maintenance product specifications and capacities* in this chapter.

Fill your engine coolant reservoir as outlined previously in the *Adding engine coolant* section.

### Severe climates

If you drive in extremely cold climates:

- **It may be necessary to increase the coolant concentration above 50%.**
- **NEVER increase the coolant concentration above 60%.**

236

## Maintenance and Specifications

- **A coolant concentration of 60% will provide improved freeze point protection. Increased engine coolant concentrations above 60% will decrease the overheat protection characteristics of the engine coolant and may cause engine damage.**
- **If available, refer to the chart on the coolant container to ensure the coolant concentration in your vehicle will provide adequate freeze protection at the temperatures in which you drive in the winter months.**

If you drive in extremely hot climates:

- **It is still necessary to maintain the coolant concentration above 40%.**
- **NEVER decrease the coolant concentration below 40%.**
- **Decreased engine coolant concentrations below 40% will decrease the corrosion/freeze protection characteristics of the engine coolant and may cause engine damage.**
- **If available, refer to the chart on the coolant container to ensure the coolant concentration in your vehicle will provide adequate protection at the temperatures in which you drive.**

Vehicles driven year-round in non-extreme climates should use a 50/50 mixture of engine coolant and distilled water for optimum cooling system and engine protection.

### What you should know about fail-safe cooling (if equipped)

If the engine coolant supply is depleted, this feature allows the vehicle to be driven temporarily before incremental component damage is incurred. The “fail-safe” distance depends on ambient temperatures, vehicle load and terrain.



**WARNING:** If fail-safe cooling activates, pull off the road as soon as safely possible, and turn the engine off, because the engine may automatically shut off while driving without further indication.

### How fail-safe cooling works

If the engine reaches a preset over-temperature condition, the engine will automatically switch to alternating cylinder operation. Each disabled cylinder acts as an air pump and cools the engine.

## Maintenance and Specifications

When this occurs the vehicle will still operate. However:

- The engine power will be limited.
- The air conditioning system will be disabled.

Continued operation will increase the engine temperature:

- The engine will completely shut down.
- Steering and braking effort will increase.

Once the engine temperature cools, the engine can be re-started. Take your vehicle to an authorized dealer as soon as possible to minimize engine damage.

### ***When fail-safe mode is activated***

You have limited engine power when in the fail-safe mode, so drive the vehicle with caution. The vehicle will not be able to maintain high speed operation and the engine will run rough. Remember that the engine is capable of completely shutting down automatically to prevent engine damage, therefore:

1. Pull off the road as soon as safely possible and turn off the engine.
2. Arrange for the vehicle to be taken to an authorized dealer.
3. If this is not possible, wait a short period for the engine to cool.
4. Check the coolant level and replenish if low.



**WARNING:** Never remove the coolant reservoir cap while the engine is running or hot.

5. Restart the engine and take your vehicle to an authorized dealer.

**Driving the vehicle without repairing the engine problem increases the chance of engine damage. Take your vehicle to an authorized dealer as soon as possible.**

### **FUEL FILTER**

Your vehicle is equipped with a lifetime fuel filter that is integrated with the fuel tank. Regular maintenance or replacement is not needed.

## Maintenance and Specifications

### WHAT YOU SHOULD KNOW ABOUT AUTOMOTIVE FUELS

#### Important safety precautions



**WARNING:** Do not overfill the fuel tank. The pressure in an overfilled tank may cause leakage and lead to fuel spray and fire.



**WARNING:** The fuel system may be under pressure. If the fuel filler cap is venting vapor or if you hear a hissing sound, wait until it stops before completely removing the fuel filler cap. Otherwise, fuel may spray out and injure you or others.



**WARNING:** If you do not use the proper fuel filler cap, excessive vacuum in the fuel tank may damage the fuel system or cause the fuel cap to disengage in a collision, which may result in serious personal injury.



**WARNING:** Automotive fuels can cause serious injury or death if misused or mishandled.



**WARNING:** Gasoline may contain benzene, which is a cancer-causing agent.

Observe the following guidelines when handling automotive fuel:

- Extinguish all smoking materials and any open flames before refueling your vehicle.
- Always turn off the vehicle before refueling.
- Automotive fuels can be harmful or fatal if swallowed. Fuel such as gasoline is highly toxic and if swallowed can cause death or permanent injury. If fuel is swallowed, call a physician immediately, even if no symptoms are immediately apparent. The toxic effects of fuel may not be visible for hours.
- Avoid inhaling fuel vapors. Inhaling too much fuel vapor of any kind can lead to eye and respiratory tract irritation. In severe cases, excessive or prolonged breathing of fuel vapor can cause serious illness and permanent injury.



## Maintenance and Specifications

- Avoid getting fuel liquid in your eyes. If fuel is splashed in the eyes, remove contact lenses (if worn), flush with water for 15 minutes and seek medical attention. Failure to seek proper medical attention could lead to permanent injury.
- Fuels can also be harmful if absorbed through the skin. If fuel is splashed on the skin and/or clothing, promptly remove contaminated clothing and wash skin thoroughly with soap and water. Repeated or prolonged skin contact with fuel liquid or vapor causes skin irritation.
- Be particularly careful if you are taking “Antabuse” or other forms of disulfiram for the treatment of alcoholism. Breathing gasoline vapors, or skin contact could cause an adverse reaction. In sensitive individuals, serious personal injury or sickness may result. If fuel is splashed on the skin, promptly wash skin thoroughly with soap and water. Consult a physician immediately if you experience an adverse reaction.



**WARNING:** When refueling always shut the engine off and never allow sparks or open flames near the filler neck. Never smoke while refueling. Fuel vapor is extremely hazardous under certain conditions. Care should be taken to avoid inhaling excess fumes.



**WARNING:** The flow of fuel through a fuel pump nozzle can produce static electricity, which can cause a fire if fuel is pumped into an ungrounded fuel container.

### Refueling



**WARNING:** Fuel vapor burns violently and a fuel fire can cause severe injuries. To help avoid injuries to you and others:

- Read and follow all the instructions on the pump island;
- Turn off your engine when you are refueling;
- Do not smoke if you are near fuel or refueling your vehicle;
- Keep sparks, flames and smoking materials away from fuel;
- Stay outside your vehicle and do not leave the fuel pump unattended when refueling your vehicle — this is against the law in some places;
- Keep children away from the fuel pump; never let children pump fuel.
- Do not use personal electronic devices while refueling.



## Maintenance and Specifications

Use the following guidelines to avoid electrostatic charge build-up when filling an ungrounded fuel container:

- Place approved fuel container on the ground.
- DO NOT fill a fuel container while it is in the vehicle (including the cargo area).
- Keep the fuel pump nozzle in contact with the fuel container while filling.
- DO NOT use a device that would hold the fuel pump handle in the fill position.

### Fuel filler cap

Your fuel tank filler cap has an indexed design with a 1/4 turn on/off feature.

When fueling your vehicle:

1. Turn the engine off.
2. Unlock the fuel filler door.
3. Carefully turn the filler cap counterclockwise until it spins off.
4. Pull to remove the cap from the fuel filler pipe.
5. To install the cap, align the tabs on the cap with the notches on the filler pipe.
6. Turn the filler cap clockwise 1/4 of a turn until it clicks at least once.
7. Lock the fuel filler door.

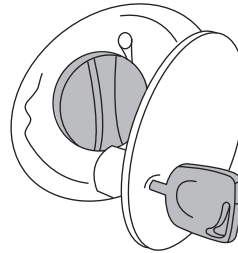

**If you must replace the fuel filler cap, replace it with a fuel filler cap that is designed for your vehicle. The customer warranty may be void for any damage to the fuel tank or fuel system if the correct genuine Ford, Motorcraft® or other certified fuel filler cap is not used.**



**WARNING:** The fuel system may be under pressure. If the fuel filler cap is venting vapor or if you hear a hissing sound, wait until it stops before completely removing the fuel filler cap. Otherwise, fuel may spray out and injure you or others.

## Maintenance and Specifications



**WARNING:** If you do not use the proper fuel filler cap, excessive vacuum in the fuel tank may damage the fuel system or cause the fuel cap to disengage in a collision, which may result in personal injury.

### Choosing the right fuel

Use only UNLEADED fuel or UNLEADED fuel blended with a maximum of 10% ethanol. Do not use fuel ethanol (E85), diesel, methanol, leaded fuel or any other fuel. The use of leaded fuel is prohibited by law and could damage your vehicle.

Your vehicle was not designed to use fuel or fuel additives with metallic compounds, including manganese-based additives.

**Note:** Use of any fuel other than those recommended may cause powertrain damage, a loss of vehicle performance, and repairs may not be covered under warranty.

### Octane recommendations

Your vehicle is designed to use “Regular” unleaded gasoline with a pump (R+M)/2 octane rating of 87. Some stations offer fuels posted as “Regular” with an octane rating below 87, particularly in high altitude areas. Fuels with octane levels below 87 are not recommended.



Do not be concerned if your engine sometimes knocks lightly. However, if it knocks heavily under most driving conditions while you are using fuel with the recommended octane rating, see your authorized dealer to prevent any engine damage.

### Fuel quality

If you are experiencing starting, rough idle or hesitation driveability problems during a cold start, try a different brand of “Regular” unleaded gasoline. Premium unleaded gasoline is not recommended for vehicles designed to use “Regular” unleaded gasoline because it may cause these problems to become more pronounced. If the problems persist, see your authorized dealer.

Do not add aftermarket fuel additive products to your fuel tank. It should not be necessary to add any aftermarket products to your fuel tank if you continue to use high quality fuel of the recommended octane

242

## Maintenance and Specifications

rating. These products have not been approved for your engine and could cause damage to the fuel system. Repairs to correct the effects of using an aftermarket product in your fuel may not be covered by your warranty.

Many of the world's automakers approved the World-Wide Fuel Charter that recommends gasoline specifications to provide improved performance and emission control system protection for your vehicle. Gasolines that meet the World-Wide Fuel Charter should be used when available. Ask your fuel supplier about gasolines that meet the World-Wide Fuel Charter.



### Cleaner air

Ford endorses the use of reformulated "cleaner-burning" gasolines to improve air quality, per the recommendations in the *Choosing the right fuel* section.

### Running out of fuel

Avoid running out of fuel because this situation may have an adverse effect on powertrain components.

If you have run out of fuel:

- You may need to cycle the ignition from off to on several times after refueling to allow the fuel system to pump the fuel from the tank to the engine. On restarting, cranking time will take a few seconds longer than normal.
- Normally, adding 1 gallon (3.8L) of fuel is enough to restart the engine. If the vehicle is out of fuel and on a steep grade, more than 1 gallon (3.8L) may be required.
- The service engine soon  indicator may come on. For more information on the service engine soon  indicator, refer to *Warning lights and chimes* in the *Instrument Cluster* chapter.

## ESSENTIALS OF GOOD FUEL ECONOMY

### Measuring techniques

Your best source of information about actual fuel economy is you, the driver. You must gather information as accurately and consistently as possible. Fuel expense, frequency of fill-ups or fuel gauge readings are NOT accurate as a measure of fuel economy. We do not recommend taking fuel economy measurements during the first 1,000 miles (1,600 km) of driving (engine break-in period). You will get a more accurate measurement after 2,000 miles–3,000 miles (3,000 km–5,000 km).

## Maintenance and Specifications

### Filling the tank

The advertised fuel capacity of the fuel tank on your vehicle is equal to the rated refill capacity of the fuel tank as listed in the *Maintenance product specifications and capacities* section of this chapter.

The advertised capacity is the amount of the indicated capacity and the empty reserve combined. Indicated capacity is the difference in the amount of fuel in a full tank and a tank when the fuel gauge indicates empty. Empty reserve is the small amount of fuel remaining in the fuel tank after the fuel gauge indicates empty.

**The amount of usable fuel in the empty reserve varies and should not be relied upon to increase driving range. When refueling your vehicle after the fuel gauge indicates empty, you might not be able to refuel the full amount of the advertised capacity of the fuel tank due to the empty reserve still present in the tank.**

For consistent results when filling the fuel tank:

- Turn the engine/ignition switch to the off position prior to refueling, an error in the reading will result if the engine is left running.
- Use the same filling rate setting (low — medium — high) each time the tank is filled.
- Allow no more than two automatic click-offs when filling.
- Always use fuel with the recommended octane rating.
- Use a known quality gasoline, preferably a national brand.
- Have the vehicle loading and distribution the same every time.

Your results will be most accurate if your filling method is consistent.

### Calculating fuel economy

1. Fill the fuel tank completely and record the initial odometer reading (in miles or kilometers).
2. Each time you fill the tank, record the amount of fuel added (in gallons or liters).
3. After at least three to five tank fill-ups, fill the fuel tank and record the current odometer reading.
4. Subtract your initial odometer reading from the current odometer reading.

## Maintenance and Specifications

5. Follow one of the simple calculations in order to determine fuel economy:

Calculation 1: **Divide total miles traveled by total gallons used.**

Calculation 2: **Multiply liters used by 100, then divide by total kilometers traveled.**

Keep a record for at least one month and record the type of driving (city or highway). This will provide an accurate estimate of the vehicle's fuel economy under current driving conditions. Additionally, keeping records during summer and winter will show how temperature impacts fuel economy. In general, lower temperatures give lower fuel economy.

### **Driving style — good driving and fuel economy habits**

Give consideration to the lists that follow and you may be able to change a number of variables and improve your fuel economy.

#### **Habits**

- Smooth, moderate operation can yield up to 10% savings in fuel.
- Steady speeds without stopping will usually give the best fuel economy.
- Idling for long periods of time (greater than one minute) may waste fuel.
- Anticipate stopping; slowing down may eliminate the need to stop.
- Sudden or hard accelerations may reduce fuel economy.
- Slow down gradually.
- Driving at reasonable speeds (traveling at 55 mph [88 km/h] uses 15% less fuel than traveling at 65 mph [105 km/h]).
- Revving the engine before turning it off may reduce fuel economy.
- Using the air conditioner or defroster may reduce fuel economy.
- You may want to turn off the speed control in hilly terrain if unnecessary shifting between the top gears occurs. Unnecessary shifting of this type could result in reduced fuel economy.
- Warming up a vehicle on cold mornings is not required and may reduce fuel economy.
- Resting your foot on the brake pedal while driving may reduce fuel economy.
- Combine errands and minimize stop-and-go driving.

## Maintenance and Specifications

### **Maintenance**

- Keep tires properly inflated and use only recommended size.
- Operating a vehicle with the wheels out of alignment will reduce fuel economy.
- Use recommended engine oil. Refer to *Maintenance product specifications and capacities* in this chapter.
- Perform all regularly scheduled maintenance items. Follow the recommended maintenance schedule and owner maintenance checks found in *scheduled maintenance information*.

### **Conditions**

- Heavily loading a vehicle or towing a trailer may reduce fuel economy at any speed.
- Carrying unnecessary weight may reduce fuel economy (approximately 1 mpg [0.4 km/L] is lost for every 400 lb [180 kg] of weight carried).
- Adding certain accessories to your vehicle (for example bug deflectors, rollbars/light bars, running boards, ski racks) may reduce fuel economy.
- Using fuel blended with alcohol may lower fuel economy.
- Fuel economy may decrease with lower temperatures during the first 8–10 miles (12–16 km) of driving.
- Driving on flat terrain offers improved fuel economy as compared to driving on hilly terrain.
- Transmissions give their best fuel economy when operated in the top cruise gear and with steady pressure on the gas pedal.
- Close windows for high speed driving.

### **EMISSION CONTROL SYSTEM**

Your vehicle is equipped with various emission control components and a catalytic converter which will enable your vehicle to comply with applicable exhaust emission standards. To make sure that the catalytic converter and other emission control components continue to work properly:

- Use only the specified fuel listed.
- Avoid running out of fuel.
- Do not turn off the ignition while your vehicle is moving, especially at high speeds.

246

## Maintenance and Specifications

- Have the items listed in *scheduled maintenance information* performed according to the specified schedule.

The scheduled maintenance items listed in *scheduled maintenance information* are essential to the life and performance of your vehicle and to its emissions system.

If other than Ford, Motorcraft® or Ford-authorized parts are used for maintenance replacements or for service of components affecting emission control, such non-Ford parts should be equivalent to genuine Ford Motor Company parts in performance and durability.



**WARNING:** Do not park, idle, or drive your vehicle in dry grass or other dry ground cover. The emission system heats up the engine compartment and exhaust system, which can start a fire.

Illumination of the service engine soon  indicator, charging system warning light or the temperature warning light, fluid leaks, strange odors, smoke or loss of engine power could indicate that the emission control system is not working properly.

An improperly operating or damaged exhaust system may allow exhaust to enter the vehicle. Have a damaged or improperly operating exhaust system inspected and repaired immediately.



**WARNING:** Exhaust leaks may result in entry of harmful and potentially lethal fumes into the passenger compartment.



Do not make any unauthorized changes to your vehicle or engine. By law, vehicle owners and anyone who manufactures, repairs, services, sells, leases, trades vehicles, or supervises a fleet of vehicles are not permitted to intentionally remove an emission control device or prevent it from working. Information about your vehicle's emission system is on the Vehicle Emission Control Information Decal located on or near the engine. This decal also lists engine displacement.

Please consult your *Warranty Guide* for complete emission warranty information.

### On-board diagnostics (OBD-II)



Your vehicle is equipped with a computer that monitors the engine's emission control system. This system is commonly known as the on-board diagnostics system (OBD-II). The OBD-II system protects the environment by ensuring that your vehicle continues to meet

## Maintenance and Specifications

government emission standards. The OBD-II system also assists your authorized dealer in properly servicing your vehicle. When the service engine soon  indicator illuminates, the OBD-II system has detected a malfunction. Temporary malfunctions may cause the service engine soon  indicator to illuminate. Examples are:

1. The vehicle has run out of fuel—the engine may misfire or run poorly.
2. Poor fuel quality or water in the fuel—the engine may misfire or run poorly.
3. The fuel cap may not have been securely tightened. See *Fuel filler cap* in this chapter.
4. Driving through deep water—the electrical system may be wet.

These temporary malfunctions can be corrected by filling the fuel tank with good quality fuel, properly tightening the fuel cap or letting the electrical system dry out. After three driving cycles without these or any other temporary malfunctions present, the service engine soon  indicator should stay off the next time the engine is started. A driving cycle consists of a cold engine startup followed by mixed city/highway driving. No additional vehicle service is required.

If the service engine soon  indicator remains on, have your vehicle serviced at the first available opportunity. Although some malfunctions detected by the OBD-II may not have symptoms that are apparent, continued driving with the service engine soon  indicator on can result in increased emissions, lower fuel economy, reduced engine and transmission smoothness, and lead to more costly repairs.



### Readiness for Inspection/Maintenance (I/M) testing

Some state/provincial and local governments may have Inspection/Maintenance (I/M) programs to inspect the emission control equipment on your vehicle. Failure to pass this inspection could prevent you from getting a vehicle registration. Your vehicle may not pass the I/M test if the service engine soon  indicator is on or not working properly (bulb is burned out), or if the OBD-II system has determined that some of the emission control systems have not been properly checked. In this case, the vehicle is considered not ready for I/M testing.

If the service engine soon  indicator is on or the bulb does not work, the vehicle may need to be serviced. Refer to *On-board diagnostics (OBD-II)* in this chapter.



## Maintenance and Specifications

If the vehicle's engine or transmission has just been serviced, or the battery has recently run down or been replaced, the OBD-II system may indicate that the vehicle is not ready for I/M testing. To determine if the vehicle is ready for I/M testing, turn the ignition key to the on position for 15 seconds without cranking the engine. If the service engine soon  indicator blinks eight times, it means that the vehicle is not ready for I/M testing; if the service engine soon  indicator stays on solid, it means that the vehicle is ready for I/M testing.

The OBD-II system is designed to check the emission control system during normal driving. A complete check may take several days. If the vehicle is not ready for I/M testing, the following driving cycle consisting of mixed city and highway driving may be performed:

15 minutes of steady driving on an expressway/highway followed by 20 minutes of stop-and-go driving with at least four 30-second idle periods.

Allow the vehicle to sit for at least eight hours without starting the engine. Then, start the engine and complete the above driving cycle. The engine must warm up to its normal operating temperature. Once started, do not turn off the engine until the above driving cycle is complete. If the vehicle is still not ready for I/M testing, the above driving cycle will have to be repeated.

## Maintenance and Specifications

### POWER STEERING FLUID

Check the fluid. Your power steering fluid reservoir may look like one of these two graphics. Refer to *scheduled maintenance information*.

1. Start the engine and let it run until it reaches normal operating temperature.
2. Turn the steering wheel left and right several times.
3. Turn the engine off.
4. Check the fluid level.
5. If the fluid is below the MIN line, add fluid in small amounts until it reaches the correct level (between the MIN and MAX lines). Refer to *Maintenance product specifications and capacities* in this chapter for the proper fluid type.

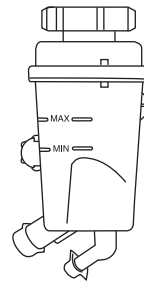
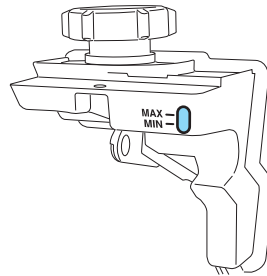

### Electric vehicles

For specific information on the Transit Connect Electric, refer to the *Azure Dynamics TC-E Owner's Guide Supplement*.

### BRAKE FLUID

The fluid level will drop slowly as the brakes wear, and will rise when the brake components are replaced. Fluid levels between the MIN and MAX lines are within the normal operating range; there is no need to add fluid. If the fluid levels are outside of the normal operating range, the performance of the system could be compromised; seek service from your authorized dealer immediately. If the brake fluid level falls below the MIN line, a brake warning lamp will come on.

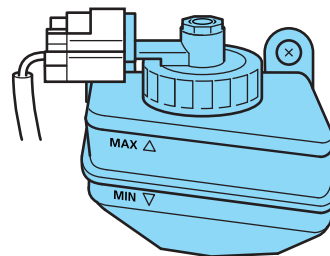

250

## Maintenance and Specifications

Brake fluid should not be allowed to contact the eyes and skin. If this happens, promptly wash the area thoroughly with soap and water. Consult a physician immediately if you experience an adverse reaction.

### TRANSMISSION FLUID

#### Electric vehicles

For specific information on the Transit Connect Electric, refer to the *Azure Dynamics TC-E Owner's Guide* Supplement.

#### Checking automatic transmission fluid

Refer to your *scheduled maintenance information* for scheduled intervals for fluid checks and changes. Your transmission does not consume fluid. However, the fluid level should be checked if the transmission is not working properly, i.e., if the transmission slips or shifts slowly or if you notice some sign of fluid leakage.

**Automatic transmission fluid expands when warmed. To obtain an accurate fluid check, drive the vehicle until it is warmed up (approximately 20 miles [30 km]). If your vehicle has been operated for an extended period at high speeds, in city traffic, or during hot weather, the vehicle should be turned off for about 30 minutes to allow fluid to cool before checking. Under these conditions, the vehicle must be restarted prior to checking the fluid level.**

1. Drive the vehicle 20 miles (30 km) or until it reaches normal operating temperature.
2. Park the vehicle on a level surface and engage the parking brake.
3. With the parking brake engaged and your foot on the brake pedal, start the engine and move the gearshift lever through all of the gear ranges. Allow sufficient time for each gear to engage.
4. Place the gearshift lever in P (Park) and leave the engine running.
5. Remove the dipstick, wiping it clean with a clean, dry lint free rag. If necessary, refer to *Identifying components in the engine compartment* in this chapter for the location of the dipstick.
6. Install the dipstick making sure it is fully seated in the filler tube.
7. Remove the dipstick and inspect the fluid level. The fluid should be in the designated areas for normal operating temperature.

251

## Maintenance and Specifications

### **Low fluid level**

Do not drive the vehicle if the fluid level is at the bottom of the dipstick. If the fluid level is below the MIN mark, add fluid in 1/2 pint (250 ml) increments.

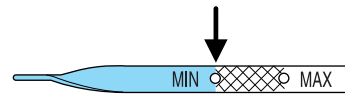

### **Correct fluid level**

The transmission fluid should be checked at normal operating temperatures 120°F-140°F (50°C-60°C) on a level surface. The normal operating temperature can be reached after approximately 20 miles (30 km) of driving.

The transmission fluid should be in this range if at normal operating temperature (120°F-140°F [50°C-60°C]).

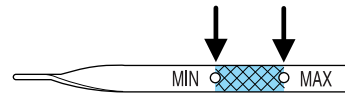

### **High fluid level**

Fluid levels above the safe range may result in transmission failure. An overfill condition of transmission fluid may cause shift and/or engagement concerns and/or possible damage.

High fluid levels can be caused by an overheating condition.



### **Adjusting automatic transmission fluid levels**

Before adding any fluid, make sure the correct type is used. The type of fluid used is normally indicated on the dipstick and also in the **Maintenance product specifications and capacities** section in this chapter.

**Use of a non-approved automatic transmission fluid may cause internal transmission component damage.**

If necessary, add fluid in 1/2 pint (250 ml) increments through the filler tube until the level is correct. After adding fluid, wait 20 minutes before checking the fluid level in order to allow the level to stabilize.

## Maintenance and Specifications

If an overfill occurs, excess fluid should be removed by an authorized dealer. If the fluid level is above the MAX mark, fluid will have to be removed.

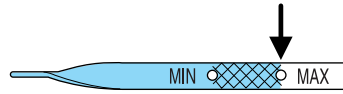

**An overfill condition of transmission fluid may cause shift and/or engagement concerns and/or possible damage.**

Do not use supplemental transmission fluid additives, treatments or cleaning agents. The use of these materials may affect transmission operation and result in damage to internal transmission components.

### AIR FILTER

Refer to *scheduled maintenance information* for the appropriate intervals for changing the air filter element.

When changing the air filter element, use only the air filter element listed. Refer to *Motorcraft® part numbers* in this chapter.



**WARNING:** To reduce the risk of vehicle damage and/or personal burn injuries do not start your engine with the air cleaner removed and do not remove it while the engine is running.

### Changing the air filter element

1. Release the clamps that secure the air filter housing cover.
2. Carefully separate the two halves of the air filter housing.
3. Remove the air filter element from the air filter housing.
4. Wipe the air filter housing and cover clean to remove any dirt or debris and to ensure good sealing.
5. Install a new air filter element. Be careful not to crimp the filter element edges between the air filter housing and cover. This could cause filter damage and allow unfiltered air to enter the engine if not properly seated.
6. Replace the air filter housing cover and secure the clamps. Be sure that the air cleaner cover tabs are engaged into the slots of the air cleaner housing.

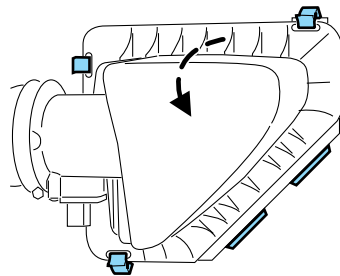

## Maintenance and Specifications

**Note:** Failure to use the correct air filter element may result in severe engine damage. The customer warranty may be void for any damage to the engine if the correct air filter element is not used.

### VEHICLE STORAGE

If you plan on storing your vehicle for an extended period of time (30 days or more), refer to the following maintenance recommendations to ensure your vehicle stays in good operating condition.

All motor vehicles and their components were engineered and tested for reliable, regular driving. Long term storage under various conditions may lead to component degradation or failure unless specific precautions are taken to preserve the components.

#### *General*

- Store all vehicles in a dry, ventilated place.
- Protect from sunlight, if possible.
- If vehicles are stored outside, they require regular maintenance to protect against rust and damage.

#### *Body*

- Wash vehicle thoroughly to remove dirt, grease, oil, tar or mud from exterior surfaces, rear-wheel housing and underside of front fenders. See the *Cleaning* chapter for more information.
- Periodically wash vehicles stored in exposed locations.
- Touch-up raw or primed metal to prevent rust.
- Cover chrome and stainless steel parts with a thick coat of auto wax to prevent discoloration. Re-wax as necessary when the vehicle is washed. See the *Cleaning* chapter for more information.
- Lubricate all hood, door and trunk lid hinges, and latches with a light grade oil. See the *Cleaning* chapter for more information.
- Cover interior trim to prevent fading.
- Keep all rubber parts free from oil and solvents.

#### *Engine*

- The engine oil and filter should be changed prior to storage, as used engine oil contain contaminants that may cause engine damage.
- Start the engine every 15 days. Run at fast idle until it reaches normal operating temperature.
- With your foot on the brake, shift through all the gears while the engine is running.

254

## Maintenance and Specifications

### *Fuel system*

- Fill the fuel tank with high-quality fuel until the first automatic shutoff of the fuel pump nozzle.

**Note:** During extended periods of vehicle storage (30 days or more), fuel may deteriorate due to oxidation. Add a quality gas stabilizer product to the vehicle fuel system whenever actual or expected storage periods exceed 30 days. Follow the instructions on the additive label. The vehicle should then be operated at idle speed to circulate the additive throughout the fuel system.

### *Cooling system*

- Protect against freezing temperatures.
- When removing vehicle from storage, check coolant fluid level. Confirm there are no cooling system leaks, and fluid is at the recommended level.

### *Battery*

- Check and recharge as necessary. Keep connections clean.
- If storing your vehicle for more than 30 days without recharging the battery, it may be advisable to disconnect the battery cables to ensure battery charge is maintained for quick starting.

**Note:** If battery cables are disconnected, it will be necessary to reset memory features.

### *Brakes*

- Make sure brakes and parking brake are fully released.

### *Tires*

- Maintain recommended air pressure.

### *Miscellaneous*

- Make sure all linkages, cables, levers and pins under vehicle are covered with grease to prevent rust.
- Move vehicles at least 25 feet (8 m) every 15 days to lubricate working parts and prevent corrosion.

### **Removing vehicle from storage**

When your vehicle is ready to come out of storage, do the following:

- Wash your vehicle to remove any dirt or grease film build-up on window surfaces.
- Check windshield wipers for any deterioration.

## Maintenance and Specifications

- Check under the hood for any foreign material that may have collected during storage (mice/squirrel nests).
- Check the exhaust for any foreign material that may have collected during storage.
- Check tire pressures and set tire inflation per the Tire Label.
- Check brake pedal operation. Drive the vehicle 15 ft (4.5 meters) back and forth to remove rust build-up.
- Check fluid levels (including coolant, oil and gas) to make sure there are no leaks, and fluids are at recommended levels.
- If the battery was removed, clean the battery cable ends and inspect.

If you have any concerns or issues, contact your authorized dealer.

### Electric vehicles

For specific information on the Transit Connect Electric, refer to the *Azure Dynamics TC-E Owner's Guide* Supplement.

### MOTORCRAFT PART NUMBERS

Component	2.0L I4 engine
Engine air filter element	FA-1900
Oil filter	FL-910S <sup>1</sup>
Battery	BXT-96R-590
Spark plugs	<sup>2</sup>
Cabin air filter	FP38

<sup>1</sup> Only use the specified replacement oil filter. The use of a non-specified oil filter can result in engine damage.

<sup>2</sup> For spark plug replacement, see your authorized dealer. Refer to *scheduled maintenance information* for the appropriate intervals for changing the spark plugs.

**Replace the spark plugs with ones that meet Ford material and design specifications for your vehicle, such as Motorcraft® or equivalent replacement parts. The customer warranty may be void for any damage to the engine if such spark plugs are not used.**



## Maintenance and Specifications

### MAINTENANCE PRODUCT SPECIFICATIONS AND CAPACITIES

Item	Capacity	Ford Part Name or Equivalent	Ford Part Number / Ford Specification
Brake fluid	Between MIN and MAX on reservoir	Motorcraft® Super DOT 4 Motor Vehicle Brake Fluid	YS4Z-19542-AA / ESD-M6C57-A or WSS-M6C57-A2
Door latch, hood latch, auxiliary hood latch, seat tracks.	—	Multi-Purpose Grease (Lithium grease)	XG-4 or XL-5 or equivalent / ESB-MIC93-B
Lock cylinder	—	Motorcraft® Penetrating and Lock Lubricant	XL-1 / None
Automatic transmission fluid	7.1 quarts (6.7L) <sup>1</sup>	Motorcraft® MERCON® LV ATF <sup>2</sup>	XT-10-QLV / MERCON® LV
Engine oil	4.5 quarts (4.3L)	<ul style="list-style-type: none"> <li>• Motorcraft® SAE 5W-20 Premium Synthetic Blend Motor Oil (US)</li> <li>• Motorcraft® SAE 5W-20 Full Synthetic Motor Oil (US)</li> <li>• Motorcraft® SAE 5W-20 Super Premium Motor Oil (Canada)</li> <li>• Motorcraft® SAE 5W-20 Synthetic Motor Oil (Canada)<sup>3</sup></li> </ul>	<ul style="list-style-type: none"> <li>• XO-5W20-QSP (US)</li> <li>• XO-5W20-QFS (US)</li> <li>• CXO-5W20-LSP12 (Canada)</li> <li>• CXO-5W20-LFS12 (Canada) / WSS-M2C930-A and API Certification Mark</li> </ul>

## Maintenance and Specifications

Item	Capacity	Ford Part Name or Equivalent	Ford Part Number / Ford Specification
Engine coolant	6.1 quarts (5.7L)	Motorcraft® Specialty Orange Engine Coolant with Bittering Agent (US) / Motorcraft® Specialty Orange Engine Coolant (Canada) <sup>4</sup>	VC-3-B (US) CVC-3-B (Canada) / WSS-M97B44-D
Power steering fluid	Fill to between MIN and MAX lines on reservoir	Motorcraft® Power Steering Fluid	XL-14 / MERCON® V
Windshield washer fluid	Fill as required	Motorcraft® Premium Windshield Washer Concentrate (US) Motorcraft® Premium Quality Windshield Washer Fluid (Canada)	ZC-32-A (US) CXC-37-(A, B, D, and F) (Canada) / WSB-M8B16-A2 / - -
Fuel tank	15.4 gallons (58.3L)	—	—

<sup>1</sup>Approximate dry fill capacity including transmission fluid cooling system, actual refill capacities will vary based on vehicle application and transmission fluid cooling system (i.e. coolers size, cooling lines, auxiliary cooler capacities). The amount of transmission fluid and fluid level should be set by the indication on the dipstick's normal operating range.

<sup>2</sup>Automatic transmissions that require MERCON® LV should only use MERCON® LV fluid. Refer to *scheduled maintenance* to determine the correct service interval. Use of any fluid other than the recommended fluid may cause transmission damage.

<sup>3</sup>Use of synthetic or synthetic blend motor oil is not mandatory. Engine oil need only meet the requirements of Ford specification WSS-M2C930-A and the API Certification mark.

<sup>4</sup>Add the coolant type originally equipped in your vehicle.

## Maintenance and Specifications

### ENGINE DATA

Engine	2.0L I4 engine
Cubic inches	121
Required fuel	Minimum 87 octane
Firing order	1-3-4-2
Ignition system	C.O.P
Compression ratio	10.0:1
Spark plug gap	.051 inch +/- .002 (1.3 mm +/- .05)

# Maintenance and Specifications

## Engine drivebelt routing

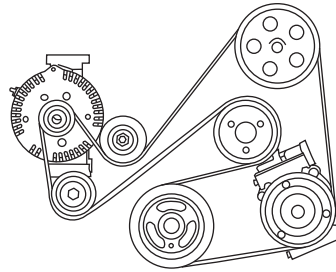

## IDENTIFYING YOUR VEHICLE

### Safety Compliance Certification Label

The National Highway Traffic Safety Administration Regulations require that a Safety Compliance Certification Label be affixed to a vehicle and prescribe where the Safety Compliance Certification Label may be located. The Safety Compliance Certification Label is located on the structure (B-Pillar) by the trailing edge of the driver's door or the edge of the driver's door.

<b>MFD. BY FORD MOTOR CO.</b>					
DATE: XX/XX	GVWR: XXXXLB/ XXXXKG		REAR GAWR: XXXLB		
FRONT GAWR: XXXL	WITH XXXKG		WITH XXXLB		
XXXXXX	TIRES: XXXX/XXXXXX	RIMS: XXXX		TIRES: XXXX/XXXXXX	
AT XXX kPa/XX	PSI COLD	AT XXX kPa/XX		PSI COLD	
THIS VEHICLE CONFORMS TO ALL APPLICABLE FEDERAL MOTOR VEHICLE SAFETY STANDARDS IN EFFECT ON THE DATE OF MANUFACTURE SHOWN ABOVE.					
VIN: XXXXXXXXXXXXXXXX				XXXXX	
TYPE: XXX				XXXXX	
EXT PNT: XX	RC: XX		DSO: XXX		
WB: XXX	INT TR: XX	TR: X	AXLE: XX	TR SPR: X XX	XXXXX
XXXXXXXXXXXX XXX XXXX-XXXXXX-XX					

## Maintenance and Specifications

### Vehicle identification number (VIN)

The vehicle identification number is located on the driver side instrument panel.

Please note that in the graphic, XXXX is representative of your vehicle identification number.

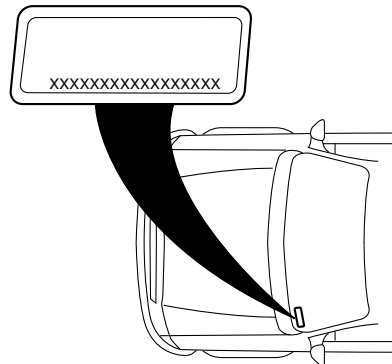

The Vehicle Identification Number (VIN) contains the following information:

1. World manufacturer identifier
2. Brake system / Gross Vehicle Weight Rating (GVWR) / Restraint Devices and their location
3. Make, vehicle line, series, body type
4. Engine type
5. Check digit
6. Model year
7. Assembly plant
8. Production sequence number

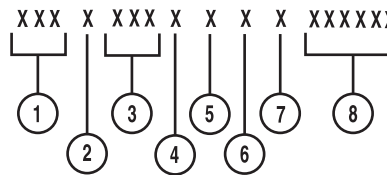

### **Electric vehicles**

For specific information on the Transit Connect Electric, refer to the *Azure Dynamics TC-E Owner's Guide Supplement*.

## Maintenance and Specifications

### TRANSMISSION CODE DESIGNATIONS

You can find a transmission code on the Safety Compliance Certification Label. The following table tells you which transmission each code represents.

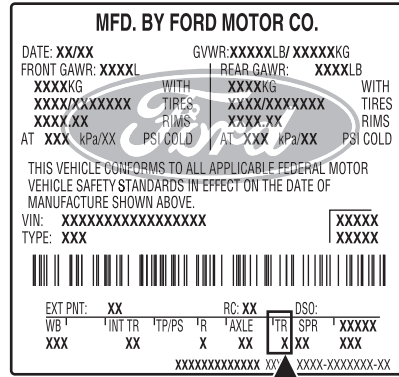

Description	Code
Four-speed automatic (4F27E)	D2

## Accessories

### FORD CUSTOM ACCESSORIES FOR YOUR VEHICLE

A wide selection of Ford Custom Accessories are available for your vehicle through your local Ford or Ford of Canada dealer. These quality accessories have been specifically engineered to fulfill your automotive needs; they are custom designed to complement the style and aerodynamic appearance of your vehicle. In addition, each accessory is made from high quality materials and meets or exceeds Ford's rigorous engineering and safety specifications. Ford Motor Company will repair or replace any properly dealer-installed Ford Custom Accessories found to be defective in factory-supplied materials or workmanship during the warranty period, as well as any component damaged by the defective accessories. The accessories will be warranted for whichever provides you the greatest benefit:

- 12 months or 12,000 miles (20,000 km) (whichever occurs first), or
- the remainder of your new vehicle limited warranty.

Contact your dealer for details and a copy of the warranty.

The following is a list of several Ford Custom Accessories. Not all accessories are available for all models. For a complete listing of the accessories that are available for your vehicle, please contact your dealer or visit our online store at: **[www.fordaccessories.com](http://www.fordaccessories.com)** (U.S. only).

#### Exterior style

- Bug shields
- Side window deflectors
- Rear window grille
- Splash guards

#### Interior style

- All-weather floor mats
- Electrochromic compass/temperature interior mirrors
- Carpeted floor mats

#### Lifestyle

- Roof racks and accessories
- Cargo organization
- Garmin navigation\*
- Racks and carriers\*

#### Peace of mind

- Remote start
- Keyless entry keypad
- Vehicle tracking and recovery\*
- Bumper mounted parking sensors\*
- Back up camera\*
- Back up alarm\*
- Protective seat covers\*

## Accessories

\*Ford Licensed Accessories (FLA) are warranted by the accessory manufacturer's warranty. Ford Licensed Accessories are fully designed and developed by the accessory manufacturer and have not been designed or tested to Ford Motor Company engineering requirements. Contact your Ford dealer for details regarding the manufacturer's limited warranty and/or a copy of the FLA product limited warranty offered by the accessory manufacturer.

For maximum vehicle performance, keep the following information in mind when adding accessories or equipment to your vehicle:

- When adding accessories, equipment, passengers and luggage to your vehicle, do not exceed the total weight capacity of the vehicle or of the front or rear axle (GVWR or GAWR as indicated on the Safety Compliance Certification label). Consult your authorized dealer for specific weight information.
- The Federal Communications Commission (FCC) and Canadian Radio Telecommunications Commission (CRTC) regulate the use of mobile communications systems — such as two-way radios, telephones and theft alarms - that are equipped with radio transmitters. Any such equipment installed in your vehicle should comply with FCC or CRTC regulations and should be installed only by a qualified service technician.
- Mobile communications systems may harm the operation of your vehicle, particularly if they are not properly designed for automotive use.
- To avoid interference with other vehicle functions, such as anti-lock braking systems, amateur radio users who install radios and antennas onto their vehicle should not locate the Amateur Radio Antennas in the area of the driver's side hood.
- Electrical or electronic accessories or components that are added to the vehicle by the authorized dealer or the owner, may adversely affect battery performance and durability, and may also adversely affect the performance of other electrical systems in the vehicle.



## Ford Extended Service Plan

### **FORD ESP EXTENDED SERVICE PLANS (U.S. ONLY)**

More than 30 million Ford and Lincoln owners have discovered the powerful protection of Ford ESP. It is the only extended service plan backed by Ford Motor Company, and provides “peace of mind” protection beyond the New Vehicle Limited Warranty coverage.

#### ***Up to 500+ Covered Vehicle Components***

There are four, new-vehicle Extended Service Plans with different levels of coverage. Ask your dealer for details.

**PremiumCare** – Our most comprehensive coverage. With over 500 covered components, this plan is so complete that we generally only discuss what’s not covered!

**ExtraCare** – Covers 113 components, and includes many high-tech items.

**BaseCare** – Covers 84 components.

**PowertrainCare** – Covers 29 critical components.

**Ford ESP is honored by all Ford and Lincoln Dealers in the U.S. and Canada** It’s the only extended service plan authorized and backed by Ford Motor Company. That means you get:

- Reliable, quality service anywhere you go.
- **Factory-trained technicians.**
- **Genuine Ford and Motorcraft® Parts.**

#### ***Rental car reimbursement***

**If your vehicle is kept overnight for covered repairs**, you are eligible for rental car coverage, including Bumper-to-Bumper warranty repairs, or manufacturer’s recalls.

#### ***Transferable coverage***

If you sell your vehicle before your Ford ESP coverage expires, you can transfer any remaining coverage to the new owner. Whenever you’re ready to sell your car, prospective buyers may feel better about taking a risk on your used vehicle. Ford ESP may add resale value!

Plus, **exclusive 24/7 roadside assistance**, including:

- Towing, flat-tire change and battery jump starts.
- Out-of-fuel and lock-out assistance.
- Travel expense reimbursement for lodging, meals and rental car.
- Destination assistance for taxi, shuttle, rental car coverage and emergency transportation.

## Ford Extended Service Plan

### ***Ford ESP Can Quickly Pay for Itself***

One service bill – the cost of parts and labor – can easily exceed the price of your Ford ESP Service Contract. With Ford ESP, you minimize your risk for unexpected repair bills and rising repair costs.

### ***Avoid the rising cost of properly maintaining your vehicle!***

Ford ESP also offers a Premium Maintenance Plan that covers items that **routinely wear out**.

The coverage is prepaid, so you never have to worry about affording your vehicle maintenance. It covers regular checkups, routine inspections, preventive care and replacement of items that require periodic attention for **normal “wear”**:

- **Wiper blades**
- **Spark plugs (except California)**
- **Clutch disc**
- **Brake pads and linings**
- **Shock absorbers**
- **Belts and hoses**

Contact your selling Ford or Lincoln dealership today so they can customize a Ford Extended Service Plan that fits your driving lifestyle and budget.

### ***Interest free finance options available***

Take advantage of our installment payment plan, just a 10% down payment will provide you with an affordable no interest, no-fee payment opportunity.

Ford Extended Service Plan

***Get Genuine Peace of Mind with Ford ESP!***

To learn more, complete the information below and mail this to:

**Ford ESP  
P.O. Box 8072  
Royal Oak, MI 48068-9933**

NAME (PLEASE PRINT) \_\_\_\_\_

ADDRESS \_\_\_\_\_ APT.NO. \_\_\_\_\_

CITY \_\_\_\_\_ STATE \_\_\_\_\_ ZIP \_\_\_\_\_

E-MAIL: \_\_\_\_\_

## Ford Extended Service Plan

### FORD ESP EXTENDED SERVICE PLANS (CANADA ONLY)

You can get more protection for your vehicle by purchasing a Ford Extended Service Plan (ESP). Ford ESP is the only service contract backed by Ford Motor Company of Canada, Limited. Depending on the plan you purchase, Ford ESP provides benefits such as:

- Rental reimbursement
- Coverage for certain maintenance and wear items
- Protection against repair costs after your New Vehicle Limited Warranty Coverage expires
- Roadside Assistance benefits

There are several Ford ESP plans available in various time, distance and deductible combinations. Each plan is tailored to fit your own driving needs, including reimbursement for towing and rental.

When you purchase Ford ESP, you receive added peace-of-mind protection throughout Canada and the United States, provided by a network of participating Ford Motor Company dealers.

For more information, visit your local Ford of Canada dealer or [www.ford.ca](http://www.ford.ca) to find the Ford Extended Service Plan that is right for you.

**Note:** Repairs performed outside of Canada and the United States are not eligible for Ford ESP coverage. This information is subject to change.

## Scheduled Maintenance

### GENERAL MAINTENANCE INFORMATION

#### Electric vehicles

For specific information on the Transit Connect Electric, refer to the *Azure Dynamics TC-E Owner's Guide* Supplement.

#### Why maintain your vehicle?

This guide describes the scheduled maintenance required for your vehicle. Carefully following this schedule helps protect against major repair expenses resulting from neglect or inadequate maintenance and may also help to increase the value of your vehicle when you sell or trade it.

It is your responsibility to see that all scheduled maintenance is performed and that the materials used meet Ford engineering specifications. Failure to perform scheduled maintenance specific in this guide will invalidate warranty coverage on parts affected by the lack of maintenance. Be sure receipts for completed maintenance are kept with the vehicle and confirmation of the work performed is always recorded in this guide.

Your dealer has factory-trained technicians who can perform the required maintenance using genuine Ford parts. They are committed to meeting your service needs and to assuring your continuing satisfaction.

#### Protecting your investment

Maintenance is an investment that will pay dividends in the form of improved reliability, durability and resale value. To ensure the proper performance of your vehicle and its emission control systems, it is imperative that scheduled maintenance be completed at the designated intervals.

Your vehicle is very sophisticated and built with multiple complex performance systems. Every manufacturer develops these systems using different specifications and performance features. That's why it's important to rely upon your dealership to properly diagnose and repair your vehicle.

Ford Motor Company has recommended maintenance intervals for various parts and component systems based upon engineering testing. Ford Motor Company relies upon this testing to determine the most appropriate mileage for replacement of oils and fluids to protect your vehicle at the lowest overall cost to you and recommends against maintenance schedules that deviate from the scheduled maintenance information.

## Scheduled Maintenance

Ford strongly recommends the use of genuine Ford replacement parts. Parts other than Ford, Motorcraft® or Ford-authorized remanufactured parts that are used for maintenance replacement or for the service of components affecting emission control must be equivalent to genuine Ford Motor Company parts in performance and durability. It is the owner's responsibility to determine the equivalency of such parts. Please consult your *Warranty Guide* for complete warranty information.

Chemicals or additives not approved by Ford are not required for factory recommended maintenance. In fact, Ford Motor Company recommends against the use of such additive products unless specifically recommended by Ford for a particular application.

### ***Oils, fluids and flushing***

In many cases, fluid discoloration is a normal operating characteristic and, by itself, does not necessarily indicate a concern or that the fluid needs to be changed. However, discolored fluids that also show signs of overheating and/or foreign material contamination should be inspected immediately by a qualified expert such as the factory-trained technicians at your dealership. Your vehicle's oils and fluids should be changed at the specified intervals or in conjunction with a repair. Flushing is a viable way to change fluid for many vehicle sub-systems during scheduled maintenance. It is critical that systems are flushed only with new fluid that is the same as that required to fill and operate the system, or using a Ford-approved flushing chemical.

### **Genuine Ford parts and service**

When planning your maintenance services, consider your dealership for all your vehicle's needs.

There are a lot of reasons why visiting your dealership for all your service needs is a great way to help keep your vehicle running great.

### ***Convenience***

Many dealerships have extended evening and Saturday hours to make your service visit more convenient. How's that for quality service?

### ***Factory-trained technicians***

Service technicians participate in extensive factory-sponsored certification training to help them become experts on the operation of your vehicle. Ask your dealership about the training and certification their technicians have received.

## Scheduled Maintenance

### ***Genuine Ford and Motorcraft® replacement parts***

Dealerships stock Ford and Motorcraft® branded replacement parts. These parts meet or exceed Ford Motor Company's specifications, and we stand behind them. Parts installed at your dealership carry a nationwide, 12 month/12,000 mile (20,000 km) parts and labor limited warranty. Your dealer can give you details.

### ***Value shopping for your vehicle's maintenance needs***

Your dealership recognizes the competitive landscape of maintenance and light repair automotive services. With factory-trained technicians, and one-stop service from routine maintenance like oil changes and tire rotations to repairs like brake service, check out the value your dealers can offer.

### **Owner checks and services**

Certain basic maintenance checks and inspections should be performed by the owner or a service technician at the intervals indicated. Service information and supporting specifications are provided in this owner's guide.

Any adverse condition should be brought to the attention of your dealer or qualified service technician as soon as possible for the proper service advice. The owner maintenance service checks are generally not covered by warranties so you may be charged for labor, parts or fluids used.

<b>Engine oil/coolant change intervals</b>	
<b>Engine oil</b>	6 months or 7,500 miles (12,000 km) (whichever comes first)
<b>Engine coolant, initial change</b>	6 years or 105,000 miles (168,000 km) (whichever comes first)
<b>Engine coolant, after initial change</b>	Every 3 years or 45,000 miles (72,000 km)

<b>Check every month</b>
Engine oil level
Function of all interior and exterior lights
Tires for wear and proper pressure, including spare
Windshield washer fluid level

## Scheduled Maintenance

Check every six months
Battery connections; clean if necessary
Body and door drain holes for obstructions; clean if necessary
Cooling system fluid level and coolant strength
Door weatherstrips for wear; lubricate if necessary
Hinges/latches/outside locks for proper operation; lubricate if necessary
Parking brake for proper operation
Safety belts and seat latches for wear and function
Safety warning lamps (brake, ABS, airbag, safety belt) for operation
Washer spray/wiper operation; clean or replace blades as necessary

### Multi-point inspection

In order to keep your vehicle running right, it is important to have the systems on your vehicle checked regularly. This can help identify potential issues and prevent major problems. Ford Motor Company recommends the following multi-point inspection be performed at every scheduled maintenance interval to help ensure your vehicle keeps running great.

Multi-point inspection – Recommended each visit	
Accessory drive belt(s)	Half-shaft dust boots (if equipped)
Battery performance	Horn operation
Clutch operation (if equipped)	Radiator, cooler, heater and A/C hoses
Engine air filter	Suspension components for leaks and damage
Exhaust system	Steering and linkage
Exterior lamps and hazard warning system operation	Tires for wear and proper pressure, including spare
Fluid levels*; fill if necessary	Windshield for cracks, chips or pits
For oil and fluid leaks	Washer spray and wiper operation
*Brake, coolant recovery reservoir, manual and automatic transmission (with an underhood dipstick), power steering (if equipped) and window washer	

Be sure to ask your dealership service advisor or technician about the multi-point vehicle inspection. It's a comprehensive way to perform a thorough inspection of your vehicle. It's your checklist that gives you immediate feedback on the overall condition of your vehicle. You'll know

272



## Scheduled Maintenance

what's been checked, what's okay, as well as those things that may require future or immediate attention. The multi-point vehicle inspection is one more way to keep your vehicle running great!

**CONUNE**  
CONNECTION PARTS & SERVICE

**Owner Advantage** Personal Member of: \_\_\_\_\_  
 Personal Service Balance: \_\_\_\_\_

**Multi-Point Inspection Report Card as Recommended by Ford Motor Company**

Name: \_\_\_\_\_ Today's Date: \_\_\_\_\_ PDI Tag: \_\_\_\_\_ State Inspection Month: \_\_\_\_\_

E-Mail Address: \_\_\_\_\_ Make/Model/Year: \_\_\_\_\_ Mileage: \_\_\_\_\_

SCHEDULED MAINTENANCE ITEMS DUE FOR SERVICE ON THIS VEHICLE			
OK	NOT OK	OK	NOT OK
<input type="checkbox"/>	<input type="checkbox"/>	<input type="checkbox"/>	<input type="checkbox"/>
<input type="checkbox"/>	<input type="checkbox"/>	<input type="checkbox"/>	<input type="checkbox"/>
<input type="checkbox"/>	<input type="checkbox"/>	<input type="checkbox"/>	<input type="checkbox"/>
<input type="checkbox"/>	<input type="checkbox"/>	<input type="checkbox"/>	<input type="checkbox"/>
<input type="checkbox"/>	<input type="checkbox"/>	<input type="checkbox"/>	<input type="checkbox"/>
<input type="checkbox"/>	<input type="checkbox"/>	<input type="checkbox"/>	<input type="checkbox"/>

\*This is only a partial list of vehicle maintenance items and is NOT all-inclusive. Please consult your Owner Manual or visit [www.ford.com/owners](http://www.ford.com/owners) for vehicle specific maintenance requirements.

CHECK FLUID LEVELS AND FILL			
OK	NOT OK	OK	NOT OK
<input type="checkbox"/>	<input type="checkbox"/>	<input type="checkbox"/>	<input type="checkbox"/>
<input type="checkbox"/>	<input type="checkbox"/>	<input type="checkbox"/>	<input type="checkbox"/>
<input type="checkbox"/>	<input type="checkbox"/>	<input type="checkbox"/>	<input type="checkbox"/>
<input type="checkbox"/>	<input type="checkbox"/>	<input type="checkbox"/>	<input type="checkbox"/>
<input type="checkbox"/>	<input type="checkbox"/>	<input type="checkbox"/>	<input type="checkbox"/>

**BATTERY**

State of Health: \_\_\_\_\_ Condition of \_\_\_\_\_

Factory spec cold cranking amps: \_\_\_\_\_ Actual Cold Cranking Amps: \_\_\_\_\_

**EXTERIOR BODY**

Note any existing exterior body damage or defects: \_\_\_\_\_

BRAKE LIVING			
OK	NOT OK	OK	NOT OK
<input type="checkbox"/>	<input type="checkbox"/>	<input type="checkbox"/>	<input type="checkbox"/>
<input type="checkbox"/>	<input type="checkbox"/>	<input type="checkbox"/>	<input type="checkbox"/>
<input type="checkbox"/>	<input type="checkbox"/>	<input type="checkbox"/>	<input type="checkbox"/>
<input type="checkbox"/>	<input type="checkbox"/>	<input type="checkbox"/>	<input type="checkbox"/>
<input type="checkbox"/>	<input type="checkbox"/>	<input type="checkbox"/>	<input type="checkbox"/>
<input type="checkbox"/>	<input type="checkbox"/>	<input type="checkbox"/>	<input type="checkbox"/>

Comments: \_\_\_\_\_

Service Advisor: \_\_\_\_\_ Customer Signature: \_\_\_\_\_

Technician: \_\_\_\_\_

12-XXXXXXXX

© 2011 Ford Motor Company. All Rights Reserved. Customer Copy

EXAMPLE

## Scheduled Maintenance

### **NORMAL SCHEDULED MAINTENANCE AND LOG**

The following section contains the “Normal Schedule”. This schedule is presented at specific mileage (kilometer) intervals with exceptions noted.

## Scheduled Maintenance

	7.5	15	22.5	30	37.5	45	52.5	60	67.5	75
<b>Miles (x 1,000)*</b>										
<b>Kilometers (x 1,000)*</b>	12	24	36	48	60	72	84	96	108	120
<b>Months*</b>	6	12	18	24	30	36	42	48	54	60
Change engine oil and filter	•	•	•	•	•	•	•	•	•	•
Rotate tires, inspect tire wear and measure tread depth; dual rear wheels should only be rotated if unusual wear is observed	•	•	•	•	•	•	•	•	•	•
Inspect wheels and related components for abnormal noise, wear, looseness or drag	•	•	•	•	•	•	•	•	•	•
Perform multi-point inspection (recommended)	•	•	•	•	•	•	•	•	•	•
Inspect automatic transmission fluid level (if equipped with dipstick); consult dealer for requirements		•		•		•		•		•
Inspect brake pads, shoes, rotors, drums, brake linings, hoses and parking brake		•		•		•		•		•
Inspect engine cooling system concentration and hoses		•		•		•		•		•
Inspect exhaust system and heat shields		•		•		•		•		•
Inspect front axle and U-joints; lubricate if equipped with grease fittings (4WD vehicles)		•		•		•		•		•
Inspect half-shaft boots (if equipped)		•		•		•		•		•
Inspect steering linkage, ball joints, suspension, tie-rod ends, driveshaft and U-joints; lubricate if equipped with grease fittings		•		•		•		•		•
Torque rear U-bolts (Transit Connect)		•		•		•		•		•
Inspect cabin air filter (if equipped)	•		•		•		•		•	

\* Whichever comes first

## Scheduled Maintenance

	82.5	90	97.5	105	112.5	120	127.5	135	142.5	150
<b>Miles (x 1,000)*</b>	132	144	156	168	180	192	204	216	228	240
<b>Kilometers (x 1,000)*</b>	66	72	78	84	90	96	102	108	114	120
<b>Months*</b>										
Change engine oil and filter	•	•	•	•	•	•	•	•	•	•
Rotate tires, inspect tire wear and measure tread depth; dual rear wheels should only be rotated if unusual wear is observed	•	•	•	•	•	•	•	•	•	•
Inspect wheels and related components for abnormal noise, wear, looseness or drag	•	•	•	•	•	•	•	•	•	•
Perform multi-point inspection (recommended)	•	•	•	•	•	•	•	•	•	•
Inspect automatic transmission fluid level (if equipped with dipstick); consult dealer for requirements		•		•		•		•		•
Inspect brake pads, shoes, rotors, drums, brake linings, hoses and parking brake		•		•		•		•		•
Inspect engine cooling system concentration and hoses		•		•		•		•		•
Inspect exhaust system and heat shields		•		•		•		•		•
Inspect front axle and U-joints; lubricate if equipped with grease fittings (4WD vehicles)		•		•		•		•		•
Inspect half-shaft boots (if equipped)		•		•		•		•		•
Inspect steering linkage, ball joints, suspension, tie-rod ends, driveshaft and U-joints; lubricate if equipped with grease fittings		•		•		•		•		•
Torque rear U-bolts (Transit Connect)		•		•		•		•		•
Inspect cabin air filter (if equipped)	•		•		•		•		•	

\* Whichever comes first

## Scheduled Maintenance

Every 15,000 miles (24,000 km)	Replace cabin air filter (if equipped)
Every 30,000 miles (48,000 km)	Replace climate-controlled seat filter (if equipped)
	Replace engine air filter
	Replace fuel filter (Ranger)
Every 37,500 miles (60,000 km)	Inspect valve clearances; adjust as necessary (Transit Connect CNG vehicles)
Every 60,000 miles (96,000 km)	Change automatic transmission fluid and filter on 5-speed TorqShift® transmission; consult dealer for requirements
	Replace front wheel bearing grease/grease seal if non-sealed bearings are used (2WD vehicles)
Every 105,000 miles (168,000 km)	Change engine coolant <sup>1</sup>
	Change manual transmission fluid (except Escape)
	Change rear axle fluid (Dana axles)
	Replace spark plugs
	Inspect accessory drive belt(s) <sup>2</sup>
Every 150,000 miles (240,000 km)	Change automatic transmission fluid and filter (except 5-speed TorqShift® transmission) (filter not required on 6F35, 6F50, DPS6 and AWF-21 transmissions); consult dealer for requirements
	Change front axle fluid (4WD vehicles)
	Change manual transmission fluid (Escape)
	Change rear axle fluid (RWD vehicles)
	Change transfer case fluid (4WD vehicles)
	Replace accessory drive belt(s) if not replaced within the last 100,000 miles (160,000 km)
	Replace front wheel bearings and seals if non-sealed bearings are used (2WD vehicles)
<sup>1</sup> Initial replacement at 105,000 miles (168,000 km) or 72 months; every 45,000 miles (72,000 km) or 36 months thereafter	
<sup>2</sup> Perform a follow-up inspection at 120,000 miles (192,000 km)	

## Scheduled Maintenance

### Maintenance schedule log

<p style="text-align: center;">DEALER VALIDATION:</p>  <p style="text-align: center;">P&amp;A CODE:</p> <p>RO#:            HOURS:</p> <p>DATE:           MILEAGE:</p>	<p style="text-align: center;">DEALER VALIDATION:</p>  <p style="text-align: center;">P&amp;A CODE:</p> <p>RO#:            HOURS:</p> <p>DATE:           MILEAGE:</p>
<p style="text-align: center;">DEALER VALIDATION:</p>  <p style="text-align: center;">P&amp;A CODE:</p> <p>RO#:            HOURS:</p> <p>DATE:           MILEAGE:</p>	<p style="text-align: center;">DEALER VALIDATION:</p>  <p style="text-align: center;">P&amp;A CODE:</p> <p>RO#:            HOURS:</p> <p>DATE:           MILEAGE:</p>
<p style="text-align: center;">DEALER VALIDATION:</p>  <p style="text-align: center;">P&amp;A CODE:</p> <p>RO#:            HOURS:</p> <p>DATE:           MILEAGE:</p>	<p style="text-align: center;">DEALER VALIDATION:</p>  <p style="text-align: center;">P&amp;A CODE:</p> <p>RO#:            HOURS:</p> <p>DATE:           MILEAGE:</p>
<p style="text-align: center;">DEALER VALIDATION:</p>  <p style="text-align: center;">P&amp;A CODE:</p> <p>RO#:            HOURS:</p> <p>DATE:           MILEAGE:</p>	<p style="text-align: center;">DEALER VALIDATION:</p>  <p style="text-align: center;">P&amp;A CODE:</p> <p>RO#:            HOURS:</p> <p>DATE:           MILEAGE:</p>
<p style="text-align: center;">DEALER VALIDATION:</p>  <p style="text-align: center;">P&amp;A CODE:</p> <p>RO#:            HOURS:</p> <p>DATE:           MILEAGE:</p>	<p style="text-align: center;">DEALER VALIDATION:</p>  <p style="text-align: center;">P&amp;A CODE:</p> <p>RO#:            HOURS:</p> <p>DATE:           MILEAGE:</p>

## Scheduled Maintenance

<p style="text-align: center;">DEALER VALIDATION:</p> <p style="text-align: center;">P&amp;A CODE:</p> <p>RO#:                    HOURS:</p> <p>DATE:                   MILEAGE:</p>	<p style="text-align: center;">DEALER VALIDATION:</p> <p style="text-align: center;">P&amp;A CODE:</p> <p>RO#:                    HOURS:</p> <p>DATE:                   MILEAGE:</p>
<p style="text-align: center;">DEALER VALIDATION:</p> <p style="text-align: center;">P&amp;A CODE:</p> <p>RO#:                    HOURS:</p> <p>DATE:                   MILEAGE:</p>	<p style="text-align: center;">DEALER VALIDATION:</p> <p style="text-align: center;">P&amp;A CODE:</p> <p>RO#:                    HOURS:</p> <p>DATE:                   MILEAGE:</p>
<p style="text-align: center;">DEALER VALIDATION:</p> <p style="text-align: center;">P&amp;A CODE:</p> <p>RO#:                    HOURS:</p> <p>DATE:                   MILEAGE:</p>	<p style="text-align: center;">DEALER VALIDATION:</p> <p style="text-align: center;">P&amp;A CODE:</p> <p>RO#:                    HOURS:</p> <p>DATE:                   MILEAGE:</p>
<p style="text-align: center;">DEALER VALIDATION:</p> <p style="text-align: center;">P&amp;A CODE:</p> <p>RO#:                    HOURS:</p> <p>DATE:                   MILEAGE:</p>	<p style="text-align: center;">DEALER VALIDATION:</p> <p style="text-align: center;">P&amp;A CODE:</p> <p>RO#:                    HOURS:</p> <p>DATE:                   MILEAGE:</p>
<p style="text-align: center;">DEALER VALIDATION:</p> <p style="text-align: center;">P&amp;A CODE:</p> <p>RO#:                    HOURS:</p> <p>DATE:                   MILEAGE:</p>	<p style="text-align: center;">DEALER VALIDATION:</p> <p style="text-align: center;">P&amp;A CODE:</p> <p>RO#:                    HOURS:</p> <p>DATE:                   MILEAGE:</p>

## Scheduled Maintenance

<p style="text-align: center;">DEALER VALIDATION:</p>  <p style="text-align: center;">P&amp;A CODE:</p> <p>RO#:            HOURS:</p> <p>DATE:           MILEAGE:</p>	<p style="text-align: center;">DEALER VALIDATION:</p>  <p style="text-align: center;">P&amp;A CODE:</p> <p>RO#:            HOURS:</p> <p>DATE:           MILEAGE:</p>
<p style="text-align: center;">DEALER VALIDATION:</p>  <p style="text-align: center;">P&amp;A CODE:</p> <p>RO#:            HOURS:</p> <p>DATE:           MILEAGE:</p>	<p style="text-align: center;">DEALER VALIDATION:</p>  <p style="text-align: center;">P&amp;A CODE:</p> <p>RO#:            HOURS:</p> <p>DATE:           MILEAGE:</p>
<p style="text-align: center;">DEALER VALIDATION:</p>  <p style="text-align: center;">P&amp;A CODE:</p> <p>RO#:            HOURS:</p> <p>DATE:           MILEAGE:</p>	<p style="text-align: center;">DEALER VALIDATION:</p>  <p style="text-align: center;">P&amp;A CODE:</p> <p>RO#:            HOURS:</p> <p>DATE:           MILEAGE:</p>
<p style="text-align: center;">DEALER VALIDATION:</p>  <p style="text-align: center;">P&amp;A CODE:</p> <p>RO#:            HOURS:</p> <p>DATE:           MILEAGE:</p>	<p style="text-align: center;">DEALER VALIDATION:</p>  <p style="text-align: center;">P&amp;A CODE:</p> <p>RO#:            HOURS:</p> <p>DATE:           MILEAGE:</p>
<p style="text-align: center;">DEALER VALIDATION:</p>  <p style="text-align: center;">P&amp;A CODE:</p> <p>RO#:            HOURS:</p> <p>DATE:           MILEAGE:</p>	<p style="text-align: center;">DEALER VALIDATION:</p>  <p style="text-align: center;">P&amp;A CODE:</p> <p>RO#:            HOURS:</p> <p>DATE:           MILEAGE:</p>



## Scheduled Maintenance

### SPECIAL OPERATING CONDITIONS

If you operate your vehicle **primarily** in one of the more demanding conditions listed below, you will need to have some items maintained more frequently. If you only **occasionally** operate your vehicle under these conditions, it is not necessary to perform the additional maintenance. For specific recommendations, see your dealership service advisor or technician.

<b>Towing a trailer or using a camper or car-top carrier</b>	
<b>Inspect frequently, service as required</b>	<ul style="list-style-type: none"><li>– Inspect and lubricate U-joints</li><li>– See axle maintenance items under <i>Exceptions</i></li></ul>
<b>Every 5,000 miles (8,000 km)</b>	<ul style="list-style-type: none"><li>– Inspect wheels and related components for abnormal noise, wear, looseness or drag</li><li>– Rotate tires, inspect tires for wear and measure tread depth</li></ul>
<b>Every 5,000 miles (8,000 km) or 6 months</b>	<ul style="list-style-type: none"><li>– Change engine oil and filter</li><li>– Inspect and lubricate U-joints</li></ul>
<b>Every 30,000 miles (48,000 km)</b>	<ul style="list-style-type: none"><li>– Change automatic transmission fluid (except 6R80 and TorqShift® transmissions)</li><li>– Replace front wheel bearing grease/grease seals if non-sealed bearings are used (2WD vehicles)</li></ul>
<b>Every 60,000 miles (96,000 km)</b>	<ul style="list-style-type: none"><li>– Change manual transmission fluid</li><li>– Change transfer case fluid (4WD vehicles)</li></ul>

## Scheduled Maintenance

### Extensive idling and/or low-speed driving for long distances as in heavy commercial use such as delivery, taxi, patrol car or livery

**Inspect frequently, service as required** – Replace cabin air filter (if equipped)  
– Replace engine air filter

**Every 5,000 miles (8,000 km)** – Inspect brake system  
– Inspect wheels and related components for abnormal noise, wear, looseness or drag  
– Lubricate control arm and steering ball joints if equipped with grease fittings  
– Rotate tires, inspect tires for wear and measure tread depth

**Every 5,000 miles (8,000 km) or 6 months** – Inspect and lubricate U-joints

**Every 5,000 miles (8,000 km), 6 months or 200 hours of engine operation** – Change engine oil and filter

**Every 15,000 miles (24,000 km)** – Replace fuel filter (Ranger)

**Every 30,000 miles (48,000 km)** – Change automatic transmission fluid (except 6R80 and TorqShift® transmissions)  
– Replace front wheel bearing grease/grease seals if non-sealed bearings are used (2WD vehicles)

**Every 60,000 miles (96,000 km)** – Change transfer case fluid (4WD vehicles)  
– Replace spark plugs

## Scheduled Maintenance

### Operating in dusty conditions such as unpaved or dusty roads

- |   |   |
|---|---|
| <b>Inspect frequently, service as required</b>  | <ul style="list-style-type: none"><li>– Replace cabin air filter (if equipped)</li><li>– Replace engine air filter</li></ul>  |
| <b>Every 5,000 miles (8,000 km)</b>             | <ul style="list-style-type: none"><li>– Inspect wheels and related components for abnormal noise, wear, looseness or drag</li><li>– Rotate tires, inspect tires for wear and measure tread depth</li></ul>                                |
| <b>Every 5,000 miles (8,000 km) or 6 months</b> | <ul style="list-style-type: none"><li>– Change engine oil and filter</li><li>– Inspect and lubricate U-joints</li></ul>   |
| <b>Every 15,000 miles (24,000 km)</b>           | <ul style="list-style-type: none"><li>– Replace fuel filter (Ranger)</li></ul>  |
| <b>Every 30,000 miles (48,000 km)</b>           | <ul style="list-style-type: none"><li>– Change automatic transmission fluid (except 6R80 and TorqShift® transmissions)</li><li>– Replace front wheel bearing grease/grease seals if non-sealed bearings are used (2WD vehicles)</li></ul> |
| <b>Every 50,000 miles (80,000 km)</b>           | <ul style="list-style-type: none"><li>– Change manual transmission fluid</li><li>– Change rear axle fluid (E-450 and F-450/550 only)</li></ul>  |
| <b>Every 60,000 miles (96,000 km)</b>           | <ul style="list-style-type: none"><li>– Change transfer case fluid (4WD vehicles)</li></ul>   |

## Scheduled Maintenance

### Off-road operation

- |   |   |
|---|---|
| <b>Inspect frequently, service as required</b>  | <ul style="list-style-type: none"><li>– Inspect steering linkage, ball joints and U-joints; lubricate if equipped with grease fittings</li><li>– Replace cabin air filter (if equipped)</li><li>– Replace engine air filter</li></ul>             |
| <b>Every 5,000 miles (8,000 km) or 6 months</b> | <ul style="list-style-type: none"><li>– Change engine oil and filter</li><li>– Inspect wheels and related components for abnormal noise, wear, looseness or drag</li><li>– Rotate tires, inspect tires for wear and measure tread depth</li></ul> |
| <b>Every 30,000 miles (48,000 km)</b>           | <ul style="list-style-type: none"><li>– Change automatic transmission fluid (except 6R80 and TorqShift® transmissions)</li><li>– Replace front wheel bearing grease/grease seals if non-sealed bearings are used (2WD vehicles)</li></ul>         |
| <b>Every 50,000 miles (80,000 km)</b>           | <ul style="list-style-type: none"><li>– Change manual transmission fluid</li><li>– Change rear axle fluid (E-450 and F-450/550 only)</li></ul>  |
| <b>Every 60,000 miles (96,000 km)</b>           | <ul style="list-style-type: none"><li>– Change transfer case fluid (4WD vehicles)</li></ul>   |

### Exclusive use of E85 (Flex Fuel Vehicles only)

- |                                  |   |
|----------------------------------|---|
| <b>Every oil change interval</b> | <ul style="list-style-type: none"><li>– If ran exclusively on E85, fill the fuel tank full with regular unleaded fuel</li></ul> |
|----------------------------------|---|

## Scheduled Maintenance

### Special operating condition log

<p style="text-align: center;">DEALER VALIDATION:</p> <p>RO#: P&amp;A CODE:            DATE: HOURS:            MILEAGE:</p>	<p style="text-align: center;">DEALER VALIDATION:</p> <p>RO#: P&amp;A CODE:            DATE: HOURS:            MILEAGE:</p>
<p style="text-align: center;">DEALER VALIDATION:</p> <p>RO#: P&amp;A CODE:            DATE: HOURS:            MILEAGE:</p>	<p style="text-align: center;">DEALER VALIDATION:</p> <p>RO#: P&amp;A CODE:            DATE: HOURS:            MILEAGE:</p>
<p style="text-align: center;">DEALER VALIDATION:</p> <p>RO#: P&amp;A CODE:            DATE: HOURS:            MILEAGE:</p>	<p style="text-align: center;">DEALER VALIDATION:</p> <p>RO#: P&amp;A CODE:            DATE: HOURS:            MILEAGE:</p>
<p style="text-align: center;">DEALER VALIDATION:</p> <p>RO#: P&amp;A CODE:            DATE: HOURS:            MILEAGE:</p>	<p style="text-align: center;">DEALER VALIDATION:</p> <p>RO#: P&amp;A CODE:            DATE: HOURS:            MILEAGE:</p>
<p style="text-align: center;">DEALER VALIDATION:</p> <p>RO#: P&amp;A CODE:            DATE: HOURS:            MILEAGE:</p>	<p style="text-align: center;">DEALER VALIDATION:</p> <p>RO#: P&amp;A CODE:            DATE: HOURS:            MILEAGE:</p>

## Scheduled Maintenance

<p style="text-align: center;">DEALER VALIDATION:</p>  <p style="text-align: center;">P&amp;A CODE:</p> <p>RO#:            HOURS:</p> <p>DATE:           MILEAGE:</p>	<p style="text-align: center;">DEALER VALIDATION:</p>  <p style="text-align: center;">P&amp;A CODE:</p> <p>RO#:            HOURS:</p> <p>DATE:           MILEAGE:</p>
<p style="text-align: center;">DEALER VALIDATION:</p>  <p style="text-align: center;">P&amp;A CODE:</p> <p>RO#:            HOURS:</p> <p>DATE:           MILEAGE:</p>	<p style="text-align: center;">DEALER VALIDATION:</p>  <p style="text-align: center;">P&amp;A CODE:</p> <p>RO#:            HOURS:</p> <p>DATE:           MILEAGE:</p>
<p style="text-align: center;">DEALER VALIDATION:</p>  <p style="text-align: center;">P&amp;A CODE:</p> <p>RO#:            HOURS:</p> <p>DATE:           MILEAGE:</p>	<p style="text-align: center;">DEALER VALIDATION:</p>  <p style="text-align: center;">P&amp;A CODE:</p> <p>RO#:            HOURS:</p> <p>DATE:           MILEAGE:</p>
<p style="text-align: center;">DEALER VALIDATION:</p>  <p style="text-align: center;">P&amp;A CODE:</p> <p>RO#:            HOURS:</p> <p>DATE:           MILEAGE:</p>	<p style="text-align: center;">DEALER VALIDATION:</p>  <p style="text-align: center;">P&amp;A CODE:</p> <p>RO#:            HOURS:</p> <p>DATE:           MILEAGE:</p>
<p style="text-align: center;">DEALER VALIDATION:</p>  <p style="text-align: center;">P&amp;A CODE:</p> <p>RO#:            HOURS:</p> <p>DATE:           MILEAGE:</p>	<p style="text-align: center;">DEALER VALIDATION:</p>  <p style="text-align: center;">P&amp;A CODE:</p> <p>RO#:            HOURS:</p> <p>DATE:           MILEAGE:</p>

## Scheduled Maintenance

### EXCEPTIONS

In addition, there are several exceptions to the Normal Schedule. They are listed below:

#### Normal vehicle axle maintenance

- Rear axles and power take-off (PTO) units containing synthetic fluid and light duty trucks equipped with Ford-design axles are lubricated for life. These fluids are not to be checked or changed unless a leak is suspected, service is required or the axle assembly has been submerged in water. The axle and PTO fluids should be changed anytime the axle and PTO have been submerged in water. During extended trailer tow operation above 70°F (21°C) ambient and wide open throttle for extended periods above 45 mph (72 km/h), non-synthetic rear axle fluids should be changed every 3,000 miles (4,800 km) or 3 months, whichever occurs first. The 3,000 mile (4,800 km) fluid change interval may be waived if the axle was filled with 75W140 synthetic gear fluid meeting Ford specification WSL-M2C192-A, part number F1TZ-19580-B or equivalent. Add friction modifier XL-3 (EST-M2C118-A) or equivalent for complete refill of Traction-Lok rear axles (refer to *Maintenance product and specifications* in the *Maintenance and Specifications* chapter for details). The axle fluid should be changed anytime an axle has been submerged in water.

#### Police/Taxi/Livery vehicle axle maintenance

- Change rear axle fluid every 100,000 miles (160,000 km). Rear axle fluid change may be waived if the axle was filled with 75W140 synthetic gear fluid meeting Ford specification WSL-M2C192-A, part number F1TZ-19580-B or equivalent. Add four ounces (118 mL) of additive friction modifier XL-3 (EST-M2C118-A) or equivalent for complete refill of Traction-Lok rear axles. The axle fluid should be changed anytime the axle has been submerged in water.

#### E-450 and F-450/550 axle maintenance

- Change rear axle fluid every 100,000 miles (160,000 km) under normal driving conditions. For vehicles operated at or near maximum Gross Vehicle Weights, the rear axle fluid should be changed every 50,000 miles (80,000 km). In addition, this 50,000 mile (80,000 km) schedule should be observed when the vehicles are operated under the Special Operating Conditions.

#### California fuel filter replacement

- If the vehicle is registered in California, the California Air Resources Board has determined that the failure to perform this maintenance item will not nullify the emission warranty or limit recall liability prior to the completion of the vehicle's useful life. Ford Motor Company, however, urges you to have all recommended maintenance services performed at the specified intervals and to record all vehicle service.

#### Class A Motorhome

- Change brake fluid every two years

## Scheduled Maintenance

### Middle East hot climate specifications

- If operating conditions are normal and you drive your vehicle under typical, everyday conditions **and** you are using an API performance category oil of SL or later (for example SM, etc.) then you can follow the 7,500 mile (12,000 km) normal service oil change intervals schedule. Vehicles operating in the Middle East, North Africa, Sub-Saharan Africa or locations with similar climates must follow the oil change interval of 3,000 mile (4,800 km) if the owner is using oils defined by the American Petroleum Institute (API) performance category of API SK or earlier (for example SJ, etc.).
- Edge/MKX AWD only** – vehicles operating off-road in sand during high ambient temperatures must replace the AWD PTU (All-wheel drive Power Transfer Unit) lube every 20,000 miles (32,000 km).

### Engine air filter & cabin air filter replacement

- Engine air filter and cabin air filter life is dependent on exposure to dusty and dirty conditions. Vehicles operated in these conditions will require frequent inspection and replacement of the engine air filter and cabin air filter.

### ENGINE COOLANT CHANGE RECORD

Initial change	6 years or 105,000 miles (168,000 km) (whichever comes first)
After initial change	Every 3 years or 45,000 miles (72,000 km)



## Scheduled Maintenance

### Engine coolant change log

<p style="text-align: center;">DEALER VALIDATION:</p> <p style="text-align: center;">P&amp;A CODE:</p> <p>RO#:                    HOURS:</p> <p>DATE:                  MILEAGE:</p>	<p style="text-align: center;">DEALER VALIDATION:</p> <p style="text-align: center;">P&amp;A CODE:</p> <p>RO#:                    HOURS:</p> <p>DATE:                  MILEAGE:</p>
<p style="text-align: center;">DEALER VALIDATION:</p> <p style="text-align: center;">P&amp;A CODE:</p> <p>RO#:                    HOURS:</p> <p>DATE:                  MILEAGE:</p>	<p style="text-align: center;">DEALER VALIDATION:</p> <p style="text-align: center;">P&amp;A CODE:</p> <p>RO#:                    HOURS:</p> <p>DATE:                  MILEAGE:</p>
<p style="text-align: center;">DEALER VALIDATION:</p> <p style="text-align: center;">P&amp;A CODE:</p> <p>RO#:                    HOURS:</p> <p>DATE:                  MILEAGE:</p>	<p style="text-align: center;">DEALER VALIDATION:</p> <p style="text-align: center;">P&amp;A CODE:</p> <p>RO#:                    HOURS:</p> <p>DATE:                  MILEAGE:</p>

## Index

### A

AdvanceTrac .....170

Airbag supplemental restraint system .....100, 109

- and child safety seats .....102
- description .....100, 109
- disposal .....111
- driver airbag .....102, 110
- indicator light .....109, 111
- operation .....102, 110
- passenger airbag .....102, 110
- side airbag .....109

Air cleaner filter .....253, 256

Ambulance packages .....7

Antifreeze (see Engine coolant) .....233

Anti-lock brake system (see Brakes) .....168

Anti-theft system .....74

- arming the system .....75

Armrests .....81

Audio system (see Radio) ...22-23

Automatic transaxle

- fluid, adding .....251
- fluid, checking .....251
- fluid, specification .....257

Automatic transmission

- driving an automatic
- overdrive .....177
- fluid, refill capacities .....257

Auxiliary input jack (Line in) ....25

Auxiliary power point .....58

Axle

- refill capacities .....257

### B

Battery .....231  
290

acid, treating emergencies .....231

- jumping a disabled battery ....203
- maintenance-free .....231
- replacement, specifications ...256
- servicing .....231

Belt-Minder® .....96

Blind spot mirror .....182

Bluetooth system .....27

Booster seats .....127

Brakes .....168

- anti-lock .....168
- anti-lock brake system (ABS)
- warning light .....169
- fluid, checking and adding ....250
- fluid, refill capacities .....257
- fluid, specifications .....257
- lubricant specifications .....257
- parking .....169
- shift interlock .....176

Bulbs .....47

### C

Capacities for refilling fluids ....257

CD player .....22

Cell phone use .....10

Changing a tire .....195

Child safety seats .....116

- attaching with tether
- straps .....123
- in front seat .....117
- in rear seat .....117
- LATCH .....120
- recommendations .....114

Child safety seats - booster seats .....127

Cleaning your vehicle

- engine compartment .....219

## Index

- instrument panel .....220
- interior .....221
- plastic parts .....219
- safety belts .....221
- washing .....217
- waxing .....218
- wheels .....218
- wiper blades .....220
- Clock .....22–23
- Console .....57
  - overhead .....58
- Controls
  - steering column .....63
- Coolant
  - checking and adding .....233
  - refill capacities .....236, 257
  - specifications .....257
- Cruise control (see Speed control) .....61
- Customer Assistance .....185
  - Ford Extended Service Plan .....265, 268
  - Getting assistance outside the U.S. and Canada .....213
  - Getting roadside assistance ...185
  - Getting the service you need .....209
  - Ordering additional owner's literature .....215
  - Utilizing the Mediation/Arbitration Program .....213
- D**
- Daytime running lamps (see Lamps) .....44
- Dipstick
  - automatic transmission fluid .....251
  - engine oil .....229
- Doors .....69
  - central unlocking .....68
- Driving under special conditions
  - through water .....183
- E**
- Emergencies, roadside
  - jump-starting .....203
- Emission control system .....246
- Engine .....259–260
  - cleaning .....219
  - coolant .....233
  - fail-safe cooling .....237
  - idle speed control .....231
  - lubrication specifications .....257
  - refill capacities .....257
  - service points .....227–228
- Engine block heater .....166
- Engine oil .....229
  - checking and adding .....229
  - dipstick .....229
  - filter, specifications .....230, 256
  - recommendations .....230
  - refill capacities .....257
  - specifications .....257
- Event data recording .....8
- Exhaust fumes .....166
- F**
- Fail safe cooling .....237
- Floor mats .....64–65
- Fluid capacities .....257  
291

## Index

- Four-Wheel Drive vehicles  
preparing to drive your  
vehicle .....174
- Fuel .....239  
calculating fuel economy .....243  
cap .....241  
capacity .....257  
choosing the right fuel .....242  
detergent in fuel .....243  
filling your vehicle with  
fuel .....239, 241, 244  
filter, specifications .....238, 256  
fuel pump shut-off switch .....186  
improving fuel economy .....243  
octane rating .....242, 259–260  
quality .....242  
running out of fuel .....243  
safety information relating to  
automotive fuels .....239
- Fuel pump shut-off switch .....186
- Fuses .....187
- G**
- Gas cap (see Fuel cap) .....241
- Gas mileage (see Fuel  
economy) .....243
- Gauges .....19
- H**
- Hazard flashers .....186
- Headlamps .....43  
aiming .....45  
bulb specifications .....48  
daytime running lights .....44  
flash to pass .....44  
high beam .....44  
replacing bulbs .....50  
turning on and off .....43
- Heating  
heating and air conditioning  
system .....38
- Hood .....226
- I**
- Ignition .....163, 259–260
- Infant seats (see Safety  
seats) .....116
- Inspection/maintenance (I/M)  
testing .....248
- Instrument panel  
cleaning .....220  
cluster .....14  
lighting up panel and  
interior .....45
- J**
- Jack .....195  
positioning .....195  
storage .....195
- Jump-starting your vehicle .....203
- K**
- Keys .....75  
positions of the ignition .....163
- L**
- Lamps  
bulb replacement  
specifications chart .....48  
daytime running light .....44  
headlamps .....43  
headlamps, flash to pass .....44  
instrument panel, dimming .....45  
interior lamps .....47–48  
replacing bulbs .....50

## Index

- LATCH anchors .....120
- Liftgate .....65
- Lights, warning and indicator ....14  
  anti-lock brakes (ABS) .....169
- Loading instructions .....161
- Load limits .....156
- Locks  
  childproof .....68
- Lubricant specifications .....257
- Lug nuts .....202
- Lumbar support, seats .....81
- M**
- Manual transaxle  
  lubricant specifications .....257
- Mirrors .....59–60  
  automatic dimming rearview  
  mirror .....60  
  fold away .....61  
  heated .....61  
  side view mirrors (power) .....60
- Motorcraft® parts .....224, 256
- O**
- Octane rating .....242
- Oil (see Engine oil) .....229
- P**
- Parking brake .....169
- Parts (see Motorcraft®  
  parts) .....256
- Passenger Occupant  
  Classification Sensor .....88
- Power distribution box (see  
  Fuses) .....192
- Power mirrors .....60
- Power point .....58
- Power steering .....173  
  fluid, checking and adding ....250  
  fluid, refill capacity .....257  
  fluid, specifications .....257
- Power Windows .....59
- Preparing to drive your  
  vehicle .....174
- R**
- Radio .....22–23
- Rear-view camera system .....181
- Recommendations for  
  attaching safety restraints for  
  children .....114
- Relays .....187
- Remote entry system .....69  
  illuminated entry .....73  
  locking/unlocking  
  doors .....68, 70–71  
  opening the trunk .....71  
  replacement/additional  
  transmitters .....72  
  replacing the batteries .....71
- Reverse sensing system .....179
- Roadside assistance .....185
- S**
- Safety belts (see Safety  
  restraints) .....87, 92–93, 95
- Safety Canopy .....109
- Safety defects,  
  reporting .....215–216  
  293

## Index

- Safety restraints .....87, 92–95  
  Belt-Minder® .....96  
  extension assembly .....95  
  for adults .....92–93  
  for children .....111  
  Occupant Classification  
  Sensor .....88  
  warning light and chime .....96
- Safety restraints - LATCH  
  anchors .....120
- Safety seats for children .....116
- Safety Compliance  
  Certification Label .....260
- Scheduled Maintenance Guide  
  Normal Scheduled  
  Maintenance and Log .....274
- Seats .....77  
  child safety seats .....116  
  cleaning .....222  
  front seats .....80
- SecuriLock passive anti-theft  
  system .....74
- Servicing your vehicle .....225
- Setting the clock .....22
- Spark plugs,  
  specifications .....256, 259–260
- Special notice  
  ambulance conversions .....7  
  utility-type vehicles .....7
- Specification chart,  
  lubricants .....257
- Speed control .....61
- Starting your vehicle .....163–165  
  jump starting .....203
- Steering wheel  
  controls .....63  
  tilting .....57
- 294
- T**
- Tilt steering wheel .....57
- Tire Pressure Monitoring  
  System (TPMS)  
  Tires, Wheels and Loading ....148
- Tires .....133–134, 195  
  alignment .....141  
  care .....137  
  changing .....195, 199  
  checking the pressure .....137  
  inflating .....135  
  label .....147  
  replacing .....139  
  rotating .....142  
  safety practices .....141  
  sidewall information .....142  
  snow tires and chains .....155  
  spare tire .....196  
  terminology .....134  
  tire grades .....134  
  treadwear .....133, 138
- Towing .....162  
  recreational towing .....162  
  trailer towing .....162  
  wrecker .....207
- Transaxle  
  lubricant specifications .....257
- Transmission .....177  
  brake-shift interlock (BSI) ....176  
  fluid, checking and adding  
  (automatic) .....251  
  fluid, refill capacities .....257
- Trunk  
  remote release .....71
- Turn signal .....46

## Index

### V

Vehicle Identification Number  
(VIN) .....261  
Vehicle loading .....156  
Ventilating your vehicle .....166

### W

Warning lights (see Lights) .....14  
Washer fluid .....228  
Water, Driving through .....183

Windows  
power .....59  
rear wiper/washer .....56  
Windshield  
defrosting .....42  
Windshield washer fluid and  
wipers  
checking and adding fluid .....228  
operation .....56  
replacing wiper blades ...228–229  
Wrecker towing .....207