

## Table of Contents

<b>Introduction</b>	<b>4</b>
<b>Instrument Cluster</b>	<b>12</b>
Warning lights and chimes	12
Gauges	16
<b>Entertainment Systems</b>	<b>19</b>
AM/FM stereo	19
AM/FM stereo with single CD	21
AM/FM stereo with in-dash six CD	25
<b>Climate Controls</b>	<b>31</b>
Heater only	31
Manual heating and air conditioning	32
<b>Lights</b>	<b>34</b>
Headlamps	34
Turn signal control	38
Bulb replacement	39
<b>Driver Controls</b>	<b>44</b>
Windshield wiper/washer control	44
Steering wheel adjustment	45
Power windows	49
Mirrors	50
Speed control	51
<b>Locks and Security</b>	<b>55</b>
Keys	55
Locks	55
<b>Seating and Safety Restraints</b>	<b>62</b>
Seating	62
Safety restraints	68
Airbags	78
Child restraints	87

## Table of Contents

<b>Tires, Wheels and Loading</b>	<b>104</b>
Tire information	106
Tire inflation	108
Vehicle loading	124
Trailer towing	130
Recreational towing	142
<b>Driving</b>	<b>143</b>
Starting	143
Brakes	146
Traction Control™/AdvanceTrac®	148
Transmission operation	154
<b>Roadside Emergencies</b>	<b>166</b>
Getting roadside assistance	166
Hazard flasher switch	168
Fuel pump shut-off switch	168
Fuses and relays	170
Changing tires	178
Lug nut torque	187
Jump starting	188
Wrecker towing	193
<b>Customer Assistance</b>	<b>194</b>
Reporting safety defects (U.S. only)	200
Reporting safety defects (Canada only)	201
<b>Cleaning</b>	<b>202</b>
Underbody preservation	207

## Table of Contents

<b>Maintenance and Specifications</b>	<b>209</b>
Engine compartment	211
Engine oil	213
Battery	216
Engine coolant	218
Fuel information	224
Air filter(s)	240
Part numbers	242
Maintenance product specifications and capacities	244
Engine data	250
<b>Accessories</b>	<b>254</b>
<b>Index</b>	<b>256</b>

All rights reserved. Reproduction by any means, electronic or mechanical including photocopying, recording or by any information storage and retrieval system or translation in whole or part is not permitted without written authorization from Ford Motor Company. Ford may change the contents without notice and without incurring obligation.

Copyright © 2007 Ford Motor Company

## Introduction

### CALIFORNIA Proposition 65 Warning



**WARNING:** Engine exhaust, some of its constituents, and certain vehicle components contain or emit chemicals known to the State of California to cause cancer and birth defects or other reproductive harm. In addition, certain fluids contained in vehicles and certain products of component wear contain or emit chemicals known to the State of California to cause cancer and birth defects or other reproductive harm.

### PERCHLORATE MATERIAL

Certain components of this vehicle such as air bag modules, seat belt pretensioners, and button cell batteries may contain Perchlorate Material – Special handling may apply for service or vehicle end of life disposal. See [www.dtsc.ca.gov/hazardouswaste/perchlorate](http://www.dtsc.ca.gov/hazardouswaste/perchlorate).

### CONGRATULATIONS

Congratulations on acquiring your new Ford. Please take the time to get well acquainted with your vehicle by reading this handbook. The more you know and understand about your vehicle, the greater the safety and pleasure you will derive from driving it.

For more information on Ford Motor Company and its products visit the following website:

- In the United States: [www.ford.com](http://www.ford.com)
- In Canada: [www.ford.ca](http://www.ford.ca)
- In Australia: [www.ford.com.au](http://www.ford.com.au)
- In Mexico: [www.ford.com.mx](http://www.ford.com.mx)

Additional owner information is given in separate publications.

This *Owner's Guide* describes every option and model variant available and therefore some of the items covered may not apply to your particular vehicle. Furthermore, due to printing cycles it may describe options before they are generally available.

Remember to pass on this *Owner's Guide* when reselling the vehicle. It is an integral part of the vehicle.



**Fuel pump shut-off switch:** In the event of an accident the safety switch will automatically cut off the fuel supply to the engine. The switch can also be activated through sudden vibration (e.g. collision when parking). To reset the switch, refer to the *Fuel pump shut-off switch* in the *Roadside Emergencies* chapter.

### SAFETY AND ENVIRONMENT PROTECTION

#### **Warning symbols in this guide**

How can you reduce the risk of personal injury to yourself or others? In this guide, answers to such questions are contained in comments highlighted by the warning triangle symbol. These comments should be read and observed.

#### **Warning symbols on your vehicle**

When you see this symbol, it is imperative that you consult the relevant section of this guide before touching or attempting adjustment of any kind.



#### **Protecting the environment**

We must all play our part in protecting the environment. Correct vehicle usage and the authorized disposal of waste, cleaning and lubrication materials are significant steps towards this aim. Information in this respect is highlighted in this guide with the tree symbol.



#### **BREAKING-IN YOUR VEHICLE**

During the first 1,000 miles (1,600 km) of driving, maintain speeds below 70 mph (110 km/h) and vary speeds frequently. This is recommended to give the moving parts a chance to break in. Do not tow a trailer during this break-in period. For more detailed information about towing a trailer, refer to *Trailer towing* in the *Tires, Wheels and Loading* chapter.

## Introduction

### SPECIAL NOTICES

#### **New Vehicle Limited Warranty**

For a detailed description of what is covered and what is not covered by your vehicle's New Vehicle Limited Warranty, refer to the *Warranty Guide* that is provided to you along with your *Owner's Guide*.

#### **Service Data Recording**

Service data recorders in your vehicle are capable of collecting and storing diagnostic information about your vehicle. This potentially includes information about the performance or status of various systems and modules in the vehicle, such as engine, throttle, steering or brake systems. In order to properly diagnose and service your vehicle, Ford Motor Company, Ford of Canada, and service and repair facilities may access vehicle diagnostic information through a direct connection to your vehicle when diagnosing or servicing your vehicle.

#### **Event Data Recording**

Other modules in your vehicle — event data recorders — are capable of collecting and storing data during a crash or near crash event. The recorded information may assist in the investigation of such an event. The modules may record information about both the vehicle and the occupants, potentially including information such as:

- how various systems in your vehicle were operating;
- whether or not the driver and passenger seatbelts were buckled;
- how far (if at all) the driver was depressing the accelerator and/or the brake pedal;
- how fast the vehicle was traveling; and
- where the driver was positioning the steering wheel.

To access this information, special equipment must be directly connected to the recording modules. Ford Motor Company and Ford of Canada do not access event data recorder information without obtaining consent, unless pursuant to court order or where required by law enforcement, other government authorities or other third parties acting with lawful authority. Other parties may seek to access the information independently of Ford Motor Company and Ford of Canada.

## Introduction

### **Vehicle Modification Data Recording**

Some aftermarket products may cause severe engine and/or transmission damage; refer to the *What is not covered* section in *The new vehicle limited warranty for your vehicle* chapter of your vehicle's *Warranty Guide* for more information. Some vehicles are equipped with Powertrain Control Systems that can detect and store information about vehicle modifications that increase horsepower and torque output; this information cannot be erased and will stay in the system's memory even if the modification is removed. When a dealer or repair facility works on your vehicle, it may be necessary for them to access the information in the Powertrain Control System. This information will likely identify if any unauthorized modifications have been made to the system and may be used to determine if repairs will be covered by warranty.

### **Special instructions**

For your added safety, your vehicle is fitted with sophisticated electronic controls.



Please read the section *Airbag supplemental restraint system (SRS)* in the *Seating and Safety Restraints* chapter. Failure to follow the specific warnings and instructions could result in personal injury.



Front seat mounted rear-facing child or infant seats should **NEVER** be placed in front of an active passenger airbag.

### **Notice to owners of diesel-powered vehicles**

Read the *6.0 Liter Power Stroke Direct Injection Turbo Diesel Owner's Guide Supplement* for information regarding correct operation and maintenance of your Diesel-powered light truck.

### **Notice to owners of pickup trucks and utility type vehicles**



Utility vehicles have a significantly higher rollover rate than other types of vehicles.

Before you drive your vehicle, please read this *Owner's Guide* carefully. Your vehicle is not a passenger car. As with other vehicles of this type, failure to operate this vehicle correctly may result in loss of vehicle control, vehicle rollover, personal injury or death.

## Introduction

### Using your vehicle as an ambulance

If your light truck is equipped with the Ford Ambulance Preparation Package, it may be utilized as an ambulance. Ford urges ambulance manufacturers to follow the recommendations of the *Ford Incomplete Vehicle Manual*, *Ford Truck Body Builder's Layout Book* and the *Qualified Vehicle Modifiers (QVM) Guidelines* as well as pertinent supplements. For additional information, please contact the Truck Body Builders Advisory Service at 1-877-840-4338.

Use of your Ford light truck as an ambulance, without the Ford Ambulance Preparation Package voids the Ford New Vehicle Limited Warranty and may void the Emissions Warranties. In addition, ambulance usage without the preparation package could cause high underbody temperatures, overpressurized fuel and a risk of spraying fuel which could lead to fires.

If your vehicle is equipped with the Ford Ambulance Preparation Package, it will be indicated on the Safety Compliance Certification Label. The label is located on the driver's side door pillar or on the rear edge of the driver's door. You can determine whether the ambulance manufacturer followed Ford's recommendations by directly contacting that manufacturer. Ford Ambulance Preparation Package is only available on certain 6.0L Diesel engine equipped vehicles.

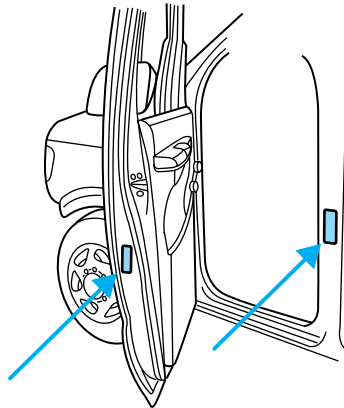

### Using your vehicle as a stationary power source (PTO)

Refer to the *Driving* chapter for more information and guidelines for operating a vehicle equipped with an aftermarket power take-off system.



## Introduction

### Cell phone use

The use of Mobile Communications Equipment has become increasingly important in the conduct of business and personal affairs. However, drivers must not compromise their own or others' safety when using such equipment. Mobile Communications can enhance personal safety and security when appropriately used, particularly in emergency situations. Safety must be paramount when using mobile communications equipment to avoid negating these benefits.

Mobile Communication Equipment includes, but is not limited to cellular phones, pagers, portable email devices, in-vehicle communications systems, telematics devices and portable two-way radios.



Driving while distracted can result in loss of vehicle control, accident and injury. Ford strongly recommends that drivers use extreme caution when using any device that may take their focus off the road. The drivers primary responsibility is the safe operation of their vehicle. Only use cell phones and other devices not essential to the driving task when it is safe to do so.







### Export unique (Non–United States/Canada) vehicle specific information

For your particular global region, your vehicle may be equipped with features and options that are different from the ones that are described in this *Owner's Guide*. A market unique supplement may be supplied that complements this book. By referring to the market unique supplement, if provided, you can properly identify those features, recommendations and specifications that are unique to your vehicle. This *Owner's Guide* is written primarily for the U.S. and Canadian Markets. Features or equipment listed as standard may be different on units built for Export. **Refer to this Owner's Guide for all other required information and warnings.**

## Introduction





These are some of the symbols you may see on your vehicle.

### Vehicle Symbol Glossary

Safety Alert		See Owner's Guide	
Fasten Safety Belt		Airbag - Front	
Airbag - Side		Child Seat	
Child Seat Installation Warning		Child Seat Lower Anchor	
Child Seat Tether Anchor		Brake System	
Anti-Lock Brake System		Brake Fluid - Non-Petroleum Based	
Powertrain Malfunction		Speed Control	
Master Lighting Switch		Hazard Warning Flasher	
Fog Lamps-Front		Fuse Compartment	
Fuel Pump Reset		Windshield Wash/Wipe	
Windshield Defrost/Demist		Rear Window Defrost/Demist	

## Introduction

### Vehicle Symbol Glossary

Power Windows Front/Rear		Power Window Lockout	
Child Safety Door Lock/Unlock		Interior Luggage Compartment Release Symbol	
Panic Alarm		Engine Oil	
Engine Coolant		Engine Coolant Temperature	
Do Not Open When Hot		Battery	
Avoid Smoking, Flames, or Sparks		Battery Acid	
Explosive Gas		Fan Warning	
Power Steering Fluid		Maintain Correct Fluid Level	
Emission System		Engine Air Filter	
Passenger Compartment Air Filter		Jack	
Check Fuel Cap		Low Tire Pressure Warning	

## Instrument Cluster

### WARNING LIGHTS AND CHIMES

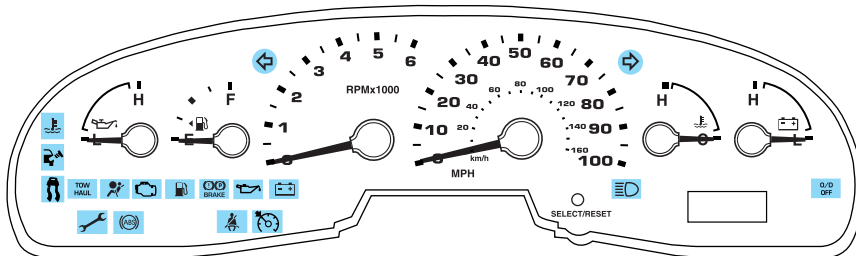

Warning lights and gauges can alert you to a vehicle condition that may become serious enough to cause expensive repairs. A warning light may illuminate when a problem exists with one of your vehicle's functions. Many lights will illuminate when you start your vehicle to make sure the bulb works. If any light remains on after starting the vehicle, refer to the respective system warning light for additional information.

If your vehicle is equipped with a Diesel engine, it has a unique cluster, refer to *Starting the engine in your 6.0 Liter Power Stroke Direct Injection Turbo Diesel Owner's Guide Supplement*.

**Service engine soon:** The *Service engine soon* indicator light illuminates when the ignition is first turned to the ON position to check

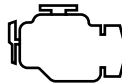

the bulb and to indicate whether the vehicle is ready for Inspection/Maintenance (I/M) testing. Normally, the "Service engine soon" light will stay on until the engine is cranked, then turn itself off if no malfunctions are present. However, if after 15 seconds the "Service engine soon" light blinks eight times, it means that the vehicle is not ready for I/M testing. See the *Readiness for Inspection/Maintenance (I/M) testing* in the *Maintenance and Specifications* chapter.

Solid illumination after the engine is started indicates the On Board Diagnostics System (OBD-II) has detected a malfunction. Refer to *On board diagnostics (OBD-II)* in the *Maintenance and Specifications* chapter. If the light is blinking, engine misfire is occurring which could damage your catalytic converter. Drive in a moderate fashion (avoid heavy acceleration and deceleration) and have your vehicle serviced immediately by your authorized dealer.

## Instrument Cluster



Under engine misfire conditions, excessive exhaust temperatures could damage the catalytic converter, the fuel system, interior floor coverings or other vehicle components, possibly causing a fire.

### **Electronic throttle control:**

Illuminates when the engine has defaulted to a 'limp-home' operation. Report the fault to a dealer at the earliest opportunity.



**Check fuel cap:** Illuminates when the fuel cap may not be properly installed. Continued driving with this light on may cause the Service Engine Soon warning light to come on, refer to *Fuel filler cap* in the *Maintenance and Specification* chapter.



**Brake system warning light:** To confirm the brake system warning light is functional, it will momentarily illuminate when the ignition is turned to the ON position when the engine is not running, or in a position between ON and START, or by applying the parking brake when the ignition is turned to the ON position. If the brake system warning light does not illuminate at this time, seek service immediately from your authorized dealer. Illumination after releasing the parking brake indicates low brake fluid level and the brake system should be inspected immediately by your authorized dealer.



Driving a vehicle with the brake system warning light on is dangerous. A significant decrease in braking performance may occur. It will take you longer to stop the vehicle. Have the vehicle checked by your authorized dealer. Driving extended distances with the parking brake engaged can cause brake failure and the risk of personal injury.

## Instrument Cluster

**Anti-lock brake system:** If the ABS light stays illuminated or continues to flash, a malfunction has been detected, have the system serviced immediately by your authorized dealer. Normal braking is still functional unless the brake warning light also is illuminated.



**Airbag readiness:** If this light fails to illuminate when ignition is turned to ON, continues to flash or remains on, have the system serviced immediately by your authorized dealer. A chime will also sound when a malfunction in the supplemental restraint system has been detected.



**Safety belt:** Reminds you to fasten your safety belt. A Belt-Minder® chime will also sound to remind you to fasten your safety belt. Refer to the *Seating and safety restraints* chapter to activate/deactivate the Belt-Minder® chime feature.



**Engine oil pressure:** Illuminates when the oil pressure falls below the normal range, refer to *Engine oil* in the *Maintenance and Specifications* chapter.



**Engine coolant temperature:** Illuminates when the engine coolant temperature is high. Stop the vehicle as soon as possible, switch off the engine and let cool. Refer to *Engine coolant* in the *Maintenance and Specifications* chapter.



Never remove the coolant reservoir cap while the engine is running or hot.

## Instrument Cluster

### **AdvanceTrac® (if equipped):**

Flashes (two times per second) when the AdvanceTrac® with RSC system is active. If the light remains on, or "SERVICE RSC NOW" is displayed in the odometer display with a chime, have the system serviced immediately by your authorized dealer. (Flashes one time every two seconds when AdvanceTrac® with RSC system has not yet initialized and is not available.) For further information, refer to *AdvanceTrac® with RSC stability enhancement system* in the *Driving* chapter.



If your vehicle is equipped with the AdvanceTrac® with RSC system, then it was designed to be operated with RSC. Driving without a functioning RSC™ system could be dangerous. Reduce speed and proceed to an authorized dealer to have the system serviced immediately.

### **Transmission Tow/Haul Feature (automatic transmission):**

Illuminates when the Tow/Haul feature has been activated. Refer to the *Driving* chapter for transmission function and operation. If the light flashes steadily, have the system serviced immediately, damage to the transmission could occur.

**TOW  
HAUL**

**Overdrive off:** Illuminates when the overdrive function of the transmission has been turned off, refer to the *Driving* chapter. If the light does not illuminate, have the transmission serviced soon, or damage may occur.

**O/D  
OFF**

**Charging system:** Illuminates when the battery is not charging properly.



**Speed control:** Illuminates when the speed control is activated. Turns off when the speed control system is deactivated.



## Instrument Cluster

**Low fuel:** Illuminates when the fuel level in the fuel tank is at or near empty (refer to *Fuel gauge* in this chapter).



**Turn signal:** Illuminates when the left or right turn signal or the hazard lights are turned on. If the indicators stay on or flash faster, check for a burned out bulb.



**High beams:** Illuminates when the high beam headlamps are turned on.



**Key-in-ignition warning chime:** Sounds when the key is left in the ignition in the OFF/LOCK or ACCESSORY position and the driver's door is opened.

**Headlamps on warning chime:** Sounds when the headlamps or parking lamps are on, the ignition is off (the key is not in the ignition) and the driver's door is opened.

**Parking brake ON warning chime:** Sounds when the parking brake is set, the engine is running and the vehicle is driven more than 3 mph (5 km/h).

## GAUGES

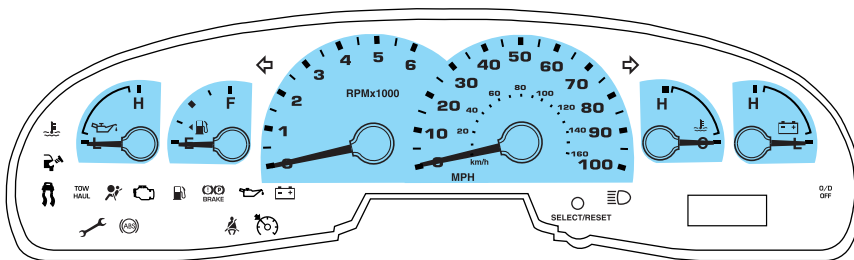



## Instrument Cluster

**Speedometer:** Indicates the current vehicle speed.

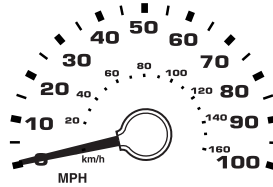

**Engine coolant temperature gauge:** Indicates engine coolant temperature. At normal operating temperature, the needle will be in the normal range (between “H” and “C”). **If it enters the red section, the engine is overheating. Stop the vehicle as soon as safely possible, switch off the engine and let the engine cool.**

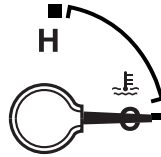

Never remove the coolant reservoir cap while the engine is running or hot.

**Odometer:** Registers the total miles (kilometers) of the vehicle.



**Trip odometer:** Registers the miles (kilometers) of individual journeys. Press the SELECT/RESET control once to switch from the odometer to the trip odometer. Press the control again to select Trip A and Trip B features. To reset the trip, press and hold the control again until the trip reading is 0.0 miles.



## Instrument Cluster

**Tachometer:** Indicates the engine speed in revolutions per minute. Driving with your tachometer pointer continuously at the top of the scale may damage the engine.



**Battery voltage gauge:** Indicates the battery voltage when the ignition is in the ON position. If the pointer moves and stays outside the normal operating range, have the vehicle's electrical system checked by your authorized dealer as soon as possible.

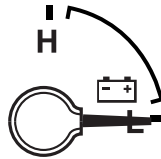

**Engine oil pressure gauge:** Indicates engine oil pressure. The needle should stay in the normal operating range (between "L" and "H"). If the needle falls below the normal range, stop the vehicle, turn off the engine and check the engine oil level. Add oil if needed. If the oil level is correct, have your vehicle checked by your authorized dealer.

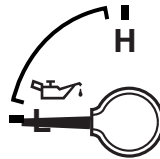

**Fuel gauge:** Indicates approximately how much fuel is left in the fuel tank (when the ignition is in the ON position). The fuel gauge may vary slightly when the vehicle is in motion or on a grade.

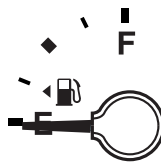

The FUEL icon and arrow indicates which side of the vehicle the fuel filler door is located.

Refer to *Filling the tank* in the *Maintenance and Specifications* chapter for more information.

## Entertainment Systems

### AUDIO SYSTEMS

#### AM/FM stereo (if equipped)

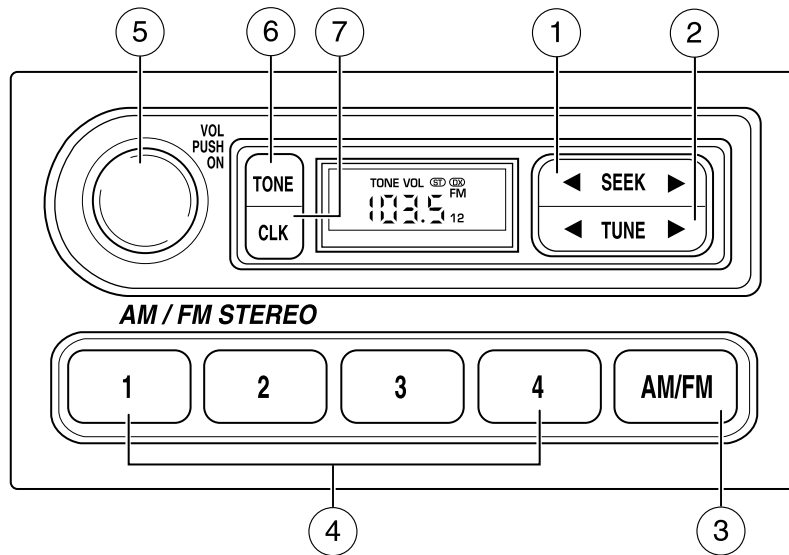

1. **Seek:** Press ◀ / ▶ to find the next listenable station down/up the frequency band.



2. **Tune:** Press ◀ / ▶ to manually adjust the radio frequency down/up.



3. **AM/FM:** Press to choose a frequency band in radio mode.



4. **Memory preset buttons:** To set a station: Select frequency band AM/FM1/FM2; tune to a station, press and hold a preset button until sound returns.



## Entertainment Systems

5. **Power/volume:** Press to turn ON/OFF; turn to increase or decrease volume levels.

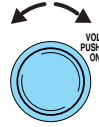

6. **Tone:** Press TONE until the desired level — Bass, Treble, Fade appears on the display. Turn the volume control to raise/lower the levels, or to move the audio sound from the right to left or the front to back (if equipped).

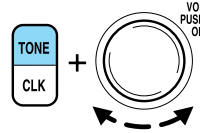

7. **CLK (Clock):** To set the hour, press and hold CLK until CLOCK SET appears in the display. Continue to hold CLK as you press SEEK to decrease ◀ or increase ▶ the hours.



To set the minute, press and hold CLK until CLOCK set appears in the display. Continue to hold CLK as you press TUNE to decrease ◀ or increase ▶ the minutes.

## Entertainment Systems

### Satellite Compatible AM/FM Stereo In-Dash Single CD/MP3 Radio (if equipped)

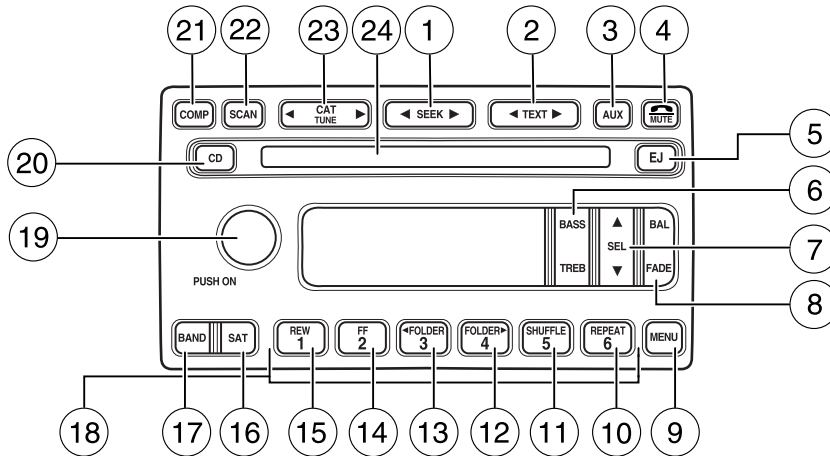

1. **SEEK:** Press and release  
SEEK ◀ / ▶ for previous/next  
strong station or track.



2. **TEXT:** The filename (Fi), song  
title (So), artist text (Ar) or album  
text (AL) may be viewed while  
playing an MP3 selection. When MP3 selection text is shown on the  
message display, its corresponding text indicator (Fi, So, Ar, or AL) is  
shown in the elapsed time display. Press TEXT to scroll through the text  
fields. The display will scroll through all of the text in the current field  
before changing to the next field. (TEXT must be pressed within 3  
seconds of the previous press to proceed to the next/last text display.  
The last text field shown on the display will become the new display  
message default.



TEXT is also available when equipped with Satellite radio. Your radio  
comes equipped with Satellite ready capability. The kit to enable Satellite  
reception is available through your dealer. Detailed Satellite instructions  
are included with the dealer installed kit.

*Check with your authorized dealer for availability.*

## Entertainment Systems

3. **AUX:** This function is not operational.



4. **MUTE:** Press to MUTE playing media; press again to return to playing media.



5. **EJ:** Press to eject a CD.



6. **Bass:** Press BASS; then press SEL ▼ / ▲ to decrease/increase the bass output.

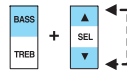

**Treble:** Press TREB; then press SEL ▼ / ▲ to decrease/increase the treble output.



7. **Select:** Use with Bass, Treble, Balance, Fade and other menu selections.



8. **Balance:** Press BAL; then press SEL ▼ / ▲ to shift sound to the left/right speakers.

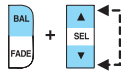

**Fade:** Press FADE; then press SEL ▼ / ▲ to shift sound to the rear/front speakers.

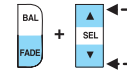

9. **Menu:** Press MENU and SEL to access/adjust the following functions:

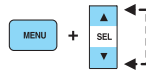

**Autoset:** Press MENU until AUTOSSET appears in the display. Press SEL to toggle ON/OFF. Allows you to set the strongest local radio stations without losing your original manually set preset stations for AM/FM1/FM2. When the six strongest stations are filled, the station stored in preset 1 will begin playing. If there are less than six strong stations, the system will store the last one in the remaining presets.

**Setting the clock:** Press MENU until SELECT HOUR or SELECT MINUTE is displayed. Use SEL to manually increase (▲) or decrease (▼) the hours/minutes. Press MENU again to disengage clock mode.

## Entertainment Systems

**Folder/Track mode:** In MP3 mode, press MENU until MODE appears in the display. Use SEL to toggle between FOLDER (only tracks within selected folder are accessible) or TRACK (all tracks on disc are accessible) MODE.

10. **REPEAT:** Repeats the current CD/MP3 track when active (ON). Press to show repeat status. Press again to toggle status.



11. **SHUFFLE:** Plays CD/MP3 tracks in random order when active (ON). Press to show shuffle status. Press again to toggle status.



12. **FOLDER▶** : Press to access the next MP3 directory.



13. **FOLDER◀** : Press to access the previous MP3 directory.



14. **FF**(Fast forward): In CD/MP3 mode, press until desired selection is reached.



15. **REW**(Rewind): In CD/MP3 mode, press until desired selection is reached.



16. **SAT (if equipped):** Your radio comes equipped with Satellite Ready capability. The kit to enable the Satellite reception is available through your dealer. Detailed satellite instructions are included with the dealer installed kit. *Check with your authorized dealer for availability.*



17. **BAND:** Press to toggle between AM/FM1/FM2 frequency band.



18. **Memory presets:** To set a station: Select frequency band; tune to a station, press and hold a preset button until sound returns.



## Entertainment Systems

19. **Power/volume:** Press to turn ON/OFF; turn to increase or decrease volume levels.

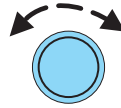

20. **CD:** Press to enter CD mode.



**CD units are designed to play commercially pressed 4.75 in (12 cm) audio compact discs only. Due to technical incompatibility, certain recordable and re-recordable compact discs may not function correctly when used in Ford CD players. Irregular shaped CDs, CDs with a scratch protection film attached, and CDs with homemade paper (adhesive) labels should not be inserted into the CD player. The label may peel and cause the CD to become jammed. It is recommended that homemade CDs be identified with permanent felt tip marker rather than adhesive labels. Ballpoint pens may damage CDs. Please contact your authorized dealer for further information.**

21. **COMP**(Compression): Brings soft and loud CD passages together for a more consistent listening level when in CD mode. Press COMP to turn the feature ON/OFF.



22. **Scan:** Press SCAN to hear a brief sampling of radio stations or CD/MP3 tracks. Press again to stop.



23. **CAT/Tune:** Press ◀ or ▶ to



manually tune down/up the radio frequency band.

**CAT:** CAT is only available when equipped with Satellite Radio. Your radio comes equipped with Satellite ready capability. The kit to enable Satellite reception is available through your dealer. Detailed Satellite instructions are included with the dealer installed kit. *Check with your authorized dealer for availability.*

For information regarding SIRIUS Satellite Radio, please call toll-free 888-539-SIRIUS (888-539-7474) or visit the SIRIUS website at [www.siriusradio.com](http://www.siriusradio.com)

24. **CD slot:** Insert a CD with the label side up.

24



## Entertainment Systems

### Premium Satellite Compatible AM/FM Stereo In-Dash Six CD/MP3 Radio (if equipped)

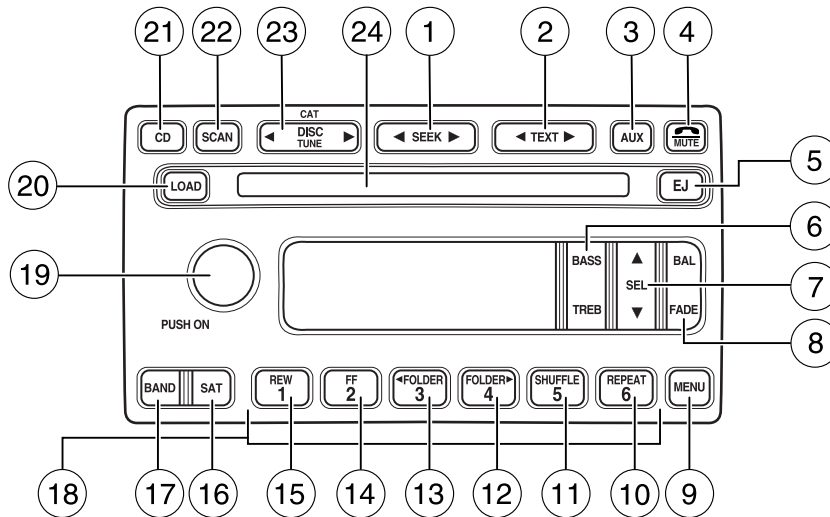

1. **SEEK:** Press and release SEEK ◀ / ▶ for previous/next strong station or track.



2. **TEXT:** The filename (Fi), song title (So), artist text (Ar) or album text (AL) may be viewed while playing an MP3 selection. When MP3 selection text is shown on the message display, its corresponding text indicator (Fi, So, Ar, or AL) is shown in the elapsed time display. Press TEXT to scroll through the text fields. The display will scroll all of the text in the current field before changing to the next field. (TEXT must be pressed within 3 seconds of the previous button press to proceed to the next/last text display.)



TEXT is also available when equipped with Satellite radio. Your radio comes equipped with Satellite ready capability. The kit to enable Satellite reception is available through your dealer. Detailed Satellite instructions are included with the dealer installed kit. *Check with your authorized dealer for availability.*

## Entertainment Systems

3. **AUX:** Press to toggle between the current playing media and DVD (if equipped).



4. **MUTE:** Press to MUTE playing media; press again to return to playing media



5. **EJ:** Press to eject a CD. Press EJ and a memory preset to eject a specific disc. Press and hold to eject all loaded discs.



6. **Bass:** Press BASS; then press SEL ▼ / ▲ to decrease/increase the bass output.

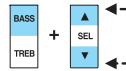

**Treble:** Press TREB; then press SEL ▼ / ▲ to decrease/increase the treble output.

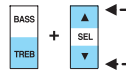

7. **Select:** Use with Bass, Treble, Balance, Fade and other menu functions.



8. **Balance:** Press BAL; then press SEL ▼ / ▲ to shift sound to the left/right speakers.

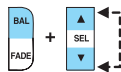

**Fade:** Press FADE; then press SEL ▼ / ▲ to shift sound to the rear/front speakers.

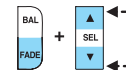

9. **Menu:** Press to access the following functions:

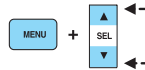

**Compression:** Brings soft and loud CD passages together for a more consistent listening level when in CD mode. Press MENU until compression status is displayed. Press the SEL control to enable the compression feature when COMPRESS OFF is displayed. Press the SEL control again to disable the feature when COMPRESS ON is displayed.

**Autoset:** Press MENU until AUTOSET appears in the display. Press SEL to toggle ON/OFF. Allows you to set the strongest local radio stations without losing your original manually set preset stations for

## Entertainment Systems

AM/FM1/FM2. When the six strongest stations are filled, the station stored in preset 1 will begin playing. If there are less than six strong stations, the system will store the last one in the remaining presets.

**Setting the clock:** Press MENU until SELECT HOUR or SELECT MINUTE is displayed. Use SEL to manually increase (▲) or decrease (▼) the hours/minutes. Press MENU again to disengage clock mode.

**Folder/Track Mode:** In MP3 mode, press MENU until MODE appears in the display. Use SEL to toggle between FOLDER (only tracks within selected folder are accessible) or TRACK (all tracks on disc are accessible) MODE.

10. **REPEAT:** Press to repeat the current CD/MP3 track. Press again to disable.



11. **SHUFFLE:** Press play the CD/MP3 tracks on the current disc in random order. Press again to disable.



12. **FOLDER ▶:** Press to access the next MP3 directory.



13. **FOLDER ◀:** Press to access the previous MP3 directory



14. **FF**(Fast forward): In CD/MP3 mode, press until desired selection is reached.



15. **REW**(Rewind): In CD/MP3 mode, press until desired selection is reached.



16. **SAT (if equipped):** Your radio comes equipped with Satellite Ready capability. The kit to enable the Satellite reception is available through your dealer. Detailed satellite instructions are included with the dealer installed kit. *Check with your authorized dealer for availability.*



17. **BAND:** Press to toggle between AM/FM1/FM2 frequency band.



## Entertainment Systems

18. **Memory presets:** To set a station: Select frequency, tune to a station, press and hold a preset button until sound returns.



19. **Power/volume:** Press to turn ON/OFF; turn to increase or decrease volume levels.

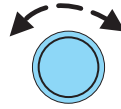

20. **Load:** Press to load a CD. Press LOAD and a memory preset to load to a specific disc slot. Press and hold to load up to six discs.



21. **CD:** Press to enter CD mode.



**CD units are designed to play commercially pressed 4.75 in (12 cm) audio compact discs only. Due to technical incompatibility, certain recordable and re-recordable compact discs may not function correctly when used in Ford CD players. Irregular shaped CDs, CDs with a scratch protection film attached, and CDs with homemade paper (adhesive) labels should not be inserted into the CD player. The label may peel and cause the CD to become jammed. It is recommended that homemade CDs be identified with permanent felt tip marker rather than adhesive labels. Ballpoint pens may damage CDs. Please contact your authorized dealer for further information.**

22. **Scan:** Press SCAN to hear a brief sampling of radio stations or CD/MP3 tracks. Press again to stop.



23. **Disc/Tune:** Press ◀ or ▶ to



manually tune down/up the radio frequency band, or to listen to the previous/next CD.

**CAT:** CAT is only available when equipped with Satellite Radio. Your Audiophile radio comes equipped with Satellite ready capability. The kit to enable Satellite reception is available through your dealer. Detailed Satellite instructions are included with the dealer installed kit. *Check with your authorized dealer for availability.*

## Entertainment Systems

For information regarding SIRIUS Satellite Radio, please call toll-free 888-539-SIRIUS (888-539-7474) or visit the SIRIUS website at [www.siriusradio.com](http://www.siriusradio.com)

24. **CD slot:** Insert a CD, label side up.

### Accessory delay

With accessory delay, the window switches, moon roof (if equipped) and audio system may be used for up to ten minutes after the ignition switch is turned off or until any door is opened.

### GENERAL AUDIO INFORMATION

#### Radio frequencies:

AM and FM frequencies are established by the Federal Communications Commission (FCC) and the Canadian Radio and Telecommunications Commission (CRTC). Those frequencies are:

AM: 530, 540–1700, 1710 kHz

FM: 87.7, 87.9–107.7, 107.9 MHz

#### Radio reception factors:

There are three factors that can affect radio reception:

- Distance/strength: The further you travel from an FM station, the weaker the signal and the weaker the reception.
- Terrain: Hills, mountains, tall buildings, power lines, electric fences, traffic lights and thunderstorms can interfere with your reception.
- Station overload: When you pass a broadcast tower, a stronger signal may overtake a weaker one and play while the weak station frequency is displayed.

#### CD/CD player care

Do:

- Handle discs by their edges only. Never touch the playing surface.
- Inspect discs before playing. Clean only with an approved CD cleaner and wipe from the center out.

Don't:

- Expose discs to direct sunlight or heat sources for extended periods of time.
- Clean using a circular motion.

## Entertainment Systems

CD units are designed to play commercially pressed 4.75 in (12 cm) audio compact discs only. Due to technical incompatibility, certain recordable and re-recordable compact discs may not function correctly when used in Ford CD players. Dirty, warped or damaged CDs, irregular shaped CDs, CDs with a scratch protection film attached, and CDs with homemade paper (adhesive) labels should not be inserted into the CD player. The label may peel and cause the CD to become jammed. It is recommended that homemade CDs be identified with permanent felt tip marker rather than adhesive labels. Ballpoint pens may damage CDs. Please contact your authorized dealer for further information.

### Audio system warranty and service

Refer to the *Warranty Guide* for audio system warranty information. If service is necessary, see your dealer or qualified technician.

## Climate Controls

### HEATER ONLY SYSTEM (IF EQUIPPED)

1. **Fan speed adjustment:** Controls the volume of air circulated in the vehicle.

2. **Temperature selection:** Controls the temperature of the airflow in the vehicle.

3. **Air flow selections:** Controls the direction of the airflow in the vehicle. See the following for a brief description on each control.

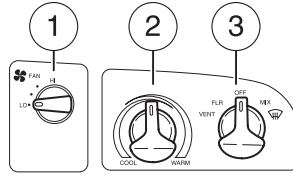

**VENT:** Distributes outside air through the instrument panel vents.

**FLR:** Distributes outside air through the floor vents.

**OFF:** Outside air is shut out and the climate system is turned off.

**MIX:** Distributes outside air through the windshield defroster vents and the floor vents.



: Distributes outside air through the windshield defroster vents.

### Operating tips

- To reduce fog build up on the windshield during humid weather, place the air flow selector in the  position.
- To reduce humidity build up inside the vehicle during cold or warm weather, do not drive with the air flow selector in the OFF position.
- Do not put objects under the front seats that will interfere with the air flow to the back seats.
- Remove any snow, ice or leaves from the air intake area at the base of the windshield.

To aid in side window defogging/demisting in cold weather:

1. Select MIX.
2. Set the temperature control to maintain comfort.
3. Set the fan speed to HI.



Do not place objects on top of the instrument panel as these objects may become projectiles in a collision or sudden stop.

## Climate Controls

### MANUAL HEATING AND AIR CONDITIONING SYSTEM (IF EQUIPPED)

1. **Fan speed adjustment:** Controls the volume of air circulated in the vehicle.

2. **Temperature selection:** Controls the temperature of the airflow in the vehicle.

3. **Air flow selections:** Controls the direction of the airflow in the vehicle. See the following for a brief description on each control.

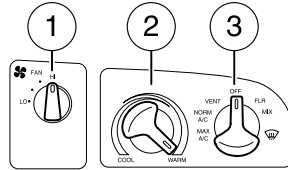

**MAX A/C:** Uses recirculated air to cool the vehicle. Air flows from the instrument panel vents only.

**NORM A/C:** Uses outside air to cool the vehicle. Air flows from the instrument panel vents only.

**VENT:** Distributes outside air through the instrument panel vents.

**OFF:** Outside air is shut out and the climate system is turned off.

**FLR:** Distributes outside air through the floor vents.

**MIX:** Distributes outside air through the windshield defroster vents and floor vents.

 : Distributes outside air through the windshield defroster vents.

### Operating tips

- To reduce fog build up on the windshield during humid weather, place the air flow selector in the  position.
- To reduce humidity build up inside the vehicle: do not drive with the air flow selector in the OFF position.
- Do not put objects under the front seats that will interfere with the airflow to the back seats.
- Remove any snow, ice or leaves from the air intake area at the base of the windshield.



## Climate Controls

To aid in side window defogging/demisting in cold weather:

1. Select MIX.
2. Set the temperature control to maintain comfort.
3. Set the fan speed to HI.



Do not place objects on top of the instrument panel as these objects may become projectiles in a collision or sudden stop.

### REAR FAN SPEED ADJUSTMENT (IF EQUIPPED)

The rear fan controls adjust the volume of air circulated in the rear of the vehicle.

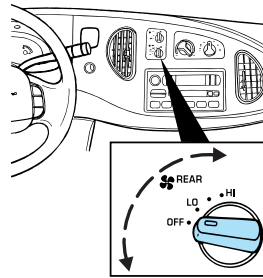

## Lights

### HEADLAMP CONTROL ☀

- The first position turns on the parking, tail, license plate and side marker lamps.
- The outer position turns on the headlamps.

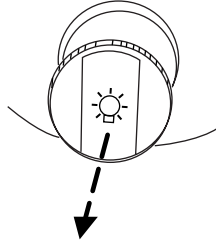

### Battery saver

The battery saver can be set to turn off the courtesy lamps within 2 or 10 minutes if a door is left open and the key is not in the ignition. Demand (manually switched on) interior lamps can be set to turn off within 2 or 30 minutes after the key has been removed from the ignition.

**Note:** The vehicle is factory set at 2 minutes to turn off demand and courtesy lamps. The vehicle will change to 10 minutes for courtesy lamps and 30 minutes for demand interior lamps once the odometer reads over 50 miles.

To change the battery saver duration time, do the following:

1. Turn the key to the RUN position. Do not start the vehicle.
2. After the odometer is displayed, press and release the reset button 10 times within 60 seconds.
3. The words 'Battery Saver' will be displayed.
4. Press the reset button to select/toggle between '2 minutes' or '30 minutes' duration.
5. Once your time choice is displayed, wait until the odometer is displayed (approximately 30 seconds).

The battery saver feature will now work with the new time duration.

**Note:** Even when choosing the 30 minute time duration, the courtesy lamps can only have a maximum on time of 10 minutes. Only demand interior lamps will stay on for the entire 30 minute period.

## Lights

### Daytime running lamps (DRL) (if equipped)

Turns the headlamps on with a reduced output.

To activate:

- the ignition must be in the ON position and
- the headlamp control is in the OFF or parking lamp position.



Always remember to turn on your headlamps at dusk or during inclement weather. The Daytime Running Lamp (DRL) system does not activate the tail lamps and generally may not provide adequate lighting during these conditions. Failure to activate your headlamps under these conditions may result in a collision.

### High beams

Push the lever toward the instrument panel to activate. Pull the lever towards you to deactivate.

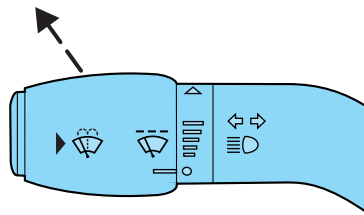

### Flash to pass

Pull toward you slightly to activate and release to deactivate.

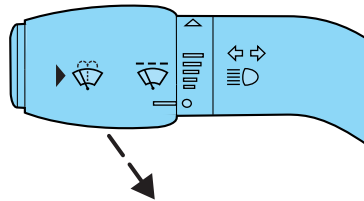

## Lights

### PANEL DIMMER CONTROL

To adjust the brightness of the instrument panel, rotate the dimmer control clockwise/counterclockwise when the headlamp control is in the parking lamp or low-beam position.

To turn on the interior lamps, rotate the dimmer control fully counterclockwise past the detent.

The dome lamp will not illuminate if the control switch is not rotated past the detent.

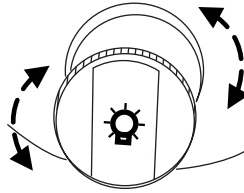

### HEADLAMP AIM ADJUSTMENT

The headlamps are designed to be mechanically aimed, but can also be aimed visually by doing the following:

1. Park your vehicle on a level surface about 25 feet (7.6 meters) away from a vertical plain surface (3). Check your headlamp alignment at night or in a dark area so that you can see the headlamp beam pattern.

- (1) 8 feet (2.4 meters)
- (2) Center height of lamp to ground
- (3) 25 feet (7.6 meters)
- (4) Horizontal reference line
- (5) Center of headlamps
- (6) Center line of the vehicle

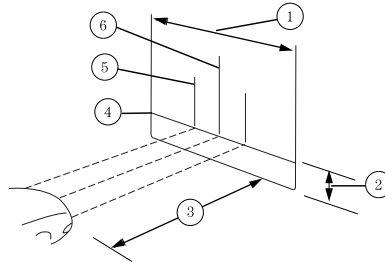

2. The center of the headlamp is marked either on the lens (a circle or cross marker) or on the bulb shield, internal to the lamp (mark or feature). Measure the height from the center of your headlamp to the ground (2) and mark an 8 foot (2.4 meter) long horizontal line on the wall or screen (1) at this height (masking tape works well).

## Lights

3. Turn on the low beam headlamps and open the hood.

4. Locate the high intensity area of the beam pattern and place the top edge of the intensity zone even with the horizontal reference line (4). If the top edge of the high intensity area is not even with the horizontal line, follow the next step to adjust it.

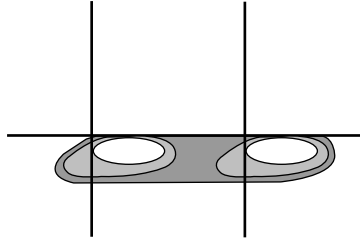

5.

- **Aerodynamic:** Locate the vertical adjuster (2) for each headlamp. Adjust the aim by turning the adjuster control either clockwise (to adjust up) or counterclockwise (to adjust down).

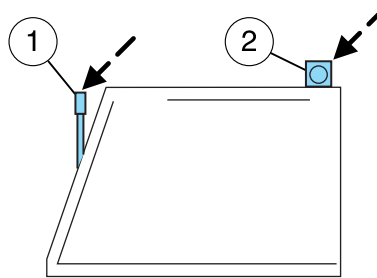

- **Sealed beam:** Locate the vertical adjuster (1) for each headlamp. Adjust the aim by turning the adjuster control either clockwise (to adjust up) or counterclockwise (to adjust down).

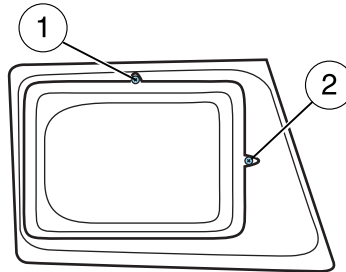

6. In addition to the horizontal line marked in step 2, a pair of vertical lines (5) must be marked at the center line of the headlamps on the wall or screen.

7. On the wall or screen, locate the high intensity area of the beam pattern. The left edge of the high intensity area should be even with the vertical line corresponding to the headlamp under adjustment. If the left edge of the high intensity area is not even with the vertical line, follow the next step to adjust it.

## Lights

8.

- **Aerodynamic:** Locate the horizontal adjuster (1) for each headlamp. Turn it clockwise or counterclockwise, to place the left edge of the high intensity area even with the vertical line corresponding to the headlamp under adjustment.
- **Sealed beam:** Locate the horizontal adjuster (2) for each headlamp. Turn it clockwise or counterclockwise, to place the left edge of the high intensity area even with the vertical line corresponding to the headlamp under adjustment.

### TURN SIGNAL CONTROL ⇐⇒

- Push down to activate the left turn signal.
- Push up to activate the right turn signal.

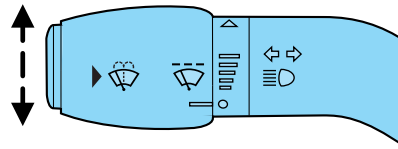

## INTERIOR LAMPS

### Cargo and dome lamps with rear headliner

Rear cargo lamps equipped with an ON/OFF/DOOR control will light when:

- doors are closed and the control is in the ON position
- control is in the DOOR position and any door is open
- headlamp control is rotated fully counterclockwise

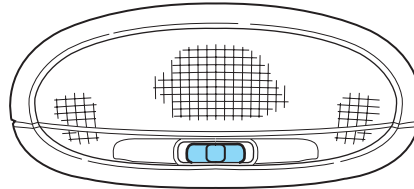

When the control is in the OFF position, it will not illuminate when you open the doors or fully rotate the headlamp control.

## Lights

### **Third row courtesy/reading/cargo lamps**

The dome portion of the lamp, the center light, can be turned on when the headlamp control is rotated fully counterclockwise or when any door is opened.

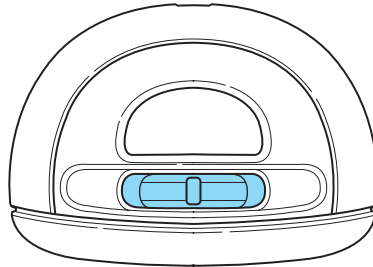

With the ignition key in the ACC or ON position, the rear dome lamp can be turned ON or OFF by sliding the control.

### **Front and rear courtesy/reading lamps**

The dome portion of the lamp, the center light, can be turned on when the headlamp control is rotated fully counterclockwise or when any door is opened.

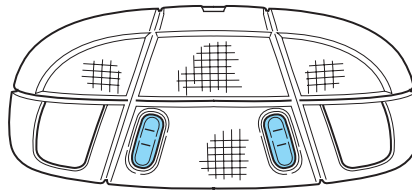

The reading lamp portion, the two outer lights, can only be toggled on and off at the lamp.

## **BULB REPLACEMENT**

### **Headlamp Condensation**

The headlamps are vented to equalize pressure. When moist air enters the headlamp(s) through the vents, there is a possibility that condensation can occur. This condensation is normal and will clear within 45 minutes of headlamp operation.

### **Using the right bulbs**

Replacement bulbs are specified in the chart below. Headlamp bulbs must be marked with an authorized "D.O.T." for North America and an "E" for Europe to ensure lamp performance, light brightness and pattern and safe visibility. The correct bulbs will not damage the lamp assembly or void the lamp assembly warranty and will provide quality bulb burn time.

## Lights

Function	Number of bulbs	Trade number
Headlamps (sealed beam)	2	H5054
Headlamps (aerodynamic)	2	9007
Park lamp and turn signal (front)	2	4157K or 3157K
Back-up lamps	2	3156K or 3156
License plate lamp	1	168
Stop/tail/turn/side marker lamp	2	3457K or 3357K
High-mount brakelamp	2	912
Cargo lamp	1	211-2
Dome lamp (standard)	1	912
Map/reading lamp	2	211-2
All replacement bulbs are clear in color except where noted.		
To replace all instrument panel lights - see your authorized dealer		

### Replacing exterior bulbs

Check the operation of all the bulbs frequently.

#### Replacing headlamp bulbs (aerodynamic)

1. Make sure headlamp switch is in the OFF position and open the hood.
2. Push each clip tab toward the engine compartment and lift upward to the stop position, then remove the headlamp assembly.

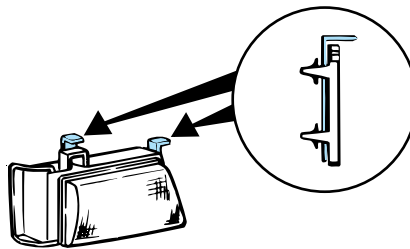



## Lights

3. Disconnect the electrical connector from the bulb by pulling rearward.

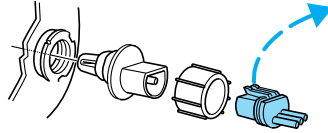

4. Remove the bulb retaining ring by rotating it counterclockwise, and slide the ring off the plastic base.

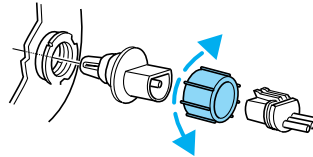

5. Pull the bulb straight out.

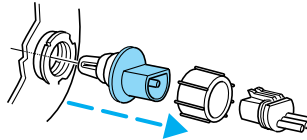

Handle a halogen headlamp bulb carefully and keep out of children's reach. Grasp the bulb only by its plastic base and do not touch the glass. The oil from your hand could cause the bulb to break the next time the headlamps are operated.

**Note:** If the bulb is accidentally touched, it should be cleaned with alcohol before being used.

To install the new bulb, follow the removal procedures in reverse order.

### **Replacing headlamp bulbs (sealed beam)**

1. Make sure headlamp switch is in the OFF position and open the hood.
2. Remove the two headlamp screws and bezel from the headlamp housing.

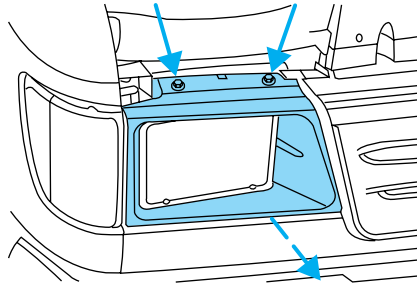

## Lights

3. Remove the four headlamp bulb retaining screws and the retaining ring.
4. Remove the headlamp.
5. Disconnect the electrical connector from the bulb and remove the bulb.

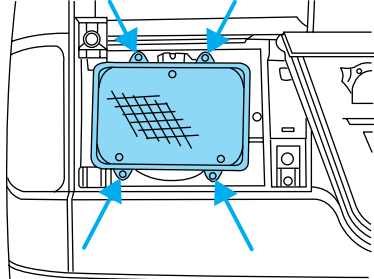

To install the new bulb, follow the removal procedures in reverse order.

### **Replacing front parking lamp/turn signal bulbs**

1. Make sure the headlamp control is in the OFF position.
2. Remove two screws and pull lamp assembly away from the vehicle.
3. Rotate the bulb socket counterclockwise and remove.
4. Carefully pull the bulb straight out of the socket.

To complete installation, follow the removal procedures in reverse order.



### **Replacing high-mount brakelamp bulbs**

The interior cargo lamp (if equipped), on vehicles without a rear headliner, will have to be removed from under the high-mount brakelamp assembly located inside the vehicle.

Your vehicle is equipped with an LED center high-mount stop lamp. It is designed to last the life of the vehicle. If replacement is required, see your authorized dealer.

### **Replacing license plate lamp bulbs**

1. Turn the headlamp switch to OFF and then remove the two screws and the license plate lamp assembly from the rear door.
2. Remove bulb socket from lamp assembly by turning counterclockwise.
3. Pull the bulb out from socket and push in the new bulb.

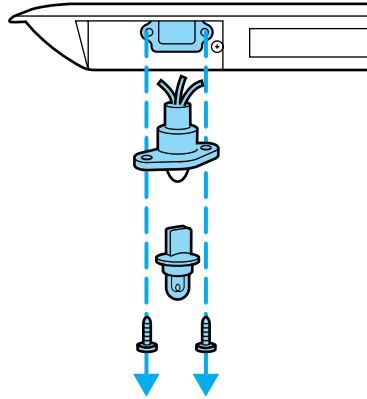

To install the new bulb, follow the removal procedures in reverse order.

### **Replacing tail lamp/turn/backup lamp bulbs**

1. Turn the headlamp switch to the OFF position and then remove the four screws and the lamp assembly from vehicle.
2. Rotate bulb socket counterclockwise and remove from lamp assembly.
3. Carefully pull the bulb straight out of the socket and push in the new bulb.

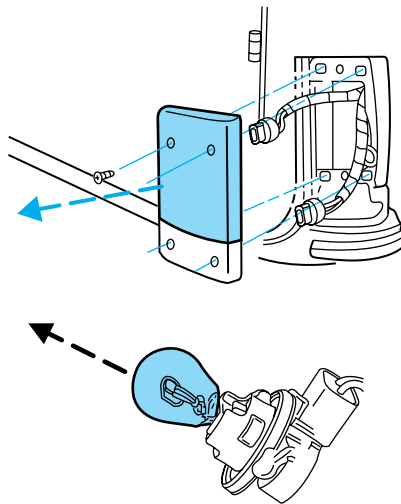

To install the lamp, follow the removal procedures in reverse order.

## Driver Controls

### MULTI-FUNCTION LEVER

**Windshield wiper:** Rotate the end of the control away from you to increase the speed of the wipers; rotate towards you to decrease the speed of the wipers.

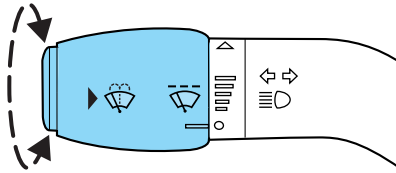

**Windshield washer:** Push the end of the stalk:

- briefly: causes a single swipe of the wipers without washer fluid.
- a quick push and hold: the wipers will swipe three times with washer fluid.
- a long push and hold: the wipers and washer fluid will be activated for up to ten seconds.

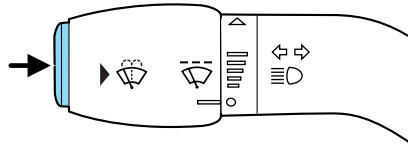

**Note:** Do not operate the washer when the washer reservoir is empty. This may cause the washer pump to overheat. Check the washer fluid level frequently. Do not operate the wipers when the windshield is dry. This may scratch the glass, damage the wiper blades and cause the wiper motor to burn out. Before operating the wiper on a dry windshield, always use the windshield washer. In freezing weather, be sure the wiper blades are not frozen to the windshield before operating the wipers.

## Driver Controls

### TILT STEERING WHEEL

To adjust the steering wheel:

1. Pull and hold the steering wheel release control toward you.
2. Move the steering wheel up or down until you find the desired location.
3. Release the steering wheel release control. This will lock the steering wheel in position.

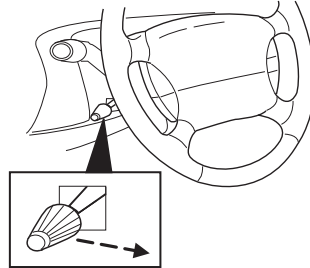

Never adjust the steering wheel when the vehicle is moving.

### ILLUMINATED VISOR MIRROR (IF EQUIPPED)

Lift the mirror cover to turn on the visor mirror lamps.

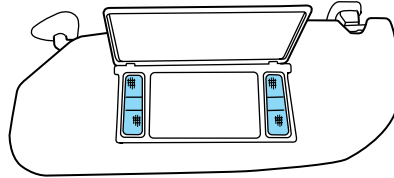

### OVERHEAD CONSOLE (IF EQUIPPED)

The appearance of your vehicle's overhead console will vary according to your option package.

## Driver Controls

### Storage compartment (if equipped)

Press the release on the door to open the storage compartment.

The storage compartment may be used to secure sunglasses or a similar object.

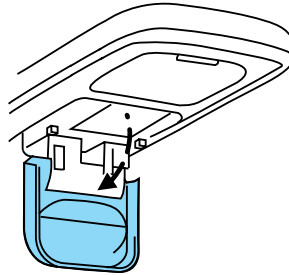

### Installing a garage door opener (if equipped)

The storage compartment can be converted to accommodate a variety of aftermarket garage door openers:

1. Place VELCRO® hook onto side of aftermarket transmitter opposite of actuator control.
2. Place the transmitter into storage compartment, control down.

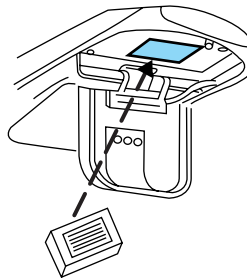

3. Place the provided height adaptors onto the back of the GARAGE control as needed.
4. Press the GARAGE control to activate the transmitter.

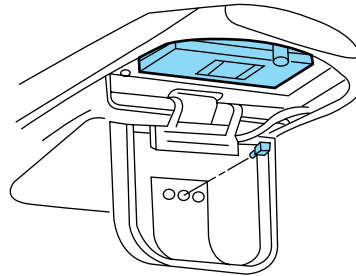

## Driver Controls

### Electronic compass/temperature display (if equipped)

#### Outside air temperature

The outside temperature display is contained in the overhead console.

The temperature display can be turned off and on by pressing the SELECT control on the overhead console. The temperature can be displayed in Centigrade or Fahrenheit by pressing the SELECT control.

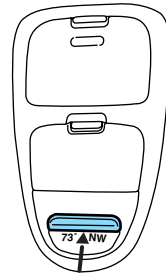

If the outside temperature falls below 3°C (38°F), the display will alternate from “ICE” to the outside temperature at a two second rate for one minute.

#### Compass

The compass display is contained in the overhead console. The vehicle heading is displayed as one of N, NE, E, SE, S, SW, W and NW.

The compass reading may be affected when you drive near large buildings, bridges, power lines and powerful broadcast antenna. Magnetic or metallic objects placed in or on the vehicle may also affect compass accuracy. Adjustments may need to be made to the zone and calibration of the compass.

#### Compass zone adjustment

1. Determine which magnetic zone you are in by referring to the zone map.
2. Turn the ignition to the ON position.

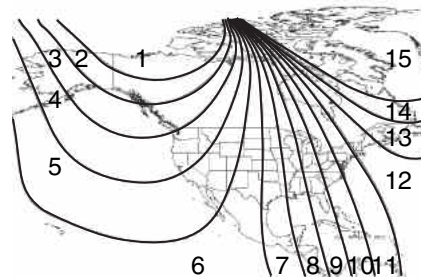

## Driver Controls

3. Press and hold the SELECT control until VAR appears in the display, then release. The display should show the current zone number.

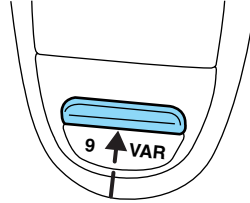

4. Press the SELECT control until the desired zone number appears. The display will flash and then return to normal operation. The zone is now updated.

### Compass calibration adjustment

Perform this adjustment in an open area free from steel structures and high voltage lines:

- Press and hold the SELECT control until CAL appears in the display (approximately eight seconds) and release.
- Drive the vehicle slowly (less than 5 km/h [3 mph]) in circles until CAL indicator turns off in about 2–3 complete circles.
- The compass is now calibrated.

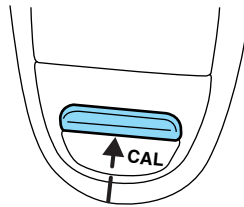

### AUXILIARY POWER POINT (12VDC)

**Power outlets are designed for accessory plugs only. Do not insert any other object in the power outlet as this will damage the outlet and blow the fuse. Do not hang any type of accessory or accessory bracket from the plug. Improper use of the power outlet can cause damage not covered by your warranty.**

The auxiliary power point (equipped with a cover or a cap plug) is located on the instrument panel.

A second power point (if equipped) is located behind the driver's seat on the upper trim panel.

Do not use the power point for operating the cigarette lighter element (if equipped).

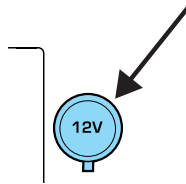



## Driver Controls

To prevent the fuse from being blown, do not use the power point(s) over the vehicle capacity of 12 VDC/180W. If the power point or cigar lighter socket is not working, a fuse may have blown. Refer to *Fuses and Relays* in the *Roadside Emergencies* chapter for information on checking and replacing fuses.

To prevent the battery from being discharged, do not use the power point longer than necessary when the engine is not running.

Always keep the power point caps closed when not being used.

### **Cigar/Cigarette lighter (if equipped)**

Do not plug optional electrical accessories into the cigarette lighter socket.

Do not hold the lighter in with your hand while it is heating, this will damage the lighter element and socket. The lighter will be released from its heating position when it is ready to be used.

Improper use of the lighter can cause damage not covered by your warranty.

### **POWER WINDOWS (IF EQUIPPED)**



Do not leave children unattended in the vehicle and do not let children play with the power windows. They may seriously injure themselves.



When closing the power windows, you should verify they are free of obstructions and ensure that children and/or pets are not in the proximity of the window openings.

Press and hold the bottom part of the rocker switch to open the window. Press and hold the top part of the rocker switch to close the window.

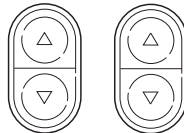



### **Accessory delay**

With accessory delay, the window switches and radio may be used for up to ten minutes after the ignition switch is turned to the OFF position, or until any door is opened.

## Driver Controls

### POWER SIDE VIEW MIRRORS (IF EQUIPPED)

To adjust your mirrors:

1. Select  to adjust the left mirror or  to adjust the right mirror.
2. Move the control in the direction you wish to tilt the mirror.
3. Return to the center position to disable the adjust function.

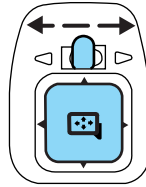

### Spotter mirror

**Note:** New spotter mirrors may be stiff, requiring several cycles before the spotter adjustment effort eases.

#### Standard mirror (if equipped)

The spotter mirror only can be tilted from top to bottom. Move the lower mirror manually up/down to increase side and rear visibility. Apply pressure only in the center of the spotter mirror along the top or bottom edges to adjust the tilt feature. **Do not apply any force on the left or right edges of the standard mirror spotter section, as this may lead to a mirror fracture.**

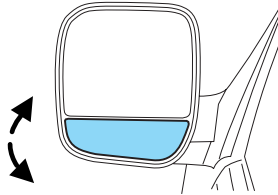

#### Telescoping mirror

The spotter mirror has a swivel that allows it to tilt up and down, and also to tilt left and right to increase side and rear visibility.

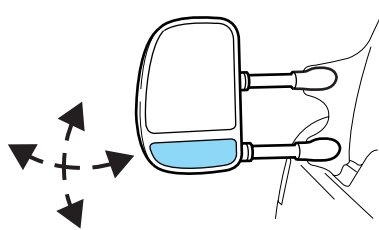

## Driver Controls

### Fold-away mirrors

The mirrors can be manually folded forward or backwards for narrow spaces like driving through an automatic car wash or backing out of a garage with the trailer tow mirror.

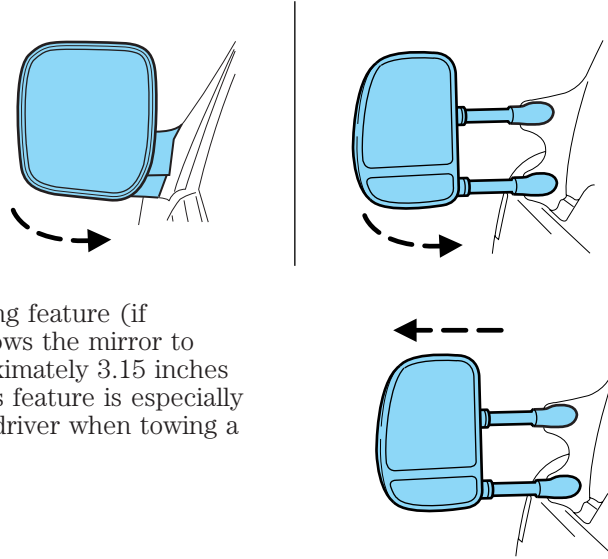

The telescoping feature (if equipped) allows the mirror to extend approximately 3.15 inches (80 mm). This feature is especially useful to the driver when towing a trailer.

### SPEED CONTROL (IF EQUIPPED)

With speed control set, you can maintain a set speed without keeping your foot on the accelerator pedal.



Do not use the speed control in heavy traffic or on roads that are winding, slippery or unpaved.

## Driver Controls

### Setting speed control

The controls for using your speed control are located on the steering wheel for your convenience.

1. Press the ON control and release it.
2. Accelerate to the desired speed.
3. Press the SET ACCEL control and release it.
4. Take your foot off the accelerator pedal.

#### Note:

- Vehicle speed may vary momentarily when driving up and down a steep hill.
- If the vehicle speed increases above the set speed on a downhill, you may want to apply the brakes to reduce the speed.
- If the vehicle speed decreases more than 10 mph (16 km/h) below your set speed on an uphill, your speed control will disengage.

### Resuming a set speed

Press the RES (resume) control and release it. This will automatically return the vehicle to the previously set speed.

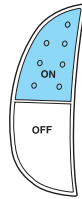

## Driver Controls

### **Increasing speed while using speed control**

There are two ways to set a higher speed:

- Press and hold the SET ACCEL control until you get to the desired speed, then release the control. You can also use the SET ACCEL control to operate the Tap-Up function. Press and release this control to increase the vehicle set speed in increments by 1 mph (1.6 km/h).
- Use the accelerator pedal to get to the desired speed. When the vehicle reaches that speed press and release the SET ACCEL control.



### **Reducing speed while using speed control**

There are two ways to reduce a set speed:

- Press and hold the COAST control until you get to the desired speed, then release the control. You can also use the COAST control to operate the Tap-Down function. Press and release this control to decrease the vehicle set speed in increments by 1 mph (1.6 km/h).
- Depress the brake pedal until the desired vehicle speed is reached, press the SET ACCEL control.



## Driver Controls

### ***Turning off speed control***

There are two ways to turn off the speed control:

- Depress the brake pedal. This will not erase your vehicle's previously set speed.
- Press the speed control OFF control.

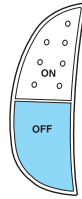

**Note:** When you turn off the speed control or the ignition, your speed control set speed memory is erased.

## Locks and Security

### KEYS

The key operates all locks on your vehicle. You should always carry a second key with you in a safe place in case you require it in an emergency.

Your keys are coded to your vehicle; using a non-coded key will not permit your vehicle to start. If you lose your dealer supplied keys, replacement keys are available through your authorized dealer.

### POWER DOOR LOCKS (IF EQUIPPED)

Press U to unlock all doors and L to lock all doors.

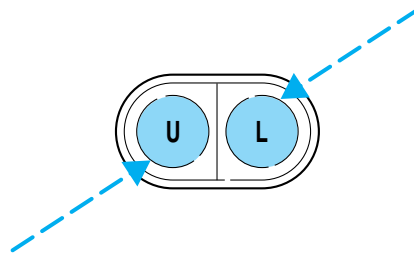

### Memory lock

If you lock your doors with the power lock switch or the remote transmitter while the sliding door is open, the door will automatically lock after it is closed.

### Autolock feature

**Note:** Your vehicle comes with the autolock feature disabled.

The autolock feature will lock all the doors when:

- all the doors are closed,
- the ignition is in the 4 (ON) position,
- you shift into any gear putting the vehicle in motion, and
- the vehicle attains a speed greater than 12 mph (20 km/h) for greater than 2 seconds.

The autolock feature repeats when:

- any door is opened then closed while the ignition is in the 4 (ON) position and the vehicle speed is 9 mph (15 km/h) or lower, and
- the vehicle then attains a speed greater than 12 mph (20 km/h) for greater than 2 seconds.

## Locks and Security

### **Deactivating/activating autolock feature**

Your vehicle comes with the autolock feature disabled; there are two methods to enable/disable this feature:

- Through your authorized dealer, or
- by using a power door unlock/lock procedure.

### **Power door lock switch autolock enable/disable procedure**

Before starting, ensure the ignition is in the 3 (OFF) position and all vehicle doors are closed. You must complete Steps 1–5 within 30 seconds or the procedure will have to be repeated. If the procedure needs to be repeated, wait a minimum of 30 seconds before beginning again.

1. Place the key in the ignition and turn the ignition to the 4 (ON) position.

2. Press the power door unlock control on the door panel three times.

3. Turn the ignition from the 4 (ON) position to the 3 (OFF) position.

4. Press the power door unlock control on the door panel three times.

5. Turn the ignition back to the 4 (ON) position. The horn will chirp one time to confirm programming mode has been entered and is active.

6. To enable/disable the autolock feature, press the unlock control, then press the lock control. The horn will chirp once if autolock was deactivated or twice (one short and one long chirp) if autolock was activated.

7. Turn the ignition to the 3 (OFF) position. The horn will chirp once to confirm the procedure is complete.

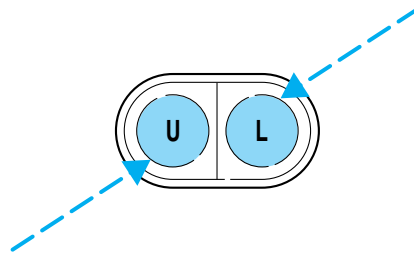



## Locks and Security

### Back cargo door lock (if equipped)

The passenger side rear cargo door has a power door lock control mounted on the inside of the door. When this lock is pressed, all doors will lock/unlock.

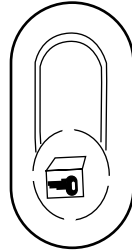

### REMOTE ENTRY SYSTEM (IF EQUIPPED)

This device complies with part 15 of the FCC rules and with RSS-210 of Industry Canada. Operation is subject to the following two conditions: (1) This device may not cause harmful interference, and (2) This device must accept any interference received, including interference that may cause undesired operation.

**Changes or modifications not expressly approved by the party responsible for compliance could void the user's authority to operate the equipment.**

The typical operating range for your remote entry transmitter is approximately 33 feet (10 meters). A decrease in operating range could be caused by:

- weather conditions,
- nearby radio towers,
- structures around the vehicle, or
- other vehicles parked next to your vehicle.

The remote entry system allows you to lock or unlock all vehicle doors without a key. **Note:**

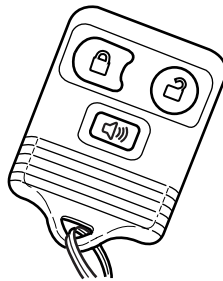

- The lock and unlock features work when the ignition is in any position.
- The panic feature is active when the ignition is in either the 1 (ACCESSORY), 2 (LOCK) or 3 (OFF) positions.



## Locks and Security

If there are problems with the remote entry system, make sure to take **ALL remote entry transmitters** with you to the authorized dealer in order to aid in troubleshooting the problem.

### Two step door unlocking



1. Press  and release to unlock the driver's door. **Note:** The interior lamps will illuminate if the control on the overhead lamp is **not** set to the **off** position.
2. Press  and release again within three seconds to unlock the passenger doors and the rear cargo doors.

The battery saver feature will turn off the interior lamps 30 minutes after the ignition is turned to the 1 (OFF/LOCK) position.



### One step door unlocking

If the one step door unlocking feature is activated, press  and release once to unlock the passenger doors and the rear cargo doors. **Note:** The interior lamps will illuminate (refer to the *Illuminated entry* feature later in this section), if the control on the overhead lamp is **not** set to the **off** position.

### Switching from two step to one step door unlocking

Your vehicle comes with two step unlocking enabled. Unlocking can be switched between two step and one step door unlocking by pressing and holding both the  and  buttons simultaneously on the remote entry transmitter for approximately 4 seconds and release. The parklamps will flash twice to indicate that the vehicle has switched to one step unlocking. Repeat the procedure to switch back to two-step unlocking.

### Locking the doors

1. Press  and release to lock all the doors.
2. Press  and release again within three seconds to confirm that all the doors are closed and locked. **Note:** The doors will lock again, and the horn will chirp once.

### Sounding a panic alarm

Press  to activate the alarm. Press the control again, or turn the ignition to the 1 (ACCESSORY) or 4 (ON) position to deactivate the alarm.

**Note:** The panic alarm will only operate when the ignition is in the 2 (LOCK) or 3 (OFF) position.

## Locks and Security

### Replacing the battery

The remote entry transmitter uses one coin type three-volt lithium battery CR2032 or equivalent.

To replace the battery:

1. Twist a thin coin between the two halves of the remote entry transmitter near the key ring. DO NOT TAKE THE RUBBER COVER AND CIRCUIT BOARD OFF THE FRONT HOUSING OF THE REMOTE ENTRY TRANSMITTER.

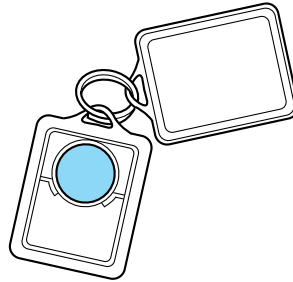

2. Do not wipe off any grease on the battery terminals on the back surface of the circuit board.

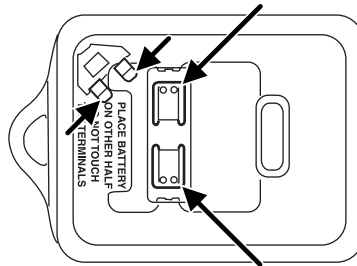

3. Remove the old battery. **Note:** Please refer to local regulations when disposing of transmitter batteries.

4. Insert the new battery. Refer to the diagram inside the remote entry transmitter for the correct orientation of the battery. Press the battery down to ensure that the battery is fully seated in the battery housing cavity.

5. Snap the two halves back together.

**Note:** Replacement of the battery will **not** cause the remote transmitter to become deprogrammed from your vehicle. The remote transmitter should operate normally after battery replacement.

## Locks and Security

### Replacing lost remote entry transmitters

If you would like to have your remote entry transmitter reprogrammed because you lost one, or would like to buy additional remote entry transmitters, you can either reprogram them yourself, or take **all remote entry transmitters** to your authorized dealer for reprogramming.

### How to reprogram your remote entry transmitters

You must have **all remote entry transmitters** (maximum of four) available before beginning this procedure. If all remote entry transmitters are not present during programming procedure, the ones missing during programming will no longer operate the vehicle.

**Note:** Ensure the brake pedal is not depressed during this sequence.

To reprogram the remote entry transmitters:

1. Ensure the vehicle is electronically unlocked.
2. Place the key in the ignition and turn from the (2) LOCK position to (3) OFF.
3. Cycle eight times rapidly (within 10 seconds) between the (3) OFF position and (4) ON. **Note:** The eighth turn must end in the (4) ON position.
4. The doors will lock, then unlock, to confirm that the programming mode has been activated.
5. Within 20 seconds press any button on the remote entry transmitter.  
**Note:** If more than 20 seconds have passed you will need to start the procedure over again.
6. The doors will lock, then unlock, to confirm that this remote entry transmitter has been programmed.
7. Repeat Steps 4 and 5 to program each additional remote entry transmitter (up to four transmitters).
8. Turn the ignition to the (3) OFF position after you have finished programming all of the remote entry transmitters.
9. The doors will lock, then unlock, to confirm that the programming mode has been exited.

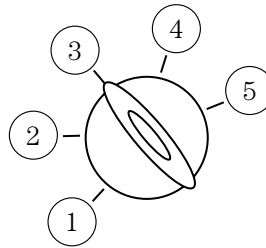

## Locks and Security

### Illuminated entry

The interior lamps illuminate when the remote entry system is used to unlock the door(s) or sound the personal alarm.

The illuminated entry system will turn off the interior lights if:

- the ignition switch is turned to the 4 (ON) or 1 (ACCESSORY) position, or
- the remote transmitter lock control is pressed, or
- after 25 seconds of illumination.

The dome lamp control (if equipped) must **not** be set to the off position for the illuminated entry system to operate.

The inside lights will not turn off if:

- they have been turned on with the dimmer control, or
- any door is open.

## Seating and Safety Restraints

### SEATING

#### Notes:



Reclining the seatback can cause an occupant to slide under the seat's safety belt, resulting in severe personal injuries in the event of a collision.



Do not pile cargo higher than the seatbacks to reduce the risk of injury in a collision or sudden stop.



Before returning the seatback to its original position, make sure that cargo or any objects are not trapped behind the seatback. After returning the seatback to its original position, pull on the seatback to ensure that it has fully latched. An unlatched seat may become dangerous in the event of a sudden stop or collision.

#### Adjusting the front manual seat (if equipped)



Never adjust the driver's seat or seatback when the vehicle is moving.



Always drive and ride with your seatback upright and the lap belt snug and low across the hips.

Lift handle to move seat forward or backward.

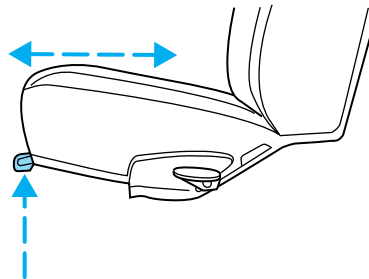

## Seating and Safety Restraints

Pull lever up to adjust seatback.

 Before returning the seatback to its original position, make sure that cargo or any objects are not trapped behind the seatback. After returning the seatback to its original position, pull on the seatback to ensure that it has fully latched. An unlatched seat may become dangerous in the event of a sudden stop or collision.

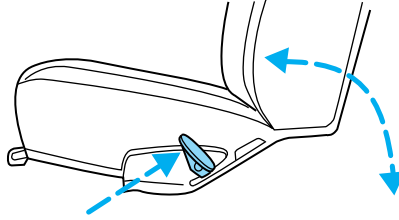

### Using the manual lumbar support

The lumbar support control is located on the inboard side of the driver's seat.

Turn the lumbar support control clockwise to increase firmness.

Turn the lumbar support control counterclockwise to increase softness.

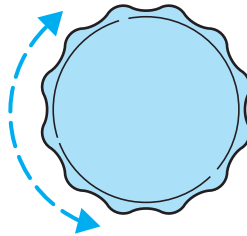

### Adjusting the front power seat (if equipped)

The control is located on the outboard side of the seat cushion.

Press to raise or lower the front portion of the seat cushion.

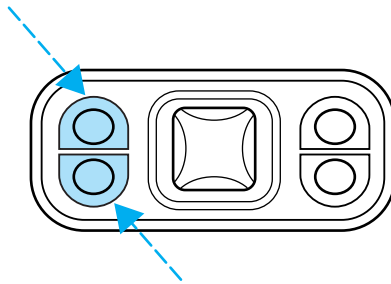

## Seating and Safety Restraints

Press to raise or lower the rear portion of the seat cushion.

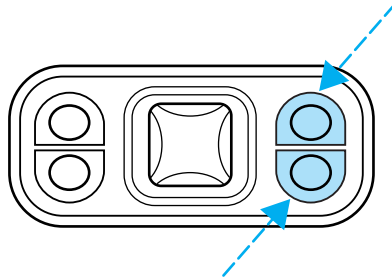

Press the control to move the seat forward, backward, up or down.

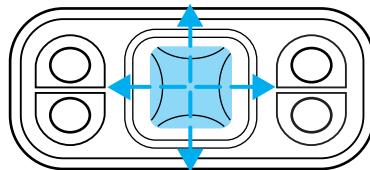

### REAR SEATS

#### Rear captains chair adjust — passenger side only

Pull the lever forward to adjust the seat forward or backward.

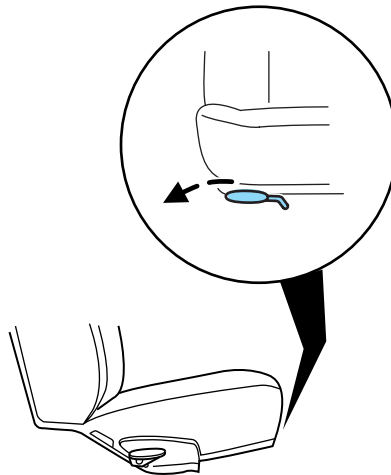



## Seating and Safety Restraints

### Quick release captains chair (7 passenger configuration second row only)

#### To remove the seat:

1. Disengage the lap/shoulder belt from the seat by inserting a key or small screwdriver into the slot in the detachable anchor and lifting upward.

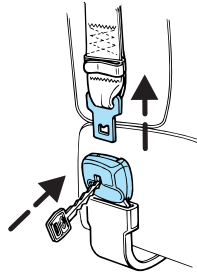

2. Stow the tongue end of the detachable anchor.

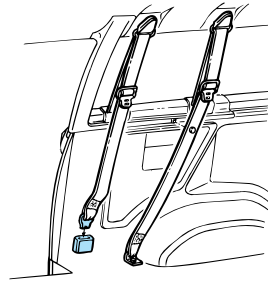

2. Pull the seat latch handle, then pull the seat toward the right side of the vehicle to disengage four pins from the floor mount.
3. Remove the seat.

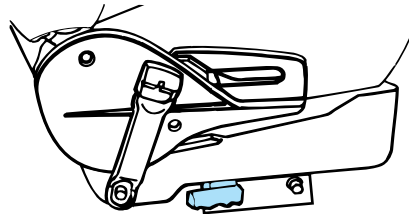

#### To install the seat:

-  Check to see that the seat and seatback is latched securely in position. Keep floor area free of objects that would prevent proper seat engagement. Never attempt to adjust the seat while the vehicle is in motion.

## Seating and Safety Restraints

 Ensure that the seat is latched to the vehicle floor by pushing/pulling on the seat. If not latched, the seat may cause injury during a sudden stop.

1. Position the seat to the floor mount.

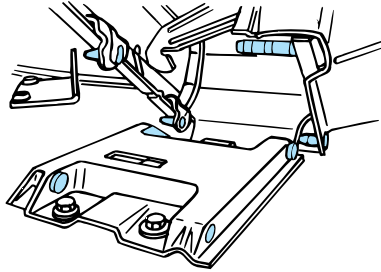

2. Pull the seat latch handle downward to lock the seat in position.
3. Make sure the safety belt is not twisted, then insert the safety belt tongue into detachable anchor until you hear a “click” and feel the latch engage.

### Accessing the 4th and 5th row seats (if equipped)

To make access to the 4th and 5th row seats easier, attach the 3rd and 4th row passenger side safety belts to the trim panel by using the snaps attached to the safety belt webbing and the trim panel.

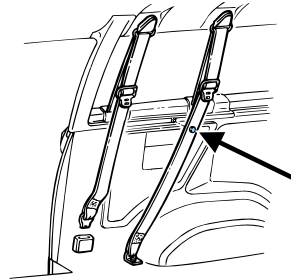

## Seating and Safety Restraints

### Rear bench seat

#### To remove the seats:

1. Disengage the lap/shoulder belt from the seat by inserting a key or small screwdriver into the slot in the detachable anchor and lifting upward (2nd row passenger side only).

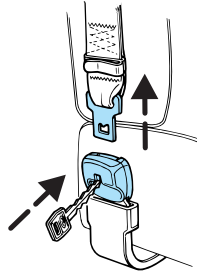

Stow the tongue end of the detachable anchor (2nd row only).

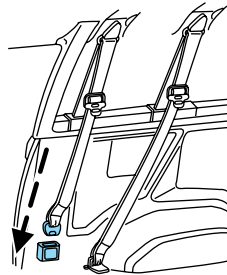

2. Pull the LH/RH seat latch handles (located under the seat) rearward to release the latch hook ends from the front strikers.

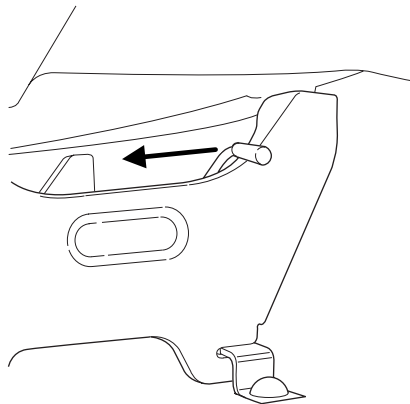

3. Move the seat rearward and lift the seats rear hooks away from the rear strikers prior to lifting the front hooks out from the front strikers.

## Seating and Safety Restraints

4. With assistance, remove the seat assembly.
  - To remove the 3rd, 4th, and 5th row seats (if equipped), repeat Steps 2 through 4.

### To install the seat:

 Ensure that the seat is latched to the vehicle floor by pushing/pulling on the seat. If not latched, the seat may cause injury during a sudden stop.

1. Position the seat in the vehicle.
2. Align front hooks to front strikers, prior to lowering the rear hooks and aligning them with the rear strikers.
3. Engage the LH/RH latch rod hook ends in the front striker locking holes.
4. Rotate the LH/RH latch handles forward, and at the same time slide the seat assembly forward to engage the strikers. Continue forward movement until the seat reaches the end of its travel.
5. Make sure the safety belt is not twisted, then insert the safety belt tongue into detachable anchor until you hear a “click” and feel the latch engage (2nd row only).

 Always latch the vehicle seat to the floor, whether the seat is occupied or empty. If not latched, the seat may cause injury during a sudden stop.

## SAFETY RESTRAINTS

### Safety restraints precautions

 Always drive and ride with your seatback upright and the lap belt snug and low across the hips.

 To reduce the risk of injury, make sure children sit in the back seat where they can be properly restrained.

 Never let a passenger hold a child on his or her lap while the vehicle is moving. The passenger cannot protect the child from injury in a collision.

## Seating and Safety Restraints



All occupants of the vehicle, including the driver, should always properly wear their safety belts, even when an airbag supplemental restraint system (SRS) is provided.



It is extremely dangerous to ride in a cargo area, inside or outside of a vehicle. In a collision, people riding in these areas are more likely to be seriously injured or killed. Do not allow people to ride in any area of your vehicle that is not equipped with seats and safety belts. Be sure everyone in your vehicle is in a seat and using a safety belt properly.



In a rollover crash, an unbelted person is significantly more likely to die than a person wearing a safety belt.



Each seating position in your vehicle has a specific safety belt assembly which is made up of one buckle and one tongue that are designed to be used as a pair. 1) Use the shoulder belt on the outside shoulder only. Never wear the shoulder belt under the arm. 2) Never swing the safety belt around your neck over the inside shoulder. 3) Never use a single belt for more than one person.



Always transport children 12 years old and under in the back seat and always properly use appropriate child restraints.



Safety belts and seats can become hot in a vehicle that has been closed up in sunny weather; they could burn a small child. Check seat covers and buckles before you place a child anywhere near them.

## Seating and Safety Restraints

### Combination lap and shoulder belts

1. Insert the belt tongue into the proper buckle (the buckle closest to the direction the tongue is coming from) until you hear a snap and feel it latch. Make sure the tongue is securely fastened in the buckle.

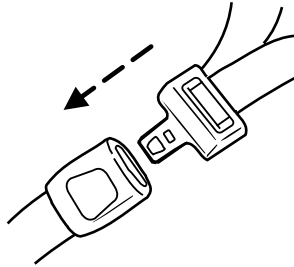

2. To unfasten, push the release button and remove the tongue from the buckle.

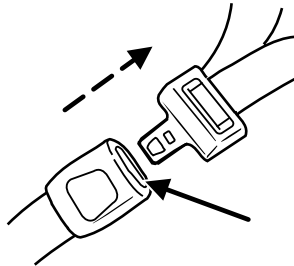

The front outboard and rear outboard safety restraints in the vehicle are combination lap and shoulder belts. The front passenger outboard and rear outboard safety belts have two types of locking modes described below:

### Vehicle sensitive mode

This is the normal retractor mode, which allows free shoulder belt length adjustment to your movements and locking in response to vehicle movement. For example, if the driver brakes suddenly or turns a corner sharply, or the vehicle receives an impact of approximately 5 mph (8 km/h) or more, the combination safety belts will lock to help reduce forward movement of the driver and passengers.

### Automatic locking mode

#### ***When to use the automatic locking mode***

In this mode, the shoulder belt is automatically pre-locked. The belt will still retract to remove any slack in the shoulder belt. The automatic locking mode is not available on the driver safety belt.

## Seating and Safety Restraints

This mode should be used **any time** a child safety seat (except a booster) is installed in a passenger front or outboard rear seating position (if equipped). Children 12 years old and under should be properly restrained in the rear seat whenever possible. Refer to *Safety restraints for children* or *Safety seats for children* later in this chapter.

### **How to use the automatic locking mode**

- Buckle the combination lap and shoulder belt.

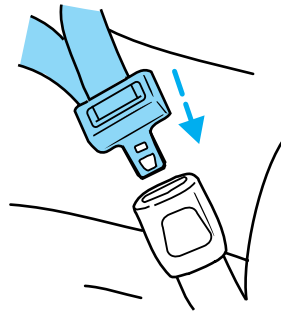

- Grasp the shoulder portion and pull downward until the entire belt is pulled out.

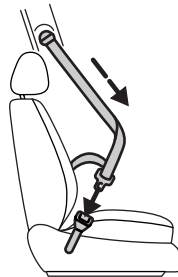



- Allow the belt to retract. As the belt retracts, you will hear a clicking sound. This indicates the safety belt is now in the automatic locking mode.

### **How to disengage the automatic locking mode**

Disconnect the combination lap/shoulder belt and allow it to retract completely to disengage the automatic locking mode and activate the vehicle sensitive (emergency) locking mode.

## Seating and Safety Restraints

 After any vehicle collision, the safety belt systems at all outboard seating positions (except the driver position, which does not have this feature) must be checked by an authorized dealer to verify that the automatic locking retractor feature for child seats is still functioning properly. In addition, all safety belts should be checked for proper function.

 **BELT AND RETRACTOR ASSEMBLY MUST BE REPLACED** if the safety belt assembly “automatic locking retractor” feature or any other safety belt function is not operating properly when checked by an authorized dealer. Failure to replace the Belt and Retractor assembly could increase the risk of injury in collisions.

### Safety belt pretensioner

Your vehicle is equipped with safety belt pretensioners at the driver and front outboard passenger seating positions.

The safety belt pretensioner tightens the safety belts firmly against the occupant’s body at the start of the crash.

 The driver and front passenger safety belt system (including retractors, buckles and height adjusters) must be replaced if the vehicle is involved in a collision that results in deployment of front airbags and safety belt pretensioners.

### Front safety belt height adjustment

The front seat and outboard positions are equipped with a height adjuster. Adjust the height of the shoulder belt so the belt rests across the middle of your shoulder.

To adjust the shoulder belt height, push the button and slide the height adjuster down. Release the button and pull down on the height adjuster to make sure it is locked in place. To adjust the belt upward, slide the adjuster up. Pull down on the height adjuster to make sure it is locked in place.

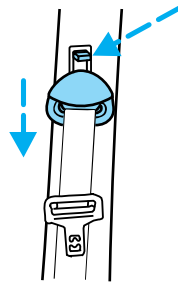



## Seating and Safety Restraints

 Position the safety belt height adjusters so that the belt rests across the middle of your shoulder. Failure to adjust the safety belt properly could reduce the effectiveness of the seat belt and increase the risk of injury in a collision.

### Lap belts

#### ***Adjusting the center lap belt***

The lap belt does not adjust automatically.

 The lap belt should fit snugly and as low as possible around the hips, not across the waist.

Insert the tongue into the correct buckle (the buckle closest to the direction the tongue is coming from). To lengthen the belt, turn the tongue at a right angle to the belt and pull across your lap until it reaches the buckle. To tighten the belt, pull the loose end of the belt through the tongue until it fits snugly across the hips.

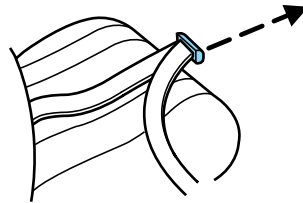

Shorten and fasten the belt when not in use.

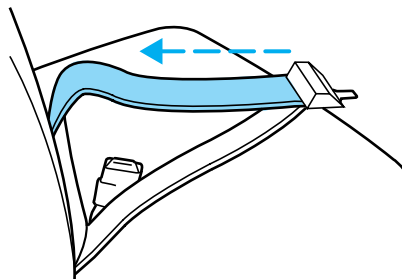

### **Safety belt warning light and indicator chime**

The safety belt warning light illuminates in the instrument cluster and a chime sounds to remind the occupants to fasten their safety belts.

## Seating and Safety Restraints

### Conditions of operation

If...	Then...
The driver's safety belt is not buckled before the ignition switch is turned to the ON position...	The safety belt warning light illuminates and the warning chime sounds 4-8 seconds.
The driver's safety belt is buckled while the indicator light is illuminated and the warning chime is sounding...	The safety belt warning light and warning chime turn off.
The driver's safety belt is buckled before the ignition switch is turned to the ON position...	The safety belt warning light and the warning chime will remain off.

### Belt-Minder®

The Belt-Minder® feature is a supplemental warning to the safety belt warning function. This feature provides additional reminders to the driver that the driver's safety belt is unbuckled by intermittently sounding a chime and illuminating the safety belt warning lamp in the instrument cluster.

If...	Then...
The driver's safety belt is not buckled approximately 5 seconds after the safety belt warning light has turned off...	The Belt-Minder® feature is activated - the safety belt warning light illuminates and the warning chime sounds for 6 seconds every 30 seconds, repeating for approximately 5 minutes or until safety belt is buckled.
The driver's safety belt is buckled while the safety belt indicator light is illuminated and the safety belt warning chime is sounding...	The Belt-Minder® feature will not activate.
The driver's safety belt is buckled before the ignition switch is turned to the ON position...	The Belt-Minder® feature will not activate.

## Seating and Safety Restraints

The following are reasons most often given for not wearing safety belts:  
(All statistics based on U.S. data)

Reasons given...	Consider...
"Crashes are rare events"	<b>36700 crashes occur every day.</b> The more we drive, the more we are exposed to "rare" events, even for good drivers. <i>1 in 4 of us will be seriously injured in a crash during our lifetime.</i>
"I'm not going far"	<b>3 of 4</b> fatal crashes occur within <b>25</b> miles of home.
"Belts are uncomfortable"	We design our safety belts to enhance comfort. If you are uncomfortable - try different positions for the safety belt upper anchorage and seatback which should be as upright as possible; this can improve comfort.
"I was in a hurry"	<b>Prime time for an accident.</b> Belt-Minder® reminds us to take a few seconds to buckle up.
"Safety belts don't work"	<b>Safety belts</b> , when used properly, <b>reduce risk of death</b> to front seat occupants by <b>45% in cars</b> , and by <b>60% in light trucks</b> .
"Traffic is light"	<b>Nearly 1 of 2 deaths occur in single-vehicle crashes</b> , many when no other vehicles are around.
"Belts wrinkle my clothes"	Possibly, but a serious crash can do much more than wrinkle your clothes, particularly if you are unbelted.
"The people I'm with don't wear belts"	Set the example, teen deaths occur 4 times more often in vehicles with TWO or MORE people. Children and younger brothers/sisters imitate behavior they see.

## Seating and Safety Restraints

Reasons given...	Consider...
"I have an airbag"	Airbags offer greater protection when used with safety belts. Frontal airbags are not designed to inflate in rear and side crashes or rollovers.
"I'd rather be thrown clear"	<b>People who are ejected are 40 times more likely to DIE.</b> Safety belts help prevent ejection, WE CAN'T "PICK OUR CRASH".



Do not sit on top of a buckled safety belt or insert a latchplate into the buckle to avoid the Belt-Minder® chime. To do so may adversely affect the performance of the vehicle's air bag system

### **One time disable**

Any time the safety belt is buckled and then unbuckled during an ignition ON cycle, the Belt-Minder® will be disabled for that ignition cycle only.

### **Deactivating/activating the Belt-Minder® feature**

*Read Steps 1 - 5 thoroughly before proceeding with the deactivation/activation programming procedure.*

The Belt-Minder® feature can be deactivated/activated by performing the following procedure:

Before following the procedure, make sure that:

- the parking brake is set
- the gearshift is in P (Park) (automatic transmission)
- the ignition switch is in the OFF position
- all vehicle doors are closed
- the driver's safety belt is unbuckled
- the parklamps/headlamps are in the OFF position



While the design allows you to deactivate your Belt-Minder®, this system is designed to improve your chances of being safely belted and surviving an accident. We recommend you leave the Belt-Minder® system activated for yourself and others who may use the vehicle. To reduce the risk of injury, do not deactivate/activate the Belt-Minder® feature while driving the vehicle.

## Seating and Safety Restraints

1. Turn the ignition switch to the ON position. (DO NOT START THE ENGINE.)
2. Wait until the safety belt warning light turns off. (Approximately 1 minute)
  - Step 3 must be completed within 50 seconds after the safety belt warning light turns off.
3. At a moderate speed, buckle then unbuckle the safety belt 9 times, ending with the safety belt in the unbuckled state.
  - After Step 3 is complete, the safety belt warning light will be turned on for 3 seconds.
  - Belt-Minder® will automatically exit programming mode without changing its enable status if Step 4 does not occur within 10 seconds of the end of Step 3.
4. Within approximately 7 seconds of the light turning off, buckle then unbuckle the safety belt.
  - This will disable the Belt-Minder® feature for that seating position if it is currently enabled. As confirmation, the safety belt warning light will flash 4 times per second for 3 seconds.
  - This will enable the Belt-Minder® feature for that seating position if it is currently disabled. As confirmation, the safety belt warning light will flash 4 times per second for 3 seconds, followed by 3 seconds with the light off, then followed by the safety belt warning light flashing 4 times per second for 3 seconds again.
5. After receiving confirmation, the deactivation/activation procedure is complete.

### Safety belt extension assembly

If the safety belt is too short when fully extended, there is a 8 inch (20 cm) safety belt extension assembly that can be added (part number 611C22). This assembly can be obtained from an authorized dealer.

Use only extensions manufactured by the same supplier as the safety belt. Manufacturer identification is located at the end of the webbing on the label. Also, use the safety belt extension only if the safety belt is too short for you when fully extended.



Do not use extensions to change the fit of the shoulder belt across the torso.

## Seating and Safety Restraints

### Safety belt maintenance

Inspect the safety belt systems periodically to make sure they work properly and are not damaged. Inspect the safety belts to make sure there are no nicks, tears or cuts. Replace if necessary. All safety belt assemblies, including retractors, buckles, front safety belt buckle assemblies, buckle support assemblies (slide bar-if equipped), shoulder belt height adjusters (if equipped), shoulder belt guide on seatback (if equipped), child safety seat LATCH and tether anchors, and attaching hardware, should be inspected after a collision. Ford Motor Company recommends that all safety belt assemblies in use in vehicles involved in a collision be replaced. However, if the collision was minor and an authorized dealer finds that the belts do not show damage and continue to operate properly, they do not need to be replaced. Safety belt assemblies not in use during a collision should also be inspected and replaced if either damage or improper operation is noted.



Failure to inspect and if necessary replace the safety belt assembly under the above conditions could result in severe personal injuries in the event of a collision.

For proper care of soiled safety belts, refer to *Interior* in the *Cleaning* chapter.

### AIRBAG SUPPLEMENTAL RESTRAINT SYSTEM (SRS)

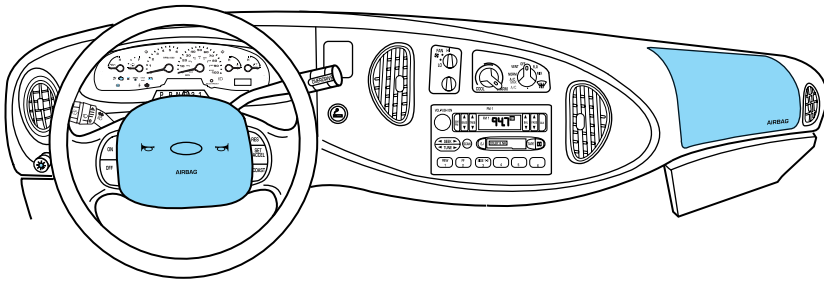



## Seating and Safety Restraints

### Important SRS precautions

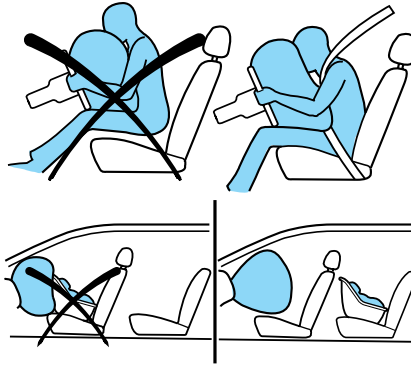
The SRS is designed to work with the safety belt to help protect the driver and right front passenger from certain upper body injuries. Airbags DO NOT inflate slowly; there is a risk of injury from a deploying airbag.



 All occupants of the vehicle, including the driver, should always properly wear their safety belts, even when an air bag supplemental restraint system (SRS) is provided.

 Always transport children 12 years old and under in the back seat and always properly use appropriate child restraints. Never place a rear-facing child seat in front of an active airbag. If you must transport a forward-facing child in the front seat, move the seat all the way back and use appropriate restraints.

 The National Highway Traffic Safety Administration (NHTSA) recommends a minimum distance of at least 25 cm (10 inches) between an occupant's chest and the driver airbag module.

 Never place your arm over the air bag module as a deploying air bag can result in serious arm fractures or other injuries.

To properly position yourself away from the airbag:

- Move your seat to the rear as far as you can while still reaching the pedals comfortably.
- Recline the seat slightly one or two degrees from the upright position.

## Seating and Safety Restraints

 Do not put anything on or over the air bag module. Placing objects on or over the air bag inflation area may cause those objects to be propelled by the air bag into your face and torso causing serious injury.

 Do not attempt to service, repair, or modify the airbag supplemental restraint systems or its fuses. See your authorized dealer.

 Modifying or adding equipment to the front end of the vehicle (including frame, bumper, front end body structure and tow hooks) may affect the performance of the airbag system, increasing the risk of injury. Do not modify the front end of the vehicle.

 Additional equipment may affect the performance of the airbag sensors increasing the risk of injury. Please refer to the *Body Builders Layout Book* for instructions about the appropriate installation of additional equipment.

### Children and airbags

Children must always be properly restrained. Accident statistics suggest that children are safer when properly restrained in the rear seating positions than in the front seating position. Failure to follow these instructions may increase the risk of injury in a collision.

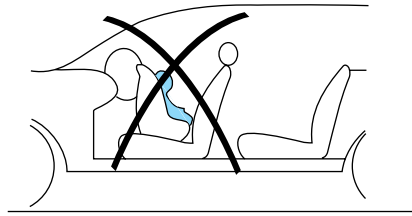

 Airbags can kill or injure a child in a child seat. **NEVER** place a rear-facing child seat in front of an active airbag. If you must use a forward-facing child seat in the front seat, move the seat all the way back.

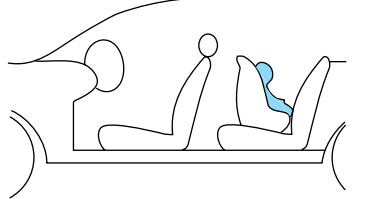



## Seating and Safety Restraints

### How does the airbag supplemental restraint system work?

The airbag SRS is designed to activate when the vehicle sustains a longitudinal deceleration sufficient to cause the airbag sensors to close an electrical circuit that initiates airbag inflation. The fact that the airbags did not inflate in a collision does not mean that something is wrong with the system. Rather, it means the forces were not sufficient enough to cause activation. Airbags are designed to inflate in frontal and near-frontal collisions, not rollover, side-impact, or rear-impacts unless the collision causes sufficient longitudinal deceleration.

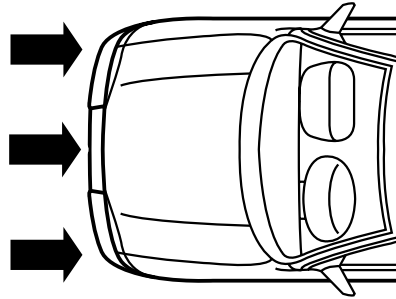

The airbags inflate and deflate rapidly upon activation. After airbag deployment, it is normal to notice a smoke-like, powdery residue or smell the burnt propellant. This may consist of cornstarch, talcum powder or sodium compounds which may irritate the skin and eyes, but none of the residue is toxic.



While the SRS is designed to help reduce serious injuries, contact with a deploying airbag may also cause abrasions, swelling or temporary hearing loss. Because airbags must inflate rapidly and with considerable force, there is the risk of death or serious injuries such as fractures, facial and eye injuries or internal injuries, particularly to occupants who are not properly restrained or are otherwise out of position at the time of airbag deployment. It is extremely important that occupants be properly restrained as far away from the airbag module as possible while maintaining vehicle control.

The SRS consists of:

- driver and passenger airbag modules (which include the inflators and airbags)
- one or more impact and safing sensors

## Seating and Safety Restraints

- a readiness light and tone
- a diagnostic module
- and the electrical wiring which connects the components

The diagnostic module monitors its own internal circuits and the supplemental airbag electrical system wiring (including the impact sensors), the system wiring, the airbag system readiness light, the airbag back up power and the airbag ignitors.



Several air bag system components get hot after inflation. Do not touch them after inflation.



If the air bag has deployed, **the air bag will not function again and must be replaced immediately.** If the air bag is not replaced, the unrepaired area will increase the risk of injury in a collision.

### Determining if the system is operational

The SRS uses a readiness light in the instrument cluster or a tone to indicate the condition of the system. Refer to *Airbag readiness* section in the *Instrument Cluster* chapter. Routine maintenance of the airbag is not required.

A difficulty with the system is indicated by one or more of the following:

- The readiness light will either flash or stay lit.
- The readiness light will not illuminate immediately after ignition is turned on.
- A series of five beeps will be heard. The tone pattern will repeat periodically until the problem and/or light are repaired.



If any of these things happen, even intermittently, have the SRS serviced at an authorized dealer immediately. Unless serviced, the system may not function properly in the event of a collision.

### Disposal of airbags and airbag equipped vehicles (including pretensioners)

See your authorized dealer. Airbags **MUST BE** disposed of by qualified personnel.

## Seating and Safety Restraints

### Passenger airbag ON/OFF switch (if equipped)

**Note:** The passenger airbag ON/OFF switch is on vehicles with no rear seats and a gross vehicle weight rating (GVWR) greater than 8500. See *Vehicle loading – with and without a trailer* in the *Tires, Wheels, and loading* chapter.

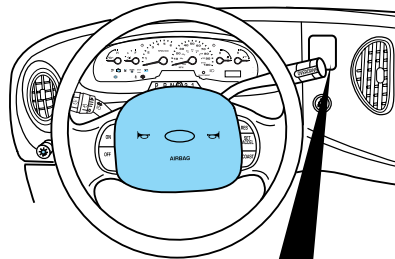

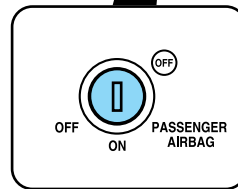

 An airbag ON/OFF switch has been installed in this vehicle. Before driving, *always* look at the face of the switch to be sure the switch is in the proper position in accordance with these instructions and warnings. Failure to put the switch in a proper position can increase the risk of serious injury or death in a collision.

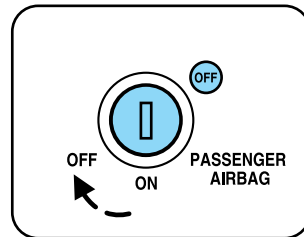

### Turning the passenger airbag off

1. Insert the ignition key, turn the switch to OFF position and hold in OFF position while removing the key.
2. When the ignition is turned to the ON position the OFF light illuminates briefly, momentarily shuts off and then turns back on. This indicates that the passenger airbag is deactivated.



 If the light fails to illuminate when the passenger air bag switch is in the OFF position and the ignition switch is in ON, have the passenger air bag switch serviced at your Ford or Lincoln-Mercury dealer immediately.

## Seating and Safety Restraints



In order to avoid inadvertent activation of the switch, always remove the ignition key from the passenger air bag ON/OFF switch.



An infant in a rear-facing seat faces a high risk of serious or fatal injuries from a deploying passenger airbag. Rear facing infant seats should NEVER be placed in the front seats, unless the passenger airbag is turned off.

### **Turning the passenger airbag back on**

The passenger airbag remains OFF until you turn it back ON.

1. Insert the ignition key and turn the switch to ON.
2. The OFF light will briefly illuminate when the ignition is turned to On. This indicates that the passenger airbag is operational.

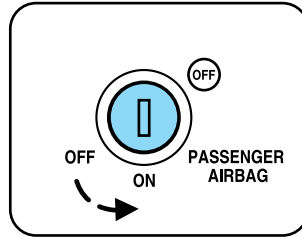

If the OFF light is illuminated when the passenger airbag switch is in the ON position and the ignition switch is in ON, have the passenger airbag switch serviced at an authorized dealer immediately.

The passenger side airbag should always be ON (the airbag OFF light should *not* be illuminated) unless the passenger is a person who meets the requirements stated either in Category 1, 2 or 3 of the NHTSA/Transport Canada deactivation criteria which follows.



The safety belts for the driver and right front passenger seating positions have been specifically designed to function together with the airbags in certain types of crashes. When you turn OFF your airbag, you not only lose the protection of the airbag, you also may reduce the effectiveness of your safety belt system, which was designed to work with the airbag. If you are not a person who meets the requirements stated in the NHTSA/Transport Canada deactivation criteria turning OFF the airbag can increase the risk of serious injury or death in a collision.

## Seating and Safety Restraints



If your vehicle has rear seats, always transport children who are 12 and younger in the rear seat. Always use safety belts and child restraints properly. If a child in a rear facing infant seat must be transported in front, the passenger airbag *must* be turned OFF. This is because the back of the infant seat is too close to the inflating airbag and the risk of a fatal injury to the infant when the airbag inflates is substantial.

The vast majority of drivers and passengers are much safer with an airbag than without. To do their job and reduce the risk of life threatening injuries, airbags must open with great force, and this force can pose a potentially deadly risk in some situations, particularly when a front seat occupant is not properly buckled up. The most effective way to reduce the risk of unnecessary airbag injuries without reducing the overall safety of the vehicle is to make sure all occupants are properly restrained in the vehicle, especially in the front seat. This provides the protection of safety belts and permits the airbags to provide the additional protection they were designed to provide. If you choose to deactivate your airbag, you are losing the very significant risk reducing benefits of the airbag and you are also reducing the effectiveness of the safety belts, because safety belts in modern vehicles are designed to work as a safety system with the airbags.

Read all airbag warning labels in the vehicle as well as the other important airbag instructions and warnings in this Owner's Guide.

### ***NHTSA deactivation criteria (excluding Canada)***

1. **Infant.** An infant (less than 1 year old) must ride in the front seat because:

- the vehicle has no rear seat;
- the vehicle has a rear seat too small to accommodate a rear-facing infant seat; or
- the infant has a medical condition which, according to the infant's physician, makes it necessary for the infant to ride in the front so that the driver can constantly monitor the child's condition.

2. **Child age 1 to 12.** A child age 1 to 12 must ride in the front seat because:

- the vehicle has no rear seat;
- although children ages 1 to 12 ride in the rear seat(s) whenever possible, children ages 1 to 12 sometimes must ride in the front because no space is available in the rear seat(s) of the vehicle; or

## Seating and Safety Restraints

- the child has a medical condition which, according to the child's physician, makes it necessary for the child to ride in the front seat so that the driver can constantly monitor the child's condition.
3. **Medical condition.** A passenger has a medical condition which, according to his or her physician:
- causes the passenger airbag to pose a special risk for the passenger; and
  - makes the potential harm from the passenger airbag in a crash greater than the potential harm from turning OFF the airbag and allowing the passenger, even if belted, to hit the dashboard or windshield in a crash.



This vehicle has special energy management safety belts for the driver and right front passenger. These particular belts are specifically designed to work with airbags to help reduce the risk of injury in a collision. The energy management safety belt is designed to give or release additional belt webbing in some accidents to reduce concentration of force on an occupant's chest and reduce the risk of certain bone fractures and injuries to underlying organs. In a crash, if the airbag is turned OFF, this energy management safety belt might permit the person wearing the belt to move forward enough to incur a serious or fatal injury. The more severe the crash, and the heavier the occupant, the greater the risk is. Be sure the airbag is turned ON for any person who does not qualify under the NHTSA deactivation criteria.

### ***Transport Canada deactivation criteria (Canada Only)***

1. **Infant:** An infant (less than 1 year old) must ride in the front seat because:
- my vehicle has no rear seat;
  - the rear seat in my vehicle cannot accommodate a rear-facing infant seat; or
  - the infant has a medical condition which, according to the infant's physician, makes it necessary for the infant to ride in the front seat so that the driver can monitor the infant's condition.
2. **Child age 12 or under:** A child age 12 or under must ride in the front seat because:
- my vehicle has no rear seat;
  - although children age 12 and under ride in the rear seat whenever possible, children age 12 and under have no option but to sometimes ride in the front seat because rear seat space is insufficient; or

## Seating and Safety Restraints

- the child has a medical condition that, according to the child's physician, makes it necessary for the child to ride in the front seat so that the driver can monitor the child's condition.
3. **Medical condition:** A passenger has a medical condition that, according to his or her physician:
- poses a special risk for the passenger if the airbag deploys; and
  - makes the potential harm from the passenger airbag deployment greater than the potential harm from turning OFF the airbag and experiencing a crash without the protection offered by the airbag



This vehicle has special energy management safety belts for the driver and right front passenger. These particular belts are specifically designed to work with airbags to help reduce the risk of injury in a collision. The energy management safety belt is designed to give or release additional belt webbing in some accidents to reduce concentration of force on an occupant's chest and reduce the risk of certain bone fractures and injuries to underlying organs. In a crash, if the airbag is turned OFF, this energy management safety belt might permit the person wearing the belt to move forward enough to incur a serious or fatal injury. The more severe the crash, and the heavier the occupant, the greater the risk is. Be sure the airbag is turned ON for any person who does not qualify under the NHTSA deactivation criteria.

### SAFETY RESTRAINTS FOR CHILDREN

See the following sections for directions on how to properly use safety restraints for children. Also see *Airbag supplemental restraint system (SRS)* in this chapter for special instructions about using airbags.

#### Important child restraint precautions

You are required by law to use safety restraints for children in the U.S. and Canada. If small children (generally children who are four years old or younger and who weigh 18 kg [40 lb.] or less) ride in your vehicle, you must put them in safety seats made especially for children. Many states require that children use approved booster seats until they are eight years old. Check your local and state or provincial laws for specific requirements regarding the safety of children in your vehicle. When possible, always place children under age 12 in the rear seat of your vehicle. Accident statistics suggest that children are safer when properly restrained in the rear seating positions than in the front seating position.

## Seating and Safety Restraints



Never let a passenger hold a child on his or her lap while the vehicle is moving. The passenger cannot protect the child from injury in a collision.

Always follow the instructions and warnings that come with any infant or child restraint you might use.

Ford recommends using child safety seats equipped with LATCH attachments, attached to LATCH anchors and tether anchors. Some child seat manufacturers sell LATCH accessory belts that attach child seats that are not equipped with LATCH attachments onto LATCH anchors. See *Attaching safety seats with LATCH attachments for child seat anchors* in this section for seating positions with LATCH anchors.

If you install a forward-facing child safety seat using the vehicle safety belts:

- use only seats equipped with lap-shoulder belts;
- forward-facing child safety seats can be used in the center of the three-passenger 2nd row bench seat only if a top tether strap is used;
- Ford recommends placing forward-facing safety seats in the 2nd row and using top tether straps for added protection.

For more information on top tether straps, see *Attaching safety seats with tether straps* in this section.

Any booster seat that places the vehicle's lap belt or shoulder belt around a shield above and ahead of the child's hips should not be used in this vehicle.



Because the last row of seats in the 12 passenger and 15 passenger configuration is not equipped with either child tether or LATCH anchors and is spaced closer to the row of seats in front, **Do not** use forward-facing or rear-facing child seats (other than belt-positioning boosters) in the last row.

### Children and safety belts

If the child is the proper size, restrain the child in a safety seat. Children who are too large for child safety seats (as specified by your child safety seat manufacturer) should always wear safety belts.

Follow all the important safety restraint and airbag precautions that apply to adult passengers in your vehicle.



## Seating and Safety Restraints

If the shoulder belt portion of a combination lap and shoulder belt can be positioned so it does not cross or rest in front of the child's face or neck, the child should wear the lap and shoulder belt. Moving the child closer to the center of the vehicle may help provide a good shoulder belt fit.



Do not leave children, unreliable adults, or pets unattended in your vehicle.

### **Child booster seats**

Children outgrow a typical convertible or toddler seat when they weigh 40 lb. (18 kg) and are around 4 years of age. Although the lap/shoulder belt will provide some protection, these children are still too small for lap/shoulder belts to fit properly, which could increase the risk of serious injury in a crash.

To improve the fit of both the lap and shoulder belt on children who have outgrown child safety seats, Ford Motor Company recommends use of a belt-positioning booster.

Booster seats position a child so that safety belts fit better. They lift the child up so that the lap belt rests low across the hips and the knees bend comfortably. Booster seats may also make the shoulder belt fit better and more comfortably. Try to keep the belt near the middle of the shoulder.

### **When children should use booster seats**

Children need to use booster seats from the time they outgrow the toddler seat until they are big enough for the vehicle seat and lap/shoulder belt to fit properly. Generally this is when they weigh about 80 lb. (36 kg) (about 8 to 12 years old).

Booster seats should be used until you can answer YES to ALL of these questions:

- Can the child sit all the way back against the vehicle seat back with knees bent comfortably at the edge of the seat without slouching?

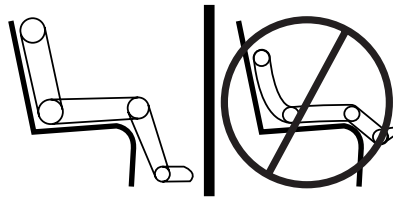

- Does the lap belt rest low across the hips?

## Seating and Safety Restraints

- Is the shoulder belt centered on the shoulder and chest?
- Can the child stay seated like this for the whole trip?

### **Types of booster seats**

There are two types of belt-positioning booster seats:

- Those that are backless.

If your backless booster seat has a removable shield, remove the shield and use the lap/shoulder belt. If a seating position has a low seat back and no head restraint, a backless booster seat may place your child's head (top of ear level) above the top of the seat. In this case, move the backless booster to another seating position with a higher seat back and lap/shoulder belts.



- Those with a high back.

If, with a backless booster seat, you cannot find a seating position that adequately supports your child's head, a high back booster seat would be a better choice.



Either type can be used at any seating position equipped with lap/shoulder belts if your child is over 40 lb. (18 kg).

## Seating and Safety Restraints

Children and booster seats vary widely in size and shape. Choose a booster that keeps the lap belt low and snug across the hips, never up across the stomach, and lets you adjust the shoulder belt to cross the chest and rest snugly near the center of the shoulder. The drawings below compare the ideal fit (center) to a shoulder belt uncomfortably close to the neck and a shoulder belt that could slip off the shoulder.

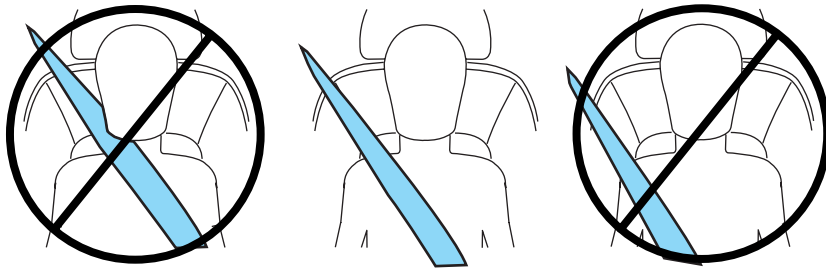

If the booster seat slides on the vehicle seat, placing a rubberized mesh sold as shelf or carpet liner under the booster seat may improve this condition.

### ***The importance of shoulder belts***

Using a booster without a shoulder belt increases the risk of a child's head hitting a hard surface in a collision. For this reason, you should never use a booster seat with a lap belt only. It is best to use a booster seat with lap/shoulder belts in the back seat- the safest place for children to ride.



Move a child to a different seating location if the shoulder belt does not stay positioned on the shoulder during use.



Follow all instructions provided by the manufacturer of the booster seat.



Never put the shoulder belt under a child's arm or behind the back because it eliminates the protection for the upper part of the body and may increase the risk of injury or death in a collision.

## Seating and Safety Restraints



Never use pillows, books, or towels to boost a child. They can slide around and increase the likelihood of injury or death in a collision.

### SAFETY SEATS FOR CHILDREN

#### Child and infant or child safety seats

Use a safety seat that is recommended for the size and weight of the child. Carefully follow all of the manufacturer's instructions with the safety seat you put in your vehicle. If you do not install and use the safety seat properly, the child may be injured in a sudden stop or collision.

When installing a child safety seat:

- Review and follow the information presented in the *Airbag Supplemental Restraint System* section in this chapter.
- Use the correct safety belt buckle for that seating position (the buckle closest to the direction the tongue is coming from).
- Insert the belt tongue into the proper buckle until you hear a snap and feel it latch. Make sure the tongue is securely fastened in the buckle.
- For the front passenger seat, keep the buckle release button pointing up and away from the safety seat, with the tongue between the child seat and the release button, to prevent accidental unbuckling.
- For the front passenger seat, place seat back in upright position.
- Put the safety belt in the automatic locking mode. Refer to *Automatic locking mode* (passenger side front and outboard rear seating positions) (if equipped).
- LATCH lower anchors are recommended for use by children up to 48 pounds (22 kg) in a child restraint. Top tether anchors can be used for children up to 60 pounds (27 kg) in a child restraint, and to provide upper torso restraint for children up to 80 pounds (36 kg) using an upper torso harness and a belt-positioning booster.

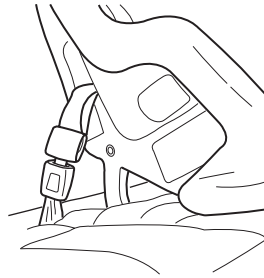

## Seating and Safety Restraints

Ford recommends the use of a child safety seat having a top tether strap. Install the child safety seat in a seating position with LATCH and tether anchors. For more information on top tether straps and anchors, refer to *Attaching safety seats with tether straps* in this chapter. For more information of LATCH anchors refer to *Attaching safety seats with LATCH (Lower Anchors and Tethers for Children) attachments* in this chapter.



Carefully follow all of the manufacturer's instructions included with the safety seat you put in your vehicle. If you do not install and use the safety seat properly, the child may be injured in a sudden stop or collision.

### Installing child safety seats with combination lap and shoulder belts

1. Position the child safety seat in a seat with a combination lap and shoulder belt.

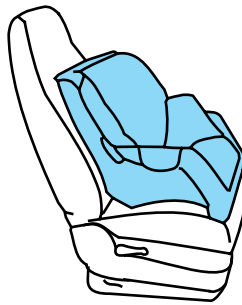

An airbag can kill or injure a child in a child seat. Never place a rear-facing child seat in front of an active airbag. If you must use a forward-facing child seat in the front seat, move the seat all the way back.



Children 12 and under should be properly restrained in the rear seat whenever possible.

## Seating and Safety Restraints

2. Pull down on the shoulder belt and then grasp the shoulder belt and lap belt together.

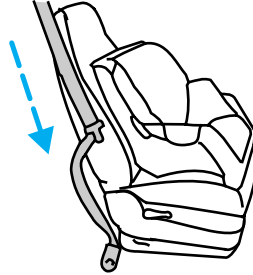

3. While holding the shoulder and lap belt portions together, route the tongue through the child seat according to the child seat manufacturer's instructions. Be sure the belt webbing is not twisted.

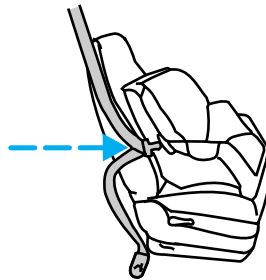

4. Insert the belt tongue into the proper buckle (the buckle closest to the direction the tongue is coming from) for that seating position until you hear a snap and feel the latch engage. Make sure the tongue is latched securely by pulling on it.

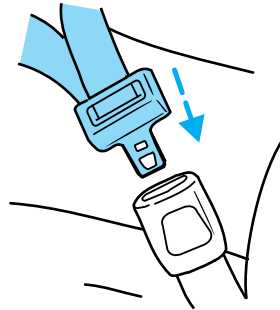

## Seating and Safety Restraints

5. To put the retractor in the automatic locking mode, grasp the shoulder portion of the belt and pull downward until all of the belt is extracted.

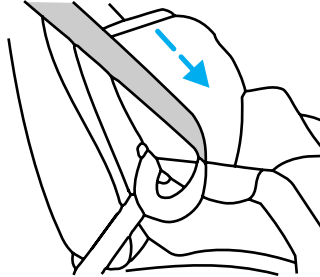

6. Allow the belt to retract. The belt will click as it retracts to indicate it is in the automatic locking mode.

7. Pull the lap belt portion across the child seat toward the buckle and pull up on the shoulder belt while pushing down with your knee on the child seat.

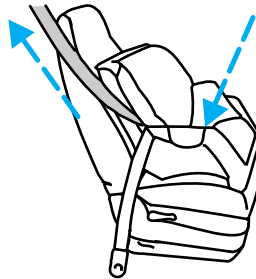

8. Allow the safety belt to retract to remove any slack in the belt.

9. Before placing the child in the seat, forcibly tilt the seat forward and back to make sure the seat is securely held in place. To check this, grab the seat at the belt path and attempt to move it side to side and forward and back. There should be no more than one inch of movement for proper installation.

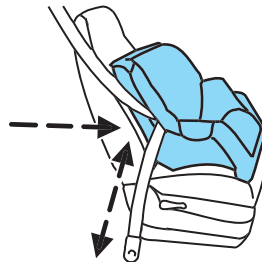

10. Try to pull the belt out of the retractor to make sure the retractor is in the automatic locking mode (you should not be able to pull more belt out). If the retractor is not locked, unbuckle the belt and repeat Steps 2 through 9.

Check to make sure the child seat is properly secured before each use.

## Seating and Safety Restraints

### Attaching safety seats with tether straps



Children should be placed in the rear in an appropriate child safety seat that is properly secured to the vehicle.



When using forward-facing child safety seats in vehicles with only two seating positions so the forward-facing child safety seat cannot be placed in the rear of the vehicle, move the passenger seat as far back from the instrument panel as possible.



Because the last row of seats in the 12 passenger and 15 passenger configuration is not equipped with either child tether or LATCH anchors and is spaced closer to the row of seats in front, **Do not** use forward-facing or rear-facing child seats (other than belt-positioning boosters) in the last row.



Air bags can kill or injure a child in a child seat. **NEVER** place a rear-facing child seat in front of an active air bag. If you must use a forward-facing child seat in the front seat, move the seat all the way back.

### Front passenger seating position

The tether can be attached directly to the rear of the front seat.

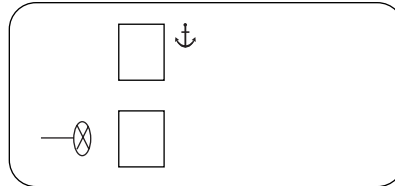



## Seating and Safety Restraints

1. Position the child safety seat on the front right-hand passenger seat.
2. Adjust the front right-hand passenger seat full forward.

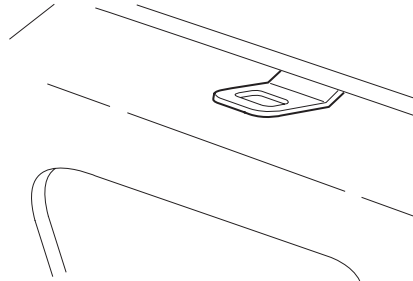

3. Route the child safety seat tether strap over the back of the front right-hand passenger seat as shown.

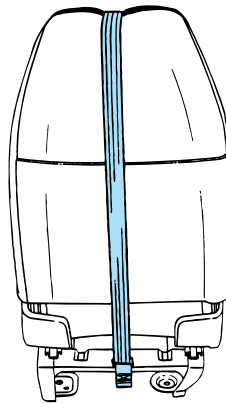

4. Clip the tether strap hook to the seat pedestal to the location shown.

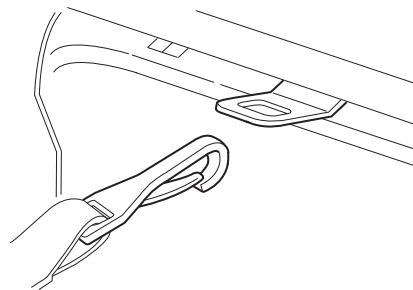

## Seating and Safety Restraints

5. Adjust the front right hand passenger seat to the full rearward position.

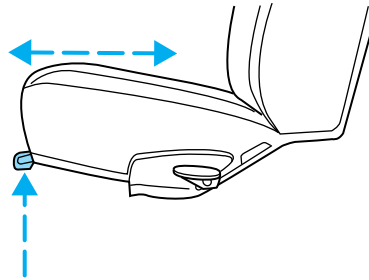

6. Install the child safety seat tightly using the LATCH anchors or safety belts. Follow the instructions in this chapter.

7. Tighten the child safety seat tether strap according to the manufacturer's instructions.

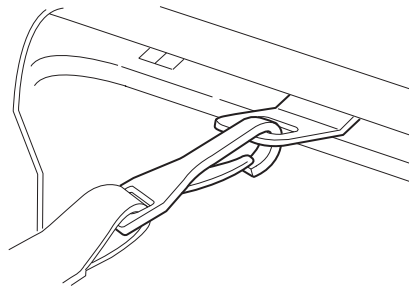

### **Second row bucket seats (Chateau Quads)**

The tether strap can be attached directly to the tether bracket under the back edge of the seat cushion.

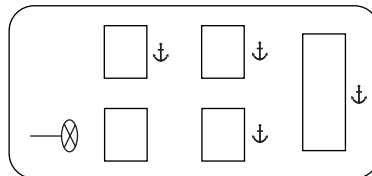

## Seating and Safety Restraints

1. Position the child safety seat on the second row left hand or right hand bucket seat.

2. Route the child safety tether strap over the back of the left hand or right hand second row bucket seat.

3. Clip the tether strap hook to the seat pedestal at the location shown.

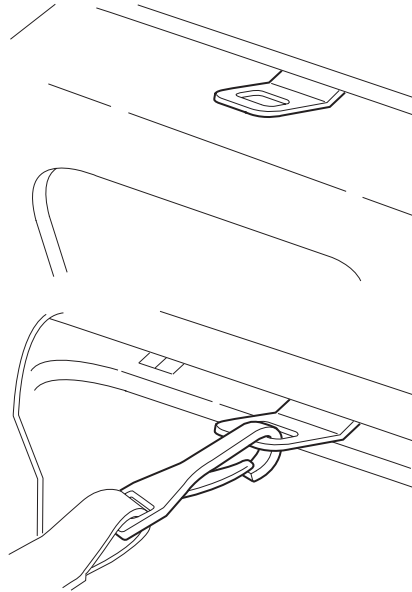

4. Install the child safety seat tightly using the LATCH anchors or safety belts. Follow the instructions in this chapter.

5. Tighten the child safety seat tether strap according to the manufacturer's instructions.

### **Second, Third and Fourth row three passenger bench seats**

The tether strap can be attached directly to the tether bracket provided under the back edge of the seat cushion.

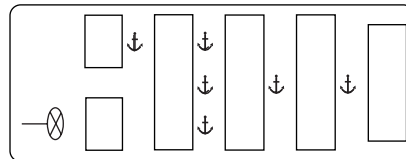

1. For second row 3-Passenger bench seat, place the child safety seat on the left hand outboard position, the center position, or the right hand outboard position as desired.

For third row or fourth row 3-Passenger bench seat, place the child safety seat on the center position.

## Seating and Safety Restraints

2. Route the child safety tether strap over the back of 3-Passenger bench seat.

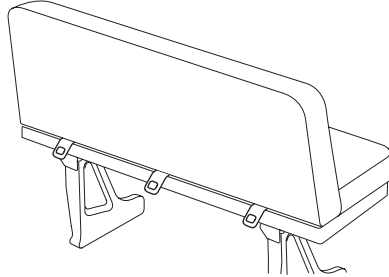

3. Clip the tether strap hook to the tether bracket mounted under rear rail of seat cushion frame.

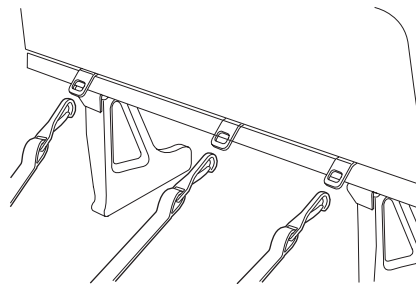

4. Install the child safety seat tightly using the LATCH anchors or safety belts. Follow the instructions in this chapter.

5. Tighten the child safety seat tether strap according to the manufacturer's instructions.

For additional important safety information on the proper use of safety belts, child seats and infant seats, please read the entire *Seating and Safety Restraints* chapter in this *Owner's Guide*.

### **Attaching safety seats with LATCH (Lower Anchors and Tethers for Children) attachments for child seat anchors**

Some child safety seats have two rigid or webbing mounted attachments that connect to two anchors at certain seating positions in your vehicle. This type of child seat eliminates the need to use safety belts to attach the child seat. For forward-facing child seats, the tether strap must also be attached to the proper tether anchor. See *Attaching safety seats with tether straps* in this chapter.

## Seating and Safety Restraints

Your vehicle may be equipped with LATCH anchors for child seat installation at the seating positions marked with the child seat symbol:

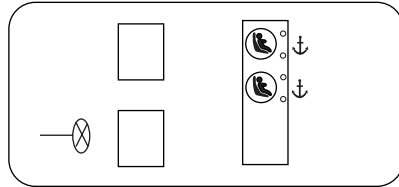

- Five passenger crew van

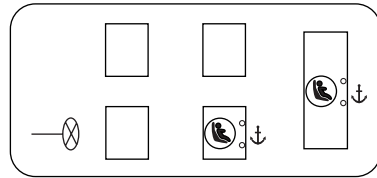

- Seven passenger wagon

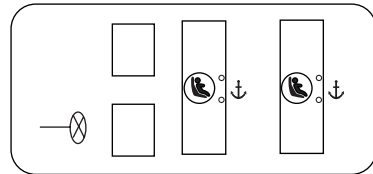

- Eight passenger wagon

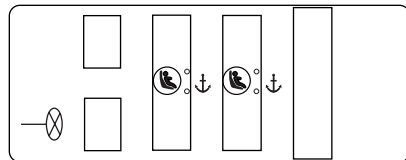

- Twelve passenger wagon

## Seating and Safety Restraints

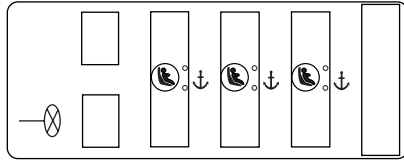

- Fifteen passenger wagon

 represents LATCH anchors.

 represents tether strap anchors.

 Never attach two LATCH child safety seats to the same anchor. In a crash, one anchor may not be strong enough to hold two child safety seat attachments and may break, causing serious injury or death.

The lower anchors for child seat installation are located at the rear section of the seat between the cushion and seat back.

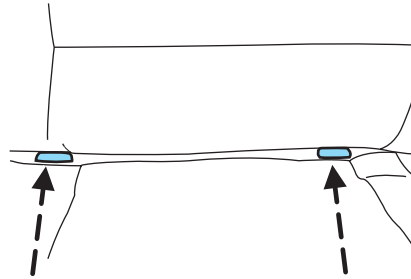

Follow the child seat manufacturer's instructions to properly install a child seat with LATCH attachments.

 Attach LATCH lower attachments of the child seat only to the anchors shown.

## Seating and Safety Restraints

If you install a child seat with rigid LATCH attachments, do not tighten the tether strap enough to lift the child seat off the vehicle seat cushion when the child is seated in it. Keep the tether strap just snug without lifting the front of the child seat. Keeping the child seat just touching the vehicle seat gives the best protection in a severe crash.

Each time you use the safety seat, check that the seat is properly attached to the lower anchors and tether anchor. Try to tilt the child seat from side to side. Also try to tug the seat forward. Check to see if the anchors hold the seat in place.



If the safety seat is not anchored properly, the risk of a child being injured in a crash greatly increases.

## Tires, Wheels and Loading

### NOTICE TO UTILITY VEHICLE AND TRUCK OWNERS

Utility vehicles and trucks handle differently than passenger cars in the various driving conditions that are encountered on streets, highways and off-road. Utility vehicles and trucks are not designed for cornering at speeds as high as passenger cars any more than low-slung sports cars are designed to perform satisfactorily under off-road conditions.

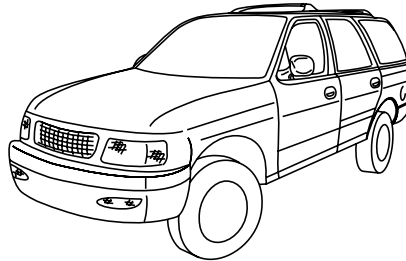

Utility vehicles have a significantly higher rollover rate than other types of vehicles. To reduce the risk of serious injury or death from a rollover or other crash you must:

- Avoid sharp turns and abrupt maneuvers;
- Drive at safe speeds for the conditions;
- Keep tires properly inflated;
- Never overload or improperly load your vehicle; and
- Make sure every passenger is properly restrained.



In a rollover crash, an unbelted person is significantly more likely to die than a person wearing a seat belt. All occupants must wear seat belts and children/infants must use appropriate restraints to minimize the risk of injury or ejection.

Study your *Owner's Guide* and any supplements for specific information about equipment features, instructions for safe driving and additional precautions to reduce the risk of an accident or serious injury.



## Tires, Wheels and Loading

### VEHICLE CHARACTERISTICS

#### How your vehicle differs from other vehicles

SUV and trucks can differ from some other vehicles in a few noticeable ways. Your vehicle may be:

- Higher – to allow higher load carrying capacity and to allow it to travel over rough terrain without getting hung up or damaging underbody components.
- Shorter – to give it the capability to approach inclines and drive over the crest of a hill without getting hung up or damaging underbody components. All other things held equal, a shorter wheelbase may make your vehicle quicker to respond to steering inputs than a vehicle with a longer wheelbase.
- Narrower — to provide greater maneuverability in tight spaces, particularly in off-road use.

As a result of the above dimensional differences, SUV's and trucks often will have a higher center of gravity and a greater difference in center of gravity between the loaded and unloaded condition.

These differences that make your vehicle so versatile also make it handle differently than an ordinary passenger car.

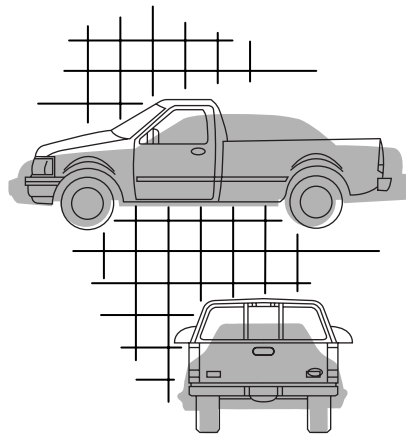
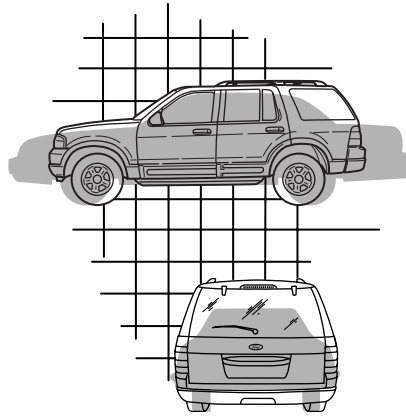

## Tires, Wheels and Loading

### INFORMATION ABOUT UNIFORM TIRE QUALITY GRADING

New vehicles are fitted with tires that have a rating on them called Tire Quality Grades. The Quality grades can be found where applicable on the tire sidewall between tread shoulder and maximum section width. For example:

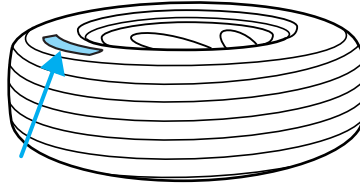

- **Treadwear 200 Traction AA Temperature A**

These Tire Quality Grades are determined by standards that the United States Department of Transportation has set.

Tire Quality Grades apply to new pneumatic tires for use on passenger cars. They do not apply to deep tread, winter-type snow tires, space-saver or temporary use spare tires, tires with nominal rim diameters of 10 to 12 inches or limited production tires as defined in Title 49 Code of Federal Regulations Part 575.104(c)(2).

**U.S. Department of Transportation-Tire quality grades:** The U.S. Department of Transportation requires Ford Motor Company to give you the following information about tire grades exactly as the government has written it.

#### Treadwear

The treadwear grade is a comparative rating based on the wear rate of the tire when tested under controlled conditions on a specified government test course. For example, a tire graded 150 would wear one and one-half (1 1/2) times as well on the government course as a tire graded 100. The relative performance of tires depends upon the actual conditions of their use, however, and may depart significantly from the norm due to variations in driving habits, service practices, and differences in road characteristics and climate.

#### Traction AA A B C

The traction grades, from highest to lowest are AA, A, B, and C. The grades represent the tire's ability to stop on wet pavement as measured under controlled conditions on specified government test surfaces of asphalt and concrete. A tire marked C may have poor traction performance.

106

## Tires, Wheels and Loading



The traction grade assigned to this tire is based on straight-ahead braking traction tests, and does not include acceleration, cornering, hydroplaning or peak traction characteristics.

### Temperature A B C

The temperature grades are A (the highest), B and C, representing the tire's resistance to the generation of heat and its ability to dissipate heat when tested under controlled conditions on a specified indoor laboratory test wheel. Sustained high temperature can cause the material of the tire to degenerate and reduce tire life, and excessive temperature can lead to sudden tire failure. The grade C corresponds to a level of performance which all passenger car tires must meet under the Federal Motor Vehicle Safety Standard No. 109. Grades B and A represent higher levels of performance on the laboratory test wheel than the minimum required by law.



The temperature grade for this tire is established for a tire that is properly inflated and not overloaded. Excessive speed, underinflation, or excessive loading, either separately or in combination, can cause heat buildup and possible tire failure.

### TIRES

Tires are designed to give many thousands of miles of service, but they must be maintained in order to get the maximum benefit from them.

#### Glossary of tire terminology

- **Tire label:** A label showing the OE (Original Equipment) tire sizes, recommended inflation pressure and the maximum weight the vehicle can carry.
- **Tire Identification Number (TIN):** A number on the sidewall of each tire providing information about the tire brand and manufacturing plant, tire size and date of manufacture. Also referred to as DOT code.
- **Inflation pressure:** A measure of the amount of air in a tire.
- **Standard load:** A class of P-metric or Metric tires designed to carry a maximum load at 35 psi [37 psi (2.5 bar) for Metric tires]. Increasing the inflation pressure beyond this pressure will not increase the tire's load carrying capability.
- **Extra load:** A class of P-metric or Metric tires designed to carry a heavier maximum load at 41 psi [43 psi (2.9 bar) for Metric tires].

## Tires, Wheels and Loading

Increasing the inflation pressure beyond this pressure will not increase the tire's load carrying capability.

- **kPa:** Kilopascal, a metric unit of air pressure.
- **PSI:** Pounds per square inch, a standard unit of air pressure.
- **Cold inflation pressure:** The tire pressure when the vehicle has been stationary and out of direct sunlight for an hour or more and prior to the vehicle being driven for 1 mile (1.6 km).
- **Recommended inflation pressure:** The cold inflation pressure found on the Safety Compliance Certification Label or Tire Label located on the B-Pillar or the edge of the driver's door.
- **B-pillar:** The structural member at the side of the vehicle behind the front door.
- **Bead area of the tire:** Area of the tire next to the rim.
- **Sidewall of the tire:** Area between the bead area and the tread.
- **Tread area of the tire:** Area of the perimeter of the tire that contacts the road when mounted on the vehicle.
- **Rim:** The metal support (wheel) for a tire or a tire and tube assembly upon which the tire beads are seated.

### INFLATING YOUR TIRES

Safe operation of your vehicle requires that your tires are properly inflated. Every day before you drive, check your tires. If one looks lower than the others, use a tire gauge to check pressure of all tires and adjust if required. Remember that a tire can lose up to half of its air pressure without appearing flat.

At least once a month and before long trips, inspect each tire and check the tire pressure with a tire gauge (including spare, if equipped). Inflate all tires to the inflation pressure recommended by Ford Motor Company.

Use a tire gauge to check the tire inflation pressure, including the spare (if equipped), at least monthly and before long trips. You are strongly urged to buy a reliable tire pressure gauge, as automatic service station gauges may be inaccurate. Ford Motor Company recommends the use of a digital or dial-type tire pressure gauge rather than a stick-type tire pressure gauge.

Use the recommended cold inflation pressure for optimum tire performance and wear. Under-inflation or over-inflation may cause uneven treadwear patterns.

## Tires, Wheels and Loading



Under-inflation is the most common cause of tire failures and may result in severe tire cracking, tread separation or "blowout", with unexpected loss of vehicle control and increased risk of injury. Under-inflation increases sidewall flexing and rolling resistance, resulting in heat buildup and internal damage to the tire. It also may result in unnecessary tire stress, irregular wear, loss of vehicle control and accidents. A tire can lose up to half of its air pressure and not appear to be flat!

Always inflate your tires to the Ford recommended inflation pressure even if it is less than the maximum inflation pressure information found on the tire. The Ford recommended tire inflation pressure is found on the Safety Compliance Certification Label or Tire Label which is located on the B-Pillar or the edge of the driver's door. Failure to follow the tire pressure recommendations can cause uneven treadwear patterns and adversely affect the way your vehicle handles.

**Maximum Permissible Inflation Pressure** is the tire manufacturer's maximum permissible pressure and/or the pressure at which the maximum load can be carried by the tire. This pressure is normally higher than the manufacturer's recommended cold inflation pressure which can be found on the Safety Compliance Certification Label or Tire Label which is located on the B-Pillar or the edge of the driver's door. The cold inflation pressure should never be set lower than the recommended pressure on the Safety Compliance Certification Label or Tire Label.

When weather temperature changes occur, tire inflation pressures also change. A 10° F (6° C) temperature drop can cause a corresponding drop of 1 psi (7 kPa) in inflation pressure. Check your tire pressures frequently and adjust them to the proper pressure which can be found on the Safety Compliance Certification Label or Tire Label.

To check the pressure in your tire(s):

1. Make sure the tires are cool, meaning they are not hot from driving even a mile.

If you are checking tire pressure when the tire is hot, (i.e. driven more than 1 mile [1.6 km]), never "bleed" or reduce air pressure. The tires are hot from driving and it is normal for pressures to increase above recommended cold pressures. A hot tire at or below recommended cold inflation pressure could be significantly under-inflated.

## Tires, Wheels and Loading

**Note:** If you have to drive a distance to get air for your tire(s), check and record the tire pressure first and add the appropriate air pressure when you get to the pump. It is normal for tires to heat up and the air pressure inside to go up as you drive.

2. Remove the cap from the valve on one tire, then firmly press the tire gauge onto the valve and measure the pressure with the tire gauge.

3. Add enough air to reach the recommended air pressure.

**Note:** If you overfill the tire, release air by pushing on the metal stem in the center of the valve. Then recheck the pressure with your tire gauge.

4. Replace the valve cap.

5. Repeat this procedure for each tire, including the spare.

**Note:** Some spare tires operate at a higher inflation pressure than the other tires. For T-type/mini-spare tires (see *T-Type/Mini-Spare Tire Information* section for description): Store and maintain at 60 psi (4.15 bar). For Full Size and Dissimilar spare tires (see *Dissimilar Spare Tire/Wheel Information* section for description): Store and maintain at the higher of the front and rear inflation pressure as shown on the Safety Compliance Certification Label or the Tire Label.

6. Visually inspect the tires to make sure there are no nails or other objects embedded that could poke a hole in the tire and cause an air leak.

7. Check the sidewalls to make sure there are no gouges, cuts or bulges.

## Tires, Wheels and Loading

### Tire inflation information

All tires with Steel Carcass Plies (if equipped):

This type of tire utilizes steel cords in the sidewalls. As such, they cannot be treated like normal light truck tires. Tire service, including adjusting tire pressure, must be performed by personnel trained, supervised and equipped according to Federal Occupational Safety and Health Administration (OSHA) regulations. For example, during any procedure involving tire inflation, the technician or individual must utilize a remote inflation device, and ensure that all persons are clear of the trajectory area.

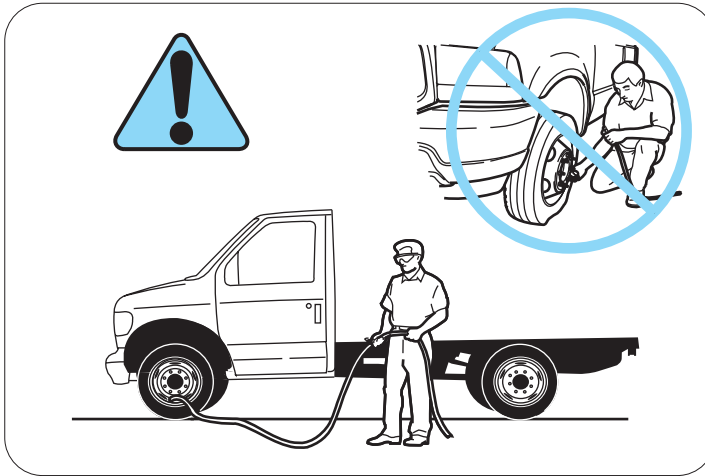

**!** **WARNING** An inflated tire and rim can be very dangerous if improperly used, serviced or maintained. To reduce the risk of serious injury, never attempt to re-inflate a tire which has been run flat or seriously under-inflated without first removing the tire from the wheel assembly for inspection. Do not attempt to add air to tires or replace tires or wheels without first taking precautions to protect persons and property.

## Tires, Wheels and Loading

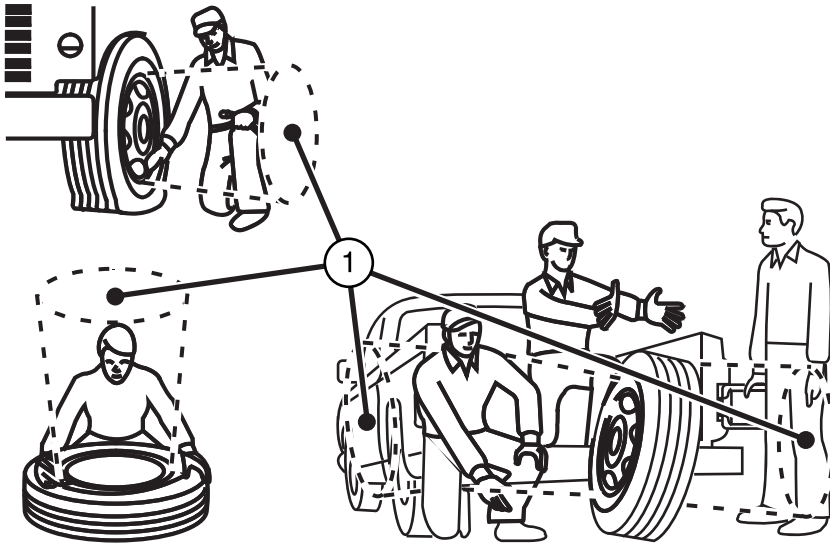

Stay out of the trajectory (1) as indicated in the illustration.

### TIRE CARE

#### Inspecting your tires

Periodically inspect the tire treads for uneven or excessive wear and remove objects such as stones, nails or glass that may be wedged in the tread grooves. Check for holes or cuts that may permit air leakage from the tire and make necessary repairs. Also inspect the tire sidewalls for cracking, cuts, bruises and other signs of damage or excessive wear. If internal damage to the tire is suspected, have the tire demounted and inspected in case it needs to be repaired or replaced. For your safety, tires that are damaged or show signs of excessive wear should not be used because they are more likely to blow out or fail.

Improper or inadequate vehicle maintenance can cause tires to wear abnormally. Inspect all your tires, including the spare, frequently, and replace them if one or more of the following conditions exist:

112



## Tires, Wheels and Loading

### Tire wear

When the tread is worn down to 1/16th of an inch (2 mm), tires must be replaced to help prevent your vehicle from skidding and hydroplaning. Built-in treadwear indicators, or “wear bars”, which look like narrow strips of smooth rubber across the tread will appear on the tire when the tread is worn down to 1/16th of an inch (2 mm).

When the tire tread wears down to the same height as these “wear bars”, the tire is worn out and must be replaced.

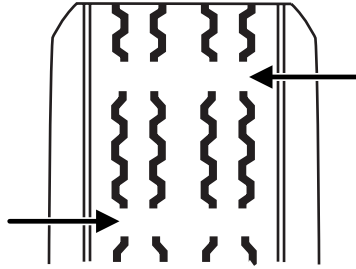

### Damage

Periodically inspect the tire treads and sidewalls for damage (such as bulges in the tread or sidewalls, cracks in the tread groove and separation in the tread or sidewall). If damage is observed or suspected have the tire inspected by a tire professional. Tires can be damaged during off-road use, so inspection after off-road use is also recommended.



### Age

Tires degrade over time depending on many factors such as weather, storage conditions, and conditions of use (load, speed, inflation pressure, etc.) the tires experience throughout their lives. In general, tires should be replaced after six years regardless of tread wear. However, heat caused by hot climates or frequent high loading conditions can accelerate the aging process and may require tires to be replaced more frequently.

You should replace your spare tire when you replace the road tires or after six years due to aging even if it has not been used.

## Tires, Wheels and Loading

### U.S. DOT Tire Identification Number (TIN)

Both U.S. and Canada Federal regulations require tire manufacturers to place standardized information on the sidewall of all tires. This information identifies and describes the fundamental characteristics of the tire and also provides a U.S. DOT Tire Identification Number for safety standard certification and in case of a recall.

This begins with the letters "DOT" and indicates that the tire meets all federal standards. The next two numbers or letters are the plant code designating where it was manufactured, the next two are the tire size code and the last four numbers represent the week and year the tire was built. For example, the numbers 317 mean the 31st week of 1997. After 2000 the numbers go to four digits. For example, 2501 means the 25th week of 2001. The numbers in between are identification codes used for traceability. This information is used to contact customers if a tire defect requires a recall.

### Tire Replacement Requirements

Your vehicle is equipped with tires designed to provide a safe ride and handling capability.



Only use replacement tires and wheels that are the same size, load index, speed rating and type (such as P-metric versus LT-metric or all-season versus all-terrain) as those originally provided by Ford. The recommended tire and wheel size may be found on either the Safety Compliance Certification Label or the Tire Label which is located on the B-Pillar or edge of the driver's door. If this information is not found on these labels then you should consult your Ford Dealer. Use of any tire or wheel not recommended by Ford can affect the safety and performance of your vehicle, which could result in an increased risk of loss of vehicle control, vehicle rollover, personal injury and death. Additionally the use of non-recommended tires and wheels could cause steering, suspension, axle or transfer case/power transfer unit failure. If you have questions regarding tire replacement, see an authorized dealer.

## Tires, Wheels and Loading



When mounting replacement tires and wheels, you should not exceed the maximum pressure indicated on the sidewall of the tire to set the beads without additional precautions listed below. If the beads do not seat at the maximum pressure indicated, re-lubricate and try again.

When inflating the tire for mounting pressures up to 20 psi greater than the maximum pressure on the tire sidewall, the following precautions must be taken to protect the person mounting the tire:

1. Make sure that you have the correct tire and wheel size.
2. Lubricate the tire bead and wheel bead seat area again.
3. Stand at a minimum of 12 feet away from the tire wheel assembly.
4. Use both eye and ear protection.

For a mounting pressure more than 20 psi greater than the maximum pressure, a Ford Dealer or other tire service professional should do the mounting.

Always inflate steel carcass tires with a remote air fill with the person inflating standing at a minimum of 12 ft. away from the tire wheel assembly.

**Important:** Remember to replace the wheel valve stems when the road tires are replaced on your vehicle.

It is recommended that the two front tires or two rear tires generally be replaced as a pair.

### Safety practices

Driving habits have a great deal to do with your tire mileage and safety.

- Observe posted speed limits
- Avoid fast starts, stops and turns
- Avoid potholes and objects on the road
- Do not run over curbs or hit the tire against a curb when parking



If your vehicle is stuck in snow, mud, sand, etc., **do not** rapidly spin the tires; spinning the tires can tear the tire and cause an explosion. A tire can explode in as little as three to five seconds.



Do not spin the wheels at over 35 mph (56 km/h). The tires may fail and injure a passenger or bystander.

## Tires, Wheels and Loading

### **Highway hazards**

No matter how carefully you drive there's always the possibility that you may eventually have a flat tire on the highway. Drive slowly to the closest safe area out of traffic. This may further damage the flat tire, but your safety is more important.

If you feel a sudden vibration or ride disturbance while driving, or you suspect your tire or vehicle has been damaged, immediately reduce your speed. Drive with caution until you can safely pull off the road. Stop and inspect the tires for damage. If a tire is under-inflated or damaged, deflate it, remove wheel and replace it with your spare tire and wheel. If you cannot detect a cause, have the vehicle towed to the nearest repair facility or tire dealer to have the vehicle inspected.

### **Tire and wheel alignment**

A bad jolt from hitting a curb or pothole can cause the front end of your vehicle to become misaligned or cause damage to your tires. If your vehicle seems to pull to one side when you're driving, the wheels may be out of alignment. Have an authorized dealer check the wheel alignment periodically.

Wheel misalignment in the front or the rear can cause uneven and rapid treadwear of your tires and should be corrected by an authorized dealer. Front wheel drive (FWD) vehicles and those with an independent rear suspension (if equipped) may require alignment of all four wheels.

The tires should also be balanced periodically. An unbalanced tire and wheel assembly may result in irregular tire wear.

### **Tire rotation**

Rotating your tires at the recommended interval (as indicated in the *scheduled maintenance information* that comes with your vehicle) will help your tires wear more evenly, providing better tire performance and longer tire life. Unless otherwise specified, rotate the tires approximately every 5,000 miles (8,000 km).

## Tires, Wheels and Loading

- Rear Wheel Drive (RWD) vehicles/Four Wheel Drive (4WD)/ All Wheel Drive (AWD) vehicles (front tires at top of diagram)

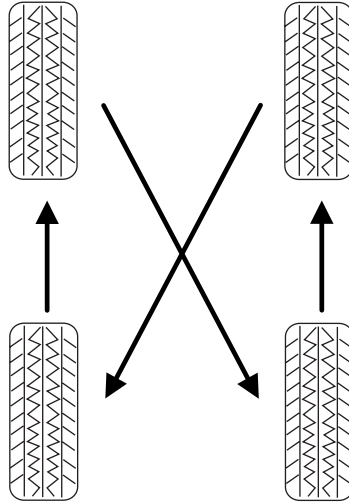

Sometimes irregular tire wear can be corrected by rotating the tires.

**Note:** If your tires show uneven wear ask an authorized dealer to check for and correct any wheel misalignment, tire imbalance or mechanical problem involved before tire rotation.

**Note:** Your vehicle may be equipped with a dissimilar spare tire/wheel. A dissimilar spare tire/wheel is defined as a spare tire and/or wheel that is different in brand, size or appearance from the road tires and wheels. If you have a dissimilar spare tire/wheel it is intended for temporary use only and should not be used in a tire rotation.

**Note:** After having your tires rotated, inflation pressure must be checked and adjusted to the vehicle requirements.

## Tires, Wheels and Loading

- DRW – Six tire rotation

If your vehicle is equipped with dual rear wheels it is recommended that the front and rear tires (in pairs) be rotated only side to side. We do not recommend splitting up the dual rear wheels. Rotate them side to side as a set/pair. After tire rotation, inflation pressures must be adjusted for the tires new positions in accordance with vehicle requirements.

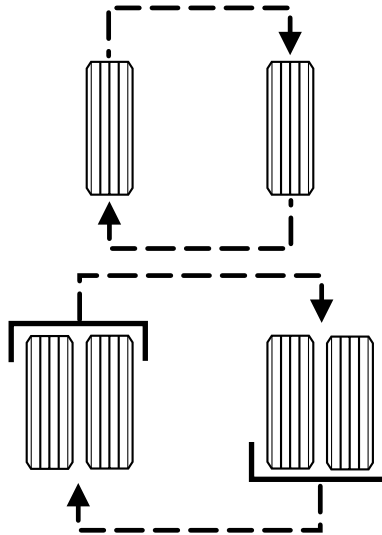

Sometimes irregular tire wear can be corrected by rotating the tires.

**Note:** If your tires show uneven wear ask your authorized dealer to check for and correct any wheel misalignment, tire imbalance or mechanical problem involved before tire rotation.

**Note:** Your vehicle may be equipped with a dissimilar spare tire/wheel. A dissimilar spare tire/wheel is defined as a spare tire and/or wheel that is different in brand, size or appearance from the road tires and wheels. If you have a dissimilar spare tire/wheel it is intended for temporary use only and should not be used in a tire rotation.

**Note:** After having your tires rotated, inflation pressure must be checked and adjusted to the vehicle requirements.

### INFORMATION CONTAINED ON THE TIRE SIDEWALL

Both U.S. and Canada Federal regulations require tire manufacturers to place standardized information on the sidewall of all tires. This information identifies and describes the fundamental characteristics of the tire and also provides a U.S. DOT Tire Identification Number for safety standard certification and in case of a recall.

## Tires, Wheels and Loading

### Information on “P” type tires

P215/65R15 95H is an example of a tire size, load index and speed rating. The definitions of these items are listed below. (Note that the tire size, load index and speed rating for your vehicle may be different from this example.)

1. **P:** Indicates a tire, designated by the Tire and Rim Association (T&RA), that may be used for service on cars, SUVs, minivans and light trucks.

**Note:** If your tire size does not begin with a letter this may mean it is designated by either ETRTO (European Tire and Rim Technical Organization) or JATMA (Japan Tire Manufacturing Association).

2. **215:** Indicates the nominal width of the tire in millimeters from sidewall edge to sidewall edge. In general, the larger the number, the wider the tire.

3. **65:** Indicates the aspect ratio which gives the tire’s ratio of height to width.

4. **R:** Indicates a “radial” type tire.

5. **15:** Indicates the wheel or rim diameter in inches. If you change your wheel size, you will have to purchase new tires to match the new wheel diameter.

6. **95:** Indicates the tire’s load index. It is an index that relates to how much weight a tire can carry. You may find this information in your *Owner’s Guide*. If not, contact a local tire dealer.

**Note:** You may not find this information on all tires because it is not required by federal law.

7. **H:** Indicates the tire’s speed rating. The speed rating denotes the speed at which a tire is designed to be driven for extended periods of time under a standard condition of load and inflation pressure. The tires on your vehicle may operate at different conditions for load and inflation pressure. These speed ratings may need to be adjusted for the difference in conditions. The ratings range from 81 mph (130 km/h) to 186 mph (299 km/h). These ratings are listed in the following chart.

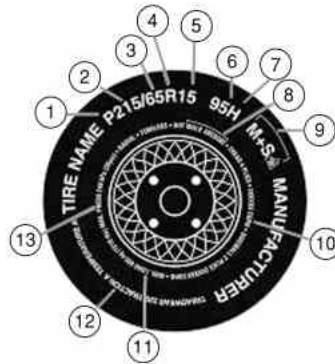

## Tires, Wheels and Loading

**Note:** You may not find this information on all tires because it is not required by federal law.

Letter rating	Speed rating - mph (km/h)
M	81 mph (130 km/h)
N	87 mph (140 km/h)
Q	99 mph (159 km/h)
R	106 mph (171 km/h)
S	112 mph (180 km/h)
T	118 mph (190 km/h)
U	124 mph (200 km/h)
H	130 mph (210 km/h)
V	149 mph (240 km/h)
W	168 mph (270 km/h)
Y	186 mph (299 km/h)

**Note:** For tires with a maximum speed capability over 149 mph (240 km/h), tire manufacturers sometimes use the letters ZR. For those with a maximum speed capability over 186 mph (299 km/h), tire manufacturers always use the letters ZR.

**8. U.S. DOT Tire Identification Number (TIN):** This begins with the letters "DOT" and indicates that the tire meets all federal standards. The next two numbers or letters are the plant code designating where it was manufactured, the next two are the tire size code and the last four numbers represent the week and year the tire was built. For example, the numbers 317 mean the 31st week of 1997. After 2000 the numbers go to four digits. For example, 2501 means the 25th week of 2001. The numbers in between are identification codes used for traceability. This information is used to contact customers if a tire defect requires a recall.

**9. M+S or M/S:** Mud and Snow, or

**AT:** All Terrain, or

**AS:** All Season.

**10. Tire Ply Composition and Material Used:** Indicates the number of plies or the number of layers of rubber-coated fabric in the tire tread and sidewall. Tire manufacturers also must indicate the ply materials in the tire and the sidewall, which include steel, nylon, polyester, and others.

**11. Maximum Load:** Indicates the maximum load in kilograms and pounds that can be carried by the tire. Refer to the Safety Compliance Certification Label, which is located on the B-Pillar or the edge of the driver's door, for the correct tire pressure for your vehicle.



## Tires, Wheels and Loading

### 12. Treadwear, Traction and Temperature Grades

- **Treadwear:** The treadwear grade is a comparative rating based on the wear rate of the tire when tested under controlled conditions on a specified government test course. For example, a tire graded 150 would wear one and one-half (1½) times as well on the government course as a tire graded 100.
- **Traction:** The traction grades, from highest to lowest are AA, A, B, and C. The grades represent the tire's ability to stop on wet pavement as measured under controlled conditions on specified government test surfaces of asphalt and concrete. A tire marked C may have poor traction performance.
- **Temperature:** The temperature grades are A (the highest), B and C, representing the tire's resistance to the generation of heat and its ability to dissipate heat when tested under controlled conditions on a specified indoor laboratory test wheel.

13. **Maximum Permissible Inflation Pressure:** Indicates the tire manufacturers' maximum permissible pressure and/or the pressure at which the maximum load can be carried by the tire. This pressure is normally higher than the manufacturer's recommended cold inflation pressure which can be found on the Safety Compliance Certification Label or Tire Label which is located on the B-Pillar or the edge of the driver's door. The cold inflation pressure should never be set lower than the recommended pressure on the vehicle label.

The tire suppliers may have additional markings, notes or warnings such as standard load, radial tubeless, etc.

## Tires, Wheels and Loading

### Additional information contained on the tire sidewall for “LT” type tires

“LT” type tires have some additional information beyond those of “P” type tires; these differences are described below:

1. **LT:** Indicates a tire, designated by the Tire and Rim Association (T&RA), that is intended for service on light trucks.

2. **Load Range/Load Inflation Limits:** Indicates the tire’s load-carrying capabilities and its inflation limits.

3. **Maximum Load Dual lb. (kg) at psi (kPa) cold:** Indicates the maximum load and tire pressure when the tire is used as a dual; defined as four tires on the rear axle (a total of six or more tires on the vehicle).

4. **Maximum Load Single lb. (kg) at psi (kPa) cold:** Indicates the maximum load and tire pressure when the tire is used as a single; defined as two tires (total) on the rear axle.



## Tires, Wheels and Loading

### Information on “T” type tires

“T” type tires have some additional information beyond those of “P” type tires; these differences are described below:

T145/80D16 is an example of a tire size.

**Note:** The temporary tire size for your vehicle may be different from this example.

1. **T:** Indicates a type of tire, designated by the Tire and Rim Association (T&RA), that is intended for temporary service on cars, SUVs, minivans and light trucks.

2. **145:** Indicates the nominal width of the tire in millimeters from sidewall edge to sidewall edge. In general, the larger the number, the wider the tire.

3. **80:** Indicates the aspect ratio which gives the tire’s ratio of height to width. Numbers of 70 or lower indicate a short sidewall.

4. **D:** Indicates a “diagonal” type tire.

**R:** Indicates a “radial” type tire.

5. **16:** Indicates the wheel or rim diameter in inches. If you change your wheel size, you will have to purchase new tires to match the new wheel diameter.

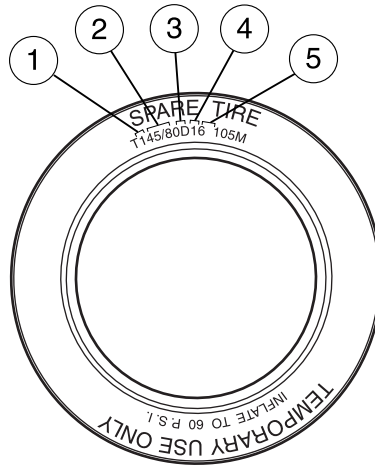

### Location of the tire label

You will find a Tire Label containing tire inflation pressure by tire size and other important information located on the B-Pillar or the edge of the driver’s door. Refer to the payload description and graphic in the *Vehicle loading — with and without a trailer* section.

## Tires, Wheels and Loading

### SNOW TIRES AND CHAINS



Snow tires must be the same size and grade as the tires you currently have on your vehicle.

The tires on your vehicle have all weather treads to provide traction in rain and snow. However, in some climates, you may need to use snow tires and chains. If you need to use chains, it is recommended that steel wheels (of the same size and specifications) be used, as chains may chip aluminum wheels.

Follow these guidelines when using snow tires and chains:

- Use only SAE Class S chains.
- Install chains securely, verifying that the chains do not touch any wiring, brake lines or fuel lines.
- Drive cautiously. If you hear the chains rub or bang against your vehicle, stop and re-tighten the chains. If this does not work, remove the chains to prevent damage to your vehicle.
- If possible, avoid fully loading your vehicle.
- Remove the tire chains when they are no longer needed. Do not use tire chains on dry roads.
- The suspension insulation and bumpers will help prevent vehicle damage. Do not remove these components from your vehicle when using snow tires and chains.

### VEHICLE LOADING – WITH AND WITHOUT A TRAILER

This section will guide you in the proper loading of your vehicle and/or trailer, to keep your loaded vehicle weight within its design rating capability, with or without a trailer. Properly loading your vehicle will provide maximum return of vehicle design performance. Before loading your vehicle, familiarize yourself with the following terms for determining your vehicle's weight ratings, with or without a trailer, from the vehicle's Tire Label or Safety Compliance Certification Label:

**Base Curb Weight** – is the weight of the vehicle including a full tank of fuel and all standard equipment. It does not include passengers, cargo, or optional equipment.

## Tires, Wheels and Loading

**Vehicle Curb Weight** – is the weight of your new vehicle when you picked it up from your authorized dealer plus any aftermarket equipment.

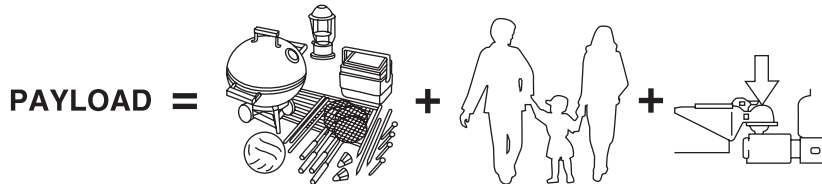

**Payload** – is the combined weight of cargo and passengers that the vehicle is carrying. The maximum payload for your vehicle can be found on the Tire Label on the B-Pillar or the edge of the driver's door (vehicles exported outside the US and Canada may not have a Tire Label). Look for **“THE COMBINED WEIGHT OF OCCUPANTS AND CARGO SHOULD NEVER EXCEED XXX kg OR XXX lb.”** for maximum payload. The payload listed on the Tire Label is the maximum payload for the vehicle as built by the assembly plant. If any aftermarket or authorized-dealer installed equipment has been installed on the vehicle, the weight of the equipment must be subtracted from the payload listed on the Tire Label in order to determine the new payload.

 The appropriate loading capacity of your vehicle can be limited either by volume capacity (how much space is available) or by payload capacity (how much weight the vehicle should carry). Once you have reached the maximum payload of your vehicle, do not add more cargo, even if there is space available. Overloading or improperly loading your vehicle can contribute to loss of vehicle control and vehicle rollover.

## Tires, Wheels and Loading

Example only:

TIRE AND LOADING INFORMATION			
SEATING CAPACITY		TOTAL 5	FRONT 2 REAR 3
The combined weight of occupants and cargo should never exceed : <b>XXX kg or XXX lbs.</b>			
TIRE	SIZE	COLD TIRE PRESSURE	SEE OWNERS MANUAL FOR ADDITIONAL INFORMATION
FRONT	LT225/75R 16.5E	200 KPA, 29 PSI	
REAR	LT225/75R 16.5E	200 KPA, 29 PSI	
SPARE	T145/80D16 P225/60R17	420 KPA, 60 PSI 200 KPA, 29 PSI	

TIRE AND LOAD INFORMATION			
SEATING CAPACITY		TOTAL XX	FRONT XX REAR X
NOMBRE DE PLACES		TOTAL	AVANT ARRIERE
The combined weight of occupants and cargo should never exceed : <b>XXX kg.</b> La charge du véhicule (occupants et bagages) ne doit jamais dépasser : <b>XXX lbs.</b>			
TIRE PNEUS	SIZE DIMENSIONS	COLD TIRE PRESSURE PRESSION A FROID	SEE OWNERS MANUAL FOR ADDITIONAL INFORMATION. CONSULTER LE GUIDE DU PROPRIETAIRE POUR DE PLUS AMPLES RENSEIGNEMENTS
FRONT/ AVANT	LT225/75R 16.5E	200 KPA, 29 PSI	
REAR/ ARRIERE	LT225/75R 16.5E	200 KPA, 29 PSI	
SPARE/ PNEU DE SECOURS	T145/80D16 P225/60R17	420 KPA, 60 PSI 200 KPA, 29 PSI	

CARGO

=



+

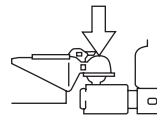

**Cargo Weight** – includes all weight added to the Base Curb Weight, including cargo and optional equipment. When towing, trailer tongue load or king pin weight is also part of cargo weight.

**GAW (Gross Axle Weight)** – is the total weight placed on each axle (front and rear) – including vehicle curb weight and all payload.

126

## Tires, Wheels and Loading

**GAWR (Gross Axle Weight Rating)** – is the maximum allowable weight that can be carried by a single axle (front or rear). **These numbers are shown on the Safety Compliance Certification Label located on the B-Pillar or the edge of the driver's door. The total load on each axle must never exceed its GAWR.**

**Note:** For trailer towing information refer to *Trailer towing* found in this chapter or the *RV and Trailer Towing Guide* provided by your authorized dealer.

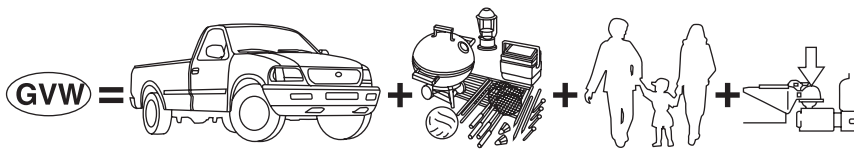

**GVW (Gross Vehicle Weight)** – is the Vehicle Curb Weight + cargo + passengers.

**GVWR (Gross Vehicle Weight Rating)** – is the maximum allowable weight of the fully loaded vehicle (including all options, equipment, passengers and cargo). **The GVWR is shown on the Safety Compliance Certification Label located on the B-Pillar or the edge of the driver's door. The GVW must never exceed the GVWR.**

MFD. BY FORD MOTOR CO.					
DATE: XX/XX	GVWR: XXXXLB/ XXXXKKG				
FRONT GAWR: XXXXL	REAR GAWR: XXXXLB				
XXXXKKG	WITH	XXXXKKG	WITH		
XXXX/XXXXXXX	TIRES	XXXX/XXXXXXX	TIRES		
XXXX.XX	RIMS	XXXX.XX	RIMS		
AT XXX kPa/XX	PSI COLD	AT XXX kPa/XX	PSI COLD		
THIS VEHICLE CONFORMS TO ALL APPLICABLE FEDERAL MOTOR VEHICLE SAFETY AND THEFT PREVENTION STANDARDS IN EFFECT ON THE DATE OF MANUFACTURE SHOWN ABOVE.					
VIN: XXXXXXXXXXXXXXXXX	XXXXX		XXXXX		
TYPE: XXX					
EXT PNT: XX	RC: XX	DSO:			
WB <sup>1</sup> BRK <sup>2</sup> INT TR <sup>3</sup> TP/PS <sup>4</sup> R <sup>5</sup> AXLE <sup>6</sup> TR <sup>7</sup> SPR <sup>8</sup> XXXXX					
XXX X XX X XX X XX XXX					
XXXXXXXXXXXX XXX XXXX-XXXXXX-XX					



Exceeding the Safety Compliance Certification Label vehicle weight rating limits could result in substandard vehicle handling or performance, engine, transmission and/or structural damage, serious damage to the vehicle, loss of control and personal injury.

## Tires, Wheels and Loading



**GCW (Gross Combined Weight)** – is the weight of the loaded vehicle (GVW) plus the weight of the fully loaded trailer.

**GCWR (Gross Combined Weight Rating)** – is the maximum allowable weight of the vehicle and the loaded trailer – including all cargo and passengers – that the vehicle can handle without risking damage.

(Important: The towing vehicle's braking system is rated for operation at GVWR, not at GCWR.) Separate functional brakes should be used for safe control of towed vehicles and for trailers where the GCW of the towing vehicle plus the trailer exceed the GVWR of the towing vehicle.

**The GCW must never exceed the GCWR.**

**Maximum Loaded Trailer Weight** – is the highest possible weight of a fully loaded trailer the vehicle can tow. It assumes a vehicle with only mandatory options, no cargo (internal or external), a tongue load of 10–15% (conventional trailer) or king pin weight of 15–25% (fifth wheel trailer), and driver only (150 lb. [68 kg]). **Consult your authorized dealer (or the *RV and Trailer Towing Guide* provided by your authorized dealer) for more detailed information.**

**Tongue Load or Fifth Wheel King Pin Weight** – refers to the amount of the weight that a trailer pushes down on a trailer hitch.

**Examples:** For a 5,000 lb. (2,268 kg) conventional trailer, multiply 5,000 by 0.10 and 0.15 to obtain a proper tongue load range of 500 to 750 lb. (227 to 340 kg). For an 11,500 lb. (5,216 kg) fifth wheel trailer, multiply by 0.15 and 0.25 to obtain a proper king pin load range of 1,725 to 2,875 lb. (782 to 1,304 kg)



Do not exceed the GVWR or the GAWR specified on the Safety Compliance Certification Label.



Do not use replacement tires with lower load carrying capacities than the original tires because they may lower the vehicle's GVWR and GAWR limitations. Replacement tires with a higher limit than the original tires do not increase the GVWR and GAWR limitations.



## Tires, Wheels and Loading



Exceeding any vehicle weight rating limitation could result in serious damage to the vehicle and/or personal injury.

### Steps for determining the correct load limit:

1. Locate the statement “The combined weight of occupants and cargo should never exceed XXX kg or XXX lbs.” on your vehicle’s placard.
2. Determine the combined weight of the driver and passengers that will be riding in your vehicle.
3. Subtract the combined weight of the driver and passengers from XXX kg or XXX lbs.
4. The resulting figure equals the available amount of cargo and luggage load capacity. For example, if the “XXX” amount equals 1,400 lbs. and there will be five 150 lb. passengers in your vehicle, the amount of available cargo and luggage load capacity is 650 lbs. ( $1400 - 750 (5 \times 150) = 650$  lb.). In metric units ( $635 - 340 (5 \times 68) = 295$  kg.)
5. Determine the combined weight of luggage and cargo being loaded on the vehicle. That weight may not safely exceed the available cargo and luggage load capacity calculated in Step 4.
6. If your vehicle will be towing a trailer, load from your trailer will be transferred to your vehicle. Consult this manual to determine how this reduces the available cargo and luggage load capacity of your vehicle.

The following gives you a few examples on how to calculate the available amount of cargo and luggage load capacity:

- Another example for your vehicle with 1400 lb. (635 kg) of cargo and luggage capacity. You decide to go golfing. Is there enough load capacity to carry you, 4 of your friends and all the golf bags? You and four friends average 220 lb. (99 kg) each and the golf bags weigh approximately 30 lb. (13.5 kg) each. The calculation would be:  $1400 - (5 \times 220) - (5 \times 30) = 1400 - 1100 - 150 = 150$  lb. Yes, you have enough load capacity in your vehicle to transport four friends and your golf bags. In metric units, the calculation would be:  $635 \text{ kg} - (5 \times 99 \text{ kg}) - (5 \times 13.5 \text{ kg}) = 635 - 495 - 67.5 = 72.5$  kg.
- A final example for your vehicle with 1400 lb. (635 kg) of cargo and luggage capacity. You and one of your friends decide to pick up cement from the local home improvement store to finish that patio you have been planning for the past 2 years. Measuring the inside of the vehicle with the rear seat folded down, you have room for 12-100 lb. (45 kg) bags of cement. Do you have enough load capacity to

## Tires, Wheels and Loading

transport the cement to your home? If you and your friend each weigh 220 lb. (99 kg), the calculation would be:  $1400 - (2 \times 220) - (12 \times 100) = 1400 - 440 - 1200 = -240$  lb. No, you do not have enough cargo capacity to carry that much weight. In metric units, the calculation would be:  $635 \text{ kg} - (2 \times 99 \text{ kg}) - (12 \times 45 \text{ kg}) = 635 - 198 - 540 = -103$  kg. You will need to reduce the load weight by at least 240 lb. (104 kg). If you remove 3-100 lb. (45 kg) cement bags, then the load calculation would be:

$1400 - (2 \times 220) - (9 \times 100) = 1400 - 440 - 900 = 60$  lb. Now you have the load capacity to transport the cement and your friend home. In metric units, the calculation would be:  $635 \text{ kg} - (2 \times 99 \text{ kg}) - (9 \times 45 \text{ kg}) = 635 - 198 - 405 = 32$  kg.

The above calculations also assume that the loads are positioned in your vehicle in a manner that does not overload the Front or the Rear Gross Axle Weight Rating specified for your vehicle on the Safety Compliance Certification Label found on the edge of the driver's door.

### Special loading instructions for owners of pickup trucks and utility-type vehicles



For important information regarding safe operation of this type of vehicle, see the *Preparing to drive your vehicle* section in the *Driving* chapter of this *Owner's Guide*.



Loaded vehicles may handle differently than unloaded vehicles. Extra precautions, such as slower speeds and increased stopping distance, should be taken when driving a heavily loaded vehicle.

Your vehicle can haul more cargo and people than most passenger cars. Depending upon the type and placement of the load, hauling cargo and people may raise the center of gravity of the vehicle.

### TRAILER TOWING

Refer to *6.0 Liter Power Stroke Direct Injection Turbo Diesel Owner's Guide Supplement* for Diesel engine towing information.

Your vehicle may tow a class I, II or III trailer, provided the maximum trailer weight is less than or equal to the maximum trailer weight listed for your engine and rear axle ratio on the following charts.

## Tires, Wheels and Loading

<b>GCWR (Gross Combined Weight Rating)/Trailer Weights</b>				
<b>Engine</b>	<b>Rear axle ratio</b>	<b>Maximum GCWR - lb. (kg)</b>	<b>Maximum Loaded Trailer Weight - lb. (kg)</b>	<b>Maximum frontal area of trailer - ft<sup>2</sup> (m<sup>2</sup>)</b>
<b>E-150 Regular/RV Van (8520 GVWR)</b>				
4.6L	3.73	11500 (5216)	6000 (2722)	60 (5.52)
4.6L	4.10	12000 (5443)	6500 (2948)	60 (5.52)
<b>E-150 Van (Crew) (8520 GVWR)</b>				
4.6L	3.73	11500 (5216)	5900 (2676)	60 (5.52)
4.6L	4.10	12000 (5443)	6400 (2903)	60 (5.52)
<b>E-150 Regular Wagon (7-passenger) (8520 GVWR)</b>				
4.6L	4.10	12000 (5443)	5900 (2676)	60 (5.52)
<b>E-150 Regular Wagon (8-passenger) (8520 GVWR)</b>				
4.6L	4.10	12000 (5443)	6200 (2812)	60 (5.52)
<b>E-150 Regular/RV Van (8600 GVWR)</b>				
5.4L	3.55	12000 (5443)	6500 (2948)	60 (5.52)
5.4L	3.73	13000 (5897)	7500 (3402)	60 (5.52)
<b>E-150 Van (Crew) (8600 GVWR)</b>				
5.4L	3.55	12000 (5443)	6300 (2858)	60 (5.52)
5.4L	3.73	13000 (5897)	7300 (3311)	60 (5.52)

## Tires, Wheels and Loading

<b>GCWR (Gross Combined Weight Rating)/Trailer Weights</b>				
<b>Engine</b>	<b>Rear axle ratio</b>	<b>Maximum GCWR - lb. (kg)</b>	<b>Maximum Loaded Trailer Weight - lb. (kg)</b>	<b>Maximum frontal area of trailer - ft<sup>2</sup> (m<sup>2</sup>)</b>
<b>E-150 Regular Wagon (7-passenger) (8600 GVWR)</b>				
5.4L	3.55	12000 (5443)	5900 (2676)	60 (5.52)
5.4L	3.73	13000 (5897)	6900 (3130)	60 (5.52)
<b>E-150 Regular Wagon (8-passenger) (8600 GVWR)</b>				
5.4L	3.55	12000 (5443)	6100 (2767)	60 (5.52)
5.4L	3.73	13000 (5897)	7100 (3221)	60 (5.52)
<b>E-250 Regular/RV Van (8900 GVWR)</b>				
4.6L	3.73	11500 (5216)	6100 (2767)	60 (5.52)
4.6L	4.10	12000 (5443)	6600 (2994)	60 (5.52)
<b>E-250 Regular Van (Crew) (8900 GVWR)</b>				
4.6L	3.73	11500 (5216)	5900 (2676)	60 (5.52)
4.6L	4.10	12000 (5443)	6400 (2903)	60 (5.52)
<b>E-250 Extended/RV Van (8900 GVWR)</b>				
4.6L	3.73	11500 (5216)	5900 (2676)	60 (5.52)
4.6L	4.10	12000 (5443)	6400 (2903)	60 (5.52)

## Tires, Wheels and Loading

<b>GCWR (Gross Combined Weight Rating)/Trailer Weights</b>				
<b>Engine</b>	<b>Rear axle ratio</b>	<b>Maximum GCWR - lb. (kg)</b>	<b>Maximum Loaded Trailer Weight - lb. (kg)</b>	<b>Maximum frontal area of trailer - ft<sup>2</sup> (m<sup>2</sup>)</b>
<b>E-250 Extended Van (Crew) (8900 GVWR)</b>				
4.6L	3.73	11500 (5216)	5700 (2585)	60 (5.52)
4.6L	4.10	12000 (5443)	6200 (2812)	60 (5.52)
<b>E-250 Regular/RV Van (9000 GVWR)</b>				
5.4L	3.73	13000 (5896)	7500 (3402)	60 (5.52)
<b>E-250 Regular Van (Crew) (9000 GVWR)</b>				
5.4L	3.73	13000 (5896)	7300 (3311)	60 (5.52)
<b>E-250 Extended/RV Van (9000 GVWR)</b>				
5.4L	3.73	13000 (5896)	7400 (3357)	60 (5.52)
<b>E-250 Extended Van (Crew) (9000 GVWR)</b>				
5.4L	3.73	13000 (5896)	7200 (3266)	60 (5.52)
<b>E-250 Cutaway (8600 GVWR)</b>				
4.6L	4.10	12000 (5443)	7500 (3402)	60 (5.52)
<b>E-350 Regular/RV Van (9500 GVWR)</b>				
5.4L	3.73	13000 (5897)	7500 (3402)	60 (5.52)
5.4L	4.10	13000 (5897)	7500 (3402)	60 (5.52)
6.8L	3.73	15000 (6804)	9200 (4173)	60 (5.52)
6.8L	4.10	18500 (8391)	10000 (4536)	60 (5.52)

## Tires, Wheels and Loading

<b>GCWR (Gross Combined Weight Rating)/Trailer Weights</b>				
<b>Engine</b>	<b>Rear axle ratio</b>	<b>Maximum GCWR - lb. (kg)</b>	<b>Maximum Loaded Trailer Weight - lb. (kg)</b>	<b>Maximum frontal area of trailer - ft<sup>2</sup> (m<sup>2</sup>)</b>
<b>E-350 Regular Van (Crew) (9500 GVWR)</b>				
5.4L	3.73	13000 (5897)	7300 (3311)	60 (5.52)
5.4L	4.10	13000 (5897)	7300 (3311)	60 (5.52)
6.8L	3.73	15000 (6804)	9000 (4082)	60 (5.52)
6.8L	4.10	18500 (8391)	10000 (4536)	60 (5.52)
<b>E-350 Extended/RV Van (9400 GVWR)</b>				
5.4L	3.73	13000 (5897)	7300 (3311)	60 (5.52)
5.4L	4.10	13000 (5897)	7300 (3311)	60 (5.52)
6.8L	3.73	15000 (6804)	9100 (4128)	60 (5.52)
6.8L	4.10	18500 (8391)	10000 (4536)	60 (5.52)
<b>E-350 Extended Van (Crew) (9400 GVWR)</b>				
5.4L	3.73	13000 (5897)	7100 (3221)	60 (5.52)
5.4L	4.10	13000 (5897)	7100 (3221)	60 (5.52)
6.8L	3.73	15000 (6804)	8900 (4037)	60 (5.52)
6.8L	4.10	18500 (8391)	10000 (4536)	60 (5.52)

## Tires, Wheels and Loading

<b>GCWR (Gross Combined Weight Rating)/Trailer Weights</b>				
<b>Engine</b>	<b>Rear axle ratio</b>	<b>Maximum GCWR - lb. (kg)</b>	<b>Maximum Loaded Trailer Weight - lb. (kg)</b>	<b>Maximum frontal area of trailer - ft<sup>2</sup> (m<sup>2</sup>)</b>
<b>E-350 Regular Wagon (11/12-passenger) (8600 GVWR)</b>				
5.4L	3.73	13000 (5897)	6900 (3130)	60 (5.52)
<b>E-350 Extended Wagon (12-passenger) (9300 GVWR)</b>				
5.4L	3.73	13000 (5897)	6700 (3039)	60 (5.52)
<b>E-350 Extended Wagon (14/15-passenger) (9100 GVWR)</b>				
5.4L	3.73	13000 (5897)	6600 (2994)	60 (5.52)
<b>E-350 Cutaway (138" wheelbase, single rear wheel) (9600 GVWR)</b>				
5.4L	4.10	13000 (5897)	8100 (3674)	60 (5.52)
6.8L	4.10	18500 (8391)	10000 (4536)	60 (5.52)
<b>E-350 Cutaway (138" wheelbase, dual rear wheel) (10000 GVWR)</b>				
5.4L	4.10	13000 (5897)	7900 (3583)	60 (5.52)
6.8L	4.10	18500 (8391)	10000 (4536)	60 (5.52)
<b>E-350 Cutaway (158" wheelbase, dual rear wheel) (10000 GVWR)</b>				
5.4L	4.10	13000 (5897)	7900 (3583)	60 (5.52)

## Tires, Wheels and Loading

<b>GCWR (Gross Combined Weight Rating)/Trailer Weights</b>				
<b>Engine</b>	<b>Rear axle ratio</b>	<b>Maximum GCWR - lb. (kg)</b>	<b>Maximum Loaded Trailer Weight - lb. (kg)</b>	<b>Maximum frontal area of trailer - ft<sup>2</sup> (m<sup>2</sup>)</b>
<b>E-350 Cutaway (138" wheelbase, dual rear wheel) (10700 GVWR)</b>				
5.4L	4.10	13000 (5897)	7900 (3583)	60 (5.52)
6.8L	4.10	18500 (8391)	10000 (4536)	60 (5.52)
<b>E-350 Cutaway (158" wheelbase, dual rear wheel) (11500 GVWR)</b>				
5.4L	4.10	13000 (5897)	7900 (3583)	60 (5.52)
6.8L	4.10	18500 (8391)	10000 (4536)	60 (5.52)
<b>E-350 Cutaway (176" wheelbase, dual rear wheel) (11500 GVWR)</b>				
5.4L	4.10	13000 (5897)	7900 (3583)	60 (5.52)
6.8L	4.10	18500 (8391)	10000 (4536)	60 (5.52)
<b>E-350 Stripped Chassis (138" wheelbase, single rear wheel) (9600 GVWR)</b>				
5.4L	3.73	13000 (5897)	8800 (3992)	8800 (3992)
5.4L	4.10	13000 (5897)	8800 (3992)	8800 (3992)
<b>E-350 Stripped Chassis (158" wheelbase, single rear wheel) (9600 GVWR)</b>				
5.4L	3.73	13000 (5897)	8700 (3946)	60 (5.52)
5.4L	4.10	13000 (5897)	8700 (3946)	60 (5.52)



## Tires, Wheels and Loading

<b>GCWR (Gross Combined Weight Rating)/Trailer Weights</b>				
<b>Engine</b>	<b>Rear axle ratio</b>	<b>Maximum GCWR - lb. (kg)</b>	<b>Maximum Loaded Trailer Weight - lb. (kg)</b>	<b>Maximum frontal area of trailer - ft<sup>2</sup> (m<sup>2</sup>)</b>
<b>E-350 Stripped Chassis (138" wheelbase, dual rear wheel) (10000 GVWR)</b>				
5.4L	4.10	13000 (5897)	8500 (3856)	60 (5.52)
6.8L	4.10	18500 (8391)	10000 (4536)	60 (5.52)
<b>E-350 Stripped Chassis (138" wheelbase, dual rear wheel) (10000 GVWR)</b>				
5.4L	4.10	13000 (5897)	8500 (3856)	60 (5.52)
6.8L	4.10	18500 (8391)	10000 (4536)	60 (5.52)
<b>E-350 Stripped Chassis (158" wheelbase, dual rear wheel) (10000 GVWR)</b>				
5.4L	4.10	13000 (5897)	8400 (3810)	60 (5.52)
6.8L	4.10	18500 (8391)	10000 (4536)	60 (5.52)
<b>E-350 Stripped Chassis (158" wheelbase, dual rear wheel) (11000 GVWR)</b>				
5.4L	4.10	13000 (5897)	8400 (3810)	60 (5.52)
6.8L	4.10	18500 (8391)	10000 (4536)	60 (5.52)
<b>E-350 Stripped Chassis (176" wheelbase, dual rear wheel) (10000 GVWR)</b>				
5.4L	4.10	13000 (5897)	8400 (3810)	60 (5.52)
6.8L	4.10	18500 (8391)	10000 (4536)	60 (5.52)

## Tires, Wheels and Loading

<b>GCWR (Gross Combined Weight Rating)/Trailer Weights</b>				
<b>Engine</b>	<b>Rear axle ratio</b>	<b>Maximum GCWR - lb. (kg)</b>	<b>Maximum Loaded Trailer Weight - lb. (kg)</b>	<b>Maximum frontal area of trailer - ft<sup>2</sup> (m<sup>2</sup>)</b>
<b>E-350 Stripped Chassis (176" wheelbase, dual rear wheel) (11000 GVWR)</b>				
5.4L	4.10	13000 (5897)	8400 (3810)	60 (5.52)
6.8L	4.10	18500 (8391)	10000 (4536)	60 (5.52)
<b>E-450 Cutaway (158" wheelbase, dual rear wheel) (14050 GVWR)</b>				
6.8L	4.56	20000 (9072)	10000 (4536)	60 (5.52)
<b>E-450 Cutaway (176" wheelbase, dual rear wheel) (14050 GVWR)</b>				
6.8L	4.56	20000 (9072)	10000 (4536)	60 (5.52)
<b>E-450 Stripped Chassis (158" wheelbase, dual rear wheel) (14050 GVWR)</b>				
5.4L	4.56	14050 (6373)	9200 (4173)	60 (5.52)
6.8L	4.56	20000 (9072)	10000 (4536)	60 (5.52)
<b>E-450 Stripped Chassis (176" wheelbase, dual rear wheel) (14050 GVWR)</b>				
5.4L	4.56	14050 (6372)	9200 (4173)	60 (5.52)
6.8L	4.56	20000 (9072)	10000 (4536)	60 (5.52)

## Tires, Wheels and Loading

<b>GCWR (Gross Combined Weight Rating)/Trailer Weights</b>				
<b>Engine</b>	<b>Rear axle ratio</b>	<b>Maximum GCWR - lb. (kg)</b>	<b>Maximum Loaded Trailer Weight - lb. (kg)</b>	<b>Maximum frontal area of trailer - ft<sup>2</sup> (m<sup>2</sup>)</b>
Maximum trailer weight for all cutaway (E-350 and E-450) vehicles must be calculated by subtracting the weight of the vehicle (including incomplete vehicle weight and payload which includes second unit body weight, cargo and passengers) from the GCW. Otherwise, maximum trailer weight is 10,000 lb. (4536 kg).				
For high altitude operation reduce GCWR by 2% per 1,000 ft. (300 meters) elevation. To determine the maximum trailer weight designed for your particular vehicle as equipped, follow the section <i>Vehicle loading</i> earlier in this chapter.				

Your vehicle's load capacity is designated by weight, not by volume, so you cannot necessarily use all available space when loading a vehicle. Distribute the load so that only 10–15% of the total is on the tongue. Tie down the load so that it does not shift and change the weight on the hitch.

Towing a trailer places an additional load on your vehicle's engine, transmission, axle, brakes, tires and suspension. Inspect these components carefully after any towing operation.

**Note:** Do not exceed the GVWR or the GAWR specified on the certification label.



Towing trailers beyond the maximum recommended gross trailer weight exceeds the limit of the vehicle and could result in engine damage, transmission damage, structural damage, loss of vehicle control, vehicle rollover and personal injury.

### Preparing to tow

Use the proper equipment for towing a trailer and make sure it is properly attached to your vehicle. See your authorized dealer or a reliable trailer dealer if you require assistance.

### Hitches

Do not use or install hitches that clamp onto the bumper or to the axle. Underbody hitches are acceptable if installed properly.

## Tires, Wheels and Loading

### Safety chains

Always connect the trailer's safety chains to the frame or hook retainers of the vehicle hitch. To connect the trailer's safety chains, cross the chains under the trailer tongue and allow slack for turning corners.

If you use a rental trailer, follow the instructions that the rental agency gives to you.

**Do not attach safety chains to the bumper.**

### Trailer brakes

Electric brakes and manual, automatic or surge-type trailer brakes are safe if installed properly and adjusted to the manufacturer's specifications. The trailer brakes must meet local and Federal regulations.



Do not connect a trailer's hydraulic brake system directly to your vehicle's brake system. Your vehicle may not have enough braking power and your chances of having a collision greatly increase.

The braking system of the tow vehicle is rated for operation at the GVWR not GCWR.

### Trailer lamps

Trailer lamps are required on most towed vehicles. Make sure all running lights, brake lights, turn signals and hazard lights are working. See your authorized dealer or trailer rental agency for proper instructions and equipment for hooking up trailer lamps.

### Using a step bumper (if equipped)

The rear bumper is equipped with an integral hitch and only requires a ball with a one inch (25.4 mm) shank diameter. The bumper has a 5,000 lb. (2,270 kg) trailer weight and 500 lb. (227 kg) tongue weight capacity.

If it is necessary to relocate the trailer hitch ball position, a frame-mounted trailer hitch must be installed.

### Driving while you tow

When towing a trailer:

- Keep your speed no faster than 70 mph (112 km/h) during the first 500 miles (800 km) of towing a trailer, and don't make full throttle starts.
- Turn off the speed control. The speed control may shut off automatically when you are towing on long, steep grades.

## Tires, Wheels and Loading

- Consult your local motor vehicle speed regulations for towing a trailer.
- To eliminate excessive shifting, use a lower gear. This will also assist in transmission cooling.
- Anticipate stops and brake gradually.

When descending long, steep downhill grades, always use a lower gear to provide engine braking to save wear on brakes. Use Drive (Overdrive OFF) on moderately steep hills, Second (2) on steep hills, and First (1) on very steep hills. **Do not apply your brakes continuously, as they may overheat and become less effective.**

### **Servicing after towing**

If you tow a trailer for long distances, your vehicle will require more frequent service intervals. Refer to your *scheduled maintenance information* for more information.

### **Trailer towing tips**

- Practice turning, stopping and backing up before starting on a trip to get the feel of the vehicle trailer combination. When turning, make wider turns so the trailer wheels will clear curbs and other obstacles.
- Allow more distance for stopping with a trailer attached.
- The trailer tongue weight should be 10–15% of the loaded trailer weight.
- If you will be towing a trailer frequently in hot weather, hilly conditions, at GCWR, or any combination of these factors, consider refilling your rear axle with synthetic gear lube if not already so equipped. Refer to the *Maintenance and specifications* chapter for the lubricant specification. Remember that regardless of the rear axle lube used, do not tow a trailer for the first 500 miles (800 km) of a new vehicle, and that the first 500 miles (800 km) of towing be done at no faster than 70 mph (112 km/h) with no full throttle starts.
- Do not tow a trailer for the first 500 miles (800 km) after changing the rear axle lube
- After you have traveled 50 miles (80 km), thoroughly check your hitch, electrical connections and trailer wheel lug nuts.
- When stopped in traffic for long periods of time in hot weather, place the gearshift in P (Park) and increase idle speed. This aids engine cooling and air conditioner efficiency.
- Vehicles with trailers should not be parked on a grade. If you must park on a grade, place wheel chocks under the trailer's wheels.

## Tires, Wheels and Loading

### Launching or retrieving a boat

**Disconnect the wiring to the trailer before backing the trailer into the water. Reconnect the wiring to the trailer after the trailer is removed from the water.**

When backing down a ramp during boat launching or retrieval:

- do not allow the static water level to rise above the bottom edge of the rear bumper.
- do not allow waves to break higher than 6 inches (15 cm) above the bottom edge of the rear bumper.

Exceeding these limits may allow water to enter vehicle components:

- causing internal damage to the components.
- affecting driveability, emissions and reliability.

Replace the rear axle lubricant any time the axle has been submerged in water. Rear axle lubricant quantities are not to be checked or changed unless a leak is suspected or repair required.

### RECREATIONAL TOWING (ALL WHEELS ON THE GROUND)

An example of recreational towing would be towing your vehicle on a trip behind a motorhome. Follow these guidelines if you have the need for recreational towing of your vehicle with all four wheels on the ground. These guidelines are designed to ensure that your transmission is not damaged.

#### **2WD vehicles (with automatic transmissions):**

- Place the transmission in N (Neutral)
- Maximum speed is 35 mph (56 km/h)
- Maximum distance is 50 miles (80 km)

If a distance of 50 miles (80 km) or a speed of 35 mph (56 km/h) must be exceeded, the drive shaft will have to be removed.

Ford recommends the driveshaft be removed/installed only by a qualified technician at an authorized dealer. See your authorized dealer for driveshaft removal/installation.

**Improper removal/installation of the driveshaft can cause transmission fluid loss, damage to the driveshaft and internal transmission components.**

### STARTING

#### Positions of the ignition

1. ACCESSORY, allows the electrical accessories such as the radio to operate while the engine is not running.
2. LOCK, locks the automatic transmission gearshift lever and allows key removal.
3. OFF, shuts off the engine and all accessories without locking the steering wheel. This position also allows the automatic transmission shift lever to be moved from the P (Park) position without the brake pedal being depressed.

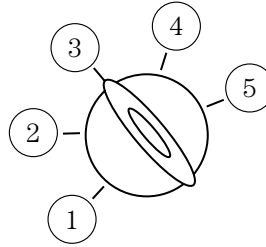

 When the key is in the ignition and in the OFF position, the automatic transmission shift lever can be moved from the P (Park) position without the brake pedal depressed. To avoid unwanted vehicle movement, always set the parking brake.

4. ON, all electrical circuits operational. Warning lights illuminated. Key position when driving.
5. START, cranks the engine. Release the key as soon as the engine starts.

#### Preparing to start your vehicle

Engine starting is controlled by the powertrain control system. This system meets all Canadian Interference-Causing Equipment standard requirements regulating the impulse electrical field strength of radio noise.

When starting a fuel-injected engine, don't press the accelerator before or during starting. Only use the accelerator when you have difficulty starting the engine. For more information on starting the vehicle, refer to *Starting the engine* in this chapter.

 Extended idling at high engine speeds can produce very high temperatures in the engine and exhaust system, creating the risk of fire or other damage.

## Driving



Do not park, idle, or drive your vehicle in dry grass or other dry ground cover. The emission system heats up the engine compartment and exhaust system, which can start a fire.



Do not start your vehicle in a closed garage or in other enclosed areas. Exhaust fumes can be toxic. Always open the garage door before you start the engine. See *Guarding against exhaust fumes* in this chapter for more instructions.



If you smell exhaust fumes inside your vehicle, have your dealer inspect your vehicle immediately. Do not drive if you smell exhaust fumes.

### **Important safety precautions**

When the engine starts, the idle RPM runs faster to warm the engine. If the engine idle speed does not slow down automatically, have the vehicle checked. If your vehicle is operated in a heavy snow storm or blowing snow conditions, the engine air induction may become partially clogged with snow and/or ice. If this occurs, the engine may experience a significant reduction in power output. At the earliest opportunity, clear all the snow and/or ice away from the air induction inlet. The following starting instructions are for vehicles equipped with a gasoline engine; if your vehicle is equipped with a Diesel engine, refer to *Starting the engine* in the *6.0 Liter Power Stroke Direct Injection Turbo Diesel Owner's Guide Supplement*.

Before starting the vehicle:

1. Make sure all occupants buckle their safety belts. For more information on safety belts and their proper usage, refer to the *Seating and Safety Restraints* chapter.
2. Make sure the headlamps and electrical accessories are off.



## Driving

- Make sure the parking brake is set.

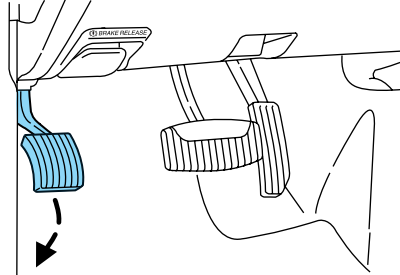

- Make sure the gearshift is in P (Park).



- Turn the key to 4 (ON) without turning the key to 5 (START).

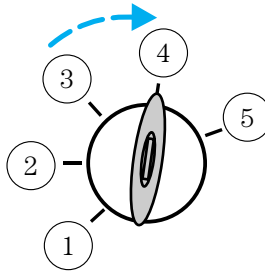

Some warning lights will briefly illuminate. See *Warning lights and chimes* in the *Instrument Cluster* chapter for more information regarding the warning lights.

### Starting the engine

1. Turn the key to 4 (ON) without turning the key to 5 (START).
2. Turn the key to 5 (START), then release the key as soon as the engine starts. Excessive cranking could damage the starter.

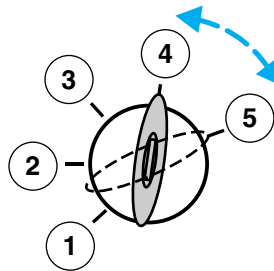

## Driving

**Note:** If the engine does not start within five seconds on the first try, turn the key to 3 (OFF), wait 10 seconds and try again. If the engine still fails to start, press the accelerator to the floor and try again; this will allow the engine to crank with the fuel shut off in case the engine is flooded with fuel.

### Guarding against exhaust fumes

Carbon monoxide is present in exhaust fumes. Take precautions to avoid its dangerous effects.



If you smell exhaust fumes inside your vehicle, have your dealer inspect your vehicle immediately. Do not drive if you smell exhaust fumes.

### Important ventilating information

If the engine is idling while the vehicle is stopped for a long period of time, open the windows at least one inch (2.5 cm) or adjust the heating or air conditioning to bring in fresh air.

### ENGINE BLOCK HEATER (IF EQUIPPED)



To reduce the risk of electrical shock, do not use your heater with ungrounded electrical systems or two-pronged (cheater) adapters.

Use of an engine block heater is strongly recommended if you live in a region where temperatures reach -10°F (-23°C) or below. For best results, plug the heater in at least three hours before starting the vehicle. The heater can be plugged in the night before starting the vehicle.

### BRAKES

Occasional brake noise is normal. If a metal-to-metal, continuous grinding or continuous squeal sound is present, the brake linings may be worn-out and should be inspected by an authorized dealer. If the vehicle has continuous vibration or shudder in the steering wheel while braking, the vehicle should be inspected by an authorized dealer.

Refer to *Brake system warning light* in the *Instrument Cluster* chapter for information on the brake system warning light.



### Four-wheel anti-lock brake system (ABS)

Your vehicle is equipped with an Anti-lock Braking System (ABS). This system helps you maintain steering control during emergency stops by keeping the brakes from locking. Noise from the ABS pump motor and brake pedal pulsation may be observed during ABS braking and the brake pedal may suddenly travel a little farther as soon as ABS braking is done and normal brake operation resumes. These are normal characteristics of the ABS and should be no reason for concern.

### Using ABS

When hard braking is required, apply continuous force on the brake pedal; do not pump the brake pedal since this will reduce the effectiveness of the ABS and will increase your vehicle's stopping distance. The ABS will be activated immediately, allowing you to retain steering control during hard braking and on slippery surfaces. However, the ABS does not decrease stopping distance.

### ABS warning lamp

The ABS lamp in the instrument cluster momentarily illuminates when the ignition is turned on. If the light does not illuminate during start up, remains on or flashes, the ABS may be disabled and may need to be serviced.



Even when the ABS is disabled, normal braking is still effective. (If your BRAKE warning lamp illuminates with the parking brake released, have your brake system serviced immediately by an authorized dealer.)



## Driving

### Parking brake

To set the parking brake (1), press the parking brake pedal down until the pedal stops.

To release, pull the lever (2).



Always set the parking brake fully and make sure that the gearshift is securely latched in P (Park).

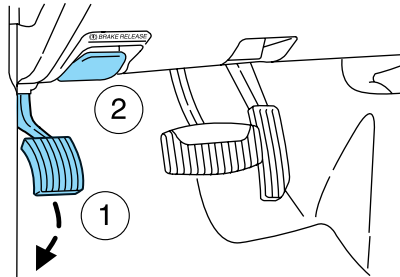

The BRAKE warning lamp will illuminate and will remain illuminated until the parking brake is released.



The parking brake is not recommended to stop a moving vehicle. However, if the normal brakes fail, the parking brake can be used to stop your vehicle in an emergency. Since the parking brake applies only the rear brakes, the vehicle's stopping distance will increase greatly and the handling of your vehicle will be adversely affected.

### **ADVANCETRAC® WITH ROLL STABILITY CONTROL™ (RSC) STABILITY ENHANCEMENT SYSTEM (IF EQUIPPED)**

The AdvanceTrac® with RSC system provides stability and traction enhancement for certain driving situations when driver assistance is needed. It helps your vehicle maintain traction, when driving on slippery and/or hilly road surfaces, by detecting and controlling wheel spin. Excessive wheel spin is controlled by momentarily reducing engine power and rapidly applying the anti-lock brakes. The system is a driver aid which makes your vehicle easier to handle primarily on snow and ice-covered roads.

If your vehicle should become stuck in deep snow or mud, try switching the AdvanceTrac® with RSC system off by pressing the AdvanceTrac® with RSC button. This will allow your tires to “dig” for traction.

## Driving

If the AdvanceTrac® with RSC system is activated excessively in a short period of time, the brake portion of the system will shut down to allow the brakes to cool down. A limited AdvanceTrac® with RSC function using only engine power reduction will still help control the wheels from over-spinning. When the brakes have cooled down, the system will again function normally. Anti-lock braking is not affected by this condition and will function normally during the cool-down period.

The AdvanceTrac® with RSC system enhances your vehicle's stability during maneuvers that require all available tire traction, like in wet/snowy/icy road conditions and/or when performing emergency maneuvers. In an emergency lane-change, the driver will experience better overall vehicle traction, and have better control of the vehicle.

The AdvanceTrac® with RSC system helps the driver maintain steering control if the vehicle begins to slide excessively left or right or spin out. AdvanceTrac® with RSC will attempt to correct the sliding motion by applying brake force at individual tires and, if necessary, by reducing engine power.

Driving conditions which may activate AdvanceTrac® with RSC system include:

- Taking a turn too fast.
- Maneuvering quickly to avoid an accident, pedestrian or obstacle.
- Hitting a patch of ice.
- Changing lanes on a snow-rutted road.
- Entering a snow-free road from a snow-covered side street, or vice versa.
- Entering a paved road from a gravel road, or vice versa.
- Hitting a curb while turning.
- Driving on slick surfaces.
- Cornering while towing a heavily loaded trailer (refer to *Trailer towing* in the *Tires, Wheels and Loading* chapter.)

The RSC system works in conjunction with the AdvanceTrac® system to further enhance the vehicle's overall stability during aggressive maneuvers. The system helps maintain roll stability of the vehicle during aggressive maneuvers by applying brake force to one or more wheels.

Driving conditions that may activate Roll Stability Control include:

- Emergency lane-change
- Taking a turn too fast

## Driving

- Quick maneuvering to avoid an accident, pedestrian or obstacle

The AdvanceTrac® with RSC system automatically turns on when the engine is started. However, the system does not function when the vehicle is traveling in R (Reverse). In R (Reverse), ABS and the traction enhancement feature will continue to function.

The AdvanceTrac® with RSC button allows the driver to control the availability of the AdvanceTrac® with RSC system. AdvanceTrac® with RSC system status is indicated by a warning indicator light with a “sliding car” icon in the instrument cluster that will flash when the system is active and an indicator light in the control button that will illuminate when the system is turned off.

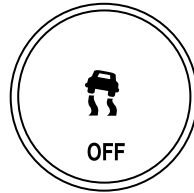

The AdvanceTrac® with RSC system warning indicator light may flash to indicate the system is not fully initialized. If this happens, slow down. If the light continues flashing, have the AdvanceTrac® with RSC system serviced by an authorized dealer.



If a failure is detected in the AdvanceTrac® with RSC system, the warning indicator light in the instrument cluster will stay on and the instrument cluster will chime repeatedly. If the warning indicator light in the instrument cluster remains on and the chime is active while the engine is running, have the system serviced by an authorized dealer immediately.

Pressing the control will disable the AdvanceTrac® with RSC system and the traction enhancement feature at and below 20 mph (32 km/h). If the vehicle is stuck in snow or mud or when driving in deep sand, switching off the AdvanceTrac® with RSC system may be beneficial so the wheels are allowed to spin. If your vehicle seems to lose engine power while driving in deep sand or very deep snow and the vehicle speed is 20 mph (32 km/h) or below, switching off the AdvanceTrac® with RSC stability enhancement feature will restore full engine power and will enhance momentum through the obstacle.

**Note:** The AdvanceTrac® with RSC system will automatically restore to full functionality every time the vehicle speed exceeds 20 mph (32 km/h) or the ignition is turned off and back on. However, the AdvanceTrac® with RSC button remains illuminated even above 20 mph (32 km/h) until it is pressed.

## Driving

Some drivers may notice a slight movement of the brake pedal when the AdvanceTrac® with RSC performs a system self-check. During AdvanceTrac® with RSC operation you may experience the following:

- A rumble or grinding noise
- A slight deceleration of the vehicle
- Steering feedback
- The AdvanceTrac® with RSC indicator light will flash
- If your foot is on the brake pedal, you will feel a vibration in the pedal.

All these conditions are normal during AdvanceTrac® with RSC operation.

**Do not alter or modify your vehicle's suspension, steering or tires; the resulting changes to the vehicle's handling can adversely affect the AdvanceTrac® with RSC system. Also, do not install a stereo loudspeaker. The speaker vibrations can adversely affect the AdvanceTrac® with RSC sensors.**



Aggressive driving in any road conditions can cause you to lose control of your vehicle increasing the risk of severe personal injury or property damage. The occurrence of a AdvanceTrac® with RSC event is an indication that at least some of the tires have exceeded their ability to grip the road; this may lead to an increased risk of loss of vehicle control, vehicle rollover, personal injury and death. If you experience a severe road event, SLOW DOWN.

### STEERING

To help prevent damage to the power steering system:

- Never hold the steering wheel at its furthest turning points (until it stops) for more than a few seconds when the engine is running.
- Do not operate the vehicle with a low power steering pump fluid level (If the fluid level is below the FULL COLD range on the dipstick).
- Some noise is normal during operation. If the noise is excessive, check for low power steering pump fluid level before seeking service by your authorized dealer.
- Heavy or uneven steering efforts may be caused by low power steering pump fluid level. Check for low power steering pump fluid level before seeking service by your authorized dealer.

## Driving

- Do not fill the power steering pump reservoir above the MAX mark on the reservoir, as this may result in leaks from the reservoir.

If the power steering system breaks down (or if the engine is turned off), you can steer the vehicle manually, but it takes more effort.

If the steering wanders or pulls, check for:

- an improperly inflated tire
- uneven tire wear
- loose or worn suspension components
- loose or worn steering components
- improper steering alignment

A high crown in the road or high crosswinds may also make the steering seem to wander/pull.

### TRACTION-LOK AXLE (IF EQUIPPED)

This axle provides added traction on slippery surfaces, particularly when one wheel is on a poor traction surface. Under normal conditions, the Traction-Lok axle functions like a standard rear axle. The axle may exhibit a slight noise or vibration in tight turns with low vehicle speed. This is normal behavior and indicates the axle is working.

### PREPARING TO DRIVE



Utility vehicles have a significantly higher rollover rate than other types of vehicles.



In a rollover crash, an unbelted person is significantly more likely to die than a person wearing a seat belt.

Utility vehicles and trucks have larger tires and increased ground clearance, giving the vehicle a higher center of gravity than a passenger car.



Vehicles with a higher center of gravity such as utility vehicles and trucks handle differently than vehicles with a lower center of gravity. Utility vehicles and trucks are **not** designed for cornering at speeds as high as passenger cars any more than low-slung sports cars are designed to perform satisfactorily under off-road conditions. Avoid sharp turns, excessive speed or abrupt maneuvers in these vehicles. Failure to drive cautiously could result in an increased risk of loss of vehicle control, vehicle rollover, personal injury and death.



## Driving



Loaded vehicles, with a higher center of gravity, may handle differently than unloaded vehicles. Do not overload your vehicle and use extra precautions, such as driving at slower speeds, avoiding abrupt steering changes and allowing for increased stopping distance, when driving a heavily loaded vehicle. Over loading or loading the vehicle improperly can deteriorate handling capability and contribute to loss of vehicle control and vehicle rollover.

### Vehicle stability and handling

The risk of a rollover crash increases as the number of people and load in the vehicle increase. This increased risk occurs because the passenger weight and load raises the vehicle's center of gravity and causes it to shift rearward. As a result, the van has less resistance to rollover and handles differently from other commonly driven passenger vehicles, making it more difficult to control in an emergency situation. Placing any load on the roof also raises the center of gravity and increases the potential for rollover.

The van should be operated by an experienced driver. An organization that owns a 15-passenger van should select one or two experienced drivers to drive the van on a regular basis. These drivers will gain valuable experience handling the van. This experience will help make each trip safer.

The van should be operated at a safe speed which, in some conditions, may be less than the posted speed limit.

Further, all occupants should be properly restrained. Most people killed in rollover crashes were unbelted. Occupants can dramatically reduce their risk of being killed or seriously injured in a rollover crash by simply using their seat belts. Organizations that own 15-passenger vans should have a written seat belt use policy. Drivers should be responsible for enforcing the policy.

### Emergency maneuvers

- In an unavoidable emergency situation where a sudden sharp turn must be made, remember to avoid “over-driving” your vehicle, i.e., turn the steering wheel only as rapidly and as far as required to avoid the emergency. Excessive steering will result in less vehicle control, not more. Additionally, smooth variations of the accelerator and/or brake pedal pressure should be utilized if changes in vehicle speed are called for. Avoid abrupt steering, acceleration or braking which could result in an increased risk of loss of vehicle control, vehicle rollover and/or personal injury. Use all available road surface to return the vehicle to a safe direction of travel.

## Driving

- In the event of an emergency stop, avoid skidding the tires and do not attempt any sharp steering wheel movements.



Vehicles with a higher center of gravity such as utility and four-wheel drive vehicles handle differently than vehicles with a lower center of gravity. Utility and four-wheel drive vehicles are **not** designed for cornering at speeds as high as passenger cars any more than low-slung sports cars are designed to perform satisfactorily under off-road conditions. Avoid sharp turns, excessive speed and abrupt maneuvers in these vehicles. Failure to drive cautiously could result in an increased risk of loss of vehicle control, vehicle rollover, personal injury and death.

- If the vehicle goes from one type of surface to another (i.e., from concrete to gravel) there will be a change in the way the vehicle responds to a maneuver (steering, acceleration or braking). Again, avoid these abrupt inputs.

### AUTOMATIC TRANSMISSION OPERATION

#### Brake-shift interlock

This vehicle is equipped with a brake-shift interlock feature that prevents the gearshift lever from being moved from P (Park) when the ignition is in the ON position unless brake pedal is depressed.

If you cannot move the gearshift lever out of P (Park) with ignition in the ON position and the brake pedal depressed:

1. Apply the parking brake, turn ignition key to LOCK, then remove the key.
2. Insert the key and turn it to OFF. **Apply the brake pedal and shift to N (Neutral).**



When the key is in the ignition and in the OFF position, the automatic transmission shift lever can be moved from the P (Park) position without the brake pedal depressed. To avoid unwanted vehicle movement, always set the parking brake.

3. Start the vehicle.

If it is necessary to use the above procedure to move the gearshift lever, it is possible that a fuse has blown or the vehicle's brakelamps are not operating properly. Refer to *Fuses and relays* in the *Roadside Emergencies* chapter.

## Driving



Do not drive your vehicle until you verify that the brakelamps are working.



Always set the parking brake fully and make sure the gearshift is latched in P (Park). Turn the ignition to the LOCK position and remove the key whenever you leave your vehicle.



If the parking brake is fully released, but the brake warning lamp remains illuminated, the brakes may not be working properly. See your authorized dealer as soon as possible.

### Understanding the gearshift positions of the 4-speed automatic transmission



This vehicle is equipped with an adaptive Transmission Shift Strategy. Adaptive Shift Strategy offers the optimal transmission operation and shift quality. When the vehicle's battery has been disconnected for any type of service or repair, the transmission will need to relearn the normal shift strategy parameters, much like having to reset your radio stations when your vehicle battery has been disconnected. The Adaptive Transmission Strategy allows the transmission to relearn these operating parameters. This learning process could take several transmission upshifts and downshifts; during this learning process, slightly firmer shifts may occur. After this learning process, normal shift feel and shift scheduling will resume.

#### **P (Park)**

This position locks the transmission and prevents the rear wheels from turning.

To put your vehicle in gear:

- Start the engine
- Depress the brake pedal
- Move the gearshift lever into the desired gear

## Driving

To put your vehicle in P (Park):

- Come to a complete stop
- Move the gearshift lever and securely latch it in P (Park)

 Always set the parking brake fully and make sure the gearshift is latched in P (Park). Turn the ignition to the LOCK position and remove the key whenever you leave your vehicle.

### **R (Reverse)**

With the gearshift lever in R (Reverse), the vehicle will move backward. Always come to a complete stop before shifting into and out of R (Reverse).

### **N (Neutral)**

With the gearshift lever in N (Neutral), the vehicle can be started and is free to roll. Hold the brake pedal down while in this position.

### **D (Overdrive)**

The normal driving position for the best fuel economy. Transmission operates in gears one through four.

Overdrive can be deactivated by pressing the transmission control switch on the end of the gearshift lever.

The O/D OFF lamp will illuminate in the instrument cluster.

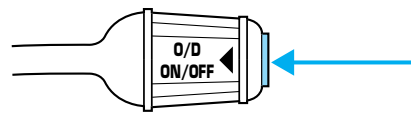

**O/D  
OFF**

### **Drive (not shown)**

Drive is activated when the transmission control switch is pressed.

- This position allows for all forward gears except overdrive.
- O/D OFF lamp is illuminated.
- Provides engine braking.
- Use when driving conditions cause excessive shifting from O/D to other gears. Examples: city traffic, hilly terrain, heavy loads, trailer towing and when engine braking is required.

## Driving

- To return to O/D (Overdrive), press the transmission control switch. The O/D OFF lamp will not be illuminated.
- O/D (Overdrive) is automatically returned each time the key is turned off.

### **2 (Second)**

This position allows for second gear only.

- Provides engine braking.
- Use to start-up on slippery roads.
- To return to **D** (Overdrive), move the gearshift lever into the **D** (Overdrive) position.
- Selecting 2 (Second) at higher speeds will cause the transmission to downshift to second gear at the appropriate vehicle speed.

### **1 (First)**

- Provides maximum engine braking.
- Allows upshifts by moving gearshift lever.
- Will not downshift into 1 (First) at high speeds; allows for 1 (First) when vehicle reaches slower speeds.

### **Forced downshifts**

- Allowed in **D** (Overdrive) or Drive.
- Depress the accelerator to the floor.
- Allows transmission to select an appropriate gear.

## Driving

### Understanding the shift positions of the 5-speed automatic transmission (if equipped - 5.4L and 6.8L gasoline engines only)



This vehicle is equipped with an adaptive Transmission Shift Strategy. Adaptive Shift Strategy offers the optimal transmission operation and shift quality. When the vehicle's battery has been disconnected for any type of service or repair, the transmission will need to relearn the normal shift strategy parameters, much like having to reset your radio stations when your vehicle battery has been disconnected. The Adaptive Transmission Strategy allows the transmission to relearn these operating parameters. This learning process could take several transmission upshifts and downshifts; during this learning process, slightly firmer shifts may occur. After this learning process, normal shift feel and shift scheduling will resume.

#### **P (Park)**

This position locks the transmission and prevents the rear wheels from turning.

To put your vehicle in gear:

- Start the engine
- Depress the brake pedal
- Move the gearshift lever into the desired gear

To put your vehicle in P (Park):

- Come to a complete stop
- Move the gearshift lever and securely latch it in P (Park)



Always set the parking brake fully and make sure the gearshift is latched in P (Park). Turn the ignition to the LOCK position and remove the key whenever you leave your vehicle.

#### **R (Reverse)**

With the gearshift lever in R (Reverse), the vehicle will move backward. Always come to a complete stop before shifting into and out of R (Reverse).

## Driving

### **N (Neutral)**

With the gearshift lever in N (Neutral), the vehicle can be started and is free to roll. Hold the brake pedal down while in this position.

### **D (Overdrive) with Tow/Haul OFF**

D (Overdrive) with Tow/Haul OFF is the normal driving position for the best fuel economy. The overdrive function allows automatic upshifts and downshifts through gears one through five.

### **D (Overdrive) with Tow/Haul ON**

The Tow/Haul feature improves transmission operation when towing a trailer or a heavy load. All transmission gear ranges are available when using Tow/Haul.

To activate Tow/Haul, press the button on the end of the gearshift lever.

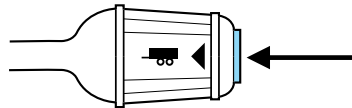

The TOW HAUL indicator light will illuminate in the instrument cluster.

**TOW  
HAUL**

Tow/Haul delays upshifts to reduce frequency of transmission shifting. Tow/Haul also provides engine braking in all forward gears when the transmission is in the D (Overdrive) position; this engine braking will slow the vehicle and assist the driver in controlling the vehicle when descending a grade. Depending on driving conditions and load conditions, the transmission may downshift, slow the vehicle and control the vehicle speed when descending a hill, without the accelerator pedal being pressed. The amount of downshift braking provided will vary based upon the amount the brake pedal is depressed.

To deactivate the Tow/Haul feature and return to normal driving mode, press the button on the end of the gearshift lever. The TOW HAUL light will no longer be illuminated.

When you shut-off and restart the engine, the transmission will automatically return to normal D (Overdrive) mode (Tow/Haul OFF).



Do not use the Tow/Haul feature when driving in icy or slippery conditions as the increased engine braking can cause the rear wheels to slide and the vehicle to swing around with the possible loss of vehicle control.

## Driving

### **3 (Third)**

Transmission starts and operates in third gear only.

Used for improved traction on slippery roads. Selecting 3 (Third) provides engine braking.

### **2 (Second)**

Use 2 (Second) to start-up on slippery roads or to provide additional engine braking on downgrades.

### **1 (First)**

- Provides maximum engine braking.
- Allows upshifts by moving gearshift lever.
- The transmission will not downshift into 1 (First) at high speeds; it will downshift to a lower gear and then shift into 1 (First) when the vehicle reaches slower speeds.

### **Forced downshifts**

- Allowed in **D** (Overdrive) or Drive.
- Depress the accelerator to the floor.
- Allows transmission to select an appropriate gear.

### **Understanding the shift positions of the 5-speed automatic transmission (if equipped - diesel engines only)**



### **P (Park)**

This position locks the transmission and prevents the rear wheels from turning.

To put your vehicle in gear:

- Start the engine
- Depress the brake pedal
- Move the gearshift lever into the desired gear

To put your vehicle in P (Park):

- Come to a complete stop

160



## Driving

- Move the gearshift lever and securely latch it in P (Park)



Always set the parking brake fully and make sure the gearshift is latched in P (Park). Turn the ignition to the LOCK position and remove the key whenever you leave your vehicle.

### **R (Reverse)**

With the gearshift lever in R (Reverse), the vehicle will move backward. Always come to a complete stop before shifting into and out of R (Reverse).

### **N (Neutral)**

With the gearshift lever in N (Neutral), the vehicle can be started and is free to roll. Hold the brake pedal down while in this position.

### **D (Drive) with Overdrive**

D (Drive) with Overdrive is the normal driving position for the best fuel economy. The overdrive function allows automatic upshifts and downshifts through gears one through five.

### **D (Drive) without Overdrive**

D (Drive) without Overdrive can be activated by pressing the transmission control switch (TCS) on the end of the gearshift lever.

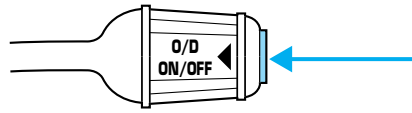

- This position allows for all forward gears except overdrive.
- The O/D OFF lamp will illuminate in the instrument cluster.

**O/D  
OFF**

- Provides engine braking.
- Use when driving conditions cause excessive shifting from O/D to other gears. Examples: city traffic, hilly terrain, heavy loads, trailer towing and when engine braking is required.
- To return to O/D (Overdrive), press the transmission control switch. The O/D OFF lamp will not be illuminated.
- O/D (Overdrive) is automatically returned each time the key is turned off.

### **3 (Third)**

Transmission starts and operates in third gear only.

## Driving

Used for improved traction on slippery roads. Selecting 3 (Third) provides additional engine braking.

### **2 (Second)**

Use 2 (Second) to start-up on slippery roads or to provide additional engine braking on downgrades.

### **1 (First)**

- Provides maximum engine braking.
- Allows upshifts by moving gearshift lever.
- The transmission will not downshift into 1 (First) at high speeds; it will downshift to a lower gear and then shift into 1 (First) when the vehicle reaches slower speeds.

### **Forced downshifts**

- Allowed in D (Drive) with Overdrive or D (Drive) without Overdrive.
- Depress the accelerator to the floor.
- Allows transmission to select an appropriate gear.

### ***If your vehicle goes off the edge of the pavement***

- If your vehicle goes off the edge of the pavement, slow down, but avoid severe brake application, ease the vehicle back onto the pavement only after reducing your speed. Do not turn the steering wheel too sharply while returning to the road surface.
- It may be safer to stay on the apron or shoulder of the road and slow down gradually before returning to the pavement. You may lose control if you do not slow down or if you turn the steering wheel too sharply or abruptly.
- It often may be less risky to strike small objects, such as highway reflectors, with minor damage to your vehicle rather than attempt a sudden return to the pavement which could cause the vehicle to slide sideways out of control or roll over. Remember, your safety and the safety of others should be your primary concern.



Vehicles with a higher center of gravity such as utility and four-wheel drive vehicles handle differently than vehicles with a lower center of gravity. Utility and four-wheel drive vehicles are **not** designed for cornering at speeds as high as passenger cars any more than low-slung sports cars are designed to perform satisfactorily under off-road conditions. Avoid sharp turns, excessive speed and abrupt maneuvers in these vehicles. Failure to drive cautiously could result in an increased risk of loss of vehicle control, vehicle rollover, personal injury and death.

### REVERSE SENSING SYSTEM (IF EQUIPPED)

The Reverse Sensing System (RSS) sounds a tone to warn the driver of obstacles near the rear bumper when the R (Reverse) is selected and the vehicle is moving at speeds less than 3 mph (5 km/h). The system is not effective at speeds above 3 mph (5 km/h) and may not detect certain angular or moving objects.



To help avoid personal injury, please read and understand the limitations of the reverse sensing system as contained in this section. Reverse sensing is only an aid for some (generally large and fixed) objects when moving in reverse on a flat surface at “parking speeds”. Inclement weather may also affect the function of the RSS; this may include reduced performance or a false activation.



To help avoid personal injury, always use caution when in reverse and when using the RSS.



This system is not designed to prevent contact with small or moving objects. The system is designed to provide a warning to assist the driver in detecting large stationary objects to avoid damaging the vehicle. The system may not detect smaller objects, particularly those close to the ground.



Certain add-on devices such as large trailer hitches, bike or surfboard racks and any device that may block the normal detection zone of the RSS system may create false beeps.

## Driving

The RSS detects obstacles up to 6 feet (2 meters) from the rear bumper with a decreased coverage area at the outer corners of the bumper, (refer to the figures for approximate zone coverage areas). As you move closer to the obstacle, the rate of the tone increases. When the obstacle is less than 10 inches (25.0 cm) away, the tone will sound continuously. If the RSS detects a stationary or receding object further than 10 inches (25.0 cm) from the side of the vehicle, the tone will sound for only three seconds. Once the system detects an object approaching, the tone will sound again.

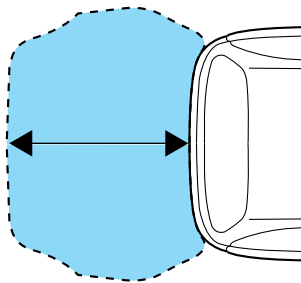
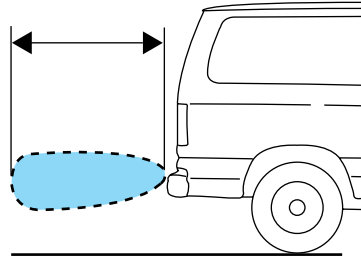

The RSS automatically turns on when the gearshift lever is placed in R (Reverse) and the ignition is ON. An RSS control allows the driver to turn the RSS on and off. To turn the RSS off, the ignition must be ON, and the gear selector in R (Reverse). An indicator light on the control will illuminate when the system is turned off. If the indicator light illuminates when the RSS is not turned off, it may indicate a failure in the RSS. The RSS will remain off until either the RSS control is pushed again or the ignition switch is recycled.

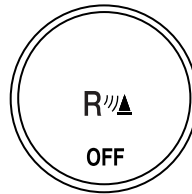

**Keep the RSS sensors (located on the rear bumper/fascia) free from snow, ice and large accumulations of dirt (do not clean the sensors with sharp objects). If the sensors are covered, it will affect the accuracy of the RSS.**

**If your vehicle sustains damage to the rear bumper/fascia, leaving it misaligned or bent, the sensing zone may be altered causing inaccurate measurement of obstacles or false alarms.**

### VEHICLE USED AS A STATIONARY POWER SOURCE

Auxiliary equipment called power take-off, or PTO, is often added to the engine or transmission to operate utility equipment. Examples include wheel-lift for tow trucks, tools for construction, and cranes. PTO applications draw auxiliary horsepower from the powertrain, often while the vehicle is stationary. In this condition there is limited cooling air flow through the radiator and around the vehicle that normally occurs when a vehicle is moving. Depending on the level and duration of auxiliary horsepower draw, vehicle and surrounding environmental conditions, and other factors, this can contribute to elevated transmission fluid temperatures and resultant accelerated fluid deterioration, fuel vapor over-pressurization, and other concerns. Ford trucks are fully qualified for stationary PTO operation for 10 minutes or less of continuous operation. For stationary PTO operation of extended duration (beyond 10 minutes), diesel engine is recommended. Further consult your aftermarket PTO installer since the duration of operation limit for the aftermarket PTO may be less than 10 minutes.

A more complete description of PTO operation is discussed in the Ford Truck Body Builders Layout Book, found at [www.fleet.ford.com/truckbbas](http://www.fleet.ford.com/truckbbas).

### DRIVING THROUGH WATER

If driving through deep or standing water is unavoidable, proceed very slowly especially when the depth is not known. Never drive through water that is higher than the bottom of the wheel rims (for cars) or the bottom of the hubs (for trucks).

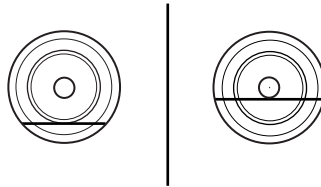

When driving through water, traction or brake capability may be limited. Also, water may enter your engine's air intake and severely damage your engine or your vehicle may stall. **Driving through deep water where the transmission vent tube is submerged may allow water into the transmission and cause internal transmission damage.**

**Once through the water, always dry the brakes by moving your vehicle slowly while applying light pressure on the brake pedal.**

Wet brakes do not stop the vehicle as quickly as dry brakes.

## Roadside Emergencies

### ROADSIDE ASSISTANCE

#### Getting roadside assistance

To fully assist you should you have a vehicle concern, Ford Motor Company offers a complimentary roadside assistance program. This program is separate from the New Vehicle Limited Warranty. The service is available:

- 24-hours, seven days a week
- for the period of five years or 60,000 miles (100,000 km), whichever occurs first on Ford and Mercury vehicles, and six years or 70,000 miles (110,000 km) on Lincoln vehicles.

Roadside assistance will cover:

- a flat tire change with a good spare (except Ford GT which has a tire inflation kit)
- battery jump start
- lock-out assistance (key replacement cost is the customer's responsibility)
- fuel delivery – Independent Service Contractors, if not prohibited by state, local or municipal law shall deliver up to 2.0 gallons (7.5L) of gasoline or 5 gallons (18.9L) of diesel fuel to a disabled vehicle. Fuel delivery service is limited to two no-charge occurrences within a 12-month period.
- winch out – available within 100 feet (30.5 meters) of a paved or county maintained road, no recoveries.
- towing – Ford/Mercury/Lincoln eligible vehicle towed to an authorized dealer within 35 miles (56.3 km) of the disablement location or to the nearest authorized dealer. If a member requests to be towed to an authorized dealer more than 35 miles (56.3 km) from the disablement location, the member shall be responsible for any mileage costs in excess of 35 miles (56.3 km).

Trailers shall be covered up to \$100 if the disabled eligible vehicle requires service at the nearest authorized dealer. If the trailer is disabled, but the towing vehicle is operational, the trailer does not qualify for any roadside services.

## Roadside Emergencies

### **Canadian customers refer to your Customer Information Guide for information on:**

- coverage period
- exact fuel amounts
- towing of your disabled vehicle
- emergency travel expense reimbursement
- travel planning benefits

### **Using roadside assistance**

Complete the roadside assistance identification card and place it in your wallet for quick reference. In the United States, this card is found in the Owner Guide portfolio in the glove compartment. In Canada, the card is found in the *Owner Information Guide* in the glove compartment.

U.S. Ford or Mercury vehicle customers who require roadside assistance, call 1-800-241-3673; Lincoln vehicle customers call 1-800-521-4140.

Canadian customers who require roadside assistance, call 1-800-665-2006.

### **Motorhome customers in the U.S and Canada should contact 1-800-444-3311.**

If you need to arrange roadside assistance for yourself, Ford Motor Company will reimburse a reasonable amount. To obtain reimbursement information, U.S. Ford or Mercury vehicles customers call 1-800-241-3673; Lincoln vehicle customers call 1-800-521-4140.

Canadian customers who need to obtain reimbursement information, call 1-800-665-2006.

### **Roadside coverage beyond basic warranty**

In the United States, you may purchase additional roadside assistance coverage beyond this period through the Ford Auto Club by contacting your authorized dealer.

Similarly in Canada, for uninterrupted Roadside Assistance coverage, you may purchase extended coverage prior to your Basic Warranty's Roadside Assistance expiring. For more information and enrollment, contact 1-877-294-2582 or visit our website at [www.ford.ca](http://www.ford.ca).

## Roadside Emergencies

### HAZARD FLASHER

The hazard flasher is located on the steering column, just behind the steering wheel. The hazard flashers will operate when the ignition is in any position or if the key is not in the ignition.

Push in the flasher control and all front and rear direction signals will flash. Press the flasher control again to turn them off. Use it when your vehicle is disabled and is creating a safety hazard for other motorists.

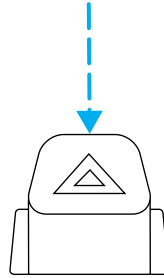

**Note:** With extended use, the flasher may run down your battery.

### FUEL PUMP SHUT-OFF SWITCH

This device stops the electric fuel pump from sending fuel to the engine when your vehicle has had a substantial jolt.

After an accident, if the engine cranks but does not start, this switch may have been activated.



## Roadside Emergencies

Except for commercial stripped chassis vehicles, this switch is located in the front passenger's footwell, by the kick panel.

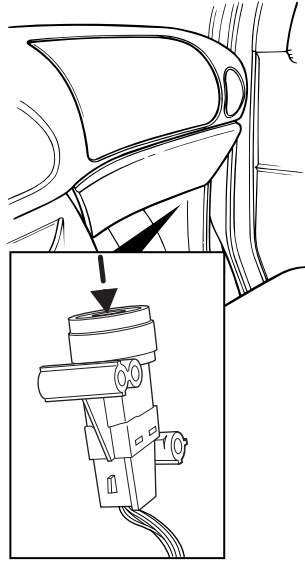

On commercial stripped chassis vehicles, this switch is located on a bracket above the brake pedal.

To reset the switch:

1. Turn the ignition OFF.
2. Check the fuel system for leaks.
3. If no leaks are apparent, reset the switch by pushing in on the reset button.
4. Turn the ignition ON.
5. Wait a few seconds and return the key to OFF.
6. Make another check for leaks.

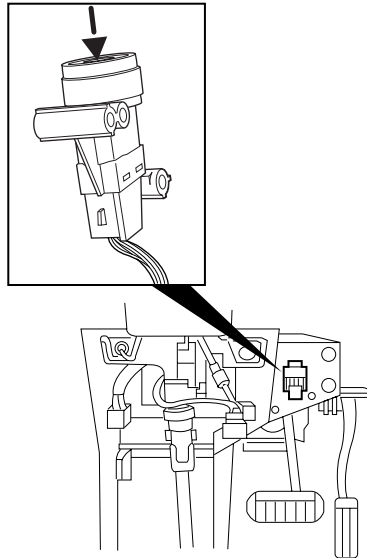

## Roadside Emergencies

### FUSES AND RELAYS

#### Fuses

If electrical components in the vehicle are not working, a fuse may have blown. Blown fuses are identified by a broken wire within the fuse. Check the appropriate fuses before replacing any electrical components.

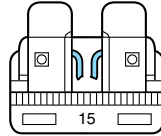

**Note:** Always replace a fuse with one that has the specified amperage rating. Using a fuse with a higher amperage rating can cause severe wire damage and could start a fire.

#### Standard fuse amperage rating and color

COLOR					
Fuse rating	Mini fuses	Standard fuses	Maxi fuses	Cartridge maxi fuses	Fuse link cartridge
2A	Grey	Grey	—	—	—
3A	Violet	Violet	—	—	—
4A	Pink	Pink	—	—	—
5A	Tan	Tan	—	—	—
7.5A	Brown	Brown	—	—	—
10A	Red	Red	—	—	—
15A	Blue	Blue	—	—	—
20A	Yellow	Yellow	Yellow	Blue	Blue
25A	Natural	Natural	—	—	—
30A	Green	Green	Green	Pink	Pink
40A	—	—	Orange	Green	Green
50A	—	—	Red	Red	Red
60A	—	—	Blue	Yellow	Yellow
70A	—	—	Tan	—	Brown
80A	—	—	Natural	Black	Black

## Roadside Emergencies

### Passenger compartment fuse panel

The fuse panel is located below and to the left of the steering wheel by the brake pedal. Remove the panel cover to access the fuses.

To remove a fuse use the fuse puller tool provided on the fuse panel cover.

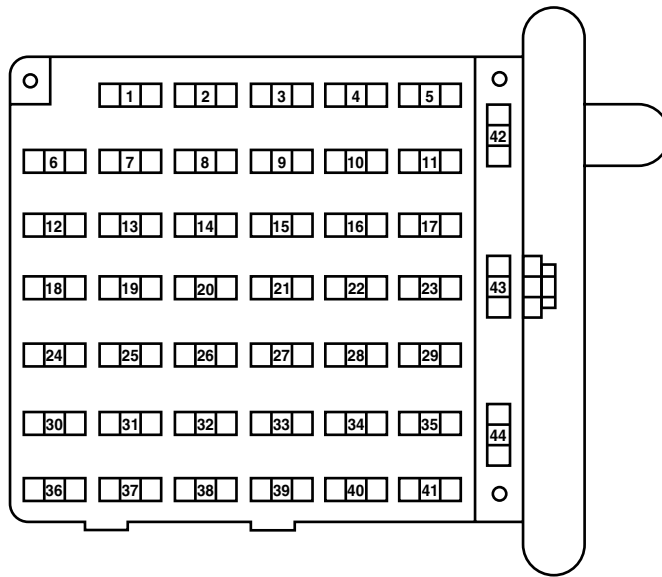

The fuses are coded as follows.

Fuse/Relay Location	Fuse Amp Rating	Passenger Compartment Fuse Panel Description
1	5A	4-Wheel Anti-lock Brake System (4WABS) module
2	10A	Remote Keyless Entry (RKE), O/D cancel, IVD module
3	15A	Trip computer, Radio, Overhead console
4	15A	Courtesy lamps

## Roadside Emergencies

Fuse/Relay Location	Fuse Amp Rating	Passenger Compartment Fuse Panel Description
5	30A	Power lock switches, Power locks without RKE
6	10A	Brake-shift interlock, Daytime Running Lamps (DRL) module, Reverse Park Aid (RPA)
7	10A	Multi-function switch, Turn signals
8	15A	Radio capacitor(s), Ignition coil, Powertrain Control Module (PCM) diode, PCM power relay
9	5A	Wiper control module
10	20A	Main light switch, Park lamps, License lamp (external lamps), Multi-function switch (flash-to-pass), BSM
11	15A	Multi-function switch (hazards), Brake lamp switch, Brake lamps, IVD relay
12	15A	Back-up lamps, Auxiliary battery relay (gasoline engine only)
13	15A	Blend door actuator, Function selector switch
14	5A	Instrument cluster
15	5A	Trailer battery charge relay, Cluster, BSM
16	30A	Power seats
17	5A	Power mirrors
18	—	Not used
19	—	Not used
20	10A	Restraints
21	—	Not used

## Roadside Emergencies

Fuse/Relay Location	Fuse Amp Rating	Passenger Compartment Fuse Panel Description
22	15A	Memory power radio, Battery saver relay, Instrument cluster, Courtesy lamp relay, Accessory delay relay
23	20A	Power locks w/RKE
24	—	Not used
25	10A	Left headlamp (low beam)
26	20A	Cigar lighter, Diagnostics
27	5A	Radio
28	—	Not used
29	—	Not used
30	15A	Headlamps (high beam indicator)
31	10A	Right headlamp (low beam)
32	20A	Power point #1 (instrument panel)
33	10A	Start relay
34	—	Not used
35	—	Not used
36	5A	Instrument illumination
37	—	Not used
38	—	Not used
39	10A	Trailer tow electric brake, Center High-Mounted Stop Lamp (CHMSL), Brake lamps
40	20A	Power point #2 (2nd row seating position - driver side)
41	30A	Modified vehicle
42	20A circuit breaker	Power windows
43	—	Not used
44	20A circuit breaker	Wiper/washer

## Roadside Emergencies

### Power distribution box

The power distribution box is located in the engine compartment. The power distribution box contains high-current fuses that protect your vehicle's main electrical systems from overloads.



Always disconnect the battery before servicing high current fuses.



To reduce risk of electrical shock, always replace the cover to the Power Distribution Box before reconnecting the battery or refilling fluid reservoirs.

If the battery has been disconnected and reconnected, refer to the *Battery* section of the *Maintenance and Specifications* chapter.

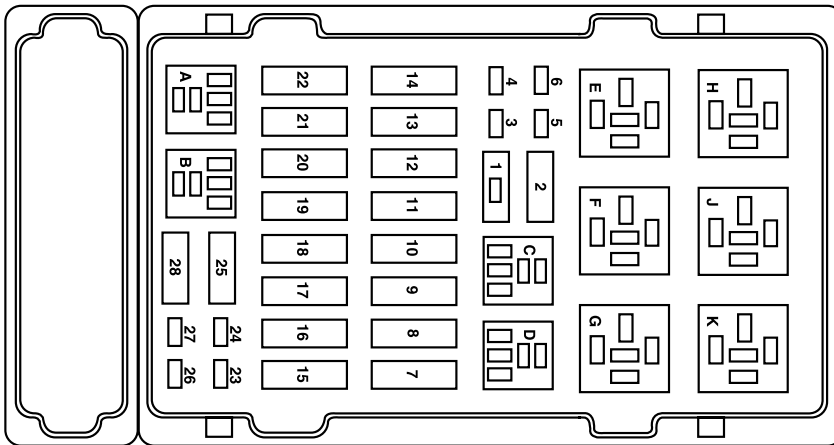

## Roadside Emergencies

The high-current fuses are coded as follows.

Fuse/Relay Location	Fuse Amp Rating	Power Distribution Box Description
1	—	Powertrain Control Module (PCM) diode
2	—	Auxiliary battery diode
3	15A*	Daytime Running Lamps (DRL) module, A/C clutch
4	5A*	Heated PCV (4.6L and 6.8L gasoline engines)
5	15A*	Horn relay
6	—	Not used
7	60A**	Ignition switch, Accessory delay
8	40A**	Trailer battery charge relay
9	50A**	Modified vehicle power
10	30A**	Electric brake controller
11	60A**	4-Wheel Anti-lock Brake System (4WABS)
	40A**	AdvanceTrac® with RSC
12	60A**	I/P fuses 29, 34, 35, 40 and 41
13	20A**	Fuel pump relay
14	50A**	Auxiliary blower relay
15	30A**	Main light switch
16	20A**	Injectors (gasoline engines)
17	50A**	Blower motor relay (blower motor)
18	60A**	Engine compartment fuses 3, 5 and 26, Instrument panel fuses 26 and 32, Start relay
19	50A**	IDM relay (diesel engine only)
	40A**	AdvanceTrac® with RSC (gasoline engines only )
20	60A**	Auxiliary battery relay (gasoline engine only), PDB fuses 8 and 24

## Roadside Emergencies

Fuse/Relay Location	Fuse Amp Rating	Power Distribution Box Description
21	30A**	PCM power relay, PDB fuse 27
22	60A**	I/P fuses 4, 5, 10, 11, 16, 17, 22 and 23, Circuit breaker 44
23	10A*	Alternator field (diesel engine only)
	20A*	CMS, HEGOS, MAF, EGR, A/C clutch relay (gasoline engine only)
24	20A*	Trailer tow running lamps and back-up lamp relays
25	—	Not used
26	20A*	Trailer tow turn signals
27	10A*	PCM keep alive, Canister vent (gasoline engine only)
28	—	Not used
A	—	Fuel pump relay
B	—	Horn relay
C	—	Trailer back-up lamps relay
D	—	Trailer running lamps relay
E	—	Trailer battery charge relay
F	—	IDM relay (diesel only), IVD (gasoline only)
G	—	PCM relay
H	—	Blower motor relay
J	—	Accessory delay relay
K	—	Start relay

\* Mini fuses \*\* Maxi fuses



## Roadside Emergencies

### Relay modules

#### *Instrument panel relay module*

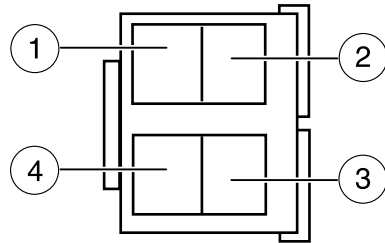

The instrument panel relay module is located behind the radio in the center of the instrument panel. Have your authorized dealer service this module, if required.

The relays are coded as follows:

Relay location	Description
1	Interior lamps
2	Open
3	Open
4	Battery saver

#### *Engine compartment relay module*

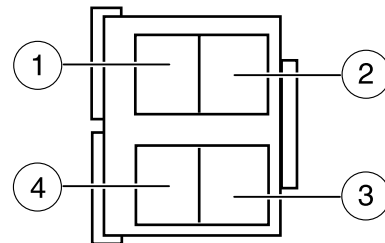

The engine compartment relay module is located in one of two places depending on which type of engine your vehicle is equipped with:

- Gasoline engine: driver side of the engine compartment above the brake master cylinder.

## Roadside Emergencies

- Diesel engine: passenger side of the engine compartment behind the power distribution box.

Have your authorized dealer service this module, if required.

The relays are coded as follows:

Relay location	Description
1	PCM back-up lamp
2	A/C control
3	Trailer tow right turn
4	Trailer tow left turn

### CHANGING A FLAT TIRE

If you get a flat tire while driving:

- do not brake heavily.
- gradually decrease the vehicle's speed.
- hold the steering wheel firmly.
- slowly move to a safe place on the side of the road.



The use of tire sealants may damage your tires.

### Dissimilar spare tire/wheel information



Failure to follow these guidelines could result in an increased risk of loss of vehicle control, injury or death.

If you have a dissimilar spare tire/wheel, then it is intended for temporary use only. This means that if you need to use it, you should replace it as soon as possible with a road tire/wheel that is the same size and type as the road tires and wheels that were originally provided by Ford. If the dissimilar spare tire or wheel is damaged, it should be replaced rather than repaired.

A dissimilar spare tire/wheel is defined as a spare tire and/or wheel that is different in brand, size or appearance from the road tires and wheels and can be one of three types:

1. **T-type mini-spares:** This spare tire begins with the letter "T" for tire size and may have "Temporary Use Only" molded in the sidewall
2. **Full-size dissimilar spare with label on wheel:** This spare tire has a label on the wheel that states: "THIS TIRE AND WHEEL FOR TEMPORARY USE ONLY"

## Roadside Emergencies

When driving with one of the dissimilar spare tires listed above, **do not:**

- Exceed 50 mph (80 km/h)
- Load the vehicle beyond maximum vehicle load rating listed on the Safety Compliance Label
- Tow a trailer
- Use snow chains on the end of the vehicle with the dissimilar spare tire
- Use more than one dissimilar spare tire at a time
- Use commercial car washing equipment
- Try to repair the dissimilar spare tire

Use of one of the dissimilar spare tires listed above at any one wheel location can lead to impairment of the following:

- Handling, stability and braking performance
- Comfort and noise
- Ground clearance and parking at curbs
- Winter weather driving capability
- Wet weather driving capability

For vehicles equipped with 4WD, it is not recommended that the vehicle be operated in 4WD modes with a temporary emergency spare tire. If 4WD operation is necessary, do not operate above speeds of 10 mph (16 km/h) or for distances above 50 miles (80 km).

### 3. Full-size dissimilar spare without label on wheel

When driving with the full-size dissimilar spare tire/wheel, **do not:**

- Exceed 70 mph (113 km/h)
- Use more than one dissimilar spare tire/wheel at a time
- Use commercial car washing equipment
- Use snow chains on the end of the vehicle with the dissimilar spare tire/wheel

The usage of a full-size dissimilar spare tire/wheel can lead to impairment of the following:

- Handling, stability and braking performance
- Comfort and noise
- Ground clearance and parking at curbs

## Roadside Emergencies

- Winter weather driving capability
- Wet weather driving capability
- All-Wheel driving capability (if applicable)
- Load leveling adjustment (if applicable)

When driving with the full-size dissimilar spare tire/wheel additional caution should be given to:

- Towing a trailer
- Driving vehicles equipped with a camper body
- Driving vehicles with a load on the cargo rack

Drive cautiously when using a full-size dissimilar spare tire/wheel and seek service as soon as possible.

### Full-size Matching Spare Tire/Wheel Information

This spare tire/wheel will match the road tire/wheel. When driving with the full size matching spare tire/wheel, do not exceed 70 mph (113 km/h). It is intended for temporary use only. This means if you need to use it, you should replace it as soon as possible.

### Stopping and securing your vehicle

1. Park on a level surface.
2. Activate the warning flashers.
3. Place the gearshift in P (Park).
4. Apply the parking brake and turn the engine off.

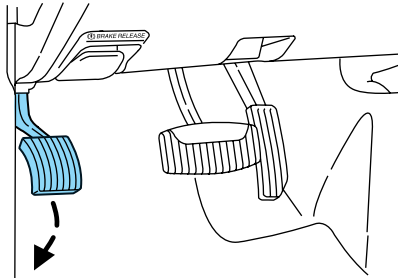

### Spare tire information

The spare tire for your vehicle is stowed under the rear of your vehicle (except cutaway and stripped chassis models).

## Roadside Emergencies

### To remove the spare tire:

1. Open the rear doors and remove the thumb screw and anti-theft bracket. If finger pressure will not remove the thumb screw, use the lug wrench to loosen the screw.

2. Remove the access plug under the left door.

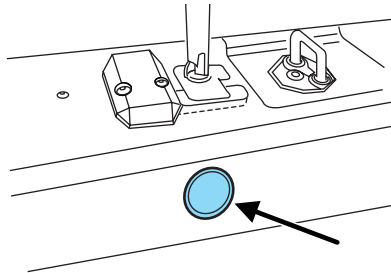

3. Remove the jack handle from the right side compartment and insert the tip of the jack handle through the access hole and into the tube.

4. Turn the jack handle counterclockwise until the cable is slack and the tire can be slid from under the vehicle.

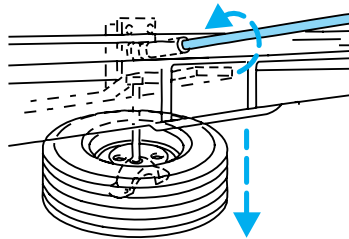

5. Remove the retainer from the spare tire.

To stow the cable retainer with the spare removed, turn the jack handle clockwise until all slack is removed.

### Tire change procedure

#### Preparing to change the tire



To help prevent the vehicle from moving when you change a tire, be sure the parking brake is set, then block (in both directions) the wheel that is diagonally opposite (other side and end of the vehicle) to the tire being changed.

1. Park on a level surface.
2. Activate the warning flashers.
3. Place the gearshift in P (Park).

## Roadside Emergencies

4. Apply the parking brake and turn the engine off.

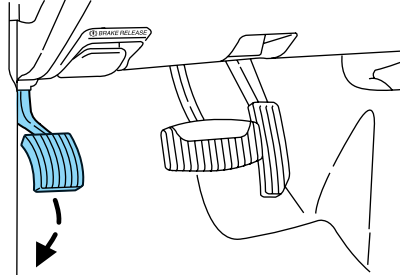

5. Block the wheel that is diagonally opposite the tire you are changing.

On E-450 vehicles, the parking brake is on the transmission.

Therefore, the vehicle will not be prevented from moving when a rear wheel is lifted, even if the parking brake is applied. Be sure to block both directions of the wheel that is diagonally opposite to the wheel that is being lifted.

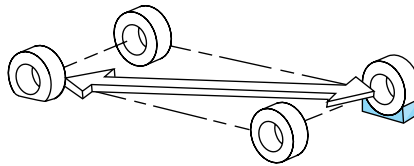

If the vehicle slips off the jack, you or someone else could be seriously injured.



Do not attempt to change a tire on the side of the vehicle close to moving traffic. Pull far enough off the road to avoid the danger of being hit when operating the jack or changing the wheel.

6. Remove the spare tire and jack from the storage location.

## Roadside Emergencies

- the jack is located in the rear right-hand side of the cargo area.

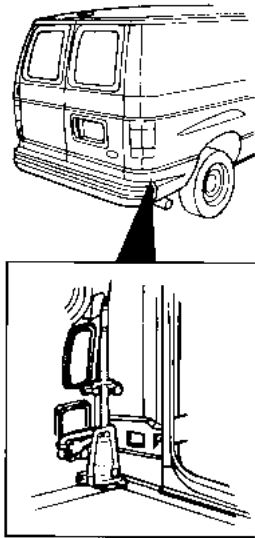

7. Use the tapered end of the lug nut wrench to unscrew wheel ornaments attached by retaining screws. Remove any wheel trim. Insert the tapered end of the lug nut wrench behind wheel covers or hubcaps and twist off.
8. Loosen the wheel nut by pulling up on the handle of the lug nut wrench about one-half turn (counterclockwise). Do not remove the wheel lug nuts until you raise the tire off the ground.

### **Replacing the tire**

1. Assemble the jack handle sections together and lock into the jack. Use the jack handle to slide the jack under the vehicle.



To lessen the risk of personal injury, do not put any part of your body under the vehicle while changing a tire. Do not start the engine when your vehicle is on the jack. The jack is only meant for changing the tire.

2. Position the jack to raise the front or rear wheel.

## Roadside Emergencies

- Never use the front or rear differential as a jacking point.

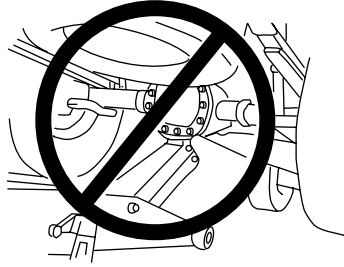

**Rear axle jacking points - All models except E-350 Dual Rear Wheel (DRW) and E-450:**

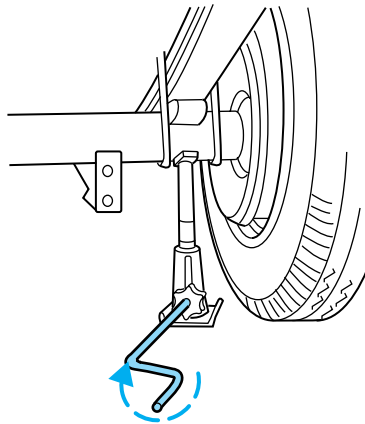

**Rear axle jacking points - E-350 Dual Rear Wheel (DRW) and E-450:**

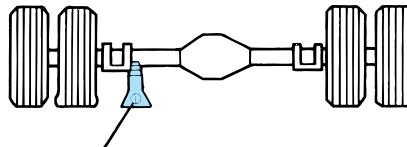



## Roadside Emergencies

### Front axle jacking points:

Place the jack under the **pin** on the front surface of the front axle.

### Do not place the jack under or on the steering linkage.

- Raise the jack until the wheel is completely off the ground. (Turn jack handle clockwise if your vehicle is equipped with a screw-type jack or pump the jack if equipped with a hydraulic jack.)
- Remove the lug nuts with the lug nut wrench.
- Replace the flat tire with the spare tire.

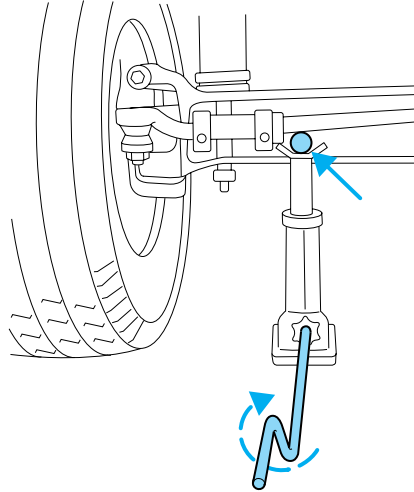

If your vehicle has single rear wheels, thread the lug nuts on the studs with the beveled face toward the wheel.

If your vehicle has dual rear wheels, thread the two element swiveling lug nuts on the studs with the flange facing toward the wheel.

3. Use the lug nut wrench to screw the lug nut snugly against the wheel.
4. Lower the vehicle by turning the jack handle counterclockwise.
5. Remove the jack and fully tighten the lug nuts in the following pattern (Refer to *Wheel lug nut torque specifications* later in this chapter for the proper lug nut torque specification):

## Roadside Emergencies



Never use wheels or lug nuts different than the original equipment as this could damage the wheel or mounting system. This damage could allow the wheels to come off while the vehicle is being driven.

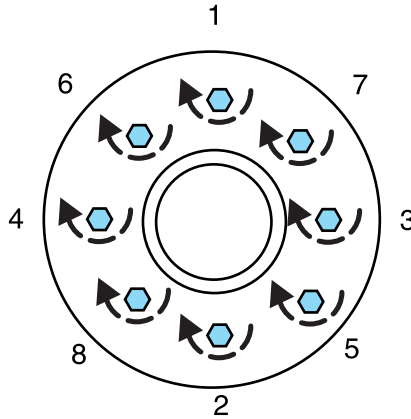

6. Install any wheel covers, ornaments or hub caps. Make sure they are screwed or snapped in place.

7. Stow the jack, handle and lug wrench.

8. Unblock the wheels.

### **Stowing the flat/spare tire**

**Note:** Failure to follow spare tire stowage instructions may result in failure of cable or loss of spare tire.

1. Lay the tire on the ground with the valve stem facing in the direction specified on the Tire Changing Instructions located with the jack hardware.

2. Slide the wheel partially under the vehicle and install the retainer through the wheel center. Pull on the cable to align the components at the end of the cable.

3. Turn the jack handle clockwise until the tire is raised to its stowed position underneath the vehicle. The effort to turn the jack handle increases significantly and the spare tire carrier ratchets or slips when the tire is raised to the maximum tightness. Tighten to the best of your ability, to the point where the ratchet/slip occurs, if possible. The spare tire carrier will not allow you to overtighten. If the spare tire carrier ratchets or slips with little effort, take the vehicle to your authorized dealer for assistance at your earliest convenience.

## Roadside Emergencies

4. Check that the tire lies flat against the frame and is properly tightened. Try to push or pull, then turn the tire to be sure it will not move. Loosen and retighten, if necessary. Failure to properly stow the spare tire may result in failure of the winch cable and loss of the tire.
5. Repeat this tightness check procedure when servicing the spare tire pressure (every six months, as per your *scheduled maintenance information*), or at any time that the spare tire is disturbed through service of other components.
6. If removed, install the spare tire lock (if equipped) into the bumper drive tube with the spare tire lock key (if equipped) and jack handle.

### WHEEL LUG NUT TORQUE SPECIFICATIONS

On vehicles equipped with single rear wheels, retighten the lug nuts to the specified torque at 100 miles (160 km) after any wheel disturbance (tire rotation, changing a flat tire, wheel removal, etc.).

On vehicles equipped with dual rear wheels, retighten the wheel lug nuts to the specified torque at 100 miles (160 km), and again at 500 miles (800 km) of new vehicle operation and after any wheel disturbance (tire rotation, changing a flat tire, wheel removal, etc.).

Bolt size	Wheel lug nut torque*	
	lb.ft.	N•m
9/16 x 18	140	190

\* Torque specifications are for nut and bolt threads free of dirt and rust. Use only Ford recommended replacement fasteners.

On all two-piece flat wheel nuts, apply one drop of motor oil between the flat washer and the nut. Do not apply motor oil to the wheel nut threads or the wheel stud threads.

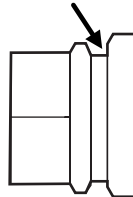

## Roadside Emergencies



When a wheel is installed, always remove any corrosion, dirt or foreign materials present on the mounting surfaces of the wheel or the surface of the wheel hub, brake drum or brake disc that contacts the wheel. Ensure that any fasteners that attach the rotor to the hub are secured so they do not interfere with the mounting surfaces of the wheel. Installing wheels without correct metal-to-metal contact at the wheel mounting surfaces can cause the wheel nuts to loosen and the wheel to come off while the vehicle is in motion, resulting in loss of control.

### JUMP STARTING YOUR VEHICLE

The following procedure is for vehicles equipped with a gasoline engine; if your vehicle is equipped with a diesel engine, refer to the *6.0L Power Stroke Direct Injection Turbo Diesel Owner's Guide Supplement* for the proper jump starting procedure.



The gases around the battery can explode if exposed to flames, sparks, or lit cigarettes. An explosion could result in injury or vehicle damage.



Batteries contain sulfuric acid which can burn skin, eyes and clothing, if contacted.

**Do not attempt to push-start your automatic transmission vehicle. Automatic transmissions do not have push-start capability. Attempting to push-start a vehicle with an automatic transmission may cause transmission damage.**

#### Preparing your vehicle

When the battery is disconnected or a new battery is installed, the automatic transmission must relearn its shift strategy. As a result, the transmission may have firm and/or soft shifts. This operation is considered normal and will not affect function or durability of the transmission. Over time, the adaptive learning process will fully update transmission operation.

1. **Use only a 12-volt supply to start your vehicle.**
2. Do not disconnect the battery of the disabled vehicle as this could damage the vehicle's electrical system.

## Roadside Emergencies

3. Park the booster vehicle close to the hood of the disabled vehicle making sure the two vehicles **do not** touch. Set the parking brake on both vehicles and stay clear of the engine cooling fan and other moving parts.
4. Check all battery terminals and remove any excessive corrosion before you attach the battery cables. Ensure that vent caps are tight and level.
5. Turn the heater fan on in both vehicles to protect from any electrical surges. Turn all other accessories off.

### Connecting the jumper cables

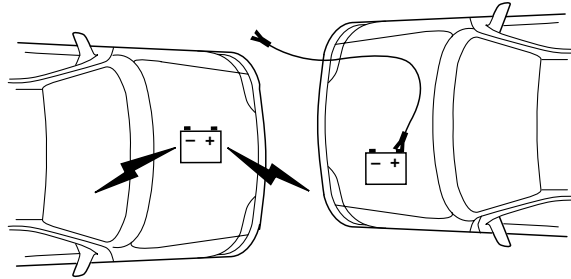

1. Connect the positive (+) jumper cable to the positive (+) terminal of the discharged battery.

**Note:** In the illustrations, *lightning bolts* are used to designate the assisting (boosting) battery.

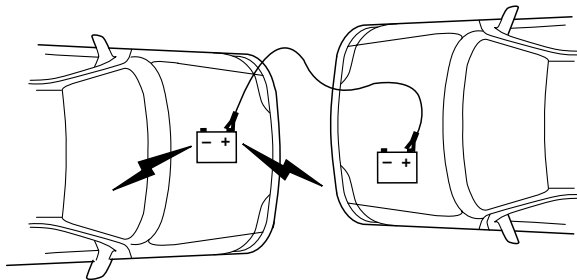

2. Connect the other end of the positive (+) cable to the positive (+) terminal of the assisting battery.

## Roadside Emergencies

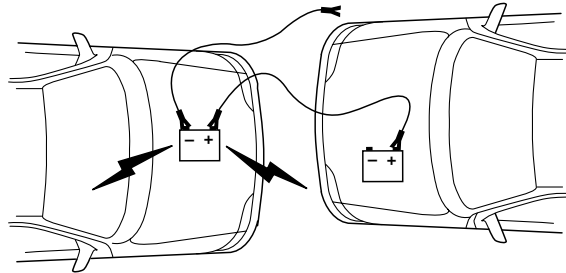

3. Connect the negative (-) cable to the negative (-) terminal of the assisting battery.

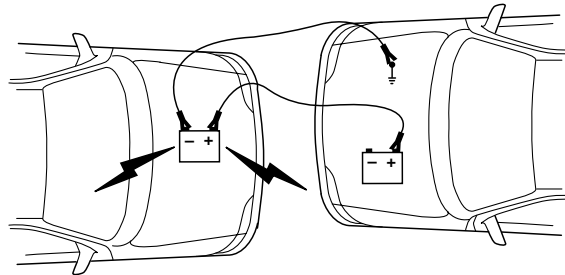

4. Make the final connection of the negative (-) cable to an exposed metal part of the stalled vehicle's engine, away from the battery and the carburetor/fuel injection system. **Do not** use fuel lines, engine rocker covers or the intake manifold as *grounding* points.



Do not connect the end of the second cable to the negative (-) terminal of the battery to be jumped. A spark may cause an explosion of the gases that surround the battery.

5. Ensure that the cables are clear of fan blades, belts, moving parts of both engines, or any fuel delivery system parts.

## Roadside Emergencies

### Jump starting

1. Start the engine of the booster vehicle and run the engine at moderately increased speed.
2. Start the engine of the disabled vehicle.
3. Once the disabled vehicle has been started, run both engines for an additional three minutes before disconnecting the jumper cables.

### Removing the jumper cables

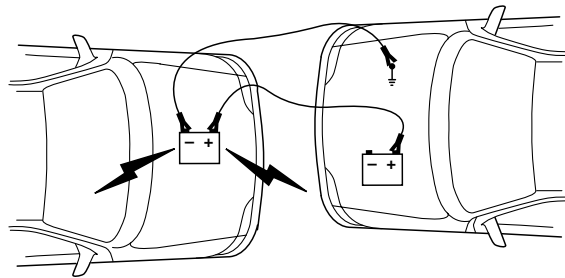

**Remove the jumper cables in the reverse order that they were connected.**

1. Remove the jumper cable from the *ground* metal surface.

**Note:** In the illustrations, *lightning bolts* are used to designate the assisting (boosting) battery.

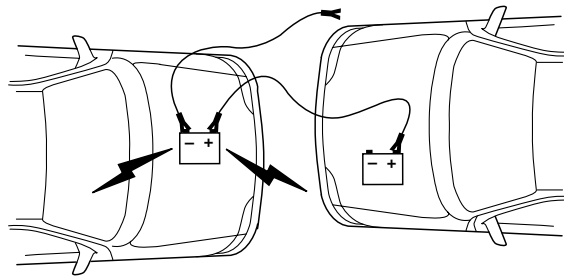

2. Remove the jumper cable on the negative (-) connection of the booster vehicle's battery.

## Roadside Emergencies

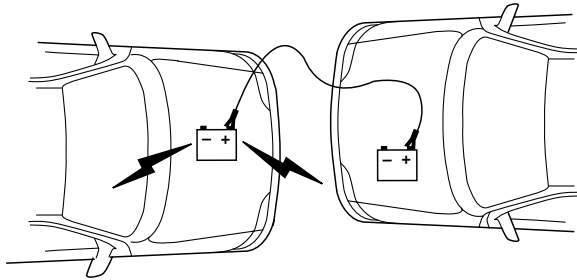

3. Remove the jumper cable from the positive (+) terminal of the booster vehicle's battery.

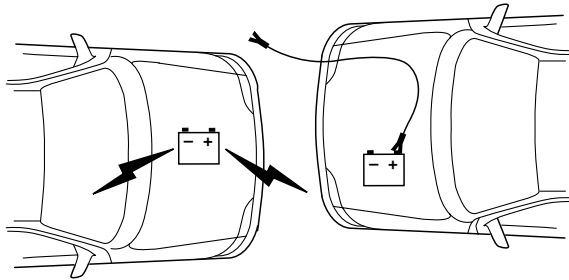

4. Remove the jumper cable from the positive (+) terminal of the disabled vehicle's battery.

After the disabled vehicle has been started and the jumper cables removed, allow it to idle for several minutes so the engine computer can *relearn* its idle conditions.



## Roadside Emergencies

### WRECKER TOWING

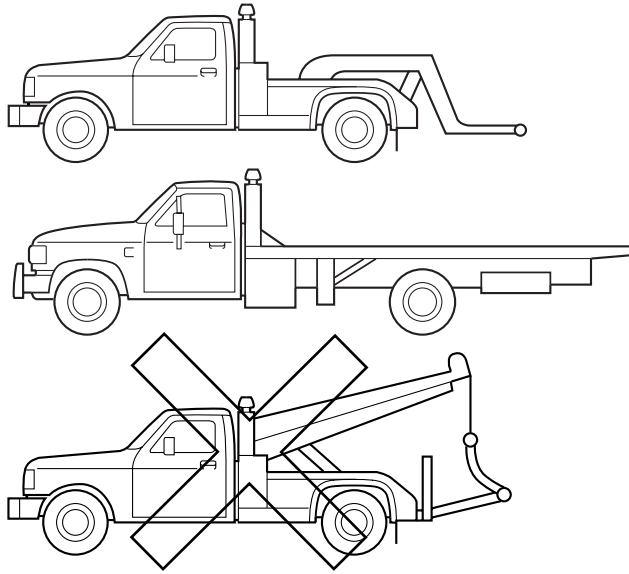

If you need to have your vehicle towed, contact a professional towing service or, if you are a member of a roadside assistance program, your roadside assistance service provider.

Ford recommends your vehicle be towed with a wheel lift or flatbed. Do not tow with a slingbelt. Ford Motor Company has not approved a slingbelt towing procedure.

If your vehicle is equipped with an air dam and must be towed from the front, it is recommended that your vehicle be towed by wheel lift or flatbed equipment to prevent damage to the air dam.

**If the vehicle is towed by other means or incorrectly, vehicle damage may occur.**

Ford Motor Company produces a towing manual for all authorized tow truck operators. Have your tow truck operator refer to this manual for proper hook-up and towing procedures for your vehicle.

## Customer Assistance

### GETTING THE SERVICES YOU NEED

#### At home

You must take your Ford vehicle to an authorized dealer for warranty repairs. While any authorized dealer handling your vehicle line will provide warranty service, we recommend you return to your selling authorized dealer who wants to ensure your continued satisfaction. Please note that certain warranty repairs require special training and/or equipment, so not all authorized dealers are authorized to perform all warranty repairs. This means that, depending on the warranty repair needed, you may have to take your vehicle to another authorized dealer. A reasonable time must be allowed to perform a repair after taking your vehicle to the authorized dealer. Repairs will be made using Ford or Motorcraft parts, or remanufactured or other parts that are authorized by Ford.

If you have questions or concerns, or are unsatisfied with the service you are receiving, follow these steps:

1. Contact your Sales Representative or Service Advisor at your selling/servicing authorized dealer.
2. If your inquiry or concern remains unresolved, contact the Sales Manager, Service Manager or Customer Relations Manager.
3. If you require assistance or clarification on Ford Motor Company policies or procedures, please contact the Ford Customer Relationship Center at 1-800-392-3673 (FORD).

#### Away from home

If you own a Ford or Mercury vehicle and are away from home when your vehicle needs service, or if you need more help than the authorized dealer could provide, after following the steps described above, contact the Ford Customer Relationship Center to find an authorized dealer to help you.

In the United States:

Ford Motor Company  
Customer Relationship Center  
P.O. Box 6248  
Dearborn, MI 48121  
1-800-392-3673 (FORD)  
(TDD for the hearing impaired: 1-800-232-5952)  
[www.customersaskford.com](http://www.customersaskford.com)

## Customer Assistance

In Canada:  
Customer Relationship Centre  
Ford Motor Company of Canada, Limited  
P.O. Box 2000  
Oakville, Ontario L6J 5E4  
1-800-565-3673 (FORD)  
www.ford.ca

### ***Away from home—motorhome service***

If you own a motorhome built on a Ford Chassis and are away from home when your vehicle needs service, or if you need more help than the authorized dealer could provide, after following the steps above, contact the Ford Motorhome Customer Assistance Center to find an authorized dealer or service location to help you. In the United States and Canada:

Ford Motorhome Customer Assistance Center  
900 N. Lake Havasu Avenue  
Lake Havasu City, AZ 86403  
1-800-444-3311  
Open 365/24/7

In order to help service your motorhome vehicle, please have the following information available when contacting the Motorhome Customer Assistance Center:

- telephone number where you can be reached
- vehicle location (city and state)
- year and make of your vehicle
- date of vehicle purchase
- current odometer reading
- vehicle identification number (VIN)

### ***Additional Assistance***

If you still have a complaint involving a warranty dispute, you may wish to contact the Better Business Bureau (BBB) AUTO LINE program (U.S. only).

In some states (in the U.S.) you must directly notify Ford in writing before pursuing remedies under your state's warranty laws. Ford is also allowed a final repair attempt in some states.

## Customer Assistance

In the United States, a warranty dispute must be submitted to the BBB AUTO LINE before taking action under the Magnuson-Moss Warranty Act, or to the extent allowed by state law, before pursuing replacement or repurchase remedies provided by certain state laws. This dispute handling procedure is not required prior to enforcing state created rights or other rights which are independent of the Magnuson-Moss Warranty Act or state replacement or repurchase laws.

### **IN CALIFORNIA (U.S. ONLY)**

California Civil Code Section 1793.2(d) requires that, if a manufacturer or its representative is unable to repair a motor vehicle to conform to the vehicle's applicable express warranty after a reasonable number of attempts, the manufacturer shall be required to either replace the vehicle with one substantially identical or repurchase the vehicle and reimburse the buyer in an amount equal to the actual price paid or payable by the consumer (less a reasonable allowance for consumer use). The consumer has the right to choose whether to receive a refund or replacement vehicle.

California Civil Code Section 1793.22(b) presumes that the manufacturer has had a reasonable number of attempts to conform the vehicle to its applicable express warranties if, within the first 18 months of ownership of a new vehicle or the first 18,000 miles (29,000 km), whichever occurs first:

1. Two or more repair attempts are made on the same non-conformity likely to cause death or serious bodily injury OR
2. Four or more repair attempts are made on the same nonconformity (a defect or condition that substantially impairs the use, value or safety of the vehicle) OR
3. The vehicle is out of service for repair of nonconformities for a total of more than 30 calendar days (not necessarily all at one time)

In the case of 1 or 2 above, the consumer must also notify the manufacturer of the need for the repair of the nonconformity at the following address:

Ford Motor Company  
16800 Executive Plaza Drive  
Mail Drop 3NE-B  
Dearborn, MI 48126

## Customer Assistance

### **THE BETTER BUSINESS BUREAU (BBB) AUTO LINE PROGRAM (U.S. ONLY)**

Your satisfaction is important to Ford Motor Company and to your dealer. Experience has shown that our customers have been very successful in achieving satisfaction by following the three-step procedure outlined on the front page of the Warranty Guide. However, if your warranty concern has not been resolved using the three-step procedure, you may be eligible to participate in the BBB AUTO LINE program.

The BBB AUTO LINE program consists of two parts – mediation and arbitration. Initially, the BBB will try to resolve your question or concern through mediation. Mediation is a process through which a representative of the BBB will contact the parties and explore options for settlement of your claim. If mediation is not successful, customers with eligible claims may participate in the BBB AUTO LINE arbitration process. An arbitration hearing will be scheduled so that you can present your case in an informal setting before an impartial person. The arbitrator will consider the testimony provided and make a decision after the hearing. You are not bound by the decision but may choose to accept it. If you choose to accept the BBB AUTO LINE decision then Ford must abide by the accepted decision as well. If the arbitrator has decided in your favor and you accept the decision, the BBB AUTO LINE program will contact you to ensure that Ford has complied with the decision in a timely manner. Disputes submitted to the BBB AUTO LINE program are usually decided within forty days after you file your claim with the BBB.

To initiate a claim with the BBB AUTO LINE, you will be asked for your name and address, general information about your new vehicle, information about your warranty concerns and any steps you have already taken to try to resolve them. You will then be mailed a Customer Claim Form that you will need to complete, provide proof of vehicle ownership, sign and return the Customer Claim Form to the BBB. Upon receipt, the BBB will review the claim for eligibility under the Program Summary Guidelines.

**You can get more information by calling BBB AUTO LINE at 1-800-955-5100, or writing to:**

**BBB AUTO LINE  
4200 Wilson Boulevard, Suite 800  
Arlington, Virginia 22203-1833**

**Note:** Ford Motor Company reserves the right to change eligibility limitations, modify procedures, or to discontinue this process at any time without notice and without obligation.

## Customer Assistance

### **UTILIZING THE MEDIATION/ARBITRATION PROGRAM (CANADA ONLY)**

For vehicles delivered to authorized Canadian dealers. In those cases where you continue to feel that the efforts by Ford of Canada and the authorized dealer to resolve a factory-related vehicle service concern have been unsatisfactory, Ford of Canada participates in an impartial third party mediation/arbitration program administered by the Canadian Motor Vehicle Arbitration Plan (CAMVAP).

The CAMVAP program is a straight-forward and relatively speedy alternative to resolve a disagreement when all other efforts to produce a settlement have failed. This procedure is without cost to you and is designed to eliminate the need for lengthy and expensive legal proceedings.

In the CAMVAP program, impartial third-party arbitrators conduct hearings at mutually convenient times and places in an informal environment. These impartial arbitrators review the positions of the parties, make decisions and, when appropriate, render awards to resolve disputes. CAMVAP decisions are fast, fair, and final as the arbitrator's award is binding both to you and Ford of Canada.

CAMVAP services are available in all territories and provinces. For more information, without charge or obligation, call your CAMVAP Provincial Administrator directly at 1-800-207-0685.

### **FORD EXTENDED SERVICE PLAN**

You can get more protection for your new car or light truck by purchasing Ford Extended Service Plan (Ford ESP) coverage. It provides the following:

- Benefits during the warranty period depending on the plan you purchase (such as: reimbursement for rentals; coverage for certain maintenance and wear items).
- Protection against covered repair costs after your Bumper-to-Bumper Warranty expires.

You may purchase Ford ESP from any participating authorized dealer. There are several plans available in various time, distance and deductible combinations which can be tailored to fit your own driving needs. Ford ESP also offers reimbursement benefits for towing and rental coverage.

When you buy Ford ESP, you receive Peace-of-Mind protection throughout the United States and Canada, provided by a network of more than 4,600 participating authorized dealers.

## Customer Assistance

If you did not take advantage of the Ford Extended Service Plan at the time of purchasing your vehicle, you may still be eligible. Since this information is subject to change, please ask your authorized dealer for complete details about Ford Extended Service Plan coverage options, or visit the Ford ESP website at [www.ford-esp.com](http://www.ford-esp.com).

### GETTING ASSISTANCE OUTSIDE THE U.S. AND CANADA

Before exporting your vehicle to a foreign country, contact the appropriate foreign embassy or consulate. These officials can inform you of local vehicle registration regulations and where to find unleaded fuel.

If you cannot find unleaded fuel or can only get fuel with an anti-knock index lower than is recommended for your vehicle, contact a regional office or owner relations/customer relationship office.

The use of leaded fuel in your vehicle without proper conversion may damage the effectiveness of your emission control system and may cause engine knocking or serious engine damage. Ford Motor Company/Ford of Canada is not responsible for any damage caused by use of improper fuel. Using leaded fuel may also result in difficulty importing your vehicle back into the U.S.

If your vehicle must be serviced while you are traveling or living in Central America, the Caribbean, or the Middle East, contact the nearest authorized dealer. If the authorized dealer cannot help you, write or call:

FORD MOTOR COMPANY  
FORD EXPORT OPERATIONS  
1555 Fairlane Drive  
Fairlane Business Park #3  
Allen Park, Michigan 48101  
U.S.A.  
Telephone: (313) 594-4857  
FAX: (313) 390-0804

If you are in another foreign country, contact the nearest authorized dealer. If the authorized dealer employees cannot help you, they can direct you to the nearest Ford affiliate office.

If you buy your vehicle in North America and then relocate outside of the U.S. or Canada, register your vehicle identification number (VIN) and new address with Ford Motor Company Export Operations.

**Customers in the U.S. should call 1-800-392-3673.**

## Customer Assistance

### ORDERING ADDITIONAL OWNER'S LITERATURE

To order the publications in this portfolio, contact Helm, Incorporated at:

HELM, INCORPORATED  
P.O. Box 07150  
Detroit, Michigan 48207

Or call:

**For a free publication catalog, order toll free: 1-800-782-4356**

Monday-Friday 8:00 a.m. - 6:00 p.m. EST

Helm, Incorporated can also be reached by their website:  
[www.helminc.com](http://www.helminc.com).

*(Items in this catalog may be purchased by credit card, check or money order.)*

### Obtaining a French owner's guide

French Owner's Guides can be obtained from your authorized dealer or by writing to:

Ford Motor Company of Canada, Limited  
Service Publications CHQ202  
The Canadian Road  
P.O. Box 2000  
Oakville, ON, Canada  
L6J 5E4

### REPORTING SAFETY DEFECTS (U.S. ONLY)

If you believe that your vehicle has a defect which could cause a crash or could cause injury or death, you should immediately inform the National Highway Traffic Safety



Administration (NHTSA) in addition to notifying Ford Motor Company.

If NHTSA receives similar complaints, it may open an investigation, and if it finds that a safety defect exists in a group of vehicles, it may order a recall and remedy campaign. However, NHTSA cannot become involved in individual problems between you, your dealer, or Ford Motor Company.

200

**2007 Econoline (eco)**  
**Owners Guide (post-2002-fmt)**  
**USA (fus)**



## Customer Assistance

To contact NHTSA, you may call the Vehicle Safety Hotline toll-free at 1-888-327-4236 (TTY: 1-800-424-9153); go to <http://www.safercar.gov>; or write to:

Administrator  
NHTSA  
400 Seventh Street, SW  
Washington, D.C. 20590

You can also obtain other information about motor vehicle safety from <http://www.safercar.gov>.

### **REPORTING SAFETY DEFECTS (CANADA ONLY)**

If you believe that your vehicle has a defect which could cause a crash or could cause injury or death, you should immediately inform Transport Canada, using their toll-free number: 1-800-333-0510.

## Cleaning

### WASHING THE EXTERIOR

Wash your vehicle regularly with cool or lukewarm water and a neutral pH shampoo, such as Motorcraft Detail Wash (ZC-3-A), which is available from your authorized dealer.

- Never use strong household detergents or soap, such as dish washing or laundry liquid. These products can discolor and spot painted surfaces.
- Never wash a vehicle that is “hot to the touch” or during exposure to strong, direct sunlight.
- Always use a clean sponge or car wash mitt with plenty of water for best results.
- Dry the vehicle with a chamois or soft terry cloth towel in order to eliminate water spotting.
- It is especially important to wash the vehicle regularly during the winter months, as dirt and road salt are difficult to remove and cause damage to the vehicle.
- Immediately remove items such as gasoline, diesel fuel, bird droppings and insect deposits because they can cause damage to the vehicle’s paintwork and trim over time. Use Bug and Tar Remover, ZC-42, which is available from your authorized dealer.
- Remove any exterior accessories, such as antennas, before entering a car wash.
- **Suntan lotions and insect repellents can damage any painted surface; if these substances come in contact with your vehicle, wash off as soon as possible.**
- **If your vehicle is equipped with running boards, do not use rubber, plastic and vinyl protectant products on the running board surface, as the area may become slippery.**

### Exterior chrome

- Wash the vehicle first, using cool or lukewarm water and a neutral pH shampoo, such as Motorcraft Detail Wash (ZC-3-A).
- Use Custom Bright Metal Cleaner (ZC-15), available from your authorized dealer. Apply the product as you would a wax to clean bumpers and other chrome parts; allow the cleaner to dry for a few minutes, then wipe off the haze with a clean, dry rag.
- **Never use abrasive materials such as steel wool or plastic pads as they can scratch the chrome surface.**

## Cleaning

- After polishing chrome bumpers, apply a coating of Motorcraft Premium Liquid Wax (ZC-53-A), available from your authorized dealer, or an equivalent quality product to help protect from environmental effects.

### WAXING

Applying Motorcraft Paint Sealant (ZC-45) to your vehicle every six months will assist in reducing minor scratches and paint damage.

- Wash the vehicle first.
- Do not use waxes that contain abrasives; use Motorcraft Premium Liquid Wax (ZC-53-A), which is available from your authorized dealer, or an equivalent quality product.
- Do not allow paint sealant to come in contact with any non-body (low-gloss black) colored trim, such as grained door handles, roof racks, bumpers, side moldings, mirror housings or the windshield cowl area. The paint sealant will “gray” or stain the parts over time.
- Do not allow paint sealant to come in contact with the sliding door electrical contact switches. Paint sealant or other contaminants could interfere with the proper operation of the power locks or radio speakers. If necessary, clean the contacts with Motorcraft Bug and Tar Remover (ZC-42) to remove any sealant. Do not use any abrasives on the contact surfaces.

### PAINT CHIPS

Your authorized dealer has touch-up paint to match your vehicle’s color. Take your color code (printed on a sticker in the driver’s door jamb) to your authorized dealer to ensure you get the correct color.

- Remove particles such as bird droppings, tree sap, insect deposits, tar spots, road salt and industrial fallout before repairing paint chips.
- Always read the instructions before using the products.

### ALUMINUM WHEELS AND WHEEL COVERS

Aluminum wheels and wheel covers are coated with a clearcoat paint finish. In order to maintain their shine:

- Clean weekly with Motorcraft Wheel and Tire Cleaner (ZC-37-A), which is available from your authorized dealer. Heavy dirt and brake dust accumulation may require agitation with a sponge. Rinse thoroughly with a strong stream of water.
- Never apply any cleaning chemical to hot or warm wheel rims or covers.

## Cleaning

- Some automatic car washes may cause damage to the finish on your wheel rims or covers. Chemical-strength cleaners, or cleaning chemicals, in combination with brush agitation to remove brake dust and dirt, could wear away the clearcoat finish over time.
- Do not use hydrofluoric acid-based or high caustic-based wheel cleaners, steel wool, fuels or strong household detergent.
- To remove tar and grease, use Motorcraft Bug and Tar Remover (ZC-42), available from your authorized dealer.

### ENGINE

Engines are more efficient when they are clean because grease and dirt buildup keep the engine warmer than normal. When washing:

- Take care when using a power washer to clean the engine. The high-pressure fluid could penetrate the sealed parts and cause damage.
- Do not spray a hot engine with cold water to avoid cracking the engine block or other engine components.
- Spray Motorcraft Engine Shampoo and Degreaser (ZC-20) on all parts that require cleaning and pressure rinse clean.

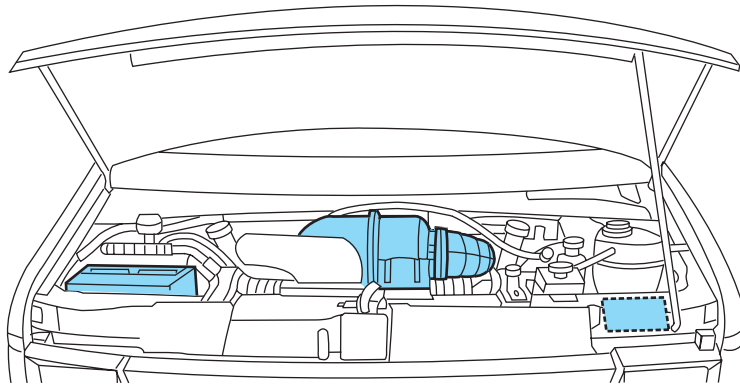

- Cover the highlighted areas to prevent water damage when cleaning the engine.
- Never wash or rinse the engine while it is running; water in the running engine may cause internal damage.

## Cleaning

### PLASTIC (NON-PAINTED) EXTERIOR PARTS

Use only approved products to clean plastic parts. These products are available from your authorized dealer.

- For routine cleaning, use Motorcraft Detail Wash (ZC-3-A).
- If tar or grease spots are present, use Motorcraft Bug and Tar Remover (ZC-42).
- For plastic headlamp lenses, use Motorcraft Ultra Clear Spray Glass Cleaner (ZC-23).

### WINDOWS AND WIPER BLADES

The windshield, rear and side windows and the wiper blades should be cleaned regularly. If the wipers do not wipe properly, substances on the vehicle's glass or the wiper blades may be the cause. These may include hot wax treatments used by commercial car washes, water repellent coatings, tree sap, or other organic contamination; these contaminants may cause squeaking or chatter noise from the blades, and streaking and smearing of the windshield. To clean these items, follow these tips:

- The windshield, rear windows and side windows may be cleaned with a non-abrasive cleaner such as Motorcraft Ultra-Clear Spray Glass Cleaner (ZC-23), available from your authorized dealer.
- The wiper blades can be cleaned with isopropyl (rubbing) alcohol or Motorcraft Premium Windshield Washer Concentrate (ZC-32-A), available from your authorized dealer. This washer fluid contains special solution in addition to alcohol which helps to remove the hot wax deposited on the wiper blade and windshield from automated car wash facilities. Be sure to replace wiper blades when they appear worn or do not function properly.
- Do not use abrasives, as they may cause scratches.
- Do not use fuel, kerosene, or paint thinner to clean any parts.

If you cannot remove those streaks after cleaning with the glass cleaner or if the wipers chatter and move in a jerky motion, clean the outer surface of the windshield and the wiper blades using a sponge or soft cloth with a neutral detergent or mild-abrasive cleaning solution. After cleaning, rinse the windshield and wiper blades with clean water. The windshield is clean if beads do not form when you rinse the windshield with water.

## Cleaning

### INSTRUMENT PANEL/INTERIOR TRIM AND CLUSTER LENS

Clean the instrument panel, interior trim areas and cluster lens with a clean and damp white cotton cloth, then with a clean and dry white cotton cloth; you may also use Motorcraft Dash & Vinyl Cleaner (ZC-38-A) on the instrument panel and interior trim areas.

- Avoid cleaners or polishes that increase the gloss of the upper portion of the instrument panel. The dull finish in this area helps protect the driver from undesirable windshield reflection.
- Be certain to wash or wipe your hands clean if you have been in contact with certain products such as insect repellent and suntan lotion in order to avoid possible damage to the interior painted surfaces.
- Do not use household or glass cleaners as these may damage the finish of the instrument panel, interior trim and cluster lens.



Do not use chemical solvents or strong detergents when cleaning the steering wheel or instrument panel to avoid contamination of the airbag system.

If a staining liquid like coffee/juice has been spilled on the instrument panel or on interior trim surfaces, clean as follows:

1. Wipe up spilled liquid using a clean white cotton cloth.
2. Apply Motorcraft Deluxe Leather and Vinyl Cleaner (ZC-11-A) [In Canada use Motorcraft Multi-Purpose Cleaner (CXC-101)] to the wiped area and spread around evenly.
3. Apply more Motorcraft cleaner to a clean white cotton cloth and press the cloth onto the soiled area—allow this to set at room temperature for 30 minutes.
4. Remove the soaked cloth, and if it is not soiled badly, use this cloth to clean the area by using a rubbing motion for 60 seconds.
5. Following this, wipe area dry with a clean white cotton cloth.

### INTERIOR

For fabric, carpets, cloth seats and safety belts:

- Remove dust and loose dirt with a vacuum cleaner.
- Remove light stains and soil with Motorcraft Professional Strength Carpet & Upholstery Cleaner (ZC-54).
- If grease or tar is present on the material, spot-clean the area first with Motorcraft Spot and Stain Remover (ZC-14).

## Cleaning

- If a ring forms on the fabric after spot cleaning, clean the entire area immediately (but do not oversaturate) or the ring will set.
- Do not use household cleaning products or glass cleaners, which can stain and discolor the fabric and affect the flame retardant abilities of the seat materials.



Do not use cleaning solvents, bleach or dye on the vehicle's seatbelts, as these actions may weaken the belt webbing.

### LEATHER SEATS (IF EQUIPPED)

Your leather seating surfaces have a clear, protective coating over the leather.

- To clean, use a soft cloth with Motorcraft Deluxe Leather and Vinyl Cleaner (ZC-11-A). Dry the area with a soft cloth.
- To help maintain its resiliency and color, use the Motorcraft Deluxe Leather Care Kit (ZC-11-D), available from your authorized dealer.
- Do not use household cleaning products, alcohol solutions, solvents or cleaners intended for rubber, vinyl and plastics, or oil/petroleum-based leather conditioners. These products may cause premature wearing of the clear, protective coating.

**Note:** In some instances, color or dye transfer can occur when wet clothing comes in contact with leather upholstery. If this occurs, the leather should be cleaned immediately to avoid permanent staining.

### UNDERBODY

Flush the complete underside of your vehicle frequently. Keep body and door drain holes free from packed dirt.

## Cleaning

### **FORD AND LINCOLN MERCURY CAR CARE PRODUCTS**

Your Ford or Lincoln Mercury authorized dealer has many quality products available to clean your vehicle and protect its finishes. These quality products have been specifically engineered to fulfill your automotive needs; they are custom designed to complement the style and appearance of your vehicle. Each product is made from high quality materials that meet or exceed rigid specifications. For best results, use the following products or products of equivalent quality:

- Motorcraft Bug and Tar Remover (ZC-42)
- Motorcraft Car Care Kit (ZC-26)
- Motorcraft Car Wash (Canada only) (CXC-21)
- Motorcraft Custom Bright Metal Cleaner (ZC-15)
- Motorcraft Custom Clear Coat Polish (ZC-8-A)
- Motorcraft Custom Vinyl Protectant (U.S. only) (ZC-40-A)
- Motorcraft Dash and Vinyl Cleaner (ZC-38-A)
- Motorcraft Deluxe Leather and Vinyl Cleaner (U.S. only) (ZC-11-A)
- Motorcraft Detail Wash (ZC-3-A)
- Motorcraft Dusting Cloth (ZC-24)
- Motorcraft Engine Shampoo and Degreaser (U.S. only) (ZC-20)
- Motorcraft Engine Shampoo (Canada only) (CXC-66-A)
- Motorcraft One Step Wash and Wax Concentrate (ZC-6-A)
- Motorcraft Paint Sealant (ZC-45)
- Motorcraft Premium Car Wash Concentrate (U.S. only) (ZC-17-B)
- Motorcraft Premium Glass Cleaner (Canada only) (CXC-100)
- Motorcraft Premium Liquid Wax (ZC-53-A)
- Motorcraft Premium Windshield Washer Concentrate (ZC-32-A)
- Motorcraft Professional Strength Carpet & Upholstery Cleaner (ZC-54)
- Motorcraft Spot and Stain Remover (U.S. only) (ZC-14)
- Motorcraft Tire Clean and Shine (ZC-28)
- Motorcraft Triple Clean (U.S. only) (ZC-13)
- Motorcraft Ultra-Clear Spray Glass Cleaner (ZC-23)
- Motorcraft Vinyl Cleaner (Canada only) (CXC-93)
- Motorcraft Wheel and Tire Cleaner (ZC-37-A)

208



## Maintenance and Specifications

### SERVICE RECOMMENDATIONS

To help you service your vehicle, we provide *scheduled maintenance information* which makes tracking routine service easy.

If your vehicle requires professional service, your authorized dealer can provide the necessary parts and service. Check your *Warranty Guide* to find out which parts and services are covered.

Use only recommended fuels, lubricants, fluids and service parts conforming to specifications. Motorcraft parts are designed and built to provide the best performance in your vehicle.

### PRECAUTIONS WHEN SERVICING YOUR VEHICLE

- Do not work on a hot engine.
- Make sure that nothing gets caught in moving parts.
- Do not work on a vehicle with the engine running in an enclosed space, unless you are sure you have enough ventilation.
- Keep all open flames and other lit material away from the battery and all fuel related parts.

#### Working with the engine off

1. Set the parking brake and shift to P (Park).
2. Turn off the engine and remove the key.
3. Block the wheels.

#### Working with the engine on

1. Set the parking brake and shift to P (Park).
2. Block the wheels.



To reduce the risk of vehicle damage and/or personal burn injuries, do not start your engine with the air cleaner removed and do not remove it while the engine is running.

## Maintenance and Specifications

### OPENING THE HOOD

1. Inside the vehicle, pull the hood release handle located under the bottom left corner of the instrument panel.

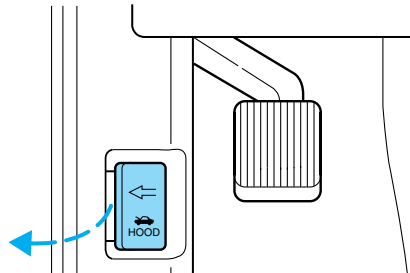

2. Go to the front of the vehicle and release the auxiliary latch that is located in the center top of the grill.

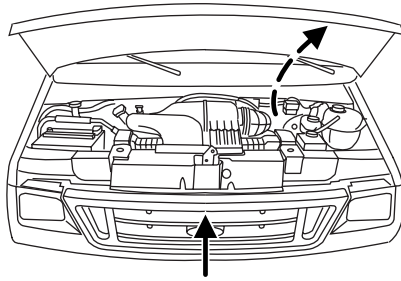

3. Lift the hood and secure it with the prop rod.

## Maintenance and Specifications

### IDENTIFYING COMPONENTS IN THE ENGINE COMPARTMENT

#### Engine compartment component locations

Refer to the *6.0 Liter Power Stroke Direct Injection Turbo Diesel Owner's Guide Supplement* for diesel engine component locations.

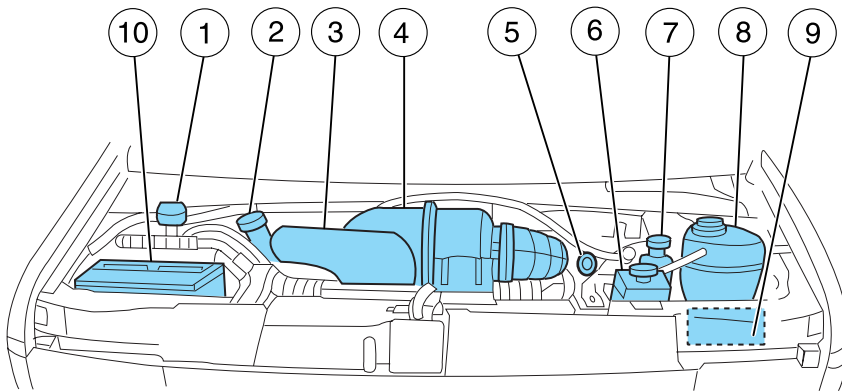

1. Windshield washer fluid reservoir
2. Engine oil filler cap
3. Automatic transmission fluid dipstick
4. Air filter assembly
5. Engine oil dipstick
6. Power steering fluid reservoir
7. Brake fluid reservoir
8. Engine coolant reservoir
9. Power distribution box
10. Battery

## Maintenance and Specifications

### WINDSHIELD WASHER FLUID

Add fluid to fill the reservoir if the level is low. In very cold weather, do not fill the reservoir completely.

Only use a washer fluid that meets Ford specification WSB-M8B16-A2. Do not use any special washer fluid such as windshield water repellent type fluid or bug wash. They may cause squeaking, chatter noise, streaking and smearing. Refer to the *Maintenance product specifications and capacities* section in this chapter.

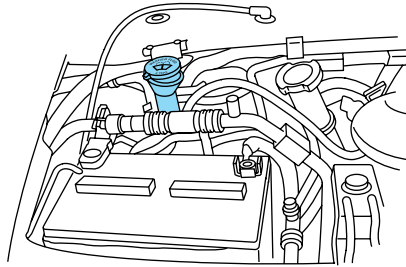

State or local regulations on volatile organic compounds may restrict the use of methanol, a common windshield washer antifreeze additive. Washer fluids containing non-methanol antifreeze agents should be used only if they provide cold weather protection without damaging the vehicle's paint finish, wiper blades or washer system.

 If you operate your vehicle in temperatures below 40° F (4.5°C), use washer fluid with antifreeze protection. Failure to use washer fluid with antifreeze protection in cold weather could result in impaired windshield vision and increase the risk of injury or accident.

**Note:** Do not put washer fluid in the engine coolant reservoir. Washer fluid placed in the cooling system may harm engine and cooling system components.

### CHANGING THE WIPER BLADES

1. Pull the wiper arm away from the vehicle. Turn the blade at an angle from the wiper arm. Push the lock pin manually to release the blade and pull the wiper blade down toward the windshield to remove it from the arm.

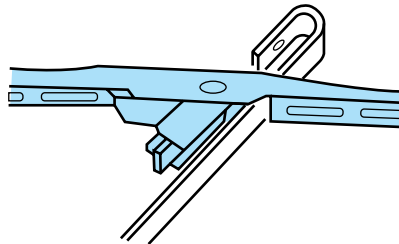

2. Attach the new wiper to the wiper arm and press it into place until a click is heard.

Replace wiper blades at least once per year for optimum performance.

## Maintenance and Specifications

Poor wiper quality can be improved by cleaning the wiper blades and the windshield, refer to *Windows and wiper blades* in the *Cleaning* chapter.

To prolong the life of the wiper blades, it is highly recommended to scrape off the ice on the windshield before turning on the wipers. The layer of ice has many sharp edges and can damage the micro edge of the wiper rubber element.

### ENGINE OIL

#### Checking the engine oil

Refer to the *scheduled maintenance information* for the appropriate intervals for checking the engine oil.

1. Make sure the vehicle is on level ground.
2. Turn the engine off and wait a few minutes for the oil to drain into the oil pan.
3. Set the parking brake and ensure the gearshift is securely latched in P (Park).
4. Open the hood. Protect yourself from engine heat.
5. Locate and carefully remove the engine oil level indicator (dipstick).

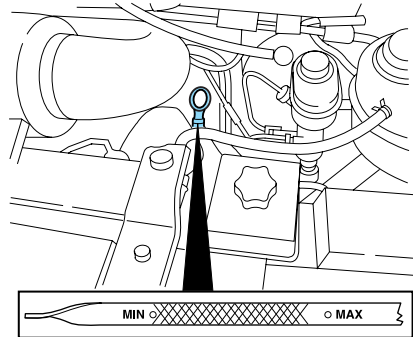

6. Wipe the indicator clean. Insert the indicator fully, then remove it again.

- If the oil level is **between the lower and upper holes or between the MIN and MAX marks (depending on application)**, the oil level is acceptable. **DO NOT ADD OIL.**

## Maintenance and Specifications

- If the oil level is below the lower hole or the MIN mark, add enough oil to raise the level within the lower and upper holes or within the MIN-MAX range.

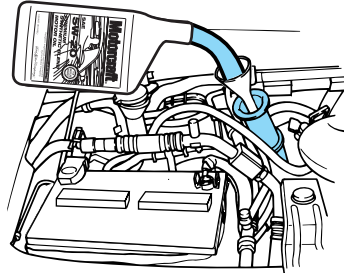

- Oil levels above the upper hole or the MAX mark may cause engine damage. Some oil must be removed from the engine by an authorized dealer.
7. Put the indicator back in and ensure it is fully seated.

### Adding engine oil

1. Check the engine oil. For instructions, refer to *Checking the engine oil* in this chapter.
2. If the engine oil level is not within the normal range, add only certified engine oil of the recommended viscosity. Remove the engine oil filler cap and use a funnel to pour the engine oil into the opening.
3. Recheck the engine oil level. Make sure the oil level is not above the normal operating range on the engine oil level indicator (dipstick).
4. Install the indicator and ensure it is fully seated.
5. Fully install the engine oil filler cap by turning the filler cap clockwise 1/4 of a turn until three clicks are heard or until the cap is fully seated.

**To avoid possible oil loss, DO NOT operate the vehicle with the engine oil level indicator and/or the engine oil filler cap removed.**

## Maintenance and Specifications

### Engine oil and filter recommendations

Look for this certification trademark.

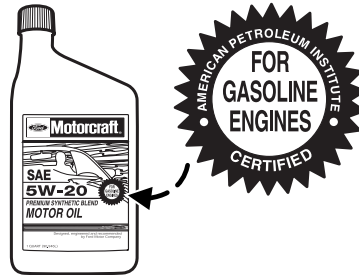

### **Use SAE 5W-20 engine oil**

Only use oils “Certified For Gasoline Engines” by the American Petroleum Institute (API). An oil with this trademark symbol conforms to the current engine and emission system protection standards and fuel economy requirements of the International Lubricant Standardization and Approval Committee (ILSAC), comprised of U.S. and Japanese automobile manufacturers.

To protect your engine’s warranty use Motorcraft SAE 5W-20 or an equivalent SAE 5W-20 oil meeting Ford specification WSS-M2C930-A.

**SAE 5W-20 oil provides optimum fuel economy and durability performance meeting all requirements for your vehicle’s engine.**

Do not use supplemental engine oil additives, cleaners or other engine treatments. They are unnecessary and could lead to engine damage that is not covered by Ford warranty.

Change your engine oil and filter according to the appropriate schedule listed in *scheduled maintenance information*.

Ford production and aftermarket (Motorcraft) oil filters are designed for added engine protection and long life. If a replacement oil filter is used that does not meet Ford material and design specifications, start-up engine noises or knock may be experienced.

It is recommended you use the appropriate Motorcraft oil filter or another with equivalent performance for your engine application.

## Maintenance and Specifications

### BATTERY

Your vehicle is equipped with a Motorcraft maintenance-free battery which normally does not require additional water during its life of service.

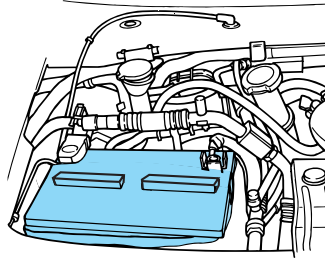

**If your battery has a cover/shield, make sure it is reinstalled after the battery has been cleaned or replaced.**

For longer, trouble-free operation, keep the top of the battery clean and dry. Also, make certain the battery cables are always tightly fastened to the battery terminals.

If you see any corrosion on the battery or terminals, remove the cables from the terminals and clean with a wire brush. You can neutralize the acid with a solution of baking soda and water.

When the battery is disconnected or a new battery installed, the transmission must learn its adaptive strategy. As a result of this, the transmission may shift firmly. This operation is considered normal and will fully update transmission operation to its optimum shift feel.

**Note: Electrical or electronic accessories or components added to the vehicle by the dealer or the owner may adversely affect battery performance and durability.**

It is recommended that the negative battery cable terminal be disconnected from the battery if you plan to store your vehicle for an extended period of time. This will minimize the discharge of your battery during storage.



Batteries normally produce explosive gases which can cause personal injury. Therefore, do not allow flames, sparks or lighted substances to come near the battery. When working near the battery, always shield your face and protect your eyes. Always provide proper ventilation.



## Maintenance and Specifications



When lifting a plastic-cased battery, excessive pressure on the end walls could cause acid to flow through the vent caps, resulting in personal injury and/or damage to the vehicle or battery. Lift the battery with a battery carrier or with your hands on opposite corners.



Keep batteries out of reach of children. Batteries contain sulfuric acid. Avoid contact with skin, eyes or clothing. Shield your eyes when working near the battery to protect against possible splashing of acid solution. In case of acid contact with skin or eyes, flush immediately with water for a minimum of 15 minutes and get prompt medical attention. If acid is swallowed, call a physician immediately.



Battery posts, terminals and related accessories contain lead and lead compounds. **Wash hands after handling.**

For information on transmission operation after the battery has been disconnected, refer to *Automatic Transmission Operation* in the *Driving* chapter.

Because your vehicle's engine is electronically controlled by a computer, some control conditions are maintained by power from the battery. When the battery is disconnected or a new battery is installed, the engine must relearn its idle and fuel trim strategy for optimum driveability and performance. To begin this process:

1. With the vehicle at a complete stop, set the parking brake.
2. Put the gearshift in P (Park), turn off all accessories and start the engine.
3. Run the engine until it reaches normal operating temperature.
4. Allow the engine to idle for at least one minute.
5. Turn the A/C on and allow the engine to idle for at least one minute.
6. Release the parking brake. With your foot on the brake pedal and with the A/C on, put the vehicle in D (Drive) and allow the engine to idle for at least one minute.
7. Drive the vehicle to complete the relearning process.
  - The vehicle may need to be driven 10 miles (16 km) or more to relearn the idle and fuel trim strategy.
  - **If you do not allow the engine to relearn its idle trim, the idle quality of your vehicle may be adversely affected until the idle trim is eventually relearned.**

## Maintenance and Specifications

If the battery has been disconnected or a new battery has been installed, the clock and radio settings must be reset once the battery is reconnected.

- Always dispose of automotive batteries in a responsible manner. Follow your local authorized standards for disposal. Call your local authorized recycling center to find out more about recycling automotive batteries.

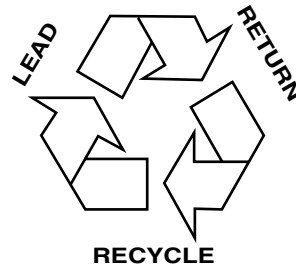

### ENGINE COOLANT

#### Checking engine coolant

The concentration and level of engine coolant should be checked at the intervals listed in *scheduled maintenance information*. The coolant concentration should be maintained at 50/50 coolant and distilled water, which equates to a freeze point of  $-34^{\circ}\text{F}$  ( $-36^{\circ}\text{C}$ ). Coolant concentration testing is possible with a hydrometer or antifreeze tester (such as the Rotunda Battery and Antifreeze Tester, 014-R1060). The level of coolant should be maintained at the "FULL COLD" level or within the "COLD FILL RANGE" in the coolant reservoir. If the level falls below, add coolant per the instructions in the *Adding engine coolant* section.

Your vehicle was factory-filled with a 50/50 engine coolant and water concentration. If the concentration of coolant falls below 40% or above 60%, the engine parts could become damaged or not work properly. **A 50–50 mixture of coolant and water provides the following:**

- **Freeze protection down to  $-34^{\circ}\text{F}$  ( $-36^{\circ}\text{C}$ ).**
- **Boiling protection up to  $265^{\circ}\text{F}$  ( $129^{\circ}\text{C}$ ).**
- **Protection against rust and other forms of corrosion.**
- **Enables calibrated gauges to work properly.**

## Maintenance and Specifications

When the engine is cold, check the level of the engine coolant in the reservoir.

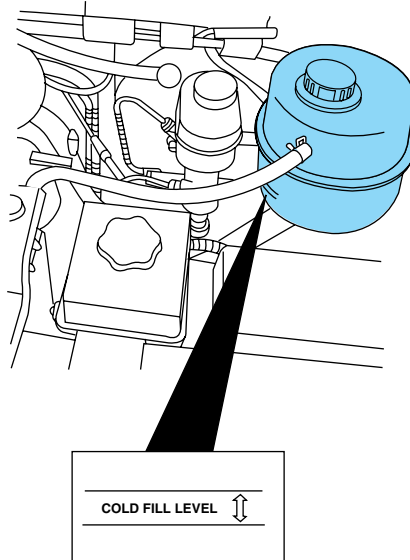

- The engine coolant should be at the “FULL COLD” level or within the “COLD FILL RANGE” as listed on the engine coolant reservoir (depending upon application).
- Refer to *scheduled maintenance information* for service interval schedules.
- Be sure to read and understand *Precautions when servicing your vehicle* in this chapter.

If the engine coolant has not been checked at the recommended interval, the engine coolant reservoir may become low or empty. If the reservoir is low or empty, add engine coolant to the reservoir. Refer to *Adding engine coolant* in this chapter.

**Note:** Automotive fluids are not interchangeable; do not use engine coolant, antifreeze or windshield washer fluid outside of its specified function and vehicle location.

### Adding engine coolant

When adding coolant, make sure it is a 50/50 mixture of engine coolant and distilled water. Add the mixture to the coolant reservoir, **when the engine is cool**, until the appropriate fill level is obtained.

## Maintenance and Specifications



Do not add engine coolant when the engine is hot. Steam and scalding liquids released from a hot cooling system can burn you badly. Also, you can be burned if you spill coolant on hot engine parts.



Do not put engine coolant in the windshield washer fluid container. If sprayed on the windshield, engine coolant could make it difficult to see through the windshield.

- **Add Motorcraft Premium Gold Engine Coolant or equivalent meeting Ford specification WSS-M97B51-A1.** Refer to *Maintenance product specifications and capacities* in this chapter.

**Note:** Use of Motorcraft Cooling System Stop Leak Pellets or an equivalent product meeting Ford specification WSS-M99B37-B6, may darken the color of Motorcraft Premium Gold Engine Coolant from yellow to golden tan.

- **Do not add/mix an orange-colored, extended life coolant such as Motorcraft Specialty Orange Engine Coolant, meeting Ford specification WSS-M97B44-D, or DEX-COOL® brand with the factory-filled coolant.** Mixing Motorcraft Specialty Orange Engine Coolant or any orange-colored extended life product such as DEX-COOL® brand with your factory filled coolant can result in degraded corrosion protection.
- A large amount of water without engine coolant may be added, in case of emergency, to reach a vehicle service location. In this instance, the cooling system must be drained and refilled with a 50/50 mixture of engine coolant and distilled water as soon as possible. Water alone (without engine coolant) can cause engine damage from corrosion, overheating or freezing.
- **Do not use alcohol, methanol, brine or any engine coolants mixed with alcohol or methanol antifreeze (coolant).** Alcohol and other liquids can cause engine damage from overheating or freezing.
- **Do not add extra inhibitors or additives to the coolant.** These can be harmful and compromise the corrosion protection of the engine coolant.

For vehicles with overflow coolant systems with a non-pressurized cap on the coolant recovery system, add coolant to the coolant recovery reservoir when the engine is cool. Add the proper mixture of coolant and water to the “FULL COLD” level. For all other vehicles which have a

## Maintenance and Specifications

coolant degas system with a pressurized cap, or if it is necessary to remove the coolant pressure relief cap on the radiator of a vehicle with an overflow system, follow these steps to add engine coolant.



To reduce the risk of personal injury, make sure the engine is cool before unscrewing the coolant pressure relief cap. The cooling system is under pressure; steam and hot liquid can come out forcefully when the cap is loosened slightly.

Add the proper mixture of coolant and water to the cooling system by following these steps:

1. Before you begin, turn the engine off and let it cool.
2. When the engine is cool, wrap a thick cloth around the coolant pressure relief cap on the coolant reservoir (a translucent plastic bottle). Slowly turn cap counterclockwise (left) until pressure begins to release.
3. Step back while the pressure releases.
4. When you are sure that all the pressure has been released, use the cloth to turn it counterclockwise and remove the cap.
5. Fill the coolant reservoir slowly with the proper coolant mixture (see above), to within the “COLD FILL RANGE” or the “FULL COLD” level on the reservoir. If you removed the radiator cap in an overflow system, fill the radiator until the coolant is visible and radiator is almost full.
6. Replace the cap. Turn until tightly installed. Cap must be tightly installed to prevent coolant loss.

After any coolant has been added, check the coolant concentration (refer to *Checking engine coolant*). If the concentration is not 50/50 (protection to  $-34^{\circ}\text{F}/-36^{\circ}\text{C}$ ), drain some coolant and adjust the concentration. It may take several drains and additions to obtain a 50/50 coolant concentration.

Whenever coolant has been added, the coolant level in the coolant reservoir should be checked the next few times you drive the vehicle. If necessary, add enough 50/50 concentration of engine coolant and distilled water to bring the liquid level to the proper level.

If you have to add more than 1.0 quart (1.0 liter) of engine coolant per month, have your authorized dealer check the engine cooling system. Your cooling system may have a leak. Operating an engine with a low level of coolant can result in engine overheating and possible engine damage.

## Maintenance and Specifications

### Recycled engine coolant

Ford Motor Company does NOT recommend the use of recycled engine coolant in vehicles originally equipped with Motorcraft Premium Gold Engine Coolant since a Ford-approved recycling process is not yet available.



Used engine coolant should be disposed of in an appropriate manner. Follow your community's regulations and standards for recycling and disposing of automotive fluids.

### Coolant refill capacity

To find out how much fluid your vehicle's cooling system can hold, refer to *Maintenance product specifications and capacities* in this chapter. Fill your engine coolant reservoir as outlined in *Adding engine coolant* in this section.

### Severe climates

If you drive in extremely cold climates (less than  $-34^{\circ}\text{F}$  [ $-36^{\circ}\text{C}$  ]):

- **It may be necessary to increase the coolant concentration above 50%.**
- **NEVER increase the coolant concentration above 60%.**
- **Increased engine coolant concentrations above 60% will decrease the overheat protection characteristics of the engine coolant and may cause engine damage.**
- **Refer to the chart on the coolant container to ensure the coolant concentration in your vehicle will provide adequate freeze protection at the temperatures in which you drive in the winter months.**

If you drive in extremely hot climates:

- **It is still necessary to maintain the coolant concentration above 40%.**
- **NEVER decrease the coolant concentration below 40%.**
- **Decreased engine coolant concentrations below 40% will decrease the corrosion protection characteristics of the engine coolant and may cause engine damage.**
- **Decreased engine coolant concentrations below 40% will decrease the freeze protection characteristics of the engine coolant and may cause engine damage.**

## Maintenance and Specifications

- **Refer to the chart on the coolant container to ensure the coolant concentration in your vehicle will provide adequate protection at the temperatures in which you drive.**

Vehicles driven year-round in non-extreme climates should use a 50/50 mixture of engine coolant and distilled water for optimum cooling system and engine protection.

### **What you should know about fail-safe cooling (if equipped)**

If the engine coolant supply is depleted, this feature allows the vehicle to be driven temporarily before incremental component damage is incurred. The “fail-safe” distance depends on ambient temperatures, vehicle load and terrain.

#### **How fail-safe cooling works**

If the engine begins to overheat:

- The engine coolant temperature gauge will move to the red (hot) area.
- The “CHECK GAGE” indicator light will illuminate.
- The “CHECK GAGE” indicator light will flash when fail-safe cooling mode has been activated.

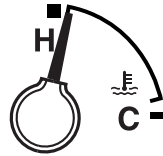

If the engine reaches a preset over-temperature condition, the engine will automatically switch to alternating cylinder operation. Each disabled cylinder acts as an air pump and cools the engine.

When this occurs the vehicle will still operate. However:

- The engine power will be limited.
- The air conditioning system will be disabled.

Continued operation will increase the engine temperature and the engine will completely shut down, causing steering and braking effort to increase.

Once the engine temperature cools, the engine can be re-started. Take your vehicle to an authorized dealer as soon as possible to minimize engine damage.

#### **When fail-safe mode is activated**

You have limited engine power when in the fail-safe mode, so drive the vehicle with caution. The vehicle will not be able to maintain high-speed

## Maintenance and Specifications

operation and the engine will run rough. Remember that the engine is capable of completely shutting down automatically to prevent engine damage, therefore:

1. Pull off the road as soon as safely possible and turn off the engine.
2. Arrange for the vehicle to be taken to an authorized dealer.
3. If this is not possible, wait a short period for the engine to cool.
4. Check the coolant level and replenish if low.



Never remove the coolant reservoir cap while the engine is running or hot.

5. Re-start the engine and take your vehicle to an authorized dealer.

**Driving the vehicle without repairing the engine problem increases the chance of engine damage. Take your vehicle to an authorized dealer as soon as possible.**

### FUEL FILTER

For fuel filter replacement, see your authorized dealer. Refer to *scheduled maintenance information* for the appropriate intervals for changing the fuel filter.

**Replace the fuel filter with an authorized Motorcraft part. The customer warranty may be void for any damage to the fuel system if an authorized Motorcraft fuel filter is not used.**

### WHAT YOU SHOULD KNOW ABOUT AUTOMOTIVE FUELS

#### Important safety precautions



Do not overfill the fuel tank. The pressure in an overfilled tank may cause leakage and lead to fuel spray and fire.



The fuel system may be under pressure. If the fuel filler cap is venting vapor or if you hear a hissing sound, wait until it stops before completely removing the fuel filler cap. Otherwise, fuel may spray out and injure you or others.



If you do not use the proper fuel filler cap, excessive vacuum in the fuel tank may damage the fuel system or cause the fuel cap to disengage in a collision, which may result in possible personal injury.



## Maintenance and Specifications



Automotive fuels can cause serious injury or death if misused or mishandled.



Gasoline may contain benzene, which is a cancer-causing agent.

Observe the following guidelines when handling automotive fuel:

- Extinguish all smoking materials and any open flames before refueling your vehicle.
- Always turn off the vehicle before refueling.
- Automotive fuels can be harmful or fatal if swallowed. Fuel such as gasoline is highly toxic and if swallowed can cause death or permanent injury. If fuel is swallowed, call a physician immediately, even if no symptoms are immediately apparent. The toxic effects of fuel may not be visible for hours.
- Avoid inhaling fuel vapors. Inhaling too much fuel vapor of any kind can lead to eye and respiratory tract irritation. In severe cases, excessive or prolonged breathing of fuel vapor can cause serious illness and permanent injury.
- Avoid getting fuel liquid in your eyes. If fuel is splashed in the eyes, remove contact lenses (if worn), flush with water for 15 minutes and seek medical attention. Failure to seek proper medical attention could lead to permanent injury.
- Fuels can also be harmful if absorbed through the skin. If fuel is splashed on the skin and/or clothing, promptly remove contaminated clothing and wash skin thoroughly with soap and water. Repeated or prolonged skin contact with fuel liquid or vapor causes skin irritation.
- Be particularly careful if you are taking “Antabuse” or other forms of disulfiram for the treatment of alcoholism. Breathing gasoline vapors, or skin contact could cause an adverse reaction. In sensitive individuals, serious personal injury or sickness may result. If fuel is splashed on the skin, promptly wash skin thoroughly with soap and water. Consult a physician immediately if you experience an adverse reaction.



## Maintenance and Specifications

 When refueling always shut the engine off and never allow sparks or open flames near the filler neck. Never smoke while refueling. Fuel vapor is extremely hazardous under certain conditions. Care should be taken to avoid inhaling excess fumes.

 The flow of fuel through a fuel pump nozzle can produce static electricity, which can cause a fire if fuel is pumped into an ungrounded fuel container.

### Refueling

 Fuel vapor burns violently and a fuel fire can cause severe injuries. To help avoid injuries to you and others:

- Read and follow all the instructions on the pump island;
- Turn off your engine when you are refueling;
- Do not smoke if you are near fuel or refueling your vehicle;
- Keep sparks, flames and smoking materials away from fuel;
- Stay outside your vehicle and do not leave the fuel pump unattended when refueling your vehicle — this is against the law in some places;
- Keep children away from the fuel pump; never let children pump fuel.

Use the following guidelines to avoid electrostatic charge build-up when filling an ungrounded fuel container:

- Place approved fuel container on the ground.
- DO NOT fill a fuel container while it is in the vehicle (including the cargo area).
- Keep the fuel pump nozzle in contact with the fuel container while filling.
- DO NOT use a device that would hold the fuel pump handle in the fill position.

## Maintenance and Specifications

### Fuel Filler Cap

Your fuel tank filler cap has an indexed design with a 1/4 turn on/off feature.

When fueling your vehicle:

1. Turn the engine off.
2. Carefully turn the filler cap counterclockwise 1/4 of a turn until it stops.
3. Pull to remove the cap from the fuel filler pipe.
4. To install the cap, align the tabs on the cap with the notches on the filler pipe.
5. Turn the filler cap clockwise 1/4 of a turn until it clicks at least once.

If the  indicator comes on and stays on after you start the engine, the fuel filler cap may not be properly installed. Turn off the engine, remove the fuel filler cap, align the cap properly and reinstall it.

**If you must replace the fuel filler cap, replace it with a fuel filler cap that is designed for your vehicle. The customer warranty may be void for any damage to the fuel tank or fuel system if the correct genuine Ford or Motorcraft fuel filler cap is not used.**



The fuel system may be under pressure. If the fuel filler cap is venting vapor or if you hear a hissing sound, wait until it stops before completely removing the fuel filler cap. Otherwise, fuel may spray out and injure you or others.

## Maintenance and Specifications

 If you do not use the proper fuel filler cap, excessive vacuum in the fuel tank may damage the fuel system or cause the fuel cap to disengage in a collision, which may result in possible personal injury.

**FORD RECOMMENDS BP**



### Choosing the right fuel

Use only UNLEADED fuel or UNLEADED fuel blended with a maximum of 10% ethanol. Your vehicle was not designed to run on E85 fuels that are blended with a maximum of 85% ethanol. The use of leaded fuel is prohibited by law and could damage your vehicle. Do not use fuel containing methanol. It can damage critical fuel system components.

Your vehicle was not designed to use fuel or fuel additives with metallic compounds, including manganese-based additives. Studies indicate that these additives can cause your vehicle's emission control system to deteriorate more rapidly.

Repairs to correct the effects of using a fuel for which your vehicle was not designed may not be covered by your warranty.

### Octane recommendations

Your vehicle is designed to use "Regular" unleaded gasoline with pump (R+M)/2 octane rating of 87. We do not recommend the use of gasolines labeled as "Regular" that are sold with octane ratings of 86 or lower in high altitude areas.

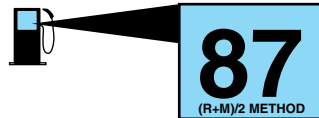

Do not be concerned if your engine sometimes knocks lightly. However, if it knocks heavily under most driving conditions while you are using fuel with the recommended octane rating, see your authorized dealer to prevent any engine damage.

228

## Maintenance and Specifications

### Fuel quality

If you are experiencing starting, rough idle or hesitation driveability problems, try a different brand of unleaded gasoline. “Premium” unleaded gasoline is not recommended for vehicles designed to use “Regular” unleaded gasoline because it may cause these problems to become more pronounced. If the problems persist, see your authorized dealer.

Do not add aftermarket fuel additive products to your fuel tank. It should not be necessary to add any aftermarket products to your fuel tank if you continue to use high quality fuel of the recommended octane rating. These products have not been approved for your engine and could cause damage to the fuel system. Repairs to correct the effects of using an aftermarket product in your fuel may not be covered by your warranty.

Many of the world’s automakers approved the World-Wide Fuel Charter that recommends gasoline specifications to provide improved performance and emission control system protection for your vehicle. Gasolines that meet the World-Wide Fuel Charter should be used when available. Ask your fuel supplier about gasolines that meet the World-Wide Fuel Charter.

### Cleaner air

Ford endorses the use of reformulated “cleaner-burning” gasolines to improve air quality, per the recommendations in the *Choosing the Right Fuel* section.

### Running out of fuel

Avoid running out of fuel because this situation may have an adverse effect on powertrain components.

If you have run out of fuel:

- You may need to cycle the ignition from OFF to ON several times after refueling to allow the fuel system to pump the fuel from the tank to the engine. On restarting, cranking time will take a few seconds longer than normal.
- Normally, adding 1 gallon (3.8L) of fuel is enough to restart the engine. If the vehicle is out of fuel and on a steep grade, more than 1 gallon (3.8L) may be required.
- The  indicator may come on. For more information on the “check engine” or the “service engine soon” indicator, refer to *Warning lights and chimes* in the *Instrument Cluster* chapter.

## Maintenance and Specifications

### ESSENTIALS OF GOOD FUEL ECONOMY

#### Measuring techniques

Your best source of information about actual fuel economy is you, the driver. You must gather information as accurately and consistently as possible. Fuel expense, frequency of fill-ups or fuel gauge readings are NOT accurate as a measure of fuel economy. We do not recommend taking fuel economy measurements during the first 1,000 miles (1,600 km) of driving (engine break-in period). You will get a more accurate measurement after 2,000 miles–3,000 miles (3,000 km–5,000 km).

#### Filling the tank

The advertised fuel capacity of the fuel tank on your vehicle is equal to the rated refill capacity of the fuel tank as listed in the *Maintenance product specifications and capacities* section of this chapter.

The advertised capacity is the amount of the indicated capacity and the empty reserve combined. Indicated capacity is the difference in the amount of fuel in a full tank and a tank when the fuel gauge indicates empty. Empty reserve is the small amount of fuel remaining in the fuel tank after the fuel gauge indicates empty.

**The amount of usable fuel in the empty reserve varies and should not be relied upon to increase driving range. When refueling your vehicle after the fuel gauge indicates empty, you might not be able to refuel the full amount of the advertised capacity of the fuel tank due to the empty reserve still present in the tank.**

For consistent results when filling the fuel tank:

- Turn the engine/ignition switch to the off position prior to refueling, an error in the reading will result if the engine is left running.
- Use the same filling rate setting (low — medium — high) each time the tank is filled.
- Allow no more than two automatic click-offs when filling.
- Always use fuel with the recommended octane rating.
- Use a known quality gasoline, preferably a national brand.
- Use the same side of the same pump and have the vehicle facing the same direction each time you fill up.
- Have the vehicle loading and distribution the same every time.

Your results will be most accurate if your filling method is consistent.

#### Calculating fuel economy

1. Fill the fuel tank completely and record the initial odometer reading (in miles or kilometers).

## Maintenance and Specifications

2. Each time you fill the tank, record the amount of fuel added (in gallons or liters).
3. After at least three to five tank fill-ups, fill the fuel tank and record the current odometer reading.
4. Subtract your initial odometer reading from the current odometer reading.
5. Follow one of the simple calculations in order to determine fuel economy:

Calculation 1: **Divide total miles traveled by total gallons used.**

Calculation 2: **Multiply liters used by 100, then divide by total kilometers traveled.**

Keep a record for at least one month and record the type of driving (city or highway). This will provide an accurate estimate of the vehicle's fuel economy under current driving conditions. Additionally, keeping records during summer and winter will show how temperature impacts fuel economy. In general, lower temperatures give lower fuel economy.

### Driving style — good driving and fuel economy habits

Give consideration to the lists that follow and you may be able to change a number of variables and improve your fuel economy.

#### **Habits**

- Smooth, moderate operation can yield up to 10% savings in fuel.
- Steady speeds without stopping will usually give the best fuel economy.
- Idling for long periods of time (greater than one minute) may waste fuel.
- Anticipate stopping; slowing down may eliminate the need to stop.
- Sudden or hard accelerations may reduce fuel economy.
- Slow down gradually.
- Driving at reasonable speeds (traveling at 55 mph [88 km/h] uses 15% less fuel than traveling at 65 mph [105 km/h]).
- Revving the engine before turning it off may reduce fuel economy.
- Using the air conditioner or defroster may reduce fuel economy.
- You may want to turn off the speed control in hilly terrain if unnecessary shifting between the top gears occurs. Unnecessary shifting of this type could result in reduced fuel economy.

## Maintenance and Specifications

- Warming up a vehicle on cold mornings is not required and may reduce fuel economy.
- Resting your foot on the brake pedal while driving may reduce fuel economy.
- Combine errands and minimize stop-and-go driving.

### **Maintenance**

- Keep tires properly inflated and use only recommended size.
- Operating a vehicle with the wheels out of alignment will reduce fuel economy.
- Use recommended engine oil. Refer to *Maintenance product specifications and capacities* in this chapter.
- Perform all regularly scheduled maintenance items. Follow the recommended maintenance schedule and owner maintenance checks found in *scheduled maintenance information*.

### **Conditions**

- Heavily loading a vehicle or towing a trailer may reduce fuel economy at any speed.
- Carrying unnecessary weight may reduce fuel economy (approximately 1 mpg [0.4 km/L] is lost for every 400 lb [180 kg] of weight carried).
- Adding certain accessories to your vehicle (for example bug deflectors, rollbars/light bars, running boards, ski/luggage racks) may reduce fuel economy.
- Using fuel blended with alcohol may lower fuel economy.
- Fuel economy may decrease with lower temperatures during the first 8–10 miles (12–16 km) of driving.
- Driving on flat terrain offers improved fuel economy as compared to driving on hilly terrain.
- Transmissions give their best fuel economy when operated in the top cruise gear and with steady pressure on the gas pedal.
- Close windows for high speed driving.

### **EPA window sticker**

Every new vehicle should have the EPA window sticker. Contact your authorized dealer if the window sticker is not supplied with your vehicle. The EPA window sticker should be your guide for the fuel economy comparisons with other vehicles.



## Maintenance and Specifications

It is important to note the box in the lower left corner of the window sticker. These numbers represent the Range of MPG (L/100 km) expected on the vehicle under optimum conditions. Your fuel economy may vary depending upon the method of operation and conditions.

**NOTE:** Vehicles over 8,500 GVW (Gross Vehicle Weight) will not have fuel economy information printed on the EPA window sticker.

### EMISSION CONTROL SYSTEM

Your vehicle is equipped with various emission control components and a catalytic converter which will enable your vehicle to comply with applicable exhaust emission standards. To make sure that the catalytic converter and other emission control components continue to work properly:

- Use only the specified fuel listed.
- Avoid running out of fuel.
- Do not turn off the ignition while your vehicle is moving, especially at high speeds.
- Have the items listed in *scheduled maintenance information* performed according to the specified schedule.

The scheduled maintenance items listed in *scheduled maintenance information* are essential to the life and performance of your vehicle and to its emissions system.

If other than Ford, Motorcraft or Ford-authorized parts are used for maintenance replacements or for service of components affecting emission control, such non-Ford parts should be equivalent to genuine Ford Motor Company parts in performance and durability.



Do not park, idle, or drive your vehicle in dry grass or other dry ground cover. The emission system heats up the engine compartment and exhaust system, which can start a fire.

Illumination of the  indicator, charging system warning light or the temperature warning light, fluid leaks, strange odors, smoke or loss of engine power could indicate that the emission control system is not working properly.

An improperly operating or damaged exhaust system may allow exhaust to enter the vehicle. Have a damaged or improperly operating exhaust system inspected and repaired immediately.

## Maintenance and Specifications





Exhaust leaks may result in entry of harmful and potentially lethal fumes into the passenger compartment.

Do not make any unauthorized changes to your vehicle or engine. By law, vehicle owners and anyone who manufactures, repairs, services, sells, leases, trades vehicles, or supervises a fleet of vehicles are not permitted to intentionally remove an emission control device or prevent it from working. Information about your vehicle's emission system is on the Vehicle Emission Control Information Decal located on or near the engine. This decal identifies engine displacement and gives some tune up specifications.

Please consult your *Warranty Guide* for complete emission warranty information.

### On board diagnostics (OBD-II)

Your vehicle is equipped with a computer that monitors the engine's emission control system. This system is commonly known as the On Board Diagnostics System (OBD-II). The OBD-II system protects the environment by ensuring that your vehicle continues to meet government emission standards. The OBD-II system also assists your authorized dealer in properly servicing your vehicle. When the  indicator illuminates, the OBD-II system has detected a malfunction. Temporary malfunctions may cause the  indicator to illuminate. Examples are:

1. The vehicle has run out of fuel—the engine may misfire or run poorly.
2. Poor fuel quality or water in the fuel—the engine may misfire or run poorly.
3. The fuel cap may not have been securely tightened. See *Fuel filler cap* in this chapter.
4. Driving through deep water—the electrical system may be wet.

These temporary malfunctions can be corrected by filling the fuel tank with good quality fuel, properly tightening the fuel cap or letting the electrical system dry out. After three driving cycles without these or any other temporary malfunctions present, the  indicator should stay off the next time the engine is started. A driving cycle consists of a cold engine startup followed by mixed city/highway driving. No additional vehicle service is required.

If the  indicator remains on, have your vehicle serviced at the first available opportunity. Although some malfunctions detected by the



## Maintenance and Specifications

OBD-II may not have symptoms that are apparent, continued driving with the  indicator on can result in increased emissions, lower fuel economy, reduced engine and transmission smoothness, and lead to more costly repairs.

### Readiness for Inspection/Maintenance (I/M) testing

Some state/provincial and local governments may have Inspection/Maintenance (I/M) programs to inspect the emission control equipment on your vehicle. Failure to pass this inspection could prevent you from getting a vehicle registration. Your vehicle may not pass the I/M test if the  indicator is on or not working properly (bulb is burned out), or if the OBD-II system has determined that some of the emission control systems have not been properly checked. In this case, the vehicle is considered not ready for I/M testing.

If the  indicator is on or the bulb does not work, the vehicle may need to be serviced. Refer to the On board diagnostics (OBD-II) description in this chapter.

If the vehicle's engine or transmission has just been serviced, or the battery has recently run down or been replaced, the OBD-II system may indicate that the vehicle is not ready for I/M testing. To determine if the vehicle is ready for I/M testing, turn the ignition key to the ON position for 15 seconds without cranking the engine. If the  indicator blinks eight times, it means that the vehicle is not ready for I/M testing; if the  indicator stays on solid, it means that the vehicle is ready for I/M testing.

The OBD-II system is designed to check the emission control system during normal driving. A complete check may take several days. If the vehicle is not ready for I/M testing, the following driving cycle consisting of mixed city and highway driving may be performed:

15 minutes of steady driving on an expressway/highway followed by 20 minutes of stop-and-go driving with at least four 30-second idle periods.

Allow the vehicle to sit for at least eight hours without starting the engine. Then, start the engine and complete the above driving cycle. The engine must warm up to its normal operating temperature. Once started, do not turn off the engine until the above driving cycle is complete. If the vehicle is still not ready for I/M testing, the above driving cycle will have to be repeated.

## Maintenance and Specifications

### POWER STEERING FLUID

Check the power steering fluid.  
Refer to the scheduled maintenance  
guide for the service interval  
schedules.

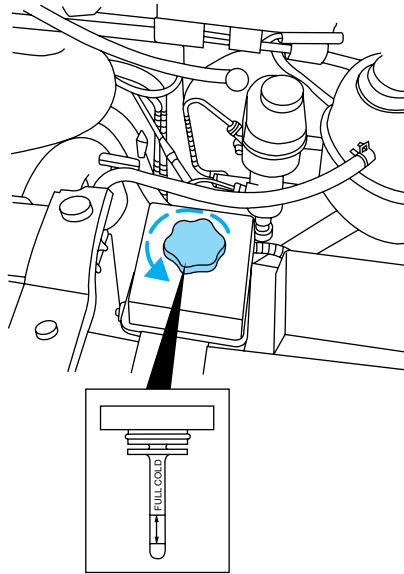

Check the fluid level when it is at ambient temperature, 20° – 80° F (-7° – 25° C):

1. Check the fluid level on the dipstick. It should be between the arrows in the FULL COLD range. Do not add fluid if the level is within this range.
2. If the fluid level is low, start the engine.
3. While the engine idles, turn the steering wheel left and right several times.
4. Turn the engine off.



For E-450 and E-550 vehicles with the Hydro-Boost Brake System, do not press the brake pedal after the engine has been turned off. Pressing the brake pedal after the engine has been turned off will give a false power steering fluid level reading.

5. Recheck the fluid level on the dipstick. Do not add fluid if the level is between the arrows in the FULL COLD range.

## Maintenance and Specifications

6. If the fluid is low, add fluid in small amounts, continuously checking the level until it reaches the FULL COLD range. Be sure to put the dipstick back in the reservoir. Refer to *Maintenance product specifications and capacities* in this chapter for the proper fluid type.

### **BRAKE FLUID**

The fluid level will drop slowly as the brakes wear, and will rise when the brake components are replaced. Fluid levels between the “MIN” and “MAX” lines are within the normal operating range; there is no need to add fluid. If the fluid levels are outside of the normal operating range the performance of the system could be compromised; seek service from your authorized dealer immediately.

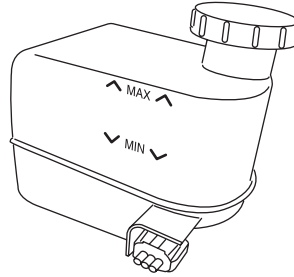

### **DRIVELINE UNIVERSAL JOINT AND SLIP YOKE**

Your vehicle may be equipped with universal joints that require lubrication. Refer to the *scheduled maintenance information* for maintenance intervals. If the original universal joints are replaced with universal joints equipped with grease fittings, lubrication will also be necessary.

### **TRANSMISSION FLUID**

#### **Checking automatic transmission fluid (if equipped)**

Refer to your *scheduled maintenance information* for scheduled intervals for fluid checks and changes. Your transmission does not consume fluid. However, the fluid level should be checked if the transmission is not working properly, i.e., if the transmission slips or shifts slowly or if you notice some sign of fluid leakage.

Automatic transmission fluid expands when warmed. To obtain an accurate fluid check, drive the vehicle until it is at normal operating temperature (approximately 20 miles [30 km]). If your vehicle has been operated for an extended period at high speeds, in city traffic during hot weather or pulling a trailer, the vehicle should be turned off for about 30 minutes to allow fluid to cool before checking.

1. Drive the vehicle 20 miles (30 km) or until it reaches normal operating temperature.

## Maintenance and Specifications

2. Park the vehicle on a level surface and engage the parking brake.
3. With the parking brake engaged and your foot on the brake pedal, start the engine and move the gearshift lever through all of the gear ranges. Allow sufficient time for each gear to engage.
4. Latch the gearshift lever in P (Park) and leave the engine running.
5. Remove the dipstick, wiping it clean with a clean, dry lint free rag. If necessary, refer to *Identifying components in the engine compartment* in this chapter for the location of the dipstick.
6. Install the dipstick making sure it is fully seated in the filler tube.
7. Remove the dipstick and inspect the fluid level. The fluid should be in the designated area for normal operating temperature or ambient temperature.

### Low fluid level

Do not drive the vehicle if the fluid level is at the bottom of the dipstick and the ambient temperature is above 50°F (10°C).



### Correct fluid level

The transmission fluid should be checked at normal operating temperature 150°F-170°F (66°C-77°C) on a level surface. The normal operating temperature can be reached after approximately 20 miles (30 km) of driving.

You can check the fluid without driving if the ambient temperature is above 50°F (10°C). However, if fluid is added at this time, an overfill condition could result when the vehicle reaches normal operating temperature.

The transmission fluid should be in this range if at normal operating temperature (150°F-170°F [66°C-77°C]).

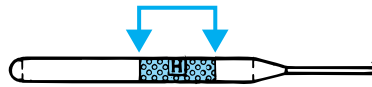

The transmission fluid should be in this range if at ambient temperature (50°F-95°F [10°C-35°C]).



## Maintenance and Specifications

### **High fluid level**

Fluid levels above the safe range may result in transmission failure. An overfill condition of transmission fluid may cause shift and/or engagement concerns and/or possible damage.

High fluid levels can be caused by an overheating condition.

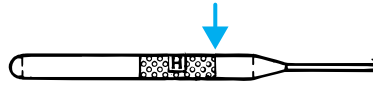

### **Adjusting automatic transmission fluid levels**

Before adding any fluid, make sure the correct type is used. The type of fluid used is normally indicated on the dipstick. Refer to *Maintenance product specifications and capacities* in this chapter.

### **Use of a non-approved automatic transmission fluid may cause internal transmission component damage.**

If necessary, add fluid in 1/2 pint (250 ml) increments through the filler tube until the level is correct.

If an overfill occurs, excess fluid should be removed by an authorized dealer.

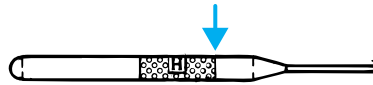

### **An overfill condition of transmission fluid may cause shift and/or engagement concerns and/or possible damage.**

Do not use supplemental transmission fluid additives, treatments or cleaning agents. The use of these materials may affect transmission operation and result in damage to internal transmission components.

## Maintenance and Specifications

### Automatic transmission fluid filter (if equipped)

The Torqshift automatic transmission is equipped with a serviceable external fluid filter mounted on the driver's side of the transmission as shown in the illustration.

Torqshift transmissions which do not have the externally mounted filter will have the transmission fluid filter located inside the transmission bottom pan.

Refer to *scheduled maintenance information* for service intervals for automatic transmission fluid and each transmission filter type.

For transmission filter maintenance, see your authorized dealer.

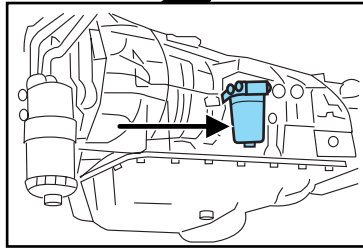
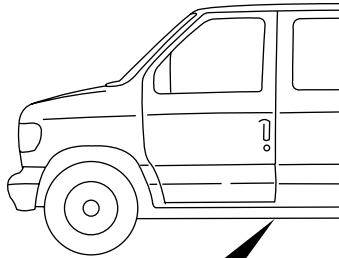

### AIR FILTER

Refer to *scheduled maintenance information* for the appropriate intervals for changing the air filter element.

When changing the air filter element, use only the Motorcraft air filter element listed. Refer to *Motorcraft part numbers* in this chapter.



To reduce the risk of vehicle damage and/or personal burn injuries do not start your engine with the air cleaner removed and do not remove it while the engine is running.



## Maintenance and Specifications

### Changing the air filter element

1. Disconnect the fresh air inlet tube from the radiator support.
2. Open the clamp that secures the two halves of the air filter housing together.

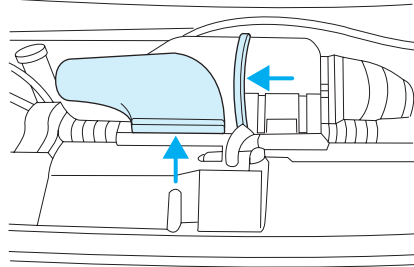

3. Carefully separate the two halves of the air filter housing.
4. Remove the air filter element from the housing.

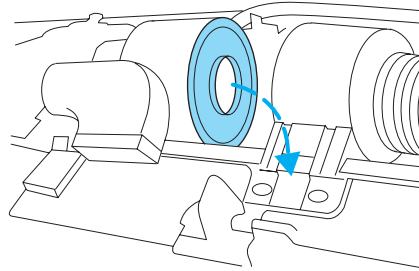

5. Install a new air filter element. Be careful not to crimp the filter element edges between the air filter housing. This could cause filter damage and allow unfiltered air to enter the engine if not properly seated.
6. Replace the two halves of the air filter housing and secure the clamp.
7. Connect the fresh air inlet tube to the radiator support.

## Maintenance and Specifications

### MOTORCRAFT PART NUMBERS

Component <sup>1</sup>	4.6L V8 engine	5.4L V8 engine	6.8L V10 engine
Air filter element	FA-1632	FA-1632	FA-1632
Battery- standard / (auxiliary)	BXT-65-650 / (BXT-65-750)	BXT-65-650 / (BXT-65-750)	BXT-65-650 / (BXT-65-750)
Fuel filter	FG-872	FG-872	FG-872
Oil filter	FL-820-S	FL-820-S	FL-820-S
PCV valve	<sup>2</sup>		
Spark plugs	<sup>3</sup>		
Torqshift automatic transmission externally-mounted filter element <sup>4</sup>	—	FT-145	FT-145
Torqshift automatic transmission internal bottom-pan filter <sup>4</sup>	—	FT-175	FT-175

<sup>1</sup>Refer to the *Power Stroke Direct Injection Turbo Diesel Owner's Guide Supplement* for Motorcraft diesel engine service part numbers.

<sup>2</sup>The PCV valve is a critical emission component. It is one of the items listed in *scheduled maintenance information* and is essential to the life and performance of your vehicle and to its emissions system.

For PCV valve replacement, see your authorized dealer. Refer to *scheduled maintenance information* for the appropriate intervals for changing the PCV valve.

**Replace the PCV valve with one that meets Ford material and design specifications for your vehicle, such as a Motorcraft or equivalent replacement part. The customer warranty may be void for any damage to the emissions system if such a PCV valve is not used.**

<sup>3</sup>For spark plug replacement, see your authorized dealer. Refer to *scheduled maintenance information* for the appropriate intervals for changing the spark plugs.

## Maintenance and Specifications

**Replace the spark plugs with ones that meet Ford material and design specifications for your vehicle, such as Motorcraft or equivalent replacement parts. The customer warranty may be void for any damage to the engine if such spark plugs are not used.**

<sup>4</sup>Also available with 6.0L Diesel engine/TorqShift transmission.  
Externally-mounted filter element part number is FT-145.

Internal bottom-pan filter is FT-175.

## Maintenance and Specifications

### MAINTENANCE PRODUCT SPECIFICATIONS AND CAPACITIES

Item	Capacity	Ford part name	Ford part number / Ford specification
Brake fluid	Between MIN and MAX on reservoir	Motorcraft High Performance DOT 3 Motor Vehicle Brake Fluid	PM-1 or PM-1-C / ESA-M6C25-A or WSS-M6C62-A
Door weatherstrips	—	Silicone Spray Lubricant	XL-6 / ESR-M13P4-A
Hinges, latches, Striker plates, fuel filler door hinge, and seat tracks	—	Motorcraft Multi-Purpose Grease	XG-4 or XL-5 / ESB-M1C93-B
Lock cylinders	—	Motorcraft Penetrating and Lock Lubricant	XL-1 / None

## Maintenance and Specifications

Item	Capacity	Ford part name	Ford part number / Ford specification
Engine coolant 4.6L engine	23.8 quarts (22.6L)	Motorcraft Premium Gold Engine Coolant with bittering agent (yellow-colored) <sup>1</sup>	VC-7-B / WSS-M97B51-A1
Engine coolant 4.6L engine with aux rear heat	26.0 quarts (24.6L)		
Engine coolant 5.4L engine	28.8 quarts (27.2L)		
Engine coolant 5.4L engine with aux rear heat	30.8 quarts (29.1L)		
Engine coolant 6.8L engine	30.4 quarts (28.8L)		
Engine coolant 6.8L engine with aux rear heat	32.6 quarts (30.8L)		
Engine coolant-diesel engine <sup>1</sup>	Refer to the <i>Power Stroke Direct Injection Turbo Diesel Owner's Guide Supplement</i> .		
Cooling system stop leak pellets	—	Motorcraft Cooling System Stop Leak Pellets	VC-6 / WSS-M99B37-B6

## Maintenance and Specifications

Item	Capacity	Ford part name	Ford part number / Ford specification
Engine oil-gasoline engine	6.0 quarts (5.7L)	Motorcraft SAE 5W-20 Premium Synthetic Blend Motor Oil (US) Motorcraft SAE 5W-20 Super Premium Motor Oil (Canada) <sup>2</sup>	XO-5W20-QSP (US) CXO-5W20-LSP12 (Canada) / WSS-M2C930-A with API Certification Mark
Engine oil-diesel engine	Refer to the <i>Power Stroke Direct Injection Turbo Diesel Owner's Guide Supplement</i> .		
Power steering fluid	Keep in FULL range on dipstick	Motorcraft MERCON® V ATF	XT-5-QM / MERCON® V
Automatic transmission fluid (4R75E)	13.9 quarts (13.1L) <sup>3</sup>	Motorcraft MERCON® V ATF <sup>4</sup>	XT-5-QM / MERCON® V
Automatic transmission fluid TorqShift (5-speed)	17.5 quarts (16.6L) <sup>3</sup>	Motorcraft MERCON® SP ATF <sup>4</sup>	XT-6-QSP / MERCON® SP
Parking brake assembly (E-450 Super Duty)	—	Motorcraft MERCON® ATF	XT-2-QDX / MERCON®
Dana conventional and Limited Slip axle fluid M60 (M248) E-350 w/ 4.10 axle ratio	5.9 pints (2.8L) <sup>5,7</sup>	SAE 75W-140 Synthetic Rear Axle Lubricant <sup>6</sup>	XY-75W140-QL / WSL-M2C192-A

## Maintenance and Specifications

Item	Capacity	Ford part name	Ford part number / Ford specification
Dana Limited Slip Axle fluid M60 (M248) E250/E350	5.9 pints (2.8L) <sup>5,7</sup>	SAE 90 Hypoid Gear Oil	XY-90-GL / ESW-M2C105-E
	6.6 pints (3.1L) <sup>7</sup>		
Dana Limited Slip Axle fluid M70FF (M267FF) E-350	8.3 pints (3.9L) <sup>7</sup>		
Dana Limited Slip Axle fluid M70HD (M273HD) E-450	5.9 pints (2.8L) <sup>7</sup>	SAE 80W-90 Premium Rear Axle Lubricant	XY-80W90-QL / WSP-M2C197-A
Dana conventional axle fluid M60 (M248) E-250/350	6.6 pints (3.1L) <sup>7</sup>		
Dana conventional axle fluid M70FF (M267FF) E-350	8.3 pints (3.9L) <sup>7</sup>		
Dana conventional axle fluid M70HD (M273HD) E-450			

## Maintenance and Specifications

Item	Capacity	Ford part name	Ford part number / Ford specification
Windshield washer fluid	4.2 quarts (4.0L)	Motorcraft Premium Windshield Washer Concentrate	ZC-32-A / WSB-M8B16-A2
Fuel tank—all regular and extended length vans and wagons	35.0 gallons (132.4L)		
Fuel tank—138 inch wheelbase (except E-Super Duty)	37.0 gallons (140.0L)		
Fuel tank—158 inch wheelbase (except E-Super Duty)	37.0 gallons (140.0L) <sup>8</sup>		—
Fuel tank—176 inch wheelbase (except E-Super Duty)	37.0 gallons (140.0L) <sup>8</sup>		
Fuel tank—158 inch and 176 inch wheelbase (E-Super Duty)	55.0 gallons (208.0L)		

<sup>1</sup>Add the coolant type originally equipped in your vehicle.

<sup>2</sup>Use of synthetic or synthetic blend motor oil is not mandatory. Engine oil need only meet the requirements of Ford specification WSS-M2C930-A and the API Certification mark.

<sup>3</sup>Indicates only approximate dry-fill capacity. Some applications may vary based on cooler size, if equipped with an in-tank cooler, if equipped with an oil to air cooler and if equipped with a remote filter assembly. The amount of transmission fluid and fluid level should be set by the indication on the dipstick's normal operating range.



## Maintenance and Specifications

<sup>4</sup>Automatic transmissions that require MERCON® V should only use MERCON® V fluid or fluid that is specified dual usage MERCON®/MERCON® V. Refer to *scheduled maintenance information* to determine the correct service interval. Use of any fluid other than the recommended fluid may cause transmission damage.

Automatic transmissions that require MERCON® SP should only use MERCON® SP fluid. Use of a dual usage fluid in an automatic transmission requiring MERCON® SP may cause transmission damage. Refer to *scheduled maintenance information* to determine the correct service interval. Use of any fluid other than the recommended fluid may cause transmission damage.

<sup>5</sup> Dana limited-slip axle (M60) requires 8 oz. (228 ml) of Additive Friction Modifier XL-3 or equivalent meeting Ford specification EST-M2C118-A.

<sup>6</sup>If your vehicle's rear axle is filled with a synthetic rear axle lubricant it is considered lubricated for life. These lubricants do not need to be checked or changed unless a leak is suspected, service is required or the axle assembly has been submerged in water. The axle lubricant should be changed any time the rear axle has been submerged in water.

<sup>7</sup>Fill Dana rear axles to 1/4 inch to 9/16 inch (6 mm to 14 mm) below bottom of fill hole.

<sup>8</sup>Optional fuel tank 55.0 gallons (208.0L).

## Maintenance and Specifications

### ENGINE DATA

Engine*	4.6L V8 engine	5.4L V8 engine	6.8L V10 engine
Cubic inches	281	330	415
Required fuel	87 octane	87 octane	87 octane
Firing order	1-3-7-2-6-5-4-8	1-3-7-2-6-5-4-8	1-6-5-10-2-7-3-8-4-9
Ignition system	Coil on plug	Coil on plug	Coil on plug
Spark plug gap	0.052–0.056 inch (1.32–1.42mm)	0.052–0.056 inch (1.32–1.42mm)	0.052–0.056 inch (1.32–1.42mm)
Compression ratio	9.4:1	9.0:1	9.0:1

\*Refer to the *Power Stroke Direct Injection Turbo Diesel Owner's Guide Supplement* for diesel engine information.

### Engine drivebelt routing

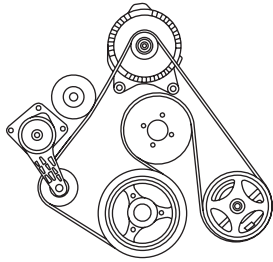

- 4.6L V8 and 5.4L V8 Engines without A/C

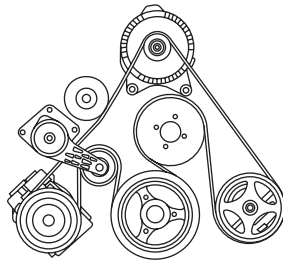

## Maintenance and Specifications

- 4.6L V8 and 5.4L V8 Engines with A/C

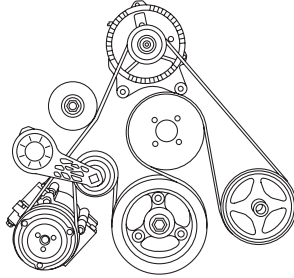

- 6.8L V10 Engine

### VEHICLE IDENTIFICATION NUMBER

#### Complete Ford built vehicles

The vehicle identification number is attached to your vehicle in the following places:

- The top of the instrument panel on the driver's side.
- On the certification label. This label is required by the National Highway Traffic Safety Administration and is made of special material. If it is tampered with, it will be destroyed or a destruction pattern will appear.

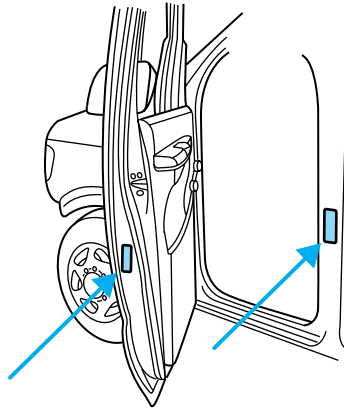

## Maintenance and Specifications

The Vehicle Identification Number (VIN) contains the following information:

1. World manufacturer identifier
2. Brake system / Gross Vehicle Weight Rating (GVWR) / Restraint System
3. Vehicle line, series, body type
4. Engine type
5. Check digit
6. Model year
7. Assembly plant
8. Production sequence number

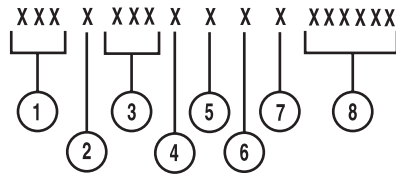

### Certification label for incomplete vehicles

On completed derivations of incomplete vehicles, the certification label is affixed at a location determined by a subsequent stage manufacturer of the completed vehicle. In these cases the completed vehicle is manufactured in two or more stages by two or more separate manufacturers.

## Maintenance and Specifications

### TRANSMISSION/TRANSAXLE CODE DESIGNATIONS

You can find a transmission/transaxle code on the Safety Compliance Certification Label. The following table tells you which transmission or transaxle each code represents.

MFD. BY FORD MOTOR CO.									
DATE: XX/XX	GVWR: XXXXXLB/ XXXXXKG								
FRONT GAWR: XXXXL	WITH XXXXKG		REAR GAWR: XXXXLB						
XXXXXX	TIRES: XXXX/XXXXXX		XXXXXX		WITH TIRES				
XXXX.XX	RIMS: XXXX.XX		XXXX.XX		RIMS				
AT XXX kPa/XX	PSI COLD		AT XXX kPa/XX		PSI COLD				
THIS VEHICLE CONFORMS TO ALL APPLICABLE FEDERAL MOTOR VEHICLE SAFETY AND THEFT PREVENTION STANDARDS IN EFFECT ON THE DATE OF MANUFACTURE SHOWN ABOVE.									
VIN: XXXXXXXXXXXXXXXXX									XXXXX
TYPE: XXX									XXXXX
									
EXT PNT: XX	RC: XX		DSO:						
WB <sup>1</sup> BRK <sup>2</sup>	INT TR <sup>3</sup>	TP/PS <sup>4</sup>	R <sup>5</sup>	AXLE <sup>6</sup>	TR <sup>7</sup>	SPR <sup>8</sup>	XXXXX		
XXX X	XX	X	XX	X	XX	XX	XXX		
XXXXXXXXXXXXX XX XXXX-XXXXXX-XX									

Description	Code
Five-speed automatic TorqShift-diesel engine with overdrive cancel	B
Four-speed automatic overdrive (4R75E)	Q
Five-speed automatic TorqShift-gasoline engine with Tow/Haul	T

## Accessories

### GENUINE FORD ACCESSORIES FOR YOUR VEHICLE

A wide selection of Genuine Ford Accessories are available for your vehicle through your local Ford or Ford of Canada dealer. These quality accessories have been specifically engineered to fulfill your automotive needs; they are custom designed to complement the style and aerodynamic appearance of your vehicle. In addition, each accessory is made from high quality materials and meets or exceeds Ford's rigorous engineering and safety specifications. Ford Motor Company will repair or replace any properly dealer-installed Genuine Ford Accessories found to be defective in factory-supplied materials or workmanship during the warranty period, as well as any component damaged by the defective accessories. The accessories will be warranted for whichever provides you the greatest benefit:

- 12 months or 12,000 miles (20,000 km) (whichever occurs first), or
- the remainder of your new vehicle limited warranty.

Contact your dealer for details and a copy of the warranty.

The following is a list of several Genuine Ford Accessories. Not all accessories are available for all models. For a complete listing of the accessories that are available for your vehicle, please contact your dealer or visit our online store at: [www.fordaccessoriesstore.com](http://www.fordaccessoriesstore.com).

#### Exterior style

Bug shields

Deflectors

Door edge guards

Front end covers

Headlamps, fog lights and Daytime Running Lamps (DRLs)

Running boards

Splash guards

#### Interior style

Electrochromatic compass/temperature interior mirrors

Floor mats

## Accessories

### Lifestyle

Cargo organization and management

Speed control

Trailer hitches, wiring harnesses and accessories

### Peace of mind

Mobile-Ease<sup>™</sup> hands-free communication system

Remote start

Vehicle security systems

For maximum vehicle performance, keep the following information in mind when adding accessories or equipment to your vehicle:

- When adding accessories, equipment, passengers and luggage to your vehicle, do not exceed the total weight capacity of the vehicle or of the front or rear axle (GVWR or GAWR as indicated on the Safety Compliance Certification label). Consult your authorized dealer for specific weight information.
- The Federal Communications Commission (FCC) and Canadian Radio Telecommunications Commission (CRTC) regulate the use of mobile communications systems — such as two-way radios, telephones and theft alarms - that are equipped with radio transmitters. Any such equipment installed in your vehicle should comply with FCC or CRTC regulations and should be installed only by a qualified service technician.
- Mobile communications systems may harm the operation of your vehicle, particularly if they are not properly designed for automotive use.
- To avoid interference with other vehicle functions, such as anti-lock braking systems, amateur radio users who install radios and antennas onto their vehicle should not locate the Amateur Radio Antennas in the area of the driver's side hood.
- Electrical or electronic accessories or components that are added to the vehicle by the authorized dealer or the owner may adversely affect battery performance and durability.

## Index

### A

Accessory delay .....49  
AdvanceTrac .....148  
Air cleaner filter .....240–242  
Airbag supplemental restraint  
system .....78–79  
    and child safety seats .....80  
    description .....79  
    disposal .....82  
    driver airbag .....81  
    indicator light .....82  
    operation .....81  
    passenger airbag .....81  
    passenger deactivation  
    switch .....83  
Ambulance packages .....8  
Antifreeze  
(see Engine coolant) .....218  
Anti-lock brake system  
(see Brakes) .....147  
Audio system  
(see Radio) .....19, 21, 25  
Automatic transmission  
    driving an automatic  
    overdrive .....155, 158, 160  
    fluid, adding .....237  
    fluid, checking .....237  
    fluid, refill capacities .....244  
    fluid, specification .....244  
Auxiliary power point .....48  
Axle  
    lubricant specifications .....244  
    refill capacities .....244  
    traction lok .....152

### B

Battery .....216

256

acid, treating emergencies .....216  
battery saver .....34  
    jumping a disabled battery ....188  
    maintenance-free .....216  
    replacement, specifications ...242  
    servicing .....216  
Belt-Minder® .....74  
Booster seats .....89  
Brakes .....146  
    anti-lock .....147  
    anti-lock brake system (ABS)  
    warning light .....147  
    fluid, checking and adding ....237  
    fluid, refill capacities .....244  
    fluid, specifications .....244  
    lubricant specifications .....244  
    parking .....148  
    shift interlock .....154  
Break-in period .....5  
Bulbs .....39

### C

Capacities for refilling fluids ....244  
Cell phone use .....9  
Child safety restraints .....88  
    child safety belts .....88  
Child safety seats .....92  
    in front seat .....93  
    in rear seat .....93  
    tether anchorage hardware ....96  
Child safety seats - booster  
seats .....89  
Cleaning your vehicle  
    engine compartment .....204  
    exterior .....207  
    instrument panel .....206  
    interior .....206  
    plastic parts .....205



## Index

- safety belts .....206
- washing .....202
- waxing .....203
- wheels .....203
- wiper blades .....205
- Climate control (see Air conditioning or Heating) .....31–33
- Clock adjust
  - 6-CD in dash .....22, 27
  - AM/FM .....20
- Compass, electronic .....47
  - calibration .....48
  - set zone adjustment .....47
- Console
  - overhead .....45–46
- Controls
  - power seat .....63
- Coolant
  - checking and adding .....218
  - refill capacities .....222, 244
  - specifications .....244
- Cruise control (see Speed control) .....51
- Customer Assistance .....166
  - Ford Extended Service Plan .....198
  - Getting assistance outside the U.S. and Canada .....199
  - Getting roadside assistance ...166
  - Getting the service you need .....194
  - Ordering additional owner's literature .....200
  - Utilizing the Mediation/Arbitration Program .....198
- D**
  - Daytime running lamps (see Lamps) .....35
  - Dipstick
    - automatic transmission fluid .....237
    - engine oil .....213
  - Driveline universal joint and slip yoke .....237
  - Driving under special conditions
    - through water .....165
- E**
  - Emergencies, roadside
    - jump-starting .....188
  - Emergency Flashers .....168
  - Emission control system .....233
  - Engine .....250
    - cleaning .....204
    - coolant .....218
    - diesel .....7
    - fail-safe cooling .....223
    - idle speed control .....216
    - lubrication specifications .....244
    - refill capacities .....244
    - service points .....211
    - starting after a collision .....168
  - Engine block heater .....146
  - Engine oil .....213
    - checking and adding .....213
    - dipstick .....213
    - filter, specifications .....215, 242
    - recommendations .....215
    - refill capacities .....244
    - specifications .....244
  - Event data recording .....6

## Index

- Exhaust fumes .....146
- F**
- Fail safe cooling .....223
- Fluid capacities .....244
- Four-Wheel Drive vehicles  
preparing to drive your  
vehicle .....152
- Fuel .....224  
calculating fuel economy .....230  
cap .....227  
capacity .....244  
choosing the right fuel .....228  
comparisons with EPA fuel  
economy estimates .....232  
detergent in fuel .....229  
filling your vehicle with  
fuel .....224, 227, 230  
filter, specifications .....224, 242  
fuel pump shut-off switch .....168  
improving fuel economy .....230  
octane rating .....228, 250  
quality .....229  
running out of fuel .....229  
safety information relating to  
automotive fuels .....224
- Fuses .....170–171
- G**
- Garage door opener .....46
- Gas cap (see Fuel cap) .....227
- Gas mileage  
(see Fuel economy) .....230
- Gauges .....16
- H**
- Hazard flashers .....168
- Headlamps .....34  
bulb specifications .....39  
daytime running lights .....35  
flash to pass .....35  
high beam .....35  
replacing bulbs .....40  
turning on and off .....34
- Heating  
heater only system .....31, 33  
heating and air conditioning  
system .....32
- Hood .....210
- I**
- Ignition .....143, 250
- Illuminated visor mirror .....45
- Infant seats (see Safety seats) ..92
- Inspection/maintenance (I/M)  
testing .....235
- Instrument panel  
cleaning .....206  
cluster .....12  
lighting up panel and  
interior .....36
- J**
- Jump-starting your vehicle .....188
- K**
- Keyless entry system  
autolock .....55
- Keys .....55  
positions of the ignition .....143

258

## Index

### L

#### Lamps

- bulb replacement specifications chart .....39
- daytime running light .....35
- headlamps .....34
- headlamps, flash to pass .....35
- instrument panel, dimming .....36
- interior lamps .....38
- replacing bulbs .....40

#### Lane change indicator

- (see Turn signal) .....38

#### Lights, warning and indicator ...12

- anti-lock brakes (ABS) .....147

#### Load limits .....124

#### Loading instructions .....130

#### Locks .....55

- autolock .....55
- doors .....55

#### Lubricant specifications .....244

#### Lug nuts .....187

#### Lumbar support, seats .....63

### M

#### Mirrors

- fold away .....51
- side view mirrors (power) .....50

#### Motorcraft parts .....208, 224, 242

### O

#### Octane rating .....228

#### Oil (see Engine oil) .....213

### P

#### Parking brake .....148

#### Parts (see Motorcraft parts) ....242

#### Power distribution box

- (see Fuses) .....174

#### Power door locks .....55

#### Power mirrors .....50

#### Power point .....48

#### Power steering .....151

- fluid, checking and adding ....236
- fluid, refill capacity .....244
- fluid, specifications .....244

#### Power Windows .....49

#### Preparing to drive your

- vehicle .....152

### R

#### Radio .....19, 21, 25

#### Relays .....170, 177

#### Remote entry system .....57

- illuminated entry .....61
- locking/unlocking doors .....58
- panic alarm .....58
- replacement/additional transmitters .....60
- replacing the batteries .....59

#### Reverse sensing system .....163

#### Roadside assistance .....166

### S

#### Safety Belt Maintenance .....78

#### Safety belts (see Safety

- restraints) .....68, 70–72

#### Safety defects, reporting ..200–201

#### Safety restraints .....68, 70–72

- Belt-Minder® .....74
- extension assembly .....77

## Index

- for adults .....70–71
- for children .....87–88
- lap belt .....73
- safety belt maintenance .....78
- warning light and chime ....73–74
- Safety seats for children .....92
- Seats .....62
  - child safety seats .....92
  - front seats .....62
- Servicing your vehicle .....209
- Setting the clock
  - AM/FM stereo .....20
  - AM/FM/In-dash 6 CD .....22, 27
- Spare tire  
(see Changing the Tire) .....180
- Spark plugs,  
specifications .....242, 250
- Special notice .....8
  - ambulance conversions .....8
  - diesel-powered vehicles .....7
  - utility-type vehicles .....7
- Specification chart,  
lubricants .....244
- Speed control .....51
- Starting your vehicle .....143–145
  - jump starting .....188
- Steering wheel
  - tilting .....45
- T**
- Temperature control  
(see Climate control) .....31, 33
- Tilt steering wheel .....45
- Tires .....106–107
  - alignment .....116
  - care .....112
  - changing .....180–181
  - checking the pressure .....111
  - inflating .....108
  - label .....123
  - replacing .....114, 183
  - rotating .....116
  - safety practices .....115
  - sidewall information .....118
  - snow tires and chains .....124
  - spare tire .....178, 180
  - terminology .....107
  - tire grades .....107
  - treadwear .....106, 113
- Towing .....130
  - recreational towing .....142
  - trailer towing .....130
  - wrecker .....193
- Traction-lok rear axle .....152
- Transmission .....154
  - brake-shift interlock (BSI) ....154
  - fluid, checking and adding  
(automatic) .....237
  - fluid, refill capacities .....244
  - lubricant specifications .....244
- Turn signal .....38
- V**
- Vehicle Identification Number  
(VIN) .....251
- Vehicle loading .....124
- Ventilating your vehicle .....146
- W**
- Warning lights (see Lights) .....12
- Washer fluid .....212
- Water, Driving through .....165
- Windows
  - power .....49

## Index

Windshield washer fluid and wipers .....	44	replacing wiper blades .....	212
checking and adding fluid .....	212	Wrecker towing .....	193





