

## Table of Contents

<b>Introduction</b>	<b>4</b>
<b>Instrument Cluster</b>	<b>10</b>
Warning and control lights	10
Gauges	14
<b>Entertainment Systems</b>	<b>17</b>
AM/FM stereo with CD	17
AM/FM stereo with in-dash six CD	20
Family entertainment system	25
<b>Climate Controls</b>	<b>40</b>
Manual heating and air conditioning	40
Automatic temperature control	42
Rear window defroster	51
<b>Lights</b>	<b>52</b>
Headlamps	52
Turn signal control	56
Bulb replacement	56
<b>Driver Controls</b>	<b>61</b>
Windshield wiper/washer control	61
Steering wheel adjustment	62
Power windows	66
Mirrors	68
Speed control	70
Message center	78
<b>Locks and Security</b>	<b>90</b>
Keys	90
Locks	90
Anti-theft system	100

## Table of Contents

<b>Seating and Safety Restraints</b>	<b>105</b>
Seating	105
Safety restraints	118
Airbags	132
Child restraints	146
<b>Tires, Wheels and Loading</b>	<b>161</b>
Tire Information	161
Tire Inflation	163
Vehicle loading	176
Trailer towing	182
Recreational towing	185
<b>Driving</b>	<b>186</b>
Starting	186
Brakes	189
Traction control	191
Transmission operation	193
<b>Roadside Emergencies</b>	<b>205</b>
Getting roadside assistance	205
Hazard flasher switch	206
Fuel pump shut-off switch	207
Fuses and relays	207
Changing tires	214
Lug Nut Torque	221
Jump starting	222
Wrecker towing	227
<b>Customer Assistance</b>	<b>229</b>
Reporting safety defects (U.S. only)	235
<b>Cleaning</b>	<b>236</b>

## Table of Contents

<b>Maintenance and Specifications</b>	<b>243</b>
Engine compartment	245
Engine oil	247
Battery	250
Engine Coolant	252
Fuel information	258
Part numbers	270
Refill capacities	271
Lubricant specifications	273
<b>Accessories</b>	<b>279</b>
<b>Index</b>	<b>282</b>

All rights reserved. Reproduction by any means, electronic or mechanical including photocopying, recording or by any information storage and retrieval system or translation in whole or part is not permitted without written authorization from Ford Motor Company. Ford may change the contents without notice and without incurring obligation.

Copyright © 2005 Ford Motor Company

## Introduction

### CALIFORNIA Proposition 65 Warning



**WARNING:** Engine exhaust, some of its constituents, and certain vehicle components contain or emit chemicals known to the State of California to cause cancer and birth defects or other reproductive harm. In addition, certain fluids contained in vehicles and certain products of component wear contain or emit chemicals known to the State of California to cause cancer and birth defects or other reproductive harm.

### CONGRATULATIONS

Congratulations on acquiring your new Ford Motor Company product. Please take the time to get well acquainted with your vehicle by reading this handbook. The more you know and understand about your vehicle, the greater the safety and pleasure you will derive from driving it.

For more information on Ford Motor Company and its products visit the following website:

- In the United States: [www.ford.com](http://www.ford.com)
- In Canada: [www.ford.ca](http://www.ford.ca)
- In Mexico: [www.ford.com.mx](http://www.ford.com.mx)
- In Australia: [www.ford.com.au](http://www.ford.com.au)

Additional owner information is given in separate publications.

This vehicle's *Owner's Guide* describes every option and model variant available and therefore some of the items covered may not apply to your particular vehicle. Furthermore, due to printing cycles it may describe options before they are generally available.

Remember to pass on this vehicle's *Owner's Guide* when reselling the vehicle. It is an integral part of the vehicle.



**Fuel pump shut-off switch:** In the event of an accident the safety switch will automatically cut off the fuel supply to the engine. The switch can also be activated through sudden vibration (e.g. collision when parking). To reset the switch, refer to the *Fuel pump shut-off switch* in the *Roadside Emergencies* chapter.

### SAFETY AND ENVIRONMENT PROTECTION

#### **Warning symbols in this guide**

How can you reduce the risk of personal injury to yourself or others? In this guide, answers to such questions are contained in comments highlighted by the warning triangle symbol. These comments should be read and observed.

#### **Warning symbols on your vehicle**

When you see this symbol, it is imperative that you consult the relevant section of this guide before touching or attempting adjustment of any kind.



#### **Protecting the environment**

We must all play our part in protecting the environment. Correct vehicle usage and the authorized disposal of waste, cleaning and lubrication materials are significant steps towards this aim. Information in this respect is highlighted in this guide with the tree symbol.



### BREAKING-IN YOUR VEHICLE

Your vehicle does not need an extensive break-in. Try not to drive continuously at the same speed for the first 1,000 miles (1,600 km) of new vehicle operation. Vary your speed frequently in order to give the moving parts a chance to break in.

Drive your new vehicle at least 500 miles (800 km) before towing a trailer. For more detailed information about towing a trailer, refer to *Trailer towing* in the *Tires, Wheels and Loading* chapter.

Do not add friction modifier compounds or special break-in oils during the first few thousand miles (kilometers) of operation, since these additives may prevent piston ring seating. See *Engine oil* in the *Maintenance and Specifications* chapter for more information on oil usage.

## Introduction

### SPECIAL NOTICES

#### New Vehicle Limited Warranty

For a detailed description of what is covered and what is not covered by your vehicle's New Vehicle Limited Warranty, refer to the *Warranty Guide* that is provided to you along with your *Owner's Guide*.

#### Special instructions

For your added safety, your vehicle is fitted with sophisticated electronic controls.



Please read the section *Supplemental restraint system (SRS)* in the *Seating and Safety Restraints* chapter. Failure to follow the specific warnings and instructions could result in personal injury.



Front seat mounted rear-facing child or infant seats should **NEVER** be placed in front of an active passenger airbag.

#### Service Data Recording

Service data recorders in your vehicle are capable of collecting and storing diagnostic information about your vehicle. This potentially includes information about the performance or status of various systems and modules in the vehicle, such as engine, throttle, steering or brake systems. In order to properly diagnose and service your vehicle, Ford Motor Company, Ford of Canada, and service and repair facilities may access vehicle diagnostic information through a direct connection to your vehicle when diagnosing or servicing your vehicle.

#### Event Data Recording

Other modules in your vehicle — event data recorders — are capable of collecting and storing data during a crash or near crash event. The recorded information may assist in the investigation of such an event. The modules may record information about both the vehicle and the occupants, potentially including information such as:

- how various systems in your vehicle were operating;
- whether or not the driver and passenger seatbelts were buckled;
- how far (if at all) the driver was depressing the accelerator and/or the brake pedal;
- how fast the vehicle was traveling; and

## Introduction

- where the driver was positioning the steering wheel.

To access this information, special equipment must be directly connected to the recording modules. Ford Motor Company and Ford of Canada do not access event data recorder information without obtaining consent, unless pursuant to court order or where required by law enforcement, other government authorities or other third parties acting with lawful authority. Other parties may seek to access the information independently of Ford Motor Company and Ford of Canada.

### Cell phone use

The use of Mobile Communications Equipment has become increasingly important in the conduct of business and personal affairs. However, drivers must not compromise their own or others' safety when using such equipment. Mobile Communications can enhance personal safety and security when appropriately used, particularly in emergency situations. Safety must be paramount when using mobile communications equipment to avoid negating these benefits.

Mobile Communication Equipment includes, but is not limited to cellular phones, pagers, portable email devices, in-vehicle communications systems, telematics devices and portable two-way radios.



A driver's first responsibility is the safe operation of the vehicle. The most important thing you can do to prevent a crash is to avoid distractions and pay attention to the road. Wait until it is safe to operate Mobile Communications Equipment.



### Middle East/North Africa vehicle specific information

For your particular global region, your vehicle may be equipped with features and options that are different from the ones that are described in this *Owner's Guide*; therefore, a supplement has been supplied that complements this book. By referring to the pages in the provided supplement, you can properly identify those features, recommendations and specifications that are unique to your vehicle. **Refer to this Owner's Guide for all other required information and warnings.**

## Introduction

These are some of the symbols you may see on your vehicle.























### Vehicle Symbol Glossary

Safety Alert		See Owner's Guide	
Fasten Safety Belt		Airbag - Front	
Airbag - Side		Child Seat	
Child Seat Installation Warning		Child Seat Lower Anchor	
Child Seat Tether Anchor		Brake System	
Anti-Lock Brake System		Brake Fluid - Non-Petroleum Based	
Powertrain Malfunction		Speed Control	
Master Lighting Switch		Hazard Warning Flasher	
Fog Lamps-Front		Fuse Compartment	
Fuel Pump Reset		Windshield Wash/Wipe	
Windshield Defrost/Demist		Rear Window Defrost/Demist	



## Introduction

### Vehicle Symbol Glossary

Power Windows Front/Rear		Power Window Lockout	
Child Safety Door Lock/Unlock		Interior Luggage Compartment Release Symbol	
Panic Alarm		Engine Oil	
Engine Coolant		Engine Coolant Temperature	
Do Not Open When Hot		Battery	
Avoid Smoking, Flames, or Sparks		Battery Acid	
Explosive Gas		Fan Warning	
Power Steering Fluid		Maintain Correct Fluid Level	
Emission System		Engine Air Filter	
Passenger Compartment Air Filter		Jack	
Check Fuel Cap		Low Tire Pressure Warning	

## Instrument Cluster

### WARNING LIGHTS AND CHIMES

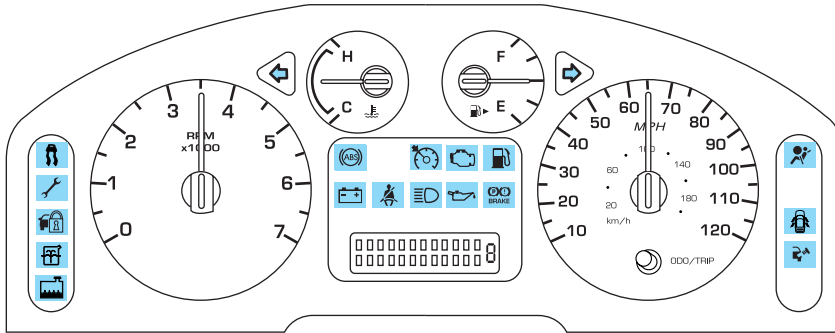

Warning lights and gauges can alert you to a vehicle condition that may become serious enough to cause extensive repairs. A warning light may illuminate when a problem exists with one of your vehicle's functions. Many lights will illuminate when you start your vehicle to make sure the bulbs work. If any light remains on after starting the vehicle, refer to the respective system warning light for additional information.

**Check engine:** The *Check Engine* indicator light illuminates when the ignition is first turned to the ON position to check the bulb. Solid illumination after the engine is started indicates the On Board Diagnostics System (OBD-II) has detected a malfunction. Refer to *On board diagnostics (OBD-II)* in the *Maintenance and Specifications* chapter. If the light is blinking, engine misfire is occurring which could damage your catalytic converter. Drive in a moderate fashion (avoid heavy acceleration and deceleration) and have your vehicle serviced immediately by your authorized dealer.



 Under engine misfire conditions, excessive exhaust temperatures could damage the catalytic converter, the fuel system, interior floor coverings or other vehicle components, possibly causing a fire.

## Instrument Cluster

### Check fuel cap (if equipped):

Illuminates when the fuel cap may not be properly installed. Continued driving with this light on may cause the Check engine warning light to come on, refer to *Fuel filler cap* in the *Maintenance and Specification* chapter.



**Brake system warning light:** To confirm the brake system warning light is functional, it will momentarily illuminate when the ignition is turned to the ON position



when the engine is not running, or in a position between ON and START, or by applying the parking brake when the ignition is turned to the ON position. If the brake system warning light does not illuminate at this time, seek service immediately from your authorized dealer. Illumination after releasing the parking brake indicates low brake fluid level or a brake system malfunction and the brake system should be inspected immediately by your authorized dealer.



Driving a vehicle with the brake system warning light on is dangerous. A significant decrease in braking performance may occur. It will take you longer to stop the vehicle. Have the vehicle checked by your authorized dealer.

**Anti-lock brake system:** If the ABS light stays illuminated or continues to flash, a malfunction has been detected, have the system serviced immediately by your authorized dealer. Normal braking is still functional unless the brake warning light also is illuminated.

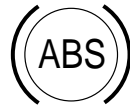

**Airbag readiness:** If this light fails to illuminate when ignition is turned to ON, continues to flash or remains on, have the system serviced



immediately by your authorized dealer. A chime will also sound when a malfunction in the supplemental restraint system has been detected.

## Instrument Cluster

**Safety belt:** Reminds you to fasten your safety belt. A chime will also sound to remind you to fasten your safety belt.



**Charging system:** Illuminates when the battery is not charging properly.



**Engine oil pressure:** Illuminates when the oil pressure falls below the normal range, refer to *Engine oil* in the *Maintenance and Specifications* chapter.



**Engine coolant level:** Illuminates when the engine coolant is low. Stop the vehicle as soon as possible, switch off the engine and let cool. Refer to *Engine coolant* in the *Maintenance and Specifications* chapter.



Never remove the coolant reservoir cap while the engine is running or hot.

**Traction Control™ active:** Illuminates when the Traction Control™ is active. If the light remains on, have the system serviced immediately, refer to the *Driving* chapter for more information.



**Low fuel (if equipped):** Illuminates when the fuel level in the fuel tank is at or near empty (refer to *Fuel gauge* in this chapter).



## Instrument Cluster

**Speed control:** Illuminates when the speed control is engaged. Turns off when the speed control system is disengaged.



**Low washer fluid (if equipped):** Illuminates when the windshield washer fluid is low.



**Door ajar (if equipped):** Illuminates when the ignition is in the ON position and any door or decklid is open.



**Anti-theft system:** Flashes when the Securilock<sup>SM</sup> Passive Anti-theft System has been activated.



**Throttle Control/Transmission:** Illuminates when a powertrain fault or an AWD fault (if equipped) has been detected. Contact your authorized dealer as soon as possible.



**Turn signal:** Illuminates when the left or right turn signal or the hazard lights are turned on. If the indicators flash faster, check for a burned out bulb.



**High beams:** Illuminates when the high beam headlamps are turned on.



**Key-in-ignition warning chime:** Sounds when the key is left in the ignition in the OFF/LOCK or ACCESSORY position and the driver's door is opened.

**Headlamps on warning chime:** Sounds when the headlamps or parking lamps are on, the ignition is off (the key is not in the ignition) and the driver's door is opened.

## Instrument Cluster

### GAUGES

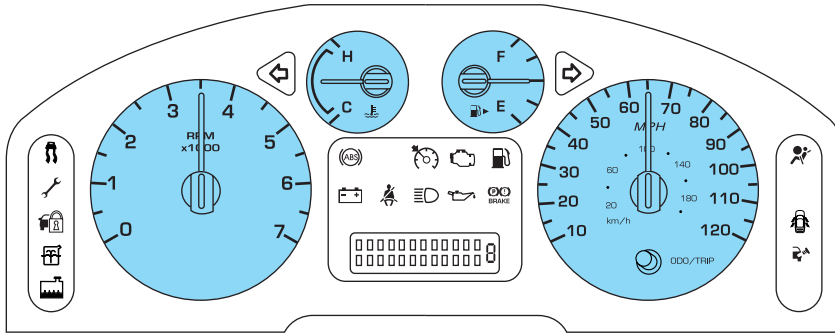

**Speedometer:** Indicates the current vehicle speed.

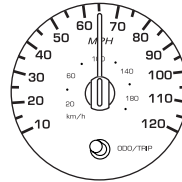

**Engine coolant temperature gauge:** Indicates engine coolant temperature. At normal operating temperature, the needle will be in the normal range (between “H” and “C”). **If it enters the red section, the engine is overheating. Stop the vehicle as soon as safely possible, switch off the engine and let the engine cool.**

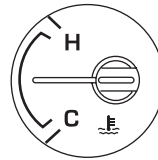

Never remove the coolant reservoir cap while the engine is running or hot.

## Instrument Cluster

**Fuel gauge:** Indicates approximately how much fuel is left in the fuel tank (when the ignition is in the ON position). The fuel gauge may vary slightly when the vehicle is in motion or on a grade.

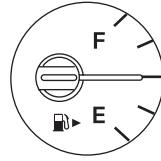

The FUEL icon and arrow indicates which side of the vehicle the fuel filler door is located.

Refer to *Filling the tank* in the *Maintenance and Specifications* chapter for more information.

**Tachometer:** Indicates the engine speed in revolutions per minute. Driving with your tachometer pointer continuously at the top of the scale may damage the engine.

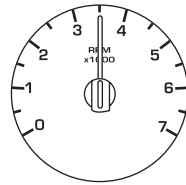

**Odometer:** Registers the total miles (kilometers) of the vehicle.

- Without Message Center



- With Message Center

Refer to *Message Center* in the *Driver Controls* chapter on how to switch the display from Metric to English.



**Trip odometer:** Registers the miles (kilometers) of individual journeys.

- Without Message Center

To reset, tap on the ODO/TRIP button to toggle the display between the trip and the odometer. Holding the ODO/TRIP button for two seconds or more will reset the trip odometer to zero.

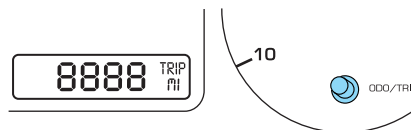

## Instrument Cluster

- With Message Center

To reset with the ODO/TRIP button:

- Tap on the button to toggle the display between the trip and the odometer. Holding the ODO/TRIP button for two seconds or more will reset the trip odometer to zero.

To reset with the message center buttons:

- Select the TRIP function from the INFO menu. Depressing the RESET control for approximately one second will reset the trip odometer to zero.

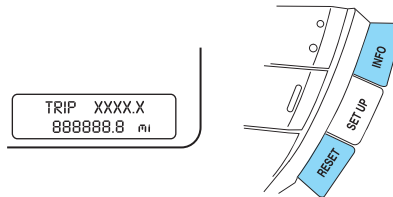

**Note:** The following is for vehicles without a message center. For vehicles with a message center, refer to *Message Center* in the *Driver Controls* chapter.

**Oil Life/Oil Change:** OIL LIFE displayed when the engine oil life remaining is 10 percent and again when the engine oil life remaining is between 5% and 1%. When oil life left reaches 0%, the OIL CHANGE message will be displayed. An oil change is required whenever indicated by the display and according to the recommended maintenance schedule. USE ONLY RECOMMENDED ENGINE OILS.



To reset the oil monitoring system to 100% after each oil change [approximately 5,000 miles (8,000 km) or 180 days] perform the following:

1. Tap on the ODO/TRIP button to toggle the display between the odometer and trip odometer.
2. Tap on the ODO/TRIP button again to toggle the display between the trip odometer and OIL LIFE XX% display.
3. Press and hold the ODO/TRIP button for ten seconds or more to display OIL LIFE 100%. Your oil life is now reset.
4. Tap on the ODO/TRIP button to return the display to odometer.



## Entertainment Systems

### AUDIO SYSTEMS

#### AM/FM stereo/ single CD sound system (if equipped)

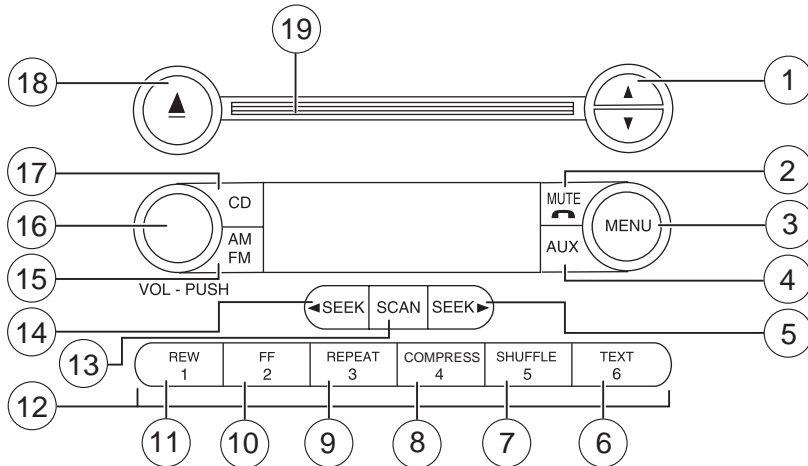

**Accessory delay:** Your vehicle is equipped with accessory delay. With this feature, the window switches and radio may be used for up to ten minutes after the ignition switches and radio may be used for up to ten minutes after the ignition switches are turned off or until either front door is opened.

1. **▲ / ▼ Tuner:** Press to manually go up or down the radio frequency. Also use in menu mode to select various settings.



2. **Phone/mute:** Press to mute the playing media. Press again to return to the playing media.



3. **Menu:** Press to toggle through the following modes:



**Autoset:** Allows you to set the strongest local radio stations without losing your original manually set preset stations for AM/FM1/FM2. Press MENU to access. Use ▲ / ▼ / ◀ SEEK ▶ to set.

## Entertainment Systems

When the six strongest stations are filled, the station stored in preset 1 will begin playing. If there are less than six strong stations, the system will store the last one in the remaining presets.

**Bass:** Press to adjust the bass setting. Use ▲ / ▼ / ◀ SEEK ▶ .

**Treble:** Press to adjust the treble setting. Use ▲ / ▼ / ◀ SEEK ▶ .

**Balance:** Press to adjust the audio between the left and right speakers. Use ▲ / ▼ / ◀ SEEK ▶ .

**Fade:** Press to adjust the audio between the front and rear speakers. Use ▲ / ▼ / ◀ SEEK ▶ .

**Speed sensitive volume (if equipped):** Radio volume automatically changes slightly with vehicle speed to compensate for road and wind noise. Press MENU to access and use ▲ / ▼ / ◀ SEEK ▶ to adjust. The recommended level is 1–3. Level 0 turns the feature off and level 7 is the maximum setting.

**Setting the clock:** Press MENU until SELECT HOUR or SELECT MINUTE is displayed. Use ▲ / ▼ to manually increase/decrease. Press MENU again to disengage clock mode.

4. **Aux:** Press to toggle between FES/DVD and AUX modes. If no auxiliary sources are available, NO AUX AUDIO will be displayed.



5. **Seek:** Press to access the next strong station or track.



6. **Text:** This control is not operational.



7. **Shuffle:** Press to play tracks in random order.



8. **Comp (Compression):** In CD mode, brings soft and loud CD passages together for a more consistent listening level.



## Entertainment Systems

9. **Repeat:** Press to repeat the current CD track.



10. **Fast forward:** Press to manually advance in a CD track.



11. **Rewind:** Press to manually reverse in a CD track.



12. **Memory presets:** To set a station: Select frequency band AM/FM; tune to a station, press and hold a preset button until sound returns.



13. **Scan:** Press for a brief sampling of radio stations or CD tracks. Press again to stop.



14. **Seek:** Press to access the previous strong station or track.



15. **AM/FM:** Press to select AM/FM frequency band.



16. **ON/OFF/Volume:** Press to turn ON/OFF. Turn to increase/decrease volume.

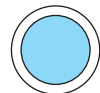

VOL - PUSH

If the volume is set above a certain level and the ignition is turned off, the volume will come back on at a "nominal" listening level when the ignition switch is turned back on.

17. **CD:** Press to enter CD mode. If a CD is already loaded into the system, CD play will begin where it ended last.



18. **CD eject:** Press to eject a CD.



## Entertainment Systems

19. **CD slot:** Insert a CD label side up.



### Premium/Audiophile In-Dash Six CD/MP3 Sound System (if equipped)

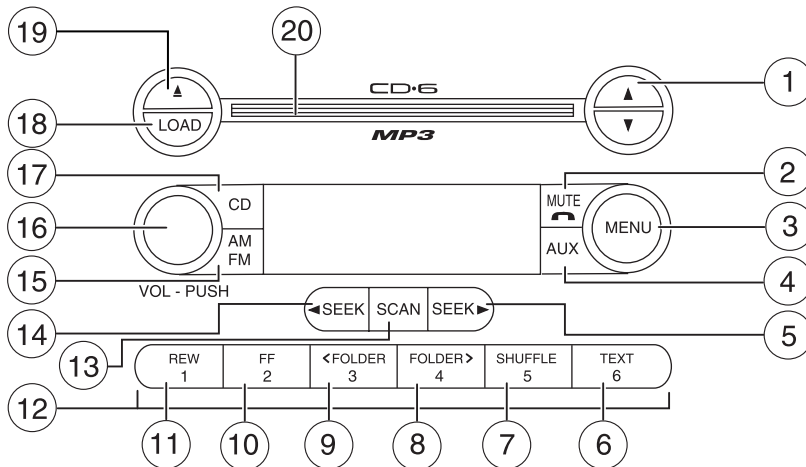

**Accessory delay:** Your vehicle is equipped with accessory delay. With this feature, the window switches and radio may be used for up to ten minutes after the ignition is turned off or until either front door is opened.

1. **▲ / ▼ Tune/Disc selector:**

Press to manually go up or down the radio frequency or to select a desired disc. Also use in menu mode to select various settings.



2. **Phone/mute:** Press to mute the playing media. Press again to return to the playing media.



## Entertainment Systems

3. **Menu:** Press to toggle through the following modes:



**Autoset:** Allows you to set the strongest local radio stations without losing your original manually set preset stations for AM/FM1/FM2 .

Use ▲ /▼ /◀ SEEK ▶ to turn on/off.

When the six strongest stations are filled, the station stored in preset 1 will begin playing. If there are less than six strong stations, the system will store the last one in the remaining presets.

**Bass:** Press to adjust the bass setting. Use ▲ /▼ /◀ SEEK ▶ .

**Treble:** Press to adjust the treble setting. Use ▲ /▼ /◀ SEEK ▶ .

**Balance:** Press to adjust the audio between the left and right speakers. Use ▲ /▼ /◀ , SEEK ▶ .

**Fade:** Press to adjust the audio between the front and rear speakers. Use ▲ /▼ /◀ , SEEK ▶ .

**Occupancy mode:** (Available on Audiophile radios only):

Use ▲ /▼ /◀ SEEK ▶ select and optimize sound for ALL SEATS, DRIVERS SEAT or REAR SEATS.

**Speed sensitive volume:** Radio volume automatically changes slightly with vehicle speed to compensate for road and wind noise.

Use ▲ /▼ /◀ SEEK ▶ to adjust. Recommended level is 1-3. Level 0 turns the feature off and level 7 is the maximum setting.

**Setting the clock:** Press until SELECT HOUR or SELECT MINS is displayed. Press ▲ /▼ /◀ SEEK ▶ to adjust the hours/minutes.

**RDS** (Available on Audiophile radios only): Allows you to search RDS-equipped stations for a certain category of music format: Classic, Country, Info, Jazz/RB, Religious, Rock, Soft, Top 40. RDS (only available in FM mode) must be activated to access Find and Show functions.

To activate, press and hold MENU until RDS (ON/OFF) appears in the display. Press MENU repeatedly to scroll through Find, Show and RDS.

Use ▲ /▼ .◀ SEEK ▶ to toggle RDS ON/OFF. When RDS is Off, you will not be able to access Find and Show functions.

## Entertainment Systems

**Find:** Allows you to search RDS-equipped stations for the desired music category. Use ▲ / ▼ to find the desired program type, then use ◀ SEEK ▶ or SCAN to begin the search.

**Show:** Allows you to display the name of the radio station or program type. Use ▲ / ▼ / ◀ SEEK ▶ to show type, name or none.

**Track/Folder Mode:** Available only on MP3 discs in CD mode. In Track Mode, pressing ◀ SEEK ▶ will scroll through all tracks on the disc. In Folder mode, pressing ◀ SEEK ▶ will scroll only through tracks within the selected folder.

**Compression:** Available only in CD mode, brings soft and loud CD passages together for a more consistent listening level.

**Repeat:** Available only in CD mode. Press to repeat the current CD track.

4. **Aux:** Press to toggle between FES/DVD and AUX modes. If no auxiliary sources are available, NO AUX AUDIO will be displayed.



5. **Seek:** Press to access the next strong station or track.



6. **Text:** In CD mode, this feature reads and displays track song title, artist name and album title.



7. **Shuffle:** Press to play the tracks in random order.



8. **FOLDER:** Press to access next folder on MP3 discs, if folders are available.



9. **FOLDER:** press to access the previous folder on MP3 discs, if folders are available.



10. **Fast forward:** Press to manually advance in a CD track.



## Entertainment Systems

11. **Rewind:** Press to manually reverse in a CD track.



12. **Memory presets:** To set a station: Select frequency band AM/FM; tune to a station, press and hold a preset button until sound returns.



13. **Scan:** Press for a brief sampling of radio stations or CD tracks. Press again to stop.



14. **Seek:** Press to access the previous strong station or track.



15. **AM/FM:** Press to select AM/FM frequency band.



16. **ON/OFF/Volume:** Press to turn ON/OFF. Turn to increase/decrease volume.



If the volume is set above a certain level and the ignition is turned off, the volume will come back on at a “nominal” listening level when the ignition switch is turned back on.

17. **CD:** Press to enter CD mode. If a CD is already loaded into the system, CD play will begin where it ended last.



18. **LOAD:** Press to load a CD. Press LOAD and a memory preset to load to a specific slot. Press and hold to autoloading up to six CDs.



19. **CD eject:** Press to eject a CD. Press and hold to auto eject all CDs present in the system. If there is no CD present, the display will read NO CD.



20. **CD slot:** Insert a CD label side up.



## Entertainment Systems

### GENERAL AUDIO INFORMATION

#### Radio frequencies:

AM and FM frequencies are established by the Federal Communications Commission (FCC) and the Canadian Radio and Telecommunications Commission (CRTC). Those frequencies are:

AM: 530, 540–1700, 1710 kHz

FM: 87.7, 87.9–107.7, 107.9 MHz

#### Radio reception factors:

There are three factors that can affect radio reception:

- Distance/strength: The further you travel from an FM station, the weaker the signal and the weaker the reception.
- Terrain: Hills, mountains, tall buildings, power lines, electric fences, traffic lights and thunderstorms can interfere with your reception.
- Station overload: When you pass a broadcast tower, a stronger signal may overtake a weaker one and play while the weak station frequency is displayed.

#### CD/CD player care

Do:

- Handle discs by their edges only. Never touch the playing surface.
- Inspect discs before playing. Clean only with an approved CD cleaner and wipe from the center out.

Don't:

- Expose discs to direct sunlight or heat sources for extended periods of time.
- Clean using a circular motion.

**CD units are designed to play commercially pressed 4.75 in (12 cm) audio compact discs only. Due to technical incompatibility, certain recordable and re-recordable compact discs may not function correctly when used in Ford CD players. Irregular shaped CDs, CDs with a scratch protection film attached, and CDs with homemade paper (adhesive) labels should not be inserted into the CD player. The label may peel and cause the CD to become jammed. It is recommended that homemade CDs be identified with permanent felt tip marker rather than adhesive labels. Ballpoint pens may damage CDs. Please contact your authorized dealer for further information.**



## Entertainment Systems

### Audio system warranty and service

Refer to the *Warranty Guide* for audio system warranty information. If service is necessary, see your dealer or qualified technician.

### Navigation system (if equipped)

Your vehicle may be equipped with a Navigation System. Refer to the *Navigation supplement* for further information.

### FAMILY ENTERTAINMENT DVD SYSTEM (IF EQUIPPED)

Your vehicle may be equipped with a Family Entertainment DVD System which allows you to play commercial DVDs, CDs and also most CD R/W, DVD R/W, VCD, and MP3 media. You can also plug in and play auxiliary media devices such as video game systems and MP3 players. Please review this material to become familiar with the Family Entertainment System (FES) features and safety information.

#### DVD player controls

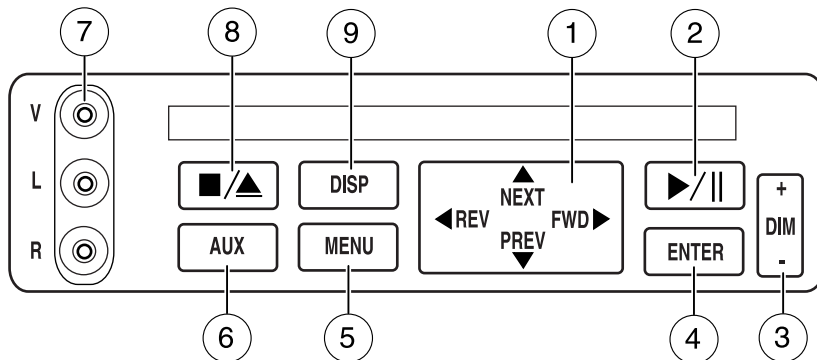

#### 1. MAIN control

- NEXT — Press to access the next track on the CD, the next chapter on the DVD, or to go up in cursor mode.
- PREV — Press to access the previous track on the CD, the previous chapter on the DVD, or to go down in cursor mode.
- REV — Press to reverse within the active CD track or DVD chapter in play mode. Also press to move the cursor left in the menu active mode.
- FWD — Press to advance within the active CD track or DVD chapter in play mode. Also press to move the cursor right in the menu active mode.

## Entertainment Systems

### 2. **PLAY/PAUSE** control

Press to playback or pause the DVD.

### 3. **DIM** control

Press (+) to increase or (-) to decrease the brightness on the screen.

### 4. **ENTER** control

Press to select the function highlighted on the active menu. ENTER may also be used by some user interactive discs during movie play.

### 5. **MENU** control

Press to bring up the disc menu.

### 6. **AUX** control

Press to switch DVD player from play mode to auxiliary mode.

### 7. **Auxiliary jacks**

Input jacks for standard video/audio media device.

### 8. **STOP/EJECT** control

Press once to stop a disc from playing. Press a second time to eject the disc. (If a disc is not playing, but is present in the system, pressing eject will eject the disc).

### 9. **DISPLAY (DISP)** control

Press to enable the on screen display of the player's menu and user's display adjustments. Double click the DISP button to change the format of the display. If the DVD disc format is NORMAL, it can be changed to full screen by selecting WIDE SCREEN. Use the NEXT and PREV button to scroll through the different format of the display. Please note that the screen quality will degrade if the display mode is changed to "Zoom."

## **DVD control features**

### **Menu control**

Press the MENU control to enter the DVD menu. This allows you to navigate and select within the DVD generated menu structure. Once in MENU mode:



## Entertainment Systems

- Press the NEXT control to move the cursor one position upward



- Press the PREV control to move the cursor one position downward

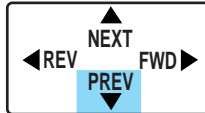

- Press the REV control to move the cursor left one position



- Press the FWD control to move the cursor right one position



### **Next/Previous control**

The NEXT (up) and PREV (down) controls allow you to access the next or previous track on a CD or chapter on a DVD. When pressed, the playing audio will mute momentarily while the next chapter is accessed.

Press and hold to advance or reverse multiple tracks or chapters.

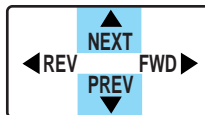

### **REV/FWD control**

Press the REV/FWD control during playback mode to reverse or advance at a normal speed. Press the REV/FWD control again to cancel the reverse/advance action and return to normal playback mode.

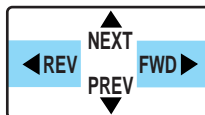

## Entertainment Systems

### **Enter control**

The ENTER control allows you to select highlighted items when in MENU mode.



### **CD play mode**

Press NEXT during CD play to advance to the next track. If you press NEXT while the last track is playing, the system will wrap around to the first track and begin play.



### **Slow play mode**

To enter slow play mode, press the PLAY/PAUSE control. This will pause the disc playing. Once the system is in pause mode, press the FWD or REV control for slow motion playback. Three different speeds in forward and one speed in reverse are available depending on how long the control is held. Slow reverse only has one speed. Press the control once for slow motion playback. Press the control again to disengage slow motion playback. Press the PLAY/PAUSE control to return to normal playback mode.



### **User menu mode**

To adjust the display setting, press DISP once and the player menu will appear. Press DISP again to adjust the display setting. Use the arrow controls and the ENTER controls to select the various screen settings. (Available screen selections are 16x9, 4x3 and Zoom).



The DVD player will read the disc type and configure the display accordingly. Some movies have a wide screen movie format to fit a normal 4x3 screen. In this case, the movie will have black bars on the top and bottom. When shown on the screen, it may appear as a small screen within the wide screen. It may be desirable to view this type of movie in zoom mode. To enter zoom mode, press DISP once for the player menu and again to adjust the display setting. Select zoom from the screen settings by using the arrow and ENTER controls.

## Entertainment Systems

### Remote control

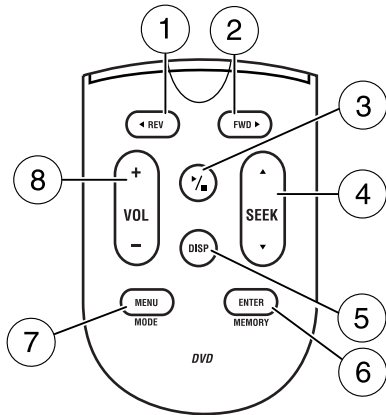

1. **REV (REVERSE)** control

Press to reverse the direction of the DVD movie.

2. **FWD (FORWARD)** control

Press to advance the direction of the DVD movie.

3. **PLAY/STOP** control

When playing, press PLAY/STOP to stop the disc. When stopped, press PLAY/STOP to play the disc.

4. **SEEK** control

Press to reverse (▼) or advance (▲) the chapter of the DVD or the track of the CD.

5. **DISP (DISPLAY)** control

Press to enable the on screen display of the player's menu and display settings. Once the display is on, use SEEK to highlight the desired screen setting.

6. **ENTER /MEMORY** control

In DVD playback mode, press the control to select a highlighted item from the menu.

In stop mode, press the control to select the next audio memory preset.

## Entertainment Systems

### 7. **MENU/MODE** control

In DVD playback mode, press to access the disc menu.

In stop mode, press to change media types (e.g. AM, FM, CD . . . )

### 8. **VOL (VOLUME)** control

Press (+) to increase or (-) to decrease the volume level.

#### **Dual play mode**

Press the radio preset controls 2 and 4 at the same time to enable or disable dual play.



During dual play, the rear vehicle speakers will be deactivated and the wireless headphones will become active. Please note that the infrared headphones are active only when the Family Entertainment System is playing a movie.

During dual play mode, two different medias can be played in the vehicle:

1. The driver can choose, and control, a source on the main radio face (radio, CD or DVD) and listen to it using the front speakers.
2. Passengers in the rear can listen to the DVD player or AUX input via the wireless headphones.

#### **Single play mode**

When the ignition is turned on, the radio will be in Single Play Mode.

Single play mode allows one media selection (FM/AM, CD, DVD or AUX) to be heard on all the vehicle speakers.

If radio is in Dual Play Mode, with a DVD playing in the rear, and another media (FM/AM, CD) playing on front speakers, changing to single play will turn the DVD player off.

When radio is powered off and back on, it will be in Single Play mode, even if upon power off the radio was in Dual play mode.

## Entertainment Systems

### **Battery replacement**

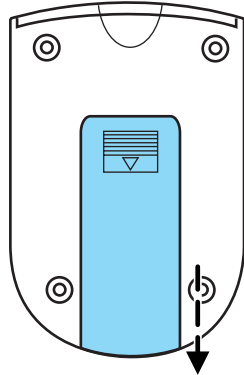

Batteries are provided with the remote control unit. Since all batteries have a limited shelf life, replace them when the remote control fails to control the DVD player. There is a LED indicator light on the remote control that will illuminate when any control is pressed.

Slide the battery cover off as shown on the remote control to access the batteries.

The remote control unit uses two AAA batteries.

### **Parental control**

Simultaneously press the preset controls 3 and 5 to enable or disable the rear seat controls, the controls on your Family Entertainment DVD system including the remote control, and the DVD screen (if equipped).



For further information about the Rear Seat Controls, refer to *Auxiliary audio controls* in the Entertainment Chapter.

## Entertainment Systems

### **Wireless headphones**

Your system is equipped with 2 sets of wireless headphones. (Two AAA batteries are needed to operate the headphones.) Batteries are included.



To install the batteries, remove the screw at the bottom of the cover. Then, lightly press down on top, and slide the cover off.

When replacing the batteries, use two new batteries (alkaline recommended) and install them with the correct orientation as indicated in the battery housing.

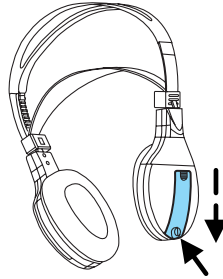

### **Wireless headphone operation**

To operate the headphones:

- Press the ON/OFF button on the earpiece to turn on the headphones. A red LED (indicator light) will illuminate indicating the headphones are powered ON. Press ON/OFF again to turn the headphones off.
- Adjust the headphones to comfortably fit your head using the headband adjustment.
- Adjust the volume control to the desired listening level.

**Note:** The volume level of the wireless headphones can only be

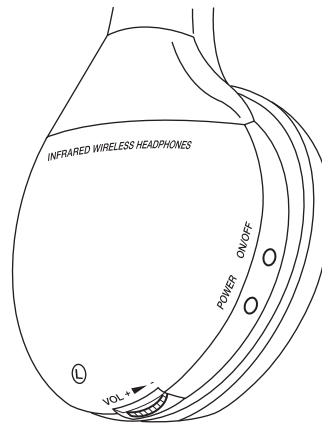



## Entertainment Systems

controlled by the thumbwheel. Neither the remote control nor the rear seat controls will affect the volume output of the wireless headphones. When not using the headphones, turn them off to preserve battery life. The headphones will automatically turn off after five minutes if they have not received an infrared audio signal from the Family Entertainment System (FES).

**Note:** Ensure that the line of sight between the headphone and infrared transmitter (mounted on the DVD housing) is not obstructed for optimal performance.

### **Liquid Crystal Display (LCD) flip-down screen**

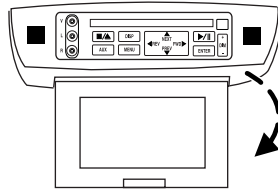

The LCD screen rotates down and can be adjusted to your desired viewing angle. When not in use, rotate the screen up into the storage housing.

**Note:** Ensure that the screen is securely latched into the housing when stored.

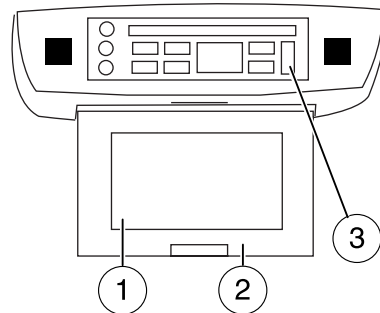

1. 7.0" (diagonal) active matrix liquid crystal display (LCD).
2. Display housing.
3. Dimmer switch. Press +/- to increase/decrease the brightness of the display.

## Entertainment Systems

### ***Playback and format***

- The DVD player of your Family Entertainment DVD System can only be used in the “playback” mode. (The DVD player does not offer a record feature.)
- The system plays standard CDs, DVDs and also plays most CD R/W, DVD R/W, VCD and MP3 media.

### ***Saving MP3 files***

- Your Family Entertainment System supports discs containing up to 255 files. Discs containing more than 255 files will not play.
- Always save MP3 files with the .mp3 extension. The player recognizes an MP3 file by the .mp3 extension, so MP3 files saved with different extensions will not be played. Never save a non-MP3 file with the .mp3 extension as the file will not play properly.
- The player supports multi session discs. However, be sure to import the previous session of the disc before you add new files. If you do not import the previous session, only the last session will be played.
- When burning a disc, **ensure that you close/finalize the disc before playback**, or the disc may not play properly or an error message may appear.
- Some CD-RW discs may operate inconsistently and may cause an error message to appear. We recommend burning MP3 files onto CD-R discs.

### ***Family Entertainment DVD System protection circuits***

#### ***High temperature sensor circuit***

- Excessively high temperatures may cause damage to the DVD player.
- When the temperature of the DVD player becomes too hot, the high temperature sensor circuit stops machine operation. DVD/CD HOT will be displayed on the radio display.
- The DVD player will remain disabled until it cools to a normal operating temperature. The length of time for the system to cool will vary depending on the climate and operating conditions.

### ***Operating***

- Only use the system when the vehicle is started for optimal performance and to maintain battery life.
- If the Family Entertainment System (FES) is playing and the ignition is turned OFF, the system will turn off, and suspend playback. When

## Entertainment Systems

the ignition is turned on again, playback will begin from the last selected media source when the play control is pressed.

- To disable the DVD player rear controls, simultaneously press the 3 and 5 memory presets on the radio face. To enable the DVD player rear controls again, press the 3 and 5 presets simultaneously.
- The DVD player is only capable of reading the bottom side of a disc. When inserting a single sided disc, the label should be up. For a multi-sided disc, the desired play side should be down when the disc is inserted into the player.
- DVDs are formatted by regions. This DVD system can only play region 1 DVDs (DVDs manufactured for U.S. and Canada).

**This unit is designed to play commercially pressed 4.75 (12 cm) audio compact discs and DVDs only. Due to technical incompatibility, certain recordable and re-recordable compact discs may not function correctly when used in Ford DVD/CD players. Irregular shaped discs, discs with a scratch protection film attached, and discs with homemade paper (adhesive) labels should not be inserted into the player. The label may peel and cause the disc to become jammed. It is recommended that homemade discs be identified with permanent felt tip marker rather than adhesive labels. Ball point pens may damage discs. Please contact your dealer for further information.**

### ***Inserting a CD/DVD***

With the ignition ON, inserting a CD/DVD into the DVD player automatically turns ON the FES and playback should begin immediately.

The counter is automatically reset to 0:00:00 when any disc is inserted into the FES.

### ***Removing a CD/DVD (while playing)***

1. Press the STOP/EJECT control to stop playback if a disc is playing.
2. Press the STOP/EJECT control again to eject the CD/DVD.

If the CD/DVD is not removed within the allotted time, the system will pull the CD/DVD back into the system for safety purposes.

If the CD/DVD will not eject from the system, press and hold the EJECT control for approximately 2 seconds. The disc should eject whether the vehicle ignition is ON or OFF.

### ***Playing an auxiliary device***

1. Connect the video line from your video device to the YELLOW auxiliary input jack.

## Entertainment Systems

2. Connect the left and right audio lines to the WHITE (left) and RED (right) auxiliary input jacks respectively.
3. Press the MODE control repeatedly until DVD/CD AUX (no disc in player) or DVD/CD play (disc in player) illuminates in the radio display. If a disc is in the system, playback should begin. To enable the aux inputs, press the STOP control or press the AUX control on the DVD player.

### On-screen indicators

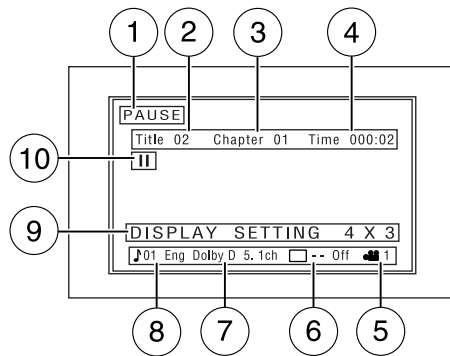

Each time a control is pressed, the operational status of the DVD player is shown on the screen. The following are some possible indicators:

1. DVD/ CD STATUS (PLAY/FWD/REV/PAUSE)
2. CD track number / DVD title
3. DVD chapter number
4. MEDIA COUNTER — displays current viewing time of desired media. (HOURS:MINUTES:SECONDS)
5. Viewing angle (of picture) - Adjustable with cursor controls and ENTER control.
6. Subtitles (specific language type - English, Spanish or French, dependent on disc capability and ON/OFF selection.)
7. AUDIO OUTPUT (not changeable)
8. AUDIO VERSION — (01 ENG., etc.)
9. DISPLAY SETTING (4x3, Zoom, 16x9)
10. STATUS ICON (FWD, x4, x8, x32, REV, x4, x8, x32, etc.)

## Entertainment Systems

### Safety information

Read all the safety and operating instructions before operating the system and retain for future reference.

- Do not attempt to service, repair or modify the Family Entertainment DVD System. See your Ford or Lincoln Mercury dealer.
- Do not insert foreign objects into the DVD compartment.



The front glass on the flip-down liquid crystal display (LCD) may break when hit with a hard surface. If the glass breaks, do not touch the liquid crystalline material. In case of contact with skin, wash immediately with soap and water.

**Do not expose the flip-down liquid crystal display (LCD) to direct sunlight or intensive ultraviolet rays for extensive periods of time. Ultraviolet rays deteriorate the liquid crystal.**

- Ensure that you review User Manuals for video games and video game equipment when used as auxiliary inputs for your Family Entertainment DVD System.
- Do not operate video games or video equipment if the power cords and/or cables are broken, split or damaged. Carefully place cords and/or cables where they will not be stepped on or interfere with the operation of seats and/or compartments.
- Disconnect video games and video equipment power cords and/or cables when not in use.
- Avoid touching auxiliary input jacks with your fingers. Do not blow on them or allow them to get wet or dirty.
- Do not clean any part of the DVD player with benzene, paint thinner or any other solvent.

**Whenever a warning notice is received, the radio volume will be lowered to a volume that will allow the tones to be heard. The radio volume will return to the previous level after the warning notice is complete.**

## Entertainment Systems

### ***Federal Communication Commission (FCC) Compliance***

Changes or modifications not approved by Ford or Lincoln Mercury could void user's authority to operate the equipment. This equipment has been tested and found to comply with the limits for a Class B digital device, pursuant to Part 15 of the FCC Rules. These limits are designed to provide reasonable protection against harmful interference in a residential installation. This equipment generates, uses and can radiate radio frequency energy. If not installed and used in accordance with the instructions, the Family Entertainment System (FES) may cause harmful interference with radio communications.

However, there is no guarantee that interference will not occur in a particular installation. If this equipment does cause harmful interference to radio or television reception, (which can be determined by turning the equipment off and on), the user is encouraged to consult the dealer or an experienced radio/TV technician for help.

### ***Care and service of the DVD player***

#### ***Environmental extremes***

DVD players that are subjected to harsh environmental conditions may be damaged or perform at less than optimal capability. To avoid these outcomes, whenever possible avoid exposing your DVD player to:

- extremely hot or cold temperatures.
- direct sunlight.
- high humidity.
- a dusty environment.
- locations where strong magnetic fields are generated.

#### ***Temperature extremes***

When the vehicle is parked under direct sunlight or in an extremely cold place for a long period of time, wait until the cabin temperature of the vehicle is at normal temperature before operating the system.

#### ***Humidity and moisture condensation***

Moisture in the air will condense in the DVD player under extremely humid conditions or when moving from a cold to a warm location. If moisture condensation occurs, do not insert a CD or DVD into the player. If one is already in the player, remove it and turn the DVD player ON to dry the moisture before inserting a DVD. This could take an hour or more depending on the amount of moisture.

## Entertainment Systems

### ***Cleaning the liquid crystal display (LCD) flip-down screen***

Clean the display screen by applying a small amount of water or any ammonia-based household glass cleaner directly to a soft cloth. Rub the screen gently until the dust, dirt or fingerprints are removed. Do not spray the screen directly with water or glass cleaning solvents. Overspray from these fluids could drip down into the internal electronics of the screen and cause damage. Do not apply excessive pressure while cleaning the screen.

### ***Foreign substances***

Exercise care to prevent dirt and foreign objects from entering the DVD player compartment. If liquid is accidentally spilled onto the system, immediately turn the system OFF and consult a qualified service technician.

### ***Cleaning compact discs***

Inspect all discs for contamination before playing. If necessary, clean discs only with an approved CD cleaner and wipe from the center out to the edge. Do not wipe in a circular motion.

### ***Cleaning the DVD player***

Clean the exterior of the DVD player with a damp cloth. Do not use CD cleaning kits or CDs intended to clean the interior of your DVD player. Use of these products may damage your system.

## Climate Controls

### MANUAL HEATING AND AIR CONDITIONING SYSTEM (IF EQUIPPED)

#### 1. **Temperature selection:**

Controls the temperature of the airflow in the vehicle.

2. **Air flow selections:** Controls the direction of the airflow in the vehicle. See the following for a brief description on each control setting:

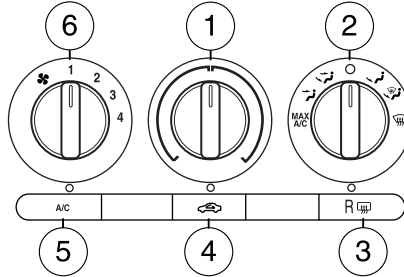

#### **MAX A/C:** Distributes recirculated

air through the instrument panel vents only to cool the vehicle. This re-cooling of the interior air is more economical and efficient. Recirculated air may also help reduce undesirable odors from entering the vehicle.

: Distributes air through the instrument panel vents.

: Distributes air through the instrument panel vents and floor vents.

**O (OFF):** Outside air is shut out and the climate system is turned off.

: Distributes air through the floor vents. **Note:** You may notice a small amount of air flowing from the demister and defroster vents.

: Distributes air through the windshield defroster vents, demisters and floor vents.

: Distributes outside air through the windshield defroster and demister vents. Can be used to clear thin ice or fog from the windshield. To exit select another mode.

3. **Rear defroster:** Press to activate/deactivate rear window defroster. Refer to *Rear window defroster* in this section for more information.

4. **Recirculated air:** Press to activate/deactivate air recirculation in the vehicle cabin. Recirculated air may reduce the amount of time to cool down the interior of the vehicle and may also help reduce undesired odors from reaching the interior of the vehicle. Recirculation engages automatically with selection of MAX A/C or can be engaged manually in any other airflow selection except defrost. Recirculation may turn off automatically in all airflow selections except MAX A/C.

5. **A/C:** Press to activate/deactivate air conditioning. Use with recirculated air to improve cooling performance and efficiency. Engages automatically in MAX A/C, (defrost) and (floor/defrost). Cannot be disabled in MAX A/C mode.



## Climate Controls

6. **Fan speed adjustment:** Controls the volume of air circulated in the vehicle.



### Operating tips

- To reduce fog build up on the windshield during humid weather, place the air flow selector in the  position.
- To reduce humidity build up inside the vehicle: do not drive with the airflow selector in the O (OFF) or with recirculated air engaged.
- Do not put objects under the front seats that will interfere with the airflow to the back seats.
- Remove any snow, ice or leaves from the air intake area at the base of the windshield.
- For maximum cooling performance (MAX A/C):

In the MAX A/C mode:

- Move the temperature control selector to the coldest setting.
- Set the fan to the highest speed initially, then adjust to maintain passenger comfort.

In the  and  modes:

- Move the temperature control selector to the coldest setting.
- Select A/C and recirculated air . Use  with A/C to provide colder airflow.
- Set the fan to the highest speed initially, then adjust to maintain passenger comfort.

In extremely cold temperatures, to maximize overall heater performance it is suggested to not operate the auxiliary system (if so equipped) until the engine temperature gauge crosses into the normal operating range.

To aid in side window defogging/demisting in cold weather:

1. Select .
2. Select A/C.
3. Set the temperature control to full heat.
4. Set the fan speed to the highest setting.
5. Direct the outer instrument panel vents towards the side windows.



Do not place objects on top of the instrument panel as these objects may become projectiles in a collision or sudden stop.

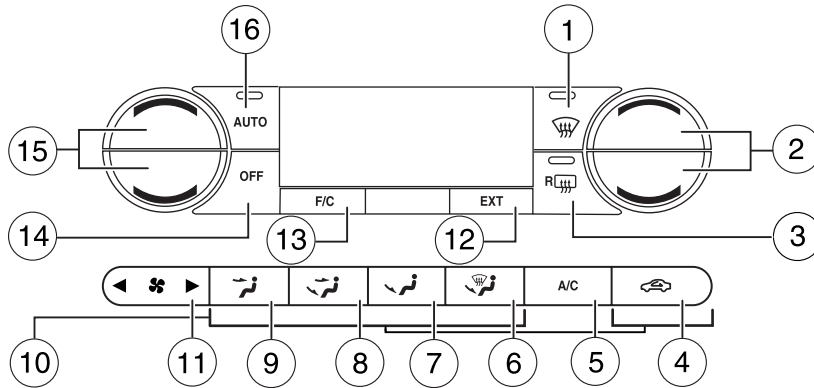

## Climate Controls

### DUAL ZONE AUTOMATIC TEMPERATURE CONTROL (IF EQUIPPED)



1. **Defrost:** Distributes outside air through the windshield defroster and demister vents. Can be used to clear thin ice or fog from the windshield. To exit select another mode.
2. **Passenger temperature control:** Press to increase/decrease the airflow temperature for the passenger in the front of the vehicle.
3. **Rear defroster:** Press to activate/deactivate rear window defroster. Refer to *Rear window defroster* in this section for more information.
4. **Recirculated air:** Press to activate/deactivate air recirculation in the cabin. Recirculated air may reduce the amount of time to cool down the interior of the vehicle and may also help reduce undesired odors from reaching the interior of the vehicle. Recirculation can be engaged manually in any other airflow selection except defrost. Recirculation may turn off automatically in all airflow selections.
5. **A/C:** Press to activate/deactivate air conditioning. Use with recirculated air to improve cooling performance and efficiency. Engages automatically in AUTO, defrost and floor/defrost.
6. : Distributes air through the windshield defroster, demister and floor vents.
7. : Distributes air through the floor vents. **Note:** You may notice a small amount of air flowing from the demister and defroster vents.

## Climate Controls

8.  : Distributes air through the instrument panel and floor vents.
  9.  : Distributes air through the instrument panel vents.
  10. **Manual override controls:** Allows you to manually select where airflow is directed. To return to full automatic control, press AUTO.
  11.  **Front fan speed control:** Press to manually increase or decrease the fan speed. To return to automatic fan operation, press AUTO.
  12. **EXT:** Press to display outside temperature. Press again to display cabin temperature settings.
  13. **F/C (Temperature conversions):** Press to switch temperature display between ° Fahrenheit and ° Celsius.
  14. **OFF:** Outside air is shut out and the climate control system is turned off.
  15. **Driver temperature control:** Press to increase/decrease the temperature on the driver side of the cabin. Sets the passenger side temperature also when DUAL is disengaged. The recommended vehicle cabin setting is between 72°F (22°C) and 75°F (24°C).
- Dual temperature control:** Press and hold the AUTO button to engage-disengage separate passenger side temperature control.
16. **AUTO:** To engage automatic temperature control, press AUTO and select the desired temperature using the temperature control. The system will automatically determine fan speed, airflow location, A/C on or off, and outside or recirculated air, to heat or cool the vehicle to reach the desired temperature.

## Climate Controls

### Dual Zone Automatic Temperature Control with heated seats (if equipped)

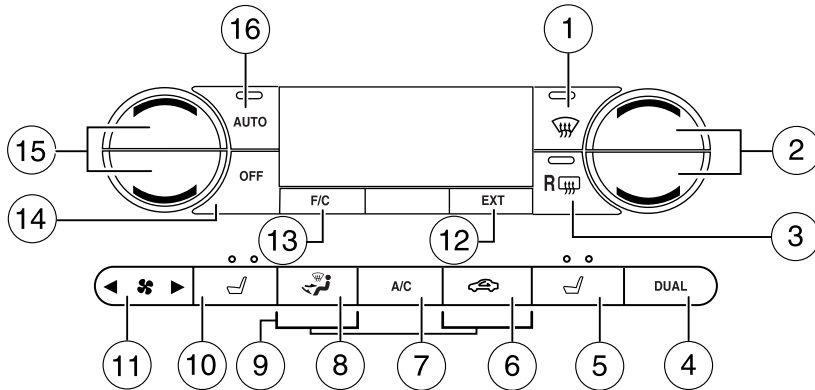

1. **Defrost:** Distributes outside air through the windshield defroster and demister vents. Can be used to clear thin ice or fog from the windshield. To exit select another mode.
2. **Passenger temperature control:** Press to increase/decrease the airflow temperature for the passenger in the front of the vehicle.
3. **Rear defroster:** Press to activate/deactivate rear window defroster. Refer to *Rear window defroster* in this section for more information.
4. **DUAL (Dual temperature control):** Press to engage/disengage separate passenger side temperature control.
5. **Passenger heated seat control:** Press once to activate high heat setting (2 indicator lights), press again to activate low heat setting (1 indicator light), and press again to deactivate the passenger heated seat. **Note:** The heated seat feature will remain on for approximately ten minutes.
6. **Recirculated air:** Press to activate/deactivate air recirculation in the cabin. Recirculated air may reduce the amount of time to cool down the interior of the vehicle and may also help reduce undesired odors from reaching the interior of the vehicle. Recirculation can be engaged manually in any other airflow selection except defrost. Recirculation may turn off automatically in all airflow selections.

## Climate Controls

7. **A/C:** Press to activate/deactivate air conditioning. Use with recirculated air to improve cooling performance and efficiency. Engages automatically in AUTO, defrost and floor/defrost.

8. **Airflow direction control:** Press to toggle through the air distribution modes listed below. The selected mode will be shown in the display.

 : Distributes air through the instrument panel and center console vents (if equipped).

 : Distributes air through the instrument panel, floor and center console vents (if equipped).

 : Distributes air through the floor vents. **Note:** You may notice a small amount of air flowing from the demister and defroster vents.

 : Distributes air through the windshield defroster, demister and floor vents.

9. **Manual override controls:** Allows you to manually select where airflow is directed. To return to full automatic control, press AUTO.

10.  **Driver heated seat control:** Press to heat the driver seat. Press once to activate high heat (two indicator lights). Press again to activate low heat (one indicator light). Press again to deactivate the driver heated seat. **Note:** The heated seat feature will remain on for approximately ten minutes.

11.  **Front fan speed control:** Press to manually increase or decrease the fan speed. To return to automatic fan operation, press AUTO.

12. **EXT:** Press to display outside temperature. Press again to display cabin temperature settings.

13. **F/C (Temperature conversions):** Press to switch temperature display between ° Fahrenheit and ° Celsius.

14. **OFF:** Outside air is shut out and the climate control system is turned off.

15. **Driver temperature control:** Press to increase/decrease the temperature on the driver side of the cabin. Sets the passenger side temperature also when DUAL is disengaged. The recommended vehicle cabin setting is between 72°F (22°C) and 75°F (24°C).

16. **AUTO:** Press to engage automatic temperature control. Select the desired temperature using the temperature control. The system will automatically determine fan speed, airflow location, A/C on or off, and outside or recirculated air, to heat or cool the vehicle to reach the desired temperature.





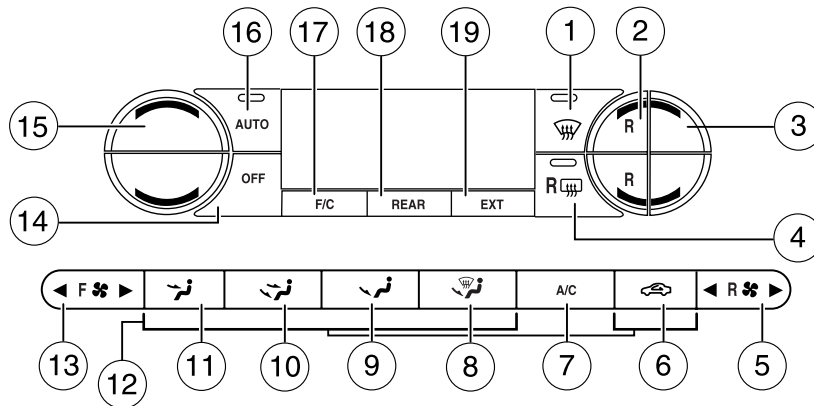

## Climate Controls

### Dual Zone Automatic Temperature Control with rear passenger compartment climate control (if equipped)



1. **Defrost:** Distributes outside air through the windshield defroster and demister vents. Can be used to clear thin ice or fog from the windshield. To exit select another mode.
2. **Rear temperature control:** Press to enable the auxiliary system and set the desired rear cabin airflow temperature with the front control. The rear cabin airflow temperature will match the driver airflow temperature setting when only the center rear temperature bar is illuminated. The rear cabin airflow temperature will be warmer or cooler than the driver airflow temperature setting when more than one temperature bar is illuminated.
3. **Passenger temperature control:** Press to increase/decrease the airflow temperature for the passenger in the front of the vehicle.
4. **Rear defroster:** Press to activate/deactivate rear window defroster. Refer to *Rear window defroster* in this section for more information.
5. **Rear fan speed control:** Press to enable the auxiliary system or to adjust the rear fan speed from the front control. The rear fan speed settings are 4, 3, 2, 1 and OFF.

## Climate Controls



6.  **Recirculated air:** Press to activate/deactivate air recirculation in the cabin. Recirculated air may reduce the amount of time to cool down the interior of the vehicle and may also help reduce undesired odors from reaching the interior of the vehicle. Recirculation can be engaged manually in any other airflow selection except defrost. Recirculation may turn off automatically in all airflow selections.
7. **A/C:** Press to activate/deactivate air conditioning. Use with recirculated air to improve cooling performance and efficiency. Engages automatically in AUTO, defrost and floor/defrost.
8.  : Distributes air through the windshield defroster, demister and floor vents.
9.  : Distributes air through the floor vents. **Note:** You may notice a small amount of air flowing from the demister and defroster vents.
10.  : Distributes air through the instrument panel and floor vents.
11.  : Distributes air through the instrument panel vents.
12. **Manual override controls:** Allows you to manually select where airflow is directed. To return to full automatic control, press AUTO.
13.  **Front fan speed control:** Press to manually increase or decrease the fan speed. To return to automatic fan operation, press AUTO.
14. **OFF:** Outside air is shut out and the climate control system is turned off.
15. **Driver temperature control:** Press to increase/decrease the temperature on the driver side of the cabin. Sets the passenger side temperature also when DUAL is disengaged. The recommended vehicle cabin setting is between 72°F (22°C) and 75°F (24°C).
16. **AUTO:** To engage automatic temperature control, press AUTO and select the desired temperature using the temperature control. The system will automatically determine fan speed, airflow location, A/C on or off, and outside or recirculated air, to heat or cool the vehicle to reach the desired temperature.
17. **F/C (Temperature conversions):** Press to switch temperature display between ° Fahrenheit and ° Celsius.
18. **REAR:** Press to enable the control located in the rear seat. Press again to turn the auxiliary system OFF.
19. **EXT:** Press to display outside temperature. Press again to display cabin temperature settings.

## Climate Controls

### Operating tips

- To reduce fog build up on the windshield during humid weather, place the air flow selector in the  position.
- To reduce humidity build up inside the vehicle: do not drive with the airflow selector in the OFF or with recirculated air engaged.
- Do not put objects under the front seats that will interfere with the airflow to the back seats.
- Remove any snow, ice or leaves from the air intake area at the base of the windshield.
- For maximum cooling performance (MAX A/C):

In AUTO mode, press AUTO control and set to desired temperature.

In manual override control, select  or , A/C and recirculated air  and set the temperature to 60°F (16°C). Set the fan to the highest speed initially, then adjust to maintain passenger comfort.

- To improve the A/C cool down, drive with the windows slightly open for 2-3 minutes after starting the vehicle or until the vehicle has “aired out.”

In extremely cold temperatures, to maximize overall heater performance it is suggested to not operate the auxiliary system (if so equipped) until the engine temperature gauge crosses into the normal operating range.

To aid in side window defogging/demisting in cold weather:

1. Select .
2. Select A/C.
3. Adjust the temperature control to maintain comfort.
4. Set the fan to the highest speed.
5. Direct the outer instrument panel vents towards the side windows.



Do not place objects on top of the instrument panel as these objects may become projectiles in a collision or sudden stop.







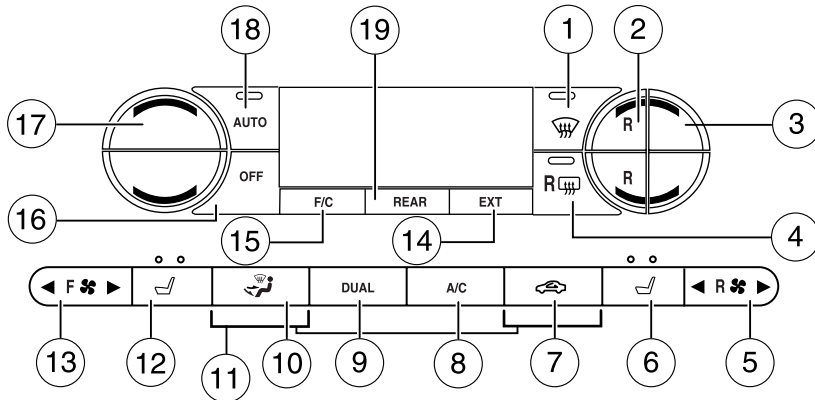

## Climate Controls

### Dual Zone Automatic Temperature Control with heated seats and rear passenger compartment climate control (if equipped)



1. **Defrost:** Distributes outside air through the windshield defroster and demister vents. Can be used to clear thin ice or fog from the windshield. To exit select another mode.
2. **Rear temperature control:** Press to enable the auxiliary system and set the desired rear cabin airflow temperature with the front control. The rear cabin airflow temperature will match the driver airflow temperature setting when only the center rear temperature bar is illuminated. The rear cabin airflow temperature will be warmer or cooler than the driver airflow temperature setting when more than one temperature bar is illuminated.
3. **Passenger temperature control:** Press to increase/decrease the airflow temperature for the passenger in the front of the vehicle.
4. **Rear defroster:** Press to activate/deactivate rear window defroster. Refer to *Rear window defroster* in this section for more information.
5. **Rear fan speed control:** Press to enable the auxiliary system or to adjust the rear fan speed from the front control. The rear fan speed settings are 4, 3, 2, 1 and OFF.
6. **Passenger heated seat control:** Press once to activate high heat setting (2 indicator lights), press again to activate low heat setting (1 indicator light), and press again to deactivate the passenger heated seat.  
**Note:** The heated seat feature will remain on for approximately ten minutes.

## Climate Controls

7.  **Recirculated air:** Press to activate/deactivate air recirculation in the cabin. Recirculated air may reduce the amount of time to cool down the interior of the vehicle and may also help reduce undesired odors from reaching the interior of the vehicle. Recirculation can be engaged manually in any other airflow selection except defrost. Recirculation may turn off automatically in all airflow selections.
8. **A/C:** Press to activate/deactivate air conditioning. Use with recirculated air to improve cooling performance and efficiency. Engages automatically in AUTO, defrost and floor/defrost.
9. **DUAL (Dual temperature control):** Press to engage/disengage separate passenger side temperature control.
10. **Airflow direction control:** Press to toggle through the air distribution modes listed below. The selected mode will be shown in the display.
  -  : Distributes air through the instrument panel and center console vents (if equipped).
  -  : Distributes air through the instrument panel, floor and center console vents (if equipped).
  -  : Distributes air through the floor vents. **Note:** You may notice a small amount of air flowing from the demister and defroster vents.
  -  : Distributes air through the windshield defroster, demister and floor vents.
11. **Manual override controls:** Allows you to manually select where airflow is directed. To return to full automatic control, press AUTO.
12.  **Driver heated seat control:** Press to heat the driver seat. Press once to activate high heat (two indicator lights). Press again to activate low heat (one indicator light). Press again to deactivate the driver heated seat. **Note:** The heated seat feature will remain on for approximately ten minutes.
13.  **Front fan speed control:** Press to manually increase or decrease the fan speed. To return to automatic fan operation, press AUTO.
14. **EXT:** Press to display outside temperature. Press again to display cabin temperature settings.
15. **F/C (Temperature conversions):** Press to switch temperature display between ° Fahrenheit and ° Celsius.
16. **OFF:** Outside air is shut out and the climate control system is turned off.

## Climate Controls

17. **Driver temperature control:** Press to increase/decrease the temperature on the driver side of the cabin. Sets the passenger side temperature also when DUAL is disengaged. The recommended vehicle cabin setting is between 72°F (22°C) and 75°F (24°C).

18. **AUTO:** Press to engage automatic temperature control. Select the desired temperature using the temperature control. The system will automatically determine fan speed, airflow location, A/C on or off, and outside or recirculated air, to heat or cool the vehicle to reach the desired temperature.

19. **REAR:** Press to enable the control located in the rear seat. Press again to turn the auxiliary system OFF.

### AUXILIARY CLIMATE CONTROL (IF EQUIPPED)

1. **Fan speed:** Turn to select the desired fan speed.

2. **Temperature/mode selection:**  
The distribution of air from the overhead and floor registers is based on the temperature selected. Turn to select for comfort.

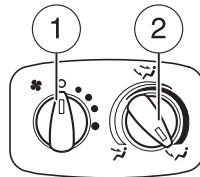

To use the rear climate controls, ensure that **REAR** is pressed on the main climate control face located on the instrument panel.

### REAR WINDOW DEFROSTER

The rear defroster control is located on the climate control panel and works to clear the rear window of fog and thin ice.

The ignition must be in the 3 (RUN) position to operate the rear window defroster.

The rear defroster turns off automatically after 10 minutes or when the ignition is turned to the 1 (LOCK) position. To manually turn off the defroster before 10 minutes have passed, push the control again.

**Do not use razor blades or other sharp objects to clean the inside of the rear window or to remove decals from the inside of the rear window. This may cause damage to the heated grid lines and will not be covered by your warranty.**

## Lights

### HEADLAMP CONTROL ☼

○ Turns the lamps off.

P☼ Turns on the parking lamps, instrument panel lamps, license plate lamps and tail lamps.

☼ Turns the headlamps on.

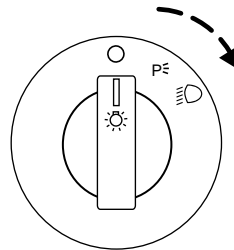

### Autolamp control (if equipped) ☼

The autolamp system provides light sensitive automatic on-off control of the exterior lights normally controlled by the headlamp control.

- To turn autolamps on, rotate the control counterclockwise to ☼.
- To turn autolamps off, rotate the control clockwise to ○.

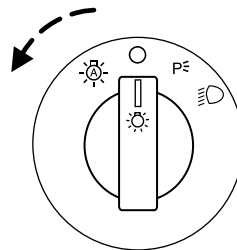

The autolamp system also keeps the lights on for a predetermined amount of time after the ignition switch is turned to LOCK. You can change the amount of time the lamps stay on by using the programming procedure that follows:

#### **Autolamps - Programmable exit delay**

Programmable exit delay allows the length of the autolamp exit delay to be changed.

To program the auto lamp exit time delay:



1. Start with the ignition in the LOCK position and the headlamp control in the autolamp position.
2. Turn the headlamp switch to ○.
3. Turn the ignition switch to RUN and then back to LOCK.
4. Turn the headlamp switch to the autolamp position. The headlamps will turn on.

## Lights

5. Wait the desired amount of time for the exit delay you want (up to three minutes), then turn the headlamp switch to . The headlamps will turn off.

### Foglamp control (if equipped)

With the ignition on, the foglamps can be turned on when the headlamp control is pulled toward you and is in any of the following positions:

- Parking lamps 
- Low beams 
- Autolamps (when active) 

The foglamps will not operate when the high beams are active.

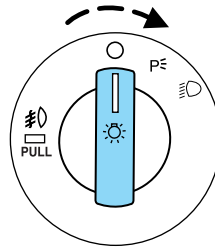

### High beams

Pull the lever towards you, to the second detent, to activate. Pull the lever towards you again to deactivate.

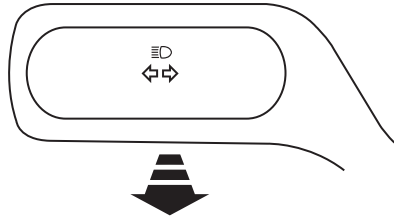

### Flash to pass

Pull toward you, to the first detent, to activate and release to deactivate.

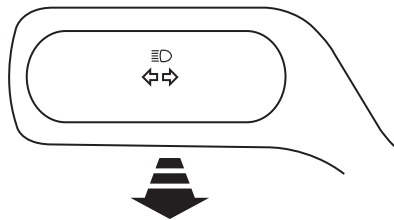

## Lights

### Daytime running lamps (DRL) (if equipped)

Turns the headlamps on with a reduced output.

To activate:

- the ignition must be in the ON position,
- the headlamp control is in the OFF, autolamps or parking lamp position and
- the transmission must be out of the Park position.



Always remember to turn on your headlamps at dusk or during inclement weather. The Daytime Running Lamp (DRL) system does not activate the tail lamps and generally may not provide adequate lighting during these conditions. Failure to activate your headlamps under these conditions may result in a collision.

### PANEL DIMMER CONTROL

Use to adjust the brightness of the instrument panel and all applicable switches in the vehicle during headlamp and parklamp operation.

Move the control to the full upright position, past detent, to turn on the interior lamps.

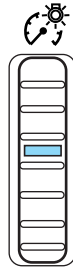

### AIMING THE HEADLAMPS

The headlamps on your vehicle are properly aimed at the assembly plant. If your vehicle has been in an accident the alignment of your headlamps should be checked by your authorized dealer.

#### Vertical aim adjustment

1. Park the vehicle directly in front of a wall or screen on a level surface, approximately 25 feet (7.6 meters) away.

## Lights

- (1) 8 feet (2.4 meters)
- (2) Center height of lamp to ground
- (3) 25 feet (7.6 meters)
- (4) Horizontal reference line

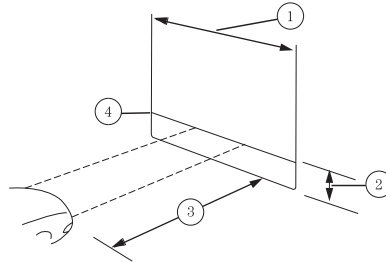

2. Measure the height of the headlamp bulb center from the ground and mark an 8 foot (2.4 meter) horizontal reference line on the vertical wall or screen at this height (a piece of masking tape works well).

3. Turn on the low beam headlights to illuminate the wall or screen and open the hood.

To see a clearer light pattern for adjusting, you may want to block the light from one headlamp while adjusting the other.

4. On the wall or screen you will observe an area of high intensity light. The top of the high intensity area should touch the horizontal reference line, if not, the beam will need to be adjusted.

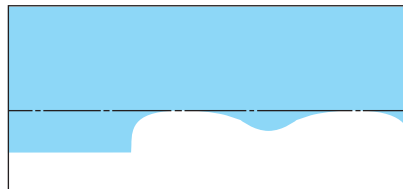

5. Locate the vertical adjuster on each headlamp. Using a Phillips #2 screwdriver, turn the adjuster either clockwise (to adjust down) or counterclockwise (to adjust up). The horizontal edge of the brighter light should touch the horizontal reference line.

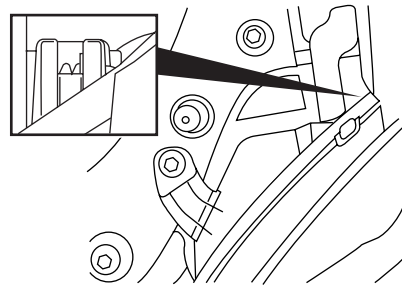

6. Close the hood and turn off the lamps.

HORIZONTAL AIM IS NOT REQUIRED FOR THIS VEHICLE AND IS NON-ADJUSTABLE.

## Lights

### TURN SIGNAL CONTROL ⇐⇒

- Push down to activate the left turn signal.
- Push up to activate the right turn signal.

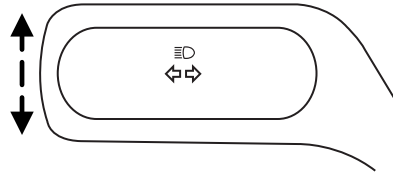

### INTERIOR LAMPS

#### Dome lamps and map lamps

The map lamps are located on the overhead console. Press the controls on either side of each map lamp to turn on the lamps.

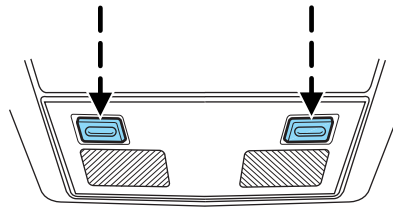

Your vehicle may also have reading lamps within the rear dome lamp(s). Press the switches on either side of the dome lamp to turn on the lamps.

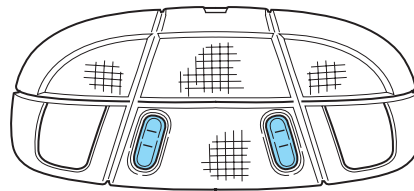

### BULB REPLACEMENT

#### Headlamp Condensation

The headlamps are vented to equalize pressure. When moist air enters the headlamp(s) through the vents, there is a possibility that condensation can occur. This condensation is normal and will clear within 45 minutes of headlamp operation.



## Lights

### Using the right bulbs

Replacement bulbs are specified in the chart below. Headlamp bulbs must be marked with an authorized "D.O.T." for North America and an "E" for Europe to ensure lamp performance, light brightness and pattern and safe visibility. The correct bulbs will not damage the lamp assembly or void the lamp assembly warranty and will provide quality bulb burn time.

Function	Number of bulbs	Trade number
Front park/turn lamp	2	3157AK or 3157A (amber)
Front sidemarker lamp	2	168
Headlamp	2	9008 H13
Tail/brake/turn signal lamp	2	4057K
Backup lamp	2	3156
License plate lamp	2	168
High-mount brake lamp	5	W5W
Foglamp (if equipped)	2	H11 LL
Map lamp	2	12V6W
Dome/reading lamps	6	578
All replacement bulbs are clear in color except where noted.		
To replace all instrument panel lights - see your authorized dealer.		

### Replacing exterior bulbs

Check the operation of all the bulbs frequently.

### Replacing headlamp (high/low beam) bulbs

1. Make sure headlamp switch is in the OFF position, then open the hood.
2. Reach behind the headlamp assembly to access the bulb sockets and connectors.

## Lights

3. Locate the outboardmost electrical connector and remove it by releasing the locking tab and pulling it off.

4. Remove the bulb socket by turning it counterclockwise and pulling it straight out.

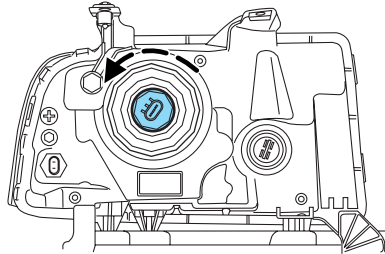

Handle a halogen headlamp bulb carefully and keep out of children's reach. Grasp the bulb only by its plastic base and do not touch the glass. The oil from your hand could cause the bulb to break the next time the headlamps are operated.

Install the new bulb(s) in reverse order.

### **Replacing front parking lamp/turn signal bulbs**

1. Make sure headlamp switch is in the OFF position, then open the hood.
2. Reach behind the headlamp assembly to access the bulb sockets and connectors.
3. Remove the bulb socket by turning it counterclockwise and pulling it straight out.
4. To remove the bulb, pull it straight out of the bulb socket.

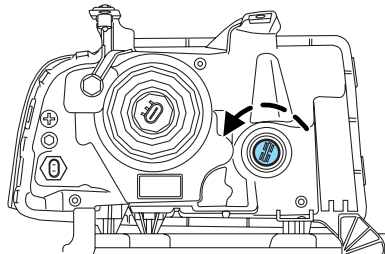

Install the new bulb(s) in reverse order.

### **Replacing front sidemarker bulbs**

1. Make sure headlamp switch is in the OFF position, then open the hood.
2. Reach behind the headlamp assembly to access the bulb sockets and connectors.

## Lights

3. Locate the front sidemarker lamp electrical connector and remove it by pulling it off.
4. Remove the bulb socket by turning it counterclockwise and pulling it straight out.
5. To remove the bulb, pull it straight out of the bulb socket.

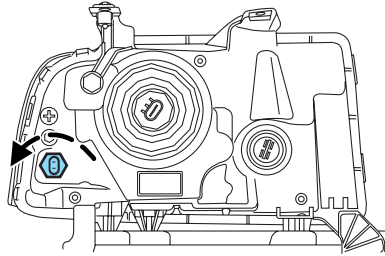

Install the new bulb(s) in reverse order.

### **Replacing stop/tail/turn/backup bulbs**

The stop, tail, turn and backup lamp bulbs are located in the tail lamp assembly. Follow the same steps to replace either bulb.

1. Make sure the headlamp switch is in the OFF position and open the liftgate.
2. Remove the two screws in the liftgate opening, then pull the lamp assembly away from the vehicle.

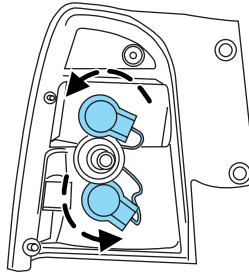

3. Remove the bulb socket by rotating it counterclockwise, then pulling it out of the lamp assembly.
4. Pull the bulb straight from the socket.

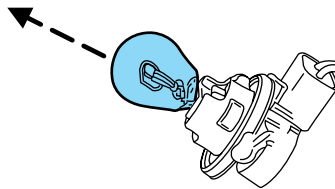

Install new bulb(s) in reverse order.

## Lights

### **Replacing high-mount brake lamp bulbs**

1. Make sure the ignition control is in the OFF position.
2. Remove the two screws.
3. Unclip the bulb holder from the reflector.
4. Pull the bulb straight out.

Install in reverse order.

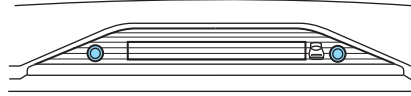

### **Replacing license plate lamp bulbs**

1. Make sure the headlamp switch is in the OFF position.
2. Remove the screw from the license plate lamp assembly and pull it down.
3. Remove bulb socket by turning counterclockwise.
4. Carefully pull the bulb out from the socket.

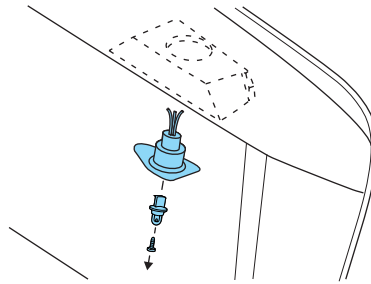

Install new bulb(s) in reverse order.

### **Replacing foglamp bulbs**

1. Make sure the foglamp switch is in the OFF position.
2. Remove the bulb socket from the foglamp by turning counterclockwise.
3. Disconnect the electrical connector.

Install the new bulb in reverse order.

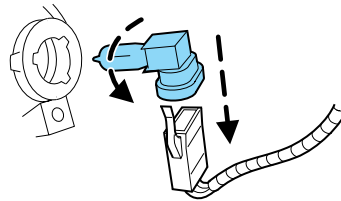

## Driver Controls

### MULTI-FUNCTION LEVER

**Windshield wiper:** For intermittent operation, move control up one position.

Adjust the rotary control to the desired speed setting.

**Mist function:** To activate mist, push control down from the OFF position and release to get one wipe.

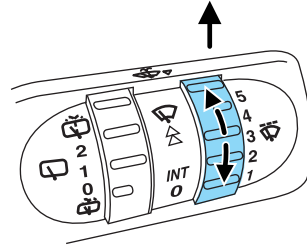

For normal or low speed wiper operation, move control up two positions from OFF.

For high speed wiper operation, move control up three positions from OFF.

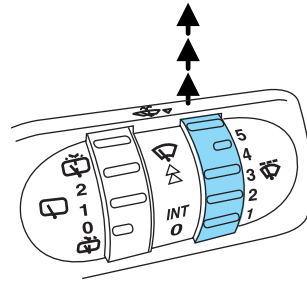

**Windshield washer:** Pull the end of the stalk towards you:

- briefly: causes a single swipe of the wipers without washer fluid.
- a quick pull and hold: the wipers will swipe three times with washer fluid.
- a long pull and hold: the wipers and washer fluid will be activated for up to ten seconds.

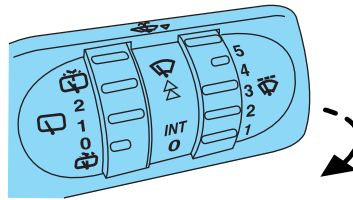

## Driver Controls

### Rear window wiper/washer controls

For rear wiper operation, rotate the rear window wiper and washer control to the desired position. Select:

- 2 — Three to four second interval rear wiper.
- 1 — Ten second interval rear wiper.
- 0 — Rear wiper and washer off.

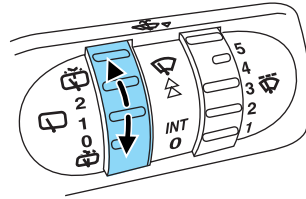

For rear wash cycle, rotate (and hold as desired) the rear wiper/washer control to either  position.

From either position, the control will automatically return to the 2 or 0 (Off) position.

**Rear heated wiper blades:** The wiper blades are heated automatically to reduce ice buildup and activates when the vehicle is started. The wiper rests are designed to operate regardless of the geographic location of the vehicle. There is no switch to turn on, or other operator involvement required other than to start the vehicle.

### TILT STEERING WHEEL

To adjust the steering wheel:

1. Pull down and hold the steering wheel release control.
2. Move the steering wheel up or down until you find the desired location.
3. Pull the steering wheel release control up. This will lock the steering wheel in position.

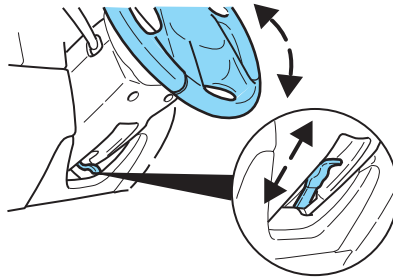

Never adjust the steering wheel when the vehicle is moving.

## Driver Controls

### ILLUMINATED VISOR MIRROR (IF EQUIPPED)

Lift the mirror cover to turn on the visor mirror lamp. The visor will slide back and forth on the rod for increased sunlight coverage.

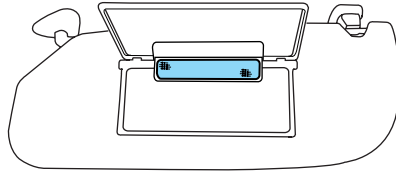

### Slide on rod feature

Rotate the visor towards the side window and extend it rearward for additional sunlight coverage.

**Note:** To stow the visor back into the headliner, visor must be retracted before moving it back towards the windshield.

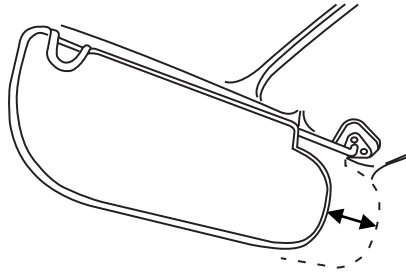

### INSTRUMENT PANEL STORAGE COMPARTMENT

The storage compartment may be used to secure sunglasses or similar sized objects. Press the control to open the storage compartment.

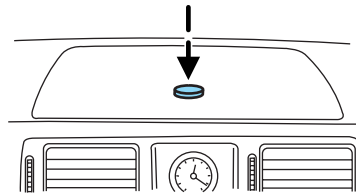

### OVERHEAD CONSOLE

The appearance of your vehicle's overhead console will vary according to your option package.

## Driver Controls

### Storage compartment

Press the latch to open the storage compartment. The door will open slightly and can be moved to full open.

The storage compartment may be used to secure sunglasses or a similar object.

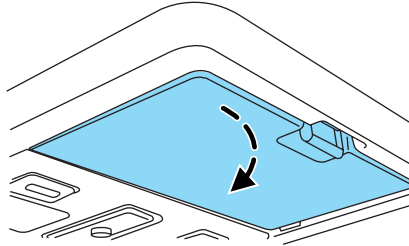

### Conversation mirror (if equipped)

The conversation mirror allows the driver to view the rear seating area.

**This does not replace the rear view mirror.**

Pull down on the housing to lock it in place. Adjust the mirror, as needed, in any direction.

The rear view mirror may have to be adjusted to its lower arm position to prevent interference when the conversation mirror is extended down.

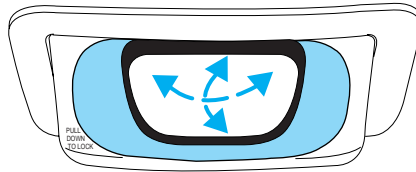

### CENTER CONSOLE

Your vehicle may be equipped with a variety of console features. These include:

- Utility compartment with power point
- Gear Shift
- Cup holders
- Rear vent and cup holders (if equipped)

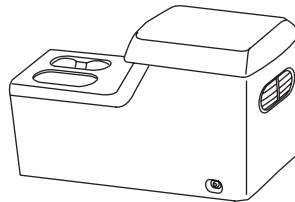

Use only soft cups in the cupholder. Hard objects can injure you in a collision.



## Driver Controls

### Second row center console features (if equipped)

The second row center console incorporates the following features:

- Utility compartment
- Cupholders
- Flip forward armrest to provide a flat load floor



Use only soft cups in the cupholder. Hard objects can injure you in a collision.

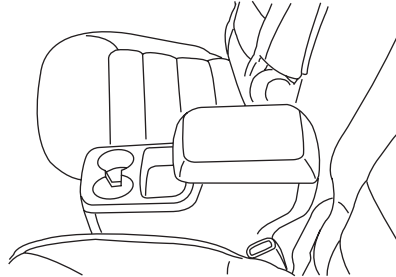

### AUXILIARY POWER POINT (12VDC)

**Power outlets are designed for accessory plugs only. Do not insert any other object in the power outlet as this will damage the outlet and blow the fuse. Do not hang any type of accessory or accessory bracket from the plug. Improper use of the power outlet can cause damage not covered by your warranty.**

The auxiliary power points are located on the instrument panel, in the center console utility compartment and on the left-hand trim panel.

Do not use the power point for operating the cigarette lighter element (if equipped).

To prevent the fuse from being blown, do not use the power point(s) over the vehicle capacity of 12 VDC/180W.

To prevent the battery from being discharged, do not use the power point longer than necessary when the engine is not running.

Always keep the power point caps closed when not being used.

### Cigar/Cigarette lighter (if equipped)

Do not plug optional electrical accessories into the cigarette lighter socket.

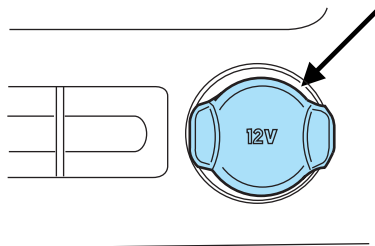



## Driver Controls

Do not hold the lighter in with your hand while it is heating, this will damage the lighter element and socket. The lighter will be released from its heating position when it is ready to be used.

Improper use of the lighter can cause damage not covered by your warranty.

### POWER WINDOWS

 Do not leave children unattended in the vehicle and do not let children play with the power windows. They may seriously injure themselves.

 When closing the power windows, you should verify they are free of obstructions and ensure that children and/or pets are not in the proximity of the window openings.

Press and pull the window switches to open and close windows.

- Push down (to the first detent) and hold the switch to open.
- Pull up (to the first detent) and hold the switch to close.

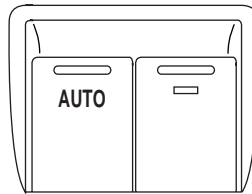

### One touch up or down

This feature is present on the driver's window only.

To operate ONE TOUCH DOWN:

- Press the switch completely down to the second detent and release quickly. The driver's window will open fully. Momentarily press the switch to any position to stop the window operation.

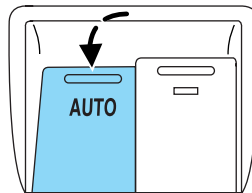

If the switch is pressed and held to the normal close or ONE TOUCH UP position during a ONE TOUCH DOWN event, the window will stop. If, after 1/2 second the switch is still held, the window will perform a normal close or ONE TOUCH UP.

## Driver Controls

To operate ONE TOUCH UP:

- Pull the switch completely up to the second detent and release quickly. The driver's window will close fully. Momentarily press the switch to any position to stop the one touch up.

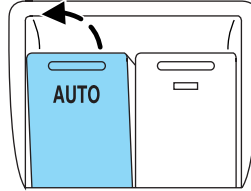

If the switch is pressed and held to the normal open or ONE TOUCH DOWN position during a ONE TOUCH UP event, the window will stop. If, after 1/2 second the switch is still held, the window will perform a normal open or ONE TOUCH DOWN.

### Window lock

The window lock feature allows only the driver to operate the power windows.

To lock out all the window controls except for the driver's press the right side of the control. Press the left side to restore the window controls.

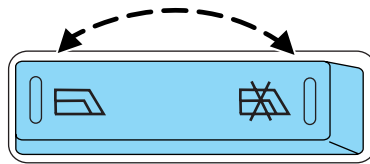

### Bounce-Back (Driver's window only)

When an obstacle has been detected in the window opening as the window is moving upward, the window will automatically reverse direction and move down. This is known as "bounce-back". If the ignition is turned OFF (without accessory delay being active) during bounce-back, the window will move down until the bounce back position is reached.

### Security Override

If during a bounce-back condition, the switch is released to the neutral position, then held in the one touch up position within two seconds after the window reaches the bounce-back position, **the window will travel up with no bounce-back protection.** If the switch is released before the window reaches fully closed or the ignition is turned OFF (without accessory delay being active), the window will stop. Security override can be used if the window movement is restricted in some way, for example, if there is ice on the window or seals.

## Driver Controls

### Accessory delay

With accessory delay, the radio, Family Entertainment DVD System (if equipped), power windows, and moonroof (if equipped) operate for up to ten minutes after the ignition switch is turned from the ON to the OFF position or until one of the front doors are opened.

### AUTOMATIC DIMMING INSIDE REAR VIEW MIRROR (IF EQUIPPED)

Your vehicle may be equipped with an inside rear view mirror with an auto-dimming function. The electronic day/night mirror will change from the normal (high reflective) state to the non-glare (darkened) state when bright lights (glare) reach the mirror. When the mirror detects bright light from behind the vehicle, it will automatically adjust (darken) to minimize glare.

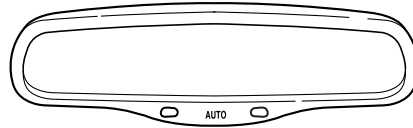

The mirror will automatically return to the normal state whenever the vehicle is placed in R (Reverse) to ensure a bright clear view when backing up.

Do not block the sensor on the backside of the inside rear view mirror since this may impair mirror performance.

### EXTERIOR MIRRORS

#### Power side view mirrors

To adjust your mirrors:

1. Rotate the control clockwise to adjust the right mirror and rotate the control counterclockwise to adjust the left mirror.
2. Move the control in the direction you wish to tilt the mirror.
3. Return to the center position to lock mirrors in place.



## Driver Controls

### **Fold-away mirrors**

Pull the side mirrors in carefully when driving through a narrow space, like an automatic car wash.

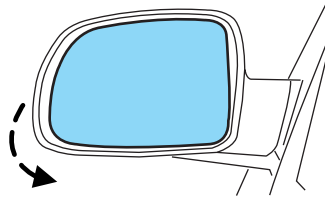

### **Heated outside mirrors (if equipped)**

Both mirrors are heated automatically to remove ice, mist and fog when the rear window defrost is activated.

**Do not remove ice from the mirrors with a scraper or attempt to readjust the mirror glass if it is frozen in place. These actions could cause damage to the glass and mirrors.**

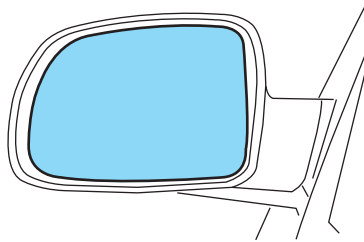

### **POWER ADJUSTABLE FOOT PEDALS (IF EQUIPPED)**

The accelerator and brake pedal should only be adjusted when the vehicle is stopped and the gearshift lever is in the P (Park) position.

Press and hold the rocker control (located on the instrument panel) to adjust accelerator and brake pedal.

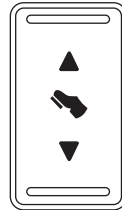

- Press the top of the control to adjust the pedals away from you.
- Press the bottom of the control to adjust the pedals towards you.

The adjustment allows for approximately 2.8 inches (71 mm) of maximum travel.



Never adjust the accelerator and brake pedal with feet on the pedals while the vehicle is moving.

## Driver Controls

### Memory feature (if equipped)

The accelerator and brake pedal positions are saved when doing a memory set function and can be recalled along with the vehicle personality features when a memory position is selected through the remote entry transmitter, keyless entry keypad or memory switch on the driver's door (if equipped with memory feature). Refer to *Memory seats/mirrors/adjustable pedals* in the *Seating and Safety Restraints* chapter.

### SPEED CONTROL

With speed control set, you can maintain a speed of 30 mph (48 km/h) or more without keeping your foot on the accelerator pedal. Speed control does not work at speeds below 30 mph (48 km/h).



Do not use the speed control in heavy traffic or on roads that are winding, slippery or unpaved.

### Setting speed control

The controls for using your speed control are located on the steering wheel for your convenience.

1. Press the ON control and release it.
2. Accelerate to the desired speed.
3. Press the SET + control and release it.
4. Take your foot off the accelerator pedal.
5. The indicator  light on the instrument cluster will turn on.

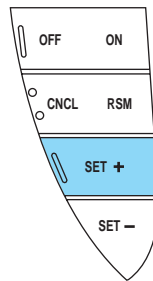
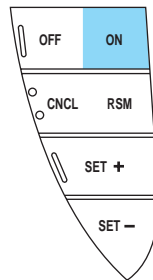

## Driver Controls

### Note:

- Vehicle speed may vary momentarily when driving up and down a steep hill.
- If the vehicle speed increases above the set speed on a downhill, you may want to apply the brakes to reduce the speed.
- If the vehicle speed decreases more than 10 mph (16 km/h) below your set speed on an uphill, your speed control will disengage.

### Disengaging speed control

To disengage the speed control:

- Depress the brake pedal or press CNCL (Cancel).

Disengaging the speed control will not erase previous set speed.

### Resuming a set speed

Press the RES control and release it. This will automatically return the vehicle to the previously set speed. The RES control will not work if the vehicle speed is not faster than 30 mph (48 km/h).

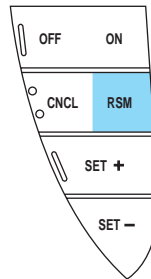

### Increasing speed while using speed control

There are two ways to set a higher speed:

- Press and hold the SET + control until you get to the desired speed, then release the control. You can also use the SET + control to operate the Tap-Up function. Press and release this control to increase the vehicle set speed in small amounts by 1 mph (1.6 km/h).
- Use the accelerator pedal to get to the desired speed. When the vehicle reaches that speed press and release the SET + control.

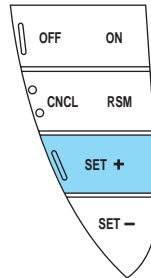

## Driver Controls

### Reducing speed while using speed control

There are two ways to reduce a set speed:

- Press and hold the SET - control until you get to the desired speed, then release the control. You can also use the SET - control to operate the Tap-Down function. Press and release this control to decrease the vehicle set speed in small amounts by 1 mph (1.6 km/h).
- Depress the brake pedal or press CNCL (Cancel) until the desired vehicle speed is reached, press the SET + control.

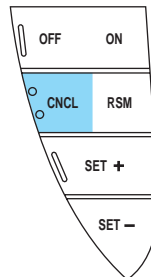
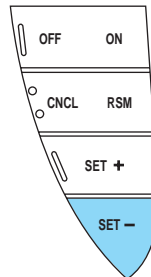

### Turning off speed control

There are two ways to turn off the speed control:

- Depress the brake pedal or press CNCL (Cancel). This will not erase your vehicle's previously set speed.
- Press the speed control OFF control.

**Note:** When you turn off the speed control or the ignition, your speed control set speed memory is erased.

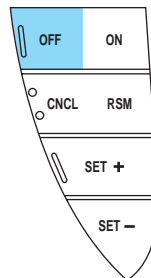



## Driver Controls

### STEERING WHEEL CONTROLS (IF EQUIPPED)

#### Radio control features

- Press MEDIA to select AM, FM1, FM2, or CD (if equipped).

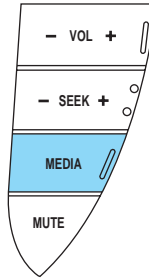

In Radio mode:

- Press SEEK to access the next/previous strong station.

In CD mode:

- Press SEEK to listen to the next track on the disc.

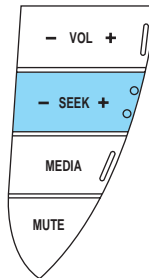

In any mode:

- Press VOL up or down to adjust the volume.
- Press MUTE to mute the volume.

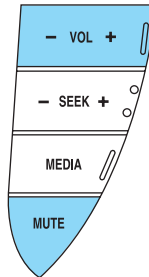

### MOON ROOF (IF EQUIPPED)

You can move the glass panel of the moon roof back to open or tilt up to ventilate the vehicle.



Do not let children play with the moon roof or leave children unattended in the vehicle. They may seriously hurt themselves.

## Driver Controls

### To open the moon roof:

The moon roof is equipped with an automatic, one-touch, express opening and closing feature. To stop motion at any time during the one-touch operation, press the control a second time.

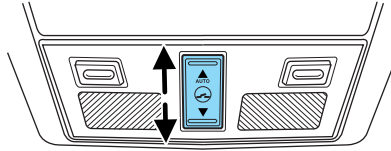

To open the moon roof, press and release the rear portion of the control.



When closing the moon roof, you should verify that it is free of obstructions and ensure that children and/or pets are not in the proximity of the moon roof opening.

### To close the moon roof:

To close, press and release the front portion of the control.

### To vent:

To tilt the moon roof into the vent position (when the glass panel is closed), press and hold the middle portion of the control. To close the moon roof from the vent position, press and hold the front portion of the control until the glass panel stops moving.

The moon roof has a sliding shade that can be opened or closed when the glass panel is shut. To close the shade, pull it toward the front of the vehicle.

### HOMELINK® WIRELESS CONTROL SYSTEM (IF EQUIPPED)

The HomeLink® Wireless Control System, located on the driver's visor, provides a convenient way to replace up to three hand-held transmitters with a single built-in device. This feature will learn the radio frequency codes of most transmitters to operate garage doors, entry gate operators, security systems, entry door locks, and home or office lighting.

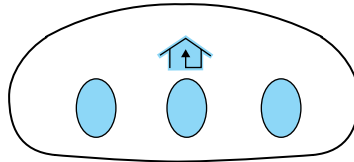

When programming your HomeLink® Wireless Control System to a garage door or gate, be sure that people and objects are out of the way to prevent potential harm or damage.

## Driver Controls

Do not use the HomeLink® Wireless Control System with any garage door opener that lacks safety stop and reverse features as required by U.S. federal safety standards (this includes any garage door opener model manufactured before April 1, 1982). A garage door which cannot detect an object, signaling the door to stop and reverse, does not meet current U.S. federal safety standards. For more information, contact HomeLink® at: **www.homelink.com** or **1-800-355-3515**.

Retain the original transmitter for use in other vehicles as well as for future programming procedures (i.e. new HomeLink® equipped vehicle purchase). It is also suggested that upon the sale of the vehicle, the programmed Homelink® buttons be erased for security purposes, refer to *Programming* in this section.

### Programming

**Do not program HomeLink® with the vehicle parked in the garage.**

**Note:** Your vehicle may require the ignition switch to be turned to the ACC position for programming and/or operation of the HomeLink®. It is also recommended that a new battery be placed in the hand-held transmitter of the device being programmed to HomeLink® for quicker training and accurate transmission of the radio-frequency signal.

1. Press and hold the two outside buttons releasing only when the indicator light begins to flash after 20 seconds. **Do not** repeat Step 1 to program additional hand-held transmitters to the remaining two HomeLink® buttons. This will erase previously programmed hand-held transmitter signals into HomeLink®.

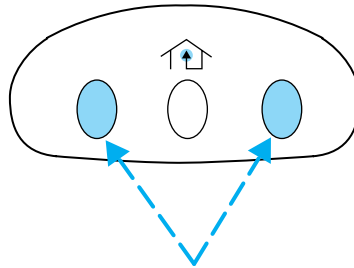

2. Position the end of your hand-held transmitter 1-3 inches (2-8 cm) away from the HomeLink® button you wish to program (located on your visor) while keeping the indicator light in view.

## Driver Controls

3. Simultaneously press and hold both the HomeLink® and hand-held transmitter button. **Do not release the buttons until Step 4 has been completed.**

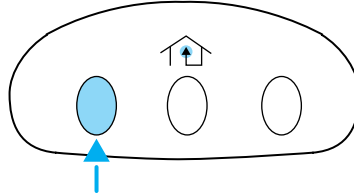

Some entry gates and garage door openers may require you to replace Step 3 with procedures noted in the “Gate Operator and Canadian Programming” in this section for Canadian residents.

4. The indicator light will flash slowly and then rapidly. Release both buttons when the indicator light flashes rapidly. (The rapid flashing light indicates acceptance of the hand-held transmitters’ radio frequency signals.)

5. Press and hold the just-trained HomeLink® button and observe the indicator light. If the light is constant, programming is complete and your device should activate when the HomeLink® button is pressed and released. **Note:** To program the remaining two HomeLink® buttons, begin with Step 2 in the “Programming” section — **do not** repeat Step 1.

**Note:** If the indicator light blinks rapidly for two seconds and then turns to a continuous red, proceed with Steps 6 through 8 to complete programming of a rolling code equipped device.

6. At the garage door opener receiver (motor-head unit) in the garage, locate the “learn” or “smart” button (usually near where the hanging antenna wire is attached to the unit).

7. Press and release the “learn” or “smart” button. (The name and color of the button may vary by manufacturer.)

**Note:** There are 30 seconds in which to initiate Step 8.

8. Return to the vehicle and firmly press, hold for two seconds and release the HomeLink® button. Repeat the press/hold/release sequence again, and, depending on the brand of the garage door opener (or other rolling code equipped device), repeat this sequence a third time to complete the programming.

HomeLink® should now activate your rolling code equipped device. To program additional HomeLink® buttons begin with Step 2 in the “Programming” section. For questions or comments, please contact HomeLink at **www.homelink.com** or **1-800-355-3515**.

## Driver Controls

### Gate Operator & Canadian Programming

During programming, your hand-held transmitter may automatically stop transmitting — not allowing enough time for HomeLink® to accept the signal from the hand-held transmitter.

After completing Steps 1 and 2 outlined in the “Programming” section, replace Step 3 with the following:

**Note:** If programming a garage door opener or gate operator, it is advised to unplug the device during the “cycling” process to prevent overheating.

- Continue to press and hold the HomeLink® button (note Step 3 in the “Programming” section) while you press and release — **every two seconds** (“cycle”) your hand-held transmitter until the frequency signal has been accepted by the HomeLink®. The indicator light will flash slowly and then rapidly after HomeLink® accepts the radio frequency signal.
- Proceed with Step 4 in the “Programming” section.

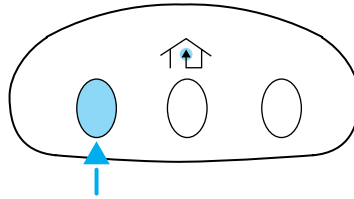

### Operating the HomeLink® Wireless Control System

To operate, simply press and release the appropriate HomeLink® button. Activation will now occur for the trained product (garage door, gate operator, security system, entry door lock, or home or office lighting etc.). For convenience, the hand-held transmitter of the device

may also be used at any time. In the event that there are still programming difficulties, contact HomeLink® at [www.homelink.com](http://www.homelink.com) or **1-800-355-3515**.

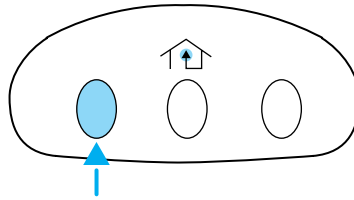

## Driver Controls

### Erasing HomeLink® buttons

To erase the three programmed buttons (individual buttons cannot be erased):

- Press and hold the two outer HomeLink® buttons until the indicator light begins to flash—after 20 seconds. Release both buttons. Do not hold for longer than 30 seconds.

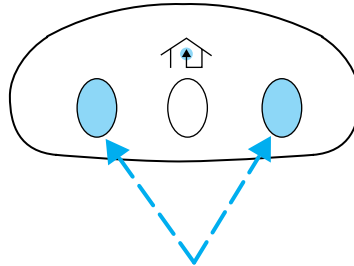

HomeLink® is now in the train (or learning) mode and can be programmed at any time beginning with Step 2 in the “Programming” section.

### Reprogramming a single HomeLink® button

To program a device to HomeLink® using a HomeLink® button previously trained, follow these steps:

1. Press and hold the desired HomeLink® button. **Do NOT** release the button.
2. The indicator light will begin to flash after 20 seconds. Without releasing the HomeLink® button, follow Step 2 in the “Programming” section.

For questions or comments, contact HomeLink® at [www.homelink.com](http://www.homelink.com) or **1-800-355-3515**.

### MESSAGE CENTER (IF EQUIPPED)

With the ignition in the ON position, the message center, located on your instrument cluster, displays important vehicle information

**through a constant monitor of vehicle systems.** You may select

display features on the message center for a display of status. The system will also notify you of potential vehicle problems with a display of system warnings followed by a long indicator chime.



## Driver Controls

### Selectable features

#### **Reset**

Press this control to select and reset functions shown in the INFO menu and SETUP menu.

#### **Info menu**

This control displays the following control displays:

- Odometer
- Distance to Empty
- Average Fuel Economy
- Trip Odometer
- Fuel Used
- Trip Elapsed Drive Time
- Compass

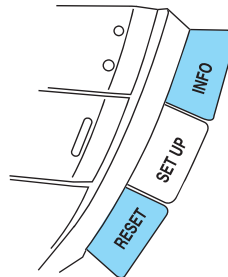

#### **Odometer/Trip odometer**

Refer to *Gauges* in the *Instrument Cluster* chapter.

#### **Distance to empty (DTE)**

Selecting this function from the INFO menu estimates approximately how far you can drive with the fuel remaining in your tank under normal driving conditions.

Remember to turn the ignition OFF when refueling to allow this feature to correctly detect the added fuel.

The DTE function will display LOW FUEL LEVEL when you have approximately 50 miles (80 km) to empty. If you RESET this warning message, this display and tone will return within 10 minutes.

DTE is calculated using a running average fuel economy, which is based on your recent driving history of 500 miles (800 km). This value is not the same as the average fuel economy display. The running average fuel economy is reinitialized to a factory default value if the battery is disconnected.



## Driver Controls

### **Average fuel economy (AFE)**

Select this function from the INFO menu to display your average fuel economy in miles/gallon or liters/100 km.



XX.X MPG  
000000.0 mi

If you calculate your average fuel economy by dividing gallons of fuel used by 100 miles traveled (kilometers traveled by liters used), your figure may be different than displayed for the following reasons:

- Your vehicle was not perfectly level during fill-up
- Differences in the automatic shut-off points on the fuel pumps at service stations
- Variations in top-off procedure from one fill-up to another
- Rounding of the displayed values to the nearest 0.1 gallon (liter)

1. Drive the vehicle at least 5 miles (8 km) with the speed control system engaged to display a stabilized average.
2. Record the highway fuel economy for future reference.

It is important to press the RESET control after setting the speed control to get accurate highway fuel economy readings.

For more information refer to *Fuel Information* in the *Maintenance and Specifications* chapter.

### **Fuel Used**

Selecting this function from the INFO menu, XX.X G USED will display the fuel used since last reset. The information displayed will be in gallons or liters, depending on English/metric mode state. Press and hold RESET to reset mode.



XX.X G USED  
000000.0 mi

### **Trip elapsed drive time**

Select this function from the INFO menu to display a timer.

To operate the Trip Elapsed Drive Time perform the following:

1. Press and release RESET in order to start the timer.



XX:XX:XX  
000000.0 mi



## Driver Controls

2. Press and release RESET to pause the timer.
3. Press and hold RESET for 2 seconds in order to reset the timer.

### **Compass display**

Select this function from the INFO menu. Press the INFO button repeatedly until the Compass and Odometer are displayed. (Do not select Trip, DTE, or AFE. The top of the message center must be blank).

The compass reading may be affected when you drive near large buildings, bridges, power lines and powerful broadcast antenna. Magnetic or metallic objects placed in, on or near the vehicle may also affect compass accuracy.

Usually, when something affects the compass readings, the compass will correct itself after a few days of operating your vehicle in normal conditions. If the compass still appears to be inaccurate, a manual calibration may be necessary. Refer to *Compass zone/calibration adjustment*.

Most geographic areas (zones) have a magnetic north compass point that varies slightly from the northerly direction on maps. This variation is four degrees between adjacent zones and will become noticeable as the vehicle crosses multiple zones. A correct zone setting will eliminate this error. Refer to *Compass zone/calibration adjustment*.

### **Compass zone adjustment**

Perform the following steps on an open area free from steel structures and high voltage lines. For optimum calibration, turn off all electrical accessories (heater / air conditioning, wipers, etc.) and make sure all vehicle doors are shut.

1. Turn ignition to the ON position.
2. Start the engine.
3. Press the INFO button repeatedly until the Compass and Odometer are displayed. (Do not select Trip, DTE, or AFE. The top of the message center must be blank).

**Note:** If message center displays the message "SLOW CIRCLES TO CALIBRATE", then perform the CALIBRATION PROCEDURE.

## Driver Controls

4. Determine your magnetic zone by referring to the zone map.

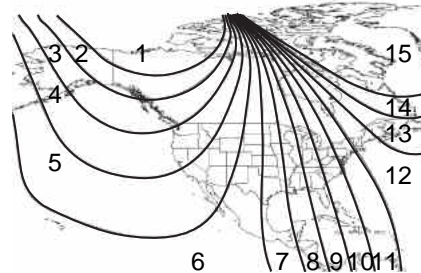

5. Press and hold the RESET until the message center display changes to show the current zone setting.

RESET FOR ZONE  
INFO TO EXIT

6. Release the RESET control, then slowly press RESET down again.

7. Press the SETUP control repeatedly until the correct zone setting for your geographic location is displayed on the message center. To exit the zone setting mode press and release the RESET control.

SETUP ZONE XX  
RESET IF DONE

8. If necessary, press the RESET control to start the compass calibration function.

### **Compass calibration adjustment**

Perform the following steps on an open area free from steel structures and high voltage lines. For optimum calibration, turn off all electrical accessories (heater / air conditioning, wipers, etc.) and make sure all vehicle doors are shut.

1. Turn ignition to the ON position.
2. Start the engine.
3. Press the INFO button repeatedly until the Compass and Odometer are displayed. (Do not select Trip, DTE, or AFE. The top of the message center must be blank).

**Note:** If message center displays the message "SLOW CIRCLES TO CALIBRATE", then continue with Step 4. Otherwise, if a heading is displayed, continue with Step 5.

## Driver Controls

4. Drive the vehicle in circles up to three times until the message "CALIBRATION COMPLETED" appears and one of the 8 valid headings (N, NE, E, SE, S, SW, W, NW) is displayed.

SLOW CIRCLES  
TO CALIBRATE

5. Verify that the calibration process has taken place by driving the vehicle in at least one circle, confirming that the heading changes accordingly. If this happens, the compass has been calibrated successfully. Otherwise, if the display shows only one heading as the vehicle is being driven around, repeat the procedure from Step 3.

### Setup menu

Press this control for the following displays:

- Language
- Units (English/Metric)
- System Check

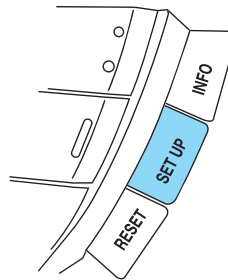

### Language

1. Select this function from the SETUP menu for the current language to be displayed.

ENGLISH  
RESET = NEW

2. Pressing the RESET control cycles the message center through each of the language choices.

FOR ENGLISH  
HOLD RESET

3. Press and hold the RESET control to set the language choice.

SET TO  
ENGLISH

## Driver Controls

### **Units (English/Metric)**

1. Select this function from the SETUP menu for the current units to be displayed.
2. Press the RESET control to change from English to Metric.



UNITS  
> ENG METRIC

### **System check**

Selecting this function from the SETUP menu causes the message center to cycle through each of the systems being monitored. For each of the monitored systems, the message center will indicate either an OK message or a warning message for two to four seconds.



PRESS RESET  
FOR SYS CHECK

Pressing the RESET control cycles the message center through each of the systems being monitored.

The sequence of the system check report is as follows:

1. OIL LIFE
2. DOORS CLOSED
3. LIFTGATE/TRUNK CLOSED
4. CHARGING SYSTEM
5. BRAKE SYSTEM
6. WASHER FLUID LEVEL
7. BRAKE FLUID LEVEL
8. COOLANT LEVEL
9. FUEL LEVEL

### **System warnings**

System warnings alert you to possible problems or malfunctions in your vehicle's operating systems.

In the event of a multiple warning situation, the message center will cycle the display to show all warnings by displaying each one for several seconds.

The message center will display the last selected feature if there are no more warning messages. This allows you to use the full functionality of the message center after you acknowledge the warning by pressing the RESET control and clearing the warning message.

## Driver Controls

Warning messages that have been reset are divided into three categories:

- They will not disappear until a condition is changed.
- They will reappear on the display ten minutes from the reset.
- They will not reappear until an ignition OFF-ON cycle has been completed.

This acts as a reminder that these warning conditions still exist within the vehicle.

Warnings	Status
Driver's door ajar	Warning cannot be reset (CLOSE DOOR TO RESET) will be displayed
Passenger door ajar	
Left rear door ajar	
Right rear door ajar	
Park brake engaged	RELEASE PARK BRAKE will be displayed
Low fuel level	Warning returns after 10 minutes
Check charging system	
Check brake system	
Low brake fluid	Warning returns after the ignition key is turned from OFF to RUN
Liftgate ajar (if equipped)	
Trunk ajar (if equipped)	
Washer Fluid level low	
Change oil soon	
Oil change required	

**DRIVER'S DOOR AJAR.** Displayed when the driver's door is not completely closed.

**PASSENGER DOOR AJAR.** Displayed when the passenger side door is not completely closed.

**LEFT REAR DOOR AJAR.** Displayed when the left rear door is not completely closed.

**RIGHT REAR DOOR AJAR.** Displayed when the right rear door is not completely closed.

**PARK BRAKE ENGAGED.** Displayed when the park brake is engaged. If the warning stays on after the park brake is off, contact your authorized dealer as soon as possible.

## Driver Controls

**LOW FUEL LEVEL.** Displayed as an early reminder of a low fuel condition.

**CHECK CHARGING SYSTEM.** Displayed when the electrical system is not maintaining proper voltage. If you are operating electrical accessories when the engine is idling at a low speed, turn off as many of the electrical loads as possible. If the warning stays on or comes on when the engine is operating at normal speeds, have the electrical system checked as soon as possible.

**CHECK BRAKE SYSTEM.** Displayed when the brake system needs servicing. If the warning stays on or continues to come on, contact your authorized dealer as soon as possible.

**LOW BRAKE FLUID.** Indicates the brake fluid level is low and the brake system should be inspected immediately. Refer to *Brake fluid reservoir* in the *Maintenance and Specifications* chapter.

**LIFTGATE AJAR (if equipped).** Displayed when the liftgate is not completely closed.

**TRUNK AJAR (if equipped).** Displayed when the trunk is not completely closed.

**LOW WASHER FLUID LEVEL.** Indicates the washer fluid reservoir is less than one quarter full. Check the washer fluid level. Refer to *Windshield washer fluid* in the *Maintenance and Specifications* chapter.

**CHANGE OIL SOON/OIL CHANGE REQUIRED.** Oil Life XX%, CHANGE SOON/OIL LIFE 0%, CHANGE OIL, OIL LIFE XX%, CHANGE SOON displayed when the engine oil life remaining is 10 percent and again when the engine oil life remaining is between 5% and 1%. When oil life left reaches 0%, the OIL LIFE 0%, CHANGE OIL message will be displayed.

An oil change is required whenever indicated by the message center and according to the recommended maintenance schedule. USE ONLY RECOMMENDED ENGINE OILS.

To reset the oil monitoring system to 100% after each oil change [approximately 5,000 miles (8,000 km) or 180 days] perform the following:

## Driver Controls

### To reset the oil life to 100% with system warnings CHANGE OIL SOON/OIL CHANGE REQUIRED displayed:

1. Select this function from the SETUP control for current display mode.

OIL LIFE XX%  
RESET IF NEW

2. Press and release the RESET control to display "IF NEW OIL HOLD RESET".

IF NEW OIL  
HOLD RESET

3. Press and hold the RESET control to display OIL LIFE SET TO 100%. Your oil life is now reset.

OIL LIFE SET  
TO 100%

### To set the oil life to 100% without system warnings displayed:

Press SETUP to display "PRESS RESET FOR SYS CHECK".

PRESS RESET  
FOR SYS CHECK

1. Press RESET to start the System Check which will display "OIL LIFE XX% RESET IF NEW".

OIL LIFE XX%  
RESET IF NEW

2. Press and hold the RESET until "IF NEW OIL HOLD RESET" is displayed, then release.

IF NEW OIL  
HOLD RESET

3. Press and hold RESET control again until OIL LIFE SET TO 100% is displayed. Your oil life is now reset.

OIL LIFE SET  
TO 100%

## Driver Controls

### LIFTGATE

Unlock the liftgate (but do not release it) with the power door lock system and remote entry transmitter.

To open the liftgate, pull the liftgate handle rearward.

- Do not open the liftgate in a garage or other enclosed area with a low ceiling. If the liftgate is opened, the liftgate could be damaged against a low ceiling.
- Do not leave the liftgate open while driving. Doing so could cause serious damage to the liftgate and its components as well as allowing carbon monoxide to enter the vehicle.

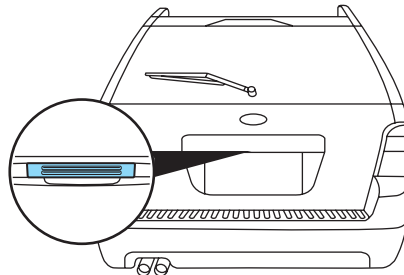

 Make sure that the liftgate door is closed to prevent exhaust fumes from being drawn into the vehicle. This will also prevent passengers and cargo from falling out. If you must drive with the liftgate door open, keep the vents open so outside air comes into the vehicle.

### CARGO AREA FEATURES

#### Cargo net (if equipped)

The cargo pouch net secures lightweight objects in the cargo area. Attach the net to the anchors provided. Do not put more than 50 lbs. (22 kg) in the net.

 The cargo net is not designed to restrain objects during a collision or heavy braking.

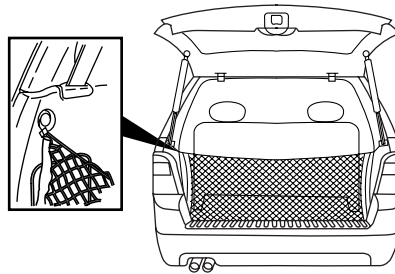



## Driver Controls

### **Cargo van storage compartment (if equipped)**

The cargo van storage compartment consists of two storage compartments located in the floor of the cargo area.

1. To open, unlock and turn the handle to lift the cover.
2. To close, lower the cover and turn the handle to lock.

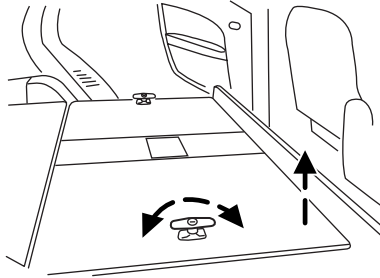

### **LUGGAGE RACK**

Maximum load is 125 lbs (57 kg) on the roof rack structure, or 100 lbs (45 kg) on the roof panel, evenly distributed. If it is not possible to distribute the load, position it as far rearward as possible.

## Locks and Security

### KEYS

One key operates all the locks and starts the vehicle. Always carry a spare key with you in case of an emergency.

Your keys are programmed to your vehicle; using a non-programmed key will not permit your vehicle to start. If you lose your authorized dealer supplied keys, replacement keys are available through your authorized dealer. Refer to the *SecuriLock<sup>™</sup> passive anti-theft system* section later in this chapter for more information.

### POWER DOOR LOCKS

Press control to unlock or lock all doors.

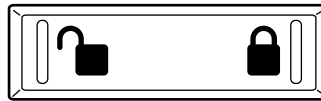

### Smart locks

This feature attempts to help prevent you from locking yourself out of the vehicle if your key is still in the ignition.

When you open the driver's door and you lock the vehicle with the power door lock control (on the driver or passenger door trim panel), all the doors will lock, then the driver's door will automatically unlock reminding you that your key is still in the ignition.

The vehicle can still be locked, with the key in the ignition, using the manual lock control on the door, locking the driver's door with a key, or using the lock control on the remote entry transmitter.

If the driver's door is closed, then the vehicle can be locked from any method, regardless of whether the key is in the ignition or not.

### Power door lock/unlock inhibit feature

As a theft deterrent, the power door lock controls can be disabled 20 seconds after the ignition has been turned to the 1 (LOCK) position and the vehicle is locked using the remote entry transmitter or the key in the door lock cylinder. The door lock controls are re-enabled when the vehicle is unlocked using the key in the door lock cylinder, the keypad, or by pressing  on the remote entry transmitter. This feature can be turned on or off using the following procedure:

Before starting, ensure the ignition is in the 1 (LOCK) position and all vehicle doors are closed. You must complete Steps 1–5 within 30 seconds or the procedure will have to be repeated.

## Locks and Security

1. Place the key in the ignition and turn the ignition to the 3 (RUN) position.
2. Press the power door unlock control on the door panel three times.
3. Turn the ignition from the 3 (RUN) position to the 1 (LOCK) position.
4. Press the power door unlock control on the door panel three times.
5. Turn the ignition back to the 3 (RUN) position. The horn will chirp one time to confirm programming mode has been entered and is active.
6. Press the power door lock control on the door panel two times within five seconds. The horn will chirp two times to confirm the feature is off; the horn will chirp two times and honk one time to confirm the feature is on.
7. Turn the ignition from the 3 (RUN) position to the 1 (LOCK) position. The horn will chirp one time to confirm the programming mode has been exited.

Repeat the procedure to turn the feature on or off.

### CHILDPROOF DOOR LOCKS

- Move control up to engage the childproof lock.
- Move control down to disengage childproof lock.

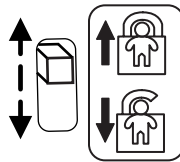

The childproof locks are located on rear edge of each rear door and must be set separately for each door. Setting the lock for one door will not automatically set the lock for both doors.

- When the childproof door locks are set, the rear doors cannot be opened from the inside.
- The rear doors can be opened from the outside when the power door locks are unlocked.

## Locks and Security

### REMOTE ENTRY SYSTEM

This device complies with part 15 of the FCC rules and with RS-210 of Industry Canada. Operation is subject to the following two conditions: (1) This device may not cause harmful interference, and (2) This device must accept any interference received, including interference that may cause undesired operation.

**Changes or modifications not expressly approved by the party responsible for compliance could void the user's authority to operate the equipment.**

The typical operating range for your remote entry transmitter is approximately 33 feet (10 meters). A decrease in operating range could be caused by:

- weather conditions,
- nearby radio towers,
- structures around the vehicle, or
- other vehicles parked next to your vehicle.

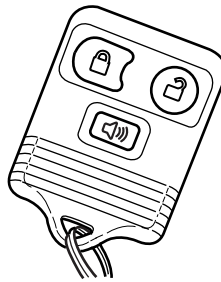

The remote entry system allows you to lock or unlock all vehicle doors without a key.



The remote entry lock/unlock feature operates in any ignition position. The panic feature operates with the key in the 1 (LOCK) or 2 (ACC) position.

If there is any potential remote keyless entry problem with your vehicle, ensure **ALL** remote entry transmitters are brought to the authorized dealer to aid in troubleshooting.

### Unlocking the doors

1. Press  and release to unlock the driver's door. **Note:** The interior lamps will illuminate.
2. Press  and release again within three seconds to unlock all the doors.

## Locks and Security

The remote entry system activates the illuminated entry feature; this feature turns on the lamps for 25 seconds or until the ignition is turned to the 3 (RUN) position.

The inside lights will not turn off if:

- they have been turned on using the dimmer control or
- any door is open.

The battery saver feature will turn off the interior lamps 30 minutes after the ignition is turned to the 1 (LOCK) position.

### Locking the doors/liftgate

1. Press  and release to lock all the doors and liftgate. The turn lamps will flash. **Note:** If any door or the liftgate is not closed properly, the lamps will not flash.

2. Press  and release again within three seconds to confirm that all the doors are closed. **Note:** The doors will lock again, the horn will chirp and the turn lamps will flash once if all the doors and liftgate are closed. If any door or the liftgate is not closed, or if the hood is not closed in vehicles equipped with the perimeter alarm feature, the horn will chirp twice and the lamps will not flash.

### Sounding a panic alarm

Press  to activate the alarm. The horn will sound and the turn lamps will flash for a maximum of 3 minutes. Press again or turn the ignition to the 3 (RUN) position to deactivate, or wait for the alarm to timeout in 3 minutes.

**Note:** The panic alarm will only operate when the ignition is in the 1 (LOCK) or 2 (ACC) position.

### Memory seats/power mirrors/adjustable pedals (if equipped)

The remote entry system can also control the memory seat /power mirrors/adjustable pedals feature.

Press  to automatically move the seat, mirrors and adjustable pedals to the desired memory position (the positions correspond to the transmitter being used). **Note:** You can associate a specific remote entry transmitter to each memory position. For more information on programming the transmitters to Driver 1 and Driver 2 memory positions respectively, refer to *How to reprogram your remote entry transmitters* later in this chapter.

## Locks and Security

### Activating the memory seat feature

To activate this feature:

1. Position the seat, mirrors and adjustable pedals to the position desired.
2. Press the SET control on the driver's door panel.
3. Within 5 five seconds, press the 1 or 2 control on the driver's door panel to which you would like to associate with the seat, mirrors and adjustable pedals and Driver 1 or Driver 2 positions.
4. Repeat this procedure for the other Driver position if desired.

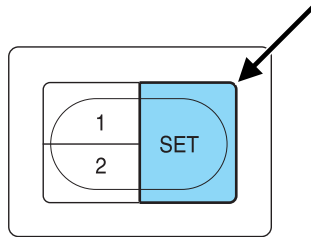

### Replacing the battery

The remote entry transmitter uses one coin type three-volt lithium battery CR2032 or equivalent.

To replace the battery:

1. Twist a thin coin between the two halves of the remote entry transmitter near the key ring. DO NOT TAKE THE RUBBER COVER AND CIRCUIT BOARD OFF THE FRONT HOUSING OF THE REMOTE ENTRY TRANSMITTER.

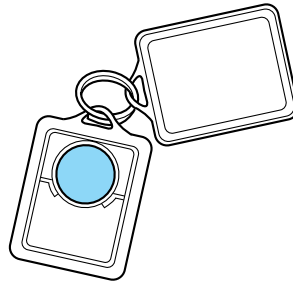

2. Do not wipe off any grease on the battery terminals on the back surface of the circuit board.

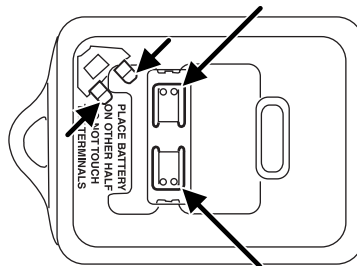

## Locks and Security

3. Remove the old battery. **Note:** Please refer to local regulations when disposing of transmitter batteries.
4. Insert the new battery. Refer to the diagram inside the remote entry transmitter for the correct orientation of the battery. Press the battery down to ensure that the battery is fully seated in the battery housing cavity.
5. Snap the two halves back together.

**Note:** Replacement of the battery will **not** cause the remote transmitter to become deprogrammed from your vehicle. The remote transmitter should operate normally after battery replacement.

### Replacing lost remote entry transmitters

If you would like to have your remote entry transmitter reprogrammed because you lost one, or would like to buy additional remote entry transmitters, you can either reprogram them yourself, or take **all remote entry transmitters** to your authorized dealer for reprogramming.

**Note:** If your vehicle is equipped with the memory seats/power mirrors/adjustable pedals feature, you can associate a remote entry transmitter to each memory position using this procedure. The first transmitter that is programmed will recall Driver 1 settings, and the second transmitter that is programmed will recall Driver 2 settings.

### How to reprogram your remote entry transmitters

You must have **all remote entry transmitters** (maximum of four) available before beginning this procedure.

To reprogram the remote entry transmitters:

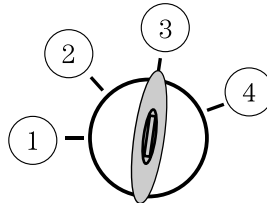

1. Ensure the vehicle is electronically unlocked.
2. Put the key in the ignition.
3. Cycle eight times rapidly (within 10 seconds) between the 1 (LOCK) position and 3 (RUN). **Note:** The eighth turn must end in the 3 (RUN) position.

## Locks and Security

4. The doors will lock, then unlock, to confirm that the programming mode has been activated.
5. Within 20 seconds press any button on the remote entry transmitter to be programmed. **Note:** If more than 20 seconds have passed you will need to start the procedure over again.
6. The doors will lock, then unlock, to confirm that each remote entry transmitter has been programmed.
7. Repeat Step 5 to program each additional remote entry transmitter.  
**Note:** The first remote transmitter programmed corresponds to Driver 1; the second, Driver 2.
8. Turn the ignition to the 1 (LOCK) position after you have finished programming all of the remote entry transmitters. **Note:** If any one of the transmitters is not reprogrammed, it will be erased.
9. The doors will lock, then unlock, to confirm that the programming mode has been exited.

### Illuminated entry

The interior lamps illuminate when the remote entry system or the keyless entry system keypad (if equipped) is used to unlock the door(s).

The illuminated entry system will turn off the interior lights if:

- the ignition is turned to the 3 (RUN) position, or
- the remote transmitter lock control is pressed, or
- after 25 seconds of illumination.

The inside lights will not turn off if:

- they have been turned on with the dimmer control, or
- any door is open.

### Battery saver

The battery saver will shut off the interior lamps 30 minutes after the ignition has been turned to the 1 (LOCK) position.

- If the dome lamps were turned on using the panel dimmer control, the battery saver will shut them off 30 minutes after the ignition has been turned to the 1 (LOCK) position.
- If the courtesy lamps were turned on because one of the vehicle doors was opened, the battery saver will shut them off 10 minutes after the ignition has been turned to the 1 (LOCK) position.
- The battery saver will shut off the headlamps and foglamps 10 minutes after the ignition has been turned to the 1 (LOCK) position.



## Locks and Security

### Illuminated exit

- When all vehicle doors and the liftgate are closed, and the key is removed from the ignition, the interior dome lamps (and the exterior mirror puddle lamps, if equipped) will illuminate.

The lights will turn off if all the doors and the liftgate remain closed and

- 25 seconds elapse, or
- the key is inserted in the ignition.

### KEYLESS ENTRY SYSTEM

You can use the keyless entry keypad to:

- lock or unlock the doors without using a key.
- activate or deactivate the autolock feature.

The keypad can be operated with the factory set 5-digit entry code; this code is located on the owner's wallet card in the glove box, is marked on the computer module, and is available from your authorized dealer. You can also create your own 5-digit personal entry code.

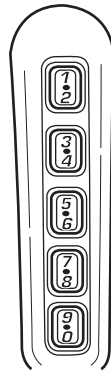

When pressing the controls on the keypad, press the middle of the controls to ensure a good activation.

### Programming a personal entry code and keypad association to memory seats, mirrors and pedals

To create your own personal entry code:

1. Enter the factory set code.
2. Within five seconds press the 1 • 2 on the keypad.
3. Enter your personal 5-digit code. Each number must be entered within five seconds of each other.
4. To associate the entry code with a memory setting, enter a sixth digit to indicate which driver should be set in a memory recalled by the personal entry code:
  - Pressing 1 • 2 recalls Driver 1 settings.

## Locks and Security

- Pressing 3 • 4 recalls Driver 2 settings.
  - Pressing other keypad buttons or not pressing a keypad button as a sixth digit does not set a driver and will not recall a memory setting.  
**Note:** The factory-set code cannot be associated with a memory setting.
5. The doors will again lock then unlock to confirm that your personal keycode has been programmed to the module.

### Tips:

- Do not set a code that uses five of the same number.
- Do not use five numbers in sequential order.
- The factory set code will work even if you have set your own personal code.

### Erasing personal code

1. Enter the factory set 5–digit code.
2. Within five seconds, press the 1 • 2 on the keypad and release.
3. Press and hold the 1 • 2 for two seconds. This must be done within five seconds of completing Step 2.

Your personal code is now erased and only the factory set 5–digit code will work.

### Anti-scan feature

If the wrong code has been entered 7 times (35 consecutive button presses), the keypad will go into an anti-scan mode. This mode disables the keypad for one minute and the keypad lamp will flash.

The anti-scan feature will turn off after:

- one minute of keypad inactivity.
- pressing the UNLOCK  control on the remote entry transmitter.
- the ignition is turned to the 3 (RUN) position.

### Unlocking and locking the doors and liftgate using keyless entry

**To unlock the driver's door,** enter the factory set 5-digit code or your personal code. Each number must be pressed within five seconds of each other. The interior lamps will illuminate.

**To unlock all doors and liftgate,** press the 3 • 4 control within five seconds.

## Locks and Security

**To lock all doors and liftgate**, press the 7 • 8 and the 9 • 0 at the same time. **Note:** The driver's door must be closed. You **do not** need to enter the keypad code first.

### **Autolock**

The autolock feature will lock all the doors and liftgate when:

- all the doors and liftgate are closed,
- the ignition is in the 3 (RUN) position,
- you shift into any gear putting the vehicle in motion, and
- the brake pedal is released and the vehicle attains a speed greater than 5 mph (8 km/h).

The autolock feature repeats when:

- any door or the liftgate is opened then closed while the ignition is in the 3 (RUN) position, and
- you put the vehicle in motion by releasing the brake pedal and the vehicle attains a speed greater than 5 mph (8 km/h).

### **Deactivating/activating autolock**

Your vehicle comes with the autolock feature activated. There are three methods to enable/disable this feature: One is through your authorized dealer, the second with a power door unlock/lock sequence, and the third with the keypad.

Before following the activation or deactivation procedures, make sure that the anti-theft system is not armed, ignition is off, and all vehicle doors and liftgate are closed.

### **Power door unlock/lock procedure**

You must complete steps 1-5 within 30 seconds or the procedure will have to be repeated. If the procedure needs to be repeated, you must wait 30 seconds.

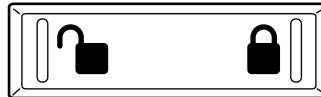

1. Turn the ignition to the 3 (RUN) position.
2. Press the power door unlock control three times.
3. Turn the ignition from the 3 (RUN) to the 1 (LOCK) position.
4. Press the power door unlock control three times.
5. Turn the ignition back to the 3 (RUN) position. The horn will chirp.
6. Press the unlock control, then press the lock control. The horn will chirp once if autolock was deactivated or twice (one short and one long chirp) if autolock was activated.

## Locks and Security

7. Turn the ignition to the 1 (LOCK) position. The horn will chirp once to confirm the procedure is complete.

### **Keyless entry key pad procedure**

1. Turn the ignition to the 1 (LOCK) position.
2. Close all the doors and liftgate.
3. Enter factory-set 5-digit entry code.
4. Press and hold the 7 • 8. While holding the 7 • 8 press the 3 • 4.
5. Release the 3 • 4.
6. Release the 7 • 8.

The user should receive a **horn chirp** to indicate the system has been disabled or a chirp followed by a honk to indicate the system has been enabled.

### **SECURILOCK™ PASSIVE ANTI-THEFT SYSTEM**

SecuriLock™ passive anti-theft system is an engine immobilization system. This system is designed to help prevent the engine from being started unless a **coded key programmed to your vehicle** is used. The use of the wrong type of coded key may lead to a “no-start” condition.

Your vehicle comes with two coded keys; additional coded keys may be purchased from your authorized dealer. The authorized dealer can program your spare keys to your vehicle or you can program the keys yourself. Refer to *Programming spare keys* for instructions on how to program the coded key.

**Note:** The SecuriLock™ passive anti-theft system is not compatible with non-Ford aftermarket remote start systems. Use of these systems may result in vehicle starting problems and a loss of security protection.

**Note:** Large metallic objects, electronic devices that are used to purchase gasoline or similar items, or a second coded key on the same key chain may cause vehicle starting issues. You need to prevent these objects from touching the coded key while starting the engine. These objects will not cause damage to the coded key, but may cause a momentary issue if they are too close to the key when starting the engine. If a problem occurs, turn the ignition off, remove all objects on the key chain away from the coded key and restart the engine.

## Locks and Security

### Anti-theft indicator

The anti-theft indicator is located in the instrument panel cluster.

- When the ignition is in the 1 (LOCK) position, the indicator will flash once every 2 seconds to indicate the SecuriLock™ system is functioning as a theft deterrent.



- When the ignition is in the 3 (RUN) position, the indicator will glow for 3 seconds to indicate normal system functionality.

If a problem occurs with the SecuriLock™ system, the indicator will flash rapidly or glow steadily when the ignition is in the 3 (RUN) position. If this occurs, the vehicle will not start and should be taken to an authorized dealer for service.

### Automatic arming

The vehicle is armed immediately after switching the ignition to the 1 (LOCK) position.

The theft indicator will flash every two seconds to act as a theft deterrent when the vehicle is armed.



### Automatic disarming

The vehicle is disarmed immediately after the ignition is turned from the 1 (LOCK) to the 3 (RUN) position.

The theft indicator will illuminate for three seconds and then go out.

If the theft indicator stays on for an extended period of time or flashes rapidly, have the system serviced by your authorized dealer.

### Replacement keys

If your keys are lost or stolen and you don't have an extra coded key, you will need to have your vehicle towed to an authorized dealer. The key codes need to be erased from your vehicle and new coded keys will need to be programmed.

Replacing coded keys can be very costly. Store an extra programmed key away from the vehicle in a safe place to help prevent any inconveniences. Please visit an authorized dealer to purchase additional spare or replacement keys.

## Locks and Security

### Programming spare keys

You can program your own coded keys to your vehicle.

#### Tips:

- A maximum of eight keys can be coded to your vehicle.
- Only use SecuriLock<sup>™</sup> keys.
- You must have two previously programmed coded keys (keys that already operate your vehicle's engine) and the new unprogrammed key(s) readily accessible.
- If two previously programmed coded keys are not available, you must take your vehicle to your authorized dealer to have the spare key(s) programmed.

Please read and understand the entire procedure before you begin.

1. Insert the first previously programmed **coded key** into the ignition.

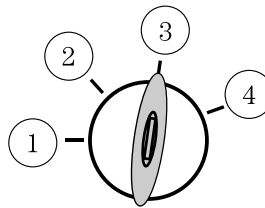

2. Turn the ignition from the 1 (LOCK) position to the 3 (RUN) position. Keep the ignition in the 3 (RUN) position for at least three seconds, but no more than 10 seconds.

3. Turn the ignition to the 1 (LOCK) position and remove the first **coded key** from the ignition.

4. Within ten seconds of turning the ignition to the 1 (LOCK) position, insert the second previously **coded key** into the ignition.

5. Turn the ignition from the 1 (LOCK) position to the 3 (RUN) position. Keep the ignition in the 3 (RUN) position for at least three seconds, but no more than 10 seconds.

6. Turn the ignition to the 1 (LOCK) position and remove the second previously programmed **coded key** from the ignition.

7. Within twenty seconds of turning the ignition to the 1 (LOCK) position and removing the previously programmed **coded key**, insert the new unprogrammed key (new key/valet key) into the ignition.

8. Turn the ignition from the 1 (LOCK) position to the 3 (RUN) position. Keep the ignition in the 3 (RUN) position for at least three seconds but not more than 10 seconds.

102

## Locks and Security

9. Remove the newly programmed **coded key** from the ignition.

If the key has been successfully programmed it will start the vehicle's engine and the theft indicator light will illuminate for three seconds and then go out.

If the key was not successfully programmed, it will not start your vehicle's engine and the theft indicator light will flash on and off. Wait 20 seconds and you may repeat Steps 1 through 8. If failure repeats, bring your vehicle to your authorized dealer to have the new key(s) programmed.

To program additional new unprogrammed key(s), wait twenty seconds and then repeat this procedure from Step 1.

### PERIMETER ALARM SYSTEM (IF EQUIPPED)

The perimeter anti-theft system will help prevent your vehicle from unauthorized entry.

If there is any potential perimeter anti-theft problem with your vehicle, ensure **ALL remote entry transmitters** are brought to the authorized dealer to aid in troubleshooting.

### Arming the system

When armed, this system will help protect your vehicle from unauthorized entry. When unauthorized entry occurs, the system will flash the headlamps and/or parking lamps, and will chirp the horn.

The system is ready to arm whenever the key is removed from the ignition. Any of the following actions will prearm the alarm system:

- Press the  control on the remote entry transmitter.

When you press the lock control twice within three seconds on your remote entry transmitter, the horn will chirp once to let you know that all doors, the hood and the liftgate are closed. If any of these are not closed, the horn will chirp twice to warn you that a door, the hood or the liftgate is still open.

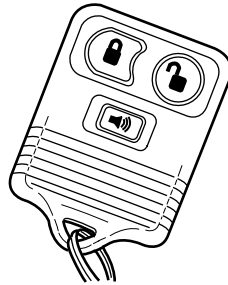

## Locks and Security

- Press the driver or passenger interior door lock control while the door is open, then close the door.

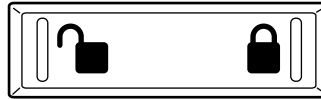

- Press the 7 • 8 and 9 • 0 controls on the keyless entry pad at the same time to lock the doors (driver's door must be closed).

There is a 20 second countdown when any of the above actions occur before the vehicle becomes armed.

Each door, the hood or the liftgate is armed individually, and if any are open, they must be closed for the system to enter the 20 second countdown.

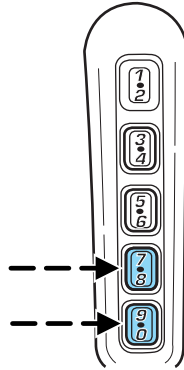

The turn signal lamps will flash once when all doors, the hood or the liftgate are closed indicating the vehicle is locked and entering the 20 second countdown.

### Disarming the system

You can disarm the system by any of the following actions:

- Unlock the doors by using your remote entry transmitter.
- Unlock the doors by using your keyless entry pad.
- Unlock the driver's door with a key. Turn the key full forward (toward the front of the vehicle) to make sure the alarm disarms.
- Turn ignition to the 3 (RUN) position.
- Press the panic control on the remote entry transmitter. This will only shut off the horn and parking lamps when the alarm is sounding. The alarm system will still be armed.

Pressing the power door UNLOCK control within the 20 second prearmed mode will return the vehicle to a disarmed state.

### Triggering the anti-theft system

The armed system will be triggered if:

- Any door, the hood or the liftgate is opened without using the door key, keypad or the remote entry transmitter.



## Seating and Safety Restraints

### SEATING

#### Notes:



Reclining the seatback can cause an occupant to slide under the seat's safety belt, resulting in severe personal injuries in the event of a collision.



Do not pile cargo higher than the seatbacks to reduce the risk of injury in a collision or sudden stop.



Before returning the seatback to its original position, make sure that cargo or any objects are not trapped behind the seatback. After returning the seatback to its original position, pull on the seatback to ensure that it has fully latched. An unlatched seat may become dangerous in the event of a sudden stop or collision.

### Adjustable head restraints

Head restraints help to limit head motion in the event of a rear collision. Adjust your head restraint so that it is located directly or as close as possible behind your head.

The head restraints can be moved up by pulling up on the head restraint.

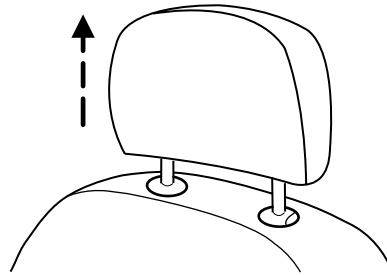

## Seating and Safety Restraints

Push release button to lower head restraint.

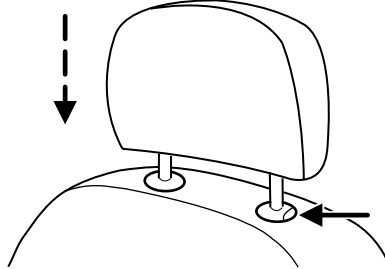

### Adjusting the front manual seat (if equipped)



Never adjust the driver's seat or seatback when the vehicle is moving.



Always drive and ride with your seatback upright and the lap belt snug and low across the hips.

Lift handle to move seat forward or backward.

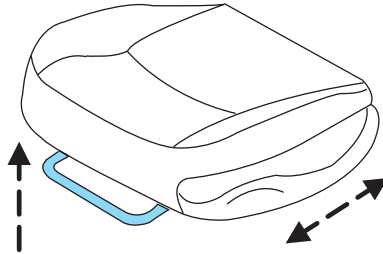

Pull lever up to adjust seatback.

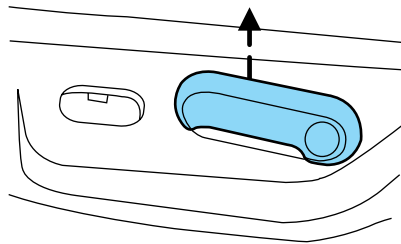

## Seating and Safety Restraints

 Before returning the seatback to its original position, make sure that cargo or any objects are not trapped behind the seatback. After returning the seatback to its original position, pull on the seatback to ensure that it has fully latched. An unlatched seat may become dangerous in the event of a sudden stop or collision.

### Using the manual lumbar support (if equipped)

The lumbar support control is located on the outboard side of the seatback.

Move the control up or down to adjust lumbar support.

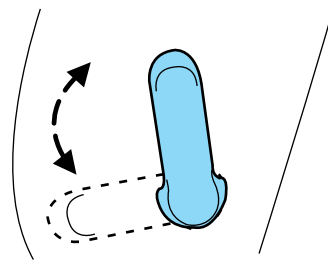

### Folding down the front passenger seatback

The front passenger seatback can be folded to a horizontal position to make room for a long load. To fold the seatback:

1. Move the seat as far back as possible.
2. Push the head restraint release button and move the head restraint fully down.
3. Pull the strap located on the back of the seat to fold the front passenger seatback.
4. Without releasing the pull strap, push the seatback forward.
5. Move the seat as far forward as possible.

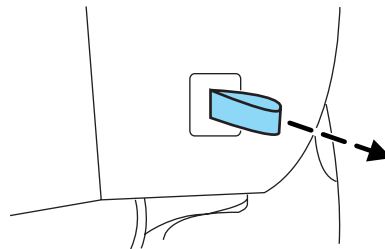



 Cover sharp edges on the load to help prevent injury to occupants. Secure the load to help prevent shifting during sudden stops.

## Seating and Safety Restraints

 Before returning the seatback to its original position, make sure that cargo or any objects are not trapped behind the seatback. After returning the seatback to its original position, pull on the seatback to ensure that it has fully latched. An unlatched seat may become dangerous in the event of a sudden stop or collision.

### Adjusting the front power seat (if equipped)

 Never adjust the driver's seat or seatback when the vehicle is moving.

 Do not pile cargo higher than the seatbacks to reduce the risk of injury in a collision or sudden stop.

 Always drive and ride with your seatback upright and the lap belt snug and low across the hips.

 Reclining the seatback can cause an occupant to slide under the seat's safety belt, resulting in severe personal injuries in the event of a collision.

 Sitting improperly out of position or with the seat back reclined too far can take off weight from the seat cushion and affect the decision of the passenger sensing system, resulting in serious injury or death in a crash. Always sit upright against your seatback, with your feet on the floor.

 To reduce the risk of possible serious injury: Do not hang objects off seat back or stow objects in map pocket (if equipped) when a child is in the front passenger seat. Do not place objects underneath the front passenger seat or between the seat and the center console (if equipped). Check the "passenger airbag off" or "pass airbag off" indicator lamp for proper airbag status. Refer to *Front passenger sensing system* section for additional details. Failure to follow these instructions may interfere with the front passenger seat sensing system.

The control is located on the outboard side of the seat cushion.

## Seating and Safety Restraints

Press the front or rear portion to tilt the seat.

- Driver

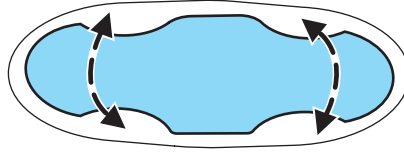

Press the control to move the seat forward, backward, up or down.

- Driver

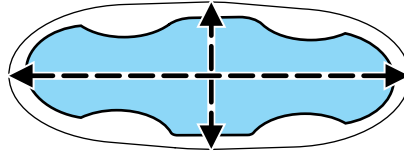

Press the control to move the seat forward, or backward.

- Passenger

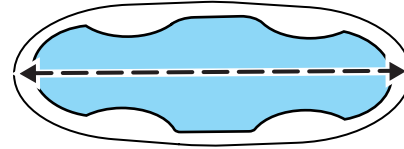

Press the control (if equipped) to recline the seatback forward or rearward.

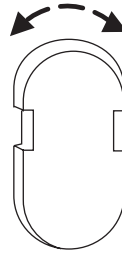

### Heated seats (if equipped)

To operate the heated seats:

- Push the control located on the climate control system panel once to activate high heat.
- Push twice to activate low heat.
- Push a third time to deactivate.



## Seating and Safety Restraints

The indicator light on the control will illuminate when activated. For low heat, one light will be lit; for high heat, both lights will be lit.

The heating of the seat turns off after 10 minutes or when the vehicle is turned off.

### Memory seats/power mirrors/adjustable pedals (if equipped)

This system allows automatic positioning of the driver seat, power mirrors, and adjustable pedals to two programmable positions.

The memory seat control is located on the driver door.

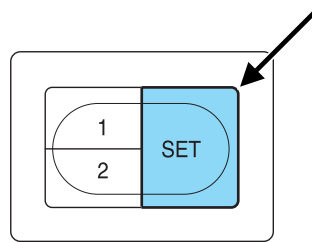

- To program position 1, move the driver seat, mirrors and pedals (if equipped) to the desired position using the associated controls. Press the SET control. The SET control indicator light will briefly illuminate. While the light is illuminated, press control 1.
- To program position 2, repeat the previous procedure using control 2.

A position can be recalled:

- in any gearshift position if the ignition is **not** in the RUN position.
- only in P (Park) or N (Neutral) if the ignition is in the RUN position.

A memory seat position may be programmed at any time.

The memory positions are also recalled when you press your remote entry transmitter UNLOCK control (if the transmitter is programmed to a memory position) or, when you enter a valid personal entry code that is programmed to a memory position.

To program the memory feature to a remote entry transmitter and for more information on how to use the keypad, refer to *Remote entry system* in the *Locks and Security* chapter.

## REAR SEATS

### Head restraints

Lift the head restraint so that it is located directly or as close as possible behind your head.

## Seating and Safety Restraints

The head restraints can be moved up by pulling up on the head restraint.

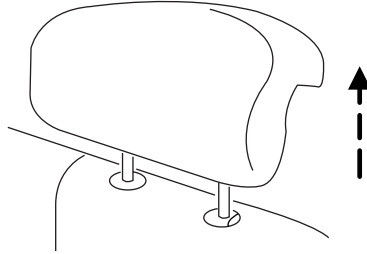

Push release button to lower head restraint.

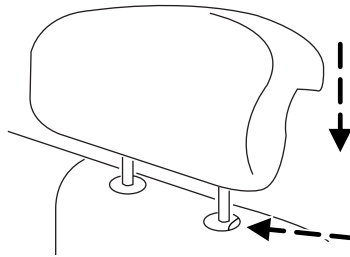

### **Adjusting second row bucket and bench seat back**

Lift the handle to adjust seatback. Using same control will fold the seatback flat.

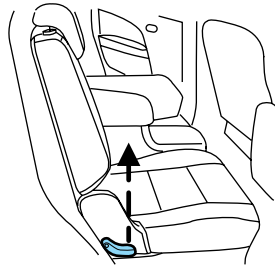

Reclining the seatback can cause an occupant to slide under the seat's safety belt, resulting in severe personal injuries in the event of a collision.

## Seating and Safety Restraints

### **Adjusting second row seats (if equipped)**

Lift the control to adjust the seat forward or backward.

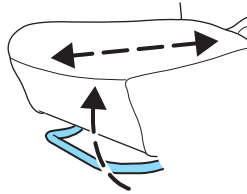

### **Accessing the third row seats**

Fold and tumble the second row seat to access the third row. Remove items from the second row seat and ensure that no bulky objects such as purses or briefcases are on the floor in front of the second row seats before tumbling them.

**Note:** You may have to move the front row seat forward to allow the 2nd row seat to be fully tumbled. Stow the head restraint by pushing the head restraint release button while sliding the head restraint fully down.

Lift the handle located on the side of the seat.

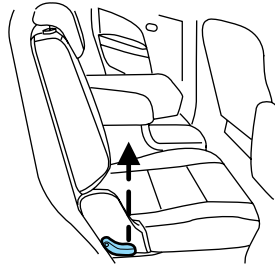

The seatback will fold flat.

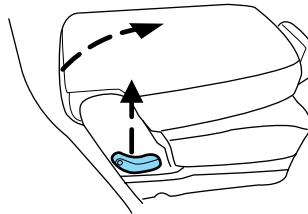



## Seating and Safety Restraints

Lift the handle all the way up until the seat releases from the floor. Rotate the seat forward to allow access to the third row.

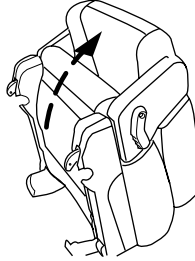

To return the seatback to the floor from tumbled position, rotate the seat down until you hear it latching to the floor.

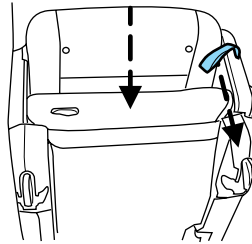

To return the seatback to the upright position

- Lift the seatback toward the rear of the vehicle, and
- Rotate the seatback until you hear a click, locking it in the upright position.

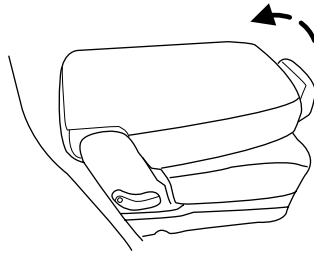

**Note:** The seatback will not raise if the rear latch hooks are not properly engaged to the floor striker.

- Pull the head restraint back up to its normal adjusted position.

## Seating and Safety Restraints

 Before returning the seatback to its original position, make sure that cargo or any objects are not trapped behind the seatback. After returning the seatback to its original position, pull on the seatback to ensure that it has fully latched. An unlatched seat may become dangerous in the event of a sudden stop or collision.

### **Exiting the third row seat**

Stow the head restraint by pushing the head restraint release button while sliding the head restraint fully down.

Pull on the strap located on the back of the second row seat. This will fold the seatback forward. Pull the strap a second time to tumble the seat forward, allowing easy exit from the 3rd row seat.

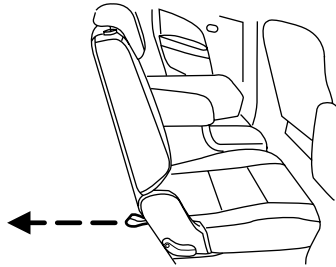

To return the seatback to the floor from tumbled position, rotate the seat down until you hear it latching to the floor.

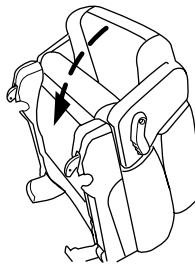

## Seating and Safety Restraints

To return the seatback to the upright position

- Lift the seatback toward the rear of the vehicle, and
- Rotate the seatback until you hear a click, locking it in the upright position.

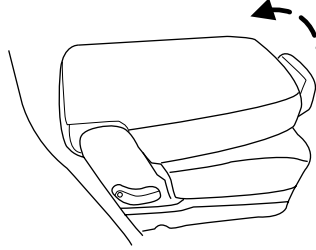

**Note:** The seatback will not raise if the rear latch hooks are not properly engaged to the floor striker.

- Pull the head restraint back up to its normal adjusted position.

 Before returning the seatback to its original position, make sure that cargo or any objects are not trapped behind the seatback. After returning the seatback to its original position, pull on the seatback to ensure that it has fully latched. An unlatched seat may become dangerous in the event of a sudden stop or collision.

Ensure that the rear latch hooks are properly engaged with the floor striker.

**Note:** Ensure that the seat and seatback are latched securely in position. Keep floor area free of objects that would prevent proper seat engagement. Do not adjust or release the seat floor latch while vehicle is in motion. Do not operate the vehicle with seats in tumbled position.

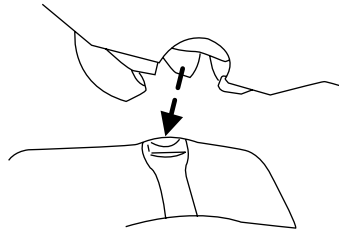

 Always latch the vehicle seat to the floor, whether the seat is occupied or empty. If not latched, the seat may cause injury during a sudden stop.

## Seating and Safety Restraints

### Stowing the third row bench or split bench seat (if equipped)

1. Stow the head restraints by pushing the head restraint release buttons while sliding the head restraints fully down. Remove all objects from the seat and stowage tub.

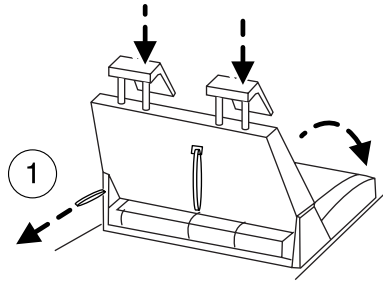
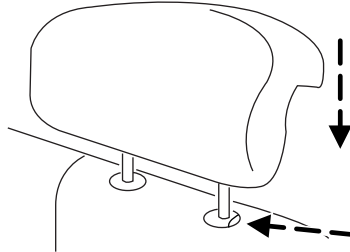

2. From the rear of the vehicle, fold seatback by pulling and holding the number 1 strap while pushing the seatback forward. Release strap once seatback starts rotating forward.

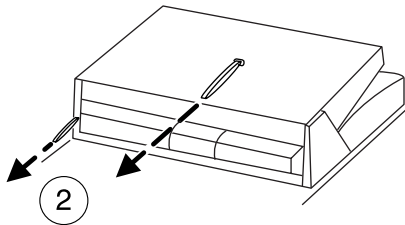

3. Release the cushion latches by pulling the number 2 strap while pulling on the strap located at the top of the seatback to tumble the seat all the way into the tub in the floor.

## Seating and Safety Restraints



Do not use the seat anchors as cargo tie downs.

**Note:** Do not use the third row seatback as a load floor when the seatback is folded.

### **Unstowing the third row seat**

**Note:** Ensure that there are no objects such as books, purses or brief cases on the load floor before unstowing the seat. Failure to remove all objects from the top of the load floor prior to unstowing it may cause damage to the seat.

**Note:** Ensure the area under the load floor is free of objects before unstowing it.

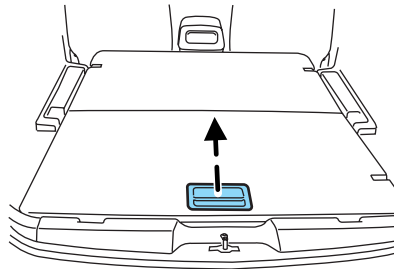

1. Unlatch and lift the seat out of the tub in the floor by squeezing and pulling up on the handle. Once the seat is at a vertical position, push the seat over, letting it fall onto the latches.

2. To return the seatback to upright position, pull the number 1 strap, then while holding the number 1 strap, pull the long strap located on the seatback to raise the seatback.

3. Pull the head restraints up to their normal adjusted positions.

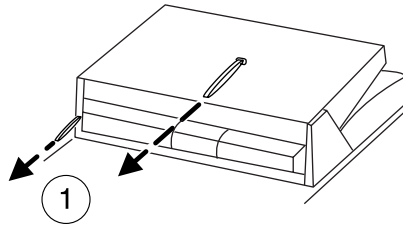



Ensure seat is latched to vehicle floor by pushing/pulling on seat. If not latched, the seat may cause injury during a sudden stop.

## Seating and Safety Restraints

 Before returning the seatback to its original position, make sure that cargo or any objects are not trapped behind the seatback. After returning the seatback to its original position, pull on the seatback to ensure that it has fully latched. An unlatched seat may become dangerous in the event of a sudden stop or collision.

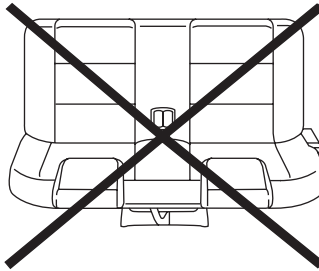
 The third row seat is NOT designed to be used in Tailgate mode. Placing the seat in this position could result in damage to the seat, surrounding components, or injury.



 The tailgate position is not a position suitable for driving. Do not drive the vehicle with the seat in the tailgate position. The safety belts are not functional when the seat is in the tailgate position.

### SAFETY RESTRAINTS

#### Personal Safety System™

The Personal Safety System™ provides an improved overall level of frontal crash protection to front seat occupants and is designed to help further reduce the risk of airbag-related injuries. The system is able to analyze different occupant conditions and crash severity before activating the appropriate safety devices to help better protect a range of occupants in a variety of frontal crash situations.

Your vehicle's Personal Safety System™ consists of:

- Driver and passenger dual-stage airbag supplemental restraints.
- Front outboard safety belts with pretensioners, energy management retractors (first row only), and safety belt usage sensors.
- Driver's seat position sensor.
- Passenger occupant classification sensor
- Front crash severity sensor.

## Seating and Safety Restraints

- Restraints Control Module (RCM) with impact and safing sensors.
- Restraint system warning light and back-up tone.
- The electrical wiring for the airbags, crash sensor(s), safety belt pretensioners, front safety belt usage sensors, driver seat position sensor, passenger occupant classification sensor, and indicator lights.

### ***How does the Personal Safety System™ work?***

The Personal Safety System™ can adapt the deployment strategy of your vehicle's safety devices according to crash severity and occupant conditions. A collection of crash and occupant sensors provides information to the Restraints Control Module (RCM). During a crash, the RCM activates the safety belt pretensioners and/or either one or both stages of the dual-stage airbag supplemental restraints based on crash severity and occupant conditions.

The fact that the pretensioners or airbags did not activate for both front seat occupants in a collision does not mean that something is wrong with the system. Rather, it means the Personal Safety System™ determined the accident conditions (crash severity, belt usage, etc.) were not appropriate to activate these safety devices. Front airbags are designed to activate only in frontal and near-frontal collisions (not rollovers, side impacts or rear impacts) unless the collision causes sufficient longitudinal deceleration. The pretensioners are designed to activate in frontal and near-frontal collisions, and in side collisions and rollovers when the vehicle is equipped with the Safety Canopy™ system.

### ***Driver and passenger dual-stage airbag supplemental restraints***

The dual-stage airbags offer the capability to tailor the level of airbag inflation energy. A lower, less forceful energy level is provided for more common, moderate-severity impacts. A higher energy level is used for the most severe impacts. Refer to *Airbag supplemental restraints* section in this chapter.

### ***Front crash severity sensor***

The front crash severity sensor enhances the ability to detect the severity of an impact. Positioned up front, it provides valuable information early in the crash event on the severity of the impact. This allows your Personal Safety System™ to distinguish between different levels of crash severity and modify the deployment strategy of the dual-stage airbags and safety belt pretensioners.

## Seating and Safety Restraints

### **Driver's seat position sensor**

The driver's seat position sensor allows your Personal Safety System™ to tailor the deployment level of the driver dual-stage airbag based on seat position. The system is designed to help protect smaller drivers sitting close to the driver airbag by providing a lower airbag output level.

### **Front passenger sensing system**

For airbags to do their job they must inflate with great force, and this force can pose a potentially deadly risk to occupants that are very close to the airbag when it begins to inflate. For some occupants, this occurs because they are initially sitting very close to the airbag. For other occupants, this occurs when the occupant is not properly restrained by safety belts or child safety seats and they move forward during pre-crash braking. The most effective way to reduce the risk of unnecessary injuries is to make sure all occupants are properly restrained. Accident statistics suggest that children are much safer when properly restrained in the rear seating positions than in the front.



Air bags can kill or injure a child in a child seat. **NEVER** place a rear-facing child seat in front of an active air bag. If you must use a forward-facing child seat in the front seat, move the seat all the way back.



Always transport children 12 years old and under in the back seat and always properly use appropriate child restraints.

The passenger occupant classification sensor can automatically turn off the passenger front airbag. The system is designed to help protect small (child size) occupants from airbag deployments when they are improperly seated or restrained in the front passenger seat contrary to proper child-seating or restraint usage recommendations. Even with this technology, parents are **STRONGLY** encouraged to always properly restrain children in the rear seat. The sensor also turns off the passenger front airbag and seat-mounted side airbag (if equipped) when the passenger seat is empty to prevent unnecessary replacement of airbag(s) after a collision.

### **Front safety belt usage sensors**

The front safety belt usage sensors detect whether or not the driver and front outboard passenger safety belts are fastened. This information allows your Personal Safety System™ to tailor the airbag deployment and



## Seating and Safety Restraints

safety belt pretensioner activation depending upon safety belt usage. Refer to *Safety belt* section in this chapter.

### **Front safety belt pretensioners**

The safety belt pretensioners at the front outboard seating positions are designed to tighten the safety belts firmly against the occupant's body during frontal collisions, and in side collisions and rollovers when the vehicle is equipped with the Safety Canopy™ system. This maximizes the effectiveness of the safety belts. In frontal collisions, the safety belt pretensioners can be activated alone or, if the collision is of sufficient severity, together with the front airbags.

### **Front safety belt energy management retractors**

The front outboard safety belt energy management retractors allow webbing to be pulled out of the retractor in a gradual and controlled manner in response to the occupant's forward momentum. This helps reduce the risk of force-related injuries to the occupant's chest by limiting the load on the occupant. Refer to *Energy management feature* section in this chapter.

### **Determining if the Personal Safety System™ is operational**

The Personal Safety System™ uses a warning light in the instrument cluster or a back-up tone to indicate the condition of the system. Refer to the *Warning lights and chimes* section in the *Instrument Cluster* chapter. Routine maintenance of the Personal Safety System™ is not required.

The Restraints Control Module (RCM) monitors its own internal circuits and the circuits for the airbag supplemental restraints, crash sensor(s), safety belt pretensioners, front safety belt buckle sensors, driver seat position sensor, and passenger occupant classification sensor. In addition, the RCM also monitors the restraints warning light in the instrument cluster. A difficulty with the system is indicated by one or more of the following.

- The warning light will either flash or stay lit.
- The warning light will not illuminate immediately after ignition is turned on.
- A series of five beeps will be heard. The tone pattern will repeat periodically until the problem and warning light are repaired.

If any of these things happen, even intermittently, have the Personal Safety System™ serviced at an authorized dealer immediately. Unless serviced, the system may not function properly in the event of a collision.

## Seating and Safety Restraints

### Safety belt precautions



Always drive and ride with your seatback upright and the lap belt snug and low across the hips.



To reduce the risk of injury, make sure children sit where they can be properly restrained.



Never let a passenger hold a child on his or her lap while the vehicle is moving. The passenger cannot protect the child from injury in a collision.



All occupants of the vehicle, including the driver, should always properly wear their safety belts, even when an air bag supplemental restraint system (SRS) is provided.



It is extremely dangerous to ride in a cargo area, inside or outside of a vehicle. In a collision, people riding in these areas are more likely to be seriously injured or killed. Do not allow people to ride in any area of your vehicle that is not equipped with seats and safety belts. Be sure everyone in your vehicle is in a seat and using a safety belt properly.



In a rollover crash, an unbelted person is significantly more likely to die than a person wearing a seat belt.



Each seating position in your vehicle has a specific safety belt assembly which is made up of one buckle and one tongue that are designed to be used as a pair. 1) Use the shoulder belt on the outside shoulder only. Never wear the shoulder belt under the arm. 2) Never swing the safety belt around your neck over the inside shoulder. 3) Never use a single belt for more than one person.



Always transport children 12 years old and under in the back seat and always properly use appropriate child restraints.

## Seating and Safety Restraints

### Combination lap and shoulder belts

1. Insert the belt tongue into the proper buckle (the buckle closest to the direction the tongue is coming from) until you hear a snap and feel it latch. Make sure the tongue is securely fastened in the buckle.

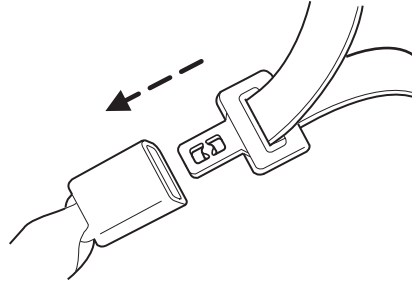

2. To unfasten, push the release button and remove the tongue from the buckle.

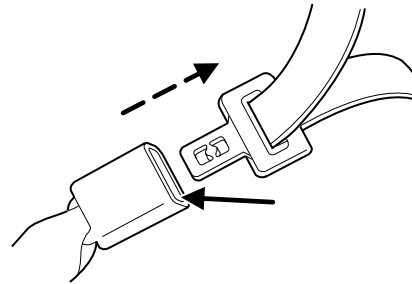

All restraints in the vehicle are combination lap and shoulder belts.

While you are fastened in the safety belt, the combination lap/shoulder belt adjusts to your movement. However, if you brake hard, turn hard, or if your vehicle receives an impact of 5 mph (8 km/h) or more, the safety belt will become locked and help reduce your forward movement.

### Energy Management Feature — Front Outboard

- This vehicle has a safety belt system with an energy management feature at the front seats to help further reduce the risk of injury in the event of a head-on collision.
- This safety belt system has a retractor assembly that is designed to extend the safety belt webbing in a controlled manner. This helps reduce the belt force acting on the user's chest.

 Failure to inspect and replace if necessary the Belt and Retractor assembly after an accident could increase the risk of injury in a collision.

## Seating and Safety Restraints

All safety restraints in the vehicle are combination lap and shoulder belts. All of the passenger combination lap and shoulder belts have two types of locking modes described below:

### Vehicle sensitive mode

This is the normal retractor mode, which allows free shoulder belt length adjustment to your movements and locking in response to vehicle movement. For example, if the driver brakes suddenly or turns a corner sharply, or the vehicle receives an impact of approximately 5 mph (8 km/h) or more, the combination safety belts will lock to help reduce forward movement of the driver and passengers.

### Automatic locking mode

#### When to use the automatic locking mode

In this mode, the shoulder belt is automatically pre-locked. The belt will still retract to remove any slack in the shoulder belt. The automatic locking mode is not available on the driver safety belt.

This mode should be used **any time** a child safety seat is installed in a passenger front or outboard rear seating position (if equipped). Children 12 years old and under should be properly restrained in the rear seat whenever possible. Refer to *Safety restraints for children* or *Safety seats for children* later in this chapter.

#### How to use the automatic locking mode

- Buckle the combination lap and shoulder belt.

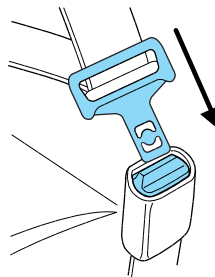

## Seating and Safety Restraints

- Grasp the shoulder portion and pull downward until the entire belt is pulled out.



- Allow the belt to retract. As the belt retracts, you will hear a clicking sound. This indicates the safety belt is now in the automatic locking mode.

### **How to disengage the automatic locking mode**

 Ford Motor Company recommends that all passenger safety belt assemblies and attaching hardware should be inspected by an authorized dealer after any collision to verify that the "automatic locking retractor" feature for child seats is still working properly. Safety belt assemblies should be inspected by an authorized dealer and must be replaced if either damage or improper operation is noted. Failure to replace the belt and retractor assembly could increase the risk of injury in a collision.

Unbuckle the combination lap/shoulder belt and allow it to retract completely to disengage the automatic locking mode and activate the vehicle sensitive (emergency) locking mode.

### **Safety belt height adjustment**

Your vehicle has safety belt height adjustments for the front outboard seating positions.

Adjust the height of the shoulder belt so the belt rests across the middle of your shoulder.

To adjust the shoulder belt height, squeeze the button and slide the height adjuster up or down. Release the button and pull down on the height adjuster to make sure it is locked in place.

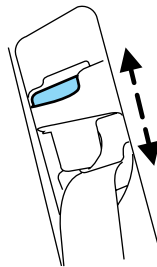

## Seating and Safety Restraints

 Position the safety belt height adjusters so that the belt rests across the middle of your shoulder. Failure to adjust the safety belt properly could reduce the effectiveness of the seat belt and increase the risk of injury in a collision.

### Safety belt warning light and indicator chime

The safety belt warning light illuminates in the instrument cluster and a chime sounds to remind the occupants to fasten their safety belts.

#### Conditions of operation

If...	Then...
The driver's safety belt is not buckled before the ignition switch is turned to the ON position...	The safety belt warning light illuminates 1-2 minutes and the warning chime sounds 4-8 seconds.
The driver's safety belt is buckled while the indicator light is illuminated and the warning chime is sounding...	The safety belt warning light and warning chime turn off.
The driver's safety belt is buckled before the ignition switch is turned to the ON position...	The safety belt warning light and indicator chime remain off.

### Safety belt extension assembly

If the safety belt is too short when fully extended, there is a 8 inch (20 cm) safety belt extension assembly that can be added (part number 611C22). This assembly can be obtained from an authorized dealer.

Use only extensions manufactured by the same supplier as the safety belt. Manufacturer identification is located at the end of the webbing on the label. Also, use the safety belt extension only if the safety belt is too short for you when fully extended.

 Do not use extensions to change the fit of the shoulder belt across the torso.

## Seating and Safety Restraints

### Safety belt maintenance

Inspect the safety belt systems periodically to make sure they work properly and are not damaged. Inspect the safety belts to make sure there are no nicks, tears or cuts. Replace if necessary. All safety belt assemblies, including retractors, buckles, front safety belt buckle assemblies, buckle support assemblies (slide bar-if equipped), shoulder belt height adjusters (if equipped), shoulder belt guide on seatback (if equipped), child safety seat LATCH and tether anchors, and attaching hardware, should be inspected after a collision. Ford Motor Company recommends that all safety belt assemblies in use in vehicles involved in a collision be replaced. However, if the collision was minor and an authorized dealer finds that the belts do not show damage and continue to operate properly, they do not need to be replaced. Safety belt assemblies not in use during a collision should also be inspected and replaced if either damage or improper operation is noted.



Failure to inspect and if necessary replace the safety belt assembly under the above conditions could result in severe personal injuries in the event of a collision.

For proper care of soiled safety belts, refer to *Interior* in the *Cleaning* chapter.

### BeltMinder®

The BeltMinder® feature is a supplemental warning to the safety belt warning function. This feature provides additional reminders by intermittently sounding a chime and illuminating the safety belt warning light in the instrument cluster when the driver's and front passenger's safety belt is unbuckled.

The BeltMinder® feature uses information from the front passenger sensing system to determine if a front seat passenger is present and therefore potentially in need of a warning. To avoid activating the BeltMinder® feature for objects placed in the front passenger seat, warnings will only be given to large front seat occupants as determined by the front passenger sensing system.

Both the driver's and passenger's safety belt usages are monitored and either may activate the BeltMinder® feature. The warnings are the same for the driver and the front passenger. If the BeltMinder® warnings have expired (warnings for approximately 5 minutes) for one occupant (driver or front passenger), the other occupant can still activate the BeltMinder® feature.

## Seating and Safety Restraints

<b>If...</b>	<b>Then...</b>
The driver's and front passenger's safety belts are buckled before the ignition switch is turned to the ON position or less than 1-2 minutes have elapsed since the ignition switch has been turned ON...	The BeltMinder® feature will not activate.
The driver's or front passenger's safety belt is not buckled when the vehicle has reached at least 3 mph (5 km/h) and 1-2 minutes have elapsed since the ignition switch has been turned to ON...	The BeltMinder® feature is activated - the safety belt warning light illuminates and the warning chime sounds for 6 seconds every 30 seconds, repeating for approximately 5 minutes or until the safety belts are buckled.
The driver's or front passenger's safety belt becomes unbuckled for approximately 1 minute while the vehicle is traveling at least 3 mph (5 km/h) and more than 1-2 minutes have elapsed since the ignition switch has been turned to ON...	The BeltMinder® feature is activated - the safety belt warning light illuminates and the warning chime sounds for 6 seconds every 30 seconds, repeating for approximately 5 minutes or until the safety belts are buckled.



## Seating and Safety Restraints

The following are reasons most often given for not wearing safety belts (All statistics based on U.S. data):

Reasons given...	Consider...
"Crashes are rare events"	<b>36700 crashes occur every day.</b> The more we drive, the more we are exposed to "rare" events, even for good drivers. <i>1 in 4 of us will be seriously injured in a crash during our lifetime.</i>
"I'm not going far"	<b>3 of 4</b> fatal crashes occur within <b>25</b> miles (40 km) of home.
"Belts are uncomfortable"	We design our safety belts to enhance comfort. If you are uncomfortable - try different positions for the safety belt upper anchorage and seatback which should be as upright as possible; this can improve comfort.
"I was in a hurry"	<b>Prime time for an accident.</b> BeltMinder® reminds us to take a few seconds to buckle up.
"Safety belts don't work"	<b>Safety belts</b> , when used properly, <b>reduce risk of death</b> to front seat occupants by <b>45% in cars</b> , and by <b>60% in light trucks</b> .
"Traffic is light"	<b>Nearly 1 of 2 deaths occur in single-vehicle crashes</b> , many when no other vehicles are around.
"Belts wrinkle my clothes"	Possibly, but a serious crash can do much more than wrinkle your clothes, particularly if you are unbelted.
"The people I'm with don't wear belts"	Set the example, teen deaths occur 4 times more often in vehicles with TWO or MORE people. Children and younger brothers/sisters imitate behavior they see.

## Seating and Safety Restraints

Reasons given...	Consider...
"I have an airbag"	Airbags offer greater protection when used with safety belts. Frontal airbags are not designed to inflate in rear and side crashes or rollovers.
"I'd rather be thrown clear"	Not a good idea. <b>People</b> who are <b>ejected are 40 times more likely to DIE</b> . Safety belts help prevent ejection, WE CAN'T "PICK OUR CRASH".



Do not sit on top of a buckled safety belt to avoid the BeltMinder® chime. Sitting on the safety belt will increase the risk of injury in an accident. To disable (one-time) or deactivate the BeltMinder® feature please follow the directions stated below.

### **One time disable**

If at any time the driver/front passenger quickly buckles then unbuckles the safety belt for that seating position, the BeltMinder® is disabled for the current ignition cycle. The BeltMinder® feature will enable during the same ignition cycle if the occupant buckles and remains buckled for approximately 30 seconds. Confirmation is not given for the one time disable.

### **Deactivating/activating the BeltMinder® feature**

**The driver and front passenger BeltMinder® are deactivated/activated independently. When deactivating/activating one seating position, do not buckle the other position as this will terminate the process.**

*Read Steps 1 - 4 thoroughly before proceeding with the deactivation/activation programming procedure.*

**Note:** The driver and front passenger BeltMinder® features must be disabled/enabled separately. Both cannot be disabled/enabled during the same key cycle.

The driver and front passenger BeltMinder® features can be deactivated/activated by performing the following procedure:

Before following the procedure, make sure that:

- The parking brake is set

## Seating and Safety Restraints

- The gearshift is in P (Park) (automatic transmission)
- The ignition switch is in the OFF position
- The driver and front passenger safety belts are unbuckled



To reduce the risk of injury, do not deactivate/activate the BeltMinder® feature while driving the vehicle.

1. Turn the ignition switch to the RUN (or ON) position. (DO NOT START THE ENGINE)
2. Wait until the safety belt warning light turns off. (Approximately 1 minute)
  - Step 3 must be completed within 50 seconds after the safety belt warning light turns off.
3. For the seating position being disabled, at a moderate speed, buckle then unbuckle the safety belt 9 times, ending in the unbuckled state. (Step 3 must be completed within 50 seconds after the safety belt warning light turns off.)
  - After Step 3, the restraint system warning light (airbag light) will be turned on for three seconds.
4. Within 10 seconds of the light turning on, at a moderate speed, buckle then unbuckle the safety belt.
  - This will disable the BeltMinder® feature for that seating position if it is currently enabled. As confirmation, the restraint system warning light will flash 4 times per second for 3 seconds.
  - This will enable the BeltMinder® feature for that seating position if it is currently disabled. As confirmation, the restraint system warning light will flash 4 times per second for 3 seconds, followed by 3 seconds with the light off, then followed by the restraint system warning light flashing 4 times per second for 3 seconds again.

## Seating and Safety Restraints

### AIRBAG SUPPLEMENTAL RESTRAINT SYSTEM (SRS)

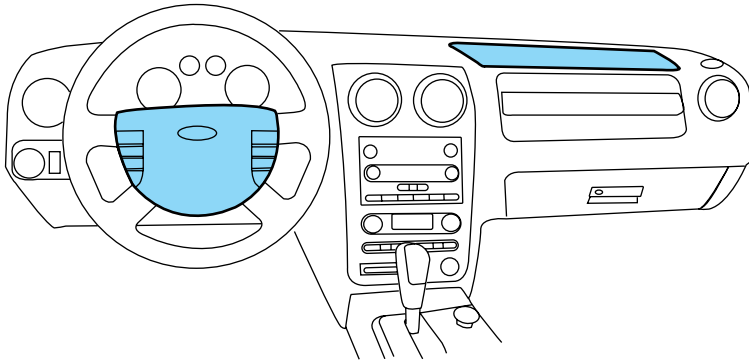

The instrument panel grab handle should never be used for storage. The path of an inflating airbag must be kept clear at all times.

The airbag supplemental restraint system (SRS) is designed to work in conjunction with the safety belts to help protect the driver and front outboard passenger from certain upper body injuries. The term “supplemental restraint” means the airbags are intended as a supplement to the safety belts. Airbags alone cannot protect as well as airbags plus safety belts in impacts for which the airbags are designed to deploy, and airbags do not offer any protection in crashes for which they do not deploy.

## Seating and Safety Restraints

### Important SRS precautions

The SRS is designed to work with the safety belt to help protect the driver and right front passenger from certain upper body injuries. Airbags DO NOT inflate slowly; there is a risk of injury from a deploying airbag.

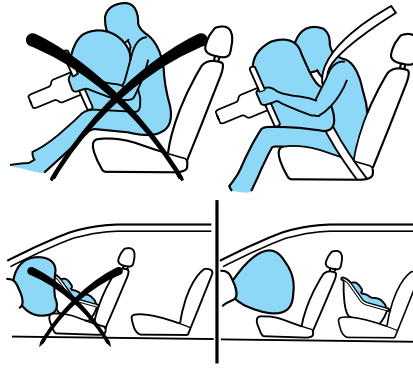

 Do not place any object between an occupant and an airbag or near any other airbag covering. The airbag may not inflate properly and might force an object into that person causing severe injury or death. The IP Grab Handle should never be used for storage. The path of an inflating airbag must be kept clear at all times.

 All occupants of the vehicle, including the driver, should always properly wear their safety belts, even when an air bag supplemental restraint system (SRS) is provided.

 Always transport children 12 years old and under in the back seat and always properly use appropriate child restraints.

 The National Highway Traffic Safety Administration (NHTSA) recommends a minimum distance of at least 10 inches (25 cm) between an occupant's chest and the driver airbag module.

 Never place your arm over the air bag module as a deploying air bag can result in serious arm fractures or other injuries.

To properly position yourself away from the airbag:

- Move your seat to the rear as far as you can while still reaching the pedals comfortably.

## Seating and Safety Restraints

- Recline the seat slightly one or two degrees from the upright position.

 Do not put anything on or over the air bag module. Placing objects on or over the air bag inflation area may cause those objects to be propelled by the air bag into your face and torso causing serious injury.

 Do not attempt to service, repair, or modify the airbag supplemental restraint systems or its fuses. See your authorized dealer.

 Modifying or adding equipment to the front end of the vehicle (including frame, bumper, front end body structure and tow hooks) may affect the performance of the airbag system, increasing the risk of injury. Do not modify the front end of the vehicle.

### Children and airbags

Children must always be properly restrained. Accident statistics suggest that children are safer when properly restrained in the rear seating positions than in the front seating position. Failure to follow these instructions may increase the risk of injury in a collision.

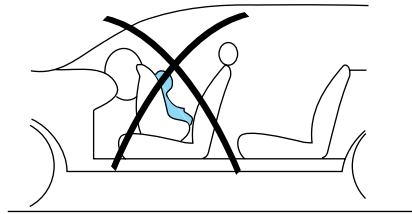

 Airbags can kill or injure a child in a child seat. **NEVER** place a rear-facing child seat in front of an active airbag. If you must use a forward-facing child seat in the front seat, move the seat all the way back.

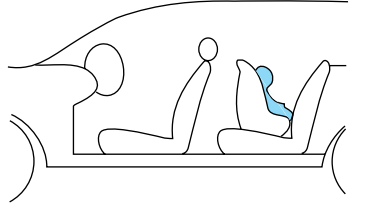

## Seating and Safety Restraints

### ***Determining if the system is operational***

The supplemental restraint system uses a warning indicator light in the instrument cluster or a back-up tone to indicate the condition of the system. Refer to the *Warning lights and chimes* section in the *Instrument Cluster* chapter. Routine maintenance of the airbag is not required.

A difficulty with the system is indicated by one or more of the following:

- The readiness light (same light for front and side airbag system) will either flash or stay lit.
- The readiness light will not illuminate immediately after ignition is turned on.
- A series of five beeps will be heard. The tone pattern will repeat periodically until the problem and/or light are repaired.



If any of these things happen, even intermittently, have the supplemental restraint system serviced at an authorized dealer immediately. Unless serviced, the system may not function properly in the event of a collision.

### **How does the airbag supplemental restraint system work?**

The airbag SRS is designed to activate when the vehicle sustains longitudinal deceleration sufficient to cause the sensors to close an electrical circuit that initiates airbag inflation. The fact that the airbags did not inflate in a collision does not mean that something is wrong with the system. Rather, it means the forces were not of the type sufficient to cause activation. Front airbags are designed to inflate in frontal and near-frontal collisions, not rollover, side-impact, or rear-impacts unless the collision causes sufficient longitudinal deceleration.

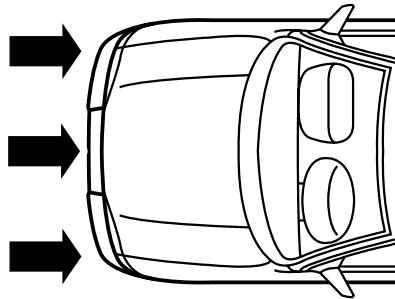

## Seating and Safety Restraints

The airbags inflate and deflate rapidly upon activation. After airbag deployment, it is normal to notice a smoke-like, powdery residue or smell the burnt propellant. This may consist of cornstarch, talcum powder (to lubricate the bag) or sodium compounds (e.g., baking soda) that result from the combustion process that inflates the airbag. Small amounts of sodium hydroxide may be present which may irritate the skin and eyes, but none of the residue is toxic.



While the system is designed to help reduce serious injuries, contact with a deploying airbag may also cause abrasions, swelling or temporary hearing loss. Because airbags must inflate rapidly and with considerable force, there is the risk of death or serious injuries such as fractures, facial and eye injuries or internal injuries, particularly to occupants who are not properly restrained or are otherwise out of position at the time of airbag deployment. Thus, it is extremely important that occupants be properly restrained as far away from the airbag module as possible while maintaining vehicle control.



Several air bag system components get hot after inflation. Do not touch them after inflation.



If the air bag has deployed, **the air bag will not function again and must be replaced immediately.** If the air bag is not replaced, the unrepaired area will increase the risk of injury in a collision.

The SRS consists of:

- driver and passenger airbag modules (which include the inflators and airbags).
- side airbags and curtain (if equipped). Refer to *Side airbag system* later in this chapter.
- one or more impact and safing sensors.
- a readiness light and tone.

136



## Seating and Safety Restraints

- diagnostic module.
- and the electrical wiring which connects the components.

The diagnostic module monitors its own internal circuits and the supplemental airbag electrical system wiring (including the impact sensors), the system wiring, the airbag system readiness light, the airbag back up power and the airbag ignitors.

### Front passenger sensing system

The front passenger sensing system is designed to meet the regulatory requirements of Federal Motor Vehicle Safety Standard (FMVSS) 208 and is designed to disable (will not inflate) the front passenger's frontal airbag under certain conditions.

The front passenger sensing system works with sensors that are part of the front passenger's seat and safety belt. The sensors are designed to detect the presence of a properly seated occupant and determine if the front passenger's frontal airbag should be enabled (may inflate) or disabled (will not inflate).

The front passenger sensing system will disable (will not inflate) the front passenger's frontal airbag if:

- the front passenger seat is unoccupied, or has small/medium objects in the front seat,
- the system determines that an infant is present in a rear-facing infant seat that is installed according to the manufacturer's instructions,
- the system determines that a small child is present in a forward-facing child restraint that is installed according to the manufacturer's instructions,
- the system determines that a small child is present in a booster seat,
- a front passenger takes his/her weight off of the seat for a period of time,
- a child or a small person occupies the front passenger seat.

For side airbag equipped vehicles, the front passenger sensing system will turn off the passenger seat side airbag if:

- the seat is empty and safety belt is unbuckled.

The front passenger sensing system uses a "passenger airbag off" or "pass airbag off" indicator which will illuminate and stay lit to remind you

PASS AIRBAG OFF

## Seating and Safety Restraints

that the front passenger frontal airbag is disabled. The indicator lamp is located in the center stack of the instrument panel above the radio.

**Note:** The indicator lamp will illuminate for a short period of time when the ignition is turned to the ON position to confirm it is functional.

When the front passenger seat is not occupied (empty seat) or in the event that the front passenger frontal airbag is enabled (may inflate), the indicator lamp will be unlit.

The front passenger sensing system is designed to disable (will not inflate) the front passenger's frontal airbag when a rear facing infant seat, a forward-facing child restraint, or a booster seat is detected.

- When the front passenger sensing system disables (will not inflate) the front passenger frontal airbag, the indicator lamp will illuminate and stay lit to remind you that the front passenger frontal airbag is disabled.
- If the child restraint has been installed and the indicator lamp is not lit, then turn the vehicle off, remove the child restraint from the vehicle and reinstall the restraint following the child restraint manufacturer's instructions.

The front passenger sensing system is designed to enable (may inflate) the front passenger's frontal airbag anytime the system senses that a person of adult size is sitting properly in the front passenger seat.

- When the front passenger sensing system enables the front passenger frontal airbag (may inflate), the indicator will be unlit and stay unlit.

If a person of adult size is sitting in the front passenger's seat, but the "passenger airbag off" or "pass airbag off" indicator lamp is lit, it is possible that the person isn't sitting properly in the seat. If this happens:

- Turn the vehicle off and ask the person to place the seatback in the full upright position.
- Have the person sit upright in the seat, centered on the seat cushion, with the person's legs comfortably extended.
- Restart the vehicle and have the person remain in this position for about two minutes. This will allow the system to detect that person and enable the passenger's frontal airbag.
- If the indicator lamp remains lit even after this, the person should be advised to ride in the rear seat.

## Seating and Safety Restraints

<b>Occupant</b>	<b>Pass Airbag Off Indicator Light</b>	<b>Passenger Airbag</b>
Empty seat	Unlit	Disabled
Small child in child safety seat or booster	Lit	Disabled
Small child with safety belt buckled or unbuckled	Lit	Disabled
Adult	Unlit	Enabled



Even with Advanced Restraints Systems, children 12 and under should be properly restrained in the back seat.

After all occupants have adjusted their seats and put on safety belts, it's very important that they continue to sit properly. A properly seated occupant sits upright, leaning against the seat back, and centered on the seat cushion, with their feet comfortably extended on the floor. Sitting improperly can increase the chance of injury in a crash event. For example, if an occupant slouches, lies down, turns sideways, sits forward, leans forward or sideways, or puts one or both feet up, the chance of injury during a crash is greatly increased.



Sitting improperly out of position or with the seat back reclined too far can take off weight from the seat cushion and affect the decision of the front passenger sensing system, resulting in serious injury or death in a crash. Always sit upright against your seatback, with your feet on the floor.

The front passenger sensing system may detect small or medium objects placed on the seat cushion. For most objects that are in the front passenger seat, the passenger airbag will be disabled. Even though the passenger airbag is disabled, the "pass airbag off" lamp may or may not be illuminated according to the table below.

<b>Objects</b>	<b>Pass Airbag Off Indicator Light</b>	<b>Passenger Airbag</b>
Small (i.e. 3 ring binder, small purse, bottled water)	Unlit	Disabled
Medium (i.e. heavy briefcase, fully packed luggage)	Lit	Disabled

## Seating and Safety Restraints

Objects	Pass Airbag Off Indicator Light	Passenger Airbag
Empty seat, Small or medium object with safety belt buckled	Lit	Disabled

If you think that the status of the passenger airbag off indicator lamp is incorrect, check for the following:

- Objects lodged underneath the seat
- Objects between the seat cushion and the center console (if equipped)
- Objects hanging off the seat back
- Objects stowed in the seatback map pocket (if equipped)
- Objects placed on the occupant's lap
- Cargo interference with the seat
- Other passengers pushing or pulling on the seat
- Rear passenger feet and knees resting or pushing on the seat

The conditions listed above may cause the weight of a properly seated occupant to be incorrectly interpreted by the passenger sensing system. The person in the front passenger seat may appear heavier or lighter due to the conditions described in the list above.



To reduce the risk of possible serious injury:

Do not stow objects in seat back map pocket (if equipped) or hang objects off seat back if a child is in the front passenger seat. Do not place objects underneath the front passenger seat or between the seat and the center console (if equipped). Check the “passenger airbag off” or “pass airbag off” indicator lamp for proper airbag Status. Failure to follow these instructions may interfere with the front passenger seat sensing system.

In case there is a problem with the front passenger sensing system, the airbag readiness lamp in the instrument cluster will stay lit.



### **If the airbag readiness lamp is lit, do the following:**

The driver and/or adult passengers should check for any objects that may be lodged underneath the front passenger seat or cargo interfering with the seat.

## Seating and Safety Restraints

If objects are lodged and/or cargo is interfering with the seat; please take the following steps to remove the obstruction:

- Pull the vehicle over.
- Turn the vehicle off.
- Driver and/or adult passengers should check for any objects lodged underneath the front passenger seat or cargo interfering with the seat.
- Remove the obstruction(s) (if found).
- Restart the vehicle.
- Wait at least 2 minutes and verify that the airbag readiness lamp is no longer illuminated
- If the airbag readiness lamp remains illuminated, this may or may/not be a problem due to the front passenger sensing system.

DO NOT attempt to repair or service the system; take your vehicle immediately to an authorized dealer.

If it is necessary to modify an advanced front airbag system to accommodate a person with disabilities, contact the Ford Customer Relationship Center at the phone number shown in the *Customer Assistance* chapter of this *Owner's Guide*.



Any alteration/modification to the front passenger seat may affect the performance of the front passenger sensing system.

### Seat-mounted side airbag system (if equipped)



Do not place objects or mount equipment on or near the airbag cover on the side of the seatbacks of the front seats or in front seat areas that may come into contact with a deploying airbag. Failure to follow these instructions may increase the risk of personal injury in the event of a collision.



Do not use accessory seat covers. The use of accessory seat covers may prevent the deployment of the side airbags and increase the risk of injury in an accident.



Do not lean your head on the door. The side airbag could injure you as it deploys from the side of the seatback.

## Seating and Safety Restraints



Do not attempt to service, repair, or modify the airbag SRS, its fuses or the seat cover on a seat containing an airbag. See your authorized dealer.



All occupants of the vehicle should always wear their safety belts even when an airbag SRS is provided.

### **How does the side airbag system work?**

The design and development of the side airbag system included recommended testing procedures that were developed by a group of automotive safety experts known as the Side Airbag Technical Working Group. These recommended testing procedures help reduce the risk of injuries related to the deployment of side airbags.

The side airbag system consists of the following:

- An inflatable nylon bag (airbag) with a gas generator concealed behind the outboard bolster of the driver and front passenger seatbacks.
- A special seat cover designed to allow airbag deployment.
- The same warning light, electronic control and diagnostic unit as used for the front airbags.
- Crash sensors located on the B and C pillars (one sensor on each pillar on each side of the vehicle).

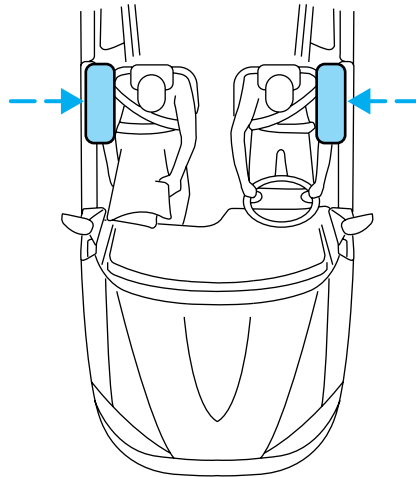

Side airbags, in combination with safety belts, can help reduce the risk of severe injuries in the event of a significant side impact collision.

The side airbags are fitted on the outboard side of the seatbacks of the front seats. In certain lateral collisions, the airbag on the side affected by the collision will be inflated. If the front passenger sensing system detects an empty seat, the front passenger seat-mounted side airbag will be deactivated. The airbag was designed to inflate between the door panel and occupant to further enhance the protection provided occupants in side impact collisions.

## Seating and Safety Restraints

The airbag SRS is designed to activate when the vehicle sustains lateral deceleration sufficient to cause the sensors to close an electrical circuit that initiates airbag inflation.

The fact that the airbags did not inflate in a collision does not mean that something is wrong with the system. Rather, it means the forces were not of the type sufficient to cause activation. Side airbags are designed to inflate in side-impact collisions, not roll-over, rear-impact, frontal or near-frontal collisions, unless the collision causes sufficient lateral deceleration.



Several air bag system components get hot after inflation. Do not touch them after inflation.



If the side airbag has deployed, **the airbag will not function again. The side airbag system (including the seat) must be inspected and serviced by an authorized dealer.** If the airbag is not replaced, the unrepaired area will increase the risk of injury in a collision.

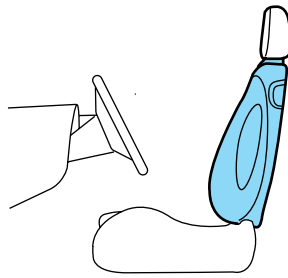

### Safety Canopy™ system (if equipped)



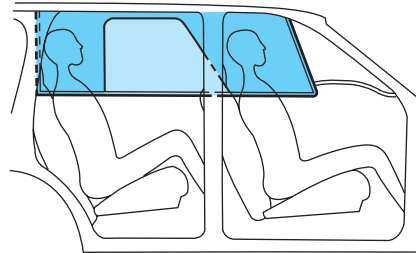

Do not place objects or mount equipment on or near the headliner at the siderail that may come into contact with a deploying Safety Canopy™. Failure to follow these instructions may increase the risk of personal injury in the event of a collision.



Do not lean your head on the door. The Safety Canopy™ could injure you as it deploys from the headliner.

## Seating and Safety Restraints

 Do not attempt to service, repair, or modify the Safety Canopy™ system, its fuses, the A, B, C or D pillar trim, or the headliner on a vehicle containing a Safety Canopy™. See your authorized dealer.

 All occupants of the vehicle including the driver should always wear their safety belts even when an airbag SRS and Safety Canopy™ system is provided.

 To reduce risk of injury, do not obstruct or place objects in the deployment path of the inflatable Safety Canopy™.

### **How does the Safety Canopy™ system work?**

The design and development of the Safety Canopy™ system included recommended testing procedures that were developed by a group of automotive safety experts known as the Side Airbag Technical Working Group. These recommended testing procedures help reduce the risk of injuries related to the deployment of side airbags (including the Safety Canopy™).

The Safety Canopy™ system consists of the following:

- An inflatable nylon curtain with a gas generator concealed behind the headliner and above the doors (one on each side of vehicle).
- A headliner designed to flex open above the side doors to allow Safety Canopy™ deployment.
- The same readiness airbag light, electronic control and diagnostic unit as used for the front airbags.
- Two crash sensors mounted on the B pillar (one on each side of the vehicle).
- Two crash sensors located at the C pillar behind the rear doors (one on each side of the vehicle).

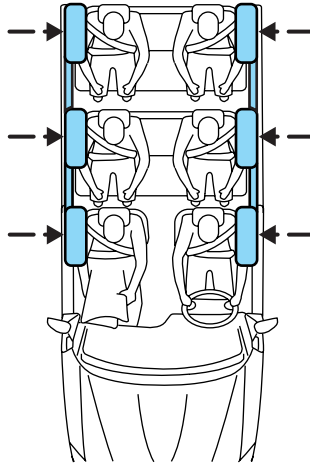



## Seating and Safety Restraints

- Rollover sensor in the restraints control module (RCM).

The Safety Canopy™ system, in combination with safety belts, can help reduce the risk of severe injuries in the event of a significant side impact collision or rollover event.

Children 12 years old and under should always be properly restrained in the second or third row seats. The Safety Canopy™ will not interfere with children restrained using a properly installed child or booster seat because it is designed to inflate downward from the headliner above the doors along the side window opening.

The Safety Canopy™ system is designed to activate when the vehicle sustains lateral deceleration sufficient to cause the side crash sensor to close an electrical circuit that initiates Safety Canopy™ inflation or when a certain likelihood of a rollover event is detected by the rollover sensor.

The Safety Canopy™ is mounted to roof side-rail sheet metal, behind the headliner, along the entire side of the vehicle. In certain lateral collisions or rollover events, the Safety Canopy™ system will be activated, regardless of which seats are occupied. The Safety Canopy™ is designed to inflate between the side window area and occupants to further enhance protection provided in side impact collisions and rollover events.

The fact that the Safety Canopy™ did not activate in a collision does not mean that something is wrong with the system. Rather, it means the forces were not of the type sufficient to cause activation. The Safety Canopy™ is designed to inflate in certain side impact collisions or rollover events, not in rear impact, frontal or near-frontal collisions, unless the collision causes sufficient lateral deceleration or rollover.



Several Safety Canopy™ system components get hot after inflation. Do not touch them after inflation.

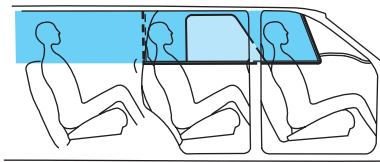

## Seating and Safety Restraints



If the Safety Canopy™ system has deployed, **the Safety Canopy™ will not function again unless replaced. The Safety Canopy™ system (including the A, B, C, and D pillar trim) must be inspected and serviced by an authorized dealer.** If the Safety Canopy™ is not replaced, the unrepaired area will increase the risk of injury in a collision.

### ***Determining if the system is operational***

The SRS uses a readiness light in the instrument cluster or a tone to indicate the condition of the system. Refer to the *Airbag readiness* section in the *Instrument Cluster* chapter. Routine maintenance of the airbag is not required.

Any difficulty with the system is indicated by one or more of the following:

- The readiness airbag light (same light as for front airbag system) will either flash or stay lit.
- The readiness light will not illuminate immediately after ignition is turned on.
- A series of five beeps will be heard. The tone pattern will repeat periodically until the problem and light are repaired.

If any of these things happen, even intermittently, have the SRS serviced at your authorized dealer immediately. Unless serviced, the system may not function properly in the event of a collision or rollover event.

### **Disposal of airbags and airbag equipped vehicles (including pretensioners)**

See your authorized dealer. Airbags MUST BE disposed of by qualified personnel.

### **SAFETY RESTRAINTS FOR CHILDREN**

See the following sections for directions on how to properly use safety restraints for children. Also see *Airbag supplemental restraint system (SRS)* in this chapter for special instructions about using airbags.

### **Important child restraint precautions**

You are required by law to use safety restraints for children in the U.S. and Canada. If small children (generally children who are four years old or younger and who weigh 40 lb. [18 kg] or less) ride in your vehicle, you must put them in safety seats made especially for children. Many states

## Seating and Safety Restraints

require that children use approved booster seats until they are eight years old. Check your local and state or provincial laws for specific requirements regarding the safety of children in your vehicle. When possible, always place children under age 12 in the rear seat of your vehicle. Accident statistics suggest that children are safer when properly restrained in the rear seating positions than in the front seating position.



Never let a passenger hold a child on his or her lap while the vehicle is moving. The passenger cannot protect the child from injury in a collision.

Always follow the instructions and warnings that come with any infant or child restraint you might use.

### Children and safety belts

If the child is the proper size, restrain the child in a safety seat. Children who are too large for child safety seats (as specified by your child safety seat manufacturer) should always wear safety belts.

Follow all the important safety restraint and airbag precautions that apply to adult passengers in your vehicle.

If the shoulder belt portion of a combination lap and shoulder belt can be positioned so it does not cross or rest in front of the child's face or neck, the child should wear the lap and shoulder belt. Moving the child closer to the center of the vehicle may help provide a good shoulder belt fit.



Do not leave children, unreliable adults, or pets unattended in your vehicle.

### Child booster seats

Children outgrow a typical convertible or toddler seat when they weigh 40 lb. (18 kg) and are around 4 years of age. Although the lap/shoulder belt will provide some protection, these children are still too small for lap/shoulder belts to fit properly, which could increase the risk of serious injury in a crash.

To improve the fit of both the lap and shoulder belt on children who have outgrown child safety seats, Ford Motor Company recommends use of a belt-positioning booster.

## Seating and Safety Restraints

Booster seats position a child so that safety belts fit better. They lift the child up so that the lap belt rests low across the hips and the knees bend comfortably. Booster seats may also make the shoulder belt fit better and more comfortably. Try to keep the belt near the middle of the shoulder.

### When children should use booster seats

Children need to use booster seats from the time they outgrow the toddler seat until they are big enough for the vehicle seat and lap/shoulder belt to fit properly. Generally this is when they weigh about 80 lb. (36 kg) (about 8 to 12 years old).

Booster seats should be used until you can answer YES to ALL of these questions:

- Can the child sit all the way back against the vehicle seat back with knees bent comfortably at the edge of the seat without slouching?

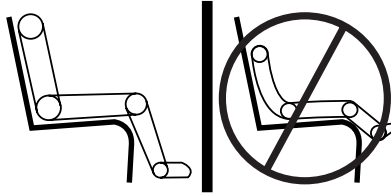

- Does the lap belt rest low across the hips?
- Is the shoulder belt centered on the shoulder and chest?
- Can the child stay seated like this for the whole trip?

### Types of booster seats

There are two types of belt-positioning booster seats:

- Those that are backless.

If your backless booster seat has a removable shield, remove the shield and use the lap/shoulder belt. If a seating position has a low seat back and no head restraint, a backless booster seat may place your child's head (top of ear level) above the top of the seat. In this case, move the backless booster to another seating position with a higher seat back and lap/shoulder belts.



## Seating and Safety Restraints

- Those with a high back.

If, with a backless booster seat, you cannot find a seating position that adequately supports your child's head, a high back booster seat would be a better choice.



Either type can be used at any seating position equipped with lap/shoulder belts if your child is over 40 lb. (18 kg).

Children and booster seats vary widely in size and shape. Choose a booster that keeps the lap belt low and snug across the hips, never up across the stomach, and lets you adjust the shoulder belt to cross the chest and rest snugly near the center of the shoulder. The drawings below compare the ideal fit (center) to a shoulder belt uncomfortably close to the neck and a shoulder belt that could slip off the shoulder.

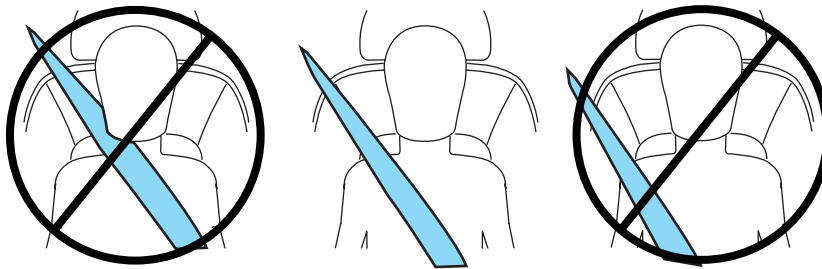

If the booster seat slides on the vehicle seat, placing a rubberized mesh sold as shelf or carpet liner under the booster seat may improve this condition.

### **The importance of shoulder belts**

Using a booster without a shoulder belt increases the risk of a child's head hitting a hard surface in a collision. For this reason, you should never use a booster seat with a lap belt only. It is best to use a booster seat with lap/shoulder belts in the back seat- the safest place for children to ride.

## Seating and Safety Restraints



Move a child to a different seating location if the shoulder belt does not stay positioned on the shoulder during use.



Follow all instructions provided by the manufacturer of the booster seat.



Never put the shoulder belt under a child's arm or behind the back because it eliminates the protection for the upper part of the body and may increase the risk of injury or death in a collision.



Never use pillows, books, or towels to boost a child. They can slide around and increase the likelihood of injury or death in a collision.

### SAFETY SEATS FOR CHILDREN

#### Child and infant or child safety seats

Use a safety seat that is recommended for the size and weight of the child. Carefully follow all of the manufacturer's instructions with the safety seat you put in your vehicle. If you do not install and use the safety seat properly, the child may be injured in a sudden stop or collision.

When installing a child safety seat:

- Review and follow the information presented in the *Airbag supplemental restraint system (SRS)* section in this chapter.
- Use the correct safety belt buckle for that seating position (the buckle closest to the direction the tongue is coming from).
- Insert the belt tongue into the proper buckle until you hear a snap and feel it latch. Make sure the tongue is securely fastened in the buckle.
- Keep the buckle release button pointing up and away from the safety seat, with the tongue between the child seat and the release button, to prevent accidental unbuckling.

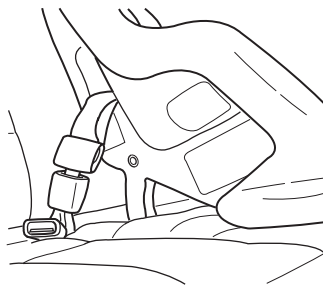

## Seating and Safety Restraints

- Place seat back in upright position.
- Put the safety belt in the automatic locking mode. Refer to *Automatic locking mode* (passenger side front and outboard rear seating positions) (if equipped) section in this chapter.
- LATCH lower anchors are recommended for use by children up to 48 lb. (22 kg) in a child restraint. Top tether anchors can be used for children up to 60 lb. (27 kg) in a child restraint, and to provide upper torso restraint for children up to 80 lb. (36 kg) using an upper torso harness and a belt-positioning booster.

Ford recommends the use of a child safety seat having a top tether strap. Install the child safety seat in a seating position with LATCH and tether anchors. For more information on top tether straps and anchors, refer to *Attaching safety seats with tether straps* in this chapter. For more information of LATCH anchors refer to *Attaching safety seats with LATCH (Lower Anchors and Tethers for Children) attachments* in this chapter.



Carefully follow all of the manufacturer's instructions included with the safety seat you put in your vehicle. If you do not install and use the safety seat properly, the child may be injured in a sudden stop or collision.



Rear-facing child seats or infant carriers should never be placed in front of an active airbag.

### Installing child safety seats with combination lap and shoulder belts



Airbags can kill or injure a child in a child seat. **NEVER** place a rear-facing child seat in front of an active airbag. If you must use a forward-facing child seat in the front seat, move the seat all the way back.



Children 12 and under should be properly restrained in the rear seat whenever possible.

## Seating and Safety Restraints

1. Position the child safety seat in a seat with a combination lap and shoulder belt.

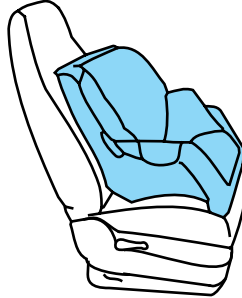

2. Pull down on the shoulder belt and then grasp the shoulder belt and lap belt together.

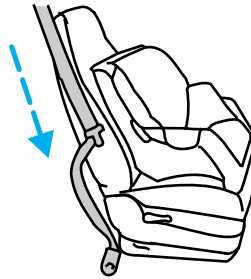

3. While holding the shoulder and lap belt portions together, route the tongue through the child seat according to the child seat manufacturer's instructions. Be sure the belt webbing is not twisted.

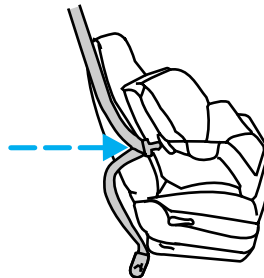



## Seating and Safety Restraints

4. Insert the belt tongue into the proper buckle (the buckle closest to the direction the tongue is coming from) for that seating position until you hear a snap and feel the latch engage. Make sure the tongue is latched securely by pulling on it.

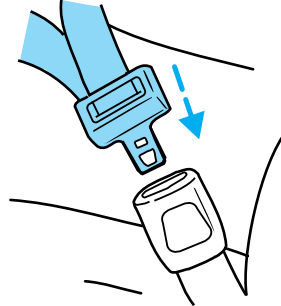

5. To put the retractor in the automatic locking mode, grasp the shoulder portion of the belt and pull downward until all of the belt is pulled out and a click is heard.

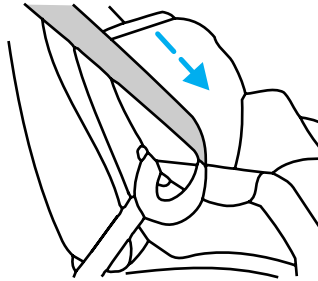

6. Allow the belt to retract. The belt will click as it retracts to indicate it is in the automatic locking mode.

7. Pull the lap belt portion across the child seat toward the buckle and pull up on the shoulder belt while pushing down with your knee on the child seat.

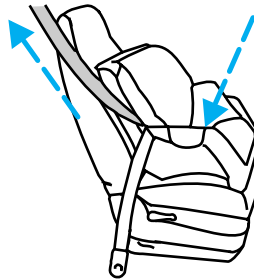

## Seating and Safety Restraints

8. Allow the safety belt to retract to remove any slack in the belt.

9. Before placing the child in the seat, forcibly move the seat forward and back to make sure the seat is securely held in place. To check this, grab the seat at the belt path and attempt to move it side to side and forward. There should be no more than one inch of movement for proper installation.

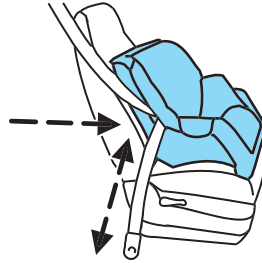

10. Try to pull the belt out of the retractor to make sure the retractor is in the automatic locking mode (you should not be able to pull more belt out). If the retractor is not locked, unbuckle the belt and repeat Steps 2 through 9.

Check to make sure the child seat is properly secured before each use.

### Attaching child safety seats with tether straps

Most new forward-facing child safety seats include a tether strap which goes over the back of the seat and hooks to an anchoring point. Tether straps are available as an accessory for many older safety seats. Contact the manufacturer of your child seat for information about ordering a tether strap.



Children should be placed in the rear in an appropriate child safety seat that is properly secured to the vehicle.

The tether anchors in your vehicle are in the positions shown:

40/40 second row seats

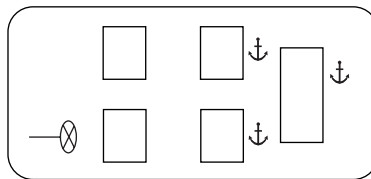

## Seating and Safety Restraints

60/40 second row seats

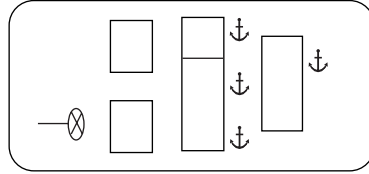

Delivery van

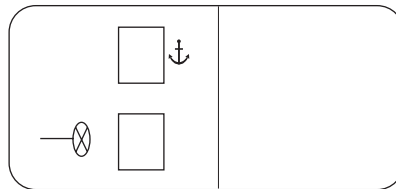

### **Front passenger seating position (delivery van only)**

1. Position the child safety seat on the passenger seat cushion.

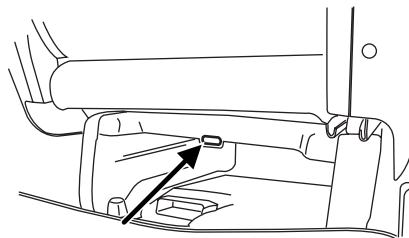

## Seating and Safety Restraints

2. Route the child safety seat tether strap over the back of the seat. If the head restraint is adjustable, route the tether strap under the head restraint and between the head restraint posts. If the top of the safety seat hits the head restraint, raise the head restraint to let the child seat fit further rearward.

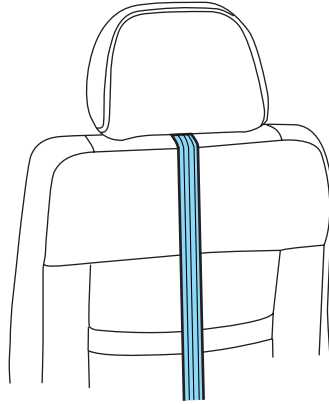

3. Grasp the tether strap and position it to the seat frame.

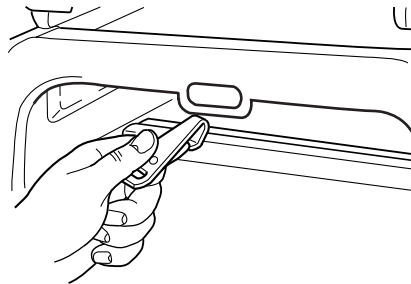

4. Rotate the tether hook, and clip the tether strap to the seat frame.

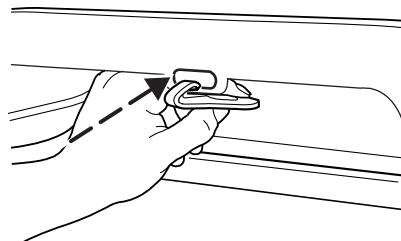

## Seating and Safety Restraints

 If the tether strap is clipped incorrectly (as shown) the child safety seat may not be retained properly in the event of a collision.

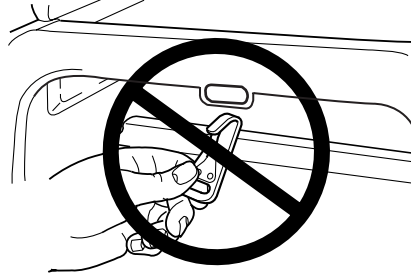

5. Rotate the tether strap clip.

6. Install the child safety seat tightly using the LATCH anchors or safety belts. Follow the instructions in this chapter.

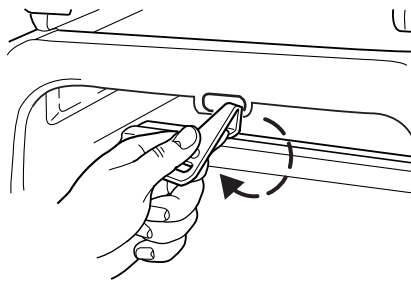

7. Tighten the child safety seat tether strap according to the manufacturer's instructions.

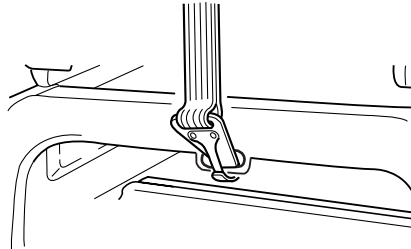

## Seating and Safety Restraints

### Rear seating positions

Follow Steps 1–7 as described above for the following available seats:

- 2nd row bucket (40/40)

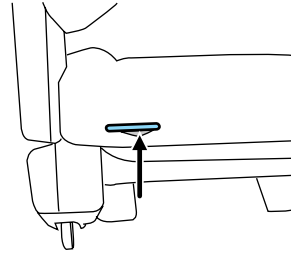

- 2nd row bench (60/40)

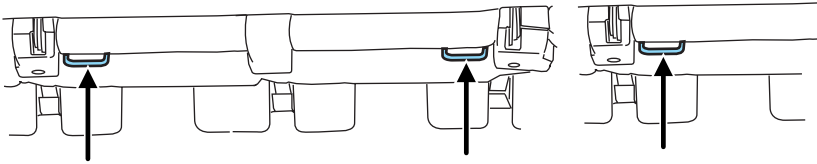

- 3rd row bench

**Note:** The cargo tie-downs at the rear edge of the floor are not tether anchors.

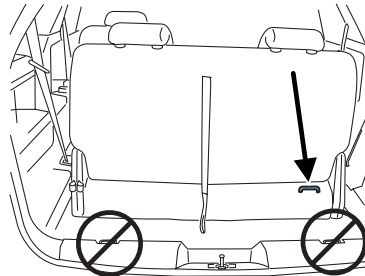

For additional important safety information on the proper use of safety belts, child seats and infant seats, please read the entire *Seating and safety restraints* chapter in this owner's guide.

## Seating and Safety Restraints

### Attaching safety seats with LATCH (Lower Anchors and Tethers for Children) attachments for child seat anchors

New child safety seats have two rigid or webbing mounted attachments that connect to two anchors at certain seating positions in your vehicle. This type of child seat eliminates the need to use safety belts to attach the child seat. For forward-facing child seats, the tether strap must also be attached to the proper tether anchor. See *Attaching safety seats with tether straps* in this chapter.

Your vehicle has LATCH anchors for child seat installation at the seating positions marked with the child seat symbol.

 Never attach two LATCH child safety seats to the same anchor. In a crash, one anchor may not be strong enough to hold two child safety seat attachments and may break, causing serious injury or death.

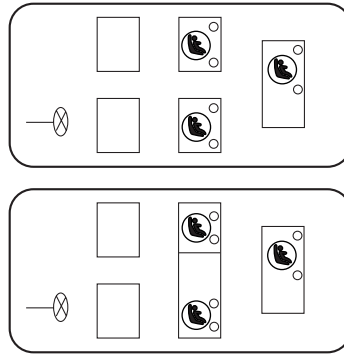

The lower anchors for child seat installation are located at the rear section of the rear seat between the cushion and seat back.

Follow the child seat manufacturer's instructions to properly install a child seat with LATCH attachments.

 Attach LATCH lower attachments of the child seat only to the anchors shown.

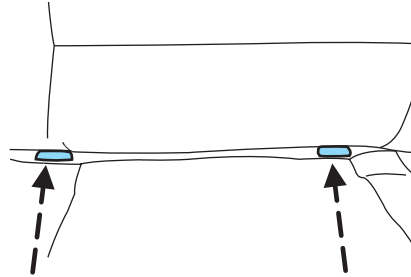

If you install a child seat with rigid LATCH attachments, do not tighten the tether strap enough to lift the child seat off the vehicle seat cushion when the child is seated in it. Keep the tether strap just snug without lifting the front of the child seat. Keeping the child seat just touching the vehicle seat gives the best protection in a severe crash. Adjusting the seat back angle may allow the tether strap to be tight without lifting the child seat.

## Seating and Safety Restraints

Each time you use the safety seat, check that the seat is properly attached to the lower anchors and tether anchor. Try to tilt the child seat from side to side. Also try to tug the seat forward. Check to see if the anchors hold the seat in place.



If the safety seat is not anchored properly, the risk of a child being injured in a crash greatly increases.



## Tires, Wheels and Loading

### INFORMATION ABOUT UNIFORM TIRE QUALITY GRADING

New vehicles are fitted with tires that have a rating on them called Tire Quality Grades. The Quality grades can be found where applicable on the tire sidewall between tread shoulder and maximum section width. For example:

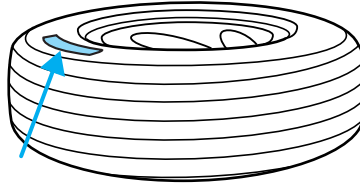

- **Treadwear 200 Traction AA Temperature A**

These Tire Quality Grades are determined by standards that the United States Department of Transportation has set.

Tire Quality Grades apply to new pneumatic tires for use on passenger cars. They do not apply to deep tread, winter-type snow tires, space-saver or temporary use spare tires, tires with nominal rim diameters of 10 to 12 inches or limited production tires as defined in Title 49 Code of Federal Regulations Part 575.104(c)(2).

**U.S. Department of Transportation-Tire quality grades:** The U.S. Department of Transportation requires Ford Motor Company to give you the following information about tire grades exactly as the government has written it.

#### Treadwear

The treadwear grade is a comparative rating based on the wear rate of the tire when tested under controlled conditions on a specified government test course. For example, a tire graded 150 would wear one and one-half (1 1/2) times as well on the government course as a tire graded 100. The relative performance of tires depends upon the actual conditions of their use, however, and may depart significantly from the norm due to variations in driving habits, service practices, and differences in road characteristics and climate.

#### Traction AA A B C

The traction grades, from highest to lowest are AA, A, B, and C. The grades represent the tire's ability to stop on wet pavement as measured under controlled conditions on specified government test surfaces of asphalt and concrete. A tire marked C may have poor traction performance.

## Tires, Wheels and Loading



The traction grade assigned to this tire is based on straight-ahead braking traction tests, and does not include acceleration, cornering, hydroplaning or peak traction characteristics.

### Temperature A B C

The temperature grades are A (the highest), B and C, representing the tire's resistance to the generation of heat and its ability to dissipate heat when tested under controlled conditions on a specified indoor laboratory test wheel. Sustained high temperature can cause the material of the tire to degenerate and reduce tire life, and excessive temperature can lead to sudden tire failure. The grade C corresponds to a level of performance which all passenger car tires must meet under the Federal Motor Vehicle Safety Standard No. 109. Grades B and A represent higher levels of performance on the laboratory test wheel than the minimum required by law.



The temperature grade for this tire is established for a tire that is properly inflated and not overloaded. Excessive speed, underinflation, or excessive loading, either separately or in combination, can cause heat buildup and possible tire failure.

## TIRES

Tires are designed to give many thousands of miles of service, but they must be maintained in order to get the maximum benefit from them.

### Glossary of tire terminology

- **Tire label:** A label showing the OE (Original Equipment) tire sizes, recommended inflation pressure and the maximum weight the vehicle can carry.
- **Tire Identification Number (TIN):** A number on the sidewall of each tire providing information about the tire brand and manufacturing plant, tire size and date of manufacture. Also referred to as DOT code.
- **Inflation pressure:** A measure of the amount of air in a tire.
- **Standard load:** A class of P-metric or Metric tires designed to carry a maximum load at 35 psi [37 psi (2.5 bar) for Metric tires]. Increasing the inflation pressure beyond this pressure will not increase the tire's load carrying capability.

## Tires, Wheels and Loading

- **Extra load:** A class of P-metric or Metric tires designed to carry a heavier maximum load at 41 psi [43 psi (2.9 bar) for Metric tires]. Increasing the inflation pressure beyond this pressure will not increase the tire's load carrying capability.
- **kPa:** Kilopascal, a metric unit of air pressure.
- **PSI:** Pounds per square inch, a standard unit of air pressure.
- **Cold inflation pressure:** The tire pressure when the vehicle has been stationary and out of direct sunlight for an hour or more and prior to the vehicle being driven for 1 mile (1.6 km).
- **Recommended inflation pressure:** The cold inflation pressure found on the Safety Compliance Certification Label or Tire Label located on the B-Pillar or the edge of the driver's door.
- **B-pillar:** The structural member at the side of the vehicle behind the front door.
- **Bead area of the tire:** Area of the tire next to the rim.
- **Sidewall of the tire:** Area between the bead area and the tread.
- **Tread area of the tire:** Area of the perimeter of the tire that contacts the road when mounted on the vehicle.
- **Rim:** The metal support (wheel) for a tire or a tire and tube assembly upon which the tire beads are seated.

### INFLATING YOUR TIRES

Safe operation of your vehicle requires that your tires are properly inflated. Remember that a tire can lose up to half of its air pressure without appearing flat.

Every day before you drive, check your tires. If one looks lower than the others, use a tire gauge to check pressure of all tires and adjust if required.

At least once a month and before long trips, inspect each tire and check the tire pressure with a tire gauge (including spare, if equipped). Inflate all tires to the inflation pressure recommended by Ford Motor Company.

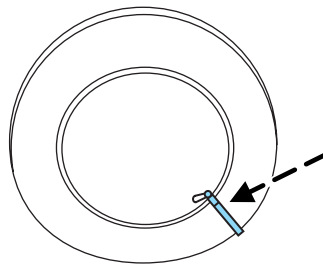

## Tires, Wheels and Loading

Use a tire gauge to check the tire inflation pressure, including the spare (if equipped), at least monthly and before long trips. You are strongly urged to buy a reliable tire pressure gauge, as automatic service station gauges may be inaccurate. Ford Motor Company recommends the use of a digital or dial-type tire pressure gauge rather than a stick-type tire pressure gauge.

Use the recommended cold inflation pressure for optimum tire performance and wear. Under-inflation or over-inflation may cause uneven treadwear patterns.



Under-inflation is the most common cause of tire failures and may result in severe tire cracking, tread separation or "blowout", with unexpected loss of vehicle control and increased risk of injury. Under-inflation increases sidewall flexing and rolling resistance, resulting in heat buildup and internal damage to the tire. It also may result in unnecessary tire stress, irregular wear, loss of vehicle control and accidents. A tire can lose up to half of its air pressure and not appear to be flat!

Always inflate your tires to the Ford recommended inflation pressure even if it is less than the maximum inflation pressure information found on the tire. The Ford recommended tire inflation pressure is found on the Safety Compliance Certification Label or Tire Label which is located on the B-Pillar or the edge of the driver's door. Failure to follow the tire pressure recommendations can cause uneven treadwear patterns and adversely affect the way your vehicle handles.

**Maximum Permissible Inflation Pressure** is the tire manufacturer's maximum permissible pressure and/or the pressure at which the maximum load can be carried by the tire. This pressure is normally higher than the manufacturer's recommended cold inflation pressure which can be found on the Safety Compliance Certification Label or Tire Label which is located on the B-Pillar or the edge of the driver's door. The cold inflation pressure should never be set lower than the recommended pressure on the Safety Compliance Certification Label or Tire Label.

When weather temperature changes occur, tire inflation pressures also change. A 10° F (6° C) temperature drop can cause a corresponding drop of 1 psi (7 kPa) in inflation pressure. Check your tire pressures frequently and adjust them to the proper pressure which can be found on the Safety Compliance Certification Label or Tire Label.

## Tires, Wheels and Loading

If you are checking tire pressure when the tire is hot, (i.e. driven more than 1 mile [1.6 km]), never “bleed” or reduce air pressure. The tires are hot from driving and it is normal for pressures to increase above recommended cold pressures. A hot tire at or below recommended cold inflation pressure could be significantly under-inflated.

To check the pressure in your tire(s):

1. Make sure the tires are cool, meaning they are not hot from driving even a mile.

**Note:** If you have to drive a distance to get air for your tire(s), check and record the tire pressure first and add the appropriate air pressure when you get to the pump. It is normal for tires to heat up and the air pressure inside to go up as you drive. Never “bleed” or reduce air pressure when tires are hot.

2. Remove the cap from the valve on one tire, then firmly press the tire gauge onto the valve and measure the pressure with the tire gauge.
3. Add enough air to reach the recommended air pressure.

**Note:** If you overfill the tire, release air by pushing on the metal stem in the center of the valve. Then recheck the pressure with your tire gauge.

4. Replace the valve cap.
5. Repeat this procedure for each tire, including the spare.

**Note:** Some spare tires operate at a higher inflation pressure than the other tires. For T-type/mini-spare tires (see *T-Type/Mini-Spare Tire Information* section for description): Store and maintain at 60psi (4.15 bars). For Full Size and Dissimilar spare tires (see *Dissimilar Spare Tire/Wheel Information* section for description): Store and maintain at the higher of the front and rear inflation pressure as shown on the Safety Compliance Certification Label or the Tire Label.

6. Visually inspect the tires to make sure there are no nails or other objects embedded that could poke a hole in the tire and cause an air leak.

7. Check the sidewalls to make sure there are no gouges, cuts or bulges.

## Tires, Wheels and Loading

### TIRE CARE

#### Inspecting your tires

Periodically inspect the tire treads for uneven or excessive wear and remove objects such as stones, nails or glass that may be wedged in the tread grooves. Check for holes or cuts that may permit air leakage from the tire and make necessary repairs. Also inspect the tire sidewalls for cracking, cuts, bruises and other signs of damage or excessive wear. If internal damage to the tire is suspected, have the tire demounted and inspected in case it needs to be repaired or replaced. For your safety, tires that are damaged or show signs of excessive wear should not be used because they are more likely to blow out or fail.

Improper or inadequate vehicle maintenance can cause tires to wear abnormally. Inspect all your tires, including the spare, frequently, and replace them if one or more of the following conditions exist:

#### Tire wear

When the tread is worn down to 1/16th of an inch (2 mm), tires must be replaced to help prevent your vehicle from skidding and hydroplaning. Built-in treadwear indicators, or “wear bars”, which look like narrow strips of smooth rubber across the tread will appear on the tire when the tread is worn down to 1/16th of an inch (2 mm).

When the tire tread wears down to the same height as these “wear bars”, the tire is worn out and must be replaced.

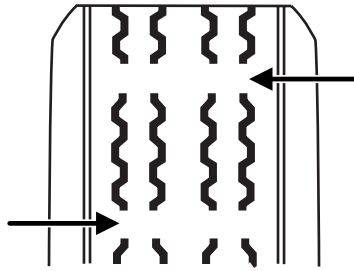

#### Damage

Periodically inspect the tire treads and sidewalls for damage (such as bulges in the tread or sidewalls, cracks in the tread groove and separation in the tread or sidewall). If damage is observed or suspected have the tire inspected by a tire professional. Tires can be damaged during off-road use, so inspection after off-road use is also recommended.

## Tires, Wheels and Loading



### Age

Tires degrade over time, even when they are not being used. It is recommended that tires generally be replaced after 6 years of normal service. Heat caused by hot climates or frequent high loading conditions can accelerate the aging process.

You should replace the spare tire when you replace the other road tires due to the aging of the spare tire.

### U.S. DOT Tire Identification Number (TIN)

Both U.S. and Canada Federal regulations require tire manufacturers to place standardized information on the sidewall of all tires. This information identifies and describes the fundamental characteristics of the tire and also provides a U.S. DOT Tire Identification Number for safety standard certification and in case of a recall.

This begins with the letters “DOT” and indicates that the tire meets all federal standards. The next two numbers or letters are the plant code designating where it was manufactured, the next two are the tire size code and the last four numbers represent the week and year the tire was built. For example, the numbers 317 mean the 31st week of 1997. After 2000 the numbers go to four digits. For example, 2501 means the 25th week of 2001. The numbers in between are identification codes used for traceability. This information is used to contact customers if a tire defect requires a recall.

### Tire Replacement Requirements

Your vehicle is equipped with tires designed to provide a safe ride and handling capability.



Only use replacement tires and wheels that are the same size and type (such as P-metric versus LT-metric or all-season versus all-terrain) as those originally provided by Ford. Use of any tire or wheel not recommended by Ford can affect the safety and performance of your vehicle, which could result in an increased risk of loss of vehicle control, vehicle rollover, personal injury and death. Additionally the use of non-recommended tires and wheels could cause steering, suspension, axle or transfer case/power transfer unit failure. If you have questions regarding tire replacement, see an authorized dealer.

**Important:** Remember to replace the wheel valve stems when the road tires are replaced on your vehicle.

## Tires, Wheels and Loading

It is recommended that the two front tires or two rear tires generally be replaced as a pair.

### Safety practices

Driving habits have a great deal to do with your tire mileage and safety.

- Observe posted speed limits
- Avoid fast starts, stops and turns
- Avoid potholes and objects on the road
- Do not run over curbs or hit the tire against a curb when parking



If your vehicle is stuck in snow, mud, sand, etc., **do not** rapidly spin the tires; spinning the tires can tear the tire and cause an explosion. A tire can explode in as little as three to five seconds.



Never spin the tires in excess of the 35 mph (55 km/h) point indicated on the speedometer.

### Highway hazards

No matter how carefully you drive there's always the possibility that you may eventually have a flat tire on the highway. Drive slowly to the closest safe area out of traffic. This may further damage the flat tire, but your safety is more important.

If you feel a sudden vibration or ride disturbance while driving, or you suspect your tire or vehicle has been damaged, immediately reduce your speed. Drive with caution until you can safely pull off the road. Stop and inspect the tires for damage. If a tire is under-inflated or damaged, deflate it, remove wheel and replace it with your spare tire and wheel. If you cannot detect a cause, have the vehicle towed to the nearest repair facility or tire dealer to have the vehicle inspected.

### Tire and wheel alignment

A bad jolt from hitting a curb or pothole can cause the front end of your vehicle to become misaligned or cause damage to your tires. If your vehicle seems to pull to one side when you're driving, the wheels may be out of alignment. Have an authorized dealer check the wheel alignment periodically.

Wheel misalignment in the front or the rear can cause uneven and rapid treadwear of your tires and should be corrected by an authorized dealer.



## Tires, Wheels and Loading

Front wheel drive (FWD) vehicles and those with an independent rear suspension (if equipped) may require alignment of all four wheels.

The tires should also be balanced periodically. An unbalanced tire and wheel assembly may result in irregular tire wear.

### Tire rotation

Rotating your tires at the recommended interval (as indicated in the *scheduled maintenance information* that comes with your vehicle) will help your tires wear more evenly, providing better tire performance and longer tire life. Unless otherwise specified, rotate the tires approximately every 5,000 miles (8,000 km).

- Front Wheel Drive (FWD) vehicles (front tires at top of diagram)

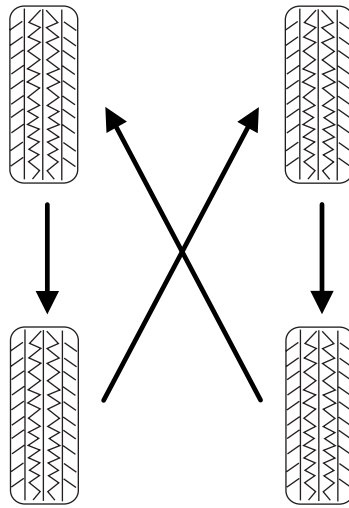

## Tires, Wheels and Loading

- Rear Wheel Drive (RWD) vehicles/Four Wheel Drive (4WD)/ All Wheel Drive (AWD) vehicles (front tires at top of diagram)

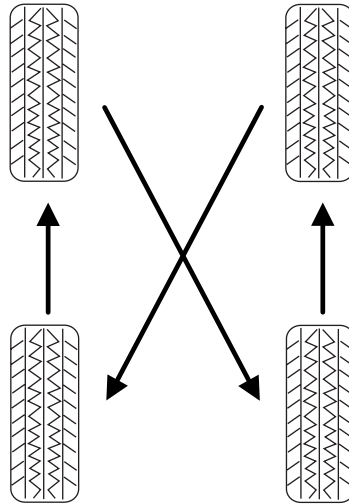

Sometimes irregular tire wear can be corrected by rotating the tires.

**Note:** If your tires show uneven wear ask an authorized dealer to check for and correct any wheel misalignment, tire imbalance or mechanical problem involved before tire rotation.

**Note:** Your vehicle may be equipped with a dissimilar spare tire/wheel. A dissimilar spare tire/wheel is defined as a spare tire and/or wheel that is different in brand, size or appearance from the road tires and wheels. If you have a dissimilar spare tire/wheel it is intended for temporary use only and should not be used in a tire rotation.

**Note:** After having your tires rotated, inflation pressure must be checked and adjusted to the vehicle requirements.

### INFORMATION CONTAINED ON THE TIRE SIDEWALL

Both U.S. and Canada Federal regulations require tire manufacturers to place standardized information on the sidewall of all tires. This information identifies and describes the fundamental characteristics of the tire and also provides a U.S. DOT Tire Identification Number for safety standard certification and in case of a recall.

## Tires, Wheels and Loading

### Information on “P” type tires

P215/65R15 95H is an example of a tire size, load index and speed rating. The definitions of these items are listed below. (Note that the tire size, load index and speed rating for your vehicle may be different from this example.)

1. **P:** Indicates a tire, designated by the Tire and Rim Association (T&RA), that may be used for service on cars, SUVs, minivans and light trucks.

**Note:** If your tire size does not begin with a letter this may mean it is designated by either ETRTO (European Tire and Rim Technical Organization) or JATMA (Japan Tire Manufacturing Association).

2. **215:** Indicates the nominal width of the tire in millimeters from sidewall edge to sidewall edge. In general, the larger the number, the wider the tire.

3. **65:** Indicates the aspect ratio which gives the tire’s ratio of height to width.

4. **R:** Indicates a “radial” type tire.

5. **15:** Indicates the wheel or rim diameter in inches. If you change your wheel size, you will have to purchase new tires to match the new wheel diameter.

6. **95:** Indicates the tire’s load index. It is an index that relates to how much weight a tire can carry. You may find this information in your *Owner’s Guide*. If not, contact a local tire dealer.

**Note:** You may not find this information on all tires because it is not required by federal law.

7. **H:** Indicates the tire’s speed rating. The speed rating denotes the speed at which a tire is designed to be driven for extended periods of time under a standard condition of load and inflation pressure. The tires on your vehicle may operate at different conditions for load and inflation pressure. These speed ratings may need to be adjusted for the difference in conditions. The ratings range from 81 mph (130 km/h) to 186 mph (299 km/h). These ratings are listed in the following chart.

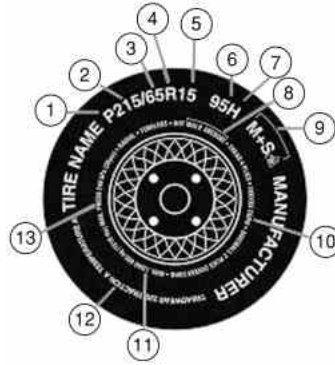

## Tires, Wheels and Loading

**Note:** You may not find this information on all tires because it is not required by federal law.

Letter rating	Speed rating - mph (km/h)
M	81 mph (130 km/h)
N	87 mph (140 km/h)
Q	99 mph (159 km/h)
R	106 mph (171 km/h)
S	112 mph (180 km/h)
T	118 mph (190 km/h)
U	124 mph (200 km/h)
H	130 mph (210 km/h)
V	149 mph (240 km/h)
W	168 mph (270 km/h)
Y	186 mph (299 km/h)

**Note:** For tires with a maximum speed capability over 149 mph (240 km/h), tire manufacturers sometimes use the letters ZR. For those with a maximum speed capability over 186 mph (299 km/h), tire manufacturers always use the letters ZR.

**8. U.S. DOT Tire Identification Number (TIN):** This begins with the letters "DOT" and indicates that the tire meets all federal standards. The next two numbers or letters are the plant code designating where it was manufactured, the next two are the tire size code and the last four numbers represent the week and year the tire was built. For example, the numbers 317 mean the 31st week of 1997. After 2000 the numbers go to four digits. For example, 2501 means the 25th week of 2001. The numbers in between are identification codes used for traceability. This information is used to contact customers if a tire defect requires a recall.

**9. M+S or M/S:** Mud and Snow, or

**AT:** All Terrain, or

**AS:** All Season.

**10. Tire Ply Composition and Material Used:** Indicates the number of plies or the number of layers of rubber-coated fabric in the tire tread and sidewall. Tire manufacturers also must indicate the ply materials in the tire and the sidewall, which include steel, nylon, polyester, and others.

**11. Maximum Load:** Indicates the maximum load in kilograms and pounds that can be carried by the tire. Refer to the Safety Compliance Certification Label, which is located on the B-Pillar or the edge of the driver's door, for the correct tire pressure for your vehicle.

## Tires, Wheels and Loading

### 12. Treadwear, Traction and Temperature Grades

- **Treadwear:** The treadwear grade is a comparative rating based on the wear rate of the tire when tested under controlled conditions on a specified government test course. For example, a tire graded 150 would wear one and one-half (1½) times as well on the government course as a tire graded 100.
- **Traction:** The traction grades, from highest to lowest are AA, A, B, and C. The grades represent the tire's ability to stop on wet pavement as measured under controlled conditions on specified government test surfaces of asphalt and concrete. A tire marked C may have poor traction performance.
- **Temperature:** The temperature grades are A (the highest), B and C, representing the tire's resistance to the generation of heat and its ability to dissipate heat when tested under controlled conditions on a specified indoor laboratory test wheel.

13. **Maximum Permissible Inflation Pressure:** Indicates the tire manufacturers' maximum permissible pressure and/or the pressure at which the maximum load can be carried by the tire. This pressure is normally higher than the manufacturer's recommended cold inflation pressure which can be found on the Safety Compliance Certification Label or Tire Label which is located on the B-Pillar or the edge of the driver's door. The cold inflation pressure should never be set lower than the recommended pressure on the vehicle label.

The tire suppliers may have additional markings, notes or warnings such as standard load, radial tubeless, etc.

## Tires, Wheels and Loading

### Additional information contained on the tire sidewall for “LT” type tires

“LT” type tires have some additional information beyond those of “P” type tires; these differences are described below:

1. **LT:** Indicates a tire, designated by the Tire and Rim Association (T&RA), that is intended for service on light trucks.

2. **Load Range/Load Inflation Limits:** Indicates the tire’s load-carrying capabilities and its inflation limits.

3. **Maximum Load Dual lb. (kg) at psi (kPa) cold:** Indicates the maximum load and tire pressure when the tire is used as a dual; defined as four tires on the rear axle (a total of six or more tires on the vehicle).

4. **Maximum Load Single lb. (kg) at psi (kPa) cold:** Indicates the maximum load and tire pressure when the tire is used as a single; defined as two tires (total) on the rear axle.



## Tires, Wheels and Loading

### Information on “T” type tires

“T” type tires have some additional information beyond those of “P” type tires; these differences are described below:

T145/80D16 is an example of a tire size.

**Note:** The temporary tire size for your vehicle may be different from this example.

1. **T:** Indicates a type of tire, designated by the Tire and Rim Association (T&RA), that is intended for temporary service on cars, SUVs, minivans and light trucks.

2. **145:** Indicates the nominal width of the tire in millimeters from sidewall edge to sidewall edge. In general, the larger the number, the wider the tire.

3. **80:** Indicates the aspect ratio which gives the tire’s ratio of height to width. Numbers of 70 or lower indicate a short sidewall.

4. **D:** Indicates a “diagonal” type tire.

**R:** Indicates a “radial” type tire.

5. **16:** Indicates the wheel or rim diameter in inches. If you change your wheel size, you will have to purchase new tires to match the new wheel diameter.

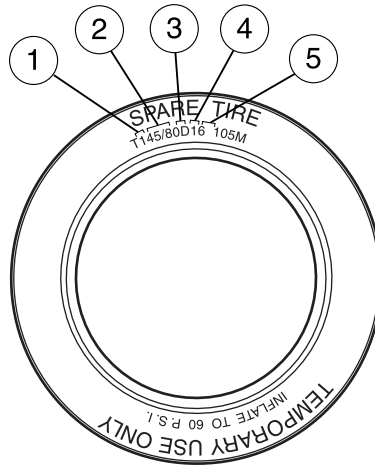

### Location of the tire label

You will find a Tire Label containing tire inflation pressure by tire size and other important information located on the B-Pillar or the edge of the driver's door. Refer to the payload description and graphic in the *Vehicle loading — with and without a trailer* section.

### SNOW TIRES AND CHAINS



Snow tires must be the same size and grade as the tires you currently have on your vehicle.

## Tires, Wheels and Loading

The tires on your vehicle have all weather treads to provide traction in rain and snow. However, in some climates, you may need to use snow tires and chains.

Follow these guidelines when using snow tires and chains:

- Use only SAE class “S” cables or equivalent on the front axle for P215/65R17 equipped vehicles. SAE class “S” chains or other conventional link chains may cause damage to the vehicles wheel house and/or body. Use of optional spike type traction devices or equivalent is also acceptable.
- Do not install tire chains, cables, or optional traction devices on the rear tires. This could cause damage to the vehicle’s wheel house or body.
- Do not use tire chains, cables, or optional traction devices with optional P225/60R18 tires.
- Install cable chains securely, verifying that the cables do not touch any wiring, brake lines or fuel lines.
- Drive cautiously. If you hear the cables rub or bang against your vehicle, stop and re-tighten the cables. If this does not work, remove the cables to prevent damage to your vehicle.
- If possible, avoid fully loading your vehicle.
- Remove the tire cables when they are no longer needed. Do not use tire cables on dry roads.
- The suspension insulation and bumpers will help prevent vehicle damage. Do not remove these components from your vehicle when using snow tires and chains.
- Do not exceed 30 mph (48 km/h) with tire cables on your vehicle.

### VEHICLE LOADING – WITH AND WITHOUT A TRAILER

This section will guide you in the proper loading of your vehicle and/or trailer, to keep your loaded vehicle weight within its design rating capability, with or without a trailer. Properly loading your vehicle will provide maximum return of vehicle design performance. Before loading your vehicle, familiarize yourself with the following terms for determining your vehicle’s weight ratings, with or without a trailer, from the vehicle’s Tire Label or Safety Compliance Certification Label:

**Base Curb Weight** – is the weight of the vehicle including a full tank of fuel and all standard equipment. It does not include passengers, cargo, or optional equipment.



## Tires, Wheels and Loading

**Vehicle Curb Weight** – is the weight of your new vehicle when you picked it up from your authorized dealer plus any aftermarket equipment.

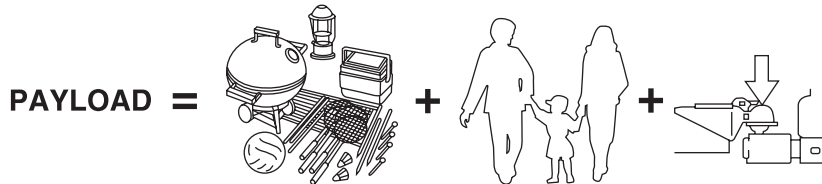

**Payload** – is the combined weight of cargo and passengers that the vehicle is carrying. The maximum payload for your vehicle can be found on the Tire Label on the B-Pillar or the edge of the driver's door (vehicles exported outside the US and Canada may not have a Tire Label). Look for **“THE COMBINED WEIGHT OF OCCUPANTS AND CARGO SHOULD NEVER EXCEED XXX kg OR XXX lb.”** for maximum payload. The payload listed on the Tire Label is the maximum payload for the vehicle as built by the assembly plant. If any aftermarket or authorized-dealer installed equipment has been installed on the vehicle, the weight of the equipment must be subtracted from the payload listed on the Tire Label in order to determine the new payload.

 The appropriate loading capacity of your vehicle can be limited either by volume capacity (how much space is available) or by payload capacity (how much weight the vehicle should carry). Once you have reached the maximum payload of your vehicle, do not add more cargo, even if there is space available. Overloading or improperly loading your vehicle can contribute to loss of vehicle control and vehicle rollover.

## Tires, Wheels and Loading

Example only:

TIRE AND LOADING INFORMATION				
SEATING CAPACITY		TOTAL 5	FRONT 2	REAR 3
The combined weight of occupants and cargo should never exceed : <b>XXX kg or XXX lbs.</b>				
TIRE	SIZE	COLD TIRE PRESSURE	SEE OWNERS MANUAL FOR ADDITIONAL INFORMATION	
FRONT	LT225/75R 16.5E	200 KPA, 29 PSI		
REAR	LT225/75R 16.5E	200 KPA, 29 PSI		
SPARE	T145/80D16 P225/60R17	420 KPA, 60 PSI 200 KPA, 29 PSI		

TIRE AND LOAD INFORMATION				
RENSEIGNEMENTS RELATIFS AUX PNEUS ET À LA CHARGE				
SEATING CAPACITY		TOTAL XX	FRONT XX	REAR X
NOMBRE DE PLACES		TOTAL	AVANT	ARRIERE
The combined weight of occupants and cargo should never exceed : <b>XXX kg.</b> La charge du véhicule (occupants et bagages) ne doit jamais dépasser : <b>XXX lbs.</b>				
TIRE PNEUS	SIZE DIMENSIONS	COLD TIRE PRESSURE PRESSION À FROID	SEE OWNERS MANUAL FOR ADDITIONAL INFORMATION CONSULTER LE GUIDE DU PROPRIÉTAIRE POUR DE PLUS AMPLES RESEIGNEMENTS	
FRONT/ AVANT	LT225/75R 16.5E	200 KPA, 29 PSI		
REAR/ ARRIERE	LT225/75R 16.5E	200 KPA, 29 PSI		
SPARE/ PNEU DE SECOURS	T145/80D16 P225/60R17	420 KPA, 60 PSI 200 KPA, 29 PSI		

CARGO

=



+

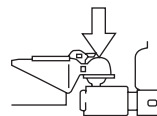

**Cargo Weight** – includes all weight added to the Base Curb Weight, including cargo and optional equipment. When towing, trailer tongue load or king pin weight is also part of cargo weight.

**GAW (Gross Axle Weight)** – is the total weight placed on each axle (front and rear) – including vehicle curb weight and all payload.

## Tires, Wheels and Loading

**GAWR (Gross Axle Weight Rating)** – is the maximum allowable weight that can be carried by a single axle (front or rear). **These numbers are shown on the Safety Compliance Certification Label located on the B-Pillar or the edge of the driver's door. The total load on each axle must never exceed its GAWR.**

 Exceeding the Safety Compliance Certification Label axle weight rating limits could result in substandard vehicle handling or performance, engine, transmission and/or structural damage, serious damage to the vehicle, loss of control and personal injury.

**Note:** For trailer towing information refer to *Trailer towing* found in this chapter or the *RV and Trailer Towing Guide* provided by your authorized dealer.

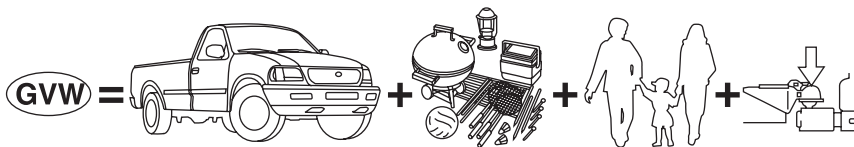

**GVW (Gross Vehicle Weight)** – is the Vehicle Curb Weight + cargo + passengers.

## Tires, Wheels and Loading

**GVWR (Gross Vehicle Weight Rating)** – is the maximum allowable weight of the fully loaded vehicle (including all options, equipment, passengers and cargo). **The GVWR is shown on the Safety Compliance Certification Label located on the B-Pillar or the edge of the driver's door. The GVW must never exceed the GVWR.**

MFD. BY FORD MOTOR CO.					
DATE: XX/XX	GVWR: XXXXXLB/ XXXXXKG				
FRONT GAWR: XXXXL	REAR GAWR: XXXXLB				
XXXXKG	WITH	XXXXKG	WITH		
XXXX/XXXXXX	TIRES	XXXX/XXXXXX	TIRES		
XXXX.XX	RIMS	XXXX.XX	RIMS		
AT XXX kPa/XX	PSI COLD	AT XXX kPa/XX	PSI COLD		
THIS VEHICLE CONFORMS TO ALL APPLICABLE FEDERAL MOTOR VEHICLE SAFETY AND THEFT PREVENTION STANDARDS IN EFFECT ON THE DATE OF MANUFACTURE SHOWN ABOVE.					
VIN: XXXXXXXXXXXXXXXXX	XXXXX		XXXXX		
TYPE: XXX					
					
EXT PNT: XX	RC: XX	DSO:			
WB BRK INT TR TP/PS R AXLE TR SPR XXXX					
XXX X XX X XX X XX XXX					
XXXXXXXXXXXXX XXX XXXX-XXXXXXXX-XX					



Exceeding the Safety Compliance Certification Label vehicle weight rating limits could result in substandard vehicle handling or performance, engine, transmission and/or structural damage, serious damage to the vehicle, loss of control and personal injury.

$$\text{GCW} = \text{GVW} +$$

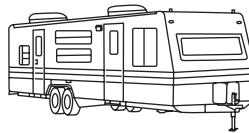

**GCW (Gross Combined Weight)** – is the weight of the loaded vehicle (GVW) plus the weight of the fully loaded trailer.

**GCWR (Gross Combined Weight Rating)** – is the maximum allowable weight of the vehicle and the loaded trailer – including all cargo and passengers – that the vehicle can handle without risking damage. (Important: The towing vehicles' braking system is rated for operation at GVWR, not at GCWR. Separate functional brakes should be used for safe control of towed vehicles and for trailers where the GCW of the towing vehicle plus the trailer exceed the GVWR of the towing vehicle. **The GCW must never exceed the GCWR.**

## Tires, Wheels and Loading

**Maximum Loaded Trailer Weight** – is the highest possible weight of a fully loaded trailer the vehicle can tow. It assumes a vehicle with only mandatory options, no cargo (internal or external), a tongue load of 10–15% (conventional trailer) or king pin weight of 15–25% (fifth wheel trailer), and driver only (150 lb. [68 kg]). **Consult your authorized dealer (or the *RV and Trailer Towing Guide* provided by your authorized dealer) for more detailed information.**



Do not exceed the GVWR or the GAWR specified on the Safety Compliance Certification Label.



Do not use replacement tires with lower load carrying capacities than the originals because they may lower the vehicle's GVWR and GAWR limitations. Replacement tires with a higher limit than the originals do not increase the GVWR and GAWR limitations.



Exceeding any vehicle weight rating limitation could result in serious damage to the vehicle and/or personal injury.

### Steps for determining the correct load limit:

1. Locate the statement “The combined weight of occupants and cargo should never exceed XXX kg or XXX lbs.” on your vehicle's placard.
2. Determine the combined weight of the driver and passengers that will be riding in your vehicle.
3. Subtract the combined weight of the driver and passengers from XXX kg or XXX lbs.
4. The resulting figure equals the available amount of cargo and luggage load capacity. For example, if the “XXX” amount equals 1,400 lbs. and there will be five 150 lb. passengers in your vehicle, the amount of available cargo and luggage load capacity is 650 lbs. (1400–750 (5 x 150) = 650 lb.). In metric units (635–340 (5 x 68) = 295 kg.)
5. Determine the combined weight of luggage and cargo being loaded on the vehicle. That weight may not safely exceed the available cargo and luggage load capacity calculated in Step 4.
6. If your vehicle will be towing a trailer, load from your trailer will be transferred to your vehicle. Consult this manual to determine how this reduces the available cargo and luggage load capacity of your vehicle.

## Tires, Wheels and Loading

The following gives you a few examples on how to calculate the available amount of cargo and luggage load capacity:

- Another example for your vehicle with 1400 lb. (635 kg) of cargo and luggage capacity. You decide to go golfing. Is there enough load capacity to carry you, 4 of your friends and all the golf bags? You and four friends average 220 lb. (99 kg) each and the golf bags weigh approximately 30 lb. (13.5 kg) each. The calculation would be:  $1400 - (5 \times 220) - (5 \times 30) = 1400 - 1100 - 150 = 150$  lb. Yes, you have enough load capacity in your vehicle to transport four friends and your golf bags. In metric units, the calculation would be:  $635 \text{ kg} - (5 \times 99 \text{ kg}) - (5 \times 13.5 \text{ kg}) = 635 - 495 - 67.5 = 72.5$  kg.
- A final example for your vehicle with 1400 lb. (635 kg) of cargo and luggage capacity. You and one of your friends decide to pick up cement from the local home improvement store to finish that patio you have been planning for the past 2 years. Measuring the inside of the vehicle with the rear seat folded down, you have room for 12-100 lb. (45 kg) bags of cement. Do you have enough load capacity to transport the cement to your home? If you and your friend each weigh 220 lb. (99 kg), the calculation would be:  $1400 - (2 \times 220) - (12 \times 100) = 1400 - 440 - 1200 = -240$  lb. No, you do not have enough cargo capacity to carry that much weight. In metric units, the calculation would be:  $635 \text{ kg} - (2 \times 99 \text{ kg}) - (12 \times 45 \text{ kg}) = 635 - 198 - 540 = -103$  kg. You will need to reduce the load weight by at least 240 lb. (104 kg). If you remove 3-100 lb. (45 kg) cement bags, then the load calculation would be:  
 $1400 - (2 \times 220) - (9 \times 100) = 1400 - 440 - 900 = 60$  lb. Now you have the load capacity to transport the cement and your friend home. In metric units, the calculation would be:  $635 \text{ kg} - (2 \times 99 \text{ kg}) - (9 \times 45 \text{ kg}) = 635 - 198 - 405 = 32$  kg.

The above calculations also assume that the loads are positioned in your vehicle in a manner that does not overload the Front or the Rear Gross Axle Weight Rating specified for your vehicle on the Safety Compliance Certification Label found on the edge of the driver's door.

### TRAILER TOWING

Your vehicle is capable of towing a trailer up to 2,000 lb. (908 kg) gross trailer weight with a maximum tongue load of 200 lb. (90 kg). Do not tow a trailer until your vehicle has been driven at least 500 miles (800 km).

Towing a trailer places an additional load on your vehicle's engine, transmission, brakes, tires and suspension. Inspect these components carefully after towing.

## Tires, Wheels and Loading



Do not exceed the GVWR or the GAWR specified on the certification label.



Towing trailers beyond the maximum recommended gross trailer weight exceeds the limit of the vehicle and could result in engine damage, transmission damage, structural damage, loss of vehicle control, vehicle rollover and personal injury.

### Preparing to tow

Use the proper equipment for towing a trailer and make sure it is properly attached to your vehicle. Use a trailer hitch with at least three attachment points to each of the rear rails. Use of a trailer hitch with only two attachment points to each rear rail is not recommended. See your authorized dealer or a reliable trailer dealer if you require assistance.

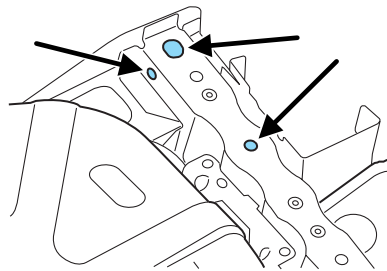

### Hitches

Do not use hitches that clamp onto the vehicle bumper. Use a load carrying hitch. You must distribute the load in your trailer so that 10–15% of the total weight of the trailer is on the tongue.

### Safety chains

Always connect the trailer's safety chains to the frame or hook retainers of the vehicle hitch. To connect the trailer's safety chains, cross the chains under the trailer tongue and allow slack for turning corners.

If you use a rental trailer, follow the instructions that the rental agency gives to you.

**Do not attach safety chains to the bumper.**

### Trailer brakes

Electric brakes and manual, automatic or surge-type trailer brakes are safe if installed properly and adjusted to the manufacturer's specifications. The trailer brakes must meet local and Federal regulations.

## Tires, Wheels and Loading



Do not connect a trailer's hydraulic brake system directly to your vehicle's brake system. Your vehicle may not have enough braking power and your chances of having a collision greatly increase.

The braking system of the tow vehicle is rated for operation at the GVWR not GCWR.

### Trailer lamps

Trailer lamps are required on most towed vehicles. Make sure all running lights, brake lights, turn signals and hazard lights are working. See your authorized dealer or trailer rental agency for proper instructions and equipment for hooking up trailer lamps.

### Driving while you tow

When towing a trailer:

- Turn off the speed control. The speed control may shut off automatically when you are towing on long, steep grades.
- Consult your local motor vehicle speed regulations for towing a trailer.
- It is recommended to select the L (Low) gear position when additional engine braking is needed. In situations such as prolonged downhill driving on steep grades (i.e., driving in mountainous areas), additional engine braking is needed to reduce the load on the vehicle's regular brake system to prevent them from overheating.
- Anticipate stops and brake gradually.

### Servicing after towing

If you tow a trailer for long distances, your vehicle will require more frequent service intervals. Refer to your *scheduled maintenance information* for more information.

### Trailer towing tips

- Practice turning, stopping and backing up before starting on a trip to get the feel of the vehicle trailer combination. When turning, make wider turns so the trailer wheels will clear curbs and other obstacles.
- Allow more distance for stopping with a trailer attached.
- If you are driving down a long or steep hill, shift into the "L" gear position. Do not apply the brakes continuously, as they may overheat and become less effective.
- The trailer tongue weight should be 10–15% of the loaded trailer weight.



## Tires, Wheels and Loading

- After you have traveled 50 miles (80 km), thoroughly check your hitch, electrical connections and trailer wheel lug nuts.
- To aid in engine/transmission cooling and A/C efficiency during hot weather while stopped in traffic, place the gearshift lever in P (Park).
- Vehicles with trailers should not be parked on a grade. If you must park on a grade, place wheel chocks under the trailer's wheels.

### RECREATIONAL TOWING

Follow these guidelines for your specific powertrain combination to tow your vehicle for personal travel (such as behind a recreational vehicle or moving truck).

In case of roadside emergency with a disabled vehicle, please refer to the *Wrecker towing* section in the *Driving* chapter.

These guidelines are designed to ensure that your transmission is not damaged due to insufficient lubrication.

#### **Front Wheel Drive (FWD) vehicles:**

Do not tow your Front Wheel Drive vehicle with the front drive wheels on the ground as transaxle damage may occur. It is recommended to tow your vehicle with the front drive wheels on a dolly or use a car-hauling trailer.

#### **All Wheel Drive (AWD) vehicles:**

Do not tow your All Wheel Drive vehicle with any wheels on the ground as vehicle or transaxle damage may occur. It is recommended to tow your vehicle using a car-hauling trailer.

## Driving

### STARTING

#### Positions of the ignition

1. LOCK, locks the automatic transaxle gearshift lever and allows key removal. This position also shuts the engine and all electrical accessories off without locking the steering wheel. To lock the steering wheel, remove the key then turn the steering wheel.

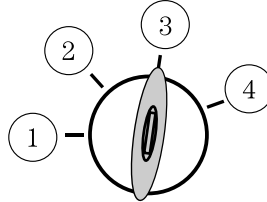

2. ACC, allows the electrical accessories such as the radio to operate while the engine is not running. This position also unlocks the steering wheel.

3. RUN, all electrical circuits operational. Warning lights illuminated. Key position when driving.

4. START, cranks the engine. Release the key as soon as the engine starts.

#### Starting your vehicle

Engine starting is controlled by the powertrain control system. This system meets all Canadian Interference-Causing Equipment standard requirements regulating the impulse electrical field strength of radio noise.

When starting a fuel-injected engine, don't press the accelerator before or during starting. Only use the accelerator when you have difficulty starting the engine. For more information on starting the vehicle, refer to *Starting the engine* in this chapter.

To avoid potential transmission damage at extremely cold temperatures (below -20°F [-30°C]), it is recommended that the vehicle be warmed up to normal operating temperature before driving at highway speeds above 50 mph (80 km/h). Normal operating temperature is normally reached after 10 minutes of moderate driving or idling.



Extended idling at high engine speeds can produce very high temperatures in the engine and exhaust system, creating the risk of fire or other damage.

## Driving

 Do not park, idle, or drive your vehicle in dry grass or other dry ground cover. The emission system heats up the engine compartment and exhaust system, which can start a fire.

 Do not start your vehicle in a closed garage or in other enclosed areas. Exhaust fumes can be toxic. Always open the garage door before you start the engine. See *Guarding against exhaust fumes* in this chapter for more instructions.

 If you smell exhaust fumes inside your vehicle, have your dealer inspect your vehicle immediately. Do not drive if you smell exhaust fumes.

### **Important safety precautions**

A computer system controls the engine's idle revolutions per minute (RPM). When the engine starts, the idle RPM runs higher than normal in order to warm the engine. If the engine idle speed does not slow down automatically, have the vehicle checked.

Before starting the vehicle:

1. Make sure all vehicle occupants have buckled their safety belts. For more information on safety belts and their proper usage, refer to the *Seating and Safety Restraints* chapter.
2. Make sure vehicle accessories are off.
  - Make sure the parking brake is set.

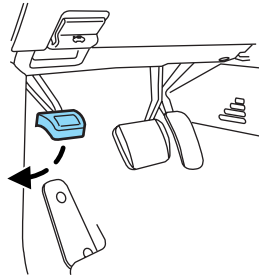

## Driving

- Make sure the gearshift lever is in P (Park).

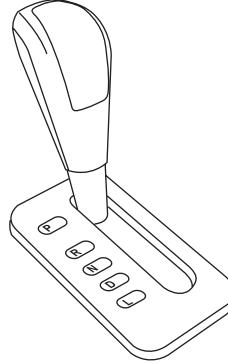

3. Turn the key to 3 (RUN) without turning the key to 4 (START).

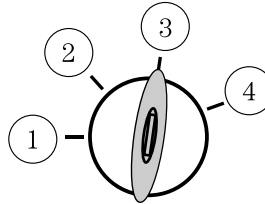

Some warning lights will briefly illuminate. See *Warning lights and chimes* in the *Instrument Cluster* chapter for more information regarding the warning lights.

### Starting the engine

1. Turn the key to 3 (RUN) without turning the key to 4 (START).
2. Turn the key to 4 (START), then release the key as soon as the engine starts. Excessive cranking could damage the starter.

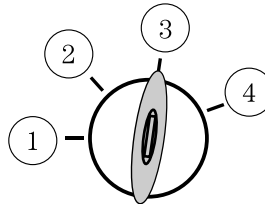

**Note:** If the engine does not start within five seconds on the first try, turn the key to LOCK, wait 10 seconds and try again. If the engine still fails to start, press the accelerator to the floor and try again; this will allow the engine to crank with the fuel shut off in case the engine is flooded with fuel.

## Driving

### Guarding against exhaust fumes

Carbon monoxide is present in exhaust fumes. Take precautions to avoid its dangerous effects.



If you smell exhaust fumes inside your vehicle, have your dealer inspect your vehicle immediately. Do not drive if you smell exhaust fumes.

### Important ventilating information

If the engine is idling while the vehicle is stopped for a long period of time, open the windows at least one inch (2.5 cm) or adjust the heating or air conditioning to bring in fresh air.

### USING THE ENGINE BLOCK HEATER (IF EQUIPPED)

An engine block heater warms the engine coolant which aids in starting and heater/defroster performance. Use of an engine block heater is strongly recommended if you live in a region where temperatures reach  $-10^{\circ}\text{F}$  ( $-23^{\circ}\text{C}$ ) or below. For best results, plug the heater in at least three hours before starting the vehicle. The heater can be plugged in the night before starting the vehicle.



To reduce the risk of electrical shock, do not use your heater with ungrounded electrical systems or two-pronged (cheater) adapters.

### BRAKES

Occasional brake noise is normal. If a metal-to-metal, continuous grinding or continuous squeal sound is present, the brake linings may be worn-out and should be inspected by an authorized dealer. If the vehicle has continuous vibration or shudder in the steering wheel while braking, the vehicle should be inspected by an authorized dealer.

Refer to *Brake system warning light* in the *Instrument Cluster* chapter for information on the brake system warning light.



## Driving

### Four-wheel anti-lock brake system (ABS)

Your vehicle is equipped with an Anti-lock Braking System (ABS). This system helps you maintain steering control during emergency stops by keeping the brakes from locking. Noise from the ABS pump motor and brake pedal pulsation may be observed during ABS braking and the brake pedal may suddenly travel a little farther as soon as ABS braking is done and normal brake operation resumes. These are normal characteristics of the ABS and should be no reason for concern.

### Using ABS

When hard braking is required, apply continuous force on the brake pedal; do not pump the brake pedal since this will reduce the effectiveness of the ABS and will increase your vehicle's stopping distance. The ABS will be activated immediately, allowing you to retain full steering control during hard braking and on slippery surfaces. However, the ABS does not decrease stopping distance.

### ABS warning lamp

The ABS lamp in the instrument cluster momentarily illuminates when the ignition is turned on. If the light does not illuminate during start up, remains on or flashes, the ABS is disabled due to a malfunction and needs to be serviced.



Even when the ABS is disabled, normal braking is still effective. (If your BRAKE warning lamp illuminates with the parking brake released, have your brake system serviced immediately.)



### Parking brake (P)

Apply the parking brake whenever the vehicle is parked. To set the parking brake, press the parking brake pedal down until the pedal stops.

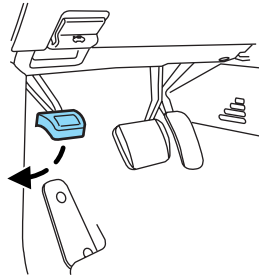

The BRAKE warning lamp in the instrument cluster illuminates and remains illuminated (when the ignition is turned ON) until the parking brake is released.



Always set the parking brake fully and make sure that the gearshift is securely latched in P (Park).

The parking brake is not recommended to stop a moving vehicle. However, if the normal brakes fail, the parking brake can be used to stop your vehicle in an emergency. Since the parking brake applies only the rear brakes, the vehicle's stopping distance will increase greatly and the handling of your vehicle will be adversely affected.

Push the pedal downward again to release the parking brake. Driving with the parking brake on will cause the brakes to wear out quickly and reduce fuel economy.

**Note:** If the vehicle is driven with the parking brake applied, a chime will sound.

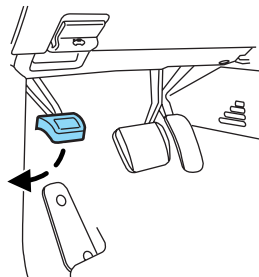

### TRACTION CONTROL™ (IF EQUIPPED)

Your vehicle may be equipped with a Traction Control™ system. This system helps you maintain the stability and steerability of your vehicle. It is especially useful on slippery road surfaces. The system operates by

## Driving

detecting and controlling wheel spin. The system borrows many of the electronic elements already present in the anti-lock braking system (ABS).

Wheel-speed sensors allow excess wheel spin to be detected by the Traction Control™ portion of the ABS computer. Excess wheel spin is controlled through engine torque reduction. This is realized via the fully electronic engine control system. This process is very sensitive to driving conditions and very fast acting. The wheels “search” for optimum traction several times a second and adjustments are made accordingly.

The Traction Control™ system will allow your vehicle to make better use of available traction on slippery surfaces. The system is a driver aid which makes your vehicle easier to handle primarily on snow and ice covered roads.

During Traction Control™ operation the engine will not “rev-up” when you push further on the accelerator. This is normal system behavior.

If you should become stuck in deep snow or on a very slippery road surface, try switching the Traction Control™ system off. This may allow excess wheel spin to “dig” the vehicle out or enable a successful “rocking” maneuver.

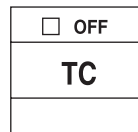

Aggressive driving in any road conditions can cause you to lose control of your vehicle increasing the risk of severe personal injury or property damage. The occurrence of a Traction Control™ event is an indication that at least some of the tires have exceeded their ability to grip the road; this may lead to an increased risk of loss of vehicle control, vehicle rollover, personal injury and death. If you experience a severe road event, SLOW DOWN.

## STEERING

To prevent damage to the power steering system, never hold the steering wheel at its furthest turning points (until it stops) for more than a few seconds when the engine is running.

It is also important to maintain a proper power steering fluid level in the power steering fluid reservoir:

- Do not operate the vehicle with a low power steering pump fluid level. See *Checking and adding power steering fluid* in the *Maintenance and Specifications* chapter.



## Driving

- Some noise is normal during operation. If the noise is excessive, check for low power steering pump fluid level before seeking service by your authorized dealer.
- Heavy or uneven steering efforts may be caused by low power steering pump fluid level. Check for low power steering pump fluid level before seeking service by your authorized dealer.
- Do not fill the power steering pump reservoir above the maximum level, as this may result in leaks from the reservoir. See *Checking and adding power steering fluid* in the *Maintenance and Specifications* chapter.

If the power steering system breaks down (or if the engine is turned off), you can steer the vehicle manually, but it takes more effort.

If the steering wanders or pulls, check for:

- an improperly inflated tire
- uneven tire wear
- loose or worn suspension components
- loose or worn steering components
- improper steering alignment

### **AUTOMATIC TRANSAXLE OPERATION**

#### **Brake-shift interlock**

This vehicle is equipped with a brake-shift interlock feature that prevents the gearshift lever from being moved from P (Park) when the ignition is in the ON position unless the brake pedal is depressed.

If you cannot move the gearshift lever out of P (Park) with ignition in the ON position and the brake pedal depressed:

1. Remove the trim ring around the gearshift lever.

## Driving

2. Remove the console panel by opening the armrest, grasping the panel firmly, then pulling up. This will allow access to the gearshift assembly.

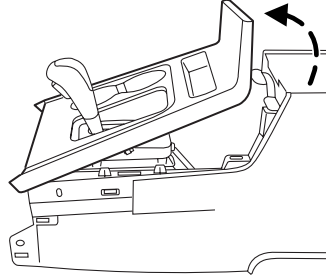

3. Locate the white plastic cover at the front driver side of the gearshift lever. Locate the screw which attaches this cover and remove using a screwdriver. Remove the cover by tilting forward while pulling up and out of the gearshift assembly.

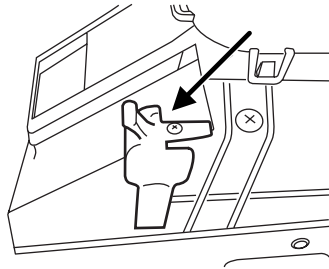

4. Locate the silver button in the driver side front area of the gearshift assembly. Press and hold the silver button while moving the gearshift lever out of P (Park) into N (Neutral).  
5. Start the vehicle and release the parking brake.  
If it is necessary to use the above procedure to move the gearshift lever, it is possible that a fuse has blown or the vehicle's brakelamps are not operating properly. Refer to *Fuses and relays* in the *Roadside Emergencies* chapter.



Do not drive your vehicle until you verify that the brakelamps are working.



Always set the parking brake fully and make sure the gearshift is latched in P (Park). Turn the ignition to the LOCK position and remove the key whenever you leave your vehicle.



If the parking brake is fully released, but the brake warning lamp remains illuminated, the brakes may not be working properly. See your authorized dealer.

### Understanding the gearshift positions of the Continuously Variable Transaxle (CVT)

The CVT is a fully automatic transaxle that electronically monitors vehicle system inputs and outputs and driver demands to select the desired drive ratio. Unlike traditional automatic transmissions/transaxles, the CVT continually adjusts the optimum overall drive ratio between engine and drive wheels for all operating conditions.

As traditional automatic transmissions/transaxles shift up or down in gears, this shifting in gear ratios is noticeable by increasing and decreasing engine RPM which causes a slight energy loss as the gears change. The gear changes can be felt by the driver.

With the CVT, there is no energy transfer loss from shifting because there is no gear shifting up or down. Acceleration up to vehicle operating speed is smooth and continuous; uninterrupted by gear shifting. The same holds true for coasting down to idle; smooth and continuous.

Unlike traditional automatic transmissions/transaxles, the CVT offers more responsive performance and increased fuel economy.

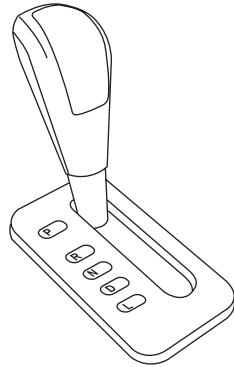

#### **P (Park)**

This position locks the transaxle and prevents the front wheels from turning.

To put your vehicle in gear:

- Depress the brake pedal
- Move the gearshift lever into the desired gear

## Driving

To put your vehicle in P (Park):

- Come to a complete stop
- Move the gearshift lever and securely latch it in P (Park)



Always set the parking brake fully and make sure the gearshift is latched in P (Park). Turn the ignition to the LOCK position and remove the key whenever you leave your vehicle.

### **R (Reverse)**

With the gearshift lever in R (Reverse), the vehicle will move backward. Always come to a complete stop before shifting into and out of R (Reverse).

### **N (Neutral)**

With the gearshift lever in N (Neutral), the vehicle can be started and is free to roll. Hold the brake pedal down while in this position.

### **D (Drive)**

The normal driving position for the best fuel economy.

### **L (Low)**

Provides more engine braking when the accelerator pedal is released than D (Drive).

### **REVERSE SENSING SYSTEM (IF EQUIPPED)**

The Reverse Sensing System (RSS) sounds a tone to warn the driver of obstacles near the rear bumper when R (Reverse) is selected and the vehicle is moving at speeds less than 3 mph (5 km/h). The system is not effective at speeds above 3 mph (5 km/h) and may not detect certain angular or moving objects.





To help avoid personal injury, please read and understand the limitations of the reverse sensing system as contained in this section. Reverse sensing is only an aid for some (generally large and fixed) objects when moving in reverse on a flat surface at "parking speeds". Inclement weather may also affect the function of the RSS; this may include reduced performance or a false activation.



To help avoid personal injury, always use caution when in R (Reverse) and when using the RSS.

## Driving

 This system is not designed to prevent contact with small or moving objects. The system is designed to provide a warning to assist the driver in detecting large stationary objects to avoid damaging the vehicle. The system may not detect smaller objects, particularly those close to the ground.

 Certain add-on devices such as large trailer hitches, bike or surfboard racks and any device that may block the normal detection zone of the RSS system may create false beeps.

The RSS detects obstacles up to six feet (two meters) from the rear bumper with a decreased coverage area at the outer corners of the bumper, (refer to the figures for approximate zone coverage areas). As you move closer to the obstacle, the rate of the tone increases. When the obstacle is less than 10 inches (25.0 cm) away, the tone will sound continuously. If the RSS detects a stationary or receding object further than 10 inches (25.0 cm) from the side of the vehicle, the tone will sound for only three seconds. Once the system detects an object approaching, the tone will sound again.

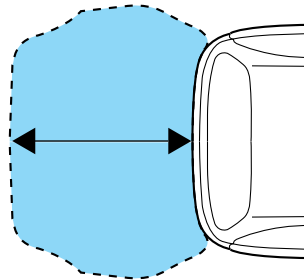
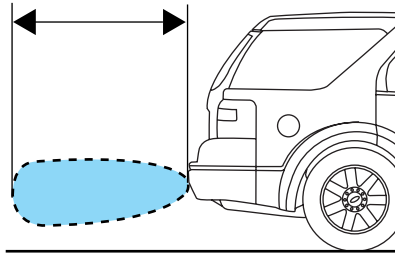

The RSS automatically turns on when the gear selector is placed in R (Reverse) and the ignition is ON. An RSS control on the instrument panel allows the driver to turn the RSS on and off. To turn the RSS off, the ignition must be ON, and the gear selector in R (Reverse). An

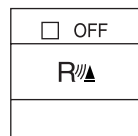

## Driving

indicator light on the control will illuminate when the system is turned off. If the indicator light illuminates when the RSS is not turned off, it may indicate a failure in the RSS.

**Keep the RSS sensors (located on the rear bumper/fascia) free from snow, ice and large accumulations of dirt (do not clean the sensors with sharp objects). If the sensors are covered, it will affect the accuracy of the RSS.**

**If your vehicle sustains damage to the rear bumper/fascia, leaving it misaligned or bent, the sensing zone may be altered causing inaccurate measurement of obstacles or false alarms.**

### **ALL WHEEL DRIVE (AWD) SYSTEM (IF EQUIPPED)**

Your vehicle may be equipped with a full-time All Wheel Drive (AWD) system. With the AWD option, power will be delivered to the front wheels and distributed to the rear wheels as needed. The AWD system is active all the time and requires no input from the operator.

All components of the AWD system are sealed for life and require no maintenance.

If your vehicle is equipped with AWD, a spare tire of a different size other than the tire provided should never be used. A dissimilar spare tire size (other than the spare tire provided) or major dissimilar tire sizes between the front and rear axles could cause the AWD system to stop functioning and default to front wheel drive.

**Note:** Your AWD vehicle is not intended for off-road use. The AWD feature gives your vehicle some limited off-road capabilities in which driving surfaces are relatively level, obstruction-free and otherwise similar to normal on-road driving conditions. Operating your vehicle under other than those conditions could subject the vehicle to excessive stress which might result in damage which is not covered under your warranty.

### **Driving off-highway with AWD vehicles**

AWD vehicles are specially equipped for driving on sand, snow, mud and rough roads and have operating characteristics that are somewhat different from conventional vehicles, both on and off the highway.

When driving at slow speeds off-highway under high outside temperatures, use L (Low) gear when possible. L (Low) gear operation will maximize the engine and transmission cooling capability.

Under severe operating conditions, the A/C may cycle on and off to protect overheating of the engine.

### ***Basic operating principles***

- Drive slower in strong crosswinds which can affect the normal steering characteristics of your vehicle.
- Be extremely careful when driving on pavement made slippery by loose sand, water, gravel, snow or ice.

### ***If your vehicle goes off the edge of the pavement***

- If your vehicle goes off the edge of the pavement, slow down, but avoid severe brake application, ease the vehicle back onto the pavement only after reducing your speed. Do not turn the steering wheel too sharply while returning to the road surface.
- It may be safer to stay on the apron or shoulder of the road and slow down gradually before returning to the pavement. You may lose control if you do not slow down or if you turn the steering wheel too sharply or abruptly.
- It often may be less risky to strike small objects, such as highway reflectors, with minor damage to your vehicle rather than attempt a sudden return to the pavement which could cause the vehicle to slide sideways out of control or rollover. Remember, your safety and the safety of others should be your primary concern.

### ***If your vehicle gets stuck***

If your vehicle gets stuck in mud or snow it may be rocked out by shifting between forward and reverse gears, stopping between shifts, in a steady pattern. Press lightly on the accelerator in each gear.

If your vehicle is equipped with Traction Control™, it may be beneficial to disengage the Traction Control™ system while attempting to rock the vehicle.

**Do not rock the vehicle if the engine is not at normal operating temperature or damage to the transmission may occur.**

**Do not rock the vehicle for more than a few minutes or damage to the transmission and tires may occur or the engine may overheat.**



Always set the parking brake fully and make sure the gearshift is latched in P (Park). Turn the ignition to the LOCK position and remove the key whenever you leave your vehicle.

## Driving

 If the parking brake is fully released, but the brake warning lamp remains illuminated, the brakes may not be working properly. See your authorized dealer.

 Do not spin the wheels at over 35 mph (56 km/h). The tires may fail and injure a passenger or bystander.

### Emergency maneuvers

- In an unavoidable emergency situation where a sudden sharp turn must be made, remember to avoid “over-driving” your vehicle (i.e., turn the steering wheel only as rapidly and as far as required to avoid the emergency). Excessive steering will result in less vehicle control, not more. Additionally, smooth variations of the accelerator and/or brake pedal pressure should be utilized if changes in vehicle speed are called for. Avoid abrupt steering, acceleration or braking which could result in an increased risk of loss of vehicle control, vehicle rollover and/or personal injury. Use all available road surface to return the vehicle to a safe direction of travel.
- In the event of an emergency stop, avoid skidding the tires and do not attempt any sharp steering wheel movements.
- If the vehicle goes from one type of surface to another (i.e., from concrete to gravel) there will be a change in the way the vehicle responds to a maneuver (steering, acceleration or braking). Again, avoid these abrupt inputs.

### AWD Systems (if equipped)

AWD uses all four wheels to power the vehicle. This increases traction, enabling you to drive over terrain and road conditions that a conventional two-wheel drive vehicle cannot.

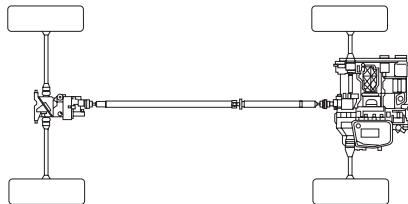

### Sand

When driving over sand, try to keep all four wheels on the most solid area of the trail. Avoid reducing the tire pressures, but drive steadily through the terrain. Apply the accelerator slowly and avoid spinning the wheels.



### **Do not use L (Low) gear when driving through sand.**

Under severe operating conditions, the A/C may cycle on and off to protect overheating of the engine.

Avoid excessive speed because vehicle momentum can work against you and cause the vehicle to become stuck to the point that assistance may be required from another vehicle. Remember, you may be able to back out the way you came if you proceed with caution.

### **Mud and water**

If you must drive through high water, drive slowly. Traction or brake capability may be limited.

When driving through water, determine the depth; avoid water higher than the bottom of the hubs (if possible) and proceed slowly. If the ignition system gets wet, the vehicle may stall.

Once through water, always try the brakes. Wet brakes do not stop the vehicle as effectively as dry brakes. Drying can be improved by moving your vehicle slowly while applying light pressure on the brake pedal.

Be cautious of sudden changes in vehicle speed or direction when you are driving in mud. Even AWD vehicles can lose traction in slick mud. As when you are driving over sand, apply the accelerator slowly and avoid spinning your wheels. If the vehicle does slide, steer in the direction of the slide until you regain control of the vehicle.

If the transmission, AWD system components or axles are submerged in water, their fluids should be checked and changed, if necessary.

### **Driving through deep water may damage the transmission.**

If the front or rear axle is submerged in water, the axle lubricant and PTU (Power Transfer Unit) lubricant should be checked and changed if necessary.

After driving through mud, clean off residue stuck to rotating driveshafts and tires. Excess mud stuck on tires and rotating driveshafts causes an imbalance that could damage drive components.

“Tread Lightly” is an educational program designed to increase public awareness of land-use regulations and responsibilities in our nation's wilderness areas. Ford Motor

Company joins the U.S. Forest Service and the Bureau of Land Management in encouraging you to help preserve our national forest and other public and private lands by “treading lightly.”



## Driving

### ***Driving on hilly or sloping terrain***

Although natural obstacles may make it necessary to travel diagonally up or down a hill or steep incline, you should always try to drive straight up or straight down. **Avoid driving crosswise or turning on steep slopes or hills.** A danger lies in losing traction, slipping sideways and possibly rolling over. Whenever driving on a hill, determine beforehand the route you will use. Do not drive over the crest of a hill without seeing what conditions are on the other side. Do not drive in reverse over a hill without the aid of an observer.

When climbing a steep slope or hill, start in a lower gear rather than downshifting to a lower gear from a higher gear once the ascent has started. This reduces strain on the engine and the possibility of stalling.

If you do stall out, do not try to turn around because you might roll over. It is better to back down to a safe location.

Apply just enough power to the wheels to climb the hill. Too much power will cause the tires to slip, spin or lose traction, resulting in loss of vehicle control.

Descend a hill in the same gear you would use to climb up the hill to avoid excessive brake application and brake overheating. Do not descend in neutral; instead, disengage overdrive or manually shift to a lower gear. When descending a steep hill, avoid sudden hard braking as you could lose control. When you brake hard, the front wheels can't turn and if they aren't turning, you won't be able to steer. The front wheels have to be turning in order to steer the vehicle.

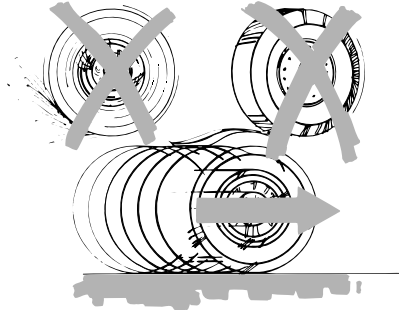

If your vehicle has anti-lock brakes, apply the brakes steadily. Do not “pump” the brakes.

### ***Driving on snow and ice***

**Note:** Excessive tire slippage can cause transaxle damage.

AWD vehicles have advantages over 2WD vehicles in snow and ice but can skid like any other vehicle.

Should you start to slide while driving on snowy or icy roads, turn the steering wheel in the direction of the slide until you regain control.

Avoid sudden applications of power and quick changes of direction on snow and ice. Apply the accelerator slowly and steadily when starting from a full stop.

Avoid sudden braking as well. Although an AWD vehicle may accelerate better than a two-wheel drive vehicle in snow and ice, it won't stop any faster, because as in other vehicles, braking occurs at all four wheels. Do not become overconfident as to road conditions.

Make sure you allow sufficient distance between you and other vehicles for stopping. Drive slower than usual and consider using one of the lower gears. In emergency stopping situations, apply the brake steadily. Since your vehicle is equipped with a four wheel anti-lock brake system (ABS), do not "pump" the brakes. Refer to the *Brakes* section of this chapter for additional information on the operation of the anti-lock brake system.

### ***Maintenance and Modifications***

The suspension and steering systems on your vehicle have been designed and tested to provide predictable performance whether loaded or empty and durable load carrying capability. For this reason, Ford Motor Company strongly recommends that you do not make modifications such as adding or removing parts (such as lift kits or stabilizer bars) or by using replacement parts not equivalent to the original factory equipment.

Any modifications to a vehicle that raise the center of gravity can make it more likely the vehicle will rollover as a result of a loss of control. Ford Motor Company recommends that caution be used with any vehicle equipped with a high load or device (such as ladder or luggage racks).

Failure to maintain your vehicle properly may void the warranty, increase your repair cost, reduce vehicle performance and operational capabilities and adversely affect driver and passenger safety. Frequent inspection of vehicle chassis components is recommended if the vehicle is subjected to heavy off-highway usage.

## Driving

### DRIVING THROUGH WATER

If driving through deep or standing water is unavoidable, proceed very slowly especially when the depth is not known. Never drive through water that is higher than the bottom of the wheel rims (for cars) or the bottom of the hubs (for trucks).

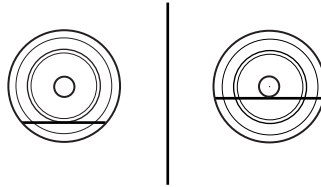

When driving through water, traction or brake capability may be limited. Also, water may enter your engine's air intake and severely damage your engine or your vehicle may stall. **Driving through deep water where the transmission vent tube is submerged may allow water into the transmission and cause internal transmission damage.**

**Once through the water, always dry the brakes by moving your vehicle slowly while applying light pressure on the brake pedal.** Wet brakes do not stop the vehicle as quickly as dry brakes.

## Roadside Emergencies

### ROADSIDE ASSISTANCE

#### Getting roadside assistance

To fully assist you should you have a vehicle concern, Ford Motor Company offers a complimentary roadside assistance program. This program is separate from the New Vehicle Limited Warranty. The service is available:

- 24-hours, seven days a week
- for the New Vehicle Limited Warranty period of three years or 36,000 miles (60,000 km), whichever occurs first on Ford and Mercury vehicles, and four years or 50,000 miles (80,000 km) on Lincoln vehicles.

Roadside assistance will cover:

- a flat tire change with a good spare (except Ford GT which has a tire inflation kit)
- battery jump start
- lock-out assistance (key replacement cost is the customer's responsibility)
- fuel delivery – Independent Service Contractors, if not prohibited by state, local or municipal law shall deliver up to 2.0 gallons (7.5L) of gasoline or 5 gallons (18.9L) of diesel fuel to a disabled vehicle.
- winch out – available within 100 feet (30.5 meters) of a paved or county maintained road, no recoveries.
- towing – Ford/Mercury/Lincoln eligible vehicle towed to an authorized dealer within 35 miles (56.3 km) of the disablement location or to the nearest authorized dealer. If a member requests to be towed to an authorized dealer more than 35 miles (56.3 km) from the disablement location, the member shall be responsible for any mileage costs in excess of 35 miles (56.3 km).

Trailers shall be covered up to \$100 if the disabled eligible vehicle requires service at the nearest authorized dealer. If the trailer is disabled, but the towing vehicle is operational, the trailer does not qualify for any roadside services.

#### **Canadian customers refer to your Owner Information Guide for information on:**

- coverage period
- exact fuel amounts
- towing of your disabled vehicle

## Roadside Emergencies

- emergency travel expense reimbursement
- travel planning benefits

### Using roadside assistance

Complete the roadside assistance identification card and place it in your wallet for quick reference. In the United States, this card is found in the Owner Guide portfolio in the glove compartment. In Canada, the card is found in the *Owner Information Guide* in the glove compartment.

U.S. Ford or Mercury vehicle customers who require roadside assistance, call 1-800-241-3673; Lincoln vehicle customers call 1-800-521-4140.

Canadian customers who require roadside assistance, call 1-800-665-2006.

If you need to arrange roadside assistance for yourself, Ford Motor Company will reimburse a reasonable amount. To obtain reimbursement information, U.S. Ford or Mercury vehicles customers call 1-800-241-3673; Lincoln vehicle customers call 1-800-521-4140.

Canadian customers who need to obtain reimbursement information, call 1-800-665-2006.

### Roadside coverage beyond basic warranty

In the United States, you may purchase additional roadside assistance coverage beyond this period through the Ford Auto Club by contacting your authorized dealer.

Similarly in Canada, for uninterrupted Roadside Assistance coverage, you may purchase extended coverage prior to your Basic Warranty's Roadside Assistance expiring. For more information and enrollment, contact 1-877-294-2582 or visit our website at [www.ford.ca](http://www.ford.ca).

### HAZARD FLASHER CONTROL

The hazard flasher is located on the instrument panel by the radio. The hazard flashers will operate when the ignition is in any position or if the key is not in the ignition.

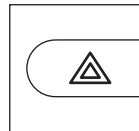

Push in the flasher control and all front and rear direction signals will flash. Press the flasher control again to turn them off. Use it when your vehicle is disabled and is creating a safety hazard for other motorists.

**Note:** With extended use, the flasher may run down your battery.

## Roadside Emergencies

### FUEL PUMP SHUT-OFF SWITCH

This device stops the electric fuel pump from sending fuel to the engine when your vehicle has had a substantial jolt.

After an accident, if the engine cranks but does not start, this switch may have been activated.

The fuel pump shut-off switch is located in the front passenger footwell area in the right upper corner.

To reset the switch:

1. Turn the ignition OFF.
2. Check the fuel system for leaks.
3. If no leaks are apparent, reset the switch by pushing in on the reset button.
4. Turn the ignition ON.
5. Wait a few seconds and return the key to OFF.
6. Make another check for leaks.

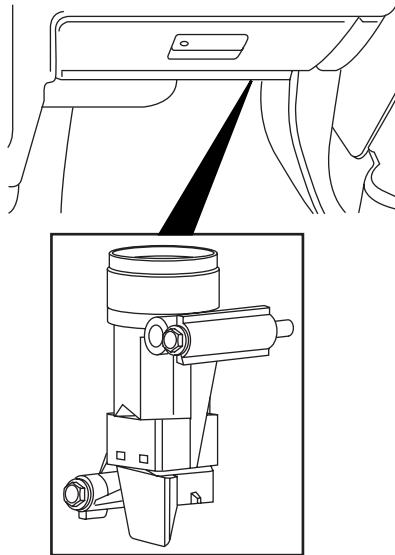

### FUSES AND RELAYS

#### Fuses

If electrical components in the vehicle are not working, a fuse may have blown. Blown fuses are identified by a broken wire within the fuse. Check the appropriate fuses before replacing any electrical components.

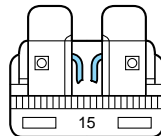

**Note:** Always replace a fuse with one that has the specified amperage rating. Using a fuse with a higher amperage rating can cause severe wire damage and could start a fire.

## Roadside Emergencies

### Standard fuse amperage rating and color

COLOR					
Fuse rating	Mini fuses	Standard fuses	Maxi fuses	Cartridge maxi fuses	Fuse link cartridge
5A	Tan	Tan	—	—	—
7.5A	Brown	Brown	—	—	—
10A	Red	Red	—	—	—
15A	Blue	Blue	—	—	—
20A	Yellow	Yellow	Yellow	Blue	Blue
25A	Natural	Natural	—	—	—
30A	Green	Green	Green	Pink	Pink
40A	—	—	Orange	Green	Green
50A	—	—	Red	Red	Red
60A	—	—	Blue	Yellow	Yellow
80A	—	—	Natural	Black	Black

### Passenger compartment fuse panel/Smart Junction Box (SJB)

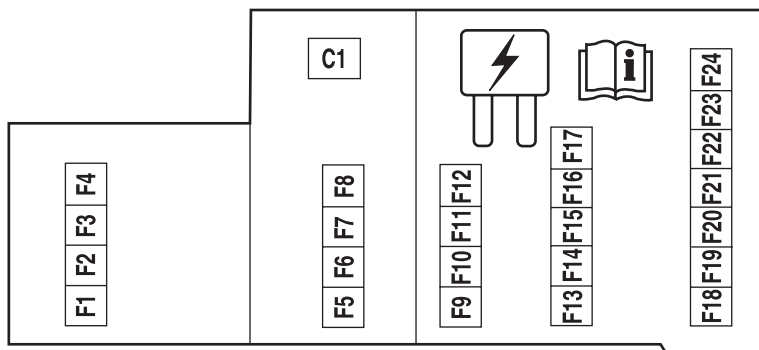

The fuse panel is located under the instrument panel to the left of the steering wheel.



## Roadside Emergencies

The fuses are coded as follows.

<b>Fuse/Relay Location</b>	<b>Fuse Amp Rating</b>	<b>Passenger Compartment Fuse Panel Description</b>
F1	20A	High beams
F2	15A	Interior lamps (Courtesy and demand lamps), Delayed accessory (Power windows and moonroof)
F3	25A	Access/Security (Power door lock actuators, Liftgate lock actuator, Liftgate solenoid)
F4	15A	Adjustable pedal switch
F5	20A	Horns
F6	20A	Audio (Subwoofer)
F7	7.5A	Power/Keep Alive Memory (KAM): Cluster and Powertrain Control Module (PCM), Climate control, Analog clock
F8	15A	Park lamps, Side markers, Trailer tow protect
F9	20A	Cigar lighter, Data Link Connector (DLC)
F10	7.5A	Mirrors and memory module
F11	20A	Audio, Family Entertainment System (FES)
F12	10A	Back-up lamps, Electrochromatic mirror, Reverse Sensing System (RSS), Trailer tow protect
F13	7.5A	Audio
F14	7.5A	Starter relay coil, PCM

## Roadside Emergencies

Fuse/Relay Location	Fuse Amp Rating	Passenger Compartment Fuse Panel Description
F15	10A	Delayed accessory (Driver window motor logic, Auxiliary climate control switch illumination, Moonroof, Audio, Driver door lock switch illumination)
F16	10A	Rear defroster indicator, Heated mirrors
F17	30A	Rear defroster
F18	10A	PCM relay coil, Shifter Brake-Shift Interlock (BSI), Passive Anti-Theft System (PATS) module, Fuel relay coil, Brake lamps, Center High-Mounted Stop Lamp (CHMSL)
F19	10A	Anti-lock Brake System (ABS)/Traction control module, All Wheel Drive (AWD) module, RSS, Heated seat modules
F20	7.5A	Cluster, Climate control
F21	7.5A	Restraint Control Module (RCM)
F22	7.5A	Auxiliary climate control relay coils, Electrochromatic mirror, Compass module
F23	7.5A	Wiper relay coil, Blower relay coil, Cluster logic
F24	7.5A	Occupant Classification Sensor (OCS), Passenger Airbag Deactivation (PAD)
C1	30A Circuit breaker	Delayed accessory (Front passenger window, Rear passenger windows [via window switch], Window switch illumination, Backlighting)

## Roadside Emergencies

### Power distribution box

The power distribution box is located in the engine compartment. The power distribution box contains high-current fuses that protect your vehicle's main electrical systems from overloads.



Always disconnect the battery before servicing high current fuses.



To reduce risk of electrical shock, always replace the cover to the Power Distribution Box before reconnecting the battery or refilling fluid reservoirs.

If the battery has been disconnected and reconnected, refer to the *Battery* section of the *Maintenance and Specifications* chapter.

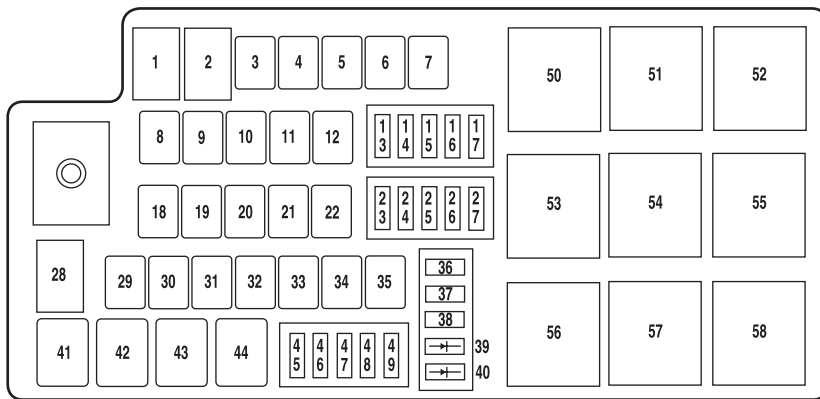

The high-current fuses are coded as follows:

Fuse/Relay Location	Fuse Amp Rating	Power Distribution Box Description
1	80A*	SJB, SJB fuses 1, 2, 3, 4, 5, 8 and 12
2	—	Not used

## Roadside Emergencies

Fuse/Relay Location	Fuse Amp Rating	Power Distribution Box Description
3	50A*	Front and rear wipers (fuses 45 and 47)
4	—	Not used
5	20A*	Moonroof
6	—	Not used
7	60A*	Engine cooling fan
8	—	Not used
9	40A*	Anti-lock Brake System (ABS) (Motor)
10	30A*	Starter
11	30A*	Powertrain Control Module (PCM) relay
12	20A*	ABS (Valves)
13	—	Not used
14	20A**	Power point (Cargo compartment)
15	15A**	Traction Control Module (TCM)
16	20A**	Power point (Console)
17	10A**	Alternator
18	40A*	Logic feed to SJB, SJB solid state devices
19	—	Not used
20	40A*	Rear defroster
21	30A*	Power seat motors (passenger)
22	30A*	Heated seat modules
23	15A**	Fog lamps
24	10A**	A/C clutch relay, A/C compressor clutch
25	—	Not used
26	—	Not used
27	15A**	Fuel relay (Fuel pump driver module, Fuel pump)

## Roadside Emergencies

Fuse/Relay Location	Fuse Amp Rating	Power Distribution Box Description
28	80A*	SJB power, SJB (Circuit breaker, Fuses 6, 7, 9, 10, 11 and 15)
29	30A*	Driver window motor
30	—	Not used
31	30A*	Auxiliary A/C rear blower motor, Auxiliary coolant pump
32	30A*	Driver seat motors, Memory module
33	30A*	Ignition switch (to SJB)
34	—	Not used
35	40A*	Front A/C blower motor, Auxiliary coolant pump relay coil
36	10A**	Auxiliary coolant pump
37	—	Not used
38	—	Not used
39	1A Diode	PCM
40	1A Diode	A/C clutch
41	½ ISO relay	Fog lamps
42	—	Not used
43	½ ISO relay	A/C clutch
44	½ ISO relay	Fuel pump driver module, Fuel pump
45	30A**	Front wiper, Front washer
46	5A**	Heated Positive Crankcase Ventilation (PCV) valve
47	25A**	Rear wiper, Rear washer
48	10A**	TCM, EVMV, Canister vent, ESM, Exhaust Gas Oxygen heaters, A/C clutch
49	15A**	PCM, Injectors, Ignition coils, Mass Air Flow (MAF) sensor
50	Full ISO relay	PCM relay, PDB fuses 40 and 41

## Roadside Emergencies

Fuse/Relay Location	Fuse Amp Rating	Power Distribution Box Description
51	Full ISO relay	Starter motor solenoid
52	Full ISO relay	Front A/C blower motor, Coolant pump relay coil
53	—	Not used
54	—	Not used
55	—	Not used
56	—	Not used
57	—	Not used
58	High current relay	Wipers

\* Cartridge Fuses \*\* Mini Fuses

### CHANGING THE TIRES

If you get a flat tire while driving:

- do not brake heavily.
- gradually decrease the vehicle's speed.
- hold the steering wheel firmly.
- slowly move to a safe place on the side of the road.



The use of tire sealants is not recommended and may damage your tires.

### Dissimilar spare tire/wheel information



Failure to follow these guidelines could result in an increased risk of loss of vehicle control, injury or death.

If you have a dissimilar spare tire/wheel, then it is intended for temporary use only. This means that if you need to use it, you should replace it as soon as possible with a road tire/wheel that is the same size and type as the road tires and wheels that were originally provided by Ford. If the dissimilar spare tire or wheel is damaged, it should be replaced rather than repaired.

## Roadside Emergencies

A dissimilar spare tire/wheel is defined as a spare tire and/or wheel that is different in brand, size or appearance from the road tires and wheels and can be one of three types:

1. **T-type mini-spare:** This spare tire begins with the letter “T” for tire size and may have “Temporary Use Only” molded in the sidewall
2. **Full-size dissimilar spare with label on wheel:** This spare tire has a label on the wheel that states: “THIS TIRE AND WHEEL FOR TEMPORARY USE ONLY”

When driving with one of the dissimilar spare tires listed above, **do not:**

- Exceed 50 mph (80 km/h)
- Load the vehicle beyond maximum vehicle load rating listed on the Safety Compliance Label
- Tow a trailer
- Use snow chains on the end of the vehicle with the dissimilar spare tire
- Use more than one dissimilar spare tire at a time
- Use commercial car washing equipment
- Try to repair the dissimilar spare tire

Use of one of the dissimilar spare tires listed above at any one wheel location can lead to impairment of the following:

- Handling, stability and braking performance
- Comfort and noise
- Ground clearance and parking at curbs
- Winter weather driving capability
- Wet weather driving capability

For vehicles equipped with 4WD, it is not recommended that the vehicle be operated in 4WD modes with a temporary emergency spare tire. If 4WD operation is necessary, do not operate above speeds of 10 mph (16 km/h) or for distances above 50 miles (80 km).

### 3. **Full-size dissimilar spare without label on wheel**

When driving with the full-size dissimilar spare tire/wheel, **do not:**

- Exceed 70 mph (113 km/h)
- Use more than one dissimilar spare tire/wheel at a time
- Use commercial car washing equipment

## Roadside Emergencies

- Use snow chains on the end of the vehicle with the dissimilar spare tire/wheel

The usage of a full-size dissimilar spare tire/wheel can lead to impairment of the following:

- Handling, stability and braking performance
- Comfort and noise
- Ground clearance and parking at curbs
- Winter weather driving capability
- Wet weather driving capability
- All-Wheel driving capability (if applicable)
- Load leveling adjustment (if applicable)

When driving with the full-size dissimilar spare tire/wheel additional caution should be given to:

- Towing a trailer
- Driving vehicles equipped with a camper body
- Driving vehicles with a load on the cargo rack

Drive cautiously when using a full-size dissimilar spare tire/wheel and seek service as soon as possible.

### Removing the spare tire and jack

If the 3rd row seat (if equipped) is stowed in the floor, you will need to unstow it to access the spare tire and jack. Refer to *Unstowing the 3rd row seat* in the *Seating and Safety Restraint* chapter for this procedure.



## Roadside Emergencies

1. Remove the carpeted floor panel located in the rear of the vehicle, remove the wing nut that secures the spare tire by turning it counterclockwise.
2. Lift and remove the spare tire from the trunk.
3. Remove the second wing nut that secures the jack retention bracket by turning it counterclockwise, remove the jack kit from the vehicle.
4. Remove the jack and the wrench from the felt bag. Fold down the wrench socket to use to loosen the lug nuts and to operate the jack.

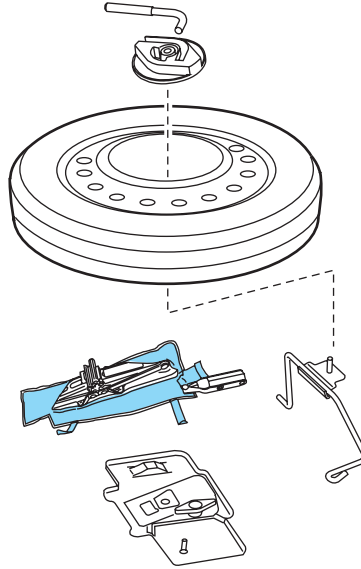

### **Tire change procedure**

1. Park on a level surface, activate hazard flashers and set the parking brake.

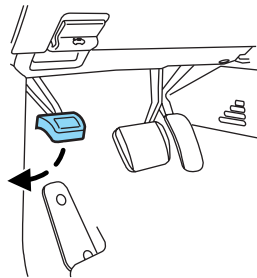

 When one of the front wheels is off the ground, the transaxle alone will not prevent the vehicle from moving or slipping off the jack, even if the vehicle is in P (Park).

## Roadside Emergencies

 To help prevent the vehicle from moving when you change a tire, be sure to place the transaxle in P (Park), set the parking brake and block (in both directions) the wheel that is diagonally opposite (other side and end of the vehicle) to the tire being changed.

 If the vehicle slips off the jack, you or someone else could be seriously injured.

2. Place gearshift lever in P (Park), turn engine OFF, and block the diagonally opposite wheel.

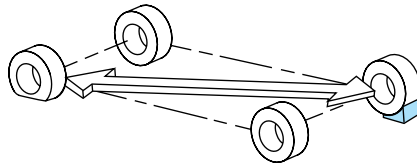

3. Remove wheel cover (if equipped) with the lug wrench tip and loosen each wheel lug nut one-half turn counterclockwise but do not remove them until the wheel is raised off the ground.

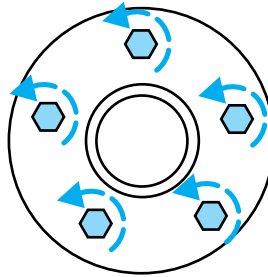

## Roadside Emergencies

4. Put the jack in the jack notch next to the tire you are changing. Turn the jack handle clockwise until the wheel is completely off the ground.

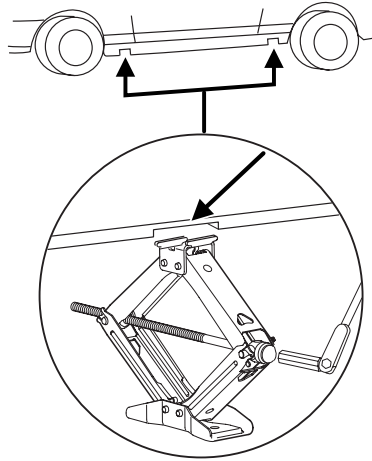

5. Remove the lug nuts with the lug wrench.

6. Replace the flat tire with the spare tire, making sure the valve stem is facing outward. Reinstall the lug nuts until the wheel is snug against the hub. Do not fully tighten the lug nuts until the wheel has been lowered.

7. Lower the wheel by turning the jack handle counterclockwise.

8. Remove the jack and fully tighten the lug nuts in the order shown. Refer to *Wheel lug nut torque specifications* later in this chapter for the proper lug nut torque specification.

9. Install the wheel cover (if equipped). The wheel cover will only install if the Ford/Mercury logo is aligned over the valve stem on the wheel.

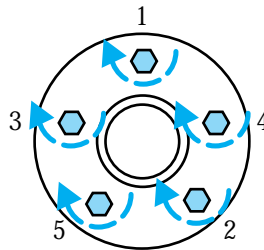

## Roadside Emergencies

### Stowing the tire and jack

1. Fully collapse the jack, fold the lug wrench socket into the handle and place the jack and wrench into the felt bag as shown. Take care to position the jack as shown to ensure that the locating holes in the jack base can be placed on the locating tabs of the jack mounting bracket in the spare tire tub.

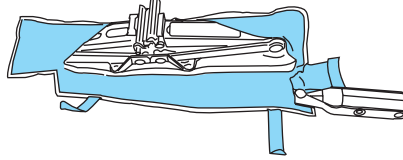

2. Securely close the wrench compartment and the jack bag using the velcro strips.

3. Place the jack kit on the angled bracket in the spare tire tub, using the locating tabs to position the jack correctly.

4. Insert the straight end of the jack retention bracket through the eyelet of the angled bracket and swing the retention bracket over the jack. With the jack in place, place the end of the retention bracket over the threaded stud in the trunk floor and secure it with the plastic wing nut.

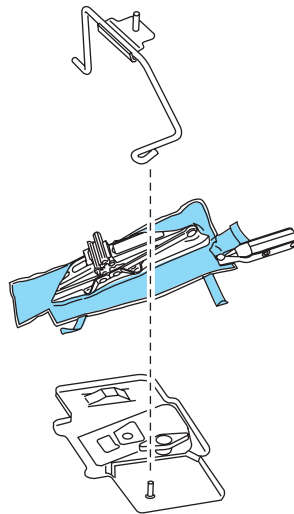

## Roadside Emergencies

**If you are stowing the flat tire,** remove the “L”-shaped bolt from the large wing nut used to secure the spare tire in the vehicle. With the 3rd row seat in the raised position, stand the flat tire in the rear of the vehicle with the tire’s valve stem facing the rear of the vehicle. Fasten the flat tire to the vehicle by inserting the “L”-shaped bolt through one of the lug bolt holes in the wheel and turning clockwise into the threaded hole in the vehicle until the tire is secured.

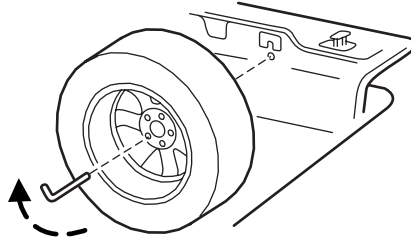

**If you are stowing the temporary spare tire,** place the tire over the jack and secure it with the large wing nut.

### WHEEL LUG NUT TORQUE SPECIFICATIONS

Retighten the lug nuts to the specified torque at 100 miles (160 km) after any wheel disturbance (tire rotation, changing a flat tire, wheel removal, etc.).

Bolt size	Wheel lug nut torque*	
	lb.ft.	N•m
1/2-20 UNF	100	135

\* Torque specifications are for nut and bolt threads free of dirt and rust. Use only Ford recommended replacement fasteners.



When a wheel is installed, always remove any corrosion, dirt or foreign materials present on the mounting surfaces of the wheel or the surface of the wheel hub, brake drum or brake disc that contacts the wheel. Ensure that any fasteners that attach the rotor to the hub are secured so they do not interfere with the mounting surfaces of the wheel. Installing wheels without correct metal-to-metal contact at the wheel mounting surfaces can cause the wheel nuts to loosen and the wheel to come off while the vehicle is in motion, resulting in loss of control.

## Roadside Emergencies

### JUMP STARTING



The gases around the battery can explode if exposed to flames, sparks, or lit cigarettes. An explosion could result in injury or vehicle damage.



Batteries contain sulfuric acid which can burn skin, eyes and clothing, if contacted.

**Do not attempt to push-start your vehicle. Automatic transmissions do not have push-start capability; doing so may damage the catalytic converter.**

### Preparing your vehicle

When the battery is disconnected or a new battery is installed, the transmission must relearn its shift strategy. As a result, the transmission may have firm and/or soft shifts. This operation is considered normal and will not affect function or durability of the transmission. Over time, the adaptive learning process will fully update transmission operation.

1. **Use only a 12-volt supply to start your vehicle.**
2. Do not disconnect the battery of the disabled vehicle as this could damage the vehicle's electrical system.
3. Park the booster vehicle close to the hood of the disabled vehicle making sure the two vehicles **do not** touch. Set the parking brake on both vehicles and stay clear of the engine cooling fan and other moving parts.
4. Check all battery terminals and remove any excessive corrosion before you attach the battery cables. Ensure that vent caps are tight and level.
5. Turn the heater fan on in both vehicles to protect any electrical surges. Turn all other accessories off.

## Roadside Emergencies

### Connecting the jumper cables

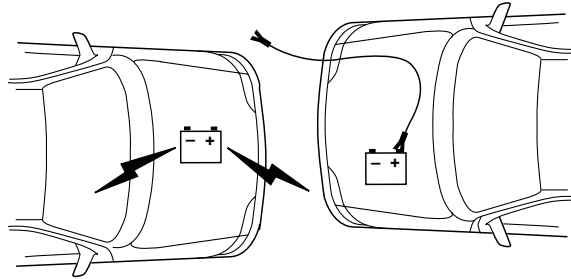

1. Connect the positive (+) jumper cable to the positive (+) terminal of the discharged battery.

**Note:** In the illustrations, *lightning bolts* are used to designate the assisting (boosting) battery.

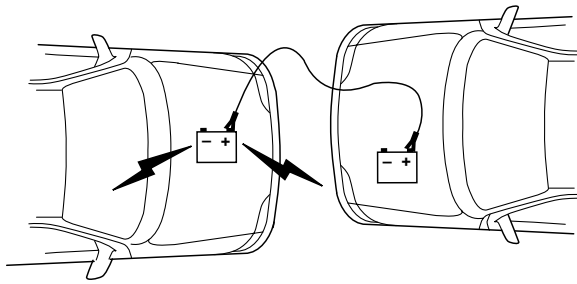

2. Connect the other end of the positive (+) cable to the positive (+) terminal of the assisting battery.

## Roadside Emergencies

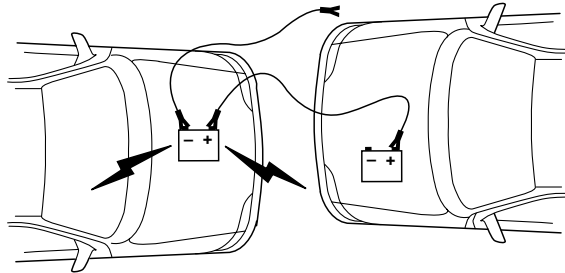

3. Connect the negative (-) cable to the negative (-) terminal of the assisting battery.

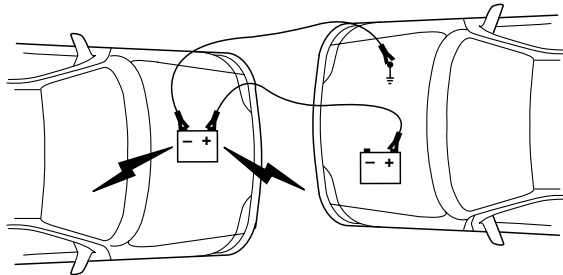

4. Make the final connection of the negative (-) cable to an exposed metal part of the stalled vehicle's engine, away from the battery and the carburetor/fuel injection system. **Do not** use fuel lines, engine rocker covers or the intake manifold as *grounding* points.



Do not connect the end of the second cable to the negative (-) terminal of the battery to be jumped. A spark may cause an explosion of the gases that surround the battery.

5. Ensure that the cables are clear of fan blades, belts, moving parts of both engines, or any fuel delivery system parts.



## Roadside Emergencies

### Jump starting

1. Start the engine of the booster vehicle and run the engine at moderately increased speed.
2. Start the engine of the disabled vehicle.
3. Once the disabled vehicle has been started, run both engines for an additional three minutes before disconnecting the jumper cables.

### Removing the jumper cables

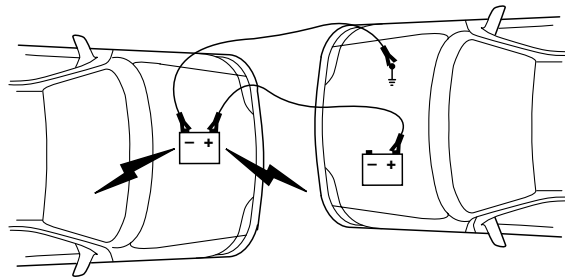

### Remove the jumper cables in the reverse order that they were connected.

1. Remove the jumper cable from the *ground* metal surface.

**Note:** In the illustrations, *lightning bolts* are used to designate the assisting (boosting) battery.

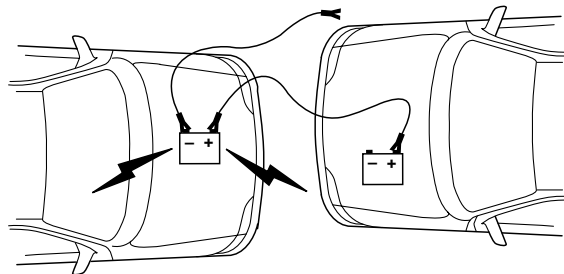

2. Remove the jumper cable on the negative (-) connection of the booster vehicle's battery.

## Roadside Emergencies

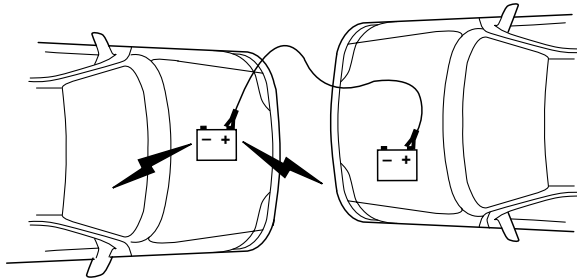

3. Remove the jumper cable from the positive (+) terminal of the booster vehicle's battery.

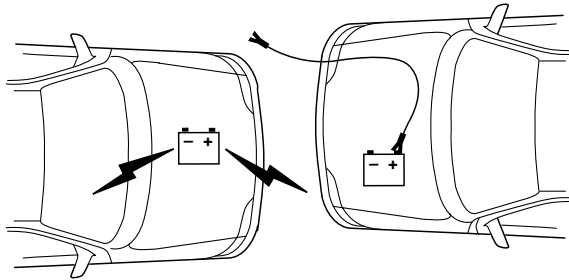

4. Remove the jumper cable from the positive (+) terminal of the disabled vehicle's battery.

After the disabled vehicle has been started and the jumper cables removed, allow it to idle for several minutes so the engine computer can *relearn* its idle conditions.

## Roadside Emergencies

### WRECKER TOWING

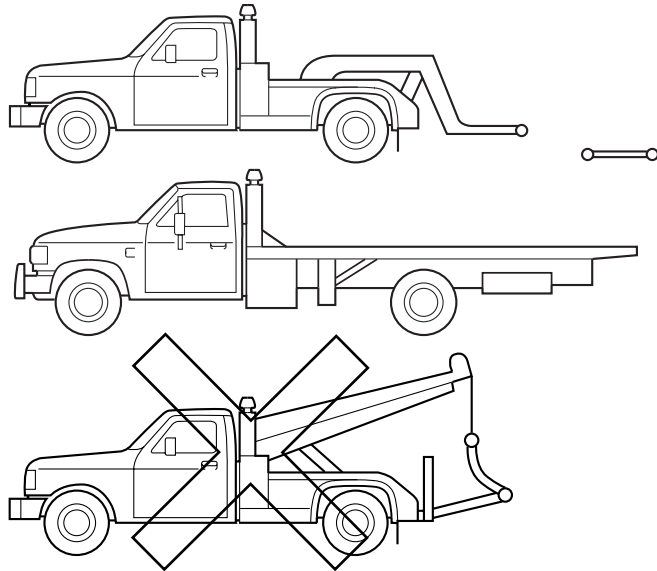

If you need to have your vehicle towed, contact a professional towing service or, if you are a member of a roadside assistance program, your roadside assistance service provider.

It is recommended that your vehicle be towed with a wheel lift or flatbed equipment. Do not tow with a slingbelt. Ford Motor Company has not approved a slingbelt towing procedure.

If the vehicle is being towed using wheel lift equipment, the wheels being raised should be brought to a height of 12 inches (30 cm) above the non-raised wheels to prevent damage to the vehicle.

**On Front Wheel Drive (FWD) models,** if your vehicle is to be towed from the rear using wheel lift equipment, it is recommended that the front wheels (drive wheels) be placed on a dolly to prevent damage to the automatic transaxle. If your vehicle is to be towed from the front using wheel lift equipment, it is recommended that the rear wheels be placed on a dolly to prevent damage to the vehicle.

## Roadside Emergencies

In case of a roadside emergency with a disabled vehicle (without access to wheel dollies, flatbed transport vehicle or a car hauling trailer) your vehicle can be flat towed (all wheels on the ground) only under the following conditions:

- The ambient temperature is above 32°F (0°C)
- Place the automatic transaxle in N (Neutral).
- DO NOT exceed the distance of 31 miles (50 km).
- DO NOT exceed the speed of 31 mph (50 km/h).

**On All Wheel Drive (AWD) models,** it is not recommended that your vehicle be towed with any wheels on the ground. It is recommended to tow your vehicle with all the wheels off the ground using wheel lift equipment and a wheel dolly, a flatbed transport vehicle or a car-hauling trailer.

In case of a roadside emergency with a disabled vehicle (without access to wheel dollies, flatbed transport vehicle or a car hauling trailer) your vehicle can be flat towed (all wheels on the ground) or wrecker towed (rear wheels on the ground) only under the following conditions:

- The ambient temperature is above 32°F (0°C).
- Place the transmission in N (Neutral).
- Maximum distance is 31 miles (50 km).
- Maximum speed is 31 mph (50 km/h).

**If the vehicle is towed by other means or incorrectly, vehicle damage may occur.**

Ford Motor Company produces a towing manual for all authorized tow truck operators. Have your tow truck operator refer to this manual for proper hook-up and towing procedures for your vehicle.

## Customer Assistance

### GETTING THE SERVICES YOU NEED

#### At home

You must take your Ford vehicle to an authorized dealer for warranty repairs. While any authorized dealer handling your vehicle line will provide warranty service, we recommend you return to your selling authorized dealer who wants to ensure your continued satisfaction. Please note that certain warranty repairs require special training and/or equipment, so not all authorized dealers are authorized to perform all warranty repairs. This means that, depending on the warranty repair needed, you may have to take your vehicle to another authorized dealer. A reasonable time must be allowed to perform a repair after taking your vehicle to the authorized dealer. Repairs will be made using Ford or Motorcraft parts, or remanufactured or other parts that are authorized by Ford.

If you have questions or concerns, or are unsatisfied with the service you are receiving, follow these steps:

1. Contact your Sales Representative or Service Advisor at your selling/servicing authorized dealer.
2. If your inquiry or concern remains unresolved, contact the Sales Manager, Service Manager or Customer Relations Manager.
3. If you require assistance or clarification on Ford Motor Company policies or procedures, please contact the Ford Customer Relationship Center at 1-800-392-3673 (FORD).

#### Away from home

If you own a Ford or Mercury vehicle and are away from home when your vehicle needs service, or if you need more help than the authorized dealer could provide, after following the steps described above, contact the Ford Customer Relationship Center to find an authorized dealer to help you.

In the United States:

Ford Motor Company  
Customer Relationship Center  
P.O. Box 6248  
Dearborn, MI 48121  
1-800-392-3673 (FORD)  
(TDD for the hearing impaired: 1-800-232-5952)  
[www.customersaskford.com](http://www.customersaskford.com)

## Customer Assistance

In Canada:  
Customer Relationship Centre  
Ford Motor Company of Canada, Limited  
P.O. Box 2000  
Oakville, Ontario L6J 5E4  
1-800-565-3673 (FORD)  
[www.ford.ca](http://www.ford.ca)

If you own a Lincoln vehicle and are away from home when your vehicle needs service, or if you need more help than the authorized dealer could provide, after following the steps described above, contact the Ford Customer Relationship Center to find an authorized dealer to help you.

In the United States:  
Ford Motor Company  
Customer Relationship Center  
P.O. Box 6248  
Dearborn, MI 48121  
1-800-521-4140  
(TDD for the hearing impaired: 1-800-232-5952)  
[www.customersaskford.com](http://www.customersaskford.com)

In Canada:  
Lincoln Centre  
Ford Motor Company of Canada, Limited  
P.O. Box 2000  
Oakville, Ontario L6J 5E4  
1-800-387-9333  
[www.lincolncanada.com](http://www.lincolncanada.com)

In order to help you service your Lincoln vehicle, please have the following information available when contacting the Lincoln Centre:

- Your telephone number (home and business)
- The name of the authorized dealer and the city where the authorized dealer is located
- The year and make of your vehicle
- The date of vehicle purchase
- The current odometer reading
- The vehicle identification number (VIN)

### **Additional Assistance**

If you still have a complaint involving a warranty dispute, you may wish to contact the Better Business Bureau (BBB) AUTO LINE program (U.S. only).

230

## Customer Assistance

In some states (in the U.S.) you must directly notify Ford in writing before pursuing remedies under your state's warranty laws. Ford is also allowed a final repair attempt in some states.

In the United States, a warranty dispute must be submitted to the BBB AUTO LINE before taking action under the Magnuson-Moss Warranty Act, or to the extent allowed by state law, before pursuing replacement or repurchase remedies provided by certain state laws. This dispute handling procedure is not required prior to enforcing state created rights or other rights which are independent of the Magnuson-Moss Warranty Act or state replacement or repurchase laws.

### **IN CALIFORNIA (U.S. ONLY)**

California Civil Code Section 1793.2(d) requires that, if a manufacturer or its representative is unable to repair a motor vehicle to conform to the vehicle's applicable express warranty after a reasonable number of attempts, the manufacturer shall be required to either replace the vehicle with one substantially identical or repurchase the vehicle and reimburse the buyer in an amount equal to the actual price paid or payable by the consumer (less a reasonable allowance for consumer use). The consumer has the right to choose whether to receive a refund or replacement vehicle.

California Civil Code Section 1793.22(b) presumes that the manufacturer has had a reasonable number of attempts to conform the vehicle to its applicable express warranties if, within the first 18 months of ownership of a new vehicle or the first 18,000 miles (29,000 km), whichever occurs first:

1. Two or more repair attempts are made on the same non-conformity likely to cause death or serious bodily injury OR
2. Four or more repair attempts are made on the same nonconformity (a defect or condition that substantially impairs the use, value or safety of the vehicle) OR
3. The vehicle is out of service for repair of nonconformities for a total of more than 30 calendar days (not necessarily all at one time)

In the case of 1 or 2 above, the consumer must also notify the manufacturer of the need for the repair of the nonconformity at the following address:

Ford Motor Company  
16800 Executive Plaza Drive  
Mail Drop 3NE-B  
Dearborn, MI 48126

## Customer Assistance

### **THE BETTER BUSINESS BUREAU (BBB) AUTO LINE PROGRAM (U.S. ONLY)**

Your satisfaction is important to Ford Motor Company and to your dealer. Experience has shown that our customers have been very successful in achieving satisfaction by following the three-step procedure outlined on the front page of the Warranty Guide. However, if your warranty concern has not been resolved using the three-step procedure, you may be eligible to participate in the BBB AUTO LINE program.

The BBB AUTO LINE program consists of two parts – mediation and arbitration. Initially, the BBB will try to resolve your question or concern through mediation. Mediation is a process through which a representative of the BBB will contact the parties and explore options for settlement of your claim. If mediation is not successful, customers with eligible claims may participate in the BBB AUTO LINE arbitration process. An arbitration hearing will be scheduled so that you can present your case in an informal setting before an impartial person. The arbitrator will consider the testimony provided and make a decision after the hearing. You are not bound by the decision but may choose to accept it. If you choose to accept the BBB AUTO LINE decision then Ford must abide by the accepted decision as well. If the arbitrator has decided in your favor and you accept the decision, the BBB AUTO LINE program will contact you to ensure that Ford has complied with the decision in a timely manner. Disputes submitted to the BBB AUTO LINE program are usually decided within forty days after you file your claim with the BBB.

To file a claim with the BBB AUTO LINE, you will be asked for your name and address, information about your vehicle, information about your concerns and any steps you have already taken to try to resolve them.

You can get more information by calling BBB AUTO LINE at 1-800-955-5100, or writing to:

BBB AUTO LINE  
4200 Wilson Boulevard, Suite 800  
Arlington, Virginia 22203-1833

**Note:** Ford Motor Company reserves the right to change eligibility limitations, modify procedures, or to discontinue this process at any time without notice and without obligation.



## Customer Assistance

### **UTILIZING THE MEDIATION/ARBITRATION PROGRAM (CANADA ONLY)**

For vehicles delivered to authorized Canadian dealers. In those cases where you continue to feel that the efforts by Ford of Canada and the authorized dealer to resolve a factory-related vehicle service concern have been unsatisfactory, Ford of Canada participates in an impartial third party mediation/arbitration program administered by the Canadian Motor Vehicle Arbitration Plan (CAMVAP).

The CAMVAP program is a straight-forward and relatively speedy alternative to resolve a disagreement when all other efforts to produce a settlement have failed. This procedure is without cost to you and is designed to eliminate the need for lengthy and expensive legal proceedings.

In the CAMVAP program, impartial third-party arbitrators conduct hearings at mutually convenient times and places in an informal environment. These impartial arbitrators review the positions of the parties, make decisions and, when appropriate, render awards to resolve disputes. CAMVAP decisions are fast, fair, and final as the arbitrator's award is binding both to you and Ford of Canada.

CAMVAP services are available in all territories and provinces. For more information, without charge or obligation, call your CAMVAP Provincial Administrator directly at 1-800-207-0685.

### **FORD EXTENDED SERVICE PLAN**

You can get more protection for your new car or light truck by purchasing Ford Extended Service Plan (Ford ESP) coverage. It provides the following:

- Benefits during the warranty period depending on the plan you purchase (such as: reimbursement for rentals; coverage for certain maintenance and wear items).
- Protection against covered repair costs after your Bumper-to-Bumper Warranty expires.

You may purchase Ford ESP from any participating authorized dealer. There are several plans available in various time, distance and deductible combinations which can be tailored to fit your own driving needs. Ford ESP also offers reimbursement benefits for towing and rental coverage.

When you buy Ford ESP, you receive Peace-of-Mind protection throughout the United States and Canada, provided by a network of more than 4,600 participating authorized dealers.

## Customer Assistance

If you did not take advantage of the Ford Extended Service Plan at the time of purchasing your vehicle, you may still be eligible. Since this information is subject to change, please ask your authorized dealer for complete details about Ford Extended Service Plan coverage options, or visit the Ford ESP website at [www.ford-esp.com](http://www.ford-esp.com).

### GETTING ASSISTANCE OUTSIDE THE U.S. AND CANADA

Before exporting your vehicle to a foreign country, contact the appropriate foreign embassy or consulate. These officials can inform you of local vehicle registration regulations and where to find unleaded fuel.

If you cannot find unleaded fuel or can only get fuel with an anti-knock index lower than is recommended for your vehicle, contact a regional office or owner relations/customer relationship office.

The use of leaded fuel in your vehicle without proper conversion may damage the effectiveness of your emission control system and may cause engine knocking or serious engine damage. Ford Motor Company/Ford of Canada is not responsible for any damage caused by use of improper fuel. Using leaded fuel may also result in difficulty importing your vehicle back into the U.S.

If your vehicle must be serviced while you are traveling or living in Central America, the Caribbean, or the Middle East, contact the nearest authorized dealer. If the authorized dealer cannot help you, write or call:

FORD MOTOR COMPANY  
WORLDWIDE DIRECT MARKET OPERATIONS  
1555 Fairlane Drive  
Fairlane Business Park #3  
Allen Park, Michigan 48101  
U.S.A.  
Telephone: (313) 594-4857  
FAX: (313) 390-0804

If you are in another foreign country, contact the nearest authorized dealer. If the authorized dealer employees cannot help you, they can direct you to the nearest Ford affiliate office.

If you buy your vehicle in North America and then relocate outside of the U.S. or Canada, register your vehicle identification number (VIN) and new address with Ford Motor Company Worldwide Direct Market Operations.

**Customers in the U.S. should call 1-800-392-3673.**

## Customer Assistance

### ORDERING ADDITIONAL OWNER'S LITERATURE

To order the publications in this portfolio, contact Helm, Incorporated at:

HELM, INCORPORATED  
P.O. Box 07150  
Detroit, Michigan 48207

Or call:

**For a free publication catalog, order toll free: 1-800-782-4356**

Monday-Friday 8:00 a.m. - 6:00 p.m. EST

Helm, Incorporated can also be reached by their website:  
[www.helminc.com](http://www.helminc.com).

*(Items in this catalog may be purchased by credit card, check or money order.)*

### Obtaining a French owner's guide

French Owner's Guides can be obtained from your authorized dealer or by writing to Ford Motor Company of Canada, Limited, Service Publications, P.O. Box 1580, Station B, Mississauga, Ontario L4Y 4G3.

### REPORTING SAFETY DEFECTS (U.S. ONLY)

If you believe that your vehicle has a defect which could cause a crash or could cause injury or death, you should immediately inform the National Highway Traffic Safety Administration (NHTSA) in addition to notifying Ford Motor Company.



If NHTSA receives similar complaints, it may open an investigation, and if it finds that a safety defect exists in a group of vehicles, it may order a recall and remedy campaign. However, NHTSA cannot become involved in individual problems between you, your dealer, or Ford Motor Company.

To contact NHTSA, you may call the Vehicle Safety Hotline toll-free at 1-888-327-4236 (TTY: 1-800-424-9153); go to <http://www.safercar.gov>; or write to:

Administrator  
NHTSA  
400 Seventh Street, SW  
Washington, D.C. 20590

You can also obtain other information about motor vehicle safety from <http://www.safercar.gov>.

## Cleaning

### WASHING THE EXTERIOR

Wash your vehicle regularly with cool or lukewarm water and a neutral pH shampoo, such as Motorcraft Detail Wash (ZC-3-A), which is available from your authorized dealer.

- Never use strong household detergents or soap, such as dish washing or laundry liquid. These products can discolor and spot painted surfaces.
- Never wash a vehicle that is “hot to the touch” or during exposure to strong, direct sunlight.
- Always use a clean sponge or car wash mitt with plenty of water for best results.
- Dry the vehicle with a chamois or soft terry cloth towel in order to eliminate water spotting.
- It is especially important to wash the vehicle regularly during the winter months, as dirt and road salt are difficult to remove and cause damage to the vehicle.
- Immediately remove items such as gasoline, diesel fuel, bird droppings and insect deposits because they can cause damage to the vehicle’s paintwork and trim over time.
- Remove any exterior accessories, such as antennas, before entering a car wash.
- **Suntan lotions and insect repellents can damage any painted surface; if these substances come in contact with your vehicle, wash off as soon as possible.**

### Exterior chrome

- Wash the vehicle first, using cool or lukewarm water and a neutral pH shampoo, such as Motorcraft Detail Wash (ZC-3-A).
- Use Custom Brite Metal Cleaner (ZC-15), available from your authorized dealer. Apply the product as you would a wax to clean bumpers and other chrome parts; allow the cleaner to dry for a few minutes, then wipe off the haze with a clean, dry rag.
- **Never use abrasive materials such as steel wool or plastic pads as they can scratch the chrome surface.**

### WAXING

Applying Motorcraft Paint Sealant (ZC-45) to your vehicle every six months will assist in reducing minor scratches and paint damage.

- Wash the vehicle first.
- Do not use waxes that contain abrasives; use Motorcraft Premium Liquid Wax (ZC-53-A), which is available from your authorized dealer, or an equivalent quality product.
- Do not allow paint sealant to come in contact with any non-body (low-gloss black) colored trim, such as grained door handles, roof racks, bumpers, side moldings, mirror housings or the windshield cowl area. The paint sealant will “gray” or stain the parts over time.

### PAINT CHIPS

Your authorized dealer has touch-up paint and sprays to match your vehicle's color. Take your color code (printed on a sticker in the driver's door jamb) to your authorized dealer to ensure you get the correct color.

- Remove particles such as bird droppings, tree sap, insect deposits, tar spots, road salt and industrial fallout before repairing paint chips.
- Always read the instructions before using the products.

### ALUMINUM WHEELS AND WHEEL COVERS

Aluminum wheels and wheel covers are coated with a clearcoat paint finish. In order to maintain their shine:

- Clean weekly with Motorcraft Wheel and Tire Cleaner (ZC-37-A), which is available from your authorized dealer. Heavy dirt and brake dust accumulation may require agitation with a sponge. Rinse thoroughly with a strong stream of water.
- Never apply any cleaning chemical to hot or warm wheel rims or covers.
- Some automatic car washes may cause damage to the finish on your wheel rims or covers. Chemical-strength cleaners, or cleaning chemicals, in combination with brush agitation to remove brake dust and dirt, could wear away the clearcoat finish over time.
- Do not use hydrofluoric acid-based or high caustic-based wheel cleaners, steel wool, fuels or strong household detergent.
- To remove tar and grease, use Motorcraft Bug and Tar Remover (ZC-42), available from your authorized dealer.

## Cleaning

### ENGINE

Engines are more efficient when they are clean because grease and dirt buildup keep the engine warmer than normal. When washing:

- Take care when using a power washer to clean the engine. The high-pressure fluid could penetrate the sealed parts and cause damage.
- Do not spray a hot engine with cold water to avoid cracking the engine block or other engine components.
- Spray Motorcraft Engine Shampoo and Degreaser (ZC-20) on all parts that require cleaning and pressure rinse clean.
- Cover the highlighted areas to prevent water damage when cleaning the engine.

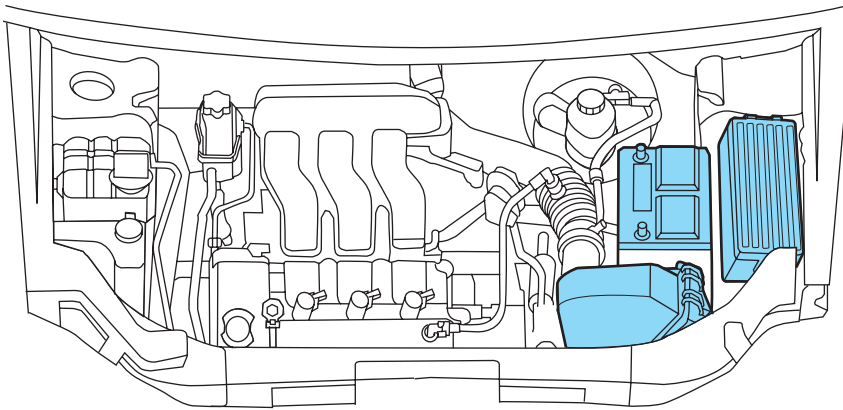

- **3.0L Duratec engine**

- Never wash or rinse the engine while it is running; water in the running engine may cause internal damage.

### PLASTIC (NON-PAINTED) EXTERIOR PARTS

Use only approved products to clean plastic parts. These products are available from your authorized dealer.

- For routine cleaning, use Motorcraft Detail Wash (ZC-3-A).
- If tar or grease spots are present, use Motorcraft Bug and Tar Remover (ZC-42).
- For plastic headlamp lenses, use Motorcraft Ultra Clear Spray Glass Cleaner (ZC-23).

### WINDOWS AND WIPER BLADES

The windshield, rear and side windows and the wiper blades should be cleaned regularly. If the wipers do not wipe properly, substances on the vehicle's glass or the wiper blades may be the cause. These may include hot wax treatments used by commercial car washes, water repellent coatings, tree sap, or other organic contamination; these contaminants may cause squeaking or chatter noise from the blades, and streaking and smearing of the windshield. To clean these items, follow these tips:

- The windshield, rear windows and side windows may be cleaned with a non-abrasive cleaner such as Motorcraft Ultra-Clear Spray Glass Cleaner (ZC-23), available from your authorized dealer.
- The wiper blades can be cleaned with isopropyl (rubbing) alcohol or Motorcraft Premium Windshield Washer Concentrate (ZC-32-A), available from your authorized dealer. This washer fluid contains special solution in addition to alcohol which helps to remove the hot wax deposited on the wiper blade and windshield from automated car wash facilities. Be sure to replace wiper blades when they appear worn or do not function properly.
- Do not use abrasives, as they may cause scratches.
- Do not use fuel, kerosene, or paint thinner to clean any parts.

**Do not use sharp objects, such as a razor blade, to clean the inside of the rear window or to remove decals, as it may cause damage to the rear window defroster's heated grid lines.**

### INSTRUMENT PANEL AND CLUSTER LENS

Clean the instrument panel with a damp cloth, then with a clean, dry cloth, or use Motorcraft Dash & Vinyl Cleaner (ZC-38-A).

- Avoid cleaners or polish that increase the gloss of the upper portion of the instrument panel. The dull finish in this area helps protect the driver from undesirable windshield reflection.



Do not use chemical solvents or strong detergents when cleaning the steering wheel or instrument panel to avoid contamination of the airbag system.

- Be certain to wash or wipe your hands clean if you have been in contact with certain products such as insect repellent and suntan lotion in order to avoid possible damage to the interior painted surfaces.

## Cleaning

### INTERIOR TRIM

- Clean the interior trim areas with a damp cloth, then with a clean, dry cloth; you may also use Motorcraft Dash & Vinyl Cleaner (ZC-38-A).
- Do not use household or glass cleaners as these may damage the finish.

### INTERIOR

For fabric, carpets, cloth seats, safety belts and seats equipped with side airbags:

- Remove dust and loose dirt with a vacuum cleaner.
- Remove light stains and soil with Motorcraft Professional Strength Carpet & Upholstery Cleaner (ZC-54).
- If grease or tar is present on the material, spot-clean the area first with Motorcraft Spot and Stain Remover (ZC-14).
- If a ring forms on the fabric after spot cleaning, clean the entire area immediately (but do not oversaturate) or the ring will set.
- Do not use household cleaning products or glass cleaners, which can stain and discolor the fabric and affect the flame retardant abilities of the seat materials.



Do not use cleaning solvents, bleach or dye on the vehicle's safety belts, as these actions may weaken the belt webbing.



Do not use chemical solvents or strong detergents when cleaning the seat-mounted side airbag (if equipped). Such products could contaminate the side airbag system and affect performance of the side airbag in a collision.

### LEATHER SEATS (IF EQUIPPED)

Your leather seating surfaces have a clear, protective coating over the leather.

- To clean, use a soft cloth with Motorcraft Deluxe Leather and Vinyl Cleaner (ZC-11-A). Dry the area with a soft cloth.
- To help maintain its resiliency and color, use the Motorcraft Deluxe Leather Care Kit (ZC-11-D), available from your authorized dealer.



## Cleaning

- Do not use household cleaning products, alcohol solutions, solvents or cleaners intended for rubber, vinyl and plastics, or oil/petroleum-based leather conditioners. These products may cause premature wearing of the clear, protective coating.

**Note:** In some instances, color or dye transfer can occur when wet clothing comes in contact with leather upholstery. If this occurs, the leather should be cleaned immediately to avoid permanent staining.

### UNDERBODY

Flush the complete underside of your vehicle frequently. Keep body and door drain holes free from packed dirt.

### FORD AND LINCOLN MERCURY CAR CARE PRODUCTS

Your Ford or Lincoln Mercury authorized dealer has many quality products available to clean your vehicle and protect its finishes. These quality products have been specifically engineered to fulfill your automotive needs; they are custom designed to complement the style and appearance of your vehicle. Each product is made from high quality materials that meet or exceed rigid specifications. For best results, use the following products or products of equivalent quality:

Motorcraft Bug and Tar Remover (ZC-42)  
Motorcraft Car Care Kit (ZC-26)  
Motorcraft Car Wash (Canada only) (CXC-21)  
Motorcraft Custom Bright Metal Cleaner (ZC-15)  
Motorcraft Custom Clear Coat Polish (ZC-8-A)  
Motorcraft Custom Vinyl Protectant (U.S. only) (ZC-40-A)  
Motorcraft Dash and Vinyl Cleaner (ZC-38-A)  
Motorcraft Deluxe Leather and Vinyl Cleaner (U.S. only) (ZC-11-A)  
Motorcraft Detail Wash (ZC-3-A)  
Motorcraft Dusting Cloth (ZC-24)  
Motorcraft Engine Shampoo and Degreaser (U.S. only) (ZC-20)  
Motorcraft Engine Shampoo (Canada only) (CXC-66-A)  
Motorcraft One Step Wash and Wax Concentrate (ZC-6-A)  
Motorcraft Paint Sealant (ZC-45)  
Motorcraft Premium Car Wash Concentrate (U.S. only) (ZC-17-B)  
Motorcraft Premium Glass Cleaner (Canada only) (CXC-100)

## Cleaning

Motorcraft Premium Liquid Wax (ZC-53-A)  
Motorcraft Premium Windshield Washer Concentrate (ZC-32-A)  
Motorcraft Professional Strength Carpet & Upholstery Cleaner (ZC-54)  
Motorcraft Spot and Stain Remover (U.S. only) (ZC-14)  
Motorcraft Tire Clean and Shine (ZC-28)  
Motorcraft Triple Clean (U.S. only) (ZC-13)  
Motorcraft Ultra-Clear Spray Glass Cleaner (ZC-23)  
Motorcraft Vinyl Cleaner (Canada only) (CXC-93)  
Motorcraft Vinyl Conditioner (Canada only) (CXC-94)  
Motorcraft Wheel and Tire Cleaner (ZC-37-A)

## Maintenance and Specifications

### SERVICE RECOMMENDATIONS

To help you service your vehicle:

- We highlight do-it-yourself items in the engine compartment for easy location.
- We provide *scheduled maintenance information* which makes tracking routine service easy.

If your vehicle requires professional service, your authorized dealer can provide the necessary parts and service. Check your *Warranty Guide/Owner Information Guide* to find out which parts and services are covered.

Use only recommended fuels, lubricants, fluids and service parts conforming to specifications. Motorcraft parts are designed and built to provide the best performance in your vehicle.

### PRECAUTIONS WHEN SERVICING YOUR VEHICLE

- Do not work on a hot engine.
- Make sure that nothing gets caught in moving parts.
- Do not work on a vehicle with the engine running in an enclosed space, unless you are sure you have enough ventilation.
- Keep all open flames and other burning (cigarettes) material away from the battery and all fuel related parts.

#### Working with the engine off

1. Set the parking brake and shift to P (Park).
2. Turn off the engine and remove the key.
3. Block the wheels.

#### Working with the engine on

1. Set the parking brake and ensure the gearshift is securely latched in P (Park).
2. Block the wheels to prevent the vehicle from moving unexpectedly.

**Note:** Do not start your engine with the air cleaner removed and do not remove it while the engine is running.

## Maintenance and Specifications

### OPENING THE HOOD

1. Inside the vehicle, pull the hood release handle located under the bottom of the instrument panel near the steering column.
2. Go to the front of the vehicle and release the auxiliary latch that is located under the front center of the hood.
3. Lift the hood and support it with the prop rod. Lift the prop rod by the sleeve and not the bare metal.

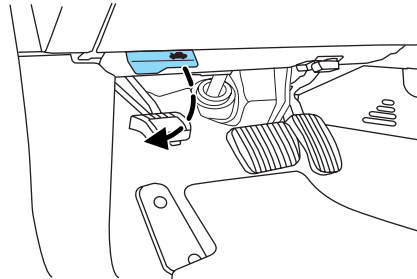

## Maintenance and Specifications

### IDENTIFYING COMPONENTS IN THE ENGINE COMPARTMENT

#### 3.0L DOHC V6 DURATEC ENGINE

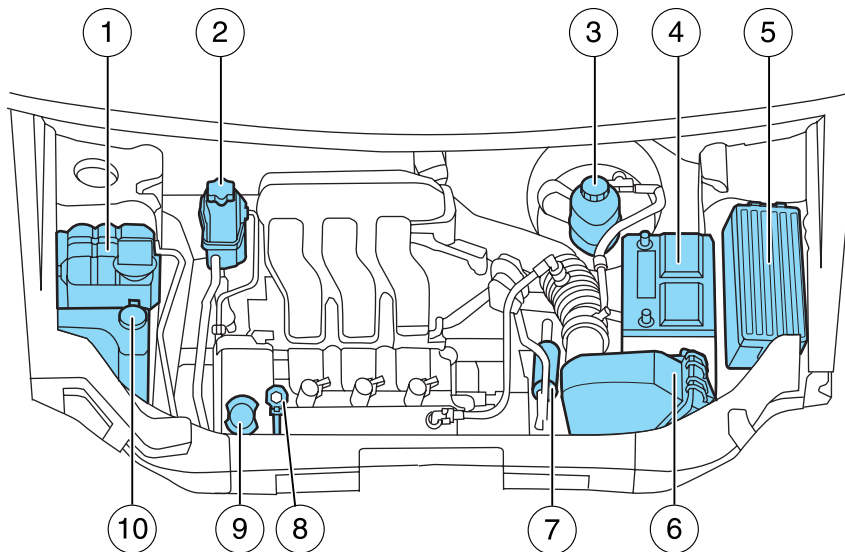

1. Engine coolant reservoir
2. Power steering fluid reservoir
3. Brake fluid reservoir
4. Battery
5. Power distribution box
6. Air filter assembly
7. Engine coolant bleed plug
8. Engine oil dipstick
9. Engine oil filler cap
10. Windshield washer fluid reservoir

## Maintenance and Specifications

### WINDSHIELD WASHER FLUID

Add fluid to fill the reservoir if the level is low. In very cold weather, do not fill the reservoir completely.

Only use a washer fluid that meets Ford specification WSB-M8B16-A2. Do not use any special washer fluid such as windshield water repellent type fluid or bug wash. They may cause squeaking, chatter noise, streaking and smearing. Refer to *Lubricant specifications* in this chapter.

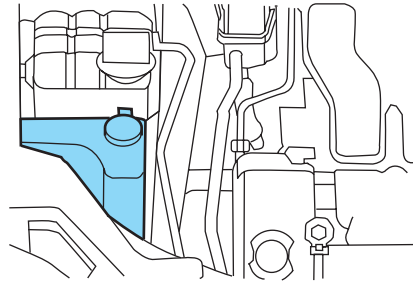

State or local regulations on volatile organic compounds may restrict the use of methanol, a common windshield washer antifreeze additive. Washer fluids containing non-methanol antifreeze agents should be used only if they provide cold weather protection without damaging the vehicle's paint finish, wiper blades or washer system.



If you operate your vehicle in temperatures below 40° F (4.5°C), use washer fluid with antifreeze protection. Failure to use washer fluid with antifreeze protection in cold weather could result in impaired windshield vision and increase the risk of injury or accident.

**Note:** Do not put washer fluid in the engine coolant reservoir. Washer fluid placed in the cooling system may harm engine and cooling system components.

### CHANGING THE WIPER BLADES

1. Pull the wiper arm away from the vehicle. Turn the blade 90 degrees from the wiper arm and remove it from the arm.
2. Attach the new wiper to the wiper arm by turning it 90 degrees it into place.

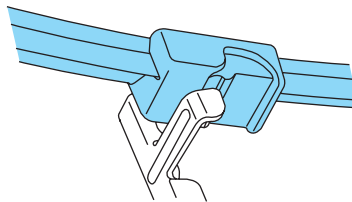

Replace wiper blades at least once per year for optimum performance.

Poor wiper quality can be improved by cleaning the wiper blades and the windshield, refer to *Windows and wiper blades* in the *Cleaning* chapter.

## Maintenance and Specifications

To prolong the life of the wiper blades, it is highly recommended to scrape off the ice on the windshield before turning on the wipers. The layer of ice has many sharp edges and can damage the micro edge of the wiper rubber element.

### ENGINE OIL

#### Checking the engine oil

Refer to the *scheduled maintenance information* for the appropriate intervals for checking the engine oil.

1. Make sure the vehicle is on level ground.
2. Turn the engine off and wait a few minutes for the oil to drain into the oil pan.
3. Set the parking brake and ensure the gearshift is securely latched in P (Park).
4. Open the hood. Protect yourself from engine heat.
5. Locate and carefully remove the engine oil level indicator (dipstick).

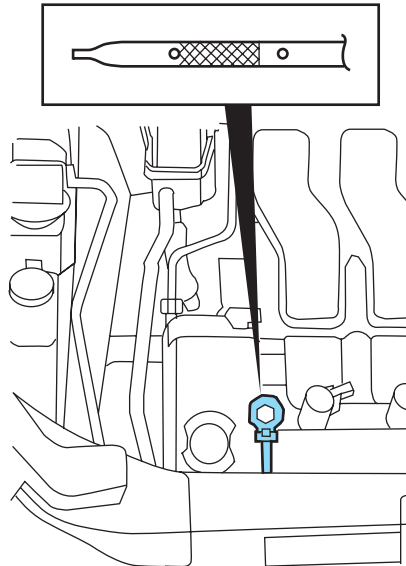

## Maintenance and Specifications

6. Wipe the indicator clean. Insert the indicator fully, then remove it again.

- If the oil level is **within this range**, the oil level is acceptable. **DO NOT ADD OIL.**

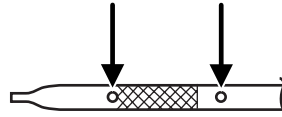

- If the oil level is **below this mark**, engine **oil must be added** to raise the level within the normal operating range.

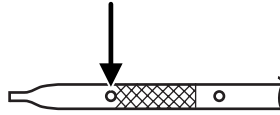

- If required, add engine oil to the engine. Refer to *Adding engine oil* in this chapter.

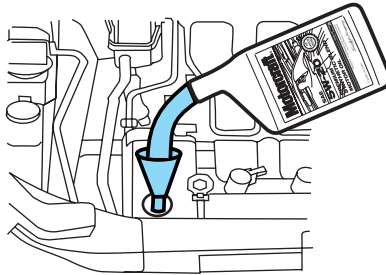

- **Do not overfill the engine with oil. Oil levels above this mark may cause engine damage.** If the engine is overfilled, some oil must be removed from the engine by an authorized dealer.

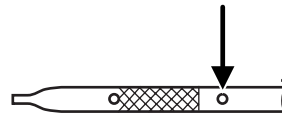

7. Put the indicator back in and ensure it is fully seated.

### Adding engine oil

1. Check the engine oil. For instructions, refer to *Checking the engine oil* in this chapter.
2. If the engine oil level is not within the normal operating range, add only certified engine oil of the recommended viscosity. Remove the engine oil filler cap and use a funnel to pour the engine oil into the opening.



## Maintenance and Specifications

3. Recheck the engine oil level. Make sure the oil level is not above the normal operating range on the engine oil level indicator (dipstick).
4. Install the indicator and ensure it is fully seated.
5. Fully install the engine oil filler cap by turning the filler cap clockwise until it stops.

**To avoid possible oil loss, DO NOT operate the vehicle with the engine oil level indicator and/or the engine oil filler cap removed.**

### Engine oil and filter recommendations

Look for this certification trademark.

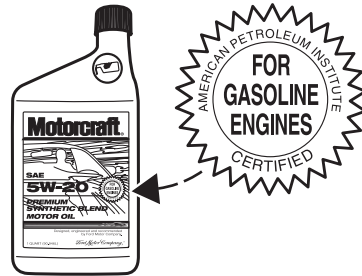

### Use SAE 5W-20 engine oil.

Only use oils “Certified For Gasoline Engines” by the American Petroleum Institute (API). An oil with this trademark symbol conforms to the current engine and emission system protection standards and fuel economy requirements of the International Lubricant Standardization and Approval Committee (ILSAC), comprised of U.S. and Japanese automobile manufacturers.

To protect your engine’s warranty use Motorcraft SAE 5W-20 or an equivalent 5W-20 oil meeting Ford specification WSS-M2C930-A. **SAE 5W-20 oil provides optimum fuel economy and durability performance meeting all requirements for your vehicle’s engine.**

Do not use supplemental engine oil additives, cleaners or other engine treatments. They are unnecessary and could lead to engine damage that is not covered by Ford warranty.

Change your engine oil and filter according to the appropriate schedule listed in *scheduled maintenance information*.

Ford production and aftermarket (Motorcraft) oil filters are designed for added engine protection and long life. If a replacement oil filter is used that does not meet Ford material and design specifications, start-up engine noises or knock may be experienced.

## Maintenance and Specifications

It is recommended you use the appropriate Motorcraft oil filter (or another brand meeting Ford specifications) for your engine application.

### BATTERY

Your vehicle is equipped with a Motorcraft maintenance-free battery which normally does not require additional water during its life of service.

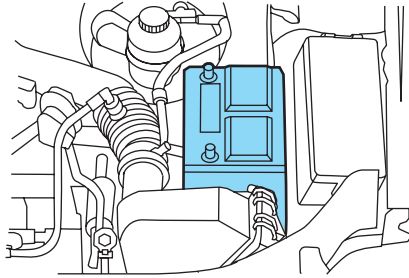

However, for severe usage or in high temperature climates, check the battery electrolyte level. Refer to *scheduled maintenance information* for the service interval schedules.

**Keep the electrolyte level in each cell up to the “level indicator”. Do not overfill the battery cells.**

If the electrolyte level in the battery is low, you can add plain tap water to the battery, as long as you do not use hard water (water with a high mineral or alkali content). If possible, however, try to only fill the battery cells with distilled water. If the battery needs water often, have the charging system checked.

**If your battery has a cover/shield, make sure it is reinstalled after the battery has been cleaned or replaced.**

For longer, trouble-free operation, keep the top of the battery clean and dry. Also, make certain the battery cables are always tightly fastened to the battery terminals.

If you see any corrosion on the battery or terminals, remove the cables from the terminals and clean with a wire brush. You can neutralize the acid with a solution of baking soda and water.



Batteries normally produce explosive gases which can cause personal injury. Therefore, do not allow flames, sparks or lighted substances to come near the battery. When working near the battery, always shield your face and protect your eyes. Always provide proper ventilation.

## Maintenance and Specifications



When lifting a plastic-cased battery, excessive pressure on the end walls could cause acid to flow through the vent caps, resulting in personal injury and/or damage to the vehicle or battery. Lift the battery with a battery carrier or with your hands on opposite corners.



Keep batteries out of reach of children. Batteries contain sulfuric acid. Avoid contact with skin, eyes or clothing. Shield your eyes when working near the battery to protect against possible splashing of acid solution. In case of acid contact with skin or eyes, flush immediately with water for a minimum of 15 minutes and get prompt medical attention. If acid is swallowed, call a physician immediately.



Battery posts, terminals and related accessories contain lead and lead compounds. **Wash hands after handling.**

Because your vehicle's engine is electronically controlled by a computer, some control conditions are maintained by power from the battery. When the battery is disconnected or a new battery is installed, the engine must relearn its idle and fuel trim strategy for optimum driveability and performance. To begin this process:

1. With the vehicle at a complete stop, set the parking brake.
2. Put the gearshift in P (Park), turn off all accessories and start the engine.
3. Run the engine until it reaches normal operating temperature.
4. Allow the engine to idle for at least one minute.
5. Turn the A/C on and allow the engine to idle for at least one minute.
6. Release the parking brake. With your foot on the brake pedal and with the A/C on, put the vehicle in D (Drive) and allow the engine to idle for at least one minute.
7. Drive the vehicle to complete the relearning process.
  - The vehicle may need to be driven 10 miles (16 km) or more to relearn the idle and fuel trim strategy.
  - **If you do not allow the engine to relearn its idle trim, the idle quality of your vehicle may be adversely affected until the idle trim is eventually relearned.**

## Maintenance and Specifications

If the battery has been disconnected or a new battery has been installed, the clock and radio settings must be reset once the battery is reconnected.

- Always dispose of automotive batteries in a responsible manner. Follow your local authorized standards for disposal. Call your local authorized recycling center to find out more about recycling automotive batteries.

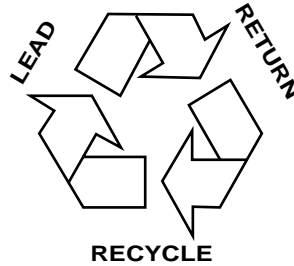

### ENGINE COOLANT

#### Checking engine coolant

The concentration and level of engine coolant should be checked at the intervals listed in *scheduled maintenance information*. The coolant concentration should be maintained at 50/50 coolant and distilled water, which equates to a freeze point of -34°F (-36°C). Coolant concentration testing is possible with a hydrometer or antifreeze tester (such as the Rotunda Battery and Antifreeze Tester, 014-R1060). The level of coolant should be maintained at the "FULL COLD" level or within the "COLD FILL RANGE" in the coolant reservoir. If the level falls below, add coolant per the instructions in the *Adding engine coolant* section.

Your vehicle was factory-filled with a 50/50 engine coolant and water concentration. If the concentration of coolant falls below 40% or above 60%, the engine parts could become damaged or not work properly. **A 50-50 mixture of coolant and water provides the following:**

- **Freeze protection down to -34°F (-36°C).**
- **Boiling protection up to 265°F (129°C).**
- **Protection against rust and other forms of corrosion.**
- **Enables calibrated gauges to work properly.**

## Maintenance and Specifications

When the engine is cold, check the level of the engine coolant in the reservoir.

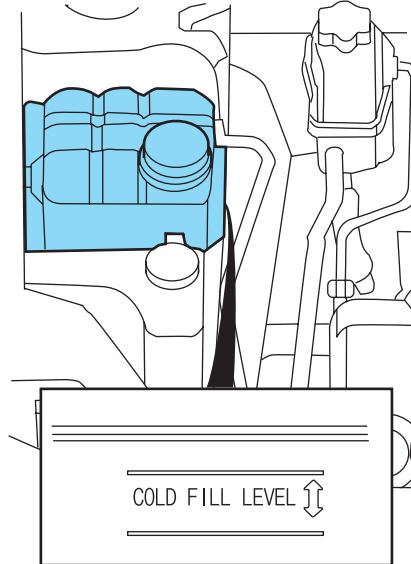

- The engine coolant should be at the “FULL COLD” level or within the “COLD FILL RANGE” as listed on the engine coolant reservoir (depending upon application).
- Refer to *scheduled maintenance information* for service interval schedules.
- Be sure to read and understand *Precautions when servicing your vehicle* in this chapter.

If the engine coolant has not been checked at the recommended interval, the engine coolant reservoir may become low or empty. If the reservoir is low or empty, add engine coolant to the reservoir. Refer to *Adding engine coolant* in this chapter.

**Note:** Automotive fluids are not interchangeable; do not use engine coolant, antifreeze or windshield washer fluid outside of its specified function and vehicle location.

### Adding engine coolant

When adding coolant, make sure it is a 50/50 mixture of engine coolant and distilled water. Add the mixture to the coolant reservoir, **when the engine is cool**, until the appropriate fill level is obtained.

## Maintenance and Specifications



Do not add engine coolant when the engine is hot. Steam and scalding liquids released from a hot cooling system can burn you badly. Also, you can be burned if you spill coolant on hot engine parts.



Do not put engine coolant in the windshield washer fluid container. If sprayed on the windshield, engine coolant could make it difficult to see through the windshield.

- **Add Motorcraft Premium Gold Engine Coolant (yellow-colored), VC-7-A (U.S., except CA, OR, and NM), VC-7-B (CA, OR and NM), meeting Ford Specification WSS-M97B51-A1.**

**Note:** Use of Motorcraft Cooling System Stop Leak Pellets, VC-6, may darken the color of Motorcraft Premium Gold Engine Coolant from yellow to golden tan.

- **Do not add/mix an orange-colored, extended life coolant such as Motorcraft Specialty Orange Engine Coolant, VC-2 (US) or CXC-209 (Canada), meeting Ford specification WSS-M97B44-D with the factory-filled coolant.** Mixing Motorcraft Specialty Orange Engine Coolant or any orange-colored extended life product with your factory filled coolant can result in degraded corrosion protection.
- A large amount of water without engine coolant may be added, in case of emergency, to reach a vehicle service location. In this instance, the cooling system must be drained and refilled with a 50/50 mixture of engine coolant and distilled water as soon as possible. Water alone (without engine coolant) can cause engine damage from corrosion, overheating or freezing.
- **Do not use alcohol, methanol, brine or any engine coolants mixed with alcohol or methanol antifreeze (coolant).** Alcohol and other liquids can cause engine damage from overheating or freezing.
- **Do not add extra inhibitors or additives to the coolant.** These can be harmful and compromise the corrosion protection of the engine coolant.



To reduce the risk of personal injury, make sure the engine is cool before unscrewing the coolant pressure relief cap. The cooling system is under pressure; steam and hot liquid can come out forcefully when the cap is loosened slightly.

## Maintenance and Specifications

1. Before you begin, turn the engine off and let it cool.
2. When the engine is cool, wrap a thick cloth around the coolant pressure relief cap on the coolant reservoir (an opaque plastic bottle). Slowly turn cap counterclockwise (left) until pressure begins to release.
3. Step back while the pressure releases.
4. When you are sure that all the pressure has been released, use the cloth to turn it counterclockwise and remove the cap.

**If coolant reservoir is empty, continue with steps 5–9, if coolant reservoir level is only slightly low (coolant still in reservoir), continue to Steps 5 and 6 only.**

5. Fill the coolant reservoir slowly with the proper coolant mixture (see above), to within the “COLD FILL RANGE” or the “FULL COLD” level on the reservoir.
6. Replace the cap. Turn until tightly installed. (Cap must be tightly installed to prevent coolant loss.)
7. Pull off metal pin and remove coolant bleed plug from the thermostat housing.

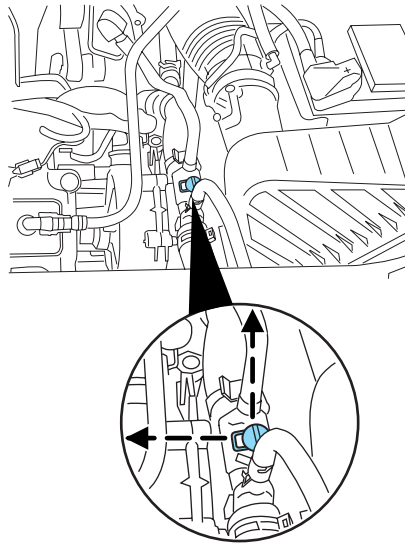

## Maintenance and Specifications

8. Add coolant/water mixture through the thermostat housing opening until full at housing opening.

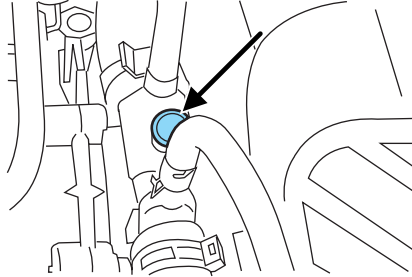

9. Install the thermostat housing bleed plug. Install metal pin by pushing into the slot.

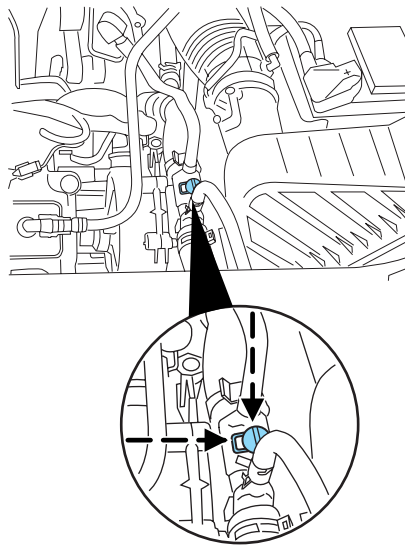

After any coolant has been added, check the coolant concentration, refer to *Checking engine coolant* section. If the concentration is not 50/50 (protection to  $-34^{\circ}\text{ F}$  [ $-36^{\circ}\text{ C}$ ]), drain some coolant and adjust the concentration. It may take several drains and additions to obtain a 50/50 coolant concentration.

Whenever coolant has been added, the coolant level in the coolant reservoir should be checked the next few times you drive the vehicle. If necessary, add enough 50/50 concentration of engine coolant and distilled water to bring the liquid level to the proper level.

256



## Maintenance and Specifications

If you have to add more than 1.0 quart (1.0 liter) of engine coolant per month, have your authorized dealer check the engine cooling system. Your cooling system may have a leak. Operating an engine with a low level of coolant can result in engine overheating and possible engine damage.

### Recycled engine coolant

Ford Motor Company does NOT recommend the use of recycled engine coolant in vehicles originally equipped with Motorcraft Premium Gold Engine Coolant since a Ford-approved recycling process is not yet available.



Used engine coolant should be disposed of in an appropriate manner. Follow your community's regulations and standards for recycling and disposing of automotive fluids.

### Coolant refill capacity

To find out how much fluid your vehicle's cooling system can hold, refer to *Refill capacities* in this section.

Fill your engine coolant reservoir as outlined in *Adding engine coolant* in this section.

### Severe climates

If you drive in extremely cold climates (less than  $-34^{\circ}\text{ F}$  [ $-36^{\circ}\text{ C}$  ]):

- **It may be necessary to increase the coolant concentration above 50%.**
- **NEVER increase the coolant concentration above 60%.**
- **Increased engine coolant concentrations above 60% will decrease the overheat protection characteristics of the engine coolant and may cause engine damage.**
- **Refer to the chart on the coolant container to ensure the coolant concentration in your vehicle will provide adequate freeze protection at the temperatures in which you drive in the winter months.**

If you drive in extremely hot climates:

- **It is still necessary to maintain the coolant concentration above 40%.**
- **NEVER decrease the coolant concentration below 40%.**

## Maintenance and Specifications

- **Decreased engine coolant concentrations below 40% will decrease the corrosion protection characteristics of the engine coolant and may cause engine damage.**
- **Decreased engine coolant concentrations below 40% will decrease the freeze protection characteristics of the engine coolant and may cause engine damage.**
- **Refer to the chart on the coolant container to ensure the coolant concentration in your vehicle will provide adequate protection at the temperatures in which you drive.**

Vehicles driven year-round in non-extreme climates should use a 50/50 mixture of engine coolant and distilled water for optimum cooling system and engine protection.

### FUEL FILTER

For fuel filter replacement, see your authorized dealer. Refer to *scheduled maintenance information* for the appropriate intervals for changing the fuel filter.

**Replace the fuel filter with an authorized Motorcraft part. The customer warranty may be void for any damage to the fuel system if an authorized Motorcraft fuel filter is not used.**

### WHAT YOU SHOULD KNOW ABOUT AUTOMOTIVE FUELS

#### Important safety precautions



Do not overfill the fuel tank. The pressure in an overfilled tank may cause leakage and lead to fuel spray and fire.



The fuel system may be under pressure. If the fuel filler cap is venting vapor or if you hear a hissing sound, wait until it stops before completely removing the fuel filler cap. Otherwise, fuel may spray out and injure you or others.



If you do not use the proper fuel filler cap, excessive pressure or vacuum in the fuel tank may damage the fuel system or cause the fuel cap to disengage in a collision, which may result in possible personal injury.

## Maintenance and Specifications



Automotive fuels can cause serious injury or death if misused or mishandled.



Gasoline may contain benzene, which is a cancer-causing agent.

Observe the following guidelines when handling automotive fuel:

- Extinguish all smoking materials and any open flames before refueling your vehicle.
- Always turn off the vehicle before refueling.
- Automotive fuels can be harmful or fatal if swallowed. Fuel such as gasoline is highly toxic and if swallowed can cause death or permanent injury. If fuel is swallowed, call a physician immediately, even if no symptoms are immediately apparent. The toxic effects of fuel may not be visible for hours.
- Avoid inhaling fuel vapors. Inhaling too much fuel vapor of any kind can lead to eye and respiratory tract irritation. In severe cases, excessive or prolonged breathing of fuel vapor can cause serious illness and permanent injury.
- Avoid getting fuel liquid in your eyes. If fuel is splashed in the eyes, remove contact lenses (if worn), flush with water for 15 minutes and seek medical attention. Failure to seek proper medical attention could lead to permanent injury.
- Fuels can also be harmful if absorbed through the skin. If fuel is splashed on the skin and/or clothing, promptly remove contaminated clothing and wash skin thoroughly with soap and water. Repeated or prolonged skin contact with fuel liquid or vapor causes skin irritation.
- Be particularly careful if you are taking “Antabuse” or other forms of disulfiram for the treatment of alcoholism. Breathing gasoline vapors, or skin contact could cause an adverse reaction. In sensitive individuals, serious personal injury or sickness may result. If fuel is splashed on the skin, promptly wash skin thoroughly with soap and water. Consult a physician immediately if you experience an adverse reaction.



## Maintenance and Specifications



When refueling always shut the engine off and never allow sparks or open flames near the filler neck. Never smoke while refueling. Fuel vapor is extremely hazardous under certain conditions. Care should be taken to avoid inhaling excess fumes.



The flow of fuel through a fuel pump nozzle can produce static electricity, which can cause a fire if fuel is pumped into an ungrounded fuel container.

### Refueling



Fuel vapor burns violently and a fuel fire can cause severe injuries. To help avoid injuries to you and others:

- Read and follow all the instructions on the pump island;
- Turn off your engine when you are refueling;
- Do not smoke if you are near fuel or refueling your vehicle;
- Keep sparks, flames and smoking materials away from fuel;
- Stay outside your vehicle and do not leave the fuel pump unattended when refueling your vehicle — this is against the law in some places;
- Keep children away from the fuel pump; never let children pump fuel

Use the following guidelines to avoid static build-up when filling an ungrounded fuel container:

- Place approved fuel container on the ground.
- DO NOT fill a fuel container while it is in the vehicle (including the cargo area).
- Keep the fuel pump nozzle in contact with the fuel container while filling.
- DO NOT use a device that would hold the fuel pump handle in the fill position.

### Fuel Filler Cap

Your fuel tank filler cap has an indexed design with a 1/4 turn on/off feature.

When fueling your vehicle:

1. Turn the engine off.
2. Carefully turn the filler cap counterclockwise 1/4 of a turn until it stops.

260

## Maintenance and Specifications

3. Pull to remove the cap from the fuel filler pipe.
4. To install the cap, align the tabs on the cap with the notches on the filler pipe.
5. Turn the filler cap clockwise 1/4 of a turn until it clicks at least once.

If the  indicator comes on and stays on after you start the engine, the fuel filler cap may not be properly installed. Turn off the engine, remove the fuel filler cap, align the cap properly and reinstall it.

**If you must replace the fuel filler cap, replace it with a fuel filler cap that is designed for your vehicle. The customer warranty may be void for any damage to the fuel tank or fuel system if the correct genuine Ford or Motorcraft fuel filler cap is not used.**

 The fuel system may be under pressure. If the fuel filler cap is venting vapor or if you hear a hissing sound, wait until it stops before completely removing the fuel filler cap. Otherwise, fuel may spray out and injure you or others.

 If you do not use the proper fuel filler cap, excessive pressure or vacuum in the fuel tank may damage the fuel system or cause the fuel cap to disengage in a collision, which may result in possible personal injury.

FORD RECOMMENDS BP



### Choosing the right fuel

Use only UNLEADED FUEL. The use of leaded fuel is prohibited by law and could damage your vehicle.

Your vehicle was not designed to use fuel or fuel additives with metallic compounds, including manganese-based additives. Studies indicate that these additives can cause your vehicle's emission control system to

## Maintenance and Specifications

deteriorate more rapidly. In Canada, premium grade fuel generally contains more metallic additives than regular grade fuel. We recommend using regular grade fuel. In Canada, many fuels contain metallic additives, but fuels free of such additives may be available; check with your local fuel dealer.

Do not use fuel containing methanol. It can damage critical fuel system components.

Repairs to correct the effects of using a fuel for which your vehicle was not designed may not be covered by your warranty.

### Octane recommendations

Your vehicle is designed to use “Regular” unleaded gasoline with pump (R+M)/2 octane rating of 87. We do not recommend the use of gasolines labeled as “Regular” that are sold with octane ratings of 86 or lower in high altitude areas.

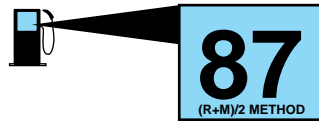

Do not be concerned if your engine sometimes knocks lightly. However, if it knocks heavily under most driving conditions while you are using fuel with the recommended octane rating, see your authorized dealer to prevent any engine damage.

### Fuel quality

If you are experiencing starting, rough idle or hesitation driveability problems, try a different brand of unleaded gasoline. “Premium” unleaded gasoline is not recommended for vehicles designed to use “Regular” unleaded gasoline because it may cause these problems to become more pronounced. If the problems persist, see your authorized dealer.

It should not be necessary to add any aftermarket products to your fuel tank if you continue to use high quality fuel of the recommended octane rating. Aftermarket products could cause damage to the fuel system. Repairs to correct the effects of using an aftermarket product in your fuel may not be covered by your warranty.

Many of the world’s automakers approved the World-wide Fuel Charter that recommends gasoline specifications to provide improved performance and emission control system protection for your vehicle. Gasolines that meet the World-wide Fuel Charter should be used when available. Ask your fuel supplier about gasolines that meet the World-wide Fuel Charter.

262

## Maintenance and Specifications

### Cleaner air

Ford endorses the use of reformulated “cleaner-burning” gasolines to improve air quality.

### Running out of fuel

Avoid running out of fuel because this situation may have an adverse effect on powertrain components.

If you have run out of fuel:

- You may need to cycle the ignition from off to on several times after refueling, to allow the fuel system to pump the fuel from the tank to the engine.
- The  indicator may come on. For more information on the “check engine” or the “service engine soon” indicator, refer to *Warning lights and chimes* in the *Instrument Cluster* chapter.

## ESSENTIALS OF GOOD FUEL ECONOMY

### Measuring techniques

Your best source of information about actual fuel economy is you, the driver. You must gather information as accurately and consistently as possible. Fuel expense, frequency of fill-ups or fuel gauge readings are NOT accurate as a measure of fuel economy. We do not recommend taking fuel economy measurements during the first 1,000 miles (1,600 km) of driving (engine break-in period). You will get a more accurate measurement after 2,000 miles-3,000 miles (3,000 km-5,000 km).

### Filling the tank

The advertised fuel capacity of the fuel tank on your vehicle is equal to the rated refill capacity of the fuel tank as listed in the *Refill capacities* section of this chapter.

The advertised capacity is the amount of the indicated capacity and the empty reserve combined. Indicated capacity is the difference in the amount of fuel in a full tank and a tank when the fuel gauge indicates empty. Empty reserve is the small amount of fuel remaining in the fuel tank after the fuel gauge indicates empty.

**The amount of usable fuel in the empty reserve varies and should not be relied upon to increase driving range. When refueling your vehicle after the fuel gauge indicates empty, you might not be able to refuel the full amount of the advertised capacity of the fuel tank due to the empty reserve still present in the tank.**

## Maintenance and Specifications

For consistent results when filling the fuel tank:

- Turn the engine/ignition switch to the off position prior to refueling, an error in the reading will result if the engine is left running.
- Use the same filling rate setting (low — medium — high) each time the tank is filled.
- Allow no more than two automatic click-offs when filling.
- Always use fuel with the recommended octane rating.
- Use a known quality gasoline, preferably a national brand.
- Use the same side of the same pump and have the vehicle facing the same direction each time you fill up.
- Have the vehicle loading and distribution the same every time.

Your results will be most accurate if your filling method is consistent.

### Calculating fuel economy

1. Fill the fuel tank completely and record the initial odometer reading (in miles or kilometers).
2. Each time you fill the tank, record the amount of fuel added (in gallons or liters).
3. After at least three to five tank fill-ups, fill the fuel tank and record the current odometer reading.
4. Subtract your initial odometer reading from the current odometer reading.
5. Follow one of the simple calculations in order to determine fuel economy:

Calculation 1: **Divide total miles traveled by total gallons used.**

Calculation 2: **Multiply liters used by 100, then divide by total kilometers traveled.**

Keep a record for at least one month and record the type of driving (city or highway). This will provide an accurate estimate of the vehicle's fuel economy under current driving conditions. Additionally, keeping records during summer and winter will show how temperature impacts fuel economy. In general, lower temperatures give lower fuel economy.

### Driving style — good driving and fuel economy habits

Give consideration to the lists that follow and you may be able to change a number of variables and improve your fuel economy.



## Maintenance and Specifications

### **Habits**

- Smooth, moderate operation can yield up to 10% savings in fuel.
- Steady speeds without stopping will usually give the best fuel economy.
- Idling for long periods of time (greater than one minute) may waste fuel.
- Anticipate stopping; slowing down may eliminate the need to stop.
- Sudden or hard accelerations may reduce fuel economy.
- Slow down gradually.
- Driving at reasonable speeds (traveling at 55 mph [88 km/h] uses 15% less fuel than traveling at 65 mph [105 km/h]).
- Revving the engine before turning it off may reduce fuel economy.
- Using the air conditioner or defroster may reduce fuel economy.
- You may want to turn off the speed control in hilly terrain if unnecessary shifting between third and fourth gear occurs. Unnecessary shifting of this type could result in reduced fuel economy.
- Warming up a vehicle on cold mornings is not required and may reduce fuel economy.
- Resting your foot on the brake pedal while driving may reduce fuel economy.
- Combine errands and minimize stop-and-go driving.

### **Maintenance**

- Keep tires properly inflated and use only recommended size.
- Operating a vehicle with the wheels out of alignment will reduce fuel economy.
- Use recommended engine oil. Refer to *Lubricant specifications* in this chapter.
- Perform all regularly scheduled maintenance items. Follow the recommended maintenance schedule and owner maintenance checks found in *scheduled maintenance information*.

### **Conditions**

- Heavily loading a vehicle or towing a trailer may reduce fuel economy at any speed.
- Carrying unnecessary weight may reduce fuel economy (approximately 1 mpg [0.4 km/L] is lost for every 400 lb [180 kg] of weight carried).

## Maintenance and Specifications

- Adding certain accessories to your vehicle (for example bug deflectors, rollbars/light bars, running boards, ski/luggage racks) may reduce fuel economy.
- Using fuel blended with alcohol may lower fuel economy.
- Fuel economy may decrease with lower temperatures during the first 8–10 miles (12–16 km) of driving.
- Driving on flat terrain offers improved fuel economy as compared to driving on hilly terrain.
- Transmissions give their best fuel economy when operated in the top cruise gear and with steady pressure on the gas pedal.
- Close windows for high speed driving.

### EPA window sticker

Every new vehicle should have the EPA window sticker. Contact your authorized dealer if the window sticker is not supplied with your vehicle. The EPA window sticker should be your guide for the fuel economy comparisons with other vehicles.

It is important to note the box in the lower left corner of the window sticker. These numbers represent the Range of MPG (L/100 km) expected on the vehicle under optimum conditions. Your fuel economy may vary depending upon the method of operation and conditions.

### EMISSION CONTROL SYSTEM

Your vehicle is equipped with various emission control components and a catalytic converter which will enable your vehicle to comply with applicable exhaust emission standards. To make sure that the catalytic converter and other emission control components continue to work properly:

- Use only the specified fuel listed.
- Avoid running out of fuel.
- Do not turn off the ignition while your vehicle is moving, especially at high speeds.
- Have the items listed in *scheduled maintenance information* performed according to the specified schedule.

The scheduled maintenance items listed in *scheduled maintenance information* are essential to the life and performance of your vehicle and to its emissions system.

266

## Maintenance and Specifications

If other than Ford, Motorcraft or Ford-authorized parts are used for maintenance replacements or for service of components affecting emission control, such non-Ford parts should be equivalent to genuine Ford Motor Company parts in performance and durability.

 Do not park, idle, or drive your vehicle in dry grass or other dry ground cover. The emission system heats up the engine compartment and exhaust system, which can start a fire.



Illumination of the  indicator, charging system warning light or the temperature warning light, fluid leaks, strange odors, smoke or loss of engine power could indicate that the emission control system is not working properly.

 Exhaust leaks may result in entry of harmful and potentially lethal fumes into the passenger compartment.

Do not make any unauthorized changes to your vehicle or engine. By law, vehicle owners and anyone who manufactures, repairs, services, sells, leases, trades vehicles, or supervises a fleet of vehicles are not permitted to intentionally remove an emission control device or prevent it from working. Information about your vehicle's emission system is on the Vehicle Emission Control Information Decal located on or near the engine. This decal identifies engine displacement and gives some tune up specifications.

Please consult your *Warranty Guide* for complete emission warranty information.

### On board diagnostics (OBD-II)

Your vehicle is equipped with a computer that monitors the engine's emission control system. This system is commonly known as the On Board Diagnostics System (OBD-II). This OBD-II system protects the environment by ensuring that your vehicle continues to meet government emission standards. The OBD-II system also assists your authorized dealer in properly servicing your vehicle. When the  indicator illuminates, the OBD-II system has detected a malfunction. Temporary malfunctions may cause the  indicator to illuminate. Examples are:

1. The vehicle has run out of fuel—the engine may misfire or run poorly.
2. Poor fuel quality or water in the fuel.



## Maintenance and Specifications

3. The fuel cap may not have been securely tightened. See *Fuel filler cap* in this chapter.

These temporary malfunctions can be corrected by filling the fuel tank with good quality fuel and/or properly tightening the fuel cap. After three driving cycles without these or any other temporary malfunctions present, the  indicator should turn off—A driving cycle consists of a cold engine startup followed by mixed city/highway driving. No additional vehicle service is required.

If the  indicator remains on, have your vehicle serviced at the first available opportunity.

### Readiness for Inspection/Maintenance (I/M) testing

In some localities, it may be a legal requirement to pass an I/M test of the on-board diagnostics system. If the  indicator is on, refer to the description in the *Warning lights and chimes* section of the *Instrument Cluster* chapter. Your vehicle may not pass the I/M test with the  indicator on.

If the vehicle's powertrain system or its battery has just been serviced, the on-board diagnostics system is reset to a "not ready for I/M test" condition. To ready the on-board diagnostics system for I/M testing, a minimum of 30 minutes of city and highway driving is necessary as described below:

- First, at least 10 minutes of driving on an expressway or highway.
- Next, at least 20 minutes driving in stop-and-go, city-type traffic with at least four idle periods.

Allow the vehicle to sit for at least eight hours without starting the engine. Then, start the engine and complete the above driving cycle. The engine must warm up to its normal operating temperature. Once started, do not turn off the engine until the above driving cycle is complete.

### POWER STEERING FLUID

Refer to the *scheduled maintenance information* for the service interval schedules. If adding fluid is necessary, use only MERCON® ATF.

## Maintenance and Specifications

1. Start the engine and let it run until it reaches normal operating temperature (the engine coolant temperature gauge indicator will be near the center of the normal area between H and C).

2. While the engine idles, turn the steering wheel left and right several times.

3. Turn the engine off.

4. Check the fluid level in the reservoir. It should be between the MIN and MAX lines. Do not add fluid if the level is in this range.

5. If the fluid is low, add fluid in small amounts, continuously checking the level until it reaches the range between the MIN and MAX lines. Be sure to put the cap back on the reservoir.

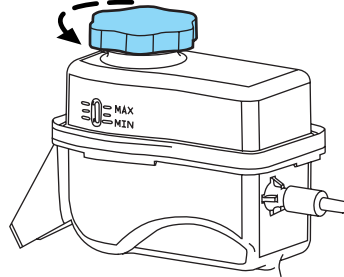

### **BRAKE FLUID**

The fluid level will drop slowly as the brakes wear, and will rise when the brake components are replaced. Fluid levels between the “MIN” and “MAX” lines are within the normal operating range; there is no need to add fluid. If the fluid levels are outside of the normal operating range the performance of your brake system could be compromised; seek service from your authorized dealer immediately.

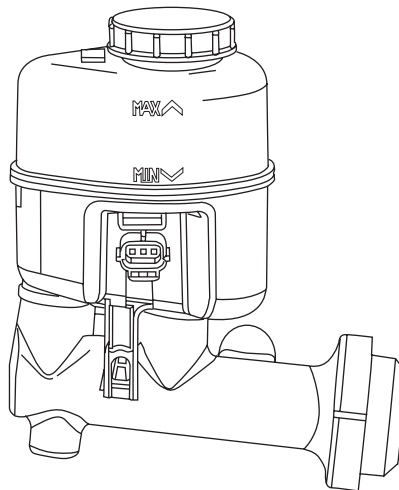

### **TRANSAXLE FLUID**

**Checking automatic transaxle fluid—CVT transaxle**

**Do not use supplemental transaxle fluid additives, treatments or cleaning agents. The use of these materials or transaxle fluids**

## Maintenance and Specifications

**other than the recommended fluid, may affect transaxle operation and result in damage to internal transaxle components.**

Refer to your *scheduled maintenance information* for scheduled intervals for fluid changes. Your transaxle does not consume fluid. However, the fluid level should be checked if the transaxle is not working properly, i.e., if the transaxle slips, takes more than a couple of seconds to engage into Drive/Reverse or if you notice some sign of fluid leakage.

**It is recommended that an authorized dealer check fluid level and add fluid if required.**

If your transaxle has a low fluid condition sufficient to affect proper operation the transaxle control module will send a signal to illuminate the  on the instrument panel.

As long as the transaxle engages normally to drive or reverse, it is safe to drive but if the  illuminates the vehicle should be taken to your authorized dealer for evaluation as soon as possible.

**If your transaxle does not engage normally, do not attempt to drive. The vehicle should be towed to your authorized dealer for evaluation.**

### MOTORCRAFT PART NUMBERS

Component	3.0L DOHC V6 Duratec engine
Engine air filter element	FA-1771
Fuel filter	FG-986
Battery	BXT-36R
Oil filter	FL-820-S
PCV valve	<sup>1</sup>
Spark plugs	<sup>2</sup>

<sup>1</sup>The PCV valve is a critical emission component. It is one of the items listed in *scheduled maintenance information* and is essential to the life and performance of your vehicle and to its emissions system.

For PCV valve replacement, see your authorized dealer. Refer to *scheduled maintenance information* for the appropriate intervals for changing the PCV valve.

**Replace the PCV valve with one that meets Ford material and design specifications for your vehicle, such as a Motorcraft or equivalent replacement part. The customer warranty may be void for any damage to the emissions system if such a PCV valve is not used.**

## Maintenance and Specifications

<sup>2</sup>For spark plug replacement, see your authorized dealer. Refer to *scheduled maintenance information* for the appropriate intervals for changing the spark plugs.

**Replace the spark plugs with ones that meet Ford material and design specifications for your vehicle, such as Motorcraft or equivalent replacement parts. The customer warranty may be void for any damage to the engine if such spark plugs are not used.**

### REFILL CAPACITIES

Fluid	Ford Part Name	Application	Capacity
Brake fluid	Motorcraft High Performance DOT 3 Motor Vehicle Brake Fluid	All	Between MAX and MIN on reservoir
Engine coolant <sup>1</sup>	Motorcraft Premium Gold Engine Coolant (yellow-colored)	3.0L engine	11.6 quarts (11.0L)
Engine oil (includes filter change) <sup>2</sup>	Motorcraft SAE 5W-20 Premium Synthetic Blend Motor Oil (US) Motorcraft SAE 5W-20 Super Premium Motor Oil (Canada)	3.0L engine	6.0 quarts (5.7L)
Fuel tank capacity	N/A	All	19.0 gallons (71.9L)
Power steering fluid	Motorcraft MERCON® ATF	3.0L engine	Between MAX and MIN on reservoir

## Maintenance and Specifications

Fluid	Ford Part Name	Application	Capacity
Automatic transaxle fluid	Motorcraft Continuously Variable Chain Type Transmission Fluid <sup>3</sup>	CVT automatic transaxle	10.0 quarts (9.5L) <sup>4</sup>
Rear axle lubricant	Motorcraft SAE 80W-90 Premium Rear Axle Lubricant	AWD	1.5 pints (0.7L)
Coupler fluid	Volvo Transmission Oil, Clutch	Coupler	1.5 pints (0.7L)
Power Transfer Unit (PTU) fluid	Motorcraft Specialty Power Transfer Unit Fluid	Power Transfer Unit (PTU)	1.9 pints (0.9L)
Windshield washer fluid	Motorcraft Premium Windshield Washer Concentrate	All	135 oz. (4.0L)

<sup>1</sup>Add the coolant type originally equipped in your vehicle.

<sup>2</sup>Use of synthetic or synthetic blend motor oil is not mandatory. Engine oil need only meet the requirements of Ford specification WSS-M2C930-A and the API Certification mark.

<sup>3</sup>Using any transmission fluid other than those that meet the recommended specification may cause internal transaxle damage.

<sup>4</sup>Approximate dry fill capacity. Actual amount may vary during fluid changes.



## Maintenance and Specifications

### LUBRICANT SPECIFICATIONS

Items	Ford Part Name or equivalent	Ford Part Number	Ford Specification
Brake fluid	Motorcraft High Performance DOT 3 Motor Vehicle Brake Fluid	PM-1 or PM-1-C	ESA-M6C25-A or WSS-M6C62-A
Door latch, hood latch, auxiliary hood latch, seat tracks, trunk and liftgate latches	Multi-Purpose Grease	XG-4 or XL-5	ESA-M1C93-B
Lock cylinders	Motorcraft Penetrating and Lock Lubricant	XL-1	none
Automatic CVT transaxle	Motorcraft Continuously Variable Chain Type Transmission Fluid <sup>1</sup>	XT-7-QCFT	WSS-M2C933-A
Rear Axle (AWD)	Motorcraft SAE 80W-90 Premium Rear Axle Lubricant	XY-80W90-QL	WSP-M2C197-A
Coupler fluid	Volvo Transmission Oil, Clutch	1161641	—
Power Transfer Unit (PTU) fluid	Motorcraft Specialty Power Transfer Unit Fluid	XY-75W90-PTU	—

## Maintenance and Specifications

Items	Ford Part Name or equivalent	Ford Part Number	Ford Specification
Engine oil	Motorcraft SAE 5W-20 Premium Synthetic Blend Motor Oil (US) Motorcraft SAE 5W-20 Super Premium Motor Oil (Canada)	XO-5W20-QSP (US) CXO-5W20-LSP12 (Canada)	WSS-M2C930-A and API Certification Mark
Constant velocity joints	CV Joint Grease (High Temp.)	XG-5	WSS-M2C258-A1
Engine coolant	Motorcraft Premium Gold Engine Coolant (yellow-colored)	VC-7-A (except CA, OR and NM), VC-7-B (CA, OR and NM)	WSS -M97B51-A1
Power steering fluid	Motorcraft MERCON® ATF	XT-2-QDX	MERCON®
Windshield washer fluid	Motorcraft Premium Windshield Washer Concentrate	ZC-32-A	WSB-M8B16-A2

<sup>1</sup>Using any transaxle fluid other than those that meet the recommended specification may cause internal transaxle damage.

### ENGINE DATA

Engine	3.0L-DOHC V6 engine
Displacement	183 cubic inches
Required fuel	87 octane
Firing order	1-4-2-5-3-6
Spark plug gap	(0.052-0.056 inch) 1.32-1.42 mm
Ignition system	Coil on plug
Compression ratio	10.0:1

## Maintenance and Specifications

### VEHICLE DIMENSIONS

Vehicle dimensions	Inches (mm)
(1) Overall length	199.8 (5075)
(2) Overall width	74.4 (1891)
(3) Overall height	68.9 (1732)
(4) Wheelbase	112.9 (2867)
(5) Tread - Front	64.6 (1640)
(5) Tread - Rear	65.0 (1650)

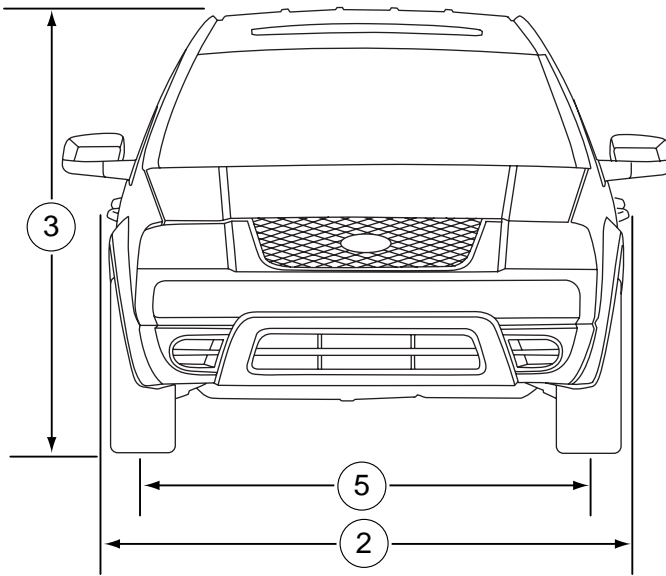

## Maintenance and Specifications

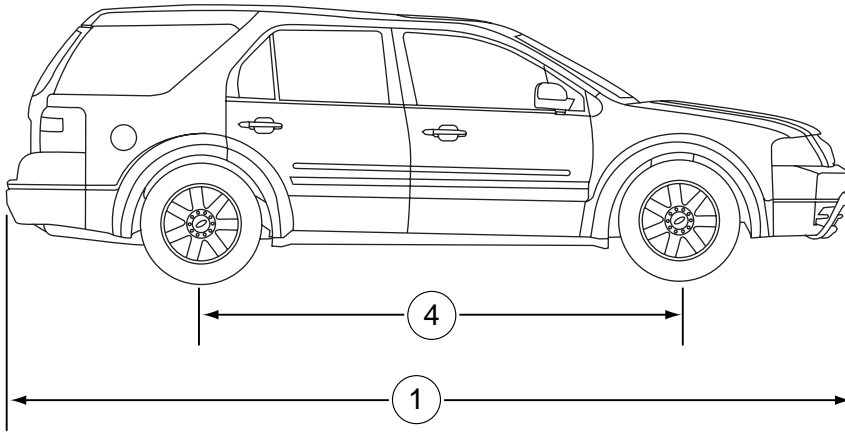

### IDENTIFYING YOUR VEHICLE

#### Safety Compliance Certification Label

The National Highway Traffic Safety Administration Regulations require that a Safety Compliance Certification Label be affixed to a vehicle and prescribe where the Safety Compliance Certification Label may be located. The Safety Compliance Certification Label is located on the structure by the trailing edge of the driver's door or the edge of the driver's door.

MFD. BY FORD MOTOR CO.					
DATE: XX/XX	GVWR: XXXXXLB/ XXXXXKG				
FRONT GAWR: XXXXL	REAR GAWR: XXXXLB				
XXXXKG	WITH	XXXXKG	WITH		
XXXX/XX/XXXXXX	TIRES	XXXX/XX/XXXXXX	TIRES		
XXXX.XX	RIMS	XXXX.XX	RIMS		
AT XXX kPa/XX	PSI COLD	AT XXX kPa/XX	PSI COLD		
THIS VEHICLE CONFORMS TO ALL APPLICABLE FEDERAL MOTOR VEHICLE SAFETY AND THEFT PREVENTION STANDARDS IN EFFECT ON THE DATE OF MANUFACTURE SHOWN ABOVE.					
VIN: XXXXXXXXXXXXXXXXX	XXXXX		XXXXX		
TYPE: XXX					
EXT PNT: XX	RC: XX	DSO: XXXXX			
WB <sup>1</sup> BRK <sup>2</sup>	INT TR <sup>3</sup>	TP/PS <sup>4</sup>	R <sup>5</sup>	AXLE <sup>6</sup>	TR <sup>7</sup> SPR <sup>8</sup>
XXX X	XX	X	XX	X XX	XXX
XXXXXXXXXXXX XXX XXXX-XXXXXX-XX					

## Maintenance and Specifications

### Vehicle identification number (VIN)

The vehicle identification number is attached to a metal tag and is located on the driver side instrument panel.

Please note that in the graphic, XXXX is representative of your vehicle identification number.

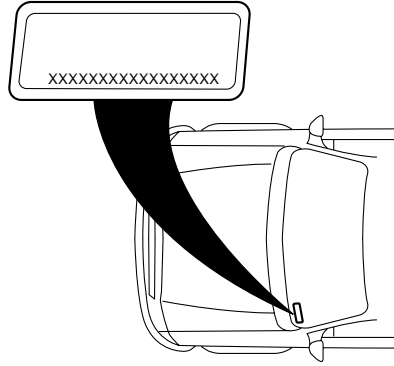

The Vehicle Identification Number (VIN) contains the following information:

1. World manufacturer identifier
2. Brake system / Gross Vehicle Weight Rating (GVWR) / Restraint System
3. Vehicle line, series, body type
4. Engine type
5. Check digit
6. Model year
7. Assembly plant
8. Production sequence number

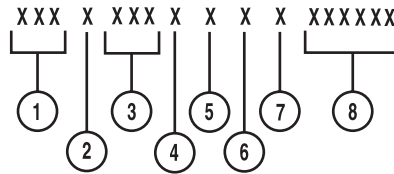

## Maintenance and Specifications

### TRANSMISSION/TRANSAXLE CODE DESIGNATIONS

You can find a transmission/transaxle code on the Safety Compliance Certification Label. The following table tells you which transmission or transaxle each code represents.

MFD. BY FORD MOTOR CO.									
DATE: XX/XX	GVWR: XXXXXLB/ XXXXXKG								
FRONT GAWR: XXXXL	WITH XXXXKG		REAR GAWR: XXXXLB						
XXXXXX	TIRES: XXXX/XXXXXX		XXXXXX		WITH TIRES				
XXXX.XX	RIMS: XXXX.XX		XXXX.XX		RIMS				
AT XXX kPa/XX	PSI COLD		AT XXX kPa/XX		PSI COLD				
THIS VEHICLE CONFORMS TO ALL APPLICABLE FEDERAL MOTOR VEHICLE SAFETY AND THEFT PREVENTION STANDARDS IN EFFECT ON THE DATE OF MANUFACTURE SHOWN ABOVE.									
VIN: XXXXXXXXXXXXXXXXX									XXXXX
TYPE: XXX									XXXXX
									
EXT PNT: XX	RC: XX		DSO:						
WB <sup>1</sup> BRK <sup>2</sup>	INT TR <sup>3</sup>	TP/PS <sup>4</sup>	R <sup>5</sup>	AXLE <sup>6</sup>	TR <sup>7</sup>	SPR <sup>8</sup>	XXXXX		
XXX X	XX	X	XX	X	X	XX	XXX		
XXXXXXXXXXXXX XX XXXX-XXXXXX-XX									

Description	Code
CVT (continuously variable transaxle)	C

## Accessories

### **GENUINE FORD ACCESSORIES FOR YOUR VEHICLE**

A wide selection of Genuine Ford Accessories are available for your vehicle through your local Ford or Ford of Canada dealer. These quality accessories have been specifically engineered to fulfill your automotive needs; they are custom designed to complement the style and aerodynamic appearance of your vehicle. In addition, each accessory is made from high quality materials and meets or exceeds Ford's rigorous engineering and safety specifications. Ford Motor Company will repair or replace any properly dealer-installed Genuine Ford Accessories found to be defective in factory-supplied materials or workmanship during the warranty period, as well as any component damaged by the defective accessory. The accessories will be warranted for whichever provides you the greatest benefit:

- 12 months or 12,000 miles (20,000 km) (whichever occurs first), or
- the remainder of your new vehicle limited warranty.

This means that Genuine Ford Accessories purchased along with your new vehicle and installed by a dealer are covered for the full length of your New Vehicle's Limited Warranty — 3 years or 36,000 miles (60,000 km) (whichever occurs first). Contact your dealer for details and a copy of the warranty.

### **Not all accessories are available for all models.**

The following is a list of several Genuine Ford Accessories. Not all accessories are available for all models. For a complete listing of the accessories that are available for your vehicle, please contact your dealer or visit our online store at: [www.fordaccessoriesstore.com](http://www.fordaccessoriesstore.com).

#### **Exterior style**

Car covers  
Deflector, hood  
Deflector, side window  
Deflector, sunroof  
Front end cover  
Flat splash guards  
Molded splash guards

## Accessories

### Interior style

Carpeted floor mats  
Electrochromic mirror w/compass  
Electrochromic mirror w/compass and homelink  
Electrochromic mirror w/compass and temperature display  
Electrochromic mirror w/compass, temperature display and homelink  
Floor mats, all weather  
Second row console

### Lifestyle

Canoe adaptor  
Cargo logic system  
Cargo net (envelope)  
Cargo net floor  
Frame mount bike rack adaptor (roof, back end)  
Fork mount bike rack adaptor w/ wheel holder  
Luggage box — hard sided (roof) 320L, 440L, 480L  
Luggage/cargo basket (roof)  
Kayak adaptor (roof)  
Roof rack raised cross bars  
Ski/snowboard carrier adaptor (roof)  
Smoker's package

### Peace of mind

Decorative wheel locks  
First aid kit  
Highway safety kit  
Keyless entry  
Locking gas cap  
Mobile-Ease<sup>™</sup> hands free communication system  
Non-decorative wheel locks  
Remote start  
Keyless entry keypad

280



## Accessories

### Security systems - vehicle perimeter protection

For maximum vehicle performance, keep the following information in mind when adding accessories or equipment to your vehicle:

- When adding accessories, equipment, passengers and luggage to your vehicle, do not exceed the total weight capacity of the vehicle or of the front or rear axle (GVWR or GAWR as indicated on the Safety Compliance Certification label). Consult your authorized dealer for specific weight information.
- The Federal Communications Commission (FCC) and Canadian Radio Telecommunications Commission (CRTC) regulate the use of mobile communications systems — such as two-way radios, telephones and theft alarms - that are equipped with radio transmitters. Any such equipment installed in your vehicle should comply with FCC or CRTC regulations and should be installed only by a qualified service technician.
- Mobile communications systems may harm the operation of your vehicle, particularly if they are not properly designed for automotive use.
- To avoid interference with other vehicle functions, such as anti-lock braking systems, amateur radio users who install radios and antennas onto their vehicle should not locate the Amateur Radio Antennas in the area of the driver's side hood.
- Electrical or electronic accessories or components that are added to the vehicle by the authorized dealer or the owner may adversely affect battery performance and durability.

## Index

### A

- Accessory delay .....68
- Air cleaner filter .....270
- Air conditioning .....42, 44, 46, 49
- Airbag supplemental restraint system .....132–133, 141, 143
  - and child safety seats .....134
  - description .....133, 141, 143
  - disposal .....146
  - driver airbag .....135, 142, 144
  - indicator light .....135, 146
  - operation .....135, 142, 144
  - passenger airbag .....135, 142, 144
  - side airbag .....141
- All Wheel Drive (AWD), driving off road .....198
- Antifreeze (see Engine coolant) .....252
- Anti-lock brake system (see Brakes) .....190
- Anti-theft system .....100, 103
  - arming the system .....103
  - disarming a triggered system .....104
  - triggering .....104
- Audio system (see Radio) ...17, 20
- Automatic transaxle
  - fluid, adding .....269
  - fluid, checking .....269
  - fluid, refill capacities .....271
  - fluid, specification .....274
- Automatic transmission
  - driving an automatic overdrive .....195
- Axle
  - lubricant specifications .....273

### B

- Battery .....250

282

- acid, treating emergencies .....250
- jumping a disabled battery ....222
- maintenance-free .....250
- replacement, specifications ...270
- servicing .....250
- BeltMinder .....127
- Brakes .....189
  - anti-lock .....190
  - anti-lock brake system (ABS)
    - warning light .....190
  - fluid, checking and adding ....269
  - fluid, refill capacities .....271
  - fluid, specifications .....273–274
  - lubricant specifications ..273–274
  - parking .....191
  - shift interlock .....193
- Bulbs .....56

### C

- Capacities for refilling fluids ....271
- Cargo cover .....89
- Cargo net .....88
- Cassette tape player .....17
- Cell phone use .....7
- Changing a tire .....214
- Child safety restraints .....147
  - child safety belts .....147
- Child safety seats .....150
  - in front seat .....151
  - in rear seat .....151
  - tether anchorage hardware ...154
- Cleaning your vehicle
  - engine compartment .....238
  - instrument panel .....239
  - interior .....240
  - interior trim .....240
  - plastic parts .....238

## Index

- washing .....236
- waxing .....237
- wheels .....237
- wiper blades .....239
- Climate control (see Air conditioning or Heating) .....42, 44, 46, 49
- Clock adjust
  - 6-CD in dash .....21
  - AM/FM/CD .....18
- Compass, electronic
  - set zone adjustment .....81
- Console .....64–65
  - overhead .....63–64
- Controls
  - power seat .....108
  - steering column .....73
- Coolant
  - checking and adding .....252
  - refill capacities .....257, 271
  - specifications .....273–274
- Cruise control (see Speed control) .....70
- Customer Assistance .....205
  - Ford Extended Service Plan .....233
  - Getting assistance outside the U.S. and Canada .....234
  - Getting roadside assistance ...205
  - Getting the service you need .....229
  - Ordering additional owner's literature .....235
  - Utilizing the Mediation/Arbitration Program .....233
- D**
  - Daytime running lamps (see Lamps) .....54
  - Dipstick
    - automatic transmission fluid .....269
    - engine oil .....247
  - Doors
    - lubricant specifications .....273
  - Driving under special conditions .....199, 202
    - sand .....200
    - snow and ice .....203
    - through water .....201, 204
- E**
  - Electronic message center .....78
  - Emergencies, roadside
    - jump-starting .....222
  - Emission control system .....266
  - Engine .....274–275
    - cleaning .....238
    - coolant .....252
    - idle speed control .....250
    - lubrication
      - specifications .....273–274
      - refill capacities .....271
      - service points .....245
      - starting after a collision .....207
  - Engine block heater .....189
  - Engine oil .....247
    - change oil soon warning, message center .....247
    - checking and adding .....247
    - dipstick .....247
    - filter, specifications .....249, 270
    - recommendations .....249
    - refill capacities .....271

## Index

- specifications .....273–274
- Exhaust fumes .....189
- F**
- Fluid capacities .....271
- Foglamps .....53
- Four-Wheel Drive vehicles
  - driving off road .....198
- Fuel .....258
  - calculating fuel economy .....80, 263
  - cap .....260
  - capacity .....271
  - choosing the right fuel .....261
  - comparisons with EPA fuel economy estimates .....266
  - detergent in fuel .....263
  - filling your vehicle with fuel .....258, 260, 263
  - filter, specifications .....258, 270
  - fuel pump shut-off switch .....207
  - improving fuel economy .....263
  - octane rating .....262, 274–275
  - quality .....262
  - running out of fuel .....263
  - safety information relating to automotive fuels .....258
- Fuel pump shut-off switch .....207
- Fuses .....207
- G**
- Gas cap (see Fuel cap) .....260
- Gas mileage (see Fuel economy) .....263
- Gauges .....14
- H**
- Hazard flashers .....206
- Head restraints .....105, 110–111
- Headlamps .....52
  - aiming .....54
  - autolamp system .....52
  - bulb specifications .....57
  - daytime running lights .....54
  - flash to pass .....53
  - high beam .....53
  - replacing bulbs .....57
  - turning on and off .....52
- Heating
  - heating and air conditioning system .....40, 42, 44, 46, 49
- Homelink wireless control system .....74
- Hood .....244
- I**
- Ignition .....186, 274–275
- Illuminated visor mirror .....63
- Infant seats (see Safety seats) .....150
- Inspection/maintenance (I/M) testing .....268
- Instrument panel .....63
  - cleaning .....239
  - cluster .....10
  - lighting up panel and interior .....54
- J**
- Jack .....214
  - positioning .....214
  - storage .....214
- Jump-starting your vehicle .....222

## Index

### K

- Keyless entry system .....97
  - autolock .....99
  - keypad .....97
  - locking and unlocking doors ....98
  - programming entry code .....97
- Keys .....101
  - positions of the ignition .....186

### L

- Lamps
  - autolamp system .....52
  - bulb replacement
    - specifications chart .....57
  - daytime running light .....54
  - fog lamps .....53
  - headlamps .....52
  - headlamps, flash to pass .....53
  - instrument panel, dimming ....54
  - interior lamps .....56
  - replacing bulbs .....57, 60
- Lane change indicator  
(see Turn signal) .....56
- Liftgate .....88
- Lights, warning and indicator ....10
  - anti-lock brakes (ABS) .....190
- Load limits .....176
- Locks
  - autolock .....99
  - childproof .....91
  - doors .....90
- Lubricant specifications ...273–274
- Lug nuts .....221
- Luggage rack .....89
- Lumbar support, seats .....107

### M

- Message center .....78–79

- english/metric button .....84
- system check button .....84
- warning messages .....84
- Mirrors .....68
  - automatic dimming rearview
    - mirror .....68
    - fold away .....69
    - heated .....69
    - side view mirrors (power) .....68
- Moon roof .....73
- Motorcraft parts .....241, 258, 270

### N

- Navigation system .....25

### O

- Octane rating .....262
- Oil (see Engine oil) .....247

### P

- Parking brake .....191
- Parts (see Motorcraft parts) ....270
- Passenger Occupant  
Classification Sensor .....120
- Power adjustable foot pedals ....69
- Power distribution box (see  
Fuses) .....211
- Power door locks .....90
- Power mirrors .....68
- Power point .....65
- Power steering .....192
  - fluid, checking and adding ....268
  - fluid, refill capacity .....271
  - fluid, specifications .....273–274
- Power Windows .....66

## Index

### R

- Radio .....17, 20
- Relays .....207
- Remote entry system .....92
  - illuminated entry .....96-97
  - locking/unlocking doors .....92-93
  - panic alarm .....93
  - replacement/additional transmitters .....95
  - replacing the batteries .....94
- Reverse sensing system .....196
- Roadside assistance .....205
- Roof rack .....89

### S

- Safety Belt Maintenance .....127
- Safety belts (see Safety restraints) .....118, 122-125
- Safety Canopy .....143
- Safety defects, reporting .....235
- Safety restraints .....118, 122-125
  - belt minder .....127
  - extension assembly .....126
  - for adults .....123-125
  - for children .....146-147
  - Occupant Classification Sensor .....120
  - safety belt maintenance .....127
  - warning light and chime .....126
- Safety seats for children .....150
- Safety Compliance Certification Label .....276
- Seat belts (see Safety restraints) .....118
- Seats .....105
  - child safety seats .....150

- front seats .....105-106, 109
- heated .....44, 46, 49
- memory seat .....93, 110
- second row seats .....111, 114
- third row seats .....114, 116-117
- SecuriLock passive anti-theft system .....100
- Servicing your vehicle .....243
- Setting the clock
  - AM/FM single CD .....18
  - AM/FM/In-dash 6 CD .....21
- Spare tire (see Changing the Tire) .....216
- Spark plugs, specifications .....270, 274-275
- Specification chart, lubricants .....273-274
- Speed control .....70
- Starting your vehicle .....186-188
  - jump starting .....222
- Steering wheel
  - controls .....73
  - tilting .....62

### T

- Tilt steering wheel .....62
- Tires .....161-162, 214
  - alignment .....168
  - care .....166
  - changing .....214, 216-217
  - checking the pressure .....166
  - inflating .....163
  - label .....175
  - replacing .....167
  - rotating .....169
  - safety practices .....168
  - sidewall information .....170
  - snow tires and chains .....175

## Index

- spare tire .....214
- terminology .....162
- tire grades .....162
- treadwear .....161, 166
- Towing .....182
  - recreational towing .....185
  - trailer towing .....182
  - wrecker .....227
- Traction control .....191
- Transaxle
  - fluid, checking and adding (automatic) .....269
  - fluid, refill capacities .....271
  - lubricant specifications .....274
- Transmission .....193
  - brake-shift interlock (BSI) ....193
  - lubricant specifications .....273
- Turn signal .....56
- V**
- Vehicle dimensions .....275
- Vehicle Identification Number (VIN) .....277
- Vehicle loading .....176
- Ventilating your vehicle .....189
- W**
- Warning lights (see Lights) .....10
- Washer fluid .....246
- Water, Driving through .....204
- Windows
  - power .....66
  - rear wiper/washer .....62
- Windshield washer fluid and wipers
  - checking and adding fluid ....246
  - operation .....61
  - replacing wiper blades .....246
- Wrecker towing .....227

