

Table of Contents

| | |
|-------------------------------------|-----------|
| Introduction | 4 |
| Instrument Cluster | 10 |
| Warning and control lights | 10 |
| Gauges | 14 |
| Entertainment Systems | 16 |
| AM/FM stereo with CD | 16 |
| AM/FM stereo cassette with CD | 19 |
| AM/FM stereo with in-dash six CD | 23 |
| AM/FM stereo with CD6/MP3 | 28 |
| Climate Controls | 33 |
| Manual heating and air conditioning | 33 |
| Lights | 35 |
| Driver Controls | 44 |
| Windshield wiper/washer control | 44 |
| Steering wheel adjustment | 45 |
| Power windows | 48 |
| Mirrors | 52 |
| Speed control | 52 |
| Locks and Security | 64 |
| Keys | 64 |
| Locks | 64 |
| Anti-theft system | 65 |

Table of Contents

| | |
|--------------------------------------|------------|
| Seating and Safety Restraints | 75 |
| Seating | 75 |
| Safety restraints | 81 |
| Air bags | 92 |
| Child restraints | 100 |
| Driving | 113 |
| Starting | 113 |
| Brakes | 117 |
| Transmission operation | 121 |
| Vehicle loading | 133 |
| Recreational towing | 143 |
| Roadside Emergencies | 145 |
| Getting roadside assistance | 145 |
| Hazard flasher switch | 146 |
| Fuel pump shut-off switch | 146 |
| Fuses and relays | 147 |
| Changing tires | 154 |
| Jump starting | 162 |
| Wrecker towing | 167 |
| Customer Assistance | 168 |
| Reporting safety defects (U.S. only) | 176 |
| Cleaning | 177 |

Table of Contents

| | |
|---------------------------------------|------------|
| Maintenance and Specifications | 183 |
| Hood | 184 |
| Engine compartment | 184 |
| Engine oil | 185 |
| Battery | 188 |
| Fuel information | 195 |
| Tire Information | 209 |
| Part numbers | 220 |
| Refill capacities | 221 |
| Lubricant specifications | 223 |
| Accessories | 230 |
| Index | 233 |

All rights reserved. Reproduction by any means, electronic or mechanical including photocopying, recording or by any information storage and retrieval system or translation in whole or part is not permitted without written authorization from Ford Motor Company. Ford may change the contents without notice and without incurring obligation.

Copyright © 2004 Ford Motor Company

Introduction

CALIFORNIA Proposition 65 Warning



WARNING: Engine exhaust, some of its constituents, and certain vehicle components contain or emit chemicals known to the State of California to cause cancer and birth defects or other reproductive harm. In addition, certain fluids contained in vehicles and certain products of component wear contain or emit chemicals known to the State of California to cause cancer and birth defects or other reproductive harm.

CONGRATULATIONS

Congratulations on acquiring your new Ford. Please take the time to get well acquainted with your vehicle by reading this handbook. The more you know and understand about your vehicle, the greater the safety and pleasure you will derive from driving it.

For more information on Ford Motor Company and its products visit the following website:

- In the United States: www.ford.com
- In Canada: www.ford.ca
- In Australia: www.ford.com.au
- In Mexico: www.ford.com.mx

Additional owner information is given in separate publications.

This *Owner's Guide* describes every option and model variant available and therefore some of the items covered may not apply to your particular vehicle. Furthermore, due to printing cycles it may describe options before they are generally available.

Remember to pass on this *Owner's Guide* when reselling the vehicle. It is an integral part of the vehicle.



Fuel pump shut-off switch: In the event of an accident the safety switch will automatically cut off the fuel supply to the engine. The switch can also be activated through sudden vibration (e.g. collision when parking). To reset the switch, refer to the *Fuel pump shut-off switch* in the *Roadside Emergencies* chapter.

SAFETY AND ENVIRONMENT PROTECTION



Warning symbols in this guide

How can you reduce the risk of personal injury to yourself or others? In this guide, answers to such questions are contained in comments highlighted by the warning triangle symbol. These comments should be read and observed.

Introduction

Warning symbols on your vehicle

When you see this symbol, it is imperative that you consult the relevant section of this guide before touching or attempting adjustment of any kind.



Protecting the environment

We must all play our part in protecting the environment. Correct vehicle usage and the authorized disposal of waste, cleaning and lubrication materials are significant steps towards this aim. Information in this respect is highlighted in this guide with the tree symbol.



BREAKING-IN YOUR VEHICLE

Your vehicle does not need an extensive break-in. Try not to drive continuously at the same speed for the first 1,000 miles (1,600 km) of new vehicle operation. Vary your speed frequently in order to give the moving parts a chance to break in.

Drive your new vehicle at least 500 miles (800 km) before towing a trailer.

Do not add friction modifier compounds or special break-in oils during the first few thousand miles (kilometers) of operation, since these additives may prevent piston ring seating. See *Engine oil* in the *Maintenance and Specifications* chapter for more information on oil usage.

SPECIAL NOTICES

Emission warranty

The New Vehicle Limited Warranty includes Bumper-to-Bumper Coverage, Safety Restraint Coverage, Corrosion Coverage, and 6.0L Power Stroke Diesel Engine Coverage. In addition, your vehicle is eligible for Emissions Defect and Emissions Performance Warranties. For a detailed description of what is covered and what is not covered, refer to the *Warranty Guide* that is provided to you along with your Owner's Guide.

Special instructions

For your added safety, your vehicle is fitted with sophisticated electronic controls.

Introduction



Please read the section *Supplemental restraint system (SRS)* in the *Seating and Safety Restraints* chapter. Failure to follow the specific warnings and instructions could result in personal injury.



Front seat mounted rear-facing child or infant seats should **NEVER** be placed in front of an active passenger air bag.

Service Data Recording

Service data recorders in your vehicle are capable of collecting and storing diagnostic information about your vehicle. This potentially includes information about the performance or status of various systems and modules in the vehicle, such as engine, throttle, steering or brake systems. In order to properly diagnose and service your vehicle, Ford Motor Company, Ford of Canada, and service and repair facilities may access vehicle diagnostic information through a direct connection to your vehicle when diagnosing or servicing your vehicle.

Event Data Recording

Other modules in your vehicle — event data recorders — are capable of collecting and storing data during a crash or near crash event. The recorded information may assist in the investigation of such an event. The modules may record information about both the vehicle and the occupants, potentially including information such as:

- how various systems in your vehicle were operating;
- whether or not the driver and passenger seatbelts were buckled;
- how far (if at all) the driver was depressing the accelerator and/or the brake pedal;
- how fast the vehicle was traveling; and
- where the driver was positioning the steering wheel.

To access this information, special equipment must be directly connected to the recording modules. Ford Motor Company and Ford of Canada do not access event data recorder information without obtaining consent, unless pursuant to court order or where required by law enforcement, other government authorities or other third parties acting with lawful authority. Other parties may seek to access the information independently of Ford Motor Company and Ford of Canada.

Introduction

Notice to owners of pickup trucks and utility type vehicles



Utility vehicles have a significantly higher rollover rate than other types of vehicles.

Before you drive your vehicle, please read this Owner's Guide carefully. Your vehicle is not a passenger car. As with other vehicles of this type, failure to operate this vehicle correctly may result in loss of vehicle control, vehicle rollover, personal injury or death.

Be sure to read *Driving off road* in the *Driving* chapter.

MIDDLE EAST/NORTH AFRICA VEHICLE SPECIFIC INFORMATION

For your particular global region, your vehicle may be equipped with features and options that are different from the ones that are described in this *Owner's Guide*; therefore, a supplement has been supplied that complements this book. By referring to the pages in the provided supplement, you can properly identify those features, recommendations and specifications that are unique to your vehicle. **Refer to this Owner's Guide for all other required information and warnings.**

Introduction





These are some of the symbols you may see on your vehicle.

Vehicle Symbol Glossary

| | | | |
|---------------------------------|---|-----------------------------------|--|
| Safety Alert |  | See Owner's Guide |  |
| Fasten Safety Belt |  | Air Bag-Front |  |
| Air Bag-Side |  | Child Seat |  |
| Child Seat Installation Warning |  | Child Seat Lower Anchor |  |
| Child Seat Tether Anchor |  | Brake System |  |
| Anti-Lock Brake System |  | Brake Fluid - Non-Petroleum Based |  |
| Traction Control |  | AdvanceTrac [™] |  |
| Master Lighting Switch |  | Hazard Warning Flasher |  |
| Fog Lamps-Front |  | Fuse Compartment |  |
| Fuel Pump Reset |  | Windshield Wash/Wipe |  |
| Windshield Defrost/Demist |  | Rear Window Defrost/Demist |  |

Introduction

Vehicle Symbol Glossary

| | | | |
|-------------------------------------|---|---|--|
| Power Windows Front/Rear |  | Power Window Lockout |  |
| Child Safety Door Lock/Unlock |  | Interior Luggage Compartment Release Symbol |  |
| Panic Alarm |  | Engine Oil |  |
| Engine Coolant |  | Engine Coolant Temperature |  |
| Do Not Open When Hot |  | Battery |  |
| Avoid Smoking, Flames, or Sparks |  | Battery Acid |  |
| Explosive Gas |  | Fan Warning |  |
| Power Steering Fluid |  | Maintain Correct Fluid Level |  |
| Emission System |  | Engine Air Filter |  |
| Passenger Compartment Air Filter |  | Jack |  |
| Check fuel cap |  | Low tire warning |  |

Instrument Cluster

WARNING LIGHTS AND CHIMES

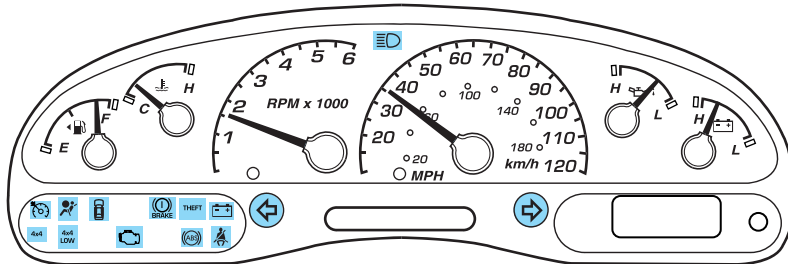

Warning lights and gauges can alert you to a vehicle condition that may become serious enough to cause expensive repairs. A warning light may illuminate when a problem exists with one of your vehicle's functions. Many lights will illuminate when you start your vehicle to make sure the bulb works. If any light remains on after starting the vehicle, have the respective system inspected immediately.

Check engine: The *Check Engine* indicator light illuminates when the ignition is first turned to the ON position to check the bulb. Solid



illumination after the engine is started indicates the On Board Diagnostics System (OBD-II) has detected a malfunction. Refer to *On board diagnostics (OBD-II)* in the *Maintenance and Specifications* chapter. If the light is blinking, engine misfire is occurring which could damage your catalytic converter. Drive in a moderate fashion (avoid heavy acceleration and deceleration) and have your vehicle serviced immediately.



Under engine misfire conditions, excessive exhaust temperatures could damage the catalytic converter, the fuel system, interior floor coverings or other vehicle components, possibly causing a fire.

Instrument Cluster

Brake system warning light: To confirm the brake system warning light is functional, it will momentarily illuminate when the ignition is turned to the ON position when the engine is not running, or in a position between ON and START, or by applying the parking brake when the ignition is turned to the ON position. If the brake system warning light does not illuminate at this time, seek service immediately from your dealership. Illumination after releasing the parking brake indicates low brake fluid level and the brake system should be inspected immediately by your servicing dealership.



 Driving a vehicle with the brake system warning light on is dangerous. A significant decrease in braking performance may occur. It will take you longer to stop the vehicle. Have the vehicle checked by your dealer immediately.

Anti-lock brake system: If the ABS light stays illuminated or continues to flash, a malfunction has been detected, have the system serviced immediately. Normal braking is still functional unless the brake warning light also is illuminated.

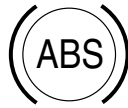

Air bag readiness: If this light fails to illuminate when ignition is turned to ON, continues to flash or remains on, have the system serviced immediately. A chime will also sound when a malfunction in the supplemental restraint system has been detected.



Safety belt: Reminds you to fasten your safety belt. A chime will also sound to remind you to fasten your safety belt.



Charging system: Illuminates when the battery is not charging properly.



Instrument Cluster

Door ajar: Illuminates when the ignition is in the ON position and any door is open.



Four wheel drive low (if equipped): Illuminates when four-wheel drive low is engaged.

4x4
LOW

Four wheel drive high (if equipped): Illuminates when four-wheel drive high is engaged.

4x4

Anti-theft system: Flashes when the SecurilockSM Passive Anti-theft System has been activated.

THEFT

Speed control (if equipped): Illuminates when the speed control is activated. Turns off when the speed control system is deactivated.



Turn signal: Illuminates when the left or right turn signal or the hazard lights are turned on. If the indicators stay on or flash faster, check for a burned out bulb.



High beams: Illuminates when the high beam headlamps are turned on.



DIGITAL DISPLAY WARNINGS

Overdrive off: Displays when the overdrive function of the transmission has been turned off, refer to the *Driving* chapter. If the display stays on, have the transmission serviced soon, or damage may occur. Press the Trip Odometer reset button to display Odometer or Trip Odometer.



Instrument Cluster

Check fuel cap: Displays when the fuel cap may not be properly installed. Continued driving with this display on may cause the Check Engine warning light to come on.

Refer to *Fuel filler cap* in the *Maintenance and Specifications* chapter. Press the Trip Odometer reset button to display Odometer or Trip Odometer.

A rectangular display box with a black border containing the text "CHECK" on the top line and "FUELCAP" on the bottom line in a bold, sans-serif font.

Check gauge: Displays when any of the following conditions has occurred:

- The engine coolant temperature is high.
- The engine oil pressure is low.

Press the Trip Odometer reset button to display Odometer or Trip Odometer.

A rectangular display box with a black border containing the text "CHECK" on the top line and "GAUGES" on the bottom line in a bold, sans-serif font.

Low fuel: Displays when the fuel level in the fuel tank is at or near empty (refer to *Fuel gauge* in this chapter). Press the Trip Odometer reset button to display Odometer or Trip Odometer.

A rectangular display box with a black border containing the text "LOW" on the top line and "FUEL" on the bottom line in a bold, sans-serif font.

Key-in-ignition warning chime: Sounds when the key is left in the ignition in the OFF/LOCK or ACCESSORY position and the driver's door is opened.

Headlamps on warning chime: Sounds when the headlamps or parking lamps are on, the ignition is off (the key is not in the ignition) and the driver's door is opened.

Instrument Cluster

GAUGES

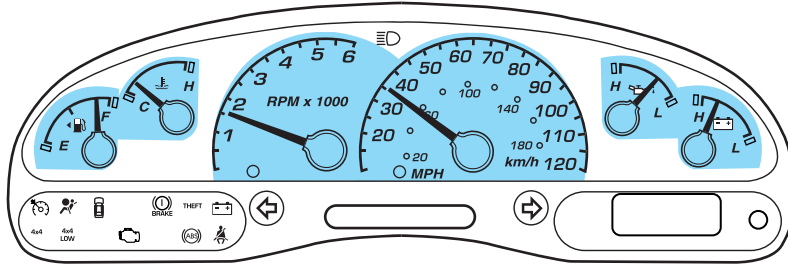

Speedometer: Indicates the current vehicle speed.

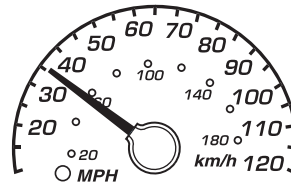

Engine coolant temperature gauge: Indicates engine coolant temperature. At normal operating temperature, the needle will be in the normal range (between “H” and “C”). If it enters the red section, the engine is overheating. Stop the vehicle as soon as safely possible, switch off the engine and let the engine cool.

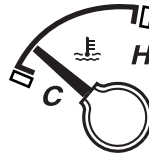

Never remove the coolant reservoir cap while the engine is running or hot.

Odometer: Registers the total miles (kilometers) of the vehicle.



Instrument Cluster

Trip odometer: Registers the miles (kilometers) of individual journeys. To reset, depress and hold the control.



Tachometer: Indicates the engine speed in revolutions per minute. Driving with your tachometer pointer continuously at the top of the scale may damage the engine.

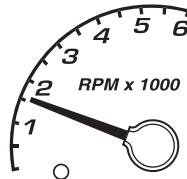

Battery voltage gauge: Indicates the battery voltage when the ignition is in the ON position. If the pointer moves and stays outside the normal operating range (as indicated by arrows), have the vehicle's electrical system checked as soon as possible.

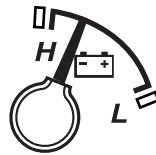

Engine oil pressure gauge: Indicates engine oil pressure. The needle should stay in the normal operating range (between "L" and "H"). If the needle falls below the normal range, stop the vehicle, turn off the engine and check the engine oil level. Add oil if needed. If the oil level is correct, have your vehicle checked at your dealership or by a qualified technician.

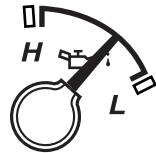

Fuel gauge: Indicates approximately how much fuel is left in the fuel tank (when the ignition is in the ON position). The fuel gauge may vary slightly when the vehicle is in motion or on a grade.



The FUEL icon and arrow indicates which side of the vehicle the fuel filler door is located.

Refer to *Filling the tank* in the *Maintenance and Specifications* chapter for more information.

Entertainment Systems

AM/FM STEREO / SINGLE CD RADIO (IF EQUIPPED)

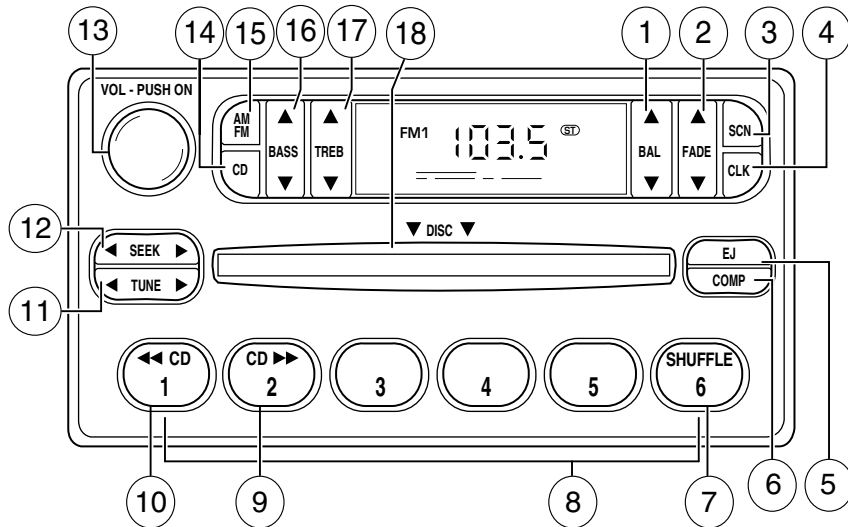

1. **Balance:** Press ▲ / ▼ to shift sound to the left/right speakers.



2. **Fade:** Press ▲ / ▼ to shift sound to the front/rear speakers.



3. **SCN (Scan):** Press to hear a brief sampling of all listenable stations or CD tracks. Press again to stop.



4. **CLK:** To set the hour, press and hold CLK and press SEEK to decrease ◀ or increase ▶ the hours.



Entertainment Systems

To set the minute, press and hold CLK and press TUNE to decrease ◀ or increase ▶ the minutes.

5. **EJ (eject):** Press to eject a CD.



6. **COMP (Compression):** In CD mode, press to bring louder and softer levels into more comfortable listening level. The compression icon (c) will appear in the display.



7. **Shuffle:** Press to listen to the tracks on the CD in random order. Press again to turn off.



8. **Memory presets:** To set a station: Select frequency band AM/FM; tune to a station. Press and hold a preset button until sound returns. This radio is equipped with six station memory preset controls which allow you to set up to six AM stations and 12 FM stations (six in FM1 and six in FM2).



9. **CD: ▶▶** Press and hold until desired point of a selection is reached.



10. **◀◀ CD:** Press and hold until desired point of a selection is reached.



11. **Tune:** In radio mode, press to move up or down the frequency band in individual increments.



12. **Seek:** Press and release SEEK ◀ / ▶ for previous/next strong station, selection or track.



13. **Power/volume:** Press to turn ON/OFF; turn to increase or decrease volume levels.

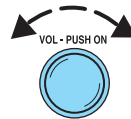

Entertainment Systems

14. **CD:** Press to enter CD mode or to play a CD already loaded into the system.



15. **AM/FM:** Press to choose a frequency band in radio mode.



16. **Bass:** Press ▲ / ▼ to increase/decrease the bass output.



17. **Treble:** Press ▲ / ▼ to increase/decrease the treble output.



18. **CD slot:** Insert a CD printed side up.

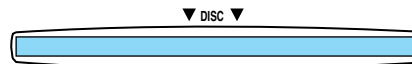

CD units are designed to play commercially pressed 4.75 in (12 cm) audio compact discs only. Due to technical incompatibility, certain recordable and re-recordable compact discs may not function correctly when used in Ford CD players. Irregular shaped CDs, CDs with a scratch protection film attached, and CDs with homemade paper (adhesive) labels should not be inserted into the CD player. The label may peel and cause the CD to become jammed. It is recommended that homemade CDs be identified with permanent felt tip marker rather than adhesive labels. Ballpoint pens may damage CDs. Please contact your dealer for further information.

Entertainment Systems

PREMIUM AM/FM STEREO/CASSETTE/SINGLE CD (IF EQUIPPED)

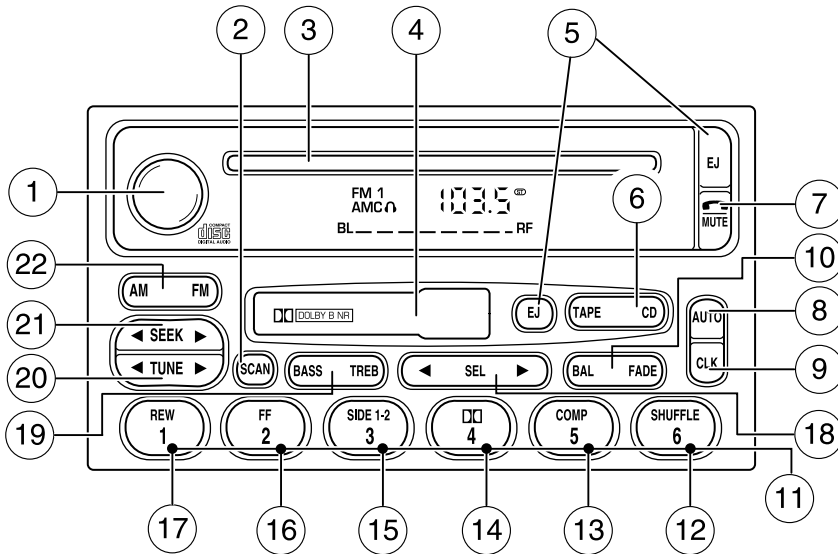

1. **Power/volume:** Press to turn ON/OFF; turn to increase/decrease volume.

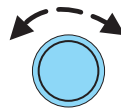

2. **Scan:** Press to hear a brief sampling of all listenable stations, tape selections or CD tracks. Press again to stop.



3. **CD slot:** Insert a CD with the label side up.

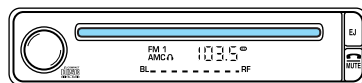

CD units are designed to play commercially pressed 4.75 in (12 cm) audio compact discs only. Due to technical incompatibility, certain recordable and re-recordable compact discs may not function correctly when used in Ford CD players. Irregular shaped CDs, CDs with a scratch protection film attached, and CDs with homemade paper (adhesive) labels should not be inserted

Entertainment Systems

into the CD player. The label may peel and cause the CD to become jammed. It is recommended that homemade CDs be identified with permanent felt tip marker rather than adhesive labels. Ballpoint pens may damage CDs. Please contact your dealer for further information.

4. **Cassette door:** Insert the cassette with the opening to the right.

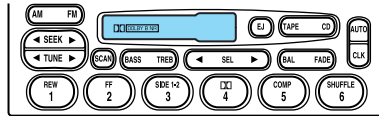

5. **Eject:** Press to eject the cassette/CD. The radio will resume playing.

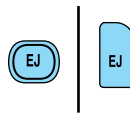

6. **Tape:** Press to start tape play. Press to stop tape during rewind/fast forward.



CD: Press to start CD play. With the dual media audio, press CD to toggle between single CD and CD changer play (if equipped).



7. **Mute:** Press to MUTE playing media; press again to return to the playing media.



8. **Auto:** Press to set first six strongest stations (if available) into AM, FM1 or FM2 memory buttons; press again to return to normal stations.



9. **Clock:** Press to toggle between station mode and clock mode. Press and hold to set the clock. Press the ◀ SEEK to decrease hours or SEEK ▶ to increase hours. Press



Entertainment Systems

the ◀ TUNE to decrease minutes or TUNE ▶ to increase minutes. If your vehicle has a stand alone clock this control will not function.

10. **Balance:** Press BAL; then press SEL ◀ / ▶ to shift sound to the left/right speakers.

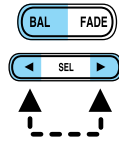

Fade: Press FADE; then press SEL ◀ / ▶ to shift sound to the rear/front speakers.

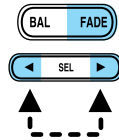

11. **Memory preset buttons:** To set a station: Select frequency band AM/FM, tune to a station, press and hold a preset button until sound returns.

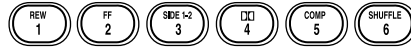

12. **Shuffle (CD):** Press to play tracks in random order. Press again to disable.



13. **Compression (CD):** Press to bring soft and loud passages together for a more consistent listening level. A small “c” will appear in the display to indicate that compression is enabled. Press again to disable.



14. **Dolby® noise reduction:** Works in tape mode only. Reduces tape noise and hiss; press to activate/deactivate.



The Dolby® noise reduction system is manufactured under license from Dolby Laboratories Licensing Corporation. Dolby® and the double-D symbol are registered trademarks of Dolby Laboratories Licensing Corporation.

Entertainment Systems

15. **Side 1-2:** Works in tape mode only. Press to play reverse side of the tape.



16. **Fast Forward (FF):** In CD mode, press for a slow advance, press and hold for a fast advance. In TAPE mode, press FF to enable Fast Forward feature. Press FF or TAPE to resume tape play.



17. **Rewind (REW):** In CD mode, press for a slow reverse, press and hold for a fast reverse. In TAPE mode, press REW to enable the rewind feature. Press REW or TAPE to resume tape play.



18. **Select (SEL):** Use with Bass, Treble, Balance and Fade controls.



19. **Bass:** Press BASS; then press SEL ◀/▶ to decrease/increase the bass output.

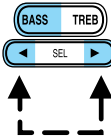

Treble: Press TREB; then press SEL ◀/▶ to decrease/increase the treble output.

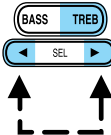

20. **Tune:** Works in radio mode only. Press TUNE ◀/▶ to change frequency down/up.

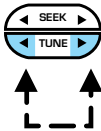

Entertainment Systems

21. **Seek:** Press and release SEEK ◀ / ▶ for previous/next strong station, selection or track.

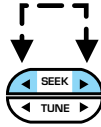

22. **AM/FM:** Press to select AM/FM1/FM2 frequency band.



AUDIOPHILE SATELLITE READY AM/FM STEREO IN-DASH SIX CD RADIO (IF EQUIPPED)

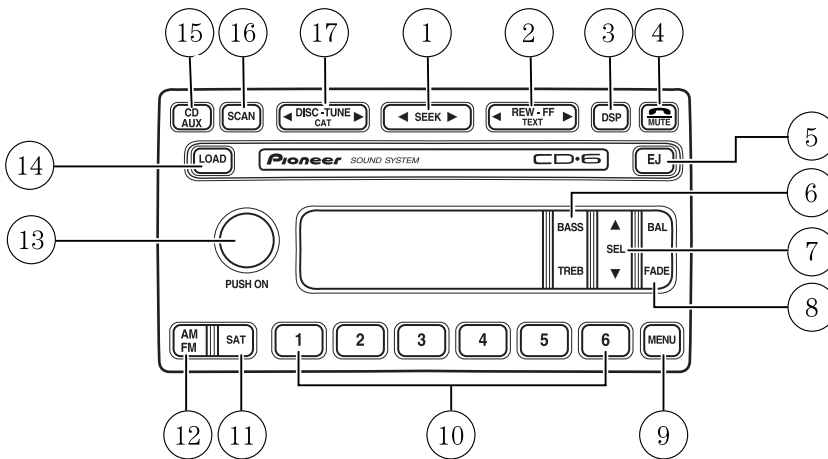

1. **Seek:** Press and release SEEK ◀ / ▶ for previous/next strong station or track.



2. **Rewind:** In CD mode, press until the desired point on the current selection is reached.



Fast forward: In CD mode, press until the desired point on the current selection is reached.

TEXT: TEXT is only available when equipped with Satellite radio. Your Audiophile radio comes equipped with Satellite ready capability. The kit to enable Satellite reception is available through your Ford dealer.

Entertainment Systems

Detailed Satellite instructions are included with the dealer installed kit. *Dealer installed satellite kit only available in the continental United States.*

3. DSP (Digital Signal

Processing): Press DSP to access the Ambiance menu. Ambiance gives the feeling of “being there” to your music, creating increased clarity as well as an open and spacious feel to the music. Press SEL to engage/disengage. Turn the volume control to increase/decrease the level of ambiance.

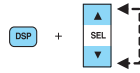

Occupancy: Press DSP again to change the occupancy mode to optimize sound for ALL SEATS, DRIVERS SEAT or REAR SEATS. Press SEL to scroll through settings.

4. **Mute:** Press to MUTE playing media; press again to return to playing media



5. **Eject:** Press to eject a CD. Press EJ and a memory preset to eject a specific disc. Press and hold to eject all loaded discs.



6. **Bass:** Press BASS; then press SEL ▼ / ▲ to decrease/increase the bass output.

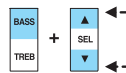

Treble: Press TREB; then press SEL ▼ / ▲ to decrease/increase the treble output.



7. **Select:** Use with Bass, Treble, Balance, Fade and other menu selections.



8. **Balance:** Press BAL; then press SEL ▼ / ▲ to shift sound to the left/right speakers.

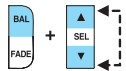

Fade: Press FADE; then press SEL ▼ / ▲ to shift sound to the rear/front speakers.

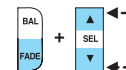

Entertainment Systems

9. **Menu:** Press MENU to access clock mode, RDS on/off, Traffic announcement mode, Program type mode, and Shuffle mode.

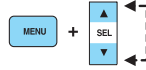

The Federal Communications Commission (FCC) and the Canadian Radio and Telecommunications Commission (CRTC) recommend that FM radio broadcasters use RDS technology to transmit information. FM radio stations are independently operated and individually elect to use RDS technology to transmit station ID and program type as desired.

Traffic: Allows you to hear traffic broadcasts. With the feature ON, press SEEK or SCAN to find a station broadcasting a traffic report (if it is broadcasting RDS data). *Traffic information is not available in most U.S. markets.*

FIND Program type: Allows you to search RDS-equipped stations for a certain category of music format: Classic, Country, Info, Jazz, Oldies, R&B, Religious, Rock, Soft, Top 40. Press MENU until FIND appears in the display. Use SEL to scroll through music types. Press SEEK or SCAN to search for a station playing the requested music category.

Show TYPE: Displays the station's call letters and format. Press MENU until SHOW appears on display. Use SEL to select NONE, NAME or TYPE.

Shuffle: Press to play tracks in a random order. Press MENU until SHUFFLE appears in the display. Use SEL to select SHUFFLE DISC, SHUFFLE TRAC or SHUFFLE OFF.

Compression: Brings soft and loud CD passages together for a more consistent listening level. Press MENU until COMPRESS is displayed. Press the SEL control to enable the compression feature when COMPRESS OFF is displayed. Press the SEL control again to disable the feature when COMPRESS ON is displayed.

Setting the clock: Press MENU until SELECT HOUR or SELECT MINS is displayed. Use SEL to manually increase (▲) or decrease (▼) the hours/minutes. Press MENU again to disengage clock mode.

Entertainment Systems

10. **Memory presets:** To set a station: Select frequency band AM/FM; tune to a station, press and hold a preset button until sound returns.



11. **SAT (if equipped):** Your Audiophile radio comes equipped with Satellite Ready capability. The kit to enable the Satellite reception is available through your Ford dealer. Detailed satellite instructions are included with the dealer installed kit. *Dealer installed satellite kit only available in the continental United States.*



12. **AM/FM:** Press to select AM/FM frequency band.



Autoset: Allows you to set the strongest local radio stations without losing your original manually set preset stations for AM/FM1/FM2 . Press and momentarily hold AM/FM. AUTOSET will be shown. When the six strongest stations are filled, the station stored in preset 1 will begin playing. If there are less than six strong stations, the system will store the last one in the remaining presets. Press and hold again to disengage.

13. **Power/volume:** Press to turn ON/OFF; turn to increase or decrease volume levels.

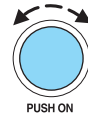

14. **Load:** Press to load a CD. Press LOAD and a memory preset to load to a specific slot. Press and hold to load up to six discs.



15. **CD AUX:** Press to access CD or AUX mode.



CD units are designed to play commercially pressed 4.75 in (12 cm) audio compact discs only. Due to technical incompatibility, certain recordable and re-recordable compact discs may not function correctly when used in Ford CD players. Irregular shaped CDs, CDs with a scratch protection film attached, and CDs with homemade paper (adhesive) labels should not be inserted into the CD player. The label may peel and cause the CD to

Entertainment Systems

become jammed. It is recommended that homemade CDs be identified with permanent felt tip marker rather than adhesive labels. Ballpoint pens may damage CDs. Please contact your dealer for further information.

16. **Scan:** Press SCAN to hear a brief sampling of radio stations or CD tracks. Press again to stop.



17. **Disc/Tune:** Press ◀ or ▶ to manually tune down/up the radio frequency band.



CAT: CAT is only available when equipped with Satellite Radio. Your Audiophile radio comes equipped with Satellite ready capability. The kit to enable Satellite reception is available through your Ford dealer. Detailed Satellite instructions are included with the dealer installed kit. *Dealer installed satellite kit only available in the continental United States.*

For information regarding SIRIUS Satellite Radio, please call toll-free 888-539-SIRIUS (888-539-7474) or visit the SIRIUS website at www.siriusradio.com

Entertainment Systems

ADRENALIN CD/MP3 AUDIO SYSTEM — (IF EQUIPPED)

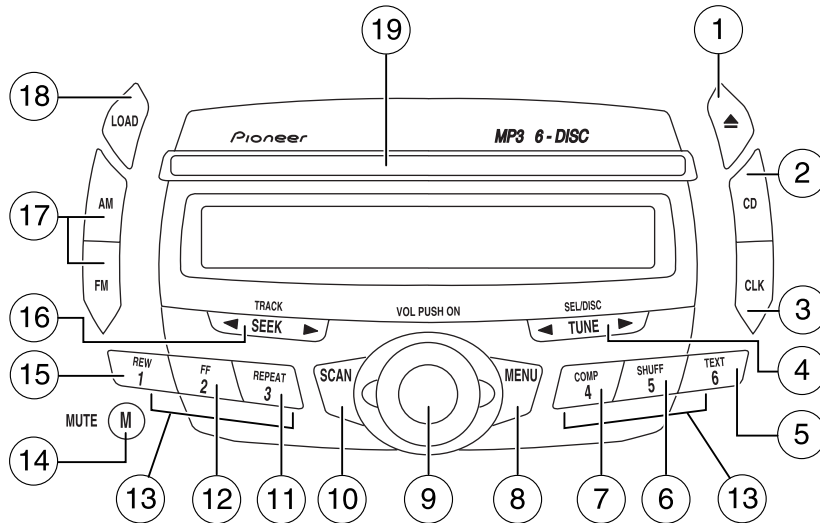

1. **EJ (Eject):** Press to eject a CD. Press EJECT and a memory preset to eject a specific disc. Press and hold to eject all loaded discs.

2. **CD:** Press to enter CD mode. If there is no disc in the system, insert a CD label side up. If a CD is already inserted, press CD to begin CD play.

3. **CLK (Clock):** Press CLK until SELECT HOUR /SELECT MINUTE is displayed. Press TUNE to decrease ◀ or increase ▶ the hours/minutes.

4. **TUNE:** Press to manually go up or down the radio frequency, or to access another CD. Also use in menu mode to select various settings.



Entertainment Systems

5. **TEXT:** In MP3 track title/file name mode, press to view the next 12 characters in the MP3 music name/file name of the current MP3 track and directory.

6. **SHUF (Shuffle):** Press to play the tracks on the current CD/MP3 in random order. In MP3 directory mode, press to play the tracks within the current directory in random order.



7. **COMP (Compression):** In CD/MP3 modes, press to bring soft and loud passages together for a more consistent listening level.



8. **MENU:** Press TUNE to toggle through the following modes and ◀ TUNE ▶ to make adjustments in these modes.



Autoset: Allows you to set the strongest local radio stations without losing your original manually set preset stations for AM/FM1/FM2. Press MENU to access, use ◀ MENU ▶ to set. When the six strongest stations are filled, the station stored in preset 1 will begin playing. If there are less than six strong stations, the system will store the last one in the remaining presets. Press again to disengage.

BASS: Press ◀ TUNE ▶ to decrease/increase the bass levels.

TREB (treble): Press ◀ TUNE ▶ to decrease/increase the treble levels.

BAL (Balance): Press ◀ TUNE ▶ to adjust the audio between the left and right speakers.

FADE: Press ◀ TUNE ▶ to adjust the audio between the front and rear speakers.

Flat file/directory mode: Press ◀ TUNE ▶ to select Flat file mode or Directory mode.

Normal/Track Title/File Name: In directory mode, press MENU until DIR NO XXX appears in the display. Press ◀ TUNE ▶ to access the previous/next directory.

Entertainment Systems

9. **ON/OFF/VOL (Volume):** Press to turn the system ON/OFF. Turn to adjust the volume levels.

If the volume is set above a certain level and the ignition is turned off, the volume will come back on at a “nominal” listening level when the ignition is turned back on.

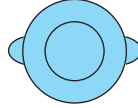

10. **SCAN:** In radio, CD and MP3 flat file mode, press for a brief sampling of radio stations or CD/MP3 tracks. In MP3 directory mode, press to hear a brief sampling of all tracks in the current directory. Press again to stop.



11. **REPEAT:** Press to repeat the current CD/MP3 track.



12. **FF (fast forward):** Press to manually advance in a CD track.



13. **Memory presets:** To set a station: Select frequency band AM/FM; tune to a station, press and hold a preset button until sound returns. To select a preset station, press the desired memory preset button.



14. **MUTE:** Press to mute the playing media. Press again to return to the playing media.



15. **REW (rewind):** Press to manually reverse a CD track.



16. **SEEK:** In radio, CD and MP3 flat file mode, press ► / ◀ to access the next/previous strong station or track. In MP3 directory mode, press to select the next/previous track in the current directory.



Entertainment Systems

17. **AM/FM:** Press to select AM/FM frequency band.

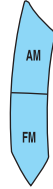

18. **LOAD:** Press to load a CD/MP3 disc. Press LOAD and a memory preset to load a specific slot. Press and hold to autoload up to six discs.



19. **CD slot:** Insert a CD, label side up.

RADIO FREQUENCIES

AM and FM frequencies are established by the Federal Communications Commission (FCC) and the Canadian Radio and Telecommunications Commission (CRTC). Those frequencies are:

AM - 530, 540–1700, 1710 kHz

FM- 87.7, 87.9–107.7, 107.9 MHz

RADIO RECEPTION FACTORS

There are three factors that can affect radio reception:

- Distance/strength: The further you travel from an FM station, the weaker the signal and the weaker the reception.
- Terrain: Hills, mountains, tall buildings, power lines, electric fences, traffic lights and thunderstorms can interfere with your reception.
- Station overload: When you pass a broadcast tower, a stronger signal may overtake a weaker one and play while the weak station frequency is displayed.

CASSETTE/PLAYER CARE

Do:

- Use only cassettes that are 90 minutes long or less.
- Tighten very loose tapes by inserting a finger or pencil into the hole and turning the hub.
- Remove loose labels before inserting tapes.
- Allow tapes which have been subjected to extreme heat, humidity or cold to reach a moderate temperature before playing.

Entertainment Systems

- Clean the cassette player head with a cassette cleaning cartridge after 10–12 hours of play to maintain good sound/operation.

Don't:

- Expose tapes to direct sunlight, extreme humidity, heat or cold.
- Leave tapes in the cassette player for a long time when not being played.

CD/CD PLAYER CARE

Do:

- Handle discs by their edges only. Never touch the playing surface.
- Inspect discs before playing. Clean only with an approved CD cleaner and wipe from the center out.

Don't:

- Expose discs to direct sunlight or heat sources for extended periods of time.
- Insert more than one disc into each slot of the CD changer magazine.
- Clean using a circular motion.

CD units are designed to play commercially pressed 12 cm (4.75 in) audio compact discs only. Due to technical incompatibility, certain recordable and re-recordable compact discs may not function correctly when used in Ford CD players. Irregular shaped CDs, CDs with a scratch protection film attached, and CDs with homemade paper (adhesive) labels should not be inserted into the CD player. The label may peel and cause the CD to become jammed. It is recommended that homemade CDs be identified with permanent felt tip marker rather than adhesive labels. Ball point pens may damage CDs. Please contact your dealer for further information.

AUDIO SYSTEM WARRANTY AND SERVICE

Refer to the *Warranty Guide* for audio system warranty information. If service is necessary, see your dealer or qualified technician.

Climate Controls

MANUAL HEATING AND AIR CONDITIONING SYSTEM

1. **Fan speed adjustment:** Controls the volume of air circulated in the vehicle.

2. **Temperature selection:** Controls the temperature of the airflow in the vehicle.

3. **Air flow selections:** Controls the direction of the airflow in the vehicle. See the following for a brief description on each control.

MAX A/C: Uses recirculated air to cool the vehicle. Air flows from the instrument panel vents only. Temperature of airflow not adjustable.

A/C : Uses outside air to cool the vehicle. Air flows from the instrument panel vents only.

 : Distributes outside air through the instrument panel vents.

O (OFF): Outside air is shut out and the fan will not operate.

 : Distributes outside air through the instrument panel vents and the floor vents.

 : Distributes outside air through the floor vents.

 : Distributes outside air through the windshield defroster vents and floor vents.

 : Distributes outside air through the windshield defroster vents.

Operating tips

- To reduce fog build up on the windshield during humid weather, place the air flow selector in the  position.
- To reduce humidity build up inside the vehicle: do not drive with the air flow selector in the OFF or MAX A/C position.
- Under normal weather conditions, do not leave the air flow selector in MAX A/C or OFF when the vehicle is parked. This allows the vehicle to “breathe” using the outside air inlet vents.
- Do not put objects under the front seats that will interfere with the airflow to the back seats.
- Remove any snow, ice or leaves from the air intake area at the base of the windshield.

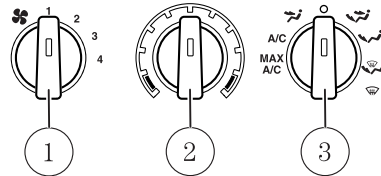

Climate Controls

To aid in side window defogging/demisting in cold weather:

1. Select .
2. Select A/C.
3. Modulate the temperature control to maintain comfort.
4. Set the highest fan speed.
5. Direct the outer instrument panel vents towards the side windows.



To increase airflow to the outer instrument panel vents, close the vents located in the middle of the instrument panel.



Do not place objects on top of the instrument panel as these objects may become projectiles in a collision or sudden stop.

Lights

HEADLAMP CONTROL

-  Turns the lamps off.
-  Turns on the parking lamps, instrument panel lamps, license plate lamps and tail lamps.
-  Turns the headlamps on.

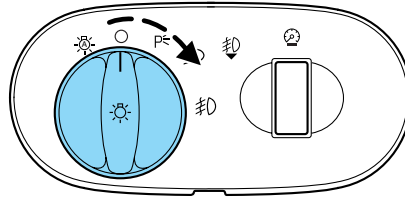

Autolamp system

The autolamp system sets the headlamps to turn on and off automatically. The autolamp control, located on the headlamp control, may be set to:

- turn on the lamps automatically at night
- turn off the lamps automatically during the daylight
- keep the lamps on for up to three minutes after the key is turned to OFF.

To turn the autolamps on, rotate the control counterclockwise to .



Autolamp exit time delay, manual sequence

The autolamp delay time is preset to 20 seconds. To change the delay time (up to a maximum of 3 minutes), perform the following procedure:

1. Start with the ignition in the RUN position and the headlamp switch in the autolamp position. Turn the ignition OFF.
 2. Turn the headlamp switch OFF.
 3. Turn the ignition to the RUN position.
 4. Turn the ignition OFF.
 5. Turn the headlamp switch to the autolamp position.
- **Note:** Steps 2 through 5 must be performed within a 10 second period.
 - At this point, the headlamps will turn on.
6. Wait until the desired autolamp delay time has passed (maximum three minutes), then turn the headlamp switch off.
- At this point, the headlamps will turn off and the autolamp delay time will be set.

Lights

Foglamp control (if equipped)

The foglamps can be turned on only when the headlamp control is in the , , and  position and the high beams are not turned on.

Pull headlamp control towards you to turn foglamps on. The foglamp indicator light  will illuminate when foglamp is activated.

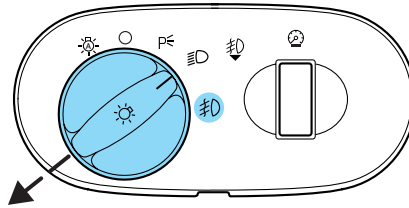

Push the headlamp control towards the instrument panel to deactivate the foglamps.

High beams

Push the lever toward the instrument panel to activate. Pull the lever towards you to deactivate.

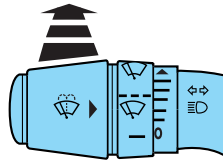

Flash to pass

Pull the lever toward you to activate. Release the lever to deactivate.

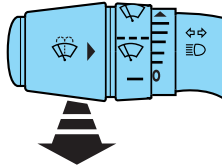

Lights

PANEL DIMMER CONTROL

Move the control up and down to adjust the intensity of the panel lighting. Operates only when the exterior lights are switched on.

Move the control to the full upright position (past detent) to turn on the interior lamps.

Move the control to the full down position (past detent) to prevent interior lamps from illuminating when the doors are opened (if equipped).

Note: On some models, when the instrument panel dimmer switch is rotated all the way up (past the detent), turning on the interior dome lamp, the exterior rear cargo lamp is also turned on.

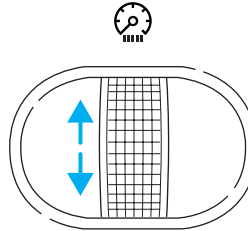

AIMING THE HEADLAMPS

The headlamps on your vehicle are properly aimed before leaving the assembly plant. If your vehicle is involved in an accident or if you have problems fixing the alignment of your headlamps, have them checked by a qualified service technician.

Headlamp aim adjustment

The headlamps on your vehicle can only be vertically adjusted. Your vehicle does not require horizontal aim adjustments.

To adjust the headlamps:

1. Park your vehicle on a level surface about 7.6 meters (25 feet) away from a vertical plain surface (3). Check your headlamp alignment at night or in a dark area so that you can see the headlamp beam pattern.

- (1) Eight feet
- (2) Center height of lamp to ground
- (3) Twenty-five feet
- (4) Horizontal reference line

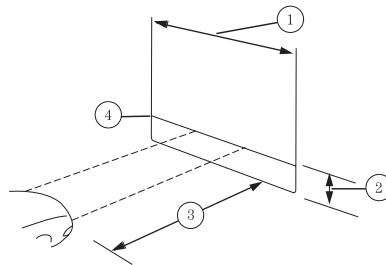

Lights

2. The center of the headlamp has a 3.0 mm circle on the lens. Measure the height from the center of your headlamp to the ground (2) and mark a 2.4 meter (8 foot) long horizontal line on the plain surface (1) at this height (masking tape works well).

3. Turn on the low beam headlamps. The brightest part of the light should be below the horizontal line (4). If it is above the line the headlamp will need to be adjusted.

4. Open the hood.

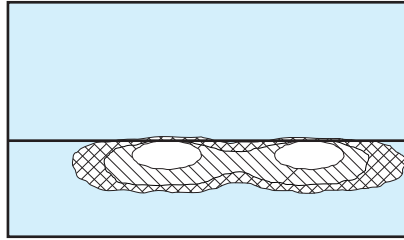

5. Locate the vertical adjuster for each headlamp. Adjust the aim by turning the adjuster control either clockwise (to adjust down) or counterclockwise (to adjust up).

Note: Use a 4 mm socket or box wrench to turn the vertical adjuster control.

6. Horizontal aiming is not required for this vehicle and is non-adjustable.

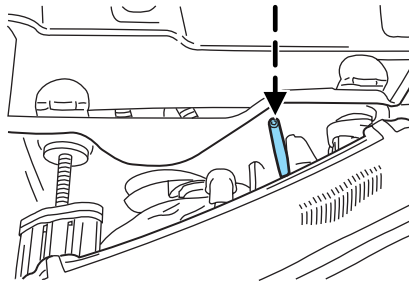

TURN SIGNAL CONTROL ⇐⇒

- Push down to activate the left turn signal.
- Push up to activate the right turn signal.

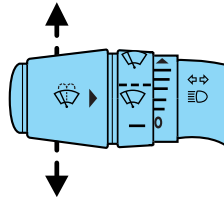

INTERIOR LAMPS

Courtesy/reading lamps

The courtesy lamp lights when:

- any door is opened.
- the instrument panel dimmer switch is rotated past the detent.
- the UNLOCK control of the remote entry controls is pressed and the ignition is OFF.

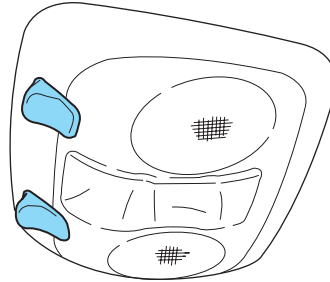

The reading lamps can be turned on by pressing the rocker controls next to each lamp.

If equipped with Remote Keyless Entry, the courtesy lamp will illuminate whenever any door is opened and will remain on for 25 seconds after the door is shut or when the ignition is turned to the ON position.

BULBS

Replacing the interior bulbs

Check the operation of the bulbs frequently. To replace any of the interior bulbs, see a dealer or qualified technician.

Replacing exterior bulbs

Check the operation of all the bulbs frequently.

Replacement bulbs

| Function | Number of bulbs | Trade number |
|-----------------------------|-----------------|-----------------|
| Headlamps | 2 | 9007 |
| Park/turn/side marker lamps | 2 | 3157 AK (Amber) |
| Rear stop/tail/turn lamps | 2 | 3157K |
| Backup lamps | 2 | 3156K |
| Hi-mount brake lamp | 1 | 922 |
| Foglamps | 2 | 9145 |
| Rear license plate lamps | 2 | 168 |

Lights

| Function | Number of bulbs | Trade number |
|--|-----------------|--------------------------|
| Overhead map lamps | 2 | PC579 (XU5B-13466-AA) |
| Cargo lamp | 1 | 211-2 |
| Map lamps | 2 | 168 (T10) |
| Dome lamp | 1 | 906 |
| Front door courtesy lamp (if equipped) | 1 | 168 |
| Ashtray lamp | 1 | 161 |
| All replacement bulbs are clear in color except where noted. | | |
| To replace all instrument panel lights – see your dealer. | | |

Replacing headlamp bulbs

To remove the headlamp bulb:

1. Make sure headlamp switch is in OFF position, then lift hood and remove the plastic headlamp cover.
2. At the back of the headlamp, remove the two retainer pins then pull headlamp forward.

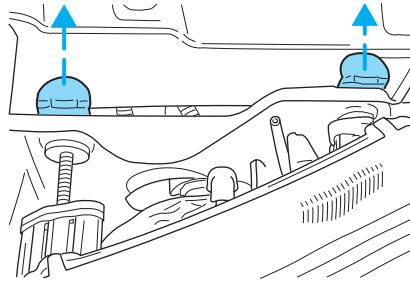

3. Disconnect the electrical connector.

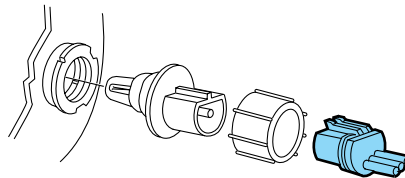

Lights

4. Remove the bulb retaining ring.

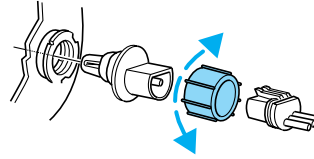

5. Carefully pull the old bulb out of the lamp assembly.

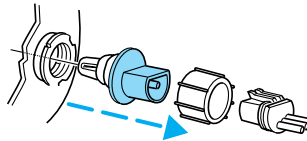

Handle a halogen headlamp bulb carefully and keep out of children's reach. Grasp the bulb only by its plastic base and do not touch the glass. The oil from your hand could cause the bulb to break the next time the headlamps are operated.

Reverse steps to reinstall the bulb(s).

Replacing front parking lamp/turn signal bulbs

1. Make sure the headlamp switch is in the OFF position and open the hood.
2. Remove screw from the lamp assembly.
3. Disengage lamp assembly.

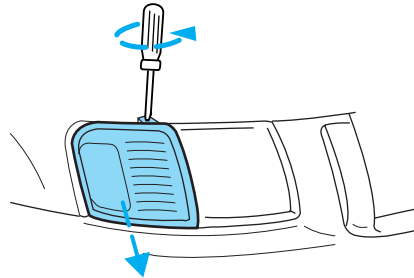

4. Remove the bulb socket.
5. Carefully pull bulb straight out of socket and push in the new bulb.

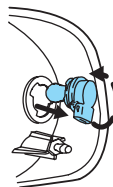

Reverse steps to reinstall the bulb(s).

Lights

Replacing tail lamp/turn/backup lamp bulbs

1. Make sure the headlamp switch is in the OFF position and lower the tailgate to expose the lamp assembly.
2. Remove the three rubber plugs, screws and the lamp assembly from vehicle.
3. Rotate bulb socket counterclockwise and remove from lamp assembly.
4. Carefully pull the bulb straight out of the socket.

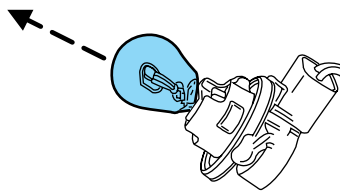
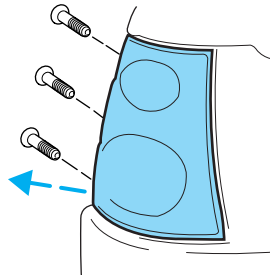

Reverse steps to reinstall the bulb(s).

Replacing foglamp bulbs

1. Make sure the headlamp switch is in the OFF position and then remove the splash shield, by removing the two screws on the front of the fenderwell.
2. Remove the bulb socket from the foglamp by turning counterclockwise.
3. Disconnect the electrical connector from the foglamp bulb.

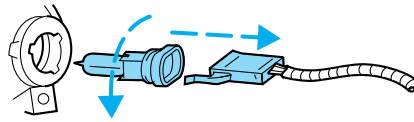

Reverse steps to reinstall the bulb(s).

Lights

Replacing high-mount brakelamp and cargo lamp bulbs

To remove the brakelamp assembly:

1. Remove the two screws and lamp assembly from vehicle.
2. Remove the bulb socket from lamp assembly by turning it counterclockwise and pull the bulb straight out.

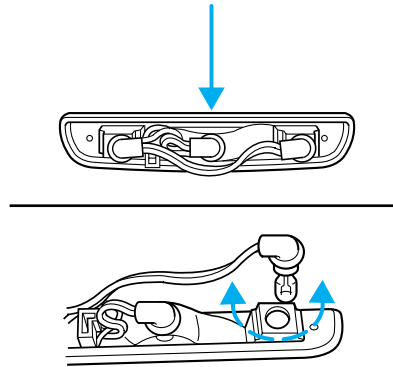

Reverse steps to reinstall the bulb(s).

Replacing license plate lamp bulbs

1. Make sure the headlamp switch is in the OFF position, then remove the license plate assembly.
2. Remove the bulb socket from the lamp assembly by turning it counterclockwise and pulling the bulb straight out.

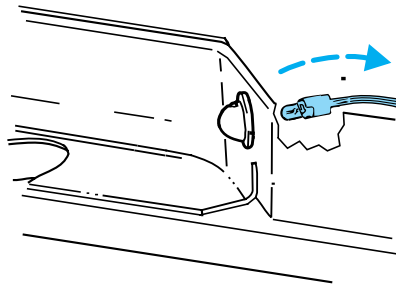

Reverse steps to reinstall the bulb(s).

Driver Controls

MULTI-FUNCTION LEVER

Windshield wiper: Rotate the end of the control away from you to increase the speed of the wipers; rotate towards you to decrease the speed of the wipers.

Speed dependent wipers: When the wiper control is on, the speed of the wipers will automatically adjust with the vehicle speed. The faster your vehicle is travelling the faster the wipers will go.

Windshield washer: Push the end of the stalk:

- briefly: causes a single swipe of the wipers without washer fluid.
- a quick push and hold: the wipers will swipe three times with washer fluid.
- a long push and hold: the wipers and washer fluid will be activated for up to ten seconds.

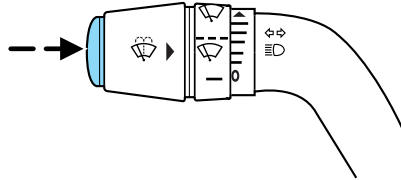
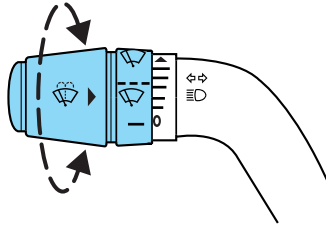

Changing the wiper blades

1. Pull the wiper arm away from the vehicle. Turn the blade at an angle from the wiper arm. Push the lock pin manually to release the blade and pull the wiper blade down toward the windshield to remove it from the arm.

2. Attach the new wiper to the wiper arm and press it into place until a click is heard.

3. Replace wiper blades every 6 months for optimum performance.

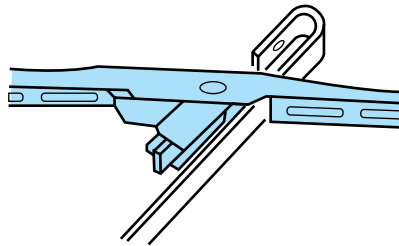

Driver Controls

TILT STEERING WHEEL (IF EQUIPPED)

To adjust the steering wheel:

1. Pull and hold the steering wheel release control toward you.
2. Move the steering wheel up or down until you find the desired location.
3. Release the steering wheel release control. This will lock the steering wheel in position.

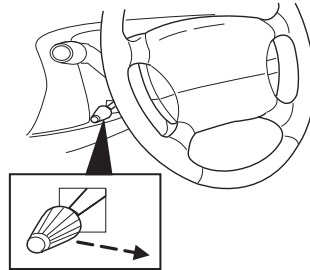

Never adjust the steering wheel when the vehicle is moving.

CENTER CONSOLE

Your vehicle may be equipped with a variety of console features. These include:

- Utility compartment with compact disc storage
- Auxiliary power point
- Cupholders
- Ashcup
- Removable utility bag
- Writing surface with note pad
- Coin holder
- Armrest

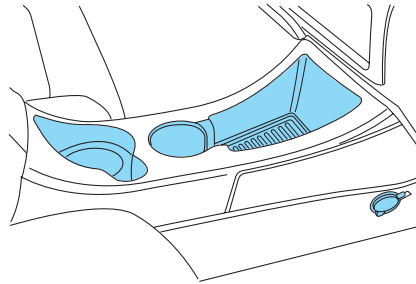

Use only soft cups in the cupholder. Hard objects can injure you in a collision.

Cell phone use

The use of Mobile Communications Equipment has become increasingly important in the conduct of business and personal affairs. However, drivers must not compromise their own or others' safety when using such equipment. Mobile Communications can enhance personal safety

Driver Controls

and security when appropriately used, particularly in emergency situations. Safety must be paramount when using mobile communications equipment to avoid negating these benefits.

Mobile Communication Equipment includes, but is not limited to cellular phones, pagers, portable email devices, in vehicle communications systems, telematics devices and portable two-way radios.



A driver's first responsibility is the safe operation of the vehicle. The most important thing you can do to prevent a crash is to avoid distractions and pay attention to the road. Wait until it is safe to operate Mobile Communications Equipment.

OVERHEAD CONSOLE (IF EQUIPPED)

The appearance of your vehicle's overhead console will vary depending on your option package.

Storage compartment (if equipped)

Press the OPEN control to open the door slightly. Pull the door down to open.

The storage compartment may be used to secure sunglasses or a similar object.

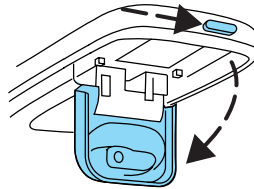

Install a garage door opener (if equipped)

The storage compartment can be used to hold a variety of aftermarket garage door openers. To install your garage door opener:

1. Open the storage compartment door.
2. Remove the storage clip and stow it away.

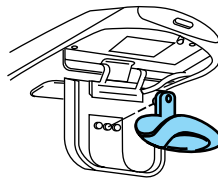

Driver Controls

3. Place the Velcro™ strip onto the back of the garage door opener control.

4. Adhere the back of garage door opener control to the Velcro™ strip found inside the storage compartment. Make sure that the controls for the garage door opener face outward.

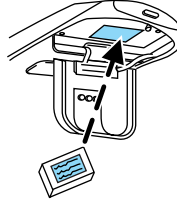

5. Place the height adjusters onto the back of the storage compartment door. Add as many adjusters as needed to activate the garage door opener.

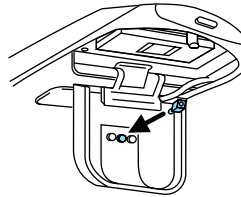

6. Close the storage compartment door and press the garage door opener control to verify that it works. If not, you may need to add more adjusters.

AUXILIARY POWER POINT

The power point is an additional power source for electrical accessories.

NOTE: Power outlets are designed for accessory plugs only. Do not hang any type of accessory or accessory bracket from the plug. Improper use of the power outlet can cause damage not covered by your warranty.

- With a full console:

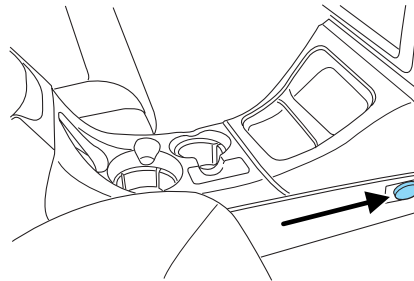

Driver Controls

- Without a full console:

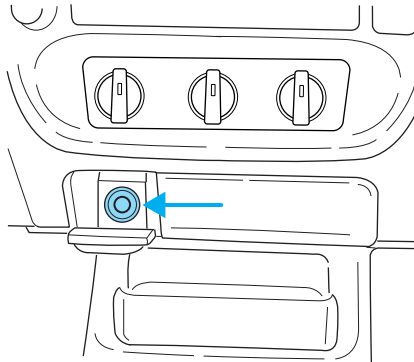

Do not plug optional electrical accessories into the cigarette lighter. Use the power point.

Do not use the power point for operating the cigarette lighter element.

The Maximum power each power point can supply depends on the fuse rating. For example: a 20A fuse should supply a maximum of 240 Watts. Exceeding these limits will result in a blown fuse.

Always keep the power point caps closed when not being used.

Truck bed auxiliary power point

An additional auxiliary power point is located in the bed of the truck.

Lift the cover to access the auxiliary power point.

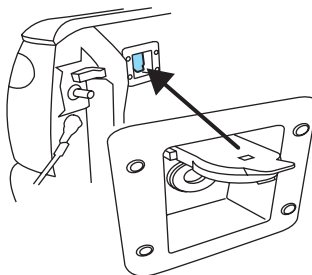

POWER WINDOWS



Do not leave children unattended in the vehicle and do not let children play with the power windows. They may seriously injure themselves.

Driver Controls

 When closing the power windows, you should verify they are free of obstructions and ensure that children and/or pets are not in the proximity of the window openings.

Press and hold the bottom part of the rocker switch to open the window. Press and hold the top part of the rocker switch to close the window.

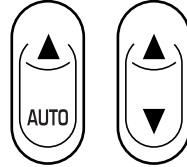

One touch down

Allows the driver's window to open fully without holding the control down. Press completely down on AUTO and release quickly. Press again to stop.

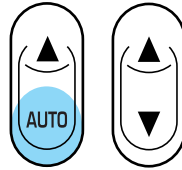

Window lock

The window lock feature allows only the driver to operate the power windows.

To lock out all the window controls except for the driver's press the left side of the control. Press the right side to restore the window controls.

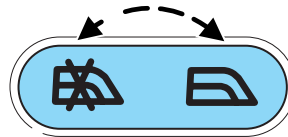

Accessory delay

With accessory delay, the radio, windows, and moonroof operate for up to ten minutes after the ignition switch is turned from the ON to the OFF position or until any door is opened.

Power Down Back Window

To operate the Power Down Back window, the ignition switch must be in the ON or ACC position (or with accessory delay power enabled).

Driver Controls

The power down back window has three window position selections:

- Fully open
- Vent
- Fully closed

Turn control counter-clockwise and release to lower window all the way to the full open position.

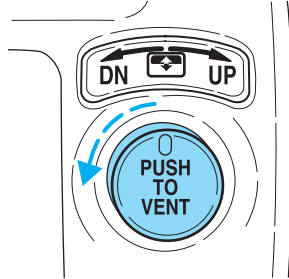

All rear seat occupants and/or cargo must be properly restrained and clear of the back window opening before operating the power down rear window.

Turn control clockwise and release to raise the window all the way to the full closed position.

Push control once to move window (up or down) to the vent position (opens approximately 2.00 inches for cab ventilation). If the window is already in the vent position and the control is pressed, no movement will occur.

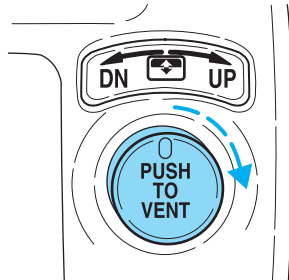

Normal Operation

If an “up” command is selected and the ignition is switched to OFF or START during window travel, the window will (or with accessory delay power enabled):

- stop if it is between the vent position and fully closed or
- continue to move up to the vent position if it is between vent and fully open.

If a “down” or “vent” command is selected and the ignition is switched to OFF or START during window travel (or with accessory delay power enabled), the window will move to the fully open or vent position and then stop.

The “down” command is the only one allowed after the ignition has been switched to OFF or START (or with accessory delay power enabled) while the window is moving.

Driver Controls

Bounce-Back

When the back window is moving upward and an obstacle interferes with the window's movement, the back window will reverse direction and move toward the fully open position. This is known as "bounce-back".

Security Override

If, during a bounce-back condition, the control is held in the clockwise ("up") direction for at least two seconds, **the back window will travel up with no bounce-back protection.** If the control is released before the window reaches fully closed or the ignition is switched to OFF or START (or with accessory delay power enabled), the back window will reverse direction with bounce-back re-enabled.

The following are possible reasons for using the security override:

- Ice on the window causing a restriction.
- Window unexpectedly reverses.

Position recovery mode

If the window fails to operate in "normal" operation mode, the control can be turned and held in the active position (up or down window direction) which will move the window in increments of approximately 15mm (0.6 inches) in the selected direction. (The "vent" feature is inoperable in this mode.) This feature allows the window to be closed. Once the window has reached the full closed position, the window should again operate in the "normal" operation mode. If the window still does not operate correctly, see your dealer for service.

AUTOMATIC DIMMING REAR VIEW MIRROR

Your vehicle may be equipped with an inside rear view mirror with an auto-dimming feature. When the auto-dimming mirror is turned on, as indicated by an illuminated green LED to the left of the button on mirror, it will detect bright lights(glare) from behind the vehicle, and will change from the normal, high reflective state, to the darkened state to minimize glare.

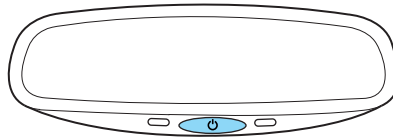



When the auto-dimming mirror is turned on, it will automatically return to the normal, high reflective, state whenever the vehicle is placed in R(reverse) to ensure a clear view while backing up.

Do not block the sensor located to the right of the mirror button or the sensor located on the back side of the mirror as this may impair mirror performance.

Driver Controls

Power side view mirrors (if equipped)

To adjust your mirrors:

1. Select  to adjust the left mirror or  to adjust the right mirror.
2. Move the control in the direction you wish to tilt the mirror.
3. Return to the center position to disable the adjust function.

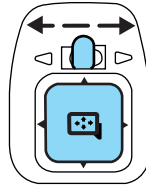

Fold-away mirrors

Pull the side mirrors in carefully when driving through a narrow space, like an automatic car wash.

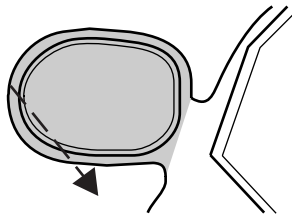

SPEED CONTROL (IF EQUIPPED)

With speed control set, you can maintain a speed of 30 mph (48 km/h) or more without keeping your foot on the accelerator pedal. Speed control does not work at speeds below 30 mph (48 km/h).



Do not use the speed control in heavy traffic or on roads that are winding, slippery or unpaved.

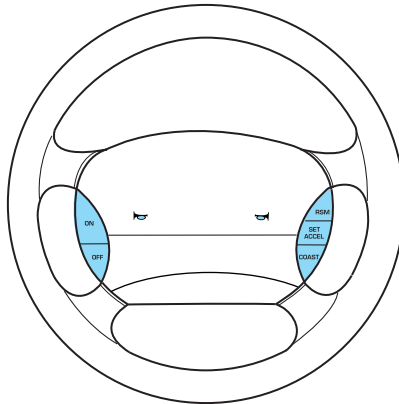

Driver Controls

Setting speed control

The controls for using your speed control are located on the steering wheel for your convenience.

1. Press the ON control and release it.
2. Accelerate to the desired speed.
3. Press the SET ACC control and release it.
4. Take your foot off the accelerator pedal.
5. The indicator light  on the instrument cluster will turn on.

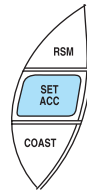

Note:

- Vehicle speed may vary momentarily when driving up and down a steep hill.
- If the vehicle speed increases above the set speed on a downhill, you may want to apply the brakes to reduce the speed.
- If the vehicle speed decreases more than 10 mph (16 km/h) below your set speed on an uphill, your speed control will disengage.

Resuming a set speed

Press the RSM (resume) control and release it. This will automatically return the vehicle to the previously set speed. The RSM control will not work if the vehicle speed is not faster than 30 mph (48 km/h).



Driver Controls

Increasing speed while using speed control

There are two ways to set a higher speed:

- Press and hold the SET ACC control until you get to the desired speed, then release the control. You can also use the SET ACC control to operate the Tap-Up function. Press and release this control to increase the vehicle set speed in small amounts by 1 mph (1.6 km/h).
- Use the accelerator pedal to get to the desired speed. When the vehicle reaches that speed, press and release the SET ACC control.



Reducing speed while using speed control

There are two ways to reduce a set speed:

- Press and hold the COAST control until you get to the desired speed, then release the control. You can also use the COAST control to operate the Tap-Down function. Press and release this control to decrease the vehicle set speed in small amounts by 1 mph (1.6 km/h).
- Depress the brake pedal until the desired vehicle speed is reached, press the SET ACC control.

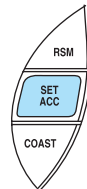
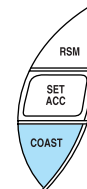

Turning off speed control

There are two ways to turn off the speed control:

- Depress the brake pedal. This will not erase your vehicle's previously set speed.

Driver Controls

- Press the speed control OFF control.

Note: When you turn off the speed control or the ignition, your speed control set speed memory is erased.



MOON ROOF (IF EQUIPPED)

The moon roof control is located on the overhead console.



Do not let children play with the moon roof. They may seriously hurt themselves.

To open the moon roof: the moon roof is equipped with a one-touch open feature. Press and release the ▲ control. To stop the one-touch open feature press the ▲ control again.

To close the moon roof: press and hold the ▼ control until the glass panel stops moving. When fully closed, the rear portion of the glass panel will appear higher than the front portion.

To vent the moon roof: press and hold the ▼ control. **The moon roof must be in the closed position in order to move it into the vent position.** To close, press and hold the ▲ control until the glass panel stops moving.

The moon roof sliding shade can be opened or closed manually. The glass panel must be closed in order to move the sliding shade.

Note: If the battery is disconnected, discharged, or a new battery is installed, the moon roof positions will need to be reset. To reset the moon roof positions, move the moon roof into the vent position.

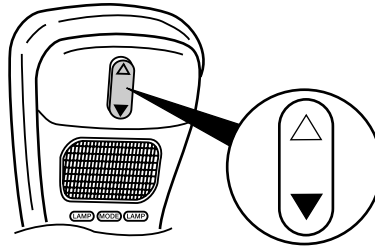

Driver Controls

ELECTRONIC COMPASS AND OUTSIDE TEMPERATURE DISPLAY (IF EQUIPPED)

This display provides the outside temperature in °C (Centigrade) or °F (Fahrenheit) and one of the eight compass headings to indicate the direction the vehicle is facing.

Outside temperature display

Press the **MODE** control to turn on the display. Press the **MODE** control again to change from °C to °F. Press the **MODE** control again to turn off the display.

If the outside temperature drops below 4° C (38° F) the word “ICE” will flash in the display alternately with the outside temperature for approximately one minute.

Electronic compass

As an orientation aid, the compass direction abbreviations are displayed here.

If you suspect that the compass is not operating correctly, it can be recalibrated.

Note: The compass reading may be affected when driving near large buildings, bridges, power lines and broadcast antennas. Magnetic or metallic objects placed on or in the vehicle may also affect the compass reading.

- Adjusting the compass

Note: The ignition must be in the ON position.

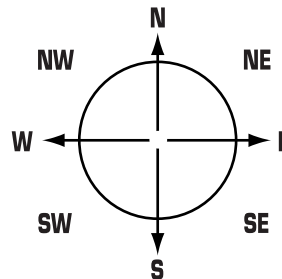
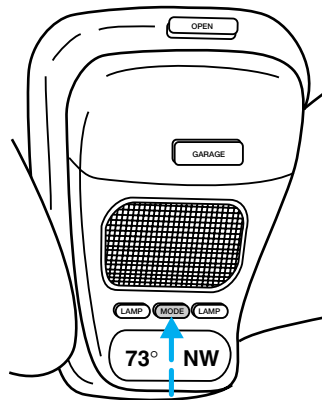

Driver Controls

1. Press and hold the **MODE** control until “VAR” appears in the display. The current location number should be displayed.

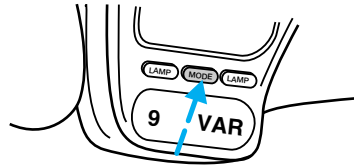

2. Press the **MODE** control repeatedly until your desired location number appears in the display. Use this zone map to determine which location number you should be using.

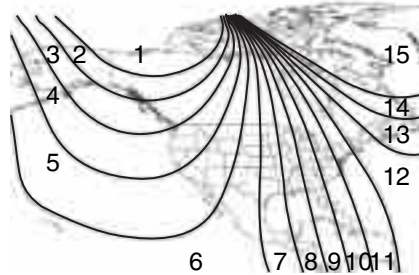

- Adjusting the calibration of the compass

Note: To adjust the calibration find an open area free from steel structures and high voltage lines.

1. Press and hold the **MODE** control until “CAL” appears in the display then release the control.

2. Drive slowly (less than 5 km/h [3 mph]) in circles until “CAL” disappears from the display (approximately 2 or 3 circles).

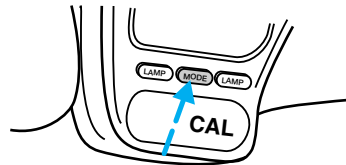

Driver Controls

POSITIVE RETENTION FLOOR MAT

Position the floor mat so that the eyelets are over the pointed end of the retention posts and rotate forward to lock in. Make sure that the mat does not interfere with the operation of the accelerator or the brake pedal.

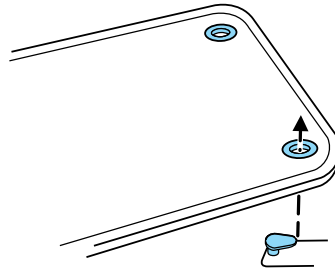

TAILGATE LOCK

The tailgate lock is designed to prevent theft of the tailgate.

- Insert ignition key and turn to the right to lock.
- Turn ignition key to the left to unlock.

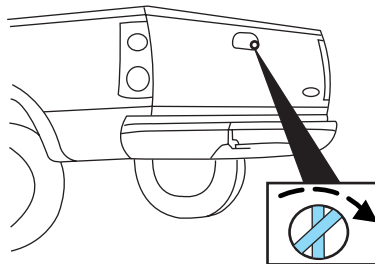

TAILGATE REMOVAL

Your tailgate is removable to allow more room for loading.

1. Lower the tailgate.
2. Use a screwdriver to pry the spring clip (on each connector) past the head of the support screw. Disconnect the cables.
3. Lift tailgate to a 45 degree angle and remove it from the left and right hinges.



To install, follow the removal procedures in reverse order.

Driver Controls

EXTERIOR TIEDOWN HOOKS

Exterior tiedown hooks mounted on the side of the pickup box:

- can be used to secure loads within the pickup box.
- can be used to secure half the tonneau cover in an open position.
- allow for continued use of the stake pockets.

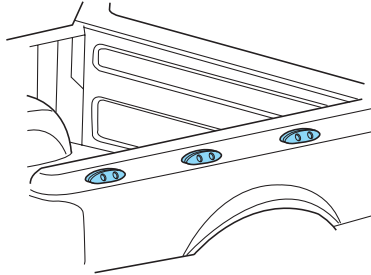

Each tiedown hook can secure loads of up to 350 kg (770 lbs.) inside the pickup box (total load not to exceed box payload of 1000kg (2,200 lbs)). Loads can be secured to the hooks with up to three wraps of 10 mm rope.

CARGO CAGE (IF EQUIPPED)

Your vehicle may be equipped with a cargo cage designed to extend the pickup box for larger loads.

To extend the cargo cage:

1. Lower tailgate.
2. Pull the round knobs on each side of the cargo cage to release it from the pickup box.

Red markings behind the knobs indicate the unlocked position.

3. Lift the cargo cage over on to the tailgate.

4. Evenly push down on the cargo cage and push the round knobs in on each side locking it in place.

To stow the cargo cage, follow steps one through four in reverse order.

The cargo cage may be used to secure a load of up to 46 kg (100 lbs.) on the tailgate.

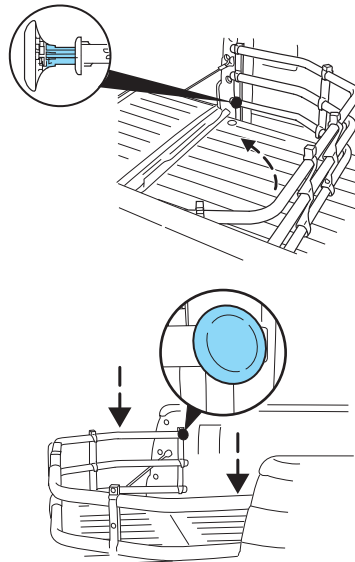

Driver Controls

The cargo cage should always be kept in the stowed position with the tailgate closed when not in use.

Activating Cargo Cage Theft Deterrent Device:

The following procedure can be done with the cargo cage in the stowed or extended position.

1. Locate the Phillips head screw in the middle of the vertical brace on the locking clip.
2. Turn the screw counterclockwise until you hear an audible click.
3. To deactivate, turn the screw clockwise until the locking clip moves freely.

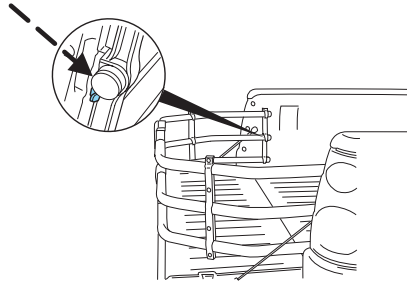

To remove the cargo cage:

1. Extend the cargo cage.
2. Pull the round knobs on each side of the cage to unlock it.

Make sure the locking clip screws are loose before removing the cargo cage.

3. Press the locking clips below the middle bar and lift the cargo cage out of the channels on the "D" pillar.

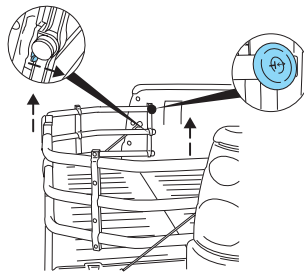

To install the cargo cage, follow the removal procedure in reverse order.

TONNEAU COVER (IF EQUIPPED)

The tonneau cover has been designed to maximize fuel economy and should be fully installed whenever possible.

The rear panel can be folded in half and secured behind the cab, or the whole cover can be removed completely from the vehicle.

To avoid damage to the cover, do not operate the vehicle unless the cover is fully installed, or securely stowed.

To avoid damage to the cover, do not stand, sit or load anything on top of the cover.

Driver Controls

To open the front panel:

- Open the driver side lock cover and unlock the front panel.
- Lift the panel to access items in the pickup box near the cab.
- To close, lower the panel down on the pickup box.

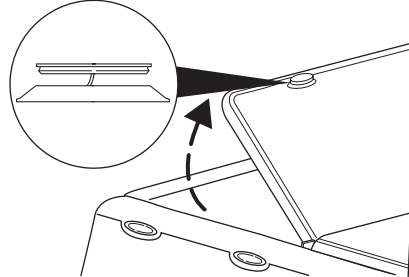

The panel will automatically lock when lowered onto the pickup box.

Do not drive with front panel unlocked or folded on top of the rear panel.

To open the rear panel:

- Open the lock cover and unlock the rear panel.
- Lift the rear panel to access items in the pickup box.
- To close, lower the rear panel on the pickup box.

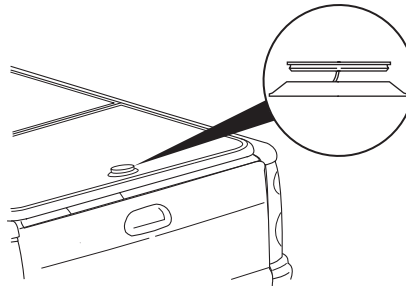

The panel will automatically lock when lowered onto the pickup box.

To stow the rear panel:

- Before driving with the rear panel open, unlock the rear panel.
- Lift the rear panel up, lay it on top of the front panel and secure it with the two straps to the exterior tiedowns on the pickup box.

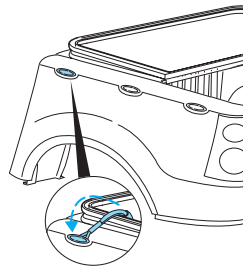

Failure to secure the rear panel could damage the tonneau cover or vehicle.

Driver Controls

To remove the tonneau cover:

The tonneau cover weighs 29 kg (70 lbs.) and needs to be supported during removal since the panels will automatically lock when set down on the pickup box. This is a two person operation.

- Unlock and support the front and rear panels.
- Fold the rear panel on top of the front panel.
- Pull the release levers on the underside of the tonneau cover from the pickup box and remove the cover.

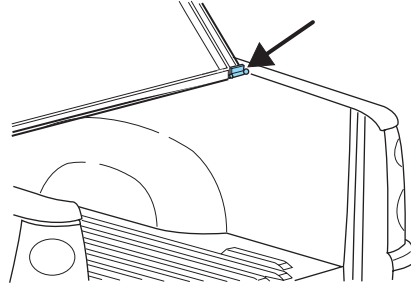

For installation of the tonneau cover, reverse the removal procedure.

Interior tonneau cover release

Your vehicle is equipped with a mechanical interior tonneau cover release handle that provides a means of escape for children and adults in the event they become locked inside the pickup box.

Adults are advised to familiarize themselves with the operation and location of the release handle.

To open the tonneau cover from the inside, pull the “T” shaped handle and push up on the tonneau cover panel. The handle is composed of a material that will glow for hours in darkness following brief exposure to ambient light.

The “T” shaped handle is located on the tonneau cover panel.

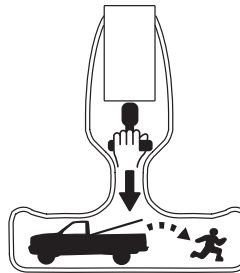

Keep vehicle doors and tonneau cover locked and keep keys and remote transmitters out of a child's reach. Unsupervised children could lock themselves in the box and risk injury. Children should be taught not to play in vehicles.

Driver Controls



On hot days, the temperature in the pickup box can rise very quickly. Exposure of people or animals to these high temperatures for even a short time can cause death or serious heat-related injuries, including brain damage. Small children are particularly at risk.

LUGGAGE RACK

Your vehicle is equipped with a roof rack without cross bars. The maximum recommended load is 44kg (100 lbs), evenly distributed. If it is not possible to distribute the load, position it as far rearward as possible. Use the tiedown loops to secure the load.



Loaded vehicles, with a higher center of gravity, may handle differently than unloaded vehicles. Extra precautions, such as slower speeds and increased stopping distance, should be taken when driving a heavily loaded vehicle.



Vehicles with a higher center of gravity such as utility and four-wheel drive vehicles handle differently than vehicles with a lower center of gravity. Utility and four-wheel drive vehicles are not designed for cornering at speeds as high as passenger cars any more than low-slung sport cars are designed to perform satisfactorily under off-road conditions. Avoid sharp turns, excessive speed and abrupt maneuvers in these vehicles. Failure to drive cautiously could result in an increase risk of loss of vehicle control, vehicle rollover, personal injury and death.

Locks and Security

KEYS



The key operates all locks on your vehicle. In case of loss, replacement keys are available from your dealer.

You should always carry a second key with you in a safe place in case you require it in an emergency.

Refer to *SecuriLock™ Passive Anti-Theft System* for more information.

POWER DOOR LOCKS

The power door lock controls are located on the driver and front passenger door panels.

- Pressing the  will unlock all the doors.
- Pressing the  will lock all the doors.

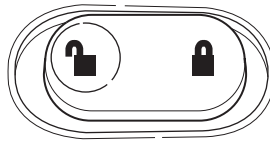

Childproof door locks

- When these locks are set, the rear doors cannot be opened from the inside.
- The rear doors can be opened from the outside when the doors are unlocked.

The childproof locks are located on rear edge of each rear door and must be set separately for each door. Setting the lock for one door will not automatically set the lock for both doors.

- Move lock control up to engage the childproof lock.
- Move control down to disengage childproof locks.

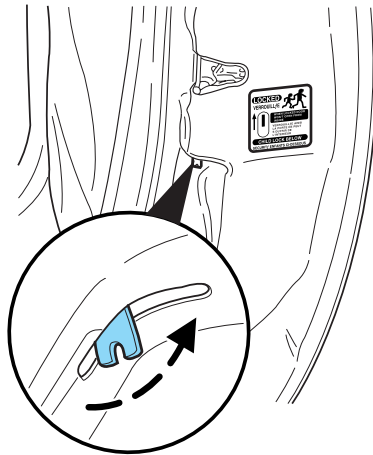

REMOTE ENTRY SYSTEM (IF EQUIPPED)

This device complies with part 15 of the FCC rules and with RS-210 of Industry Canada. Operation is subject to the following two conditions: (1) This device may not cause harmful interference, and (2) This device must accept any interference received, including interference that may cause undesired operation.

Locks and Security

Changes or modifications not expressly approved by the party responsible for compliance could void the user's authority to operate the equipment.

The typical operating range for your remote entry transmitter is approximately 33 feet (10 meters). A decrease in operating range could be caused by:

- weather conditions,
- nearby radio towers,
- structures around the vehicle, or
- other vehicles parked next to your vehicle.

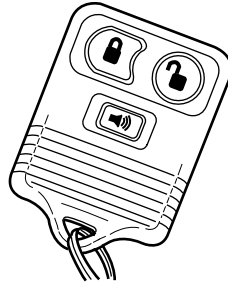

Your vehicle is equipped with a remote entry system which allows you to:

- unlock the vehicle doors without a key.
- lock all the vehicle doors without a key.
- activate the personal alarm.



If there is any potential remote keyless entry problem with your vehicle, ensure **ALL remote entry transmitters** are taken to the dealership, to aid in troubleshooting.

Unlocking the doors

1. Press  and release to unlock the driver's door. **Note:** The interior lamps will illuminate.
2. Press  and release again within three seconds to unlock all the doors.

The remote entry system activates the illuminated entry feature. This feature turns on the interior lamps for 25 seconds or until the ignition is turned to the 4 (ON) position. If the dome lamp control is in the **off** position the illuminated entry feature will not work.



The inside lights will not turn off if:

- they have been turned on using the dimmer control or
- any door is open.

Locks and Security

The battery saver feature will turn off the interior lamps 30 minutes after the ignition is turned to the 3 (OFF) position.

Locking the doors

1. Press  and release to lock all the doors. **Note:** The interior lamps will turn off (unless the dome lamp control is in the full-up position), and the lamps will flash.
2. Press  and release again within three seconds to confirm that all the doors are closed and locked. **Note:** The doors will lock again, the horn will chirp once and the lamps will flash.

If any of the doors are not properly closed the horn will make two quick chirps.

Sounding a panic alarm

Press  to activate the alarm. The horn will sound for a maximum of 30 seconds and the parklamps will flash for a maximum of 3 minutes. Press again or turn the ignition to the 4 (ON) position to deactivate, or wait for the alarm to timeout in 3 minutes.

Note: The panic alarm will only operate when the ignition is in either the 3 (OFF) or the 1 (ACCESSORY) position.

Replacing the battery

The remote entry transmitter uses one coin type three-volt lithium battery CR2032 or equivalent.

To replace the battery:

1. Twist a thin coin between the two halves of the remote entry transmitter near the key ring. DO NOT TAKE THE RUBBER COVER AND CIRCUIT BOARD OFF THE FRONT HOUSING OF THE REMOTE ENTRY TRANSMITTER.

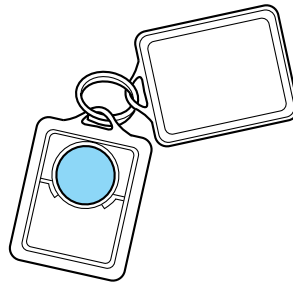

Locks and Security

2. Do not wipe off any grease on the battery terminals on the back surface of the circuit board.

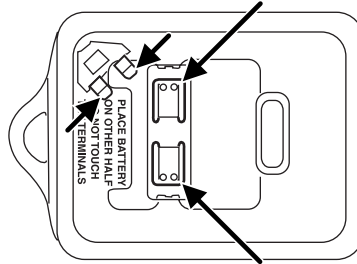

3. Remove the old battery. **Note:** Please refer to local regulations when disposing of transmitter batteries.

4. Insert the new battery. Refer to the diagram inside the remote entry transmitter for the correct orientation of the battery. Press the battery down to ensure that the battery is fully seated in the battery housing cavity.

5. Snap the two halves back together.

Note: Replacement of the battery will **not** cause the remote transmitter to become deprogrammed from your vehicle. The remote transmitter should operate normally after battery replacement.

Replacing lost remote entry transmitters

If you would like to have your remote entry transmitter reprogrammed because you lost one, or would like to buy additional remote entry transmitters, you can either reprogram them yourself, or take **all remote entry transmitters** to your authorized dealer for reprogramming.

How to reprogram your remote entry transmitters

You must have **all remote entry transmitters** (maximum of four) available before beginning this procedure.

Locks and Security

To reprogram the remote entry transmitters:

1. Ensure the vehicle is electronically unlocked.
2. Put the key in the ignition.
3. Turn the key from the 2 (LOCK) position to 3 (OFF).
4. Cycle eight times rapidly (within 10 seconds) between the 3 (OFF) position and 4 (ON). **Note:** The eighth turn must end in the 4 (ON) position.
5. The doors will lock, then unlock, to confirm that the programming mode has been activated.
6. Within 20 seconds press any button on the remote entry transmitter. **Note:** If more than 20 seconds have passed you will need to start the procedure over again.
7. The doors will lock, then unlock, to confirm that this remote entry transmitter has been programmed.
8. Repeat Step 6 to program each additional remote entry transmitter.
9. Turn the ignition to the 3 (OFF) position after you have finished programming all of the remote entry transmitters. **Note:** After 20 seconds, you will automatically exit the programming mode.
10. The doors will lock, then unlock, to confirm that the programming mode has been exited.

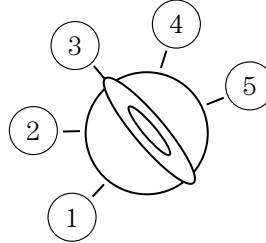

KEYLESS ENTRY SYSTEM (IF EQUIPPED)

You can use the keyless entry keypad to lock or unlock the doors without using a key.



The keypad can be operated with the factory set 5-digit entry code; this code is located on the owner's wallet card in the glove box, is marked on the computer module, and is available from your authorized dealer. You can also create your own 5-digit personal entry code.

When pressing the controls on the keypad, press the middle of the controls to ensure a good activation.

Programming a personal entry code

To create your own personal entry code:

1. Enter the factory set code.

Locks and Security

2. Within five seconds press the 1 • 2 on the keypad.
3. Enter your personal 5-digit code. Each number must be entered within five seconds of each other.
4. The doors will again lock then unlock to confirm that your personal keycode has been programmed to the module.

Tips:

- Do not set a code that uses five of the same number.
- Do not use five numbers in sequential order.
- The factory set code will work even if you have set your own personal code.
- If you set a second personal code it will erase your first personal code.

Erasing personal code

1. Enter the factory set 5–digit code.
2. Press and release 1 • 2 then,
3. Press and hold the 1 • 2 for two seconds. This must be done within five seconds of completing Step 1.

Your personal code is now erased and only the factory set 5–digit code will work.

Anti-scan feature

If an incorrect code has been entered 7 times (35 consecutive button presses), the keypad will go into an anti-scan mode. This mode disables the keypad for one minute and the keypad lamp will flash during this time.

The anti-scan feature will turn off after:

- one minute of keypad inactivity.
- pressing the  control on the remote entry transmitter.
- the ignition is turned to the 4 (ON) position.

Unlocking and locking the doors using keyless entry keypad

To unlock the driver's door, enter the factory set 5-digit code or your personal code. Each number must be pressed within five seconds of each other. The interior lamps will illuminate after pressing the first control on the keypad.

To unlock all doors, press the 3 • 4 control within five seconds.

Locks and Security

To lock all doors, press the 7 • 8 and the 9 • 0 at the same time. You **do not** need to enter the keypad code first. **Note:** The interior lamps will turn off.

Autolock (if equipped)

This feature will automatically lock all the doors when:

- all the doors are closed,
- the ignition is in the 4 (ON) position,
- the gearshift lever is shifted into, then out of, R (Reverse) and then
- the brake pedal is released.

This feature will also automatically relock all the doors when:

- the ignition is in the 4 (ON) position and any door is opened then closed, and
- you put the vehicle in motion by releasing the brake pedal.

Deactivating/reactivating the autolock feature

The autolock feature can be deactivated/reactivated using the following two methods:

- keyless entry keypad, or
- ignition lock cylinder and interior power door locks control.

To deactivate/reactivate the autolock feature using the keypad

Your vehicle comes with the autolock feature activated. To deactivate/reactivate this feature:

1. Turn the ignition to the 3 (OFF) position.
2. Close all the doors.
3. Enter the 5-digit entry code.
4. Press and hold the 7 • 8. While holding the 7 • 8, press the 3 • 4 within five seconds.
5. Within 5 seconds of Step 4, release the 3 • 4.
6. Within 5 seconds of Step 5, Release the 7 • 8.





The horn will chirp once when the system has been successfully deactivated.

The horn will chirp twice (one short and one long chirp) when the system has been successfully reactivated.

To deactivate/reactivate the autolock feature using the ignition lock cylinder and interior power door locks control

1. Close all the doors.
2. Ensure that the ignition is in the 3 (OFF) position.

Locks and Security

3. **Note:** Steps 4 through 8 must be carried out within 30 seconds. Turn the ignition from the 3 (OFF) to the 4 (ON) position.
4. Press the power door locks  (unlock) control three times.
5. Turn the ignition lock from the 4 (ON) to the 3 (OFF) position.
6. Press the power door locks  (unlock) control three times.
7. Turn the ignition from the 3 (OFF) to the 4 (ON) position.
8. Ensure the vehicle's horn chirps. This chirp indicates the feature is in an enable/disable mode and ready to accept program changes.
9. Press the power door locks  (unlock) control once, then the  (lock) control once, in order to toggle the autolock feature.
10. Ensure that the horn chirps once; there should only be one horn chirp, indicating that the autolock feature has been deactivated. If one chirp is heard, followed by a longer sound of the horn, the autolock feature has been reactivated.
11. Turn the ignition to the 3 (OFF) position, or wait two minutes, in order to exit the enable/disable mode.
12. Exit the vehicle and ensure the horn chirps once to indicate that a feature has been changed and the autolock feature has been toggled.

SECURILOCK™ PASSIVE ANTI-THEFT SYSTEM

SecuriLock™ passive anti-theft system is an engine immobilization system. This system is designed to prevent the engine from being started unless a **coded key programmed to your vehicle** is used. The use of the wrong type of coded key may lead to a “no-start” condition.

Your vehicle comes with two coded keys; additional coded keys may be purchased from your dealer. The dealer can program your spare keys to your vehicle or you can program the keys yourself. Refer to *Programming spare keys* for instructions on how to program the coded key.

Note: The SecuriLock™ passive anti-theft system is not compatible with non-Ford aftermarket remote start systems. Use of these systems may result in vehicle starting problems and a loss of security protection.

Note: Large metallic objects, electronic devices that are used to purchase gasoline or similar items, or a second coded key on the same key chain may cause vehicle starting issues. You need to prevent these objects from touching the coded key while starting the engine. These objects will not cause damage to the coded key, but may cause a

Locks and Security

momentary issue if they are too close to the key when starting the engine. If a problem occurs, turn the ignition off, remove all objects on the key chain away from the coded key and restart the engine.

Theft indicator

The theft indicator is located in the instrument cluster.

- When the ignition is in the 2 (LOCK) position, the **THEFT** indicator will flash once every 2 seconds to indicate the SecuriLock™ system is functioning as a theft deterrent.
- When the ignition is in the 4 (ON) position, the **THEFT** indicator will glow for 3 seconds, then turn off to indicate normal system functionality.

If a problem occurs with the SecuriLock™ system, the indicator will flash rapidly or glow steadily when the ignition is in the 4 (ON) position. If this occurs, the vehicle should be taken to an authorized dealer for service.

Automatic arming

The vehicle is armed immediately after switching the ignition to the 3 (OFF) position.

The **THEFT** indicator will flash every two seconds when the vehicle is armed.

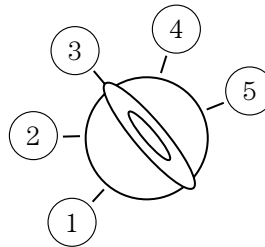

Automatic disarming

Switching the ignition to the 4 (ON) position with a **coded key** disarms the vehicle.

- The **THEFT** indicator will illuminate for three seconds and then go out.
- If the **THEFT** indicator stays on for an extended period of time or flashes rapidly, have the system serviced by your dealer.

Replacement keys

If your keys are lost or stolen and you don't have an extra coded key, you will need to have your vehicle towed to a dealership. The key codes need to be erased from your vehicle and new coded keys will need to be programmed.

Locks and Security

Replacing coded keys can be very costly. Store an extra programmed key away from the vehicle in a safe place to help prevent any inconveniences. Please visit an authorized dealer to purchase additional spare or replacement keys.

Programming spare keys

You can program your own coded keys to your vehicle. Please read and understand the entire procedure before you begin.

Tips:

- A maximum of eight keys can be coded to your vehicle.
- Only use Securilock[™] keys.
- You must have two previously programmed coded keys (keys that already operate your vehicle's engine) and the new unprogrammed key(s) readily accessible.
- If no previously programmed coded keys are available, you must take your vehicle to your dealer to have the spare key(s) programmed.

1. Insert a previously programmed coded key into the ignition.
2. Turn the ignition from the 3 (OFF) position to the 4 (ON) position. Keep the ignition in the 4 (ON) position for at least one second, but no more than 10 seconds.

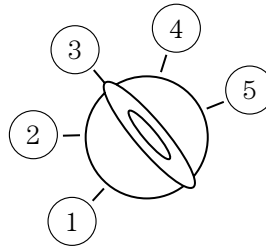

3. Turn the ignition to the 3 (OFF) position, and remove the coded key from the ignition.
4. Within ten seconds of removing the previously programmed coded key, insert the other previously programmed coded key into the ignition.
5. Turn the ignition from the 3 (OFF) position to the 4 (ON) position. Keep the ignition in the 4 (ON) position for at least one second but not more than 10 seconds.
6. Turn the ignition to the 3 (OFF) position, and remove the second key from the ignition.
7. Within twenty seconds of removing the previously programmed coded key, insert the unprogrammed key (new/valet key) into the ignition.
8. Turn the ignition from the 3 (OFF) position to the 4 (ON) position. Keep the ignition in the 4 (ON) position for at least one second.

Locks and Security

9. Your new unprogrammed key is now programmed.

If the key has been successfully programmed it will start the vehicle's engine and the theft indicator light will illuminate for three seconds and then go out. If the key was not successfully programmed, it will not start your vehicle's engine and the theft indicator light will flash on and off rapidly. If failure repeats, bring your vehicle to your dealer to have the new key(s) programmed.

To program additional new unprogrammed key(s), repeat this procedure from Step 1 for each additional key.

Seating and Safety Restraints

FRONT SEATS

Notes:



Reclining the seatback can cause an occupant to slide under the seat's safety belt, resulting in severe personal injuries in the event of a collision.



Do not pile cargo higher than the seatbacks to reduce the risk of injury in a collision or sudden stop.

Adjustable head restraints (if equipped)

Head restraints help to limit head motion in the event of a rear collision. The seats in your vehicle may have adjustable head restraints. Adjust your head restraint so that it is located directly or as close as possible behind your head.

To adjust the head restraint:

- Raise the head restraint by pulling it upward.

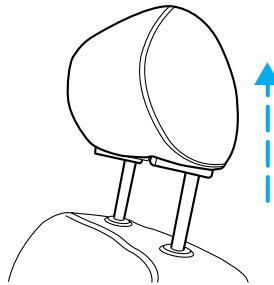

To lower the head restraint:

- Push the release control.
- Push down on the head restraint.

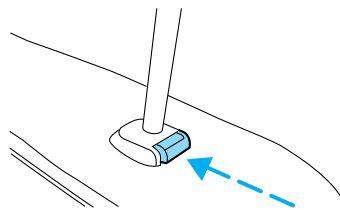

Seating and Safety Restraints

Adjusting the front manual seat

Pull the lever located at the front edge of the seat to move the seat forward or backward. Release the lever to lock the seat in place.

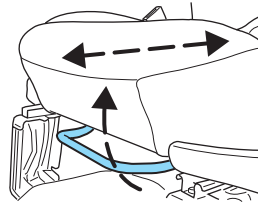

Adjusting the front power seat (if equipped)

The control is located on the outboard side of the seat cushion.

Press to raise or lower the front portion of the seat cushion.

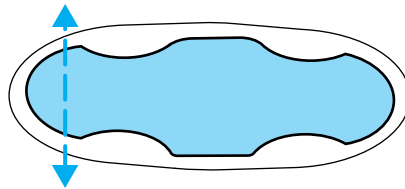

Press to raise or lower the rear portion of the seat cushion.

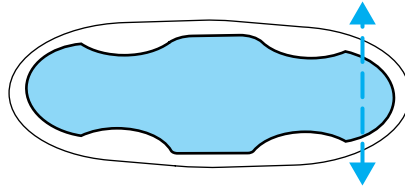

Press the control to move the seat forward, backward, up or down.

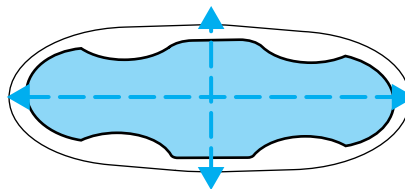

Seating and Safety Restraints

Reclining the seats

Pull the lever located on the outside of the seat to recline the seatback. Release the lever to lock the seatback in place.

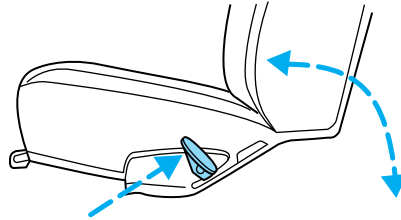

Reclining the seatback can cause an occupant to slide under the seat's safety belt, resulting in severe personal injuries in the event of a collision.



Never adjust the driver's seat or seatback when the vehicle is moving.

Power lumbar (if equipped)

Depress the button forward to inflate, or rearward to deflate.

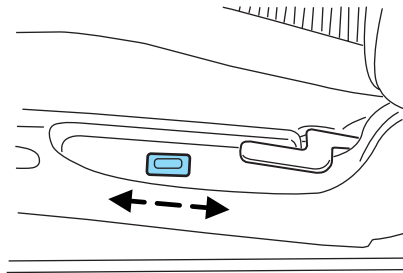

Seating and Safety Restraints

Heated seats (if equipped)

To operate the heated seats:

- Push control to activate.
- Push again to deactivate.



The system will not automatically shutoff unless the control is pushed again to deactivate. If the system is not manually terminated at last use, then the system will remain active at the next ignition key cycle.

REAR SEATS

Adjustable rear head restraints

Lift the head restraint so that it is located directly or as close as possible behind your head.

Push or pull the head restraint to the desired position.

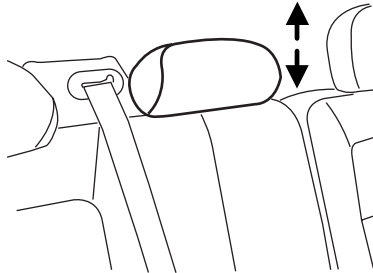

Seating and Safety Restraints

Folding down rear 60/40 seats

1. Raise the rear seat head restraint.

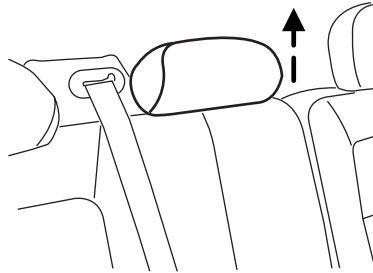

2. Flip the bottom of the head restraint up, toward the front seat.

Note: Rotate center head restraint in opposite direction (in order to clear center console in fold down position).

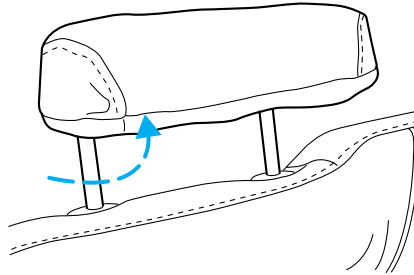

3. While holding the head restraint in a “flat” position, lower the head restraint to the seat back.

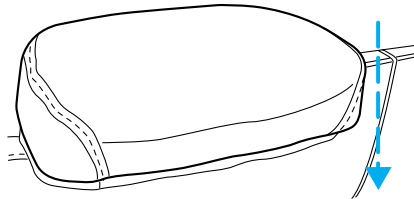

4. Flip the seat release control toward the front seat.

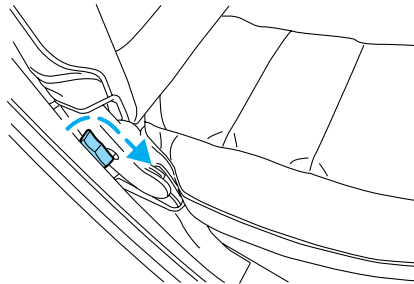

Seating and Safety Restraints

5. The seat will automatically fall forward. For 40% seat move the handle and push the seat forward to fold. For Adrenalin vehicles, the 40 percent rear seat (behind the driver) does not fold due to the subwoofer location. See *Attaching child safety seats with tether straps* in this chapter for tether access behind this seat.

Note: To prevent possible damage to the seat or safety belts, ensure that the safety belts are not buckled when folding the seat.

A carpeted panel will flip down from the back panel to complete the load floor.

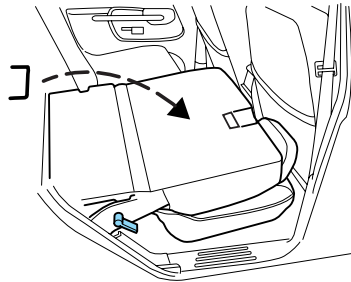
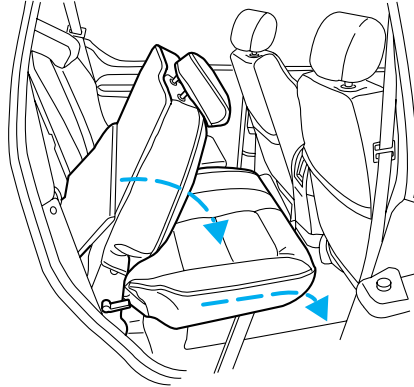

Returning the rear 60/40 seats to upright position

1. Push down seatback release control and pull seatback up and into upright position making sure seatback locks into place.

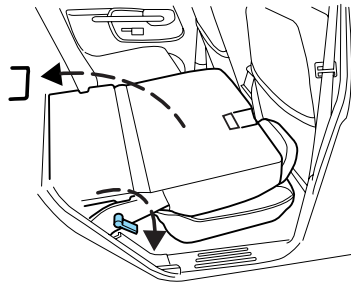

2. Pull head restraint up and return to upright position.

Seating and Safety Restraints

SAFETY RESTRAINTS

Personal Safety System

The Personal Safety System provides an improved overall level of frontal crash protection to front seat occupants and is designed to help further reduce the risk of air bag-related injuries. The system is able to analyze different occupant conditions and crash severity before activating the appropriate safety devices to help better protect a range of occupants in a variety of frontal crash situations.

Your vehicle's Personal Safety System consists of:

- driver and passenger air bag modules (which include the inflators and air bags)
- front safety belts with pretensioners and energy management retractors.
- front safety belt usage sensors
- one or more impact and safing sensors
- a readiness light and tone
- a diagnostic module
- and the electrical wiring which connects the components

How does the personal safety system work?

The Personal Safety System can adapt the deployment strategy of your vehicle's safety devices according to crash severity and occupant conditions. A collection of crash and occupant sensors provides information to the Restraints Control Module (RCM). During a crash, the RCM activates the safety belt pretensioners and air bag supplemental restraints based on crash severity and occupant conditions.

The fact that the pretensioners or air bags did not activate for both front seat occupants in a collision does not mean that something is wrong with the system. Rather, it means the Personal Safety System determined the accident conditions (crash severity, belt usage, etc.) were not appropriate to activate these safety devices. Front air bags are designed to activate only in frontal and near-frontal collisions, not rollovers, side-impacts, or rear-impacts unless the collision causes sufficient longitudinal deceleration.

Front crash severity sensor

The front crash severity sensor enhances the ability to detect the severity of an impact. Positioned up front, it provides valuable

Seating and Safety Restraints

information early in the crash event on the severity of the impact. This allows your Personal Safety System to distinguish between different levels of crash severity and modify the deployment strategy of the air bags and safety belt pretensioners.

Front safety belt usage sensors

The front safety belt usage sensors detect whether or not the driver and front outboard passenger safety belts are fastened. This information allows your Personal Safety System to tailor the air bag deployment and safety belt pretensioner activation depending upon safety belt usage. Refer to *Safety Belt* section in this chapter.

Front safety belt pretensioners

The front outboard safety belt pretensioners are designed to tighten the safety belts firmly against the occupant's body during a collision. This maximizes the effectiveness of the safety belts and helps properly position the occupant relative to the air bag to improve protection. The safety belt pretensioners can be either activated alone or, if the collision is of sufficient severity, together with the air bags.

Front safety belt energy management retractors

The front outboard safety belt energy management retractors allow webbing to be pulled out of the retractor in a gradual and controlled manner in response to the occupant's forward momentum. This helps reduce the risk of force-related injuries to the occupant's chest by limiting the load on the occupant. Refer to *Safety Belt* section in this chapter.

Determining if the Personal Safety System is operational

The Personal Safety System uses a warning light in the instrument cluster or a back-up tone to indicate the condition of the system. Refer to the *Warning Light* section in the *Instrument Cluster* chapter. Routine maintenance of the Personal Safety System is not required.

The Restraints Control Module (RCM) monitors its own internal circuits and the circuits for the air bag supplemental restraints, crash sensor(s), safety belt pretensioners, and front safety belt buckle sensors. In addition, the RCM also monitors the restraints warning light in the instrument cluster. A difficulty with the system is indicated by one or more of the following:

- The warning light will either flash or stay lit.
- The warning light will not illuminate immediately after the ignition is turned on.

Seating and Safety Restraints

- A series of five beeps will be heard. The tone pattern will repeat periodically until the problem and warning light are repaired. If any of these things happen, even intermittently, have the Personal Safety System serviced at your dealership or by a qualified technician immediately. Unless serviced, the system may not function properly in the event of a collision.

Safety restraints precautions



Always drive and ride with your seatback upright and the lap belt snug and low across the hips.



To reduce the risk of injury, make sure children sit where they can be properly restrained.



Never let a passenger hold a child on his or her lap while the vehicle is moving. The passenger cannot protect the child from injury in a collision.



All occupants of the vehicle, including the driver, should always properly wear their safety belts, even when an air bag supplemental restraint system (SRS) is provided.



It is extremely dangerous to ride in a cargo area, inside or outside of a vehicle. In a collision, people riding in these areas are more likely to be seriously injured or killed. Do not allow people to ride in any area of your vehicle that is not equipped with seats and safety belts. Be sure everyone in your vehicle is in a seat and using a safety belt properly.



In a rollover crash, an unbelted person is significantly more likely to die than a person wearing a safety belt.



Each seating position in your vehicle has a specific safety belt assembly which is made up of one buckle and one tongue that are designed to be used as a pair. 1) Use the shoulder belt on the outside shoulder only. Never wear the shoulder belt under the arm. 2) Never swing the safety belt around your neck over the inside shoulder. 3) Never use a single belt for more than one person.

Seating and Safety Restraints



Always transport children 12 years old and under in the back seat and always properly use appropriate child restraints.



Safety belts and seats can become hot in a vehicle that has been closed up in sunny weather; they could burn a small child. Check seat covers and buckles before you place a child anywhere near them.

Energy Management Feature

- This vehicle has a safety belt system with an energy management feature at the front seating positions to help further reduce the risk of injury in the event of a head-on collision.
- The front outboard safety belt system has a retractor assembly that is designed to extend the seat belt webbing in a controlled manner. This helps reduce the belt force acting on the user's chest.



BELT AND RETRACTOR ASSEMBLY MUST BE REPLACED if the safety belt assembly automatic locking retractor feature or any other safety belt function is not operating properly when checked according to the procedures in Workshop Manual. Failure to replace the Belt and Retractor assembly could increase the risk of injury in collisions.

Combination lap and shoulder belts

1. Insert the belt tongue into the proper buckle (the buckle closest to the direction the tongue is coming from) until you hear a snap and feel it latch. Make sure the tongue is securely fastened in the buckle.

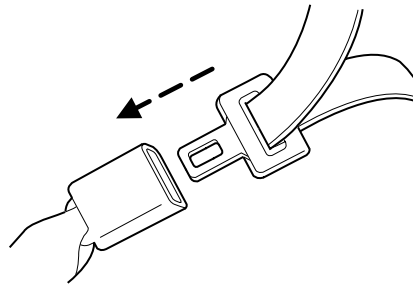

Seating and Safety Restraints

2. To unfasten, push the release button and remove the tongue from the buckle.

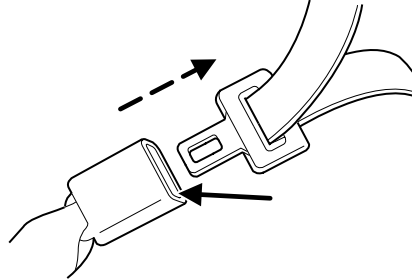

The front and rear outboard safety restraints in the vehicle are combination lap and shoulder belts. The front passenger and rear seat outboard safety belts have two types of locking modes described below:

Vehicle sensitive mode

This is the normal retractor mode, which allows free shoulder belt length adjustment to your movements and locking in response to vehicle movement. For example, if the driver brakes suddenly or turns a corner sharply, or the vehicle receives an impact of approximately 8 km/h (5 mph) or more, the combination safety belts will lock to help reduce forward movement of the driver and passengers.

Automatic locking mode

How to use the automatic locking mode

- Buckle the combination lap and shoulder belt.

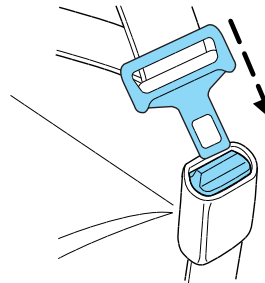

Seating and Safety Restraints

- Grasp the shoulder portion and pull downward until the entire belt is extracted.



- Allow the belt to retract. As the belt retracts, you will hear a clicking sound. When you hear the clicking sound, the safety belt is now in the automatic locking mode.

How to disengage the automatic locking mode

Disconnect the combination lap/shoulder belt and allow it to retract completely to disengage the automatic locking mode and activate the vehicle sensitive (emergency) locking mode.

 After any vehicle collision, the safety belt systems at all outboard seating positions (except the driver position, which doesn't have this feature) must be checked by a qualified technician to verify that the automatic locking retractor feature for child seats is still functioning properly. In addition, all seat belts should be checked for proper function.

 **BELT AND RETRACTOR ASSEMBLY MUST BE REPLACED** if the seat belt assembly “automatic locking retractor” feature or any other seat belt function is not operating properly when checked according to the procedures in Workshop Manual. Failure to replace the Belt and Retractor assembly could increase the risk of injury in collisions.

In this mode, the shoulder belt is automatically pre-locked. The belt will still retract to remove any slack in the shoulder belt. The automatic locking mode is not available on the driver safety belt.

This mode should be used **any time** a child safety seat is installed in a passenger front or outboard rear seating position (if equipped). Children 12 years old and under should be properly restrained in the rear seat whenever possible. Refer to *Safety restraints for children* or *Safety seats for children* later in this chapter.

Seating and Safety Restraints

Front safety belt height adjustment

Adjust the height of the shoulder belt so the belt rests across the middle of your shoulder.

To adjust the shoulder belt height, push the button and slide the height adjuster up or down. Release the button and pull down on the height adjuster to make sure it is locked in place.

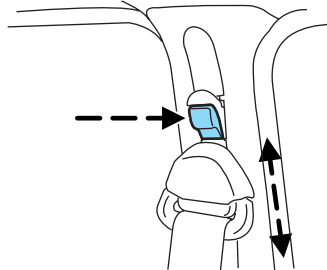

Position the safety belt height adjusters so that the belt rests across the middle of your shoulder. Failure to adjust the safety belt properly could reduce the effectiveness of the seat belt and increase the risk of injury in a collision.

Safety belt pretensioner

Your vehicle is equipped with safety belt pretensioners at the driver and right front passenger seating positions.

The safety belt pretensioner removes some slack from the safety belt system at the start of a crash. The safety belt pretensioner uses the same crash sensor system as the front airbags and Safety Canopy[™] system. When the safety belt pretensioner deploys, the lap and shoulder belt are tightened.

When the Safety Canopy[™] system (if equipped) and/or the front airbags are activated, the safety belt pretensioners for the driver and right front passenger seating positions will be activated when the respective seatbelt is properly buckled.



The driver and the right front passenger seat belt system (including retractors, buckles and height adjusters) must be replaced if the vehicle is involved in a collision that results in deployment of front air bags or Safety Canopy[™] and safety belt pretensioners.

Refer to the *Safety belt maintenance* section in this chapter.

Seating and Safety Restraints

Safety belt warning light and indicator chime

The seat belt warning light illuminates in the instrument cluster and a chime sounds to remind the occupants to fasten their safety belts.

Conditions of operation

| If... | Then... |
|---|---|
| The driver's safety belt is not buckled before the ignition switch is turned to the ON position... | The safety belt warning light illuminates 1-2 minutes and the warning chime sounds 4-8 seconds. |
| The driver's safety belt is buckled while the indicator light is illuminated and the warning chime is sounding... | The safety belt warning light and warning chime turn off. |
| The driver's safety belt is buckled before the ignition switch is turned to the ON position... | The safety belt warning light and indicator chime remain off. |

BeltMinder

The BeltMinder feature is a supplemental warning to the safety belt warning function. This feature provides additional reminders to the driver that the driver's safety belt is unbuckled by intermittently sounding a chime and illuminating the safety belt warning lamp in the instrument cluster.

| If... | Then... |
|--|---|
| The driver's safety belt is not buckled before the vehicle has reached at least 3 mph (5 km/h) and 1-2 minutes have elapsed since the ignition switch has been turned to ON... | The BeltMinder feature is activated - the safety belt warning light illuminates and the warning chime sounds for 6 seconds every 30 seconds, repeating for approximately 5 minutes or until safety belt is buckled. |
| The driver's safety belt is buckled for 20 seconds or longer... | The BeltMinder feature is re-activated. |

Seating and Safety Restraints

| If... | Then... |
|---|---|
| The driver's safety belt is buckled while the safety belt indicator light is illuminated and the safety belt warning chime is sounding... | The BeltMinder feature will not activate. |
| The driver's safety belt is buckled before the ignition switch is turned to the ON position... | The BeltMinder feature will not activate. |

The following are reasons most often given for not wearing safety belts:
(All statistics based on U.S. data)

| Reasons given... | Consider... |
|---------------------------|--|
| "Crashes are rare events" | 36700 crashes occur every day. The more we drive, the more we are exposed to "rare" events, even for good drivers. <i>1 in 4 of us will be seriously injured in a crash during our lifetime.</i> |
| "I'm not going far" | 3 of 4 fatal crashes occur within 25 miles of home. |
| "Belts are uncomfortable" | We design our safety belts to enhance comfort. If you are uncomfortable - try different positions for the safety belt upper anchorage and seatback which should be as upright as possible; this can improve comfort. |
| "I was in a hurry" | Prime time for an accident. BeltMinder reminds us to take a few seconds to buckle up. |
| "Seat belts don't work" | Safety belts , when used properly, reduce risk of death to front seat occupants by 45% in cars , and by 60% in light trucks . |
| "Traffic is light" | Nearly 1 of 2 deaths occur in single-vehicle crashes , many when no other vehicles are around. |

Seating and Safety Restraints

| Reasons given... | Consider... |
|--|---|
| “Belts wrinkle my clothes” | Possibly, but a serious crash can do much more than wrinkle your clothes, particularly if you are unbelted. |
| “The people I’m with don’t wear belts” | Set the example, teen deaths occur 4 times more often in vehicles with TWO or MORE people. Children and younger brothers/sisters imitate behavior they see. |
| “I have an air bag” | Air bags offer greater protection when used with safety belts. Frontal airbags are not designed to inflate in rear and side crashes or rollovers. |
| “I’d rather be thrown clear” | Not a good idea. People who are ejected are 40 times more likely to DIE . Safety belts help prevent ejection, WE CAN’T “PICK OUR CRASH”. |

 Do not sit on top of a buckled safety belt to avoid the Belt Minder chime. Sitting on the safety belt will increase the risk of injury in an accident. To disable (one-time) or deactivate the Belt Minder feature please follow the directions stated below.

One time disable

Any time the safety belt is buckled and then unbuckled during an ignition ON cycle, BeltMinder will be disabled for that ignition cycle only.

Deactivating/activating the BeltMinder feature (driver’s side)- Late Availability

Read steps 1 - 4 thoroughly before proceeding with the deactivation/activation programming procedure.

The BeltMinder feature can be deactivated/activated by performing the following procedure:

Before following the procedure, make sure that:

- The parking brake is set
- The gearshift is in P (Park) (automatic transmission)
- The ignition switch is in the OFF position
- The driver and passenger safety belt is unbuckled

90

Seating and Safety Restraints



To reduce the risk of injury, do not deactivate/activate the Belt Minder feature while driving the vehicle.

1. Turn the ignition switch to the RUN (or ON) position. (DO NOT START THE ENGINE)
2. Wait until the safety belt warning light turns off. (Approximately 1 minute)
 - Step 3 must be completed within 50 seconds after the safety belt warning light turns off.
3. Buckle then unbuckle the safety belt on the driver's side 9 times, ending in the unbuckled state. (Step 3 must be completed within 50 seconds after the safety belt warning light turns off.)
 - After step 3, the restraint system warning light (airbag light) will be turned on for three seconds.
4. Within 10 seconds of the light turning on, buckle then unbuckle the safety belt once.
 - This will disable the BeltMinder feature if it is currently enabled. As confirmation, the restraint system warning light will flash 4 times per second for 3 seconds.
 - This will enable the BeltMinder feature if it is currently disabled. As confirmation, the restraint system warning light will flash 4 times per second for 3 seconds, followed by 3 seconds with the light off, then followed by the restraint system warning light flashing 4 times per second for 3 seconds again.

Safety belt extension assembly

If the safety belt is too short when fully extended, there is an 8 inch (20 cm) safety belt extension assembly that can be added (part number 611C22). This assembly can be obtained from your dealer at no cost.

Use only extensions manufactured by the same supplier as the safety belt. Manufacturer identification is located at the end of the webbing on the label. Also, use the safety belt extension only if the safety belt is too short for you when fully extended.



Do not use extensions to change the fit of the shoulder belt across the torso.

Safety belt maintenance

Inspect the safety belt systems periodically to make sure they work properly and are not damaged (nicks, tears or cuts). Replace parts as

Seating and Safety Restraints

necessary. All safety belt assemblies, including retractors, buckles, front seat belt buckle assemblies, buckle support assemblies (slide bar-if equipped), shoulder belt height adjusters (if equipped), shoulder belt guide on seatback (if equipped), child safety seat tether bracket assemblies (if equipped), LATCH child seat tether anchors and lower anchors (if equipped), and attaching hardware, should be inspected after a collision. Ford Motor Company recommends that all safety belt assemblies in use in vehicles involved in a collision be replaced. However, if the collision was minor and a qualified technician finds that the belts do not show damage and continue to operate properly, they do not need to be replaced. Safety belt assemblies not in use during a collision should also be inspected and replaced if either damage or improper operation is noted.



Failure to inspect and if necessary replace the safety belt assembly under the above conditions could result in severe personal injuries in the event of a collision.

Refer to *Interior* in the *Cleaning* chapter.

AIR BAG SUPPLEMENTAL RESTRAINT SYSTEM (SRS)

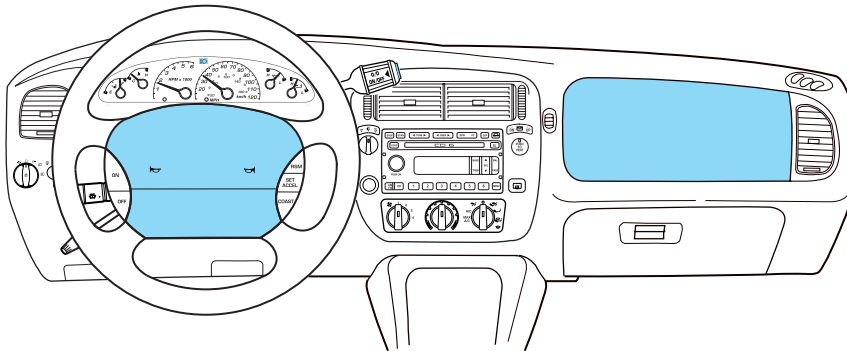



Your vehicle is equipped with a crash sensing and diagnostic module which records information about the air bag and sensor systems. In the event of a collision this module may save information related to the collision including information about the air bag system and impact severity. This information will assist Ford Motor Company in servicing the vehicle and in helping to better understand real world collisions and further improve the safety of future vehicles.

Seating and Safety Restraints

Important SRS precautions

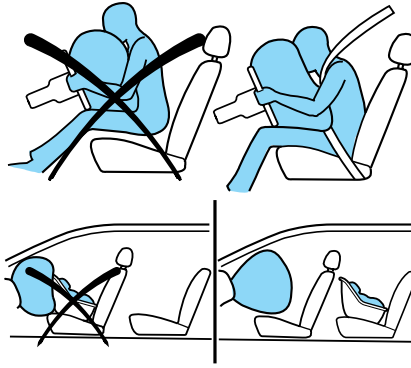
The SRS is designed to work with the safety belt to help protect the driver and right front passenger from certain upper body injuries. Air bags DO NOT inflate slowly; there is a risk of injury from a deploying air bag.



 All occupants of the vehicle, including the driver, should always properly wear their safety belts, even when an air bag supplemental restraint system (SRS) is provided.

 Always transport children 12 years old and under in the back seat and always properly use appropriate child restraints.

 National Highway Traffic Safety Administration (NHTSA) recommends a minimum distance of at least 10 inches (25 cm) between an occupant's chest and the air bag module.

 Never place your arm over the air bag module as a deploying air bag can result in serious arm fractures or other injuries.

To properly position yourself away from the air bag:

- Move your seat to the rear as far as you can while still reaching the pedals comfortably.
- Recline the seat slightly one or two degrees from the upright position.

 Do not put anything on or over the air bag module. Placing objects on or over the air bag inflation area may cause those objects to be propelled by the air bag into your face and torso causing serious injury.

Seating and Safety Restraints

 Do not attempt to service, repair, or modify the air bag supplemental restraint systems or its fuses. See your Ford or Lincoln Mercury dealer.

 Modifying or adding equipment to the front end of the vehicle (including frame, bumper, front end body structure and tow hooks) may affect the performance of the air bag system, increasing the risk of injury. Do not modify the front end of the vehicle.

Children and air bags

Children must always be properly restrained; accident statistics suggest that children are safer when properly restrained in the rear seating positions than in the front seating position. Failure to follow these instructions may increase the risk of injury in a collision.

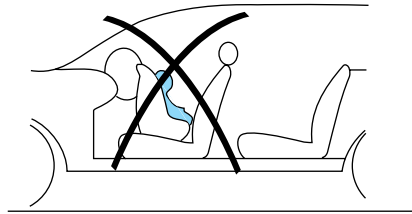

 Air bags can kill or injure a child in a child seat. **NEVER** place a rear-facing child seat in front of an active air bag. If you must use a forward-facing child seat in the front seat, move the seat all the way back.

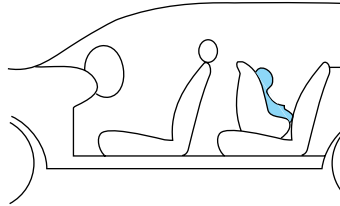

Seating and Safety Restraints

How does the air bag supplemental restraint system work?

The air bag SRS is designed to activate when the vehicle sustains a longitudinal deceleration sufficient to cause the air bag sensors to close an electrical circuit that initiates air bag inflation. The fact that the air bags did not inflate in a collision does not mean that something is wrong with the system. Rather, it means the forces were not sufficient enough to cause activation. Front air bags are designed to inflate in frontal and near-frontal collisions, not rollover, side-impact, or rear-impacts unless the collision causes sufficient longitudinal deceleration.

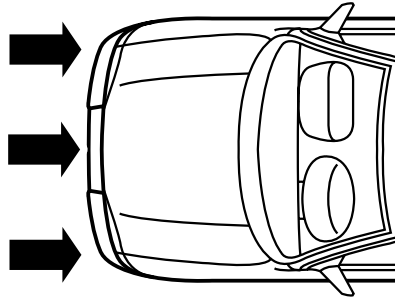

The air bags inflate and deflate rapidly upon activation. After air bag deployment, it is normal to notice a smoke-like, powdery residue or smell the burnt propellant. This may consist of cornstarch, talcum powder or sodium compounds which may irritate the skin and eyes, but none of the residue is toxic.



While the SRS is designed to help reduce serious injuries, contact with a deploying air bag may also cause abrasions, swelling or temporary hearing loss. Because air bags must inflate rapidly and with considerable force, there is the risk of death or serious injuries such as fractures, facial and eye injuries or internal injuries, particularly to occupants who are not properly restrained or are otherwise out of position at the time of air bag deployment. It is extremely important that occupants be properly restrained as far away from the air bag module as possible while maintaining vehicle control.

The SRS consists of:

- driver and passenger air bag modules (which include the inflators and air bags)

Seating and Safety Restraints

- one or more impact and safing sensors
- a readiness light and tone
- a diagnostic module
- and the electrical wiring which connects the components

The RCM (restraints control module) monitors its own internal circuits and the supplemental air bag electrical system wiring (including the impact sensors, the system wiring, the air bag system readiness light, the air bag back up power and the air bag ignitors).



Several air bag system components get hot after inflation. Do not touch them after inflation.



If the air bag has deployed, **the air bag will not function again and must be replaced immediately.** If the air bag is not replaced, the unrepaired area will increase the risk of injury in a collision.

Determining if the system is operational

The SRS uses a readiness light in the instrument cluster or a tone to indicate the status of the system. Refer to *Air bag readiness* section in the *Instrument cluster* chapter. Routine maintenance of the air bag is not required.

A difficulty with the system is indicated by one or more of the following:

- The readiness light will either flash or stay lit.
- The readiness light will not illuminate immediately after ignition is turned on.
- A series of five beeps will be heard. The tone pattern will repeat periodically until the problem and/or light are repaired.





If any of these things happen, even intermittently, have the SRS serviced at your dealership or by a qualified technician immediately. Unless serviced, the system may not function properly in the event of a collision.

Seating and Safety Restraints

SAFETY CANOPY™ SYSTEM (IF EQUIPPED)

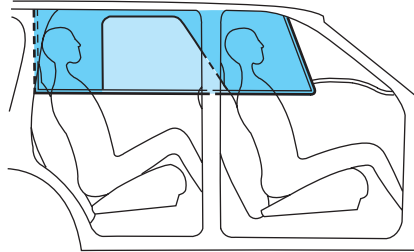
 Do not place objects or mount equipment on or near the headliner at the siderail that may come into contact with a deploying Safety Canopy™. Failure to follow these instructions may increase the risk of personal injury in the event of a collision.



 Do not lean your head on the door. The Safety Canopy™ could injure you as it deploys from the headliner.

 Do not attempt to service, repair, or modify the Safety Canopy™ system, its fuses, the A, B, or C pillar trim, or the headliner on a vehicle containing a Safety Canopy™. See your Ford or Lincoln Mercury dealer.

 All occupants of the vehicle including the driver should always wear their safety belts even when an air bag SRS and Safety Canopy™ system is provided.

 To reduce risk of injury, do not obstruct or place objects in the deployment path of the inflatable Safety Canopy™.

Seating and Safety Restraints

How does the Safety Canopy™ system work?

The design and development of the Safety Canopy™ system included recommended testing procedures that were developed by a group of automotive safety experts known as the Side Air Bag Technical Working Group. These recommended testing procedures help reduce the risk of injuries related to the deployment of side airbags (including the Safety Canopy™).

The Safety Canopy™ system consists of the following:

- An inflatable nylon curtain with a gas generator concealed behind the headliner and above the doors (one on each side of vehicle).
- A headliner designed to flex open above the side doors to allow Safety Canopy™ deployment.
- The same warning light, electronic control and diagnostic unit as used for the front airbags.
- Two crash sensors mounted in the b-pillars (one on each side).
- Two crash sensors located at the c-pillar (one on each side).
- Rollover sensor in the restraints control module (RCM).

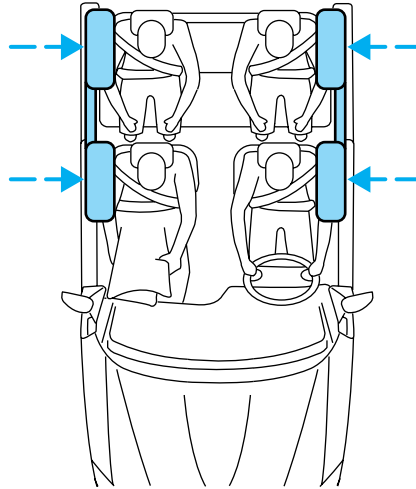

The Safety Canopy™ system, in combination with seat belts, can help reduce the risk of severe injuries in the event of a significant side impact collision or rollover event.

Children 12 years old and under should always be properly restrained in the rear seats. The Safety Canopy™ will not interfere with children restrained using a properly installed child or booster seat because it is designed to inflate downward from the headliner above the doors along the side window opening.

The Safety Canopy™ system is designed to activate when the vehicle sustains lateral deceleration sufficient to cause the side crash sensor to close an electrical circuit that initiates Safety Canopy™ inflation or when a certain likelihood of a rollover event is detected by the rollover sensor.

The Safety Canopy™ is mounted to roof side-rail sheet metal, behind the headliner, above the first and second row seats. In certain lateral

Seating and Safety Restraints

collisions or rollover events, the Safety Canopy™ system will be activated on both sides of the vehicle, regardless of which seats are occupied. The Safety Canopy™ is designed to inflate between the side window area and occupants to further enhance protection provided in side impact collisions and rollover events.

The fact that the Safety Canopy™ did not activate in a collision does not mean that something is wrong with the system. Rather, it means the forces were not of the type sufficient to cause activation. The Safety Canopy™ is designed to inflate in certain side impact collisions or rollover events, not in rear impact, frontal or near-frontal collisions, unless the collision causes sufficient lateral deceleration or rollover likelihood.



Several Safety Canopy™ system components get hot after inflation. Do not touch them after inflation.



If the Safety Canopy™ system has deployed, **the Safety Canopy™ will not function again unless replaced. The Safety Canopy™ system (including the A, B and C pillar trim) must be inspected and serviced by a qualified technician in accordance with the vehicle service manual.** If the Safety Canopy™ is not replaced, the unrepaired area will increase the risk of injury in a collision.

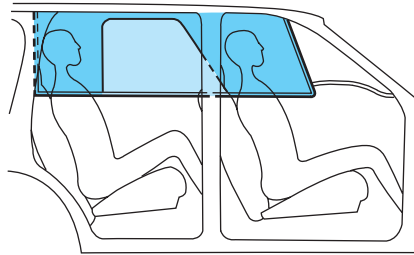

Determining if the system is operational

The SRS uses a readiness light in the instrument cluster or a tone to indicate the condition of the system. Refer to the *Air bag readiness* section in the *Instrument Cluster* chapter. Routine maintenance of the air bag is not required.

Seating and Safety Restraints

Any difficulty with the system is indicated by one or more of the following:

- The readiness light (same light as for front air bag system) will either flash or stay lit.
- The readiness light will not illuminate immediately after ignition is turned on.
- A series of five beeps will be heard. The tone pattern will repeat periodically until the problem and light are repaired.

If any of these things happen, even intermittently, have the SRS serviced at your dealership or by a qualified technician immediately. Unless serviced, the system may not function properly in the event of a collision or rollover event.

Disposal of air bags and air bag equipped vehicles (including pretensioners)

See your local dealership or qualified technician. Air bags **MUST BE** disposed of by qualified personnel.

SAFETY RESTRAINTS FOR CHILDREN

Read the following sections for directions on how to properly use safety restraints for children. Also see *Air bag supplemental restraint system (SRS)* in this chapter for special instructions about air bags.

Important child restraint precautions

You are required by law to use safety restraints for children in the U.S. and Canada. If small children (generally children who are four years old or younger and who weigh 40 lbs [18 kg] or less) ride in your vehicle, you must put them in safety seats made especially for children. Many states require that children use approved booster seats until they are eight years old. Check your local and state or provincial laws for specific requirements regarding the safety of children in your vehicle. When possible, always place children under age 12 in the rear seat of your vehicle. Accident statistics suggest that children are safer when properly restrained in the rear seating positions than in the front seating position.



Never let a passenger hold a child on his or her lap while the vehicle is moving. The passenger cannot protect the child from injury in a collision.

Always follow the instructions and warnings that come with any infant or child restraint you might use.

Seating and Safety Restraints

Children and safety belts

If the child is the proper size, restrain the child in a safety seat. Children who are too large for child safety seats (as specified by your child safety seat manufacturer) should always wear safety belts.

Follow all the important safety restraint and air bag precautions that apply to adult passengers in your vehicle.



Do not leave children, unreliable adults, or pets unattended in your vehicle.

To improve the fit of lap and shoulder belts on children who have outgrown child safety seats, Ford recommends use of a belt-positioning booster seat that is labeled as conforming to all applicable Federal motor vehicle safety standards. Belt-positioning booster seats raise the child and provide a shorter, firmer seating cushion that encourages safer seating posture and better fit of lap and shoulder belts on the child.

A belt-positioning booster seat should be used if the shoulder belt rests in front of the child's face or neck, or if the lap belt does not fit snugly on both thighs, or if the thighs are too short to let the child sit all the way back on the seat cushion when the lower legs hang over the edge of the seat cushion. You may wish to discuss the special needs of your child with your pediatrician.

Child booster seats

Children outgrow a typical convertible or toddler seat when they weigh 40 pounds (18 kg) and are around 4 years of age. Although the lap/shoulder belt will provide some protection, these children are still too small for lap/shoulder belts to fit properly, which could increase the risk of serious injury.

To improve the fit of both the lap and shoulder belt on children who have outgrown child safety seats, Ford Motor Company recommends use of a belt-positioning booster.

Booster seats position a child so that safety belts fit better. They lift the child up so that the lap belt rests low across the hips and the knees bend comfortably. Booster seats also make the shoulder belt fit better and more comfortably for growing children.

When children should use booster seats

Children need to use booster seats from the time they outgrow the toddler seat until they are big enough for the vehicle seat and lap/shoulder belt to fit properly. Generally this is when they weigh about 80 lbs (36 kg) (about 8 to 12 years old).

Seating and Safety Restraints

Booster seats should be used until you can answer YES to ALL of these questions:

- Can the child sit all the way back against the vehicle seat back with knees bent comfortably at the edge of the seat without slouching?

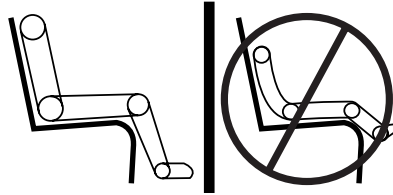

- Does the lap belt rest low across the hips?
- Is the shoulder belt centered on the shoulder and chest?
- Can the child stay seated like this for the whole trip?

Types of booster seats

There are two types of belt-positioning booster seats:

- Those that are backless.

If your backless booster seat has a removable shield, remove the shield and use the lap/shoulder belt. If a seating position has a low seat back and no head restraint, a backless booster seat may place your child's head (top of ear level) above the top of the seat. In this case, move the backless booster to another seating position with a higher seat back and lap/shoulder belts.

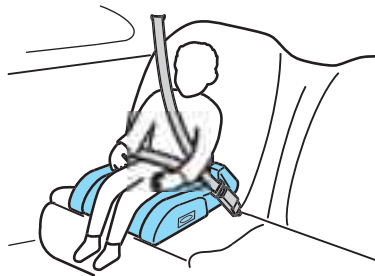

- Those with a high back.

If, with a backless booster seat, you cannot find a seating position that adequately supports your child's head, a high back booster seat would be a better choice.



Both can be used in any vehicle in a seating position equipped with lap/shoulder belts if your child is over 40 lbs (18 kg).

Seating and Safety Restraints

The shoulder belt should cross the chest, resting snugly on the center of the shoulder. The lap belt should rest low and snug across the hips, never up high across the stomach.

If the booster seat slides on the vehicle seat, placing a rubberized mesh sold as shelf or carpet liner under the booster seat may improve this condition.

The importance of shoulder belts

Using a booster without a shoulder belt increases the risk of a child's head hitting a hard surface in a collision. For this reason, you should never use a booster seat with a lap belt only. It is best to use a booster seat with lap/shoulder belts in the back seat- the safest place for children to ride.



Follow all instructions provided by the manufacturer of the booster seat.



Never put the shoulder belt under a child's arm or behind the back because it eliminates the protection for the upper part of the body and may increase the risk of injury or death in a collision.



Never use pillows, books, or towels to boost a child. They can slide around and increase the likelihood of injury or death in a collision.

SAFETY SEATS FOR CHILDREN

Child and infant or child safety seats

Use a safety seat that is recommended for the size and weight of the child. Carefully follow all of the manufacturer's instructions with the safety seat you put in your vehicle. If you do not install and use the safety seat properly, the child may be injured in a sudden stop or collision.

Seating and Safety Restraints

When installing a child safety seat:

- Review and follow the information presented in the *Air Bag Supplemental Restraint System (SRS)* section in this chapter.
- Use the correct safety belt buckle for that seating position (the buckle closest to the direction the tongue is coming from).
- Insert the belt tongue into the proper buckle until you hear a snap and feel it latch. Make sure the tongue is securely fastened in the buckle.
- Keep the buckle release button pointing up and away from the safety seat, with the tongue between the child seat and the release button, to prevent accidental unbuckling.
- Place seat back in upright position.
- Put the safety belt in the automatic locking mode. Refer to *Automatic locking mode* (passenger side front and outboard rear seating positions) (if equipped) section in this chapter.
- LATCH lower anchors are recommended for use by children up to 48 pounds (22 kg) in a child restraint. Top tether anchors can be used for children up to 60 pounds (27 kg) in a child restraint, and to provide upper torso restraint for children up to 80 pounds (36 kg) using an upper torso harness and a belt-positioning booster.

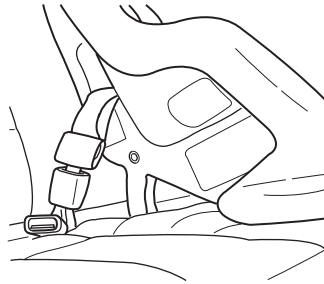

Ford recommends the use of a child safety seat having a top tether strap. Install the child safety seat in a seating position with LATCH and tether anchors. For more information on top tether straps and anchors, refer to *Attaching safety seats with tether straps* in this chapter. For more information of LATCH anchors refer to *Attaching safety seats with LATCH (Lower Anchors and Tethers for Children) attachments* in this chapter.



Carefully follow all of the manufacturer's instructions included with the safety seat you put in your vehicle. If you do not install and use the safety seat properly, the child may be injured in a sudden stop or collision.

Seating and Safety Restraints

Installing child safety seats in combination lap and shoulder belt seating positions

 Air bags can kill or injure a child in a child seat. **NEVER** place a rear-facing child seat in front of an active air bag. If you must use a forward-facing child seat in the front seat, move the seat all the way back.

 Children 12 and under should be properly restrained in the rear seat whenever possible.

1. Position the child safety seat in a seat with a combination lap and shoulder belt.

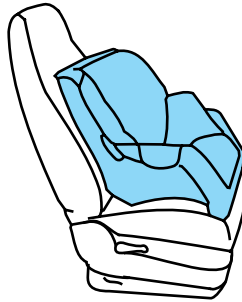

2. Pull down on the shoulder belt and then grasp the shoulder belt and lap belt together.

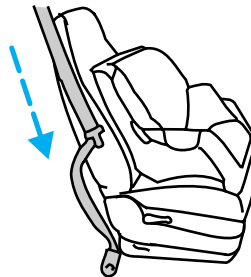

Seating and Safety Restraints

3. While holding the shoulder and lap belt portions together, route the tongue through the child seat according to the child seat manufacturer's instructions. Be sure the belt webbing is not twisted.

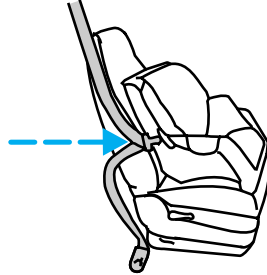

4. Insert the belt tongue into the proper buckle (the buckle closest to the direction the tongue is coming from) for that seating position until you hear a snap and feel the latch engage. Make sure the tongue is latched securely by pulling on it.

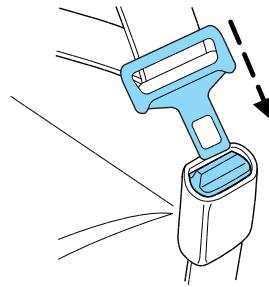

5. To put the retractor in the automatic locking mode, grasp the shoulder portion of the belt and pull downward until all of the belt is extracted and a click is heard.

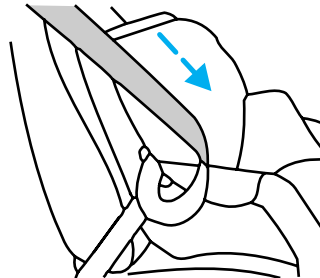

6. Allow the belt to retract. The belt will click as it retracts to indicate it is in the automatic locking mode.

Seating and Safety Restraints

7. Pull the lap belt portion across the child seat toward the buckle and pull up on the shoulder belt while pushing down with your knee on the child seat.

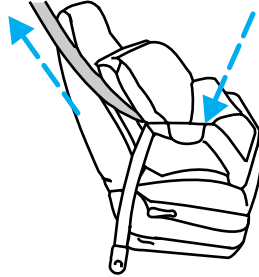

8. Allow the safety belt to retract to remove any slack in the belt.

9. Before placing the child in the seat, forcibly tilt the seat forward and back to make sure the seat is securely held in place. To check this, grab the seat at the belt path and attempt to move it side to side and forward and back. There should be no more than one inch of movement for proper installation.

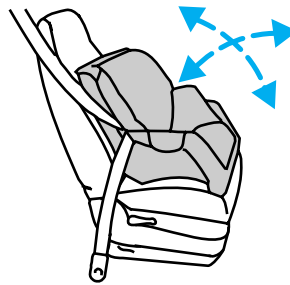

10. Try to pull the belt out of the retractor to make sure the retractor is in the automatic locking mode (you should not be able to pull more belt out). If the retractor is not locked, unbuckle the belt and repeat steps two through nine.

Check to make sure the child seat is properly secured before each use.

Installing child safety seat in the second row center seating position with an automatic locking retractor lap belt

1. Place the child safety seat in the center seating position.
2. In a continuous motion, pull out enough webbing from the retractor to route the tongue through the child seat.
3. While holding the webbing to prevent it from retracting, route the webbing through the child seat according to the child seat manufacturer's instructions. Be sure the belt webbing is not twisted.
4. Insert the tongue into the correct buckle for that seating position until you hear and feel the buckle engage. Make sure the buckle is latched securely by pulling on the webbing.

Seating and Safety Restraints

5. If you have not pulled out enough webbing to reach, allow the webbing to fully retract before attempting to pull it out again and repeat steps 2 through 4.
6. Pull the webbing through the child seat toward the retractor while pushing down with your knee on the child seat.
7. Allow the safety belt to retract to remove any slack in the belt. It will make a clicking noise while doing this.
8. Before placing the child in the seat, forcibly move the seat forward and side-to-side to make sure the seat is securely held in place.
9. Check to make sure the child seat is properly secured before each use.

Attaching child safety seats with tether straps

Most new forward-facing child safety seats include a tether strap which goes over the back of the seat and hooks to an anchoring point. Tether straps are available as an accessory for many older safety seats. Contact the manufacturer of your child seat for information about ordering a tether strap.

The rear seats of your vehicle are equipped with built-in tether strap anchors located behind the seats as described below.

The tether anchors in your vehicle are located behind sliding covers marked with the tether anchor symbol (shown with title).

The tether strap anchors in your vehicle are in the following positions (shown from top view):

 Attach the tether strap only to the appropriate tether anchor as shown. The tether strap may not work properly if attached somewhere other than the correct tether anchor.

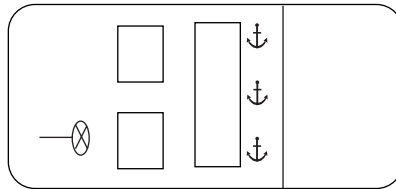

1. Position the child safety seat on the rear seat cushion.
2. Route the child safety seat tether strap over the back of the seat.

For vehicles with adjustable head restraints, route the tether strap under the head restraint and between the head restraint posts, otherwise route the tether strap over the top of the seatback.

Seating and Safety Restraints

3. Locate the correct anchor for the selected rear seating position. To install a tethered child seat in the fixed left rear seat of Adrenalin vehicles, fold the right/center seat back down so that you can reach around the back of the left seat with your left hand to attach the tether hook onto the anchor.

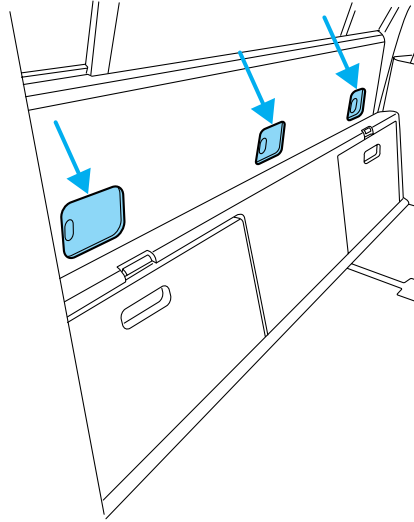

- You may need to pull the seatback forward to access the tether anchors. Make sure the seat is locked in the upright position before installing the child seat. Refer to the *Folding Down The Rear Seats* section in this chapter for information on how to operate the rear seats.

4. Slide open the tether anchor cover.

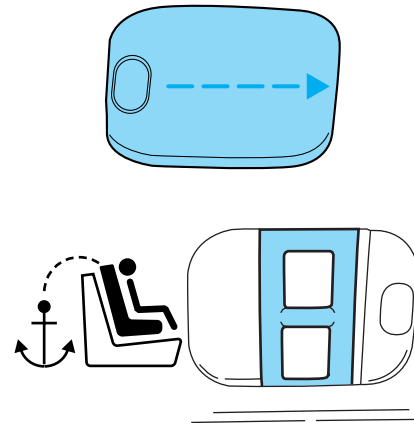

Seating and Safety Restraints

5. Clip the tether strap to the anchor and return the seat back to its locked position. For Adrenalin vehicles fixed left rear seat, clip the tether hook onto the anchor bar with the hook toward the rear of the vehicle.



If the tether strap is clipped incorrectly, the child safety seat may not be retained properly in the event of a collision.

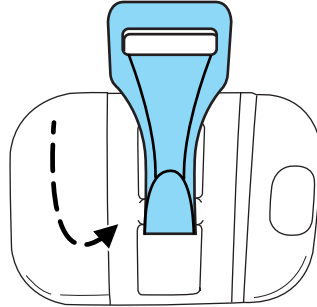

6. Refer to the *Installing child safety seats in combination lap and shoulder belt seating positions* section of this chapter for further instructions to secure the child safety seat.

7. Tighten the child safety seat tether strap according to the manufacturer's instructions.

To unhook the tether strap, unfasten the seat belts securing the child seat and put some slack into the tether strap. Tip the seat back forward enough so that you can reach behind the seat and unhook the tether hook. For the Adrenalin Edition fixed left rear seat, fold the other seat back down so that you can reach around the side of the left seat back with your left hand to unclip the tether hook.



If the safety seat is not anchored properly, the risk of a child being injured in a collision greatly increases.

Attaching safety seats with LATCH (Lower Anchors and Tethers for Children) attachments for child seat anchors

Some child safety seats have two rigid or webbing mounted attachments that connect to two anchors at certain seating positions in your vehicle. This type of child seat eliminates the need to use seat belts to attach the child seat. For forward-facing child seats, the tether strap must also be attached to the proper tether anchor. See *Attaching safety seats with tether straps* in this chapter.

Seating and Safety Restraints

Your vehicle has LATCH anchors for child seat installation at the following locations:

The LATCH anchors on both sides of the center of the rear seat are provided only for child seats at the outboard seats. These anchors are further apart than the pairs of lower anchors for child seat installation at other seats. **DO NOT** install a child seat with LATCH attachments (rigid or mounted on belt webbing) to the lower anchors on both sides of the center rear seat. **If you install a child seat at the center rear position, use the vehicle belt and the top tether anchor.**

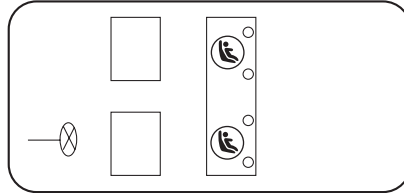

 Never attach two LATCH child safety seats to the same anchor. In a crash, one anchor may not be strong enough to hold two child safety seat attachments and may break, causing serious injury or death.

The lower anchors for child seat installation are located at the rear section of the rear seat between the cushion and seat back.

The LATCH anchors are below the locator symbols (if provided) on the seat back.

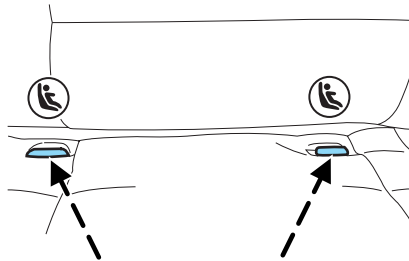

Follow the child seat manufacturer's instructions to properly install a child seat with LATCH attachments.

 Attach LATCH lower attachments of the child seat only to the anchors shown.

If you install a child seat with rigid LATCH attachments, do not tighten the tether strap enough to lift the child seat off the vehicle seat cushion when the child is seated in it. Keep the tether strap just snug without

Seating and Safety Restraints

lifting the front of the child seat. Keeping the child seat just touching the vehicle seat gives the best protection in a severe crash.

Each time you use the safety seat, check that the seat is properly attached to the lower anchors and tether anchor. Try to tilt the child seat from side to side. Also try to tug the seat forward. Check to see if the anchors hold the seat in place.





If the safety seat is not anchored properly, the risk of a child being injured in a crash greatly increases.

STARTING YOUR VEHICLE

Positions of the ignition

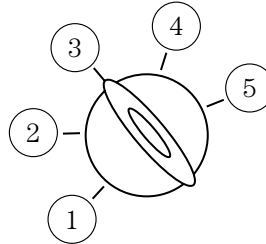
1. ACCESSORY, electrical accessories such as the radio to operate while the engine is not running.
2. LOCK, locks the steering wheel and allows key removal.
3. OFF, shuts off the engine and all accessories without locking the steering wheel. This position also allows the automatic transmission gearshift lever to be moved from the P (Park) position without the brake pedal being depressed.



 When the key is in the ignition and in the OFF position, the automatic transmission shift lever can be moved from the P (Park) position without the brake pedal depressed. To avoid unwanted vehicle movement, always set the parking brake.

4. ON, all electrical accessories are operational and warning lights will illuminate. This is the position the key is in when you're driving.
5. START, cranks the engine. Release the key as soon as the engine starts.

Preparing to start your vehicle

Engine starting is controlled by the powertrain control system. This system meets all Canadian Interference-Causing Equipment standard requirements regulating the impulse electrical field strength of radio noise.

When starting a fuel-injected engine, don't press the accelerator before or during starting. Only use the accelerator when you have difficulty starting the engine. For more information on starting the vehicle, refer to *Starting the engine* in this chapter.

 Extended idling at high engine speeds can produce very high temperatures in the engine and exhaust system, creating the risk of fire or other damage.

Driving

 Do not park, idle, or drive your vehicle in dry grass or other dry ground cover. The emission system heats up the engine compartment and exhaust system, which can start a fire.

 Do not start your vehicle in a closed garage or in other enclosed areas. Exhaust fumes can be toxic. Always open the garage door before you start the engine. See *Guarding against exhaust fumes* in this chapter for more instructions.

 If you smell exhaust fumes inside your vehicle, have your dealer inspect your vehicle immediately. Do not drive if you smell exhaust fumes.

Important safety precautions

A computer system controls the engine's idle revolutions per minute (RPM). When the engine starts, the idle RPM runs higher than normal in order to warm the engine. If the engine idle speed does not slow down automatically, have the vehicle checked. Do not allow the vehicle to idle for more than 10 minutes at the higher engine RPM.

Before starting the vehicle:

1. Make sure all vehicle occupants have buckled their safety belts. For more information on safety belts and their proper usage, refer to the *Seating and Safety Restraints* chapter.
2. Make sure the headlamps and vehicle accessories are off.
3. Make sure the gearshift is in P (Park).

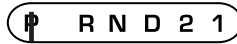

Driving

4. Make sure the parking brake is set.

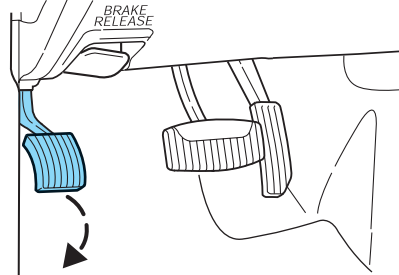

5. Turn the key to 4 (ON) without turning the key to 5 (START).

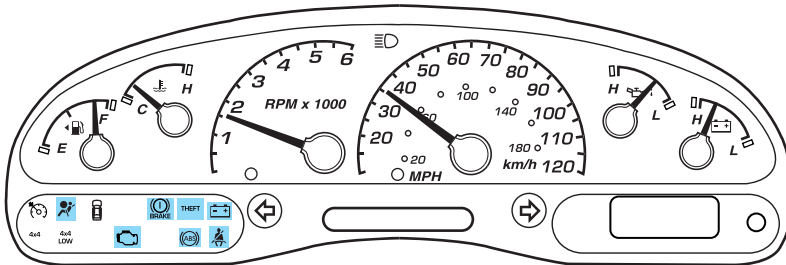
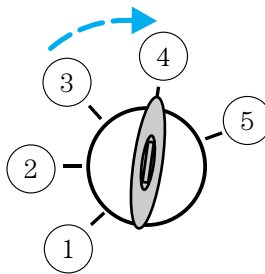

Make sure the corresponding lights illuminate or illuminate briefly. If a light fails to illuminate, have the vehicle serviced.

- If the driver's safety belt is fastened, the  light may not illuminate.

Driving

Starting the engine

1. Turn the key to 4 (ON) without turning the key to 5 (START). If there is difficulty in turning the key, rotate the steering wheel until the key turns freely.
2. Turn the key to 5 (START), then release the key as soon as the engine starts. Excessive cranking could damage the starter.

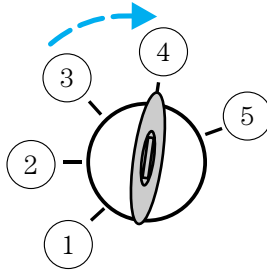

Note: If the engine does not start within five seconds on the first try, turn the key to OFF, wait 10 seconds and try again. If the engine still fails to start, press the accelerator to the floor and try again; this will allow the engine to crank with the fuel shut off in case the engine is flooded with fuel.

Cold weather starting (flexible fuel vehicles only)

As the outside temperature approaches freezing, ethanol fuel distributors should supply winter grade ethanol (same as with unleaded gasoline). If summer grade ethanol is used in cold weather conditions, you may experience increased cranking times, rough idle or hesitation until the engine has warmed up. Consult your fuel distributor for the availability of winter grade ethanol.

Do not crank the engine for more than 30 seconds at a time as starter damage may occur. If the engine fails to start, turn the key to OFF and wait 30 seconds before trying again.

Do not use starting fluid such as ether in the air intake system (see Air Cleaner decal). Such fluid could cause immediate explosive damage to the engine and possible personal injury.

If you should experience cold weather starting problems on E₈₅ ethanol, and neither an alternative brand of E₈₅ ethanol nor an engine block heater is available, the addition of unleaded gasoline to your tank will improve cold starting performance. Your vehicle is designed to operate on E₈₅ ethanol alone, unleaded gasoline alone, or any mixture of the two.

See *Choosing the right fuel* in the *Maintenance and specifications* chapter for more information on ethanol.

Driving

If the engine fails to start using the preceding instructions (flexible fuel vehicles only)

1. Press and hold down the accelerator 1/3 to 1/2 way to floor, then crank the engine.
2. When the engine starts, release the key, then gradually release the accelerator pedal as the engine speeds up. If the engine still fails to start, repeat Step 1.

Using the engine block heater (if equipped)

An engine block heater warms the engine coolant which aids in starting and heater/defroster performance. Use of an engine block heater is strongly recommended if you live in a region where temperatures reach -10°F (-23°C) or below. For best results, plug the heater in at least three hours before starting the vehicle. The heater can be plugged in the night before starting the vehicle.



To reduce the risk of electrical shock, do not use your heater with ungrounded electrical systems or two-pronged (cheater) adapters.

Guarding against exhaust fumes

Carbon monoxide is present in exhaust fumes. Take precautions to avoid its dangerous effects.



If you smell exhaust fumes inside your vehicle, have your dealer inspect your vehicle immediately. Do not drive if you smell exhaust fumes.

Important ventilating information

If the engine is idling while the vehicle is stopped for a long period of time, open the windows at least one inch (2.5 cm) or adjust the heating or air conditioning to bring in fresh air.

BRAKES

Occasional brake noise is normal. If a metal-to-metal, continuous grinding or continuous squeal sound is present, the brake linings may be worn-out and should be inspected by a qualified service technician. If the vehicle has continuous vibration or shudder in the steering wheel while braking, the vehicle should be inspected by a qualified service technician.

Driving

Refer to *Brake system warning light* in the *Instrument Cluster* chapter for information on the brake system warning light.



Four-wheel anti-lock brake system (ABS)

Your vehicle is equipped with an Anti-lock Braking System (ABS). This system helps you maintain steering control during emergency stops by keeping the brakes from locking. Noise from the ABS pump motor and brake pedal pulsation may be observed during ABS braking; this is normal and should be no reason for concern.

ABS warning lamp

The ABS lamp in the instrument cluster momentarily illuminates when the ignition is turned on. If the light does not illuminate during start up, remains on or flashes, the ABS may be disabled and may need to be serviced.



Even when the ABS is disabled, normal braking is still effective. (If your BRAKE warning lamp illuminates with the parking brake released, have your brake system serviced immediately.)



Using ABS

When hard braking is required, apply continuous force on the brake pedal; do not pump the brake pedal since this will reduce the effectiveness of the ABS and will increase your vehicle's stopping distance. The ABS will be activated immediately, allowing you to retain full steering control during hard braking and on slippery surfaces. However, the ABS does not decrease stopping distance.

Parking brake

To set the parking brake (1), press the parking brake pedal down until the pedal stops.

To release, pull the lever (2).



Always set the parking brake fully and make sure that the gearshift is securely latched in P (Park).

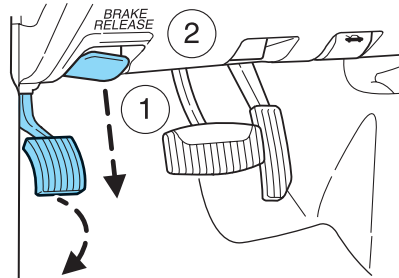

The BRAKE warning lamp will illuminate and will remain illuminated until the parking brake is released.



The parking brake is not recommended to stop a moving vehicle. However, if the normal brakes fail, the parking brake can be used to stop your vehicle in an emergency. Since the parking brake applies only the rear brakes, the vehicle's stopping distance will increase greatly and the handling of your vehicle will be adversely affected.

STEERING

To prevent damage to the power steering system:

- Never hold the steering wheel at its furthest turning points (until it stops) for more than a few seconds when the engine is running.
- Do not operate the vehicle with a low power steering pump fluid level (below the MIN mark on the reservoir).

If the power steering system breaks down (or if the engine is turned off), you can steer the vehicle manually, but it takes more effort.

If the steering wanders or pulls, check for:

- an improperly inflated tire
- uneven tire wear
- loose or worn suspension components
- loose or worn steering components
- improper steering alignment

Driving

A high crown in the road or high crosswinds may also make the steering seem to wander/pull.

TRACTION-LOK AXLE (IF EQUIPPED)

This axle provides added traction on slippery surfaces, particularly when one wheel is on a poor traction surface. Under normal conditions, the Traction-Lok axle functions like a standard rear axle. The axle may exhibit a slight noise or vibration in tight turns with low vehicle speed. This is normal behavior and indicates the axle is working.

PREPARING TO DRIVE YOUR VEHICLE



Utility vehicles have a significantly higher rollover rate than other types of vehicles.



In a rollover crash, an unbelted person is significantly more likely to die than a person wearing a safety belt.

Your vehicle has larger tires and increased ground clearance, giving the vehicle a higher center of gravity than a passenger car.



Vehicles with a higher center of gravity such as utility and four-wheel drive vehicles handle differently than vehicles with a lower center of gravity. Utility and four-wheel drive vehicles are **not** designed for cornering at speeds as high as passenger cars any more than low-slung sports cars are designed to perform satisfactorily under off-road conditions. Avoid sharp turns, excessive speed and abrupt maneuvers in these vehicles. Failure to drive cautiously could result in an increased risk of loss of vehicle control, vehicle rollover, personal injury and death.



Loaded vehicles, with a higher center of gravity, may handle differently than unloaded vehicles. Extra precautions such as slower speeds and increased stopping distance should be taken when driving a heavily loaded vehicle.

AUTOMATIC TRANSMISSION OPERATION

Brake-shift interlock

This vehicle is equipped with a brake-shift interlock feature that prevents the gearshift lever from being moved from P (Park) when the ignition is in the ON position unless brake pedal is depressed.

If you cannot move the gearshift lever out of P (Park) with ignition in the ON position and the brake pedal depressed:

1. Apply the parking brake, turn ignition key to LOCK, then remove the key.
2. Insert the key and turn it to OFF. **Apply the brake pedal and shift to N (Neutral).**



When the key is in the ignition and in the OFF position, the automatic transmission shift lever can be moved from the P (Park) position without the brake pedal depressed. To avoid unwanted vehicle movement, always set the parking brake.

3. Start the vehicle.

If it is necessary to use the above procedure to move the gearshift lever, it is possible that a fuse has blown or the vehicle's brakelamps are not operating properly. Refer to *Fuses and relays* in the *Roadside Emergencies* chapter.



Do not drive your vehicle until you verify that the brakelamps are working.



Always set the parking brake fully and make sure the gearshift is latched in P (Park). Turn the ignition to the LOCK position and remove the key whenever you leave your vehicle.



If the parking brake is fully released, but the brake warning lamp remains illuminated, the brakes may not be working properly. See your dealer or a qualified service technician.

Driving

Driving with a 5-speed automatic transmission

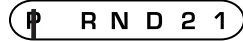

This vehicle is equipped with an adaptive Transmission Shift Strategy. Adaptive Shift Strategy offers the optimal transmission operation and shift quality. When the vehicle's battery has been disconnected for any type of service or repair, the transmission will need to relearn the normal shift strategy parameters, much like having to reset your radio stations when your vehicle battery has been disconnected. The Adaptive Transmission Strategy allows the transmission to relearn these operating parameters. This learning process could take several transmission upshifts and downshifts; during this learning process, slightly firmer shifts may occur. After this learning process, normal shift feel and shift scheduling will resume.

P (Park)

This position locks the transmission and prevents the rear wheels from turning.

To put your vehicle in gear:

- Start the engine
- Depress the brake pedal
- Move the gearshift lever into the desired gear

To put your vehicle in P (Park):

- Come to a complete stop
- Move the gearshift lever and securely latch it in P (Park)



Always set the parking brake fully and make sure the gearshift is latched in P (Park). Turn the ignition to the LOCK position and remove the key whenever you leave your vehicle.

R (Reverse)

With the gearshift lever in R (Reverse), the vehicle will move backward. Always come to a complete stop before shifting into and out of R (Reverse).

N (Neutral)

With the gearshift lever in N (Neutral), the vehicle can be started and is free to roll. Hold the brake pedal down while in this position.

D (Overdrive)

The normal driving position for the best fuel economy. Transmission operates in gears one through five.

D (Overdrive) can be deactivated by pressing the transmission control switch on the end of the gearshift lever.

This will illuminate the O/D OFF lamp and activate Drive.

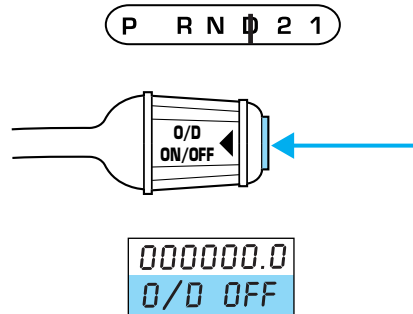

Drive (not shown)

Drive is activated when the transmission control switch is pressed.

- This position allows for all forward gears except overdrive.
- O/D OFF lamp is illuminated.
- Provides engine braking.
- Use when driving conditions cause excessive shifting from O/D to other gears. Examples: city traffic, hilly terrain, heavy loads, trailer towing and when engine braking is required.
- To return to O/D (overdrive mode), press the transmission control switch. The O/D OFF lamp will not be illuminated.
- O/D (Overdrive) is automatically returned each time the key is turned off.

2 (Second)

Use 2 (Second) to start-up on slippery roads or to provide additional engine braking on downgrades.

1 (First)

- Provides maximum engine braking.
- Allows upshifts by moving gearshift lever.
- Will not downshift into 1 (First) at high speeds; allows for 1 (First) when vehicle reaches slower speeds.

Driving

Forced downshifts

- Allowed in **D** (Overdrive) or Drive.
- Depress the accelerator to the floor.
- Allows transmission to select an appropriate gear.

If your vehicle gets stuck in mud or snow

If your vehicle gets stuck in mud or snow, it may be rocked out by shifting between forward and reverse gears, stopping between shifts in a steady pattern. Press lightly on the accelerator in each gear.

Do not rock the vehicle if the engine is not at normal operating temperature or damage to the transmission may occur.

Do not rock the vehicle for more than a minute or damage to the transmission and tires may occur, or the engine may overheat.

FOUR-WHEEL DRIVE (4WD) OPERATION (IF EQUIPPED)



For important information regarding safe operation of this type of vehicle, see *Preparing to drive your vehicle* in this chapter.

Four-wheel drive (4WD) supplies power to all four wheels. 4WD should not be operated on dry pavement; driveline damage may occur.



Utility and four-wheel drive vehicles are not designed for cornering at speeds as high as passenger cars any more than low-slung sports cars are designed to perform satisfactorily under off-road conditions. Avoid sharp turns, excessive speeds and abrupt maneuvers in these vehicles. Failure to drive cautiously could result in an increased risk of loss of vehicle control, vehicle rollover, personal injury and death.

4WD system indicator lights

- **4x4**- illuminates when 4x4 HIGH is selected. **4x4**
- **4WD LOW**- illuminates when 4x4 LOW is selected. **4WD LOW**

If these lights illuminate when driving in 2WD, contact your Ford dealer as soon as possible.

Electronic shift on the fly 4WD system

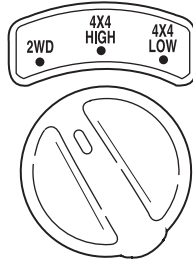

2WD - Power to the rear wheels only; used for street and highway driving.

4X4 HIGH - Used for extra traction such as in snow or icy roads or in off-road situations. Not intended for use on dry pavement.

4X4 LOW - Uses extra gearing to provide maximum power to all four wheels. Intended only for off-road applications such as deep sand, steep grades or pulling heavy objects. 4X4 LOW will not engage while the vehicle is moving; this is normal and should be no reason for concern. Refer to *Shifting to/from 4X4 LOW* for proper operation.

Shifting between 2WD and 4X4 HIGH

- Move the 4WD control between 2WD and 4X4 HIGH at any forward speed.

Note: Do not perform this operation if the rear wheels are slipping.

Shifting to/from 4X4 LOW

1. Bring the vehicle to a complete stop
 2. Depress the brake
 3. Place the transmission in N (Neutral).
 4. Move the 4WD control to the desired position.
- If shifting into 4WD LOW, wait for the 4X4 LOW light in the instrument cluster to turn **on** indicating the shift is complete.
 - If shifting out of 4WD LOW, wait for the 4X4 LOW light in the instrument cluster turn **off** indicating the shift is complete.

Driving off-road with truck and utility vehicles

How your vehicle differs from other vehicles

Truck and utility vehicles can differ from some other vehicles. Your vehicle may be higher to allow it to travel over rough terrain without getting hung up or damaging underbody components.

Driving

The differences that make your vehicle so versatile also make it handle differently than an ordinary passenger car.

Maintain steering wheel control at all times, especially in rough terrain. Since sudden changes in terrain can result in abrupt steering wheel motion, make sure you grip the steering wheel from the outside. Do not grip the spokes.

Drive cautiously to avoid vehicle damage from concealed objects such as rocks and stumps.

You should either know the terrain or examine maps of the area before driving. Map out your route before driving in the area. To maintain steering and braking control of your vehicle, you must have all four wheels on the ground and they must be rolling, not sliding or spinning.

Basic operating principles

Maintain steering wheel control at all times, especially in rough terrain; sudden changes in terrain can result in abrupt steering wheel motion. Do not use 4WD on dry, hard surfaced roads (except models equipped with Auto 4WD).

If your vehicle goes off the edge of the pavement

- If your vehicle goes off the edge of the pavement, slow down, but avoid severe brake application, ease the vehicle back onto the pavement only after reducing your speed. Do not turn the steering wheel too sharply while returning to the road surface.
- It may be safer to stay on the apron or shoulder of the road and slow down gradually before returning to the pavement. You may lose control if you do not slow down or if you turn the steering wheel too sharply or abruptly.
- It often may be less risky to strike small objects, such as highway reflectors, with minor damage to your vehicle rather than attempt a sudden return to the pavement which could cause the vehicle to slide sideways out of control or rollover. Remember, your safety and the safety of others should be your primary concern.



Vehicles with a higher center of gravity such as utility and four-wheel drive vehicles handle differently than vehicles with a lower center of gravity. Utility and four-wheel drive vehicles are **not** designed for cornering at speeds as high as passenger cars any more than low-slung sports cars are designed to perform satisfactorily under off-road conditions. Avoid sharp turns, excessive speed and abrupt maneuvers in these vehicles. Failure to drive cautiously could result in an increased risk of loss of vehicle control, vehicle rollover, personal injury and death.

Driving

If your vehicle gets stuck

The vehicle may be rocked out by shifting from forward and reverse gears, stopping between shifts, in a steady pattern. Press lightly on the accelerator in each gear. **Do not rock the vehicle for more than a few minutes or damage to the transmission and tires may occur or the engine may overheat.**



Do not spin the wheels at over 35 mph (56 km/h). The tires may fail and injure a passenger or bystander.

Emergency maneuvers

- In an unavoidable emergency situation where a sudden sharp turn must be made, remember to avoid “over-driving” your vehicle (i.e., turn the steering wheel only as rapidly and as far as required to avoid the emergency). Excessive steering will result in less vehicle control, not more. Additionally, smooth variations of the accelerator and/or brake pedal pressure should be utilized if changes in vehicle speed are called for. Avoid abrupt steering, acceleration or braking which could result in an increased risk of loss of vehicle control, vehicle rollover and/or personal injury. Use all available road surface to return the vehicle to a safe direction of travel.
- In the event of an emergency stop, avoid skidding the tires and do not attempt any sharp steering wheel movements.



Vehicles with a higher center of gravity such as utility and four-wheel drive vehicles handle differently than vehicles with a lower center of gravity. Utility and four-wheel drive vehicles are **not** designed for cornering at speeds as high as passenger cars any more than low-slung sports cars are designed to perform satisfactorily under off-road conditions. Avoid sharp turns, excessive speed and abrupt maneuvers in these vehicles. Failure to drive cautiously could result in an increased risk of loss of vehicle control, vehicle rollover, personal injury and death.



Loaded vehicles, with a higher center of gravity, may handle differently than unloaded vehicles. Extra precautions, such as slower speeds and increased stopping distances, should be taken when driving a heavily loaded vehicle.

Driving

- If the vehicle goes from one type of surface to another (i.e., from concrete to gravel) there will be a change in the way the vehicle responds to a maneuver (steering, acceleration or braking). Again, avoid these abrupt inputs.

Parking

On some 4WD vehicles, when the transfer case is in the N (Neutral) position, the engine and transmission are disconnected from the rest of the driveline. Therefore, the vehicle is free to roll even if the automatic transmission is in P (Park). Do not leave the vehicle unattended with the transfer case in N (Neutral) position. Always set the parking brake fully and turn off the ignition when leaving the vehicle.



Always set the parking brake fully and make sure the gearshift is latched in P (Park). Turn the ignition to the LOCK position and remove the key whenever you leave your vehicle.



If the parking brake is fully released, but the brake warning lamp remains illuminated, the brakes may not be working properly. See your dealer or a qualified service technician.

Normal characteristics

On some 4WD vehicles, the initial shift from two-wheel drive to four-wheel drive while the vehicle is moving can cause some momentary clunk and ratcheting sounds. This is normal and should be no cause for concern.

Driving on sand, mud and water

When driving over sand, avoid reducing the tire pressures; instead, shift to a lower gear. Apply the accelerator slowly and avoid spinning the wheels. If you must reduce the tire pressure, make sure you re-inflate the tires as soon as possible. Avoid excessive speed because vehicle momentum can work against your vehicle and cause it to become stuck.

Driving

If you must drive through high water, drive slowly. Traction or braking ability may be reduced. Also, if the ignition system gets wet, the vehicle may stall.

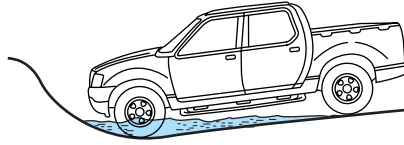

Once you're through the water, always dry the brakes by moving your vehicle slowly while applying light pressure on the brake pedal. Wet brakes do not stop the vehicle as quickly as dry brakes.

When driving through mud, be cautious of sudden changes in vehicle speed or direction. Even 4WD vehicles can lose traction in slick mud. Apply the accelerator slowly and avoid spinning your wheels. If the vehicle does slide, steer in the direction of the slide until you regain control of the vehicle. If the transmission, transfer case or either axle become submerged in mud or water, their fluids should be checked and changed, if necessary. After driving through mud, clean off residue stuck to rotating driveshafts and tires. Excess mud stuck on tires and rotating driveshafts could damage driveline components.

"Tread Lightly" is an educational program designed to increase public awareness of land-use regulations and responsibilities in our nation's wilderness areas. Ford joins the U.S.



Forest Service and the Bureau of Land Management in encouraging you to help preserve our national forest and other public and private lands by "treading lightly."

Driving on hilly or sloping terrain

Avoid driving crosswise or turning on steep slopes or hills. Your vehicle may lose traction and slip sideways and possibly roll over. Do not drive in reverse over a hill without the aid of an observer.

Driving

When climbing a steep slope or hill, start in a lower gear rather than downshifting to a lower gear from a higher gear once the ascent has started. This reduces the possibility of the vehicle stalling. If your vehicle does stall, do not try to turn around because your vehicle may roll over. Apply just enough power to the wheels to climb the hill. Too much power will cause the tires to slip or spin, resulting in loss of vehicle control.

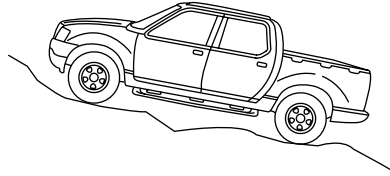

When descending a hill, use the same gear you would use to climb up the hill and do not descend the hill with the transmission in neutral. Disengage overdrive or manually shift to a lower gear. When descending a steep hill, avoid sudden hard braking as you could lose control. When you brake hard, the front wheels can't turn. Rapid pumping of the brake pedal will help you slow the vehicle and still maintain steering control.

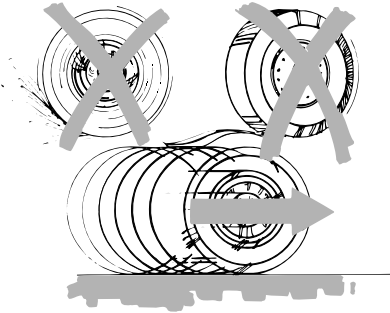

If your vehicle has anti-lock brakes, apply the brakes steadily. Do not “pump” the brakes.

Driving on snow and ice

4WD vehicles can skid like any other vehicle. If you start to skid while driving on a snowy or icy road, turn the steering wheel in the direction of the slide until you regain control. Although a 4WD vehicle may accelerate better than a two-wheel drive vehicle in snow and ice, it won't stop any faster.

Don't press hard on the accelerator or brake pedal or make quick steering changes while on snow or ice. Apply the accelerator slowly and steadily when starting from a full stop. If your vehicle is equipped with ABS, apply the brake steadily. Do not “pump” the brakes. Refer to the *Brakes* section of this chapter for additional information on the operation of the anti-lock brake system. If your vehicle is not equipped with ABS, use a “squeeze” braking technique. Push on the brake pedal with a steadily increasing force which allows the wheels to brake yet

continue to roll so that you may steer in the direction you want to travel. If you lock the wheels, release the brake pedal and repeat the squeeze technique.

Never drive with chains on the front tires of 4WD vehicles without also putting them on the rear tires. This could cause the rear to slide and swing around during braking.

Tires, Replacement Requirements



Do not use a size and type of tire and wheel other than that originally provided by Ford Motor Company because it can affect the safety and performance of your vehicle, which could result in an increased risk of loss of vehicle control, vehicle rollover and/or serious personal injury or death.

Your vehicle is equipped with tires designed to provide for safe ride and handling capability.

Make sure all tires and wheels on the vehicle are of the same size, type, tread design and load-carrying capacity. When replacing tires, have all four tires replaced at the same time. If you have questions regarding tire replacement, see an authorized Ford or Lincoln Mercury dealer.

If you nevertheless decide to equip your AWD for off-road use with tires larger than what Ford Motor Company recommends, you should not use these tires for highway driving.

If you use any tire/wheel combination not recommended by Ford Motor Company, it may adversely affect vehicle handling and could cause steering, suspension, axle or transfer case failure as well as the increased risk of loss of vehicle control.

Do not use “aftermarket lift kits” or other suspension modifications, whether or not they are used with larger tires and wheels.

These “aftermarket lift kits” could adversely affect the vehicle’s handling characteristics, which could lead to loss of vehicle control or rollover and serious injury.

Tires can be damaged during off-road use. For your safety, tires that are damaged should not be used for highway driving because they are more likely to blow out or fail.

You should carefully observe the recommended tire inflation pressure found on the safety compliance certification label attached to the left front door lock facing or door latch post pillar. Failure to follow tire pressure recommendations can adversely affect the way your vehicle

Driving

handles. Do not exceed the Ford Motor Company recommended pressure even if it is less than the maximum pressure allowed for the tire.

Each day before you drive, check your tires. If one looks lower than the others, use a tire gauge to check pressure of all tires, and adjust if required. Check tire pressure with a tire gauge monthly (including spare). Safe vehicle operation requires your tires to be set at the proper pressure and your vehicle not be overloaded.

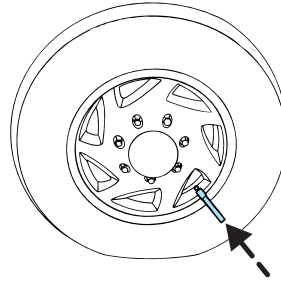

Periodically inspect the tire treads and remove stones, nails, glass or other objects that may be wedged in the tread grooves. Check for holes or cuts that may permit air leakage from the tire and make necessary repairs.

Inspect the tire sidewalls for cuts, bruises and other damage. If internal damage to the tire is suspected, have the tire demounted and inspected in case it needs to be repaired or replaced.

Maintenance and Modifications

Ford strongly recommends that you do not add or remove steering or suspension parts (such as lift kits or stabilizer bars) or by using replacement parts not equivalent to the original factory equipment. Do not use aftermarket "lift kits" or other suspension modifications. These could adversely affect the vehicle's handling characteristics, which could lead to loss of vehicle control or roll over and serious injury. Frequent inspection of vehicle chassis components is recommended if the vehicle is subjected to heavy off-road usage.

DRIVING THROUGH WATER

If driving through deep or standing water is unavoidable, proceed very slowly especially when the depth is not known. Never drive through water that is higher than the bottom of the hubs (for trucks) or the bottom of the wheel rims (for cars). When driving through water, traction or brake capability may be limited. Also, water may enter your engine's air intake and severely damage your engine or your vehicle may stall. **Driving through deep water where the transmission vent tube is submerged may allow water into the transmission and cause internal transmission damage.**

Once through the water, always dry the brakes by moving your vehicle slowly while applying light pressure on the brake pedal.

Wet brakes do not stop the vehicle as quickly as dry brakes.

VEHICLE LOADING – WITH AND WITHOUT A TRAILER

This section will guide you in the proper loading of your vehicle and/or trailer, to keep your loaded vehicle weight within its design rating capability, with or without a trailer. Properly loading your vehicle will provide maximum return of vehicle design performance. Before loading your vehicle, familiarize yourself with the following terms for determining your vehicle's weight ratings, with or without a trailer, from the vehicle's Safety Certification Label and Tire Label:

Base Curb Weight – is the weight of the vehicle including a full tank of fuel and all standard equipment. It does not include passengers, cargo, or optional equipment.

Vehicle Curb Weight – is the weight of your new vehicle when you picked it up from your dealer plus any aftermarket equipment.

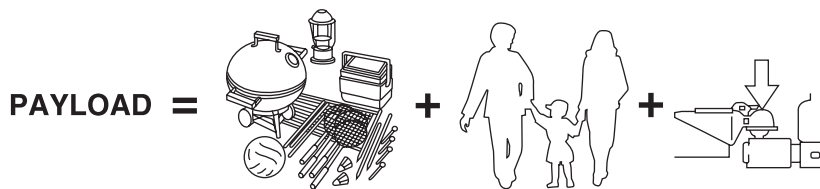

Payload – is the combined weight of cargo and passengers that the vehicle is carrying. The maximum payload for your vehicle can be found on the Tire Label on the B-Pillar or the edge of the driver's door. Look for **“THE COMBINED WEIGHT OF OCCUPANTS AND CARGO SHOULD NEVER EXCEED XXX kg OR XXX lbs”** for maximum payload. The payload listed on the tire label is the maximum payload for the vehicle as built by the assembly plant. If any aftermarket or dealer installed equipment has been installed on the vehicle, the weight of the equipment must be subtracted from the payload listed on the tire label in order to determine the new payload.

Driving

 The appropriate loading capacity of your vehicle can be limited either by volume capacity (how much space is available) or by payload capacity (how much weight the vehicle should carry). Once you have reached the maximum payload of your vehicle, do not add more cargo, even if there is space available. Overloading or improperly loading your vehicle can contribute to loss of vehicle control and vehicle rollover.

EXAMPLE



TIRE AND LOAD INFORMATION
SEE OWNERS MANUAL FOR ADDITIONAL INFORMATION

The combined weight of occupants and cargo should never exceed XXX kg or XXX lbs.

| | | | |
|------------------|----------|----------|---------|
| SEATING CAPACITY | TOTAL; 5 | FRONT; 2 | REAR; 3 |
|------------------|----------|----------|---------|

| ORIGINAL TIRE SIZE | | COLD TIRE INFLATION PRESSURE | |
|--------------------|--------------|------------------------------|---------------|
| FRONT | P195 / 70R14 | FRONT | 200KPA, 29PSI |
| REAR | P195 / 70R14 | REAR | 200KPA, 29PSI |
| SPARE TIRE SIZE | | COLD TIRE INFLATION PRESSURE | |
| T125/70D15 | | 420KPA, 50PSI | |



TIRE AND LOAD INFORMATION
SEE OWNERS MANUAL FOR ADDITIONAL INFORMATION
RENSEIGNEMENTS RELATIFS AUX PNEUS ET À LA CHARGE
CONSULTER LE GUIDE DU PROPRIÉTAIRE POUR DE PLUS AMPLES RENSEIGNEMENTS

The combined weight of occupants and cargo should never exceed ^{kg or} ^{PM, kg ou} ^{PSI, lb.} XXX kg or XXX lbs.
La charge du véhicule (occupants et bagages) ne doit jamais dépasser

| | | | |
|------------------|-----------|-----------|-------------|
| SEATING CAPACITY | TOTAL | FRONT | REAR |
| NOMBRE DE PLACES | TOTAL: TS | AVANT: FS | ARRIÈRE: RS |

| ORIGINAL TIRE SIZE DIMENSIONS DES PNEUS D'ORIGINE | | COLD TIRE INFLATION PRESSURE PRESSION DE GONFLAGE À FROID | |
|--|-------------|--|-------------------|
| FRONT/ AVANT | FTIREXXXXXE | FRONT/ AVANT | FKPA KPA, FPS PSI |
| REAR/ ARRIÈRE | RTIREXXXXXE | REAR/ ARRIÈRE | RKPA KPA, RPS PSI |
| SPARE TIRE SIZE DIMENSION DU PNEU SECOURS | | COLD TIRE INFLATION PRESSURE PRESSION DE GONFLAGE À FROID | |
| STIREXXXXXE | | SKP KPA, SPS PSI | |



Cargo Weight – includes all weight added to the Base Curb Weight, including cargo and optional equipment. When towing, trailer tongue load or king pin weight is also part of cargo weight.

GAW (Gross Axle Weight) – is the total weight placed on each axle (front and rear) – including vehicle curb weight and all payload.

GAWR (Gross Axle Weight Rating) – is the maximum allowable weight that can be carried by a single axle (front or rear). **These numbers are shown on the Safety Compliance Certification Label located on the driver's door or door pillar. The total load on each axle must never exceed its GAWR.**



Exceeding the Safety Certification Label axle weight rating limits could result in substandard vehicle handling, performance, engine, transmission and/or structural damage, serious damage to the vehicle, loss of control and personal injury.

Note: For trailer towing information refer to *Trailer towing* found in this chapter or the *RV and Trailer Towing Guide* provided by your dealership.

Driving

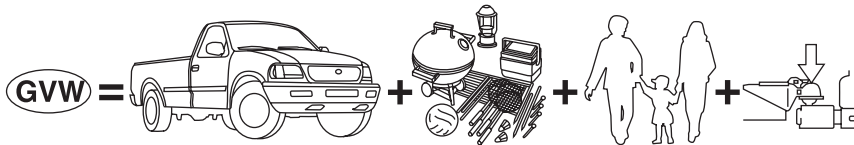

GVW (Gross Vehicle Weight) – is the Vehicle Curb Weight + cargo + passengers.

GVWR (Gross Vehicle Weight Rating) – is the maximum allowable weight of the fully loaded vehicle (including all options, equipment, passengers and cargo). **The GVWR is shown on the Safety Compliance Certification Label located on the driver's door or door pillar. The GVW must never exceed the GVWR.**

| Sample Safety Compliance Certification Label <small>(Refer to actual label on your vehicle)</small> | | | |
|--|-------------------------|--------------------|---------|
| Front GAWR | GVWR | Rear GAWR | |
| MFD. BY FORD MOTOR CO. IN U.S.A. | | | |
| DATE: 06/95 | GVWR: 6250 LB/2834 KG | | |
| FRONT GAWR: 3450 LB 1564KG | WITH 1713KG | REAR GAWR: 3777 LB | WITH |
| P265/75R15SL | TIRES P265/75R15SL | | TIRES |
| 15X7.5J | RIMS 15X7.5J | | RIMS |
| AT 30 PSI COLD | AT 30 PSI COLD | | |
| THIS VEHICLE CONFORMS TO ALL APPLICABLE FEDERAL MOTOR VEHICLE SAFETY STANDARDS IN EFFECT ON THE DATE OF MANUFACTURE SHOWN ABOVE. | | | |
| XXXXXXXXXXXX | VIN: 1FTEX14H0SKB 00000 | F0018 | |
| TYPE: XXXXXXXXXXXX | | TC183 | |
| | | | |
| EXT PNT: XXXXXXXXXX | | | DSO |
| WD | TYPE-GVW | BODY | TRANS |
| 155 | | REM | E |
| | | | HB |
| | | | TAPE |
| | | | SPRINGS |
| | | | MM |



Exceeding the Safety Certification Label axle weight rating limits could result in substandard vehicle handling, performance, engine, transmission and/or structural damage, serious damage to the vehicle, loss of control and personal injury.



GCW (Gross Combined Weight) – is the weight of the loaded vehicle (GVW) plus the weight of the fully loaded trailer.

GCWR (Gross Combined Weight Rating) – is the maximum allowable weight of the vehicle and the loaded trailer – including all cargo and passengers – that the vehicle can handle without risking damage. (Important: The towing vehicle's braking system is rated for operation at GVWR, not at GCWR. Separate functional brakes should be used for safe control of towed vehicles and for trailers where the GCW of the towing vehicle plus the trailer exceed the GVWR of the towing vehicle. **The GCW must never exceed the GCWR.**

Maximum Loaded Trailer Weight – is the highest possible weight of a fully loaded trailer the vehicle can tow. It assumes a vehicle with only mandatory options, no cargo (internal or external), a tongue load of 10–15% (conventional trailer) or king pin weight of 15–25% (fifth wheel trailer), and driver only (150 lbs. [68 kg]). **Consult your dealership (or the *RV and Trailer Towing Guide* provided by your dealership) for more detailed information.**

Tongue Load or Fifth Wheel King Pin Weight – refers to the amount of the weight that a trailer pushes down on a trailer hitch.

Examples: For a 5,000 lbs. (2,268 kg) conventional trailer, multiply 5,000 by 0.10 and 0.15 to obtain a proper tongue load range of 500 to 750 lbs. (227 to 340 kg). For an 11,500 lbs. (5,216 kg) fifth wheel trailer, multiply by 0.15 and 0.25 to obtain a proper king pin load range of 1,725 to 2,875 lbs. (782 to 1,304 kg)



Do not exceed the GVWR or the GAWR specified on the certification label.



Do not use replacement tires with lower load carrying capacities than the originals because they may lower the vehicle's GVWR and GAWR limitations. Replacement tires with a higher limit than the originals do not increase the GVWR and GAWR limitations.

Driving



Exceeding any vehicle weight rating limitation could result in serious damage to the vehicle and/or personal injury.

Steps for determining the correct load limit:

1. Locate the statement “The combined weight of occupants and cargo should never exceed XXX pounds” on your vehicle’s label.
2. Determine the combined weight of the driver and passengers that will be riding in your vehicle.
3. Subtract the combined weight of the driver and passengers from XXX kilograms or XXX pounds.
4. The resulting figure equals the available amount of cargo and luggage load capacity. For example, if the “XXX” amount equals 1,400 lbs (635 kg) and there will be five 150 lbs. (68 kg) passengers in your vehicle, the amount of available cargo and luggage load capacity is 650 lbs. $(1400 - 750 (5 \times 150) = 650 \text{ lbs.})$. Metric conversion; 295 kg $(635 - 340 (5 \times 68) = 295 \text{ kg})$.
5. Determine the combined weight of luggage and cargo being loaded on the vehicle. That weight may not safely exceed the available cargo and luggage load capacity calculated in Step 4.
6. If your vehicle will be towing a trailer, load from your trailer will be transferred to your vehicle. Consult this manual to determine how this reduces the available cargo and luggage load capacity of your vehicle.

Special loading instructions for owners of pickup trucks and utility-type vehicles



For important information regarding safe operation of this type of vehicle, see the **Preparing to drive your vehicle** section in this chapter.



Loaded vehicles may handle differently than unloaded vehicles. Extra precautions, such as slower speeds and increased stopping distance, should be taken when driving a heavily loaded vehicle.

Your vehicle can haul more cargo and people than most passenger cars. Depending upon the type and placement of the load, hauling cargo and people may raise the center of gravity of the vehicle.

Calculating the load your vehicle can carry/tow

1. Use the appropriate maximum GCWR chart (in the *Trailer towing* section in this chapter) for your type of engine and rear axle ratio.
2. Weigh your vehicle without cargo. To obtain correct weights, take your vehicle to a shipping company or an inspection station for trucks.
3. Subtract your loaded weight from the maximum GCWR in the chart. This is the maximum trailer weight your vehicle can tow. It must be below the maximum trailer weight shown in the chart.

TRAILER TOWING

Trailer towing with your vehicle may require the use of a trailer tow option package.

Trailer towing puts additional loads on your vehicle's engine, transmission, axle, brakes, tires, and suspension. For your safety and to maximize vehicle performance, be sure to use the proper equipment while towing.

Follow these guidelines to ensure safe towing procedure:

- Stay within your vehicle's load limits.
- Thoroughly prepare your vehicle for towing. Refer to *Preparing to tow* in this chapter.
- Use extra caution when driving while trailer towing. Refer to *Driving while you tow* in this chapter.
- Service your vehicle more frequently if you tow a trailer. Refer to the severe duty schedule in the scheduled maintenance guide.
- Do not tow a trailer until your vehicle has been driven at least 500 miles (800 km).
- Refer to the instructions included with towing accessories for the proper installation and adjustment specifications.

Do not exceed the maximum loads listed on the Safety Compliance Certification label. For load specification terms found on the label, refer to *Vehicle loading* in this chapter. Remember to figure in the tongue load of your loaded vehicle when figuring the total vehicle weight.

Driving

| 4x2 | | | |
|--|------------|--------------------------|---|
| GCWR (Gross Combined Weight Rating)/Trailer weights | | | |
| Engine | Axle ratio | Maximum GCWR - lbs. (kg) | Trailer Weight Range - lbs. (kg) 0-Maximum |
| 4.0L SOHC | All | 9600 (4354) | 0-5300 (0-2404) |
| <p>Notes: For high altitude operation, reduce GCW by 2% per 1,000 ft. (300 meters) elevation. For definition of terms and instructions on calculating your vehicle's load, refer to <i>Vehicle loading</i> in this chapter. Maximum trailer weights shown. The combined weight of the completed towing vehicle and the loaded trailer must not exceed the GCWR.</p> | | | |

| 4x4 | | | |
|--|------------|--------------------------|--|
| GCWR (Gross Combined Weight Rating)/Trailer Weights | | | |
| Engine | Axle ratio | Maximum GCWR - lbs. (kg) | Trailer Weight Range (0-Maximum) - lbs. (kg) |
| 4.0L SOHC | All | 9600 (4354) | 0-5080 (0-2304) |
| <p>Notes: For high altitude operation, reduce GCW by 2% per 1,000 ft. (300 meters) elevation. For definition of terms and instructions on calculating your vehicle's load, refer to <i>Vehicle loading</i> in this chapter. Maximum trailer weights shown. The combined weight of the completed towing vehicle and the loaded trailer must not exceed the GCWR.</p> | | | |



Do not exceed the GVWR or the GAWR specified on the certification label.



Towing trailers beyond the maximum recommended gross trailer weight exceeds the limit of the vehicle and could result in engine damage, transmission damage, structural damage, loss of vehicle control, vehicle rollover and personal injury.

Preparing to tow

Use the proper equipment for towing a trailer and make sure it is properly attached to your vehicle. See your dealer or a reliable trailer dealer if you require assistance.

Hitches

Do not use hitches that clamp onto the vehicle bumper. Use a weight-carrying or weight distributing hitch; a weight-distributing hitch is required for trailers over 3,500 lbs (1,588 kg).

For proper handling, tongue weight must meet these requirements:

- For trailers up to 2,000 lbs (907 kg), do not exceed 200 lbs (91 kg).
- For trailers over 2,000 lbs (907 kg), use 10-15% of trailer weight.
- For Class II receiver hitches, do not exceed tongue weight of 350 lbs (159 kg). For class III/IV receiver, do not exceed tongue weight of 500 lbs (227 kg) (weight carrying); 770 lbs (349 kg) (weight distributing).

For additional information, please see Ford's RV & Trailer Towing Guide.

Safety chains

Always connect the trailer's safety chains to the frame or hook retainers of the vehicle hitch. To connect the trailer's safety chains, cross the chains under the trailer tongue and allow slack for turning corners. **Do not attach safety chains to the bumper.**

Trailer brakes

Electric brakes and manual, automatic or surge-type trailer brakes are safe if installed properly and adjusted to the manufacturer's specifications.



Do not connect a trailer's hydraulic brake system directly to your vehicle's brake system. Your vehicle may not have enough braking power and your chances of having a collision greatly increase.

The braking system of the towing vehicle is rated for operation at the GVWR not GCWR.

Trailer lamps

Make sure all running lights, brake lights, turn signals and hazard lights are working. See your dealer or trailer rental agency for proper instructions and equipment for hooking up trailer lamps.

Driving



Never connect any trailer lighting to the vehicle's taillamp circuits, because it may damage the electrical system resulting in fire. Contact your local Ford dealership for assistance in proper trailer tow wiring installation. Additional electrical equipment may be required.

Using a step bumper

The rear bumper is equipped with an integral hitch and requires only a ball with a $\frac{3}{4}$ " (19 mm) shank diameter. The bumper has a 3,500 lbs. (1,590 kg) trailer weight and 350 lbs. (159 kg) tongue weight capability. Use a frame-mounted weight distributing hitch for trailers over 3,500 lbs. (1,590 kg).

Driving while you tow

When towing a trailer:

- Turn off your speed control. The speed control may shut off automatically when you are towing on long, steep grades.
- Consult your local motor vehicle speed regulations for towing a trailer.
- Use a lower gear when towing up or down steep hills.
- Anticipate stops and brake gradually.

Servicing after towing

If you tow a trailer for long distances, your vehicle will require more frequent service intervals. Refer to your *Scheduled Maintenance Guide* for more information.

Trailer towing tips

- Practice turning, stopping and backing up before starting on a trip to get the feel of the vehicle/trailer combination. When turning, make wider turns so the trailer wheels will clear curbs and other obstacles.
- Allow more distance for stopping with a trailer attached.
- The trailer tongue weight should be no more than 10–15% of the loaded trailer weight.
- After you have traveled 50 miles (80 km), thoroughly check your hitch, electrical connections and trailer wheel lug nuts.
- When stopped in traffic for long periods of time in hot weather, place the gearshift in P (Park). This aids engine cooling and air conditioner efficiency.

Driving

- Vehicles with trailers should not be parked on a grade. If you must park on a grade, place wheel chocks under the trailer's wheels.

Launching or retrieving a boat

When backing down a ramp during boat launching or retrieval:

- do not allow the static water level to rise above the bottom edge of the rear bumper.
- do not allow waves to break higher than 6 inches (15 cm) above the bottom edge of the rear bumper.

Exceeding these limits may allow water to enter critical vehicle components, adversely affecting driveability, emissions, reliability and causing internal transmission damage. Replace the rear axle lubricant any time the axle has been submerged in water.

Disconnect the wiring to the trailer before backing the trailer into the water. Reconnect the wiring to the trailer after the trailer is removed from the water.

Camper bodies

Your Explorer Sport Trac is not recommended for slide-in camper bodies.

RECREATIONAL TOWING (ALL WHEELS ON THE GROUND)

Follow these guidelines for your specific powertrain combination to tow your vehicle with all four wheels on the ground (such as behind a recreational vehicle).

These guidelines are designed to ensure that your transmission is not damaged due to insufficient lubrication.

4x2 vehicles and 4x4 vehicles without the Neutral tow kit accessory:

- Release parking brake.
- Place the transmission in N (Neutral).
- Maximum speed is 35 mph (56 km/h).
- Maximum distance is 50 miles (80 km).

If a distance of 50 miles (80 km) or a speed of 35 mph (56 km/h) must be exceeded, you must disconnect the front (on 4x4 vehicles) and rear driveshafts. Ford recommends the driveshaft(s) be removed/installed only by a qualified technician. See your local dealer for driveshaft removal/installation.

Driving

Improper removal/installation of the driveshaft can cause transmission fluid loss, damage to the driveshaft and internal transmission components.

4x4 vehicles with Neutral tow kit accessory:

- Release the parking brake.
- Place transmission in N (Neutral).
- Engage the neutral tow.

On vehicles equipped with 4WD, an accessory is available that allows you to tow your vehicle, with unlimited mileage (maximum speed of 55 mph [88 km/h]) behind another vehicle, with all the wheels on the ground. Contact your dealer for more details. Do not tow your vehicle with all wheels on the ground more than 50 miles (80 km) (with a maximum speed of 35 mph [56 km/h]) unless you install the neutral tow kit as vehicle damage may occur.

Roadside Emergencies

GETTING ROADSIDE ASSISTANCE

To fully assist you should you have a vehicle concern, Ford Motor Company offers a complimentary roadside assistance program. This program is separate from the New Vehicle Limited Warranty. The service is available:

- 24-hours, seven days a week
- for the New Vehicle Limited Warranty period of three years or 36,000 miles (60,000 km), whichever occurs first on Ford and Mercury vehicles, and four years or 50,000 miles (80,000 km) on Lincoln vehicles.

Roadside assistance will cover:

- changing a flat tire
- jump-starts
- lock-out assistance
- limited fuel delivery
- towing of your disabled vehicle to the nearest Ford Motor Company dealership, or your selling dealer if within 35 miles (56.3 km) of the nearest Ford Motor Company dealership (one tow per disablement). Even non-warranty related tows, like accidents or getting stuck in the mud or snow, are covered (some exclusions apply, such as impound towing or repossession).

Canadian customers refer to your Owner Information Guide for information on:

- coverage period
- exact fuel amounts
- towing of your disabled vehicle
- emergency travel expense reimbursement
- travel planning benefits

Using roadside assistance

Complete the roadside assistance identification card and place it in your wallet for quick reference. In the United States, this card is found in the Owner Guide portfolio in the glove compartment in Ford vehicles and is mailed to you if you own a Mercury or Lincoln. In Canada, the card is found in the Roadside Assistance book in the glove compartment.

U.S. Ford or Mercury vehicle customers who require roadside assistance, call 1-800-241-3673; Lincoln vehicle customers call 1-800-521-4140.

Roadside Emergencies

Canadian customers who require roadside assistance, call 1-800-665-2006.

If you need to arrange roadside assistance for yourself, Ford Motor Company will reimburse a reasonable amount. To obtain reimbursement information, U.S. Ford or Mercury vehicles customers call 1-800-241-3673; Lincoln vehicle customers call 1-800-521-4140.

Canadian customers who need to obtain reimbursement information, call 1-800-665-2006.

Roadside coverage beyond basic warranty

In the United States, you may purchase additional roadside assistance coverage beyond this period through the Ford Auto Club by contacting your Ford or Lincoln Mercury dealer.

Similarly in Canada, for uninterrupted Roadside Assistance coverage, you may purchase extended coverage prior to your Basic Warranty's Roadside Assistance expiring. For more information and enrollment, contact 1-877-294-2582 or visit our website at www.ford.ca.

HAZARD FLASHER

The hazard flasher is located on the steering column, just behind the steering wheel. The hazard flashers will operate when the ignition is in any position or if the key is not in the ignition.

Push in the flasher control and all front and rear direction signals will flash. Press the flasher control again to turn them off. Use it when your vehicle is disabled and is creating a safety hazard for other motorists.

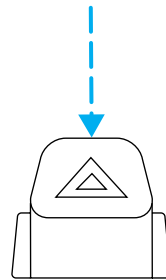

Note: With extended use, the flasher may run down your battery.

FUEL PUMP SHUT-OFF SWITCH

This device stops the electric fuel pump from sending fuel to the engine when your vehicle has had a substantial jolt.

After an accident, if the engine cranks but does not start, this switch may have been activated.

Roadside Emergencies

This switch is located in the front passenger's footwell, behind the kick panel access cover.

To reset the switch:

1. Turn the ignition OFF.
2. Check the fuel system for leaks.
3. If no leaks are apparent, reset the switch by pushing in on the reset button.
4. Turn the ignition ON.
5. Wait a few seconds and return the key to OFF.
6. Make another check for leaks.

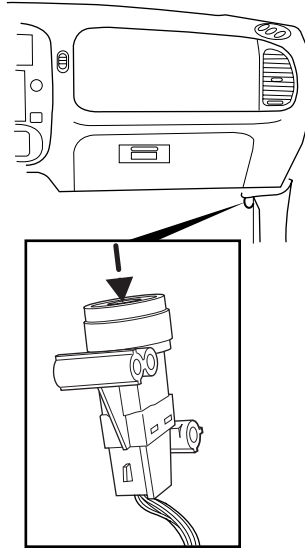

FUSES AND RELAYS

If electrical components are not working, a fuse may have blown. If a fuse is blown the wire in the fuse will be broken.

Note: Always replace a fuse with one that has the specified amperage rating.

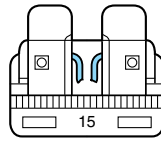

Replacing a blown fuse with a fuse that has a higher amperage can cause severe wire damage and could start a fire.

Roadside Emergencies

Standard fuse amperage rating and color

| Fuse rating | COLOR | | | | |
|-------------|------------|----------------|------------|----------------------|---------------------|
| | Mini fuses | Standard fuses | Maxi fuses | Cartridge maxi fuses | Fuse link cartridge |
| 2A | Grey | Grey | — | — | — |
| 3A | Violet | Violet | — | — | — |
| 4A | Pink | Pink | — | — | — |
| 5A | Tan | Tan | — | — | — |
| 7.5A | Brown | Brown | — | — | — |
| 10A | Red | Red | — | — | — |
| 15A | Blue | Blue | — | — | — |
| 20A | Yellow | Yellow | Yellow | Blue | Blue |
| 25A | Natural | Natural | — | — | — |
| 30A | Green | Green | Green | Pink | Pink |
| 40A | — | — | Orange | Green | Green |
| 50A | — | — | Red | Red | Red |
| 60A | — | — | Blue | — | Yellow |
| 70A | — | — | Tan | — | Brown |
| 80A | — | — | Natural | — | Black |

Passenger compartment fuse panel

The fuse panel is behind the end cover at the left side of the instrument panel. Pull the cover outward to access the fuses.

To remove a fuse, use the tool on the panel cover.

Fuses 4, 8, 12 and 16 are empty (no fuses present) and can not be accessed as they are blocked by the fuse cover.

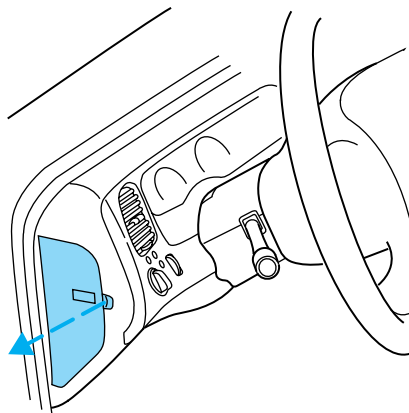

Roadside Emergencies

The fuses are:

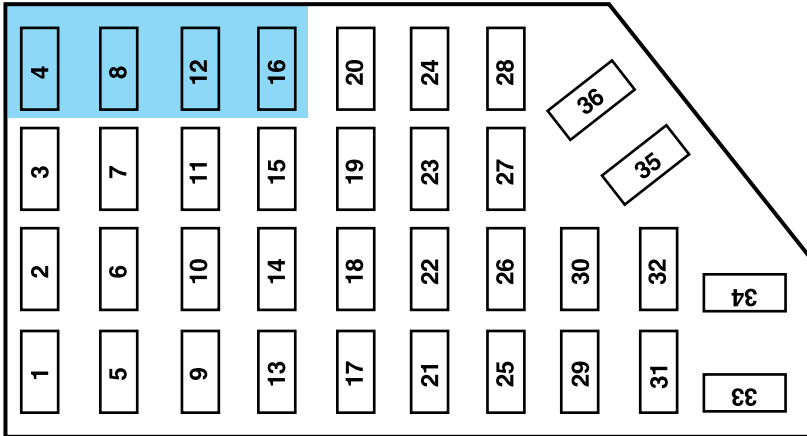

| Fuse/Relay Location | Fuse Amp Rating | Passenger Compartment Fuse Panel Description |
|---------------------|-----------------|--|
| 1 | 5A | Mirrors |
| 2 | 15A | Ignition |
| 3 | 7.5A | Trailer tow right-hand stop/turn lamps |
| 4 | — | Not used |
| 5 | 15A | Park lamps, Autolamps, Instrument panel dimming, Trailer tow |
| 6 | 7.5A | Cluster |
| 7 | 7.5A | Trailer tow left-hand stop/turn lamps |
| 8 | — | Not used |
| 9 | 7.5A | Speed control, Anti-lock Brake System (ABS), 4x4, Powertrain Control Module (PCM), Park interlock, Keyless entry |
| 10 | 10A | Air bags |

Roadside Emergencies

| Fuse/Relay Location | Fuse Amp Rating | Passenger Compartment Fuse Panel Description |
|---------------------|-----------------|---|
| 11 | 15A | Climate control, Rear climate control |
| 12 | — | Not used |
| 13 | 15A | Subwoofer |
| 14 | 7.5A | Cluster, Keyless entry, 4x4 |
| 15 | 7.5A | Turn signals, Park interlock, Overhead console, Climate control, 4x4, Speed control |
| 16 | — | Not used |
| 17 | 20A | Cigar lighter, OBD II |
| 18 | — | Not used |
| 19 | 15A | Daytime Running Lamps (DRL), Reverse lamps, PCM |
| 20 | — | Not used |
| 21 | — | Not used |
| 22 | 20A | Instrument panel power point |
| 23 | — | Not used |
| 24 | 7.5A | Starter |
| 25 | 7.5A | Cluster, 4x4 |
| 26 | 10A | Interior illumination, Battery saver |
| 27 | 7.5A | Cluster, Delayed accessory, Front wiper |
| 28 | 7.5A | Cluster, Audio |
| 29 | 20A | Audio |
| 30 | — | Not used |
| 31 | 5A | Rear climate control |
| 32 | 5A | Auxiliary Center High-Mounted Stop Lamp (CHMSL) |
| 33 | 15A | High beam headlamps |
| 34 | — | Not used |
| 35 | 5A | ABS module |
| 36 | — | Not used |

Roadside Emergencies

Power distribution box

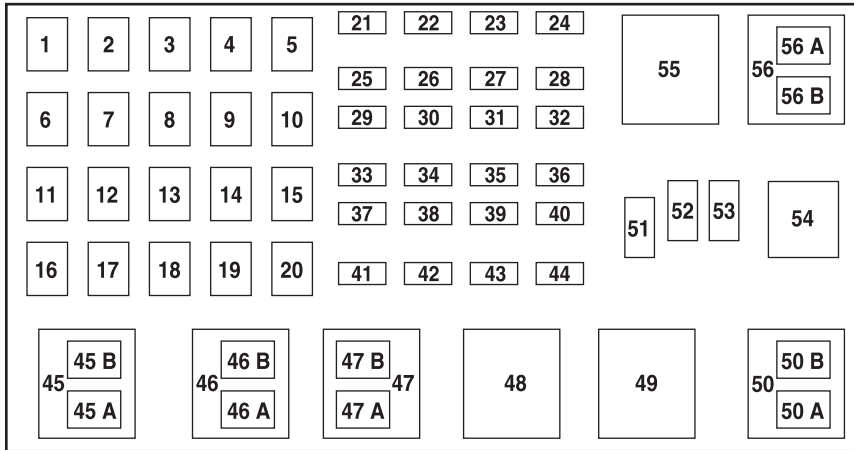

The power distribution box is in the engine compartment. It contains high-current fuses that protect the main electrical systems from overloads.

Note: Always disconnect the battery before servicing high-current fuses.

Note: Always replace the cover to the power distribution box before reconnecting the battery or refilling fluid reservoirs.

If the battery has been disconnected and reconnected, refer to the *Battery* section.

The high-current fuses are:

| Fuse/Relay Location | Fuse Amp Rating | Power Distribution Box Description |
|---------------------|-----------------|------------------------------------|
| 1 | 50A** | I/P fuse panel |
| 2 | — | Not used |
| 3 | 30A** | Powertrain control |
| 4 | — | Not used |
| 5 | 20A** | Fuel pump |
| 6 | — | Not used |
| 7 | 40A** | Blower motor |

Roadside Emergencies

| Fuse/Relay Location | Fuse Amp Rating | Power Distribution Box Description |
|---------------------|-----------------|--|
| 8 | 30A** | Starter motor |
| 9 | 20A** | Wiper motor |
| 10 | 20A** | Rear window/roof |
| 11 | 50A** | Adrenalin audio |
| 12 | — | Not used |
| 13 | — | Not used |
| 14 | 25A** | Ignition switch |
| 15 | 20A** | Rear power point |
| 16 | 50A** | Anti-lock Brake System (ABS) pump motor |
| 17 | — | Not used |
| 18 | 30A** | ABS module |
| 19 | — | Not used |
| 20 | 20A** | 4x4 motor |
| 21 | — | Not used |
| 22 | 15A* | 4x4 module |
| 23 | 15A* | Trailer tow |
| 24 | 10A* | Powertrain Control Module (PCM) memory |
| 25 | — | Not used |
| 26 | 20A* | Door locks |
| 27 | 15A* | Daytime Running Lamps (DRL) |
| 28 | 10A* | A/C clutch |
| 29 | 25A* | Headlamps |
| 30 | — | Not used |
| 31 | 15A* | Fog lamps |
| 32 | 15A* | Heated Exhaust Gas Oxygen (HEGO) sensors and solenoids |
| 33 | — | Not used |
| 34 | 15A* | Stop lamps |
| 35 | 15A* | Horn |
| 36 | 10A* | Automatic transmission |
| 37 | — | Not used |

Roadside Emergencies

| Fuse/Relay Location | Fuse Amp Rating | Power Distribution Box Description |
|---------------------|---------------------|---------------------------------------|
| 38 | 10A* | Left low beam |
| 39 | 10A* | Delayed accessory |
| 40 | 15A* | Injectors, Mass Air Flow (MAF) sensor |
| 41 | — | Not used |
| 42 | 10A* | Right low beam |
| 43 | 2A* | Speed control |
| 44 | 15A* | PCM |
| 45A | 1/2 ISO | Fog lamps relay |
| 45B | — | Not used |
| 46A | 1/2 ISO | Trailer tow relay |
| 46B | — | Not used |
| 47A | 20A Circuit breaker | Windows |
| 47B | 20A Circuit breaker | Seats |
| 48 | Full ISO | Window safety relay |
| 49 | Full ISO | Starter relay |
| 50A | — | Not used |
| 50B | 1/2 ISO | Fuel pump relay |
| 51 | 750 Ohm resistor | Brake On/Off (BOO) switch resistor |
| 52 | — | A/C clutch diode |
| 53 | — | PCM diode |
| 54 | Full ISO | PCM relay |
| 55 | Full ISO | Blower relay |
| 56A | — | Not used |
| 56B | 1/2 ISO | A/C clutch solenoid relay |

*Mini fuse **Cartridge fuse

Roadside Emergencies

CHANGING A FLAT TIRE

If you get a flat tire while driving:

- do not brake heavily.
- gradually decrease the vehicle's speed.
- hold the steering wheel firmly.
- slowly move to a safe place on the side of the road.



The use of tire sealants may damage your tires.

Dissimilar spare tire/wheel information



Failure to follow these guidelines could result in an increased risk of tire failure, loss of vehicle control, injury or death.

Your vehicle may be equipped with a dissimilar spare tire/wheel. A dissimilar spare tire/wheel is defined as a spare tire and/or wheel that is different in brand, size or appearance from the road tires and wheels. If you have a dissimilar spare tire/wheel, then it is intended for temporary use only. This means that if you need to use it, you should replace it as soon as possible with a road tire/wheel that is the same size and type as the road tires and wheels that were originally provided by Ford. If the dissimilar spare tire or wheel is damaged, it should be replaced rather than repaired.

When driving with the dissimilar spare tire/wheel, **do not:**

- Exceed 70 mph (113 km/h)
- Use more than one dissimilar spare tire/wheel at a time
- Use commercial car washing equipment
- Use snow chains on the end of the vehicle with the dissimilar spare tire/wheel

The usage of a dissimilar spare tire/wheel can lead to impairment of the following:

- Handling, stability and braking performance
- Comfort and noise
- Ground clearance and parking at curbs
- Winter weather driving capability

Roadside Emergencies

- Wet weather driving capability
- All-Wheel Driving Capability (if applicable)
- Load Leveling Adjustment (if applicable)

When driving with the dissimilar spare tire/wheel additional caution should be given to:

- Towing a trailer
- Driving vehicles equipped with a camper body
- Driving vehicles with a load on the cargo rack

Drive cautiously when using a dissimilar spare tire/wheel and seek service as soon as possible.

Location of the spare tire and tools

The spare tire and tools for your vehicle are stowed in the following locations:

| Tool | Location |
|--|---|
| Spare tire | Under the vehicle, just in front of the rear bumper |
| Jack, Jack handle, jack handle extension, wheel lug nut wrench | In the passenger side rear cab compartment behind the access door in trim panel |

Removing the jack

To remove the jack, turn the thumbwheel (1) counterclockwise, then remove the jack (2), lug wrench (3) and jack handles (4) from the bracket.

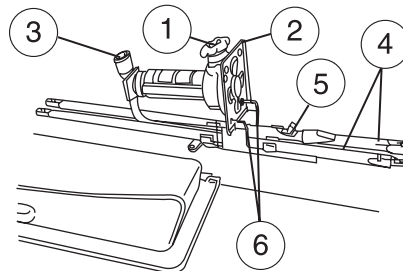

Installing the jack

To install the jack, place the jack handles (4) in the clips, then replace the lug wrench (3). **Note:** The square hole fits over the peg (5) on the jack stowage bracket. Ensure that the lug wrench handle is seated under the nib at the base of the peg. Fully lower the jack (2) by turning the

Roadside Emergencies

thumbwheel (1) clockwise, then install the jack (2) by placing the base of the jack onto the stands (6). Place the plastic clip that is attached to the lug nut wrench between the head of the jack and the head of the lug wrench. Turn the thumbwheel (1) clockwise to raise the jack between the stands (6) and the top of the lug wrench (3).

Removing the spare tire

1. Assemble the jack handle with the spade end to the lug wrench as shown in the illustration.

- To assemble, depress button and slide the pieces together. To disassemble, depress the button and pull the pieces apart.

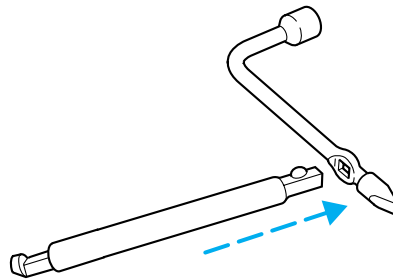

2. Insert the jack handle into the opening just above the rear bumper.

The handle will stop moving forward and resistance to turning will be felt when properly engaged.

3. Turn the handle counterclockwise until tire is lowered to the ground, and the cable is slack. Slide the tire rearward.

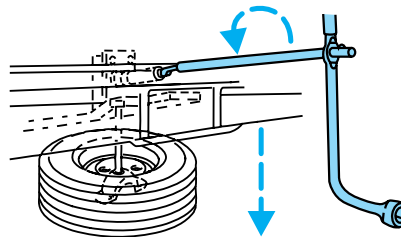

4. Remove the retainer from the center of the spare tire.

Roadside Emergencies

Stowing the jack and tools

1. Install the jack handles into the clips.
2. Install the lug wrench ensuring that the square hole is over the peg on the bracket. Ensure that the lug wrench handle is seated below the nib at the base of the peg.
3. Install the jack on the bracket and place the plastic clip that is attached to the lug wrench between the head of the jack and the head of the lug wrench. Turn the thumbwheel clockwise to raise the jack between the stands and the top of the lug wrench.

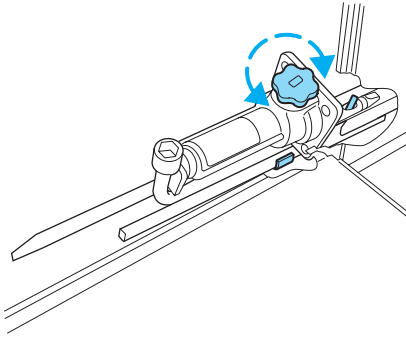

How to change a flat tire

 When one of the front wheels is off the ground, the transmission alone will not prevent the vehicle from moving or slipping off the jack, even if the vehicle is in P (Park) (automatic transmission) or R (Reverse) (manual transmission).

 To help prevent the vehicle from moving when you change a tire, be sure the parking brake is set, then block (in both directions) the wheel that is diagonally opposite (other side and end of the vehicle) to the tire being changed.

 If the vehicle slips off the jack, you or someone else could be seriously injured.

 Do not attempt to change a tire on the side of the vehicle close to moving traffic. Pull far enough off the road to avoid the danger of being hit when operating the jack or changing the wheel.

Roadside Emergencies

Before changing the tire:

1. Park on a level surface.
2. Activate the hazard flashers.
3. Place the gearshift lever in P (Park) (automatic transmission) or R (Reverse) (manual transmission).
4. Set the parking brake.
5. Turn off the ignition.

To change the tire:

Note: Passengers should not remain in the vehicle when the vehicle is being jacked.

1. Block both the front and rear of the wheel diagonally opposite the flat tire. For example, if the right front tire is flat, block the left rear wheel.

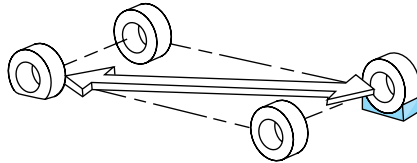

2. Remove any wheel trim by inserting the flat end of the lug nut wrench under the wheel trim flange, then twisting the wrench to pry it off.

3. Loosen, but do not remove, the wheel lug nuts by turning them one-half turn counterclockwise.

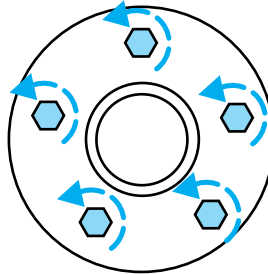

Slide the jack handle and jack handle extension together. Slide the jack handle assembly into the end of the lug nut wrench. To disconnect, depress the button and pull the pieces apart.

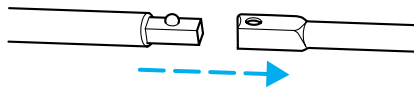

4. Position the jack properly and insert the jack handle into the opening in the thumbwheel at the base of the jack. Turn the handle clockwise until the tire is a maximum of 1 inch (25 mm) off the ground.

Roadside Emergencies

 To lessen the risk of personal injury, do not put any part of your body under the vehicle while changing a tire. Do not start the engine when your vehicle is on the jack. The jack is only meant for changing the tire.

- Front

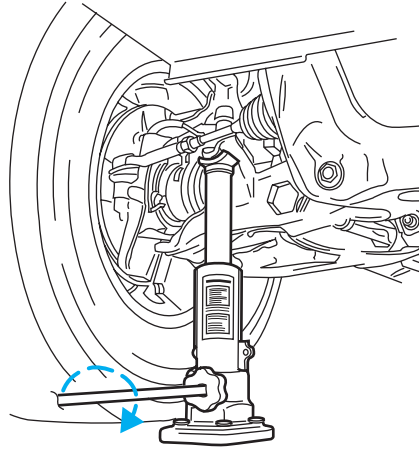

- Rear

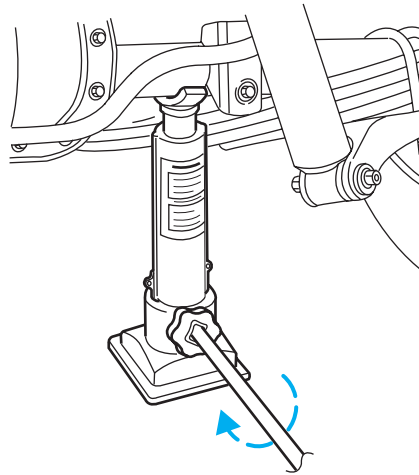

Roadside Emergencies

 To lessen the risk of personal injury, do not put any part of your body under the vehicle while changing a tire. Do not start the engine when your vehicle is on the jack. The jack is only meant for changing the tire.

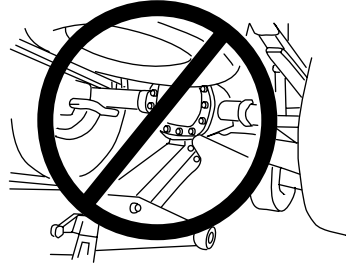

- **Never use the differential as a jacking point.**

5. Remove the wheel lug nuts with the lug nut wrench.
6. Replace the flat tire with the spare tire, making sure the valve stem is facing outward. Reinstall the lug nuts (cone side in) until the wheel is snug against the hub. Do not fully tighten the lug nuts until the wheel has been lowered.
7. Lower the wheel by turning the jack handle counterclockwise.
8. Remove the jack and fully tighten the lug nuts in the order shown. Refer to *Wheel lug nut torque specifications* later in this chapter for the proper lug nut torque specification.
9. Stow the flat tire. Refer to *Stowing the spare tire*.
10. Stow the jack and lug nut wrench. Make sure the jack is fastened so it does not rattle when you drive.
11. Unblock the wheels.

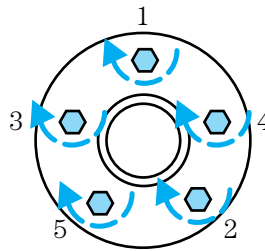

Stowing the flat/spare tire

Note: Failure to follow spare tire stowage instructions may result in failure of cable or loss of spare tire.

1. Lay the tire on the ground with the valve stem facing in the direction specified on the Tire Changing Instructions located with the jack hardware.
2. Slide the wheel partially under the vehicle and install the retainer through the wheel center. Pull on the cable to align the components at the end of the cable.

Roadside Emergencies

3. Turn the jack handle clockwise until the tire is raised to its stowed position underneath the vehicle. The effort to turn the jack handle increases significantly and the spare tire carrier ratchets or slips when the tire is raised to the maximum tightness. Tighten to the best of your ability, to the point where the ratchet/slip occurs, if possible. The spare tire carrier will not allow you to overtighten. If the spare tire carrier ratchets or slips with little effort, take the vehicle to your dealer for assistance at your earliest convenience.
4. Check that the tire lies flat against the frame and is properly tightened. Try to push or pull, then turn the tire to be sure it will not move. Loosen and retighten, if necessary. Failure to properly stow the spare tire may result in failure of the winch cable and loss of the tire.
5. Repeat this tightness check procedure when servicing the spare tire pressure (every six months, per *Scheduled Maintenance Guide*), or at any time that the spare tire is disturbed through service of other components.
6. If removed, install the spare tire lock (if equipped) into the bumper drive tube with the spare tire lock key (if equipped) and jack handle.

WHEEL LUG NUT TORQUE SPECIFICATIONS

Retighten the lug nuts to the specified torque at 50–100 miles (80–160 km) after any wheel disturbance (rotation, flat tire, wheel removal, etc.).

| Lug nut socket size/Bolt size | Wheel lug nut torque* | |
|--|-----------------------|-----|
| | lb.ft. | N•m |
| Lug nut socket size: ¾" (19 mm) hex Bolt size: ½ x 20 | 100 | 135 |
| * Torque specifications are for nut and bolt threads free of dirt and rust. Use only Ford recommended replacement fasteners. | | |



When a wheel is installed, always remove any corrosion, dirt and foreign materials present on the mounting surfaces of the wheel and the surface of the front disc brake hub and rotor that contacts the wheel. Installing wheels without correct metal-to-metal contact at the wheel mounting surfaces can cause the wheel nuts to loosen and the wheel to come off while the vehicle is in motion, resulting in loss of control.

Note: If there is corrosion on the area where the wheel contacts the hub, apply a thin film of grease or anti-seize compound on that area.

Roadside Emergencies

JUMP STARTING YOUR VEHICLE



The gases around the battery can explode if exposed to flames, sparks, or lit cigarettes. An explosion could result in injury or vehicle damage.



Batteries contain sulfuric acid which can burn skin, eyes and clothing, if contacted.

Do not attempt to push-start your vehicle. Automatic transmissions do not have push-start capability; doing so may damage the catalytic converter.

Preparing your vehicle

When the battery is disconnected or a new battery is installed, the transmission must relearn its shift strategy. As a result, the transmission may have firm and/or soft shifts. This operation is considered normal and will not affect function or durability of the transmission. Over time, the adaptive learning process will fully update transmission operation.

1. **Use only a 12-volt supply to start your vehicle.**
2. Do not disconnect the battery of the disabled vehicle as this could damage the vehicle's electrical system.
3. Park the booster vehicle close to the hood of the disabled vehicle making sure the two vehicles **do not** touch. Set the parking brake on both vehicles and stay clear of the engine cooling fan and other moving parts.
4. Check all battery terminals and remove any excessive corrosion before you attach the battery cables. Ensure that vent caps are tight and level.
5. Turn the heater fan on in both vehicles to protect any electrical surges. Turn all other accessories off.

Roadside Emergencies

Connecting the jumper cables

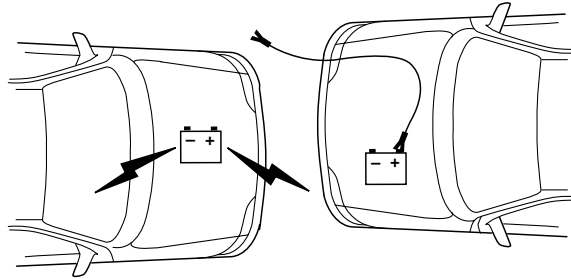

1. Connect the positive (+) jumper cable to the positive (+) terminal of the discharged battery.

Note: In the illustrations, *lightning bolts* are used to designate the assisting (boosting) battery.

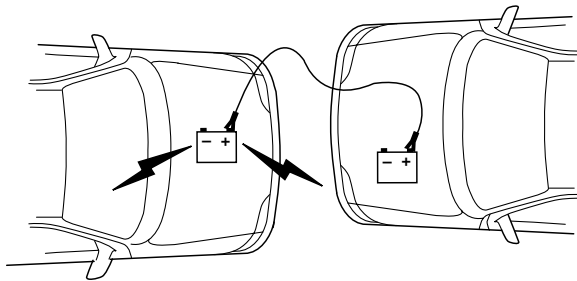

2. Connect the other end of the positive (+) cable to the positive (+) terminal of the assisting battery.

Roadside Emergencies

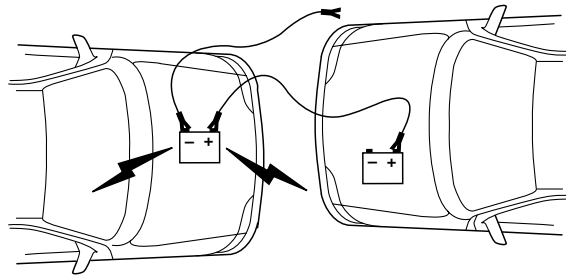

3. Connect the negative (-) cable to the negative (-) terminal of the assisting battery.

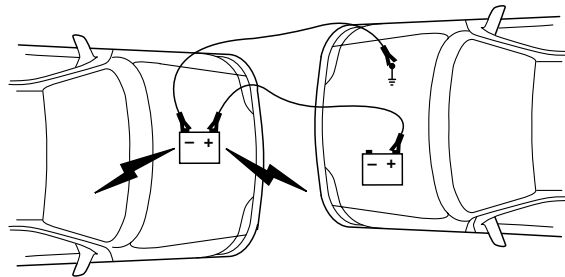

4. Make the final connection of the negative (-) cable to an exposed metal part of the stalled vehicle's engine, away from the battery and the carburetor/fuel injection system. **Do not** use fuel lines, engine rocker covers or the intake manifold as *grounding* points.



Do not connect the end of the second cable to the negative (-) terminal of the battery to be jumped. A spark may cause an explosion of the gases that surround the battery.

5. Ensure that the cables are clear of fan blades, belts, moving parts of both engines, or any fuel delivery system parts.

Jump starting

1. Start the engine of the booster vehicle and run the engine at moderately increased speed.
2. Start the engine of the disabled vehicle.

Roadside Emergencies

3. Once the disabled vehicle has been started, run both engines for an additional three minutes before disconnecting the jumper cables.

Removing the jumper cables

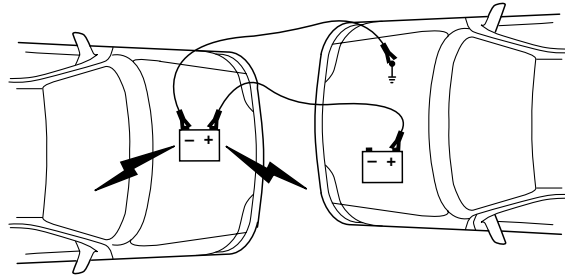

Remove the jumper cables in the reverse order that they were connected.

1. Remove the jumper cable from the *ground* metal surface.

Note: In the illustrations, *lightning bolts* are used to designate the assisting (boosting) battery.

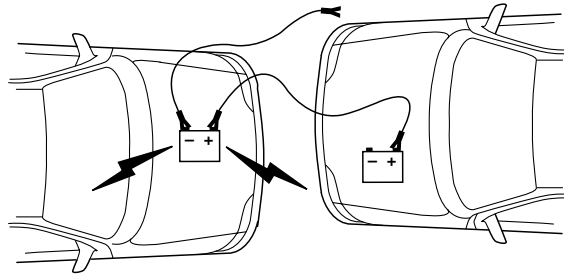

2. Remove the jumper cable on the negative (-) connection of the booster vehicle's battery.

Roadside Emergencies

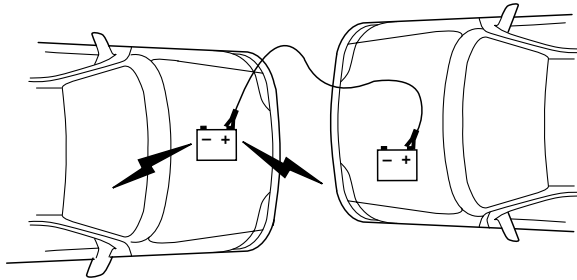

3. Remove the jumper cable from the positive (+) terminal of the booster vehicle's battery.

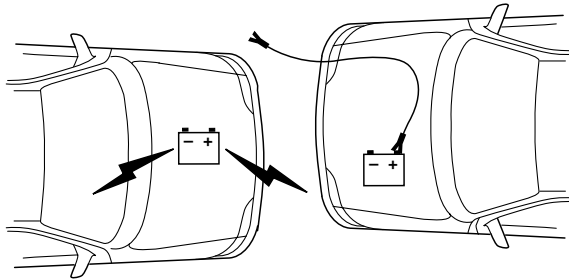

4. Remove the jumper cable from the positive (+) terminal of the disabled vehicle's battery.

After the disabled vehicle has been started and the jumper cables removed, allow it to idle for several minutes so the engine computer can *relearn* its idle conditions.

Roadside Emergencies

WRECKER TOWING

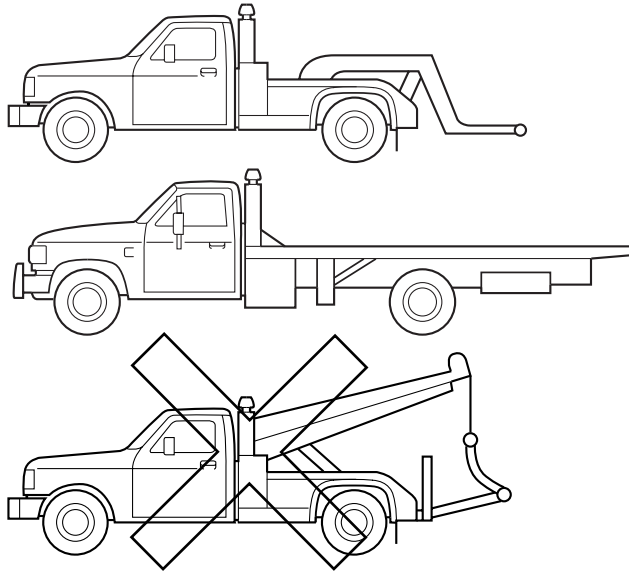

If you need to have your vehicle towed, contact a professional towing service or, if you are a member of a roadside assistance program, your roadside assistance service provider.

Ford recommends your vehicle be towed with a wheel lift or flatbed. Do not tow with a slingbelt. Ford Motor Company has not approved a slingbelt towing procedure.

Customer Assistance

GETTING THE SERVICES YOU NEED

At home

You must take your Ford vehicle to an authorized Ford dealer for warranty repairs. While any Ford dealership handling your vehicle line will provide warranty service, we recommend you return to your selling dealer who wants to ensure your continued satisfaction. Please note that certain warranty repairs require special training and/or equipment, so not all dealers are authorized to perform all warranty repairs. This means that, depending on the warranty repair needed, you may have to take your vehicle to another dealer. A reasonable time must be allowed to perform a repair after taking your vehicle to the dealership. Repairs will be made using Ford or Motorcraft parts, or remanufactured or other parts that are authorized by Ford.

If you have questions or concerns, or are unsatisfied with the service you are receiving, follow these steps:

1. Contact your Sales Representative or Service Advisor at your selling/servicing dealership.
2. If your inquiry or concern remains unresolved, contact the Sales Manager, Service Manager or Customer Relations Manager.
3. If you require assistance or clarification on Ford Motor Company policies or procedures, please contact the Ford Customer Relationship Center at the number below.

Away from home

If you own a Ford or Mercury vehicle and are away from home when your vehicle needs service, or if you need more help than the dealership could provide, after following the steps described above, contact the Ford Customer Relationship Center to find an authorized dealership to help you.

In the United States:

Ford Motor Company
Customer Relationship Center
P.O. Box 6248
Dearborn, MI 48121
1-800-392-3673 (FORD)
(TDD for the hearing impaired: 1-800-232-5952)
www.customersaskford.com

Customer Assistance

In Canada:
Customer Relationship Centre
Ford Motor Company of Canada, Limited
P.O. Box 2000
Oakville, Ontario L6J 5E4
1-800-565-3673 (FORD)
www.ford.ca

If you own a Lincoln vehicle and are away from home when your vehicle needs service, or if you need more help than the dealership could provide, after following the steps described above, contact the Ford Customer Relationship Center to find an authorized dealership to help you.

In the United States:
Ford Motor Company
Customer Relationship Center
P.O. Box 6248
Dearborn, MI 48121
1-800-521-4140
(TDD for the hearing impaired: 1-800-232-5952)
www.customersaskford.com

In Canada:
Lincoln Centre
Ford Motor Company of Canada, Limited
P.O. Box 2000
Oakville, Ontario L6J 5E4
1-800-387-9333
www.lincolncanada.com

In order to help you service your Lincoln vehicle, please have the following information available when contacting the Lincoln Centre:

- Your telephone number (home and business)
- The name of the dealer and the city where the dealership is located
- The year and make of your vehicle
- The date of vehicle purchase
- The current odometer reading
- The vehicle identification number (VIN)

Customer Assistance

Additional Assistance

If you still have a complaint involving a warranty dispute, you may wish to contact the Dispute Settlement Board (U.S.).

In some states (in the U.S.) you must directly notify Ford in writing before pursuing remedies under your state's warranty laws. Ford is also allowed a final repair attempt in some states.

In the United States, a warranty dispute must be submitted to the Dispute Settlement Board before taking action under the Magnuson-Moss Warranty Act, or to the extent allowed by state law, before pursuing replacement or repurchase remedies provided by certain state laws. This dispute handling procedure is not required prior to enforcing state created rights or other rights which are independent of the Magnuson-Moss Warranty Act or state replacement or repurchase laws.

FORD EXTENDED SERVICE PLAN

You can get more protection for your new car or light truck by purchasing Ford Extended Service Plan (Ford ESP) coverage. It provides the following:

- Benefits during the warranty period depending on the plan you purchase (such as: reimbursement for rentals; coverage for certain maintenance and wear items).
- Protection against covered repair costs after your Bumper-to-Bumper Warranty expires.

You may purchase Ford ESP from any participating Ford and Lincoln Mercury and Ford of Canada dealer. There are several plans available in various time, distance and deductible combinations which can be tailored to fit your own driving needs. Ford ESP also offers reimbursement benefits for towing and rental coverage.

When you buy Ford ESP, you receive Peace-of-Mind protection throughout the United States and Canada, provided by a network of more than 5,000 participating Ford or Lincoln Mercury and Ford of Canada dealers.

If you did not take advantage of the Ford Extended Service Plan at the time of purchasing your vehicle, you may still be eligible. Since this information is subject to change, please ask your dealer for complete details about Ford Extended Service Plan coverage options, or visit the Ford ESP website at www.ford-esp.com.

THE DISPUTE SETTLEMENT BOARD (U.S. ONLY)

The Dispute Settlement Board is:

- an independent, third-party arbitration program for warranty disputes.

Customer Assistance

- available free to owners and lessees of qualifying Ford Motor Company vehicles.

The Dispute Settlement Board may not be available in all states. Ford Motor Company reserves the right to change eligibility limitations, modify procedures and/or to discontinue this service without notice and without incurring obligations per applicable state law.

What kinds of cases does the Board review?

Unresolved warranty repair concerns or vehicle performance concerns as on Ford and Lincoln Mercury cars and Ford and Lincoln Mercury light trucks which are within the terms of any applicable written new vehicle warranty are eligible for review, except those involving:

- a non-Ford product
- a non-Ford dealership
- sales disputes between customer and dealer except those associated with warranty repairs or concerns with the vehicle's performance as designed
- a request for reimbursement of consequential expenses unless a service or product concern is being reviewed
- items not covered by the New Vehicle Limited Warranty (including maintenance and wear items)
- alleged personal injury/property damage claims
- cases currently in litigation
- vehicles not used primarily for family, personal or household purposes (except in states where the Dispute Settlement Board is required to review commercial vehicles)
- vehicles with non-U.S. warranties

Concerns are ineligible for review if the New Vehicle Limited Warranty has expired at receipt of your application and, in certain states eligibility is dependent upon the customer's possession of the vehicle.

Eligibility may differ according to state law. For example, see the unique brochures for California, West Virginia, Georgia and Wisconsin purchasers/lessees.

Board membership

The Board consists of:

- Three consumer representatives
- A Ford or Lincoln Mercury dealership representative

Customer Assistance

Consumer candidates for Board membership are recruited and trained by an independent consulting firm. The dealership Board member is chosen from Ford and Lincoln Mercury dealership management, recognized for their business leadership qualities.

What the Board needs

To have your case reviewed you must complete the application in the DSB brochure and mail it to the address provided on the application form. Some states will require you to use certified mail, with return receipt requested.

Your application is reviewed and, if it is determined to be eligible, you will receive an acknowledgment indicating:

- The file number assigned to your application.
- The toll-free phone number of the DSB's independent administrator.

Your dealership and a Ford Motor Company representative will then be asked to submit statements.

To properly review your case, the Board needs the following information:

- Legible copies of all documents and maintenance or repair orders relevant to the case.
- The year, make, model, and Vehicle Identification Number (VIN) listed on your vehicle ownership license.
- The date of repair(s) and mileage at the time of occurrence(s).
- The current mileage.
- The name of the dealer(s) who sold or serviced the vehicle.
- A brief description of your unresolved concern.
- A brief summary of the action taken by the dealer(s) and Ford Motor Company.
- The names (if known) of all the people you contacted at the dealership(s).
- A description of the action you expect to resolve your concern.

You will receive a letter of explanation if your application does not qualify for Board review.

Oral presentations

If you would like to make an oral presentation, indicate YES to question 6 on the application. While it is your right to make an oral presentation before the Board, this is not a requirement and the Board will decide the case whether or not an oral presentation is made. An oral presentation may be requested by the Board as well.

Customer Assistance

Making a decision

Board members review all available information related to each complaint, including oral presentations, and arrive at a fair and impartial decision. Board review may be terminated at any time by either party.

Every effort is made to decide the case within 40 days of the date that all requested information is received by the Board. Since the Board generally meets once a month, it may take longer for the Board to consider some cases.

After a case is reviewed, the Board mails you a decision letter and a form on which to accept or reject the Board's decision. The decisions of the Board are binding on Ford (and, in some cases, on the dealer) but not on consumers who are free to pursue other remedies available to them under state or federal law.

To request a DSB Brochure/Application

For a brochure/application, speak to your dealer or write/call the Board at the following address/phone number:

Dispute Settlement Board
P.O. Box 1424
Waukesha, WI 53187-1424
1-800-428-3718

You may also contact the North American Customer Relationship Center at 1-800-392-3673 (Ford), TDD for the hearing impaired: 1-800-232-5952 or by writing to the Center at the following address:

Ford Motor Company
Customer Relationship Center
P.O. Box 6248
Dearborn, Michigan 48121

UTILIZING THE MEDIATION/ARBITRATION PROGRAM (CANADA ONLY)

In those cases where you continue to feel that the efforts by Ford and the dealer to resolve a factory-related vehicle service concern have been unsatisfactory, Ford of Canada participates in an impartial third party mediation/arbitration program administered by the Canadian Motor Vehicle Arbitration Plan (CAMVAP).

The CAMVAP program is a straight-forward and relatively speedy alternative to resolve a disagreement when all other efforts to produce a settlement have failed. This procedure is without cost to you and is designed to eliminate the need for lengthy and expensive legal proceedings.

Customer Assistance

In the CAMVAP program, impartial third-party arbitrators conduct hearings at mutually convenient times and places in an informal environment. These impartial arbitrators review the positions of the parties, make decisions and, when appropriate, render awards to resolve disputes. CAMVAP decisions are fast, fair, and final; the arbitrator's award is binding both to you and Ford of Canada.

CAMVAP services are available in all territories and provinces. For more information, without charge or obligation, call your CAMVAP Provincial Administrator directly at 1-800-207-0685.

GETTING ASSISTANCE OUTSIDE THE U.S. AND CANADA

Before exporting your vehicle to a foreign country, contact the appropriate foreign embassy or consulate. These officials can inform you of local vehicle registration regulations and where to find unleaded fuel.

If you cannot find unleaded fuel or can only get fuel with an anti-knock index lower than is recommended for your vehicle, contact a district or owner relations/customer relationship office.

The use of leaded fuel in your vehicle without proper conversion may damage the effectiveness of your emission control system and may cause engine knocking or serious engine damage. Ford Motor Company/Ford of Canada is not responsible for any damage caused by use of improper fuel.

In the United States, using leaded fuel may also result in difficulty importing your vehicle back into the U.S.

If your vehicle must be serviced while you are traveling or living in Central or South America, the Caribbean, or the Middle East, contact the nearest Ford dealership. If the dealership cannot help you, write or call:

FORD MOTOR COMPANY
WORLDWIDE DIRECT MARKET OPERATIONS
1555 Fairlane Drive
Fairlane Business Park #3
Allen Park, Michigan 48101
U.S.A.
Telephone: (313) 594-4857
FAX: (313) 390-0804

If you are in another foreign country, contact the nearest Ford dealership. If the dealership employees cannot help you, they can direct you to the nearest Ford affiliate office.

If you buy your vehicle in North America and then relocate outside of the U.S. or Canada, register your vehicle identification number (VIN) and new address with Ford Motor Company Worldwide Direct Market Operations.

Customer Assistance

ORDERING ADDITIONAL OWNER'S LITERATURE

To order the publications in this portfolio, contact Helm, Incorporated at:

HELM, INCORPORATED
P.O. Box 07150
Detroit, Michigan 48207

Or call:

For a free publication catalog, order toll free: 1-800-782-4356

Monday-Friday 8:00 a.m. - 6:00 p.m. EST

Helm, Incorporated can also be reached by their website:
www.helminc.com.

(Items in this catalog may be purchased by credit card, check or money order.)

Obtaining a French owner's guide

French Owner's Guides can be obtained from your dealer or by writing to Ford Motor Company of Canada, Limited, Service Publications, P.O. Box 1580, Station B, Mississauga, Ontario L4Y 4G3.

IN CALIFORNIA (U.S. ONLY)

California Civil Code Section 1793.2(d) requires that, if a manufacturer or its representative is unable to repair a motor vehicle to conform to the vehicle's applicable express warranty after a reasonable number of attempts, the manufacturer shall be required to either replace the vehicle with one substantially identical or repurchase the vehicle and reimburse the buyer in an amount equal to the actual price paid or payable by the consumer (less a reasonable allowance for consumer use). The consumer has the right to choose whether to receive a refund or replacement vehicle.

California Civil Code Section 1793.22(b) presumes that the manufacturer has had a reasonable number of attempts to conform the vehicle to its applicable express warranties if, within the first 18 months of ownership of a new vehicle or the first 18,000 miles (29,000 km), whichever occurs first:

1. Two or more repair attempts are made on the same non-conformity likely to cause death or serious bodily injury OR
2. Four or more repair attempts are made on the same nonconformity (a defect or condition that substantially impairs the use, value or safety of the vehicle) OR

Customer Assistance

3. The vehicle is out of service for repair of nonconformities for a total of more than 30 calendar days (not necessarily all at one time)

In the case of 1 or 2 above, the consumer must also notify the manufacturer of the need for the repair of the nonconformity at the following address:

Ford Motor Company
16800 Executive Plaza Drive
Mail Drop 3NE-B
Dearborn, MI 48126

REPORTING SAFETY DEFECTS (U.S. ONLY)

If you believe that your vehicle has a defect which could cause a crash or could cause injury or death, you should immediately inform the National Highway Traffic Safety



Administration (NHTSA) in addition to notifying Ford Motor Company.

If NHTSA receives similar complaints, it may open an investigation, and if it finds that a safety defect exists in a group of vehicles, it may order a recall and remedy campaign. However, NHTSA cannot become involved in individual problems between you, your dealer, or Ford Motor Company.

To contact NHTSA, you may either call the Auto Safety Hotline toll-free at 1-800-424-9393 (or 366-0123 in the Washington D.C. area) or write to:

NHTSA
400 Seventh Street
U.S. Department of Transportation
Washington, D.C. 20590

You can also obtain other information about motor vehicle safety from the Hotline.

WASHING THE EXTERIOR

Wash your vehicle regularly with cool or lukewarm water and a neutral Ph shampoo, such as Motorcraft Detail Wash (ZC-3-A), which is available from your dealer.

- Never use strong household detergents or soap, such as dish washing or laundry liquid. These products can discolor and spot painted surfaces.
- Never wash a vehicle that is “hot to the touch” or during exposure to strong, direct sunlight.
- Always use a clean sponge or car wash mitt with plenty of water for best results.
- Dry the vehicle with a chamois or soft terry cloth towel in order to eliminate water spotting.
- It is especially important to wash the vehicle regularly during the winter months, as dirt and road salt are difficult to remove and cause damage to the vehicle.
- Immediately remove items such as gasoline, diesel fuel, bird droppings and insect deposits because they can cause damage to the vehicle’s paintwork and trim over time.
- Remove any exterior accessories, such as antennas, before entering a car wash.
- **Suntan lotions and insect repellents can damage any painted surface; if these substances come in contact with your vehicle, wash off as soon as possible.**

WAXING

Applying a polymer paint sealant to your vehicle every six months will assist in reducing minor scratches and paint damage.

- Wash the vehicle first.
- Do not use waxes that contain abrasives.
- Do not allow paint sealant to come in contact with any non-body (low-gloss black) colored trim, such as grained door handles, roof racks, bumpers, side moldings, mirror housings or the windshield cowl area. The paint sealant will “gray” or stain the parts over time.

PAINT CHIPS

Your dealer has touch-up paint and sprays to match your vehicle’s color. Take your color code (printed on a sticker in the driver’s door jam) to your dealer to ensure you get the correct color.

Cleaning

- Remove particles such as bird droppings, tree sap, insect deposits, tar spots, road salt and industrial fallout before repairing paint chips.
- Always read the instructions before using the products.

ALUMINUM WHEELS AND WHEEL COVERS

Aluminum wheels and wheel covers are coated with a clearcoat paint finish. In order to maintain their shine:

- Clean weekly with Motorcraft Wheel and Tire Cleaner (ZC-37-A), which is available from your dealer. Heavy dirt and brake dust accumulation may require agitation with a sponge. Rinse thoroughly with a strong stream of water.
- Never apply any cleaning chemical to hot or warm wheel rims or covers.
- Some automatic car washes may cause damage to the finish on your wheel rims or covers. Chemical-strength cleaners, or cleaning chemicals, in combination with brush agitation to remove brake dust and dirt, could wear away the clearcoat finish over time.
- Do not use hydrofluoric acid-based or high caustic-based wheel cleaners, steel wool, fuels or strong household detergent.
- To remove tar and grease, use Motorcraft Bug and Tar Remover (ZC-42), available from your dealer.

ENGINE

Engines are more efficient when they are clean because grease and dirt buildup keep the engine warmer than normal. When washing:

- Take care when using a power washer to clean the engine. The high-pressure fluid could penetrate the sealed parts and cause damage.
- Do not spray a hot engine with cold water to avoid cracking the engine block or other engine components.
- Spray Motorcraft Engine Shampoo and Degreaser (ZC-20) on all parts that require cleaning and pressure rinse clean.
- Cover the highlighted areas to prevent water damage when cleaning the engine.

178

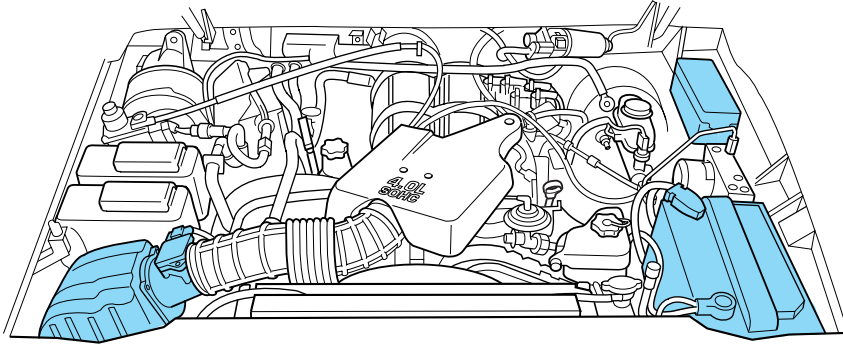

4.0L SOHC

- Never wash or rinse the engine while it is running; water in the running engine may cause internal damage.

PLASTIC (NON-PAINTED) EXTERIOR PARTS

Use only approved products to clean plastic parts. These products are available from your dealer.

- For routine cleaning, use Motorcraft Detail Wash (ZC-3-A).
- If tar or grease spots are present, use Motorcraft Bug and Tar Remover (ZC-42).

WINDOWS AND WIPER BLADES

The windshield, rear and side windows and the wiper blades should be cleaned regularly. If the wipers do not wipe properly, substances on the vehicle's glass or the wiper blades may be the cause. These may include hot wax treatments used by commercial car washes, tree sap, or other organic contamination. To clean these items, please follow these tips:

- The windshield, rear windows and side windows may be cleaned with a non-abrasive cleaner such as Motorcraft Ultra Clear Spray Glass Cleaner (ZC-23), available from your dealer.
- Do not use abrasives, as they may cause scratches.
- Do not use fuel, kerosene, or paint thinner to clean any parts.
- Wiper blades can be cleaned with isopropyl (rubbing) alcohol or windshield washer solution. Be sure to replace wiper blades when they appear worn or do not function properly.

Cleaning

INSTRUMENT PANEL AND CLUSTER LENS

Clean the instrument panel with a damp cloth, then dry with a dry cloth.

- Avoid cleaners or polish that increase the gloss of the upper portion of the instrument panel. The dull finish in this area helps protect the driver from undesirable windshield reflection.



Do not use chemical solvents or strong detergents when cleaning the steering wheel or instrument panel to avoid contamination of the air bag system.

- Be certain to wash or wipe your hands clean if you have been in contact with certain products such as insect repellent and suntan lotion in order to avoid possible damage to the interior painted surfaces.

INTERIOR TRIM

- Clean the interior trim areas with a damp cloth, then dry by wiping with a dry, soft, clean cloth.
- Do not use household or glass cleaners as these may damage the finish.

INTERIOR

For fabric, carpets, cloth seats and safety belts:

- Remove dust and loose dirt with a vacuum cleaner.
- Remove light stains and soil with Motorcraft Extra Strength Upholstery Cleaner (ZC-41).
- If grease or tar is present on the material, spot-clean the area first with Motorcraft Spot and Stain Remover (ZC-14).
- Never saturate the seat covers with cleaning solution.
- Do not use household cleaning products or glass cleaners, which can stain and discolor the fabric and affect the flame retardant abilities of the seat materials.



Do not use cleaning solvents, bleach or dye on the vehicle's seatbelts, as these actions may weaken the belt webbing.

Cleaning

LEATHER SEATS (IF EQUIPPED)

Your leather seating surfaces have a clear, protective coating over the leather.

- To clean, use a soft cloth with Motorcraft Deluxe Leather and Vinyl Cleaner (ZC-11-A). Dry the area with a soft cloth.
- To help maintain its resiliency and color, use the Motorcraft Deluxe Leather Care Kit (ZC-11-D), available from your authorized dealer.
- Do not use household cleaning products, alcohol solutions, solvents or cleaners intended for rubber, vinyl and plastics, or oil/petroleum-based leather conditioners. These products may cause premature wearing of the clear, protective coating.

Note: In some instances, color or dye transfer can occur when wet clothing comes in contact with leather upholstery. If this occurs, the leather should be cleaned immediately to avoid permanent staining.

UNDERBODY

Flush the complete underside of your vehicle frequently. Keep body and door drain holes free from packed dirt.

FORD, LINCOLN AND MERCURY CAR CARE PRODUCTS

Your Ford, Lincoln or Mercury dealer has many quality products available to clean your vehicle and protect its finishes. These quality products have been specifically engineered to fulfill your automotive needs; they are custom designed to complement the style and appearance of your vehicle. Each product is made from high quality materials that meet or exceed rigid specifications. For best results, use the following products or products of equivalent quality:

Motorcraft Custom Clearcoat Polish (ZC-8-A)

Motorcraft Custom Vinyl Protectant (not available in Canada) (ZC-40-A)

Motorcraft Vinyl Cleaner (Canada only) (CXC-93)

Motorcraft Vinyl Conditioner (Canada only) (CXC-94)

Motorcraft Deluxe Leather and Vinyl Cleaner (not available in Canada) (ZC-11-A)

Motorcraft Bug and Tar Remover (ZC-42)

Motorcraft Extra Strength Upholstery Cleaner (not available in Canada) (ZC-41)

Motorcraft Custom Bright Metal Cleaner (ZC-15)

Cleaning

Motorcraft Wheel and Tire Cleaner (ZC-37-A)

Motorcraft Dash and Vinyl Cleaner (ZC-38-A)

Motorcraft Car Care Kit (ZC-26)

Ford Premium Car Wash Concentrate (F2SZ-19523-WC)

Motorcraft Carlite Glass Cleaner (Canada only) (CXC-100)

Motorcraft Spot and Stain Remover (ZC-14)

Motorcraft Detail Wash (ZC-3-A)

Motorcraft Tire Clean and Shine (ZC-28)

Motorcraft Triple Clean (ZC-13)

Motorcraft Ultra-Clear Spray Glass Cleaner (not available in Canada)
(ZC-23)

Motorcraft Engine Shampoo and Degreaser (ZC-20)

Maintenance and Specifications

SERVICE RECOMMENDATIONS

- Use the *Scheduled Maintenance Guide* to track routine service.
- Use only recommended fuels, lubricants, fluids and service parts conforming to specifications.
- Your dealership can provide parts and service.

PRECAUTIONS WHEN SERVICING YOUR VEHICLE

- Do not work on a hot engine.
- Make sure that nothing gets caught in moving parts.
- Do not work on a vehicle with the engine running in an enclosed space, unless you are sure you have enough ventilation.
- Keep all open flames and other lit material away from the battery and all fuel related parts.

Working with the engine off

1. Set the parking brake and shift to P (Park).
2. Turn off the engine and remove the key.
3. Block the wheels.

Working with the engine on

1. Set the parking brake and shift to P (Park).
2. Block the wheels.



Do not start your engine with the air cleaner removed and do not remove it while the engine is running.

Maintenance and Specifications

OPENING THE HOOD

1. Inside the vehicle, pull the hood release handle.
2. Go to the front of the vehicle and release the latch located in the center between the hood and the grille.
3. Lift the hood.



4.0L SOHC V6 ENGINE

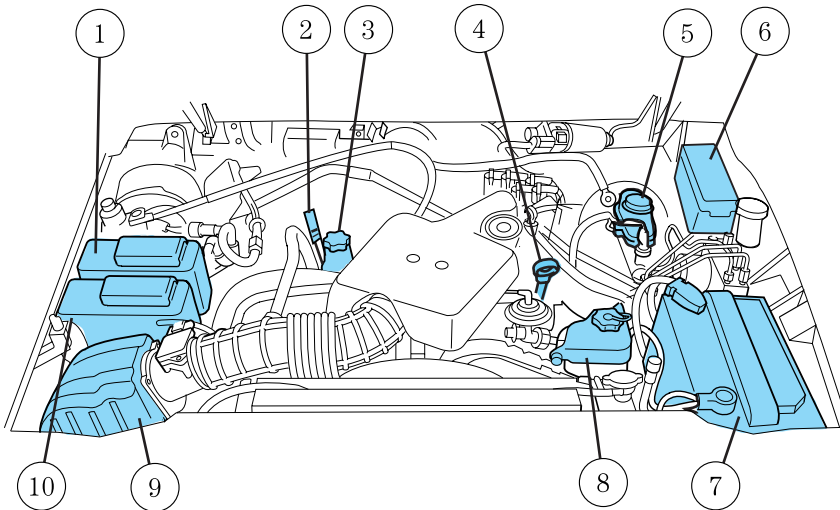

- | | |
|--|-----------------------------------|
| 1. Windshield washer fluid reservoir | 6. Power distribution box |
| 2. Automatic transmission fluid dipstick | 7. Battery |
| 3. Engine oil filler cap | 8. Power steering fluid reservoir |
| 4. Engine oil dipstick | 9. Air filter assembly |
| 5. Brake fluid reservoir | 10. Engine coolant reservoir |

Maintenance and Specifications

WINDSHIELD WASHER FLUID

Add fluid to fill the reservoir if the level is low. In very cold weather, do not fill the reservoir completely.

Use washer fluid that meets Ford specifications. Check State or local regulations for restrictions on the use of methanol, a common windshield washer fluid additive.

Do not put washer fluid in the engine coolant reservoir.

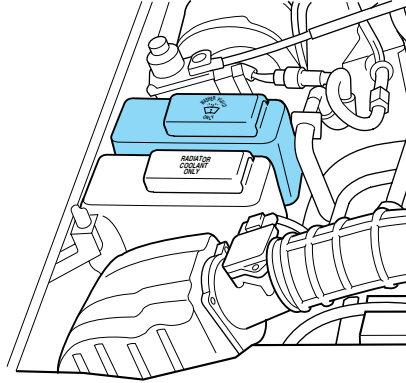

ENGINE OIL

Checking the engine oil

1. Make sure the vehicle is on level ground.
2. Turn the engine off and wait a few minutes.
3. Set the parking brake and place the gearshift in P (Park).
4. Open the hood.

Maintenance and Specifications

5. Remove the engine oil dipstick and wipe clean.
6. Insert the dipstick fully, then remove it again.
7. If the oil level is low, add enough oil to raise the level to within the acceptable range.

Note: Oil levels above the mark indicating full may cause engine damage. Consult a service technician.

8. Replace the dipstick.

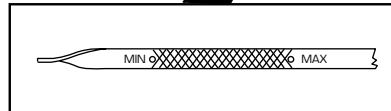
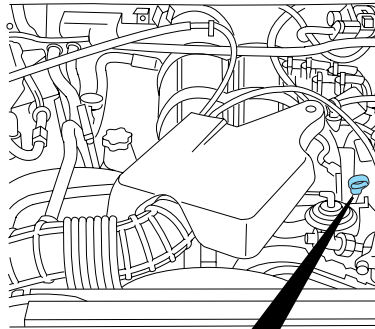

Adding engine oil

1. Check the engine oil.
2. If the engine oil level is below normal range, remove the engine oil filler cap and use a funnel to pour the engine oil into the opening.
3. Recheck the engine oil level to ensure the oil level is not above the mark indicating full on the dipstick.
4. Install the dipstick and engine oil filler cap.

Note: Do not operate the vehicle with the dipstick and/or the engine oil filler cap removed.

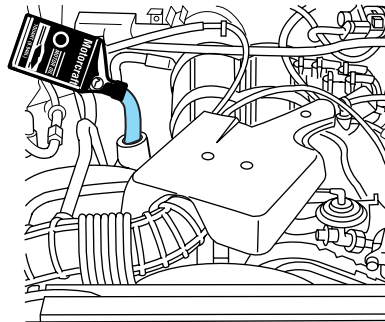

Maintenance and Specifications

Engine oil and filter recommendations

Look for this certification trademark.

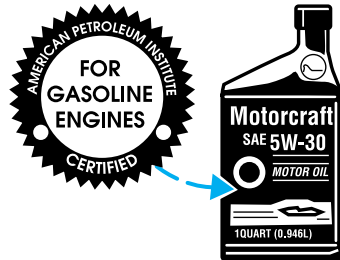

Use SAE 5W-30 engine oil.

Only use oils “Certified For Gasoline Engines” by the American Petroleum Institute (API). To protect your engine’s warranty use Motorcraft SAE 5W-30 or an equivalent 5W-30 oil meeting Ford specification WSS-M2C205-A.

Do not use supplemental engine oil additives, cleaners or other engine treatments. They are unnecessary and could lead to engine damage that is not covered by Ford warranty.

Change your engine oil according to the appropriate schedule listed in the scheduled maintenance guide.

Ford production and aftermarket (Motorcraft) oil filters are designed for added engine protection and long life. If a replacement oil filter is used that does not meet Ford material and design specifications, start-up engine noises or knock may be experienced.

It is recommended you use the appropriate Motorcraft oil filter (or another brand meeting Ford specifications) for your engine application.

Maintenance and Specifications

BATTERY

Your vehicle is equipped with a Motorcraft maintenance-free battery which normally does not require additional water during its life of service.

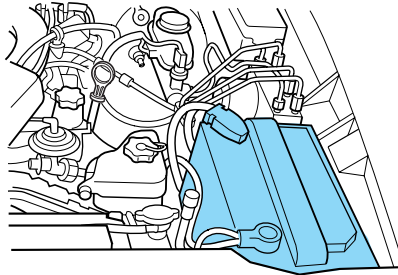

However, for severe usage or in high temperature climates, check the battery electrolyte level. Refer to the *Scheduled Maintenance Guide* for the service interval schedules.

Keep the electrolyte level in each cell up to the “level indicator”. Do not overfill the battery cells.

If the electrolyte level in the battery is low, you can add plain tap water to the battery, as long as you do not use hard water (water with a high mineral or alkali content). If possible, however, try to only fill the battery cells with distilled water. If the battery needs water often, have the charging system checked.

If your battery has a cover/shield, make sure it is reinstalled after the battery has been cleaned or replaced.

For longer, trouble-free operation, keep the top of the battery clean and dry. Also, make certain the battery cables are always tightly fastened to the battery terminals.

If you see any corrosion on the battery or terminals, remove the cables from the terminals and clean with a wire brush. You can neutralize the acid with a solution of baking soda and water.



Batteries normally produce explosive gases which can cause personal injury. Therefore, do not allow flames, sparks or lighted substances to come near the battery. When working near the battery, always shield your face and protect your eyes. Always provide proper ventilation.

Maintenance and Specifications



When lifting a plastic-cased battery, excessive pressure on the end walls could cause acid to flow through the vent caps, resulting in personal injury and/or damage to the vehicle or battery. Lift the battery with a battery carrier or with your hands on opposite corners.



Keep batteries out of reach of children. Batteries contain sulfuric acid. Avoid contact with skin, eyes or clothing. Shield your eyes when working near the battery to protect against possible splashing of acid solution. In case of acid contact with skin or eyes, flush immediately with water for a minimum of 15 minutes and get prompt medical attention. If acid is swallowed, call a physician immediately.



Battery posts, terminals and related accessories contain lead and lead compounds. **Wash hands after handling.**

Because your vehicle's engine is electronically controlled by a computer, some control conditions are maintained by power from the battery. When the battery is disconnected or a new battery is installed, the engine must relearn its idle and fuel trim strategy for optimum driveability and performance. To begin this process:

1. With the vehicle at a complete stop, set the parking brake.
 2. Put the gearshift in P (Park), turn off all accessories and start the engine.
 3. Run the engine until it reaches normal operating temperature.
 4. Allow the engine to idle for at least one minute.
 5. Turn the A/C on and allow the engine to idle for at least one minute.
 6. Drive the vehicle to complete the relearning process.
- The vehicle may need to be driven 10 miles (16 km) or more to relearn the idle and fuel trim strategy.
 - **If you do not allow the engine to relearn its idle trim, the idle quality of your vehicle may be adversely affected until the idle trim is eventually relearned.**

When the battery is disconnected or a new battery installed, the transmission must relearn its adaptive strategy. As a result of this, the transmission may shift firmly. This operation is considered normal and will not affect function or durability of the transmission. Over time the adaptive learning process will fully update transmission operation to its optimum shift feel.

Maintenance and Specifications

If the battery has been disconnected or a new battery has been installed, the clock and the preset radio stations must be reset once the battery is reconnected.

- Always dispose of automotive batteries in a responsible manner. Follow your local authorized standards for disposal. Call your local authorized recycling center to find out more about recycling automotive batteries.

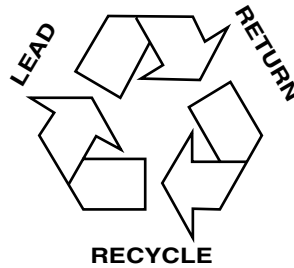

ENGINE COOLANT

Checking engine coolant

The concentration and level of engine coolant should be checked at the mileage intervals listed in the *Scheduled Maintenance Guide*. The coolant concentration should be maintained at 50/50 coolant and distilled water, which equates to a freeze point of -34°F (-36°C). Coolant concentration testing is possible with a hydrometer or antifreeze tester (such as the Rotunda Battery and Antifreeze Tester, 014-R1060). The level of coolant should be maintained at the "FULL COLD" level or within the "COLD FILL RANGE" in the coolant reservoir. If the level falls below, add coolant per the instructions in the *Adding engine coolant* section.

Your vehicle was factory-filled with a 50/50 engine coolant and water concentration. If the concentration of coolant falls below 40% or above 60%, the engine parts could become damaged or not work properly. **A 50–50 mixture of coolant and water provides the following:**

- **Freeze protection down to -34°F (-36°C).**
- **Boiling protection up to 265°F (129°C).**
- **Protection against rust and other forms of corrosion.**
- **Enables calibrated gauges to work properly.**

Maintenance and Specifications

When the engine is cold, check the level of the engine coolant in the reservoir.

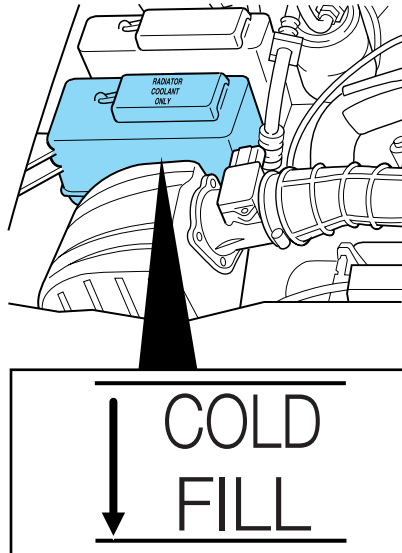

- The engine coolant should be at the “FULL COLD” level or within the “COLD FILL RANGE” as listed on the engine coolant reservoir (depending upon application).
- Refer to the *Scheduled Maintenance Guide* for service interval schedules.
- Be sure to read and understand *Precautions when servicing your vehicle* in this chapter.

If the engine coolant has not been checked at the recommended interval, the engine coolant reservoir may become low or empty. If the reservoir is low or empty, add engine coolant to the reservoir. Refer to *Adding engine coolant* in this chapter.

Note: Automotive fluids are not interchangeable; do not use engine coolant, antifreeze or windshield washer fluid outside of its specified function and vehicle location.

Adding engine coolant

When adding coolant, make sure it is a 50/50 mixture of engine coolant and distilled water. Add the mixture to the coolant reservoir, **when the engine is cool**, until the appropriate fill level is obtained.

Maintenance and Specifications



Do not add engine coolant when the engine is hot. Steam and scalding liquids released from a hot cooling system can burn you badly. Also, you can be burned if you spill coolant on hot engine parts.



Do not put engine coolant in the windshield washer fluid container. If sprayed on the windshield, engine coolant could make it difficult to see through the windshield.

- **Add Motorcraft Premium Gold Engine Coolant (yellow-colored), VC-7-A (U.S., except CA and OR), VC-7-B (CA and OR only), meeting Ford Specification WSS-M97B51-A1.**

Note: Use of Motorcraft Cooling System Stop Leak Pellets, VC-6, may darken the color of Motorcraft Premium Gold Engine Coolant from yellow to golden tan.

- **Do not add/mix an orange-colored, extended life coolant such as Motorcraft Speciality Orange Engine Coolant, VC-2 (US) or CXC-209 (Canada), meeting Ford specification WSS-M97B44-D with the factory-filled coolant.** Mixing Motorcraft Speciality Orange Engine Coolant or any orange-colored extended life product with your factory filled coolant can result in degraded corrosion protection.
- A large amount of water without engine coolant may be added, in case of emergency, to reach a vehicle service location. In this instance, the cooling system must be drained and refilled with a 50/50 mixture of engine coolant and distilled water as soon as possible. Water alone (without engine coolant) can cause engine damage from corrosion, overheating or freezing.
- **Do not use alcohol, methanol, brine or any engine coolants mixed with alcohol or methanol antifreeze (coolant).** Alcohol and other liquids can cause engine damage from overheating or freezing.
- **Do not add extra inhibitors or additives to the coolant.** These can be harmful and compromise the corrosion protection of the engine coolant.

For vehicles with overflow coolant systems with a non-pressurized cap on the coolant recovery system, add coolant to the coolant recovery reservoir when the engine is cool. Add the proper mixture of coolant and water to the "FULL COLD" level. If it is necessary to remove the coolant pressure relief cap on the radiator of a vehicle with an overflow system, follow these steps to add engine coolant.

Maintenance and Specifications



To reduce the risk of personal injury, make sure the engine is cool before unscrewing the coolant pressure relief cap. The cooling system is under pressure; steam and hot liquid can come out forcefully when the cap is loosened slightly.

1. Before you begin, turn the engine off and let it cool.
2. When the engine is cool, wrap a thick cloth around the coolant pressure relief cap on the coolant reservoir (a translucent plastic bottle). Slowly turn cap counterclockwise (left) until pressure begins to release.
3. Step back while the pressure releases.
4. When you are sure that all the pressure has been released, use the cloth to turn it counterclockwise and remove the cap.
5. Fill the coolant reservoir slowly with the proper coolant mixture (see above), to within the “COLD FILL RANGE” or the “FULL COLD” level on the reservoir. If you removed the radiator cap in an overflow system, fill the radiator until the coolant is visible and radiator is almost full.
6. Replace the cap. Turn until tightly installed. (Cap must be tightly installed to prevent coolant loss.)

After any coolant has been added, check the coolant concentration, refer to *Checking engine coolant*. If the concentration is not 50/50 (protection to $-34^{\circ}\text{ F}/-36^{\circ}\text{ C}$), drain some coolant and adjust the concentration. It may take several drains and additions to obtain a 50/50 coolant concentration.

Whenever coolant has been added, the coolant level in the coolant reservoir should be checked the next few times you drive the vehicle. If necessary, add enough 50/50 concentration of engine coolant and distilled water to bring the liquid level to the proper level.

If you have to add more than 1.0 liter (1.0 quart) of engine coolant per month, have your dealer check the engine cooling system. Your cooling system may have a leak. Operating an engine with a low level of coolant can result in engine overheating and possible engine damage.

Recycled engine coolant

Ford Motor Company does NOT recommend the use of recycled engine coolant in vehicles originally equipped with Motorcraft Premium Gold Engine Coolant since a Ford-approved recycling process is not yet available.



Used engine coolant should be disposed of in an appropriate manner. Follow your community's regulations and standards for recycling and disposing of automotive fluids.

Maintenance and Specifications

Coolant refill capacity

To find out how much fluid your vehicle's cooling system can hold, refer to *Refill capacities* in this section.

Fill your engine coolant reservoir as outlined in *Adding engine coolant* in this section.

Severe climates

If you drive in extremely cold climates (less than -36°C [-34°F):

- **It may be necessary to increase the coolant concentration above 50%.**
- **NEVER increase the coolant concentration above 60%.**
- **Increased engine coolant concentrations above 60% will decrease the overheat protection characteristics of the engine coolant and may cause engine damage.**
- **Refer to the chart on the coolant container to ensure the coolant concentration in your vehicle will provide adequate freeze protection at the temperatures in which you drive in the winter months.**

If you drive in extremely hot climates:

- **It is still necessary to maintain the coolant concentration above 40%.**
- **NEVER decrease the coolant concentration below 40%.**
- **Decreased engine coolant concentrations below 40% will decrease the corrosion protection characteristics of the engine coolant and may cause engine damage.**
- **Decreased engine coolant concentrations below 40% will decrease the freeze protection characteristics of the engine coolant and may cause engine damage.**
- **Refer to the chart on the coolant container to ensure the coolant concentration in your vehicle will provide adequate protection at the temperatures in which you drive.**

Vehicles driven year-round in non-extreme climates should use a 50/50 mixture of engine coolant and distilled water for optimum cooling system and engine protection.

Maintenance and Specifications

WHAT YOU SHOULD KNOW ABOUT AUTOMOTIVE FUELS

Important safety precautions



Do not overfill the fuel tank. The pressure in an overfilled tank may cause leakage and lead to fuel spray and fire.



The fuel system may be under pressure. If the fuel filler cap is venting vapor or if you hear a hissing sound, wait until it stops before completely removing the fuel filler cap. Otherwise, fuel may spray out and injure you or others.



If you do not use the proper fuel filler cap, excessive pressure or vacuum in the fuel tank may damage the fuel system or cause the fuel cap to disengage in a collision, which may result in possible personal injury.



Automotive fuels can cause serious injury or death if misused or mishandled.



Fuel ethanol and gasoline may contain benzene, which is a cancer-causing agent.

Observe the following guidelines when handling automotive fuel:

- Extinguish all smoking materials and any open flames before fueling your vehicle.
- Always turn off the vehicle before fueling.
- Automotive fuels can be harmful or fatal if swallowed. Fuels such as gasoline and ethanol are highly toxic and if swallowed can cause death or permanent injury. If fuel is swallowed, call a physician immediately, even if no symptoms are immediately apparent. The toxic effects of fuel may not be visible for hours.
- Avoid inhaling fuel vapors. Inhaling too much fuel vapor of any kind can lead to eye and respiratory tract irritation. In severe cases, excessive or prolonged breathing of fuel vapor can cause serious illness and permanent injury.



Maintenance and Specifications

- Avoid getting fuel liquid in your eyes. If fuel is splashed in the eyes, remove contact lenses (if worn), flush with water for 15 minutes and seek medical attention. Failure to seek proper medical attention could lead to permanent injury.
- Fuels can also be harmful if absorbed through the skin. If fuel is splashed on the skin and/or clothing, promptly remove contaminated clothing and wash skin thoroughly with soap and water. Repeated or prolonged skin contact with fuel liquid or vapor causes skin irritation.
- Be particularly careful if you are taking “Antabuse” or other forms of disulfiram for the treatment of alcoholism. Breathing gasoline and/or ethanol vapors, or skin contact could cause an adverse reaction. In sensitive individuals, serious personal injury or sickness may result. If fuel is splashed on the skin, promptly wash skin thoroughly with soap and water. Consult a physician immediately if you experience an adverse reaction.
- FFV fuel tanks may contain zero to 85 percent ethanol. Any fuel blends containing gasoline and ethanol should be treated the same as “Fuel Ethanol”. To identify if your vehicle is an FFV, check your VIN or the label on the inside of your fuel filler door. When checking the VIN look for the engine type identifier (8th character). If your vehicle is an FFV, then the character will be labeled as a “K.”

Pure ethanol is the alcohol which is the intoxicating agent in liquor, beer and wine. It is distilled from the fermentation of plants such as field corn and sugar cane. When ethanol is used in the making of motor fuels, a small amount of a bad tasting chemical is added to discourage beverage use. The resulting fuel is called E_d100 meaning 100% pure ethanol diluted by 2% to 5% gasoline as the “denaturant.”

Fuel ethanol (summer blend_d) is then made by adding 15% more unleaded gasoline. The resulting fuel also has a higher octane rating than unleaded regular gasoline and other properties which allow engine designs with greater efficiency and power.

Winter blends may contain up to 30% (E70) unleaded gasoline (25% plus the denaturant) to enhance cold engine starts. Severely cold weather may require additional measures for reliable starting. Refer to *Cold Weather Starting* in the *Driving* chapter.

Ethanol is more chemically active than gasoline. It corrodes some metals and causes some plastic and rubber components to swell, break down or become brittle and crack, especially when mixed with gasoline. Special materials and procedures have been developed for flexible fuel vehicles and the dispensers used by ethanol fuel providers.

Maintenance and Specifications

 Flexible fuel components and standard unleaded gasoline fuel components are not interchangeable. If your vehicle is not serviced in accordance with flexible fuel vehicles procedures, damage may occur and your warranty may be invalidated.

 When refueling always shut the engine off and never allow sparks or open flames near the filler neck. Never smoke while refueling. Fuel vapor is extremely hazardous under certain conditions. Care should be taken to avoid inhaling excess fumes.

 The flow of fuel through a fuel pump nozzle can produce static electricity, which can cause a fire if fuel is pumped into an ungrounded fuel container.

Use the following guidelines to avoid static build-up when filling an ungrounded fuel container:

- Place approved fuel container on the ground.
- DO NOT fill a fuel container while it is in the vehicle (including the cargo area).
- Keep the fuel pump nozzle in contact with the fuel container while filling.
- DO NOT use a device that would hold the fuel pump handle in the fill position.

Fuel Filler Cap

Your fuel tank filler cap has an indexed design with a 1/8 turn on/off feature.

When fueling your vehicle:

1. Turn the engine off.
2. Carefully turn the filler cap counterclockwise 1/8 of a turn until it stops.
3. Pull to remove the cap from the fuel filler pipe.
4. To install the cap, align the tabs on the cap with the notches on the filler pipe.
5. Turn the filler cap clockwise 1/8 of a turn until it stops.

Maintenance and Specifications

If the Digital Display reads “CHECK FUEL CAP” and stays on after you start the engine, the fuel filler cap may not be properly installed. Turn off the engine, remove the fuel filler cap, align the cap properly and reinstall it.



If you must replace the fuel filler cap, replace it with a fuel filler cap that is designed for your vehicle. The customer warranty may be void for any damage to the fuel tank or fuel system if the correct genuine Ford or Motorcraft fuel filler cap is not used.



The fuel system may be under pressure. If the fuel filler cap is venting vapor or if you hear a hissing sound, wait until it stops before completely removing the fuel filler cap. Otherwise, fuel may spray out and injure you or others.



If you do not use the proper fuel filler cap, excessive pressure or vacuum in the fuel tank may damage the fuel system or cause the fuel cap to disengage in a collision, which may result in possible personal injury.

Choosing the right fuel

If your vehicle is a flexible fuel vehicle (FFV), use only UNLEADED FUEL and (E85) FUEL ETHANOL. The use of leaded fuel is prohibited by law and could damage your vehicle.

Your vehicle was not designed to use fuel or fuel additives with metallic compounds, including manganese-based additives. Studies indicate that these additives can cause your vehicle’s emission control system to deteriorate more rapidly. In Canada, premium grade fuel generally contains more metallic additives than regular fuel. We recommend using regular grade fuel. In Canada, many fuels contain metallic additives, but fuels free of such additives may be available; check with your local fuel dealer.

Do not use fuel containing methanol. It can damage critical fuel system components.

Repairs to correct the effects of using a fuel for which your vehicle was not designed may not be covered by your warranty.

Maintenance and Specifications

Octane recommendations

Do not be concerned if your engine sometimes knocks lightly. However, if it knocks heavily under most driving conditions while you are using fuel with the recommended octane rating, see your dealer or a qualified service technician to prevent any engine damage.

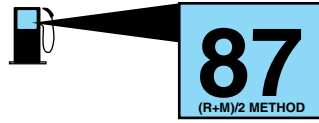

Unleaded Gasoline engines

Your vehicle is designed to use “Regular” unleaded gasoline with an (R+M)/2 octane rating of 87. We do not recommend the use of gasolines labeled as “Regular” that are sold with octane ratings of 86 or lower in high altitude areas.

FFV engine (if equipped)

Your vehicle is designed to use (E85) Fuel Ethanol, “Regular” unleaded gasoline or any mixture of the two fuels.

U.S. government regulations require fuel ethanol dispensing pumps to have a small, square, orange and black label with the common abbreviation or the appropriate percentage for that region. Use of other fuels such as Fuel Methanol may cause powertrain damage, a loss of vehicle performance, and your warranty may be invalidated.

Fuel quality

Many of the world’s automakers approved the World-wide Fuel Charter that recommends gasoline specifications to provide improved performance and emission control system protection for your vehicle. Gasolines that meet the World-wide Fuel Charter should be used when available. Ask your fuel supplier about gasolines that meet the World-wide Fuel Charter.

It should not be necessary to add any aftermarket products to your fuel tank if you continue to use high quality fuel of the recommended octane rating. Aftermarket products could cause damage to the fuel system. Repairs to correct the effects of using an aftermarket product in your fuel may not be covered by your warranty.

Unleaded Gasoline engines

If you are experiencing starting, rough idle or hesitation driveability problems during a cold start, try a different brand of “Regular” unleaded gasoline. “Premium” unleaded gasoline is not recommended (particularly

Maintenance and Specifications

in the United States) because it may cause these problems to become more pronounced. If the problems persist, see your dealer or a qualified service technician.

FFV engine (if equipped)

Your FFV will operate well on ordinary “Regular” unleaded gasoline, but only the highest quality fuel ethanol will provide the same level of protection and performance. To identify if your vehicle is an FFV, check your VIN or the label on the inside of your fuel filler door. When checking the VIN, look for the engine type identifier (8th character). If your vehicle is an FFV, then the character will be labeled as a “K.”

If you operate your vehicle 50% or more of the time on ethanol, you should follow a different maintenance schedule. See the *Scheduled Maintenance Guide* for more information.

If you are experiencing a rough or rolling idle after start-up with the outside temperature above 27° C (80° F), the idle should improve within 10 to 30 seconds. If the problems persist below this temperature, see your dealer or a qualified service technician.

Cleaner air

Ford endorses the use of reformulated “cleaner-burning” gasolines to improve air quality.

Running out of fuel

Avoid running out of fuel because this situation may have an adverse affect on powertrain components.

If you have run out of fuel:

- You may need to cycle the ignition from OFF to ON several times after refueling, to allow the fuel system to pump the fuel from the tank to the engine.
- Your “Check Engine” indicator may come on. For more information on the “Check Engine” indicator, refer to the *Instrument Cluster* chapter.

Fuel Filter

For fuel filter replacement, see your dealer or a qualified service technician. Refer to the scheduled maintenance guide for the appropriate intervals for changing the fuel filter.

Replace the fuel filter with an authorized Motorcraft part. The customer warranty may be void for any damage to the fuel system if an authorized Motorcraft fuel filter is not used.

200

Maintenance and Specifications

ESSENTIALS OF GOOD FUEL ECONOMY

We do not recommend taking fuel economy measurements during the first 1,600 km (1,000 miles) of driving. You will get a more accurate measurement after 3,000 km - 5,000 km (2,000 miles - 3,000 miles)

Filling the tank

The advertised fuel capacity of the fuel tank on your vehicle is equal to the rated refill capacity of the fuel tank as listed in the *Refill capacities* section of this chapter.

The advertised capacity is the amount of the indicated capacity and the empty reserve combined. Indicated capacity is the difference in the amount of fuel in a full tank and a tank when the fuel gauge indicates empty. Empty reserve is the small amount of fuel remaining in the fuel tank after the fuel gauge indicates empty.

The amount of usable fuel in the empty reserve varies and should not be relied upon to increase driving range. When refueling your vehicle after the fuel gauge indicates empty, you might not be able to refuel the full amount of the advertised capacity of the fuel tank due to the empty reserve still present in the tank.

For consistent results when filling the fuel tank:

- Turn the engine/ignition switch to the off position prior to refueling, an error in the reading will result if the engine is left running.
- Use the same filling rate setting (low — medium — high) each time the tank is filled.
- Allow no more than 2 automatic click-offs when filling.
- Always use fuel with the recommended octane rating.
- Use a known quality gasoline, preferably a national brand.
- Use the same side of the same pump and have the vehicle facing the same direction each time you fill up.
- Have the vehicle loading and distribution the same every time.

Your results will be most accurate if your filling method is consistent.

Filling the tank for FFV equipped vehicles

Your vehicle will operate on both unleaded gasoline with an octane rating of 87, or E-85 fuel, or any mixture of these two. For best results it is recommended that you do not add less than 5 gallons of fuel when refueling. Observing this precaution will avoid possible hard starting and/or deterioration in drivability during warm up.

Maintenance and Specifications

Calculating fuel economy

1. Fill the fuel tank completely and record the initial odometer reading (in kilometers or miles).
2. Each time you fill the tank, record the amount of fuel added (in liters or gallons).
3. After at least three to five tank fill-ups, fill the fuel tank and record the current odometer reading.
4. Subtract your initial odometer reading from the current odometer reading.
5. Follow one of the simple calculations in order to determine fuel economy:

Calculation 1: **Multiply liters used by 100, then divide by total kilometers traveled.**

Calculation 2: **Divide total miles traveled by total gallons used.**

Keep a record for at least one month and record the type of driving (city or highway). This will provide an accurate estimate of the vehicle's fuel economy under current driving conditions. Additionally, keeping records during summer and winter will show how temperature impacts fuel economy. In general, lower temperatures give lower fuel economy.

Ethanol has less energy per gallon than gasoline. Fuel economy will decrease as the percentage of ethanol used is increased.

Improving fuel economy

To improve your fuel economy:

- Do not leave your vehicle idling for long periods of time.
- Drive at a moderate pace, with smooth acceleration and deceleration.
- Turn off speed control in hilly terrain.
- Follow the recommended maintenance schedule in your *Scheduled Maintenance Guide*.
- Do not carry unnecessary weight.

Flex fuel (E-85) cruising range

Because E-85 fuel contains less energy per gallon than gasoline, you will experience an increase in fuel consumption. You can expect your Miles Per Gallon (MPG) and your driving range to decrease by about 30% compared to gasoline operation.

EPA window sticker

The EPA window sticker should be your guide for fuel economy comparisons. If you have any questions about this sticker, contact your dealer.

Maintenance and Specifications

EMISSION CONTROL SYSTEM

Your vehicle has emission control components and a catalytic converter that enable your vehicle to comply with applicable exhaust emission standards. To make sure that the emission control components work properly:

- Use only unleaded fuel.
- Avoid running out of fuel.
- Do not turn off your ignition while the vehicle is moving.
- Follow your *Scheduled Maintenance Guide*.
- Use Ford Motor Company authorized parts for maintenance replacements or for service.

Consult your *Warranty Guide* for emission warranty information.



Do not park, idle, or drive your vehicle in dry ground cover. The emission system heats up the engine and exhaust system, which could cause a fire.

The following signs could indicate a problem with your emission control system:

- Fluid leaks
- Strange odors
- Smoke
- Loss of engine power
- Illumination of the charging system, temperature, or “Check Engine” light in the instrument panel.



Exhaust leaks may result in harmful and potentially lethal fumes entering the passenger compartment.

It is unlawful to intentionally remove an emission control device or prevent it from working. Information about your vehicle's emission system is on the Vehicle Emission Control Information decal located on or near the engine.

On board diagnostics (OBD-II)

Your vehicle is equipped with a computer that monitors the engine's emission control system. This system is commonly known as the On

Maintenance and Specifications

Board Diagnostics System (OBD-II). This OBD-II system protects the environment by ensuring that your vehicle continues to meet government emission standards. The OBD-II system also assists the service technician in properly servicing your vehicle. When the *Check engine/Service engine soon* light illuminates, the OBD-II system has detected a malfunction. Temporary malfunctions may cause your *Check engine/Service engine soon* light to illuminate. Examples are:

1. The vehicle has run out of fuel. (The engine may misfire or run poorly.)
2. Poor fuel quality or water in the fuel.
3. The fuel cap may not have been securely tightened.

These temporary malfunctions can be corrected by filling the fuel tank with good quality fuel and/or properly tightening the fuel cap. After three driving cycles without these or any other temporary malfunctions present, the *Check engine/Service engine soon* light should turn off. (A driving cycle consists of a cold engine startup followed by mixed city/highway driving.) No additional vehicle service is required.

If the *Check engine/Service engine soon* light remains on, have your vehicle serviced at the first available opportunity.

Readiness for Inspection/Maintenance (I/M) testing

It may be a legal requirement in your area to pass an I/M test of the on-board diagnostics system. If the system or battery has just been serviced, the on-board diagnostic system is reset to a “not ready for I/M test” condition. To ready the system, allow the vehicle to sit for at least eight hours without starting. Then, start the engine and complete the following driving cycle:

1. Drive on an expressway or highway for at least 10 minutes.
2. Drive in stop-and-go traffic for at least 20 minutes with a minimum of four idle periods.

The engine must warm up to its normal operating temperature. Once started, do not turn off the engine until the above drive cycle is complete.

Note: If your “Check Engine” light is on, your vehicle may not pass an I/M test.

Maintenance and Specifications

CHECKING AND ADDING POWER STEERING FLUID

Check the fluid. Refer to the *Scheduled Maintenance Guide* for service maintenance schedules.

1. Start the engine and let it run until it reaches normal operating schedules.
2. Turn the steering wheel left and right several times.
3. Turn the engine off.
4. Check the fluid level.
5. If the fluid is below the MIN line, add fluid in small amounts until it reaches the correct level (between the MIN and MAX lines).

Use only MERCON® ATF.

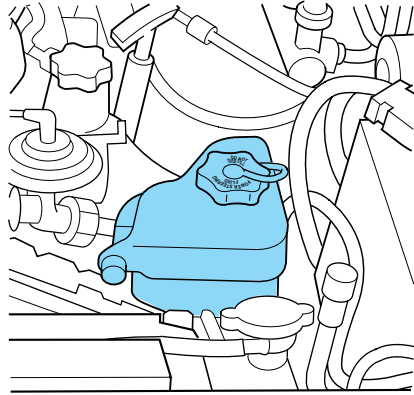

BRAKE FLUID RESERVOIR

The fluid level will drop slowly as the brakes wear, and will rise when the brake components are replaced. Fluid levels below the “MAX” line that do not trigger the brake system warning lamp are within the normal operating range, there is no need to add fluid. If the fluid levels are outside of the normal operating range, the performance of your brake system could be compromised, seek service from your dealer immediately.

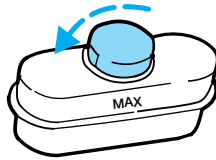

TRANSMISSION FLUID

Checking automatic transmission fluid

- Refer to your *Scheduled Maintenance Guide* for scheduled check and change intervals.
- Transmission does not consume fluid.
- Check fluid when transmission is not operating properly or if you see a leak.
- Fluid level must be checked at normal operating temperature, 30 km (20 miles) of driving.

Maintenance and Specifications

To check and add fluid:

1. Drive the vehicle 30 km (20 miles) to reach normal operating temperatures.
2. If driven in hot weather, city traffic, pulling a trailer, allow transmission to cool for 30 minutes before checking.
3. Engage parking brake, start engine.
4. Put your foot on the brake pedal and move the gearshift lever slowly through all of the gear ranges.
5. Shift to P (Park) and leave the engine running.
6. Remove the dipstick, wipe clean with a dry lint free rag.
7. Install and fully seat the dipstick into the filler tube.

8. Remove the dipstick and inspect the fluid level. Level should be in the cross-hatched area.

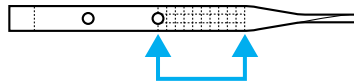

9. If necessary, add fluid in 250ml (1/2 pint) increments through the filler tube until the level is correct at normal operating temperatures. Refer to the *Lubricant specifications* section in this chapter for the correct fluid type. The use of any other non-approved fluid may cause internal transmission damage.

10. Fluid can be checked at ambient temperatures between 10–30°C (50–95°F). DO NOT ADD fluid until the transmission is at normal operating temperatures or the transmission will be overfilled.

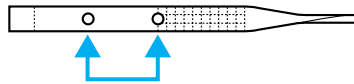

Low fluid level

Do not drive the vehicle if the fluid level is at or below the bottom of the dipstick.

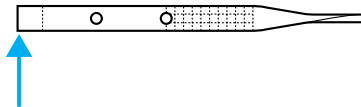

High fluid level

Fluid levels above the safe range may cause overheating, shift and/or engagement concerns and internal transmission damage. If an overfill condition occurs, excess fluid should be removed by a qualified technician.

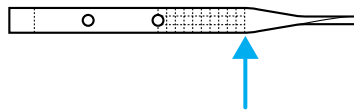

Maintenance and Specifications

TRANSFER CASE FLUID (IF EQUIPPED)

To check and add transfer case fluid

1. Clean the filler plug.
2. Remove the filler plug and inspect the fluid level.
3. Add only enough fluid through the filler opening so that the fluid level is at the bottom of the opening.

Use only fluid that meets Ford specifications. Refer to *Lubricant specifications* in this chapter.

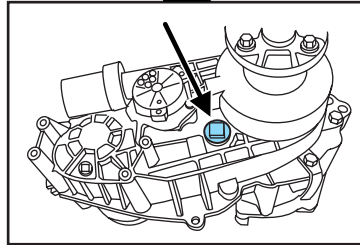
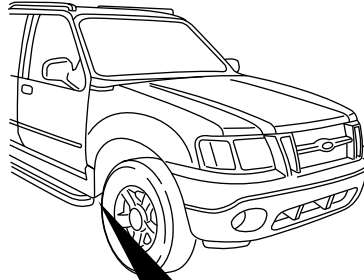

INFORMATION ABOUT UNIFORM TIRE QUALITY GRADING

New vehicles are fitted with tires that have a rating on them called Tire Quality Grades. The Quality grades can be found where applicable on the tire sidewall between tread shoulder and maximum section width. For example:

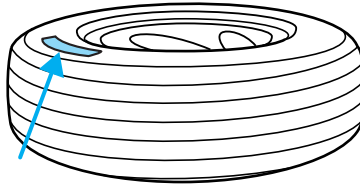

• Treadwear 200 Traction AA Temperature A

These Tire Quality Grades are determined by standards that the United States Department of Transportation has set.

Tire Quality Grades apply to new pneumatic tires for use on passenger cars. They do not apply to deep tread, winter-type snow tires, space-saver or temporary use spare tires, tires with nominal rim diameters of 10 to 12 inches or limited production tires as defined in Title 49 Code of Federal Regulations Part 575.104(c)(2).

Maintenance and Specifications

U.S. Department of Transportation-Tire quality grades: The U.S. Department of Transportation requires Ford to give you the following information about tire grades exactly as the government has written it.

Treadwear

The treadwear grade is a comparative rating based on the wear rate of the tire when tested under controlled conditions on a specified government test course. For example, a tire graded 150 would wear one and one-half (1 1/2) times as well on the government course as a tire graded 100. The relative performance of tires depends upon the actual conditions of their use, however, and may depart significantly from the norm due to variations in driving habits, service practices, and differences in road characteristics and climate.

Traction AA A B C

The traction grades, from highest to lowest are AA, A, B, and C. The grades represent the tire's ability to stop on wet pavement as measured under controlled conditions on specified government test surfaces of asphalt and concrete. A tire marked C may have poor traction performance.



The traction grade assigned to this tire is based on straight-ahead braking traction tests, and does not include acceleration, cornering, hydroplaning or peak traction characteristics.

Temperature A B C

The temperature grades are A (the highest), B and C, representing the tire's resistance to the generation of heat and its ability to dissipate heat when tested under controlled conditions on a specified indoor laboratory test wheel. Sustained high temperature can cause the material of the tire to degenerate and reduce tire life, and excessive temperature can lead to sudden tire failure. The grade C corresponds to a level of performance which all passenger car tires must meet under the Federal Motor Vehicle Safety Standard No. 109. Grades B and A represent higher levels of performance on the laboratory test wheel than the minimum required by law.



The temperature grade for this tire is established for a tire that is properly inflated and not overloaded. Excessive speed, underinflation, or excessive loading, either separately or in combination, can cause heat buildup and possible tire failure.

Maintenance and Specifications

TIRES

Tires are designed to give many thousands of miles of service, but they must be maintained in order to get the maximum benefit from them.

Glossary of tire terminology

- **Tire label:** A label showing the OE (Original Equipment) tire sizes, recommended inflation pressure and the maximum weight the vehicle can carry.
- **Tire Identification Number (TIN):** A number on the sidewall of each tire providing information about the tire brand and manufacturing plant, tire size and date of manufacture.
- **Inflation pressure:** A measure of the amount of air in a tire.
- **Standard load:** A class of P-metric or Metric tires designed to carry a maximum load at 35 psi [37 psi (2.5 bar) for Metric tires]. Increasing the inflation pressure beyond this pressure will not increase the tire's load carrying capability.
- **Extra load:** A class of P-metric or Metric tires designed to carry a heavier maximum load at 41 psi [43 psi (2.9 bar) for Metric tires]. Increasing the inflation pressure beyond this pressure will not increase the tire's load carrying capability.
- **kPa:** Kilopascal, a metric unit of air pressure.
- **PSI:** Pounds per square inch, a standard unit of air pressure.
- **B-pillar:** The structural member at the side of the vehicle behind the front door.
- **Bead area of the tire:** Area of the tire next to the rim.
- **Sidewall of the tire:** Area between the bead area and the tread.
- **Tread area of the tire:** Area of the perimeter of the tire that contacts the road when mounted on the vehicle.
- **Rim:** The metal support (wheel) for a tire or a tire and tube assembly upon which the tire beads are seated.

INFORMATION CONTAINED ON THE TIRE SIDEWALL

Federal law requires tire manufacturer's to place standardized information on the sidewall of all tires. This information identifies and describes the fundamental characteristics of the tire and also provides a U.S. DOT Tire Identification Number for safety standard certification and in case of a recall.

Maintenance and Specifications

Information on “P” type tires

P215/65R15 95H is an example of a tire size, load index and speed rating. The definitions of these items are listed below. (Note that the tire size, load index and speed rating for your vehicle may be different from this example.)

1. **P:** Indicates a tire, designated by the Tire and Rim Association (T&RA), that may be used for service on cars, SUVs, minivans and light trucks.

Note: If your tire size does not begin with a letter this may mean it is designated by either ETRTO (European Tire and Rim Technical Organization) or JATMA (Japan Tire Manufacturing Association).

2. **215:** Indicates the nominal width of the tire in millimeters from sidewall edge to sidewall edge. In general, the larger the number, the wider the tire.

3. **65:** Indicates the aspect ratio which gives the tire’s ratio of height to width.

4. **R:** Indicates a “radial” type tire.

5. **15:** Indicates the wheel or rim diameter in inches. If you change your wheel size, you will have to purchase new tires to match the new wheel diameter.

6. **95:** Indicates the tire’s load index. It is an index that relates to how much weight a tire can carry. You may find this information in your owner’s guide. If not, contact a local tire dealer.

Note: You may not find this information on all tires because it is not required by federal law.

7. **H:** Indicates the tire’s speed rating. The speed rating denotes the speed at which a tire is designed to be driven for extended periods of time under a standard condition of load and inflation pressure. The tires on your vehicle may operate at different conditions for load and inflation pressure. These speed ratings may need to be adjusted for the difference in conditions. The ratings range from 99 mph (159 km/h) to 186 mph (299 km/h). These ratings are listed in the following chart.

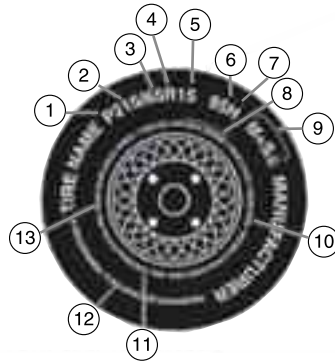

Maintenance and Specifications

Note: You may not find this information on all tires because it is not required by federal law.

| Letter rating | Speed rating - mph (km/h) |
|---------------|---------------------------|
| Q | 99 mph (159 km/h) |
| R | 106 mph (171 km/h) |
| S | 112 mph (180 km/h) |
| T | 118 mph (190 km/h) |
| U | 124 mph (200 km/h) |
| H | 130 mph (210 km/h) |
| V | 149 mph (240 km/h) |
| W | 168 mph (270 km/h) |
| Y | 186 mph (299 km/h) |

Note: For tires with a maximum speed capability over 149 mph (240 km/h), tire manufacturers sometimes use the letters ZR. For those with a maximum speed capability over 186 mph (299 km/h), tire manufacturers always use the letters ZR.

8. U.S. DOT Tire Identification Number (TIN): This begins with the letters “DOT” and indicates that the tire meets all federal standards. The next two numbers or letters are the plant code for where it was manufactured, the next two are the tire size code and the last four numbers represent the week and year the tire was built. For example, the numbers 317 mean the 31st week of 1997. After 2000 the numbers go to four digits. For example, 2501 means the 25th week of 2001. The numbers in between are identification codes used for traceability. This information is used to contact customers if a tire defect requires a recall.

9. M+S or M/S: Mud and Snow. or

AT: All Terrain. or

AS: All Season.

10. Tire Ply Composition and Material Used: Indicates the number of plies or the number of layers of rubber-coated fabric in the tire tread and sidewall. Tire manufacturers also must indicate the ply materials in the tire and the sidewall, which include steel, nylon, polyester, and others.

11. Maximum Load: Indicates the maximum load in kilograms and pounds that can be carried by the tire. Refer to the tire label or the safety certification label, which is located on the B-Pillar or the edge of the driver’s door, for the correct tire pressure for your vehicle

Maintenance and Specifications

12. Treadwear, Traction and Temperature Grades

- **Treadwear:** The treadwear grade is a comparative rating based on the wear rate of the tire when tested under controlled conditions on a specified government test course. For example, a tire graded 150 would wear one and one-half (1½) times as well on the government course as a tire graded 100.
- **Traction:** The traction grades, from highest to lowest are AA, A, B, and C. The grades represent the tire's ability to stop on wet pavement as measured under controlled conditions on specified government test surfaces of asphalt and concrete. A tire marked C may have poor traction performance.
- **Temperature:** The temperature grades are A (the highest), B and C, representing the tire's resistance to the generation of heat and its ability to dissipate heat when tested under controlled conditions on a specified indoor laboratory test wheel.

13. **Maximum Permissible Inflation Pressure:** Tire manufacturer's maximum permissible pressure and/or the pressure at which the maximum load can be carried by the tire. This pressure is normally higher than the manufacturer's recommended cold inflation pressure which can be found on either the tire label or certification label which is located on the B-Pillar or the edge of the driver's door. The cold inflation pressure should never be set lower than the recommended pressure on the vehicle label.

The tire suppliers may have additional markings, notes or warnings such as standard load, radial tubeless, etc.

Maintenance and Specifications

Additional information contained on the tire sidewall for “LT” type tires

“LT” type tires have some additional information beyond those of “P” type tires; these differences are described below:

1. **LT:** Indicates a tire, designated by the Tire and Rim Association (T&RA), that is intended for service on light trucks.

2. **Load Range/Load Inflation Limits:** Indicates the tire’s load-carrying capabilities and its inflation limits.

3. **Maximum Load Dual lbs. (kg) at psi (kPa) cold:** Indicates the maximum load and tire pressure when the tire is used as a dual; defined as four tires on the rear axle (a total of six or more tires on the vehicle).

4. **Maximum Load Single lbs. (kg) at psi (kPa) cold:** Indicates the maximum load and tire pressure when the tire is used as a single; defined as two tires (total) on the rear axle.

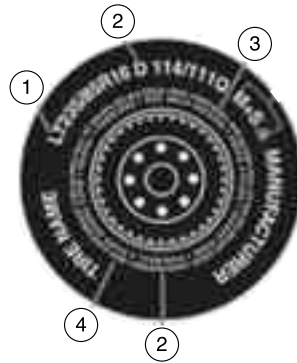

Maintenance and Specifications

Information on “T” type tires

T145/80D16 is an example of a tire size.

Note: The temporary tire size for your vehicle may be different from this example.

1. **T:** Indicates a type of tire, designated by the Tire and Rim Association (T&RA), that is intended for temporary service on cars, SUVs, minivans and light trucks.

2. **145:** Indicates the nominal width of the tire in millimeters from sidewall edge to sidewall edge. In general, the larger the number, the wider the tire.

3. **80:** Indicates the aspect ratio which gives the tire’s ratio of height to width. Numbers of 70 or lower indicate a short sidewall.

4. **D:** Indicates a “diagonal” type tire.

R: Indicates a “radial” type tire.

5. **16:** Indicates the wheel or rim diameter in inches. If you change your wheel size, you will have to purchase new tires to match the new wheel diameter.

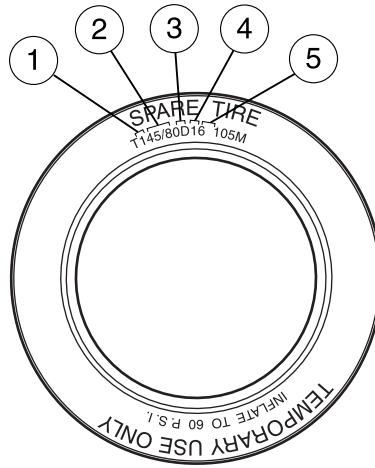

Location of the tire label

You will find a tire label containing tire inflation pressure by tire size and other important information located on the B-Pillar or the edge of the driver’s door.

TIRE CARE

Improper or inadequate vehicle maintenance can also cause tires to wear abnormally. Here are some of the important maintenance items:

Inflating your tires

Use a tire gauge to check the tire inflation pressure, including the spare, at least monthly and before long trips. You are strongly urged to buy a reliable tire pressure gauge, as automatic service station gauges may be

Maintenance and Specifications

inaccurate. Ford recommends the use of a digital or dial type tire pressure gauge rather than a stick type tire pressure gauge.

Use the recommended cold inflation pressure for optimum tire performance and wear. Under-inflation or over-inflation may cause uneven treadwear patterns.



Under-inflation is the most common cause of tire failures and may result in severe tire cracking, tread separation or "blowout", with unexpected loss of vehicle control and increased risk of injury. Under-inflation increases sidewall flexing and rolling resistance, resulting in heat buildup and internal damage to the tire. It also may result in unnecessary tire stress, irregular wear, loss of vehicle control and accidents. A tire can lose up to half of its air pressure and not appear to be flat!

When weather temperature changes occur, tire inflation pressures also change. A 10° F (6° C) temperature drop can cause a corresponding drop of 1 psi (7 kPa) in inflation pressure. Check your tire pressures frequently and adjust them to the proper pressure which can be found on the tire label or certification label.

If you are checking tire pressure when the tire is hot, (i.e. driven more than 1 mile [1.6 km]), never "bleed" or reduce air pressure. The tires are hot from driving and it is normal for pressures to increase above recommended cold pressures. A hot tire at or below recommended cold inflation pressure could be significantly under-inflated.

To check the pressure in your tire(s):

1. Make sure the tires are cool, meaning they are not hot from driving even a mile.

Note: If you have to drive a distance to get air for your tire(s), check and record the tire pressure first and add the appropriate air pressure when you get to the pump. It is normal for tires to heat up and the air pressure inside to go up as you drive. Never "bleed" or reduce air pressure when tires are hot.

2. Remove the cap from the valve on one tire, then firmly press the tire gauge onto the valve and measure the pressure.

3. Add enough air to reach the recommended air pressure

Note: If you overfill the tire, release air by pushing on the metal stem in the center of the valve. Then recheck the pressure with your tire gauge.

4. Replace the valve cap.

Maintenance and Specifications

5. Repeat this procedure for each tire, including the spare.

Note: Some spare tires require higher inflation pressure than the other tires. Check the tire label on the B pillar or the edge of the driver's door for the recommended spare tire pressure.

6. Visually inspect the tires to make sure there are no nails or other objects embedded that could poke a hole in the tire and cause an air leak.

7. Check the sidewalls to make sure there are no gouges, cuts or bulges.

Tire and wheel alignment

A bad jolt from hitting a curb or pothole can cause the front end of your vehicle to become misaligned or cause damage to your tires. If your vehicle seems to pull to one side when you're driving, the wheels may be out of alignment. Have a qualified technician at a Ford or Lincoln/Mercury dealer check the wheel alignment periodically.

Wheel misalignment in the front or the rear can cause uneven and rapid treadwear of your tires and should be corrected by a qualified technician at a Ford or Lincoln/Mercury dealer. Front wheel drive (FWD) vehicles and those with an independent rear suspension require alignment of all four wheels.

The tires should also be balanced periodically. An unbalanced tire and wheel assembly may result in irregular tire wear.

Tire rotation

Rotating your tires at the recommended interval (as indicated in the *Scheduled Maintenance Guide* that comes with your vehicle) will help your tires wear more evenly, providing better tire performance and longer tire life. Unless otherwise specified, rotate the tires approximately every 5,000 miles (8,000 km).

Maintenance and Specifications

- Front Wheel Drive (FWD) vehicles (front tires at top of diagram)

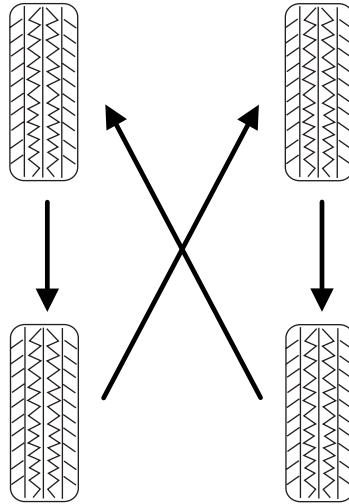

- Rear Wheel Drive (RWD) vehicles/Four Wheel Drive (4WD) vehicles (front tires at top of diagram)

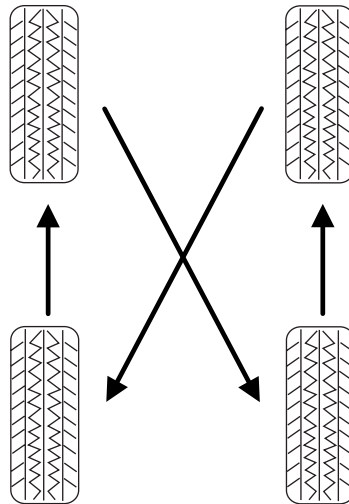

Sometimes irregular tire wear can be corrected by rotating the tires.

Maintenance and Specifications

Note: If your tires show uneven wear ask a qualified technician at a Ford or Lincoln/Mercury dealership to check for and correct any wheel misalignment, tire imbalance or mechanical problem involved before tire rotation.

Note: Your vehicle may be equipped with a dissimilar spare tire/wheel. A dissimilar spare tire/wheel is defined as a spare tire and/or wheel that is different in brand, size or appearance from the road tires and wheels. If you have a dissimilar spare tire/wheel it is intended for temporary use only and should not be used in a tire rotation.

Note: After having your tires rotated, inflation pressure must be checked and adjusted to the vehicle requirements.

Tire wear

Measure and inspect the tire tread on all your tires periodically. Advanced and unusual tire wear can reduce the ability of tread to grip the road in adverse (wet, snowy, etc.) conditions. Visually check your tires for uneven wear, looking for high and low areas or unusually smooth areas. Also check for signs of tire damage.

When the tread is worn down to 1/16th of an inch (2 mm), tires must be replaced to prevent your vehicle from skidding and hydroplaning. Built-in treadwear indicators, or “wear bars”, which look like narrow strips of smooth rubber across the tread will appear on the tire when the tread is worn down to 1/16th of an inch (2 mm). When you see these “wear bars”, the tire is worn out and should be replaced.

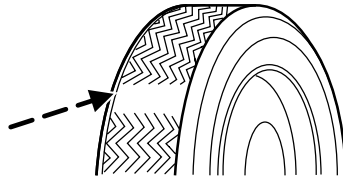

Inspect your tires frequently for any of the following conditions and replace them if one or more of the following conditions exist:

- Fabric showing through the tire rubber
- Bulges in the tread or sidewalls
- Cracks or cuts on the sidewalls
- Cracks in the tread groove
- Impact damage resulting from use
- Separation in the tread
- Separation in the sidewall
- Severe abrasion on the sidewall

If your vehicle has a leak in the exhaust system, a road tire or the spare tire may be exposed to hot exhaust temperatures requiring the tire to be replaced.

Maintenance and Specifications

Safety practices

Driving habits have a great deal to do with your tire mileage and safety.

- Observe posted speed limits
- Avoid fast starts, stops and turns
- Avoid potholes and objects on the road
- Do not run over curbs or hit the tire against a curb when parking

If your vehicle is stuck in snow, mud, sand, etc., **do not** rapidly spin the tires; spinning the tires can tear the tire and cause an explosion. A tire can explode in as little as three to five seconds.



Tire explosions can cause death, personal injury or property damage. Do not allow anyone to stand near, directly ahead or behind the spinning tire.



Never spin the tires in excess of the 35 mph (55 km/h) point indicated on the speedometer.

Highway hazards

No matter how carefully you drive there's always the possibility that you may eventually have a flat tire on the highway. Drive slowly to the closest safe area out of traffic. This may further damage the flat tire, but your safety is more important.

If you feel a sudden vibration or ride disturbance while driving, or you suspect your tire or vehicle has been damaged, immediately reduce your speed. Drive with caution until you can safely pull off the road. Stop and inspect the tires for damage. If a tire is under-inflated or damaged, deflate it, remove wheel and replace it with your spare tire and wheel. If you cannot detect a cause, have the vehicle towed to the nearest repair facility or tire dealer to have the vehicle inspected.

SNOW TIRES AND TRACTION DEVICES



Snow tires must be the same size and grade as the original tires.

Your tires have all-weather treads to provide traction in the rain and snow. In some climate, using snow tires or traction devices may be necessary. Ford Motor Company offers tire cables as a Ford approved

Maintenance and Specifications

accessory and recommends use of these or SAE class “S” cables. See your dealer for more information.

Follow these guidelines:

- Do not use tire cables or chains with P255/70R16 size tires.
- Cables or chains should only be used on the rear wheels.
- If you need to use chains, it is recommended that steel wheels (of the same size and specification) be used, as chains may chip aluminum wheels.
- Install cables or chains securely, verifying that they do not touch any wiring, brake lines or fuel lines.
- Avoid overloading your vehicle.
- Do not use cables or chains on dry roads.
- Do not exceed 30 mph (48 km/h).
- Drive cautiously.

Remove the cables or chains when they are no longer needed.

MOTORCRAFT PART NUMBERS

| Component | 4.0L SOHC V6 engine |
|--------------------|---------------------|
| Air filter element | FA-1744 |
| Fuel filter | FG-1036 |
| Battery | BXT-65-650 |
| Oil filter | FL-820S |
| PCV valve | ¹ |
| Spark plugs | ² |

¹The PCV valve is a critical emission component. It is one of the items listed in the *Scheduled Maintenance Guide* and is essential to the life and performance of your vehicle and to its emissions system.

For PCV valve replacement, see your dealer or a qualified service technician. Refer to the *Scheduled Maintenance Guide* for the appropriate intervals for changing the PCV valve.

Replace the PCV valve with one that meets Ford material and design specifications for your vehicle, such as a Motorcraft or equivalent replacement part. The customer warranty may be void for any damage to the emissions system if such a PCV valve is not used.

²For spark plug replacement, see your dealer or a qualified service technician. Refer to the *Scheduled Maintenance Guide* for the appropriate intervals for changing the spark plugs.

Maintenance and Specifications

Replace the spark plugs with ones that meet Ford material and design specifications for your vehicle, such as Motorcraft or equivalent replacement parts. The customer warranty may be void for any damage to the engine if such spark plugs are not used.

Refer to Vehicle Emissions Control Information (VECI) decal for spark plug gap information.

REFILL CAPACITIES

| Fluid | Ford Part Name | Application | Capacity |
|--------------------------------------|---|-----------------------|---------------------------------|
| Brake fluid | Motorcraft High Performance DOT 3 Motor Vehicle Brake Fluid | All | Fill to line on reservoir |
| Engine oil (including filter change) | Motorcraft SAE 5W-30 Super Premium Motor Oil | All | 4.7L (5.0 quarts) |
| Fuel tank | N/A | All | 85.2L (22.5 gallons) |
| Power steering fluid | Motorcraft MERCON® ATF | All | Fill to line on reservoir |
| Transmission fluid ¹ | Motorcraft MERCON®V ATF | 5R55E Automatic (4x2) | 9.5L (10.0 quarts) ² |
| | | 5R55E Automatic (4x4) | 9.8L (10.3 quarts) ² |
| Transfer case | Motorcraft MERCON® ATF | 4WD | 1.2L (1.3 quarts) ³ |
| Engine coolant ⁴ | Motorcraft Premium Gold Engine Coolant (yellow-colored) | 4.0L SOHC V6 engine | 13.2L (14.0 quarts) |

Maintenance and Specifications

| Fluid | Ford Part Name | Application | Capacity |
|----------------------------------|---|---|--------------------------|
| Front axle lubricant | Motorcraft SAE 80W-90 Premium Rear Axle Lubricant | 4x4 vehicles | 1.7L (1.8 quarts) |
| Rear axle lubricant ⁵ | Motorcraft SAE 75W-90 Fuel Efficient High Performance Synthetic Rear Axle Lubricant | 8,8 inch conventional and Traction-Lok axles ⁶ | 2.9-3.1L (5.5-5.8 pints) |
| Windshield washer fluid | Motorcraft Premium Windshield Washer Concentrate | All | 2.6L (2.7 quarts) |

¹Ensure the correct automatic transmission fluid is used. Transmission fluid requirements are indicated on the dipstick or on the dipstick handle. MERCON® and MERCON® V are not interchangeable. DO NOT MIX MERCON® and MERCON® V. Refer to the *Scheduled Maintenance Guide* to determine the correct service interval.

²Indicates only approximate dry-fill capacity. Some applications may vary based on cooler size and if equipped with an in-tank cooler. The amount of transmission fluid and fluid level should be set by the indication on the dipstick's normal operating range.

³Fill to bottom of filler plug hole.

⁴Add the coolant type originally equipped in your vehicle.

⁵Fill to 6 mm to 14 mm (1/4 inch to 9/16 inch) below bottom of filler plug hole.

⁶Rear axles containing synthetic lubricant are lubricated for life. These lubricants are not to be checked or changed unless a leak is suspected or service is required. The axle lubricant should be changed any time the axle has been submerged in water.

Add 118 ml (4 oz.) of Additive Friction Modifier XL-7 or equivalent for complete refill of Traction-Lok axles.

Maintenance and Specifications

LUBRICANT SPECIFICATIONS

| Item | Ford Part Name or equivalent | Ford Part Number | Ford Specification |
|--|---|--|--|
| Body hinges, latches, door striker plates and rotors, seat tracks, fuel filler door hinge and spring, hood latch, auxiliary latch, seat tracks | Multi-Purpose Grease | XG-4 or XL-5 | ESB-M1C93-B or ESR-M1C159-A |
| Hydraulic clutch fluid and brake fluid | Motorcraft High Performance DOT 3 Motor Vehicle Brake Fluid | PM-1 | ESA-M6C25-A and DOT 3 |
| Driveshaft, slip spline, universal joints | Premium Long Life Grease | XG-1-C or XG-1-T or XG-1-K | ESA-M1C75-B |
| Engine coolant | Motorcraft Premium Gold Engine Coolant (yellow-colored) | VC-7-A (U.S., except CA and OR), VC-7-B (CA and OR only) | WSS-M97B51-A1 |
| Engine oil | Motorcraft SAE 5W-30 Super Premium Motor Oil | XO-5W30-QSP (US) | WSS-M2C205-A with API Certification Mark |
| Automatic transmission (5R55E) ₁ | Motorcraft MERCON®V ATF | XT-5-QM | MERCON®V |

Maintenance and Specifications

| Item | Ford Part Name or equivalent | Ford Part Number | Ford Specification |
|---|--|----------------------------------|--------------------|
| Power steering fluid | Motorcraft MERCON Multi-Purpose® ATF | XT-2-QDX | MERCON® |
| Rear Axle | Motorcraft SAE 75W-90 Fuel Efficient High Performance Synthetic Rear Axle Lubricant | XY-75W90-QFEHP | — |
| Front axle (4X4) | Motorcraft SAE 80W-90 Premium Rear Axle Lubricant | XY-80W90-QL | WSP-M2C197-A |
| Transfer case (4X4) | Motorcraft MERCON Multi-Purpose® ATF | XT-2-QDX | MERCON® |
| Transfer case Front Output Slip Shaft | Premium Long-Life Grease | XG-1-C or XG-1-T or XG-1-K | ESA-M1C75-B |
| Windshield washer fluid | Motorcraft Premium Windshield Washer Concentrate | ZC-32-A | WSB-M8B16-A2 |

¹Ensure the correct automatic transmission fluid is used. Transmission fluid requirements are indicated on the dipstick or on the dipstick handle. MERCON® and MERCON® V are not interchangeable. DO NOT mix MERCON® and MERCON® V. Refer to your *Scheduled Maintenance Guide* to determine the correct service interval.

²Add 118 ml (4 oz) of Additive Friction Modifier XL-7 or equivalent to Traction-Lok rear axles whenever the axle has been serviced.

Maintenance and Specifications

ENGINE DATA

| Engine | 4.0L SOHC FFV V6 engine |
|-------------------|---|
| Cubic inches | 245 |
| Required fuel | 87 octane unleaded gasoline or Ethanol (E 85 max) |
| Firing order | 1-4-2-5-3-6 |
| Ignition system | EDIS |
| Compression ratio | 9.7:1 |

VEHICLE DIMENSIONS

| Dimensions | 4-Door - inches (mm) |
|-------------------------------------|--------------------------|
| (1) Overall length | 205.9 (5230) |
| (2) Overall width | 71.8 (1823) |
| (3) Vehicle height/ Maximum height* | 69.9 (1776)/70.6 (1794)* |
| (4) Wheelbase | 125.9 (3198) |
| (5) Front track /Rear track | 58.5 (1486)/58.3 (1480) |

*Denotes a 4x4 vehicle with 16" tires

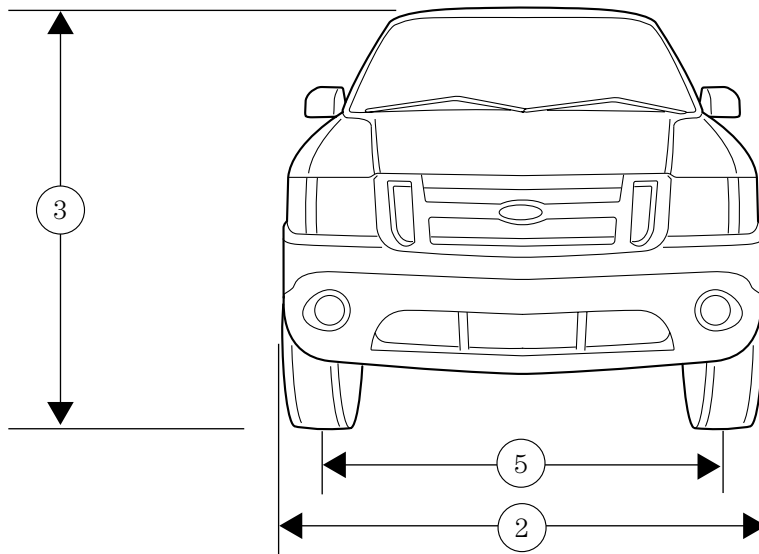

Maintenance and Specifications

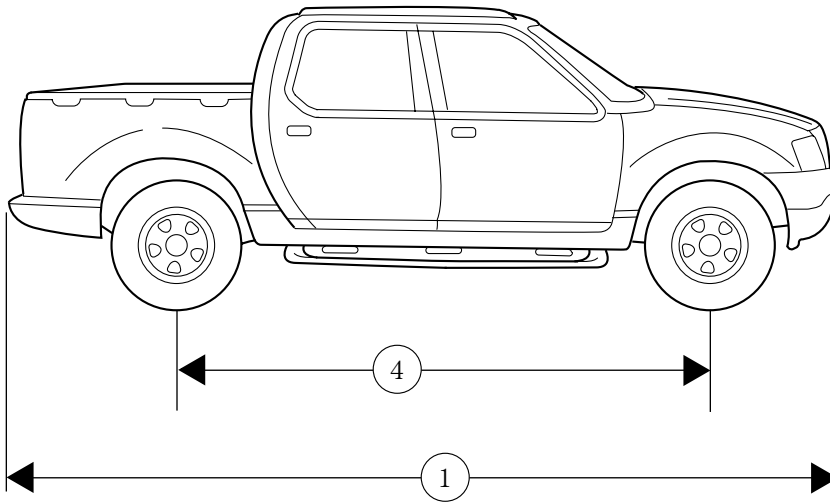

IDENTIFYING YOUR VEHICLE

Certification label

The National Highway Traffic Safety Administration Regulations require that a Certification label be affixed to a vehicle and prescribe where the Certification label may be located. The Certification label is located on the structure by the trailing edge of the driver's door or the edge of the driver's door.

| MFD. BY FORD MOTOR CO. IN U.S.A. | | | | | |
|---|------------------------|---------------|----------|--|--|
| DATE: XX/XX | GVWR: XXXXXLB/ XXXXXKG | | | | |
| FRONT GAWR: XXXXL | REAR GAWR: XXXXLB | | | | |
| XXXXKG | WITH | XXXXKG | WITH | | |
| XXXX/XXXXXX | TIRES | XXXX/XXXXXX | TIRES | | |
| XXXX.XX | RIMS | XXXX.XX | RIMS | | |
| AT XXX kPa/XX | PSI COLD | AT XXX kPa/XX | PSI COLD | | |
| THIS VEHICLE CONFORMS TO ALL APPLICABLE FEDERAL MOTOR VEHICLE SAFETY AND THEFT PREVENTION STANDARDS IN EFFECT ON THE DATE OF MANUFACTURE SHOWN ABOVE. | | | | | |
| VIN: XXXXXXXXXXXXXXXXX | | | XXXXX | | |
| TYPE: XXX | | | XXXXX | | |
| | | | | | |
| EXT PNT: XX | RC: XX | DSQ: | | | |
| WB ¹ BRK ¹ INT TR ¹ TP/PS ¹ R ¹ AXLE ¹ TR ¹ SPR ¹ | XXXXX | | | | |
| XXX X XX | X XX | X XX | XXX | | |
| XXXXXXXXXXXXX UTC V2USA-1520472-AA | | | | | |

Maintenance and Specifications

Vehicle identification number (VIN)

The vehicle identification number is attached to a metal tag and is located on the driver side instrument panel. (Please note that in the graphic XXXX is representative of your vehicle identification number.)

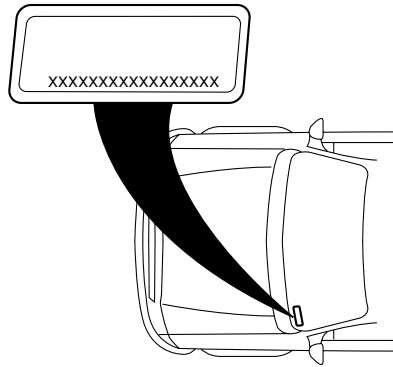

Engine number

The engine number (the last eight numbers of the vehicle identification number) is stamped on the engine block, transmission, frame and transfer case (if equipped).

Transmission/Transaxle code designations

| MFD. BY FORD MOTOR CO. IN U.S.A. | | | | | | | | | |
|---|----------|------------------------|----|-------------------|---------------|-----|----------|---------------|--|
| DATE: XX/XX | | GVWR: XXXXXLB/ XXXXXKG | | | | | | | |
| FRONT GAWR: XXXXL | | | | REAR GAWR: XXXXLB | | | | | |
| XXXXKG | WITH | XXXXKG | | WITH | XXXXKG | | WITH | XXXXKG | |
| XXXX/XXXXXXXX | TIRES | XXXX/XXXXXXXX | | TIRES | XXXX/XXXXXXXX | | TIRES | XXXX/XXXXXXXX | |
| XXXX.XX | RIMS | XXXX.XX | | RIMS | XXXX.XX | | RIMS | XXXX.XX | |
| AT XXX kPa/XX | PSI COLD | AT XXX kPa/XX | | PSI COLD | AT XXX kPa/XX | | PSI COLD | AT XXX kPa/XX | |
| THIS VEHICLE CONFORMS TO ALL APPLICABLE FEDERAL MOTOR VEHICLE SAFETY AND THEFT PREVENTION STANDARDS IN EFFECT ON THE DATE OF MANUFACTURE SHOWN ABOVE. | | | | | | | | | |
| VIN: XXXXXXXXXXXXXXXX | | | | | | | XXXXX | | |
| TYPE: XXX | | | | | | | XXXXX | | |
| | | | | | | | | | |
| EXT PNT: XX | | RC: XX | | DSO: | | | | | |
| WB ¹ BRK | INT TR | TP/PS | TR | AXLE | TR | SPR | XXXXX | | |
| XXX X | XX | X | XX | X | XX | XXX | XXX | | |
| XXXXXXXXXX UTC | | | | | | | | | |
| 72USA-1520472-4A | | | | | | | | | |

You can find a transmission/transaxle code on the vehicle certification label. The following table tells you which transmission or transaxle each code represents.

Maintenance and Specifications

Truck application:

| Code | Transmission Description |
|------|--|
| | <i>Manual transmission</i> |
| M | Manual 5-speed (AKK) |
| C | Manual 5-speed overdrive (Close ratio) |
| W | Manual 5-speed overdrive (Dana ZF) |
| G | Manual 6-speed ZF |
| | <i>Automatic transmission</i> |
| Y | Automatic 4-speed overdrive (CD4E) |
| U | Automatic 4-speed overdrive (4R70W) |
| T | Automatic 4-speed overdrive (4R44E) |
| E | Automatic 4-speed overdrive (4R100) |
| J | Automatic 5-speed overdrive (5R55E) |
| | <i>Electric</i> |
| H | One speed electric |
| D | Automatic 5-speed overdrive (5R44E) |
| R | Automatic 5-speed overdrive (5R55S) |

Passenger car application:

| Code | Transmission/Transaxle Description |
|------|--|
| | <i>Front wheel drive manual transaxle</i> |
| R | 5-speed overdrive (MTX75) |
| W | 5-speed overdrive (M5) |
| | <i>Front wheel drive automatic transaxle</i> |
| A | 4-speed overdrive (4F27E) |
| E | 4-speed overdrive (4FE) |
| J | 3-speed (Mazda) |
| L | 4-speed overdrive (AX4S) |
| P | 4-speed overdrive (4F20E) |
| X | 4-speed overdrive (4F50N) |
| Y | 4-speed overdrive (CD4E) |
| | <i>Rear wheel drive manual transaxle</i> |
| 5 | 5-speed (Mazda M5) |

Maintenance and Specifications

| Code | Transmission/Transaxle Description |
|-------------|--|
| | <i>Rear wheel drive automatic transmission</i> |
| U | 4-speed overdrive (4R70W) |
| A | 5-speed overdrive (5R55N) |

Accessories

GENUINE FORD ACCESSORIES FOR YOUR VEHICLE

A wide selection of Genuine Ford Accessories are available for your vehicle through your local authorized Ford or Ford of Canada dealer. These quality accessories have been specifically engineered to fulfill your automotive needs; they are custom designed to complement the style and aerodynamic appearance of your vehicle. In addition, each accessory is made from high quality materials and meets or exceeds Ford's rigorous engineering and safety specifications. Ford Motor Company will repair or replace any properly dealer-installed Genuine Ford Accessory found to be defective in factory-supplied materials or workmanship during the warranty period, as well as any component damaged by the defective accessory. The accessory will be warranted for whichever provides you the greatest benefit:

- 12 months or 12,000 miles (20,000 km) (whichever occurs first), or
- the remainder of your new vehicle limited warranty.

This means that Genuine Ford Accessories purchased along with your new vehicle and installed by the dealer are covered for the full length of your New Vehicle's Limited Warranty — 3 years or 36,000 miles (60,000 km) (whichever occurs first). Contact your dealer for details and a copy of the warranty.

Not all accessories are available for all models.

The following is a list of several Genuine Ford Accessory products for your vehicle. Not all accessories are available for all models. For a complete listing of the accessories that are available for your vehicle, please contact your dealer or visit our online store at: www.fordaccessoriesstore.com.

Exterior style

Bug shields
Deflectors
Fender flares
Front end covers
Grille inserts
Headlamps, fog lights and Daytime Running Lamps (DRLs)
Running boards
Splash guards
Step Bars
Wheels

230

Accessories

Interior style

Cell phone holders
Electrochromatic compass/temperature interior mirrors
Floor mats
Interior trim kits
Leather wrapped steering wheels
Scuff plates

Lifestyle

Bike racks
Cargo organization and management
Engine block heaters and blankets
Rear seat entertainment systems
Towing mirrors
Trailer hitches, wiring harnesses and accessories

Peace of mind

Airbag anti-theft locks
First aid and safety kits
Full vehicle covers
Locking gas cap
Navigation systems
Remote start
Vehicle security systems

For maximum vehicle performance, keep the following information in mind when adding accessories or equipment to your vehicle:

- When adding accessories, equipment, passengers and luggage to your vehicle, do not exceed the total weight capacity of the vehicle or of the front or rear axle (GVWR or GAWR as indicated on the Safety Compliance Certification label). Consult your dealer for specific weight information.

Accessories

- The Federal Communications Commission (FCC) and Canadian Radio Telecommunications Commission (CRTC) regulate the use of mobile communications systems — such as two-way radios, telephones and theft alarms - that are equipped with radio transmitters. Any such equipment installed in your vehicle should comply with FCC or CRTC regulations and should be installed only by a qualified service technician.
- Mobile communications systems may harm the operation of your vehicle, particularly if they are not properly designed for automotive use.

Index

A

- Accessory delay49
- Air bag supplemental restraint system92–93, 97
 - and child safety seats94
 - description93, 97
 - disposal100
 - driver air bag95, 98
 - indicator light96, 99
 - operation95, 98
 - passenger air bag95, 98
- Air cleaner filter220
- Anti-lock brake system (see Brakes)118
- Audio system (see Radio)16, 19, 23
- Automatic transmission
 - driving an automatic overdrive122
 - fluid, refill capacities221
 - fluid, specification225
- Auxiliary power point47
- Axle
 - lubricant specifications ..223, 225
 - refill capacities221
 - traction lok120

B

- Battery188
 - acid, treating emergencies188
 - jumping a disabled battery162
 - maintenance-free188
 - replacement, specifications ...220
 - servicing188
- BeltMinder88
- Brakes117
 - anti-lock118

- anti-lock brake system (ABS)
 - warning light118
- fluid, checking and adding205
- fluid, refill capacities221
- fluid, specifications223, 225
- lubricant specifications ..223, 225
- parking119
- shift interlock121

C

- Calculating load139
- Capacities for refilling fluids221
- Cargo cage59
- Cell phone use45
- Certification Label226
- Child safety restraints101
 - child safety belts101
- Child safety seats103
 - attaching with tether straps ..108
 - in front seat105
 - in rear seat105
- Cleaning your vehicle
 - engine compartment178
 - instrument panel180
 - interior180
 - interior trim180
 - plastic parts179
 - safety belts180
 - washing177
 - waxing177
 - wheels178
 - wiper blades179
- Clock adjust
 - 6-CD in dash25
 - AM/FM/CD16
 - AM/FM/CD/MP328
 - AM/FM/Tape/CD20
- Compass/temperature display ...56

Index

- Console45
 floor45
 overhead46
- Controls
 power seat76
- Coolant
 checking and adding190
 refill capacities194, 221
 specifications223, 225
- Cruise control
(see Speed control)52
- Customer Assistance145
 Ford accessories for your
 vehicle181
 Ford Extended Service
 Plan170
 Getting assistance outside
 the U.S. and Canada174
 Getting roadside assistance ...145
 Getting the service you
 need168
 Ordering additional owner's
 literature175
 The Dispute Settlement
 Board170
 Utilizing the
 Mediation/Arbitration
 Program173
- D**
- Doors
 lubricant specifications223
- Driving under special
conditions124, 127, 129
 sand128
 snow and ice130
 through water132
- E**
- Emergencies, roadside
 jump-starting162
- Emergency Flashers146
- Engine225
 cleaning178
 idle speed control188
 lubrication specifications223,
 225
 refill capacities221
 service points184
 starting after a collision146
- Engine block heater117
- Engine oil
 filter, specifications187, 220
 recommendations187
 refill capacities221
 specifications223, 225
- Exhaust fumes117
- F**
- Flexible Fuel Vehicle (FFV)195
- Floor mats58
- Fluid capacities221
- Foglamps36
- Four-Wheel Drive vehicles124
 description125
 driving off road125
 electronic shift125
 indicator light124
 preparing to drive your
 vehicle120
- Fuel
 cap197
 capacity221
 choosing the right fuel198
 detergent in fuel200

Index

- filling your vehicle with fuel197, 201
- filter, specifications200, 220
- fuel pump shut-off switch146
- octane rating199, 225
- quality199
- running out of fuel200
- safety information relating to automotive fuels195
- Fuel - flex fuel vehicle (FFV)195, 198–199
- Fuel pump shut-off switch146
- G**
- Garage door opener46
- Gas cap (see Fuel cap)197
- Gauges14
- GAWR (Gross Axle Weight Rating) calculating139
- GVWR (Gross Vehicle Weight Rating) calculating139
- H**
- Hazard flashers146
- Head restraints78
- Headlamps
 - aiming37
 - flash to pass36
 - high beam36
 - replacing bulbs40
- Heating
 - heating and air conditioning system33
- I**
- Ignition113, 225
- Infant seats (see Safety seats)103
- Instrument panel
 - cleaning180
 - cluster10
- J**
- Jump-starting your vehicle162
- K**
- Keyless entry system68
- Keys
 - positions of the ignition113
- L**
- Lamps
 - bulb replacement specifications chart39
 - fog lamps36
 - high beams36
 - instrument panel, dimming37
 - interior lamps39
 - replacing bulbs40–43
- Lights, warning and indicator
 - anti-lock brakes (ABS)118
- Load limits133
- Loading instructions138
- Locks
 - childproof64
- Lubricant specifications ...223, 225
- Lug nuts161
- M**
- Manual transmission
 - fluid capacities221
 - lubricant specifications225

Index

- Mirrors51
 automatic dimming rearview
 mirror51
 fold away52
 side view mirrors (power)52
- Moon roof55
- Motorcraft parts200, 220
- O**
- Octane rating199
- P**
- Parking brake119
- Parts (see Motorcraft parts) ...220
- Power point47–48
- Power steering119
 fluid, checking and adding205
 fluid, refill capacity221
 fluid, specifications223, 225
- Power Windows48
- Preparing to drive your
vehicle120
- R**
- Radio16, 19, 23
- Remote entry system65
 locking/unlocking doors64
- Roadside assistance145
- S**
- Safety belts
(see Safety restraints) ...81, 83–87
- Safety Canopy97
- Safety defects, reporting176
- Safety restraints81, 83–87
 belt minder88
 cleaning the safety belts91
 extension assembly91
 for adults84–86
 for children100–101
 warning light and chime88
- Safety seats for children103
- Seat belts
(see Safety restraints)81
- Seats75
 child safety seats103
- Setting the clock
 AM/FM stereo
 in-dash/CD/MP328
 AM/FM/CD16
 AM/FM/In-dash 6 CD25
 AM/FM/Tape/CD20
- Spark plugs, specifications220,
 225
- Special notice
 utility-type vehicles7
- Specification chart,
lubricants223, 225
- Speed control52
- Starting a flex fuel vehicle116
- Starting your vehicle113–114,
 116
 jump starting162
- Steering wheel
 tilting45
- T**
- Tailgate58
- Tilt steering wheel45
- Tires207–209
 alignment216

Index

- care214
- checking the pressure214
- label214
- rotating216
- safety practices219
- sidewall information209
- spare tire154
- terminology209
- tire grades208
- treadwear208, 218
- Tonneau cover60
- Towing139
 - recreational towing143
 - trailer towing139
- Traction-lok rear axle120
- Transmission121
 - brake-shift interlock (BSI)121
 - fluid, refill capacities221
 - lubricant specifications ..223, 225
- Trunk62
- Turn signal38
- V**
 - Vehicle dimensions225
 - Vehicle Identification Number (VIN)227
 - Vehicle loading133
 - camper bodies143
 - Ventilating your vehicle117
- W**
 - Warning lights (see Lights)10
 - Water, Driving through132
 - Windows
 - power48
 - power down back window49
 - Windshield washer fluid and wipers44
 - replacing wiper blades44

