

Contents

Before driving

| | |
|---------------------|----------|
| Introduction | 2 |
|---------------------|----------|

| | |
|------------------------|----------|
| Instrumentation | 6 |
|------------------------|----------|

| | |
|------------------------------|-----------|
| Controls and features | 20 |
|------------------------------|-----------|

| | |
|--------------------------------------|-----------|
| Seating and safety restraints | 82 |
|--------------------------------------|-----------|

Starting and driving

| | |
|-----------------|------------|
| Starting | 126 |
|-----------------|------------|

| | |
|----------------|------------|
| Driving | 133 |
|----------------|------------|

| | |
|-----------------------------|------------|
| Roadside emergencies | 167 |
|-----------------------------|------------|

Servicing

| | |
|-----------------------------|------------|
| Maintenance and care | 193 |
|-----------------------------|------------|

| | |
|--------------------------------------|------------|
| Capacities and specifications | 263 |
|--------------------------------------|------------|

| | |
|----------------------------|------------|
| Customer assistance | 272 |
|----------------------------|------------|

| | |
|--|------------|
| Reporting safety defects (U. S. only) | 283 |
|--|------------|

| | |
|--------------|------------|
| Index | 284 |
|--------------|------------|

All rights reserved. Reproduction by any means, electronic or mechanical including photocopying, recording or by any information storage and retrieval system or translation in whole or part is not permitted without written authorization from Ford Motor Company.

Copyright © 2001 Ford Motor Company

Introduction

CALIFORNIA Proposition 65 Warning

 **Warning:** Engine exhaust, some of its constituents, and certain vehicle components contain or emit chemicals known to the State of California to cause cancer and birth defects or other reproductive harm. In addition, certain fluids contained in vehicles and certain products of component wear contain or emit chemicals known to the State of California to cause cancer and birth defects or other reproductive harm.

ICONS

Indicates a safety alert. Read the following section on *Warnings*.

Indicates that vehicle information related to recycling and other environmental concerns will follow.

Correct vehicle usage and the authorized disposal of waste, cleaning and lubrication materials are significant steps towards protecting the environment.

Indicates a message regarding child safety restraints. Refer to *Seating and safety restraints* for more information.

Indicates that this Owner Guide contains information on this subject. Please refer to the *Index* to locate the appropriate section which will provide you more information.



WARNINGS

Provide information which may reduce the risk of personal injury and prevent possible damage to others, your vehicle and its equipment.

BREAKING IN YOUR VEHICLE

There are no particular breaking-in rules for your vehicle. During the first 1 600 km (1 000 miles) of driving, vary speeds frequently. This is necessary to give the moving parts a chance to break in.

If possible, you should avoid full use of the brakes for the first 1 600 km (1 000 miles).









INFORMATION ABOUT THIS GUIDE

The information found in this guide was in effect at the time of printing. Ford may change the contents without notice and without incurring obligation.

Introduction

Vehicle symbol glossary

These are some of the symbols you may have on your vehicle.

| | | | |
|-----------------------------------|---|-----------------------------|---|
| Safety Alert |  | See Owner's Guide |  |
| Fasten Safety Belt |  | Airbag – Front |  |
| Airbag – Side |  | Child Seat |  |
| Child Seat Installation Warning |  | Child Seat Tether Anchorage |  |
| Brake System |  | Anti-Lock Brake System |  |
| Brake Fluid – Non-Petroleum Based |  | AdvanceTrac™ |  |
| Master Lighting Switch |  | Hazard Warning Flasher |  |
| Fog Lamps – Front |  | Fuse Compartment |  |
| Fuel Pump Reset |  | Windshield Wash/Wipe |  |
| Windshield Defrost/Demist |  | Rear Window Defrost/Demist |  |
| Power Windows Front/Rear |  | Power Window Lockout |  |

Introduction

Vehicle symbol glossary

Child Safety Door
Lock/Unlock



Panic Alarm



Engine Oil



Engine Coolant



Engine Coolant
Temperature



Do Not Open When Hot



Battery



Avoid Smoking, Flames, or
Sparks



Battery Acid



Explosive Gas



Fan Warning



Power Steering Fluid



Maintain Correct Fluid
Level



Emission System



Engine Air Filter



Passenger Compartment
Air Filter



Jack



Instrumentation

Page 20–21
Headlamp control

Page 22
Panel dimmer control

Page 22
Luggage compartment control

Page 21, 59
Direction indicators/
high beam

Page 8–19
Instrument cluster

Page 60
Wiper lever

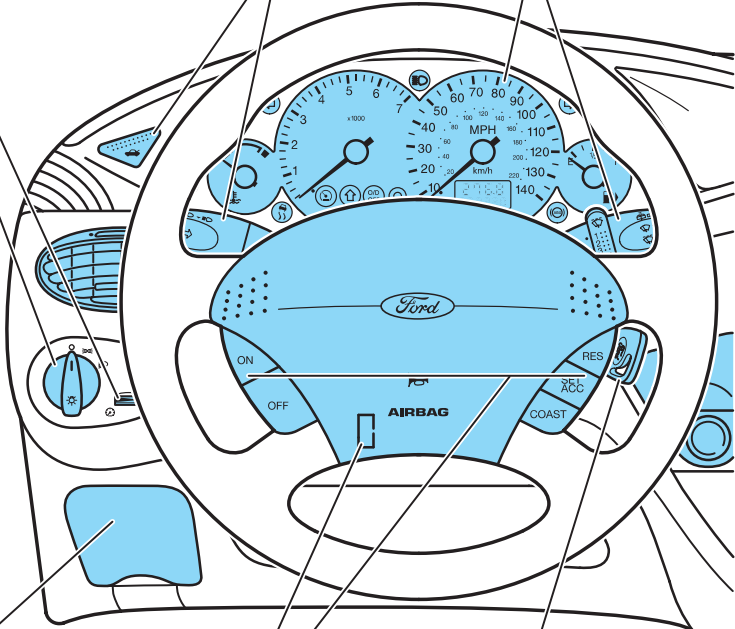

Page 169–176
Fuse panel

Page 61–64
Speed control

Page 59
Steering wheel
adjustment

Page 58
Ignition switch

Instrumentation

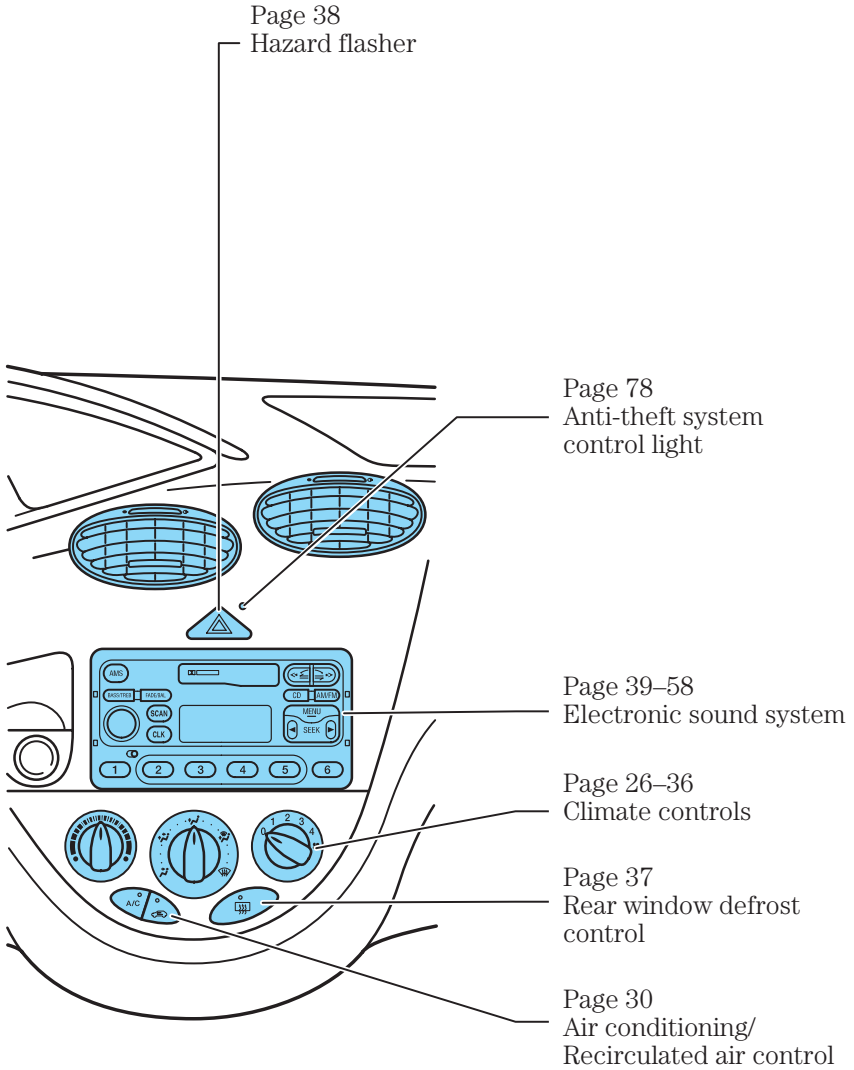

Instrumentation

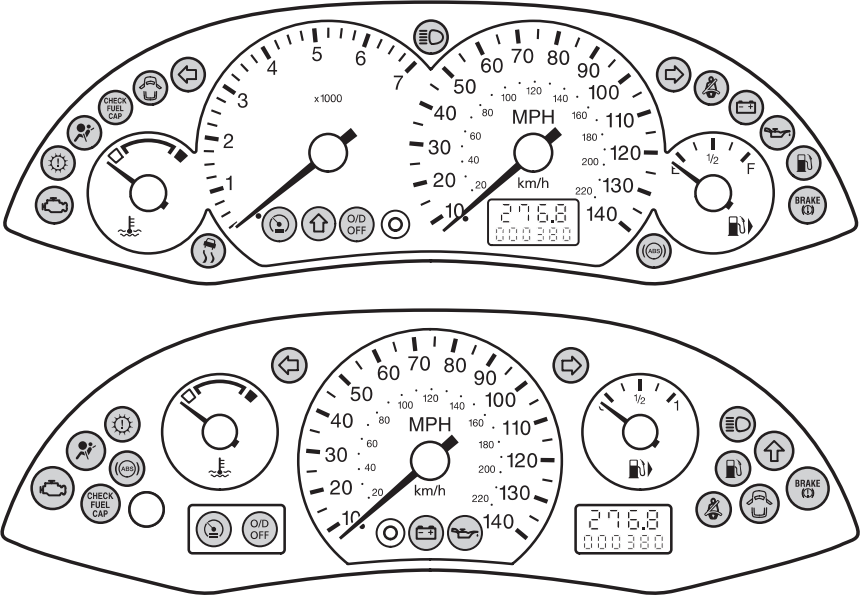

INSTRUMENT CLUSTER WARNING LIGHTS AND CHIMES

Check engine

Your vehicle is equipped with a computer that monitors the engine's emission control system. This system is commonly known as the On Board Diagnostics System (OBD II). This OBD II system protects the environment by ensuring that your vehicle continues to meet government emission standards. The OBD II system also assists the service technician in properly servicing your vehicle.



Instrumentation

The *Check engine* indicator light illuminates when the ignition is first turned to the ON/RUN position to check the bulb. If it comes on after the engine is started, one of the engine's emission control systems may be malfunctioning. The light may illuminate without a driveability concern being noted. The vehicle will usually be driveable and will not require towing.

What you should do if the check engine light illuminates

Light turns on solid:

This means that the OBD II system has detected a malfunction.

Temporary malfunctions may cause your *Check engine* light to illuminate. Examples are:

1. The vehicle has run out of fuel. (The engine may misfire or run poorly).
2. Poor fuel quality or water in the fuel.
3. The fuel cap may not have been properly installed and securely tightened.

These temporary malfunctions can be corrected by filling the fuel tank with good quality fuel and/or properly installing and securely tightening the gas cap. After three drive cycles without these or any other temporary malfunctions present, the *Check engine* light should turn off. (A driving cycle consists of a cold engine startup followed by mixed city/highway driving). No additional vehicle service is required.

Instrumentation

If the *Check engine* light remains on, have your vehicle serviced at the first available opportunity.

Light is blinking:

Engine misfire is occurring which could damage your catalytic converter. You should drive in a moderate fashion (avoid heavy acceleration and deceleration) and have your vehicle serviced at the first available opportunity.



Under engine misfire conditions, excessive exhaust temperatures could damage the catalytic converter, the fuel system, interior floor coverings or other vehicle components, possibly causing a fire.

Multi-function: Automatic transaxle/cooling system (On Zetec or automatic transaxle vehicles only)



Momentarily illuminates when the ignition is turned to the ON/RUN position and the engine is off. If the light illuminates while driving, have your vehicle serviced.

AdvanceTrac™

Momentarily illuminates when the ignition is turned on, to confirm that the system is operational.

While driving, the light flashes when the feature is active. The control switch will toggle the feature on or off, but the feature will default to on after each cycle of the ignition key. The light illuminates continuously when the feature is switched off.

After turning the ignition on, if the light does not illuminate or illuminates continuously (assuming the light has not come as a result of pressing the AdvanceTrac™ switch, which disables the system) while driving, it indicates a malfunction. During a malfunction the system will be switched off. Have the system serviced.

For further details, refer to the sections *AdvanceTrac™ switch* and *AdvanceTrac™*.



Instrumentation

Check fuel cap

Momentarily illuminates when the ignition is turned to the ON/RUN position to ensure your bulb is working. When the light turns on, check the fuel filler cap. Continuing to operate the vehicle with the check fuel cap light on, can activate the *Service Engine soon/Check Engine* warning light. When the fuel filler cap is properly re-installed, the light(s) will turn off after a period of normal driving.



It may take a long period of time for the system to detect an improperly installed fuel filler cap.

For more information, refer to *Fuel filler cap* in the *Maintenance and care* chapter.

Air bag readiness

Momentarily illuminates when the ignition is turned on. If the light fails to illuminate, continues to flash or remains on, have the system serviced immediately.



Doors ajar

Illuminates when the ignition is in the ON/RUN or START position and any door or the luggage compartment is open.



Instrumentation

Turn signal

Illuminates when the left or right turn signal or the hazard lights are turned on. If one or both of the indicators stay on continuously or flash faster, check for a burned-out turn signal bulb. Refer to *Exterior bulbs* in the *Maintenance and care* chapter.

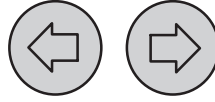

High beams

Illuminates when the high beam headlamps are turned on.



Safety belt

Momentarily illuminates when the ignition is turned to the ON/RUN position to remind you to fasten your safety belts. For more information, refer to the *Seating and safety restraints* chapter.



Charging system

Illuminates when the ignition is turned to the ON/RUN position and the engine is off. The light also illuminates when the battery is not charging properly, requiring electrical system service.



Instrumentation

Engine oil pressure

Illuminates when the oil pressure falls below the normal range. Stop the vehicle as soon as safely possible and switch off the engine immediately. Check the oil level and add oil if needed. Refer to the *Maintenance and care* chapter.



Low fuel level warning light

When the warning light illuminates, refuel as soon as possible.



Brake system warning

Momentarily illuminates when the ignition is turned to the ON/RUN position and the engine is off. If brake warning lamp does not illuminate at this time, seek service immediately. Also illuminates when the parking brake is engaged. Illumination after releasing the parking brake indicates low brake fluid level or ABS (if equipped) failure and the brake system should be serviced immediately.



Instrumentation

Anti-lock brake system (ABS) (if equipped)

Momentarily illuminates when the ignition is turned to the ON/RUN position and the engine is off. If the light remains on, continues to flash or fails to illuminate, have the system serviced immediately. With the ABS light on, the anti-lock brake system is disabled and normal braking is still effective unless the brake warning light also remains illuminated with parking brake released.

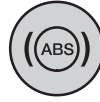

Speed control (if equipped)

Illuminates when the speed control system is switched on. Refer to *Speed control* in the *Controls and features* chapter.



Upshift (if equipped)

Illuminates when it is best to shift to the next highest manual transaxle gear for the maximum fuel economy.



O/D off (if equipped)

Illuminates when the transaxle control switch has been pushed. When the light is on, the transaxle does not switch into overdrive.



Instrumentation

Headlamps on warning chime

Sounds when the headlamps or parking lamps are on, the ignition is off (and the key is not in the ignition) and the driver's door is opened.

Safety belt warning chime

Chimes to remind you to fasten your safety belts.

For information on the safety belt warning chime, refer to the *Seating and safety restraints* chapter.

Supplemental restraint system (SRS) warning chime

For information on the SRS warning chime, refer to the *Seating and safety restraints* chapter.

Key-in-ignition warning chime

Sounds when the key is left in the OFF/LOCK, ACC or ON/RUN position and the driver's door is opened.

Gearshift warning chime (automatic transaxle only)

Sounds when the gearshift lever is not in P (Park) and the driver's door is opened.

Instrumentation

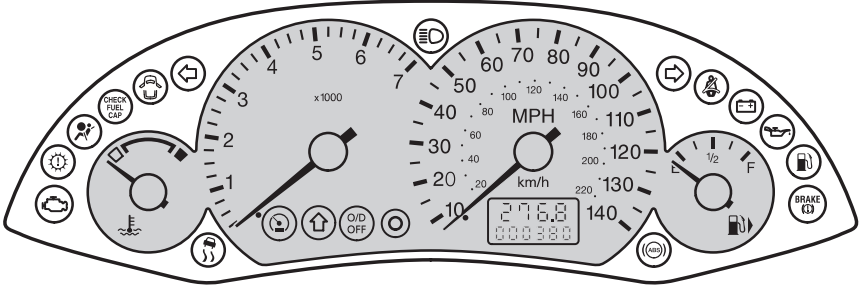

INSTRUMENT CLUSTER GAUGES

Temperature gauge

Indicates the temperature of the engine coolant. At normal operating temperature, the needle remains within the normal area. If it enters the red section, the engine is overheating. Stop the vehicle as soon as safely possible, switch off the engine immediately and let the engine cool. Refer to *Engine coolant* in the *Maintenance and care* chapter.

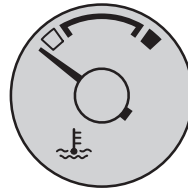

 Never remove the coolant reservoir cap while the engine is running or hot.

Instrumentation

This gauge indicates the temperature of the engine coolant, not the coolant level. If the coolant is not at its proper level the gauge indication will not be accurate. If the gauge enters the red section and the multi-function warning light illuminates, refer to *What you should know about fail-safe cooling* in the *Maintenance and care* chapter.

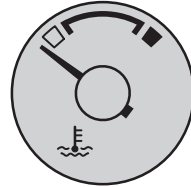

 Never remove the coolant reservoir cap while the engine is running or hot.

Tachometer (if equipped)

Indicates the engine speed in revolutions per minute.

Driving with your tachometer pointer continuously at the top of the scale may damage the engine.

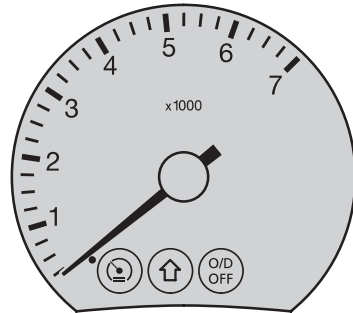

Instrumentation

Speedometer

Indicates the current vehicle speed.

Odometer

Registers the total kilometers (miles) of the vehicle.

Tripmeter

Registers the kilometers (miles) of individual journeys. To reset depress the control.

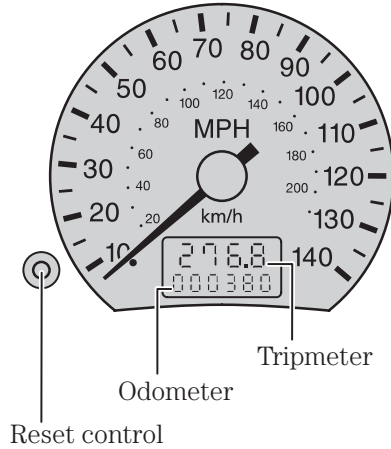

Fuel gauge

Displays approximately how much fuel is in the fuel tank (when the key is in the ON/RUN position). The fuel gauge may vary slightly when the vehicle is in motion. The ignition should be in the OFF position while the vehicle is being refueled. When the gauge first indicates empty, there is a small amount of reserve fuel in the tank. When refueling the vehicle from empty indication, the amount of fuel that can be added will be less than the advertised capacity due to the reserve fuel.

If the key is not in the OFF position when you refuel the vehicle, the fuel gauge will not indicate the new volume until the ignition is turned OFF and then to ON/RUN.

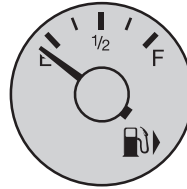

Controls and features

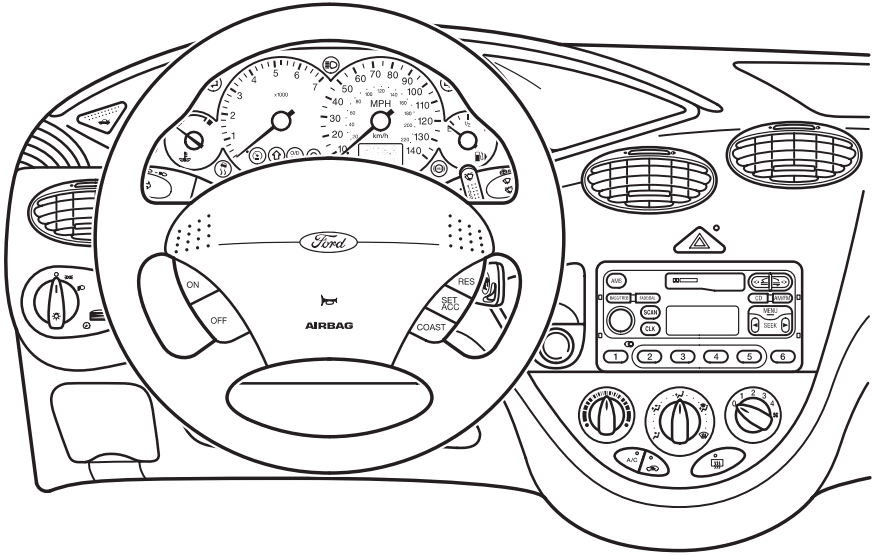

HEADLAMP CONTROL

Rotate the headlamp control to the first position to turn on the parking lamps. Rotate to the second position to also turn on the headlamps.

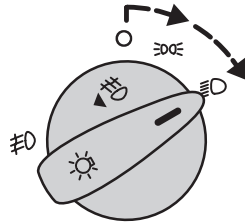

Fog lights (if equipped)

Switch on the headlamps and pull out the control switch one position.

Fog lights do not operate when high beams are activated.

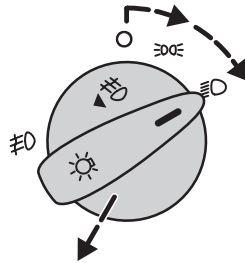

Controls and features

The control light will illuminate when the fog lights are in use. The **fog lights** should be used only when visibility is considerably restricted by fog, snow or rain.



Daytime running lights (DRL) (if equipped)

Turns the headlamps on. To activate:

- The engine must be running and
- The headlamp control is in the OFF or parking lamps position.



The Daytime Running Light (DRL) system will not illuminate the tail lamps and parking lamps. Turn on your headlamps at dusk. Failure to do so may result in a collision.

High beams

Pull toward you to activate. To deactivate, pull the lever toward you again.

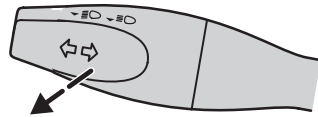

Flash to pass

Pull the lever slightly toward you and release to deactivate.

Controls and features

PANEL DIMMER CONTROL

This can be adjusted to vary the intensity of the panel lighting. Operates only when the exterior lights are switched on.

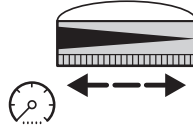

REMOTE LUGGAGE COMPARTMENT RELEASE (if equipped)

To open the luggage compartment, press the control.

The control does not function if the vehicle is traveling faster than 7 km/h (4 mph).

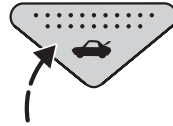

Interior luggage compartment release

Your vehicle is equipped with a mechanical interior luggage compartment release handle that provides a means of escape for children and adults in the event they become trapped inside the luggage compartment.

All drivers are advised to familiarize themselves with the operation and location of the release handle.

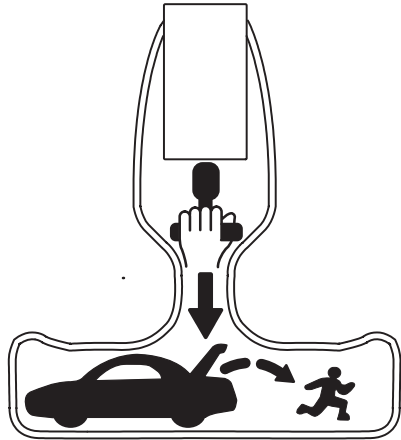

Controls and features

To open the luggage compartment door (lid) from the inside, pull the illuminated “T” shaped handle and push open the door (lid). The material the handle is made of will glow in the darkness of the luggage compartment following a brief exposure to ambient light.

The “T” shaped handle will be located either on the luggage compartment door (lid) or inside the luggage compartment near the tail lamps.



Keep vehicle doors and luggage compartment locked and keep keys out of a child's reach. Unsupervised children could lock themselves in an open trunk and risk injury. Children should be taught not to play in vehicles.

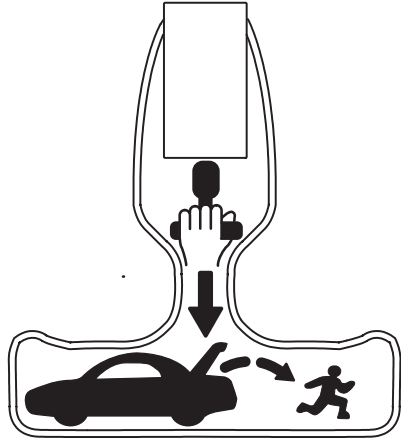

Controls and features

 On hot days, the temperature in the trunk can rise very quickly and cause injury or death to any living thing (animal, small child) entrapped in the trunk.

Sedans may be equipped with glow in the dark unlocking controls, which allow a means of escape by exiting through the folding rear seatback.

These are located near the upper front edge of the decklid opening, on each side of the opening.

Pull one or both of the unlocking controls and push the rear seatback forward.

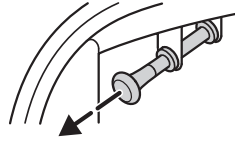

Controls and features

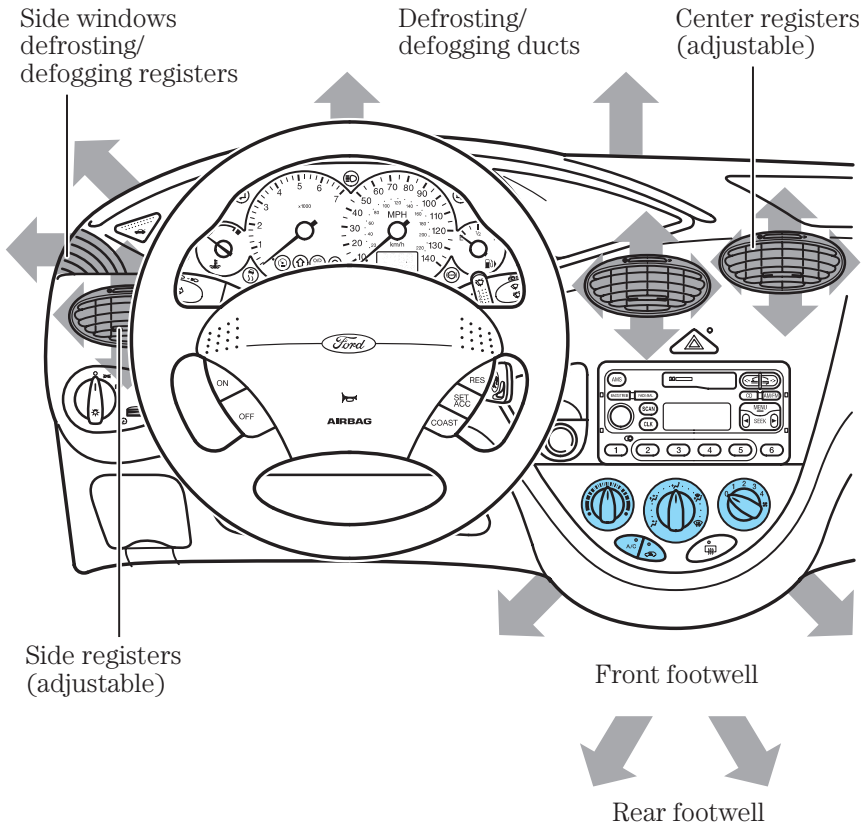

Air distribution

The air flow volume and direction can be regulated with the controls on the instrument panel and the controls on the side and center registers.

Center and side registers

Adjust as necessary for comfort or to direct air to the windows for defogging.

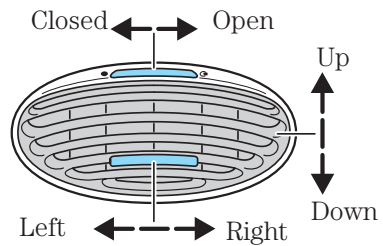

Controls and features

Temperature control

Adjust as necessary.

Note: The heating effect depends upon the coolant temperature and is therefore only effective when the engine is warm.

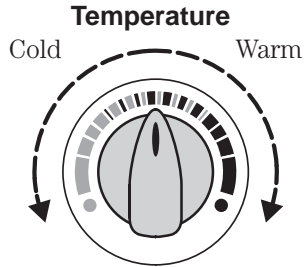

Mode selector control

Controls the direction of the airflow to the interior of the vehicle. Selecting a position part way between modes will distribute the air accordingly.

Air is distributed as follows:

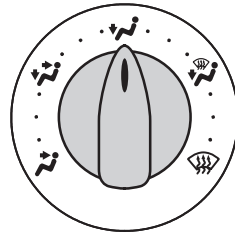

Panel Mode

The main air stream flows from the instrument panel registers to the face level area or to the side windows.

Panel and Floor Mode

The air stream flows from the instrument panel registers and the floor ducts to the face level area and to the front and rear footwell areas. A small portion of air is directed to the windshield.

Floor Mode

The main air stream flows from the floor ducts to the front and rear footwell areas. A small portion of air is directed to the windshield.

Controls and features

Floor and Defrost Mode

The air stream flows from the floor ducts and the windshield defroster ducts to the front and rear footwell areas and towards the windshield.

Defrost Mode

The main air stream flows from the windshield defroster ducts towards the windshield to defrost or defog it. When this mode is selected, the recirculated air will be turned off automatically.

If equipped, the air conditioning will switch on automatically to dehumidify the air.

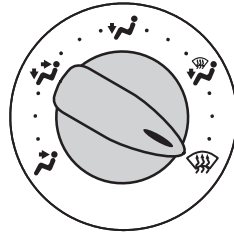

Fan speed control

Controls the volume of air circulated in the vehicle. To increase air flow, select a higher number.

The fan is in the off position when position **0** is selected. At higher road speeds air may continue to flow into the passenger compartment even with the fan turned to **0**. To stop it, activate the recirculated air function.

Do not turn the fan to **0** when  has been selected. In certain weather conditions, the windshield may fog.

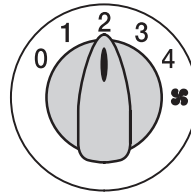

Controls and features

Recirculated Air Control

Press the button to toggle between outside air and recirculated air. The control light in the switch illuminates while the recirculated air function is active, indicating that no outside air is flowing into the vehicle.

Activate the recirculated air function to help stop undesirable odors from entering the vehicle.

The recirculated air function cannot be activated when  has been selected.



Air Conditioning Control (if equipped)

Press the air conditioning button to cool the vehicle. The control light in the switch illuminates to indicate operation.

Press the air conditioning and recirculated air buttons for maximum air conditioning performance. This will cool the vehicle using recirculated air.

The air conditioning will switch off automatically if the fan is turned to **0**. When the fan is turned on again, the air conditioning will reactivate.

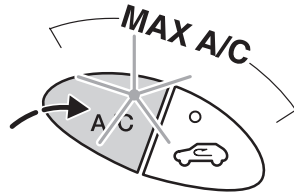

Controls and features

Rear Window Defroster

The rear window defroster control is located on the instrument panel.

Press the defroster control to clear the rear window of thin ice and fog.

The control light in the switch illuminates to indicate operation.

The defroster turns off automatically after 14 minutes or when the ignition is turned to the OFF position. To turn off the defroster manually before 14 minutes have passed, push the control again.



Controls and features

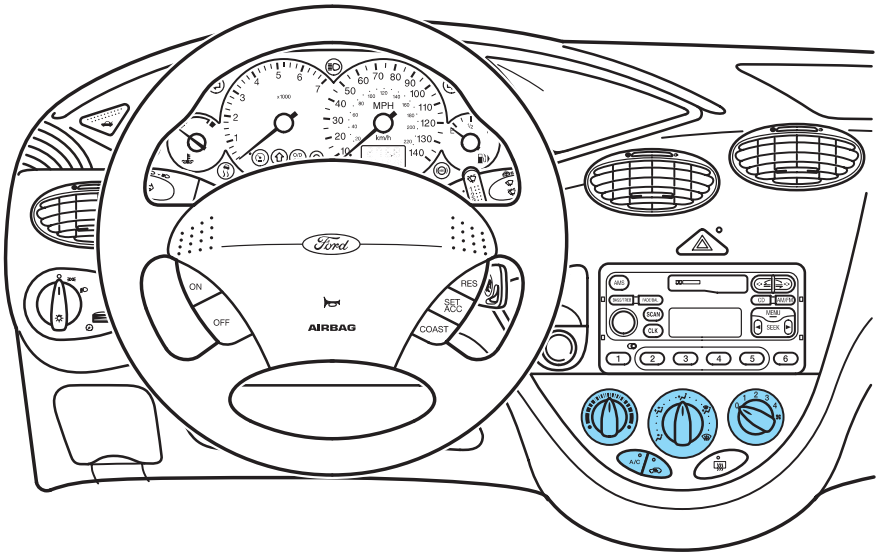

AIR CONDITIONING (if equipped)

The air conditioning system operates only when the temperature is above +4°C (40°F), the engine is running and the fan is turned on.

When the mode selector control is set to , the air conditioning is automatically activated to dehumidify the air.

The air conditioning removes moisture from the cooled air (condensation). Therefore, it is normal to see a small pool of water underneath the vehicle when it is parked.

When entering a hot vehicle, open the windows for a couple of minutes to let out the hot air. This will aid cooling performance.

Controls and features

Maximum air conditioning – Cooling with recirculated air

To rapidly cool the interior of the vehicle, set the temperature control to the coldest setting, select , select a fan speed of **2, 3** or **4** and activate the air conditioning and recirculated air. To avoid stale air, deactivate the recirculated air once the vehicle has cooled.

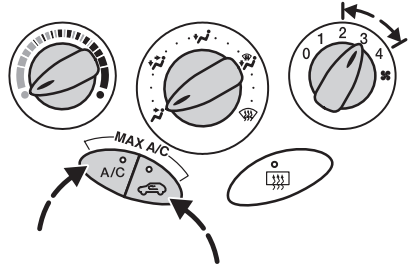

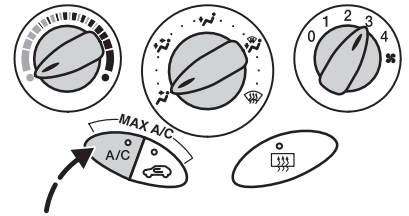

Cooling with outside air

To cool the interior of the vehicle, set the temperature control to cold, select , select a fan speed and turn the air conditioning on.



Rapid heating

To warm the interior of the vehicle, set the temperature control to the warmest setting, select  or , and select a fan speed of **3** or **4**. Turn the rear window defroster on for a clear view.

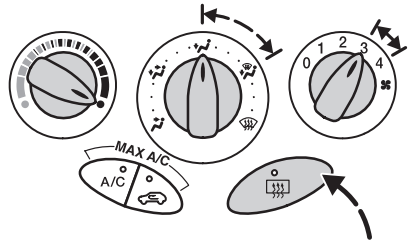

Windshield defrost/defogging

To clear the windows of frost or fog, set the temperature control to the warmest setting, select  and select a fan speed of **2, 3** or **4**. The air conditioning will be activated automatically to dehumidify the air. Recirculated air can not be selected in this mode and will turn off automatically. Turn the rear window defroster on for a clear view.

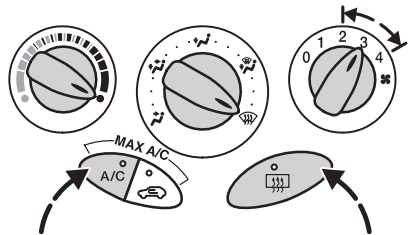



Controls and features

Suitable comfort settings

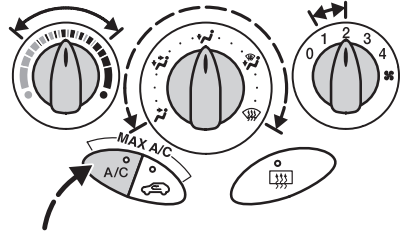
To maintain comfort at moderate outside temperatures, set the desired temperature, select any mode and select a fan speed of **1** or **2**. Activate the air conditioning as needed to maintain comfort or prevent fogging. The air conditioning may be deactivated for improved fuel economy.



Stabilized comfort/defogging

To maintain comfort at moderate outside temperatures and to clear the windows of fog, set the temperature control, select  or , select a fan speed of **1**, **2** or **3** and turn the air conditioning on for dehumidification. The air conditioning may be deactivated for improved fuel economy.

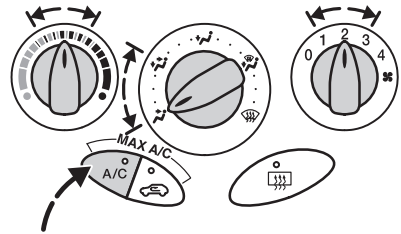

Temporary outside odor

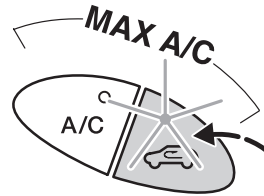

To help stop undesirable odors from entering the vehicle, activate the recirculated air function. Deactivate the recirculated air function when the odor has cleared or if window fogging occurs.



Controls and features



Without air conditioning:

Maximum ventilation

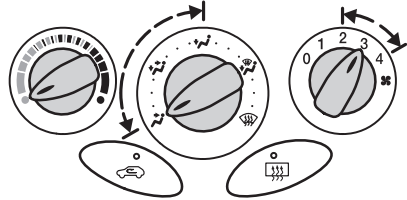
To rapidly ventilate the interior of the vehicle, set the temperature control to the coldest setting, select ,  or  and select a fan speed of **2**, **3** or **4**.



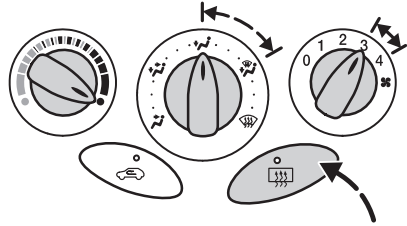

Rapid heating

To warm the interior of the vehicle, set the temperature control to the warmest setting, select  or  and select a fan speed of **3** or **4**. Turn the rear window defroster on for a clear view.



Windshield defrost/defogging

To clear the windows of frost or fog, set the temperature control to the warmest setting, select  and select a fan speed of **2**, **3** or **4**. Recirculated air can not be selected in this mode and will turn off automatically. Turn the rear window defroster on for a clear view. After the fog or frost has cleared, select  to obtain comfortable distribution of the air flow.

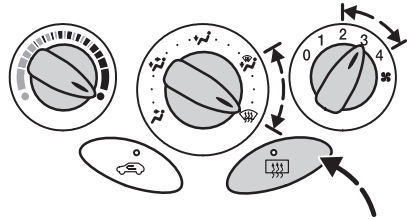



Controls and features

Suitable comfort settings

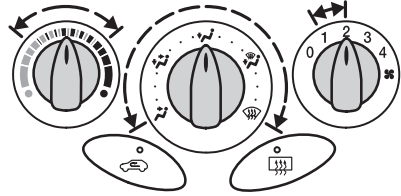
To maintain comfort at moderate outside temperatures, set the desired temperature, select any mode and select a fan speed of **1** or **2**.



Stabilized comfort/defogging

To maintain comfort at moderate outside temperatures and to clear the windows of fog, set the desired temperature, select  or  and select a fan speed of **1**, **2** or **3**.

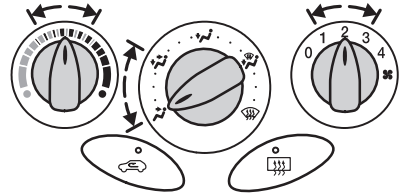

Temporary outside odor

To help stop undesirable odors from entering the vehicle, activate the recirculated air function. Deactivate the recirculated air function when the odor has cleared or if window fogging occurs.



Controls and features

Operating Tips

- Do not put objects under the front seats that will interfere with airflow to the back seats.
- Do not place objects on top of your instrument panel. These objects can block air flow or fall into the defroster outlets and possibly damage your climate control system. Objects placed on top of your instrument panel can also reduce your ability to see through the windshield.
- Remove snow, ice or leaves from the air intake area (located at the bottom of the windshield under the hood).
- If the vehicle has been parked with the windows closed during hot weather, the air conditioning will do a much faster job of cooling if you drive for a few minutes with the windows open. This will force most of the hot, stale air out of the vehicle.
- Clean the inside and outside of the windows periodically with a clean, soft cloth. This will remove the dirt film that can absorb moisture and increase window fogging.

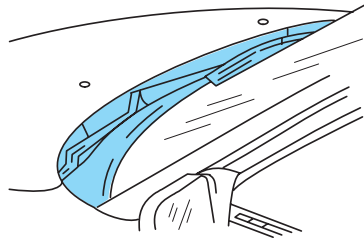

Controls and features

- Do not use recirculated air when defogging the windows.
- If equipped, activate the air conditioning when fogging occurs. Use of the air conditioning system is the most effective technique for dehumidifying the air and reducing fogging/misting of the windows.
- Additional ways to reduce window fogging include: Select  and adjust the registers to blow along the windows. Increase the blower speed. This reduces moisture by increasing the air flow rate. Increase the temperature setting. This will warm up the glass and reduce fogging/misting of the windows.
- Before turning the vehicle off, turn off the air conditioning, select fan speed **4** and allow the system to operate at this speed for a few minutes. This will help reduce any fogging that may occur the next time the vehicle is started.



Do not place objects on top of the instrument panel, as these objects may become projectiles in a collision or sudden stop.

Controls and features

AdvanceTrac™ switch

Press the switch to turn the system on or off. When the system is off, the AdvanceTrac™ light in the instrument cluster illuminates continuously. When the ignition is turned on, the system is automatically selected.

For further details, refer to the section *AdvanceTrac™*.

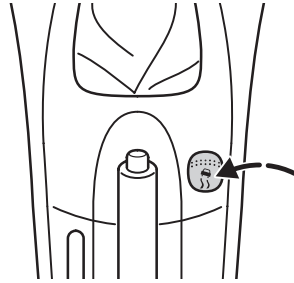

REAR WINDOW DEFROSTER

The rear window defroster control is located on the instrument panel.

Press the defroster control to clear the rear window of thin ice and fog.

The small LED will illuminate when the defroster is activated.

The defroster turns off automatically after 14 minutes or when the ignition is turned to the OFF position. To manually turn off the defroster before 14 minutes have passed, push the control again.

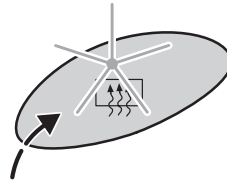

Controls and features

HAZARD FLASHER CONTROL

For information on the hazard flasher control, refer to *Hazard flasher* in the *Roadside emergencies* chapter.



ASHTRAY

Pull to open.

To empty, push the cover completely down and firmly extract the ashtray.

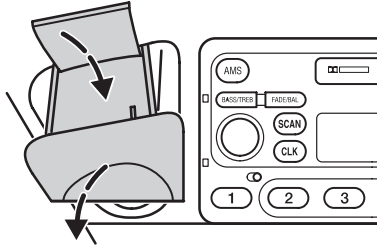

Controls and features

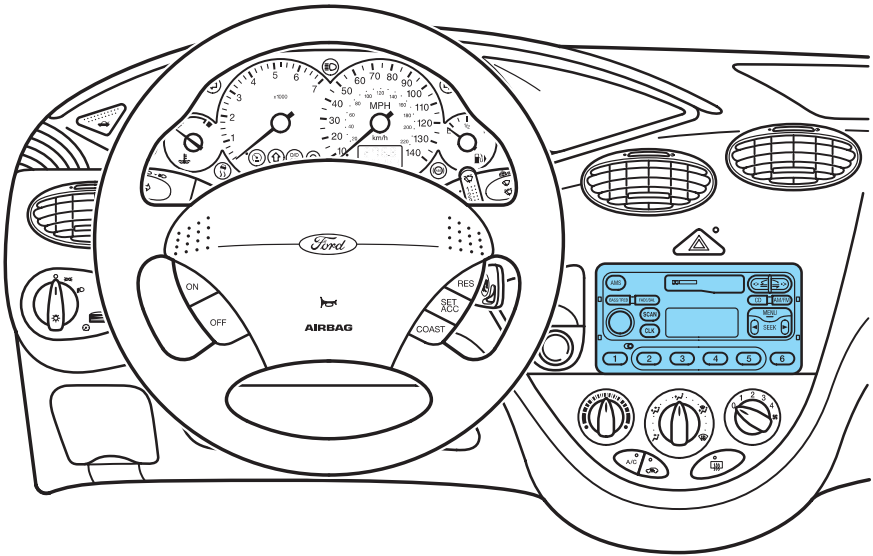

AUDIO SYSTEM

Anti-theft protection panel

To deter would-be thieves, Ford audio units have a removable front panel without which the unit will not work.

Avoid touching the contacts on the back of the panel and do not use excessive force to refit it.

Slide the security release button to the left and remove the front panel. To reposition the panel, insert the right-hand edge first, then the left-hand side, until the retaining latch is engaged.

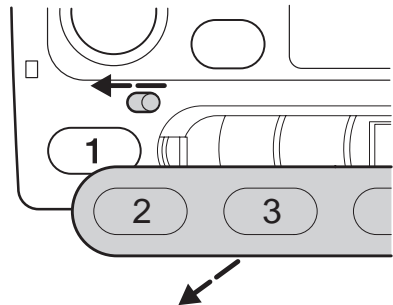

Controls and features

Replacement panels

Your Ford Dealer will require the following if you need to order a replacement panel:

1. Your name and address.
2. The Vehicle Identification Number (visible on a plate mounted on the instrument panel). Refer to illustration under *Vehicle identification number* in the *Capacities and specifications* chapter.
3. The audio unit type (e.g., 4500N, 4600N).
4. Proof of identification (e.g., driver's license, identity card).
5. A vehicle invoice (if the audio unit was installed in the vehicle prior to delivery) or a parts invoice if the audio unit was purchased separately from the vehicle, or an appropriate vehicle registration document.

Radio reception

To gain the best reception, always tune to the strongest station signal available.

The following tips will help you gain the best reception from your Ford audio system.

AM reception

Under most conditions, strong signals provide stable sound quality and little signal disturbance.

However, at night, atmospheric conditions may sometimes lead to interference from other stations.

FM reception

The FM waveband offers higher quality sound broadcasts, but signal strength can be subject to interference caused by:

- The limited range of some transmitters.
- Reception distortion as signals reflect off local buildings and other objects.
- Signal “dead spots” where reception is obstructed or restricted.

Controls and features

4300N, 4500N AND 4600N AUDIO CONTROLS

The 4300N radio is compatible with a CD changer.

Note: The 4300N radio is available only in Canada and Mexico.

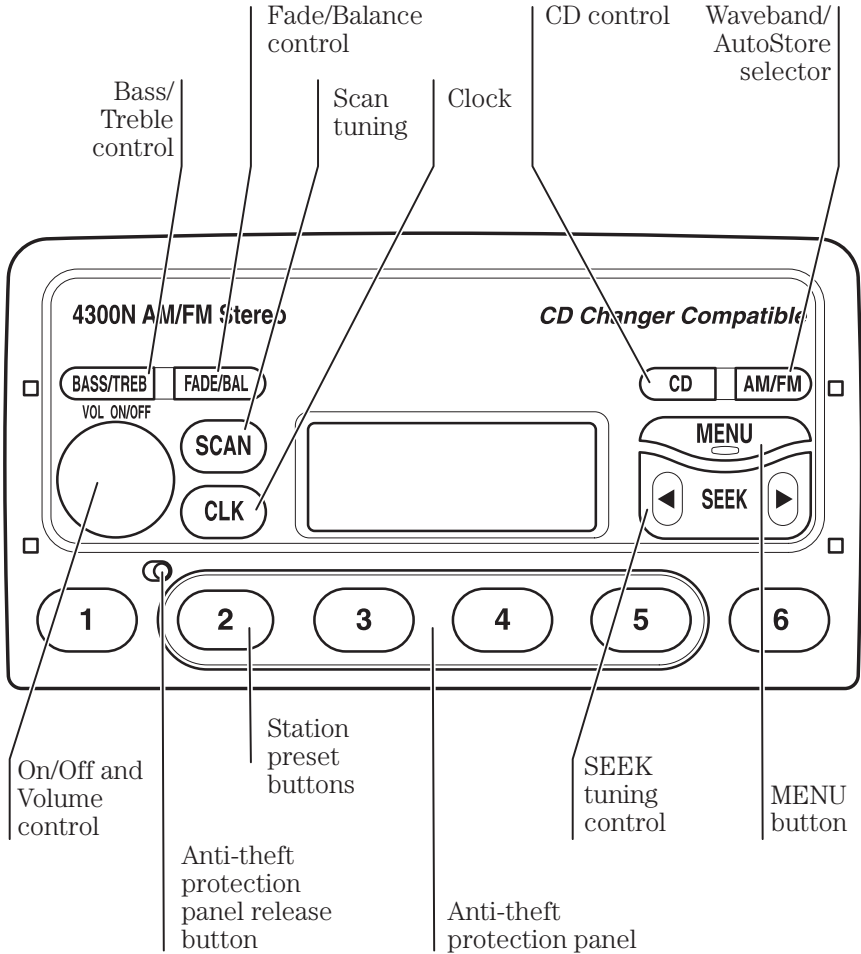

Controls and features

The 4500N radio/cassette is compatible with a CD changer.

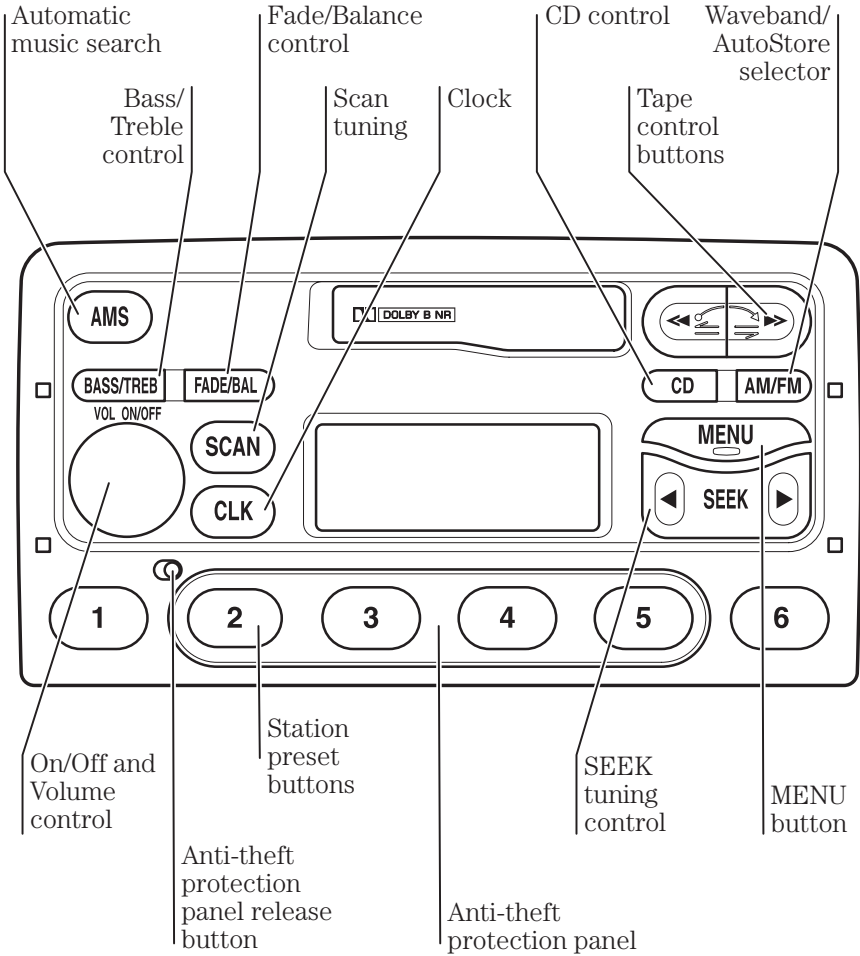

Controls and features

The 4600N radio/ CD player is compatible with a CD changer.

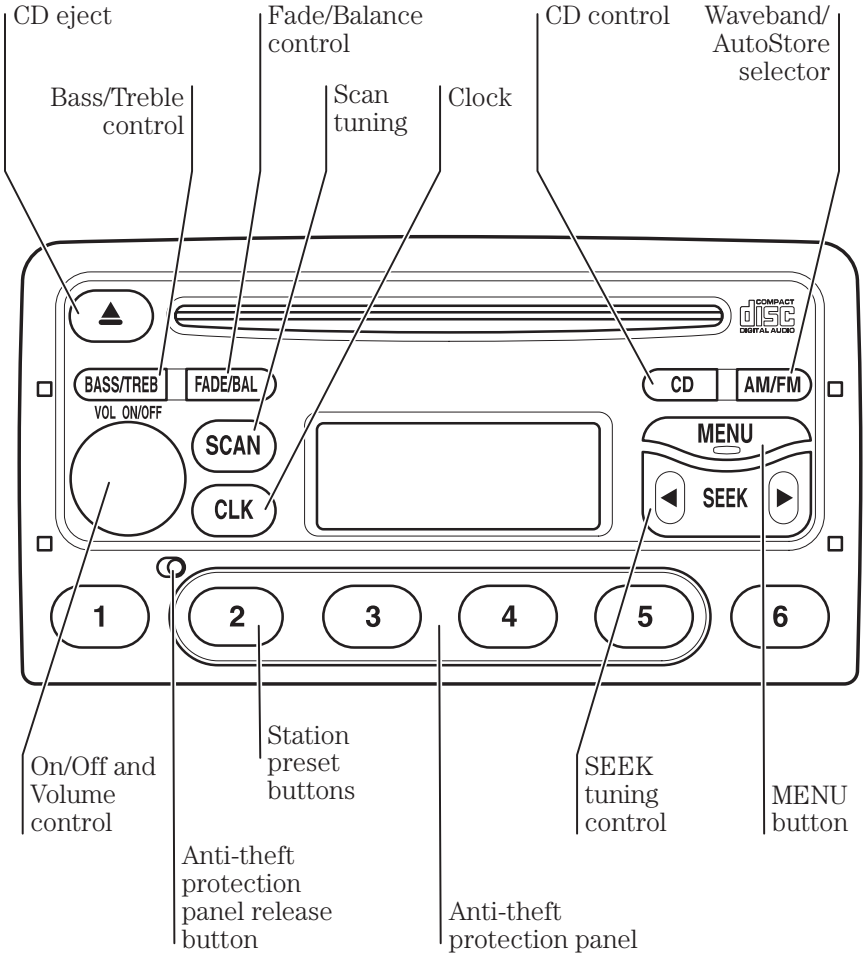

Controls and features

On/off

Press for on/off. This button can also operate the radio for up to one hour with the ignition turned off. The radio automatically switches off after one hour. This function can be used repeatedly.

VOL ON/OFF

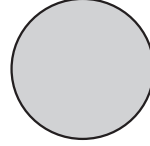

Volume control

The display indicates the level selected.

VOL ON/OFF

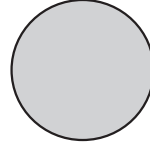

Bass/Treble control

Press "BASS/TREBLE" once for bass or twice for treble and use the volume control for adjustment. The display indicates the level selected. To adjust beyond the "0" setting, stop rotating the control at "0" then restart.

BASS/TREB

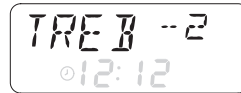
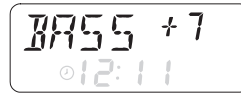

Controls and features

Fade/Balance control

Press “FADE/BAL” once for fade (front to rear) or twice for balance (left to right), and use the volume control for sound system adjustment. The display indicates the level selected. To adjust beyond the “0” setting, stop rotating the control at “0” then restart.

The fade function is applicable to vehicles with front and rear speakers only.

FADE/BAL

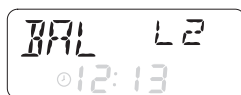

Seek tuning control (SEEK)

During radio reception, press ◀ or ▶ to locate the next station down or up the waveband selected.



Scan tuning control

Press the SCAN button. The radio tunes to and plays the next station on the waveband. After a short period it tunes to and plays the next station.

During this scan, “SCAN” flashes in the display.

If you wish to continue listening to a station tuned to, press SCAN.

Pressing SCAN at any time will end the scan.

SCAN



Controls and features

Waveband selector (AM/FM)

- Press repeatedly during radio reception to select AM, FM1, FM2 or AutoStore (see *AutoStore selector*). The display indicates the selection made.
- Press during tape or CD playback to return to radio reception.



CD playback

Press the CD button for CD playback. Press AM/FM to return to radio reception.

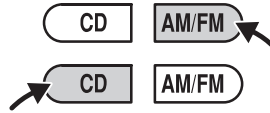

AutoStore selector

AutoStore selects six strong FM station signals and stores them on the preset buttons.

- Press and hold the AM/FM button to activate AutoStore.
- “AST” flashes in the display while the unit searches through the FM frequencies. You can release the button at this point.
- When the search is complete, sound is restored on preset button 1.
- Other stored stations can be selected using the other preset buttons.
- Alternatively, AutoStore can be used as an additional waveband to store other stations manually (see Station preset buttons).

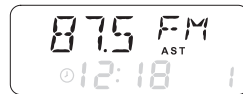

Controls and features

Station preset buttons

Select a waveband (FM or AM) and tune to the station required. Press and hold one of the preset buttons. When sound returns, the station has been stored.

24 preset frequencies can be stored – six on each of the AM, FM1, FM2 and AutoStore bands.

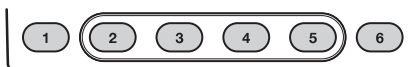

Stereo indicator

The **ST** symbol shows whenever a stereo signal is received.



Clock (CLK)

Press CLK to alternate the display between clock and, when playing, CD elapsed time.

With the ignition switched off, press CLK to display the time for a short period.



Adjusting the clock

With the radio switched on, press and hold CLK until the hour digit flashes. Use the volume control to adjust.

Press CLK again for the minutes and use the volume control to adjust. Press CLK again to return to normal operation.



Controls and features

MENU button (main features) – radio

Use the MENU button to access main menu features and the SEEK button for adjustment.

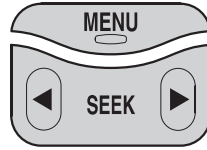

Manual tuning

Press the MENU button once until a display like the one shown opposite appears. Then use the SEEK button to make manual tuning adjustments. The FM waveband allows 200kHz tuning steps, and the AM band 10kHz steps.



Automatic Volume Control (AVC)

Press the MENU button twice until a display like the one shown opposite appears. Then use the SEEK button to turn this function on (“AVC + 1” to “AVC + 7”) or off (“AVC OFF”).

- When selected, Automatic Volume Control increases or decreases the audio unit’s volume level to compensate for engine and road speed noise.

- The SEEK button provides a selection of settings between “AVC OFF” and “AVC +7”. The display shows the level selected.

This feature is not available on some vehicles and will not appear as a menu function.

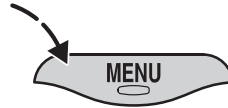

Controls and features

4500N Units only

Tape control buttons

Insert a tape and playback will automatically override radio or CD. "TAPE A" or "TAPE B" appears in the display to indicate which side of the tape is playing. Note that the tape side facing upward in the audio unit is always considered "TAPE A".

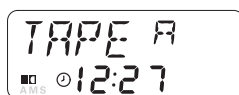

Fast forward/rewind

- Press **▶▶** button fully in for fast forward.
- Press and release **◀◀** button to end fast forward and restart the tape.
- Press **◀◀** button fully in for rewind.
- Press and release **▶▶** button to end rewind and restart the tape. If the beginning of the tape is reached, playback will start automatically.

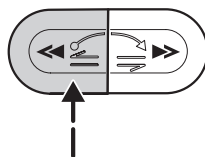
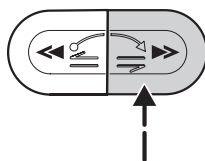

If rewind is engaged during radio reception, tape playback will automatically restart when the beginning of the tape is reached.

During fast forward and rewind, radio transmission is automatically restored (with Automatic Music Search function turned off).

Auto reverse

If the end of the tape is reached, auto reverse operates with playback resuming at the start of the tape's other side.

Controls and features

Tape side selection

During tape playback, press both ◀◀ and ▶▶ buttons partially in to change the tape side being played.

Tape eject

Press both ◀◀ and ▶▶ buttons fully in to eject the cassette and restore radio reception.

To pause tape playback

Press AM/FM to pause tape playback and restore radio reception, or the CD button for CD playback.

A square in the display indicates there is a tape inserted.

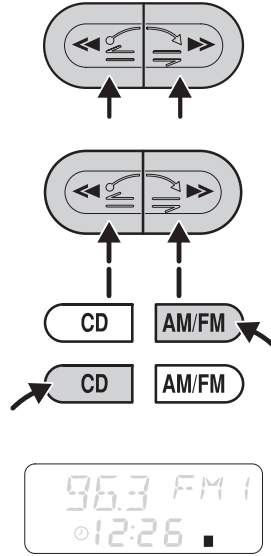

Controls and features

To restart tape playback

Press both tape buttons partially in or press AMS to resume tape playback.



Automatic Music Search (AMS)

Press AMS to turn this function on or off.

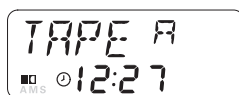

With this feature activated, press either ◀ or ▶ buttons (as appropriate), to obtain the previous or next track on the tape.

Cassette care and maintenance

For best possible sound quality, use tape cassettes that are clean and in good condition.

It is also recommended that the tape head in the audio unit is cleaned regularly with a wet cleaning cassette, which is available from your Ford Dealer.

MENU button (main features) – tape

Use the MENU button to access main menu features, and the SEEK button for adjustment.

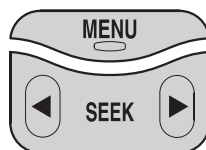

Dolby B® noise reduction

Press the MENU button repeatedly until a display like the one shown opposite appears. Then use the SEEK button to turn this function on ("NR ON") or off ("NR OFF"). With the function on, background tape noise is reduced.



Controls and features

Automatic Volume Control (AVC)

Press the MENU button repeatedly until a display like the one shown opposite appears. Then use the SEEK button to turn this function on (“AVC + 1” to “AVC + 7”) or off (“AVC OFF”).

- When selected, Automatic Volume Control increases or decreases the audio unit’s volume level to compensate for engine and road speed noise.

- The SEEK button provides a selection of settings between “AVC OFF” and “AVC +7”. The display shows the level selected.

This feature is not available on certain vehicles and will not appear as a menu function.

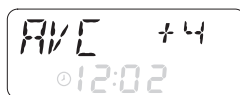
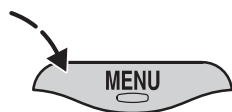

Controls and features

4600N units only

CD Playback

(8cm and 12cm CDs can be played)

CD playback starts and radio reception is interrupted, when a CD is inserted into the entry slot.

“PLAY CD” appears in the display.

Press CD to start playback from a CD already in the audio unit. If no disc is inserted, “NO CD” appears in the display.

Pressing CLK alternates the display between elapsed track time and clock time.

The display indicates elapsed track time up to 19:59. If the track is longer than twenty minutes, the first digit flashes while the rest of the numeral returns to zero and starts counting again.

Track selection

Press ◀ SEEK to return to the start of the track being played. If pressed within three seconds of the start of a track, the previous track will be selected. Press repeatedly to select previous tracks.

Press SEEK ▶ to select the next track or press repeatedly to access later tracks.

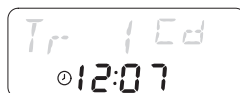

Controls and features

Fast forward/reverse

Press and hold ◀SEEK or SEEK▶ to search backwards or forwards across the tracks on the disc.



Scan mode

Press the SCAN button. Each track is played in turn for a short period.

During this scan, "SCAN" appears in the display. To continue listening to a track, press SCAN.

Pressing SCAN at any time will end the scan.



To end CD playback

Press the AM/FM button to restore radio reception without ejecting the disc. If reselected, the CD will start from wherever playback was last interrupted.

A square in the display indicates there is a disc inserted.



CD eject

During CD playback, press ▲.

When ejected, the disc is held ready for removal. If it is left as it is, the disc will be pulled back inside the audio unit automatically, and retained ready for playback.



Controls and features

CD care and maintenance

For best possible sound quality, use CDs that are clean and in good condition.

CD error codes

Codes may be shown in the audio unit display that indicate errors with the CD unit. These codes are as follows:

| Display | Description/rectification |
|----------------|--|
| E11 or E15 | Internal fault, see your dealer. |
| E12 | Clean the disc and try again. If error still shows, see your dealer. |
| E14 | Ambient temperature too hot – unit will not work until it has cooled down. |
| E16 | There is an eject fault, see your dealer. |

MENU button (main features) – CD

Use the MENU button to access main menu features, and the SEEK button for adjustment.



Controls and features

Random track playback (SHUF)

Press the MENU button until a display like the one shown opposite appears. Then use the SEEK button to turn this function on (“SHUF-ON”) or off (“SHUF-OFF”).

With the function on, the “Cd” indicator is replaced by “SHUF” as a new track is selected.

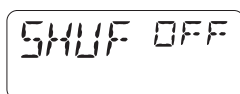
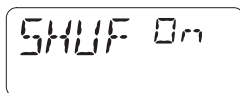
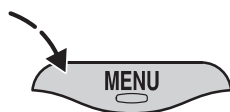

Track compression (COMP)

Press the MENU button repeatedly until a display like the one shown opposite appears. Then use the SEEK button to turn this function on or off.

With the function on, quieter music is boosted and louder music lowered to minimize repeated volume adjustments.

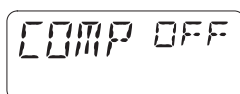
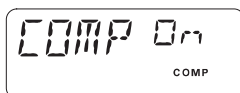

Automatic Volume Control

Press the MENU button repeatedly until a display like the one shown opposite appears. Then use the SEEK button to turn this function on (“AVC + 1” to “AVC + 7”) or off (“AVC OFF”).



Controls and features

- When selected, Automatic Volume Control increases or decreases the audio unit's volume level to compensate for engine and road speed noise.
- The SEEK button provides a selection of settings between "AVC OFF" and "AVC +7". The display shows the level selected.

This feature is not available on some vehicles and may not appear as a menu function.



POSITIONS OF THE IGNITION

1. LOCK, locks the steering wheel, automatic transmission gearshift lever and allows key removal.

Note: The key may be difficult to remove if the ignition is switched off with an automatic gearshift lever in any other position than P (Park). If this occurs, place the gearshift lever in P (Park), turn the ignition switch to the ON/RUN and then to the OFF position. Remove the key normally.

2. OFF, shuts off the engine and all accessories without locking the steering wheel. The audio system will still function.

3. ON/RUN, all electrical circuits operational. Warning lights illuminated. Key position when driving.

4. START, cranks the engine. Release the key as soon as the engine starts.

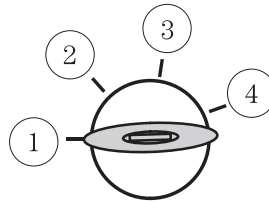

Controls and features

TILT AND TELESCOPE STEERING (if equipped)



Never adjust the steering wheel while the vehicle is moving.

Pull the locking lever down to adjust the steering column position. Return the lever to its original position to secure the wheel from “sliding”.

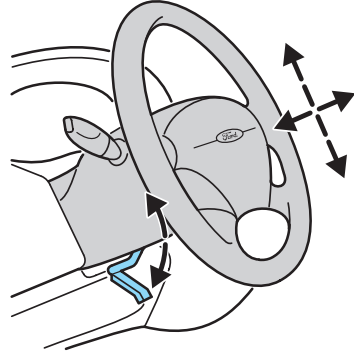

Always place both hands opposite each other on the steering wheel to adjust telescope position.

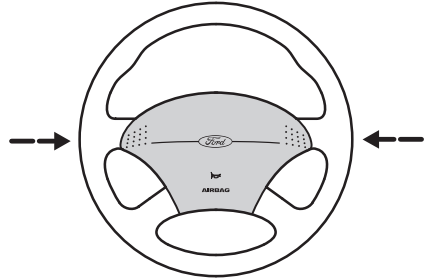

TURN SIGNAL CONTROL

- Push down to activate the left turn signal.
- Push up to activate the right turn signal.

The control also activates the high beams. Refer to *Headlamp control* in this chapter.

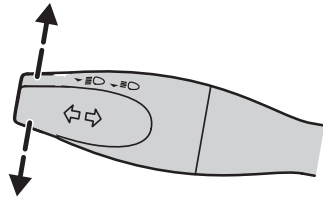

Controls and features

WINDSHIELD WIPER/WASHER CONTROL

Move the lever down for a single wipe.

For intermittent operation, move the lever up one position and adjust the rotary switch to the desired speed.

For normal operation, move the lever up two positions.

For high speed operation, move the lever up three positions.

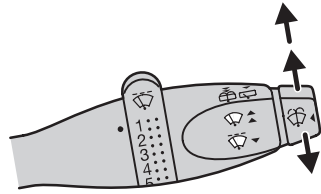

Mist function

To operate the mist function of the windshield wipers, push and release the windshield washer control quickly. The wipers will cycle two or three times.

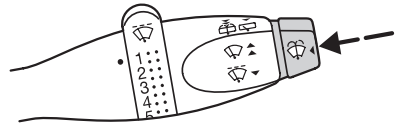

Rear window wiper and washer (if equipped)

Pull the lever towards you for intermittent wiping.

Pull the lever further to operate the washer.

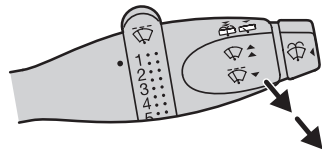

Controls and features

SPEED CONTROL (if equipped)

To turn speed control on

- Press ON.

Vehicle speed cannot be controlled until the vehicle is travelling at or above 48 km/h (30 mph).



Do not use the speed control in heavy traffic or on roads that are winding, slippery, or unpaved.



Do not shift the gearshift lever into N (Neutral) with the speed control on.

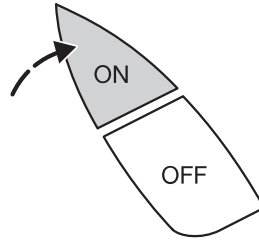

To turn speed control off

- Press OFF or
- turn off the vehicle ignition.

Once speed control is switched off, the previously programmed set speed will be erased.

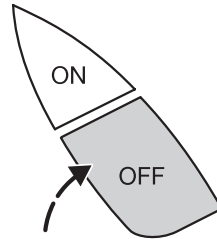

Controls and features

To set a speed

- Press SET ACC. For speed control to operate, the speed control must be ON and the vehicle speed must be greater than 48 km/h (30 mph).

The control light in the instrument panel will illuminate.

If you drive up or down a steep hill, your vehicle speed may vary momentarily slower or faster than the set speed. This is normal.

Speed control cannot reduce the vehicle speed if it increases above the set speed on a downhill. If your vehicle speed is faster than the set speed while driving on a downhill in overdrive, you may want to shift to the next lower gear or apply the brakes to reduce your vehicle speed.

If your vehicle slows down more than 16 km/h (10 mph) below your set speed on an uphill, your speed control will disengage. This is normal. Pressing RES will re-engage it.

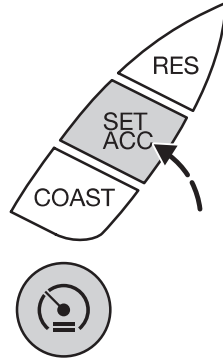

Do not use the speed control in heavy traffic or on roads that are winding, slippery, or unpaved.

Controls and features

To set a higher speed

- Press and hold SET ACC. Release the control when the desired vehicle speed is reached, or
- press and release SET ACC. Each press will increase the set speed by 1.6 km/h (1 mph) or
- accelerate with your accelerator pedal. When the desired vehicle speed is reached, press and release SET ACC.

You can accelerate with the accelerator pedal at any time during speed control usage. Releasing the accelerator pedal will return your vehicle to the previously programmed set speed.

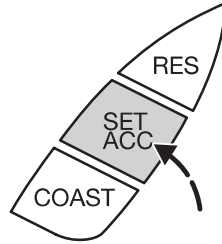

To set a lower speed

- Press and hold COAST. Release the control when the desired vehicle speed is reached, or
- press and release COAST. Each press will decrease the set speed by 1.6 km/h (1 mph), or
- depress the brake pedal. When the desired vehicle speed is reached, press SET ACC or COAST.

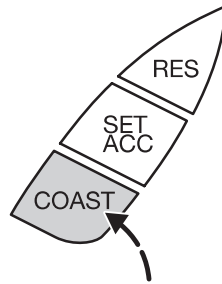

Controls and features

To disengage speed control

- Depress the brake pedal or

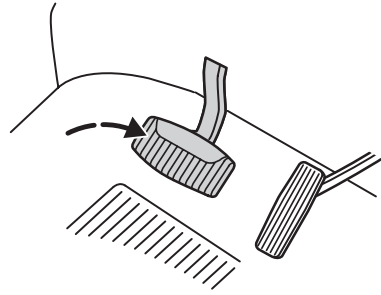

- depress the clutch pedal (if equipped).

Disengaging the speed control will not erase the previously programmed set speed.

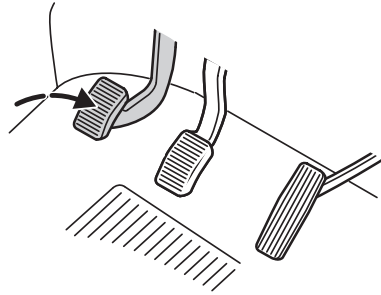

To return to a set speed

- Press RES. For RES to operate, the vehicle speed must be faster than 48 km/h (30 mph).

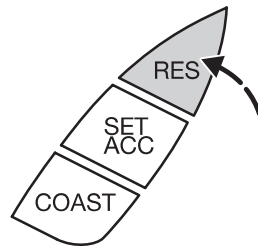

Controls and features

DOME LAMPS

The dome lamp equipped with a control switch will illuminate when:

- the doors are closed and the switch is in the on position.
- the switch is in the door activated position and any door is open.

When the dome lamp switch is in the off position, it will not illuminate when you open the doors.

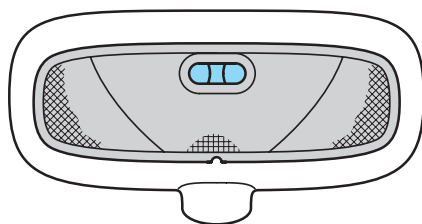

Reading lamps (if equipped)

The reading lamps are operated by separate on/off controls.

Theater dimming: The dome lamp dims 20 seconds after the doors are closed.

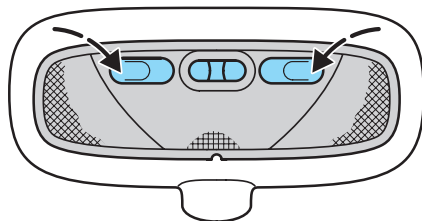

MOONROOF

To open and close the moonroof

Pull out the handle and turn it counterclockwise to open the moonroof and clockwise to close it. Push the handle back again.

To lift the rear of the moonroof

Pull out the handle and turn it clockwise beyond the end stop. Turn it counterclockwise back to the end stop to close it again.

Always push the handle back into its recess after use.

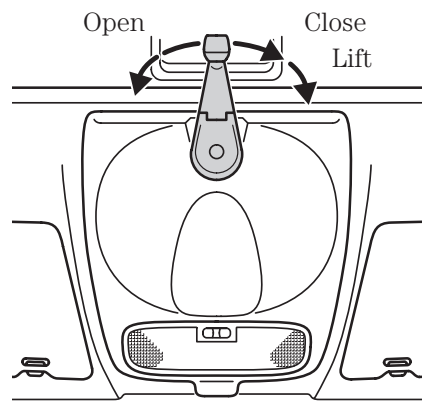

Controls and features

POWER WINDOWS (if equipped)

Press and hold the rocker switches to open and close the windows.

- Press the top portion of the rocker switch to close.
- Press the bottom portion of the rocker switch to open.

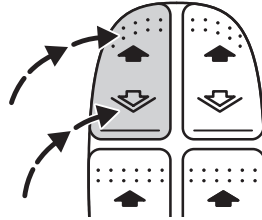

One touch down

To make the driver window open fully without holding the window control, momentarily press the driver window control completely down then release. Press again to stop window operation.

Window lock

The window lock feature allows only the driver to operate the rear power windows.

To lock out the rear window controls slide the control to the left. Slide the control to the right to restore the window controls.

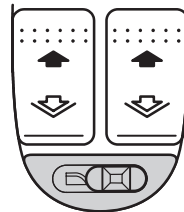

Controls and features

POWER SIDE VIEW MIRRORS

The control can be swiveled and turned.

Turn the control counterclockwise to adjust the driver's side mirror, clockwise to adjust the passenger's side mirror. Adjust the selected mirror by moving the center control in the desired direction. Then turn the control back to the center position.

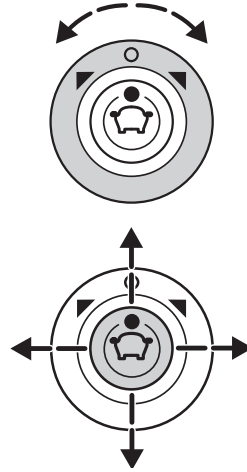

CHILDPROOF REAR DOOR LOCKS

When these locks are set, the rear doors cannot be opened from inside. The rear doors can be opened from the outside when the doors are unlocked.

The childproof locks are located on the rear edge of each rear door and must be set separately for each door. Setting the lock for one door will not automatically set the lock for both doors.

Insert the key and turn to the lock position (key vertical). Turn the key towards the center of the vehicle to disengage.

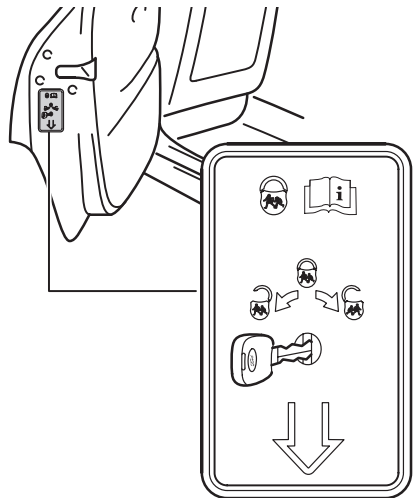

Controls and features

LUGGAGE COVER

Coupe

Detach the lifting straps on the liftgate. Release the cover at the sides and pull it out horizontally without tilting it.

Replace in reverse order. Make sure the cover is properly aligned when inserting it.

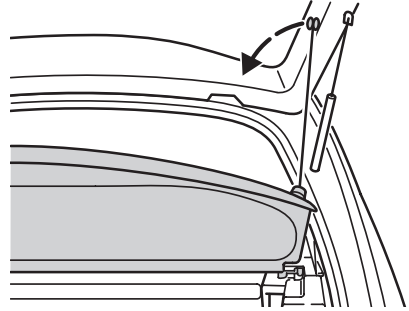

Wagon

Pull out the roller cover and secure the retaining points. The cover can be removed completely by pressing inward on both ends of the support.

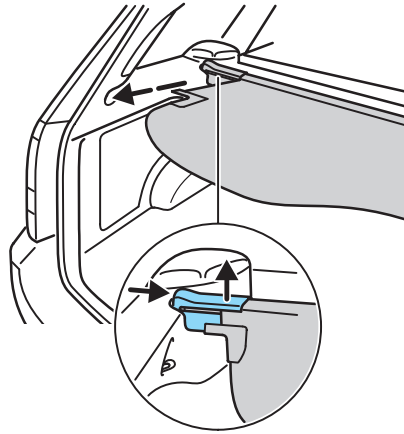

Controls and features

POSITIVE RETENTION FLOOR MAT

Position the floor mat so that the eyelet is over the pointed end of the retention post and rotate forward to lock in. Make sure that the mat does not interfere with the operation of the accelerator or the break pedal. To remove the floor mat, reverse the installation procedure.

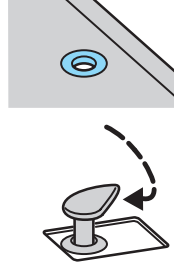

REMOTE ENTRY SYSTEM (if equipped)

Your vehicle is equipped with a remote entry system which allows you to:

- unlock the vehicle doors without a key.
- lock all the vehicle doors without a key.
- open the luggage compartment without a key.
- activate the personal alarm.
- arm and disarm the perimeter anti-theft system.
- operate the illuminated entry feature.

The remote entry features only operate with the ignition in the OFF or ACC positions. The personal alarm feature, however, will not operate when the ignition is in the ON/RUN position.

Controls and features

Unlocking the doors

Press this control to unlock the driver door and disarm the anti-theft system (if equipped). The interior lamps will illuminate.

Press the control again within three seconds to unlock all doors.

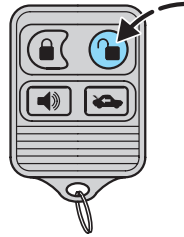

Locking the doors

Press this control to lock all doors. The hazard flashers will flash.

To confirm the doors are locked, press the control a second time within three seconds. The horn will chirp and the hazard flashers will flash.

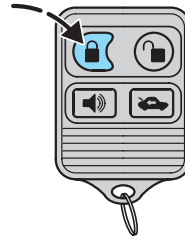

If the vehicle is equipped with the perimeter anti-theft system, it will arm when the control is pressed the second time.

Controls and features

Opening the luggage compartment

Press the control once to open the luggage compartment.

Be certain the luggage compartment is closed before driving your vehicle. The luggage compartment may appear closed, but it may not be latched. Failure to do so may cause objects to fall out of the luggage compartment or block rear view vision.

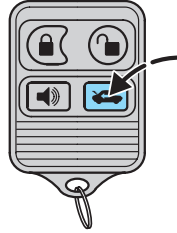

Sounding a panic alarm

Press this control to turn on the alarm.

Press the control a second time to turn off the personal alarm. The personal alarm will also turn off if the ignition switch is turned to the ON/RUN position, or after 2 minutes of operation.

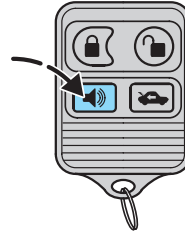

This device complies with part 15 of the FCC rules and with RS-210 of Industry Canada. Operation is subject to the following two conditions: (1) This device may not cause harmful interference, and (2) This device must accept any interference received, including interference that may cause undesired operation.

Changes or modifications not expressly approved by the party responsible for compliance could void the user's authority to operate the equipment.

Controls and features

Illuminated entry

The interior lamps will illuminate when the remote entry system is used to unlock the door(s).

The illuminated entry system will automatically turn off the interior lights if the ignition switch is turned to the ON/RUN position, or if the remote transmitter lock control is pressed, or after 20 seconds of illumination if all doors are closed.

Note that the illuminated entry system will not function if the dome lamp switch is in the OFF position.

Replacing the battery

The transmitter is powered by one coin type three-volt lithium battery CR2032 or equivalent. Typical operating range will allow you to be up to 10 meters (33 feet) away from your vehicle.

A decrease in operating range can be caused by:

- weather conditions
- nearby radio towers
- structures around the vehicle
- other vehicles parked next to the vehicle.

To replace the battery:

1. Twist a thin coin between the two halves of the transmitter near the key ring. **DO NOT TAKE THE FRONT PART OF THE TRANSMITTER APART.**

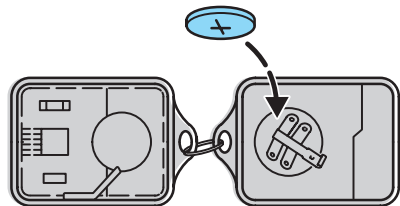

Controls and features

2. Place the positive (+) side of new battery in the same orientation. Refer to the diagram inside the transmitter unit.
3. Snap the two halves back together.

Replacement of the battery will **not** cause the remote transmitter to become deprogrammed from your vehicle. The remote transmitter should operate normally after battery replacement.

Replacing lost transmitters

If a remote transmitter has been lost and you would like to remove it from the vehicle's memory, or you would like to purchase additional transmitters for your vehicle (up to four may be programmed into memory), take **all** your vehicle's remote transmitters either to your dealer or perform the programming procedure yourself. It will be necessary to reprogram **all** the remote transmitters to your vehicle at the same time while performing this service.

Programming procedure

1. Close all doors and fasten the seat belt to ensure conflicting chimes do not sound during programming.

Controls and features

2. Turn the ignition lock from OFF (2) to ON/RUN (3) at least 4 times in 6 seconds.

3. Switch off the ignition.

Now the control module has entered the “learning mode” for 10 seconds. This mode is indicated by a chime.

4. While the control module is in the “learning mode”, press and hold one of the buttons of the remote transmitter until a chime sounds. This indicates a new transmitter code has been successfully received. After each successful programming, another 10 second “learning mode” is automatically entered, up to a maximum of four times. Another transmitter can now be programmed (repeat step 4).

5. The system will leave the “learning mode” after starting the ignition, if no new transmitter is programmed during the 10 seconds, or if 4 remotes have been programmed. After successful programming, only the new programmed transmitters will be accepted. Note that an incorrect programming procedure does not affect the stored codes.

6. After programming, the system can be checked by activating/deactivating the remote locking functions.

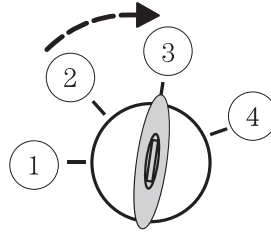

Controls and features

PERIMETER ALARM SYSTEM (if equipped)

The perimeter anti-theft system will help prevent your vehicle from unauthorized entry.

Arming the system

When armed, the perimeter alarm will help protect your vehicle from unauthorized entry. When unauthorized entry occurs, the system will flash the hazard flashers and will sound the horn.

The system is ready to arm whenever the key is out of ignition. Any of the following actions will arm the alarm system:

- Press the remote transmitter lock control.
- Lock all doors with the key.

If a door is open, the system is prearmed and is waiting for the door to close. Once the doors are closed, the system will arm in 20 seconds.

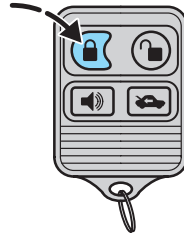

Disarming the system

You can disarm the system by any of the following actions:

- Unlock the doors by using your remote entry transmitter.
- Unlock the doors by using your key.

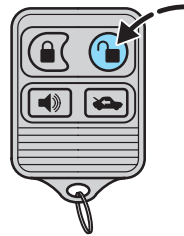

Controls and features

SECURILOCK™ PASSIVE ANTI-THEFT SYSTEM

Your vehicle is equipped with a coded-key anti-theft system. Only the correct key will be able to start your vehicle. If your keys are lost or stolen, you must take your vehicle to your dealership for key reprogramming.

The SecuriLock™ passive anti-theft system provides an advanced level of vehicle theft protection. Your vehicle's engine can only be started with the two special SecuriLock™ electronically coded keys provided with your vehicle. Each time you start your vehicle, the SecuriLock™ key is read by the SecuriLock™ passive anti-theft system. If the SecuriLock™ key identification code matches the code stored in the SecuriLock™ anti-theft system, the vehicle's engine is allowed to start. If the SecuriLock™ key identification code does not match the code stored in the system or if a SecuriLock™ key is not detected (vehicle theft situation), the vehicle's engine will not operate.

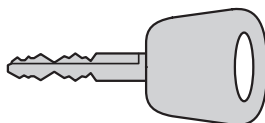

Controls and features

The SecuriLock™ passive anti-theft system is not compatible with aftermarket remote start systems. Use of these systems may result in vehicle starting problems and a loss of security protection. Large metallic objects or devices such as the Mobil Speedpass™ on the same key ring as your SecuriLock™ key may cause vehicle starting problems. These objects and devices cannot damage the SecuriLock™ key, but can cause a momentary problem if they are too close to the key when starting the engine. If a problem occurs, turn ignition off and restart the engine with all other objects on the key ring held away from the SecuriLock™ ignition key.

Spare SecuriLock™ keys can be purchased from your dealership and programmed to your SecuriLock™ passive anti-theft system. Refer to *Programming spare SecuriLock™ keys* for more information.

If one or both of your SecuriLock™ keys are lost or stolen and you want to ensure the lost or stolen key will not operate your vehicle, bring your vehicle and all available SecuriLock™ keys to your dealership for reinitialization.

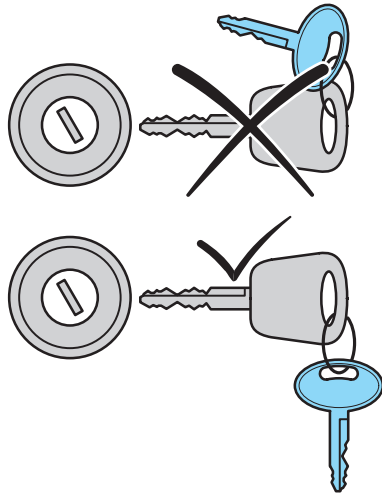

Controls and features

Theft indicator

When the ignition is turned to ON/RUN or START, the theft indicator on the instrument panel will light for three seconds and then go out (indicates proper SecuriLock™ system operation). If the key is in the ignition and the theft indicator stays on for an extended period of time or flashes rapidly, have the system serviced by your dealership or a qualified technician.

Programming spare SecuriLock™ keys

Spare SecuriLock™ keys can be purchased from your dealership and programmed to your SecuriLock™ anti-theft system (up to a total of 8 keys). Your dealership can program your new SecuriLock™ key(s) to your vehicle or you can do it yourself using the following simple procedure.

To program a new SecuriLock™ key yourself, you will need two previously programmed SecuriLock™ keys (keys that already operate your vehicle's engine). If two previously programmed SecuriLock™ keys are not available (one or both of your original keys were lost or stolen), you must bring your vehicle to your dealership to have the spare SecuriLock™ key(s) programmed.

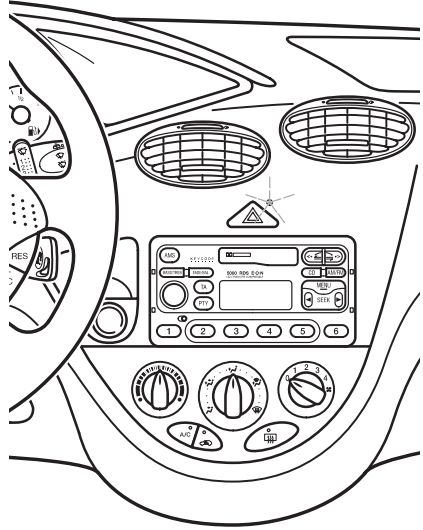

Controls and features

Procedure to program spare SecuriLock™ keys

New SecuriLock™ keys must have the correct mechanical key cut for your vehicle.

Conventional (non SecuriLock™) keys **cannot** be programmed to your vehicle.

The correct type of SecuriLock™ key for your vehicle is identifiable by the alphanumeric characters stamped on the key blade. The SecuriLock™ key identification for your vehicle is: one letter of the English alphabet followed by the number “1” (for example, “S1” or “I1” on the key blade indicate you have the correct type of SecuriLock™ key). If the SecuriLock™ key does not have this information stamped on the key blade, the key will not operate your vehicle.

You will need to have two previously programmed SecuriLock™ keys and the new unprogrammed SecuriLock™ key readily accessible for timely implementation of each step in the procedure. Please read and understand the entire procedure before you begin.



Controls and features

1. Insert the first previously programmed SecuriLock™ key into the ignition and turn the ignition from OFF (2) to ON/RUN (3) (maintain ignition in ON/RUN for at least one second).
2. Turn ignition to OFF and remove the first SecuriLock™ key from the ignition.
3. Within five seconds of turning the ignition to OFF, insert the second previously programmed SecuriLock™ key into the ignition and turn the ignition from OFF to ON/RUN (maintain ignition in ON/RUN for at least one second but no more than 5 seconds).
4. Turn the ignition to OFF and remove the second SecuriLock™ key from the ignition.
5. Within 10 seconds of turning the ignition to OFF, insert the unprogrammed SecuriLock™ key (new key/valet key) into the ignition and turn the ignition from OFF to ON/RUN (maintain ignition in ON/RUN for at least one second). This step will program your new SecuriLock™ key.
6. To program additional SecuriLock™ key(s), repeat this procedure from step 1.

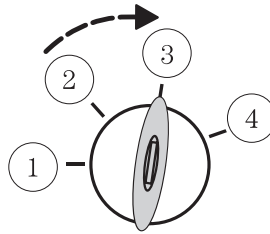

Controls and features

If the programming procedure was successful, the new SecuriLock™ key(s) will start the vehicle's engine. The theft indicator (located on the instrument panel) will light for three seconds and then go out.

If the programming procedure was not successful, the new SecuriLock™ key(s) will not operate the vehicle's engine. The theft indicator will flash on and off. Wait at least one minute and then repeat the procedure from step 1. If failure repeats, bring your vehicle to your dealership to have the spare SecuriLock™ key(s) programmed.

Seating and safety restraints

SEATING



Never adjust the driver's seat or seatback when the vehicle is moving.

Head restraints

Front seat

Your vehicle is equipped with head restraints which are vertically adjustable. The purpose of these head restraints is to limit head motion in the event of a rear collision. To properly adjust your head restraints, lift the head restraint so that it is located directly behind your head or as close to that position as possible. Refer to the following to raise and lower the head restraints.

To raise: Pull the head restraint up.

To lower: Press the control on the left-hand stem and push the head restraint down.

To remove the head restraint, see your dealer or qualified technician.

Rear seat (if equipped)

Rear head restraints can be removed altogether if the left-hand locking button is pressed.

Front seats

Lift the lever to slide the seat forward or backward.

Turn the control to adjust lumbar support (if equipped).

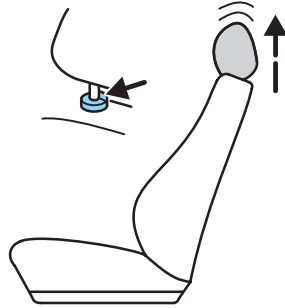

Seating and safety restraints

Turn the handle to adjust the height of the seat.

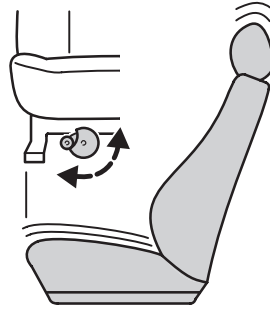

Lift the control to adjust the angle of the seatback.

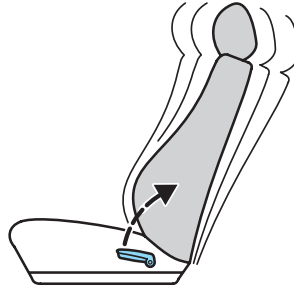

Folding the seat forward (Coupe)

Pull the control and fold the seatback forward.

Fold back the seatback until it locks with a distinct “click”. Rock the seat to ensure that the catch is securely engaged.

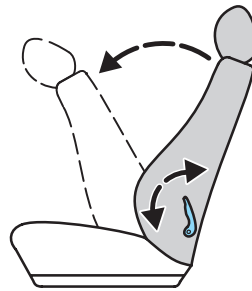

Do not place any objects behind the seat which could prevent the engagement of the seat lock.

Seating and safety restraints

Folding the rear seat cushion forward

Lift the seat cushion and pull it forward.

When returning the seats back to their original positions, make sure the safety restraints will function properly and are positioned in front of the seat back.

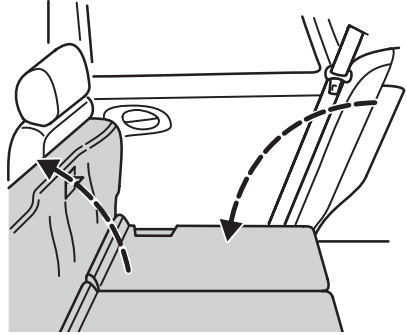

Folding the rear seatback forward

Coupe and wagon

Remove the head restraints (if equipped) of the rear seats and stow them on the floor behind the front seats.

Push the unlocking control on the rear seatback and fold the rear seatback forward.

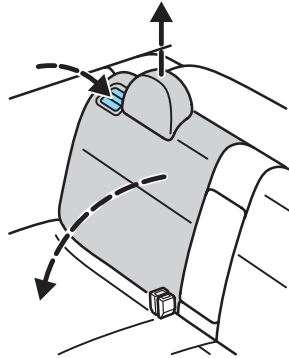

Sedan

Remove the head restraints (if equipped) of the rear seats and stow them on the floor behind the front seats.

Pull one or both of the unlocking controls in the luggage compartment and fold the rear seatback forward.

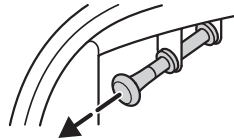

Seating and safety restraints

Returning the rear seatback to an upright position

Fold back the seatback until it locks with a distinct “click”. Do not place any objects behind the seat which could prevent the seat from locking.



Make sure the safety restraints will function properly and are positioned in front of the seatback. Reinstall the head restraints.

Note that the center rear seat belt cannot be pulled out until the seatback has latched completely.

Seating and safety restraints

SAFETY RESTRAINTS

Safety restraints precautions

 Always drive and ride with your seatback upright and the lap belt snug and low across the hips.

 To prevent the risk of injury, make sure children sit where they can be properly restrained.

 Always transport children 12 years old and under in the back seat and always use appropriate child restraints.

 Never let a passenger hold a child on his or her lap while the vehicle is moving. The passenger cannot protect the child from injury in a collision.

 All occupants of the vehicle, including the driver, should always properly wear their safety belts, even when an air bag SRS is provided.

 Reclining the seat back can reduce the effectiveness of the seat's safety belt in the event of a collision.

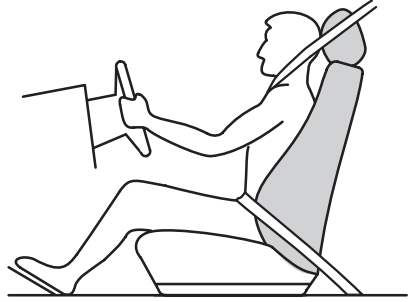

Seating and safety restraints



It is extremely dangerous to ride in a cargo area, inside or outside of a vehicle. In a collision, people riding in these areas are more likely to be seriously injured or killed. Do not allow people to ride in any area of your vehicle that is not equipped with seats and safety belts. Be sure everyone in your vehicle is in a seat and using a safety belt properly.



Each seating position in your vehicle has a specific safety belt assembly which is made up of one buckle and one tongue that are designed to be used as a pair. 1) Use the shoulder belt on the outside shoulder only. Never wear the shoulder belt under the arm. 2) Never swing it around your neck over the inside shoulder. 3) Never use a single belt for more than one person.

Combination lap and shoulder belts

1. Insert the belt tongue into the proper buckle (the buckle closest to the direction the tongue is coming from) until you hear a snap and feel it latch. Make sure the tongue is securely fastened in the buckle.

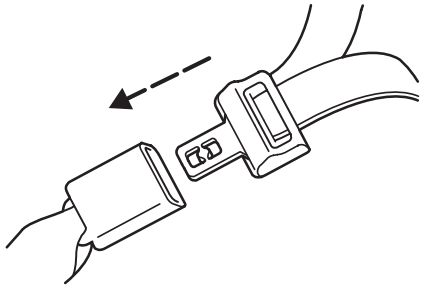

Seating and safety restraints

2. To unfasten, push the release button and remove the tongue from the buckle.

The front outboard and rear safety restraints in the vehicle are combination lap and shoulder belts. The front and rear seat passenger safety belts have two types of locking modes described below:

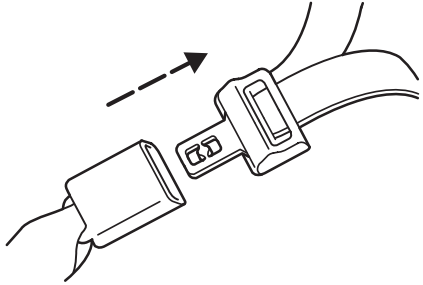

Energy Management Feature

This vehicle has a seat belt system with an energy management feature at the front outboard seating positions to help further reduce the risk of injury in the event of a head-on collision.

This seat belt system has a retractor assembly that is designed to pay out webbing in a controlled manner. This feature is designed to help reduce the belt force acting on the occupant's chest.

Seating and safety restraints



**BELT AND RETRACTOR ASSEMBLY
MUST BE REPLACED** if the seat

belt assembly automatic locking retractor feature or any other seat belt function is not operating properly when checked according to the procedures in Workshop Manual.



Failure to replace the Belt and Retractor assembly could increase the risk of injury in collisions.

Vehicle sensitive mode

The vehicle sensitive mode is the normal retractor mode, allowing free shoulder belt length adjustment to your movements and locking in response to vehicle movement. For example, if the driver brakes suddenly or turns a corner sharply, or the vehicle receives an impact of 8 km/h (5 mph) or more, the combination safety belts will lock to help reduce forward movement of the driver and passengers.

Seating and safety restraints

Safety belt pretensioner

Your vehicle is equipped with safety belt pretensioners at the driver and front passenger seating positions.

The safety belt pretensioner is a device which removes excess webbing from the safety belt system. The safety belt pretensioner uses the same crash sensor system as the front air bag supplemental restraint system (SRS). When the safety belt pretensioner deploys, webbing from the lap and shoulder belt is tightened. The driver and front passenger seat belt system (including retractors, buckles and height adjusters) must be replaced if the vehicle is involved in a collision that results in deployment of front airbags and safety belt pretensioners.

Automatic locking mode

In this mode, the shoulder belt is automatically pre-locked. The belt will still retract to remove any slack in the shoulder belt.

The automatic locking mode is not available on the driver safety belt.

Seating and safety restraints

When to use the automatic locking mode

- When a tight lap/shoulder fit is desired.
- **Anytime** a child safety seat is installed in a passenger front or outboard rear seating position (if equipped). Refer to *Safety restraints for children* or *Safety seats for children* later in this chapter.



Always transport children 12 years old and under in the back seat and always use appropriate child restraints.

How to use the automatic locking mode

- Buckle the combination lap and shoulder belt.
- Grasp the shoulder portion and pull downward until the entire belt is extracted.
- Allow the belt to retract. As the belt retracts, you will hear a clicking sound. This indicates the safety belt is now in the automatic locking mode.

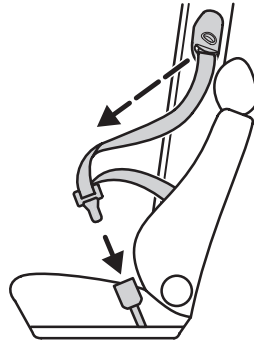

How to disengage the automatic locking mode

Disconnect the combination lap/shoulder belt and allow it to retract completely to disengage the automatic locking mode and activate the vehicle sensitive (emergency) locking mode.

Seating and safety restraints

 After any vehicle collision, the seat belt system at all passenger seating positions must be checked by a qualified technician to verify that the automatic locking retractor for child seats is still functioning properly in addition to other checks for proper seat belt function.

Front safety belt height adjustment

Your vehicle has safety belt height adjustments for the driver and front passenger. Adjust the height of the shoulder belt so the belt rests across the middle of your shoulder.

To lower the shoulder belt height, push the button and slide the height control down. To raise the height of the shoulder belt, slide the height adjuster up. Pull down on the height adjustment assembly to make sure it is locked in place.

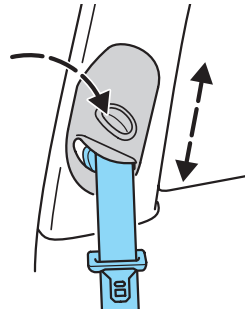

 Position the shoulder belt height adjuster so that the belt rests across the middle of your shoulder. Failure to adjust the safety belt properly could reduce the effectiveness of the safety belt and increase the risk of injury in a collision.

Seating and safety restraints

Safety belt warning light and warning chime

Illuminates in the instrument cluster and a chime sounds to remind the driver to fasten his or her safety belt.



Conditions of operation

| If... | Then... |
|---|---|
| If the driver's safety belt is not buckled before the ignition switch is turned to the ON/RUN position ... | The <i>Safety belt</i> warning light illuminates for one to two minutes and the warning chime sounds for four to eight seconds. |
| The driver's safety belt is buckled while the indicator light is illuminated and the warning chime is sounding... | The <i>Safety belt</i> warning light and warning chime turn off. |
| The driver's safety belt is buckled before the ignition switch is turned to the ON/RUN position ... | The <i>Safety belt</i> warning light and warning chime remain off. |

Seating and safety restraints

Belt Minder (if equipped)

The Belt Minder feature is a supplemental warning to the safety belt warning function. This feature provides additional reminders to the driver that the driver's safety belt is unbuckled by intermittently sounding a chime and illuminating the *Safety belt* warning light in the instrument cluster.



| If... | Then... |
|---|---|
| If the driver's safety belt is not buckled approximately 5 seconds after the safety belt warning light has turned off ... | The Belt Minder feature is activated – the <i>Safety belt</i> warning light illuminates and the warning chime sounds for 6 seconds every 30 seconds, repeating for approximately 5 minutes or until safety belt is buckled. |
| The driver's safety belt is buckled while the indicator light is illuminated and the warning chime is sounding... | The Belt Minder feature will not activate. |
| The driver's safety belt is buckled before the ignition switch is turned to the ON/RUN position ... | The Belt Minder feature will not activate. |

Seating and safety restraints

The purpose of the Belt Minder is to remind occasional wearers to wear safety belts all of the time.

The following are reasons most often given for not wearing safety belts: (All statistics based on U.S. data)

| Reasons given... | Consider... |
|---------------------------|---|
| “Crashes are rare events” | 36 700 crashes occur every day. The more we drive, the more we are exposed to “rare” events, even for good drivers. <i>1 in 4 of us will be seriously injured in a crash during our lifetimes.</i> |
| “I’m not going far” | 3 of 4 fatal crashes occur within 25 miles of home. |
| “Belts are uncomfortable” | Ford designs its safety belts to enhance comfort. If you are uncomfortable - try different positions for the safety belt upper anchorage and seatback which should be as upright as possible; this can improve comfort. |
| “I was in a hurry” | Prime time for an accident. Belt Minder reminds us to take a few seconds to buckle up. |
| “Seat belts don’t work” | Safety belts , when used properly, reduce risk of death to front seat occupants by 45% in cars , and by 60% in light trucks . |
| “Traffic is light” | Nearly 1 of 2 deaths occur in single-vehicle crashes , many when no other vehicles are around. |

Seating and safety restraints

| Reasons given... | Consider... |
|--|---|
| “Belts wrinkle my clothes” | Possibly, but a serious crash can do much more than wrinkle your clothes, particularly if you are unbelted. |
| “The people I’m with don’t wear belts” | Set the example, teen deaths occur 4 times more often in vehicles with TWO or MORE people. Children and younger brothers/sisters imitate behavior they see. |
| “I have an air bag” | Air bags offer greater protection when used with safety belts. Frontal airbags are not designed to inflate in rear and side crashes or rollovers. |
| “I’d rather be thrown clear” | Not a good idea, people who are ejected are 40 times more likely to DIE . Safety belts help prevent ejection. WE CAN’T “PICK OUR CRASH”. |

Seating and safety restraints



Do not sit on top of a buckled safety belt to avoid the Belt Minder chime. Sitting on the safety belt will increase the risk of injury in an accident. To disable (one time) or deactivate the Belt Minder feature please follow the directions stated below.

One time disable

Any time the safety belt is buckled and then unbuckled during an ignition ON/RUN cycle, Belt Minder will be disabled for that ignition cycle only.

Deactivating/activating the Belt Minder feature

Read steps 1-9 thoroughly before proceeding with the deactivation/activation programming procedure.

The Belt Minder feature can be deactivated/activated by performing the following procedure:

Before following the procedure, make sure that:

- the parking brake is set.
- the gearshift is in P (Park) (automatic transaxle) or the neutral position (manual transaxle).
- the ignition switch is in the OFF position.
- all vehicle doors are closed.

Seating and safety restraints

- the driver's safety belt is unbuckled.
- the parklamps/headlamps are in OFF position.



To reduce the risk of injury, do not deactivate/activate the Belt Minder feature while driving the vehicle.

1. Turn the ignition switch to the ON/RUN position (DO NOT START THE ENGINE).
2. Wait until the *Safety belt* warning light turns off (approximately 1-2 minutes).
 - Steps 3–5 must be completed within 60 seconds or the procedure will have to be repeated.
3. Buckle then unbuckle the safety belt three times, ending with the safety belt unbuckled. This can be done before or during Belt Minder warning activation.
4. Turn on the headlamps, turn off the headlamps.
5. Buckle then unbuckle the safety belt three times, ending with the safety belt unbuckled.
 - After step 5, the *Safety belt warning light* will be turned on for three seconds.

Seating and safety restraints

6. Within seven seconds of the *Safety belt* warning light turning off, buckle then unbuckle the safety belt.

- This will disable Belt Minder if it is currently enabled, or enable Belt Minder if it is currently disabled.

7. Confirmation of disabling Belt Minder is provided by flashing the *Safety belt* light four times per second for three seconds.

8. Confirmation of enabling Belt Minder is provided by flashing the *Safety belt* light four times per second for three seconds, followed by three seconds with the *Safety belt* light off, then followed by flashing the *Safety belt* light four times per second for three seconds again.

9. After receiving confirmation, the deactivation/activation procedure is complete.

Seating and safety restraints

Safety belt extension assembly

If the safety belt is too short, even when fully extended, 20 cm (8 inches) can be added to the safety belt assembly by adding a safety belt extension assembly (part number 611C22). Safety belt extension assemblies can be obtained from your dealer at no cost.

Use only extensions manufactured by the same supplier as the safety belt. Manufacturer identification is located at the end of the webbing on the label.

Also, use the safety belt extension only if the safety belt is too short for you when fully extended. Do not use extensions to change the fit of the shoulder belt across the torso.

Seating and safety restraints

Safety belt maintenance

Inspect the safety belt systems periodically to make sure they work properly and are not damaged. Inspect the safety belts to make sure there are no nicks, wears or cuts, replacing if necessary. All safety belt assemblies (slide bar) (if equipped), shoulder belt height adjusters (if equipped), child safety seat tether bracket assemblies (if equipped), and attaching hardware, should be inspected after a collision. Ford recommends that all safety belt assemblies used in vehicles involved in a collision be replaced. However, if the collision was minor and a qualified technician finds that the belts do not show damage and continue to operate properly, they do not need to be replaced. Safety belt assemblies not in use during a collision should also be inspected and replaced if either damage or improper operation is noted.



Failure to inspect and, if necessary, replace the safety belt assembly under the above conditions could result in severe personal injuries in the event of a collision.

Refer to *Cleaning and maintaining the safety belts* in the *Maintenance and care* chapter.

Seating and safety restraints

AIR BAG SUPPLEMENTAL RESTRAINT SYSTEM (SRS)

Important supplemental restraint system (SRS) precautions

The supplemental restraint system is designed to work with the safety belt to help protect the driver and right front passenger from certain upper body injuries.

Air bags DO NOT inflate slowly or gently and the risk of injury from a deploying air bag is the greatest close to the trim covering the air bag module.

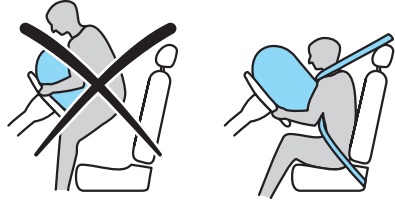



All occupants of the vehicle including the driver should always properly wear their safety belts even when air bag SRS is provided.



Always transport children 12 years old and under in the back seat and always use appropriate child restraints.

Seating and safety restraints

 NHTSA recommends a minimum distance of at least 25 cm (ten [10] inches) between an occupant's chest and the air bag module.

 Never place your arm over the air bag module as a deploying air bag can result in serious arm fractures or other injuries.

Steps you can take to properly position yourself away from the air bag:

- Move your seat to the rear as far as you can while still reaching the pedals comfortably.
- Recline your seat slightly (one or two degrees) from the upright position.

 Do not put anything on or over the air bag module. Placing objects on or over the air bag inflation area may cause those objects to be propelled by the air bag into your face and torso causing serious injury.

 Do not attempt to service, repair, or modify the Air Bag Supplemental Restraint System or its fuses. See your Ford or Lincoln-Mercury dealer.

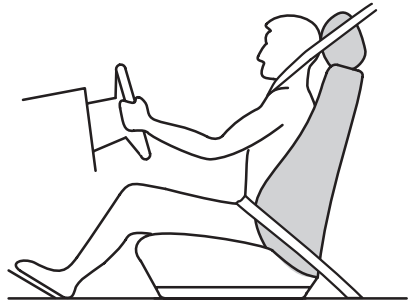

Seating and safety restraints

Children and air bags

For additional important safety information, read all information on safety restraints in this guide.

Children must always be properly restrained. Accident statistics suggest that children are safer when properly restrained in the rear seating positions than in the front seating positions. Failure to follow these instructions may increase the risk of injury in a collision.



Air bags can kill or injure a child in a child seat.

NEVER place a rear-facing child seat in front of an active air bag. If you must use a forward-facing child seat in the front seat, move the seat all the way back.



How does the air bag supplemental restraint system work?

The air bag SRS is designed to activate when the vehicle sustains sufficient longitudinal deceleration to cause the sensors to close an electrical circuit that initiates air bag inflation.

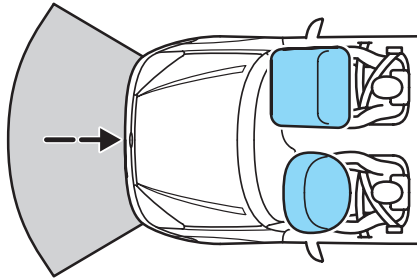

Seating and safety restraints

The fact that the air bags did not inflate in a collision does not mean that something is wrong with the system. Rather, it means the forces were not of the type sufficient to cause activation. The front air bags are designed to inflate in frontal and near-frontal collisions, not rollover, side-impact, or rear impacts.

For information on side-impact collisions, refer to *Side airbag system (if equipped)* in this chapter.

The air bags inflate and deflate rapidly upon activation. After air bag deployment, it is normal to notice a smoke-like, powdery residue or smell the burnt propellant. This may consist of cornstarch, talcum powder (to lubricate the bag) or sodium compounds (e.g., baking soda) that result from the combustion process that inflates the air bag. Small amounts of sodium hydroxide may be present which may irritate the skin and eyes, but none of the residue is toxic.



Seating and safety restraints

While the system is designed to help reduce serious injuries, it may also cause abrasions, swelling or temporary hearing loss.

Because air bags must inflate rapidly and with considerable force, there is the risk of death or serious injuries such as fractures, facial and eye injuries or internal injuries, particularly to occupants who are not properly restrained or are otherwise out of position at the time of air bag deployment. Thus, it is extremely important that occupants be properly restrained as far away from the air bag module as possible while maintaining vehicle control.



Several air bag system components get hot after inflation. Do not touch them after inflation.



If the air bag is inflated, **the air bag will not function again and must be replaced immediately**. If the air bag is not replaced, the unrepaired area will increase the risk of injury in a collision.

Seating and safety restraints

The SRS consists of:

- driver and passenger air bag modules (which include the inflators and air bags).
- side air bags (if equipped). Refer to *Side air bag system* later in this chapter.
- one or more impact and safing sensors.
- a readiness light and tone.
- and the electrical wiring which connects the components.

The diagnostic module monitors its own internal circuits and the supplemental air bag electrical system warning (including the impact sensors), the system wiring, the air bag system readiness light, the air bag back up power and the air bag ignitors.

Determining if the system is operational

The SRS uses a readiness light in the instrument cluster or a tone to indicate the condition of the system. Refer to the *Air bag readiness* section in the *Instrumentation* chapter. Routine maintenance of the air bag is not required.

Seating and safety restraints

A difficulty with the system is indicated by one or more of the following:

- The readiness light will either flash or stay lit.
- The readiness light will not illuminate immediately after ignition is turned on.
- A series of five beeps will be heard. The tone pattern will repeat periodically until the program and light are repaired.

If any of these things happen, even intermittently, have the SRS serviced at your dealership or by a qualified technician immediately. Unless serviced, the system may not function properly in the event of a collision.



Side air bag system (if equipped)

 Do not use accessory seat covers. The use of accessory seat covers may prevent the deployment of the side air bags and increase the risk of injury in an accident.

 Do not lean your head on the door; the side air bag could injure you as it deploys from the side of the seatback.

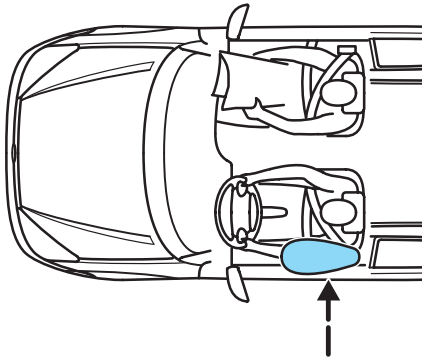

Seating and safety restraints



Do not attempt to service, repair, or modify the air bag Supplemental Restraint System or its fuses. See your Ford or Lincoln-Mercury dealer.



All occupants of the vehicle including the driver should always wear their safety belts even when an air bag SRS is provided.

How does the side air bag system work?

The side air bag system consists of the following:

- An inflatable nylon bag (air bag) with a gas generator concealed behind the outboard bolster of the driver and front passenger seatbacks.
- The same warning light, electronic control and diagnostic unit as used for the front air bags.
- Two crash sensors located under the outboard side of the front seats, attached to the floor.

Side air bags, in combination with seat belts, can help reduce the risk of severe injuries in the event of a significant side impact collision.

Seating and safety restraints

The side air bags are fitted on the outboard side of the seatbacks of the front seats. In certain lateral collisions, the air bag on the side affected by the collision will be inflated, even if the respective seat is not occupied. The air bag was designed to inflate between the door panel and occupant to further enhance the protection provided occupants in side impact collisions.

The air bag SRS is designed to activate when the vehicle sustains sufficient lateral deceleration to cause the sensors to close an electrical circuit that initiates air bag inflation.

The fact that the air bags did not inflate in a collision does not mean that something is wrong with the system. Rather, it means the forces were not of the type sufficient to cause activation. Side air bags are designed to inflate in side-impact collisions, not rollover, rear-impact, frontal or near-frontal collisions, unless the collision causes sufficient lateral deceleration.

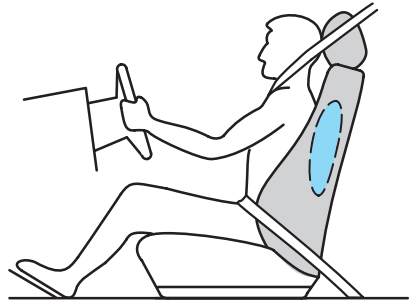

Several air bag system components get hot after inflation. Do not touch them after inflation.

Seating and safety restraints



If the side air bag has deployed, **the air bag will not function again. The side air bag system (including the seat) must be inspected and serviced by a qualified technician in accordance with the vehicle service manual.** If the air bag is not replaced, the unrepaired area will increase the risk of injury in a collision.

Determining if the system is operational

The SRS uses a readiness light in the instrument cluster or a tone to indicate the condition of the system. Refer to the *Air bag readiness* section in the *Instrumentation* chapter. Routine maintenance of the air bag is not required.

A difficulty with the system is indicated by one or more of the following:

- The readiness light will either flash or stay lit.
- The readiness light will not illuminate immediately after ignition is turned on.

Seating and safety restraints

If either of these indications occurs, even intermittently, have the SRS serviced at your dealership or by a qualified technician immediately. Unless serviced, the system may not function properly in the event of a collision.

Disposal of air bags and air bag equipped vehicles

For disposal of air bags or air bag equipped vehicles, see your local dealership or a qualified technician. Air bags **MUST BE** disposed of by qualified personnel.

SAFETY RESTRAINTS FOR CHILDREN

See the following sections for directions on how to properly use safety restraints for children. Also see *Air Bag Supplemental Restraint System (SRS)* in this chapter for special instructions about using air bags.

Seating and safety restraints

Important child restraint precautions

You are required by law to use safety restraints for children in the U.S. and Canada. If small children ride in your vehicle (generally children who are four years old or younger and who weigh 18 kg [40 lbs] or less), you must put them in safety seats made especially for children. Check your local and state or provincial laws for specific requirements regarding the safety of children in your vehicle.

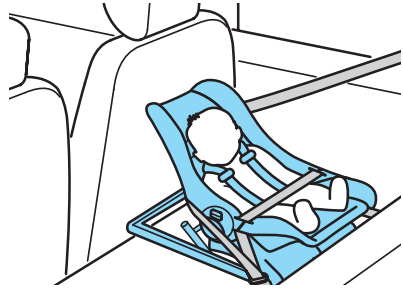

Never let a passenger hold a child on his or her lap while the vehicle is moving. The passenger cannot protect the child from injury in a collision.

Always follow the instructions and warnings that come with any infant or child restraint you might use.

When possible, place children in the rear seat of your vehicle. Accident statistics suggest that children are safer when properly restrained in the rear seating positions than in the front seating positions.

Seating and safety restraints

Children and safety belts

If the child is the proper size, restrain the child in a safety seat.

Children who are too large for child safety seats (as specified by the child safety seat manufacturer) should always wear safety belts.

Follow all the important safety restraints and air bag precautions that apply to adult passengers in your vehicle.

If the shoulder belt portion of a combination lap and shoulder belt can be positioned so it does not cross or rest in front of the child's face or neck, the child should wear the lap and shoulder belt. Moving the child closer to the center of the vehicle may help provide a good shoulder belt fit.



Do not leave children, unreliable adults, or pets unattended in your vehicle.

Seating and safety restraints

To improve the fit of lap and shoulder belts on children who have outgrown child safety seats, Ford recommends use of a belt-positioning booster seat that is labelled as conforming to all Federal motor vehicle safety standards. Belt-positioning booster seats raise the child and provide a shorter, firmer seating cushion that encourages safer seating posture and better fit of lap and shoulder belts on the child.

A belt-positioning booster seat should be used if the shoulder belt rests in front of the child's face or neck, or if the lap belt does not fit snugly on both thighs, or if the thighs are too short to let the child sit all the way back on the seat cushion when the lower legs hang over the edge of the seat cushion. You may wish to discuss the special needs of your child with your pediatrician.



Seating and safety restraints

SAFETY BELTS FOR CHILDREN

Child and infant or child safety seats

Use a safety seat that is recommended for the size and weight of the child. Carefully follow all of the manufacturer's instructions with the safety seat you put in your vehicle. If you do not install and use the safety seat properly, the child may be injured in a sudden stop or collision.



When installing a child safety seat:

- Review and follow the information presented in the *Air Bag Supplemental Restraint System* section in this chapter.
- Use the correct safety belt buckle for that seating position.
- Insert the belt tongue into the proper buckle until you hear a snap and feel it latch. Make sure the tongue is securely fastened in the buckle.
- Keep the buckle release button pointing up and away from the safety seat, with the tongue between the child seat and the release button, to prevent accidental unbuckling.

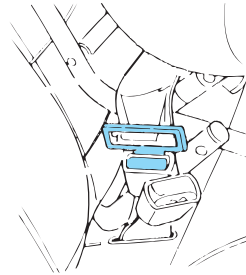

Seating and safety restraints

- Place seatback in upright position.
- Put the safety belt in the automatic locking mode. Refer to *Using automatic locking mode* (passenger side front and outboard rear seating positions) (if equipped).

Ford recommends the use of a child safety seat having a top tether strap. Install the child safety seat in a seating position which is capable of providing a tether anchorage. For more information on top tether straps see *Attaching safety seats with tether straps* in this chapter.



Carefully follow all of the manufacturer's instructions included with the safety seat you put in your vehicle. If you do not install and use the safety seat properly, the child may be injured in a sudden stop or collision.

Seating and safety restraints

Installing child safety seats in combination lap and shoulder belt seat positions

1. Position the child safety seat in a seat with a combination lap and shoulder belt. **NEVER** place a rear-facing child seat in front of an active air bag.



Air bags can kill or injure a child in a child seat. If you must use a forward-facing child seat in the front seat, move the seat all the way back.



Rear-facing child seats should **NEVER** be placed in the front seats.

2. Pull down on the shoulder belt and then grasp the shoulder belt and lap belt together.

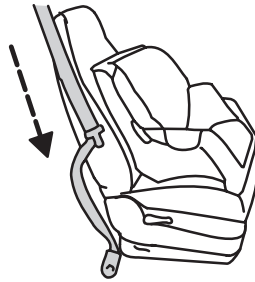
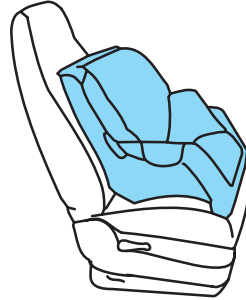

Seating and safety restraints

3. While holding the shoulder and lap belt portions together, route the tongue through the child seat according to the child seat manufacturer's instructions. Be sure the belt webbing is not twisted.

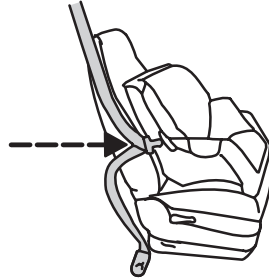

4. Insert the belt tongue into the proper buckle (the buckle closest to the direction the tongue is coming from) for that seating position until you hear and feel the latch engage. Make sure the tongue is latched securely by pulling on it.

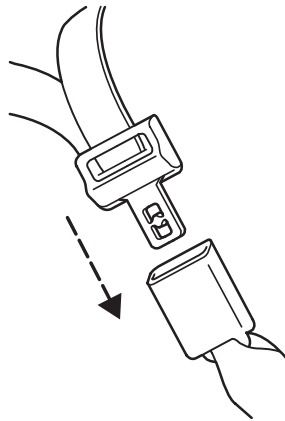

5. To put the retractor in the automatic locking mode, grasp the shoulder portion of the belt and pull downward until all of the belt is extracted and a click is heard.



Seating and safety restraints

6. Allow the belt to retract. The belt will click as it retracts to indicate it is in the automatic locking mode.

7. Pull the lap belt portion across the child seat toward the buckle and pull up on the shoulder belt while pushing down with your knee on the child seat.

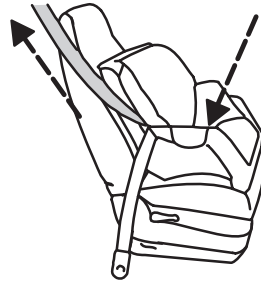

8. Allow the safety belt to retract to remove any slack in the belt.

9. Before placing the child in the seat, forcibly tilt the seat forward and back to make sure the seat is securely held in place.

10. Try to pull the belt out of the retractor to make sure the retractor is in automatic locking mode (you should not be able to pull more belt out). If the retractor is not locked, unbuckle the belt and repeat steps two through nine.

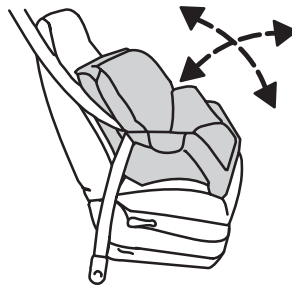

Check to make sure the child seat is properly secured before each use.

Seating and safety restraints

Attaching child safety seats with LATCH attachments

Some child seat manufacturers make safety seats that are labeled as LATCH or LATCH-compatible child seats. These seats include two rigid or webbing mounted attachments that connect to two LATCH anchors at specific seating positions in your vehicle. This type of child seat eliminates the need to use seat belts to attach the child seat. For forward-facing child seats, the tether strap must also be attached to a proper tether anchor point. For information on using tether straps with the child safety seats, refer to *Attaching safety seats with tether straps* in this chapter.

LATCH lower anchors have been provided in your vehicle at the following locations:

The anchors at the center of the rear seat are much further apart than the sets of lower anchors for child seat installation at other seating positions. A child seat with rigid LATCH attachments cannot be installed at this seating position.

LATCH compatible child seats (with attachments on belt webbing) can be used at this seating position only if the child seat instructions state that the child seat can be installed to anchors that are 450 mm apart.

Do not attach a child seat to any lower anchor if an adjacent child seat is attached to that anchor.

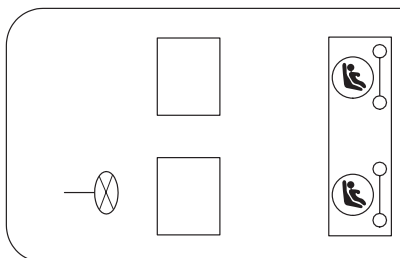

Seating and safety restraints

 Do not attach a child seat to any lower anchors for child seat installation anchor if an adjacent child seat is attached to that anchor. In a crash, one anchor may not be strong enough to hold two child seat attachments and may break, causing serious injury or death.

The LATCH anchors are located on the rear section of the seat cushion, at the bottom of the seatback.

Follow the child seat manufacturer's instructions to properly install safety seats with LATCH or LATCH-compatible attachments.

 Attach the LATCH or LATCH-compatible child seat only to the appropriate locations shown.

Once you have installed the LATCH safety seat, assure that the seat is properly attached to the LATCH and tether anchors. Also, test the safety seat before you place the child in it. Tilt the seat from side to side. Also try to tug the seat forward. Check to see if the anchors hold the seat in place.

 If the safety seat is not anchored properly, the risk of a child being injured in a collision greatly increases.

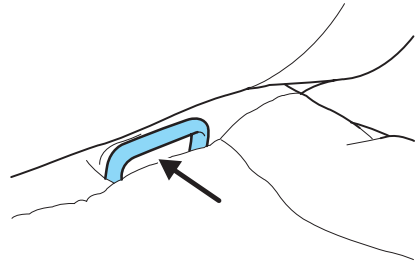
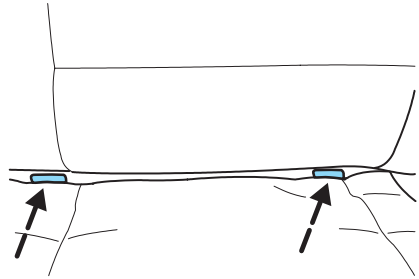

Seating and safety restraints

Attaching child safety seats with tether straps

Most new forward-facing child safety seats include a tether strap which goes over the back of the seat and hooks to an anchoring point. Tether straps are available as an accessory for many older safety seats. Contact the manufacturer of your child safety seat for information about ordering a tether strap.

The rear seats of your vehicle are equipped with built-in tether strap anchors located behind the seats as described below.

The tether anchors in your vehicle are either located under a cover marked with the tether anchor symbol (shown with title) or are recessed bars on the back side of the seatback.

The tether strap anchors in your vehicle are in the following positions (shown from top view, left is front of vehicle):



Attach the tether strap only to the appropriate tether anchor as shown. The tether strap may not work properly if attached somewhere other than the correct tether anchor.

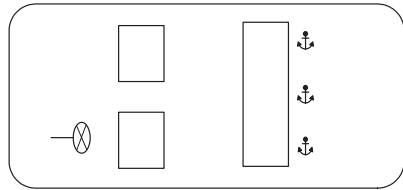

1. Position the child safety seat on the seat cushion.

Seating and safety restraints

2. Route the child safety seat tether strap over the back of the seat.

On hatchbacks, the removable luggage area cover must be removed prior to attaching the tether strap to the tether anchor.

On wagons, it may be necessary to remove the cargo cover assembly prior to attaching the tether strap to the tether anchor. The tether must not go around the cargo cover retractor assembly.

For vehicles with adjustable head restraints, route the tether strap under the head restraint and between the head restraint posts, otherwise route the tether strap over the top of the seatback.

3. Locate the correct anchor for the selected seating position.

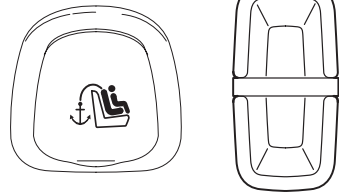

4. On a sedan, open the tether anchor cover.

5. Clip the tether strap to the anchor as shown.

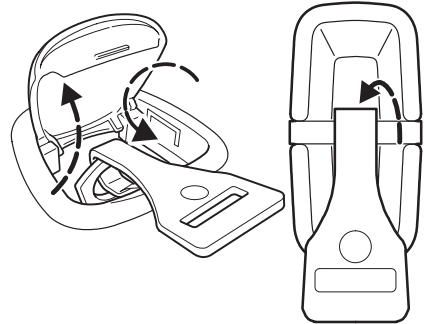

Seating and safety restraints



If the tether strap is clipped incorrectly, the child safety seat may not be retained properly in the event of a collision.

6. Refer to the *Installing child safety seats in combination lap and shoulder belt seating positions* section of this chapter for further instructions to secure the child safety seat.

7. Tighten the child safety seat tether strap according to the manufacturer's instructions.



If the safety seat is not anchored properly, the risk of a child being injured in a collision greatly increases.

Starting

PREPARING TO START YOUR VEHICLE

Engine starting is controlled by the ignition system. This system meets all Canadian Interference-Causing Equipment standard requirements regulating the impulse electrical field strength of radio noise.

When starting a fuel-injected engine, avoid pressing the accelerator before or during starting. Only use the accelerator pedal when you have difficulty starting the engine. For more information on starting the vehicle, refer to *Starting the engine* in this chapter.

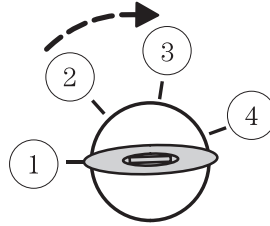

Extended idling at high engine speeds can produce very high temperatures in the engine and exhaust system, creating the risk of fire or other damage.



Do not park, idle, or drive your vehicle in dry grass or other dry ground cover. The emission system heats up the engine compartment and exhaust system, which can start a fire.



Do not start your vehicle in a closed garage or in other enclosed areas. Exhaust fumes can be toxic. Always open the garage door before you start the engine. See *Guarding against exhaust fumes* in this chapter for more instructions.



If you smell exhaust fumes inside your vehicle, have your dealer inspect your vehicle immediately. Do not drive if you smell exhaust fumes.

Important safety precautions

A computer system controls the engine's idle revolutions per minute (RPM). When the engine starts, the idle RPM runs faster to warm the engine. If the engine idle speed does not slow down automatically, have the vehicle checked.

Starting

Before starting the vehicle:

1. Make sure all vehicle occupants have buckled their safety belts. For more information on safety belts and their proper usage, refer to the *Seating and safety restraints* chapter.
2. Make sure the headlamps and vehicle accessories are off.

If starting a vehicle with an automatic transaxle:

- Make sure the parking brake is set.
- Make sure the gearshift is in P (Park).

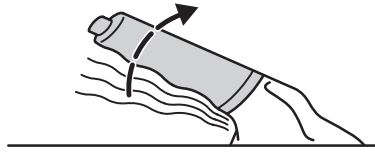
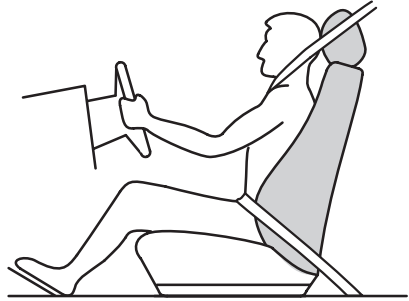

If starting a vehicle with a manual transaxle:

- Make sure the parking brake is set.
- Push the clutch pedal to the floor.

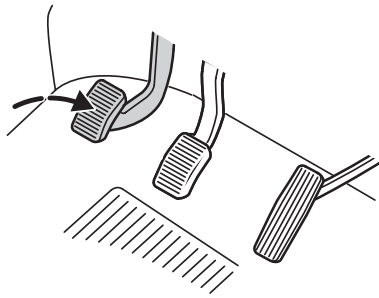

3. Turn the key to 3 (ON/RUN) without turning the key to 4 (START).

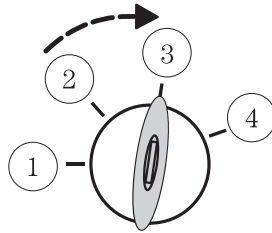

Starting

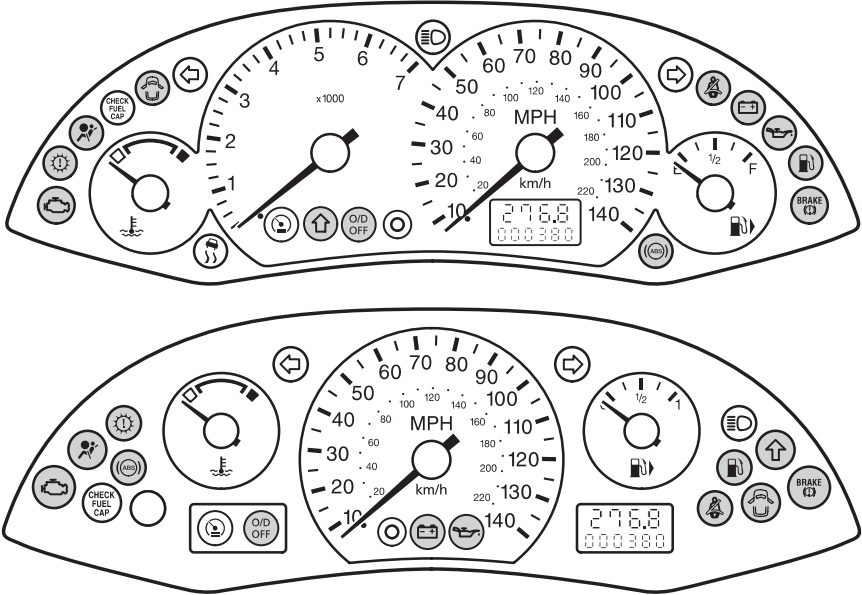

Make sure the corresponding lights (if equipped) illuminate briefly. If a light fails to illuminate, have the vehicle serviced.

- If the driver's safety belt is fastened the light will not illuminate.



STARTING THE ENGINE

1. Turn the key to 4 (START) without pressing the accelerator pedal and release as soon as the engine starts. The key will return to 3 (ON/RUN).

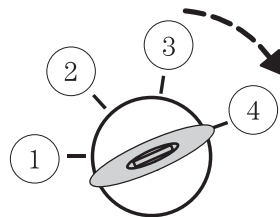

Starting

2. If the temperature is above -12°C (10°F) and the engine does not start within five seconds on the first try, turn the key to OFF, wait ten seconds and try again.

3. If the temperature is below -12°C (10°F) and the engine does not start in fifteen seconds on the first try, turn the key to OFF and wait ten seconds and try again. If the engine does not start in two attempts, depress the accelerator and start the engine while holding the accelerator down to the floor. Release the accelerator when the engine starts.

4. After idling for a few seconds, apply the brake and release the parking brake.

Using the engine block heater (if equipped)

An engine block heater warms the engine coolant, which improves starting, warms up the engine faster and allows the heater- defroster system to respond quickly. Use of an engine block heater is strongly recommended if you live in a region where temperatures reach -23°C (-10°F) or below.

For best results, plug the heater in at least three hours before starting the vehicle. Using the heater for longer than three hours will not harm the engine, so the heater can be plugged in the night before starting the vehicle.



To prevent electrical shock, do not use your heater with ungrounded electrical systems or two-pronged (cheater) adapters.

Guarding against exhaust fumes

Although odorless and colorless, carbon monoxide is present in exhaust fumes. Take precautions to avoid its dangerous effects.



If you ever smell exhaust fumes of any kind inside your vehicle, have your dealer inspect and fix your vehicle immediately. Do not drive if you smell exhaust fumes. These fumes are harmful and could kill you.

Have the exhaust and body ventilation system checked whenever:

- the vehicle is raised for service.
- the sound of the exhaust system changes.
- the vehicle has been damaged in a collision.

Starting

CALIFORNIA Proposition 65 Warning

 Engine exhaust, some of its constituents, and certain vehicle components contain or emit chemicals known to the State of California to cause cancer and birth defects or other reproductive harm. In addition, certain fluids contained in vehicles and certain products of component wear contain or emit chemicals known to the State of California to cause cancer and birth defects or other reproductive harm.

Important ventilating information

If the engine is idling while the vehicle is stopped in an open area for long periods of time, open the windows at least 2.5 cm (one inch).

Adjust the heating or air conditioning (if equipped) to bring in fresh air.

Improve vehicle ventilation by keeping all air inlet vents clear of snow, leaves and other debris.

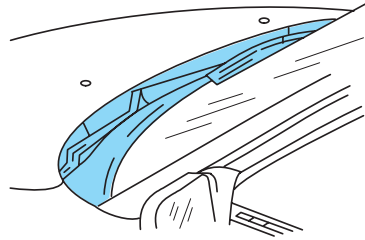

BRAKES

Your service brakes are self-adjusting. Refer to the “Scheduled Maintenance Guide” for scheduled maintenance.

Occasional brake noise is normal and often does not indicate a performance concern with the vehicle’s brake system. In normal operation, automotive brake systems may emit occasional or intermittent squeal or groan noises when the brakes are applied. Such noises are usually heard during the first few brake applications in the morning; however, they may be heard at any time while braking and can be aggravated by environmental conditions such as cold, heat, moisture, road dust, salt or mud. If a “metal-to-metal”, “continuous grinding” or “continuous squeal” sound is present while braking, have the brakes inspected by a qualified service technician.

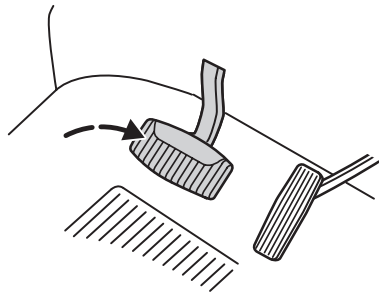

Driving

Anti-lock brake system (ABS) (if equipped)

On vehicles equipped with an anti-lock braking system (ABS), a noise from the hydraulic pump motor and pulsation in the pedal may be observed during ABS braking events. Rapid pedal pulsation coupled with noise while braking under panic conditions or on loose gravel, bumps, wet or snowy roads is normal and indicates proper functioning of the vehicle's anti-lock brake system. The ABS performs a self-check at 17 km/h (10 mph) after you start the engine and begin to drive away. A brief mechanical noise may be heard during this test. This is normal. If a malfunction is found, the ABS warning light will come on. If the vehicle has continuous vibration or shudder in the steering wheel while braking, the vehicle should be inspected by a qualified service technician.

The ABS operates by detecting the onset of wheel lockup during brake applications and compensating for this tendency. The wheels are prevented from locking even when the brakes are firmly applied. The accompanying illustration depicts the advantage of an ABS equipped vehicle (on bottom) to a non-ABS equipped vehicle (on top) during hard braking with loss of front braking traction.

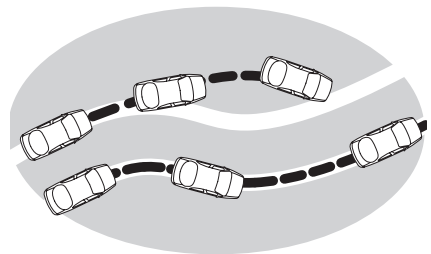

ABS warning lamp (if equipped)

The *ABS* warning lamp in the instrument cluster momentarily illuminates when the ignition is turned on and the engine is off. If the light does not illuminate momentarily at start up, remains on or continues to flash, the ABS needs to be serviced. With the ABS light on, the anti-lock brake system is disabled and normal braking is still effective unless the *brake* warning light also remains illuminated with parking brake released.

If the *ABS* and/or *brake* warning lights illuminate when the engine is on and the parking brake is in the fully off position, have your vehicle serviced immediately.

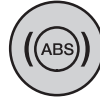

Driving

Using ABS (if equipped)

- In an emergency or when maximum efficiency from the ABS is required, apply continuous full force on the brake. The ABS will be activated immediately, thus allowing you to retain full steering control of your vehicle and, providing there is sufficient space, will enable you to avoid obstacles and bring the vehicle to a controlled stop.
- The Anti-Lock system does not decrease the time necessary to apply the brakes or always reduce stopping distance. Always leave enough room between your vehicle and the vehicle in front of you to stop.
- We recommend that you familiarize yourself with this braking technique. However, avoid any unnecessary risks.

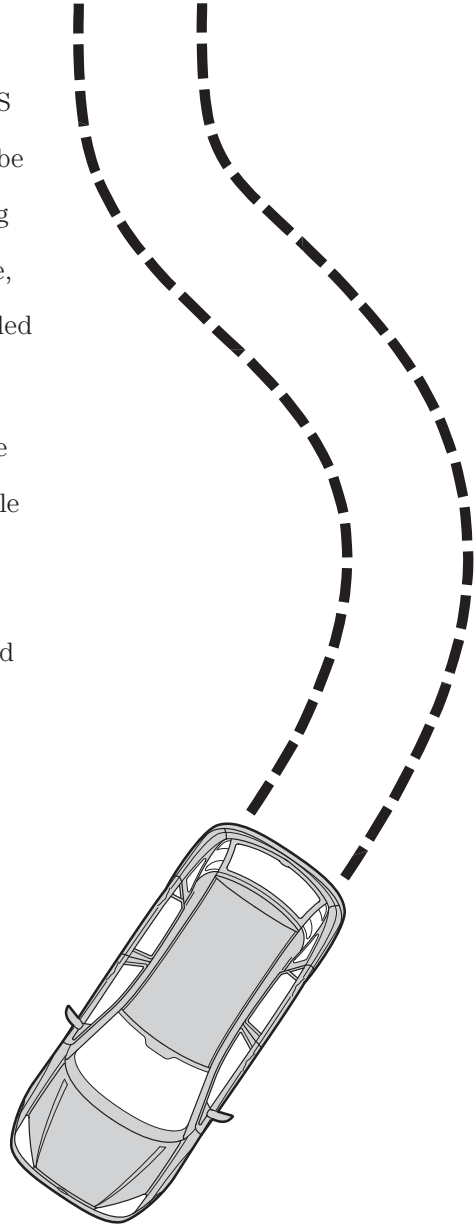

AdvanceTrac™ Stability Enhancement System (if equipped)

The AdvanceTrac™ system helps the driver maintain the stability and steerability of the vehicle. The system integrates the anti-lock braking (ABS) and Traction Control™ systems with a yaw reduction feature, to further enhance the stability of the vehicle. The system shares many of the electronic and mechanical elements already present in the Traction Control™ and ABS systems.

AdvanceTrac™ constantly monitors the vehicle motion relative to the driver's intended course. This is done by using added sensors that compare the steering inputs from the driver with the actual motion of the vehicle. When there is a discrepancy between the driver's inputs and the vehicle motion, AdvanceTrac™ changes the force at each tire to help control the vehicle. If the vehicle begins to rotate excessively left or right, spin out, or slide sideways, the system will attempt to correct the excessive motion. If the vehicle does not respond to steering inputs, the system will attempt to alter the turning response of the vehicle.

Driving

AdvanceTrac[™] enhances stability during maneuvers that require all available tire traction to control the vehicle. The benefits of the AdvanceTrac[™] system are most noticeable when driving in wet/snowy/icy road conditions and/or when performing emergency maneuvers. In an emergency lane-change, the driver will have better control of the vehicle.

Driving conditions which may activate AdvanceTrac[™] include:

- Taking a turn too fast
- Evasively maneuvering to avoid an accident, pedestrian or obstacle
- Hitting a patch of ice
- Changing lanes on a snow-rutted road
- Entering a snow-free road from a snow-covered side street
- Entering a paved road from a gravel road
- Hitting a curb while turning
- Driving on slick surfaces

During AdvanceTrac[™] operation you may experience the following:

- A rumble or grinding sound much like ABS
- A slight deceleration or a reduction in the acceleration of the vehicle

- The AdvanceTrac[™] indicator light will flash
- If your foot is on the brake pedal, you will feel a vibration in the pedal much like ABS. As with any vehicle equipped with four-wheel ABS, do not pump the brakes, but instead, press firmly on the pedal.
- If your foot is not on the brake, the brake pedal will move to apply higher brake forces. You may also hear a whoosh of air from under the instrument panel during the event.

All these conditions are normal during AdvanceTrac[™] operation.

The AdvanceTrac[™] system defaults to ON when the engine is started. The system does not work when the vehicle is traveling backwards. In reverse, the ABS and Traction Control[™] systems will continue to function.

The AdvanceTrac[™] system continually monitors and checks all sensors used in improving the stability of the vehicle. Some drivers may notice a slight movement of the brake pedal when the system checks itself.

Driving



Aggressive driving in any road conditions can cause you to lose control of your vehicle increasing the risk of severe personal injury or property damage. The occurrence of an AdvanceTrac™ event is an indication that at least some of the tires have exceeded their ability to grip the road and that you may lose control of the vehicle. If you experience a severe road event, SLOW DOWN.



If you find yourself regularly experiencing AdvanceTrac™ events, you are driving too fast for conditions, you should reduce your speed, and drive less aggressively. AdvanceTrac™ is limited by the laws of physics. It is always possible to lose control of a vehicle due to inappropriate driver inputs for the conditions. The occurrence of an AdvanceTrac™ event is an indication that at least some of the tires have exceeded their ability to grip the road; this may cause you to lose control of the vehicle increasing the risk of severe personal injury or property damage.

Switching off AdvanceTrac™

If you should become stuck in snow or on a very slippery road surface, try switching the AdvanceTrac™ system off. This may allow excess wheel spin to “dig” the vehicle out or enable a successful “rocking” maneuver. Do not rock the vehicle for more than a few minutes, because it could damage the vehicle.

The AdvanceTrac™ light in the instrument cluster illuminates continuously when the system has been switched off. To reactivate the system, press the switch again or restart the vehicle.

For further details, refer to the section *AdvanceTrac™ switch*.



Driving

Parking brake

Apply the parking brake whenever the vehicle is parked. To set the parking brake, pull the handle up as far as possible.

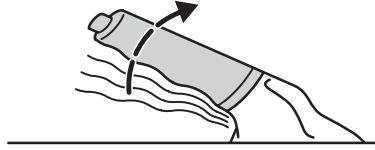

The *brake* warning lamp in the instrument cluster illuminates and remains illuminated (when the ignition is turned ON/RUN) until the parking brake is released.



The parking brake is not recommended to stop a moving vehicle. However, if the normal brakes fail, the parking brake can be used to stop your vehicle in an emergency. Since the parking brake applies only the rear brakes, the vehicle's stopping distance will increase greatly and the handling of your vehicle will be adversely affected.



Always set the parking brake fully and make sure that the gearshift is securely latched in P (Park) (Automatic transaxle) or in 1 (First) (manual transaxle).

Push the button on the end of the parking brake and push the handle down as far as possible to release the brake. Driving with the parking brake on will cause the brakes to wear out quickly and reduce fuel economy.

STEERING

Your vehicle is equipped with power steering. Power steering uses energy from the engine to help steer the vehicle.

To prevent damage to the power steering pump:

- Never hold the steering wheel to the extreme right or the extreme left for more than a few seconds when the engine is running.
- Do not operate the vehicle with a low power steering pump fluid level.

If the power steering system breaks down (or if the engine is turned off), you can steer the vehicle manually, but it takes more effort.

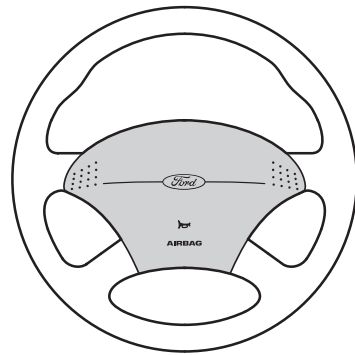

Driving

If the steering wanders or pulls, the condition could be caused by any of the following:

- underinflated tire(s) on any wheel(s)
- high crosswinds
- wheels out of alignment
- loose or worn components in steering linkage.

AUTOMATIC TRANSAXLE OPERATION (if equipped)

Brake-shift interlock

This vehicle is equipped with a brake-shift interlock feature that prevents the gearshift from being moved from P (Park) unless the brake pedal is depressed.

If you cannot move the gearshift out of P (Park) with the brake pedal depressed:

1. Apply the parking brake, turn ignition key to LOCK, then remove the key.
2. Remove the protective cover to the interlock access hole on the console. Insert a screwdriver or other similar tool to release the interlock. Apply the brake pedal and shift to N (Neutral).
3. Start the vehicle.

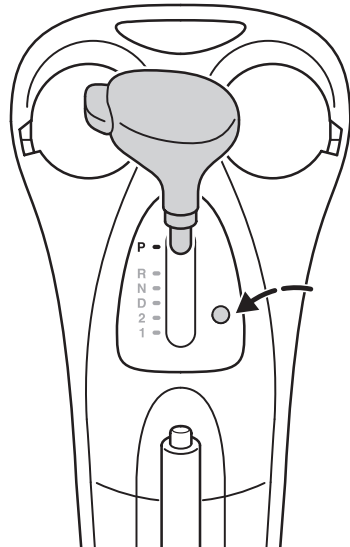

If it is necessary to use the above procedure to move the gearshift, it is possible that a fuse has blown or the vehicle's brakelamps are not operating properly. Refer to *Fuses and relays* in the *Roadside emergencies* chapter.



Do not drive your vehicle until you verify that the brakelamps are working.

If your vehicle gets stuck in mud or snow it may be rocked out by shifting between forward and reverse gears, stopping between shifts, in a steady pattern. Press lightly on the accelerator in each gear.

Do not rock the vehicle for more than a few minutes or excessively spin the wheels. The transaxle and tires may be damaged or the engine may overheat.



Always set the parking brake fully and make sure the gearshift is latched in P (Park). Turn off the ignition whenever you leave your vehicle.

Driving

Driving with automatic transaxle (if equipped)

Understanding gearshift positions

Depress the locking button and move the automatic gearshift to the desired position.

 Hold the brake pedal down while you move the gearshift lever from P (Park) to another position. If you do not hold the brake pedal down, your vehicle may move unexpectedly and injure someone.

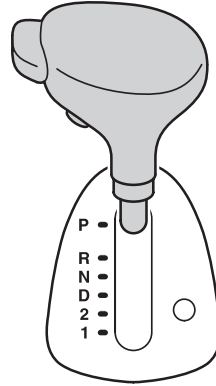

P (Park)

Always come to a complete stop before shifting into P (Park). Make sure the gearshift is securely latched in P (Park). This position locks the transaxle and prevents the front wheels from turning.

 Always set the parking brake fully and make sure the gearshift is securely latched in P (Park).

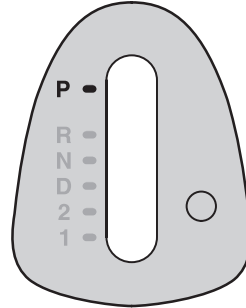

If the gearshift is not in P (Park) and the driver's door is open, a warning chime will sound.

Note: The key may be difficult to remove if the ignition is switched off with an automatic gearshift lever in any other position than P (Park). If this occurs, place the gearshift lever in P (Park), turn the ignition switch to the ON/RUN and then to the OFF position. Remove the key normally.



Never leave your vehicle unattended while it is running.

R (Reverse)

With the gearshift in R (Reverse), the vehicle will move backward. Always come to a complete stop before shifting into and out of R (Reverse)

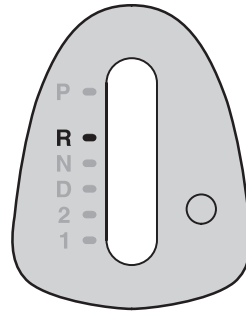

N (Neutral)

With the gearshift in N (Neutral), the vehicle can be started and is free to roll. Hold the brake pedal down while in this gear.

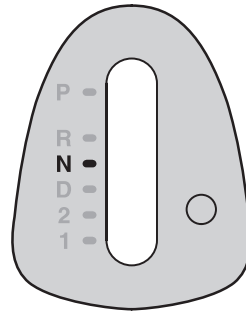

Driving

D (Overdrive)

The normal driving position for the best fuel economy. Transaxle operates in gears One through Four.

D (Overdrive) can be deactivated by pressing the transaxle control switch on the gearshift lever.

The O/D OFF light will illuminate on the instrument cluster.

Engine braking is provided in gears 2, 3, and 4.

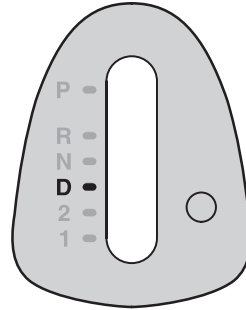

D (Drive)

Transaxle operates in gears One through Three. Activate by pressing the transaxle control switch on the gearshift lever. The O/D OFF light will illuminate on the instrument cluster. D (Drive) provides engine braking in gears 2 and 3 and is useful when:

- driving with a heavy load.
- towing a trailer up or down steep hills.
- additional engine downhill braking is desired. If towing a trailer, refer to *Driving while you tow* in the *Trailer towing* chapter.

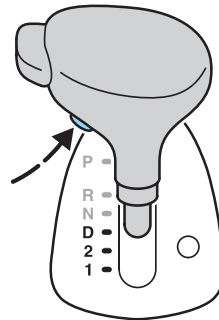

To return to D (Overdrive) mode, press the transaxle control switch and the O/D OFF light will no longer be illuminated.

Each time the vehicle is started, the transaxle will automatically return to normal overdrive mode.

2 (Second)

Use 2 (Second) to start-up on slippery roads or to provide additional engine braking on downgrades.

Upshifts can be made by shifting to D (Drive) or D (Overdrive). Selecting 2 (Second) at higher speeds causes the transaxle to shift to a lower gear, and will shift to 2 (Second) after vehicle decelerates to the proper speed.

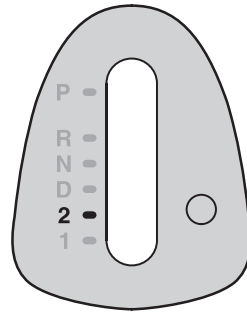

1 (First)

Use 1 (First) to provide maximum engine braking on steep downgrades.

Upshifts can be made by shifting to 2 (Second), D (Drive) or D (Overdrive). Selecting 1 (First) at higher speeds causes the transaxle to shift to a lower gear, and will shift to 1 (First) after vehicle decelerates to the proper speed.

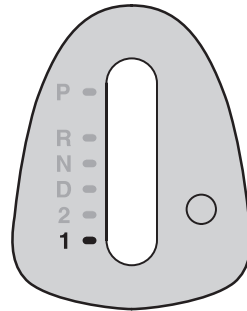

Driving

Manual transaxle operation (if equipped)

Using the clutch

Vehicles equipped with a manual transaxle have a starter interlock that prevents cranking the engine unless the clutch pedal is fully depressed.

When starting a vehicle with a manual transaxle, you must:

1. Put gearshift in N (Neutral).
2. Hold down brake pedal.
3. Depress clutch pedal.

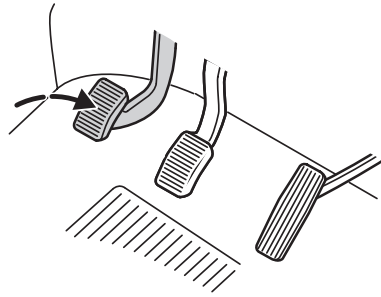
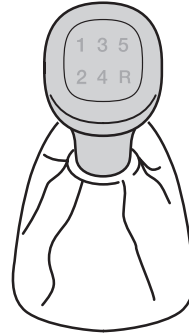

4. Turn ignition to position 4 (START) to start the engine, let the engine idle for a few seconds, then shift into gear.

5. Release the brake pedal.
6. Release clutch slowly while pressing down slowly on the accelerator pedal.

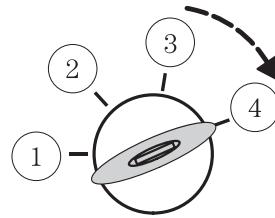

Do not drive with your foot resting on the clutch pedal and do not use the clutch to hold your vehicle at a standstill while waiting on a hill. These actions will seriously reduce clutch life.

Recommended shift speeds

Upshift and downshift according to the following charts for your specific engine/drivetrain combination:

| Upshifts when accelerating (recommended for best fuel economy) | | |
|---|------|-----|
| 5-speed manual transaxle | | |
| Shift from: | km/h | mph |
| First to second | 23 | 14 |
| Second to third | 40 | 25 |
| Third to fourth | 58 | 36 |
| Fourth to fifth | 72 | 45 |

Driving

Parking your vehicle

1. Apply brake and shift into N (Neutral).
2. Set parking brake.
3. Shift into 1 (First).

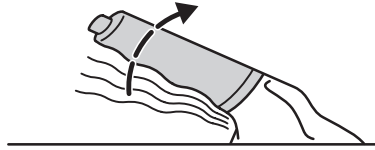

4. Turn ignition to position 2 (OFF).



Do not park your vehicle in Neutral, it may move unexpectedly and injure someone. Use 1 (First) gear and set the parking brake fully.

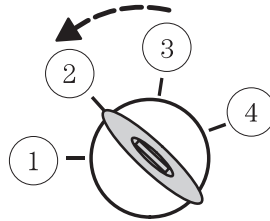

Reverse

Make sure that your vehicle is at a complete stop before you shift into R (Reverse). Failure to do so may damage the transaxle.

Put the gearshift in N (Neutral) and wait at least three seconds before shifting into R (Reverse).

- **IB5 transaxle (with SPI engine)**

You shift into R (Reverse) only by moving the gearshift fully to the right against a spring pressure and then rearward into R (Reverse) gear.

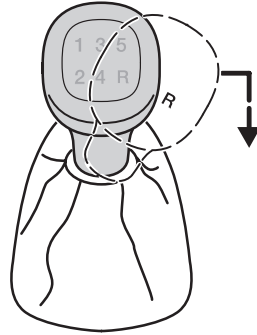

- **MTX 75 transaxle (with Zetec engine)**

To select reverse gear, lift the locking ring (1) and then move the gearshift fully to the right and rearward into R (Reverse) gear (2).

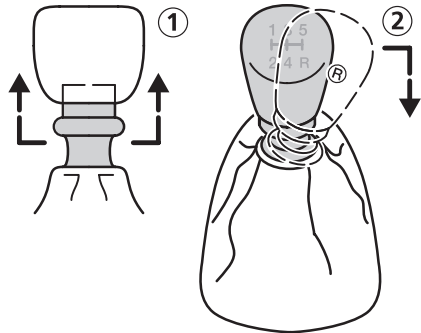

Removing key from ignition

- Turn the ignition key to position 1.
- Remove the ignition key.

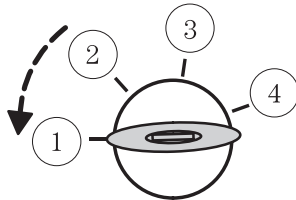

Driving

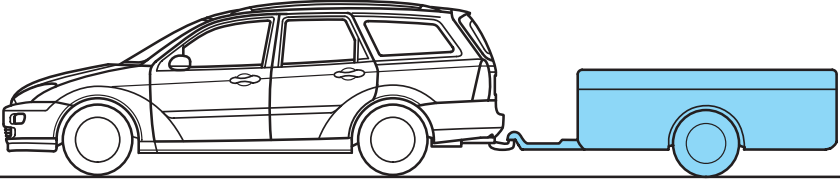

VEHICLE LOADING

Before loading your vehicle, familiarize yourself with these terms.

- **Base curb weight:** Weight of the vehicle including any standard equipment, fluids, lubricants, etc. It does not include passengers or aftermarket equipment.
- **Payload:** Combined maximum allowable weight of cargo, passengers and optional equipment. The payload equals the gross vehicle weight rating minus base curb weight.
- **GVW (Gross Vehicle Weight):** Base curb weight plus payload weight. The GVW is not a limit or a specification.
- **GVWR (Gross Vehicle Weight Rating):** Maximum total weight of the base vehicle, passengers, optional equipment and cargo. The GVWR is specific to each vehicle and is listed on the Safety Compliance Certification Label on the driver's door pillar.

- **GAWR (Gross Axle Weight Rating):** Carrying capacity for each axle system. The GAWR is specific to each vehicle and is listed on the Safety Compliance Certification Label on the driver's door pillar.
- **GCWR (Gross Combined Weight Rating):** Maximum combined weight of towing vehicle (including passengers and cargo) and the trailer. The GCWR indicates the maximum loaded weight that the vehicle is designed to tow.
- **Maximum Trailer Weight Rating:** Maximum weight of a trailer the vehicle is permitted to tow. The maximum trailer weight rating is determined by subtracting the vehicle curb weight for each engine/transaxle combination, any required option weight for trailer towing and the weight of the driver from the GCWR for the towing vehicle.
- **Maximum Trailer Weight:** Maximum weight of a trailer the loaded vehicle (including passengers and cargo) is permitted to tow. It is determined by subtracting the weight of the loaded trailer towing vehicle from the GCWR for the towing vehicle.

Driving

- **Trailer Weight Range:** Specified weight range that the trailer must fall within that ranges from zero to the maximum trailer weight rating.

Remember to figure in the tongue load of your loaded trailer when figuring the total weight.



Do not exceed the GVWR or the GAWR specified on the Safety Compliance Certification Label.

Do not use replacement tires with lower load carrying capacities than the originals because they may lower the vehicle's GVWR and GAWR limitations. Replacement tires with a higher limit than the originals do not increase the GVWR and GAWR limitations.

The Certification Label, found on the inside pillar of the driver's door, lists several important vehicle weight rating limitations. Before adding any additional equipment, refer to these limitations.

If you are adding weight to the front of your vehicle (potentially including weight added to the cab), the weight added should not exceed the Front Axle Reserve Capacity (FARC). Additional frontal weight may be added to the front axle reserve capacity provided you limit your payload in other ways (i. e. restrict the number of passengers or amount of cargo carried).

You may add equipment throughout your vehicle if the total weight added is equal to or less than the Total Axle Reserve Capacity (TARC) weight. You should NEVER exceed the Total Axle Reserve Capacity.

Always ensure that the weight of passengers, cargo and equipment being carried is within the weight limitations that have been established for your vehicle including both Gross Vehicle Weight and Front and Rear Gross Axle Weight Rating limits. Under no circumstance should these limitations be exceeded. Exceeding any vehicle weight rating limitation could result in serious damage to the vehicle and/or personal injury.

Driving

TRAILER TOWING

Your vehicle is classified as a light duty towing vehicle. Refer to the following chart for towing limits:

| | |
|-------------------------------------|-------------------------------|
| Towing class | Light duty |
| Maximum gross trailer weight | 454 kg (1 000 lbs.)* |
| Maximum tongue load | 45 kg (100 lbs.) |
| Engine | All |
| Hitch design | Appropriate aftermarket hitch |

* Vehicle speed should not exceed 72 km/h (45 mph) when towing on grades. Limit maximum gross trailer weight to 454 kg (1 000 lbs.) and maximum tongue load to 45 kg (100 lbs.): (1) when you are towing a trailer on steep hills or on moderate hills for distances longer than 8 km (5 miles) or more and; (2) on very hot days (when the temperature is above 38°C [100°F]).

Your vehicle does not come from the factory fully equipped to tow. However, you can contact your local Ford dealer to get the proper towing equipment. Do not tow a trailer until your vehicle has been driven at least 3 000 km (2 000 miles).

Towing a trailer places an additional load on your vehicle's engine, transaxle, brakes, tires and suspension. Inspect these components carefully after towing.



Do not tow a trailer when using a temporary spare tire.

Your loaded trailer should weigh no more than 454 kg (1 000 lbs.).



Do not exceed the GVWR or the GAWR specified on the Safety Compliance Certification Label.



Towing trailers beyond the maximum recommended gross trailer weight could result in engine damage, transmission/ axle damage, structural damage, loss of control, and personal injury.

Driving

Preparing to tow

Use the proper equipment for towing a trailer, and make sure it is properly attached to your vehicle. See your dealer or a reliable trailer dealer if you require assistance.

Hitches

Do not use hitches that clamp onto the vehicle bumper. Use a load carrying hitch. You must distribute the load in your trailer so that 10 – 15% of the total weight of the trailer is on the tongue.

Safety chains

Always connect the trailer's safety chains to the vehicle. To connect the trailer's safety chains, cross the chains under the trailer tongue and allow slack for turning corners.

If you use a rental trailer, follow the instructions that the rental agency gives to you.

Do not attach safety chains to the bumper.

Trailer brakes

Electric brakes and manual, automatic or surge-type brakes are safe if installed properly and adjusted to the manufacturer's specifications. The trailer brakes must meet local and Federal regulations.



Do not connect a trailer's hydraulic brake system directly to your vehicle's brake system. Your vehicle may not have enough braking power and your chances of having a collision greatly increase.

The braking system of the tow vehicle is rated for operation at the GVWR not GCWR.

Trailer lamps

Do not connect a trailer's lighting system directly to your vehicle's lighting system. To get the proper equipment for hooking up your trailer's lamps, see your Ford dealer. Be sure to follow their instructions carefully.

If you do not install trailer lights correctly, you may cause damage to the vehicle's lighting system or other vehicle systems.

Driving while you tow

Do not drive faster than 88 km/h (55 mph) when towing a trailer.

Speed control may shut off if you are towing on long, steep grades.

Towing a trailer will result in a deterioration in fuel economy.

Driving

When towing a trailer:

- Shift out of D (Overdrive) and into 2 (Second) or a lower gear when towing up or down steep hills. This will eliminate excessive downshifting and upshifting for optimum fuel economy and transaxle cooling.
- Anticipate stops and brake gradually.

Servicing after towing

If you tow a trailer for long distances, your vehicle will require more frequent service intervals. Refer to your “Scheduled Maintenance Guide” for more information.

Trailer towing tips

- Practice turning, stopping and backing up in an area before starting on a trip to get the feel of the vehicle trailer combination. When turning, make wider turns so the trailer wheels will clear curbs and other obstacles.

- Allow more distance for stopping with a trailer attached.
- The trailer tongue weight should be 10–15% of the loaded trailer weight.
- After you have traveled 80 km (50 miles), thoroughly check your hitch, electrical connections and trailer wheel lug nuts.
- When stopped in traffic for long periods of time in hot weather, place the gearshift in P (Park) and increase idle speed. This aids engine cooling and air conditioner efficiency.
- Vehicles with trailers should not be parked on a grade. If you must park on a grade, place wheel chocks under the trailer's wheels.

TOWING YOUR VEHICLE BEHIND ANOTHER VEHICLE

At times you may want to tow your vehicle behind another vehicle. Before you have your vehicle towed:

- Release the parking brake.
- Move the gearshift to N (Neutral).
- Turn the key in the ignition to off.
- Unlock the steering wheel.

Driving

Recreational towing

Follow these guidelines for your specific powertrain combination to tow your vehicle with all four wheels on the ground (such as behind a recreational vehicle).

These guidelines are designed to ensure that your transmission is not damaged due to insufficient lubrication.

All Front Wheel Drive (FWD) vehicles

An example of recreational towing is towing your vehicle behind a Motorhome. The following recreational towing guidelines are designed to ensure that your transmission is not damaged. It is not recommended to tow front wheel drive vehicles with the front drive wheels on the ground. It is recommended to tow your vehicle with the drive wheels on a dolly or two wheel car hauling trailer.

Automatic transaxle

In case of a roadside emergency with a disabled vehicle (without access to wheel dollies, car hauling trailer or flatbed transport vehicle) your vehicle can be flat towed (all wheels on the ground) under the following conditions.

- Transmission is placed in N (Neutral).
- Maximum speed is 50 km/h (30 mph).
- Maximum distance is 50 km (30 miles).

Manual transaxle

- Transmission is placed in N (Neutral).
- Your maximum towing distance is unlimited.



Never use a tow bar that attaches to the bumper when you tow your vehicle. You could damage the bumper and cause an accident.

LUGGAGE RACK (if equipped)

The maximum load is 100 kg (220 lb) on the luggage rack structure. The load **must** be placed directly on the luggage rack. The vehicle's roof panel **is not** designed to carry a load.

When loading the luggage rack, it is recommended to evenly distribute the load, as well as maintain a low center of gravity. Ensure that the load is securely fastened.

Driving with items on the luggage rack will result in a deterioration in fuel economy.

When rack is loaded, check tightness of rear adjusting thumbwheel before driving. Recheck tightness of rear thumbwheel at each refueling stop if rack is loaded.



Driving

DRIVING THROUGH WATER

Do not drive quickly through standing water, especially if the depth is unknown. Traction or brake capability may be limited and if the ignition system gets wet, your engine may stall. Water may also enter your engine's air intake and severely damage your engine.

If driving through deep or standing water is unavoidable, proceed very slowly. Never drive through water that is higher than the bottom of the hubs.

Once through the water, always try the brakes. Wet brakes do not stop the vehicle as effectively as dry brakes. Drying can be improved by moving your vehicle slowly while applying light pressure on the brake pedal.

Driving through deep water where the transaxle is submerged may allow water into the transaxle and cause internal transaxle damage.

Roadside emergencies

HAZARD LIGHTS CONTROL

Use only in an emergency to warn traffic of vehicle breakdown, approaching danger, etc. The hazard flashers can be operated when the ignition is on or off.

- The hazard lights control is located on the instrument panel.
- Depress hazard lights control to activate all hazard flashers simultaneously.
- Depress control again to turn the flashers off.



Roadside emergencies

FUEL PUMP SHUT-OFF SWITCH

After a collision, if the engine cranks but does not start, the fuel pump shut-off switch may have been activated. The shut-off switch is a device intended to stop the electric fuel pump when your vehicle has been involved in a substantial jolt.

1. Turn the ignition to the OFF position.
2. Check the fuel system for leaks.
3. If no fuel leak is apparent, remove the cover plug in the trim and reset the fuel pump shut-off switch by pushing in the button on the switch.
4. Turn the ignition to the ON/RUN position. Pause for a few seconds and return the key to the OFF position.
5. Make a further check for leaks in the fuel system.

The fuel pump shut-off switch is located in the passenger's foot well, behind the kick panel. The reset button is accessible through the recess in the kick panel.

Replace the cover plug in trim after reset procedure.

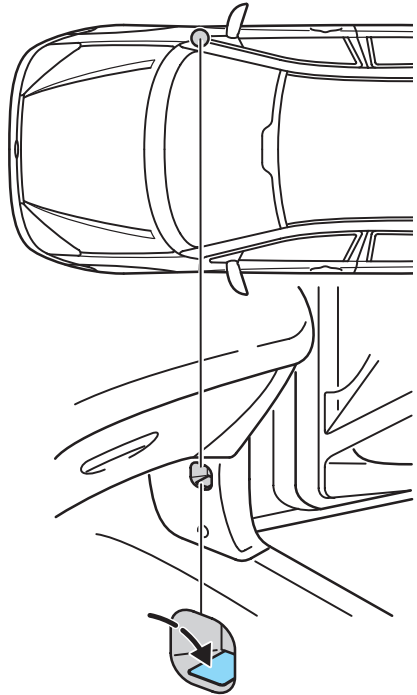

Roadside emergencies

FUSES AND RELAYS

Fuses

If electrical components in the vehicle are not working, a fuse may have blown. Blown fuses are identified by a broken wire within the fuse. Check the appropriate fuses before replacing any electrical components.

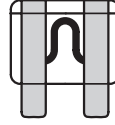

Always replace a fuse with one that has the specified amperage rating. Using a fuse with a higher amperage rating can cause severe wire damage and could start a fire.

Roadside emergencies

Standard fuse amperage rating and color

| Color | | | | |
|-------------|------------|----------------|------------|---------------------|
| Fuse rating | Mini fuses | Standard fuses | Maxi fuses | Fuse link cartridge |
| 2A | Grey | Grey | – | – |
| 3A | Violet | Violet | – | – |
| 4A | Pink | Pink | – | – |
| 5A | Tan | Tan | – | – |
| 7.5A | Brown | Brown | – | – |
| 10A | Red | Red | – | – |
| 15A | Blue | Blue | – | – |
| 20A | Yellow | Yellow | Yellow | Blue |
| 25A | Natural | Natural | – | – |
| 30A | Green | Green | Green | Pink |
| 40A | – | – | Orange | Orange |
| 50A | – | – | Red | Red |
| 60A | – | – | Blue | Yellow |
| 70A | – | – | Tan | Brown |
| 80A | – | – | Natural | Black |

Passenger compartment fuse panel

The fuse panel is located below and to the left of the steering wheel by the brake pedal. Remove the panel cover to view the fuses.

Access the fuses from below the panel cover.

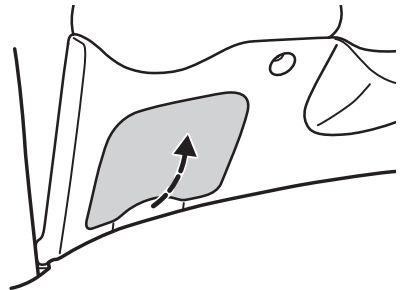

Roadside emergencies

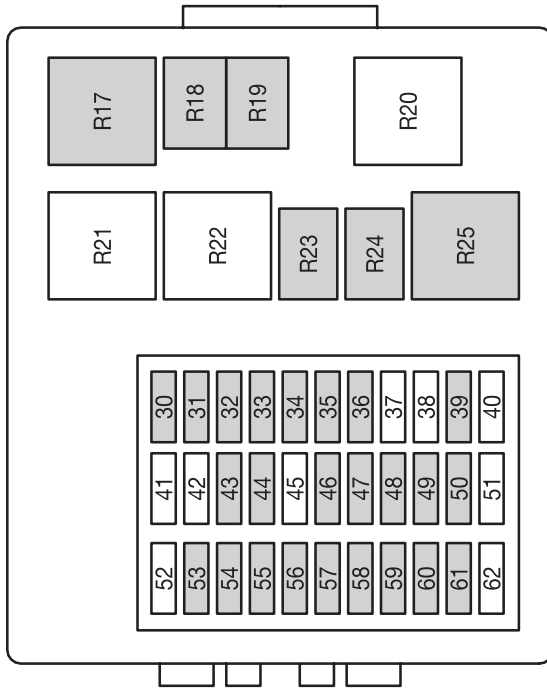

The fuses and relays are coded as follows.

Roadside emergencies

| Passenger compartment fuse panel | | |
|----------------------------------|------------------|-----------------------------------|
| Fuse | Fuse amp. rating | Description |
| 30 | 7.5 | ABS |
| 31 | 15 | Radio |
| 32 | 10 | Light switch |
| 33 | 15 | Hazard flasher |
| 34 | 20 | Horn |
| 35 | 7.5 | Interior lamps, power mirrors |
| 36 | 7.5 | Central timer, electronic modules |
| 37 | – | Not used |
| 38 | – | Not used |
| 39 | 10 | Back-up lamps |
| 40 | – | Not used |
| 41 | – | Not used |
| 42 | – | Not used |
| 43 | 15 | Rear wiper |
| 44 | 20 | Fog lamps |
| 45 | – | Not used |
| 46 | 15 | Cigar lighter |
| 47 | 7.5 | Side lights (left) |
| 48 | 7.5 | Side lights (right) |
| 49 | 25 | Rear defrost |
| 50 | 7.5 | Radio, central timer |

Roadside emergencies

| Passenger compartment fuse panel | | |
|---|------------------|--|
| Fuse | Fuse amp. rating | Description |
| 51 | – | Not used |
| 52 | – | Not used |
| 53 | 10 | Back-up lamps |
| 54 | 15 | Brake lamps |
| 55 | 20 | Front wipers |
| 56 | 25 | Front power windows |
| 57 | 25 | Rear power windows |
| 58 | 7.5 | Air conditioning, recirculated air |
| 59 | 7.5 | Electronic modules, instrument cluster |
| 60 | 7.5 | Air bag module |
| 61 | 7.5 | Light switch |
| 62 | – | Not used |
| 63 | 20 | Central lock module (on back side of fuse panel) |

| Relays in the passenger compartment fuse panel | |
|---|--|
| Relay | Description |
| 17 | Starter |
| 18 | Rear intermittent wiper (may be incorporated with relay 19) |
| 19 | Front intermittent wiper (may be incorporated with relay 18) |
| 20 | Not used |
| 21 | Not used |
| 22 | Not used |
| 23 | Horn |
| 24 | Battery saver |
| 25 | Rear defrost |

Roadside emergencies

Power distribution box

The power distribution box is located in the engine compartment. The power distribution box contains high-current fuses that protect your vehicle's main electrical systems from overloads.

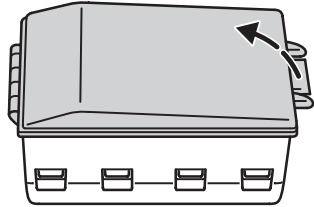

 Always disconnect the battery before servicing high current fuses.

 Always replace the cover to the Power Distribution Box before reconnecting the battery or refilling fluid reservoirs.

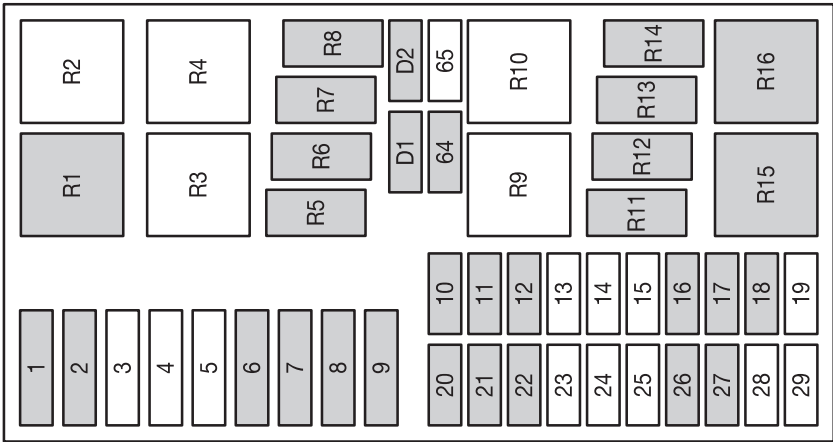

The high-current fuses are coded as follows.

Roadside emergencies

| Power distribution box | | |
|------------------------|------------------|---|
| Fuse | Fuse amp. rating | Description |
| 1 | 40 | Main power supply to electrical system |
| 2 | 30 | Engine cooling fan (A/C) 2nd fuse |
| 3 | – | Not used |
| 4 | – | Not used |
| 5 | – | Not used |
| 6 | 50 | Engine cooling fan (A/C) 1st fuse |
| 7 | 40 | Main power supply to electrical system |
| 8 | 30 | Ignition |
| 9 | 20 | Engine management |
| 10 | 10 | Battery voltage sensor, diagnostic plug |
| 11 | 30 | ABS |
| 12 | 15 | Fuel pump |
| 13 | – | Not used |
| 14 | – | Not used |
| 15 | – | Not used |
| 16 | 10 | Low beam (left side) |
| 17 | 10 | Low beam (right side) |
| 18 | 10 | Heated oxygen sensors |
| 19 | – | Not used |
| 20 | 10 | Engine management |
| 21 | 20 | ABS |
| 22 | 20 | DRL (low beams) |
| 23 | – | Not used |
| 24 | – | Not used |
| 25 | – | Not used |
| 26 | 10 | High beam (left side) |
| 27 | 10 | High beam (right side) |
| 28 | – | Not used |
| 29 | – | Not used |
| 64 | 30 | Heater blower motor |
| 65 | – | Not used |

Roadside emergencies

| Relays in the power distribution box | |
|--------------------------------------|---|
| Relay | Description |
| 1 | Ignition |
| 2 | Not used |
| 3 | Not used |
| 4 | Not used |
| 5 | High beams |
| 6 | Low beams |
| 7 | Fuel pump |
| 8 | Engine management |
| 9 | Not used |
| 10 | Not used |
| 11 | Air conditioning |
| 12 | Daytime running lights |
| 13 | Fog lamps |
| 14 | Stop lamp inhibit relay (AdvanceTrac [™] only) |
| 15 | Engine cooling fan level 2 (A/C) |
| 16 | Engine cooling fan level 1 |

Roadside emergencies

CHANGING THE TIRES

If you get a flat tire while driving, do not apply the brake heavily. Instead, gradually decrease your speed. Hold the steering wheel firmly and slowly move to a safe place on the side of the road.

The temporary spare tire

Your vehicle has a temporary spare tire. The temporary spare tire for your vehicle is labeled as such. It is smaller than a regular tire and is designed for emergency use only.

Vehicles with AdvanceTrac™ (if equipped) may exhibit some unusual driving characteristics which can be avoided by switching AdvanceTrac™ off. Drive cautiously and replace the temporary spare tire as soon as possible.

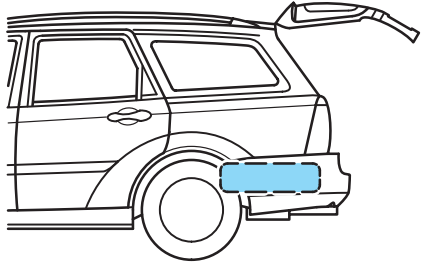

If you use the temporary spare tire continuously or do not follow these precautions, the tire could fail, causing you to lose control of the vehicle, possibly injuring yourself or others.

Roadside emergencies

When driving with a temporary spare tire **do not**:

- exceed the maximum speed of 80 km/h (50 mph) under any circumstances
- load the vehicle beyond maximum vehicle load rating listed on the Safety Compliance Label
- tow a trailer
- drive through an automatic car wash, because of the vehicle's reduced ground clearance
- try to repair the temporary spare tire or remove it from its wheel
- drive for long distances when the temporary-use spare is on
- operate the vehicle with more than one temporary-use spare tire
- improperly inflate the temporary-use spare
- use the wheel for any other type of vehicle



Roadside emergencies

Tire change procedure

 To prevent the vehicle from moving when you change a tire, be sure the parking brake is set, then block (in both directions) the wheel that is diagonally opposite (other side and end of the vehicle) to the tire being changed.

 If the vehicle slips off the jack, you or someone else could be seriously injured.

1. Park on a level surface, activate hazard flashers and set parking brake.
2. Place gearshift lever in P (Park) or R (manual transaxle), turn engine OFF, and block the wheel diagonally opposite from the flat tire.

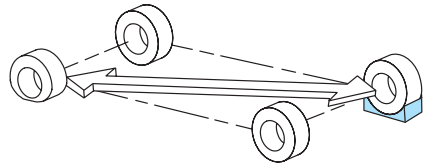

Roadside emergencies

3. Remove the spare tire by loosening the tie down bolt in a counterclockwise direction. Take note of the jack position before removal in order to assist in restowing when finished. The jack can be removed by loosening the jack tie down bolt in the counterclockwise direction.

The lug wrench is located under the spare tire (Sedan and Coupe) and on the underside of the access cover on Wagons.

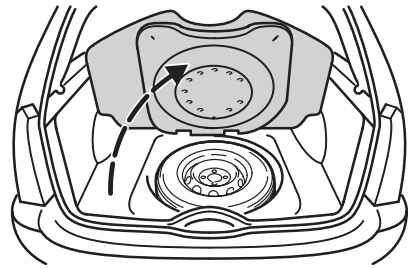
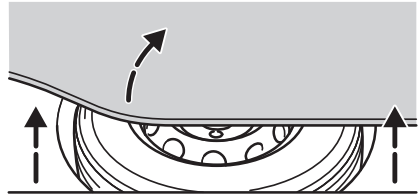

On Coupe models, remove the access door (if equipped) on the lower rocker moulding by unsnapping. This allows access to the proper jack lift points.

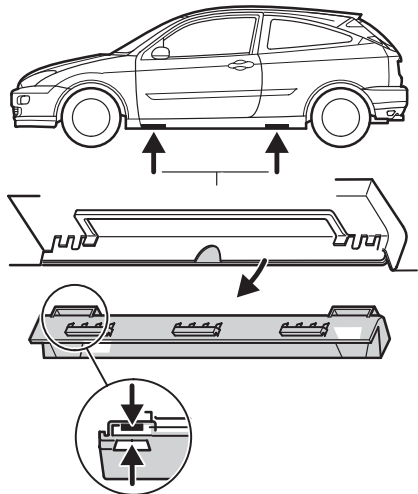

Roadside emergencies

4. Remove the center cap or wheel cover. Loosen each wheel lug nut one-half turn counterclockwise but do not remove them until the wheel is raised off the ground.

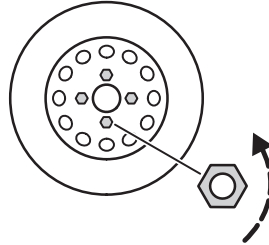

5. The vehicle jacking points are depicted on the yellow warning label on the jack shown here. Locate the jack at the half moon cutout located

- approximately 15 cm (6 inches) from the front wheel opening (1).
- approximately 38 cm (15 inches) from the rear wheel opening (2).

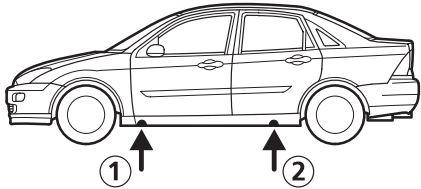
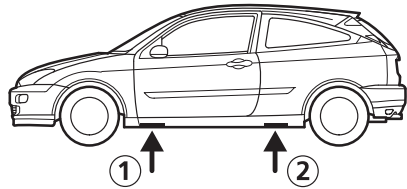

Jack at the specified locations to avoid damage to the vehicle.

Turn the jack handle counterclockwise to lower the jack until it can be inserted under the vehicle at the jacking point.

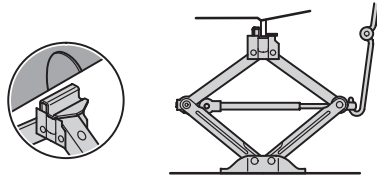

Turn the jack handle clockwise to raise the jack. While raising the jack, be sure the body flange engages the slot on top of jack as shown.

Turn the jack handle clockwise until the wheel is completely off the ground.

Roadside emergencies

In a heavily loaded vehicle condition and/or unusual emergency conditions such as the loss of the tire from the wheel rim, the vehicle may be resting so close to the ground that it may be difficult to insert the jack under the vehicle at the specified jacking location. In this event, insert the jack under the vehicle at a point forward or rearward of the jacking location and slide it into the correct jacking position location.



To lessen the risk of personal injury, do not put any part of your body under the vehicle while changing a tire. Do not start the engine when your vehicle is on the jack. The jack is only meant for changing the tire.

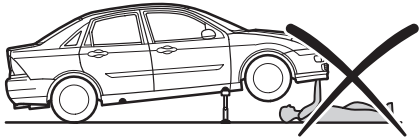

Do not use the suspension as a jacking point.

Roadside emergencies

6. Remove the lug nuts with the lug wrench.
7. Replace the flat tire with the spare tire, making sure the valve stem is facing outward. Reinstall lug nuts until the wheel is snug against the hub. Do not fully tighten the lug nuts until the wheel has been lowered.

When using a temporary tire, the lug nut washers will not appear to be flush with the rim. This is normal when using the temporary spare tire only.

8. Lower the wheel by turning the jack handle counterclockwise.
9. Remove the jack and fully tighten the lug nuts.
10. Put flat tire, jack and lug wrench away. Make sure jack and flat tire are fastened so they do not rattle when you drive.

To restow the jack, adjust the jack to the half raised position. The jack has been correctly adjusted for restowage when the tip of the jack screw extends 1 inch beyond the edge on the jack channel as shown. Reposition the jack under the spare and fasten with the hold down screw. Reinstall the spare tire and lug wrench and fasten into position.

11. On Coupe models, reinstall lower rocker moulding access door (if equipped).
12. Unblock the wheels.

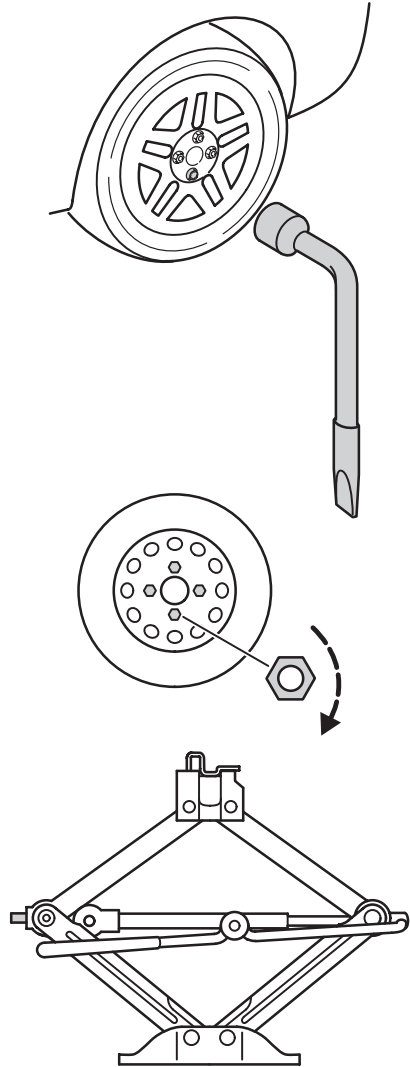

Roadside emergencies

JUMP STARTING YOUR VEHICLE



The gases around the battery can explode if exposed to flames, sparks, or lit cigarettes. An explosion could result in injury or vehicle damage.



Do not push start your vehicle. You could damage the catalytic converter.



Batteries contain sulfuric acid which burns skin, eyes, and clothing, if contacted.

Do not attempt to push start your vehicle. Automatic transaxles do not have push-start capability.

Preparing your vehicle

- 1. Use only a 12-volt supply to start your vehicle.**
2. Do not disconnect the battery of your disabled vehicle as this could damage the vehicle's electrical system.

Roadside emergencies

3. Park the booster vehicle close to the hood of your disabled vehicle, making sure the two vehicles **do not** touch. Set the parking brake on both vehicles and stay clear of the engine cooling fan and other moving parts.
4. Check all battery terminals and remove any excessive corrosion before you attach the battery cables.
5. Turn the heater fan on in both vehicles to protect from electrical surges. Turn all other accessories off.

Connecting the jumper cables

1. Connect the positive (+) booster cable to the positive (+) terminal of the discharged battery.

Note: In the illustrations, *lightning bolts* are used to designate the assisting (boosting) battery.

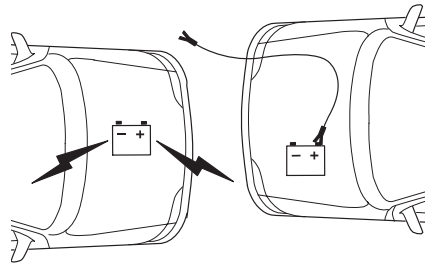

Roadside emergencies

2. Connect the other end of the positive (+) cable to the positive (+) terminal of the assisting battery.

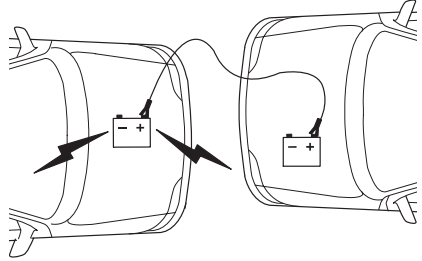

3. Connect the negative (-) cable to the negative (-) terminal of the assisting battery.

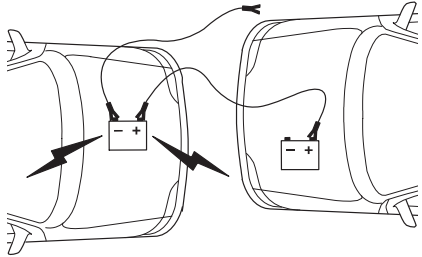

Roadside emergencies

4. Make the final connection of the negative (-) cable to an exposed metal part of the stalled vehicle's engine, away from the battery.

Do not use fuel lines, engine rocker covers, or the intake manifold as *grounding* points.



Do not connect the end of the second cable to the negative (-) terminal of the battery to be jumped. A spark may cause an explosion of the gases that surround the battery.

- 2.0 litre Zetec engine

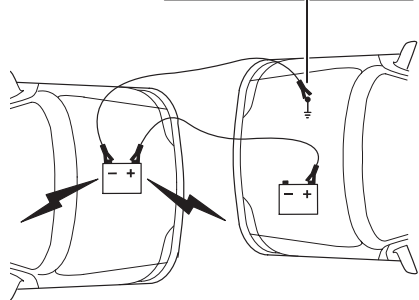
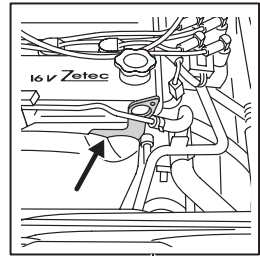
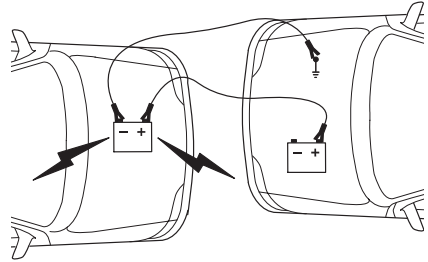

Roadside emergencies

- 2.0 litre SPI engine
5. Be sure that the cables are clear of fan blades, belts and other moving parts of both engines.

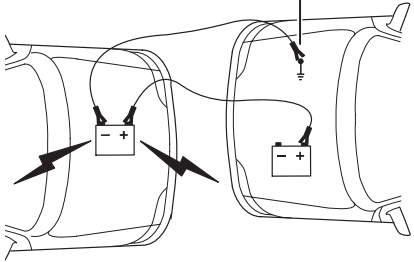
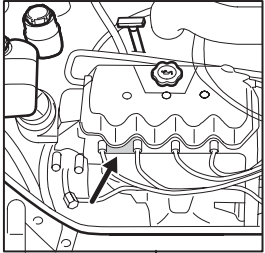

Roadside emergencies

Jump starting

1. Start the engine of the booster vehicle and run the engine at a moderately increased speed.
2. Start the engine of the disabled vehicle.
3. Once the disabled vehicle has been started, run both engines for a further three minutes before disconnecting the jumper cables.

Removing the jumper cables

Remove the jumper cables in the reverse order that they were connected.

1. Remove the jumper cable from the *ground* metal surface.

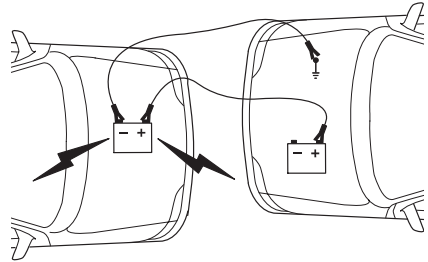

Roadside emergencies

2. Remove the jumper cable on the negative (-) connection of the booster vehicle's battery.

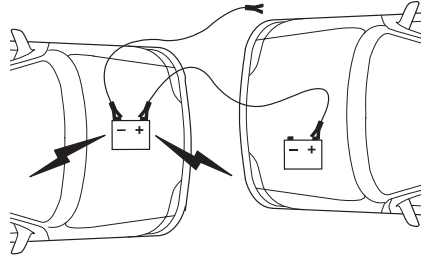

3. Remove the jumper cable from the positive (+) terminal of the booster vehicle's battery.

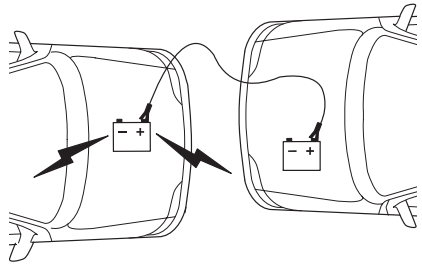

4. Remove the jumper cable from the positive (+) terminal of the disabled vehicle's battery.

After the disabled vehicle has been started and the jumper cables removed, allow it to idle for several minutes so the engine computer can *relearn* its idle conditions.

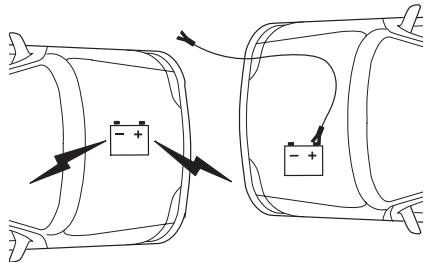

Roadside emergencies

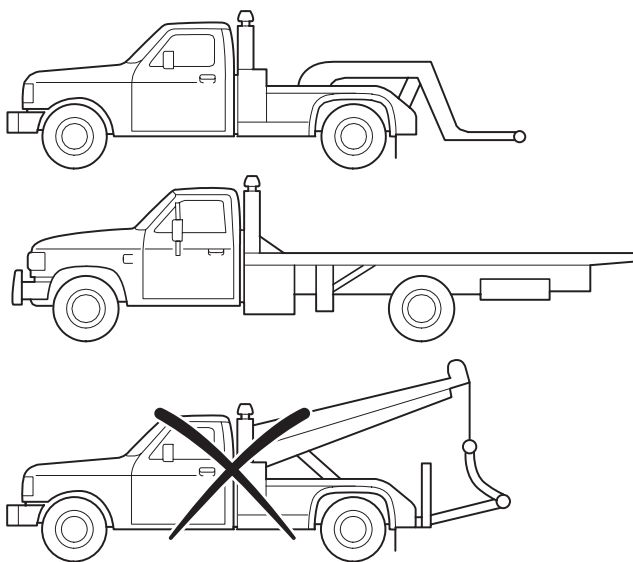

WRECKER TOWING

If you need to have your vehicle towed, contact a professional towing service or, if you are a member, your roadside assistance center.

It is recommended that your vehicle be towed with a wheel lift or flatbed equipment. Do not tow with a slingbelt. Ford Motor Company has not approved a slingbelt towing procedure.

Roadside emergencies

If your vehicle is to be towed from the rear using wheel lift equipment, the front wheels (drive wheels) must be placed on a dolly to prevent damage to the transaxle.

Ford Motor Company provides a towing manual for all authorized tow truck operators. Have your tow truck operator refer to this manual for proper hook-up and towing procedures for your vehicle.

In case of a roadside emergency with a disabled vehicle (without access to wheel dollies, car hauling trailer or flatbed transport vehicle) your vehicle can be flat towed (all wheels on the ground) under the following conditions:

- The transmission is placed in N (Neutral).
- Maximum speed is 56 km/h (35 mph).
- Maximum distance is 80 km (50 miles).

SERVICE RECOMMENDATIONS

To help you service your vehicle:

- We highlight do-it-yourself items in the engine compartment for easy location.
- We provide a “Scheduled Maintenance Guide” which makes tracking routine service easy.

If your vehicle requires professional service, your dealership can provide necessary parts and service. Check your “Warranty Guide” to find out which parts and services are covered.

Use only recommended fuels, lubricants, fluids and service parts conforming to specifications. Motorcraft parts are designed and built to provide the best performance in your vehicle.

PRECAUTIONS WHEN SERVICING YOUR VEHICLE

Be especially careful when inspecting or servicing your vehicle.

- Do not work on a hot engine.
- When the engine is running, keep loose clothing, jewelry or long hair away from moving parts.

Maintenance and care

- Do not work on a vehicle with the engine running in an enclosed space, unless you are sure you have enough ventilation.
- Keep all lit cigarettes, open flames and other lit material away from the battery and all fuel related parts.

If you disconnect the battery, the engine must “relearn” its idle conditions before your vehicle will drive properly, as explained under the *Battery* section in this chapter.

OPENING THE HOOD

1. Inside the vehicle, pull the hood release handle located at the bottom of the instrument panel below the steering wheel.
2. Go to the front of the vehicle and release the auxiliary latch that is located under the front of the hood.
3. Lift the hood and support it with the yellow end of its strut in the holes in the hood ensuring it is secure.
4. To close, replace the support strut in its retaining clip, lower the hood and allow it to drop into the catch for at least 20 – 30 cm (8 – 12 inches).

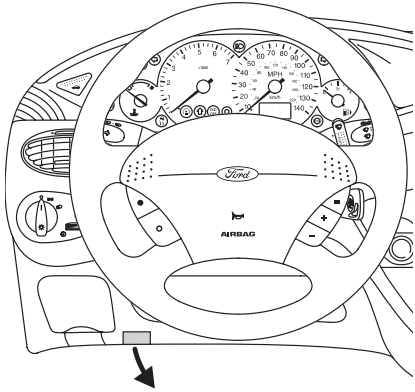

Maintenance and care

IDENTIFYING COMPONENTS IN THE ENGINE COMPARTMENT

2.0 SPI engine

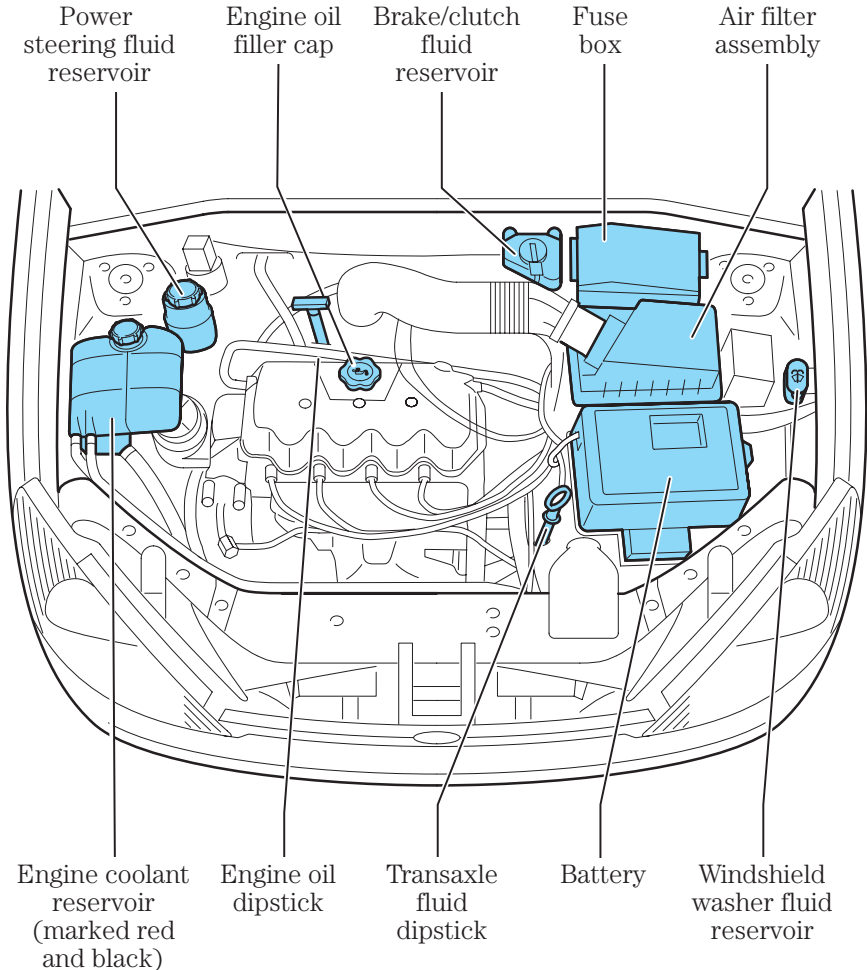

For ease of identification, most filler caps and the engine oil dipstick are marked yellow and black.

Maintenance and care

IDENTIFYING COMPONENTS IN THE ENGINE COMPARTMENT

2.0 Zetec-E engine

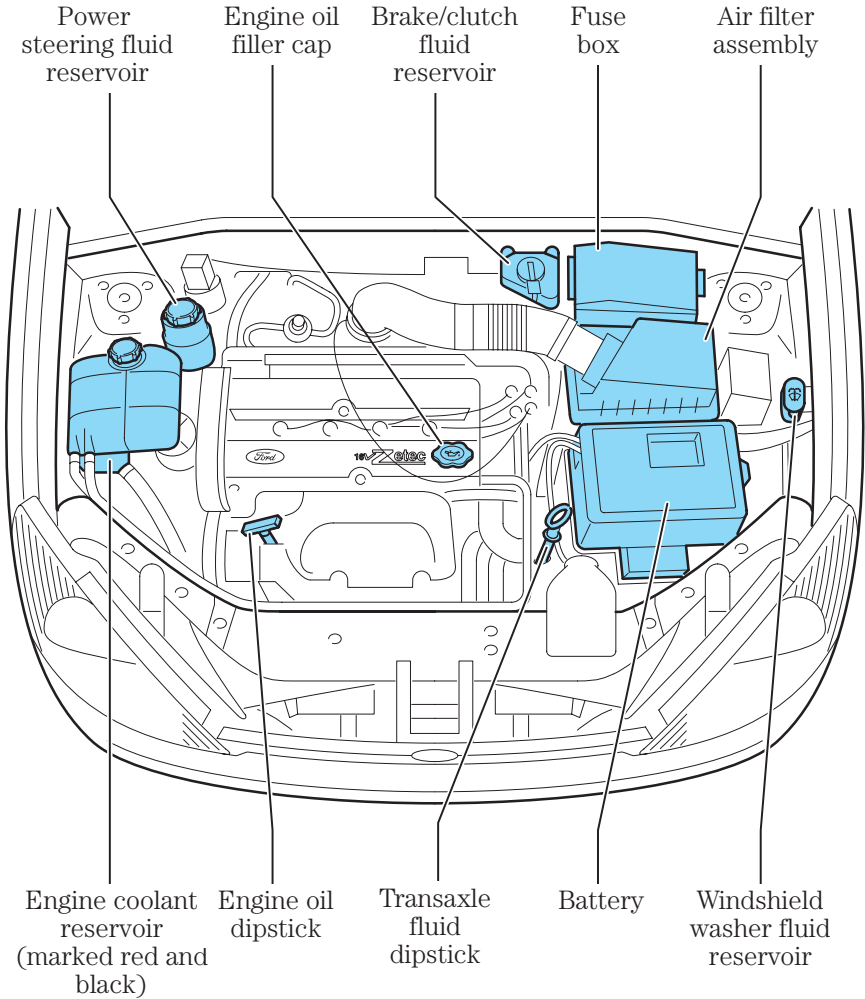

For ease of identification, most filler caps and the engine oil dipstick are marked yellow and black.

ENGINE OIL

Checking the engine oil

Refer to the “Scheduled Maintenance Guide” for the appropriate intervals for checking the engine oil.

1. Make sure the vehicle is on level ground.
2. Turn the engine off and wait a few minutes for the oil to drain into the oil pan.
3. Set the parking brake and ensure the gearshift is securely latched in P (Park) (automatic transaxle) or 1 (First) (manual transaxle).
4. Open the hood. Protect yourself from engine heat.
5. Locate and carefully remove the engine oil level indicator (dipstick).
6. Wipe the indicator clean. Insert the indicator fully, then remove it again.

Maintenance and care

- If the oil level is **between the MIN and MAX marks** (2.0 SPI engine) or **between ADD and FULL** (2.0 Zetec-engine), the oil level is acceptable. **DO NOT ADD OIL.**
 - If the oil level is below the MIN mark, add enough oil to raise the level within the MIN–MAX range.
 - Oil levels above the MAX mark may cause engine damage. Some oil must be removed from the engine by a service technician.
7. Put the indicator back in and ensure it is fully seated.

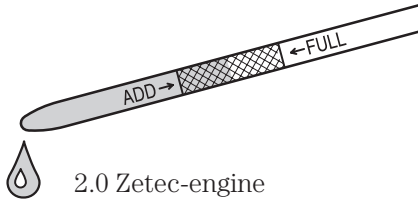
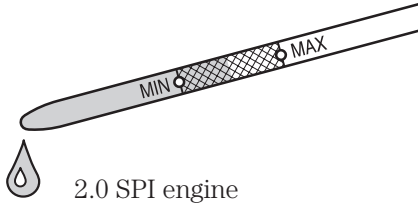

Adding engine oil

1. Check the engine oil. For instructions, refer to *Checking the engine oil* in this chapter.
2. If the engine oil level is not within the MIN and MAX ranges, add only certified engine oil of the recommended viscosity. Remove the engine oil filler cap and use a funnel to pour the engine oil into the opening.
3. Recheck the oil level. **Make sure the oil level is not above the MAX mark** (2.0 SPI engine) **or the FULL mark** (2.0 Zetec-engine) **on the dipstick.**
4. Replace oil filler cap and ensure it is fully tightened.

Maintenance and care

Engine oil and filter recommendations

Look for this certification trademark.

SAE 5W-20 engine oil is recommended.

Use oils “Certified For Gasoline Engines” by the American Petroleum Institute (API).

Use Motorcraft or an equivalent oil meeting Ford specification WSS-M2C153-H.

SAE 5W-20 oil provides optimum fuel economy and durability performance meeting all requirements for your vehicle’s engine.

Do not use supplemental engine oil additives, oil treatments or engine treatments. They are unnecessary and could, under certain conditions, lead to engine damage which is not covered by your warranty.

Change your engine oil and filter according to the appropriate schedule listed in the scheduled maintenance guide.

Ford production and aftermarket (Motorcraft) oil filters are designed for added engine protection and long life. If a replacement oil filter is used that does not meet Ford material and design specifications, start-up engine noises or knock may be experienced.

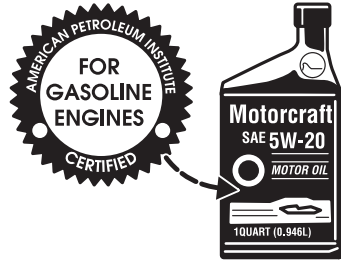

Maintenance and care

It is recommended you use the appropriate Motorcraft oil filter (or another brand meeting Ford specifications) for your engine application.

CLUTCH FLUID (if equipped)

Check the clutch fluid level. Refer to the “Scheduled Maintenance Guide” for the service interval schedules.

The clutch master cylinder and brake master cylinder are part of the same system; both are refillable through the brake master cylinder with brake fluid. During normal operation, the fluid level in the brake fluid reservoir should remain constant. For more information on brake fluid maintenance, refer to *Brake fluid* in this chapter.

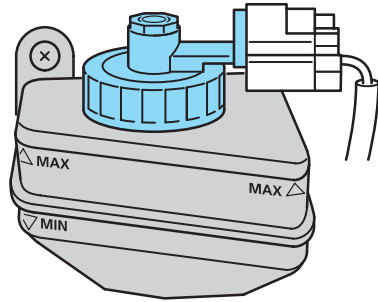

Maintenance and care

BRAKE FLUID

Checking and adding brake fluid

Brake fluid should be checked and refilled as needed. Refer to the “Scheduled Maintenance Guide” for the service interval schedules:

1. Clean the reservoir cap before removal to prevent dirt or water from entering the reservoir.
2. Visually inspect the fluid level.
3. If necessary, add brake fluid until the level reaches MAX. Do not fill above this line.
4. Use only brake fluids certified to meet Ford specifications. Refer to *Lubricant specifications* in the *Capacities and specifications* chapter. Use only DOT 3 or DOT 4 brake fluid from a sealed container.

Note: for service, Ford recommends the use of Super DOT 4 brake fluid (Ford specification Delta ESD-M6C57-A) for all vehicles equipped with manual transaxles.



Brake fluid is toxic.



If you use DOT 5 or any other brake fluid that is not DOT 3 or DOT 4, you will cause permanent damage to your brakes.



Do not let the reservoir for the master cylinder run dry. This may cause the brakes to fail.

Maintenance and care

WINDSHIELD WASHER FLUID

Checking and adding washer fluid



Check the washer fluid whenever you stop for fuel.

If the level is low, add enough fluid to fill the reservoir. In very cold weather, do not fill the reservoir all the way.

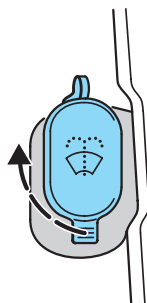

Do not put engine coolant in the container for the windshield washer fluid.

ENGINE COOLANT

Check the level of the engine coolant in the reservoir. Refer to the “Scheduled Maintenance Guide” for the service interval schedules. Be sure to read and understand *Precautions when servicing your vehicle* in this chapter.

If the engine coolant has not been checked at the above recommended interval, the engine coolant reservoir may become empty. If this occurs, add engine coolant to the reservoir. For more information on engine coolant maintenance, refer to *Adding engine coolant* in this chapter.

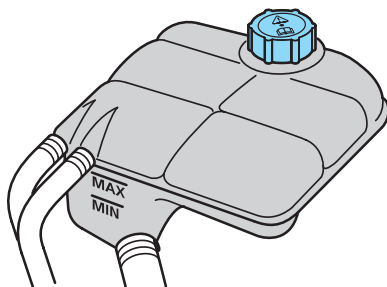

Maintenance and care

If the engine coolant reservoir has become completely empty, have the engine cooling system inspected and refilled by a qualified service technician.

Automotive fluids are not interchangeable; do not use engine coolant, antifreeze or windshield washer fluid outside of its specified function and vehicle location.

Adding engine coolant



Do not add engine coolant when the engine is hot.

Steam and scalding liquids released from a hot cooling system can burn you badly. Also, you can be burned if you spill coolant on hot engine parts.



Do not put engine coolant in the windshield washer fluid container. If sprayed on the windshield, engine coolant could make it difficult to see through the windshield.

The cooling system in your vehicle is filled with either green-colored Motorcraft Premium Engine Coolant meeting Ford specification ESE-M97B44-A or yellow-colored Motorcraft Premium Gold Engine Coolant meeting Ford specification WSS-M97B51-A1. To determine your vehicle's coolant type (color), check your coolant reservoir.

Maintenance and care

Before adding engine coolant, check the color of the coolant in your vehicle.

Add Motorcraft Premium Engine Coolant (green-colored), VC-4-A (U.S.) or CXC-10 (Canada) or Motorcraft Premium Gold Engine Coolant (yellow-colored), VC-7-A, depending on the type of coolant originally equipped in your vehicle. If you are unsure which type of coolant your vehicle requires, check your coolant reservoir or contact your local dealer.

Do not add/mix an orange-colored, extended life coolant such as Motorcraft Speciality Orange Engine Coolant, VC-2 (U.S.) or CXC-209 (Canada), meeting Ford specification WSS-M97B44-D with the factory-filled coolant. Mixing Motorcraft Speciality Orange Engine Coolant or any orange-colored extended life product with your factory-filled coolant can result in degraded corrosion protection.

Maintenance and care

A large amount of water without engine coolant may be added, in case of emergency, to reach a vehicle service location. In this instance, the cooling system must be drained and refilled with a 50/50 mixture of engine coolant and distilled water as soon as possible. Water alone (without engine coolant) can cause engine damage from corrosion, overheating or freezing.

Do not use alcohol, methanol or brine or any engine coolants mixed with alcohol or methanol antifreeze (coolant). Alcohol and other liquids can cause engine damage from overheating or freezing.

Do not add extra inhibitors or additives to the coolant. These can be harmful and compromise the corrosion protection of the engine coolant.

Maintenance and care

Recycled engine coolant

Ford Motor Company recommends that Ford dealers use recycled engine coolant produced by Ford-approved processes.



Always dispose of used automotive fluids in a responsible manner. Follow your community's regulations and standards for recycling and disposing of automotive fluids.

Coolant refill capacity

To find out how much fluid your vehicle's cooling system can hold, refer to *Refill capacities* in the *Capacities and specifications* chapter.

Have your dealer check the engine cooling system for leaks if you have to add more than 1.0 liter (1.0 quart) of engine coolant per month.

Maintenance and care

Severe winter climate

If you drive in extremely cold climates (less than -36°C [-34°F]), it may be necessary to increase the coolant concentration above 50%. Refer to the chart on the coolant container to ensure the coolant concentration in your vehicle is such that the coolant will not freeze at the temperature level in which you drive during the winter months. Never increase the engine coolant concentration above 60%. Leave a 50/50 mixture of engine coolant and water in your vehicle year-round in non-extreme climates.

What you should know about fail-safe cooling (2.0 L Zetec engines only)

If the engine coolant supply is depleted, this feature allows the vehicle to be driven temporarily before incremental component damage is incurred. The “fail-safe” distance depends on ambient temperatures, vehicle load and terrain.

Maintenance and care

How fail-safe cooling works

If the engine begins to overheat:

- the engine coolant temperature gauge will move to the red area.
- the *Multi-function warning light: automatic transaxle/cooling system* will illuminate.

If the engine reaches a preset over-temperature condition, the engine will automatically switch to alternating cylinder operation. Each disabled cylinder acts as an air pump and cools the engine.

When this occurs the vehicle will still operate, however:

- the engine power will be limited.
- the air conditioning system will be disabled.
- the *Check engine* warning light also illuminates.

Continued operation will increase the engine temperature and the engine will completely shut down, causing steering and braking effort to increase.

Once the engine temperature cools, the engine can be re-started. Take your vehicle to a service facility as soon as possible to minimize engine damage.

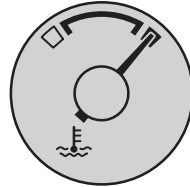

Maintenance and care

When fail-safe mode is activated

You have limited engine power when in the fail-safe mode, so drive the vehicle with caution. The vehicle will not be able to maintain high-speed operation and the engine will run rough. Remember that the engine is capable of completely shutting down automatically to prevent engine damage, therefore:

1. Pull off the road as soon as safely possible and turn off the engine.
2. Arrange for the vehicle to be taken to a service facility.
3. If this is not possible, wait until the engine has cooled.
4. Check the coolant level and replenish if low.



Never remove the coolant reservoir cap while the engine is running or hot.

5. Re-start the engine and take your vehicle to a service facility.



Driving the vehicle without repairing the engine problem increases the chance of engine damage. Take your vehicle to a service facility as soon as possible.

Maintenance and care

CHECKING AND ADDING POWER STEERING FLUID

Check the power steering fluid. Refer to the “Scheduled Maintenance Guide” for the service interval schedules. If adding fluid is necessary, use only MERCON® ATF.

1. The power steering fluid level should be checked before starting the engine.
2. Check the fluid level in the reservoir. It should be between the MIN and MAX lines. Do not add fluid if the level is in this range.
3. If the fluid is low, add fluid in small amounts, continuously checking the level until it reaches the range between the MIN and MAX lines. Be sure to put the cap back on the reservoir.



TRANSAXLE FLUID

Checking automatic transaxle fluid

Refer to your “Scheduled Maintenance Guide” for scheduled intervals for fluid checks and changes. Your transaxle does not consume fluid. However, the fluid level should be checked if the transaxle is not working properly, i. e., if the transaxle slips or shifts slowly or if you notice some sign of fluid leakage.

Automatic transaxle fluid expands when warmed. To obtain an accurate fluid check, drive the vehicle until it is warmed up (approximately 30 km [20 miles]). If your vehicle has been operated for an extended period at high speeds, in city traffic during hot weather or pulling a trailer, the vehicle should be turned off for about 30 minutes to allow fluid to cool before checking.

1. Drive the vehicle 30 km (20 miles) or until it reaches normal operating temperature.
2. Park the vehicle on a level surface and engage the parking brake.

Maintenance and care

3. With the parking brake engaged and your foot on the brake pedal, start the engine and move the gearshift lever through all of the gear ranges. Allow sufficient time for each gear to engage.
4. Latch the gearshift lever in P (Park) and leave the engine running.
5. Remove the dipstick, wiping it clean with a clean, dry lint free rag.
6. Install the dipstick making sure it is fully seated in the filler tube.
7. Remove the dipstick and inspect the fluid level. The fluid should be in the designated areas indicated by the figure to the right.

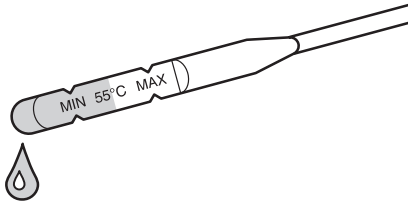

Low fluid level

Do not drive the vehicle if the fluid level is at the bottom of the dipstick and the outside temperatures are above 10°C (50°F).

Correct fluid level

The transaxle fluid should be checked at normal operating temperatures of 50°C-60°C (120°F-140°F) on a level surface. The transaxle fluid should be within the MIN and MAX marks shown on the indicator.

Maintenance and care

High fluid level

Fluid levels above the safe range may result in transaxle failure. An overfill condition of transaxle fluid may cause shift and/or engagement concerns and/or possible damage.

High fluid levels can be caused by overheated or aerated fluid. This can be caused by operating for an extended period at high speeds, in city traffic during hot weather, pulling a trailer, aggressive braking or aggressive steering maneuvers. If this occurs turn the vehicle off for about 30 minutes. This will allow the transaxle to return to normal operating conditions. Recheck the fluid level before correction of the overfill condition.

Adjusting automatic transaxle fluid levels

Before adding any fluid, make sure the correct type is used. The type of fluid used is normally indicated on the dipstick and/or dipstick handle and also in the *Lubricant specifications* section in the *Capacities and specifications* chapter.

Use of a non-approved automatic transaxle fluid may cause internal transaxle component damage.

If necessary, add fluid in 250 ml (1/2 pint) increments through the filler tube until the level is correct.

If an overfill occurs, excess fluid should be removed by a qualified technician.

An overfill condition of transaxle fluid may cause shift and/or engagement concerns and/or possible damage.

Maintenance and care

BATTERY

Your vehicle is equipped with a Motorcraft maintenance-free battery which normally does not require additional water during its life of service.

However, for severe usage or in high temperature climates, check the battery electrolyte level. Refer to the “Scheduled Maintenance Guide” for the service interval schedules.

If the electrolyte level in the battery is low, you can add plain tap water to the battery, as long as you do not use hard water (water with a high mineral or alkali content). If possible, however, try to only fill the battery cells with distilled water. If the battery needs water often, have the charging system checked.

Keep the electrolyte level in each cell up the the “level indicator”. Do not overfill the battery cells.

For longer, trouble-free operation, keep the top of the battery clean and dry. Also, make certain the battery cables are always tightly fastened to the battery terminals.

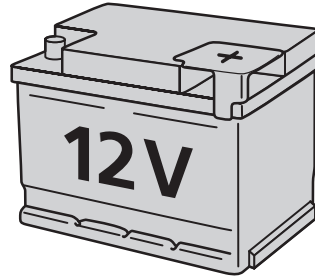

Maintenance and care

If you see any corrosion on the battery cables or terminals, remove the cables from the terminals and clean with a wire brush. You can neutralize the acid with a solution of baking soda and water. Reinstall the cables when you are done cleaning them, and apply a small quantity of grease to the top of each battery terminal to help prevent corrosion.

If your battery has a cover/shield, make sure it is reinstalled after the battery has been cleaned or replaced.



Batteries normally produce explosive gases which can cause personal injury. Therefore, do not allow flames, sparks or lighted substances to come near the battery. When working near the battery, always shield your face and protect your eyes. Always provide proper ventilation.

Maintenance and care

 When lifting a plastic-cased battery, excessive pressure on the end walls could cause acid to flow through the vent caps, resulting in personal injury and/or damage to the vehicle or battery. Lift the battery with a battery carrier or with your hands on opposite corners.

 Keep batteries out of reach of children. Batteries contain sulfuric acid. Avoid contact with skin, eyes or clothing. Shield your eyes when working near the battery to protect against possible splashing of acid solution. In case of acid contact with skin or eyes, flush immediately with water for a minimum of 15 minutes and get prompt medical attention. If acid is swallowed, call a physician immediately.

 Battery posts, terminals and related accessories contain lead and lead compounds. **Wash hands after handling.**

Because your vehicle's engine is electronically controlled by a computer, some control conditions are maintained by power from the battery. When the battery is disconnected or a new battery is installed, the engine must relearn its idle conditions before your vehicle will drive properly. To begin this process:

Maintenance and care

1. Set your parking brake.
2. Put the gearshift in P (Park) (automatic transaxle) or the neutral position (manual transaxle). Turn off all accessories and start the engine.
3. Let the engine idle for at least one minute.
4. The relearning process will automatically complete as you drive the vehicle.
 - If you do not allow the engine to relearn its idle, the idle quality of your vehicle may be adversely affected until the idle is eventually relearned.
 - If the battery has been disconnected or if a new battery has been installed, the clock and preset radio stations must be reset once the battery is reconnected.



Always dispose of automotive batteries in a responsible manner. Follow your local authorized standards for disposal. Call your local authorized recycling center to find out more about recycling automotive batteries.

Maintenance and care

WINDSHIELD WIPER BLADES

Change the wiper blades on your vehicle at least twice a year or when they seem less effective. Substances such as tree sap and some hot wax treatments used by commercial car washes reduce the effectiveness of wiper blades.

Checking the wiper blades

If the wiper blades do not wipe properly, clean both the windshield and wiper blades using undiluted windshield wiper solution or a mild detergent. Rinse thoroughly with clean water. To avoid damaging the blades, do not use fuel, kerosene, paint thinner or other solvents.

Changing the wiper blades

To replace the wiper blades:

1. Pull the wiper arm away from the windshield and lock into the service position.
2. Turn the blade at an angle from the wiper arm. Push the lock pin manually to release the blade and pull the wiper blade down toward the windshield to remove it from the arm.
3. Attach the new wiper to the wiper arm and press it into place until a click is heard.

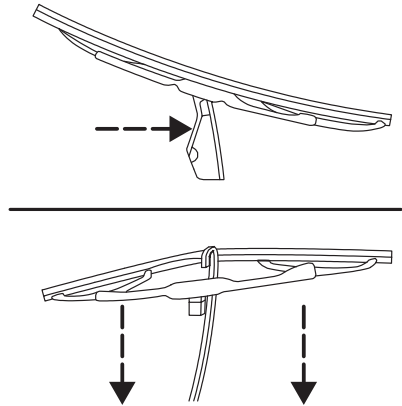

Maintenance and care

INFORMATION ABOUT UNIFORM TIRE QUALITY GRADING

New vehicles are fitted with tires that have a rating on them called Tire Quality Grades. The Quality grades can be found where applicable on the tire sidewall between tread shoulder and maximum section width. For example:

- **Treadwear 200 Traction AA Temperature A**

These Tire Quality Grades are determined by standards that the United States Department of Transportation has set.

Tire Quality Grades apply to new pneumatic tires for use on passenger cars. They do not apply to deep tread, winter-type snow tires, space-saver or temporary use spare tires, tires with nominal rim diameters of 10 to 12 inches or limited production tires as defined in Title 49 Code of Federal Regulation Part 575.104(c)(2).

U.S. Department of Transportation-Tire quality grades: The U.S. Department of Transportation requires Ford to give you the following information about tire grades exactly as the government has written it.

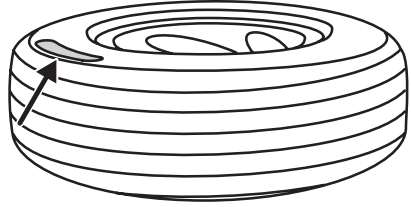

Maintenance and care

Treadwear

The treadwear grade is a comparative rating based on the wear rate of the tire when tested under controlled conditions on a specified government test course. For example, a tire grade 150 would wear one and one-half (1 1/2) times as well on the government course as a tire grade 100. The relative performance of tires depends upon the actual conditions of their use, however, and may depart significantly from the norm due to variations in driving habits, service practices, and differences in road characteristics and climate.

Traction AA A B C

The traction grades, from highest to lowest are AA, A, B, and C. Those grades represent the tire's ability to stop on wet pavement as measured under controlled conditions on specified government test surfaces of asphalt and concrete. A tire marked C may have poor traction performance.



The traction grade assigned to this tire is based on straight-ahead braking traction tests, and does not include acceleration, cornering, hydroplaning, or peak traction characteristics.

Maintenance and care

Temperature A B C

The temperature grades are A (the highest), B, and C, representing the tire's resistance to the generation of heat and its ability to dissipate heat when tested under controlled conditions on a specified indoor laboratory test wheel. Sustained high temperature can cause the material of the tire to degenerate and reduce tire life, and excessive temperature can lead to sudden tire failure. The grade C corresponds to a level of performance which all passenger car tires must meet under the Federal Motor Vehicle Safety Standard No. 109. Grades B and A represent higher levels of performance on the laboratory test wheel than the minimum required by law.



The temperature grade for this tire is established for a tire that is properly inflated and not overloaded. Excessive speed, underinflation, or excessive loading, either separately or in combination, can cause heat buildup and possible tire failure.

Maintenance and care

SERVICING YOUR TIRES

Checking the tire pressure

- Use an accurate tire pressure gauge.
- Check the tire pressure when tires are cold, after the vehicle has been parked for at least one hour or has been driven less than 5 km (3 miles).
- Adjust tire pressure to recommended specifications found on the label located on the rear most driver-side door jamb.



Improperly inflated tires can affect vehicle handling and can fail suddenly, possibly resulting in loss of vehicle control.

Tire rotation

Because your vehicle's tires perform different jobs, they often wear differently. To make sure your tires wear evenly and last longer, rotate them as indicated in the "Scheduled Maintenance Guide". If you notice that the tires wear unevenly, have them checked.

- Four tire rotation

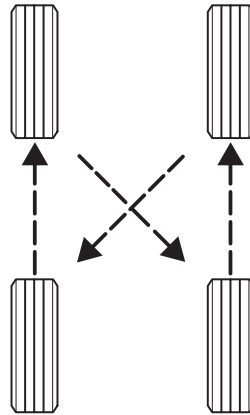

Maintenance and care

Replacing the tires

Replace tires when the wear band is visible through the tire treads.



When replacing full size tires, never mix radial, bias-belted, or bias-type tires. Use only the tire sizes that are listed on the Certification Label. Make sure that all tires are the same size, speed rating, and load-carrying capacity. Use only the tire combinations recommended on the label. If you do not follow these precautions, your vehicle may not drive properly and safely.

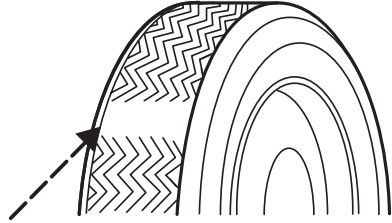

Make sure that all replacement tires are of the same size, type, load-carrying and tread design (e.g., “All Terrain”, etc.), as originally offered by Ford.



Failure to follow these precautions may adversely affect the handling of the vehicle and make it easier for the driver to lose control and roll over.

Tires that are larger or smaller than your vehicle’s original tires may also affect the accuracy of your speedometer.

Maintenance and care

SNOW TIRES AND CHAINS



Snow tires must be the same size and grade as the tires you currently have on your vehicle.

The tires on your vehicle have all-weather treads to provide traction in rain and snow. However, in some climates, you may need to use snow tires and chains. If you need to use chains, it is recommended that steel wheels (of the same size and specifications) be used as chains may chip aluminum wheels.

Vehicles with AdvanceTrac[™] (if equipped) may exhibit some unusual driving characteristics, when using snow chains, which can be avoided by switching AdvanceTrac[™] off.

Follow these guidelines when using snow tires and chains:

Snow chains should only be fitted to size P 185/65 R14 tires.

Snow chains should never be used on the spare tire.

Maintenance and care

- Use only SAE Class S chains.
- Install chains securely, verifying that the chains do not touch any wiring, brake lines or fuel lines.
- Drive cautiously. If you hear the chains rub or bang against your vehicle, stop and re-tighten the chains. If this does not work, remove the chains to prevent damage to your vehicle.
- If possible, avoid fully loading your vehicle.
- Remove the tire chains when they are no longer needed. Do not use tire chains on dry roads.
- The suspension insulation and bumpers will help prevent vehicle damage. Do not remove these components from your vehicle when using snow tires and chains.

Maintenance and care

WHAT YOU SHOULD KNOW ABOUT AUTOMOTIVE FUELS

Important safety precautions



Do not overfill the fuel tank. The pressure in an overfilled tank may cause leakage and lead to fuel spray and fire.



If you do not use the proper fuel cap, the pressure in the fuel tank can damage the fuel system or cause it to work improperly in a collision.



The fuel system may be under pressure. If the fuel cap is venting vapor or if you hear a hissing sound, wait until it stops before completely removing the cap.



Automotive fuels can cause serious injury or death if misused or mishandled.

Maintenance and care

Observe the following guidelines when handling automotive fuel:

- Extinguish all smoking materials and any open flames before fueling your vehicle.
- Always turn off the vehicle before fueling.
- Automotive fuels can be harmful or fatal if swallowed. Fuel such as gasoline is highly toxic and if swallowed can cause death or permanent injury. If fuel is swallowed, call a physician immediately, even if no symptoms are immediately apparent. The toxic effects of fuel may not be visible for hours.
- Avoid inhaling fuel vapors. Inhaling too much fuel vapor of any kind can lead to eye and respiratory tract irritation. In severe cases, excessive or prolonged breathing of fuel vapor can cause serious illness and permanent injury.
- Avoid getting fuel liquid in your eyes. If fuel is splashed in the eyes, remove contact lenses (if worn), flush with water for 15 minutes and seek medical attention. Failure to seek proper medical attention could lead to permanent injury.



Maintenance and care

- Fuels can also be harmful if absorbed through the skin. If fuel is splashed on the skin and/or clothing, promptly remove contaminated clothing and wash skin thoroughly with soap and water. Repeated or prolonged skin contact with fuel liquid or vapor causes skin irritation.
- Be particularly careful if you are taking “Antabuse” or other forms of disulfiram for the treatment of alcoholism. Breathing gasoline vapors or skin contact could cause an adverse reaction. In sensitive individuals, serious personal injury or sickness may result. If fuel is splashed on the skin, promptly wash skin thoroughly with soap and water. Consult a physician immediately if you experience an adverse reaction.

Maintenance and care

Fuel filler cap

After refueling, if the *Check fuel cap* indicator comes on and stays on when you start the engine, the fuel filler cap may not be properly installed. Turn off the engine, remove the fuel filler cap, align the cap properly and reinstall it securely. The *Check fuel cap* indicator should turn off after three driving cycles with the fuel filler cap properly installed. A driving cycle consists of a cold engine start-up followed by mixed city/highway driving.

If you must replace the fuel filler cap, replace it with a fuel filler cap that is designed for your vehicle. The customer warranty may be void for any damage to the fuel tank or fuel system if the correct genuine Ford or Motorcraft fuel filler cap is not used.



The fuel system may be under pressure. If the fuel filler cap is venting vapor or if you hear a hissing sound, wait until it stops before completely removing the fuel filler cap. Otherwise, fuel may spray out and injure you or others.



If you do not use the proper fuel filler cap, excessive pressure or vacuum in the fuel tank may damage the fuel system or cause the fuel cap to disengage in a collision, which may result in possible personal injury.

Fuel filler cap lock (if equipped)

Your vehicle may be equipped with a locking fuel filler cap.

When fueling your vehicle:

1. Turn the engine off.
2. Open the fuel filler flap.
3. Unlock the fuel filler cap, using the key and turn cap counterclockwise to remove.
4. To close, turn the cap clockwise until it clicks.

Refer to the previous section *Fuel filler cap* for additional information.

Maintenance and care

Choosing the right fuel

Use only UNLEADED FUEL. The use of leaded fuel is prohibited by law and could damage your vehicle.

Your vehicle was not designed to use fuel or fuel additives with metallic compounds, including manganese-based compounds containing (MMT).

Vehicles certified to meet California emission standards (indicated on the underhood Vehicle Emission Control Information label) are designed to operate on California reformulated gasolines. If California reformulated gasoline is not available when you refuel, your vehicle can be operated on non-California fuels. However, even though your engine will perform adequately on other gasolines, the performance of the emission control devices and systems may be adversely affected.

Repair of damage caused by using a fuel for which your vehicle was not designed may not be covered by your warranty.

Maintenance and care

Octane recommendations

Your vehicle is designed to use “regular” unleaded gasoline with an (R+M)/2 octane rating of 87. We do not recommend gasolines labeled as “Regular” that are sold with octane ratings of 86 or lower in high altitude areas.

Do not be concerned if your engine sometimes knocks lightly. However, if it knocks heavily under most driving conditions while you are using fuel with the recommended octane rating, see your dealer or a qualified service technician to prevent any engine damage.



Fuel quality

If you are experiencing starting, rough idle or hesitation driveability problems during a cold start, try a different brand of “Regular” unleaded gasoline. “Premium” unleaded gasoline is not recommended (particularly in the United States) because it may cause these problems to become more pronounced. If the problems persist, see your dealer or qualified service technician.

Maintenance and care

It should not be necessary to add any aftermarket products to your fuel tank if you continue to use high quality fuel of the recommended octane rating. Aftermarket products could cause damage to the fuel system. Repairs to correct the effects of using an aftermarket product in your fuel may not be covered by your warranty.

Many of the world's automakers issued the World-wide Fuel Charter that recommends gasoline specifications to provide improved performance and emission control system protection for your vehicle. Gasolines that meet the World-wide Fuel Charter should be used when available. Ask your fuel supplier about gasolines that meet the World-wide Fuel Charter. In Canada, look for fuels that display the **Auto Makers' Choice**[™] logo.



Cleaner air

Ford approves the use of gasolines to improve air quality, including reformulated gasolines that contain oxygenates up to 10% ethanol or 15% MTBE.

Do not use gasolines containing methanol, which can damage critical fuel system components. Damage resulting from the use of methanol may not be covered by your warranty.

Maintenance and care

Running out of fuel

Avoid running out of fuel because this situation may have an adverse affect on modern powertrain components.

If you have run out of fuel:

- You may need to crank the engine several times before the system starts to pump fuel from the tank to the engine.
- Your *Check engine* light may come on. For more information on the *Check engine* light, refer to the *Instrumentation* chapter.



Fuel filter

Your vehicle is equipped with a fuel filter that is mounted on the underbody.

For fuel filter replacement, see your dealer or a qualified service technician. Refer to the “Scheduled Maintenance Guide” for the appropriate intervals for changing the fuel filter.

If you replace the fuel filter, replace it with an authorized Motorcraft part. The customer warranty may be void for any damage to the fuel system if an authorized Motorcraft fuel filter is not used.

Maintenance and care

ESSENTIALS OF GOOD FUEL ECONOMY

Measuring techniques

Your best source of information about actual fuel economy is you, the driver. You must gather information as accurately and consistently as possible. Fuel expense, frequency of fillups or fuel gauge readings are NOT accurate as a measure of fuel economy. We do not recommend taking fuel economy measurements during the first 1 600 km (1 000 miles) of driving (engine break-in period). You will get a more accurate measurement after 3 000 km – 5 000 km (2 000 miles – 3 000 miles).

The advertised fuel capacity of the fuel tank on your vehicle is equal to the rated refill capacity of the fuel tank as listed in the Refill Capacities chart in this “Owner Guide”. The advertised capacity is the amount of the Indicated Capacity and the Empty Reserve combined. Indicated Capacity is the difference in the amount of fuel in a full tank and a tank when the fuel gauge indicates empty. Empty Reserve is the small amount of usable fuel remaining in the fuel tank after the fuel gauge indicates empty.

Maintenance and care

The amount of Empty Reserve varies and should not be relied upon to increase driving range. When refueling your vehicle after the fuel gauge indicates empty, you might not be able to refuel the full amount of the advertised capacity of the fuel tank due to the empty reserve still present in the tank.

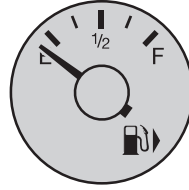

Filling the tank

Use the same filling rate setting (low – medium – high) each time the tank is filled. Allow three automatic click-offs when filling. Always use fuel with the recommended octane rating of a known quality gasoline, preferably a national brand.

It may seem insignificant, but you should use the same side of the same pump and have the vehicle facing the same direction each time you fill up. The driver should also have the vehicle loading and distribution the same every time. Your results will be most accurate if your filling method is consistent. This is also true when calculating fuel economy.

Maintenance and care

Calculating fuel economy

1. Fill the fuel tank completely and record the initial odometer reading.
2. Each time you fill the tank, record the amount of fuel added (in liters or gallons).
3. After at least three to five tank fill-ups, fill the fuel tank and record the current kilometer (mileage) reading.
4. Follow one of the simple calculations in order to determine fuel economy:

Multiply liters used by 100, then divide by total kilometers traveled.

Divide total miles traveled by total gallons used.

Keep a record for at least one month and record the type of driving (city or highway). This will provide an accurate estimate of the vehicle's fuel economy under current driving conditions. Additionally, keeping records during summer and winter will show how temperature impacts fuel economy. In general, lower temperatures give a deterioration in fuel economy.

Maintenance and care

Driving style – good driving and fuel economy habits

Give consideration to the lists that follow and you may be able to change a number of variables and improve your fuel economy.



Habits

- Smooth, moderate operation can yield up to 10% savings in fuel.
- Steady speeds without stopping will always give the best fuel economy.
- Idling for long periods of time (greater than one minute) will waste fuel.
- Anticipate stopping; slowing down may eliminate the need to stop.
- Sudden or hard accelerations will deteriorate fuel economy.
- Slow down gradually.
- Driving at reasonable speeds (traveling at 105 km/h [65 mph] uses 15% more fuel than traveling at 88 km/h [55 mph]).
- Revving the engine before turning it off will deteriorate fuel economy.
- Use of the air conditioner or defroster may deteriorate fuel economy.

Maintenance and care

- Use of speed control (if equipped) can improve fuel economy. Speed control can help maintain a constant speed and reduce speed changes. You may want to turn off the speed control in hilly terrain as unnecessary shifting between third and fourth gears may occur causing deterioration in fuel economy.
- Warming up a vehicle on cold mornings is not required and deteriorates fuel economy.
- Resting your foot on the brake pedal while driving will deteriorate fuel economy.
- Combine errands and minimize stop-and-go driving.

Maintenance

- Keep tires properly inflated and use only recommended size.
- Operating a vehicle with the wheels out of alignment will deteriorate fuel economy.
- Use recommended engine oil. Refer to *Lubricant Specifications*.
- Perform all regularly scheduled maintenance items. Follow the recommended maintenance schedule and owner maintenance checks found in your vehicle “Scheduled Maintenance Guide”.

Maintenance and care

Conditions

- Heavily loading a vehicle or towing a trailer will sharply deteriorate fuel economy at any speed.
- Carrying unnecessary weight will deteriorate fuel economy (approximately 0.4 l/100 km [1 mpg] is lost for every 180 kg [400 lb] of weight carried).
- Adding certain accessories to your vehicle (for example bug deflectors, rollover/light bars, running boards, ski/luggage racks) will deteriorate fuel economy.
- Use of fuel blended with alcohol will deteriorate fuel economy.
- Fuel economy will deteriorate with lower temperatures during the first 12 – 16 km (8 – 10 miles) of driving.
- Flat terrain driving improves fuel economy over hilly roads.
- Transaxles give their best fuel economy when operated in the top cruise gear and with steady pressure on the gas pedal.
- Close windows for high speed driving.



Maintenance and care

EPA window sticker

Every new vehicle should have the EPA window sticker. Contact your dealer if the window sticker is not supplied with your vehicle. The EPA window sticker should be your guide for the fuel economy comparisons with other vehicles.

It is important to note the box in the lower left corner of the window sticker. These numbers represent the Range of L/100 km (MPG) expected on the vehicle depending upon the driver's method of operation and conditions.

EMISSION CONTROL SYSTEM

Your vehicle is equipped with various emission control components and a catalytic converter which will enable your vehicle to comply with applicable exhaust emission standards. To make sure that the catalytic converter and other emission control components continue to work properly:

Maintenance and care

- Use only unleaded fuel.
- Avoid running out of fuel.
- Do not turn off the ignition while your vehicle is moving, especially at high speeds.
- Have the items listed in your “Scheduled Maintenance Guide” performed according to the specified schedule.

The scheduled maintenance items listed in the “Scheduled Maintenance Guide” are essential to the life and performance of your vehicle and to its emissions system.

If other than Ford, Motorcraft or Ford-authorized parts are used for maintenance replacements or for service of components affecting emission control, such non-Ford parts should be equivalent to genuine Ford Motor Company parts in performance and durability.



Do not park, idle, or drive your vehicle in dry grass or other dry ground cover. The emission system heats up the engine compartment and exhaust system, which can start a fire.

Maintenance and care

Illumination of the *Charging system* warning light, *Check engine* light or a high engine temperature, fluid leaks, strange odors, smoke or loss of oil pressure, could indicate that the emission control system is not working properly.



Exhaust leaks may result in entry of harmful and potentially lethal fumes into the passenger compartment.

Do not make any unauthorized changes to your vehicle or engine. By law, vehicle owners and anyone who manufactures, repairs, sells, leases, trades vehicles, or supervises a fleet of vehicles are not permitted to intentionally remove an emission control device or prevent it from working.

Information about your vehicle's emission system is on the Vehicle Emission Control Information Decal located on or near the engine. This decal identifies engine displacement and gives some tune up specifications.

Please consult your "Warranty Guide" for complete emission warranty information.

Readiness for inspection/ maintenance (I/M) testing

In some localities, it may be a legal requirement to pass an I/M test of the on-board diagnostics system (OBD-II). If your *Check engine* light is on, refer to the description in the *Warning Lights and Chimes* section of the *Instrumentation* chapter. Your vehicle may not pass the I/M test with the *Check engine* light on.

If the vehicle's powertrain system or its battery has just been serviced, the OBD-II system is reset to a "not ready for I/M test" condition. To ready the OBD-II system for I/M testing, a minimum of 30 minutes of city and highway driving is necessary as described below:

- First, at least 10 minutes of driving on an expressway or highway.
- Next, at least 20 minutes driving in stop-and-go, city-type traffic with at least four idle periods.

Allow the vehicle to sit for at least eight hours without starting the engine. Then, start the engine and complete the above driving cycle. The engine must warm up to its normal operating temperature. Once started, do not turn off the engine until the above driving cycle is complete.



Maintenance and care

EXTERIOR BULBS

Replacing exterior bulbs

Check the operation of the following lamps frequently:

- Headlamps
- Tail lamps
- Brakelamps
- High-mounted brakelamp
- Turn signals
- Backup lamps
- License plate lamp

Do not remove lamp bulbs unless they will be replaced immediately. If a bulb is removed for an extended period of time, contaminants may enter the lamp housings and affect performance.

Replacing headlamp bulbs



Handle a halogen bulb carefully and keep out of children's reach. Grasp the bulb only by its plastic base and do not touch the glass; the oil from your hand could cause the bulb to break the next time that the headlamps are operated.

Maintenance and care

To remove the headlamp bulb:

1. Make sure that the headlamp control is in OFF position.
2. Open the hood.
3. Rotate the bulb cover counterclockwise and remove.
4. Swivel the wire clip to the side and pull out the lamp.
5. Remove bulb from electrical connector.
6. Install in reverse order.

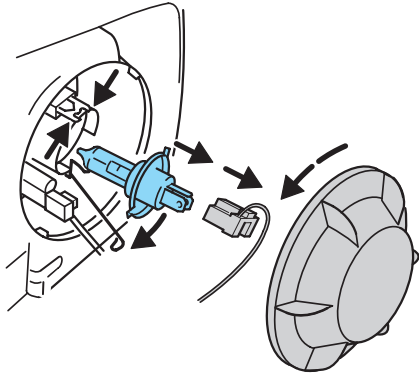
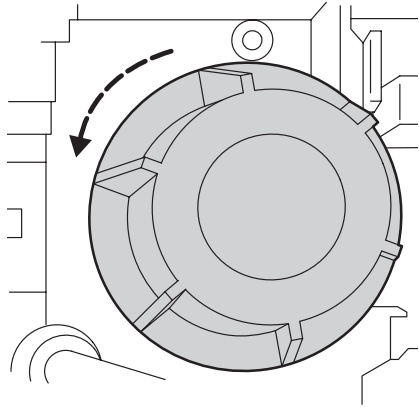

Replacing front parking lamp/turn signal bulbs

1. Make sure the headlamp control is in OFF position.
2. Open the hood and remove the bulb socket from the grille by turning counterclockwise.

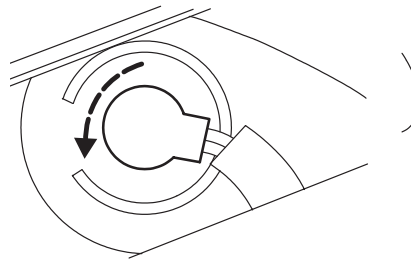

Maintenance and care

3. Pull the bulb straight out of the socket and push in the new bulb.
4. Install the bulb socket in grille by turning clockwise.

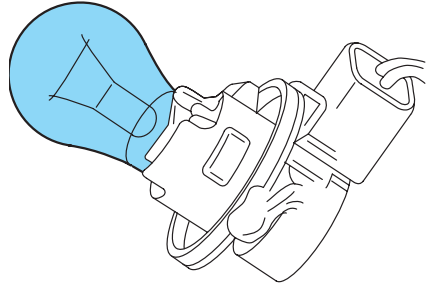

Replacing foglamp bulbs

1. Reach under the bumper cover and remove the bulb socket from the foglamp by turning counterclockwise.
2. Disconnect the electrical connector from the foglamp bulb.
3. Connect the electrical connector to the new foglamp bulb.
4. Install the bulb socket in the foglamp turning clockwise.

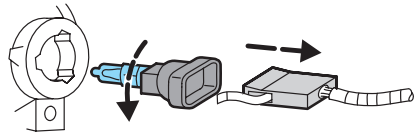
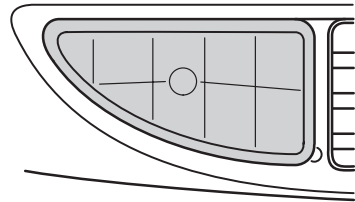

Side marker lamp

1. Reach under front fender and grasp the bulb socket, turn the light housing counterclockwise.
2. Pull the bulb out.
3. Install in reverse order.

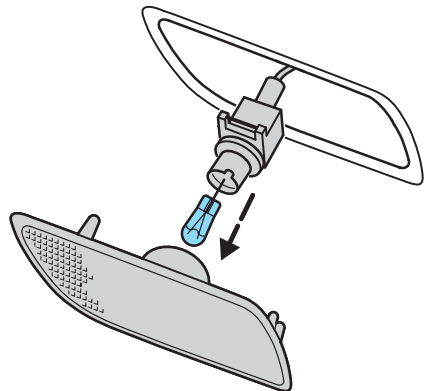

Maintenance and care

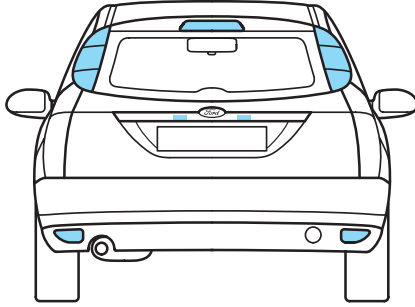

Replacing tail/brake/backup lights and turn signal bulbs (Coupe)

1. Open the tailgate.
2. From inside the luggage compartment remove the wing nut of the rear light assembly cover.
3. Using a Phillips screw driver remove the screw. The lamp is still retained by a spring loaded clip. Remove by gently pulling out the light housing.
4. Turn the bulb socket counterclockwise as far as possible and pull it out.
5. Pull the bulb straight out of the socket and push in the new bulb.
6. Install the bulb socket in lamp assembly by turning clockwise.

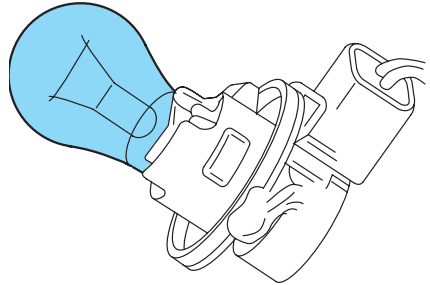
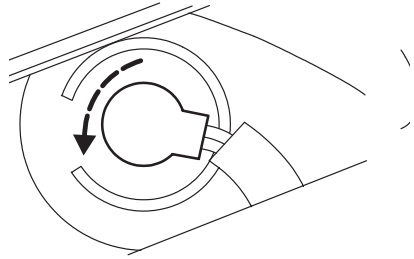

Maintenance and care

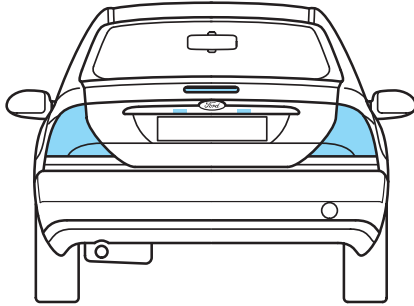

Replacing tail/brake/backup lights and turn signal bulbs (Sedan)

1. Open the tailgate.
2. From inside the luggage compartment remove the three wing nuts of the light housing.
3. Gently pull the light housing to the outside.
4. Turn the bulb socket counterclockwise and pull out the socket.
5. Pull the bulb straight out of the socket and push in the new bulb.
6. Install the bulb socket in lamp assembly by turning clockwise.

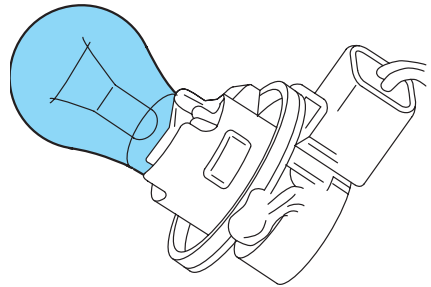
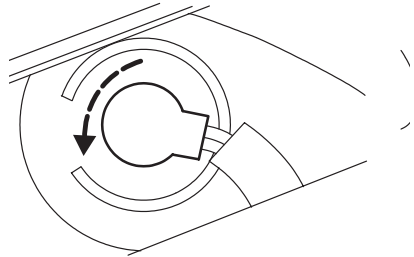

Maintenance and care

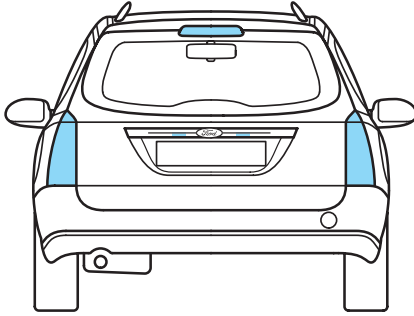

Replacing tail/brake/backup lights and turn signal bulbs (Wagon)

1. Open the tailgate.
2. With a screw driver remove the fixings and trim from the body.
3. Remove the socket from the lamp assembly.
4. Pull the bulb straight out of the socket and push in the new bulb.
5. Install the bulb socket in lamp assembly by turning clockwise.

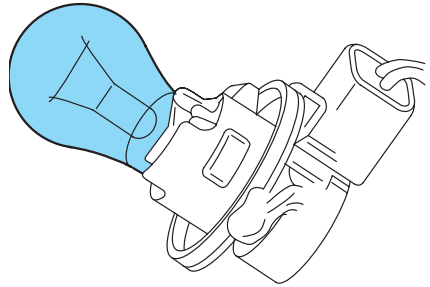
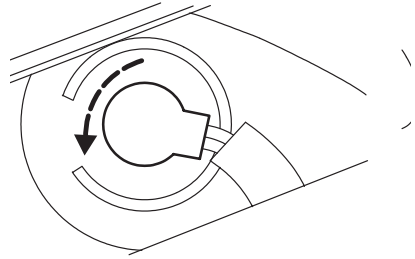

Maintenance and care

High-mount brake lamp bulbs

Open the luggage compartment. With a screw driver remove the fixings and trim from the tailgate. Pull the bulb holder from the lamp assembly. Pull the bulb out.

Install in reverse order.

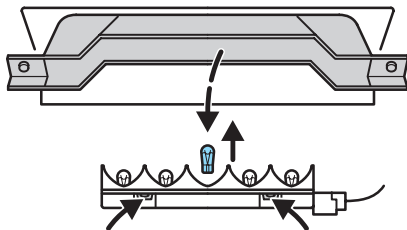

Replacing interior lights

Switch off the interior lights (middle switch position). Pry out the light assembly with a flat screw driver at the side opposite the switch.

Dome lamp

Replace the bulb. Fit new bulb in the reverse order.

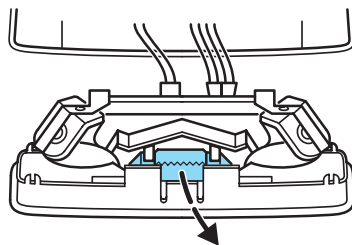

Rear dome lamp

Remove the reflector and replace the bulb. Fit new bulb in the reverse order.

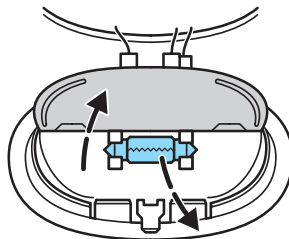

Map lamps

The bulbs can be replaced after the contact plate has been hinged back.

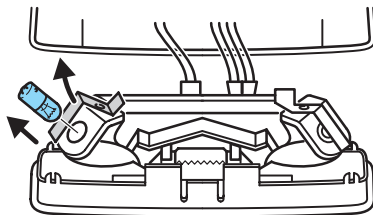

Maintenance and care

Luggage compartment light

Carefully pry out the light assembly from the holder with a flat-bladed screwdriver and remove the bulb.

Install in the reverse order.

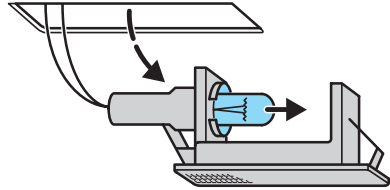

Using the right bulbs

| Function | Trade number |
|----------------------------|--------------|
| Headlamps | HB2 |
| Park and turn lamp (front) | 3157K |
| Side marker lamp (front) | GE194 |
| Fog lamps (if equipped) | 899 |
| Stop/turn and park lamps | 3157K |
| Back up lamp (Sedan/Wagon) | 3156K |
| (Coupe) | 921 |
| License plate lamp | C-5W |
| High-mount brakelamp | W5W |
| Dome lamp (front/rear) | 12V10W |
| Map lamp | 12V6W |
| Luggage compartment | 12V10W |

To replace all instrument panel lights – see your dealer.

Maintenance and care

AIMING THE HEADLAMPS

The headlamps on your vehicle are properly aimed at the assembly plant.

If your vehicle has been in an accident the alignment of your headlamps should be checked by a qualified service technician.

Vertical aim adjustment

1. Park the vehicle on a level surface approximately 7.6 meters (25 feet) from a vertical wall or screen directly in front of it.
2. Measure the height of the headlamp bulb center from the ground and mark a 2.5 meters (8 foot) horizontal reference line on the vertical wall or screen at this height (a piece of masking tape works well).
3. Turn on the low beam headlamps to illuminate the wall or screen and open the hood.

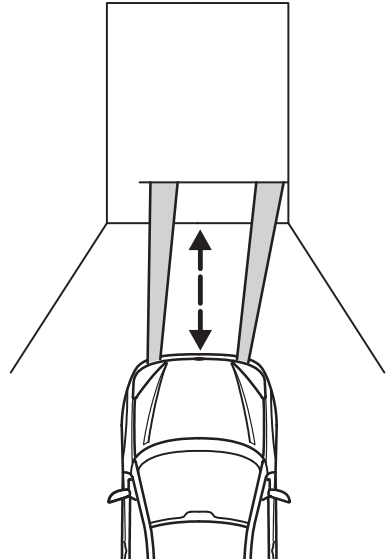

Maintenance and care

4. On the wall or screen you will observe an area of high intensity light. The top of the high intensity area should touch the horizontal reference line, if not, the beam will need to be adjusted.
5. Locate the vertical adjuster on each headlamp, using a 7 mm Allen head wrench, turn the adjuster either clockwise (to adjust down) or counterclockwise (to adjust up), the high intensity area should touch the horizontal reference line.
6. HORIZONTAL AIM IS NOT REQUIRED FOR THIS VEHICLE AND IS NON-ADJUSTABLE.
7. Close the hood and turn off the lamps.

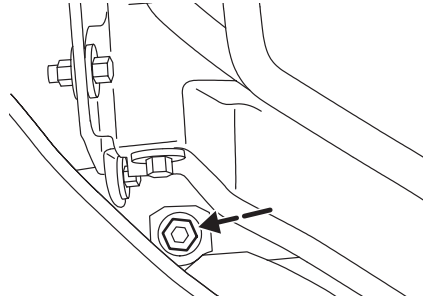

Maintenance and care

CLEANING AND CARING FOR YOUR VEHICLE

Refer to the *Customer assistance* chapter for a list of Ford-approved cleaners, polishes and waxes.

Washing your vehicle

Wash your vehicle regularly with cold or lukewarm water. Never use strong detergents or soap. If your vehicle is particularly dirty, use a quality car wash detergent. Always use a clean sponge, washing glove or similar device and plenty of water for best results. To avoid spots, avoid washing when the hood is still warm, immediately after or during exposure to strong sunlight.

During winter months, it is especially important to wash the vehicle on a regular basis. Large quantities of dirt and road salt are difficult to remove and also cause damage to the vehicle.

Remove any exterior accessories, such as antennas, before entering a car wash. If you have wax applied to the vehicle at a commercial car wash, it is recommended that you clean the wiper blades and windshield as described in *Cleaning the wiper blades and windshield*.

After washing, apply the brakes several times to dry them.

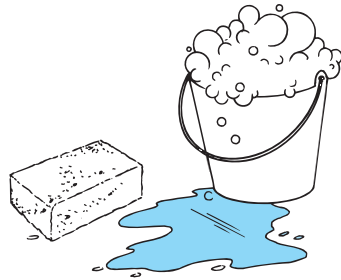

Maintenance and care

Waxing your vehicle

Wax when water stops beading on the surface. This could be every three or four months, depending on operating conditions.

Use only carnauba or synthetic-based waxes. Use cleaning fluid or alcohol with a clean cloth to remove any bugs and tar before waxing the vehicle. Use tar remover to remove any tar spots.

Avoid getting wax on the windshield. If you have wax applied at a commercial car wash, it is recommended that you clean the wiper blades and windshield as described in *Cleaning the wiper blades and windshield*.

Repairing paint chips

Minor scratches or paint damage from road debris may be repaired with touch-up paint, repair foil or aerosol paint spray from the Ford accessories line. Observe the application instructions on the products.

Remove particles such as bird droppings, tree sap, insect remains, tar spots, road salt and industrial fallout immediately.

Maintenance and care

Cleaning the wheels

Wash with the same detergent as the body of your vehicle. Do not use acid-based or alcohol-based wheel cleaners, steel wool, fuel or strong detergents. Never use abrasives that will damage the finish of special wheel surfaces. Use a tar remover to remove grease and tar.

Cleaning plastic exterior parts

Use vinyl cleaner for routine cleaning. Clean with a tar remover if necessary. Do not clean plastic parts with thinners, solvents or petroleum-based cleaners.

Cleaning the exterior lamps

Wash with the same detergent as the exterior of your vehicle. Use glass cleaner or tar remover if necessary.

To avoid scratching the lamps, do not use a dry paper towel, chemical solvents or abrasive cleaners.

Maintenance and care

Cleaning the wiper blades

If the wiper blades do not wipe properly, clean the wiper blade rubber element with undiluted windshield wiper solution or a mild detergent. To avoid damaging the blades, do not use fuel, kerosene, paint thinner or other solvents.

If the wiper still does not wipe properly, this could be caused by substances on the windshield such as tree sap and some hot wax treatments used by commercial car washes. Clean the outside of the windshield with a non-abrasive cleanser such as the non-abrasive Bon-Ami® powder. Rinse thoroughly with clean water. **Do not** use abrasive cleansers on glass as they may cause scratches. The windshield is clean if beads do not form when you rinse it with water. The windshield and wiper blades should be cleaned on a regular basis, and blades or rubber elements replaced when worn.

Maintenance and care

Cleaning the instrument panel

Clean with a damp cloth, then dry with a dry cloth.

Avoid cleaner or polish that increases the gloss of the upper portion of the instrument panel. The dull finish in this area helps protect the driver from undesirable windshield reflection.

Cleaning the interior fabric

Remove dust and loose dirt with a whisk broom or a vacuum cleaner. Remove fresh spots immediately. Do not use household or glass cleaners. These agents can stain and discolor the fabric. Use a mild soap and water solution if necessary.

Cleaning seats equipped with side air bags

Remove dust and loose dirt with a whisk broom or a vacuum cleaner. Remove fresh spots immediately. Follow the directions that come with the cleaner. Do not saturate the seat cover with upholstery cleaner.



Do not use chemical solvents or strong detergents when cleaning the seat mounted side air bag. Such products could contaminate the side air bag system and affect performance of the side air bag in a collision.

Maintenance and care

Cleaning and maintaining the safety belts

Clean the safety belts with a mild soap solution recommended for cleaning upholstery or carpets. Do not bleach or dye the belts, because these actions may weaken the belt webbing.

Check the safety belt system periodically to make sure there are no nicks, wear or cuts. If your vehicle has been involved in an accident, refer to the *Safety belt maintenance* section in the *Seating and safety restraints* chapter.

Underbody

Flush the complete underside of vehicle frequently. Keep body drain holes unplugged. Inspect for road damage.

Cleaning leather seats (if equipped)

For routine cleaning, wipe the surface with a soft, damp cloth. For more thorough cleaning, wipe the surface with a mild soap.

Maintenance and care

If the leather cannot be completely cleaned using a mild soap and water solution, the leather may be cleaned using a commercially available cleaning product “Tanners Preserve Leather Cleaner” and a 3M “Type T” scrubbing pad by using the following steps:

The type of scrubbing pad is very critical because the common 3M “Scotch Brite” green pad is too aggressive and will damage the leather surface.

- Spray a small amount of the leather cleaner on the pad and rub the area to be cleaned with the pad using a circular motion. Only clean 1/4 of the area at a time. For heavily soiled areas, spray the cleaner directly onto the leather (two squirts should be adequate) and rub with the pad. Repeat if necessary.
- Use a soft, damp cloth to remove the loosened dirt and foam.
- Dry with a soft cloth.

Maintenance and care

Do not use household cleaners, glass cleaner, alcohol solutions or cleaner intended for vinyl, rubber or plastics. These products can damage the leather.

In some instances, color or dye transfer can occur when wet clothing (wool, denim, leathers or other non-colorfast garments) comes in contact with leather upholstery. If this occurs, the leather should be cleaned immediately to avoid permanent staining.

“Tanners Preserve Leather Cleaner” (product number AS-300) is available from “First Brands” by calling 1-800-726-1001. This product may also be available at many local automotive after market stores.

3M “Type T” Clean And Finish Scrubbing Pads (UPC 04011-01276) are available through your local 3M distributor. Call 1-800-742-9649 for the nearest distributor in your area.

| Part number | Part name |
|------------------|---|
| (Obtain Locally) | Tanners Preserve Leather Cleaner |
| (Obtain Locally) | 3M “Type T” Clean And Finish Scrubbing Pads |

Maintenance and care

Woodtone trim

Wipe stains with a soft cloth and a multi-purpose cleaning solution.

Inside windows

Use glass cleaner for the inside windows if they become fogged.

Cleaning mirrors

Do not clean your mirrors with a dry cloth or abrasive materials. Use a soft cloth and mild detergents and water. Be careful when removing ice from outside mirrors because you may damage the reflective surface.

Capacities and specifications

MOTORCRAFT PART NUMBERS

| Component | 2.0L SPI engine | 2.0L Zetec-E engine |
|-------------|-----------------|---------------------|
| Air filter | 98AB-9601-C | 98AB-9601-C |
| Battery | BXT-40R | BXT-96R |
| Oil filter | FL-400 S | FL-400 S |
| PCV valve | EV-244 | 988F-6A666-AA |
| Spark plug* | AGSF 34EE ** | AZFS 32FE |

* Refer to Vehicle Emission Control Information (VECI) decal for spark plug gap information.

** If a spark plug is removed for inspection purposes, it must be reinstalled in the same cylinder it was taken from. If a spark plug requires replacement, use only spark plugs with the same service part number suffix letter as shown on the engine decal.

Capacities and specifications

REFILL CAPACITIES

| Fluid | Ford part name | Application | Capacity |
|--|---|--------------|--|
| Brake fluid | High performance DOT 3 brake fluid or DOT 4 brake fluid For service, Ford recommends Super DOT 4 for manual transaxles | All | Fill to line on reservoir |
| Engine oil (includes filter change) | Motorcraft 5W20 Super Premium Motor Oil | Zetec engine | 4.25 L (4.5 quarts) |
| | | SPI engine | 3.78 L (4.0 quarts) |
| Engine coolant | Motorcraft Premium Engine Coolant (green-colored) or Motorcraft Premium Gold Engine Coolant (yellow colored) | All | 5.75 L (6.1 quarts) |
| Power steering fluid | MERCON® ATF | All | Fill to line on reservoir 0.9 L (0.95 quarts) |
| Fuel tank | N/A | All | 50 L (13.2 gallons) |
| Transaxle fluid | see <i>Lubricant specifications</i> | Manual | 2.0 L (2.1 quarts) |
| | MERCON® V | Automatic | 6.6 L (6.9 quarts) |
| Windshield washer fluid | Ultra-Clear Windshield Washer Concentrate | Sedan | 2.5 L (2.6 quarts) |
| | | Coupe, Wagon | 4.0 L (4.2 quarts) |

Capacities and specifications

LUBRICANT SPECIFICATIONS

| Item | Ford part name or equivalent | Ford part number | Ford specification |
|---|---|---------------------------------|---|
| Brake fluid | High performance DOT 3 brake fluid or DOT 4 brake fluid For service, Ford recommends Super DOT 4 for manual transaxles | C6AZ-19542-AB for DOT 3 | ESA-M6C25-A or ESD-M6C57-A Delta ESD-M6C57-A (Super DOT 4) |
| Door weatherstrips | Silicone Lubricant | COAZ-19553-AA and F5AZ-19553-AA | ESR-M13P4-A |
| Door + hood latches, door hinges, striker plates, seat tracks, fuel filler door hinge | Multi-Purpose Grease | DOAZ-19584-AA or F5AZ-19G209-AA | ESB-M1C93-B or ESR-M1C159-A |
| Engine coolant | Motorcraft Premium Engine Coolant (green-colored) | VC-4-A (US) or CXC-10 (Canada) | ESE-M97B44-A |
| | Motorcraft Premium Gold Engine Coolant (yellow-colored) | VC-7-A | WSS-M97B51-A1 |
| Engine oil | Motorcraft 5W-20 Super Premium Motor Oil | XO-5W20-QSP | WSS-M2C153-H with API Certification Mark |
| Lock cylinders | Penetrating Lubricant | E8AZ-19A501-B | None |
| Power steering fluid | MERCON® Automatic Transmission Fluid | XT-2-QDX | MERCON® |
| Automatic transaxle fluid | MERCON® V | XT-5-QM | WSS-M2C202-B |
| Manual transaxle fluid – IB5 | Synthetic Manual Transmission Fluid | XT-M5-QS | WSD-M2C200-C |
| Manual transaxle fluid – MTX 75 | MERCON® Automatic Transmission Fluid | XT-2-QDX | MERCON® |
| Windshield washer fluid | Ultra-Clear Windshield Washer Concentrate | C9AZ-19550-AB | ESR-M17P5-A |

Capacities and specifications

ENGINE DATA

| Engine | 2.0L SPI engine | 2.0L Zetec-E engine |
|-------------------|---------------------|----------------------|
| Cubic inches | 121 | 121 |
| Horsepower | 110 @ 5000 | 130 @ 5300 rpm |
| Torque | 125 lb-ft @ 3750 | 130 lb-ft @ 4500 rpm |
| Recommended fuel | 87 octane | 87 octane |
| Firing order | 1-3-4-2 | 1-3-4-2 |
| Spark plug gap | 1.4 mm (0.054 inch) | 1.3 mm (0.051 inch) |
| Ignition system | Electronic ignition | Electronic ignition |
| Compression ratio | 9.35:1 | 9.6:1 |

Capacities and specifications

Sedan

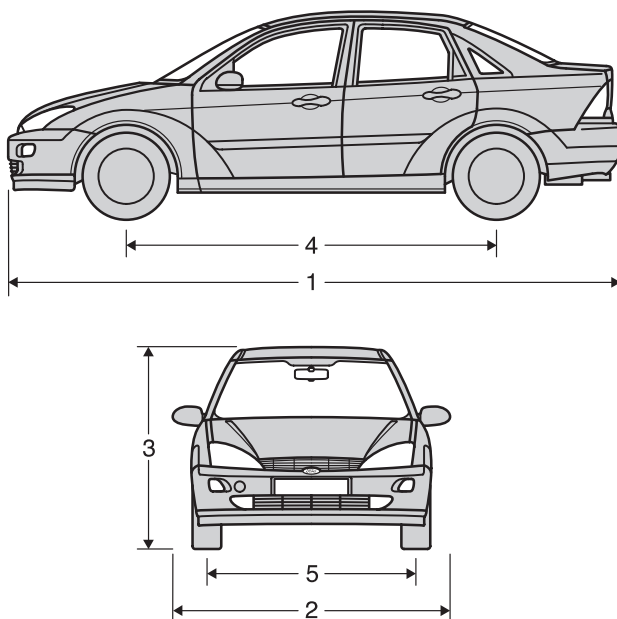

VEHICLE DIMENSIONS

| Dimensions | | mm (in) |
|--------------------|-------|-----------------------|
| (1) Overall length | | 4362–4369 (171.7–172) |
| (2) Overall width | | 1998 (78.7) |
| (3) Overall height | | 1440–1481 (56.7–58.3) |
| (4) Wheelbase | | 2615 (103) |
| (5) Track | front | 1484–1502 (58.4–59.1) |
| | rear | 1477–1495 (58.1–58.9) |

Capacities and specifications

Coupe

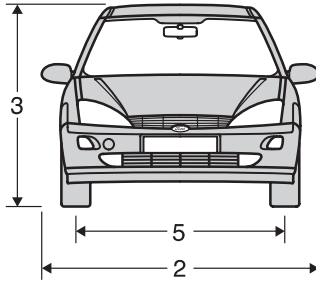
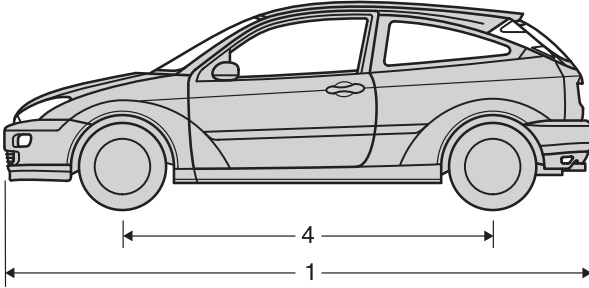

| Dimensions | | mm (in) |
|--------------------|-------|-------------------------|
| (1) Overall length | | 4150–4178 (163.3–164.5) |
| (2) Overall width | | 1998 (78.7) |
| (3) Overall height | | 1440–1481 (56.7–58.3) |
| (4) Wheelbase | | 2615 (103) |
| (5) Track | front | 1484–1502 (58.4–59.1) |
| | rear | 1477–1495 (58.1–58.9) |

Capacities and specifications

Wagon

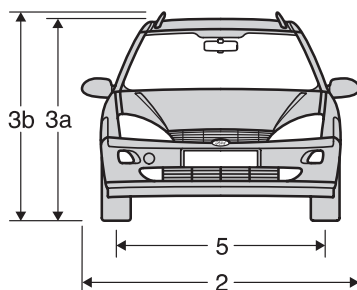
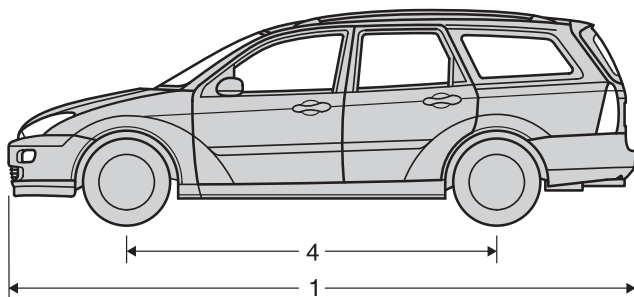

| Dimensions | mm (in) | |
|-------------------------------------|-------------------------|-----------------------|
| (1) Overall length | 4438–4465 (174.7–175.8) | |
| (2) Overall width | 1998 (78.7) | |
| (3a) Overall height (w/o roofrack) | 1492–1532 (58.7–60.3) | |
| (3b) Overall height (with roofrack) | 1451–1491 (57.1–58.7) | |
| (4) Wheelbase | 2615 (103) | |
| (5) Track | front | 1484–1502 (58.4–59.1) |
| | rear | 1477–1495 (58.1–58.9) |

Capacities and specifications

IDENTIFYING YOUR VEHICLE

Safety compliance label

The National Highway Traffic Safety Administration Regulations require that a Safety Compliance Certification Label be affixed to a vehicle and prescribe where the Safety Compliance Certification Label may be located. The Safety Compliance Certification Label is located on the front door latch pillar on the driver's side.

| | | | |
|--|----------------------------|-----------|-------|
| MFD. BY FORD MOTOR CO. IN U.S.A. | | | |
| DATE: XXXXX | GVWR: XXXXX LB/ XXXXX KG | | |
| FGAWR: XXXXXX/XXXXXXXX | RGAWR: XXXXXX/XXXXXXXX | | |
| THIS VEHICLE CONFORMS TO ALL APPLICABLE FEDERAL MOTOR VEHICLE SAFETY STANDARDS IN EFFECT ON THE DATE OF MANUFACTURE SHOWN ABOVE. | | | |
| VIN: XXXXXXXXXXXXXXXXXXXX | TYPE: XXXXXXXXXXXXXXXXXXXX | | |
|  | | | |
| MAXIMUM LOAD=OCCUPANTS + LUGGAGE=XXXKG/XXXLB | | | |
| OCCUPANTS: X TOTAL X FR X 2ND X RR OCCUPANTS LUGGAGE | | | |
| XX XXXKG/XXXLB | | | |
| X XXXKG/XXXLB | | | |
| TIRE: XXXX/XXXXX XXX | | | |
| PRESSURE (FR) XXX kPa/33 PSI COLD | | | |
| PRESSURE (RR) XXX kPa/33 PSI COLD | | | |
| TRAILER TOWING- SEE OWNER GUIDE | | | |
| EXT PNT: XXXXXX XXXXXX | RC: XX | DSO: XXXX | F0000 |
| BAR INT TR TP/PS R | AXLE TR | SPR | T0000 |
| X XX XXX X | XX X | XXXX | |
| UTC VFOHT-15294A10-GA | | | |

Capacities and specifications

Vehicle identification number

The vehicle identification number (VIN) is attached to a metal tag and is located on the driver side instrument panel. The VIN tag may be seen by looking through the windshield from outside the vehicle.

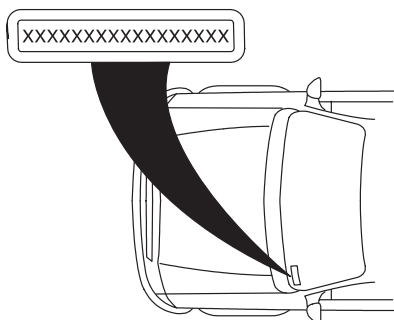

Engine number

The engine number (at last eight numbers of the vehicle identification number) is stamped on the engine block, transaxle, frame and transfer case (if equipped).

Customer assistance

GETTING ROADSIDE ASSISTANCE

To fully assist you should you have a vehicle concern, Ford offers a complimentary roadside assistance program. This program is separate from the New Vehicle Limited Warranty. The service is available:

- 24-hours, seven days a week
- for the Basic warranty period (Canada) or New Vehicle Limited Warranty period (U.S.) of three years or 60,000 km (36,000 miles), whichever comes first on Ford and Mercury vehicles, and four years or 80,000 km (50,000 miles) on Lincoln vehicles.

In the United States, you may purchase additional roadside assistance coverage beyond this period through the Ford Auto Club by contacting your Ford or Lincoln-Mercury dealer.

Roadside assistance will cover

- changing a flat tire
- jump-starts
- lock-out assistance
- fuel delivery
- towing to the nearest Ford of Canada or Ford Motor Company dealership, or towing to your selling dealership if within 56 km (35 miles). Even non-warranty related tows, like accidents or getting stuck in the mud or snow, are covered (some exclusions apply, such as impound towing or repossession).

Using roadside assistance

Complete the roadside assistance identification card and place it in your wallet for quick reference. In the United States, this card is found in the Owner Guide portfolio in the glove compartment in Ford vehicles and is mailed to you if you own a Mercury or Lincoln. In Canada, it's found in the Roadside Assistance book in the glove compartment.

To receive roadside assistance in the United States for Ford or Mercury vehicles, call 1-800-241-3673 or if you own a Lincoln vehicle, call 1-800-521-4140. In Canada call 1-800-665-2006.

Should you need to arrange assistance for yourself, Ford will reimburse a reasonable amount. To obtain information about reimbursement, call 1-800-241-3673 in the United States for Ford or Mercury vehicles; or if you own a Lincoln vehicle, call 1-800-521-4140. Call 1-800-665-2006 in Canada.

Customer assistance

Ford extended service plan

You can get more protection for your new car or light truck by purchasing Ford Extended Service Plan (Ford ESP) coverage. Ford ESP is an optional service contract which is backed by Ford Motor Company or Ford Motor Service Company (in the U.S.) and Ford of Canada (in Canada). It provides:

- Protection against repair costs after your New Vehicle Limited Warranty period expires;
- and
- other benefits during the warranty period (such as reimbursement for rentals and towing).

You may purchase Ford ESP from any participating Ford or Lincoln-Mercury or Ford of Canada dealer. There are several plans available in various time, distance and deductible combinations which can be tailored to fit your own driving needs. Ford ESP also offers reimbursement benefits for towing and rental coverage. (In Hawaii, rules vary. See your dealer for details.)

When you buy Ford ESP you receive Peace-of-Mind protection throughout the United States and Canada, provided by a network of more than 5,200 participating Ford, Lincoln-Mercury and Ford of Canada dealers.

If you did not take advantage of the Ford Extended Service Plan at the time of purchasing your vehicle, you may still be eligible. Please contact your dealer for further information. Since this information is subject to change, please ask your dealer for complete details about Ford Extended Service Plan coverage options.

Also, please be aware that some dealers offer service contracts that are not backed by Ford Motor Company or Ford of Canada. On the surface, many independent plans appear to be like Ford's. The problem is that they can often require the use of non-factory approved parts and have much more complex and restrictive claims coverage terms than Ford.

At Ford Motor Company and Ford of Canada, we are dedicated to providing Ford, Lincoln and Mercury vehicle owners with programs that will enhance your ownership experience and protect you from unexpected repair bills. Genuine Ford ESP is the only Extended Service Plan that enables us to provide that service.

Customer assistance

Getting the service you need

At home

Ford Motor Company and Ford of Canada have authorized dealerships to service your vehicle. When you need warranty repairs your selling dealer would like you to return to it for that service, but you may also take your vehicle to another Ford Motor Company dealership authorized for warranty repairs. Certain warranty repairs require special training though, so not all dealers are authorized to perform all warranty repairs. That means that depending on the warranty repair needed, the vehicle may need to be taken to another dealer. If a particular dealership can not assist you, then contact the Customer Assistance Center.

If you are not satisfied with the service you receive at the dealership, contact your Service Advisor for assistance. If the concern or injury remains unresolved, speak with the service manager. If you are still not satisfied, speak with the owner or general manager of the dealership. In most cases, your concern will be resolved at this level.

Ford Motor Company and Ford of Canada dealerships also carry genuine Ford parts and accessories, providing you with original equipment reliability.

Away from home

If you are away from home when your vehicle needs service, or if you need more help than the dealership could provide after following the steps described above, contact the Ford Customer Assistance Center to find an authorized dealership to help you in the United States

Ford Motor Company
Customer Assistance Center
16800 Executive Plaza Drive
P.O. Box 6248
Dearborn, Michigan 48121
1-800-392-3673 (FORD)
(TDD for the hearing impaired:
1-800-232-5952)

In Canada:
Customer Assistance Centre
Ford Motor Company of Canada,
Limited
P.O. Box 2000
Oakville, Ontario L6J 5E4
1-800-565-3673 (FORD)

Please have the following information available when contacting Ford Customer Assistance:

- Your telephone number (home and business)
- The name of the dealer and the city where the dealership is located
- The year and make of your vehicle

Customer assistance

- The date of vehicle purchase
- The current odometer reading
- The vehicle identification number (VIN)

If you still have a complaint involving a warranty dispute, you may wish to contact the Dispute Settlement Board (U.S.) or the Mediation/Arbitration Program (Canada).

In the United States, a warranty dispute must be submitted to the Dispute Settlement Board before taking action under the Magnuson-Moss Warranty Act, or to the extent allowed by state law, before pursuing replacement or repurchase remedies provided by certain state laws. This dispute handling procedure is not required prior to enforcing state created rights or other rights which are independent of the Magnuson-Moss Warranty Act or state replacement or repurchase laws.

THE DISPUTE SETTLEMENT BOARD (U.S. only)

The Dispute Settlement Board is

- an independent, third-party arbitration program for warranty disputes

- available free to owners and lessees of qualifying Ford Motor Company vehicles

NOTE: The Dispute Settlement Board may not be available in all states: Ford Motor Company reserves the right to change eligibility limitations, modify procedures and/or to discontinue this service without notice and without incurring obligations per applicable state law.

What kinds of cases does the Board review?

Unresolved warranty repair concerns or vehicle performance as designed concerns on Ford, Mercury and Lincoln cars and Ford, Mercury and Lincoln light trucks which are within the terms of any applicable written new vehicle warranty are eligible for review, except those involving:

- a non-Ford product
- a non-Ford dealership

Customer assistance

- sales disputes between customer and dealer except those associated with warranty repairs or concerns with the vehicle's performance as designed
 - a request for reimbursement of consequential expenses unless a service or product concern is being reviewed
 - items not covered by the New Vehicle Limited Warranty (including maintenance and wear items)
 - alleged personal injury/property damage claims
 - cases currently in litigation
 - vehicles not used primarily for family, personal or household purposes (except in states where the Dispute Settlement Board is required to review commercial vehicles).
 - vehicles with non-U.S. warranties
- Concerns are ineligible for review if the New Vehicle Limited Warranty has expired at receipt of your application and in certain states eligibility is dependent upon the customer's possession of the vehicle.

Eligibility may differ according to state law. For example see the unique brochures for California, West Virginia, Georgia and Wisconsin purchasers/lessees.

Board membership

The Board consists of:

- three consumer representatives
- a Ford or Lincoln-Mercury dealership representative

Consumer candidates for Board membership are recruited and trained by an independent consulting firm. The dealership Board member is chosen from Ford and Lincoln-Mercury dealership management, recognized for their business leadership qualities.

What the Board needs

To have your case reviewed you must complete the application in the DSB brochure and mail it to the address provided on the application form.

Your application is reviewed and, if it is determined to be eligible, you will receive an acknowledgement indicating:

- the file number assigned to your application
- the toll-free phone number of the DSB's independent administrator

Your dealership and a Ford Motor Company representative will be asked to submit statements.

Customer assistance

To properly review your case, the Board needs the following information:

- legible copies of all documents and maintenance or repair orders relevant to the case
- the year, make, model, and Vehicle Identification Number (VIN) listed on your vehicle ownership license
- the date of repair(s) and mileage at the time of occurrence(s)
- the current mileage
- the name of the dealer(s) who sold or serviced the vehicle
- a brief description of your unresolved concern
- a brief summary of the action taken by the dealer(s) and Ford Motor Company
- the names (if known) of all the people you contacted at the dealership(s)
- a description of the action you expect to resolve your concern

You will receive a letter of explanation if your application does not qualify for Board review.

Oral presentations

If you would like to make an oral presentation indicate YES to question #6 on the application. While it is your right to make an oral presentation before the Board, this is not a requirement and the Board will decide the case whether or not an oral presentation is made. Oral presentation may be requested by the Board as well.

Making a decision

Board members review all available information related to each complaint, including oral presentations, and arrive at a fair and impartial decision.

Every effort is made to decide the case within 40 days of the date that all requested information is received by the Board. Since the Board generally meets once a month, it may take longer for the Board can consider some cases.

After a case is reviewed, the Board mails you a decision letter and a form on which to accept or reject the Board's decision. The decisions of the Board are binding on Ford (and, in some cases, on the dealer) but not on consumers who are free to pursue other remedies available to them under state or federal law.

Customer assistance

To request a DSB brochure/application

For a brochure/application, speak to your dealer or write/call to the Board at the following address/phone number:

Dispute Settlement Board
P.O. Box 5120
Southfield, MI 48086-5120
1-800-428-3718

You may also contact the North American Customer Assistance Center at 1-800-392-3673 (Ford). TDD for the hearing impaired: 1-800-232-5952 or by writing to the Center at the following address:

Ford Motor Company
Customer Assistance Center
16800 Executive Plaza Drive
P.O. Box 6248
Dearborn, Michigan 48121

UTILIZING THE MEDIATION/ARBITRATION PROGRAM (CANADA ONLY)

In those cases where you continue to feel that the efforts by Ford and the dealer to resolve a factory-related vehicle service concern have been unsatisfactory, Ford of Canada participates in an impartial third party mediation/arbitration program administered by the Canadian Motor Vehicle Arbitration Plan (CAMVAP)

The CAMVAP program is a straight forward and relatively speedy alternative to resolve a disagreement when all other efforts

to produce a settlement have failed. This procedure is without cost to you and is designed to eliminate the need for lengthy and expensive legal proceedings.

In the CAMVAP program, impartial third party arbitrators conduct hearings at mutually convenient times and places in an informal environment. These impartial arbitrators review the positions of the parties, make decisions and, when appropriate, render awards to resolve disputes. CAMVAP decisions are fast, fair, and final, the arbitrator's award is binding both to you and Ford of Canada.

CAMVAP services are available in all territories and provinces, except Quebec. For more information, without charge or obligation, call your CAMVAP Provincial Administrator directly at 1 800-207-0685.

Customer assistance

GETTING ASSISTANCE OUTSIDE THE U.S. AND CANADA

Before exporting your vehicle to a foreign country, contact the appropriate foreign embassy or consulate. These officials can inform you of local vehicle registration regulations and where to find unleaded fuel.

If you cannot find unleaded fuel or can only get fuel with an anti-knock index lower than is recommended for your vehicle, contact a district or owner relations/customer assistance office.

The use of leaded fuel in your vehicle without proper conversion may damage the effectiveness of your emission control system and may cause engine knocking or serious engine damage. Ford Motor Company/Ford of Canada is not responsible for any damage caused by use of improper fuel.

In the United States, using leaded fuel may also result in difficulty importing your vehicle back into the U.S.

If your vehicle must be serviced while you are traveling or living in Central or South America, the Caribbean, or the Middle East, contact the nearest Ford dealership. If the dealership cannot help you, write or call:

FORD MOTOR COMPANY
WORLDWIDE DIRECT MARKET
OPERATIONS
1555 Fairlane Drive

Fairlane Business Park #3
Allen Park, Michigan 48101
U.S.A.

Telephone: (313) 594-4857
FAX: (313) 390-9804

If you are in another foreign country, contact the nearest Ford dealership. If the dealership employees cannot help you, they can direct you to the nearest Ford affiliate office.

If you buy your vehicle in North America and then relocate outside of the U.S. or Canada, register your vehicle identification number (VIN) and new address with Ford Motor Company Worldwide Direct Market Operations.

Customer assistance

FORD ACCESSORIES FOR YOUR VEHICLE

Ford has many quality products available from your dealer to clean your vehicle and protect its finishes. For best results, use the following or products of equivalent quality

Ford Custom Clearcoat Polish*

Ford Custom Silicone Gloss Polish

Ford Custom Vinyl Protectant*

Ford Deluxe Leather and Vinyl Cleaner

Ford Extra Strength Tar and Road Oil Remover*

Ford Extra Strength Upholstery Cleaner

Ford Metal Surface Cleaner

Ford Multi-Purpose Cleaner*

Motorcraft Car Wash Concentrate

Motorcraft Carlite Glass Cleaner

Ford Spot and Stain Remover*

Ford Super Premium Tire and Trim Dressing

Ford Triple Clean

Ford Ultra-Clear Spray Glass Cleaner

* May be sold with the Motorcraft name

A wide selection of accessories is available through your local authorized Ford, Lincoln-Mercury or Ford of Canada dealer. These quality accessories have been specifically engineered to fulfill your automotive needs; they are custom designed to complement the style and aerodynamic appearance of your vehicle. In addition, each accessory is made from high quality materials and meets or exceeds Ford's rigid engineering and safety specifications. Ford accessories are warranted for up to 12 months or 20,000 km (12,000 miles) on all cars and light trucks and 12 months with unlimited distance on medium/heavy duty trucks unless the accessory is installed on a new vehicle, then the warranty becomes the balance of the new vehicle's warranty or the accessories warranty, whichever is greater. See your dealer for complete warranty information and availability.

Not all accessories are available for all models.

Customer assistance

Vehicle Security

Remote keyless entry
Styled wheel protector locks
Vehicle security systems
Wheel locks for alloy wheels

Comfort and convenience

Air conditioner
Cargo nets
Cargo shades
Dash trim
Electrochromic/compass/mirror
Electrochromic/compass/
o/s temp mirror
Engine block heaters
Gear shift knob
Smokers pack

Travel equipment

Automatic headlamp system
Console
Daytime running lights
Factory luggage rack adapters
Fog lights
Framed luggage covers
Heavy-duty battery
Luggage/cargo basket
Removable luggage rack
Removable luggage rack adapters
Soft luggage cover
Speed control

Protection and appearance equipment

Air bag anti-theft locks
Car/truck covers
Carpet floor mats
Cleaners, waxes and polishes
Door edge guards
Flat splash guards
Front end covers (full and mini)
Handbrake cover
Hood deflectors
Leather wrap steering wheel
Lubricants and oils
Molded splash guards
Molded vinyl floor mats
Rear decklid spoilers
Sunglass holder
Touch-up paint

For maximum vehicle performance, keep the following information in mind when adding accessories or equipment to your vehicle:

- When adding accessories, equipment, passengers and luggage to your vehicle, do not exceed the total weight capacity of the vehicle or of the front or rear axle (GVWR or GAWR as indicated on the Safety Compliance Certification Label). Consult your dealer for specific weight information.

Customer assistance

- The Federal Communications Commission (FCC) and Canadian Radio Telecommunications Commission (CRTC) regulate the use of mobile communications systems – such as two-way radios, telephones and theft alarms – that are equipped with radio transmitters. Any such equipment installed in your vehicle should comply with FCC or CRTC regulations and should be installed only by a qualified service technician.
- Mobile communications systems may harm the operation of your vehicle, particularly if they are not properly designed for automotive use or are not properly installed. When operated, such systems may cause the engine to stumble or stall. In addition, such systems may be damaged or their performance may be affected by operating your vehicle. (Citizens band [CB] transceivers, garage door openers and other transmitters with outputs of five watts or less will not ordinarily affect your vehicle's operation.)
- Ford cannot assume responsibility for any adverse effects or damage that may result from the use of such equipment.

ORDERING ADDITIONAL OWNER'S LITERATURE

To order the publications in this portfolio:

Make checks payable to:
HELM, INCORPORATED
P.O. Box 07150
Detroit, Michigan, 48207

For a free publication catalog, order toll free: 1-800-782-4356

Monday–Friday 8:00 a.m. – 6:00 p.m. EST.,
for credit card holders only.

Reporting safety defects

REPORTING SAFETY DEFECTS (U.S. ONLY)

If you believe that your vehicle has a defect that could cause a crash, or could cause injury or death, you should immediately inform the National Highway Traffic Safety Administration (NHTSA) in addition to notifying Ford Motor Company.

If NHTSA receives similar complaints, it may open an investigation, and if it finds that a safety defect exists in a group of vehicles, it may order a recall and remedy campaign. However, NHTSA cannot become involved in individual problems between you, your dealer or Ford Motor Company.

To contact NHTSA, you may either call the Auto Safety Hotline toll-free at 1-800-424-9393 (202-366-0123 in the Washington D.C. area) or write to:

NHTSA
U.S. Department of Transportation
400 Seventh Street
Washington D.C. 20590

You can also obtain other information about motor vehicle safety from the Hotline.

Ford Motor Company

Index

A

ABS warning lamp 135
Accessories 280
Adding brake fluid 201
Adding engine coolant 203
Adding washer fluid 202
Additives, engine oil 197
AdvanceTrac[™] 11, 37
AdvanceTrac[™] light 11
Air bag 12
Air bag disposal 112
Air bag readiness light 12
Air bag supplemental restraint system 102
Air bag system, side 108
Air conditioning 30-32
Air distribution 25-26
Air filter 263
Anti-lock brake system (ABS) . 134
Anti-lock brake system (ABS) light 15
Anti-theft protection panel 39
Ashtray 38
Audio System 39
Automatic transaxle fluid 265
Automatic transaxle operation . 144

B

Backup lamps 247
Base curb weight 154
Battery 184, 214, 263
Belt Minder 94
Blower 27
Brake fluid 201, 264
Brake lamps 247
Brake system warning 14
Brake-shift interlock 144
Brake/clutch fluid 265
Brakes 133
Break-in period 3
Bulb replacement 244-252
Bulb specifications 251

C

Cabin air filter 263
Capacities 264
Car care products 280
Catalytic converter 10
Changing the tires 177
Charging system warning light . . 13
Child restraint precautions 113
Child safety seats, installing . . . 118
Child safety seats, tether straps 123
Childproof door locks 67
Children and air bags 104
Children and safety belts 114
Chimes 16

C

Clutch fluid 200
 Components in the engine
 compartment 195, 196
 Control lights 8-14
 Coolant refill capacity 206
 Cooling system 10
 Cruise control. *See* Speed control
 Customer assistance 272

D

Daytime running lights (DRL) . . 21
 De-icing the windows 31
 Dimensions 267
 Dispute settlement board 275
 Dome lamps 65
 Doors ajar 12
 Driving through water 166
 Driving with a trailer 158
 Driving with automatic
 transaxle 146

E

Emission control system 240
 Engine compartment 195, 196
 Engine coolant 202, 264, 265
 Engine coolant, recycled 206
 Engine data 266
 Engine number 271
 Engine oil 197, 264, 265
 Engine oil pressure warning light 14

E

EPA window sticker 240
 Exhaust fumes 131
 Exterior bulbs 244

F

Fail safe cooling system 17
 Fail-safe cooling 207
 Floor mat 69
 Fog lights 20
 Fog lights, replacing bulbs 246
 Footwell heating 25
 Front seats 82
 Fuel economy 234
 Fuel economy habits 237
 Fuel filler cap 229
 Fuel filter 233, 263
 Fuel for cleaner air 232
 Fuel gauge 19
 Fuel level 14
 Fuel pump shut-off switch 168
 Fuel quality 231
 Fuel tank 264
 Fuel, choosing 230
 Fuel, octane recommendations 231
 Fuel, safety information 226
 Fuses 169
 Fuses and relays 169

Index

G

- Gearshift warning chime 16
- Good fuel economy 234
- Gross axle weight rating (GAWR) 155
- Gross combined weight (GCW) 155
- Gross vehicle weight (GVW) . . . 154
- Gross vehicle weight rating (GVWR) 154

H

- Hazard flasher 38
- Hazard lights control 167
- Head restraints 82
- Headlamp control 20
- Headlamps on warning chime . . . 16
- Headlamps, aiming 252
- Headlamps, replacing bulbs . . . 244
- High beams 13, 21
- Hood, opening 194

I

- Icons 2
- Identifying your vehicle 270
- Ignition positions 58
- Instrument cluster 8-15
- Instrument cluster gauges 17
- Instrument panel 6-7
- Introduction 2
- ISOFIX attachments 121

J

- Jack 180
- Jack positioning 181
- Jump starting 184

K

- Key programming 78
- Key-in-ignition warning chime . . 16

L

- Lamps, replacing bulbs 244
- Lights, warning and indicator . . . 8
- Load limits 154
- Loading your vehicle 154
- Lost transmitters 73
- Lubricant specifications 265
- Luggage compartment 22
- Luggage cover 68
- Luggage rack 165

M

- Maintenance and care 193
- Manual transaxle operation . . . 150
- Mileage. *See* Fuel economy
- Mirror 67
- Moonroof 65
- Motorcraft parts 263

N

National Highway Traffic Safety
Administration 283

O

Octane rating 231
Odometer 19
Oil filter 263
Opening the luggage
compartment 22
Overdrive 15
Owner's literature 282

P

Panic alarm 71
Parking brake 142
Parts 263
Payload 154
PCV valve 263
Perimeter alarm system 75
Plastic exterior parts 256
Power distribution box 174
Power door locks 69
Power side view mirrors 67
Power steering 264, 265
Power steering fluid 210
Power windows 66
Preparing to start your vehicle . 126
Preparing to tow 160

R

Radio 39
Reading lamps 65
Rear window defroster 37
Recirculated air 28, 31
Recycled engine coolant 206
Refill capacities 264
Relays 169
Remote entry system 69
Reporting safety defects 283
Roadside assistance 272
Running out of fuel 233

S

Safety belt extension assembly 100
Safety belt maintenance . 101, 259
Safety belt warning chime . . . 16, 93
Safety belt warning light 13, 93
Safety belts 86
Safety belts for children 116
Safety compliance label 270
Safety defects, reporting 283
Safety restraints 86
Safety restraints for children . . 112
Safety restraints, cleaning 259
Seating 82
SecuriLock[™] passive anti-theft
system 76
Service plan 273
Servicing your vehicle 193

Index

S

- Snow tires and chains 224
- Spare tire 177
- Spark plugs 263
- Specifications 263
- Speed control 15, 61
- Speedometer 19
- Steering 143
- Steering column 59

T

- Tachometer 18
- Temperature control 26
- Temperature gauge 17
- Tilt steering wheel 59
- Tires, changing 177
- Tires, checking the pressure . . . 222
- Tires, replacing 223
- Tires, spare 177
- Tires, tire grades 219
- Tires, treadwear 220
- Towing your vehicle 163, 191
- Trailer lamps 161
- Trailer towing 158
- Transaxle fluid 211
- Transaxle, automatic 265

T

- Transaxle, manual 265
- Tripmeter 19
- Trunk. *See* Luggage compartment
- Turn signal control 59
- Turn signals 13

U

- Upshift 15

V

- Vehicle identification number . . 271
- Vehicle symbol glossary 4
- Vents 25
- Viscosity. *See* Engine oil

W

- Warning lights 8-14
- Waxing your vehicle 255
- Weight limits 154
- Wheels, inspection and maintenance 256
- Windshield washer fluid . . 202, 264
- Windshield wiper 60
- Windshield wiper blades 218
- Wrecker towing 191

Filling station information

| Item | Information |
|---|---|
| Recommended fuel | Unleaded fuel only – 87 octane |
| Fuel tank capacity | 50 L (13.2 gallons) |
| Engine oil capacity (includes filter change) | Zetec: 4.25 L (4.5 quarts) SPI: 3.78 L (4.0 quarts) |
| Tire size and pressure | See label on the rear most driver's side door jamb |
| Hood release | Pull handle under the left side of the instrument panel |
| Coolant capacity* | 5.75 L (6.1 quarts) |
| Power steering fluid capacity | Fill to line on reservoir. |
| Manual transaxle fluid capacity | 2.0 L (2.1 quarts) |
| Automatic transaxle fluid capacity** | 6.6 L (6.9 quarts) |

* If your engine requires additional coolant, use Ford Premium Cooling System Fluid. Refer to *Lubricant Specifications*.

** Ensure correct automatic transaxle fluid is used for a specific application. Check the container to verify the fluid is MERCON® and/or MERCON® V approved. Some fluids have been approved as meeting both MERCON® and MERCON® V requirements and will be labeled as such. Fluids labeled as meeting only MERCON® or only MERCON® V requirements must not be used interchangeably. DO NOT mix MERCON® and MERCON® V. Transaxle fluid requirements are indicated on the dipstick or on the dipstick handle. Refer to your “Scheduled Maintenance Guide” to determine the correct service interval.