

Contents

Before driving

Introduction	2
Instrumentation	5
Controls and features	22
Seating and safety restraints	82

Starting and driving

Starting	107
Driving	112
Roadside emergencies	144

Servicing

Maintenance and care	169
Capacities and specifications	212
Customer assistance	223
Reporting safety defects	235
Index	236

All rights reserved. Reproduction by any means, electronic or mechanical including photocopying, recording or by any information storage and retrieval system or translation in whole or part is not permitted without written authorization from Ford Motor Company.

Copyright © 1998 Ford Motor Company

Introduction

ICONS

Indicates a safety alert. Read the following section on *Warnings*.



Indicates vehicle information related to recycling and other environmental concerns will follow.



Correct vehicle usage and the authorized disposal of waste cleaning and lubrication materials are significant steps towards protecting the environment.

Indicates a message regarding child safety restraints. Refer to *Seating and safety restraints* for more information.



Indicates that this Owner Guide contains information on this subject. Please refer to the Index to locate the appropriate section which will provide you more information.



WARNINGS

Warnings provide information which may reduce the risk of personal injury and prevent possible damage to others, your vehicle and its equipment.

BREAKING-IN YOUR VEHICLE

There are no particular breaking-in rules for your vehicle. During the first 1 600 km (1 000 miles) of driving, vary speeds frequently. This is necessary to give the moving parts a chance to break in.

INFORMATION ABOUT THIS GUIDE

The information found in this guide was in effect at the time of printing. Ford may change the contents without notice and without incurring obligation.

Introduction

SPECIAL NOTICES

Notice to owners of diesel-powered vehicles

Read the 7.3 Liter Power Stroke Direct Injection Turbo Diesel Owner's Guide Supplement for information regarding correct operation and maintenance of your diesel-powered light truck.

Notice to owners of utility type vehicles

Before you drive your vehicle, please read this Owner's Guide carefully. Your vehicle is not a passenger car. As with other vehicles of this type, failure to operate this vehicle correctly may result in loss of control or an accident.

Be sure to read *Driving off road* in the *Driving* chapter as well as the "Four Wheeling" supplement included with 4WD and utility type vehicles.

Using your vehicle with a snowplow

For more information and guidelines for using your vehicle with a snowplow, refer to the *Driving* chapter.

Using your vehicle as an ambulance

If your light truck is equipped with the *Ford ambulance preparation package*, it may be utilized as an ambulance. Ford urges ambulance manufacturers to follow the recommendations of the *Ford incomplete vehicle manual*, *Ford truck body builder's layout book* and the *QVM guidelines* as well as pertinent supplements. For additional information, please contact the Light Truck Body Builders Advisory Service 1-800-635-5560.

Use of your Ford light truck as an ambulance, without the Ford Ambulance Preparation Package voids the Ford New Vehicle Limited Warranty and may void the Emissions Warranties. In addition, ambulance usage without the preparation package could cause high underbody temperatures, overpressurized fuel and a risk of spraying fuel which could lead to fires.

Introduction

If your vehicle is equipped with the Ford ambulance preparation package, it will be indicated on the Certification label. The label is located on the driver's side door pillar or on the rear edge of the driver's door. You can determine whether the ambulance manufacturer followed Ford's recommendations by directly contacting that manufacturer. Ford Ambulance preparation package is only available on certain 7.3L Diesel engine equipped vehicles.

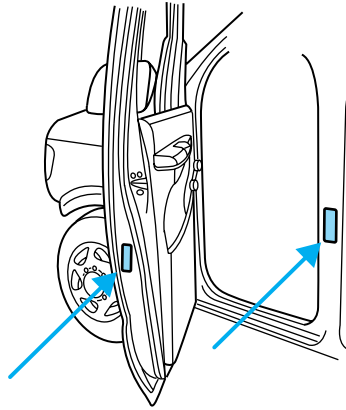

Notice to owners with vehicles equipped with Power Take Off (PTO) capability

Refer to the *Driving* chapter for more information and guidelines for operating vehicles equipped with PTO.

Instrumentation

Instrumentation

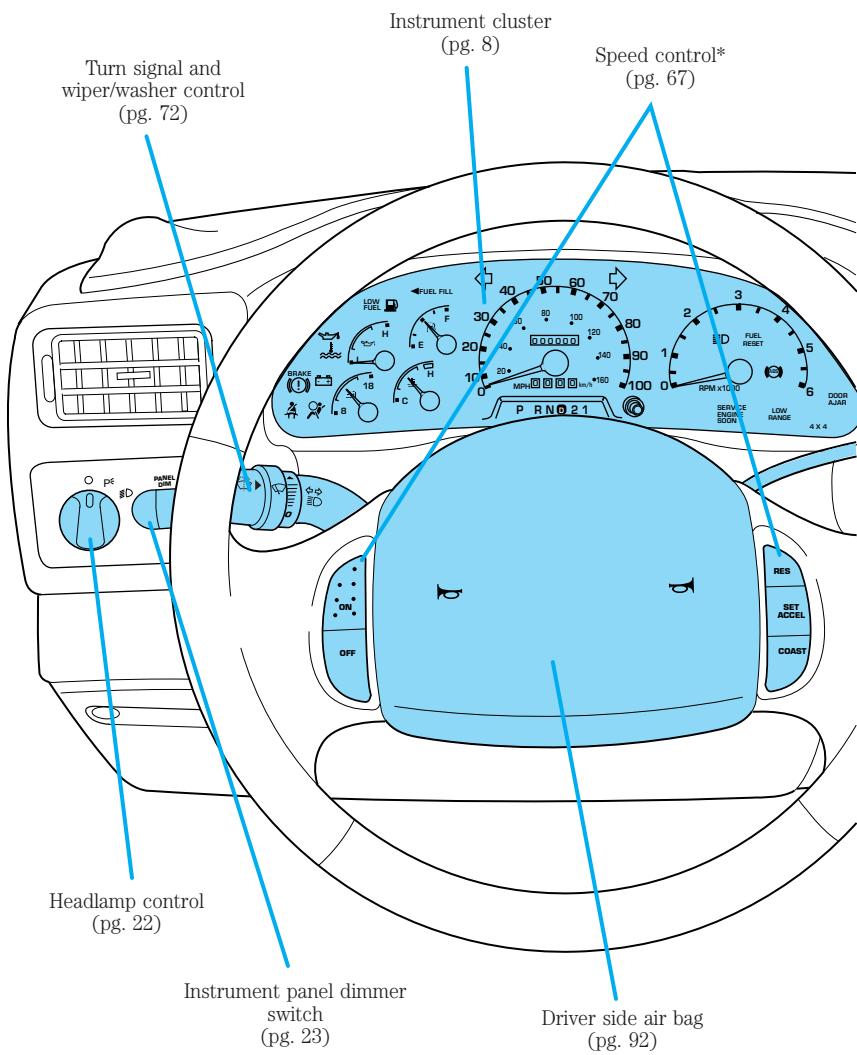

* if equipped

Instrumentation

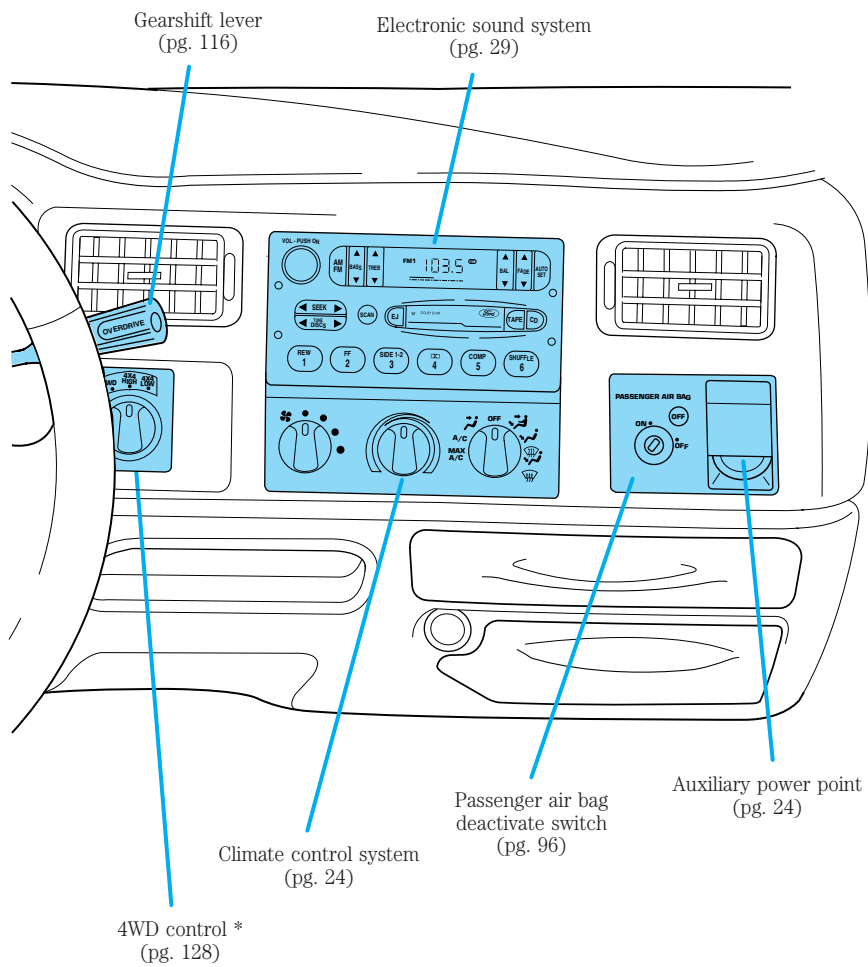

Instrumentation

WARNING LIGHTS AND CHIMES

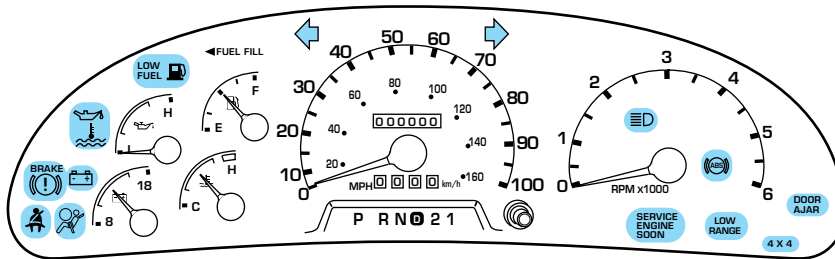

Low fuel

Illuminates as an early reminder of a low fuel condition indicated on the fuel gauge. The light comes on when there is approximately 1/16th of a tank indicated on the fuel gauge (refer to *Fuel Gauge* in this chapter for more information). The ignition must be in the ON position for this lamp to illuminate. The lamp will also illuminate for several seconds after the ignition is turned to the ON position regardless of the fuel level.



Service engine soon (Federal only)

Your vehicle is equipped with a computer that monitors the engine's emission control system. This system is commonly known as the On Board Diagnostics System (OBD I). This OBD I system protects the environment by ensuring that your vehicle continues to meet government emission standards. The OBD I system also assists the service technician in properly servicing your vehicle.



The *Check Engine/Service Engine Soon* indicator light illuminates when the ignition is first turned to the ON position to check the bulb. If it comes on after the engine is started, one of the engine's emission control systems may be malfunctioning. The light may illuminate without a driveability concern being noted. The vehicle will usually be drivable and will not require towing.

Instrumentation

What you should do if the Check Engine/Service Engine Soon light illuminates

Light turns on solid:

This means that the OBD I system has detected a malfunction.

Temporary malfunctions may cause your *Service Engine Soon* light to illuminate. Examples are:

1. The vehicle has run out of fuel. (The engine may misfire or run poorly.)
2. Poor fuel quality or water in the fuel.

These and other temporary malfunctions can be corrected by filling the fuel tank with good quality fuel. After three driving cycles without these or any other temporary malfunctions present, the *Check Engine/Service Engine Soon* light should turn off. (A driving cycle consists of a cold engine startup followed by mixed city/highway driving.) No additional vehicle service is required.

If the *Check Engine/Service Engine Soon* light remains on, have your vehicle serviced at the first available opportunity.



Under engine misfire conditions, excessive exhaust temperatures could damage the catalytic converter, the fuel system, interior floor coverings or other vehicle components, possibly causing a fire.

Service engine soon (California only)

Your vehicle is equipped with a computer that monitors the engine's emission control system. This system is commonly known as the On Board Diagnostics System (OBD II). This OBD II system protects the environment by ensuring that your vehicle continues to meet government emission standards. The OBD II system also assists the service technician in properly servicing your vehicle.

**SERVICE
ENGINE
SOON**

The *Service Engine Soon* indicator light illuminates when the ignition is first turned to the ON position to check the bulb. If it comes on after the engine is started, one of the engine's emission control systems may be malfunctioning. The light may illuminate without a driveability concern being noted. The vehicle will usually be drivable and will not require towing.

Instrumentation

What you should do if the Service Engine Soon light illuminates

Light turns on solid:

This means that the OBD II system has detected a malfunction.

Temporary malfunctions may cause your *Service Engine Soon* light to illuminate. Examples are:

1. The vehicle has run out of fuel. (The engine may misfire or run poorly.)
2. Poor fuel quality or water in the fuel.
3. The fuel cap may not have been properly installed and securely tightened.

These temporary malfunctions can be corrected by filling the fuel tank with good quality fuel and/or properly installing and securely tightening the gas cap. After three driving cycles without these or any other temporary malfunctions present, the *Service Engine Soon* light should turn off. (A driving cycle consists of a cold engine startup followed by mixed city/highway driving.) No additional vehicle service is required.

If the *Service Engine Soon* light remains on, have your vehicle serviced at the first available opportunity.

Light is blinking:

Engine misfire is occurring which could damage your catalytic converter. You should drive in a moderate fashion (avoid heavy acceleration and deceleration) and have your vehicle serviced at the first available opportunity.



Under engine misfire conditions, excessive exhaust temperatures could damage the catalytic converter, the fuel system, interior floor coverings or other vehicle components, possibly causing a fire.

Air bag readiness

Momentarily illuminates when the ignition is turned ON. If the light fails to illuminate, continues to flash or remains on, have the system serviced immediately.



Instrumentation

Transmission control indicator light (TCIL) (if equipped)

The word OFF located on the end of the gearshift lever is the transmission control indicator light (TCIL).

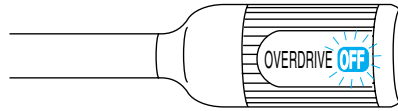

The TCIL may flash steadily if a malfunction is detected. If the TCIL is flashing, contact your Ford dealer as soon as possible. If this condition persists, damage to the transmission could occur.

Safety belt

Momentarily illuminates when the ignition is turned to the ON position to remind you to fasten your safety belts. For more information, refer to the *Seating and safety restraints* chapter.



Brake system warning

Momentarily illuminates when the ignition is turned to the ON position, the engine is off and the parking brake is engaged. If the brake warning lamp does not illuminate at this time, seek service immediately. Illumination after releasing the parking brake indicates low brake fluid level and the brake system should be inspected immediately.



Anti-lock brake system (ABS)

Momentarily illuminates when the ignition is turned to the ON position and the engine is off. If the light remains on, continues to flash or fails to illuminate, have the system serviced immediately. With the ABS light on, the anti-lock brake system is disabled and normal braking is still effective unless the brake warning light also remains illuminated with parking brake released.



Instrumentation

Turn signal

Illuminates when the left or right turn signal or the hazard lights are turned on. If one or both of the indicators stay on continuously or flash faster, check for a burned-out turn signal bulb. Refer to *Exterior bulbs* in the *Maintenance and care* chapter.



High beams

Illuminates when the high beam headlamps are turned on.



Charging system

Illuminates when the ignition is turned to the ON position and the engine is off. The light also illuminates when the battery is not charging properly, requiring electrical system service.



Four wheel drive low (if equipped)

This light momentarily illuminates when the ignition is turned to ON. Illuminates when four-wheel drive low is engaged. If the light continues to flash have the system serviced.



Four wheel drive indicator (if equipped)

This light momentarily illuminates when the ignition is turned to ON. Illuminates when 4x4 range is engaged.



Instrumentation

Door ajar

Illuminates when the ignition is in the ON or START position and any door is open.

**DOOR
AJAR**

Oil pressure/Engine coolant

This light will illuminate when the ignition is in the ON position and the:

- engine coolant temperature is very high
- engine oil pressure is low
- engine is off

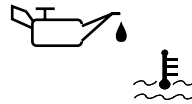

The light serves as a notice that a system needs your attention and to check the engine coolant temperature gauge and the engine oil pressure gauge.

Refer to *Engine coolant temperature gauge* and *Engine oil pressure gauge* in this chapter for more information.

Safety belt warning chime

Chimes to remind you to fasten your safety belts.

For information on the safety belt warning chime, refer to the *Seating and safety restraints* chapter.

Supplemental restraint system (SRS) warning chime

For information on the SRS warning chime, refer to the *Seating and safety restraints* chapter.

Key-in-ignition warning chime

Sounds when the ignition key is left in the ignition in the OFF/LOCK or ACC position and the driver's door is opened.

Headlamps on warning chime

Sounds when the headlamps or parking lamps are on, the ignition in the OFF position (and the key is not in the ignition) and the driver's door is opened.

Instrumentation

GAUGES

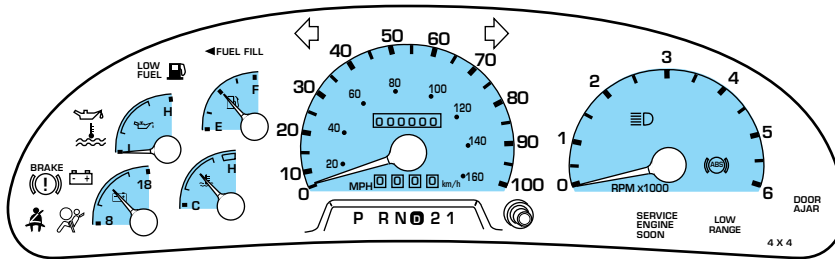

Fuel gauge

Displays approximately how much fuel is in the fuel tank (when the ignition is in the ON position). The fuel gauge may vary slightly when the vehicle is in motion. The ignition should be in the OFF position while the vehicle is being refueled. When the gauge first indicates empty, there is a small amount of reserve fuel in the tank. When refueling the vehicle from empty indication, the amount of fuel that can be added will be less than the advertised capacity due to the reserve fuel.

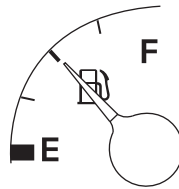

Speedometer

Indicates the current vehicle speed.

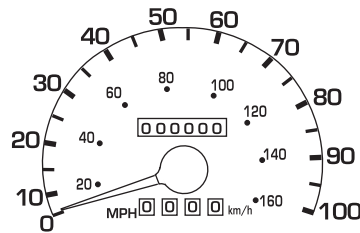

Instrumentation

Engine coolant temperature gauge

Indicates the temperature of the engine coolant. At normal operating temperature, the needle remains within the normal area (the area between the “H” and “C”). If it enters the red section, the engine is overheating. Stop the vehicle as soon as safely possible, switch off the engine immediately and let the engine cool. Refer to *Engine coolant* in the *Maintenance and care* chapter.

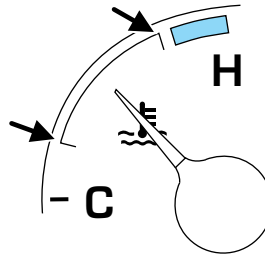

Never remove the coolant reservoir cap while the engine is running or hot.

This gauge indicates the temperature of the engine coolant, not the coolant level. If the coolant is not at its proper level the gauge indication will not be accurate.

Odometer

Registers the total kilometers (miles) of the vehicle.

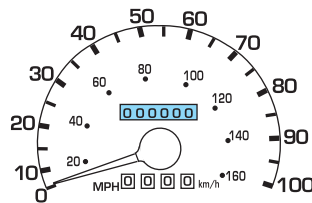

Instrumentation

Trip odometer

Registers the kilometers (miles) of individual journeys. To reset, depress the control.

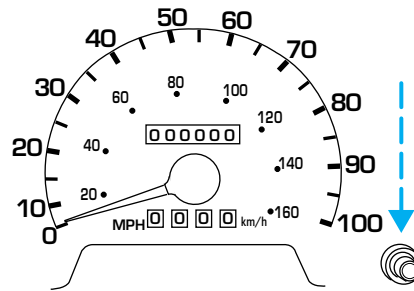

Tachometer

Indicates the engine speed in revolutions per minute.

Driving with your tachometer pointer in the red zone may damage the engine.

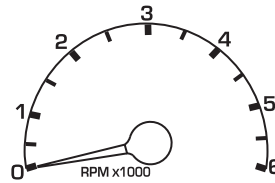

Battery voltage gauge

This gauge shows the battery voltage when the ignition is in the ON position. If the pointer moves and stays outside the normal operating range (as indicated), have the vehicle's electrical system checked as soon as possible.

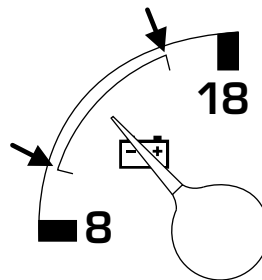

Instrumentation

Engine oil pressure gauge

This shows the engine oil pressure in the system. Sufficient pressure exists as long as the needle remains in the normal range (the area between the “L” and “H”).

If the gauge indicates low pressure, stop the vehicle as soon as safely possible and switch off the engine immediately. Check the oil level. Add oil if needed (refer to *Engine oil* in the *Maintenance and care* chapter). If the oil level is correct, have your vehicle checked at your dealership or by a qualified technician.

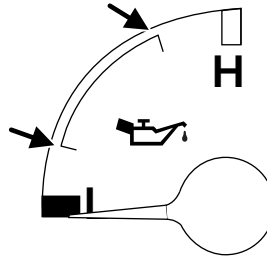

TRIP COMPUTER (IF EQUIPPED)

The trip computer tells you about the condition of your vehicle through a constant monitor of vehicle systems. You may select display features on the trip computer for a display of status.

The appearance of your vehicle's trip computer may differ depending on your vehicle's option package, but the functions are the same.

The trip computer only operates with the ignition in the ON position. Trip computer features follow:

Selectable features

English/metric display

Press this control to change the trip computer display between metric and English units.

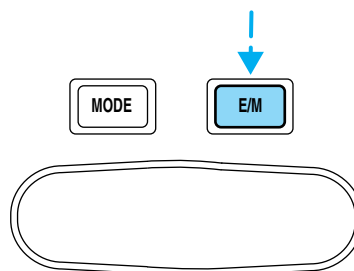

Instrumentation

Mode control

Each press of the MODE control will display a different feature as follows:

Average fuel economy. The display will indicate the vehicle's average fuel economy in liters/100 km (or miles/gallon) since the average fuel economy was last reset.

If you calculate your average fuel economy by dividing liters of fuel used by 100 kilometers traveled (miles traveled by gallons used), your figure may be different than displayed for the following reasons:

- your vehicle was not perfectly level during fill-up
- differences in the automatic shut-off points on the fuel pumps at service stations
- variations in top-off procedure from one fill-up to another
- rounding of the displayed values to the nearest 0.1 liter (gallon)

To reset the average fuel economy:

1. Press the MODE control repeatedly until average fuel economy is displayed (this is the only resettable display).

2. Press the E/M and MODE controls simultaneously. The display will illuminate the "AVG" indicator. While the indicator is lit, release both controls to reset the average fuel economy.

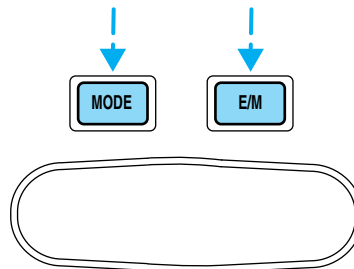
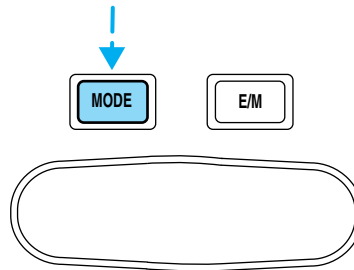

Fuel range. This displays the approximate number of kilometers (miles) left to drive before the fuel tank is empty. The indicated distance to empty may be inaccurate:

- with sustained, drastic changes in fuel economy (such as trailer towing), but will eventually recover.

Instrumentation

- if the vehicle is started while parked on an incline.
- if less than 30 liters (8 gallons) of fuel is added to the fuel tank.

The fuel range function will flash for 5 seconds at the following distances based on fuel remaining and fuel economy calculations:

- 80 km (50 miles)
- 40 km (25 miles)
- 16 km (10 miles)

Off. In this mode the display is off.

Outside air temperature

The temperature can be displayed in Centigrade or Fahrenheit by pressing the E/M control.

If the outside temperature falls below 3°C (38°F), the display will alternate from “ICE” to the outside temperature at a two second rate for one minute.

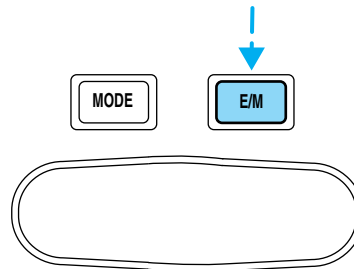

Compass

The compass display is contained in the overhead console. The vehicle heading is displayed as one of N, NE, E, SE, S, SW, W and NW.

The compass heading is displayed in average fuel economy modes, fuel range modes and temperature modes.

The compass reading may be affected when you drive near large buildings, bridges, power lines and powerful broadcast antenna. Magnetic or metallic objects placed in or on the vehicle may also affect compass accuracy. Adjustments may need to be made to the zone and calibration of the compass.

Instrumentation

Compass zone adjustment

1. Determine which magnetic zone you are in for your geographic location by referring to the zone map.
2. Locate the trip computer on the overhead console.
3. Turn ignition to the ON position.

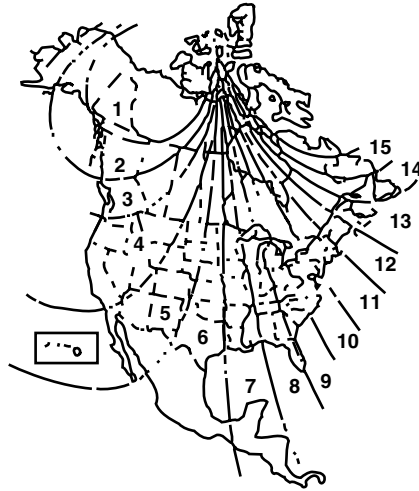

4. Press and hold both trip computer controls. After approximately four seconds, the trip computer will enter zone setting mode. Zone setting mode is indicated when the display lights the "ZONE" indicator.

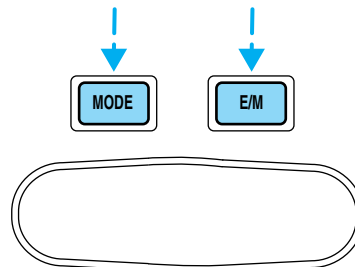

5. Release both controls. Subsequent pressing of either control will increment the zone. Press the control repeatedly until the correct zone setting for your geographic location is displayed on the trip computer.
6. To exit the zone setting mode and save the displayed zone in memory, release both controls for greater than five seconds.

Instrumentation

Compass calibration adjustment

Perform this adjustment in an open area free from steel structures and high voltage lines.

For optimum calibration, turn off all electrical accessories (heater/air conditioning, wipers, etc.) and make sure all vehicle doors are shut.

1. Locate the trip computer located in the overhead console.
2. Start the vehicle.

3. Press and hold both trip computer controls. After approximately 8 seconds, the trip computer will enter CAL mode. CAL mode is indicated when the display lights the “CAL” indicator.

4. Release both controls. The display will return to normal, except that the CAL indicator will remain lit until the compass is successfully calibrated.

5. Slowly drive the vehicle in a circle (less than 5 km/h [3 mph]) until the CAL indicator turns off. It may take up to five circles to complete calibration.

6. The compass is now calibrated.

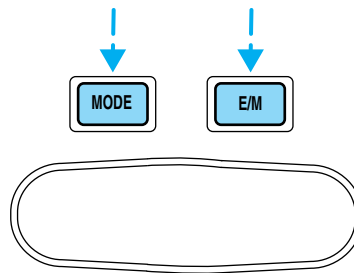

Controls and features

HEADLAMP CONTROL

Rotate the headlamp control to the first position to turn on the parking lamps. Rotate to the second position to also turn on the headlamps.

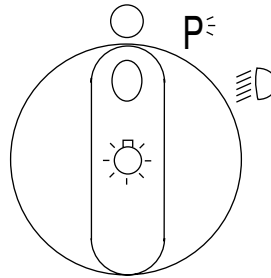

Daytime running lamps (DRL) (if equipped)

Turns the headlamps on with a reduced output. To activate:

- the ignition must be in the ON position and
- the headlamp control is in the OFF or Parking lamps position.

 Always remember to turn on your headlamps at dusk or during inclement weather. The Daytime Running Light (DRL) System does not activate your tail lamps and generally may not provide adequate lighting during these conditions. Failure to activate your headlamps under these conditions may result in a collision.

High beams

Push forward to activate.

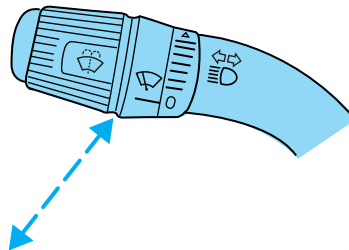

Controls and features

Flash to pass

Pull toward you to activate and release to deactivate.

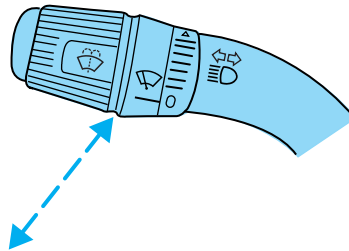

PANEL DIMMER CONTROL

Use to adjust the brightness of the instrument panel during headlamp and parklamp operation.

- Rotate up to brighten.
- Rotate down to dim.
- Rotate to full up position (past detent) to turn on interior lamps.

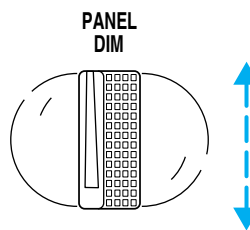

4WD CONTROL (IF EQUIPPED)

This control operates the 4WD. Refer to the *Driving* chapter for more information.

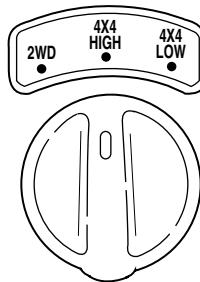

Controls and features

AUXILIARY POWER POINT

The auxiliary power point is located on the instrument panel.

Do not plug optional electrical accessories into the cigarette lighter. Use the power point.

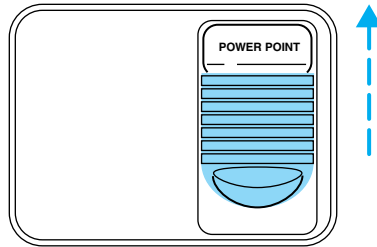

CLIMATE CONTROL SYSTEM

Heater only system (if equipped)



Fan speed control

Controls the volume of air circulated in the vehicle.

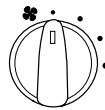

Temperature control

Controls the temperature of the airflow inside the vehicle. On heater-only systems, the air cannot be cooled below the outside temperature.

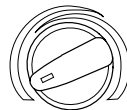





Mode selector control

Controls the direction of the airflow to the inside of the vehicle.



Controls and features

-  (Panel) -Distributes outside air through the instrument panel registers.
- OFF-Outside air is shut out and the fan will not operate.
-  (Panel and floor) -Distributes outside air through the instrument panel registers and the floor ducts.
-  (Floor) -Allows for maximum heating. Distributes outside air through the floor ducts.
-  (Floor and defrost) -Distributes outside air through the floor ducts and the windshield defroster ducts.
-  (Defrost) -Distributes outside air through the windshield defroster ducts. It can be used to clear ice or fog from the windshield.

Operating tips

- In humid weather, select  before driving. This will help to reduce your windshield from fogging. After a few minutes, select any desired position.
- To prevent humidity buildup inside the vehicle, don't drive with the climate control system in the OFF position.
- Don't put objects under the front seat that will interfere with the airflow to the back seats (if equipped).
- Remove any snow, ice or leaves from the air intake area (at the bottom of the windshield under the hood).

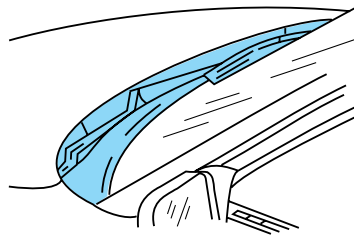

- When placing objects on top of your instrument panel, be careful to not place them over the defroster outlets. These objects can block airflow and reduce your ability to see through your windshield. Also, avoid placing small objects on top of your instrument panel. These objects can fall down into the defroster outlets and block airflow and possibly damage your climate control system.

Controls and features



Do not place objects on top of the instrument panel, as these objects may become projectiles in a collision or a sudden stop.

Manual heating and air conditioning system (if equipped)



Fan speed control

Controls the volume of air circulated in the vehicle.

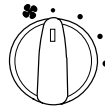

Temperature control knob

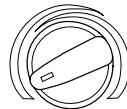

Controls the temperature of the airflow inside the vehicle.

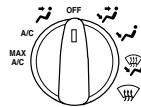

Mode selector control

Controls the direction of the airflow to the inside of the vehicle.







The air conditioning compressor will operate in all modes except  (Panel) and  (Floor). However, the air conditioning will only function if the outside temperature is about 10°C (50°F) or above.

Since the air conditioner removes considerable moisture from the air during operation, it is normal if clear water drips on the ground under the air conditioner drain while the system is working and even after you have stopped the vehicle.

Under normal conditions, your vehicle's climate control system should be left in any position other than MAX A/C or OFF when the vehicle is parked. This allows the vehicle to "breathe" through the outside air inlet duct. In snowy or dirty conditions, leave the mode selector in the OFF position.

Controls and features

- MAX A/C-Uses recirculated air to cool the vehicle. MAX A/C is noisier than A/C but more economical and will cool the inside of the vehicle faster. Airflow will be from the instrument panel registers. This mode can also be used to prevent undesirable odors from entering the vehicle.
- A/C-Uses outside air to cool the vehicle. It is quieter than MAX A/C but not as economical. Airflow will be from the instrument panel registers.
-  (Panel) -Distributes outside air through the instrument panel registers. However, the air will not be cooled below the outside temperature because the air conditioning does not operate in this mode.
- OFF-Outside air is shut out and the fan will not operate. For short periods of time only, use this mode to prevent undesirable odors from entering the vehicle.
-  (Panel and floor) -Distributes outside air through the instrument panel registers and the floor ducts. Heating and air conditioning capabilities are provided in this mode. For added customer comfort, when the temperature control knob is anywhere in between the full hot and full cold positions, the air distributed through the floor ducts will be slightly warmer than the air sent to the instrument panel registers.
-  (Floor) -Allows for maximum heating by distributing outside air through the floor ducts. However, the air will not be cooled below the outside temperature because the air conditioning does not operate in this mode.
-  (Floor and defrost) -Distributes outside air through the windshield defroster ducts and the floor ducts. Heating and air conditioning capabilities are provided in this mode. For added customer comfort, the air distributed through the floor ducts will be slightly warmer than the air sent to the windshield defroster ducts. If the temperature is about 10°C (50°F) or higher, the air conditioner will automatically dehumidify the air to reduce fogging.
-  (Defrost) -Distributes outside air through the windshield defroster ducts. It can be used to clear ice or fog from the windshield. If the temperature is about 10°C (50°F) or higher, the air conditioner will automatically dehumidify the air to reduce fogging.

Controls and features

Operating tips

- In humid weather, select  before driving. This will reduce your windshield from fogging. After a few minutes, select any desired position.
- To prevent humidity buildup inside the vehicle, don't drive with the climate control system in the OFF position.
- Don't put objects under the front seat that will interfere with the airflow to the back seats (if equipped).
- Remove any snow, ice or leaves from the air intake area (at the bottom of the windshield under the hood).

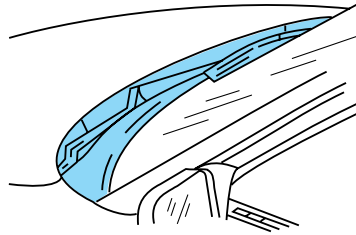

- If your vehicle has been parked with the windows closed during hot weather, the air conditioner will do a much faster job of cooling if you drive for two or three minutes with the windows open. This will force most of the hot, stale air out of the vehicle. Then operate your air conditioner as you would normally.
- When placing objects on top of your instrument panel, be careful to not place them over the defroster outlets. These objects can block airflow and reduce your ability to see through your windshield. Also, avoid placing small objects on top of your instrument panel. These objects can fall down into the defroster outlets and block airflow and possibly damage your climate control system.



Do not place objects on top of the instrument panel, as these objects may become projectiles in a collision or sudden stop.

Controls and features

USING YOUR AUDIO SYSTEM

AM/FM Stereo

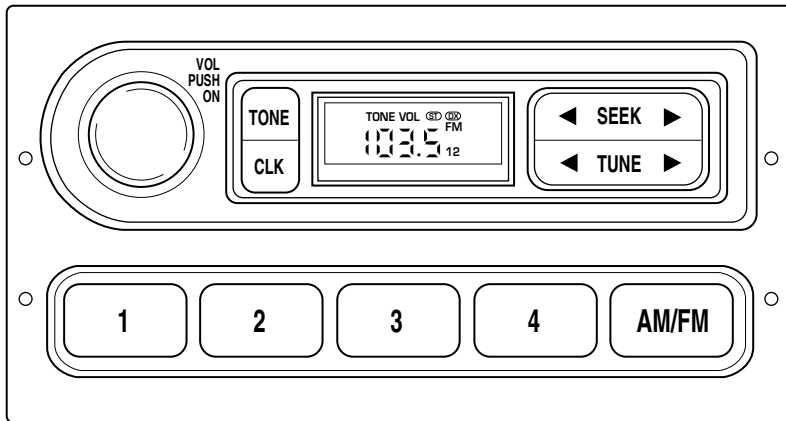

AM/FM Stereo

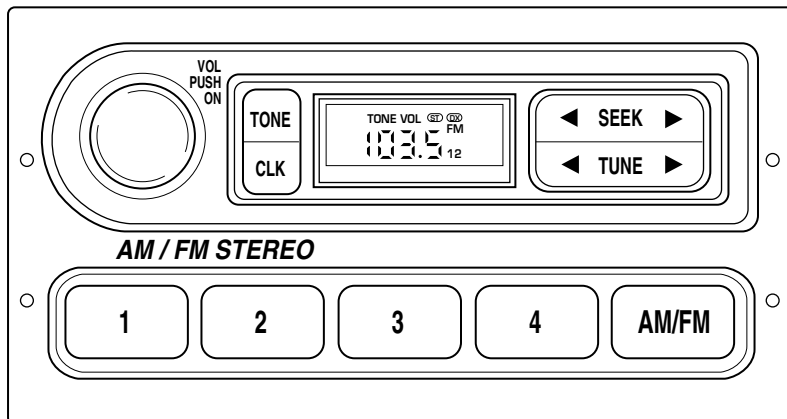

Controls and features

Volume/power control

Press the control to turn the audio system on or off.

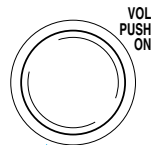

Turn the control to raise or lower volume.

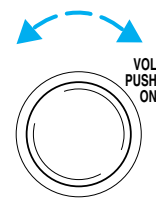

If the volume is set above a certain level and the ignition is turned off, the volume will come back on at a “nominal” listening level when the ignition switch is turned back on.

AM/FM select

The AM/FM select control works in radio mode.



AM/FM select in radio mode

This control allows you to select AM or FM frequency bands. Press the control to switch between AM, FM1 or FM2 memory preset stations.

Tune adjust

The tune control works in radio mode.

Controls and features

Tune adjust in radio mode

- Press ◀ to move to the next frequency down the band (whether or not a listenable station is located there). Hold the control to move through the frequencies quickly.
- Press ▶ to move to the next frequency up the band (whether or not a listenable station is located there). Hold for quick movement.

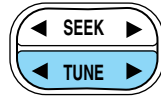

Seek function

The seek function control works in radio mode.

Seek function in radio mode

- Press ◀ to find the next listenable station down the frequency band.
- Press ▶ to find the next listenable station up the frequency band.



Radio station memory preset

The radio is equipped with four station memory preset controls. These controls can be used to select up to four preset AM stations and eight FM stations (four in FM1 and four in FM2).

Setting memory preset stations

1. Select the frequency band with the AM/FM select control.
2. Select a station. Refer to *Tune adjust* or *Seek function* for more information on selecting a station.
3. Press and hold a memory preset control until the sound returns, indicating the station is held in memory on the control you selected.

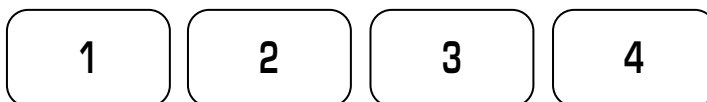

Controls and features

Bass adjust

The bass adjust control allows you to increase or decrease the audio system's bass output.

With the electronic AM/FM stereo, press the TONE control once, then use the volume knob to adjust the level.

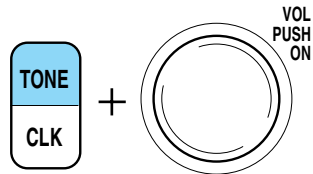

Treble adjust

The treble adjust control allows you to increase or decrease the audio system's treble output.

With the electronic AM/FM stereo, press the TONE control twice, then use the volume knob to adjust the level.

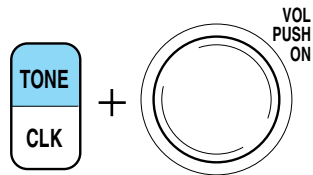

Speaker balance adjust

Speaker sound distribution can be adjusted between the right and left speakers.

With the electronic AM/FM stereo, press the TONE control three times, then use the volume knob to adjust the level.

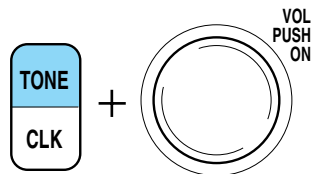

Speaker fade adjust (if equipped)

Speaker sound can be adjusted between the front and rear speakers.

With the electronic AM/FM stereo, press the TONE control four times, then use the volume knob to adjust the level.

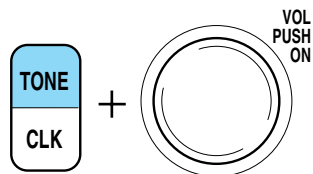

Controls and features

Setting the clock

Press CLK to toggle between listening frequencies and clock mode.

To set the hour, press and hold the CLK control and press:

- ◀ to decrease hours and
- ▶ to increase hours.

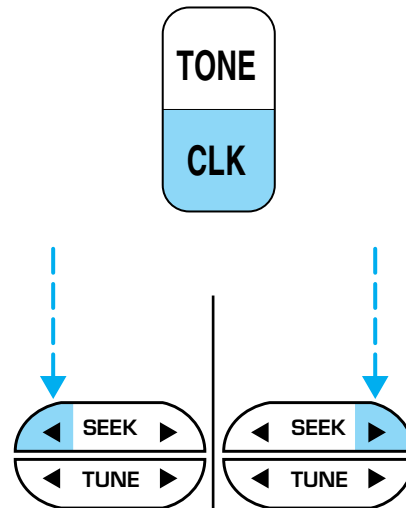

To set the minute, press and hold the CLK control and press:

- ◀ to decrease minutes and
- ▶ to increase minutes.

The CLK control will allow you to switch between media display mode (radio station, stereo information, etc.) and clock display mode (time). When in clock mode, the media information will display for ten seconds, when the radio is turned on, and then revert to clock information. Anytime that the media is changed, (new radio station, etc.), the media information will again display for ten seconds before

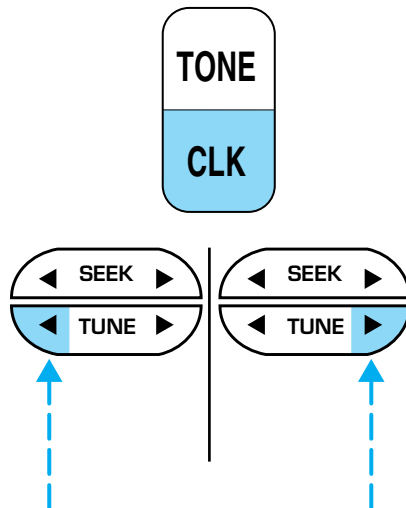

Controls and features

reverting back to the clock. In media mode, the media information will always be displayed.

AM/FM stereo cassette

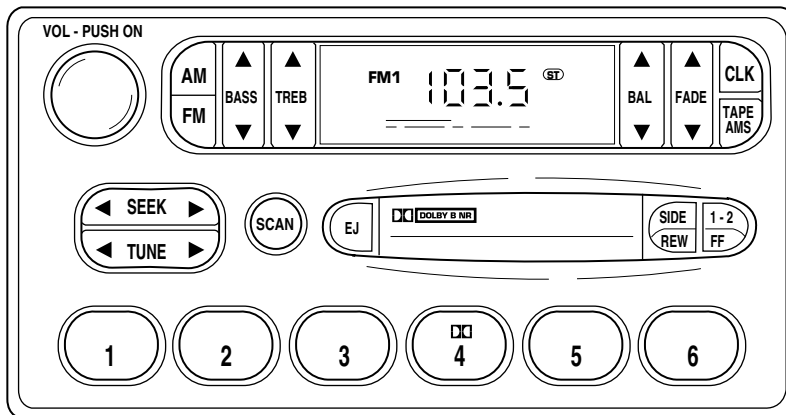

Volume/power control

Press the control to turn the audio system on or off.

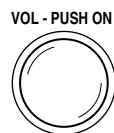

Turn the control to raise or lower volume.



Controls and features

If the volume is set above a certain level and the ignition is turned off, the volume will come back on at a “nominal” listening level when the ignition switch is turned back on.

AM/FM select

The AM/FM select control works in radio and tape modes.

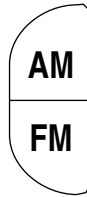

AM/FM select in radio mode

This control allows you to select AM or FM frequency bands. Press the AM control to select from AM selections, and press the FM control to select from FM1 or FM2 memory preset stations.

AM/FM select in tape mode

Press this control to stop tape play and begin radio play.

Tune adjust

The tune control works in radio mode.

Tune adjust in radio mode

- Press ◀ to move to the next frequency down the band (whether or not a listenable station is located there). Hold the control to move through the frequencies quickly.
- Press ▶ to move to the next frequency up the band (whether or not a listenable station is located there). Hold for quick movement.



Seek function

The seek function control works in radio mode.

Controls and features

Seek function in radio mode

- Press ◀ to find the next listenable station down the frequency band.
- Press ▶ to find the next listenable station up the frequency band.

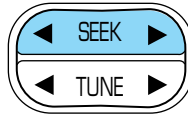

Scan function

The scan function works in radio mode.



Scan function in radio mode

Press the SCAN control to hear a brief sampling of all listenable stations on the frequency band. Press the SCAN control again to stop the scan mode.

Radio station memory preset

The radio is equipped with six station memory preset controls. These controls can be used to select up to six preset AM stations and twelve FM stations (six in FM1 and six in FM2).

Setting memory preset stations

1. Select the frequency band with the AM or the FM select control.
2. Select a station. Refer to *Tune adjust* or *Seek function* for more information on selecting a station.
3. Press and hold a memory preset control until the sound returns, indicating the station is held in memory on the control you selected.

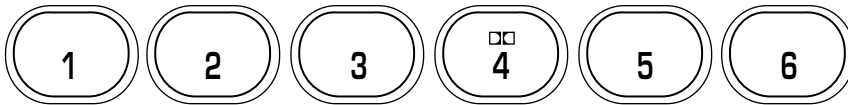

Controls and features

Bass adjust

The bass adjust control allows you to increase or decrease the audio system's bass output.

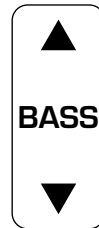

Treble adjust

The treble adjust control allows you to increase or decrease the audio system's treble output.



Speaker balance adjust

Speaker sound distribution can be adjusted between the right and left speakers.



Speaker fade adjust

Speaker sound can be adjusted between the front and rear speakers.



Controls and features

Tape select

- To enter tape mode while in radio mode, press the TAPE AMS control.



Automatic Music Search

The Automatic Music Search feature allows you to quickly locate the beginning of the tape selection being played or to skip to the next selection.

To activate the feature, momentarily depress the TAPE AMS button.

Then, press either REW (for the beginning of the current selection) or FF (to advance to the next selection). The tape deck stops and returns to play mode when the AMS circuit senses a blank section on the tape.

In order to ensure proper operation of the AMS feature, the tape **MUST** have a blank section of at least 4 seconds duration between programs.



Tape direction select

Press SIDE and 1-2 at the same time to play the alternate side of a tape.



Eject function

Press the control to stop and eject a tape.



Controls and features

Dolby® noise reduction

Dolby® noise reduction operates only in tape mode. Dolby® reduces the amount of hiss and static during tape playback.

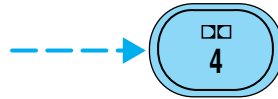

Press the  control to activate (and deactivate) Dolby® noise reduction.



The noise reduction system is manufactured under license from Dolby Laboratories Licensing Corporation.

Setting the clock

Press CLK to toggle between listening frequencies and clock mode while in radio mode.

To set the hour, press and hold the CLK control and press:



-  to decrease hours and
-  to increase hours.

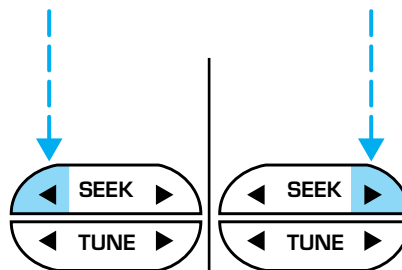

To set the minute, press and hold the CLK control and press:



Controls and features

- ◀ to decrease minutes and
- ▶ to increase minutes.

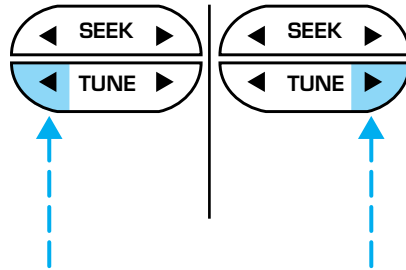

The CLK control will allow you to switch between media display mode (radio station, stereo information, etc.) and clock display mode (time). When in clock mode, the media information will display for ten seconds, when the radio is turned on, and then revert to clock information. Anytime that the media is changed, (new radio station, etc.), the media information will again display for ten seconds before reverting back to the clock. In media mode, the media information will always be displayed.

Premium AM/FM Stereo/Cassette/Single CD/Premium Sound

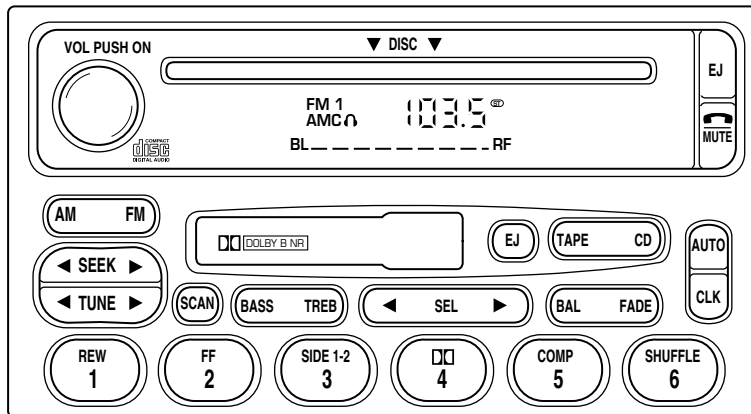

Controls and features

Volume/power control

Press the control to turn the audio system on or off.

Audio power can also be turned on by pressing the AM/FM select control or the tape/CD select control. Audio power is turned off by using the volume/power control.

VOL - PUSH ON

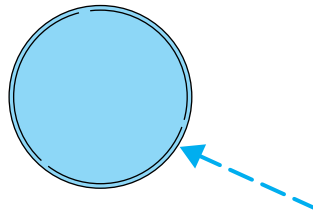

Turn control to raise or lower volume.

VOL - PUSH ON

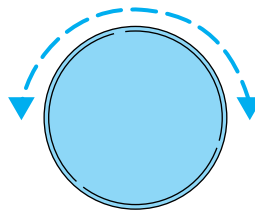

If the volume is set above a certain level and the ignition is turned off, the volume will come back on at a “nominal” listening level when the ignition switch is turned back on.

AM/FM select

The AM/FM select control works in radio, tape and CD modes.



AM/FM select in radio mode

This control allows you to select AM or FM frequency bands. Press the control to switch between AM, FM1 or FM2 memory preset stations.

AM/FM select in tape mode

Press this control to stop tape play and begin radio play.

AM/FM select in CD or CD changer mode (if equipped)

Press this control to stop CD play and begin radio play.

Controls and features

Tune adjust

The tune control works in radio or CD changer mode.

Tune adjust in radio mode

- Press ◀ to move to the next frequency down the band (whether or not a listenable station is located there). Hold the control to move through the frequencies quickly.
- Press ▶ to move to the next frequency up the band (whether or not a listenable station is located there). Hold for quick movement.

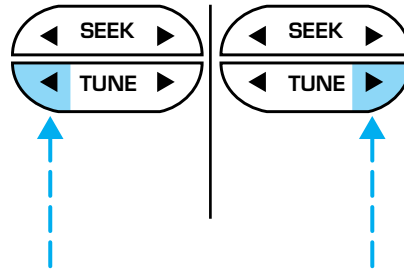

Tune adjust for CD changer (if equipped)

- Press ◀ to select the previous disc in the CD changer. (Play will begin on the first track of the disc unless the CD changer is in shuffle mode. Refer to *Shuffle feature* for more information. Hold the control to continue reversing through the remaining discs.
- Press ▶ to select the next disc in the CD changer. Hold the control to fast-forward through the remaining discs.

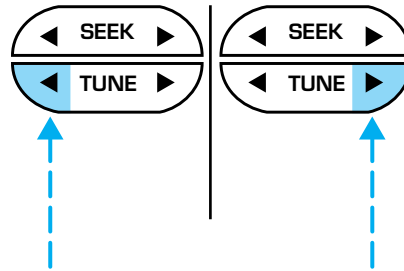

Seek function

The seek function control works in radio, tape or CD mode.

Controls and features

Seek function in radio mode

- Press ◀ to find the next listenable station down the frequency band.
- Press ▶ to find the next listenable station up the frequency band.

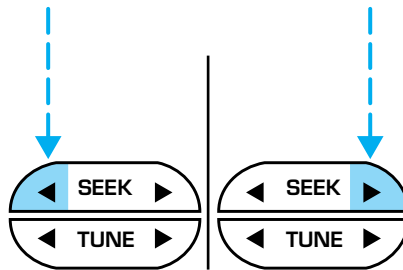

Seek function in tape mode

- Press ◀ to listen to the previous selection on the tape.
- Press ▶ to listen to the next selection on the tape.

Seek function for CD or CD changer (if equipped)

- Press ◀ to seek to the previous track of the current disc. If a selection has been playing for three seconds or more and you press ◀, the CD changer will replay that selection from the beginning.
- Press ▶ to seek forward to the next track of the current disc. After the last track has been completed, the first track of the current disc will automatically replay.

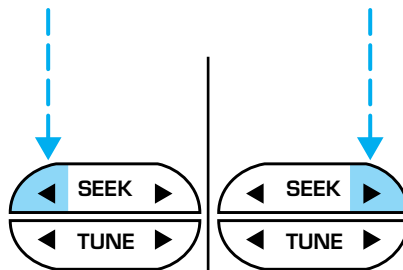

Scan function

The scan function works in radio, tape or CD mode.



Scan function in radio mode

Press the SCAN control to hear a brief sampling of all listenable stations on the frequency band. Press the control again to stop the scan mode.

Controls and features

Scan function in tape mode

Press the SCAN control to hear a short sampling of all selections on the tape. (The tape scans in a forward direction. At the end of the tape's first side, direction automatically reverses to the opposite side of the tape.) To stop on a particular selection, press the control again.

Scan function in CD or CD changer mode (if equipped)

Press the SCAN control to hear a short sampling of all selections on the CD. (The CD scans in a forward direction, wrapping back to the first track at the end of the CD.) To stop on a particular selection, press the control again.

Radio station memory preset

The radio is equipped with six station memory preset controls. These controls can be used to select up to six preset AM stations and twelve FM stations (six in FM1 and six in FM2).

Setting memory preset stations



1. Select the frequency band with the AM/FM select control.
2. Select a station. Refer to *Tune adjust* or *Seek function* for more information on selecting a station.

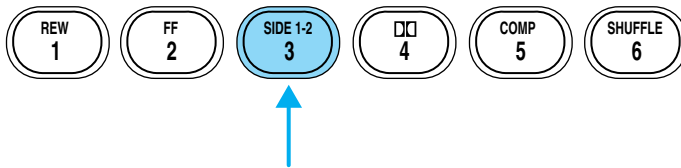

3. Press and hold a memory preset control until the sound returns, indicating the station is held in memory on the control you selected.

Autoset memory preset

Autoset allows you to set strong radio stations without losing your original manually set preset stations. This feature is helpful on trips when you travel between cities with different radio stations.

Controls and features

Starting autose memory preset

1. Select a frequency using the AM/FM select controls.
2. Press the AUTO control.
3. When the first six strong stations are filled, the station stored in memory preset control 1 will start playing.

If there are less than six strong stations available on the frequency band, the remaining memory preset controls will all store the last strong station available.

These stations are temporarily stored in the memory preset controls (until deactivated) and are accessed in the same manner of your original presets.

To deactivate autose and return to your audio system's manually set memory stations, press the AUTO control again.

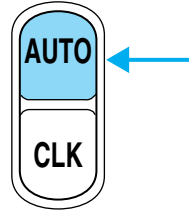

Bass adjust

The bass adjust control allows you to increase or decrease the audio system's bass output.

Press the BASS control then press:

- ◀ to decrease the bass output and
- ▶ to increase the bass output.



Treble adjust

The treble adjust control allows you to increase or decrease the audio system's treble output.

Controls and features

Press the TREB control then press:

- ◀ to decrease the treble output and
- ▶ to increase the treble output.

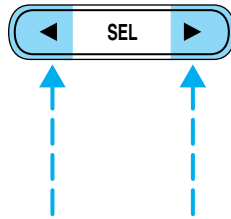

Speaker balance adjust

Speaker sound distribution can be adjusted between the right and left speakers.

Press the BAL control then press:

- ◀ to shift sound to the left and
- ▶ to shift sound to the right.

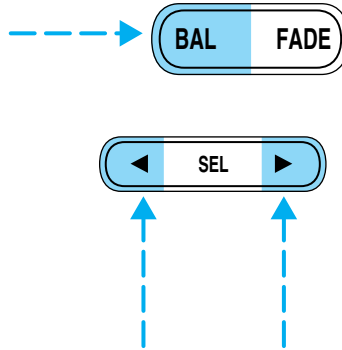

Speaker fade adjust

Speaker sound can be adjusted between the front and rear speakers.

Press the FADE control then press:

- ▶ to shift the sound to the front and
- ◀ to shift the sound to the rear.

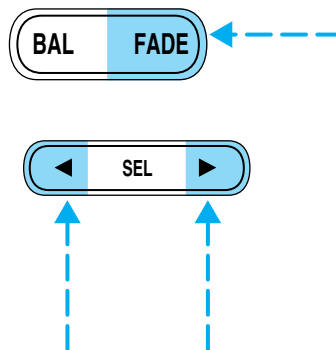

Controls and features

Tape/CD select

- To begin tape play (with a tape loaded into the audio system) while in the radio or CD mode, press the TAPE control. Press the button during rewind or fast forward to stop the rewind or fast forward function.
- To begin CD play (if CD(s) are loaded), press the CD control. The first track of the disc will begin playing. If returning from radio or tape mode, CD play will begin where it stopped last.



With the dual media audio system, press the CD control to toggle between single CD and CD changer play (if equipped).

Rewind

The rewind control works in tape and CD modes.

- In tape mode, radio play will continue until rewind is stopped (with the TAPE control) or the beginning of the tape is reached.
- In CD mode, pressing the REW control rewinds the CD within the current track.

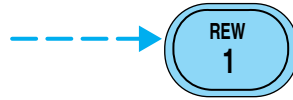

Fast forward

The fast forward control works in tape and CD modes.

- In the tape mode, tape direction will automatically reverse when the end of the tape is reached.
- In CD mode, pressing the control fast forwards the CD within the current track.

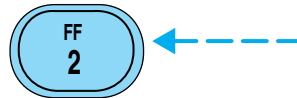

Tape direction select

Press SIDE 1-2 to play the alternate side of a tape.

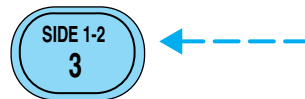

Controls and features

Eject function

Press the EJ control to stop and eject a tape.

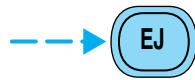

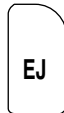

Press the EJ control to stop and eject a CD.

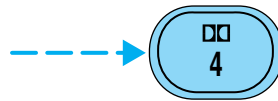

Dolby noise reduction

Dolby noise reduction reduces the amount of hiss and static during tape playback. Press the control to activate (and deactivate) the noise reduction.



Dolby noise reduction manufactured under license from Dolby Laboratories Licensing Corporation. "Dolby" and the double-D symbol  are trademarks of Dolby Laboratories Licensing Corporation.

Compression adjust

Compression adjust brings soft and loud CD passages together for a more consistent listening level.

Press the COMP control to activate and deactivate compression adjust.

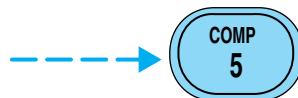

Shuffle feature

The shuffle feature operates in CD mode (if equipped) and plays all tracks on the current disc in random order. If equipped with the CD changer, the shuffle feature continues to the next disc after all tracks on the current disc are played.

Press the SHUFFLE control to start this feature. Random order play will continue until the SHUFFLE control is pressed again.

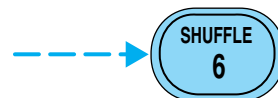

Controls and features

Setting the clock

To set the hour, press and hold the CLK control and press SEEK:

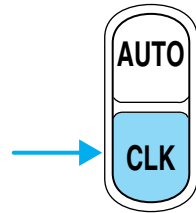

- ◀ to decrease hours and
- ▶ to increase hours.

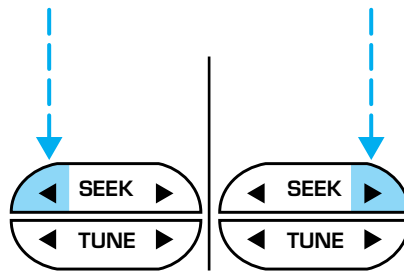

To set the minute, press and hold the CLK control and press TUNE:

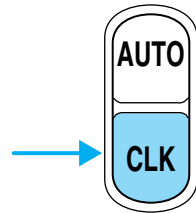

- ◀ to decrease minutes and
- ▶ to increase minutes.

If your vehicle has a separate clock module, (other than the digital radio display), the CLK button will not function in the above manner.

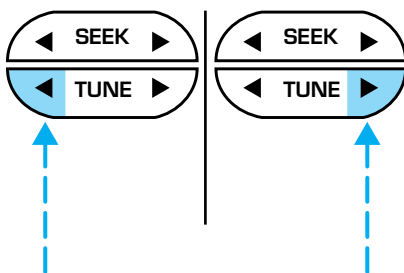

Controls and features

The CLK button will allow you to switch between media display mode (radio station, stereo information, etc.) and clock display mode (time). When in clock mode, the media information will display for ten seconds, when the radio is turned on, and then revert to clock information. Anytime that the media

is changed, (new radio station, etc.), the media information will again display for ten seconds before reverting back to the clock. In media mode, the media information will always be displayed.

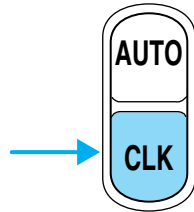

Mute mode

Press the control to mute the playing media. Press the control again to return to the playing media.

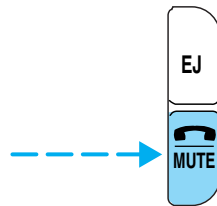

MACH® Audio System with AM/FM Stereo/Cassette/Single CD

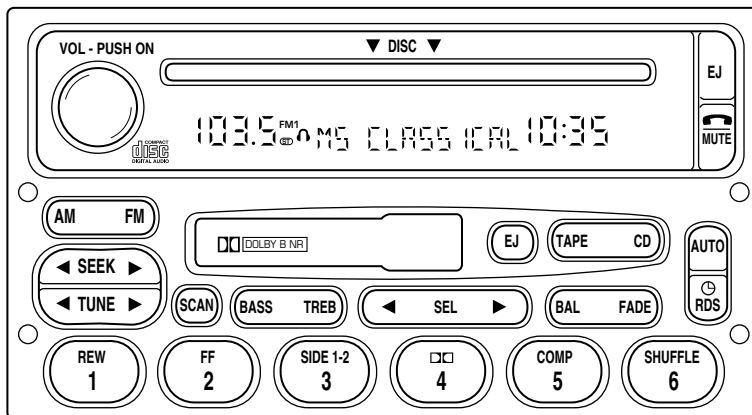

Controls and features

Your audio system is equipped with selective lighting, a unique lighting strategy. This lighting feature is operable when the headlamps are illuminated. During the operation of any selected mode, lighting for the individual function controls will either illuminate or turn off. Those controls which have a function for the specific mode of operation selected will be lit, while the controls which have no function for that mode will be turned off.

Volume/power control

Press the control to turn the audio system on or off.

VOL - PUSH ON

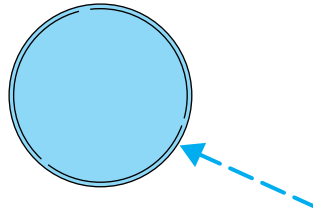

Turn control to raise or lower volume.

VOL - PUSH ON

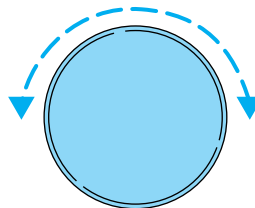

If the volume is set above a certain level and the ignition is turned off, the volume will come back on at a “nominal” listening level when the ignition switch is turned back on. If you wish to maintain your preset volume level, turn the audio system off with the power control before switching off the ignition.

AM/FM select

The AM/FM select control works in radio, tape and CD modes.



Controls and features

AM/FM select in radio mode

This control allows you to select AM or FM frequency bands. Press the control to switch between AM, FM1 or FM2 memory preset stations.

AM/FM select in tape mode

Press this control to stop tape play and begin radio play.

AM/FM select in CD mode

Press this control to stop CD play and begin radio play.

Tune adjust

The tune control works in radio or CD mode.

Tune adjust in radio mode

- Press ◀ to move to the next frequency down the band (whether or not a listenable station is located there). Hold the control to move through the frequencies quickly.
- Press ▶ to move to the next frequency up the band (whether or not a listenable station is located there). Hold for quick movement.

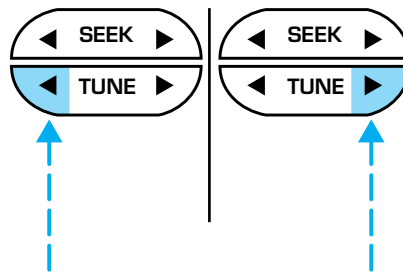

Tune adjust for CD changer (if equipped)

- Press ◀ to select the previous disc in the CD changer. (Play will begin on the first track of the disc unless the CD changer is in shuffle mode. Refer to *Shuffle feature* for more information. Hold the control to continue reversing through the disc.
- Press ▶ to select the next disc in the CD changer. Hold the control to fast-forward through the remaining discs.

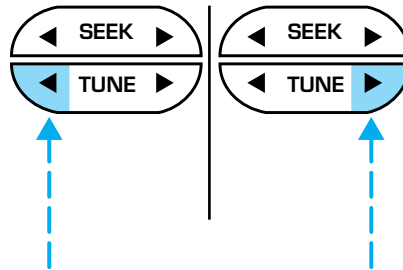

Seek function

The seek function control works in radio, tape or CD mode.

Controls and features

Seek function in radio mode

- Press ◀ to find the next listenable station down the frequency band.
- Press ▶ to find the next listenable station up the frequency band.

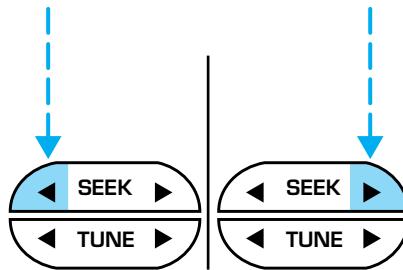

Seek function in tape mode

- Press ◀ to listen to the previous selection on the tape.
- Press ▶ to listen to the next selection on the tape.

Seek function for CD changer (if equipped)

- Press ◀ to seek to the previous track of the current disc. If a selection has been playing for three seconds or more and you press ◀, the CD changer will replay that selection from the beginning.
- Press ▶ to seek forward to the next track of the current disc. After the last track has been completed, the first track of the current disc will automatically replay.

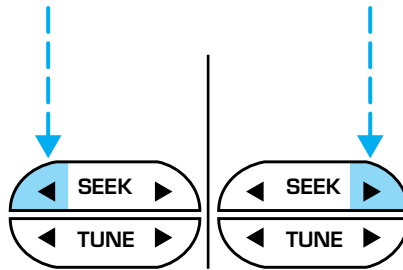

Scan function

The scan function works in radio, tape or CD mode.



Scan function in radio mode

Press the SCAN control to hear a brief sampling of all listenable stations on the frequency band. Press the control again to stop the scan mode.

Controls and features

Scan function in tape mode

Press the SCAN control to hear a short sampling of all selections on the tape. (The tape scans in a forward direction. At the end of the tape's first side, direction automatically reverses to the opposite side of the tape.) To stop on a particular selection, press the control again.

Scan function in CD mode

Press the SCAN control to hear a short sampling of all selections on the CD. (The CD scans in a forward direction, wrapping back to the first track at the end of the CD.) To stop on a particular selection, press the control again.

Radio station memory preset

The radio is equipped with six station memory preset controls. These controls can be used to select up to six preset AM stations and twelve FM stations (six in FM1 and six in FM2).

Setting memory preset stations

1. Select the frequency band with the AM/FM select control.

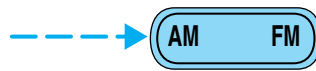

2. Select a station. Refer to *Tune adjust* or *Seek function* for more information on selecting a station.

3. Press and hold a memory preset control until the sound returns, indicating the station is held in memory on the control you selected.

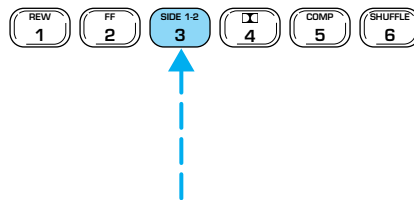

Autoset memory preset

Autoset allows you to set strong radio stations without losing your original manually set preset stations. This feature is helpful on trips when you travel between cities with different radio stations.

Controls and features

Starting autoselect memory preset

1. Select a frequency using the AM/FM select controls.
2. Press the AUTO control.
3. When the first six strong stations are filled, the station stored in memory preset control 1 will start playing.

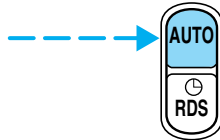

If there are less than six strong stations available on the frequency band, the remaining memory preset controls will all store the last strong station available.

To deactivate autoselect and return to your audio system's manually set memory stations, press the AUTO control again.

Bass adjust

The bass adjust control allows you to increase or decrease the audio system's bass output.

Press the BASS control then press:

- ◀ to decrease bass output and
- ▶ to increase bass output.

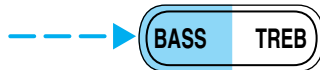

Treble adjust

The treble adjust control allows you to increase or decrease the audio system's treble output.



Controls and features

Press the TREB control then press:

- ◀ to decrease treble output and
- ▶ to increase treble output.

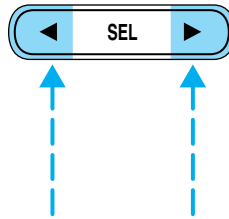

Speaker balance adjust

Speaker sound distribution can be adjusted between the right and left speakers.

Press the BAL control then press:

- ◀ to shift sound to the left and
- ▶ to shift sound to the right.

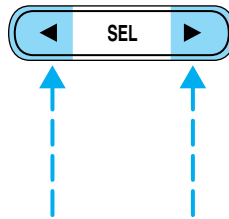

Speaker fade adjust

Speaker sound can be adjusted between the front and rear speakers.

Press the FADE control then press:

- ▶ to shift sound to the front and
- ◀ to shift sound to the rear.

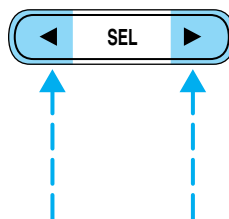

Controls and features

Tape/CD/CD changer (if equipped) select

- To begin tape play (with a tape loaded into the audio system) while in the radio or CD mode, press the TAPE control. Press the button during rewind or fast forward to stop the rewind or fast forward function.
- To begin CD play (if CD(s) are loaded), press the CD control. The first track of the disc will begin playing. After that CD play will begin where it stopped last.



If equipped with a CD changer, press the CD control to toggle between single CD and CD changer play.

Rewind

The rewind control works in tape and CD modes.

- In tape mode, radio play will continue until rewind is stopped (with the TAPE control) or the beginning of the tape is reached.
- In CD mode, pressing the REW control for less than three seconds results in slow rewind. Pressing the control for more than three seconds results in fast rewind.

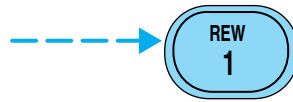

Fast forward

The fast forward control works in tape and CD modes.

- In the tape mode, tape direction will automatically reverse when the end of the tape is reached.
- In CD mode, pressing the control for less than three seconds results in slow forward action. Pressing the control for more than three seconds results in fast forward action.

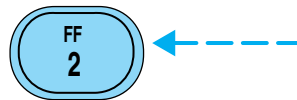

Controls and features

Tape direction select

Press SIDE 1-2 to play the alternate side of a tape.

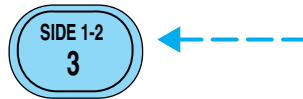

Eject function

Press the control to stop and eject a tape and/or a CD.

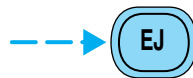

Dolby noise reduction

Dolby noise reduction reduces the amount of hiss and static during tape playback. Press the control to activate (and deactivate) the noise reduction.

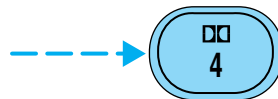

Dolby noise reduction manufactured under license from Dolby Laboratories Licensing Corporation. "Dolby" and the double-D symbol  are trademarks of Dolby Laboratories Licensing Corporation.

Compression adjust

Compression adjust brings soft and loud CD passages together for a more consistent listening level.

Press the COMP control to activate and deactivate compression adjust.

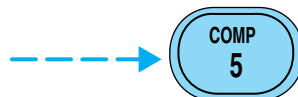

Shuffle feature

The shuffle feature operates in CD mode and plays all tracks on the current disc in random order. If equipped with the CD changer, the shuffle feature continues to the next disc after all tracks on the current disc are played.

Press the SHUFFLE control to start this feature. Random order play will continue until the SHUFFLE control is pressed again.

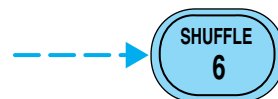

Controls and features

Setting the clock

Press the clock/RDS control until SELECT HOUR is displayed and press:

- ◀ to decrease hours and
- ▶ to increase hours.

To set the minute, press the clock/RDS control until SELECT MIN is displayed and press:

- ◀ to decrease minutes and
- ▶ to increase minutes.

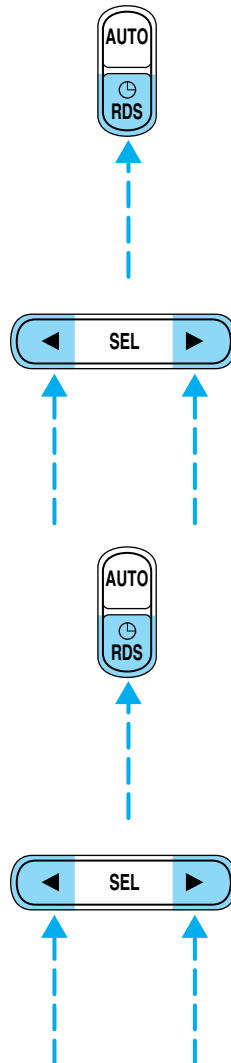

Controls and features

Radio Data System (RDS) feature

This feature allows your audio system to receive text information from RDS-equipped FM radio stations.

Press and hold the control for three seconds to turn the feature on or off. Press the control to scroll through the following selections:



RDS traffic announcement

- Press the RDS control until TRAFFIC is displayed.
- Use the SELECT control to select ON or OFF. With the feature ON, use the SEEK or SCAN control to find a radio station broadcasting a traffic report (if it is broadcasting RDS data).

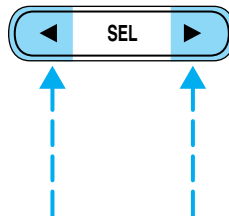

Controls and features

RDS select program type

- Press the RDS control until FIND program type is displayed.



- Use the SEL control to select the program type. With the feature on, use the SEEK or AUTOSET or SCAN control to find the desired program type from the following selections:

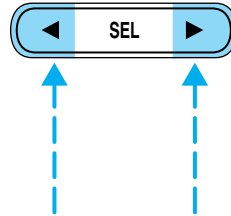

- Classic
- Country
- Info
- Jazz/R&B
- Religious
- Rock
- Soft
- Top 40

RDS show

- With the RDS menu enabled, press the RDS control until SHOW is displayed.



Controls and features

- Use the SEL control to select TYPE, NAME, TEXT or NONE. When your radio is turned to a RDS station, RDS station TYPE, station NAME, or TEXT message will be displayed along with the frequency. Press SEL in order to scroll through the text messages.

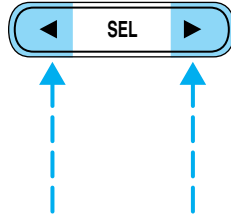

Mute mode

Press the control to mute the playing media. Press the control again to return to the playing media.

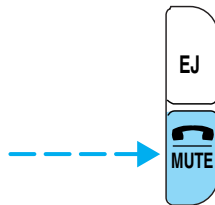

CD changer (if equipped)

The CD changer is located behind the driver's seat in your vehicle. Slide the door to access the CD changer magazine.

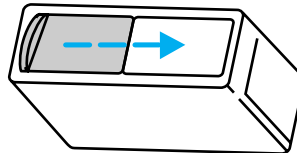

Controls and features

Press ▲ to eject the magazine.

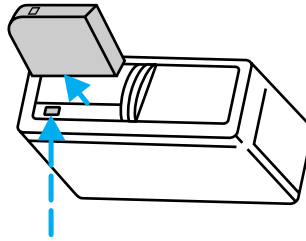

Make sure only one disc is inserted in each slot. Each disc must be inserted with the label surface upward. Depending on your system, you may insert up to six or ten CDs.

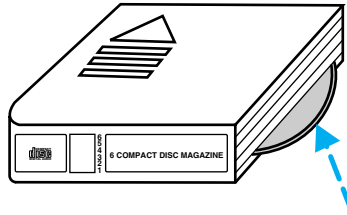

The magazine does not need to be full for the changer to operate.

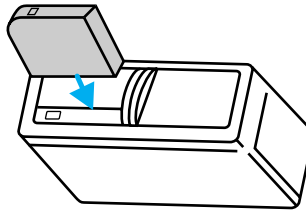

Radio power must be turned on to play the CDs in the changer. The magazine may be stored in the glove compartment when not being used. The CD magazine may be inserted or ejected with the radio power off.

Controls and features

Troubleshooting the CD changer (if equipped)



The laser beam used in the compact disc player is harmful to the eyes. Do not attempt to disassemble the case.

If sound skips:

- You may be traveling on a rough road, playing badly scratched discs or the disc may be dirty. Skipping will not scratch the discs or damage the player.

If your changer does not work, it may be that:

- A disc is already loaded where you want to insert a disc.
- The disc is inserted with the label surface downward.
- The disc is dusty or defective.
- The player's internal temperature is above 60°C (140°F). Allow the player to cool down before operating.
- A disc with format and dimensions not within industry standards is inserted.

Cleaning compact discs

Inspect all discs for contamination before playing. If necessary, clean discs only with an approved CD cleaner and wipe from the center out to the edge. Do not use circular motion.

CD and CD changer care

- Handle discs by their edges only. Never touch the playing surface.
- Do not expose discs to direct sunlight or heat sources for extended periods of time.
- Do not insert more than one disc into each slot of the CD changer magazine.

Cleaning cassette player (if equipped)

Clean the tape player head with a cassette cleaning cartridge after ten to twelve hours of play in order to maintain the best sound and operation.

Cassette and cassette player care

- Use only cassettes that are 90 minutes long or less.

Controls and features

- Do not expose tapes to direct sunlight, high humidity, extreme heat or extreme cold. Allow tapes that may have been exposed to extreme temperatures to reach a moderate temperature before playing.
- Tighten very loose tapes by inserting a finger or pencil into the hole and turning the hub.
- Remove loose labels before inserting tapes.
- Do not leave tapes in the cassette player for a long time when not being played.

Radio frequency information

The Federal Communications Commission (FCC) and the Canadian Radio and Telecommunications Commission (CRTC) establish the frequencies AM and FM stations may use for their broadcasts. Allowable frequencies are:

- AM 530, 540–1600, 1610 kHz^a
- FM 87.9^b, 88.1–107.7, 107.9 MHz

Not all frequencies are used in a given area.

^a Some radios may tune up to 1710 kHz.

^b Some radios may tune down to 87.7 MHz.

Radio reception factors

Three factors can affect radio reception:

- **Distance/strength.** The further an FM signal travels, the weaker it is. The listenable range of the average FM station is approximately 40 km (24 miles). This range can be affected by “signal modulation.” Signal modulation is a process radio stations use to increase their strength/volume relative to other stations.
- **Terrain.** Hills, mountains and tall buildings between your vehicle’s antenna and the radio station signal can cause FM reception problems. Static can be caused on AM stations by power lines, electric fences, traffic lights and thunderstorms. Moving away from an interfering structure (out of its “shadow”) returns your reception to normal.
- **Station overload.** Weak signals are sometimes captured by stronger signals when you pass a broadcast tower. A stronger signal may temporarily overtake a weaker signal and play while the weak station frequency is displayed.

Controls and features

The audio system automatically switches to single channel reception if it will improve the reception of a station normally received in stereo.

Audio system warranties and service

Refer to the “Warranty Guide” for audio system warranty information.

If service is necessary, see your dealer or a qualified technician.

POSITIONS OF THE IGNITION

1. ACCESSORY, allows the electrical accessories such as the radio to operate while the engine is not running.

2. LOCK, locks the steering wheel, automatic transmission gearshift lever and allows key removal.

3. OFF, shuts off the engine and all accessories without locking the steering wheel.

4. ON, all electrical circuits operational. Warning lights illuminated. Key position when driving.

5. START, cranks the engine. Release the key as soon as the engine starts.

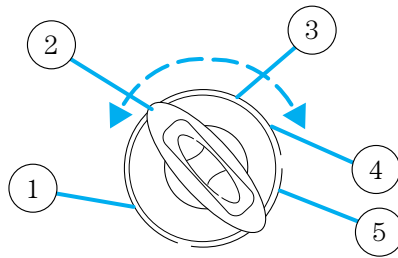

TURN SIGNAL CONTROL

- Push down to activate the left turn signal.
- Push up to activate the right turn signal.

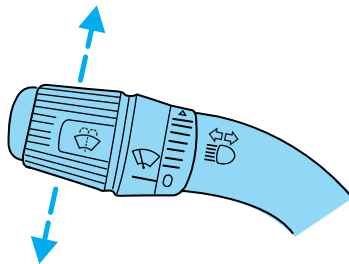

Controls and features

SPEED CONTROL (IF EQUIPPED)

To turn speed control on

- Press ON.

Vehicle speed cannot be controlled until the vehicle is traveling at or above 48 km/h (30 mph).

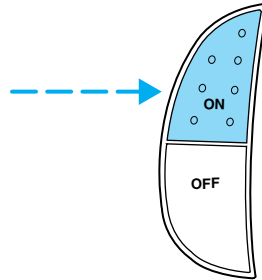

Do not use the speed control in heavy traffic or on roads that are winding, slippery, or unpaved.



Do not shift the gearshift lever into N (Neutral) with the speed control on.

To turn speed control off

- Press OFF or
- Turn off the vehicle ignition.

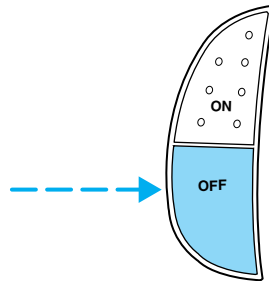

Once speed control is switched off, the previously programmed set speed will be erased.

Controls and features

To set a speed

- Press SET/SET ACC/SET ACCEL. For speed control to operate, the speed control must be ON and the vehicle speed must be greater than 48 km/h (30 mph).

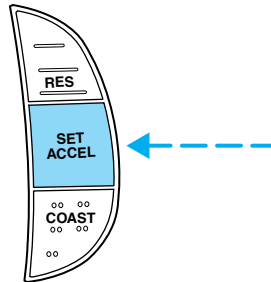

If you drive up or down a steep hill, your vehicle speed may vary momentarily slower or faster than the set speed. This is normal.

Speed control cannot reduce the vehicle speed if it increases above the set speed on a downhill. If your vehicle speed is faster than the set speed while driving on a downhill, you may want to shift to the next lower gear or apply the brakes to reduce your vehicle speed.

If your vehicle slows down more than 16 km/h (10 mph) below your set speed on an uphill, your speed control will disengage. This is normal. Pressing RES/RSM/RESUME will re-engage it.



Do not use the speed control in heavy traffic or on roads that are winding, slippery, or unpaved.

To set a higher set speed

- Press and hold SET/SET ACC/SET ACCEL. Release the control when the desired vehicle speed is reached or
- Press and release SET/SET ACC/SET ACCEL. Each press will increase the set speed by 1.6 km/h (1 mph) or
- Accelerate with your accelerator pedal. When the desired vehicle speed is reached, press and release SET/SET ACC/SET ACCEL.

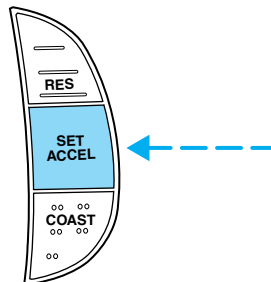

Controls and features

You can accelerate with the accelerator pedal at any time during speed control usage. Releasing the accelerator pedal will return your vehicle to the previously programmed set speed.

To set a lower set speed

- Press and hold CST/COAST.
Release the control when the desired speed is reached or
- Press and release CST/COAST.
Each press will decrease the set speed by 1.6 km/h (1 mph) or
- Depress the brake pedal. When the desired vehicle speed is reached, press SET/SET ACC/SET ACCEL.

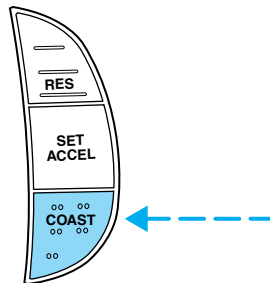
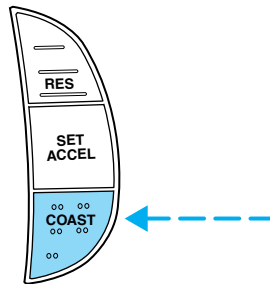

Controls and features

To disengage speed control

- Depress the brake pedal or

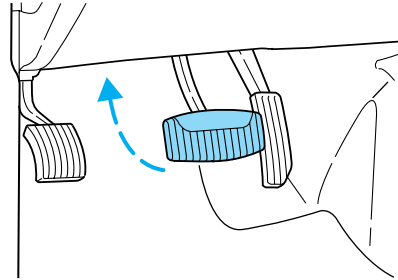

- Depress the clutch pedal (if equipped)

Disengaging the speed control will not erase the previously programmed set speed.

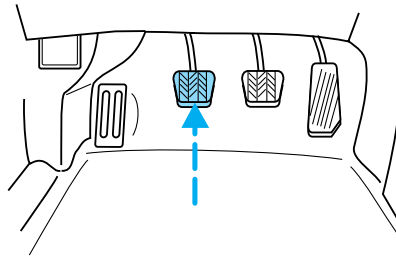

Pressing OFF will erase the previously programmed set speed.

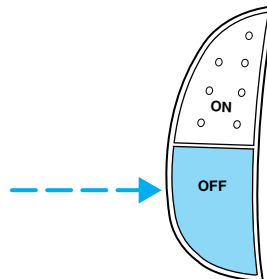

Controls and features

To return to a previously set speed

- Press RES/RSM/RESUME. For RES/RSM/RESUME to operate, the vehicle speed must be faster than 48 km/h (30 mph).

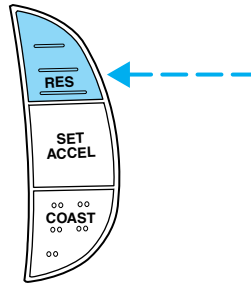

TILT STEERING WHEEL (IF EQUIPPED)

Pull the tilt steering control toward you to move the steering wheel up or down. Hold the control while adjusting the wheel to the desired position, then release the control to lock the steering wheel in position.

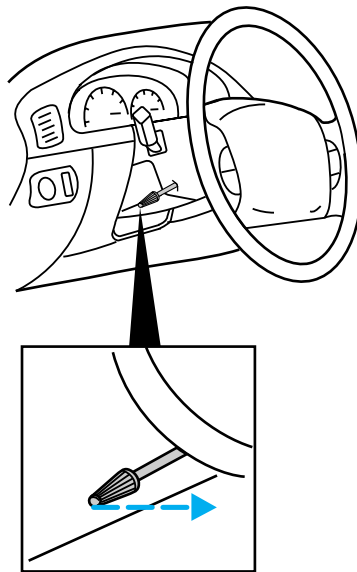

Never adjust the steering wheel when the vehicle is moving.

Controls and features

HAZARD FLASHER

For information on the hazard flasher control, refer to *Hazard flasher* in the *Roadside emergencies* chapter.

WINDSHIELD WIPER/WASHER CONTROLS

Rotate the windshield wiper control to the desired interval, low or high speed position.

The bars of varying length are for intermittent wipers. When in this position rotate the control upward for fast intervals and downward for slow intervals.

Push the control on the end of the stalk to activate washer. Push and hold for a longer wash cycle. The washer will automatically shut off after ten seconds of continuous use.

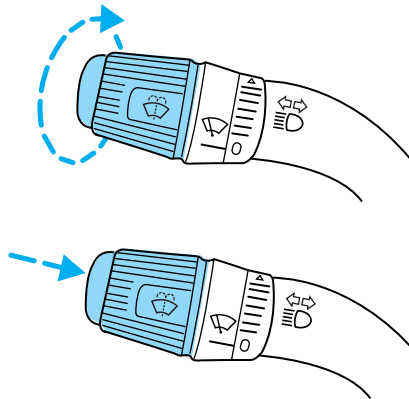

HIGH BEAMS

Push forward to activate.

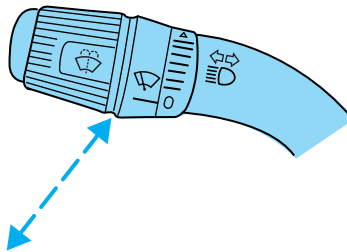

Controls and features

FLASH TO PASS

Pull toward you to activate and release to deactivate.

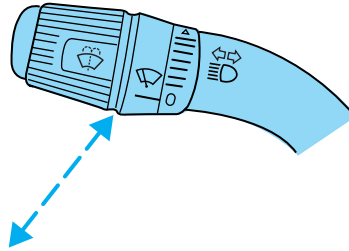

OVERDRIVE CONTROL (IF EQUIPPED)

Activating overdrive

D (Overdrive) is the normal drive position for the best fuel economy.

The overdrive function allows automatic upshifts to second, third and fourth gear.

Deactivating overdrive

Press the Transmission Control Switch (TCS) located on the end of the gearshift lever. The Transmission Control Indicator Light (TCIL) (the word OFF) will illuminate on the end of the gearshift lever.

The transmission will operate in gears one through three. To return to normal overdrive mode, press the Transmission Control Switch again. The TCIL (the word OFF) will no longer be illuminated.

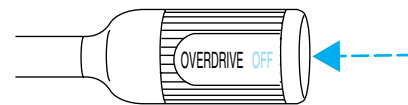
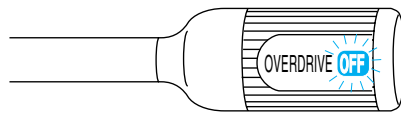

When you shut off and re-start your vehicle, the transmission will automatically return to normal **D** (Overdrive) mode.

Controls and features

POWER WINDOWS (IF EQUIPPED)

Press and hold the rocker switches to open and close windows.

- Press the top portion of the rocker switch to close.

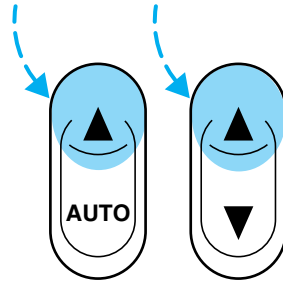

- Press the bottom portion of the rocker switch to open.

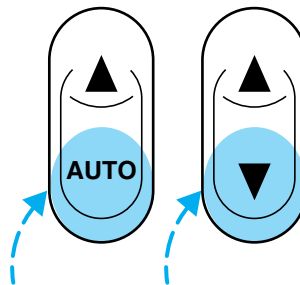

One touch down

- Press AUTO completely down and release quickly. The driver's window will open fully. Depress again to stop window operation.

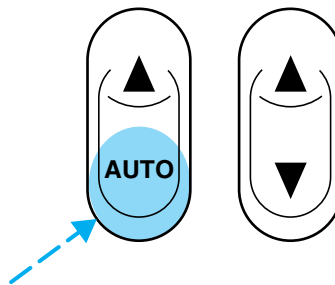

Controls and features

Window lock

The window lock feature allows only the driver to operate the power windows.

To lock out all the window controls except for the driver's press the left side of the control. Press the right side to restore the window controls.

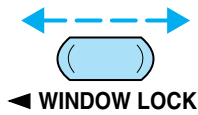

Accessory delay (if equipped)

With accessory delay, the window switches may be used for up to ten minutes after the ignition switch is turned to the OFF position or until any door is opened.

POWER DOOR LOCKS (IF EQUIPPED)

Press U to unlock all doors and L to lock all doors.

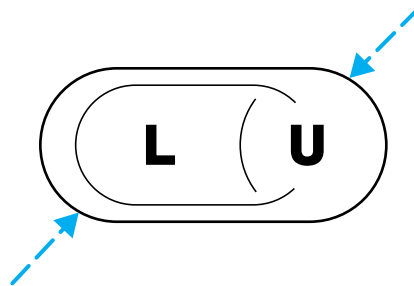

POWER SIDE VIEW MIRRORS (IF EQUIPPED)

The ignition must be in ACC or ON position to adjust the power side view mirrors.

To adjust your mirrors:

1. Select L to adjust the left mirror or R to adjust the right mirror.

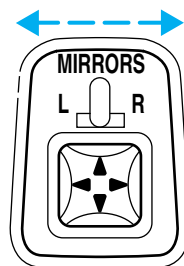

Controls and features

2. Move the control in the direction you wish to tilt the mirror.

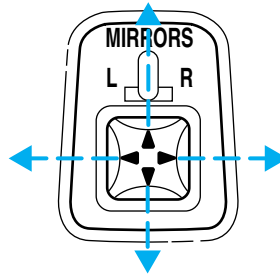

3. Return to the center position to lock mirrors in place.

Fold-away mirrors

Pull the side mirrors in carefully when driving through a narrow space, like an automatic car wash.

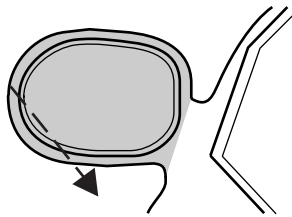

CENTER CONSOLE (IF EQUIPPED)

Your vehicle may be equipped with a variety of console features. These include:

- utility compartment with cassette/CD holder
- coin holder
- pen holder
- writing surface

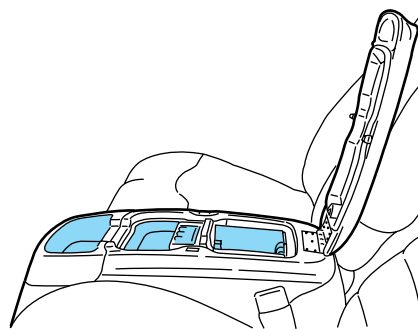

Controls and features

REMOTE ENTRY SYSTEM (IF EQUIPPED)

The remote entry system allows you to lock or unlock all vehicle doors without a key.

The remote entry features only operate with the ignition in the OFF position.

If there is any potential remote keyless entry problem with your vehicle, ensure **ALL key fobs** (remote entry transmitters) are brought to the dealership, to aid in troubleshooting.

Unlocking the doors

Press this control to unlock the driver's door. The interior lamps will illuminate.

Press the control a second time within five seconds to unlock all doors.

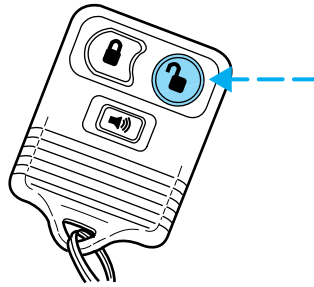

Locking the doors

Press this control to lock all doors.

To confirm all doors are closed and locked, press the control a second time within five seconds. The doors will lock again, the horn will chirp and the lamps will flash.

If any of the doors are ajar, the horn will make two quick chirps, reminding you to properly close all doors.

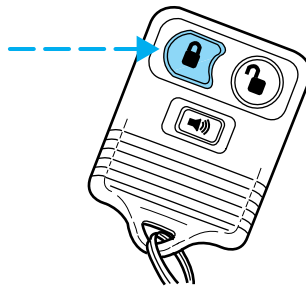

Controls and features

Sounding a panic alarm

Press this control to activate the alarm.

To deactivate the alarm, press the control again or turn the ignition to ACC or ON.

This device complies with part 15 of the FCC rules and with RS-210 of Industry Canada. Operation is subject to the following two conditions: (1) This device may not cause harmful interference, and (2) This device must accept any interference received, including interference that may cause undesired operation.

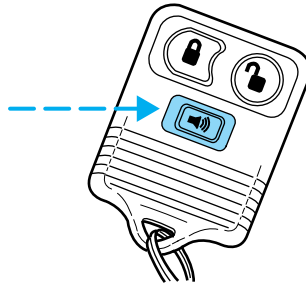

Changes or modifications not expressly approved by the party responsible for compliance could void the user's authority to operate the equipment.

Replacing the battery

The transmitter is powered by one coin type three-volt lithium battery CR2032 or equivalent. Typical operating range will allow you to be up to 10 meters (33 feet) away from your vehicle. A decrease in operating range can be caused by:

- weather conditions
- nearby radio towers
- structures around the vehicle
- other vehicles parked next to the vehicle

Controls and features

To replace the battery:

1. Twist a thin coin between the two halves of the transmitter near the key ring. **DO NOT TAKE THE FRONT PART OF THE TRANSMITTER APART.**
2. Place the positive (+) side of new battery in the same orientation. Refer to the diagram inside the transmitter unit.
3. Snap the two halves back together.

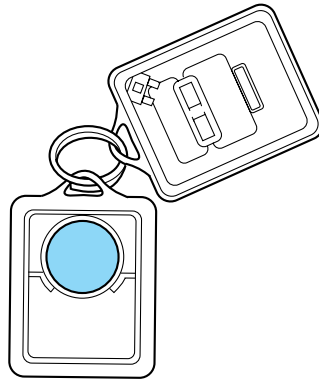

Illuminated entry

The interior lamps illuminate when the remote entry system is used to unlock the door(s) or sound the personal alarm.

The system automatically turns off after 25 seconds or when the ignition is turned to the RUN or ACC position. The dome lamp control (if equipped) must **not** be set to the OFF position for the illuminated entry system to operate.

The inside lights will not turn off if:

- they have been turned on with the dimmer control or
- any door is open.

The battery saver will shut off the interior lamps 40 minutes after the ignition has been turned to the OFF position.

Controls and features

Replacing lost transmitters

Take all your vehicle's transmitters to your dealer if service is required.

If you purchase additional transmitters (up to four may be programmed), perform the following procedure:

To reprogram the transmitters yourself, place the key in the ignition and turn from OFF to ON eight times in rapid succession (within 10 seconds) ending in ON. After doors lock/unlock, press any control on all transmitters (up to four). When completed, turn the ignition to OFF. The doors will lock/unlock one last time to confirm completion of program mode.

All transmitters must be programmed at the same time.

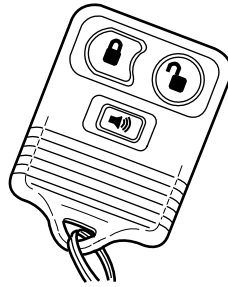

Reprogramming transmitters

To reprogram all transmitters, place the key in the ignition and turn from OFF to ON eight times in a row (within 10 seconds). After doors lock/unlock, press any control on all transmitters (up to four). When completed, turn the ignition to OFF.

All transmitters must be reprogrammed at the same time.

Controls and features

TAILGATE LOCK (IF EQUIPPED)

Your vehicle is equipped with a tailgate lock designed to prevent theft of the tailgate.

- Insert ignition key and turn to the right to engage lock.
- Turn ignition key to the left to unlock.

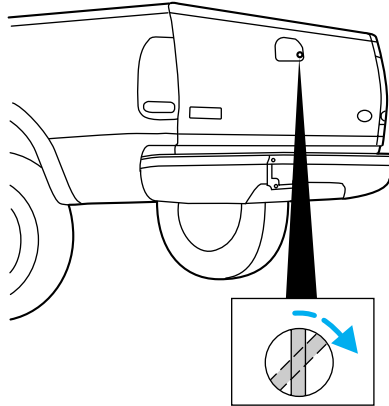

Tailgate removal

Your tailgate is removable to allow more room for loading.

1. Lower the tailgate.
2. Use a screwdriver to pry the spring clip (on each connector) past the head of the support screw. Disconnect cable.
3. Disconnect the other cable.
4. Lift tailgate to a 45 degree angle.
5. Lift right side off of its hinge.
6. Lift left side off of its hinge.

To install, follow the removal procedures in reverse order.

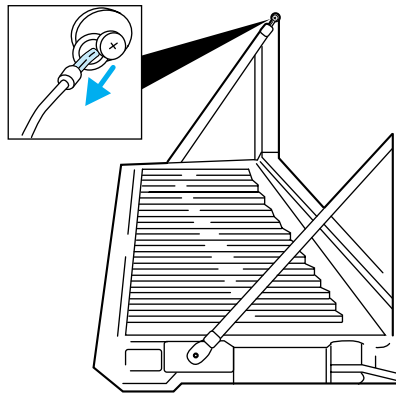

Seating and safety restraints

SEATING

Full bench seat (if equipped)

- Lift the release bar to move the seat forward or backward. Ensure that the seat is related into place.
- Pull up on the release lever to quickly fold the seatback forward.

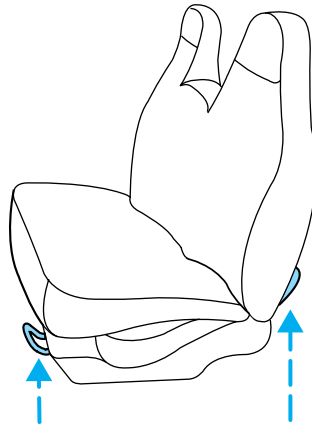

60/40 split bench seat (if equipped)

- Lift the release bar to move the seat forward or backward. Ensure the seat is related into place.
- Pull the seatback handle up to recline the seat.
- Push down the release lever located on the back of the seat to quickly fold the seatback forward.

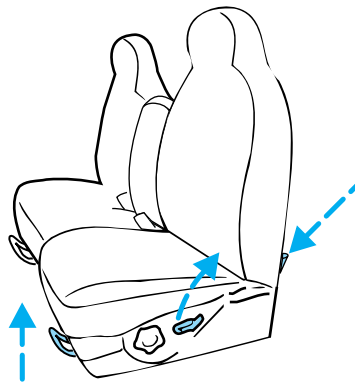

Seating and safety restraints

Captain's chair (if equipped)

- Lift the release bar to move the seat forward or rearward. Make sure that the seat is related into place.
- Pull the seatback handle up to recline the seat.
- Push the release lever down to quickly fold the seatback forward.

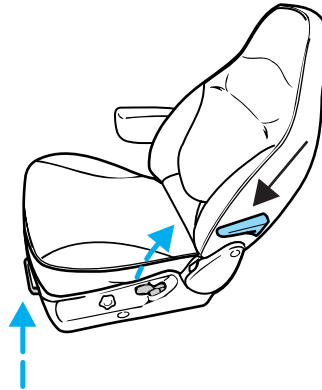

Adjusting the front power seat (if equipped)



Never adjust the driver's seat or seatback when the vehicle is moving.



Do not pile cargo higher than the seatbacks to avoid injuring people in a collision or sudden stop.



Always drive and ride with your seatback upright and the lap belt snug and low across the hips.

Press to raise or lower the front portion of the seat cushion.

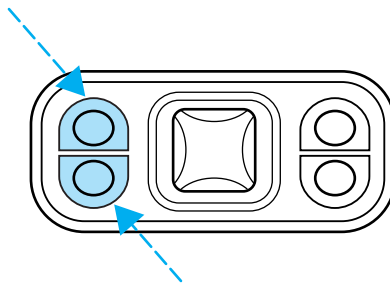

Seating and safety restraints

Press to raise or lower the rear portion of the seat cushion.

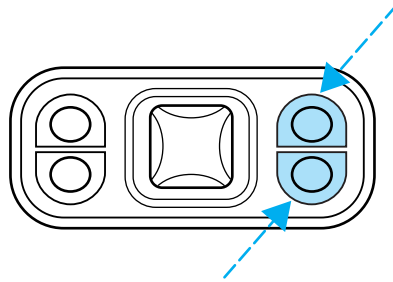

Press the control to move the seat forward, backward, up or down.

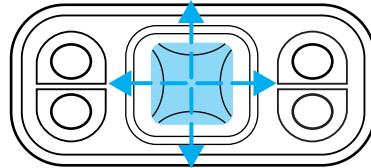

Using the manual lumbar support

Turn the lumbar support control toward the front of vehicle to increase firmness.

Turn the lumbar support control toward the rear of vehicle to increase softness.

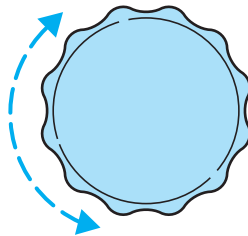

Seating and safety restraints

Rear folding bench seat (if equipped)

Folding down the rear seats

 All safety belts should be properly stowed in the seat pockets before folding down the rear seat.

Make sure that no objects such as books, purses or briefcases are on the floor in front of the second row seats before folding them down.

1. Locate the strap on the rear of the lower seat cushion.
2. Lift the strap and rotate the lower seat cushion toward the front of the vehicle.
3. Locate the strap below the seatback.
4. Pull downward on the strap to release the seatback.
5. Rotate the seatback forward.

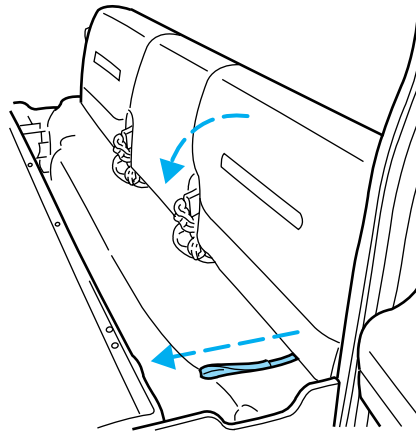
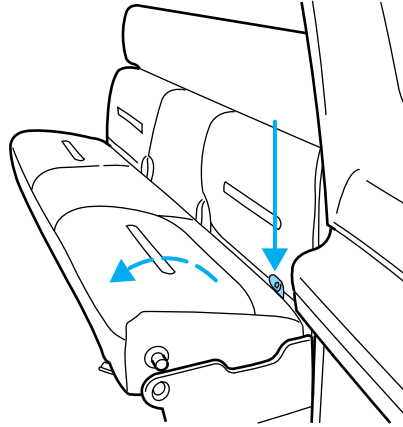

Returning the seat to upright

 Always latch the vehicle seat to the floor, whether the seat is occupied or empty. If not latched, the seat may cause injury during a sudden stop.

Seating and safety restraints

1. Lift/rotate the seatback toward the rear of the vehicle and make sure it latches securely.
2. Lift/rotate the lower seat cushion to its seating position.

SAFETY RESTRAINTS

Safety restraints precautions



Always drive and ride with your seatback upright and the lap belt snug and low across the hips.



To reduce the risk of injury, make sure children sit where they can be properly restrained.



Never let a passenger hold a child on his or her lap while the vehicle is moving. The passenger cannot protect the child from injury in a collision.



All occupants of the vehicle, including the driver, should always properly wear their safety belts, even when an air bag SRS is provided.



It is extremely dangerous to ride in a cargo area, inside or outside of a vehicle. In a collision, people riding in these areas are more likely to be seriously injured or killed. Do not allow people to ride in any area of your vehicle that is not equipped with seats and safety belts. Be sure everyone in your vehicle is in a seat and using a safety belt properly.



Each seating position in your vehicle has a specific safety belt assembly which is made up of one buckle and one tongue that are designed to be used as a pair. 1) Use the shoulder belt on the outside shoulder only. Never wear the shoulder belt under the arm. 2) Never swing the safety belt around your neck over the inside shoulder. 3) Never use a single belt for more than one person.

Seating and safety restraints



Always transport children 12 years old and under in the back seat and always properly use appropriate child restraints.

Combination lap and shoulder belts

1. Insert the belt tongue into the proper buckle (the buckle closest to the direction the tongue is coming from) until you hear a snap and feel it latch. Make sure the tongue is securely fastened in the buckle.

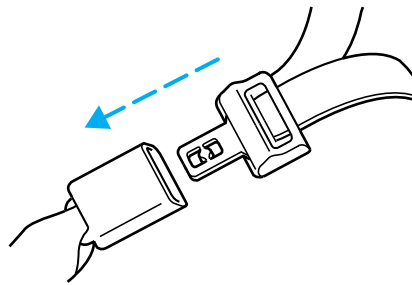

2. To unfasten, push the release button and remove the tongue from the buckle.

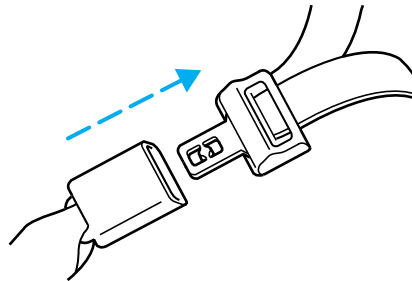

The front and rear outboard safety restraints in the vehicle are combination lap and shoulder belts. The front passenger and rear seat outboard safety belts have two types of locking modes described below:

Vehicle sensitive mode

The vehicle sensitive mode is the normal retractor mode, allowing free shoulder belt length adjustment to your movements and locking in response to vehicle movement. For example, if the driver brakes suddenly or turns a corner sharply, or the vehicle receives an impact of 8 km/h (5 mph) or more, the combination safety belts will lock to help reduce forward movement of the driver and passengers.

On SuperCab and CrewCab models, the front seat belt system can also be made to lock manually by quickly pulling on the shoulder belt.

Rear seat belts (if equipped) cannot be made to lock up by pulling quickly on the belt.

Seating and safety restraints

Automatic locking mode

In this mode, the shoulder belt is automatically pre-locked. The belt will still retract to remove any slack in the shoulder belt.

The automatic locking mode is not available on the driver safety belt.

When to use the automatic locking mode

- When a tight lap/shoulder fit is desired.
- **Anytime** a child safety seat is installed in a passenger front or outboard rear seating position (if equipped). Refer to *Safety Restraints for Children* or *Safety Seats for Children* later in this chapter.

How to use the automatic locking mode

- Buckle the combination lap and shoulder belt.

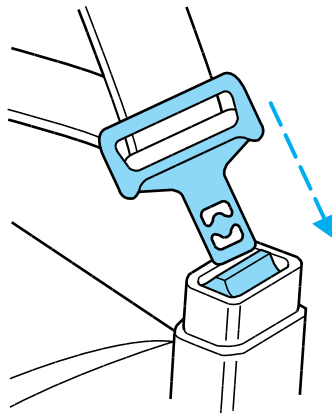

- Grasp the shoulder portion and pull downward until the entire belt is extracted.



Seating and safety restraints

- Allow the belt to retract. As the belt retracts, you will hear a clicking sound. This indicates the safety belt is now in the automatic locking mode.

How to disengage the automatic locking mode

Disconnect the combination lap/shoulder belt and allow it to retract completely to disengage the automatic locking mode and activate the vehicle sensitive (emergency) locking mode.

Front safety belt height adjustment

Your vehicle has safety belt height adjustments for the driver and front passenger. Adjust the height of the shoulder belt so the belt rests across the middle of your shoulder.

To lower the shoulder belt height, push the button and slide the height control down. To raise the height of the shoulder belt, slide the height adjuster up. Pull down on the height adjustment assembly to make sure it is locked in place.

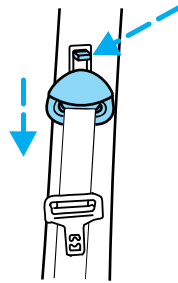

Position the shoulder belt height adjuster so that the belt rests across the middle of your shoulder. Failure to adjust the safety belt properly could reduce the effectiveness of the safety belt and increase the risk of injury in a collision.

Lap belts

Adjusting the lap belt

The lap belt does not adjust automatically.



The lap belts should fit snugly and as low as possible around the hips, not around the waist.

Seating and safety restraints

Insert the tongue into the correct buckle (the buckle closest to the direction the tongue is coming from). To lengthen the belt, turn the tongue at a right angle to the belt and pull across your lap until it reaches the buckle. To tighten the belt, pull the loose end of the belt through the tongue until it fits snugly across the hips.

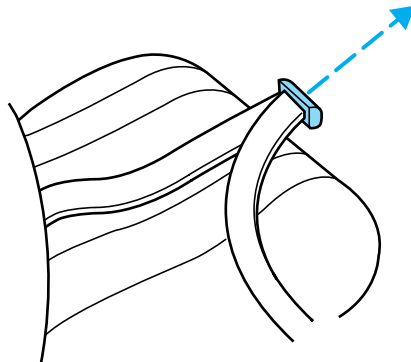

Shorten and fasten the belt when not in use.

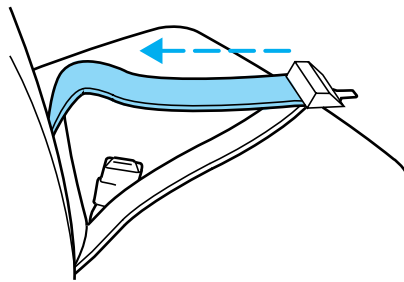

Safety belt extension assembly

If the safety belt assembly is too short, even when fully extended, 20 cm (8 inches) can be added to the safety belt assembly by adding a safety belt extension assembly (part number 611C22). Safety belt extension assemblies can be obtained from your dealer at no cost.

Use only extensions manufactured by the same supplier as the safety belt. Manufacturer identification is located at the end of the webbing on the label. Also, use the safety belt extension only if the safety belt is too short for you when fully extended. Do not use extensions to change the fit of the shoulder belt across the torso.

Safety belt warning light and indicator chime

The seat belt warning light illuminates in the instrument cluster and a chime sounds to remind the occupants to fasten their safety belts.

Seating and safety restraints

Conditions of operation

If...	Then...
The driver's safety belt is not buckled before the ignition switch is turned to the ON position...	The safety belt warning light illuminates for one to two minutes and the warning chime sounds for four to eight seconds.
The driver's safety belt is buckled while the indicator light is illuminated and the warning chime is sounding...	The safety belt warning light and warning chime turn off.
The driver's safety belt is buckled before the ignition switch is turned to the ON position...	The safety belt warning light and indicator chime remain off.

Safety belt maintenance

Inspect the safety belt systems periodically to make sure they work properly and are not damaged. Inspect the safety belts to make sure there are no nicks, wears or cuts, replacing if necessary. All safety belt assemblies, including retractors, buckles, front seat belt buckle assemblies, buckle support assemblies (slide bar-if equipped), shoulder belt height adjusters (if equipped), child safety seat tether bracket assemblies (if equipped), and attaching hardware, should be inspected after a collision. Ford recommends that all safety belt assemblies used in vehicles involved in a collision be replaced. However, if the collision was minor and a qualified technician finds that the belts do not show damage and continue to operate properly, they do not need to be replaced. Safety belt assemblies not in use during a collision should also be inspected and replaced if either damage or improper operation is noted.



Failure to inspect and if necessary replace the safety belt assembly under the above conditions could result in severe personal injuries in the event of a collision.

Refer to *Cleaning and maintaining the safety belts* in the *Maintenance and care* section.

Seating and safety restraints

AIR BAG SUPPLEMENTAL RESTRAINT SYSTEM (SRS)

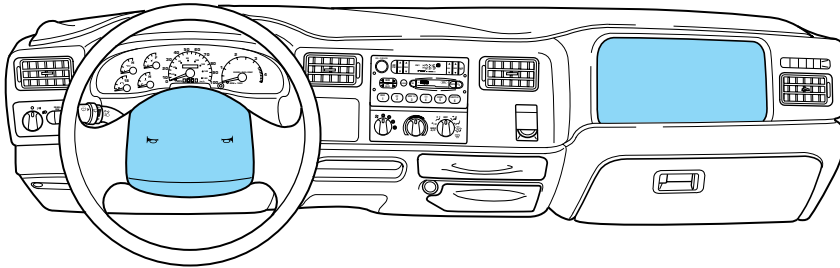



Important supplemental restraint system (SRS) precautions

The supplemental restraint system is designed to work with the safety belt to help protect the driver and right front passenger from certain upper body injuries.

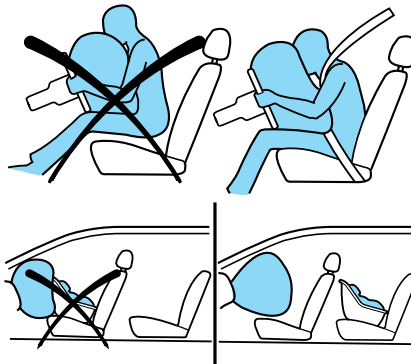
Air bags DO NOT inflate slowly or gently and the risk of injury from a deploying air bag is greatest close to the trim covering the air bag module.



 All occupants of the vehicle, including the driver, should always properly wear their safety belts, even when an air bag SRS is provided.

 Always transport children 12 years old and under in the back seat and always properly use appropriate child restraints.

 National Highway Traffic Safety Administration (NHTSA) recommends a minimum distance of at least 25 cm (ten [10] inches) between an occupant's chest and the driver air bag module.

Seating and safety restraints



Never place your arm over the air bag module as a deploying air bag can result in serious arm fractures or other injuries.

Steps you can take to properly position yourself away from the airbag:

- Move your seat to the rear as far as you can while still reaching the pedals comfortably.
- Recline the seat slightly (one or two degrees) from the upright position.



Do not put anything on or over the air bag module. Placing objects on or over the air bag inflation area may cause those objects to be propelled by the air bag into your face and torso causing serious injury.



Do not attempt to service, repair, or modify the Air Bag Supplemental Restraint System or its fuses. See your Ford or Lincoln-Mercury dealer.

Children and air bags

For additional important safety information, read all information on safety restraints in this guide.

Children must always be properly restrained. Failure to follow these instructions may increase the risk of injury in a collision.



An infant in a rear-facing seat faces a high risk of serious or fatal injuries from a deploying passenger air bag. Rear facing infant seats should NEVER be placed in the front seats, unless the passenger air bag is turned off. See *Passenger air bag ON/OFF switch*.

Seating and safety restraints

How does the air bag supplemental restraint system work?

The air bag SRS is designed to activate when the vehicle sustains sufficient longitudinal deceleration.

The fact that the air bags did not inflate in a collision does not mean that something is wrong with the system. Rather, it means the forces were not of the type sufficient to cause activation. Air bags are designed to inflate in frontal and near-frontal collisions, not rollover, side-impact, or rear-impacts.

The air bags inflate and deflate rapidly upon activation. After air bag deployment, it is normal to notice a smoke-like, powdery residue or smell the burnt propellant. This may consist of cornstarch, talcum powder (to lubricate the bag) or sodium compounds (e.g., baking soda) that result from the combustion process that inflates the air bag. Small amounts of sodium hydroxide may be present which may irritate the skin and eyes, but none of the residue is toxic.

While the system is designed to help reduce serious injuries, it may also cause minor burns, abrasions, swelling or temporary hearing loss. Because air bags must inflate rapidly and with considerable force, there is the risk of death or serious injuries such as fractures, facial and eye injuries or internal injuries, particularly to occupants who are not properly restrained or are otherwise out of position at the time of air bag deployment. Thus, it is extremely important that occupants be properly restrained as far away from the air bag module as possible while maintaining vehicle control.

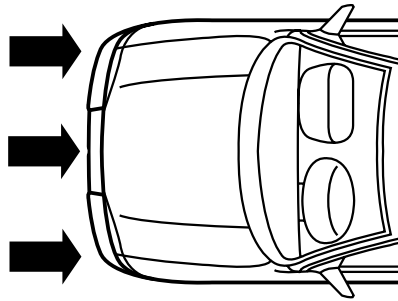

Seating and safety restraints



Several air bag system components get hot after inflation. Do not touch them after inflation.



If the air bag is inflated, **the air bag will not function again and must be replaced immediately.** If the air bag is not replaced, the unrepaired area will increase the risk of injury in a collision.

The SRS consists of:

- driver and passenger (if equipped) air bag modules (which include the inflators and air bags),
- one or more impact and safing sensors,
- a readiness light and tone
- and the electrical wiring which connects the components.

The diagnostic module monitors its own internal circuits and the supplemental air bag electrical system warning (including the impact sensors), the system wiring, the air bag system readiness light, the air bag back up power and the air bag ignitors.

Determining if the system is operational

The SRS uses a readiness light in the instrument cluster or a tone to indicate the condition of the system. Refer to the *Air bag readiness* section in the *Instrumentation* chapter. Routine maintenance of the air bag is not required.

A difficulty with the system is indicated by one or more of the following:

- The readiness light will either flash or stay lit.
- The readiness light will not illuminate immediately after ignition is turned on.
- A series of five beeps will be heard. The tone pattern will repeat periodically until the problem and light are repaired.



If any of these things happen, even intermittently, have the SRS serviced at your dealership or by a qualified technician immediately. Unless serviced, the system may not function properly in the event of a collision.

Seating and safety restraints

Disposal of air bags and air bag equipped vehicles (including pretensioners)

For disposal of air bags or air bag equipped vehicles, see your local dealership or qualified technician. Air bags MUST BE disposed of by qualified personnel.

Passenger air bag ON/OFF switch (if equipped)

 An air bag ON/OFF switch has been installed in this vehicle. Before driving, *always* look at the face of the switch to be sure the switch is in the proper position in accordance with these instructions and warnings. Failure to put the switch in a proper position can increase the risk of serious injury or death in a collision.

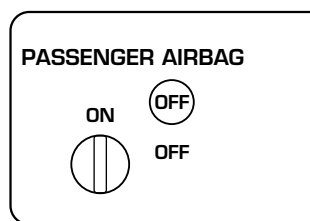

Turning the passenger air bag off

1. Insert the ignition key, turn the switch to OFF position and hold in OFF position while removing the key.
2. When the ignition is turned to the ON position the OFF light illuminates briefly, momentarily shuts off and then turns back on. This indicates that the passenger air bag is deactivated.

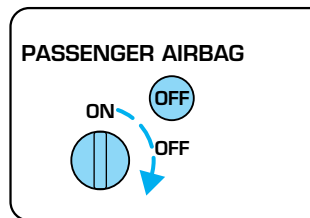

 If the light fails to illuminate when the passenger air bag switch is in the OFF position and the ignition switch is in ON, have the passenger air bag switch serviced at your Ford or Lincoln-Mercury dealer immediately.

Seating and safety restraints



In order to avoid inadvertent activation of the switch, always remove the ignition key from the passenger air bag ON/OFF switch.

Turning the passenger air bag back on

The passenger air bag remains OFF until you turn it back ON.

1. Insert the ignition key and turn the switch to ON.
2. The OFF light will briefly illuminate when the ignition is turned to On. This indicates that the passenger air bag is operational.

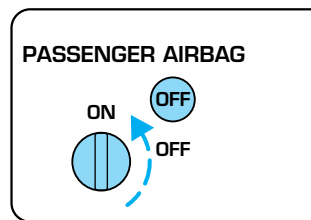

If the light is illuminated when the passenger air bag switch is in the ON position and the ignition switch is in ON, have the passenger air bag switch serviced at your Ford or Lincoln-Mercury dealer immediately.

The passenger side air bag should always be ON (the air bag OFF light should *not* be illuminated) unless the passenger is a person who meets the requirements stated either in Category 1, 2 or 3 of the NHTSA/Transport Canada deactivation criteria which follows.



The safety belts for the driver and right front passenger seating positions have been specifically designed to function together with the air bags in certain types of crashes. When you turn OFF your air bag, you not only lose the protection of the air bag, you also may reduce the effectiveness of your safety belt system, which was designed to work with the air bag. If you are not a person who meets the requirements stated in the NHTSA/Transport Canada deactivation criteria turning OFF the air bag can increase the risk of serious injury or death in a collision.

Seating and safety restraints



Always transport children who are 12 and younger in the rear seat. Always use safety belts and child restraints properly. If a child in a rear facing infant seat must be transported in front, the passenger air bag *must* be turned OFF. This is because the back of the infant seat is too close to the inflating air bag and the risk of a fatal injury to the infant when the air bag inflates is substantial.

The vast majority of drivers and passengers are much safer with an air bag than without. To do their job and reduce the risk of life threatening injuries, air bags must open with great force, and this force can pose a potentially deadly risk in some situations, particularly when a front seat occupant is not properly buckled up. The most effective way to reduce the risk of unnecessary air bag injuries without reducing the overall safety of the vehicle is to make sure all occupants are properly restrained in the vehicle, especially in the front seat. This provides the protection of safety belts and permits the air bags to provide the additional protection they were designed to provide. If you choose to deactivate your air bag, you are losing the very significant risk reducing benefits of the air bag and you are also reducing the effectiveness of the safety belts, because safety belts in modern vehicles are designed to work as a safety system with the air bags.

Read all air bag Warning labels in the vehicle as well as the other important air bag instructions and Warnings in this Owner's Guide.

NHTSA deactivation criteria (excluding Canada)

1. **Infant.** An infant (less than 1 year old) must ride in the front seat because:
 - the vehicle has no rear seat;
 - the vehicle has a rear seat too small to accommodate a rear-facing infant seat; or
 - the infant has a medical condition which, according to the infant's physician, makes it necessary for the infant to ride in the front so that the driver can constantly monitor the child's condition.
2. **Child age 1 to 12.** A child age 1 to 12 must ride in the front seat because:
 - the vehicle has no rear seat;

Seating and safety restraints

- although children ages 1 to 12 ride in the rear seat(s) whenever possible, children ages 1 to 12 sometimes must ride in the front because no space is available in the rear seat(s) of the vehicle; or
 - the child has a medical condition which, according to the child's physician, makes it necessary for the child to ride in the front seat so that the driver can constantly monitor the child's condition.
3. **Medical condition.** A passenger has a medical condition which, according to his or her physician:
- causes the passenger air bag to pose a special risk for the passenger; and
 - makes the potential harm from the passenger air bag in a crash greater than the potential harm from turning OFF the air bag and allowing the passenger, even if belted, to hit the dashboard or windshield in a crash.



This vehicle has special energy management safety belts for the driver and/or right front passenger. These particular belts are specifically designed to work with air bags to help reduce the risk of injury in a collision. The energy management safety belt is designed to give or release additional belt webbing in some accidents to reduce concentration of force on an occupant's chest and reduce the risk of certain bone fractures and injuries to underlying organs. In a crash, if the air bag is turned OFF, this energy management safety belt might permit the person wearing the belt to move forward enough to incur a serious or fatal injury. The more severe the crash, and the heavier the occupant, the greater the risk is. Be sure the air bag is turned ON for any person who does not qualify under the NHTSA deactivation criteria.

Transport Canada deactivation criteria (Canada Only)

1. **Infant:** An infant (less than 1 year old) must ride in the front seat because:
- my vehicle has no rear seat;
 - the rear seat in my vehicle cannot accommodate a rear-facing infant seat; or
 - the infant has a medical condition which, according to the infant's physician, makes it necessary for the infant to ride in the front seat so that the driver can monitor the infant's condition.

Seating and safety restraints

2. **Child age 12 or under:** A child age 12 or under must ride in the front seat because:

- my vehicle has no rear seat;
- although children age 12 and under ride in the rear seat whenever possible, children age 12 and under have no option but to sometimes ride in the front seat because rear seat space is insufficient; or
- the child has a medical condition that, according to the child's physician, makes it necessary for the child to ride in the front seat so that the driver can monitor the child's condition.

3. **Medical condition:** A passenger has a medical condition that, according to his or her physician:

- poses a special risk for the passenger if the air bag deploys; and
- makes the potential harm from the passenger air bag deployment greater than the potential harm from turning OFF the air bag and experiencing a crash without the protection offered by the air bag



This vehicle has special energy management safety belts for the driver and/or right front passenger. These particular belts are specifically designed to work with air bags to help reduce the risk of injury in a collision. The energy management safety belt is designed to give or release additional belt webbing in some accidents to reduce concentration of force on an occupant's chest and reduce the risk of certain bone fractures and injuries to underlying organs. In a crash, if the air bag is turned OFF, this energy management safety belt might permit the person wearing the belt to move forward enough to incur a serious or fatal injury. The more severe the crash, and the heavier the occupant, the greater the risk is. Be sure the air bag is turned ON for any person who does not qualify under the Transport Canada deactivation criteria.

SAFETY RESTRAINTS FOR CHILDREN

See the following sections for directions on how to properly use safety restraints for children. Also see *Air Bag Supplemental Restraint System (SRS)* in this chapter for special instructions about using air bags.

Seating and safety restraints

Important child restraint precautions

You are required by law to use safety restraints for children in the U.S. and Canada. If small children ride in your vehicle (generally children who are four years old or younger and who weigh 18 kg [40 lbs] or less), you must put them in safety seats made especially for children. Check your local and state or provincial laws for specific requirements regarding the safety of children in your vehicle.



Never let a passenger hold a child on his or her lap while the vehicle is moving. The passenger cannot protect the child from injury in a collision.

Always follow the instructions and warnings that come with any infant or child restraint you might use.

When possible, always place children under age 12 in the rear seat of your vehicle. Accident statistics suggest that children are safer when properly restrained in the rear seating positions than in the front seating position.

Children and safety belts

If the child is the proper size, restrain the child in a safety seat.

Children who are too large for child safety seats (as specified by your child safety seat manufacturer) should always wear safety belts.

Follow all the important safety restraint and air bag precautions that apply to adult passengers in your vehicle.

If the shoulder belt portion of a combination lap and shoulder belt can be positioned so it does not cross or rest in front of the child's face or neck, the child should wear the lap and shoulder belt. Moving the child closer to the center of the vehicle may help provide a good shoulder belt fit.



Do not leave children, unreliable adults, or pets unattended in your vehicle.

To improve the fit of lap and shoulder belts on children who have outgrown child safety seats, Ford recommends use of a belt-positioning booster seat that is labelled as conforming to all Federal motor vehicle safety standards. Belt-positioning booster seats raise the child and provide a shorter, firmer seating cushion that encourages safer seating posture and better fit of lap and shoulder belts on the child.

Seating and safety restraints

A belt-positioning booster should be used if the shoulder belt rests in front of the child's face or neck, or if the lap belt does not fit snugly on both thighs, or if the thighs are too short to let the child sit all the way back on the seat cushion when the lower legs hang over the edge of the seat cushion. You may wish to discuss the special needs of your child with your pediatrician.

SAFETY SEATS FOR CHILDREN



Child and infant or child safety seats

Use a safety seat that is recommended for the size and weight of the child. Carefully follow all of the manufacturer's instructions with the safety seat you put in your vehicle. If you do not install and use the safety seat properly, the child may be injured in a sudden stop or collision.

When installing a child safety seat:

- Review and follow the information presented in the *Air Bag Supplemental Restraint System* section in this chapter.
- Use the correct safety belt buckle for that seating position.
- Insert the belt tongue into the proper buckle until you hear a snap and feel it latch. Make sure the tongue is securely fastened in the buckle.

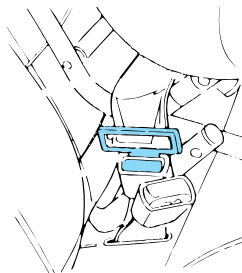

Seating and safety restraints

- Keep the buckle release button pointing up and away from the safety seat, with the tongue between the child seat and the release button, to prevent accidental unbuckling.
- Place seat back in upright position.
- Put the safety belt in the automatic locking mode. Refer to *Automatic locking mode* (passenger side front and outboard rear seating positions)(if equipped).

Ford recommends the use of a child safety seat having a top tether strap. Install the child safety seat in a seating position which is capable of providing a tether anchorage. For more information on top tether straps, refer to *Attaching safety seats with tether straps*.

 Carefully follow all of the manufacturer's instructions included with the safety seat you put in your vehicle. If you do not install and use the safety seat properly, the child may be injured in a sudden stop or collision.

Installing child safety seats in combination lap and shoulder belt seating positions

1. Position the child safety seat in a seat with a combination lap and shoulder belt.

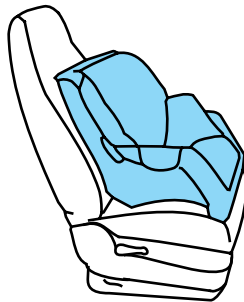

 An air bag can kill or injure a child in a child seat. If you must use a forward-facing child seat in the front seat, move seat all the way back.

 An air bag can kill or injure a child in a child seat. Child seats should never be placed in the front seats, unless passenger air bag switch is turned off, See **Passenger air bag deactivation switch**.

Seating and safety restraints



Rear facing child seats should NEVER be placed in the front seats.

2. Pull down on the shoulder belt and then grasp the shoulder belt and lap belt together.

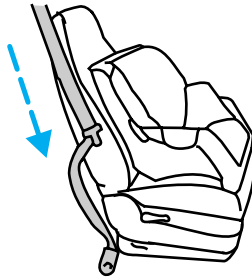

3. While holding the shoulder and lap belt portions together, route the tongue through the child seat according to the child seat manufacturer's instructions. Be sure the belt webbing is not twisted.

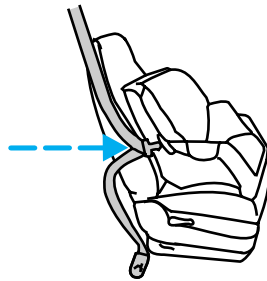

4. Insert the belt tongue into the proper buckle (the buckle closest to the direction the tongue is coming from) for that seating position until you hear and feel the latch engage. Make sure the tongue is latched securely by pulling on it.

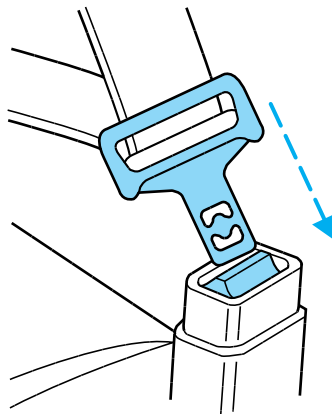

Seating and safety restraints

5. To put the retractor in the automatic locking mode, grasp the shoulder portion of the belt and pull downward until all of the belt is extracted and a click is heard.

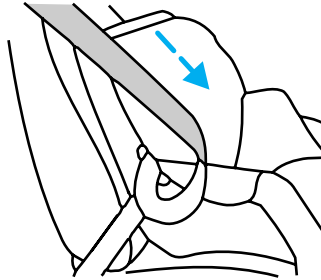

6. Allow the belt to retract. The belt will click as it retracts to indicate it is in the automatic locking mode.

7. Pull the lap belt portion across the child seat toward the buckle and pull up on the shoulder belt while pushing down with knee on the child seat.

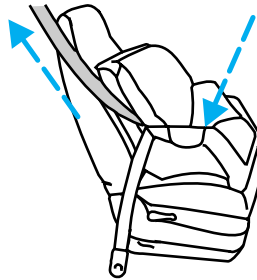

8. Allow the safety belt to retract to remove any slack in the belt.

9. Before placing the child in the seat, forcibly tilt the seat forward and back to make sure the seat is securely held in place.

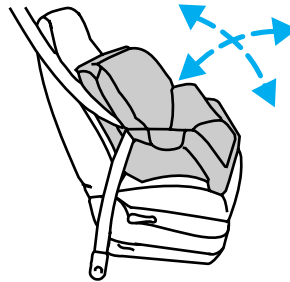

10. Try to pull the belt out of the retractor to make sure the retractor is in the automatic locking mode (you should not be able to pull more belt out). If the retractor is not locked, unbuckle the belt and repeat steps two through nine.

Check to make sure the child seat is properly secured before each use.

Seating and safety restraints

Attaching safety seats with tether straps

Some manufacturers make safety seats that include a tether strap that goes over the back of the vehicle seat and attaches to an anchoring point. Other manufacturers offer the tether strap as an accessory. Contact the manufacturer of your child safety seat for information about ordering a tether strap.

Tether anchorage hardware

A tethered seat can be installed in the front seat. Put the tether strap over the seatback and attach it to an anchor bracket.

An anchor bracket can be installed to the inside of the back panel of your vehicle.

The anchor bracket must be installed using the instructions provided with the tether anchorage hardware kit.

Tether anchorage hardware kits (part number 613D74) including instructions, may be obtained at no charge from any Ford or Lincoln-Mercury dealer.

If you have a SuperCab or Crew Cab, Ford recommends you attach tether safety seats in the rear seating position (if possible) with the tether strap attached to the tether anchorage bracket as shown in the instructions provided with the tether anchor kit.



Tighten the anchor according to specifications. Otherwise, the safety seat may not be properly secured and the child may be injured in a sudden stop or collision.

Starting

PREPARING TO START YOUR VEHICLE

Engine starting is controlled by the ignition system. This system meets all Canadian Interference-Causing Equipment standard requirements regulating the impulse electrical field strength of radio noise.

When starting a fuel-injected engine, avoid pressing the accelerator before or during starting. Only use the accelerator when you have difficulty starting the engine. For more information on starting the vehicle, refer to *Starting the engine* in this chapter.



Extended idling at high engine speeds can produce very high temperatures in the engine and exhaust system, creating the risk of fire or other damage.



Do not park, idle, or drive your vehicle in dry grass or other dry ground cover. The emission system heats up the engine compartment and exhaust system, which can start a fire.



Do not start your vehicle in a closed garage or in other enclosed areas. Exhaust fumes can be toxic. Always open the garage door before you start the engine. See *Guarding against exhaust fumes* in this chapter for more instructions.



If you smell exhaust fumes inside your vehicle, have your dealer inspect your vehicle immediately. Do not drive if you smell exhaust fumes.

Important safety precautions

A computer system controls the engine's idle revolutions per minute (RPM). When the engine starts, the idle RPM runs faster to warm the engine. If the engine idle speed does not slow down automatically, have the vehicle checked. Do not allow the vehicle to idle for more than ten minutes at high engine RPM.

Before starting the vehicle:

1. Make sure all vehicle occupants have buckled their safety belts. For more information on safety belts and their proper usage, refer to the *Seating and safety restraints* chapter.

Starting

2. Make sure the headlamps and vehicle accessories are off.

If starting a vehicle with an automatic transmission:

- Make sure the parking brake is set.

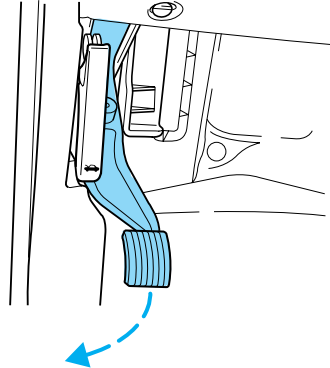

- Make sure the gearshift is in P (Park).

If starting a vehicle with a manual transmission:

- Make sure the parking brake is set.
- Push the clutch pedal to the floor.

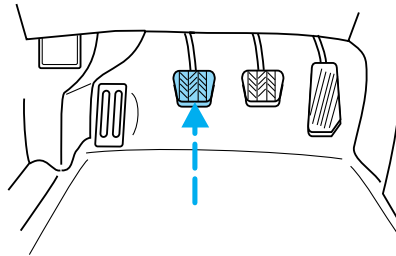

3. Turn the key to 4 (ON) without turning the key to 5 (START).

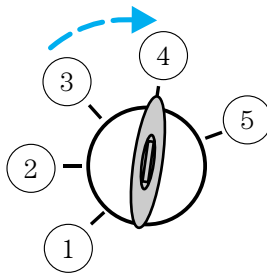

Starting

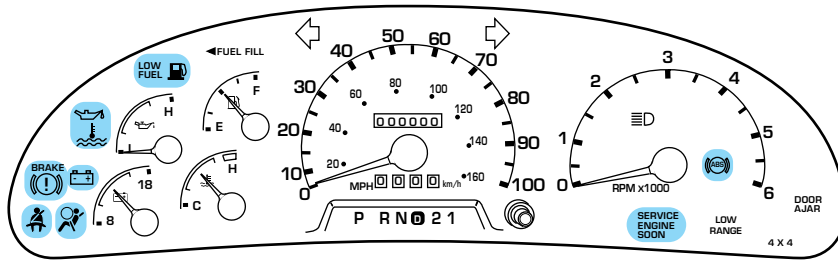

Make sure the corresponding lights illuminate briefly. If a light fails to illuminate, have the vehicle serviced.

- If the driver's safety belt is fastened, the  light may not illuminate.

STARTING THE ENGINE

1. Turn the key to 5 (START) without pressing the accelerator pedal and release as soon as the engine starts. The key will return to 4 (ON).

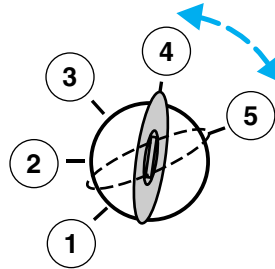

2. If the temperature is above -12°C (10°F) and the engine does not start within five seconds on the first try, turn the key to OFF, wait ten seconds and try again.

3. If the temperature is below -12°C (10°F) and the engine does not start in fifteen seconds on the first try, turn the key OFF and wait ten seconds and try again. If the engine does not start in two attempts, depress the accelerator and start the engine while holding the accelerator down to the floor. Release the accelerator when the engine starts.

4. After idling for a few seconds, apply the brake and release the parking brake.

Starting

Using the engine block heater (if equipped)

An engine block heater warms the engine coolant, which improves starting, warms up the engine faster and allows the heater-defroster system to respond quickly. Use of an engine block heater is strongly recommended if you live in a region where temperatures reach -23°C (-10°F) or below.

For best results, plug the heater in at least three hours before starting the vehicle. Using the heater for longer than three hours will not harm the engine, so the heater can be plugged in the night before starting the vehicle.

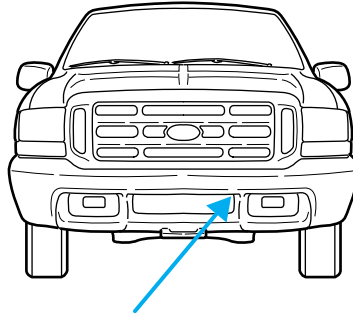

To prevent electrical shock, do not use your heater with ungrounded electrical systems or two-pronged (cheater) adapters.

Guarding against exhaust fumes

Although odorless and colorless, carbon monoxide is present in exhaust fumes. Take precautions to avoid its dangerous effects.



If you ever smell exhaust fumes of any kind inside your vehicle, have your dealer inspect and fix your vehicle immediately. Do not drive if you smell exhaust fumes. These fumes are harmful and could kill you.

Have the exhaust and body ventilation systems checked whenever:

- the vehicle is raised for service.
- the sound of the exhaust system changes.
- the vehicle has been damaged in a collision.

Starting



Engine exhaust, some of its constituents, and certain vehicle components contain or emit chemicals known to the State of California to cause cancer, and birth defects or other reproductive harm.

Important ventilating information

If the engine is idling while the vehicle is stopped in an open area for long periods of time, open the windows at least 2.5 cm (one inch).

Adjust the heating or air conditioning (if equipped) to bring in fresh air.

Improve vehicle ventilation by keeping all air inlet vents clear of snow, leaves and other debris.

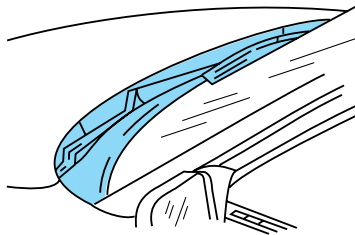

Driving

BRAKES

Your service brakes are self-adjusting. Refer to the scheduled maintenance guide for scheduled maintenance.

Occasional brake noise is normal and often does not indicate a performance concern with the vehicle's brake system. In normal operation, automotive brake systems may emit occasional or intermittent squeal or groan noises when the brakes are applied. Such noises are usually heard during the first few brake applications in the morning; however, they may be heard at any time while braking and can be aggravated by environmental conditions such as cold, heat, moisture, road dust, salt or mud. If a "metal-to-metal," "continuous grinding" or "continuous squeal" sound is present while braking, the brake linings may be worn-out and should be inspected by a qualified service technician.

Rear anti-lock brake system (RABS) (if equipped)

Rear Anti-lock Brake System (RABS) is designed to help you maintain directional stability in emergency stopping situations. With RABS, the rear brakes are kept from locking during panic stops; however, the front wheels can lock because they are not controlled by RABS.

A clicking noise and slight pedal pulsation during RABS braking events indicates the RABS is functioning. Pedal pulsation coupled with clicking noise while braking under panic conditions on loose gravel, wet or snowy roads is normal and indicates proper functioning of the vehicle's RABS. If the vehicle has continuous vibration or shudder in the steering wheel while braking, the vehicle should be inspected by a qualified service technician.

The RABS operates by detecting the onset of rear wheel lockup during brake applications and compensating for this tendency.

RABS warning lamp

The  warning lamp in the instrument cluster illuminates if a RABS fault is detected. Have your vehicle serviced as soon as possible.

Normal braking is still effective unless the BRAKE warning lamp is also illuminated.

BRAKE



Using RABS

- In an emergency, applying full pressure may cause the front wheels to lock. **If the front brakes lock, the vehicle cannot be steered.** You should apply the brakes with steadily increasing force, as if “squeezing” the brakes. If you feel the front wheels begin to lock, momentarily release the pedal and repeat the “squeeze” technique.
- We recommend that you familiarize yourself with how the RABS performs. However, avoid unnecessary risks.

Anti-lock brake system (ABS) (if equipped)

On vehicles equipped with an anti-lock braking system (ABS), a noise from the hydraulic pump motor and pulsation in the pedal may be observed during ABS braking events. Pedal pulsation coupled with noise while braking under panic conditions or on loose gravel, bumps, wet or snowy roads is normal and indicates proper functioning of the vehicle’s anti-lock brake system. The ABS performs a self-check at 17 km/h (10 mph) after you start the engine and begin to drive away. A brief mechanical noise may be heard during this test. This is normal. If a malfunction is found, the ABS warning light will come on. If the vehicle has continuous vibration or shudder in the steering wheel while braking, the vehicle should be inspected by a qualified service technician.

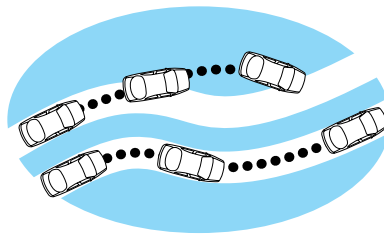
The ABS operates by detecting the onset of wheel lockup during brake applications and compensating for this tendency. The wheels are prevented from locking even when the brakes are firmly applied. The accompanying illustration depicts the advantage of an ABS equipped vehicle (on bottom) to a non-ABS equipped vehicle (on top) during hard braking with loss of front braking traction.



ABS warning lamp

The  warning lamp in the instrument cluster momentarily illuminates when the ignition is turned on and the engine is off. If the light does not illuminate momentarily at start up, remains on or continues to flash, the ABS needs to be serviced.

Driving

With the ABS light on, the anti-lock brake system is disabled and normal braking is still effective unless the brake warning light also remains illuminated with parking brake released. (If your brake warning lamp illuminates, have your vehicle serviced immediately).

BRAKE
(!)

Using ABS

- In an emergency or when maximum efficiency from the ABS is required, apply continuous full force on the brake. The ABS will be activated immediately, thus allowing you to retain full steering control of your vehicle and, providing there is sufficient space, will enable you to avoid obstacles and bring the vehicle to a controlled stop.
- The Anti-Lock system does not decrease the time necessary to apply the brakes or always reduce stopping distance. Always leave enough room between your vehicle and the vehicle in front of you to stop.
- We recommend that you familiarize yourself with this braking technique. However, avoid taking any unnecessary risks.

Parking brake

Apply the parking brake whenever the vehicle is parked. To set the parking brake, press the parking brake pedal down until the pedal stops.

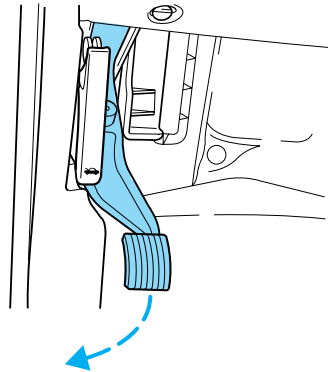

BRAKE
(!)

The BRAKE warning lamp in the instrument cluster illuminates and remains illuminated (when the ignition is turned ON) until the parking brake is released.

Driving



Always set the parking brake fully and make sure that the gearshift is securely latched in P (Park) (automatic transmission) or in 1 (First) (manual transmission).

The parking brake is not recommended to stop a moving vehicle. However, if the normal brakes fail, the parking brake can be used to stop your vehicle in an emergency. Since the parking brake applies only the rear brakes, the vehicle's stopping distance will increase greatly and the handling of your vehicle will be adversely affected.

Pull the release lever to release the brake. Driving with the parking brake on will cause the brakes to wear out quickly and reduce fuel economy.

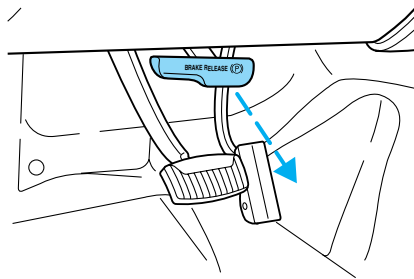

STEERING YOUR VEHICLE

Your vehicle is equipped with power steering. Power steering uses energy from the engine to help steer the vehicle.

Never hold the steering wheel to the extreme right or the extreme left position for more than a few seconds when the engine is running. This action could damage the power steering pump.

If the amount of effort needed to steer your vehicle changes at a constant vehicle speed, have the power steering system checked. If the power steering system breaks down (or if the engine is turned off), you can steer the vehicle manually, but it takes more effort.

After any severe impact such as striking large potholes, sliding into curbs on icy roads or a collision involving the front end, have the front suspension and steering checked for possible damage.

TRACTION-LOK AXLE (IF EQUIPPED)

This axle provides added traction on slippery surfaces, particularly when one wheel is on a poor traction surface. Under normal conditions, the Traction-Lok axle functions like a standard rear axle.

Driving

Extended use of other than the manufacturer's specified size tires on a Traction-Lok rear axle could result in a permanent reduction in effectiveness. This loss of effectiveness does not affect normal driving and should not be noticeable to the driver.



To avoid injury, never run the engine with one wheel off the ground, such as when changing a tire.

TRANSMISSION OPERATION

AUTOMATIC TRANSMISSION OPERATION (IF EQUIPPED)

Brake-shift interlock

This vehicle is equipped with a brake-shift interlock feature that prevents the gearshift from being moved from P (Park) unless the brake pedal is depressed.

If you cannot move the gearshift out of P (Park) with the brake pedal depressed:

1. Apply the parking brake, turn ignition key to LOCK, then remove the key.
2. Insert the key and turn it to OFF. Apply the brake pedal and shift to N (Neutral).
3. Start the vehicle.

If it is necessary to use the above procedure to move the gearshift, it is possible that a fuse has blown or the vehicle's brakelamps are not operating properly. Refer to *Fuses and relays* in the *Roadside emergencies* chapter.





Do not drive your vehicle until you verify that the brakelamps are working.

If your vehicle gets stuck in mud or snow it may be rocked out by shifting from forward and reverse gears, stopping between shifts, in a steady pattern. Press lightly on the accelerator in each gear.

Do not rock the vehicle for more than a few minutes. The transmission and tires may be damaged or the engine may overheat.

Driving

 Always set the parking brake fully and make sure the gearshift is latched in P (Park). Turn off the ignition whenever you leave your vehicle.

 If the parking brake is fully released, but the brake warning lamp remains illuminated, the brakes may not be working properly. See your dealer or a qualified service technician.

Driving with a 4-speed automatic transmission

Understanding gearshift positions

Pull the gearshift lever towards you and downward to move the automatic gearshift.

 Hold the brake pedal down while you move the gearshift lever from P (Park) to another position. If you do not hold the brake pedal down, your vehicle may move unexpectedly and injure someone.

P (Park)

Always come to a complete stop before shifting into P (Park). Make sure the gearshift is securely latched in P (Park). This position locks the transmission and prevents the rear wheels from turning.



 Always set the parking brake fully and make sure the gearshift is latched in P (Park). Turn off the ignition whenever you leave your vehicle.

R (Reverse)

With the gearshift in R (Reverse), the vehicle will move backward. Always come to a complete stop before shifting into and out of R (Reverse).



Driving

N (Neutral)

With the gearshift in N (Neutral), the vehicle can be started and is free to roll. Hold the brake pedal down while in this gear.



D (Overdrive)

The normal driving position for the best fuel economy. Transmission operates in gears one through four.



D (Overdrive) can be deactivated by pressing the Transmission Control Switch (TCS) on the end of the gearshift lever.

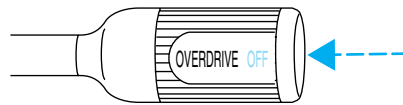

The transmission control indicator light (TCIL) (the word OFF) on the end of the gearshift lever will illuminate.

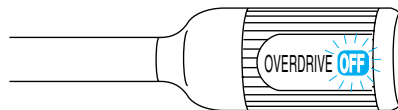

Drive – Not shown on the display. Activate by pressing the Transmission Control Switch (TCS) on the end of the gearshift lever with the gearshift in the **D** position. The TCIL (the word OFF) will illuminate on the gearshift lever. Transmission operates in gears one through three.

D (Drive) provides more engine braking than **D** (Overdrive) and is useful when:

- driving with a heavy load.
- towing a trailer up or down steep hills.
- additional engine downhill braking is desired. If towing a trailer, refer to *Driving while you tow* in the *Trailer towing* section.

To return to **D** (Overdrive) mode, press the Transmission Control Switch (TCS). The TCIL (the word OFF) will no longer be illuminated.

Each time the vehicle is started, the transmission will automatically return to normal overdrive mode.

Every time the vehicle is shut off and restarted, you must press the transmission control switch to cancel overdrive operation if driving in overdrive is not desired.

2 (Second)

Use 2 (Second) to start-up on slippery roads or to provide additional engine braking on downgrades.



1 (First)

Use 1 (Low) to provide maximum engine braking on steep downgrades. Upshifts can be made by shifting to 2 (Second) or to **D** (Overdrive). Selecting 1 (Low)



at higher speeds causes the transmission to shift to a lower gear, and will shift to 1 (Low) after vehicle decelerates to the proper speed.

MANUAL TRANSMISSION OPERATION (IF EQUIPPED)

Using the clutch

Vehicles equipped with a manual transmission have a starter interlock that prevents cranking the engine unless the clutch pedal is fully depressed.

When starting a vehicle with a manual transmission, you must:

1. Put gearshift in N (Neutral).
2. Hold down brake pedal.
3. Depress clutch pedal.

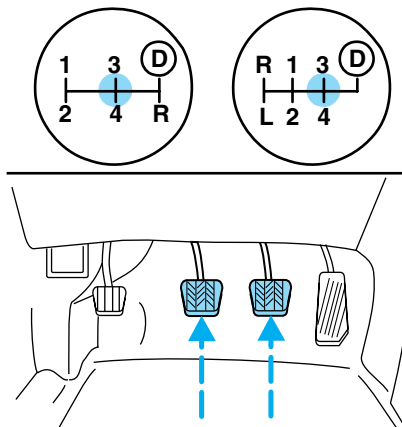

Driving

4. Turn ignition to position 5 (START) to start the engine, let the engine idle for a few seconds, then shift into gear.
5. Release the brake pedal.
6. Release clutch slowly while pressing down slowly on the accelerator pedal.

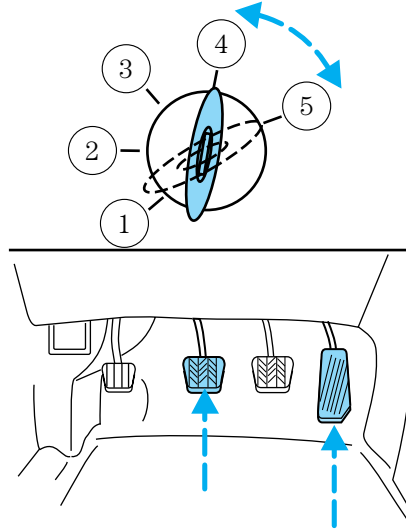

- Do not drive with your foot resting on the clutch pedal and do not use the clutch to hold your vehicle at a standstill while waiting on a hill. These actions will seriously reduce clutch life.

Recommended shift speeds

Downshift according to the following charts for your specific engine/drivetrain combination:

Maximum downshift speeds ¹		
5-speed transmission		
Shift from:	Transfer case position (if equipped) ²	
	2H or 4H	4L
Ⓧ (Overdrive) - 4	72 km/h (45 mph)	35 km/h (22 mph)
4 - 3	56 km/h (35 mph)	23 km/h (14 mph)
3 - 2	32 km/h (20 mph)	13 km/h (8 mph)
2 - 1	8 km/h (5 mph)	0 km/h (0 mph)

¹ Use 2H or 4H for 4WD equipped vehicles.

² Downshift at lower speeds when driving on slippery surfaces.

Driving

Maximum downshift speeds ¹		
6-speed transmission		
Shift from:	Transfer case position (if equipped) ²	
	2H or 4H	4L
ⓓ (Overdrive) - 4	72 km/h (45 mph)	26 km/h (16 mph)
4 - 3	56 km/h (35 mph)	19 km/h (12 mph)
3 - 2	32 km/h (20 mph)	13 km/h (8 mph)
2 - 1	8 km/h (5 mph)	3 km/h (2 mph)
1 - LO	Only shift to LO when at a stop.	
¹ Use 2H or 4H for 4WD equipped vehicles.		
² Downshift at lower speeds when driving on slippery surfaces.		

Parking your vehicle

1. Disengage the clutch, apply brake and shift into N (Neutral).

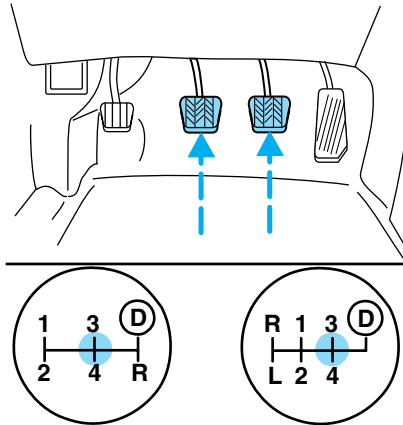

Driving

2. Set parking brake.
3. Shift into 1 (First).

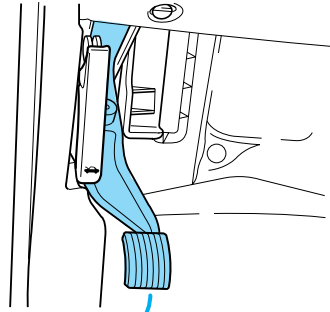

4. Turn the ignition key to position 3 (OFF).

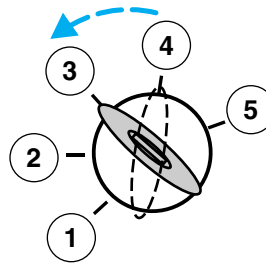

Do not park your vehicle in Neutral, it may move unexpectedly and injure someone. Use 1 (First) gear and set the parking brake fully.

Reverse

Make sure that your vehicle is at a complete stop before you shift into R (Reverse). Failure to do so may damage the transmission.

Put the gearshift in N (Neutral) and wait at least three seconds before shifting into R (Reverse).

Driving

With the 5-speed transmission you can shift into R (Reverse) only by moving the gearshift from left of 3 (Third) and 4 (Fourth) gears before you shift into R (Reverse). This is a special lockout feature that protects you from accidentally shifting into R (Reverse) when you downshift from **D** (Overdrive).

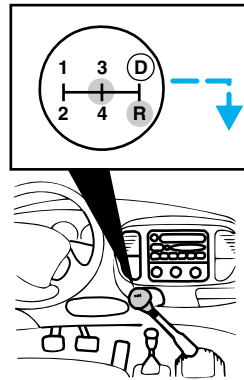

With the 6-speed transmission you can shift into R (Reverse) by moving the gearshift left from N (Neutral).

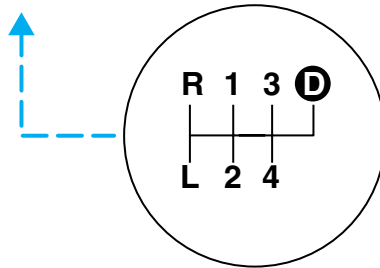

Driving

Removing key from ignition

- Turn the ignition key until it stops.
- Push the release lever forward and rotate the key towards you and remove.

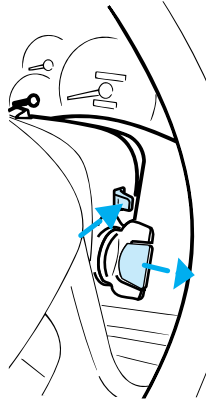

POWER TAKE OFF (PTO) CAPABILITY (IF EQUIPPED)

Some vehicles with 6.8L and 7.3L engines are equipped with Power Take Off (PTO) capability. These vehicles have a special transmission case, internal components and calibration for PTO usage. If your vehicle is equipped with a 7.3L Diesel engine, refer to the 7.3L Diesel Supplement for information on the auxiliary powertrain control module (APCM) and its operation.

The PTO can be used during mobile and stationary continuous/intermittent applications.

PTO operation is disabled while the vehicle is in Overdrive (the TCIL will not be illuminated), in N (Neutral), during engine cranking. Transmission upshift and downshift schedules will be reduced by about 15% and will have a firmer shift feel during PTO mobile applications.

The PTO cannot be disabled while the transmission is in Manual 3 (Overdrive position with Overdrive canceled), Manual 2, Manual 1.

Refer to the “Body Builder’s Layout Book” for recommended electrical installation.

FOUR-WHEEL DRIVE (4WD) OPERATION (IF EQUIPPED)

When Four-wheel drive (4WD) is engaged, power is supplied to all four wheels through a transfer case. 4WD power can be selected when additional driving power is desired.

If equipped with the Electronic Shift 4WD System, and the instrument panel control is moved to 4WD Low while the vehicle is moving, the system will not engage and no damage will occur to the 4WD system.

All utility-type vehicles and 4WD vehicles have special design and equipment features to make them capable of performing in a wide variety of off-road applications. Specific design characteristics give them higher centers of gravity than ordinary passenger cars.



Utility and four-wheel drive vehicles are **not** designed for cornering at speeds as high as passenger cars any more than low-slung sports cars are designed to perform satisfactorily under off-road conditions. Avoid sharp turns or abrupt maneuvers in these vehicles.

4WD operation is not recommended on dry pavement. Doing so could result in difficult disengagement of the transfer case, increased tire wear and decreased fuel economy.

Electronic shift on the fly (ESOF) 4x4 system (if equipped)

The 4WD system:

- provides 4x4 High engagement and disengagement while the vehicle is moving.
- is operated by a rotary control located on the instrument panel that allows you select 2WD, 4x4 High or 4x4 Low operation.
- uses hub locks that can be engaged and disengaged automatically by using a rotary control located on the instrument panel.

Driving

- automatic hub locks can be manually overridden by rotating the hub lock control from AUTO to LOCK.

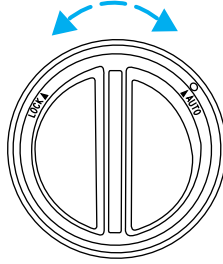

Manual 4x4 system (if equipped)

The 4WD system is engaged or disengaged by rotating the front wheel hub lock control from FREE to LOCK, then manually engaging the transfer case with a floor-mounted shifter.

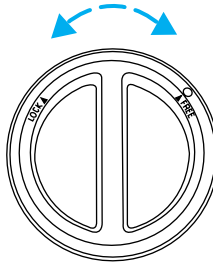

4WD system indicator lights

The 4WD system indicator lights illuminate only under the following conditions. If these lights illuminate during normal driving, have your vehicle serviced.

- **4x4** -illuminates when the ignition is turned on and when 4H (4x4 High) is selected.
- **LOW RANGE** -illuminates when the ignition is turned on or when 4L (4x4 Low) is selected.

4x4

LOW
RANGE

Using a manual 4WD system (if equipped)

2H (2WD High) – Power to rear axle only.

4H (4WD High) – Power to front and rear axles.

N (Neutral) – No power to either axle.

4L (4WD Low) – Power to front and rear axles at reduced speed.

Shifting from 2H (2WD high) to 4H (4WD high)

Engage the locking hubs by rotating the hub lock control from FREE to LOCK, then move the transfer case lever from 2H (2WD High) to 4H (4WD High).

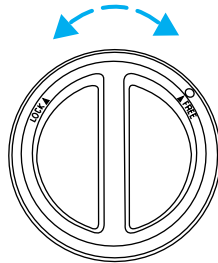

Do not shift into 4H (4WD High) with the rear wheels slipping.

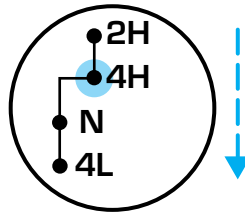

Shifting from 4H (4WD high) to 2H (2WD high)

Move the transfer case lever to 2H (2WD High) at a stop or any forward speed up to 88 km/h (55 mph).

With the vehicle at complete stop, disengage the locking hubs (optional) by rotating the hub lock control from LOCK to FREE.

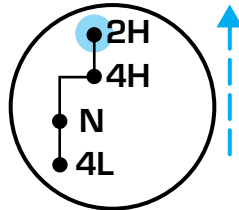

Shifting from 4H (4WD high) to 4L (4WD low)

1. Bring the vehicle to a complete stop.
2. Depress the brake.
3. Place the gearshift lever in N (Neutral) (automatic transmission) or depress the clutch (manual transmission).

Driving

4. Move the transfer case shift lever through N (Neutral) directly to 4H (4WD High) or 4L (4WD Low).

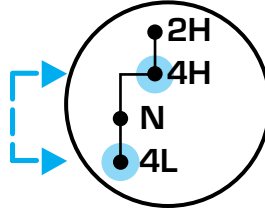

Using the N (Neutral) position

The transfer case neutral position overrides the transmission and puts the vehicle in neutral regardless of transmission gearshift lever position. The vehicle can move forward or backwards.

This position should only be used when towing the vehicle. Refer to *Wrecker towing* in the *Roadside emergencies* chapter.

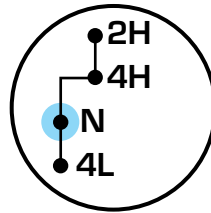

Do not leave the vehicle unattended with the transfer case in the N (Neutral) position. Always set the parking brake fully and turn off the ignition when leaving the vehicle.

Using the electronic shift 4WD system (if equipped)

Positions of the electronic shift system

To prevent damage, the electronic shift 4WD system is designed to allow up to 45 seconds before the shift command is performed. In the event that conflicting shift commands are selected, allow up to 45 seconds for the shift command to be performed prior to reporting any shift concerns to your dealer.

2WD (2WD High) – Power to rear axle only.

4x4 HIGH (4WD High) – Power delivered to front and rear axles for increased traction.

4x4 LOW (4WD Low) – Power to front and rear axles at low speeds.

Shifting from 2WD (2WD high) to 4x4 HIGH (4WD high)

Rotate the 4WD control to the 4x4 HIGH position at speeds up to 88 km/h (55 mph).

- Do not shift into 4x4 HIGH with the rear wheels slipping.

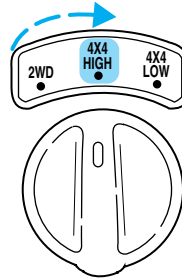

Shifting from 4x4 HIGH (4WD high) to 2WD (2WD high)

Rotate the 4WD control to 2WD at any forward speed. You do not need to put the gearshift in R (Reverse) to disengage your front hubs.

To prevent damage, the electronic shift 4WD system is designed to allow up to 45 seconds before the shift command is performed. In the event that conflicting shift commands are selected, allow up to 45 seconds for the shift command to be performed prior to reporting any shift concerns to your dealer.

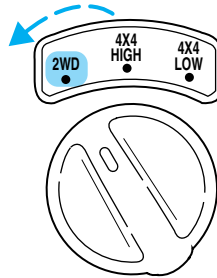

Shifting between 4x4 HIGH (4WD high) and 4x4 LOW (4WD low)

1. Bring the vehicle to a complete stop.
2. Depress the brake.
3. Place the gearshift in N (Neutral) (automatic transmission) or depress the clutch (manual transmission).

Driving

4. Move the 4WD control to the 4x4 HIGH or 4x4 LOW position.

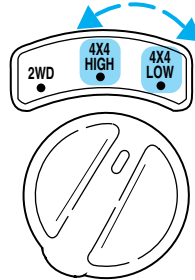

Driving off-road with 4WD

Your vehicle is specially equipped for driving on sand, snow, mud and rough terrain and has operating characteristics that are somewhat different from conventional vehicles, both on and off the road.

Maintain steering wheel control at all times, especially in rough terrain. Since sudden changes in terrain can result in abrupt steering wheel motion, make sure you grip the steering wheel from the outside. Do not grip the spokes.

Drive cautiously to avoid vehicle damage from concealed objects such as rocks and stumps.

You should either know the terrain or examine maps of the area before driving. Map out your route before driving in the area. For more information on driving off-road, read the “Four Wheeling” supplement in your owner’s portfolio.

If your vehicle gets stuck

If the vehicle is stuck it may be rocked out by shifting from forward and reverse gears, stopping between shifts, in a steady pattern. Press lightly on the accelerator in each gear.

Do not rock the vehicle for more than a few minutes. The transmission and tires may be damaged or the engine can overheat.



Do not spin the wheels at over 56 km/h (35 mph). The tires may fail and injure a passenger or bystander.

Sand

When driving over sand, try to keep all four wheels on the most solid area of the trail. Do not reduce the tire pressures but shift to a lower gear and drive steadily through the terrain. Apply the accelerator slowly and avoid spinning the wheels.

Mud and water

If you must drive through high water, drive slowly. Traction or brake capability may be limited.

When driving through water, determine the depth; avoid water higher than the bottom of the hubs (if possible) and proceed slowly. If the ignition system gets wet, the vehicle may stall.

Once through water, always try the brakes. Wet brakes do not stop the vehicle as effectively as dry brakes. Drying can be improved by moving your vehicle slowly while applying light pressure on the brake pedal.

After driving through mud, clean off residue stuck to rotating driveshafts and tires. Excess mud stuck on tires and rotating driveshafts causes an imbalance that could damage drive components.

If the transmission, transfer case or front axle are submerged in water, their fluids should be checked and changed, if necessary.

Water intrusion into the transmission may damage the transmission.

If the front or rear axle is submerged in water, the axle lubricant should be replaced.

Driving on hilly or sloping terrain

When driving on a hill, avoid driving crosswise or turning on steep slopes. You could lose traction and slip sideways. Drive straight up, straight down or avoid the hill completely. Know the conditions on the other side of a hill before driving over the crest.

When climbing a steep hill, start in a lower gear rather than downshifting to a lower gear from a higher gear once the ascent has started. This reduces strain on the engine and the possibility of stalling.

When descending a steep hill, avoid sudden braking. Shift to a lower gear when added engine braking is desired.

When speed control is on and you are driving uphill, your vehicle speed may drop considerably, especially if you are carrying a heavy load.

Driving

If vehicle speed drops more than 16 km/h (10 mph), the speed control will cancel automatically. Resume speed with accelerator pedal.

If speed control cancels after climbing the hill, reset speed by pressing and holding the SET ACCEL button to resume speeds over 50 km/h (30 mph).

Automatic transmissions may shift frequently while driving up steep grades. Eliminate frequent shifting by shifting out of **D** (Overdrive) into a lower gear.

Driving on snow and ice

A 4WD vehicle has advantages over 2WD vehicles in snow and ice but can skid like any other vehicle.

Avoid sudden applications of power and quick changes of direction on snow and ice. Apply the accelerator slowly and steadily when starting from a full stop.

If your vehicle is equipped with a Rear Anti-lock Brake System (RABS), you should be careful when braking. Front brake lock-up, on any surface, causes loss of steering control.

If your vehicle is equipped with a Four Wheel Anti-lock Brake System (ABS), apply the brakes as you normally would. In order to allow the ABS to operate properly, keep steady pressure on the brake pedal.

When driving on snow or ice with either braking system, allow more stopping distance and drive slower than usual. Consider using one of the lower gears.

VEHICLE LOADING

Before loading a vehicle, familiarize yourself with the following terms:

- **Base Curb Weight** : Weight of the vehicle including any standard equipment, fluids, lubricants, etc. It does not include passengers or aftermarket equipment.
- **Payload** : Combined maximum allowable weight of cargo, passengers and optional equipment. The payload equals the gross vehicle weight rating minus base curb weight.
- **GVW (Gross Vehicle Weight)** : Base curb weight plus payload weight. The GVW is not a limit or a specification.

Driving

- **GVWR (Gross Vehicle Weight Rating)** : Maximum total weight of the base vehicle, passengers, optional equipment and cargo. The GVWR is specific to each vehicle and is listed on the Safety Compliance Label on the driver's door pillar.
- **GAWR (Gross Axle Weight Rating)** : Carrying capacity for each axle system. The GAWR is specific to each vehicle and is listed on the Safety Compliance Label on the driver's door pillar.
- **GCW (Gross Combined Weight)** : The combined weight of the towing vehicle (including passengers and cargo) and the trailer.
- **GCWR (Gross Combined Weight Rating)** : Maximum combined weight of towing vehicle (including passengers and cargo) and the trailer. The GCWR indicates the maximum loaded weight that the vehicle is designed to tow.
- **Maximum Trailer Weight Rating** : Maximum weight of a trailer the vehicle is permitted to tow. The maximum trailer weight rating is determined by subtracting the vehicle curb weight for each engine/transmission combination, any required option weight for trailer towing and the weight of the driver from the GCWR for the towing vehicle.
- **Maximum Trailer Weight** : maximum weight of a trailer the loaded vehicle (including passengers and cargo) is permitted to tow. It is determined by subtracting the weight of the loaded trailer towing vehicle from the GCWR for the towing vehicle.
- **Trailer Weight Range** : Specified weight range that the trailer must fall within that ranges from zero to the maximum trailer weight rating.

Remember to figure in the tongue load of your loaded trailer when figuring the total weight.



Do not exceed the GVWR or the GAWR specified on the certification label.

Do not use replacement tires with lower load carrying capacities than the originals because they may lower the vehicle's GVWR and GAWR limitations. Replacement tires with a higher limit than the originals do not increase the GVWR and GAWR limitations.

The Certification Label, found on the inside pillar of the driver's door, lists several important vehicle weight rating limitations. Before adding any additional equipment, refer to these limitations. If you are adding

Driving

weight to the front of your vehicle, (potentially including weight added to the cab), the weight added should not exceed the Front Axle Reserve Capacity (FARC). Additional frontal weight may be added to the front axle reserve capacity provided you limit your payload in other ways (i.e. restrict the number of passengers or amount of cargo carried).

You may add equipment throughout your vehicle if the total weight added is equal to or less than the Total Axle Reserve Capacity (TARC) weight. You should NEVER exceed the Total Axle Reserve Capacity.

Always ensure that the weight of passengers, cargo and equipment being carried is within the weight limitations that have been established for your vehicle including both Gross Vehicle Weight and Front and Rear Gross Axle Weight Rating limits. Under no circumstance should these limitations be exceeded. Exceeding any vehicle weight rating limitation could result in serious damage to the vehicle and/or personal injury.

Calculating the load your vehicle can carry/tow

1. Use the appropriate maximum gross combined weight rating (GCWR) chart to find the maximum GCWR for your type engine and rear axle ratio.
2. Weigh your vehicle as you customarily operate the vehicle without cargo. To obtain correct weights, try taking your vehicle to a shipping company or an inspection station for trucks.
3. Subtract your loaded vehicle weight from the maximum GCWR on the following charts. This is the maximum trailer weight your vehicle can tow and must fall below the maximum shown under maximum trailer weight on the chart.

DRIVING THROUGH WATER

Do not drive quickly through standing water, especially if the depth is unknown. Traction or brake capability may be limited and if the ignition system gets wet, your engine may stall. Water may also enter your engine's air intake and severely damage your engine.

If driving through deep or standing water is unavoidable, proceed very slowly. Never drive through water that is higher than the bottom of the hubs.

Once through the water, always try the brakes. Wet brakes do not stop the vehicle as effectively as dry brakes. Drying can be improved by moving your vehicle slowly while applying light pressure on the brake pedal.

Driving

Driving through deep water where the transmission is submerged may allow water into the transmission and cause internal transmission damage.

TOWING A TRAILER

Your vehicle may tow a Conventional/Class IV trailer or fifth wheel trailer provided the maximum trailer weight is less than or equal to the maximum trailer weight listed for your engine and rear axle ratio on the following charts.

2nd unit bodies are not included in maximum trailer weight ratings. Weight of additional “body” must be subtracted from the maximum trailer weight.

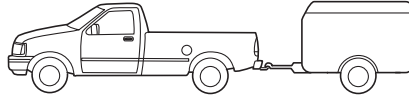

Your vehicle's load capacity is designated by weight, not by volume, so you cannot necessarily use all available space when loading a vehicle.

Towing a trailer places an additional load on your vehicle's engine, transmission, axle, brakes, tires and suspension. Inspect these components carefully after any towing operation.



Do not exceed the GVWR or the GAWR specified on the certification label.



Towing trailers beyond the maximum recommended gross trailer weight could result in engine damage, transmission/axle damage, structural damage, loss of control, and personal injury.

Driving

Trailer towing tables

F-250 with manual transmission			
Engine	Rear axle ratio	Maximum GCWR-kg (lbs.)	Maximum trailer weight-kg (lbs.)¹
5.4L	3.73	6 124 (13 500)	4 536 (10 000)
5.4L	4.10	6 804 (15 000)	4 536 (10 000)
6.8L	3.73	7 484 (16 500)	4 536 (10 000)
6.8L	4.30	8 165 (18 000)	4 536 (10 000)

¹ Conventional/Class IV trailer hitch only. Fifth wheel trailer maximum weights can be calculated by subtracting GVW from GCWR.

F-250 with automatic transmission			
Engine	Rear axle ratio	Maximum GCWR-kg (lbs.)	Maximum trailer weight-kg (lbs.)¹
5.4L	3.73	6 124 (13 500)	4 536 (10 000)
5.4L	4.10	6 804 (15 000)	4 536 (10 000)
6.8L	3.73	7 711 (17 000)	4 536 (10 000)
6.8L	4.30	8 165 (18 000)	4 536 (10 000)

¹ Conventional/Class IV trailer hitch only. Fifth wheel trailer maximum weights can be calculated by subtracting GVW from GCWR.

F-350 with manual transmission			
Engine	Rear axle ratio	Maximum GCWR-kg (lbs.)	Maximum trailer weight-kg (lbs.)¹
5.4L	3.73	6 124 (13 500)	4 536 (10 000)
5.4L	4.10	6 804 (15 000)	4 536 (10 000)
6.8L	3.73	7 484 (16 500)	4 536 (10 000)
6.8L	4.10	8 392 (18 500)	4 536 (10 000)
6.8L	4.30	9 072 (20 000)	4 536 (10 000)

¹ Conventional/Class IV trailer hitch only. Fifth wheel trailer maximum weights can be calculated by subtracting GVW from GCWR.

Driving

F-350 with automatic transmission			
Engine	Rear axle ratio	Maximum GCWR-kg (lbs.)	Maximum trailer weight-kg (lbs.)¹
5.4L	3.73	6 124 (13 500)	4 536 (10 000)
5.4L	4.10	6 804 (15 000)	4 536 (10 000)
6.8L	3.73	7 711 (17 000)	4 536 (10 000)
6.8L	4.30	9 072 (20 000)	4 536 (10 000)

¹ Conventional/Class IV trailer hitch only. Fifth wheel trailer maximum weights can be calculated by subtracting GVW from GCWR.

F-450 with manual transmission			
Engine	Rear axle ratio	Maximum GCWR-kg (lbs.)	Maximum trailer weight-kg (lbs.)¹
6.8L	4.88	9 979 (22 000)	4 536 (10 000)
6.8L	5.38	9 979 (22 000)	4 536 (10 000)

¹ Conventional/Class IV trailer hitch only. Fifth wheel trailer maximum weights can be calculated by subtracting GVW from GCWR.

F-450 with automatic transmission			
Engine	Rear axle ratio	Maximum GCWR-kg (lbs.)	Maximum trailer weight-kg (lbs.)¹
6.8L	4.88	10 886 (24 000)	4 536 (10 000)
6.8L	5.38	11 794 (26 000)	4 536 (10 000)

¹ Conventional/Class IV trailer hitch only. Fifth wheel trailer maximum weights can be calculated by subtracting GVW from GCWR.

F-550			
Engine	Rear axle ratio	Maximum GCWR-kg (lbs.)	Maximum trailer weight-kg (lbs.)¹
6.8L	4.88	10 886 (24 000)	4 536 (10 000)
6.8L	5.38	11 794 (26 000)	4 536 (10 000)

¹ Conventional/Class IV trailer hitch only. Fifth wheel trailer maximum weights can be calculated by subtracting GVW from GCWR.

Driving

Preparing to tow

Use the proper equipment for towing a trailer, and make sure it is properly attached to your vehicle. See your dealer or a reliable trailer dealer if you require assistance.

Hitches

Do not use hitches that clamp onto the vehicle's bumper or attach to the axle. You must distribute the load in your trailer so that 10% of the total weight of the trailer is on the tongue.

Load equalizing hitch

When hooking up a trailer using a load equalizing hitch, always use the following procedure:

1. Park the unloaded vehicle on a level surface. With the ignition on and all doors closed, allow the vehicle to stand for several minutes so that it can level.
2. Measure the height of a reference point on the front and rear bumpers at the center of the vehicle.
3. Attach the trailer to the vehicle and adjust the hitch equalizers so that the front bumper height is within 0–13 mm (1/2 inch) of the reference point. After proper adjustment, the rear bumper should be no higher than in Step 3.



Adjusting an equalizing hitch so the rear bumper of the vehicle is lower or higher than it was unloaded will defeat the function of the load equalizing hitch and may cause unpredictable handling.

Safety chains

Always connect the trailer's safety chains to the vehicle. To connect the trailer's safety chains, cross the chains under the trailer tongue and allow slack for turning corners.

If you use a rental trailer, follow the instructions that the rental agency gives to you.

Do not attach safety chains to the bumper.

Driving

Trailer brakes

Electric brakes and manual, automatic or surge-type brakes are safe if installed properly and adjusted to the manufacturer's specifications. The trailer brakes must meet local and Federal regulations.



Do not connect a trailer's hydraulic brake system directly to your vehicle's brake system. Your vehicle may not have enough braking power and your chances of having a collision greatly increase.

The braking system of the tow vehicle is rated for operation at the GVWR not GCWR.

Trailer lamps

Trailer lamps are required on most towed vehicles. Make sure your trailer lamps conform to local and Federal regulations. See your dealer or trailer rental agency for proper instructions and equipment for hooking up trailer lamps.

Using a step bumper

The rear bumper is equipped with an integral hitch and requires only a ball with a 25.4 mm (one inch) shank diameter. The bumper has a 2 270 kg (5 000 lb.) trailer weight and 227 kg (500 lb.) tongue weight capability.

If it is necessary to relocate the trailer hitch ball position, a frame-mounted trailer hitch must be installed.

Driving while you tow

Do not drive faster than 88 km/h (55 mph) when towing a trailer.

Speed control may shut off if you are towing on long, steep grades.

When towing a trailer:

- Use a lower gear when towing up or down steep hills. This will eliminate excessive downshifting and upshifting for optimum fuel economy and transmission cooling.
- Anticipate stops and brake gradually.

Exceeding the GCWR rating may cause internal transmission damage and void your warranty coverage.

Driving

Servicing after towing

If you tow a trailer for long distances, your vehicle will require more frequent service intervals. Refer to your Scheduled Maintenance guide for more information.

Trailer towing tips

- Practice turning, stopping and backing up in an area before starting on a trip to get the feel of the vehicle trailer combination. When turning, make wider turns so the trailer wheels will clear curbs and other obstacles.
- Allow more distance for stopping with a trailer attached.
- The trailer tongue weight should be 10–15% of the loaded trailer weight.
- After you have traveled 80 km (50 miles), thoroughly check your hitch, electrical connections and trailer wheel lug nuts.
- When stopped in traffic for long periods of time in hot weather, place the gearshift in P (Park) (automatic transmissions) or N (Neutral) (manual transmissions). This aids engine cooling and air conditioner efficiency.
- Vehicles with trailers should not be parked on a grade. If you must park on a grade, place wheel chocks under the trailer's wheels.

Launching or retrieving a boat

When backing down a ramp during boat launching or retrieval,

- Do not allow the static water level to rise above the bottom edge of the rear bumper and
- Do not allow waves to break higher than 15 cm (six inches) above the bottom edge of the rear bumper.

Exceeding these limits may allow water to enter critical vehicle components, adversely affecting driveability, emissions and reliability.

Replace front and rear axle lubricants anytime the axles have been submerged in water. Axle lubricant quantities are not to be checked unless a leak is suspected.

Recreational towing

If you may want to tow your vehicle behind another vehicle, such as an RV, follow these guidelines:

Driving

- 4x2 vehicles must have the driveshaft removed if the rear wheels are to be kept on the ground. If only the front wheels will be on the ground, the driveshaft does not need to be removed.
- 4x4 Electronic Shift on the Fly vehicles cannot be towed with any wheels on the ground.
- 4x4 vehicles with a manual shift (floor-mounted) transfer case shifter must have the transfer case and transmission gearshift levers placed in the N (Neutral) position in order to tow with all wheels on the ground.

SNOWPLOWING

For low speed snow removal, Ford offers a Snowplow Package as an option. If you do not have this equipment, do not use your vehicle as a snowplow or powertrain and suspension system damage may occur.

Do not install a snowplow and plow with your vehicle until it has been driven at least 800 km (500 miles).

Installing snowplow

Read the following instructions before installing a snowplow:

- Front GAWR must not exceed 63% of the GVW. Add ballast weight to the back of the vehicle, if necessary. Refer to the Safety Compliance Certification Label to find Front GAWR.
- The Front Axle Accessory Reserve Capacity and the Total Accessory Reserve Capacity listed on the bottom right of the Safety Compliance Certification Label will determine whether or not the addition of a snowplow will overload your vehicle.
- The weight of the snowplow and supporting components distributed to the front axle must not exceed the front accessory reserve capacity.
- The total weight of the snowplow and aftermarket equipment must not exceed the Total Accessory Reserve Capacity.
- The weight of the installed snowplow and aftermarket equipment must not load the vehicle beyond the GAWR (front/rear) and GVWR listed on the Safety Compliance Certification Label.
- The total weight of the snowplow and aftermarket equipment must be considered part of the payload and must not exceed the Gross Combined Weight Rating (GCWR) for towing.
- Federal and most local regulations require additional exterior lamps for snowplow-equipped vehicles. Consult your dealer for additional information.

Driving

- After installing a snowplow to the vehicle, ensure the vehicle's front toe alignment and front ride height are within specification (reset if required). These specifications are located in the vehicle's Workshop Manual. Adherence to the toe, tire pressures and ride height specification is important for proper tire wear, ride, handling and headlight aim. Also, maintain the engine oil and transmission fluid change intervals following the severe duty schedule.



Do not exceed the GVWR or the GAWR specified on the certification label.

Removing snowplow

Read the following instructions before removing a snowplow:

- After removing a snowplow from the vehicle, ensure the vehicle's front toe alignment and front ride height are within specification (reset if required). These specifications are located in the vehicle's Workshop Manual. Adherence to the toe and ride height specification is important for proper tire wear, ride, handling and headlight aim.

Snowplowing with your air bag equipped vehicle

Your vehicle is equipped with driver and passenger (if equipped) air bag Supplemental Restraint System (SRS). The SRS is designed to activate when the vehicle sustains sufficient longitudinal deceleration.



Careless or high speed driving while plowing snow which results in sufficient vehicle decelerations can deploy the air bag. Such driving also increases the risk of accidents.



All occupants of the vehicle, including the driver, should always properly wear their safety belts, even when an air bag SRS is provided.

Never remove or defeat the “tripping mechanisms” designed into the snow removal equipment by its manufacturer. Doing so may cause damage to the vehicle and the snow removal equipment as well as possible air bag deployment.

Driving

 Do not attempt to service, repair, or modify the Air Bag Supplemental Restraint System or its fuses. See your Ford or Lincoln-Mercury dealer.

Engine temperature while plowing

When driving with a plow, your engine may run at a higher temperature than normal because the attached snowplow blade will restrict airflow to the radiator.

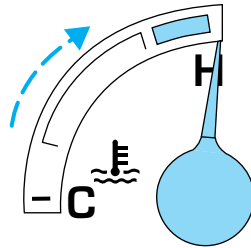

If you are driving more than 24 km (15 miles) at temperatures above freezing, angle the plow blade either full left or full right to provide maximum airflow to the radiator.

If you are driving less than 24 km (15 miles) at speeds up to 64 km/h (40 mph) in cold weather, you will not need to worry about blade position to provide maximum airflow.

4WD operation while plowing

- Shift transfer case to 4x4 LOW (4WD Low) when plowing in small areas at speeds below 8 km/h (5 mph).
- Shift transfer case to 4x4 HIGH (4WD High) when plowing larger areas or light snow at higher speeds. Do not exceed 24 km/h (15 mph).
- Do not shift the transmission from a forward gear to R (Reverse) until the engine is at idle and the wheels are stopped.
- If the vehicle is stuck, shift the transmission in a steady motion between forward and reverse gears. Do not rock the vehicle for more than a few minutes. The transmission and tires may be damaged or the engine can overheat.

 Do not spin the wheels at over 35 mph (55 km/h). The tires may fail and injure a passenger or bystander.

Roadside emergencies

HAZARD FLASHER

Use only in an emergency to warn traffic of vehicle breakdown, approaching danger, etc. The hazard flashers can be operated when the ignition is off.

- The hazard lights control is located on top of the steering column.
- Depress hazard lights control to activate all hazard flashers simultaneously.
- Depress control again to turn the flashers off.

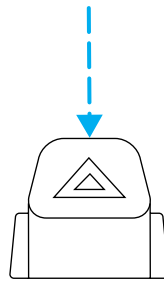

RESETTING THE FUEL PUMP SHUT-OFF SWITCH

After a collision, if the engine cranks but does not start, the fuel pump shut-off switch may have been activated. The shut-off switch is a device intended to stop the electric fuel pump when your vehicle has been involved in a substantial jolt.

The fuel pump shut-off switch is located in the passenger's foot well, behind the kick panel.

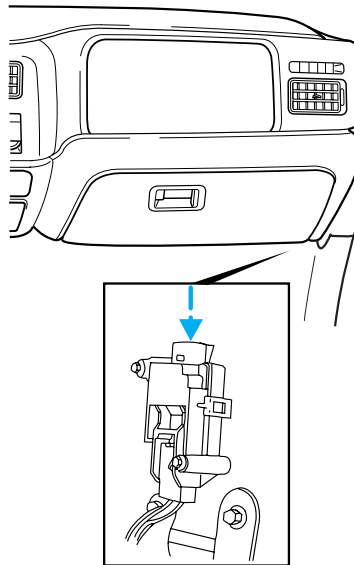

Roadside emergencies

Use the following procedure to reset the fuel pump shut-off switch.

1. Turn the ignition to the OFF position.
2. Check the fuel system for leaks.
3. If no fuel leak is apparent, reset the fuel pump shut-off switch by pushing in on the reset button.
4. Turn the ignition to the ON position. Pause for a few seconds and return the key to the OFF position.
5. Make a further check for leaks in the fuel system.

FUSES AND RELAYS

Fuses

If electrical components in the vehicle are not working, a fuse may have blown. Blown fuses are identified by a broken wire within the fuse. Check the appropriate fuses before replacing any electrical components.

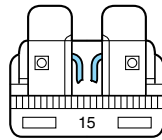

Always replace a fuse with one that has the specified amperage rating. Using a fuse with a higher amperage rating can cause severe wire damage and could start a fire.

Roadside emergencies

Standard fuse amperage rating and color

COLOR					
Fuse Rating	Mini Fuses	Standard Fuses	Maxi Fuses	Cartridge Maxi Fuses	Fuse Link Cartridge
2A	Grey	Grey	—	—	—
3A	Violet	Violet	—	—	—
4A	Pink	Pink	—	—	—
5A	Tan	Tan	—	—	—
7.5A	Brown	Brown	—	—	—
10A	Red	Red	—	—	—
15A	Blue	Blue	—	—	—
20A	Yellow	Yellow	Yellow	Blue	Blue
25A	Natural	Natural	—	—	—
30A	Green	Green	Green	Pink	Pink
40A	—	—	Orange	Green	Green
50A	—	—	Red	Red	Red
60A	—	—	Blue	—	Yellow
70A	—	—	Tan	—	Brown
80A	—	—	Natural	—	Black

Passenger compartment fuse panel

The fuse panel is located below and to the left of the steering wheel by the brake pedal. Remove the panel cover to access the fuses.

To remove the fuse panel cover, turn the panel fasteners counterclockwise.

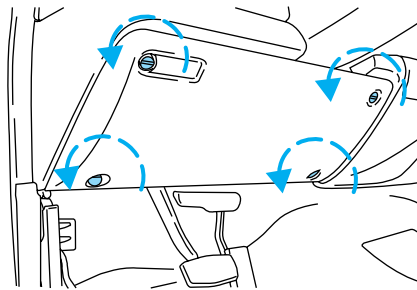

Roadside emergencies

To remove a fuse use the fuse puller tool provided on the fuse panel cover.

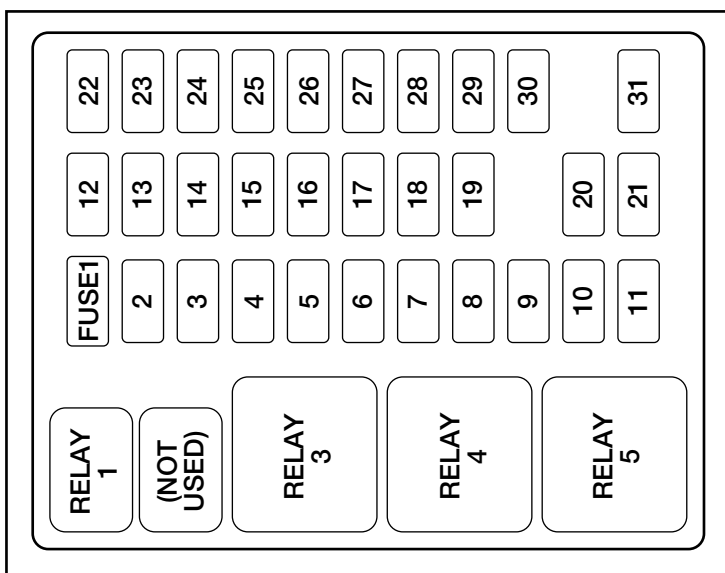
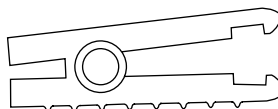

The fuses are coded as follows.

Fuse/Relay Location	Fuse Amp Rating	Description
1	20A	Electronic Flasher
2	5A	Instrument Cluster, Powertrain Control Module (PCM) Keep Alive Memory
3	20A	Cigar Lighter, OBDII
4	10A	Glove Box Lamp, Map Lamps, Power Mirrors, Underhood Lamp
5	—	Not Used
6	—	Not Used
7	5A	Power Window Lock Switch Illumination

Roadside emergencies

Fuse/Relay Location	Fuse Amp Rating	Description
8	5A	Radio, Headlamp Switch Illumination
9	—	Not Used
10	—	Not Used
11	10A	Washer Pump, Wiper Run/Park Relay Coil, Wiper Hi/LO Relay Coil, Washer Pump Relay Coil
12	15A	Horn
13	20A	Stop Lamps, Center High-mount Stop Lamp, Trailer Tow Stop Lamp
14	10A	Dome Lamp, Cargo Lamp, Courtesy Lamps
15	5A	Generic Electronic Module (GEM), Powertrain Control Module (PCM), Anti-lock Brake System (ABS) Module, Brake Shift Interlock, Speed Control
16	15A	Instrument Cluster, Hi-beam Headlamps
17	—	Not Used
18	—	Not Used
19	10A	Auxiliary Powertrain Control Module (APCM) (Diesel only), Instrument Cluster, GEM Module, Overdrive Cancel Switch, Idle Validation Switch (Diesel only), Overhead Console
20	15A	Starter Motor Relay Coil, PCM (Gasoline only)
21	—	Not Used
22	10A	Air Bag Module, Passenger Air Bag Activation Switch, Blower Motor Relay Coil
23	10A	Electronic Flasher
24	10A	Blend Door Actuator, Trailer Tow Battery Charge Relay Coil
25	5A	4-Wheel Anti-Lock Brake System (4WABS) Module
26	—	Not Used

Roadside emergencies

Fuse/Relay Location	Fuse Amp Rating	Description
27	10A	Ignition Run Power Feed (Customer Access)
28	10A	Brake Shift Interlock, DRL Relay Coil, Speed Control Module, Backup Lamps, Trailer Tow Backup Lamp Relay Coil, Electronic Shift On The Fly Hub Lock Solenoid
29	5A	Instrument Cluster (Charge and Airbag Warning Lamps)
30	30A	PCM Relay Coil, Ignition Coil (Gasoline only), Fuel Heater (Diesel only), Wastegate Solenoid (Diesel only), Injector Driver Module Relay Coil (Diesel only)
31	—	Not Used
Relay 1	—	Interior Lamp Relay
Relay 2	—	Not Used
Relay 3	—	Horn
Relay 4	—	Power Window One Touch Down Relay
Relay 5	—	Accessory Delay Relay

Power distribution box

The power distribution box, trailer tow and electronic shift on the fly relay blocks are located in the engine compartment near the brake master cylinder.

The power distribution box contains high-current fuses that protect your vehicle's main electrical systems from overloads.



Always disconnect the battery before servicing high current fuses.



Always replace the cover to the Power Distribution Box before reconnecting the battery or refilling fluid reservoirs.

If the battery has been disconnected and reconnected, refer to the *Battery* section of the *Maintenance and Care* chapter.

Roadside emergencies

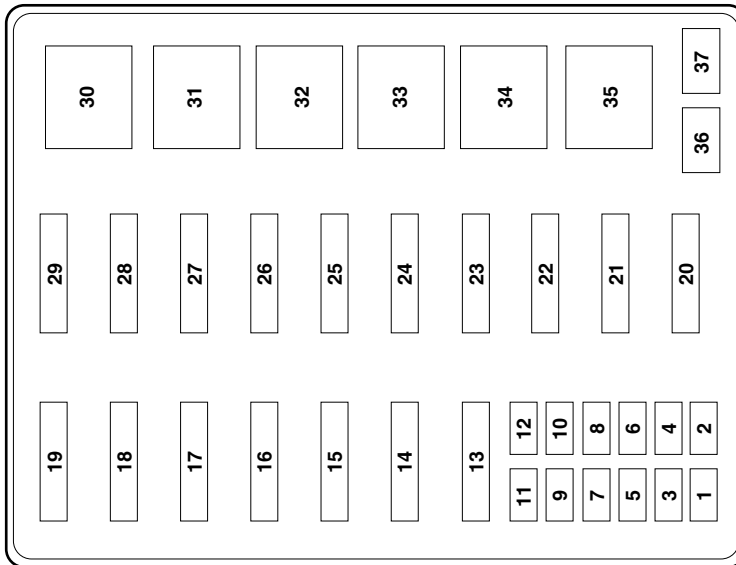

The high-current fuses and relays are coded as follows.

Fuse/Relay Location	Fuse Amp Rating	Description
1	7.5A *	Trailer Tow Left Stop/Turn Lamp
2	10A*	Air Bag Module
3	7.5A*	Trailer Tow Right Stop/Turn Lamp
4	20A*	Trailer Tow Backup Lamps, Trailer Tow Park Lamps
5	20A* (Gasoline only) 5A* (Diesel only)	Gasoline only-PCM, Two Speed Fuel Pump Relay Coil, Fuel Pump Relay Coil, Mass Air Flow Sensor, Fuel Injectors Diesel only-Dual Alternator "A" Field
6	- (Gasoline only) 10A*(Diesel only)	Gasoline only-Not Used Diesel only-Single or Dual Alternator "A" Field, Regulator

Roadside emergencies

Fuse/Relay Location	Fuse Amp Rating	Description
7	20A* (Gasoline only) 5A* (Diesel only)	Gasoline only-Vapor Management Valve, HEGO Sensors, Intake Manifold Communication Control, EVR Solenoid, PCM, Canister Vent Solenoid Diesel only-Dual Alternator "A" Field
8	15A*	Trailer Tow Electronic Brake Illumination, Park Lamps, Trailer Tow Park Lamp Relay Coil
9	10A*	Left Headlamp
10	25A*	Power Point
11	10A*	Right Headlamp (Low Beam)
12	10A*	Daytime Running Lamps (DRL) Resistor
13	30A**	Multi-function Switch, Headlamps
14	60A**	Anti-Lock Brake System
15	30A**	Windshield Wiper Motor
16	30A**	Trailer Tow Battery Charge
17	30A**	Electronic Shift On The Fly Relay, Transfer Case Shift Motor
18	30A**	Power Seat
19	20A**	Fuel Pump Motor, PCM
20	50A**	Ignition Switch (B4 & B5)
21	50A**	Ignition Switch (B1 & B3)
22	50A**	Instrument Panel Junction Box
23	40A**	Blower Motor
24	30A**	Power Distribution Box
25	30A***	Power Windows
26	20A**	If equipped with Remote Keyless Entry-Driver Door Unlock Relay Coil, All Door Unlock Relay Coil, All Door Lock Relay Coil, Park Lamp Flash Relay, If not equipped with Remote Keyless Entry-Power Door Lock Motors

Roadside emergencies

Fuse/Relay Location	Fuse Amp Rating	Description
27	- (Gasoline only) 30A* (Diesel only)	Gasoline only-Not Used Diesel only-Injector Driver Module
28	30A**	Trailer Tow Electronic Brake Controller
29	20A**	Radio
30	--	PCM Power Relay
31	--	Blower Motor Relay
32	--	Two Speed Fuel Pump Relay (Gasoline only), Injector Driver Module Power Relay (Diesel only)
33	--	Washer Pump Relay
34	--	Windshield Wiper Park/Run Relay
35	--	Windshield Wiper HI/LO Relay
36	--	Not Used
37	--	PCM Relay Diode
38	--	Trailer Tow Backup Lamp Relay
39	--	Trailer Tow Battery Charge Relay
40	--	Electronic Shift On The Fly Relay #1, Electronic Shift On The Fly Relay #2
* Mini Fuses ** Maxi Fuses ***Circuit Breaker		

CHANGING THE TIRES

If you get a flat tire while driving, do not apply the brake heavily. Instead, gradually decrease your speed. Hold the steering wheel firmly and slowly move to a safe place on the side of the road.

Spare tire information

Your vehicle may be equipped with a spare tire that can be used as either a spare or a regular tire. The spare tire is not equipped with wheel trim. The wheel trim from the original wheel/tire may be used on the spare.

Roadside emergencies

If your vehicle is equipped with 4WD, a spare tire of a different size than the road tires should not be used. Such a tire could result in damage to driveline components and make the vehicle difficult to control.

Location of the spare tire and tools

The spare tire and tools for your vehicle are stowed in the following locations:

Tool	Location
Spare tire (pick-up trucks only)	Under the vehicle, just forward of the rear bumper
Jack	Regular cab, crew cab and SuperCab without rear bench seat: Fastened to floor pan behind rearmost seat on passenger side SuperCab with rear bench seat: Under rear bench on passenger side
Jack handle and lug wrench	On top of the radiator support at the front of the engine compartment

Removing the spare tire (with spare tire carrier only)

1. The following tools are required to remove the spare tire:

- one handle extension and one typical extension. To assemble, align button with hole and slide parts together. To disconnect, depress button and pull apart.
- one wheel nut wrench. Slide over square end of jack handle.

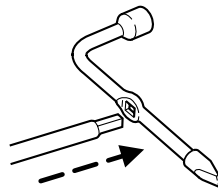
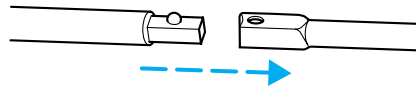

Roadside emergencies

2. The following steps are required to move the support bracket (if equipped) away from the spare tire:

- With tapered end of lug wrench, loosen the eyebolt on the support bracket.
- Line up the eyebolt with the slot in the support bracket.
- Slide the support bracket off the eyebolt and move the support bracket away from the spare tire.

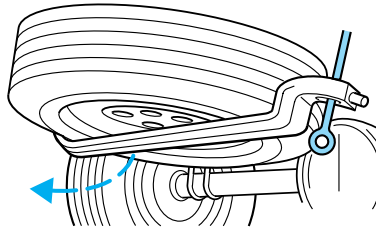

3. Insert the hooked end of the jack handle into the rear bumper opening.

The handle will stop moving and you will feel forward resistance to turning when properly engaged.

4. Turn the handle counterclockwise and lower the spare until you can slide the tire rearward and the cable is slack.

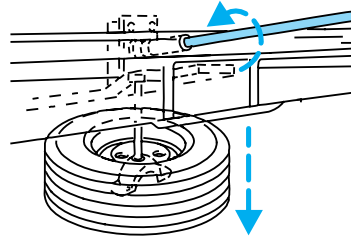

5. Remove the retainer through the center of the wheel.

Stowing the spare

1. Lay the tire on the ground with the valve stem facing up.

2. Slide the wheel under the vehicle and install the retainer through the wheel center.

3. Turn the jack handle clockwise until the tire is raised to its original position underneath the vehicle. The effort to turn the jack handle increases significantly and the spare tire carrier ratchets when the tire is raised to the stowed position. The spare tire carrier has a built-in ratchet feature that will not allow you to overtighten.

4. Check that the tire lies flat to the frame assembly. Push against the tire to make sure it is tightly seated under the vehicle. Loosen or retighten if necessary.

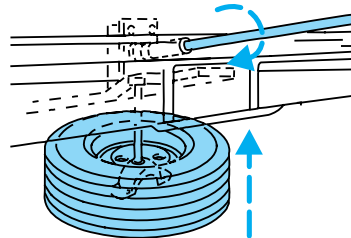

Roadside emergencies

5. The following steps are required to secure the support bracket (if equipped) under the spare tire:

- Move the support bracket over the spare tire.
- Slide the support bracket over the eyebolt into the slot on the support bracket.
- Tighten the eyebolt with tapered end of lug wrench leaving it positioned at a right angle of the slot on the support bracket.

Tire change procedure

1. Park on a level surface, activate hazard flashers and set the parking brake.

- Automatic transmission: Place gearshift lever in P (Park).
- Manual transmission: Place gearshift lever in R (Reverse).
- Electronic Shift On the Fly four wheel drive: Place transfer case in 2WD, 4x4 HIGH or 4x4 LOW.
- Manual shift transfer case four wheel drive: Place transfer case in 2H, 4H or 4L.

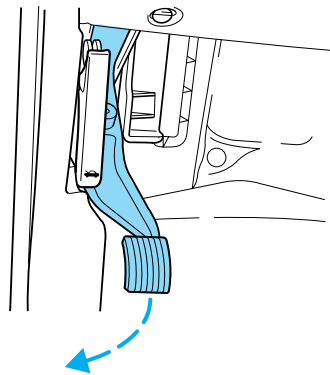

 To prevent the vehicle from moving when you change a tire, be sure the parking brake is set, then block (in both directions) the wheel that is diagonally opposite (other side and end of the vehicle) to the tire being changed.

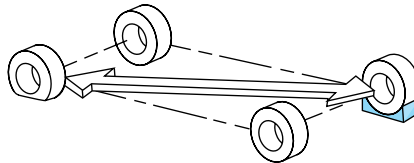

2. Turn engine OFF and block the diagonally opposite wheel (block not provided).

3. Remove the jack, jack handle, lug wrench and spare tire from the stowage locations.

4. Use the tip of the lug wrench to remove any wheel trim.

Roadside emergencies

5. Loosen each wheel lug nut one-half turn counterclockwise but do not remove them until the wheel is raised off the ground.

 When one of the rear wheels is off the ground, the transmission alone will not prevent the vehicle from moving or slipping off the jack, even if the transmission is in P (Park) (automatic transmission) or R (Reverse) (manual transmission). To prevent the vehicle from moving when you change the tire, be sure that the parking brake is set and the diagonally opposite wheel is blocked.

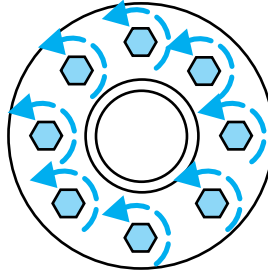

 If the vehicle slips off the jack, you or someone else could be seriously injured.

The following steps apply to F250/F350 only:

6. Insert the hooked end of the jack handle into the jack and use the handle to slide the jack under the vehicle.

7. Position the jack according to the following guides:

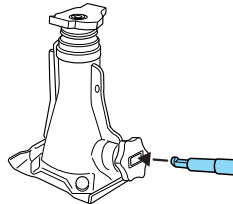

Roadside emergencies

- Front (4x2)

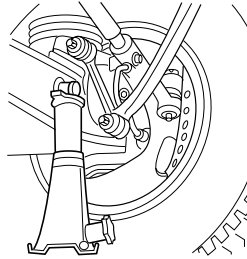

- Front passenger side (4x4)

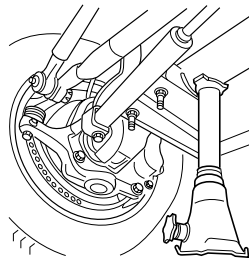

Roadside emergencies

- Front driver side (4x4)

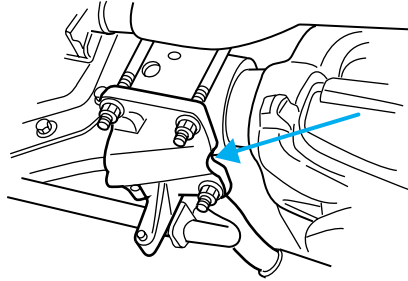

Make sure the jack fits into the notched area on the differential housing.

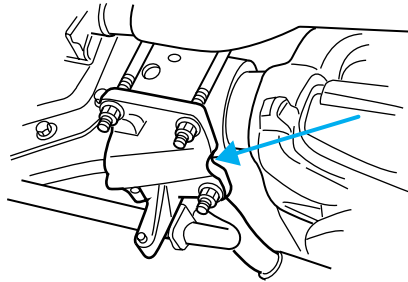

- Rear

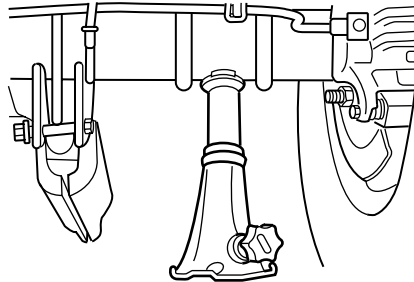

Roadside emergencies

8. Turn the jack handle clockwise until the wheel is completely off the ground and high enough to install the spare tire.

9. Remove the lug nuts with the lug wrench.

10. On single rear wheel vehicles, replace the flat tire with the spare tire, making sure the valve stem is facing outward for all front tires and vehicles equipped with single rear wheels. If replacing an inboard rear tire on a dual rear wheel vehicle, the valve stem must be facing outward. If replacing the outboard wheel, the valve stem must be facing inward. Reinstall the lug nuts until the wheel is snug against the hub. Do not fully tighten the lug nuts until the wheel has been lowered.

11. Lower the wheel by turning the jack handle counterclockwise.

Go to step 19.

The following steps apply to F450/F550 only:

12. Slide the notched end of the jack handle over the release valve and use the handle to slide the jack under the vehicle. Make sure the valve is closed by turning it clockwise.

13. Position the jack according to the following guides:

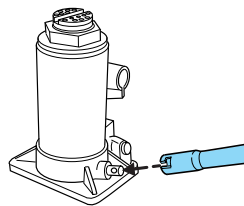
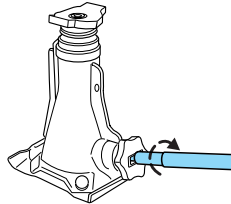

Roadside emergencies

- Front (4x2)

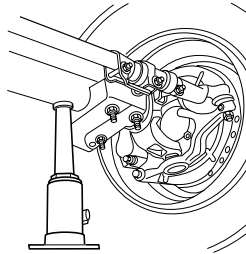

- Front driver side (4x4)

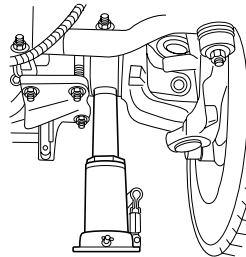

- Front passenger side (4x4)

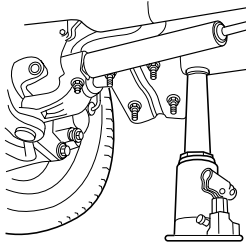

Roadside emergencies

- Rear

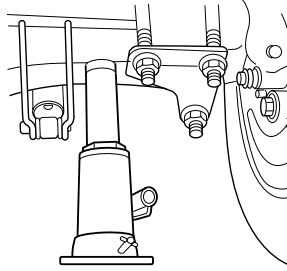

14. Insert the jack handle into the pump linkage.

15. Use an up-and-down motion with the jack handle to raise the wheel completely off the ground.

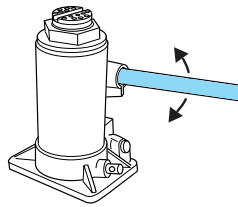

Hydraulic jacks are equipped with a pressure release valve that prevents lifting loads which exceed the jack's rated capacity.

16. Remove the lug nuts with the lug wrench.

17. Replace the flat tire with the spare tire, making sure the valve stem is facing outward on all front and inboard rear wheels. If replacing the outboard wheel, the valve stem must be facing inward. Reinstall the lug nuts until the wheel is snug against the hub. Do not fully tighten the lug nuts until the wheel has been lowered.

18. Lower the wheel by slowly turning the release valve counterclockwise.

Opening the release valve slowly will provide a more controlled rate of descent.

Roadside emergencies

The following steps apply to all vehicles:

19. Remove the jack and fully tighten the lug nuts in the order shown.

20. Stow the flat tire. Refer to *Stowing the spare* if the vehicle is equipped with a spare tire carrier.

21. Stow the jack, jack handle and lug wrench. Make sure the jack is securely fastened so it does not rattle when driving.

22. Unblock the wheels.

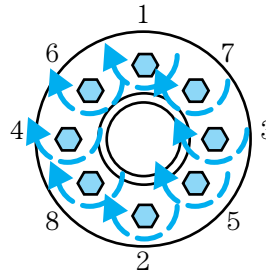

On vehicles equipped with single rear wheels, retighten the lug nuts to the specified torque at 800 km (500 miles) after any wheel disturbance (tire rotation, changing a flat tire, wheel removal, etc.).

On vehicles equipped with dual rear wheels, retighten the wheel lug nuts to the specified torque at 160 km (100 miles), and again at 800 km (500 miles) of new vehicle operation and after any wheel disturbance (tire rotation, changing a flat tire, wheel removal, etc.).

Bolt size	Wheel lug nut torque*	
	Nm	Lb-ft
M14 x 1.5	200-225	150-165

* Torque specifications are for nut and bolt threads free of dirt and rust. Use only Ford recommended replacement fasteners.

On all two-piece flat wheel nuts, apply one drop of motor oil between the flat washer and the nut. Do not apply motor oil to the wheel nut threads or the wheel stud threads.

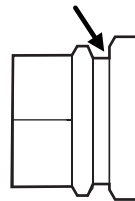

When a wheel is installed, always remove any corrosion, dirt or foreign materials present on the mounting surfaces of the wheel or the surface of the front disc brake hub and rotor that contacts the wheel. Installing wheels without correct metal-to-metal contact at the wheel mounting surfaces can cause the wheel nuts to loosen and the wheel to come off while the vehicle is in motion, resulting in loss of control.

Roadside emergencies

JUMP STARTING YOUR VEHICLE



The gases around the battery can explode if exposed to flames, sparks, or lit cigarettes. An explosion could result in injury or vehicle damage.



Do not push start your vehicle. You could damage the catalytic converter.



Batteries contain sulfuric acid which can burn skin, eyes, and clothing, if contacted.

Do not attempt to push start your vehicle. Automatic transmissions do not have push-start capability.

Preparing your vehicle

1. Use **only a 12-volt supply to start your vehicle.**
2. Do not disconnect the battery of the disabled vehicle as this could damage the vehicle's electrical system.
3. Park the booster vehicle close to the hood of the disabled vehicle making sure the two vehicles **do not** touch. Set the parking brake on both vehicles and stay clear of the engine cooling fan and other moving parts.
4. Check all battery terminals and remove any excessive corrosion before you attach the battery cables. Ensure that vent caps are tight and level.
5. Turn the heater fan on in both vehicles to protect any electrical surges. Turn all other accessories off.

Roadside emergencies

Connecting the jumper cables

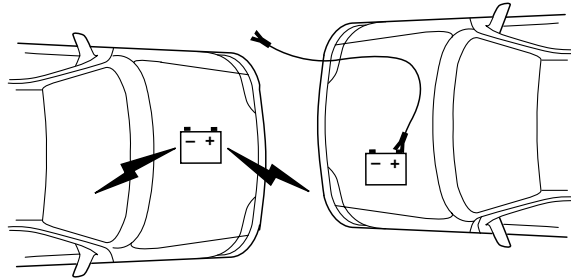

1. Connect the positive (+) booster cable to the positive (+) terminal of the discharged battery.

Note: In the illustrations, *lightning bolts* are used to designate the assisting (boosting) battery.

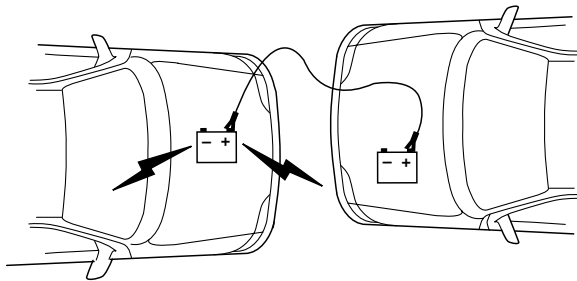

2. Connect the other end of the positive (+) cable to the positive (+) terminal of the assisting battery.

Roadside emergencies

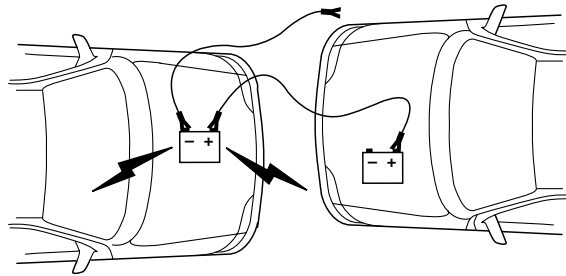

3. Connect the negative (-) cable to the negative (-) terminal of the assisting battery.

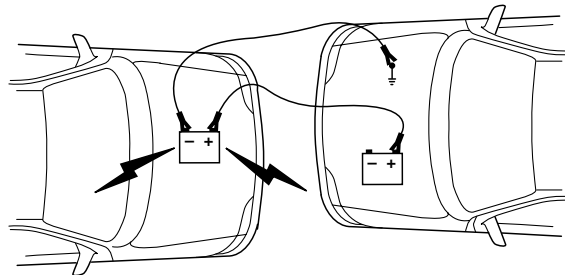

4. Make the final connection of the negative (-) cable to an exposed metal part of the stalled vehicle's engine, away from the battery and the carburetor/fuel injection system.

The preferred locations of an exposed metal part (to *ground* the circuit) are the alternator mounting brackets or an engine lifting *eye*. **Do not** use fuel lines, engine rocker covers or the intake manifold as *grounding* points.



Do not connect the end of the second cable to the negative (-) terminal of the battery to be jumped. A spark may cause an explosion of the gases that surround the battery.

5. Be sure that the cables are clear of fan blades, belts and other moving parts of both engines.

Roadside emergencies

Jump starting

1. Start the engine of the booster vehicle and run the engine at moderately increased speed.
2. Start the engine of the disabled vehicle.
3. Once the disabled vehicle has been started, run both engines for an additional three minutes before disconnecting the jumper cables.

Removing the jumper cables

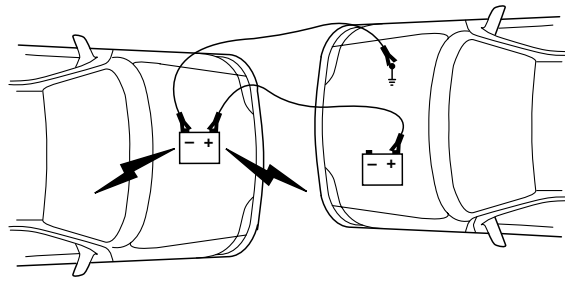

Remove the jumper cables in the reverse order that they were connected.

1. Remove the jumper cable from the *ground* metal surface.

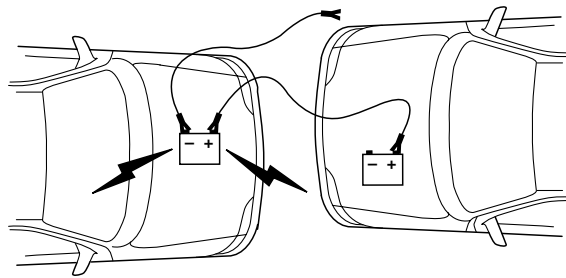

2. Remove the jumper cable on the negative (-) connection of the booster vehicle's battery.

Roadside emergencies

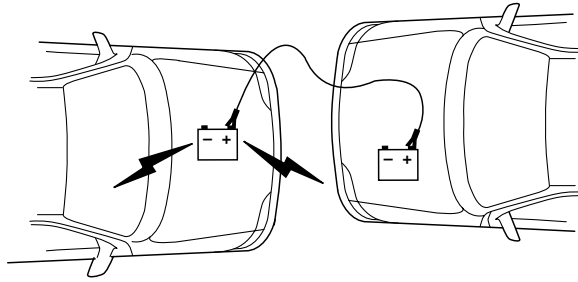

3. Remove the jumper cable from the positive (+) terminal of the booster vehicle's battery.

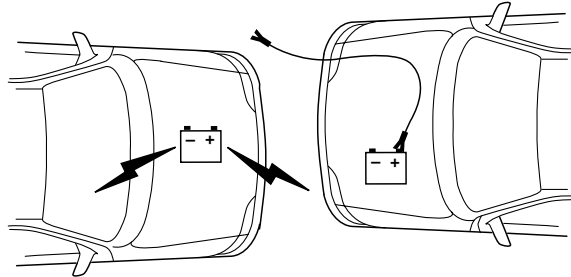

4. Remove the jumper cable from the positive (+) terminal of the disabled vehicle's battery.

After the disabled vehicle has been started and the jumper cables removed, allow it to idle for several minutes so the engine computer can *relearn* its idle conditions.

Roadside emergencies

WRECKER TOWING

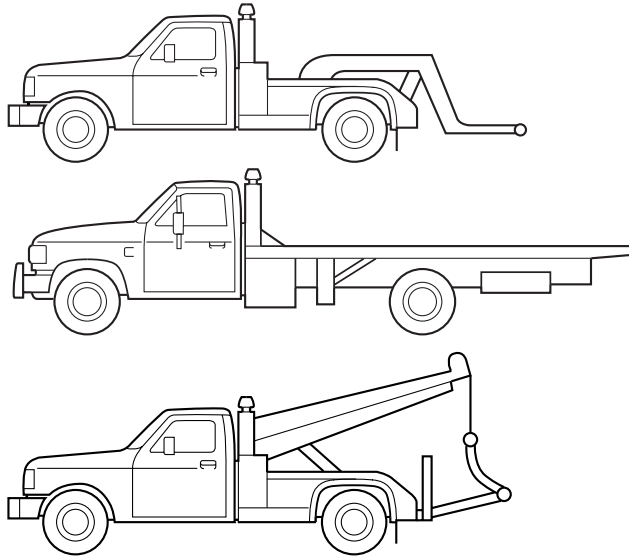

If you need to have your vehicle towed, contact a professional towing service or, if you are a member, your roadside assistance center.

On 4x2 vehicles, it is acceptable to tow the vehicle with the front wheels on the ground and the rear wheels off the ground using a wheel lift or a slingbelt with T-hooks.

On 4x4 vehicles, it is recommended that your vehicle be towed with a wheel lift or flatbed equipment with all the wheels off the ground. However, a slingbelt with T-hooks and a wheel dolly can also be used.

Ford Motor Company provides a towing manual for all authorized tow truck operators. Have your tow truck operator refer to this manual for proper hook-up and towing procedures for your vehicle.

Maintenance and care

SERVICE RECOMMENDATIONS

To help you service your vehicle:

- We highlight do-it-yourself items in the engine compartment for easy location.
- We provide a Scheduled Maintenance Guide which makes tracking routine service easy.

If your vehicle requires professional service, your dealership can provide necessary parts and service. Check your “Warranty Guide” to find out which parts and services are covered.

Use only recommended fuels, lubricants, fluids and service parts conforming to specifications. Motorcraft parts are designed and built to provide the best performance in your vehicle.

PRECAUTIONS WHEN SERVICING YOUR VEHICLE

Be especially careful when inspecting or servicing your vehicle.

- Do not work on a hot engine.
- When the engine is running, keep loose clothing, jewelry or long hair away from moving parts.
- Do not work on a vehicle with the engine running in an enclosed space, unless you are sure you have enough ventilation.
- Keep all lit cigarettes, open flames and other lit material away from the battery and all fuel related parts.

If you disconnect the battery, the engine must “relearn” its idle conditions before your vehicle will drive properly, as explained in the *Battery* section in this chapter.

Maintenance and care

Working with the engine off

- Automatic transmission:
 1. Set the parking brake and ensure the gearshift is securely latched in P (Park).
 2. Turn off the engine and remove the key.
 3. Block the wheels to prevent the vehicle from moving unexpectedly.
- Manual transmission:
 1. Set the parking brake.
 2. Depress the clutch and place the gearshift in 1 (First).
 3. Turn off the engine and remove the key.
 4. Block the wheels to prevent the vehicle from moving unexpectedly.

Working with the engine on

- Automatic transmission:
 1. Set the parking brake and ensure the gearshift is securely latched in P (Park).
 2. Block the wheels to prevent the vehicle from moving unexpectedly.



Do not start your engine with the air cleaner removed and do not remove it while the engine is running.

- Manual transmission:
 1. Set the parking brake, depress the clutch and place the gearshift in N (Neutral).
 2. Block the wheels to prevent the vehicle from moving unexpectedly.



Do not start your engine with the air cleaner removed and do not remove it while the engine is running.

Maintenance and care

OPENING THE HOOD

1. Inside the vehicle, pull the hood release handle located under the bottom left corner of the instrument panel.

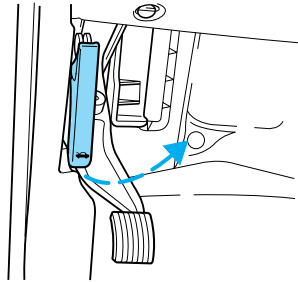

2. Go to the front of the vehicle and release the auxiliary latch located under the right center of the hood. Slide the handle to release the auxiliary latch.

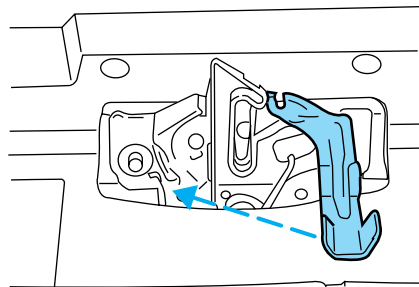

3. Lift the hood until the lift cylinders hold it open.

Maintenance and care

IDENTIFYING COMPONENTS IN THE ENGINE COMPARTMENT

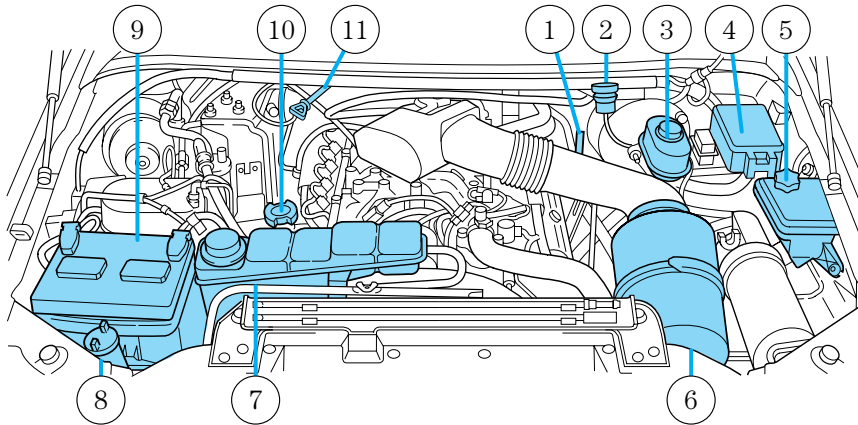

1. Engine oil dipstick
2. Clutch fluid reservoir (manual transmission)
3. Brake fluid reservoir
4. Power distribution box
5. Power steering fluid reservoir
6. Air filter assembly
7. Engine coolant reservoir
8. Windshield washer fluid reservoir
9. Battery
10. Engine oil filler cap
11. Transmission fluid dipstick (automatic transmission)

ENGINE OIL

Checking the engine oil

Refer to the Scheduled Maintenance Guide for the appropriate intervals for checking the engine oil.

1. Make sure the vehicle is on level ground.

Maintenance and care

2. Turn the engine off and wait a few minutes for the oil to drain into the oil pan.
3. Set the parking brake and ensure the gearshift is securely latched in P (Park) (automatic transmission) or 1 (First) (manual transmission).
4. Open the hood. Protect yourself from engine heat.
5. Locate and carefully remove the engine oil level indicator (dipstick).

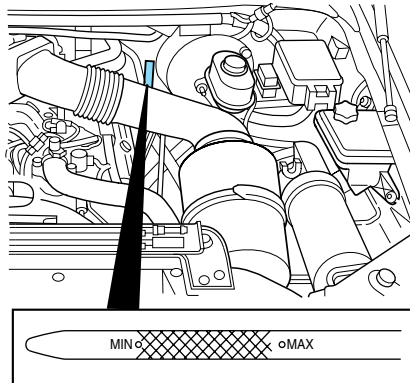

6. Wipe the indicator clean. Insert the indicator fully, then remove it again.

- If the oil level is **between the MIN and MAX marks**, the oil level is acceptable. **DO NOT ADD OIL.**
- If the oil level is below the MIN mark, add enough oil to raise the level within the MIN-MAX range.

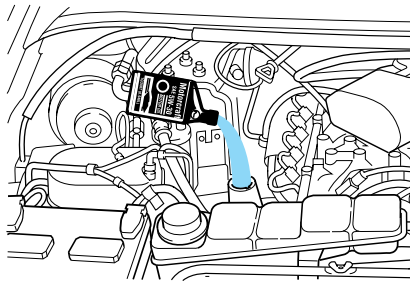

- Oil levels above the MAX mark may cause engine damage. Some oil must be removed from the engine by a service technician.

7. Put the indicator back in and ensure it is fully seated.

Maintenance and care

Adding engine oil

1. Check the engine oil. For instructions, refer to *Checking the engine oil* in this chapter.
2. If the engine oil level is not within the MIN and MAX ranges, add only certified engine oil of the recommended viscosity. Remove the engine oil filler cap and use a funnel to pour the engine oil into the opening.
3. Recheck the engine oil level. Make sure the oil level is not above the MAX mark on the engine oil level indicator (dipstick).
4. Install the indicator and ensure it is fully seated.
5. Fully install the engine oil filler cap by turning the filler cap clockwise until three clicks can be heard.

To avoid possible oil loss, DO NOT operate the vehicle with the engine oil level indicator and/or the engine oil filler cap removed.

Engine oil and filter recommendations

Look for this Certification Trademark.

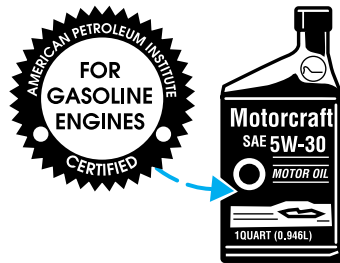

Use SAE 5W-30 motor oil certified for gasoline engines by the American Petroleum Institute (API).

Motor oil displaying the API Certification Trademark will meet all requirements for your vehicle's engine.

Ford oil specification is WSS-M2C153-G.

Do not use supplemental engine oil additives, oil treatments or engine treatments. They are unnecessary and could, under certain conditions, lead to engine damage which is not covered by your warranty.

Change your engine oil and filter according to the appropriate schedule listed in the Scheduled Maintenance Guide.

Maintenance and care

Ford production and aftermarket (Motorcraft) oil filters are designed for added engine protection and long life. If a replacement oil filter is used that does not meet Ford material and design specifications, startup engine noises or knock may be experienced.

It is recommended you use the appropriate Motorcraft oil filter (or another brand meeting Ford specifications) for your engine application.

BRAKE FLUID

Checking and adding brake fluid

Brake fluid should be checked and refilled as needed. Refer to the Scheduled Maintenance Guide for the service interval schedules:

1. Clean the reservoir cap before removal to prevent dirt or water from entering the reservoir.

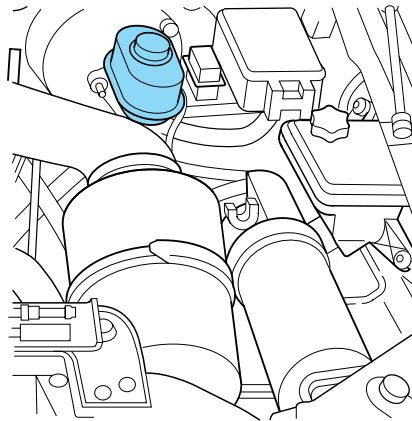

Maintenance and care

2. Visually inspect the fluid level.
3. If necessary, add brake fluid until the level reaches MAX. Do not fill above this line.
4. Use only a DOT 3 brake fluid certified to meet Ford specifications. Refer to *Lubricant specifications* in the *Capacities and specifications* chapter.

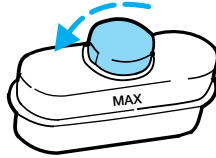

Brake fluid is toxic.



If you use a brake fluid that is not DOT 3, you will cause permanent damage to your brakes.



Do not let the reservoir for the master cylinder run dry. This may cause the brakes to fail.

CLUTCH FLUID (IF EQUIPPED)

Check the clutch fluid level. Refer to the Scheduled Maintenance Guide for the service interval schedules.

Use only a DOT 3 brake fluid designed to meet Ford specifications. Refer to *Capacities and specifications*.

For vehicles equipped with the 5-speed manual transmission, during normal operation, the fluid level in the clutch reservoir should remain constant. If the fluid level drops, maintain the fluid level at the step in the reservoir.

For vehicles equipped with the 6-speed manual transmission, during normal operation, the fluid level in the clutch reservoir will drop slightly. As this occurs, maintain the fluid level at the step in the reservoir.

Maintenance and care

1. Clean the reservoir cap before removal to prevent dirt and water from entering the reservoir.
2. Remove cap and rubber diaphragm from reservoir.
3. Add fluid until the level reaches the step in the reservoir.
4. Reinstall rubber diaphragm and cap onto reservoir.

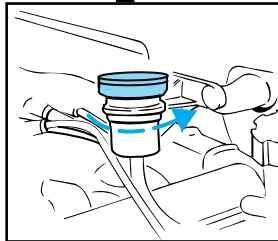
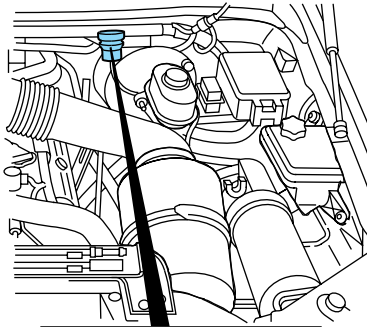

WINDSHIELD WASHER FLUID

Checking and adding washer fluid

Check the washer fluid whenever you stop for fuel. The reservoir is highlighted with a  symbol.

If the level is low, add enough fluid to fill the reservoir. In very cold weather, do not fill the reservoir all the way.

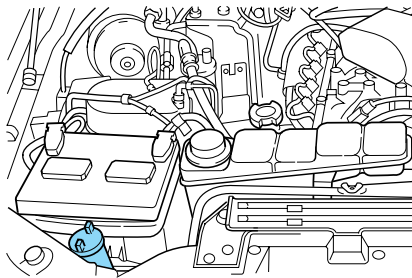

Do not put engine coolant in the container for the windshield washer fluid.

Maintenance and care

ENGINE COOLANT

Check the level of the engine coolant in the reservoir. Refer to the Scheduled Maintenance Guide for service interval schedules. Be sure to read and understand *Precautions when servicing your vehicle* in this chapter.

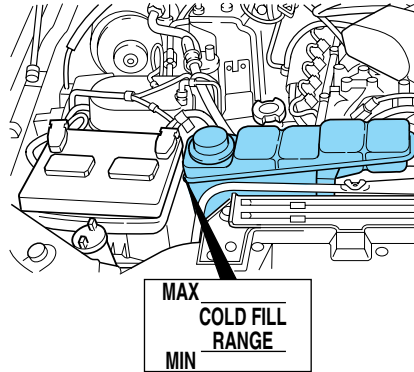

If the engine coolant has not been checked at the recommended interval, the engine coolant reservoir may become empty. If this occurs, add engine coolant to the reservoir. For more information on engine coolant maintenance, refer to *Adding engine coolant* in this chapter.

Automotive fluids are not interchangeable; **do not** use engine coolant, antifreeze or windshield washer fluid outside of its specified function and vehicle location.

Adding engine coolant

Use only Ford Premium Engine Coolant E2FZ-19549-AA (in Oregon, F5FZ-19549-CC, in Canada, Motorcraft CXC-10) or a premium engine coolant that meets Ford specification ESE-M97B44-A.

- **DO NOT USE Ford Extended Life Engine Coolant F6AZ-19544-AA (orange in color).**
- **DO NOT USE a DEX-COOL® engine coolant or an equivalent engine coolant that meets Ford specification WSS-M97B44-D.**
- **DO NOT USE alcohol or methanol antifreeze or any engine coolants mixed with alcohol or methanol antifreeze.**
- **DO NOT USE supplemental coolant additives in your vehicle. These additives may harm your engine's cooling system.**

Maintenance and care

- **DO NOT MIX recycled coolant and conventional coolant together in your vehicle. Mixing of engine coolants may harm your engine's cooling system.**
- **The use of an improper coolant may harm engine and cooling system components and may void the warranty of your vehicle's engine cooling system.**
- **Use only the type of coolant with which your vehicle was originally equipped. If you are unsure which type of coolant your vehicle requires, contact your local dealer.**



Do not put engine coolant in the container for the windshield washer fluid.

If sprayed on the windshield, engine coolant could make it difficult to see through the windshield.

When the engine is cool, add a 50/50 mixture of engine coolant and distilled water to the engine coolant reservoir.

Plain water may be added in an emergency, but you **must** replace it with a 50/50 mixture of coolant and distilled water as soon as possible.

Check the coolant level in the coolant reservoir the next few times you drive the vehicle. If necessary, add enough of a 50/50 mixture of coolant and distilled water to bring the liquid level to the fill line on the reservoir.



Never remove the coolant reservoir cap while the engine is running or hot.

If you must remove the coolant reservoir cap, follow these steps to avoid personal injury:

1. Before you remove the cap, turn the engine off and let it cool.
2. When the engine is cool, wrap a thick cloth around the cap. Slowly turn cap counterclockwise until pressure begins to release.
3. Step back while the pressure releases.
4. When you are sure that all the pressure has been released, use the cloth to turn it counterclockwise and remove the cap.

Change your engine coolant according to the appropriate schedule listed in the Scheduled Maintenance Guide.

Maintenance and care

Recycled engine coolant

Ford Motor Company recommends that Ford and Lincoln-Mercury dealers use recycled engine coolant produced by Ford-approved processes.

Not all coolant recycling processes produce coolant which meets Ford specification ESE-M97B44-A, and use of such coolant may harm engine and cooling system components.



Always dispose of used automotive fluids in a responsible manner. Follow your community's regulations and standards for recycling and disposing of automotive fluids.

Coolant refill capacity

To find out how much fluid your vehicle's cooling system can hold, refer to *Refill capacities* in the *Capacities and specifications* chapter.

Have your dealer check the engine cooling system for leaks if you have to add more than 1.0 liter (1.0 quart) of engine coolant per month.

Severe winter climate

If you drive in extremely cold climates (less than -36°C [-34°F]), it may be necessary to increase the coolant concentration above 50%. Refer to the chart on the coolant container to ensure the coolant concentration in your vehicle is such that the coolant will not freeze at the temperature level in which you drive during winter months. Never increase the coolant concentration above 60%. Increased engine coolant concentrations above 60% will decrease the freeze protection characteristics of the engine coolant. Vehicles driven year-round in non-extreme climates should use a 50/50 mixture of engine coolant and distilled water for optimum freeze protection.



What you should know about fail-safe cooling (if equipped)

If the engine coolant supply is depleted, this feature allows the vehicle to be driven temporarily before incremental component damage is incurred. The "fail-safe" distance depends on ambient temperatures, vehicle load and terrain.

Maintenance and care

How fail-safe cooling works

If the engine begins to overheat:

- the engine coolant temperature gauge will move to the red (hot) area.
- the  symbol will illuminate.
- the  symbol will illuminate.
- the *Service Engine Soon* indicator light will illuminate.

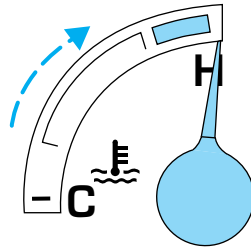

If the engine reaches a preset over-temperature condition, the engine will automatically switch to alternating cylinder operation. Each disabled cylinder acts as an air pump and cools the engine.

When this occurs the vehicle will still operate, however:

- the engine power will be limited.
- the air conditioning system will be disabled.

Continued operation will increase the engine temperature and the engine will completely shut down, causing steering and braking effort to increase.

Once the engine temperature cools, the engine can be re-started. Take your vehicle to a service facility as soon as possible to minimize engine damage.

When fail-safe mode is activated

You have limited engine power when in the fail-safe mode, so drive the vehicle with caution. The vehicle will not be able to maintain high-speed operation and the engine will run rough. Remember that the engine is capable of completely shutting down automatically to prevent engine damage, therefore:

1. Pull off the road as soon as safely possible and turn off the engine.
2. Arrange for the vehicle to be taken to a service facility.
3. If this is not possible, wait a short period for the engine to cool.
4. Check the coolant level and replenish if low.



Never remove the coolant reservoir cap while the engine is running or hot.

5. Re-start the engine and take your vehicle to a service facility.

Maintenance and care



Driving the vehicle without repairing the engine problem increases the chance of engine damage. Take your vehicle to a service facility as soon as possible.

CHECKING AND ADDING POWER STEERING FLUID

Check the power steering fluid. Refer to the “Service Guide” for the service interval schedules. If adding fluid is necessary, use only MERCON® ATF.

1. Start the engine and let it run until it reaches normal operating temperature (the engine coolant temperature gauge indicator will be near the center of the normal area between H and C).
2. While the engine idles, turn the steering wheel left and right several times.
3. Turn the engine off.
4. Check the fluid level in the reservoir. It should be between the ADD/MIN and MAX lines. Do not add fluid if the level is in this range.
5. If the fluid is low, add fluid in small amounts, continuously checking the level until it reaches the range between the ADD/MIN and MAX lines. Be sure to put the cap back on the reservoir.

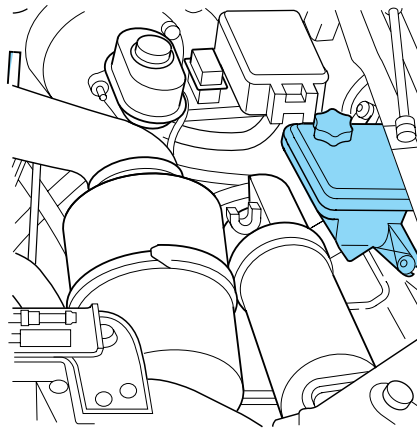

TRANSMISSION FLUID

Checking automatic transmission fluid

Refer to your Scheduled Maintenance Guide for scheduled intervals for fluid checks and changes. Your transmission does not consume fluid. However, the fluid level should be checked if the transmission is not working properly, i.e., if the transmission slips or shifts slowly or if you notice some sign of fluid leakage.

Automatic transmission fluid expands when warmed. To obtain an accurate fluid check, drive the vehicle until it is at normal operating temperature (approximately 30 km [20 miles]). If your vehicle has been

Maintenance and care

operated for an extended period at high speeds, in city traffic during hot weather or pulling a trailer, the vehicle should be turned off for about 30 minutes to allow fluid to cool before checking.

1. Drive the vehicle 30 km (20 miles) or until it reaches normal operating temperature.
2. Park the vehicle on a level surface and engage the parking brake.
3. With the parking brake engaged and your foot on the brake pedal, start the engine and move the gearshift lever through all of the gear ranges. Allow sufficient time for each gear to engage.
4. Latch the gearshift lever in P (Park) and leave the engine running.
5. Remove the dipstick, wiping it clean with a clean, dry lint free rag.
6. Install the dipstick making sure it is fully seated in the filler tube.
7. Remove the dipstick and inspect the fluid level. The fluid should be in the designated area for normal operating temperature or ambient temperature.

Low fluid level

Do not drive the vehicle if the fluid level is at the bottom of the dipstick and the ambient temperature is above 10°C (50°F).

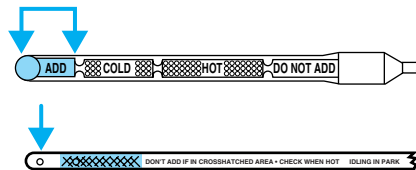

Correct fluid level

The transmission fluid should be checked at normal operating temperature 66°C-77°C (150°F-170°F) on a level surface. The normal operating temperature can be reached after approximately 30 km (20 miles) of driving.

You can check the fluid without driving if the ambient temperature is above 10°C (50°F). However, if fluid is added at this time, an overfill condition could result when the vehicle reaches normal operating temperature.

The transmission fluid should be in this range if at normal operating temperature (66°C-77°C [150°F-170°F]).

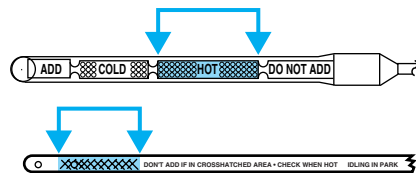

Maintenance and care

The transmission fluid should be in this range if at ambient temperature (10°C-35°C [50°F-95°F]).

High fluid level

Fluid levels above the safe range may result in transmission failure. An overfill condition of transmission fluid may cause shift and/or engagement concerns and/or possible damage.

High fluid levels can be caused by an overheating condition.

Adjusting automatic transmission fluid levels

Before adding any fluid, make sure the correct type is used. The type of fluid used is normally indicated on the dipstick and/or dipstick handle and also in the *Lubricant specifications* section in the *Capacities and specifications* chapter.

Use of a non-approved automatic transmission fluid may cause internal transmission component damage.

If necessary, add fluid in 250 mL (1/2 pint) increments through the filler tube until the level is correct.

If an overfill occurs, excess fluid should be removed by a qualified technician.

An overfill condition of transmission fluid may cause shift and/or engagement concerns and/or possible damage.

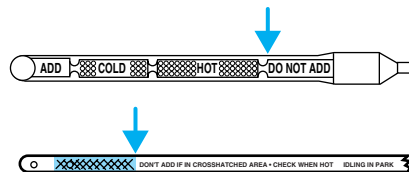
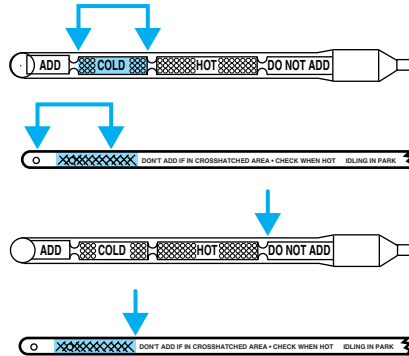

Maintenance and care

Checking and adding manual transmission fluid

1. Clean the filler plug.
2. Remove the filler plug and inspect the fluid level.

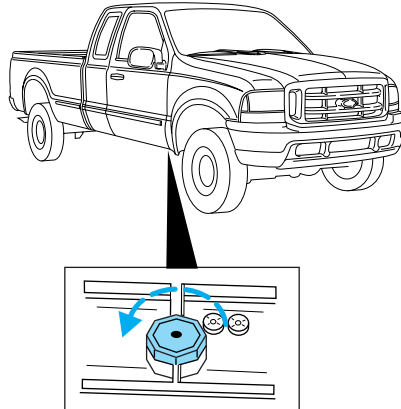

3. Fluid level should be at bottom of the opening.
4. Add enough fluid through the filler opening so that the fluid level is at the bottom of the opening.
5. Install and tighten the fill plug securely.

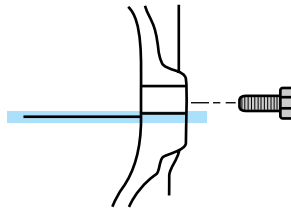

Use only fluid that meets Ford specifications. Refer to the *Capacities and specifications* chapter.

Maintenance and care

Checking and adding transfer case fluid

1. Clean the filler plug.
2. Remove the filler plug and inspect the fluid level.

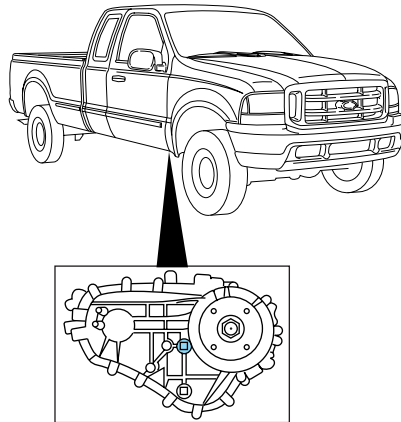

3. Add only enough fluid through the filler opening so that the fluid level is at the bottom of the opening.

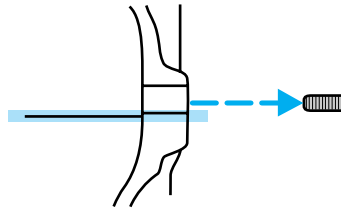

Use only fluid that meets Ford specifications. Refer to the *Capacities and specifications* chapter.

DRIVELINE UNIVERSAL JOINT AND SLIP YOKE

Your vehicle may be equipped with universal joints that require lubrication. Refer to the Scheduled Maintenance Guide for maintenance intervals. If the original universal joints are replaced with universal joints equipped with grease fittings, lubrication will also be necessary.

Maintenance and care

BATTERY

Your vehicle is equipped with a Motorcraft maintenance-free battery which normally does not require additional water during its life of service.

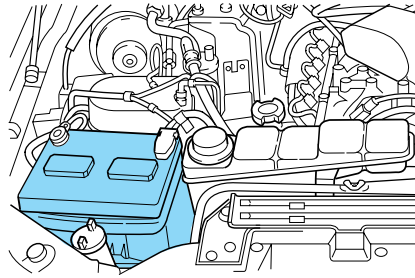

However, for severe usage or in high temperature climates, check the battery electrolyte level. Refer to the Scheduled Maintenance Guide for the service interval schedules.

Keep the electrolyte level in each cell up to the “level indicator”. Do not overfill the battery cells.

If the electrolyte level in the battery is low, you can add plain tap water to the battery, as long as you do not use hard water (water with a high mineral or alkali content). If possible, however, try to only fill the battery cells with distilled water. If the battery needs water often, have the charging system checked.

If your battery has a cover/shield, make sure it is reinstalled after the battery has been cleaned or replaced.

For longer, trouble-free operation, keep the top of the battery clean and dry. Also, make certain the battery cables are always tightly fastened to the battery terminals.

If you see any corrosion on the battery or terminals, remove the cables from the terminals and clean with a wire brush. You can neutralize the acid with a solution of baking soda and water.



Batteries normally produce explosive gases which can cause personal injury. Therefore, do not allow flames, sparks or lighted substances to come near the battery. When working near the battery, always shield your face and protect your eyes. Always provide proper ventilation.

Maintenance and care



When lifting a plastic-cased battery, excessive pressure on the end walls could cause acid to flow through the vent caps, resulting in personal injury and/or damage to the vehicle or battery. Lift the battery with a battery carrier or with your hands on opposite corners.



Keep batteries out of reach of children. Batteries contain sulfuric acid. Avoid contact with skin, eyes or clothing. Shield your eyes when working near the battery to protect against possible splashing of acid solution. In case of acid contact with skin or eyes, flush immediately with water for a minimum of 15 minutes and get prompt medical attention. If acid is swallowed, call a physician immediately.

Because your vehicle's engine is also electronically controlled by a computer, some control conditions are maintained by power from the battery. When the battery is disconnected or a new battery is installed, the engine must relearn its idle and fuel trim strategy for optimum driveability and performance. To begin this process:

1. Set your parking brake.
2. Put the gearshift in P (Park) (automatic transmission) or the neutral position (manual transmission), turn off all accessories and start the engine.
3. Let the engine idle for at least one minute.
4. The relearning process will automatically complete as you drive the vehicle.
 - The vehicle may need to be driven 16 km (10 miles) or more to relearn the idle and fuel trim strategy.
 - If you do not allow the engine to relearn its idle trim, the idle quality of your vehicle may be adversely affected until the idle trim is eventually relearned.

If the battery has been disconnected or a new battery has been installed, the clock and the preset radio stations must be reset once the battery is reconnected.

Maintenance and care

- Always dispose of automotive batteries in a responsible manner. Follow your local authorized standards for disposal. Call your local authorized recycling center to find out more about recycling automotive batteries.

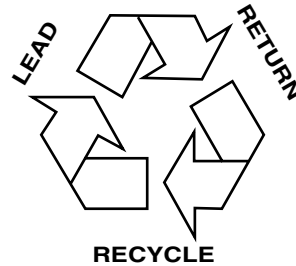

WINDSHIELD WIPER BLADES

Check the wiper blades at least twice a year or when they seem less effective. Substances such as tree sap and some hot wax treatments used by commercial car washes reduce the effectiveness of wiper blades.

Checking the wiper blades

If the wiper blades do not wipe properly, clean both the windshield and wiper blades using undiluted windshield wiper solution or a mild detergent. Rinse thoroughly with clean water. To avoid damaging the blades, do not use fuel, kerosene, paint thinner or other solvents.

Changing the wiper blades

To replace the wiper blades:

1. Pull the wiper arm away from the windshield and lock into the service position.
2. Turn the blade at an angle from the wiper arm. Push the lock pin manually to release the blade and pull the wiper blade down toward the windshield to remove it from the arm.
3. Attach the new wiper to the wiper arm and press it into place until a click is heard.

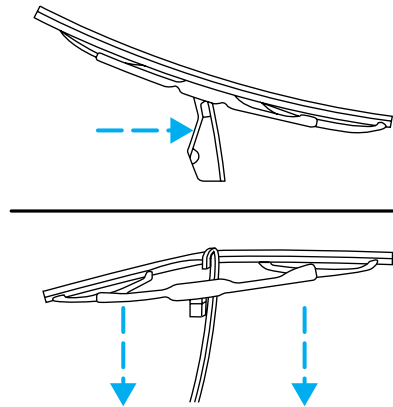

Maintenance and care

INFORMATION ABOUT TIRE QUALITY GRADES

New vehicles are fitted with tires that have their Tire Quality Grade (described below) molded into the tire's sidewall. These Tire Quality Grades are determined by standards that the United States Department of Transportation has set.

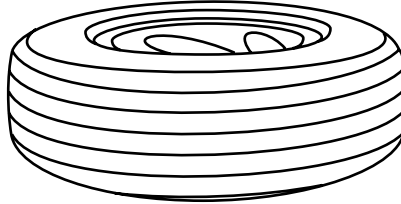

Tire Quality Grades apply to new pneumatic tires for use on passenger cars. They do not apply to deep tread, winter-type snow tires, space-saver or temporary use spare tires, tires with nominal rim diameters of 10 to 12 inches or limited production tires as defined in Title 49 Code of Federal Regulations Part 575.104(c)(2).

U.S. Department of Transportation-Tire quality grades: The U.S. Department of Transportation requires Ford to give you the following information about tire grades exactly as the government has written it.

Treadwear

The treadwear grade is a comparative rating based on the wear rate of the tire when tested under controlled conditions on a specified government test course. For example, a tire graded 150 would wear one and one-half (1 1/2) times as well on the government course as a tire graded 100. The relative performance of tires depends upon the actual conditions of their use, however, and may depart significantly from the norm due to variations in driving habits, service practices, and differences in road characteristics and climate.

Traction AA A B C

The traction grades, from highest to lowest are AA, A, B, and C. Those grades represent the tire's ability to stop on wet pavement as measured under controlled conditions on specified government test surfaces of asphalt and concrete. A tire marked C may have poor traction performance.



The traction grade assigned to this tire is based on straight-ahead braking traction tests, and does not include acceleration, cornering, hydroplaning or peak traction characteristics.

Maintenance and care

Temperature A B C

The temperature grades are A (the highest), B, and C, representing the tire's resistance to the generation of heat and its ability to dissipate heat when tested under controlled conditions on a specified indoor laboratory test wheel. Sustained high temperature can cause the material of the tire to degenerate and reduce tire life, and excessive temperature can lead to sudden tire failure. The grade C corresponds to a level of performance which all passenger car tires must meet under the Federal Motor Vehicle Safety Standard No. 109. Grades B and A represent higher levels of performance on the laboratory test wheel than the minimum required by law.



The temperature grade for this tire is established for a tire that is properly inflated and not overloaded. Excessive speed, underinflation, or excessive loading, either separately or in combination, can cause heat buildup and possible tire failure.

SERVICING YOUR TIRES

Checking the tire pressure

- Use an accurate tire pressure gauge.
- Check the tire pressure when tires are cold, after the vehicle has been parked for at least one hour or has been driven less than 5 km (3 miles).
- Adjust tire pressure to recommended specifications found on the Certification Label.



Improperly inflated tires can affect vehicle handling and can fail suddenly, possibly resulting in loss of vehicle control.

Tire rotation

Because your vehicle's tires perform different jobs, they often wear differently. To make sure your tires wear evenly and last longer, rotate them as indicated in the Scheduled Maintenance Guide. If you notice that the tires wear unevenly, have them checked.

The following procedure applies to vehicles equipped with single rear wheels, if your vehicle is equipped with dual rear wheels it is recommended that only the front wheels be rotated (side to side).

Maintenance and care

- Four tire rotation

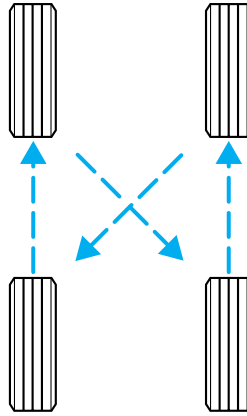

- Five tire rotation

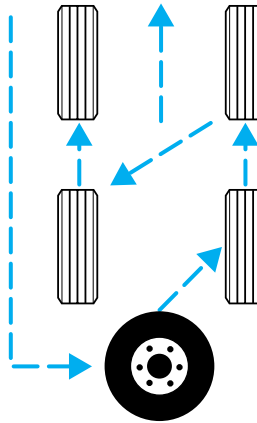



Maintenance and care

Replacing the tires

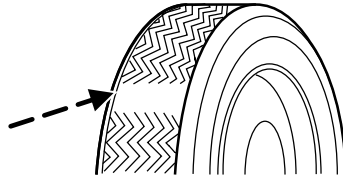
Replace the tires when the wear band is visible through the tire treads.



 When replacing full size tires, never mix radial bias-belted, or bias-type tires. Use only the tire sizes that are listed on the Certification Label. Make sure that all tires are the same size, speed rating, and load-carrying capacity. Use only the tire combinations recommended on the label. If you do not follow these precautions, your vehicle may not drive properly and safely.

 Make sure that all replacement tires are of the same size, type, load-carrying capacity and tread design (e.g., “All Terrain”, etc.), as originally offered by Ford.

 Do not replace your tires with “high performance” tires or larger size tires.

 Failure to follow these precautions may adversely affect the handling of the vehicle and make it easier for the driver to lose control and roll over.

Tires that are larger or smaller than your vehicle’s original tires may also affect the accuracy of your speedometer.

SNOW TIRES AND CHAINS

 Snow tires must be the same size and grade as the tires you currently have on your vehicle.

Maintenance and care

The tires on your vehicle have all weather treads to provide traction in rain and snow. However, in some climates, you may need to use snow tires and chains. If you need to use chains, it is recommended that steel wheels (of the same size and specifications) be used as chains may chip aluminum wheels.

Follow these guidelines when using snow tires and chains:

- Use only SAE Class S chains.
- Install chains securely, verifying that the chains do not touch any wiring, brake lines or fuel lines.
- Drive cautiously. If you hear the chains rub or bang against your vehicle, stop and re-tighten the chains. If this does not work, remove the chains to prevent damage to your vehicle.
- If possible, avoid fully loading your vehicle.
- Remove the tire chains when they are no longer needed. Do not use tire chains on dry roads.
- The suspension insulation and bumpers will help prevent vehicle damage. Do not remove these components from your vehicle when using snow tires and chains.

WHAT YOU SHOULD KNOW ABOUT AUTOMOTIVE FUELS

Important safety precautions



Do not overfill the fuel tank. The pressure in an overfilled tank may cause leakage and lead to fuel spray and fire.



The fuel system may be under pressure. If the fuel filler cap is venting vapor or if you hear a hissing sound, wait until it stops before completely removing the fuel filler cap. Otherwise, fuel may spray out and injure you or others.



If you do not use the proper fuel filler cap, excessive pressure or vacuum in the fuel tank may damage the fuel system or cause the fuel system to work improperly in a collision, which may result in possible personal injury.

Maintenance and care



Automotive fuels can cause serious injury or death if misused or mishandled.

Observe the following guidelines when handling automotive fuel:

- Extinguish all smoking materials and any open flames before fueling your vehicle.
- Always turn off the vehicle before fueling.
- Automotive fuels can be harmful or fatal if swallowed. Fuel such as gasoline is highly toxic and if swallowed can cause death or permanent injury. If fuel is swallowed, call a physician immediately, even if no symptoms are immediately apparent. The toxic effects of fuel may not be visible for hours.
- Avoid inhaling fuel vapors. Inhaling too much fuel vapor of any kind can lead to eye and respiratory tract irritation. In severe cases, excessive or prolonged breathing of fuel vapor can cause serious illness and permanent injury.
- Avoid getting fuel liquid in your eyes. If fuel is splashed in the eyes, remove contact lenses (if worn), flush with water for 15 minutes and seek medical attention. Failure to seek proper medical attention could lead to permanent injury.
- Fuels can also be harmful if absorbed through the skin. If fuel is splashed on the skin and/or clothing, promptly remove contaminated clothing and wash skin thoroughly with soap and water. Repeated or prolonged skin contact with fuel liquid or vapor causes skin irritation.
- Be particularly careful if you are taking “Antabuse” or other forms of disulfiram for the treatment of alcoholism. Breathing gasoline vapors, or skin contact could cause an adverse reaction. In sensitive individuals, serious personal injury or sickness may result. If fuel is splashed on the skin, promptly wash skin thoroughly with soap and water. Consult a physician immediately if you experience an adverse reaction.



Maintenance and care



When refueling always shut the engine off and never allow sparks or open flames near the filler neck. Never smoke while refueling. Fuel vapor is extremely hazardous under certain conditions. Care should be taken to avoid inhaling excess fumes.



The flow of fuel through a fuel pump nozzle can produce static electricity, which can cause a fire if fuel is pumped into an ungrounded fuel container.

Use the following guidelines to avoid static build-up when filling an ungrounded fuel container:

- Place approved fuel container on the ground.
- DO NOT fill a fuel container while it is in the vehicle.
- Keep the fuel pump nozzle in contact with the fuel container while filling.
- DO NOT use a device that would hold the fuel pump handle in the fill position.

Choosing the right fuel

Use only UNLEADED FUEL. The use of leaded fuel is prohibited by law and could damage your vehicle.

Do not use fuel containing methanol. It can damage critical fuel system components.

Your vehicle was not designed to use fuel or fuel additives with metallic compounds, including manganese-based compounds containing MMT.

Repairs to correct the effects of using a fuel for which your vehicle was not designed may not be covered by your warranty.

Octane recommendations

Your vehicle is designed to use “Regular” unleaded gasoline with an (R+M)/2 octane rating of 87. We do not recommend the use of gasolines labeled as “Regular” that are sold with octane ratings of 86 or lower in high altitude areas.

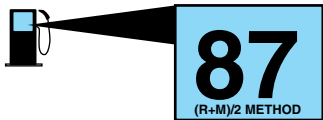

Do not be concerned if your engine sometimes knocks lightly. However, if it knocks heavily under most driving conditions while you are using fuel

Maintenance and care

with the recommended octane rating, see your dealer or a qualified service technician to prevent any engine damage.

Fuel quality

If you are experiencing starting, rough idle or hesitation driveability problems during a cold start, try a different brand of “Regular” unleaded gasoline. “Premium” unleaded gasoline is not recommended (particularly in the United States) because it may cause these problems to become more pronounced. If the problems persist, see your dealer or a qualified service technician.

It should not be necessary to add any aftermarket products to your fuel tank if you continue to use a high quality fuel.

Cleaner air

Ford approves the use of gasolines to improve air quality, including reformulated gasolines that contain oxygenates up to 10% ethanol or 15% MTBE.

Running out of fuel

Avoid running out of fuel because this situation may have an adverse affect on powertrain components.

If you have run out of fuel:

- You may need to crank the engine several times after refueling before the system starts to pump the fuel from the tank to the engine.
- Your “Service Engine Soon” indicator may come on. For more information on the “Service Engine Soon” indicator, refer to the *Instrumentation* chapter.

Fuel Filler Cap

Your fuel tank filler cap has an indexed design with a 1/8 turn on/off feature.

When fueling your vehicle:

1. Turn the engine off.
2. Carefully turn the filler cap counterclockwise 1/8 of a turn until it stops.
3. Pull to remove the cap from the fuel filler pipe.

Maintenance and care

4. To install the cap, align the tabs on the cap with the notches on the filler pipe.

5. Turn the filler cap clockwise 1/8 of a turn until it stops.

If the “Service Engine Soon/Check Engine” indicator comes on and stays on when you start the engine, the fuel filler cap may not be properly installed. Turn off the engine, remove the fuel filler cap, align the cap properly and reinstall it.

If you must replace the fuel filler cap, replace it with a fuel filler cap that is designed for your vehicle. The customer warranty may be void for any damage to the fuel tank or fuel system if the correct genuine Ford or Motorcraft fuel filler cap is not used.



The fuel system may be under pressure. If the fuel filler cap is venting vapor or if you hear a hissing sound, wait until it stops before completely removing the fuel filler cap. Otherwise, fuel may spray out and injure you or others.



If you do not use the proper fuel filler cap, excessive pressure or vacuum in the fuel tank may damage the fuel system or cause the fuel system to work improperly in a collision, which may result in possible personal injury.

Fuel Filter

For fuel filter replacement, see your dealer or a qualified service technician. Refer to the Scheduled Maintenance Guide for the appropriate intervals for changing the fuel filter.

Replace the fuel filter with an authorized Motorcraft part. The customer warranty may be void for any damage to the fuel system if an authorized Motorcraft fuel filter is not used.

ESSENTIALS OF GOOD FUEL ECONOMY

Measuring techniques

Your best source of information about actual fuel economy is you, the driver. You must gather information as accurately and consistently as possible. Fuel expense, frequency of fillups or fuel gauge readings are NOT accurate as a measure of fuel economy. We do not recommend taking fuel economy measurements during the first 1 600 km (1 000 miles) of

Maintenance and care

driving (engine break-in period). You will get a more accurate measurement after 3 000 km–5 000 km (2 000 miles–3 000 miles).

Filling the tank

The advertised fuel capacity of the fuel tank on your vehicle is equal to the rated refill capacity of the fuel tank as listed in the *Refill Capacities* chart in this “Owner Guide.” The advertised capacity is the amount of the Indicated Capacity and the Empty Reserve combined. Indicated Capacity is the difference in the amount of fuel in a full tank and a tank when the fuel gauge indicates empty. Empty Reserve is the small amount of usable fuel remaining in the fuel tank after the fuel gauge indicates empty.

The amount of Empty Reserve varies and should not be relied upon to increase driving range. When refueling your vehicle after the fuel gauge indicates empty, you might not be able to refuel the full amount of the advertised capacity of the fuel tank due to the empty reserve still present in the tank.

For consistent results when filling the fuel tank:

- Use the same filling rate setting (low — medium — high) each time the tank is filled.
- Allow three automatic click-offs when filling.
- Always use fuel with the recommended octane rating.
- Use a known quality gasoline, preferably a national brand.
- Use the same side of the same pump and have the vehicle facing the same direction each time you fill up.
- Have the vehicle loading and distribution the same every time.

Your results will be most accurate if your filling method is consistent.

Calculating fuel economy

1. Fill the fuel tank completely and record the initial odometer reading (in kilometers or miles).
2. Each time you fill the tank, record the amount of fuel added (in liters or gallons).
3. After at least three to five tank fill-ups, fill the fuel tank and record the current odometer reading.
4. Subtract your initial odometer reading from the current odometer reading.

Maintenance and care

5. Follow one of the simple calculations in order to determine fuel economy:

Multiply liters used by 100, then divide by total kilometers traveled.

Divide total miles traveled by total gallons used.

Keep a record for at least one month and record the type of driving (city or highway). This will provide an accurate estimate of the vehicle's fuel economy under current driving conditions. Additionally, keeping records during summer and winter will show how temperature impacts fuel economy. In general, lower temperatures give lower fuel economy.

Driving style — good driving and fuel economy habits

Give consideration to the lists that follow and you may be able to change a number of variables and improve your fuel economy.

Habits

- Smooth, moderate operation can yield up to 10% savings in fuel.
- Steady speeds without stopping will usually give the best fuel economy.
- Idling for long periods of time (greater than one minute) may waste fuel.
- Anticipate stopping; slowing down may eliminate the need to stop.
- Sudden or hard accelerations may reduce fuel economy.
- Slow down gradually.
- Driving at reasonable speeds (traveling at 88 km/h [55 mph] uses 15% less fuel than traveling at 105 km/h [65 mph]).
- Revving the engine before turning it off may reduce fuel economy.
- Using the air conditioner or defroster may reduce fuel economy.
- Using speed control (if equipped) may improve fuel economy. Speed control can help maintain a constant speed and reduce speed changes. You may want to turn off the speed control in hilly terrain as unnecessary shifting between third and fourth gears may occur and could result in reduced fuel economy.
- Warming up a vehicle on cold mornings is not required and may reduce fuel economy.

Maintenance and care

- Resting your foot on the brake pedal while driving may reduce fuel economy.
- Combine errands and minimize stop-and-go driving.

Maintenance

- Keep tires properly inflated and use only recommended size.
- Operating a vehicle with the wheels out of alignment will reduce fuel economy.
- Use recommended engine oil. Refer to *Lubricant Specifications*.
- Perform all regularly scheduled maintenance items. Follow the recommended maintenance schedule and owner maintenance checks found in your vehicle Scheduled Maintenance Guide.

Conditions

- Heavily loading a vehicle or towing a trailer may reduce fuel economy at any speed.
- Carrying unnecessary weight may reduce fuel economy (approximately 2 km/h [1 mpg] is lost for every 180 kg [400 lb] of weight carried).
- Adding certain accessories to your vehicle (for example bug deflectors, rollover/light bars, running boards, ski/luggage racks) may reduce fuel economy.
- Using fuel blended with alcohol may lower fuel economy.
- Fuel economy may decrease with lower temperatures during the first 12–16 km (8–10 miles) of driving.
- Driving on flat terrain offers improved fuel economy as compared to driving on hilly terrain.
- Transmissions give their best fuel economy when operated in the top cruise gear and with steady pressure on the gas pedal.
- Four-wheel-drive operation (if equipped) is less fuel efficient than two-wheel-drive operation.
- Close windows for high speed driving.

EPA window sticker

Every new vehicle should have the EPA window sticker. Contact your dealer if the window sticker is not supplied with your vehicle. The EPA window sticker should be your guide for the fuel economy comparisons with other vehicles.

Maintenance and care

It is important to note the box in the lower left corner of the window sticker. These numbers represent the Range of Km/L (MPG) expected on the vehicle under optimum conditions. Your fuel economy may vary depending upon the method of operation and conditions.

EMISSION CONTROL SYSTEM

Your vehicle is equipped with various emission control components and a catalytic converter which will enable your vehicle to comply with applicable exhaust emission standards. To make sure that the catalytic converter and other emission control components continue to work properly:

- Use only unleaded fuel.
- Avoid running out of fuel.
- Do not turn off the ignition while your vehicle is moving, especially at high speeds.
- Have the items listed in your Scheduled Maintenance Guide performed according to the specified schedule.

The scheduled maintenance items listed in the Scheduled Maintenance Guide are essential to the life and performance of your vehicle and to its emissions system.

If other than Ford, Motorcraft or Ford-authorized parts are used for maintenance replacements or for service of components affecting emission control, such non-Ford parts should be equivalent to genuine Ford Motor Company parts in performance and durability.



Do not park, idle, or drive your vehicle in dry grass or other dry ground cover. The emission system heats up the engine compartment and exhaust system, which can start a fire.

Illumination of the charging system warning light, “Service Engine Soon” light or the temperature warning light, fluid leaks, strange odors, smoke or loss of oil pressure, could indicate that the emission control system is not working properly.



Exhaust leaks may result in entry of harmful and potentially lethal fumes into the passenger compartment.

Do not make any unauthorized changes to your vehicle or engine. By law, vehicle owners and anyone who manufactures, repairs, services,

Maintenance and care

sells, leases, trades vehicles, or supervises a fleet of vehicles are not permitted to intentionally remove an emission control device or prevent it from working. Information about your vehicle's emission system is on the Vehicle Emission Control Information Decal located on or near the engine. This decal identifies engine displacement and gives some tune up specifications.

Please consult your "Warranty Guide" for complete emission warranty information.

Readiness for Inspection/Maintenance (I/M) testing

In some localities, it may be a legal requirement to pass an I/M test of the on-board diagnostics system. If your "Check Engine/Service Engine Soon" light is on, refer to the description in the *Warning Lights and Chimes* section of the *Instrumentation* chapter. Your vehicle may not pass the I/M test with the "Check Engine/Service Engine Soon" light on.

If the vehicle's powertrain system or its battery has just been serviced, the on-board diagnostics system is reset to a "not ready for I/M test" condition. To ready the on-board diagnostics system for I/M testing, a minimum of 30 minutes of city and highway driving is necessary as described below:

- First, at least 10 minutes of driving on an expressway or highway.
- Next, at least 20 minutes driving in stop-and-go, city-type traffic with at least four idle periods.

Allow the vehicle to sit for at least eight hours without starting the engine. Then, start the engine and complete the above driving cycle. The engine must warm up to its normal operating temperature. Once started, do not turn off the engine until the above driving cycle is complete.

EXTERIOR BULBS

Replacing exterior bulbs

Check the operation of the following lamps frequently:

- Headlamps
- High-mount brakelamp
- Brakelamps
- Turn signals
- License plate lamp

Maintenance and care

- Tail lamps
- Back-up lamps

Do not remove lamp bulbs unless they can be replaced immediately with new ones. If a bulb is removed for an extended period of time, contaminants may enter the lamp housings and affect lamp performance.

Replacing headlamp bulbs (aerodynamic)



Handle a halogen headlamp bulb carefully and keep out of children's reach. Grasp the bulb only by its plastic base and do not touch the glass. The oil from your hand could cause the bulb to break the next time the headlamps are operated.

1. Make sure that the headlamp control is in the OFF position.
2. Open the hood.
3. Release clip and disconnect the electrical connector from the bulb.
4. Remove bulb retainer ring by turning it counterclockwise about $\frac{1}{4}$ turn, then slide the ring off the plastic base.

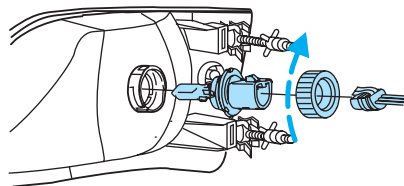

5. Without turning, carefully pull bulb out of headlamp assembly.
6. Insert the glass end of the new bulb into the headlamp assembly. When the grooves in the plastic base are aligned, push the bulb into the lamp assembly until the plastic base contacts the rear of the lamp assembly.
7. Install bulb retaining ring over the plastic base and lock the ring into the socket by turning it clockwise until you feel a "stop."
8. Connect the electrical connector into the rear of the plastic base until it "snaps."

Maintenance and care

Replacing headlamp bulbs (sealed beam)

To remove the headlamp bulb:

1. Make sure headlamp switch is in OFF position.
2. Open the hood.
3. Remove the two screws and parking lamp/side marker assembly by pulling gently
4. Disconnect the electrical connectors from the parking lamp/side marker assembly and remove.

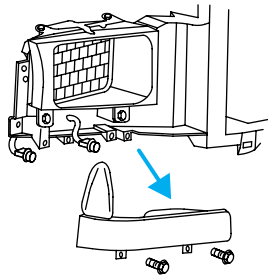

5. Remove the four bolts and headlamp bezel.

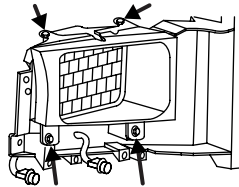

6. Remove the four screws and the headlamp retaining ring from headlamp.
7. Disconnect the electrical connector and remove headlamp.

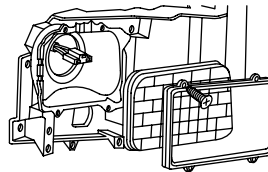

To install the new headlamp, reverse the removal procedure.

Maintenance and care

Replacing tail lamp/Backup lamp bulbs

The tail lamp/backup lamp bulbs are located in the same portion of the tail lamp assembly, one just below the other. Follow the same steps to replace either bulb:

1. Open the liftgate to expose the lamp assemblies.
2. Remove the two screws from the tail lamp assembly.
3. Carefully pull the lamp assembly from the tailgate pillar by releasing the two retaining tabs.
4. Twist the bulb socket $\frac{1}{4}$ turn counterclockwise and remove from lamp assembly.
5. Pull the bulb straight out of the socket and push in the new bulb.
6. Install bulb socket in lamp assembly by turning clockwise.
7. Carefully install the tail lamp assembly on tailgate pillar snapping the two retaining tabs into place.
8. Secure the tail lamp with two screws.

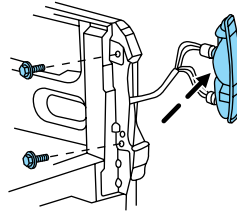

High-mount brakelamp bulbs

To remove the brakelamp assembly:

1. Remove the two screws and lamp assembly from vehicle as wiring permits.
2. Remove the bulb socket by rotating counterclockwise and pulling it out of the lamp assembly.
3. Pull the bulb straight out of the socket and push in the new bulb.

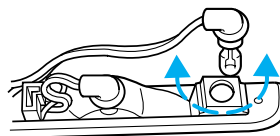
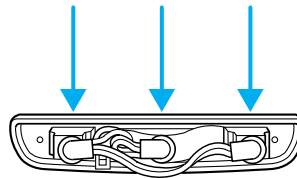

Maintenance and care

To install the brakelamp assembly:

1. Install the bulb into the lamp assembly and rotate clockwise.
2. Install the lamp assembly on the vehicle with two screws.

Replacing license plate lamp bulbs

The license plate bulbs are located behind the rear bumper. To change the license plate lamp bulbs:

1. Reach behind the rear bumper to locate the bulb.
2. Twist the bulb socket counterclockwise $\frac{1}{4}$ turn and carefully pull to remove it from the lamp assembly.
3. Pull out the old bulb from the socket and push in the new bulb.
4. Install the bulb socket in lamp assembly by turning it clockwise.

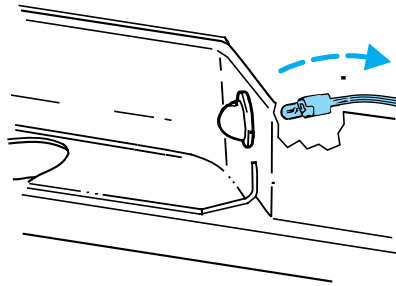

Using the right bulbs

Function	Number of bulbs	Trade number
Headlamps (aerodynamic)	2	9007
Headlamps (sealed beam)	2	H6054
Park/turn	2	3157
Sidemarkers	2	194
Tail/stop/turn/sidemarkers	2	3157 K
Backup	2	3156K
High-mount stoplamp	1	921
Cargo lamp	2	906
Roofmarker	5	194
Rear fender clearance	4	(a)
Rear identification	3	194
To replace all instrument panel lights - see your dealer		
(a) Replace entire lamp assembly; bulb is not serviceable.		

Maintenance and care

AIMING THE HEADLAMPS

The alignment of your headlamps should be checked by a qualified service technician if:

- Oncoming motorists frequently signal you to deactivate your high beams, and your high beams are not activated.
- The headlamps do not seem to provide enough light for clear night vision.
- The headlamp beams are pointed substantially away from a slightly down and to the right position.

CLEANING AND CARING FOR YOUR VEHICLE

Refer to the Customer Assistance chapter for a list of Ford-approved cleaners, polishes and waxes.

Washing your vehicle

Wash your vehicle regularly with cold or lukewarm water. Never use strong detergents or soap. If your vehicle is particularly dirty, use a quality car wash detergent. Always use a clean sponge, washing glove or similar device and plenty of water for best results. To avoid spots, avoid washing when the hood is still warm, immediately after or during exposure to strong sunlight.

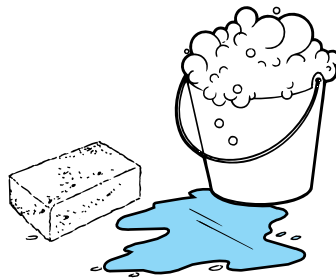

During winter months, it is especially important to wash the vehicle on a regular basis. Large quantities of dirt and road salt are difficult to remove and also cause damage to the vehicle.

Remove any exterior accessories (such as antennas) and fold in the side view mirrors before entering a car wash. If you have wax applied to the vehicle at a commercial car wash, it is recommended that you clean the wiper blades and windshield as described in *Cleaning the wiper blades and windshield*.

After washing, apply the brakes several times to dry them.

Maintenance and care

Waxing your vehicle

Wax when water stops beading on the surface. This could be every three or four months, depending on operating conditions.

Use only carnauba or synthetic-based waxes. Use cleaning fluid or alcohol with a clean cloth to remove any bugs before waxing vehicle. Use tar remover to remove any tar spots.

Avoid getting wax on the windshield. If you have wax applied at a commercial car wash, it is recommended that you clean the wiper blades and windshield as described in *Cleaning the wiper blades and windshield*.

Repairing paint chips

Minor scratches or paint damage from road debris may be repaired with the Ultra Touch Prep and Finishing Kit (#F7AZ-19K507-BA), touch-up paint (#ALBZ-19500-XXXXA), or aerosol paint spray (#ALAZ-19500-XXXXA) from the Ford Car Care Chemicals line. Please note that the part numbers (shown as XXXX above) will vary with your vehicle's specific coloring. Observe the application instructions on the products.

Remove particles such as bird droppings, tree sap, insect remains, tar spots, road salt and industrial fallout immediately.

Cleaning the wheels

Wash with the same detergent as the body of your vehicle. Do not use acid-based or alcohol-based wheel cleaners, steel wool, fuel or strong detergents. Never use abrasives that will damage the finish of special wheel surfaces. Use a tar remover to remove grease and tar.

The brushes used in some automatic car washes may damage the finish on your wheels. Before going to a car wash, find out if the brushes are abrasive.

Cleaning the engine

Engines are more efficient when they are clean because grease and dirt buildup keep the engine warmer than normal. When washing:

- Take care when using a power washer to clean the engine. The high pressure fluid could penetrate the sealed parts and cause damage.
- Do not spray with cold water to avoid cracking the engine block or other engine components.
- Never wash or rinse the engine while it is running; water in the running engine may cause internal damage.

Maintenance and care

Cleaning plastic exterior parts

Use vinyl cleaner for routine cleaning. Clean with a tar remover if necessary. Do not clean plastic parts with thinners, solvents or petroleum-based cleaners.

Cleaning the exterior lamps

Wash with the same detergent as the exterior of your vehicle. Use glass cleaner or tar remover if necessary.

To avoid scratching the lamps, do not use a dry paper towel, chemical solvents or abrasive cleaners.

Cleaning the wiper blades and windshield

If the wiper blades do not wipe properly, clean the wiper blade rubber element with undiluted windshield washer solution or a mild detergent. To avoid damaging the blades, do not use fuel, kerosene, paint thinner or other solvents.

If the wiper still does not wipe properly, this could be caused by substances on the windshield such as tree sap and some hot wax treatments used by commercial car washes. Clean the outside of the windshield with a non-abrasive cleanser such as the non-abrasive Bon-Ami® powder. Rinse thoroughly with clean water. **Do not** use abrasive cleansers on glass as they may cause scratches. The windshield is clean if beads do not form when you rinse it with water. The windshield and wiper blades should be cleaned on a regular basis, and blades or rubber elements replaced when worn.

Cleaning the instrument panel

Clean with a damp cloth, then dry with a dry cloth.

Avoid cleaner or polish that increases the gloss of the upper portion of the instrument panel. The dull finish in this area helps protect the driver from undesirable windshield reflection.

Cleaning the interior fabric

Remove dust and loose dirt with a whisk broom or a vacuum cleaner. Remove fresh spots immediately. Do not use household or glass cleaners. These agents can stain and discolor the fabric. Use a mild soap and water solution if necessary.

Maintenance and care

Cleaning and maintaining the safety belts

Clean the safety belts with a mild soap solution recommended for cleaning upholstery or carpets. Do not bleach or dye the belts, because these actions may weaken the belt webbing.

Check the safety belt system periodically to make sure there are no nicks, wear or cuts. If your vehicle has been involved in an accident, refer to the *Safety belt maintenance* section in the *Seating and safety restraints* chapter.

Cleaning leather seats (if equipped)

To clean, simply use a soft cloth dampened with water and a mild soap. Wipe the leather again with a damp cloth to remove soap residue. Dry with a soft cloth. For tougher soiling concerns, Ford recommends using the Deluxe Leather Care Kit F8AZ-19G253-AA, which is available from your Ford Dealer. This mild cleaner and special pad, cleans the leather and maintains its natural beauty. Follow the instructions on the cleaner label. Regular cleaning of your leather upholstery helps maintain its resiliency and color.

Do not use household cleaning products, alcohol solutions, solvents or cleaners intended for rubber, vinyl or plastics.

Capacities and specifications

MOTORCRAFT PART NUMBERS

Component*	5.4L V8 engine	6.8L V10 engine
Air filter element	FA-1634	FA-1634
Fuel filter	FG-986B	FG-986B
Oil filter	FL-820-S	FL-820-S
PCV valve	EV-233	EV-233
Battery (Standard)	BXT-65-650	BXT-65-650
Battery (Optional)	BXT-65-750	BXT-65-650
Spark plugs-platinum**	AWSF-22E	AWSF-22E

*Refer to the *7.3 Liter Power Stroke Direct Injection Turbo Diesel Owner's Guide Supplement* for Motorcraft diesel engine service part numbers.

**Refer to Vehicle Emissions Control Information (VECI) decal for spark plug gap information.

REFILL CAPACITIES

Fluid	Ford Part Name	Application	Capacity
Front axle	Motorcraft SAE 75W90 Axle Lubricant	F-250/350 Dana 50 axle	1.8L (3.8 pints)
		F-350/450/550 Dana 60 axle	2.7L (5.8 pints)
Rear axle ^{1,2,3}	Motorcraft SAE 75W140 Synthetic Rear Axle Lubricant	F-250 /350 (10.50 inch axle)	3.3L (6.9 pints)
	Motorcraft SAE 75W90 Synthetic Rear Axle Lubricant	F-350/450 Dana 80	3.9L (8.3 pints)
	Motorcraft SAE 80W90 Premium Rear Axle Lubricant	F-550 Dana 135	11.6L (24.5 pints)
Brake fluid	High Performance DOT 3 Motor Vehicle Brake Fluid	All	Fill to line on reservoir

Capacities and specifications

Fluid	Ford Part Name	Application	Capacity
Engine coolant ⁵	Premium Engine Coolant	5.4L V8 engine without A/C	16.9L (17.9 quarts)
		5.4L V8 engine with A/C	18.4L (19.4 quarts)
		6.8L V10 engine	29.0L (30.6 quarts)
Engine oil (includes filter change)- Gas engines	Motorcraft 5W-30 Super Premium Motor Oil	All	5.7L (6.0 quarts)
Engine oil (includes filter change)- Diesel engine	Refer to your 7.3L Diesel Supplement		
Fuel tank	N/A	Mid-ship tank (optional aft axle on narrow frame Chassis Cab)	71.9L (19.0 gallons)
		Right side saddle mounted tank (optional on narrow frame Chassis Cab)	87.1L (23.0 gallons)
		Short box (wide frame regular cab)	109.8L (29.0 gallons)
		Aft axle (narrow frame chassis cab)	136.3L (36.0 gallons)
		Long box wide frame (Regular cab, SuperCab or Crew Cab)	143.9L (38.0 gallons)
Power steering fluid	Motorcraft MERCON® ATF	All	Fill to line on reservoir
Transfer case fluid	Motorcraft MERCON® ATF	4x4 vehicles	1.9L (2.0 quarts)

Capacities and specifications

Fluid	Ford Part Name	Application	Capacity
Transmission fluid ³	Synthetic MERCON® ATF	5-speed manual	3.2L (3.4 quarts)
	Motorcraft MERCON® ATF	6-speed manual	5.5L (5.8 quarts)
		Automatic - 4R100 with small cooler (vehicles equipped with 20 oil-to-air-plate cooler)	16.1L (17.1 quarts) ⁴
		Automatic - 4R100 with large cooler (vehicles equipped with 26 oil-to-air-plate cooler)	16.7L (17.7 quarts) ⁴
Windshield washer fluid	Ultra-Clear Windshield Washer Concentrate	All	4.0L (4.25 quarts)

¹ Your vehicle's rear axle(s) may be filled with a synthetic lubricant that may require a lubricant change. Refer to the Scheduled Maintenance Guide. Axle lubricant quantities should not need to be checked unless a leak is suspected, service is required or the axle assembly has been submerged in water. The axle lubricant should be changed any time the rear axle has been submerged in water.

² Add 236 ml (8 oz.) of additive Friction Modifier C8AZ-19B546-A, Ford Specification EST-M2C118-A for complete refill of Traction-Lok axles.

³ Ensure the correct automatic transmission fluid is used. Transmission fluid requirements are indicated on the dipstick or on the dipstick handle. MERCON® and MERCON® V are not interchangeable. DO NOT mix MERCON® and MERCON® V. Refer to your Scheduled Maintenance Guide to determine the correct service interval.

⁴ Indicates only approximate dry-fill capacity. Some applications may vary based on cooler size and if equipped with an in-tank cooler. The amount of transmission fluid and fluid level should be set by the indication on the dipstick's normal operating range.

⁵ Use Ford Premium Engine Coolant (green in color). DO NOT USE Ford Extended Life Engine Coolant (orange in color). Refer to *Adding engine coolant, in the Maintenance and Care chapter*.

Capacities and specifications

LUBRICANT SPECIFICATIONS

Item	Ford part name or equivalent	Ford part number	Ford specification
Front axle (4X4)	Motorcraft SAE 75W90 Axle Lubricant	XY-75W90-QL	WSP-M2C201-A
Rear axle	Motorcraft SAE 75W140 High Performance Synthetic Rear Axle Lube ¹	F1TZ-19580-B	WSL-M2C192-A
	Motorcraft SAE 75W90 Synthetic Rear Axle Lube ¹ (Dana 80 axles)	XY-75W90-QL	WSP-M2C201-A
	Motorcraft SAE 80W90 Premium Rear Axle Lubricant ¹ (Dana 135 axles)	XY-80W90-QL	WSP-19580-B
Brake fluid and clutch fluid (if equipped)	High Performance DOT 3 Motor Vehicle Brake Fluid	C6AZ-19542-AB	ESA-M6C25-A and DOT 3
Engine coolant	Ford Premium Engine Coolant	E2FZ-19549-AA (in Oregon, F5FZ-19549-CC, in Canada, Motorcraft CXC-10)	ESE-M97B44-A
Engine oil	Motorcraft 5W-30 Super Premium Motor Oil	XO-5W30-QSP	WSS-M2C153-G and API Certification Mark

Capacities and specifications

Item	Ford part name or equivalent	Ford part number	Ford specification
Hinges, latches, striker plates, fuel filler door hinge and seat tracks	Multi-Purpose Grease	DOAZ-19584-AA or F5AZ-19G209-AA	ESB-M1C93-A or ESR-M1C159-A
Transmission /steering/parking brake linkages and pivots, brake and clutch pedal shaft (if equipped)	Premium Long-Life Grease	XG-1-C	ESA-M1C75-B
Power steering fluid and transfer case fluid (if equipped)	Motorcraft MERCON® ATF	XT-2-BDX or QDX	MERCON®
Manual transmission (5-speed)	Synthetic MERCON® ATF	E6AZ-19582-B	MERCON®
Manual transmission (6-speed)	Motorcraft MERCON® ATF	XT-2-QDX	MERCON®
Automatic transmission	Motorcraft MERCON® ATF	XT-2-QDX	MERCON®
Windshield washer fluid	Ultra-clear windshield washer concentrate	C9AZ-19550-AC	ESR-M17P5-A

¹ Add 236 ml (8 oz.) of additive friction modifier C8AZ-19B546-A, Ford specification EST-M2C118-A for complete refill of Traction-Lok axles. Ford design rear axles contain a synthetic lubricant that does not require changing unless the axle has been submerged in water. Dana rear axles also contain a synthetic lubricant but **do** require a change. Refer to your “Service Guide” for change intervals on Dana rear axles.

Capacities and specifications

ENGINE DATA

Engine	5.4L V8 engine	6.8L V10 engine
Cubic inches	330	415
Horsepower	235 @ 4250 rpm	275 @ 4250 rpm
Torque	335 lb.-ft. @ 3000 rpm	410 lb.-ft. @ 2650 rpm
Required fuel	87 octane	87 octane
Firing order	1-3-7-2-6-5-4-8	1-6-5-10-2-7-3-8-4-9
Spark plug gap	1.3-1.4 mm (0.052-0.056 inch)	1.3-1.4 mm (0.052-0.056 inch)
Ignition system	Coil on plug	Coil on plug
Compression ratio	9.0:1	9.0:1

VEHICLE DIMENSIONS

F250—except Crew cab

Dimension	Body style			
	Regular Cab 4x2	Regular Cab 4x4	Super Cab 4x2	Super Cab 4x4
(1) Overall height	1 864 mm (74 in)	1 958 mm (77.1 in)	1 870 mm (73.6 in)	1 964 mm (77.3 in)
(2) Track (Front / Rear)	1 736.3 mm (68.3 in) / 1 729.3 mm (68 in)	1 736.3 mm (68.3 in) / 1 729.3 mm (68 in)	1 736.3 mm (68.3 in) / 1 729.3 mm (68 in)	1 736.3 mm (68.3 in) / 1 729.3 mm (68 in)
(3) Overall width	2 031 mm (79.9 in)	2 031 mm (79.9 in)	2 031 mm (79.9 in)	2 031 mm (79.9 in)
(4) Wheelbase	3 479.8 mm (137 in)	3 479.8 mm (137 in)	3 601.7 mm (141.8 in) ^a 4 013.2 mm (158 in) ^b	3 601.7 mm (141.8 in) ^a 4 013.2 mm (158 in) ^b
(5) Overall length	5 646 mm (222.2 in)	5 757 mm (226.6 in)	5 876 mm (231.3 in) ^a 6 177 mm (243.1 in) ^b	5 879 mm (231.4 in) ^a 6 180 mm (243.3 in) ^b
^a Short wheel base				
^b Long wheel base				

Capacities and specifications

F250-Crew cab

Dimension	Body style	
	Crew Cab 4x2	Crew Cab 4x4
(1) Overall height	1 960 mm (77.2 in) ^a / 1 883 mm (74.1 in) ^b	2 053mm (80.8 in) ^a / 2 052 mm (80.8 in) ^b
(2) Track (Front / Rear)	1 745 mm (68.7 in)/ 1 729 mm (68.1 in) ^{a,b}	1 736 mm (68.4 in)/ 1 729 mm (68.1 in) ^{a,b}
(3) Overall width	1 988 mm (78.3 in) ^{a,b}	1 988 mm (78.3 in) ^{a,b}
(4) Wheelbase	3 967 mm (156.2 in) ^a / 4 379 mm (172.4 in) ^b	3 967 mm (156.2 in) ^a / 4 379 mm (172.4 in) ^b
(5) Overall length	6 242 mm (245.8 in) ^a / 6 654 mm (262.0 in) ^b	6 242 mm (245.8 in) ^a / 6 654 mm (262.0 in) ^b
^a Short wheel base		
^b Long wheel base		

F350—except Crew cab

Dimension	Body style			
	Chassis Cab	Regular Cab	Super Cab 4x2	Super Cab 4x4
(1) Overall height	1 972 mm (77.6 in)	1 860 mm (73.2 in) ^{c,e}	1 865 mm (73.4 in) ^a 1 861 mm (73.6 in) ^b	1 960 mm (77.2 in)
(2) Track (Front / Rear)	1 736.3 mm (68.3 in) / 1 879.6 mm (74.0 in)	1 736.3 mm (68.3 in) / 1 729.3 mm (68.0 in)	1 736.3 mm (68.3 in) / 1 729.3 mm (68.0 in) ^{a,c} 1 736.3 mm (68.3 in) / 1 879.6 mm (74.0 in) ^{b,d}	1 737.3 mm (68.4 in) / 1 729.3 mm (68.0 in)
(3) Overall width	2 025 mm (79.7 in)	2 031 mm (79.9 in)	2 031 mm (79.9 in)	2 031 mm (79.9 in)
(4) Wheel-base	3 576.3 mm (140.8 in)	3 479.8 mm (137.0 in)	3 601 mm (141.8 in) ^a / 4 013.2 mm (158.0 in) ^b	3 601 mm (141.8 in) ^a / 4 013.2 mm (158.0 in) ^b

Capacities and specifications

(5) Overall length	5 732 mm (225.7 in)	5 754 mm (226.5 in)	5 879 mm (231.4 in) ^a / 6 288 mm (247.6 in) ^b	6 291 mm (247.7 in)
^a Short wheel base ^b Long wheel base ^c Single rear wheels ^d Dual rear wheels				

F350-Crew cab

Dimension	Body style	
	Crew Cab 4x2	Crew Cab 4x4
(1) Overall height	1 929 mm (75.9 in)	2 038 mm (80.2 in)
(2) Track (Front / Rear)	1 745 mm (68.7 in) / 1 729 mm (68.1 in) ^{a,b}	1 736 mm (68.4 in) / 1 729 mm (68.1 in) ^{a,b}
(3) Overall width	1 988 mm (78.3 in) ^{a,b}	2 077 mm (79.0 in) ^{a,b}
(4) Wheelbase	3 967 mm (156.2 in) ^a / 4 379 mm (172.4 in) ^b	3 967 mm (156.2 in) ^a / 4 379 mm (172.4 in) ^b
(5) Overall length	6 242 mm (245.8 in) ^a / 6 654 mm (262.0 in) ^b	6 242 mm (245.8 in) ^a / 6 654 mm (262.0 in) ^b
^a Short wheel base ^b Long wheel base		

F450

Dimension	Body style			
	Chassis Cab 4x2	Chassis Cab 4x4	Crew Cab 4x2	Crew Cab 4x4
(1) Overall height	2 044 mm (80.5 in)	2 051 mm (80.7 in)	2 053 mm (80.8 in)	2 056 mm (80.9 in)
(2) Track (Front / Rear)	1 736 mm (68.4 in) / 1 610 mm (63.4 in)	1 736 mm (68.4 in) / 1 610 mm (63.4 in)	1 736 mm (68.4 in) / 1 610 mm (63.4 in)	1 736 mm (68.4 in) / 1 610 mm (63.4 in)
(3) Overall width	2 025 mm (79.7 in)	2 376 mm (93.5 in)	2 376 mm (93.5 in)	2 376 mm (93.5 in)

Capacities and specifications

(4) Wheelbase	3 576 mm (140.8 in)	4 186 mm (164.8 in)	4 475 mm (176.2 in)	4 475 mm (176.2 in)
(5) Overall length	5 732 mm (225.7 in) ^a 6 341 mm (249.6 in) ^b	-	-	-
^a Short wheel base ^b Long wheel base				

F550

Dimension	Body style			
	Chassis Cab 4x2	Chassis Cab 4x4	Crew Cab 4x2	Crew Cab 4x4
(1) Overall height	2 076 mm (81.7 in)	2 075 mm (81.6 in)	2 067 mm (81.4 in)	2 066 mm (81.3 in)
(2) Track (Front / Rear)	1 736 mm (68.3 in) / 1 879 mm (74 in)	1 736 mm (68.3 in) / 1 879 mm (74 in)	1 736 mm (68.4 in) / 1 610 mm (63.4 in)	1 736 mm (68.4 in) / 1 610 mm (63.4 in)
(3) Overall width	2 025 mm (79.7 in)	2 376 mm (93.5 in)	2 376 mm (93.5 in)	2 376 mm (93.5 in)
(4) Wheelbase	3 576 mm (140.8 in)	3 576 mm (140.8 in)	4 475 mm (176.2 in)	4 475 mm (176.2 in)
(5) Overall length	5 732 mm (225.7 in) ^a 6 341 mm (249.6 in) ^b	-	-	-
^a Short wheel base ^b Long wheel base				

Capacities and specifications

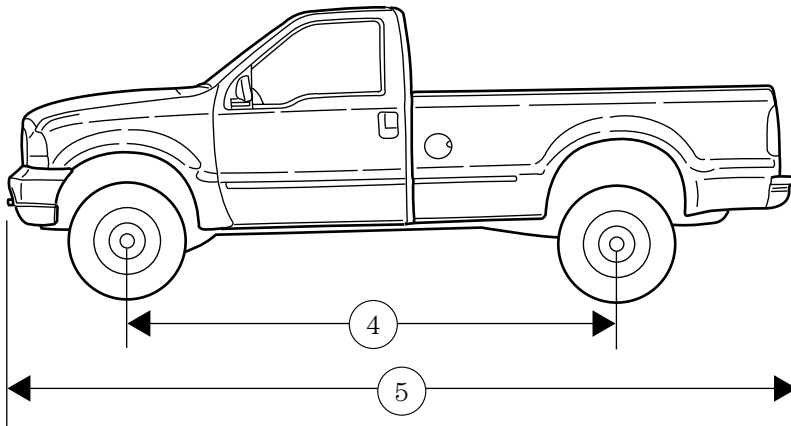
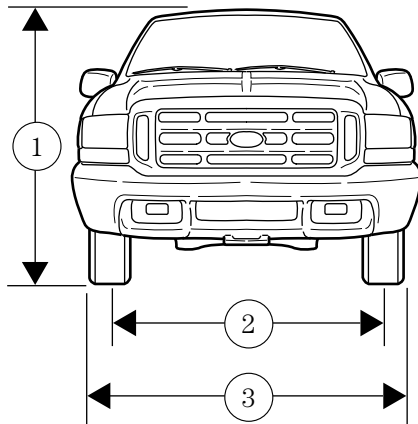

Capacities and specifications

IDENTIFYING YOUR VEHICLE

Certification label

The National Highway Traffic Safety Administration Regulations require that a Certification Label be affixed to a vehicle and prescribe where the Certification Label may be located. The Certification Label is located on the front door latch pillar on the driver's side.

MFD. BY FORD MOTOR CO. IN U.S.A.	
DATE: XXXXX	GVWR: XXXXX LB/ XXXXX KG
FGAWR: XXXXX/XXXXXXXX	RGAWR: XXXXX/XXXXXXXX
THIS VEHICLE CONFORMS TO ALL APPLICABLE FEDERAL MOTOR VEHICLE SAFETY STANDARDS IN EFFECT ON THE DATE OF MANUFACTURE SHOWN ABOVE.	
VIN: XXXXXXXXXXXXXXXXXXXX	TYPE: XXXXXXXXXXXXXXXX
	
MAXIMUM LOAD=OCCUPANTS + LUGGAGE=XXXKG/XXXLB	
OCCUPANTS: X TOTAL X FR X 2ND X RR OCCUPANTS LUGGAGE	
XX XXXKG/XXXLB	
TIRE: XXXX/XXXXX XXX X XXXKG/XXXLB	
PRESSURE (FR) XXX kPa/33 PSI COLD	
PRESSURE (RR) XXX kPa/33 PSI COLD	
TRAILER TOWING - SEE OWNER GUIDE	
EXT PNT: XXXXX XXXXX	RC: XX DSO: XXXX F0000
BAR INT TR TP/PS TR AXLE TR SPR T0000	
X XX XXX X XX X XXXX	
UTC VFOHT-15294A10-GA	

Vehicle identification number

The vehicle identification number is attached to a metal tag and is located on the driver side instrument panel.



Engine number

The engine number (the last eight numbers of the vehicle identification number) is stamped on the engine block, transmission, frame and transfer case (if equipped).

Customer assistance

GETTING ROADSIDE ASSISTANCE

To fully assist you should you have a vehicle concern, Ford offers a complimentary roadside assistance program. This program is separate from the New Vehicle Limited Warranty. The service is available:

- 24-hours, seven days a week
- for the Basic warranty period (Canada) or New Vehicle Limited Warranty period (U.S.) of three years or 60,000 km (36,000 miles), whichever comes first on Ford and Mercury vehicles, and four years or 80,000 km (50,000 miles) on Lincoln vehicles

In the United States, you may purchase additional roadside assistance coverage beyond this period through the Ford Auto Club by contacting your Ford or Lincoln-Mercury dealer.

Roadside assistance will cover:

- changing a flat tire
- jump-starts
- lock-out assistance
- fuel delivery
- towing to the nearest Ford of Canada or Ford Motor Company dealership, or towing to your selling dealership if within 56 km (35 miles). Even non-warranty related tows, like accidents or getting stuck in the mud or snow, are covered (some exclusions apply, such as impound towing or repossession).

Using roadside assistance

Complete the roadside assistance identification card and place it in your wallet for quick reference. In the United States, this card is found in the Owner Guide portfolio in the glove compartment in Ford vehicles and is mailed to you if you own a Mercury or Lincoln. In Canada, it's found in the Roadside Assistance book in the glove compartment.

To receive roadside assistance in the United States for Ford or Mercury vehicles, call 1-800-241-3673 or if you own a Lincoln vehicle, call 1-800-521-4140. In Canada call 1-800-665-2006.

Should you need to arrange assistance for yourself, Ford will reimburse a reasonable amount. To obtain information about reimbursement, call 1-800-241-3673 in the United States for Ford or Mercury vehicles; or if you own a Lincoln vehicle, call 1-800-521-4140. Call 1-800-665-2006 in Canada.

Customer assistance

Ford extended service plan

You can get more protection for your new car or light truck by purchasing Ford Extended Service Plan (Ford ESP) coverage. Ford ESP is an optional service contract which is backed by Ford Motor Company or Ford Motor Service Company (in the U.S.) and Ford of Canada (in Canada). It provides:

- Protection against repair costs after your New Vehicle Limited Warranty period expires;
- and
- Other benefits during the warranty period (such as reimbursement for rentals and towing.)

You may purchase Ford ESP from any participating Ford or Lincoln-Mercury or Ford of Canada dealer. There are several plans available in various time, distance and deductible combinations which can be tailored to fit your own driving needs. Ford ESP also offers reimbursement benefits for towing and rental coverage. (In Hawaii, rules vary. See your dealer for details.)

When you buy Ford ESP, you receive Peace-of-Mind protection throughout the United States and Canada, provided by a network of more than 5,200 participating Ford, Lincoln-Mercury and Ford of Canada dealers.

If you did not take advantage of the Ford Extended Service Plan at the time of purchasing your vehicle, you may still be eligible. Please contact your dealer for further information. Since this information is subject to change, please ask your dealer for complete details about Ford Extended Service Plan coverage options.

Also, please be aware that some dealers offer service contracts that are not backed by Ford Motor Company or Ford of Canada. On the surface, many independent plans appear to be like Ford's. The problem is that they can often require the use of non-factory approved parts and have much more complex and restrictive claims coverage terms than Ford.

At Ford Motor Company and Ford of Canada, we are dedicated to providing Ford, Lincoln and Mercury vehicle owners with programs that will enhance your ownership experience and protect you from unexpected repair bills. Genuine Ford ESP is the only Extended Service Plan that enables us to provide that service.

Customer assistance

Getting the service you need

At home

Ford Motor Company and Ford of Canada have authorized dealerships to service your vehicle. When you need warranty repairs your selling dealer would like you to return to it for that service, but you may also take your vehicle to another Ford Motor Company dealership authorized for warranty repairs. Certain warranty repairs require special training though, so not all dealers are authorized to perform all warranty repairs. That means that depending on the warranty repair needed, the vehicle may need to be taken to another dealer. If a particular dealership can not assist you, then contact the Customer Assistance Center.

If you are not satisfied with the service you receive at the dealership, speak with the service manager. If you are still not satisfied, speak with the owner or general manager of the dealership. In most cases, your concern will be resolved at this level.

Ford Motor Company and Ford of Canada dealerships also carry genuine Ford parts and accessories, providing you with original equipment reliability.

Away from home

If you are away from home when your vehicle needs service, or if you need more help than the dealership could provide, contact the Ford Customer Assistance Center to find an authorized dealership to help you. In the United States:

Ford Motor Company
Customer Assistance Center
16800 Executive Plaza Drive
P.O. Box 6248
Dearborn, Michigan 48121
1-800-392-3673 (FORD)
(TDD for the hearing impaired: 1-800-232-5952)

In Canada:
Customer Assistance Centre
Ford Motor Company of Canada, Limited
P.O. Box 2000
Oakville, Ontario L6J 5E4
1-800-565-3673 (FORD)

Customer assistance

Please have the following information available when contacting Ford Customer Assistance:

- Your telephone number (home and business)
- The name of the dealer and the city where the dealership is located
- The year and make of your vehicle
- The date of vehicle purchase
- The current odometer reading
- The vehicle identification number (VIN)

If you still have a complaint involving a warranty dispute, you may wish to contact the Dispute Settlement Board (U.S.) or the Mediation/Arbitration Program (Canada).

In the United States, a warranty dispute must be submitted to the Dispute Settlement Board before taking action under the Magnuson-Moss Warranty Act, or to the extent allowed by state law, before pursuing replacement or repurchase remedies provided by certain state laws. This dispute handling procedure is not required prior to enforcing state created rights or other rights which are independent of the Magnuson-Moss Warranty Act or state replacement or repurchase laws.

THE DISPUTE SETTLEMENT BOARD

The Dispute Settlement Board is:

- an independent, third-party arbitration program for warranty disputes
- available free to owners and lessees of qualifying Ford Motor Company vehicles

The Dispute Settlement Board may not be available in all states. Ford Motor Company reserves the right to change eligibility limitations, modify procedures and/or to discontinue this service without notice and without incurring obligations per applicable state law.

What kinds of cases does the Board review?

Unresolved warranty repair concerns or vehicle performance as designed concerns on Ford, Mercury and Lincoln cars and Ford or Mercury light trucks which are within the terms of any applicable written new vehicle warranty are eligible for review, except those involving:

- a non-Ford product
- a non-Ford dealership

Customer assistance

- sales disputes between customer and dealer except those associated with warranty repairs or concerns with the vehicle's performance as designed
- a request for reimbursement of consequential expenses unless a service or product concern being reviewed
- items not covered by the New Vehicle Limited Warranty (including maintenance and wear items)
- alleged personal injury/property damage claims
- cases currently in litigation
- vehicles not used primarily for family, personal or household purposes (except in states where the Dispute Settlement Board is required to review commercial vehicles)
- vehicles with non-U.S. warranties

Concerns are ineligible for review if the New Vehicle Limited Warranty has expired at receipt of your application and, in certain states of eligibility is dependent upon the customer's possession of the vehicle.

Eligibility may differ according to state law. For example, see the unique brochures for California, West Virginia, Georgia and Wisconsin purchasers/lessees.

Board membership

The Board consists of:

- three consumer representatives
- a Ford or Lincoln/Mercury dealership representative

Consumer candidates for Board membership are recruited and trained by an independent consulting firm. The dealership Board member is chosen from Ford and Lincoln-Mercury dealership management, recognized for their business leadership qualities.

What the Board needs

To have your case reviewed you must complete the application in the DSB brochure and mail it to the address provided on the application form.

Your application is reviewed and, if it is determined to be eligible, you will receive an acknowledgment indicating:

- the file number assigned to your application
- the toll-free phone number of the DSB's independent administrator

Customer assistance

Your dealership and a Ford Motor Company representative are asked to submit statements at this time.

To properly review your case, the Board needs the following information:

- legible copies of all documents and maintenance or repair orders relevant to the case
- the year, make, model, and Vehicle Identification Number (VIN) listed on your vehicle ownership license
- the date of repair(s) and mileage at the time of occurrence(s)
- the current mileage
- the name of the dealer who sold or serviced the vehicle
- a brief description of your unresolved concern
- a brief summary of the action taken by the dealer(s) and Ford Motor Company
- the names (if known) of all the people you contacted at the dealership(s)
- a description of the action you expect to resolve your concern

You will receive a letter of explanation if your application does not qualify for Board review.

Oral presentations

If you would like to make an oral presentation, indicate YES to question #6 on the application. While it is your right to make an oral presentation before the Board, this is not a requirement and the Board will decide the case whether or not an oral presentation is made. Oral presentation may be requested by the Board as well.

Making a decision

Board members review all available information related to each complaint, including oral presentations, and arrive at a fair and impartial decision.

Every effort is made to decide the case within 40 days of the date that all requested information is received by the Board. Since the Board generally meets once a month, it may take more than a month before the Board can consider some cases.

After a case is reviewed, the Board mails you a decision letter and a form on which to accept or reject the Board's decision. The decisions of

Customer assistance

the Board are binding on Ford (and, in some cases, on the dealer) but not on consumers who are free to pursue other remedies available to them under state or federal law.

To Request a DSB Brochure/Application

For a brochure/application, speak to your dealer or write/call to the Board at the following address/phone number:

Dispute Settlement Board
P.O. Box 5120
Southfield, MI 48086-5120
1-800-428-3718

You may also contact the North American Customer Assistance Center at 1-800-392-3673 (Ford), TDD for the hearing impaired: 1-800-232-5952 or by writing to the Center at the following address:

Ford Motor Company
Customer Assistance Center
16800 Executive Plaza Drive
P.O. Box 6248
Dearborn, Michigan 48121

GETTING ASSISTANCE OUTSIDE THE U.S. AND CANADA

Before exporting your vehicle to a foreign country, contact the appropriate foreign embassy or consulate. These officials can inform you of local vehicle registration regulations and where to find unleaded fuel.

If you cannot find unleaded fuel or can only get fuel with an anti-knock index lower than is recommended for your vehicle, contact a district or owner relations/customer assistance office.

The use of leaded fuel in your vehicle without proper conversion may damage the effectiveness of your emission control system and may cause engine knocking or serious engine damage. Ford Motor Company/Ford of Canada is not responsible for any damage caused by use of improper fuel.

In the United States, using leaded fuel may also result in difficulty importing your vehicle back into the U.S.

If your vehicle must be serviced while you are traveling or living in Central or South America, the Caribbean, or the Middle East, contact the nearest Ford dealership. If the dealership cannot help you, write or call:

Customer assistance

FORD MOTOR COMPANY
WORLDWIDE DIRECT MARKET OPERATIONS
1555 Fairlane Drive
Fairlane Business Park #3
Allen Park, Michigan 48101
U.S.A.
Telephone: (313) 594-4857
FAX: (313) 390-0804

If you are in another foreign country, contact the nearest Ford dealership. If the dealership employees cannot help you, they can direct you to the nearest Ford affiliate office.

If you buy your vehicle in North America and then relocate outside of the U.S. or Canada, register your vehicle identification number (VIN) and new address with Ford Motor Company Worldwide Direct Market Operations.

FORD ACCESSORIES FOR YOUR VEHICLE

Ford has many quality products available from your dealer to clean your vehicle and protect its finishes. For best results, use the following or products of equivalent quality:

Ford Custom Clearcoat Polish*
Ford Custom Silicone Gloss Polish
Ford Custom Vinyl Protectant*
Ford Deluxe Leather and Vinyl Cleaner
Ford Extra Strength Tar and Road Oil Remover*
Ford Extra Strength Upholstery Cleaner
Ford Metal Surface Cleaner
Ford Multi-Purpose Cleaner*
Motorcraft Car Wash Concentrate
Motorcraft Carlite Glass Cleaner
Ford Spot and Stain Remover*
Ford Super Premium Tire and Trim Dressing
Ford Triple Clean
Ford Ultra-Clear Spray Glass Cleaner

* May be sold with the Motorcraft name

Customer assistance

A wide selection of accessories is available through your local authorized Ford, Lincoln-Mercury or Ford of Canada dealer. These quality accessories have been specifically engineered to fulfill your automotive needs; they are custom designed to complement the style and aerodynamic appearance of your vehicle. In addition, each accessory is made from high quality materials and meets or exceeds Ford's rigid engineering and safety specifications. Ford accessories are warranted for up to 12 months or 20,000 km (12,000 miles) on all cars and light trucks and 12 months with unlimited distance on medium/heavy duty trucks unless the accessory is installed on a new vehicle, then the warranty becomes the balance of the new vehicle's warranty or the accessories warranty, whichever is greater. See your dealer for complete warranty information and availability.

Not all accessories are available for all models.

Vehicle Security

- Remote keyless entry
- Styled wheel protector locks
- Vehicle security systems

Comfort and convenience

- Air conditioner
- Air filtration systems
- Cargo nets
- Cargo organizers
- Cargo shades
- Cargo trays
- Dash trim
- Engine block heaters
- Gear shift knob
- Luggage presenter (Continental only)
- Manual sliding rear window
- Tire step

Customer assistance

Travel equipment

Console
Console armrest
Daytime running lights
Factory luggage rack
Factory luggage rack adaptors
Fog lights
Framed luggage covers
Heavy-duty battery
Neutral towing transfer case kit (Explorer 4.0L only)
Off road lights
Pickup box rails
Removable luggage rack
Removable luggage rack adapters
Retractable bed hooks and loops
Running boards
Snow traction cables
Soft luggage cover
Speed control
Towing mirrors
Trailer hitch
Trailer hitch bars and balls
Trailer hitch wiring adaptor

Protection and appearance equipment

Air bag anti-theft locks
Bed mat/bedliner tailgate covers
Bed mats
Bedliners
Car/truck covers
Cargo liners, interior

Customer assistance

Carpet floor mats
Cleaners, waxes and polishes
Flat splash guards
Front end covers (full and mini)
Hood deflectors
Locking gas cap
Lubricants and oils
Molded splash guards
Molded vinyl floor mats
Rallye bars
Rear air deflectors
Rear decklid spoilers
Side window air deflectors
Spare tire lock
Step bumpers
Step/sill plates
Tailgate covers
Tailgate lock
Tailgate protector
Tonneau covers
Touch-up paint
Universal floor mats

For maximum vehicle performance, keep the following information in mind when adding accessories or equipment to your vehicle:

- When adding accessories, equipment, passengers and luggage to your vehicle, do not exceed the total weight capacity of the vehicle or of the front or rear axle (GVWR or GAWR as indicated on the Safety compliance certification label). Consult your dealer for specific weight information.

Customer assistance

- The Federal Communications Commission (FCC) and Canadian Radio Telecommunications Commission (CRTC) regulate the use of mobile communications systems - such as two-way radios, telephones and theft alarms - that are equipped with radio transmitters. Any such equipment installed in your vehicle should comply with FCC or CRTC regulations and should be installed only by a qualified service technician.
- Mobile communications systems may harm the operation of your vehicle, particularly if they are not properly designed for automotive use or are not properly installed. When operated, such systems may cause the engine to stumble or stall. In addition, such systems may be damaged or their performance may be affected by operating your vehicle. (Citizens band [CB] transceivers, garage door openers and other transmitters with outputs of five watts or less will not ordinarily affect your vehicle's operation.)
- Ford cannot assume responsibility for any adverse effects or damage that may result from the use of such equipment.

ORDERING ADDITIONAL OWNER'S LITERATURE

To order the publications in this portfolio in the United States:

Make checks payable to:

HELM, INCORPORATED
P.O. Box 07150
Detroit, Michigan 48207

For a free publication catalog, order toll free: 1-800-782-4356

Monday-Friday 8:00 a.m. - 6:00 p.m. EST,
for credit card holders only

To order the publications in this portfolio in Canada:

Make cheques payable to:

Ford Motor Company of Canada, Ltd.
Service Publications
P.O. Box 1580, Station B
Mississauga, Ontario, Canada L4Y 4G3

or order toll free: 1-800-387-4966

Monday-Friday 8:00 a.m. - 6:00 p.m. EST,
for credit card holder orders only

Reporting safety defects

REPORTING SAFETY DEFECTS (U.S. ONLY)

If you believe that your vehicle has a defect that could cause a crash, or could cause injury or death, you should immediately inform the National Highway Traffic Safety Administration (NHTSA) in addition to notifying Ford Motor Company.



If NHTSA receives similar complaints, it may open an investigation, and if it finds that a safety defect exists in a group of vehicles, it may order a recall and remedy campaign. However, NHTSA cannot become involved in individual problems between you, your dealer or Ford Motor Company.

To contact NHTSA, you may either call the Auto Safety Hotline toll-free at 1-800-424-9393 (202-366-0123 in the Washington D.C. area) or write to:

NHTSA
U.S. Department of Transportation
400 Seventh Street
Washington D.C. 20590

You can also obtain other information about motor vehicle safety from the Hotline.

Index

- Accessory delay75
- Air bag supplemental restraint system92
 - and child safety seats93
 - description92
 - disposal96
 - driver air bag94
 - indicator light10,95
 - operation94
 - passenger air bag94
 - passenger deactivation switch ...96
- Air cleaner filter212
- Air conditioning24
- Ambulance packages3
- Automatic transmission116
 - driving an automatic overdrive117
 - fluid, refill capacities212
 - fluid, specification217
- Axle
 - lubricant specifications217
 - refill capacities212
 - traction lok115
- Battery187
 - acid, treating emergencies187
 - charging system warning light ...12
 - jumping a disabled battery163
 - maintenance-free187
 - replacement, specifications ...212
 - servicing187
 - voltage gauge16
- Brakes112
 - anti-lock112,113,114
 - anti-lock brake system (ABS) warning light11,113
 - brake warning light11
 - fluid, checking and adding175
 - fluid, refill capacities212
 - fluid, specifications215,217
 - lubricant specifications ...215,217
 - parking114
 - shift interlock116
- Break-in period2
- Capacities for refilling fluids212
- CD changer62
- Child safety restraints101
 - child safety belts101
 - child safety seats102
- Child safety seats102
 - attaching with tether straps ..106
 - built-in child seat102
 - in front seat103
 - in rear seat103
 - tether anchorage hardware ...106
- Cleaning your vehicle208
 - engine compartment209
 - exterior209
 - exterior lamps210
 - instrument panel210
 - interior210
 - plastic parts210
 - safety belts211
 - washing208
 - waxing209
 - wheels209
 - wiper blades210
- Clock33,39,49,59
- Clutch
 - fluid176
 - operation while driving119
 - recommended shift speeds120
- Compass, electronic19
 - calibration21
 - set zone adjustment20
- Console76
- Controls
 - power seat83
- Coolant178,180
 - checking and adding178
 - refill capacities180,212
 - specifications215,217
- Customer Assistance223
 - Ford accessories for your vehicle230

Index

- Ford Extended Service Plan ...224
- Getting assistance outside the
 - U.S. and Canada229
 - Getting roadside assistance ...223
 - Getting the service you need ...225
 - Ordering additional owner's literature234
 - The Dispute Settlement Board ...226
- Dipstick
 - engine oil172
- Doors
 - door ajar warning13
- Driveline universal joint and slip yoke186
- Driving under special conditions130,131
 - sand131
 - snow and ice132
 - through water131,134
- Emergencies, roadside
 - jump-starting163
- Emission control system202
- Engine217
 - check engine/service engine soon light8,9
 - coolant178
 - diesel3
 - idle speed control187
 - lubrication specifications ...215,217
 - refill capacities212
 - service points172
 - starting after a collision144
- Engine block heater110
- Engine oil172
 - checking and adding172,174
 - dipstick172
 - filter, specifications174,212
 - recommendations174
 - refill capacities172,212
 - specifications172,174,215,217
- Exhaust fumes110
- Fail safe cooling180
- Fluid capacities212
- Four-Wheel Drive vehicles ..12,125
 - control trac23
 - description128
 - driving off road130
 - electronic shift23,125,128
 - indicator light12,126
 - lever operated shift126
 - manual locking hubs126
- Fuel194
 - calculating fuel economy198
 - cap197
 - capacity212
 - choosing the right fuel196
 - comparisons with EPA fuel economy estimates201
 - detergent in fuel197
 - filling your vehicle
 - with fuel194,197,199
 - filter, specifications198,212
 - fuel pump shut-off switch144
 - improving fuel economy198
 - low fuel warning light8
 - octane rating196,217
 - quality197
 - running out of fuel197
 - safety information relating to automotive fuels194
- Fuses145,146
- Gas cap (see Fuel cap)197
- Gas mileage (see Fuel economy)198
- Gauges14
 - battery voltage gauge16
 - engine coolant temperature gauge15
 - engine oil pressure gauge17
 - odometer15
 - speedometer14
 - tachometer16
 - trip odometer16

Index

- GAWR (Gross Axle Weight Rating)132
 - calculating134
 - definition132
 - driving with a heavy load132
 - location132
- GVWR (Gross Vehicle Weight Rating)132
 - calculating132,134
 - definition132
 - driving with a heavy load132
 - location132
- Hazard flashers144
- Headlamps22
 - aiming208
 - daytime running lights22
 - flash to pass23,73
 - high beam12,22,72
 - turning on and off22
 - warning chime13
- Heating24
 - heater only system24
 - heating and air conditioning system26
- Hood171
- Ignition217
 - positions of the ignition66
 - removing the key124
- Infant seats (see Safety seats) ...102
- Inspection/maintenance (I/M) testing203
- Instrument panel
 - cleaning210
 - lighting up panel and interior23
 - location of components8
- Jump-starting your vehicle163
- Keys
 - key in ignition chime13
 - positions of the ignition66
- Lamps
 - autolamp system203
 - cargo lamps23
 - daytime running light22
 - headlamps22
 - headlamps, flash to pass23,73
 - instrument panel, dimming23
 - replacing
 - bulbs203,204,205,206,207
- Lane change indicator (see Turn signal)66
- Lights, warning and indicator8
 - air bag10
 - anti-lock brakes (ABS)11,113
 - brake11
 - charging system12
 - check coolant13
 - door ajar13
 - engine oil pressure13
 - high beam12
 - low fuel8
 - safety belt11
 - service engine soon8,9
 - turn signal indicator12
- Load limits132
 - GAWR132
 - GVWR132
 - trailer towing132
- Lubricant specifications215,217
- Lumbar support, seats84
- Manual transmission119
 - fluid capacities212
 - lubricant specifications217
- Message center17
 - english/metric button17
 - menu button18
- Mirrors
 - fold away76
 - side view mirrors (power)75
- Motorcraft parts198,212
- Octane rating196
- Odometer15
- Overdrive73
- Panic alarm feature, remote entry system78

Index

- Parking brake114
- Parts (see Motorcraft parts)212
- Power distribution box (see Fuses)149
- Power door locks75
- Power steering115
 - fluid, checking and adding182
 - fluid, refill capacity212
 - fluid, specifications215,217
- Radio29
- Relays145
- Remote entry system77,78
 - illuminated entry79
 - locking/unlocking doors77
 - panic alarm78
 - replacement/additional transmitters80
 - replacing the batteries78
- Safety belts (see Safety restraints)13,86,87,88,89
- Safety Compliance Certification Label222
- Safety defects, reporting235
- Safety restraints86,87,88,89
 - cleaning the safety belts ...91,211
 - extension assembly90
 - for adults87,88,89
 - for children100,101
 - lap belt89
 - warning light and chime11,13,90,91
- Safety seats for children102
- Seat belts (see Safety restraints)86
- Seats82
 - child safety seats102
 - cleaning211
- Servicing your vehicle169
- Snowplowing3,141,142
- Spark plugs, specifications212,217
- Special notice3,4
 - ambulance conversions3
 - diesel-powered vehicles3
 - four-wheel drive vehicles143
 - utility-type vehicles3
- Specification chart, lubricants215,217
- Speed control67
- Speedometer14
- Starting your vehicle107,109
 - jump starting163
- Steering wheel
 - tilting71
- Tachometer16
- Tailgate81
- Tilt steering wheel71
- Tires152,190,191
 - changing152,155
 - checking the pressure191
 - replacing193
 - rotating191
 - snow tires and chains193
 - tire grades191
 - treadwear190
- Towing
 - recreational towing140
 - wrecker168
- Traction-lok rear axle115
- Transfer case
 - fluid checking186
- Transmission116
 - automatic operation116
 - fluid, checking and adding (automatic)182
 - fluid, checking and adding (manual)185
 - fluid, refill capacities212
 - lubricant specifications217
 - manual operation119
- Transmission control indicator light11
- Trip odometer16
- Turn signal12,66

Index

Vehicle Identification Number (VIN)	222
Vehicle loading	132
Ventilating your vehicle	111
Warning chimes	13
Warning lights (see Lights)	8
Washer fluid	177
Water, Driving through	134
Windows	
power	74
Windshield washer fluid and wipers	
checking and cleaning	189
operation	72
replacing wiper blades	189
Wrecker towing	168

Filling station information

Item	Information
Required fuel	Unleaded fuel only - 87 octane
Fuel tank capacity	Refer to <i>Refill capacities</i> in the <i>Capacities and specifications</i> chapter.
Engine oil (includes filter change)	5.7L (6.0 quarts). Use Motorcraft 5W30 Super Premium Motor Oil, Ford specification WSS-M2C153-G.
Tire size and pressure	Refer to the Certification Label inside of driver's door
Hood release	Pull handle under the left side of the instrument panel.
Coolant capacity	Refer to <i>Refill capacities</i> in the <i>Capacities and specifications</i> chapter.
Power steering fluid capacity	Fill to line on reservoir. Use Motorcraft MERCON® ATF.
Manual transmission-5-speed	3.2L (3.4 quarts). Use Synthetic MERCON® ATF.
Manual transmission-6-speed	5.5L (5.8 quarts). Use Motorcraft MERCON® ATF.
Automatic transmission fluid capacity ¹ (with 20 plate oil-to-air cooler)	16.1L (17.1 quarts). Use Motorcraft MERCON® ATF. ²
Automatic transmission fluid capacity ¹ (with 26 plate oil-to-air cooler)	16.7L (17.7 quarts). Use Motorcraft MERCON® ATF. ²

¹ Ensure the correct automatic transmission fluid is used. Transmission fluid requirements are indicated on the dipstick or on the dipstick handle. MERCON® and MERCON® V are not interchangeable. DO NOT mix MERCON® and MERCON® V. Refer to your Scheduled Maintenance Guide to determine the correct service interval.

² Indicates only approximate dry-fill capacity. Some applications may vary based on cooler size and if equipped with in-tank cooler. The transmission fluid level should be set by the indication on the dipstick.