

# Contents

## Before driving

Introduction	2
--------------	---

Instrumentation	4
-----------------	---

Controls and features	23
-----------------------	----

Seating and safety restraints	91
-------------------------------	----

## Starting and driving

Starting	112
----------	-----

Driving	117
---------	-----

Roadside emergencies	132
----------------------	-----

## Servicing

Maintenance and care	148
----------------------	-----

Capacities and specifications	187
-------------------------------	-----

Customer assistance	192
---------------------	-----

Reporting safety defects	204
--------------------------	-----

Index	205
-------	-----

All rights reserved. Reproduction by any means, electronic or mechanical including photocopying, recording or by any information storage and retrieval system or translation in whole or part is not permitted without written authorization from Ford Motor Company.

# Introduction

## ICONS

Indicates a safety alert. Read the following section on *Warnings*.



Indicates vehicle information related to recycling and other environmental concerns will follow.



Correct vehicle usage and the authorized disposal of waste cleaning and lubrication materials are significant steps towards protecting the environment.

Indicates a message regarding child safety restraints. Refer to *Seating and safety restraints* for more information.



Indicates that this Owner Guide contains information on this subject. Please refer to the Index to locate the appropriate section which will provide you more information.



## WARNINGS

Warnings provide information which may reduce the risk of personal injury and prevent possible damage to others, your vehicle and its equipment.

## BREAKING-IN YOUR VEHICLE

There are no particular breaking-in rules for your vehicle. During the first 1 600 km (1 000 miles) of driving, vary speeds frequently. This is necessary to give the moving parts a chance to break in.

## INFORMATION ABOUT THIS GUIDE

The information found in this guide was in effect at the time of printing. Ford may change the contents without notice and without incurring obligation.

### **SPECIAL NOTICES**

#### **Notice to owners of Severe Duty vehicles**

Before you drive your vehicle, be sure to read the “Severe Duty Owner’s Guide Supplement.” This book contains important operation and maintenance information.

#### **Notice to owners of natural gas fueled vehicles**

Before you drive your vehicle, be sure to read the “Natural Gas Vehicle Owner’s Guide Supplement.” This book contains important operation and maintenance information.

# Instrumentation

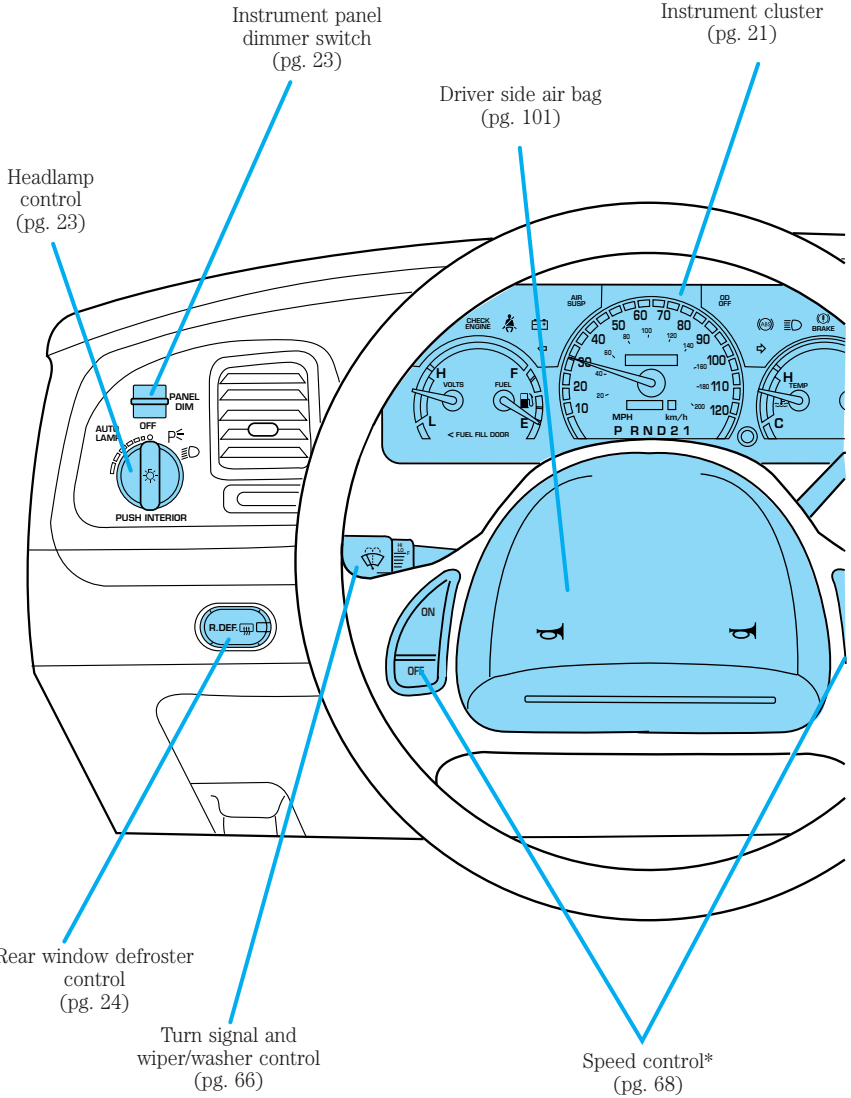

\*If equipped

# Instrumentation

Gearshift  
(w/overdrive button)  
(pg. 125)

Electronic sound system  
(pg. 34)

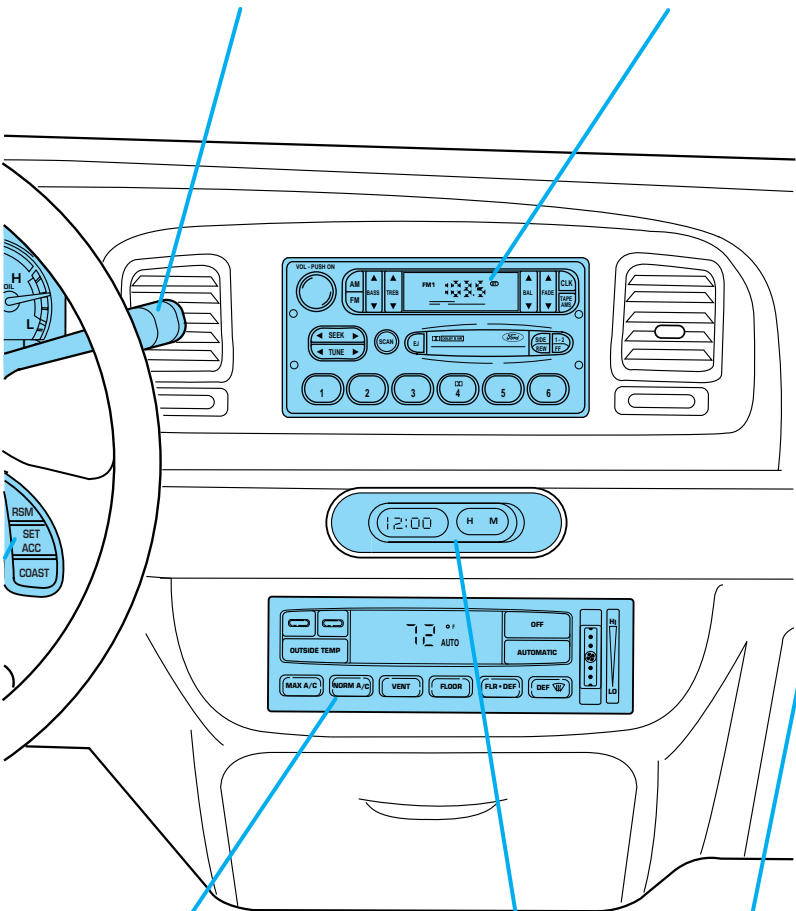

Climate control systems  
(pg. 25)

Clock  
(pg. 33)

Traction control switch\*  
(pg. 120)

# Instrumentation

## WARNING LIGHTS AND CHIMES

### Standard instrument cluster

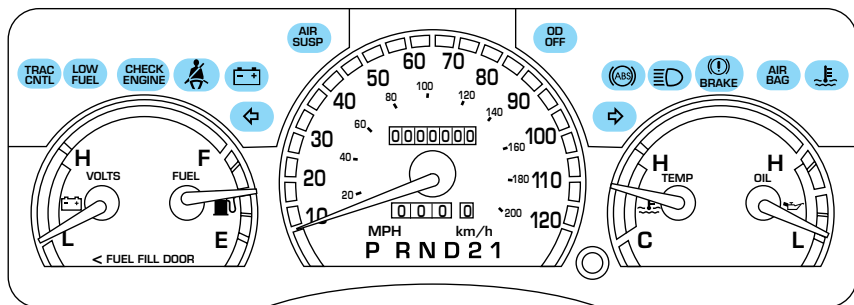

### Optional instrument cluster

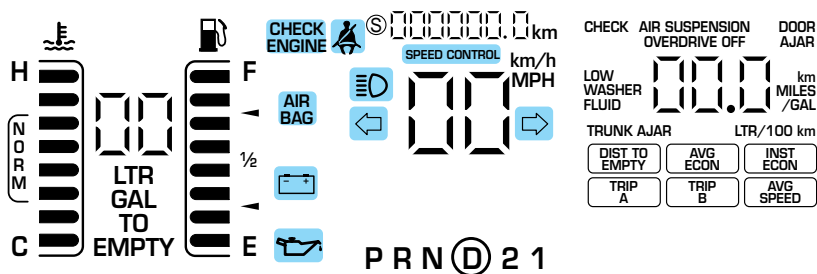

### Low fuel

Illuminates as an early reminder of a low fuel condition indicated on the fuel gauge. The light comes on when there is approximately 1/16th of a tank indicated on the fuel gauge

(refer to *Fuel Gauge* in this chapter for more information). The ignition must be in the ON position for this lamp to illuminate. The lamp will also illuminate for several seconds after the ignition is turned to the ON position regardless of the fuel level.



### Check engine

Your vehicle is equipped with a computer that monitors the engine's emission control system. This system is commonly known as the On Board Diagnostics System (OBD II). This

OBD II system protects the environment by ensuring that your vehicle continues to meet government emission standards. The OBD II system also assists the service technician in properly servicing your vehicle.

The *Check Engine* indicator light illuminates when the ignition is first turned to the ON position to check the bulb. If it comes on after the engine is started, one of the engine's emission control systems may be malfunctioning. The light may illuminate without a driveability concern being noted. The vehicle will usually be drivable and will not require towing.

## CHECK ENGINE

### ***What you should do if the check engine light illuminates***

#### **Light turns on solid:**

This means that the OBD II system has detected a malfunction.

Temporary malfunctions may cause your *Check Engine* light to illuminate. Examples are:

1. The vehicle has run out of fuel. (The engine may misfire or run poorly.)
2. Poor fuel quality or water in the fuel.
3. The fuel cap may not have been properly installed and securely tightened.

These temporary malfunctions can be corrected by filling the fuel tank with good quality fuel and/or properly installing and securely tightening the gas cap. After three driving cycles without these or any other temporary malfunctions present, the *Check Engine* light should turn off. (A driving cycle consists of a cold engine startup followed by mixed city/highway driving.) No additional vehicle service is required.

If the *Check Engine* light remains on, have your vehicle serviced at the first available opportunity.

#### **Light is blinking:**

Engine misfire is occurring which could damage your catalytic converter. You should drive in a moderate fashion (avoid heavy acceleration and deceleration) and have your vehicle serviced at the first available opportunity.

## Instrumentation



Under engine misfire conditions, excessive exhaust temperatures could damage the catalytic converter, the fuel system, interior floor coverings or other vehicle components, possibly causing a fire.

### Air bag readiness

Momentarily illuminates when the ignition is turned ON. If the light fails to illuminate, continues to flash or remains on, have the system serviced immediately.

AIR  
BAG

### Safety belt

Momentarily illuminates when the ignition is turned to the ON position to remind you to fasten your safety belts. For more information, refer to the *Seating and safety restraints* chapter.



### Brake system warning (if equipped)

Momentarily illuminates when the ignition is turned to the ON position, the engine is off and the parking brake is engaged. If brake warning lamp does not illuminate at this time, seek service immediately. Illumination after releasing the parking brake indicates low brake fluid level and the brake system should be inspected immediately.

(!)  
BRAKE

### Anti-lock brake system (ABS) (If equipped)

Momentarily illuminates when the ignition is turned on and the engine is off. If the light does not illuminate momentarily at start up, remains on or continues to flash, the ABS needs to be serviced. With the ABS light on, the anti-lock brake system is disabled and normal braking is still effective unless the brake warning light also remains illuminated with parking brake released.





## Turn signal

Illuminates when the left or right turn signal or the hazard lights are turned on. If one or both of the indicators stay on continuously or flash faster, check for a burned-out turn signal bulb. Refer to *Exterior bulbs* in the *Maintenance and care* chapter.

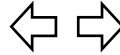

## High beams

Illuminates when the high beam headlamps are turned on.



## Charging system

Illuminates when the ignition is turned to the ON position and the engine is off. The light also illuminates when the battery is not charging properly, requiring electrical system service.

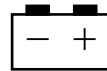

## Engine oil pressure (if equipped)

Illuminates when the oil pressure falls below the normal range. Stop the vehicle as soon as safely possible and switch off the engine immediately. Check the oil level and add oil if needed. Refer to *Engine oil* in the *Maintenance and Care* chapter.

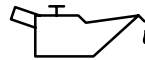

This lamp also illuminates when the ignition is turned to ON and the engine is off.

## Engine coolant temperature

Illuminates when the engine coolant temperature is high. Stop the vehicle as soon as safely possible, switch off the engine and let it cool.



## Instrumentation



Never remove the coolant recovery cap while the engine is running or hot.

Refer to *Engine coolant* in the *Maintenance and care* chapter. If light stays on or continues to turn on after the vehicle warms up, have your vehicle serviced.

This light also illuminates briefly when the ignition key is turned to ON.

### **Air suspension (if equipped)**

This light tells you if the air suspension needs repair or if the air suspension switch is OFF. For information on the air suspension system, refer to the *Driving* chapter.

AIR  
SUSP

### **O/D off**

Illuminates when the ignition is turned to the ON position and transmission control switch has been pushed. When the light is on, the transmission does not shift into overdrive. If the light does not come on when the transmission control switch is depressed or if the light flashes when you are driving, have your vehicle serviced.

O/D  
OFF

### **Traction Control™ active (if equipped)**

Flashes when the Traction Control™ system begins applying and releasing the brakes and adjusting the engine characteristics to limit a wheelspin condition. It will be lit for a minimum of four seconds or for the duration of the Traction Control™ event.

TRAC  
CNTL

If the Traction Control™ indicator comes on or stays lit, either:

- the Traction Control™ system needs service, or

- the customer has disabled the system using the traction control switch.

For more information, refer to the *Driving* chapter.

## Safety belt warning chime

Chimes to remind you to fasten your safety belts.

For information on the safety belt warning chime, refer to the *Seating and safety restraints* chapter.

## Supplemental restraint system (SRS) warning chime

For information on the SRS warning chime, refer to the *Seating and safety restraints* chapter.

## Key-in-ignition warning chime

Sounds when the key is left in the ignition in the OFF/LOCK or ACC position and the driver's door is opened.

## Headlamps on warning chime

Sounds when the headlamps or parking lamps are on, the ignition is off (and the key is not in the ignition) and the driver's door is opened.

## Turn signal chime

Sounds when the turn signal lever has been activated to signal a turn and the vehicle is driven more than 0.8 km (1/2 mile).

## GAUGES

### Standard instrument cluster gauges

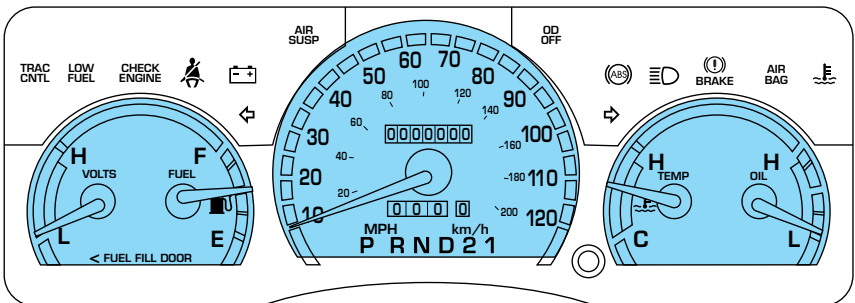

# Instrumentation

## Optional instrument cluster gauges

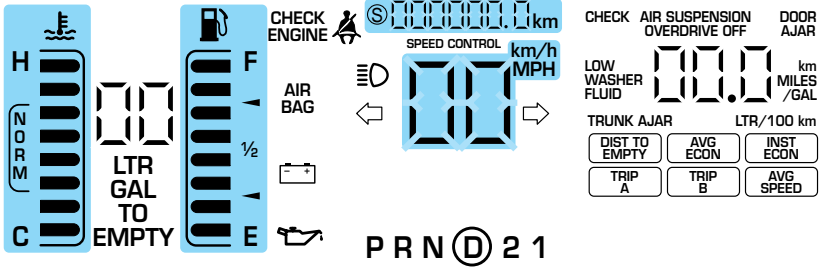

## Fuel gauge

Displays approximately how much fuel is in the fuel tank (when the key is in the ON position). The fuel gauge may vary slightly when the vehicle is in motion. The ignition should be in the OFF position while the vehicle is being refueled. When the gauge first indicates empty, there is a small amount of reserve fuel in the tank. When refueling the vehicle from empty indication, the amount of fuel that can be added will be less than the advertised capacity due to the reserve fuel.

- Standard instrument cluster

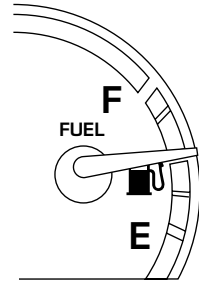

## Instrumentation

- Optional instrument cluster

This shows the approximate amount of fuel in the fuel tank in whole numbers (liters or gallons). If your tank is full or nearly full, the display will be “F”. If your tank is empty or nearly empty, the display will be “E”.



### Speedometer

Indicates the current vehicle speed.

- Standard instrument cluster

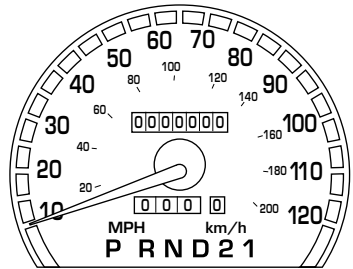

- Optional instrument cluster



# Instrumentation

## Odometer

Registers the total kilometers (miles) of the vehicle.

- Standard instrument cluster

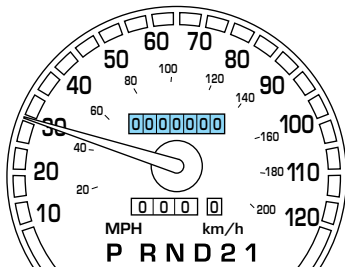

- Optional instrument cluster



Refer to *Electronic Message Center* for information on how to switch the display from metric to English measurements.

## Trip odometer

Registers the kilometers (miles) of individual journeys. To reset, depress the control.

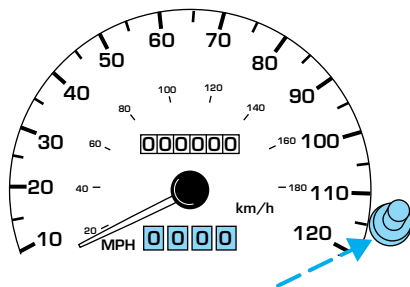

Refer to *Electronic Message Center* for Trip A and Trip B features on the optional instrument cluster.

## Engine coolant temperature gauge

Indicates the temperature of the engine coolant. At normal operating temperature, the needle remains within the normal area (the area between the “H” and “C”). If it enters the red section, the engine is overheating. Stop the vehicle as soon as safely possible, switch off the ignition and let it cool. Refer to *Engine coolant* in the *Maintenance and care* chapter.



Never remove the coolant recovery cap while the engine is running or hot.

- Standard instrument cluster

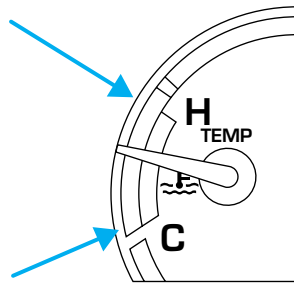

- Optional instrument cluster



This gauge indicates the temperature of the engine coolant, not the coolant level. If the coolant is not at its proper level the gauge indication will not be accurate. If the gauge enters the red section, the engine coolant and *Check Engine/Service Engine Soon* indicators illuminate, refer to *What you should know about fail-safe cooling* in the *Maintenance and care* chapter.

## Instrumentation

### Battery voltage gauge (if equipped)

This gauge shows the battery voltage when the ignition is in the ON position. If the pointer moves and stays outside the normal operating range (as indicated), have the vehicle's electrical system checked as soon as possible.

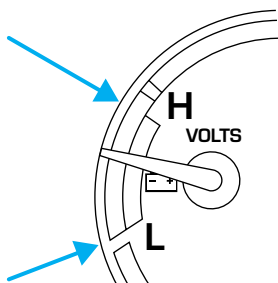

### Engine oil pressure gauge (if equipped)

This shows the engine oil pressure in the system. Sufficient pressure exists as long as the needle remains in the normal range (the area between the "H" and "L").

If the gauge indicates low pressure, stop the vehicle as soon as safely possible and switch off the engine immediately. Check the oil level.

Add oil if needed (refer to *Engine oil* in the *Maintenance and care* chapter). If the oil level is correct, have your vehicle checked at your dealership or by a qualified technician.

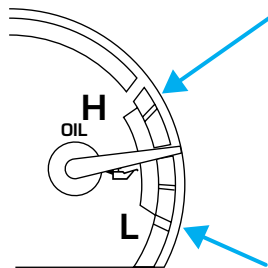

## ELECTRONIC MESSAGE CENTER

The electronic message center only works when the ignition is in the ON position.

The message center allows you to:

- see problems such as door ajar, air suspension, trunk ajar, washer fluid low
- see how many kilometers/miles you can drive before running out of fuel

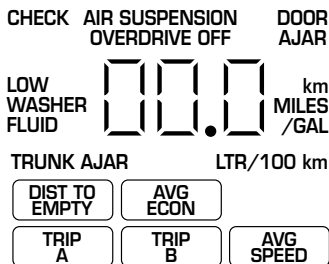



- see when overdrive has been deactivated
- monitor the average fuel economy
- check the distance traveled during a trip on either Trip A or Trip B
- monitor the average speed

## Selectable features

### **Reset**

Press this control to reset the selected message center function to zero. The only functions which can be reset are:

- AVG ECON
- TRIP A or TRIP B
- AVG SPEED

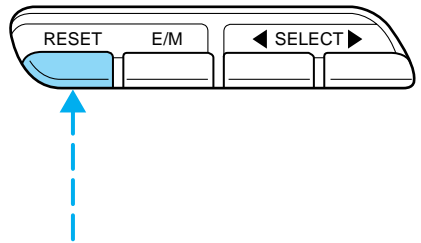

### **E/M**

Press this control to switch the electronic instrument cluster display and the message center display from metric to English units.

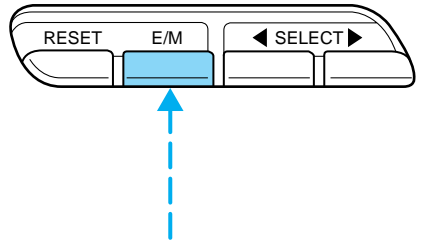

### **Select**

Each press of the SELECT control will select a different function.

Press the right side of the control to advance the function to the right, and press the left side of the control to advance the function to the left.

To reset any function:

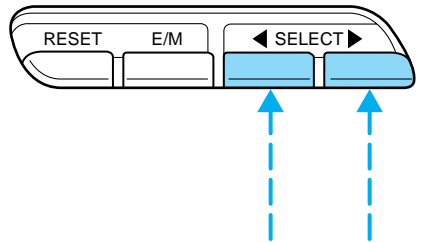

## Instrumentation

1. Push either the right or left side of the SELECT control to choose the desired function.
2. Press the RESET control and the selected message center function will be reset to zero.

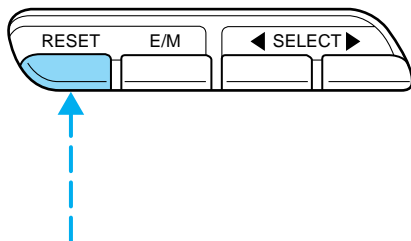

### Message center functions

#### ***DIST TO EMPTY (DTE)***

This function estimates approximately how far you can drive with the fuel remaining in your tank under normal driving conditions.

Remember to turn the ignition OFF when refueling your vehicle.

Otherwise, the display will not show the addition of fuel for a few miles. At least 9.5 liters (2.5 gallons) of fuel must be added for the fuel gauge to immediately show the new fuel level.

The DTE function will flash for 5 seconds and sound a tone for 1 second when you have approximately:

- 80 km (50 miles) left before you run out of fuel
- 40 km (25 miles)
- 16 km (10 miles)

The message center will remain in the DTE function until the SELECT control is pressed to change functions.

Displayed DTE will not be equal to AVG ECON multiplied by the FUEL REMAIN value. DTE is calculated using a method that considers the fuel economy of the last 800 km (500 miles) driven.

<b>DIST TO EMPTY</b>	<b>AVG ECON</b>	
<b>TRIP A</b>	<b>TRIP B</b>	<b>AVG SPEED</b>

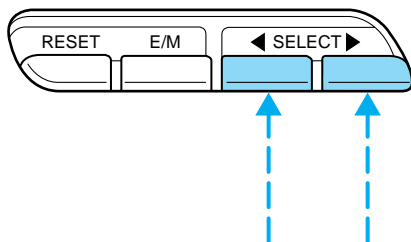

If “CO” or “CS” is displayed, there is a problem with the fuel indication system and you should contact your dealer for service as soon as possible.

## **AVG ECON (average fuel economy)**

Select this function to display your average fuel economy in liters/100 km or miles/gallon.



If you calculate your average fuel economy by dividing miles traveled by gallons used, your figure may be different than displayed for the following reasons:

- your vehicle was not perfectly level during fill-up
- differences in the automatic shut-off points on the fuel pumps at service stations
- variations in top-off procedure from one fill-up to another
- rounding of the displayed values to the nearest 0.1 liter (gallons)

Press the RESET control while AVG ECON is displayed to reset the function.

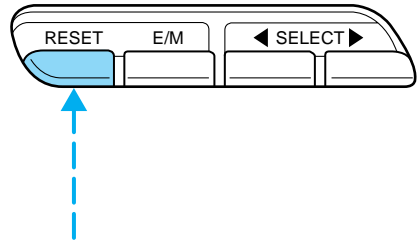

The average displayed is the average since the last reset.

## **TRIP A and TRIP B**

These two functions allow you to see how far you have traveled since you last reset. Trip A and Trip B are completely independent and must be reset individually.

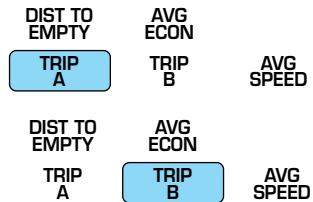

## Instrumentation

To reset either trip feature to zero, press the RESET control while the appropriate trip distance feature (TRIP A or TRIP B) is displayed.



### **AVG SPEED (average speed)**

Select this function to display your average speed in miles per hour or kilometers per hour.

Your vehicle must be moving to calculate your average speed. When your vehicle is not moving, the average speed is displayed at 0 kilometers (0 miles) per hour.



### **Message center indicator lights**

#### **Check air suspension**

Briefly illuminates when the ignition is turned ON. This light will remain on to indicate that the air suspension switch is off or to indicate a possible system fault. For more information on the air suspension system, refer to the *Driving* chapter.

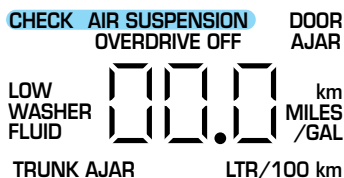

#### **Overdrive off**

Illuminates when the transmission control switch (TCS) has been pushed. When the light is on, the transmission does not shift into overdrive. If the light does not come on when the TCS is depressed or if the light flashes when you are driving, have your vehicle serviced.

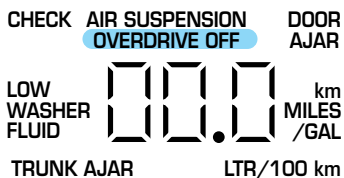

## Door ajar

Illuminates when one of the doors is not completely shut and the ignition is turned to ON. With the ignition ON, this light will flash five times and sound a tone for one second, then remain on (if a door is open).

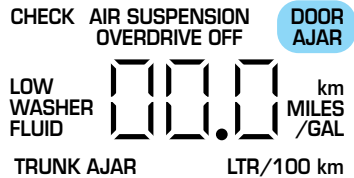

## Low washer fluid

Momentarily illuminates when the ignition is turned to ON and will stay on when the windshield washer fluid is low.

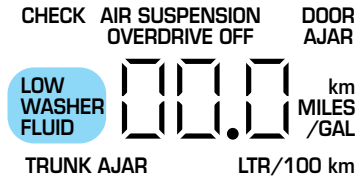

## Trunk ajar

If the trunk is not completely closed, this light comes on when you turn the ignition to ON. With the ignition ON, this light will flash five times and sound a tone for one second, then remain on (if the trunk is open).

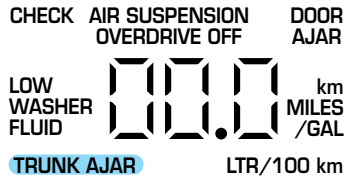

## INDICATOR LAMP MODULE

The indicator lamp module contains the following lamps:

### Traction Control™ active (if equipped)

Flashes when the Traction Control™ system begins applying and releasing the brakes and adjusting the engine characteristics to limit a wheelspin condition. It will be lit for a minimum of four seconds or for the duration of the Traction Control™ event.

TRAC  
CNTL

## Instrumentation

If the Traction Control<sup>™</sup> indicator comes on or stays lit, either:

- the Traction Control<sup>™</sup> system needs service, or
- the customer has disabled the system using the traction control switch.

For more information, refer to the *Driving* chapter.

### Anti-lock brake system (ABS) (If equipped)

Momentarily illuminates when the ignition is turned on and the engine is off. If the light does not illuminate momentarily at start up, remains on or continues to flash, the ABS needs to be serviced. With the ABS light on, the anti-lock brake system is disabled and normal braking is still effective unless the brake warning light also remains illuminated with parking brake released.



### Brake system warning

Momentarily illuminates when the ignition is turned to the ON position and the engine is off. If brake warning lamp does not illuminate at this time, seek service immediately.

Also illuminates when the parking brake is engaged. Illumination after releasing the parking brake indicates low brake fluid level and the brake system should be inspected immediately.



## Controls and features

### PANEL DIMMER CONTROL

Use to adjust the brightness of the instrument panel during headlight and parklamp operation.

- Push up to brighten.
- Push down to dim.

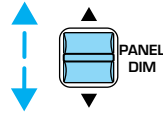

### HEADLAMP CONTROL

Rotate the headlamp control to the first position to turn on the parking lamps. Rotate to the second position to also turn on the headlamps.

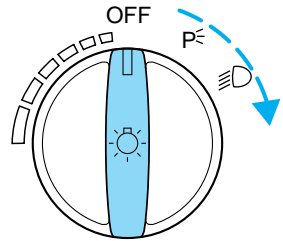

### High beams

Push forward to activate.

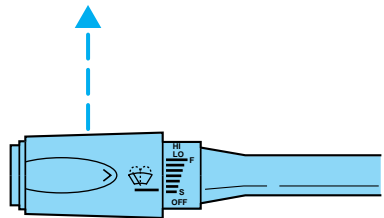

### Flash to pass

Pull toward you to activate and release to deactivate.

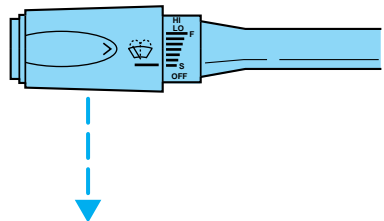

## Controls and features

### Autolamp control (if equipped)

The autolamp system provides light sensitive automatic on-off control of the exterior lights normally controlled by the headlamp control.

The autolamp system also keeps the lights on for a preselected period of time after the ignition switch is turned to OFF.

- To turn autolamps on, rotate the control counterclockwise. The preselected time lapse is adjustable up to approximately three minutes by continuing to rotate the control counterclockwise.
- To turn autolamps off, rotate the control clockwise to OFF.

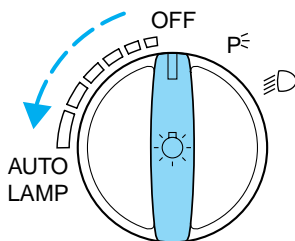

### Daytime running lamps (DRL) (if equipped)

Turns the highbeam headlamps on with a reduced output. To activate:

- the key must be in the ON position,
- the parking brake released, and
- the headlamp control is in the OFF or Parking lamps position.



Always remember to turn on your headlamps at dusk or during inclement weather. The Daytime Running Light (DRL) System does not activate your tail lamps and generally may not provide adequate lighting during these conditions. Failure to activate your headlamps under these conditions may result in a collision.

### REAR WINDOW DEFROSTER

The rear defroster control is located on the instrument panel.

Press the rear defroster control to clear the rear window of thin ice and fog.

- The small LED will illuminate when the rear defroster is activated.

The ignition must be in the ON position to operate the rear window defroster.





## Controls and features

The defroster turns off automatically after 10 minutes or when the ignition is turned to the OFF position. To manually turn off the defroster before ten minutes have passed, push the control again.

### CLIMATE CONTROL SYSTEM

#### Manual heating and air conditioning system (if equipped)

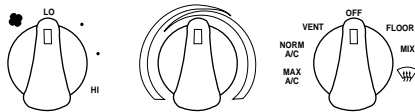

#### **Fan speed control**

Controls the volume of air circulated in the vehicle.

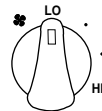

#### **Temperature control knob**

Controls the temperature of the airflow inside the vehicle.



#### **Mode selector control**

Controls the direction of the airflow to the inside of the vehicle.

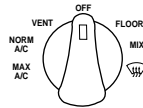

The air conditioning compressor will operate in all modes except VENT and FLR. However, the air conditioning will only function if the outside temperature is about 10°C (50°F) or above.

Since the air conditioner removes considerable moisture from the air during operation, it is normal if clear water drips on the ground under the air conditioner drain while the system is working and even after you have stopped the vehicle.

## Controls and features

Under normal conditions, your vehicle's climate control system should be left in any position other than MAX A/C or OFF when the vehicle is parked. This allows the vehicle to "breathe" through the outside air inlet duct.

- MAX A/C-Uses recirculated air to cool the vehicle. MAX A/C is noisier than NORM A/C but more economical and will cool the inside of the vehicle faster. Airflow will be from the instrument panel registers. This mode can also be used to prevent undesirable odors from entering the vehicle.
- NORM A/C-Uses outside air to cool the vehicle. It is quieter than MAX A/C but not as economical. Airflow will be from the instrument panel registers.
- VENT-Distributes outside air through the instrument panel registers. However, the air will not be cooled below the outside temperature because the air conditioning does not operate in this mode.
- OFF-Outside air is shut out and the fan will not operate. For short periods of time only, use this mode to prevent undesirable odors from entering the vehicle.
- FLR-Allows for maximum heating by distributing outside air through the floor ducts. However, the air will not be cooled below the outside temperature because the air conditioning does not operate in this mode.
- MIX-Distributes outside air through the windshield defroster ducts and the floor ducts. Heating and air conditioning capabilities are provided in this mode. For added customer comfort, when the temperature control knob is anywhere in between the full hot and full cold positions, the air distributed through the floor ducts will be slightly warmer than the air sent to the windshield defroster ducts. If the temperature is about 10°C (50°F) or higher, the air conditioner will automatically dehumidify the air to prevent fogging.
-  -Distributes outside air through the windshield defroster ducts. It can be used to clear ice or fog from the windshield. If the temperature is about 10°C (50°F) or higher, the air conditioner will automatically dehumidify the air to prevent fogging.

## Controls and features

### Operating tips

- In humid weather, select  before driving. This will prevent your windshield from fogging. After a few minutes, select any desired position.
- To prevent humidity buildup inside the vehicle, don't drive with the climate control system in the OFF position.
- Don't put objects under the front seat that will interfere with the airflow to the back seats.
- Remove any snow, ice or leaves from the air intake area (at the bottom of the windshield).

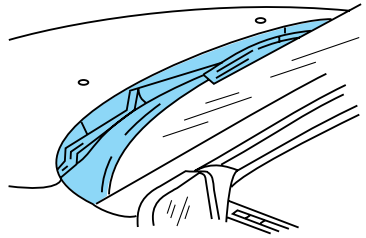

- If your vehicle has been parked with the windows closed during hot weather, the air conditioner will do a much faster job of cooling if you drive for two or three minutes with the windows open. This will force most of the hot, stale air out of the vehicle. Then operate your air conditioner as you would normally.
- When placing objects on top of your instrument panel, be careful to not place them over the defroster outlets. These objects can block airflow and reduce your ability to see through your windshield. Also, avoid placing small objects on top of your instrument panel. These objects can fall down into the defroster outlets and block airflow and possibly damage your climate control system.

### Electronic Automatic Temperature Control (EATC) system (if equipped)

The EATC system will maintain a selected temperature and automatically control airflow. You can override automatic operation with any of the override controls or the fan speed control.

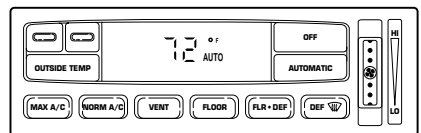

## Controls and features

### Turning the EATC on

Press AUTOMATIC, any of the override controls or the fan speed control. The EATC will only operate when the ignition is in the ON position.

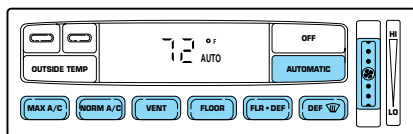

### Turning the EATC off

Press OFF. The Outside Temperature function will continue to operate until the ignition is turned off.

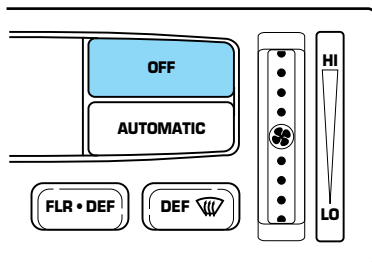

### Automatic operation

Press AUTOMATIC and select the desired temperature. The selected temperature and the word AUTO will appear in the display window. The EATC system will either heat or cool to achieve the selected temperature. The system will automatically determine fan speed, airflow location and if fresh outside air or recirculated air is required. Fan speed remains automatic unless the fan speed thumbwheel is turned.

When in AUTOMATIC and weather conditions require heat, air will be sent to the floor. However, if the engine is not warm enough to provide heat, the fan will be at a low speed and the air will be directed to the windshield. In 3½ minutes or less, the fan speed will start to increase and the airflow location will change to the floor area.

If unusual conditions exist (i.e.-window fogging, etc.), the manual override controls allow you to select airflow locations and the fan control allows you to adjust fan speed as necessary.

### Temperature selection

The display window indicates the selected temperature, function (AUTO or one of the override controls) and manual control of fan speed (☼) if automatic fan speed is not desired.



## Controls and features

To control the temperature, select any temperature between 18°C (65°F) and 29°C (85°F) by pressing the blue (cooler) or red (warmer) buttons.

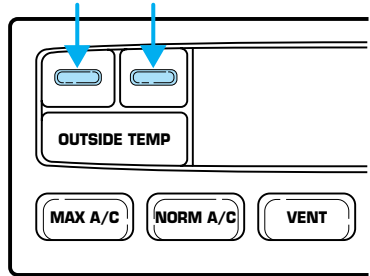

For continuous maximum cooling, push the blue button until 15°C (59°F) is shown in the display window. The EATC will continue maximum cooling (disregarding the displayed temperature) until a warmer temperature is selected by pressing the red button.

For continuous maximum heating, push the red button until 32°C (90°F) is shown in the display window. The EATC will continue maximum heating (disregarding the displayed temperature) until a cooler temperature is selected by pressing the blue button.

### Temperature conversion

Press MAX A/C and DEF  at the same time (for one second) to switch between Fahrenheit and Celsius.

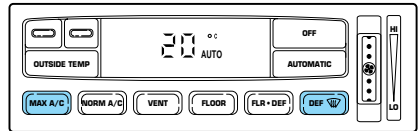

If your vehicle has an English/Metric (E/M) control to change your electronic instrument cluster display (if equipped) and the message center display (if equipped) from English to Metric, this control will also change the temperature display. Refer to *Electronic Message Center* in the *Instrumentation Chapter*.

# Controls and features

## Fan speed (🌀 )

When AUTOMATIC is pressed, fan speed is adjusted automatically for existing conditions. You can override fan speed at any time. To control fan speed manually, use the thumbwheel to cancel automatic fan speed operation. Rotate the thumbwheel up for higher fan speed or down for lower fan speed.

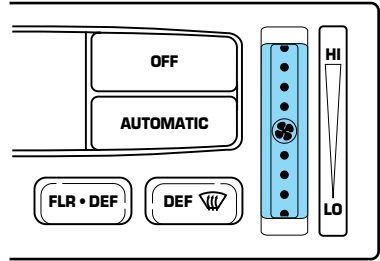

The display will show 🌀 to indicate manual fan operation.



To return to automatic fan operation, press AUTOMATIC.

## Manual override controls

The override controls are located at the bottom of the EATC and allow you to determine where airflow is directed. To return to full automatic control, press AUTOMATIC.

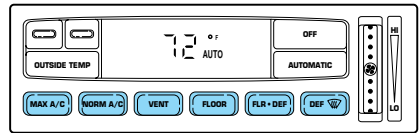

The air conditioning compressor will operate in all modes except FLOOR and VENT. It will also operate only when required when AUTOMATIC has been selected. However, the air conditioning will only function if the outside temperature is about 10°C (50°F) or above.

Since the air conditioner removes considerable moisture from the air during operation, it is normal if clear water drips on the ground under the air conditioner drain while the system is working and even after you have stopped the vehicle.

Under normal conditions, your vehicle's climate control system should be left in any position other than MAX A/C or OFF when the vehicle is parked. This allows the vehicle to "breathe" through the outside air inlet duct.

## Controls and features

- **MAX A/C**-Uses recirculated air to cool the vehicle. The temperature display will remain the same and air will be cooled based on the selected temperature. To exit, press **AUTOMATIC** or any other override controls. **MAX A/C** is noisier than **NORM A/C** but more economical and will cool the inside of the vehicle faster. Airflow is from the instrument panel registers. This mode can also be used to prevent undesirable odors from entering the vehicle.
- **NORM A/C**-Uses outside air to cool the vehicle. The temperature display will remain the same and air will be cooled based on the selected temperature. It is quieter than **MAX A/C** but not as economical. Fan speed will remain automatic. Airflow is from the instrument panel registers.
- **VENT**-Distributes outside air through the instrument panel registers. However, the air cannot be cooled below the outside temperature because the air conditioning does not operate in this mode.
- **FLOOR**-Allows for maximum heating by distributing outside air through the floor ducts. However, the air cannot be cooled below the outside temperature because the air conditioning does not operate in this mode.
- **FLR•DEF**-Distributes outside air through the windshield defroster ducts and the floor ducts. Heating and air conditioning capabilities are provided in this mode. The air will be heated or cooled based on the temperature selection. For added customer comfort, the air distributed through the floor ducts will be slightly warmer than the air sent to the windshield defroster ducts. If the temperature is about 10°C (50°F) or higher, the air conditioner will automatically dehumidify the air to prevent fogging.
- **DEF**  -Distributes outside air through the windshield defroster ducts. It can be used to clear ice or fog from the windshield. If the outside air temperature is about 10°C (50°F) or higher, the air conditioner will automatically dehumidify the air to prevent fogging.
- **OFF**-Outside air is shut out and the fan will not operate. For short periods of time, use this mode to prevent undesirable odors from entering the vehicle.

## Controls and features

### **Displaying outside temperature**

Press OUTSIDE TEMP to display the outside air temperature. It will be displayed until OUTSIDE TEMP is pressed again.

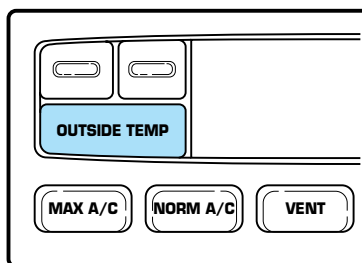

If the selected temperature is changed while the outside temperature is displayed, the new temperature will be displayed for four seconds after it is changed, then the outside temperature will return to the window.

If a manual override function is selected while the outside temperature is displayed, the new function will be displayed for four seconds after it is changed, then the outside temperature will return to the window along with the override selection.

The outside temperature reading is most accurate when the vehicle is moving. Higher readings may be obtained when the vehicle is not moving. The readings that you get may not agree with temperatures given on the radio due to differences in vehicle and station locations.

### **Operating tips**

- In humid weather, select DEF  before driving. This will prevent your windshield from fogging. After a few minutes, select any desired position.
- To prevent humidity buildup inside the vehicle, don't drive with the climate control system in the OFF position.
- Don't put objects under the front seat that will interfere with the airflow to the back seats.



## Controls and features

- Remove any snow, ice or leaves from the air intake area (at the bottom of the windshield).

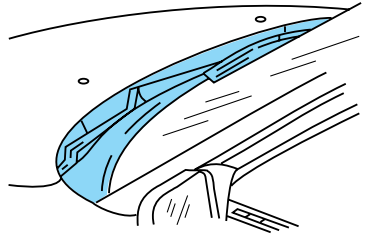

- If your vehicle has been parked with the windows closed during hot weather, the air conditioner will do a much faster job of cooling if you drive for two or three minutes with the windows open. This will force most of the hot, stale air out of the vehicle. Then operate the air conditioner as you would normally.
- When placing objects on top of your instrument panel, be careful to not place them over the defroster outlets. These objects can block airflow and reduce your ability to see through your windshield. Also, avoid placing small objects on top of your instrument panel. These objects can fall down into the defroster outlets and block airflow and possibly damage your climate control system.

### CLOCK

Press H to set the hour.

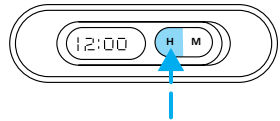

Press M to set the minute.

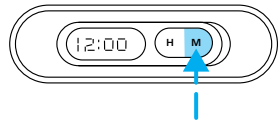

# Controls and features

## USING YOUR AUDIO SYSTEM

### AM/FM Stereo

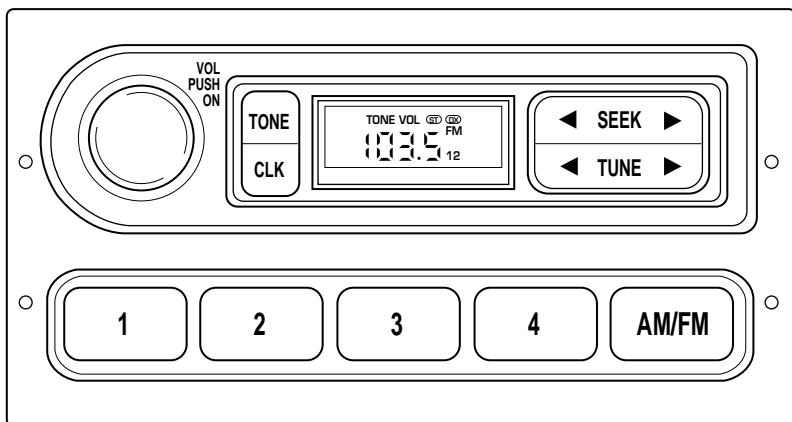

#### ***Volume/power control***

Press the control to turn the audio system on or off.

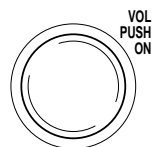

Turn the control to raise or lower volume.

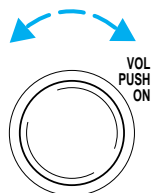

If the volume is set above a certain level and the ignition is turned off, the volume will come back on at a “nominal” listening level when the ignition switch is turned back on.

### **AM/FM select**

The AM/FM select control works in radio mode.



### **AM/FM select in radio mode**

This control allows you to select AM or FM frequency bands. Press the control to switch between AM, FM1 or FM2 memory preset stations.

### **Tune adjust**

The tune control works in radio mode.

### **Tune adjust in radio mode**

- Press ◀ to move to the next frequency down the band (whether or not a listenable station is located there). Hold the control to move through the frequencies quickly.
- Press ▶ to move to the next frequency up the band (whether or not a listenable station is located there). Hold for quick movement.



### **Seek function**

The seek function control works in radio mode.

### **Seek function in radio mode**

- Press ◀ to find the next listenable station down the frequency band.
- Press ▶ to find the next listenable station up the frequency band.

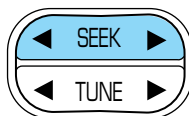

### **Radio station memory preset**

The radio is equipped with four station memory preset controls. These controls can be used to select up to four preset AM stations and eight FM stations (four in FM1 and four in FM2).

## Controls and features

### Setting memory preset stations

1. Select the frequency band with the AM/FM select control.
2. Select a station. Refer to *Tune adjust* or *Seek function* for more information on selecting a station.
3. Press and hold a memory preset control until the sound returns, indicating the station is held in memory on the control you selected.



### Bass adjust

The bass adjust control allows you to increase or decrease the audio system's bass output.

With the electronic AM/FM stereo, press the TONE control once, then use the volume knob to adjust the level.

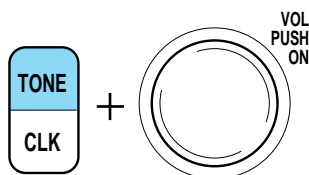

### Treble adjust

The treble adjust control allows you to increase or decrease the audio system's treble output.

With the electronic AM/FM stereo, press the TONE control twice, then use the volume knob to adjust the level.

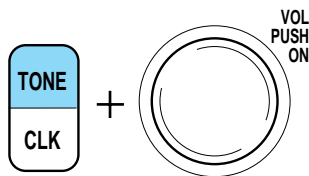

### Speaker balance adjust

Speaker sound distribution can be adjusted between the right and left speakers.

With the electronic AM/FM stereo, press the TONE control three times, then use the volume knob to adjust the level.

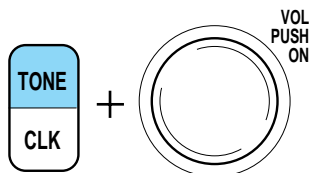

## Controls and features

### **Speaker fade adjust (if equipped)**

Speaker sound can be adjusted between the front and rear speakers.

With the electronic AM/FM stereo, press the TONE control four times, then use the volume knob to adjust the level.

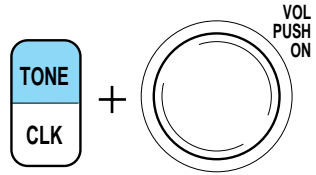

### **Setting the clock**

Press CLK to toggle between listening frequencies and clock mode.

To set the hour, press and hold the CLK control and press:

- ◀ to decrease hours and
- ▶ to increase hours.

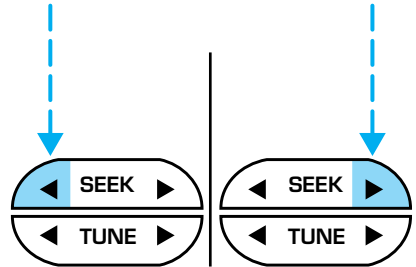
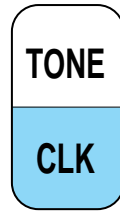

To set the minute, press and hold the CLK control and press:

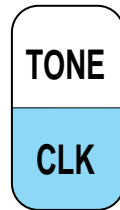

# Controls and features

- ◀ to decrease minutes and
- ▶ to increase minutes.

The CLK control will allow you to switch between media display mode (radio station, stereo information, etc.) and clock display mode (time). When in clock mode, the media information will display for ten seconds, when the radio is turned on, and then revert to clock information. Anytime that the media is changed, (new radio station, etc.), the media information will again display for ten seconds before reverting back to the clock. In media mode, the media information will always be displayed.

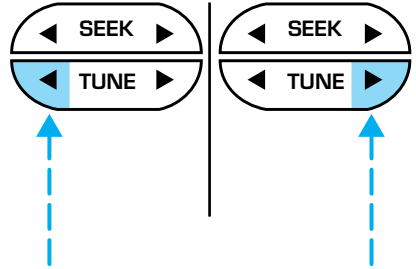

## AM/FM stereo cassette

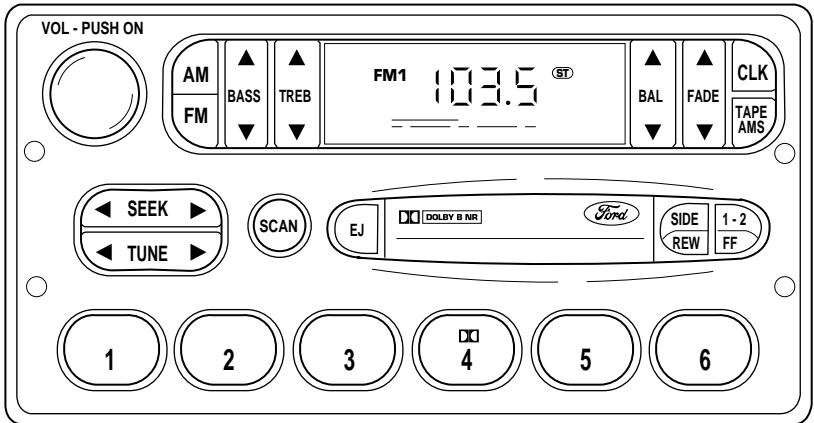

## Controls and features

### **Volume/power control**

Press the control to turn the audio system on or off.

VOL - PUSH ON

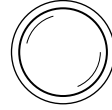

Turn the control to raise or lower volume.



VOL - PUSH ON

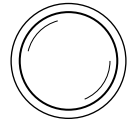

If the volume is set above a certain level and the ignition is turned off, the volume will come back on at a “nominal” listening level when the ignition switch is turned back on.

### **AM/FM select**

The AM/FM select control works in radio and tape modes.



### **AM/FM select in radio mode**

This control allows you to select AM or FM frequency bands. Press the AM control to select from AM selections, and press the FM control to select from FM1 or FM2 memory preset stations.

### **AM/FM select in tape mode**

Press this control to stop tape play and begin radio play.

## Controls and features

### **Tune adjust**

The tune control works in radio mode.

#### **Tune adjust in radio mode**

- Press ◀ to move to the next frequency down the band (whether or not a listenable station is located there). Hold the control to move through the frequencies quickly.
- Press ▶ to move to the next frequency up the band (whether or not a listenable station is located there). Hold for quick movement.



### **Seek function**

The seek function control works in radio mode.

#### **Seek function in radio mode**

- Press ◀ to find the next listenable station down the frequency band.
- Press ▶ to find the next listenable station up the frequency band.

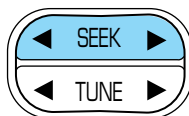

### **Scan function**

The scan function works in radio mode.



#### **Scan function in radio mode**

Press the SCAN control to hear a brief sampling of all listenable stations on the frequency band. Press the SCAN control again to stop the scan mode.

### **Radio station memory preset**

The radio is equipped with six station memory preset controls. These controls can be used to select up to six preset AM stations and twelve FM stations (six in FM1 and six in FM2).



### **Setting memory preset stations**

1. Select the frequency band with the AM or the FM select control.
2. Select a station. Refer to *Tune adjust* or *Seek function* for more information on selecting a station.
3. Press and hold a memory preset control until the sound returns, indicating the station is held in memory on the control you selected.

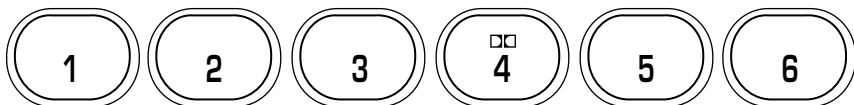

### **Bass adjust**

The bass adjust control allows you to increase or decrease the audio system's bass output.

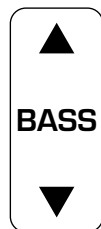

### **Treble adjust**

The treble adjust control allows you to increase or decrease the audio system's treble output.



## Controls and features

### **Speaker balance adjust**

Speaker sound distribution can be adjusted between the right and left speakers.

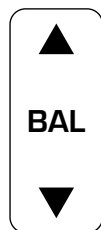

### **Speaker fade adjust**

Speaker sound can be adjusted between the front and rear speakers.



### **Tape select**

- To enter tape mode while in radio mode, press the TAPE AMS control.



### **Automatic Music Search**

The Automatic Music Search feature allows you to quickly locate the beginning of the tape selection being played or to skip to the next selection.

To activate the feature, momentarily depress the TAPE AMS button.

Then, press either REW (for the beginning of the current selection) or FF (to advance to the next



## Controls and features

selection). The tape deck stops and returns to play mode when the AMS circuit senses a blank section on the tape.

In order to ensure proper operation of the AMS feature, the tape **MUST** have a blank section of at least 4 seconds duration between programs.

### **Rewind**

The rewind control works in tape mode.

To rewind in tape mode, press the REW control. Radio play will continue until rewind is stopped (with the FF control or the AM/FM control) or the beginning of the tape is reached.



### **Fast forward**

The fast forward control works in tape mode.

- In the tape mode, tape direction will automatically reverse when the end of the tape is reached.

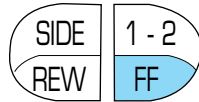

### **Tape direction select**

Press SIDE and 1-2 at the same time to play the alternate side of a tape.



### **Eject function**

Press the control to stop and eject a tape.

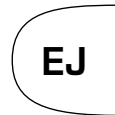

### **Dolby® noise reduction**

Dolby® noise reduction operates only in tape mode. Dolby® reduces the amount of hiss and static during tape playback.

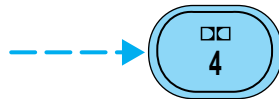

Press the  control to activate (and deactivate) Dolby® noise reduction.

The noise reduction system is manufactured under license from Dolby Laboratories Licensing Corporation.

# Controls and features

## Setting the clock

Press CLK to toggle between listening frequencies and clock mode while in radio mode.

To set the hour, press and hold the CLK control and press:

- ◀ to decrease hours and
- ▶ to increase hours.

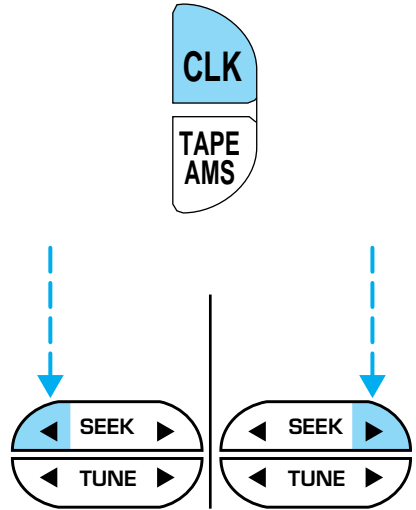

To set the minute, press and hold the CLK control and press:

- ◀ to decrease minutes and
- ▶ to increase minutes.

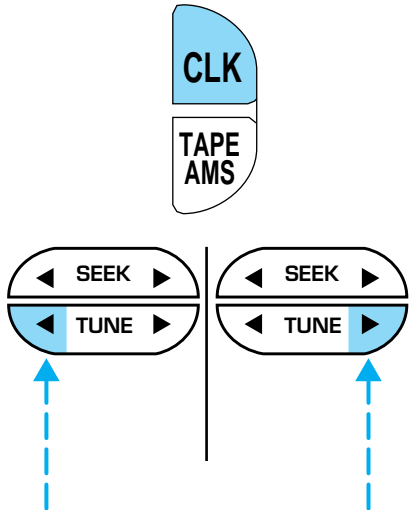

The CLK control will allow you to switch between media display mode (radio station, stereo information, etc.) and clock display mode (time).

## Controls and features

When in clock mode, the media information will display for ten seconds, when the radio is turned on, and then revert to clock information. Anytime that the media is changed, (new radio station, etc.), the media information will again display for ten seconds before reverting back to the clock. In media mode, the media information will always be displayed.

### AM/FM Stereo / Single CD Radio

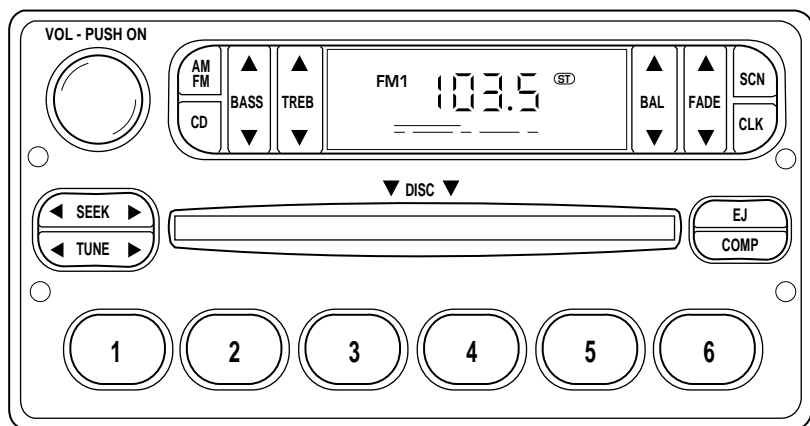

#### ***Volume/power control***

Press the control to turn the audio system on or off.

VOL - PUSH ON

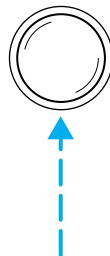

## Controls and features

Turn the control to raise or lower volume.



If the volume is set above a certain level and the ignition is turned off, the volume will come back on at a “nominal” listening level when the ignition switch is turned back on.

### **AM/FM select**

The AM/FM select control works in radio and CD modes.



### **AM/FM select in radio mode**

This control allows you to select AM or FM frequency bands. Press the control to switch between AM, FM1 or FM2 memory preset stations.

### **AM/FM select in CD mode**

Press this control to stop CD play and begin radio play.

### **Tune adjust**

The tune control works in radio mode.

### **Tune adjust in radio mode**

- Press ◀ to move to the next frequency down the band (whether or not a listenable station is located there). Hold the control to move through the frequencies quickly.
- Press ▶ to move to the next frequency up the band (whether or not a listenable station is located there). Hold for quick movement.

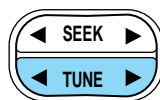

### **Seek function**

The seek function control works in radio or CD mode.

#### **Seek function in radio mode**

- Press ◀ to find the next listenable station down the frequency band.
- Press ▶ to find the next listenable station up the frequency band.

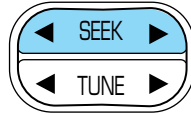

#### **Seek function in CD mode**

- Press ◀ to listen to the next selection.
- Press ▶ to listen to the previous selection.

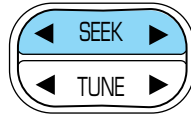

### **Scan function**

The scan function works in radio or CD mode.



#### **Scan function in radio mode**

Press the SCAN control to hear a brief sampling of all listenable stations on the frequency band. Press the SCAN control again to stop the scan mode.

#### **Scan function in CD mode**

Press the SCAN control to hear a short sampling of all selections on the CD. (The CD scans in a forward direction, wrapping back to the first track at the end of the CD.) To stop on a particular selection, press the control again.

### **Radio station memory preset**

The radio is equipped with four or six station memory preset controls. These controls can be used to select up to four or six preset AM stations and eight or twelve FM stations (four to six in FM1 and four to six in FM2).

## Controls and features

### **Setting memory preset stations**

1. Select the frequency band with the AM/FM select control.
2. Select a station. Refer to *Tune adjust* or *Seek function* for more information on selecting a station.
3. Press and hold a memory preset control until the sound returns, indicating the station is held in memory on the control you selected.

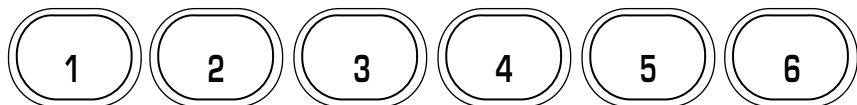

### **Autoset memory preset**

Autoset allows you to set strong radio stations without losing your original manually set preset stations. This feature is helpful on trips when you travel between cities with different radio stations.

### **Starting autoset memory preset**

1. Select a frequency using the AM/FM select controls.
2. Press the control.
3. When the first six strong stations are filled, the station stored in memory preset control 1 will start playing.

If there are less than six strong stations available on the frequency band, the remaining memory preset controls will all store the last strong station available.

To deactivate autoset and return to your audio system's manually set memory stations, press the control again.





## Controls and features

### ***Bass adjust***

The bass adjust control allows you to increase or decrease the audio system's bass output.

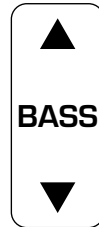

### ***Treble adjust***

The treble adjust control allows you to increase or decrease the audio system's treble output.



### ***Speaker balance adjust***

Speaker sound distribution can be adjusted between the right and left speakers.

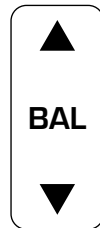

### ***Speaker fade adjust***

Speaker sound can be adjusted between the front and rear speakers.



# Controls and features

## CD select

- To begin CD play (if CD[s] are loaded), press the CD control. The first track of the disc will begin playing. After that, CD play will begin where it stopped last.



## Eject function

Press the control to stop and eject a CD.



## Compression feature

Compression adjust brings soft and loud CD passages together for a more consistent listening level.

Press the COMP control to activate and deactivate compression adjust.



## Setting the clock

To set the hour, press and hold the CLK control and press:

- ◀ to decrease hours and
- ▶ to increase hours.

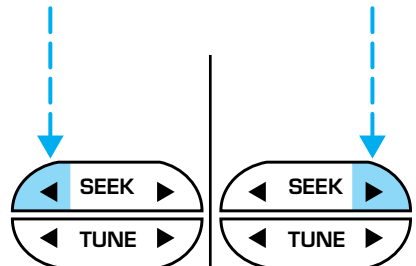

## Controls and features

To set the minute, press and hold the CLK control and press:

- ◀ to decrease minutes and
- ▶ to increase minutes.

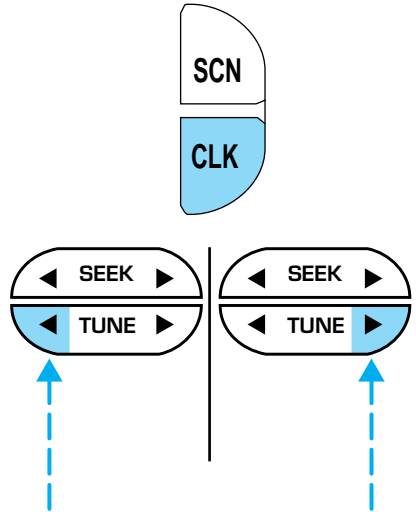

### Premium AM/FM Stereo/Cassette/Premium Sound with DSP

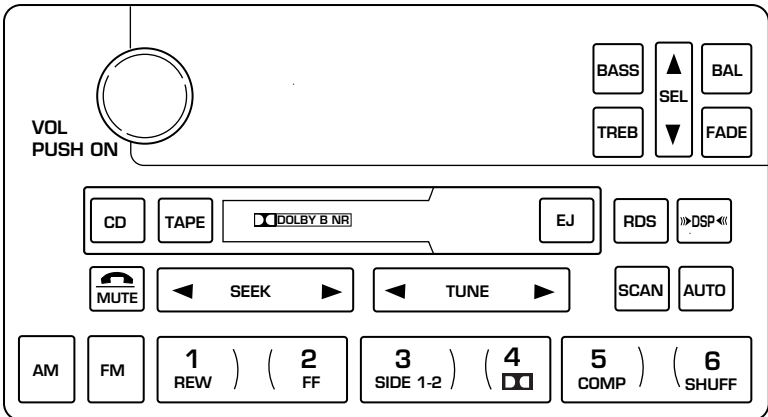

Your audio system is equipped with selective lighting, a unique lighting strategy. This lighting feature is operable when the headlamps are illuminated. During the operation of any selected mode, lighting for the

## Controls and features

individual function controls will either illuminate or turn off. Those controls which have a function for the specific mode of operation selected will be lit, while the controls which have no function for that mode will be turned off.

### **Volume/power control**

Press the control to turn the audio system on or off.

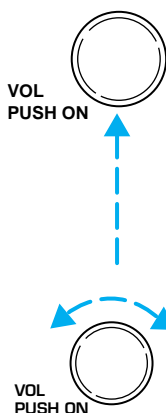

Turn the control to raise or lower volume.

If the volume is set above a certain level and the ignition is turned off, the volume will come back on at a “nominal” listening level when the ignition switch is turned back on.

### **AM/FM select**

The AM/FM select control works in radio, tape and CD modes (if equipped).

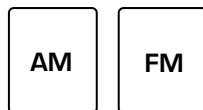

### **AM/FM select in radio mode**

This control allows you to select AM or FM frequency bands. Press the control to switch between AM, FM1 or FM2 memory preset stations.

### **AM/FM select in tape mode**

Press this control to stop tape play and begin radio play.

### **AM/FM select in CD mode (if equipped)**

Press this control to stop CD play and begin radio play.

### **Tune adjust**

The tune control works in radio or CD mode (if equipped).

#### **Tune adjust in radio mode**

- Press ◀ to move to the next frequency down the band (whether or not a listenable station is located there). Hold the control to move through the frequencies quickly.
- Press ▶ to move to the next frequency up the band (whether or not a listenable station is located there). Hold for quick movement.



#### **Tune adjust for CD changer (if equipped)**

- Press ◀ to select the previous disc in the CD changer. (Play will begin on the first track of the disc unless the CD changer is in shuffle mode.) Refer to *Shuffle feature* for more information. Hold the control to continue reversing through the disc.
- Press ▶ to select the next disc in the CD changer. Hold the control to fast-forward through the remaining discs.



### **Seek function**

The seek function control works in radio, tape or CD mode (if equipped).

#### **Seek function in radio mode**

- Press ◀ to find the next listenable station down the frequency band.
- Press ▶ to find the next listenable station up the frequency band.



#### **Seek function in tape mode**

- Press ◀ to listen to the previous selection on the tape or return to the beginning of the current selection.
- Press ▶ to listen to the next selection on the tape.

## Controls and features

### **Seek function for CD changer (if equipped)**

- Press ◀ to seek to the previous track of the current disc. If a selection has been playing for three seconds or more and you press ◀, the CD changer will replay that selection from the beginning.
- Press ▶ to seek forward to the next track of the current disc. After the last track has been completed, the first track of the current disc will automatically replay.



### **Scan function**

The scan function works in radio, tape or CD mode (if equipped).



### **Scan function in radio mode**

Press the SCAN control to hear a brief sampling of all listenable stations on the frequency band. Press the SCAN control again to stop the scan mode.

### **Scan function in tape mode**

Press the SCAN control to hear a short sampling of all selections on the tape. (The tape scans in a forward direction. At the end of the tape's first side, direction automatically reverses to the opposite side of the tape.) To stop on a particular selection, press the control again.

### **Scan function in CD mode (if equipped)**

Press the SCAN control to hear a short sampling of all selections on the CD. (The CD scans in a forward direction, wrapping back to the first track at the end of the CD.) To stop on a particular selection, press the control again.

### **Radio station memory preset**

The radio is equipped with four or six station memory preset controls. These controls can be used to select up to four or six preset AM stations and eight or twelve FM stations (four to six in FM1 and four to six in FM2).

## Controls and features

### Setting memory preset stations

1. Select the frequency band with the AM/FM select control.
2. Select a station. Refer to *Tune adjust* or *Seek function* for more information on selecting a station.
3. Press and hold a memory preset control until the sound returns, indicating the station is held in memory on the control you selected.

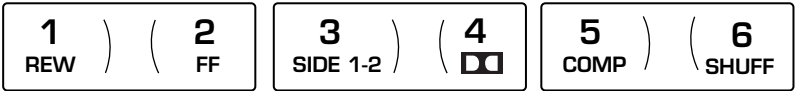

### Autoset memory preset

Autoset allows you to set strong radio stations without losing your original manually set preset stations. This feature is helpful on trips when you travel between cities with different radio stations.

### Starting autoset memory preset

1. Select a frequency using the AM/FM select controls.
2. Press the control.
3. When the first six strong stations are filled, the station stored in memory preset control 1 will start playing.



If there are less than six strong stations available on the frequency band, the remaining memory preset controls will all store the last strong station available.

To deactivate autoset and return to your audio system's manually set memory stations, press the control again.

### Bass adjust

The bass adjust control allows you to increase or decrease the audio system's bass output.

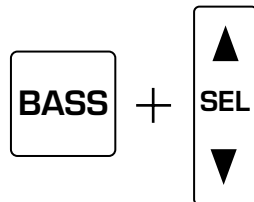

## Controls and features

### **Treble adjust**

The treble adjust control allows you to increase or decrease the audio system's treble output.

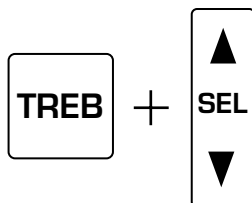

### **Speaker balance adjust**

Speaker sound distribution can be adjusted between the right and left speakers.

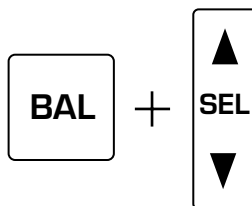

### **Speaker fade adjust**

Speaker sound can be adjusted between the front and rear speakers.

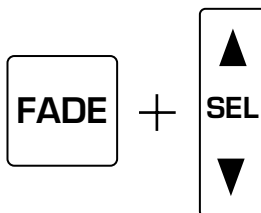

### **Tape/CD select (if equipped)**

- To begin tape play (with a tape loaded into the audio system) while in the radio or CD mode, press the TAPE control. Press the button during rewind or fast forward to stop the rewind or fast forward function.
- To begin CD play (if CD[s] are loaded), press the CD control. The first track of the disc will begin playing. After that, CD play will begin where it stopped last.





## Controls and features

### Rewind

The rewind control works in tape and CD modes (if equipped).

- In tape mode, radio play will continue until rewind is stopped (with the TAPE control) or the beginning of the tape is reached.
- In CD mode, pressing the REW control for less than three seconds results in slow rewind. Pressing the control for more than three seconds results in fast rewind.

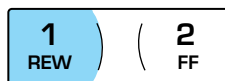

### Fast forward

The fast forward control works in tape and CD modes (if equipped).

- In the tape mode, tape direction will automatically reverse when the end of the tape is reached.
- In CD mode, pressing the control for less than three seconds results in slow forward action. Pressing the control for more than three seconds results in fast forward action.

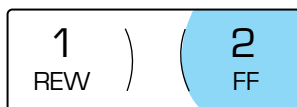

### Tape direction select

Press SIDE 1-2 to play the alternate side of a tape.

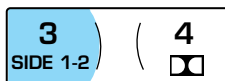

### Eject function

Press the control to stop and eject a tape.



### Dolby® noise reduction

Dolby® noise reduction operates only in tape mode. Dolby® reduces the amount of hiss and static during tape playback.

Press the  control to activate (and deactivate) Dolby® noise reduction.

The noise reduction system is manufactured under license from Dolby Laboratories Licensing Corporation.

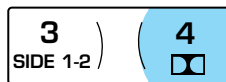

## Controls and features

### **Compression feature**

Compression adjust brings soft and loud CD passages together for a more consistent listening level.

Press the COMP control to activate and deactivate compression adjust.

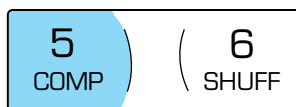

### **Shuffle feature**

The shuffle feature operates in CD mode and plays all tracks on the current disc in random order. If equipped with the CD changer, the shuffle feature continues to the next disc after all tracks are played.

Press the SHUFFLE control to start this feature. Random order play will continue until the SHUFFLE control is pressed again.



### **Radio data system (RDS) feature**

When selected, the RDS (Radio Data System) function performs the following:

- Displays the radio station call letters
- Displays the type of music format (jazz, country, rock)
- Searches for a particular type of music format by selecting the SEEK control
- Allows traffic information broadcasts to be turned on and off with the SEL control



Press the RDS control. Use the SEL control to select ON or OFF to enable or disable the feature.

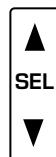

### **Traffic**

- Press the RDS control until TRAFFIC is displayed.
- Use the SEL control to select ON or OFF. With the feature on, use the SEEK or SCAN control to find a radio station broadcasting a traffic report (if it is broadcasting RDS data).

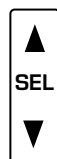

### **Program type**

- Press the RDS control until FIND program type is displayed.
- Use the SEL control to select the program type. With the feature on, use the SEEK or SCAN control to find the desired program type from the following selections:
  - Classic
  - Country
  - Info
  - Jazz
  - Oldies
  - R & B
  - Religious
  - Rock
  - Soft
  - Top 40

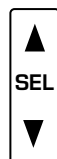

## Controls and features

### Show

- RDS sends information with the FM broadcast: station name, station type, and/or radio text.
- With RDS activated, press the RDS control until SHOW is displayed.
- Use the SEL control to select (program) TYPE, (station) NAME or NONE (no text displayed).



### Mute mode

Press the control to mute the playing media. Press the control again to return to the playing media.



### Digital signal processing (if equipped)

The digital signal processing (DSP) feature allows you to change the signal mode to suit your listening tastes.

Press the control to turn the feature on or off.

Use the SEL control to select the desired signal mode (the selected mode will appear in the display). The following signal modes can be selected:

- JAZZ CLUB—jazz club with clearly reflected sounds.
- HALL—rectangular concert hall capacity of about 2 000.
- CHURCH—church with a high vault.
- STADIUM—outdoor stadium with a capacity of about 30 000.

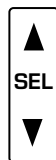

## Controls and features

- NEWS—“voice-only” type of sound with a limited audio band.

Press the DSP control until one of the following appears:

- ALL SEATS
- DRIVER SEAT
- REAR SEATS



Use the SELECT control to change the equalization to the desired mode.

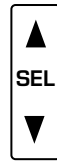

### CD changer (if equipped)

The CD changer is located in one of the following locations:

- in the trunk
- in the center console
- under the driver's seat

1. Slide the door to access the CD changer magazine.

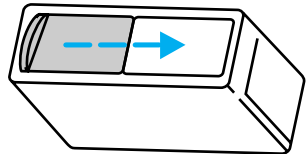

## Controls and features

2. Press ▲ to eject the magazine.

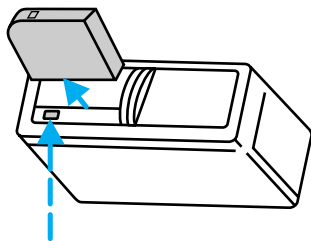

3. Turn the magazine (A) over.

4. Using the disc holder release knob (C), pull the disc holder (B) out of the magazine.

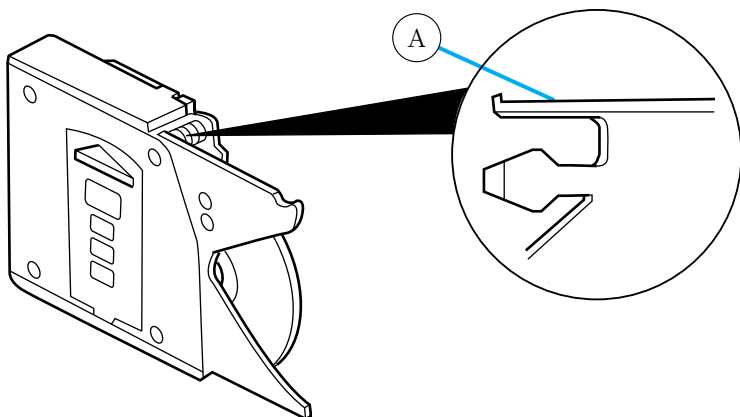
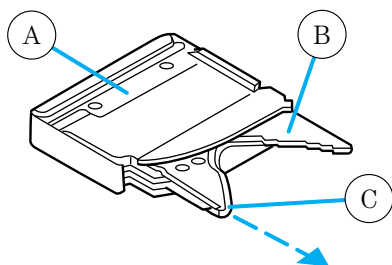

If you pull too hard on the disc holder, the disc holder may come completely out of the magazine. If this happens, reinsert the disc holder back into the magazine while pressing on the lever (A).

## Controls and features

- Line up the CD with the groove of the disc holder. Ensure that the label on the CD faces downwards.
- Press in on the disc holder until it locks securely into the magazine. If the disc holders are not fully locked into the magazine, the unit will not operate.

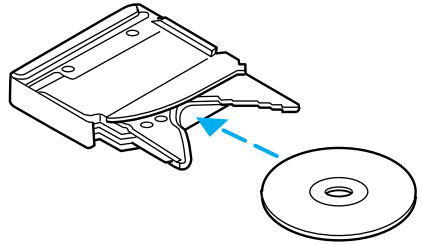

Ensure that the disc holder is evenly inserted and at the same level as the magazine (A). The unit will not operate if the disc holder is not inserted at the same level (B).

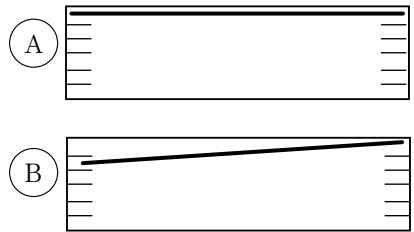

Radio power must be turned on to play the CDs in the changer. The magazine may be stored in the glove box when not being used.

The CD magazine may be inserted or ejected with the radio power off.

ONLY use the magazine supplied with the CD changer, other types will damage the unit.

Keep the CD changer door closed. Coins and foreign objects will damage the CD player and void your audio system warranty.

### Troubleshooting the CD changer (if equipped)



The laser beam used in the compact disc player is harmful to the eyes. Do not attempt to disassemble the case.

If sound skips:

- You may be traveling on a rough road, playing badly scratched discs or the disc may be dirty. Skipping will not scratch the discs or damage the player.

If your changer does not work, it may be that:

- A disc is already loaded where you want to insert a disc.
- The disc is inserted with the label surface downward.

## Controls and features

- The disc is dusty or defective.
- The player's internal temperature is above 60°C (140°F). Allow the player to cool down before operating.
- A disc with format and dimensions not within industry standards is inserted.

### Cleaning compact discs

Inspect all discs for contamination before playing. If necessary, clean discs only with an approved CD cleaner and wipe from the center out to the edge. Do not use circular motion.

### CD and CD changer care

- Handle discs by their edges only. Never touch the playing surface.
- Do not expose discs to direct sunlight or heat sources for extended periods of time.
- Do not insert more than one disc into each slot of the CD changer magazine.

### Cleaning cassette player (if equipped)

Clean the tape player head with a cassette cleaning cartridge after ten to twelve hours of play in order to maintain the best sound and operation.

### Cassette and cassette player care

- Use only cassettes that are 90 minutes long or less.
- Do not expose tapes to direct sunlight, high humidity, extreme heat or extreme cold. Allow tapes that may have been exposed to extreme temperatures to reach a moderate temperature before playing.
- Tighten very loose tapes by inserting a finger or pencil into the hole and turning the hub.
- Remove loose labels before inserting tapes.
- Do not leave tapes in the cassette player for a long time when not being played.



### Radio frequency information

The Federal Communications Commission (FCC) and the Canadian Radio and Telecommunications Commission (CRTC) establish the frequencies AM and FM stations may use for their broadcasts. Allowable frequencies are:

AM 530, 540–1600, 1610 kHz

FM 87.9, 88.1–107.1, 107.9 MHz

Not all frequencies are used in a given area.

### Radio reception factors

Three factors can affect radio reception:

- **Distance/strength.** The further an FM signal travels, the weaker it is. The listenable range of the average FM station is approximately 40 km (24 miles). This range can be affected by “signal modulation.” Signal modulation is a process radio stations use to increase their strength/volume relative to other stations.
- **Terrain.** Hills, mountains and tall buildings between your vehicle’s antenna and the radio station signal can cause FM reception problems. Static can be caused on AM stations by power lines, electric fences, traffic lights and thunderstorms. Moving away from an interfering structure (out of its “shadow”) returns your reception to normal.
- **Station overload.** Weak signals are sometimes captured by stronger signals when you pass a broadcast tower. A stronger signal may temporarily overtake a weaker signal and play while the weak station frequency is displayed.

The audio system automatically switches to single channel reception if it will improve the reception of a station normally received in stereo.

### Audio system warranties and service

Refer to the “Warranty Guide” for audio system warranty information.

If service is necessary, see your dealer or a qualified technician.

## Controls and features

### TURN SIGNAL CONTROL

- Push down to activate the left turn signal.
- Push up to activate the right turn signal.

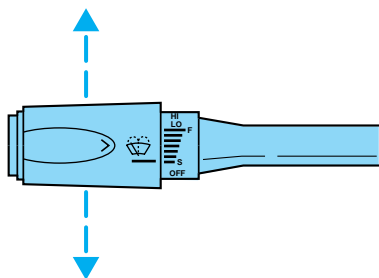

The flash rate of the turn signal will speed up considerably if the Lighting Control Module detects a left or right turn lamp bulb (front or rear) is burned out.

### WINDSHIELD WIPER/WASHER CONTROLS

Rotate the windshield wiper control to the desired interval, low or high speed position.

The bars of varying length are for intermittent wipers. When in this position rotate the control upward for fast intervals and downward for slow intervals.

Push the control on the end of the stalk to activate washer. Push and hold for a longer wash cycle. The washer will automatically shut off after ten seconds of continuous use.

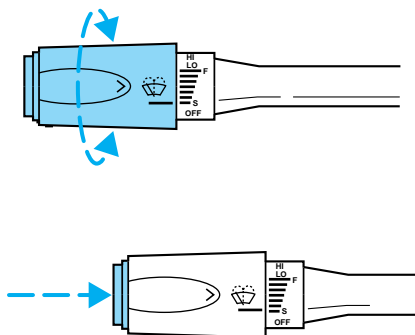

## Controls and features

### POSITIONS OF THE IGNITION

1. **ACCESSORY**, allows the electrical accessories such as the radio to operate while the engine is not running.

2. **LOCK**, locks the steering wheel, automatic transmission gearshift lever and allows key removal.

3. **OFF**, shuts off the engine and all accessories without locking the steering wheel.

4. **ON**, all electrical circuits operational. Warning lights illuminated. Key position when driving.

5. **START**, cranks the engine. Release the key as soon as the engine starts.

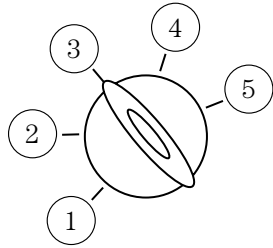

### TILT STEERING

Pull the tilt steering control toward you to move the steering wheel up or down. Hold the control while adjusting the wheel to the desired position, then release the control.

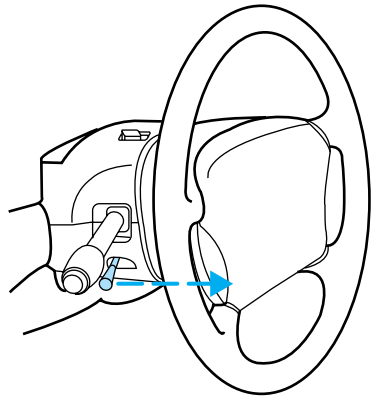

Never adjust the steering wheel when the vehicle is moving.

# Controls and features

## OVERDRIVE CONTROL

### Activating overdrive

**D** (Overdrive) is the normal drive position for the best fuel economy. The overdrive function allows automatic upshifts to second, third and fourth gear.

### Deactivating overdrive

Press the Transmission Control Switch (TCS) located on the end of the gearshift lever. The Transmission Control Indicator Light (TCIL) will illuminate on the instrument cluster.

The transmission will operate in gears one through three. To return to normal overdrive mode, press the Transmission Control Switch again. The TCIL will no longer be illuminated.

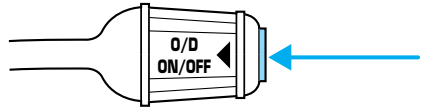
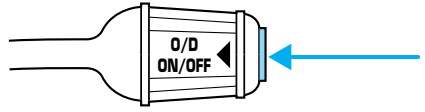

When you shut off and re-start your vehicle, the transmission will automatically return to normal **D** (Overdrive) mode.

## SPEED CONTROL (IF EQUIPPED)

### To turn speed control on

- Press ON.

Vehicle speed cannot be controlled until the vehicle is traveling at or above 48 km/h (30 mph).

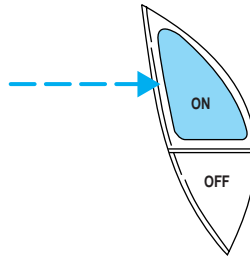

Do not use the speed control in heavy traffic or on roads that are winding, slippery, or unpaved.

## Controls and features



Do not shift the gearshift lever into N (Neutral) with the speed control on.

### To turn speed control off

- Press OFF or
- Turn off the vehicle ignition.

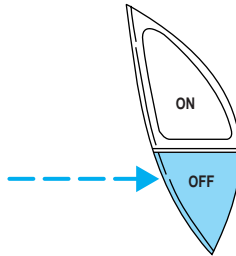

Once speed control is switched off, the previously programmed set speed will be erased.

### To set a speed

- Press SET/SET ACC/SET ACCEL.  
For speed control to operate, the speed control must be ON and the vehicle speed must be greater than 48 km/h (30 mph).



If you drive up or down a steep hill, your vehicle speed may vary momentarily slower or faster than the set speed. This is normal.

Speed control cannot reduce the vehicle speed if it increases above the set speed on a downhill. If your vehicle speed is faster than the set speed while driving on a downhill, you may want to shift to the next lower gear or apply the brakes to reduce your vehicle speed.

If your vehicle slows down more than 16 km/h (10 mph) below your set speed on an uphill, your speed control will disengage. This is normal. Pressing RES/RSM/RESUME will re-engage it.

## Controls and features



Do not use the speed control in heavy traffic or on roads that are winding, slippery, or unpaved.

### To set a higher set speed

- Press and hold SET/SET ACC/SET ACCEL. Release the control when the desired vehicle speed is reached or
- Press and release SET/SET ACC/SET ACCEL. Each press will increase the set speed by 1.6 km/h (1 mph) or
- Accelerate with your accelerator pedal. When the desired vehicle speed is reached, press and release SET/SET ACC/SET ACCEL.

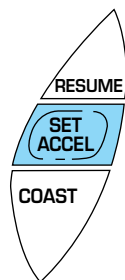

You can accelerate with the accelerator pedal at any time during speed control usage. Releasing the accelerator pedal will return your vehicle to the previously programmed set speed.

### To set a lower set speed

- Press and hold CST/COAST. Release the control when the desired speed is reached or
- Press and release CST/COAST. Each press will decrease the set speed by 1.6 km/h (1 mph) or



## Controls and features

- Depress the brake pedal. When the desired vehicle speed is reached, press SET/SET ACC/SET ACCEL.



### To disengage speed control

- Depress the brake pedal.  
Disengaging the speed control will not erase the previously programmed set speed.

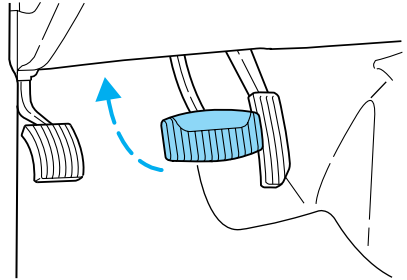

Pressing OFF will erase the previously programmed set speed.

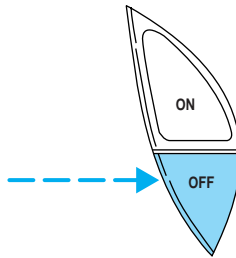

## Controls and features

### To return to a previously set speed

- Press RES/RSM/RESUME. For RES/RSM/RESUME to operate, the vehicle speed must be faster than 48 km/h (30 mph).



### Indicator light

This light comes on when either the SET ACC/SET ACCEL or RES/RSM/RESUME controls are pressed. It

turns off when the speed control OFF control is pressed, the brake is applied or the ignition is turned to the OFF position.

## SPEED CONTROL

### HOMELINK® UNIVERSAL TRANSCEIVER (IF EQUIPPED)

The HomeLink® Universal Transceiver, located on the driver's visor, provides a convenient way to replace up to three hand-held transmitters with a single built-in device. This feature will learn the radio frequency codes of most current transmitters to operate garage doors, entry gates, security systems, entry door locks, and home or office lighting.



When programming your HomeLink® Universal Transceiver, to a garage door or gate be sure that people and objects are out of the way to prevent potential harm or damage.

Do not use the HomeLink® Universal Transceiver with any garage door opener that lacks safety stop and reverse features as required by U.S. federal safety standards (this includes any garage door opener model manufactured before April 1, 1982). A garage door which cannot detect an object, signaling the door to stop and reverse, does not meet current U.S. federal safety standards. For more information on this matter, call toll-free: 1-800-355-3515 or on the Internet at **HomeLink.jci.com**.



### Programming

1. Prepare for programming the HomeLink® Universal Transceiver by erasing the three factory default codes by holding down the two outside buttons until the red light begins to flash after 20 seconds. Release both buttons.

2. Hold the end of your hand-held transmitter 5–14 cm (2–5 inches) away from the HomeLink® Universal Transceiver surface (located on your visor) while keeping the red light in view.

3. Using both hands simultaneously press and hold the hand-held transmitter button and the desired HomeLink® button. Do not release the buttons until step 4 has been completed.

4. The red light will flash slowly and then rapidly. Release both buttons when the red light flashes rapidly.

5. Follow steps 2 through 4 to program the remaining two buttons.

If you do not successfully program the HomeLink® Universal Transceiver after repeated attempts, refer to *Rolling code programming* which follows, or call toll-free customer assistance: 1-800-355-3515 or on the Internet at **HomeLink.jci.com**.

### Canadian Programming

During programming, your hand-held transmitter may automatically stop transmitting after two seconds which may not be long enough to program the HomeLink® Universal Transceiver.

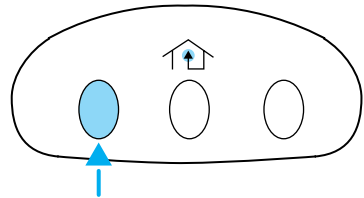
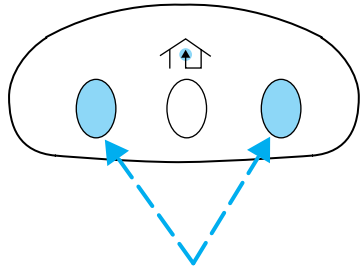

## Controls and features

To program your hand-held transmitters:

- continue to hold the button on the HomeLink® Universal Transceiver.
- press and re-press the hand-held transmitter button every two seconds until the red light changes from a slow to a fast flash.

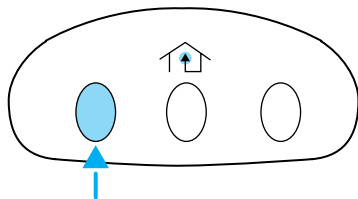

### Operating the HomeLink® Universal Transceiver

Once programmed, the HomeLink® Universal Transceiver can be used in place of hand-held transmitters. To operate, simply press and release the appropriate HomeLink® button (the red light will illuminate, indicating the signal is being transmitted).

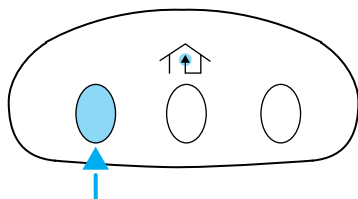

### Rolling code programming

Rolling code garage door openers (or other rolling code devices) which are “code protected” and manufactured after 1996, may be determined by the following:

- Reference the device owner’s manual for verification
- The hand-held transmitter appears to program the HomeLink® Universal Transceiver but does not activate the device.
- Press and hold the trained HomeLink® button. The device has the rolling code feature if the indicator light flashes rapidly and then turns solid after 2 seconds.

After completing the “Programming” functions, follow these steps to train a garage door opener with the rolling code feature:

1. Locate the **training button** on the garage door motor head unit. Refer to the garage door opener manual or call 1-800-355-3515 or on the Internet at **HomeLink.jci.com**. if there is difficulty locating the training button.
2. Press the training button on the garage door motor head unit (which will activate the **“training” light.**)

## Controls and features

3. Press and release the programmed HomeLink® button. Press and release the HomeLink® button a *second time* to complete the training process. (Some garage door openers may require this procedure to be done a third time to complete the training).

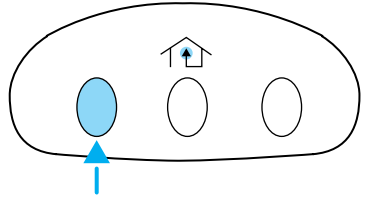

The 2nd or 3rd press from step 3 will activate the door. The HomeLink® Universal Transceiver has now been trained to the receiver. The remaining two buttons may now be programmed if this has not previously been done.

### Erasing HomeLink® buttons

Individual buttons cannot be erased, however, to erase the three programmed buttons:

1. Hold down the two outside buttons until the red light begins to flash after 20 seconds.
2. Release both buttons.

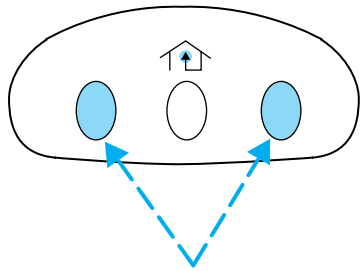

### Reprogramming a single HomeLink® button

To program a device to HomeLink® using a HomeLink® button previously trained, follow these steps:

1. Press and hold the desired HomeLink® button. **Do NOT** release until **step 4** has been completed.
2. When the indicator light begins to flash slowly (after 20 seconds), position the hand-held transmitter 5–14 cm (2 to 5 inches) away from the HomeLink® surface.
3. Press and hold the hand-held transmitter button.
4. The HomeLink® indicator light will flash, first slowly and then rapidly. When the indicator light begins to flash rapidly, release both buttons.

The previous device has now been erased and the new device can be activated by pushing the HomeLink® button that has just been programmed.

## Controls and features

### AUTOMATIC DIMMING INSIDE REAR VIEW MIRROR (IF EQUIPPED)

Your vehicle is equipped with an inside rear view mirror which has an auto-dimming function. The electronic day/night mirror will change from the normal state to the non-glare state when bright lights (glare) reach the mirror. When the mirror detects bright light from front or behind, it will automatically adjust (darken) to minimize glare.

Do not block the sensor on the backside of the mirror since this may impair proper mirror performance.

Press the control to turn the mirror on or off.

The mirror will automatically return to the normal state whenever the vehicle is placed in R (Reverse) (when the mirror is on) to ensure a bright clear view when backing up.

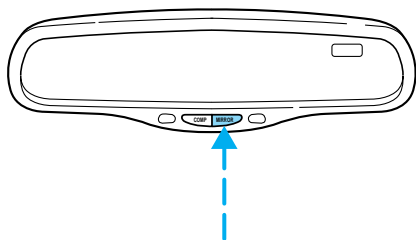

### ELECTRONIC COMPASS (IF EQUIPPED)

The compass reading will remain accurate during most driving conditions. Unknown to the driver, the compass is continuously recalibrating due to magnetic fields and subtle, slow changes in vehicle magnetics which can occur over the life of the vehicle.

The compass reading will remain fixed when significant levels are experienced (such as steel bridges). The compass will return to normal operation upon leaving the magnetized area.

If highly magnetized items (such as magnetic mount antennas) are placed very near the compass the display will change to "C" for 15 seconds, then display all segments until the magnetized item is removed.

Most geographic areas (zones) have a magnetic north compass point that varies slightly from the northerly direction on maps. This variation is four degrees between adjacent zones and will become noticeable as the vehicle crosses multiple zones. A correct zone setting will eliminate this error. Refer to *Compass zone adjustment*.

## Controls and features

### Compass zone adjustment

1. Determine which compass zone you are in by referring to the zone map.

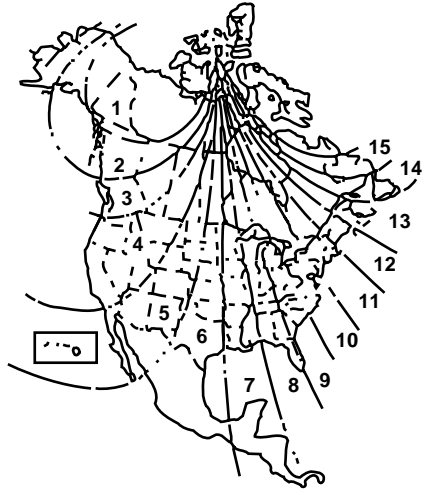

2. With the compass display turned on, press and hold the COMP side of the control until the zone selection number appears in the mirror display window.

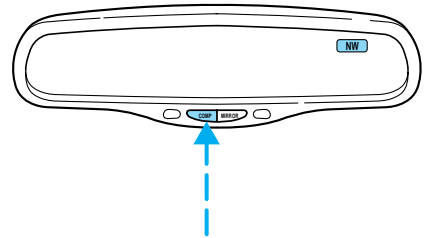

3. Release the COMP side of the control, then press it down again.

4. Continue to press until your zone number is shown in the mirror display, then release.

5. The display will show all segments, then return to normal compass mode within ten seconds.

### Compass calibration adjustment

Perform this adjustment in an open area free from steel structures and high voltage lines.

1. Start the vehicle.

## Controls and features

2. Press and hold the COMP side of the control for approximately six seconds until “C” appears in the mirror display.

3. Drive the vehicle slowly (less than 5 km/h [3 mph]) in circles or on your everyday routine until the display reads a direction.

4. The compass is now calibrated.

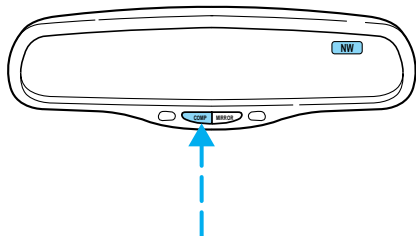

### TRUNK REMOTE CONTROL

The remote trunk release control is located on the driver's door trim panel and can be operated at any time.

Use the key to lock and unlock the release control.

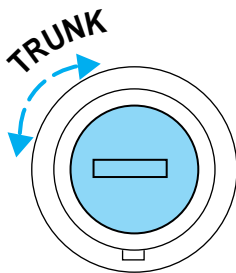

### POWER WINDOWS

Press and hold the rocker switches to open and close windows.

- Press the top portion of the rocker switch to close.

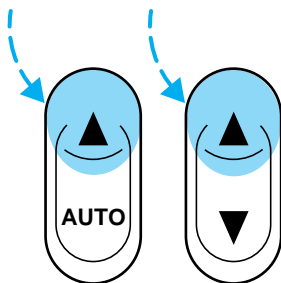

## Controls and features

- Press the bottom portion of the rocker switch to open.

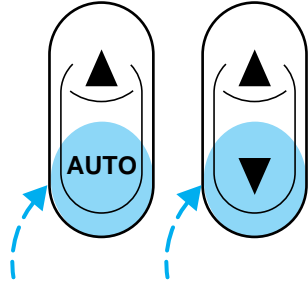

### Express down

- Press AUTO and release quickly. The window will open fully. Depress again to stop window operation.

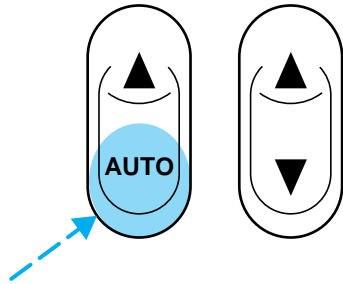

### Window lock

The window lock feature allows only the driver to operate the power windows.

To lock out all the window controls except for the driver's press the left side of the control. Press the right side to restore the window controls.

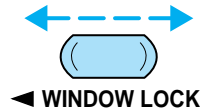

# Controls and features

## POWER DOOR LOCKS (IF EQUIPPED)

Press U to unlock all doors and L to lock all doors.

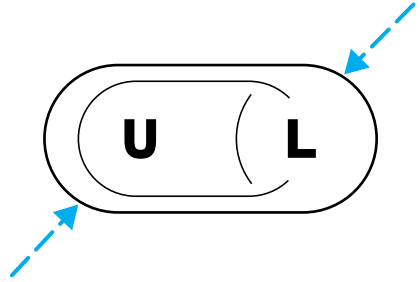

## POWER SIDE VIEW MIRRORS

The power mirrors can be operated at any time.

To adjust your mirrors:

1. Select L to adjust the left mirror or R to adjust the right mirror.

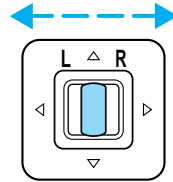

2. Move the control in the direction you wish to tilt the mirror.

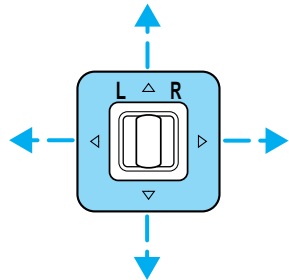

3. Return to the center position to lock mirrors in place.



### CHILDPROOF DOOR LOCKS

When these locks are set, the rear doors cannot be opened from the inside. The rear doors can be opened from the outside when the doors are unlocked.

The childproof locks are located on rear edge of each rear door and must be set separately for each door. Setting the lock for one door will not automatically set the lock for both doors.

Move lock control up to engage the lock. Move control down to disengage childproof locks.

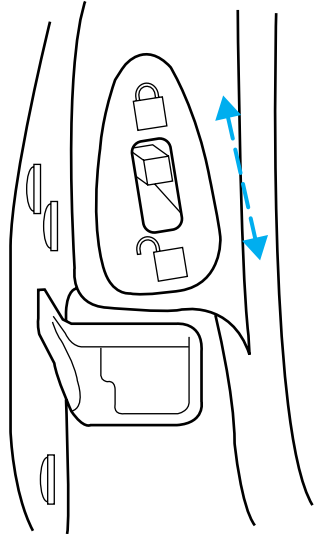

### POSITIVE RETENTION FLOOR MAT

Position the floor mat so that the eyelet is over the pointed end of the retention post and rotate forward to lock in. Make sure that the mat does not interfere with the operation of the accelerator or the brake pedal. To remove the floor mat, reverse the installation procedure.

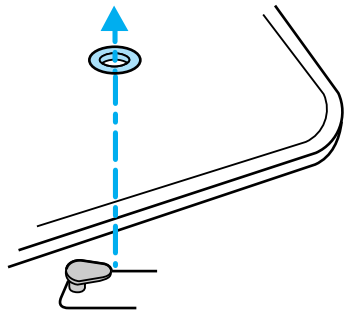

### REMOTE ENTRY SYSTEM (IF EQUIPPED)

The remote entry system allows you to lock or unlock all vehicle doors without a key.

The remote entry features only operate with the ignition in the OFF position.

## Controls and features

### Unlocking the doors

Press this control to unlock the driver's door. The interior lamps will illuminate.

Press the control a second time within five seconds to unlock all doors.

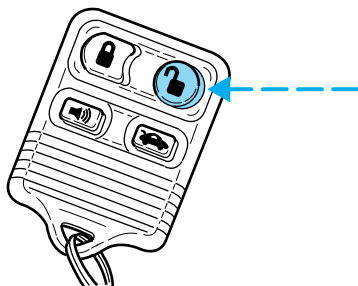

### Locking the doors

Press this control to lock all doors.

The horn will chirp and the parklamps/taillamps will flash to confirm the control was pressed. This feature can be turned on/off through the following procedure:

You must complete steps 1-7 within 30 seconds or the procedure will have to be repeated. If the procedure needs to be repeated, you must wait 30 seconds.

1. Turn the ignition key to ON.
2. Press the power door unlock control on the door panel three times.
3. Turn the ignition key from ON to OFF.
4. Press the power door unlock control three times.
5. Turn the ignition back to ON.
6. Press the unlock control twice.
7. After a five to ten second delay, the door locks will cycle lock/unlock to confirm successful programming.
8. Turn the ignition to OFF.

This feature can be turned on/off through the following procedure using the keyless entry keypad.

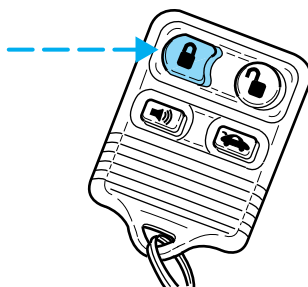

## Controls and features

1. Enter the keyless entry keypad factory-set code.
2. Within 5 seconds press and hold 7/8 control.
3. Within 5 seconds with 7/8 held down, press and release 1/2 control.
4. Release 7/8 control. The doors will lock/unlock to confirm successful programming.

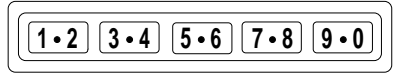

### **Autolock (if equipped)**

This feature automatically locks all doors when:

- all vehicle doors are closed
- the ignition is in the ON position
- you shift into R (Reverse) or D (Drive).

### **Relock**

The autolock feature repeats when:

- any door is opened and closed

### **Deactivating/activating the autolock feature**

Before following the procedure, make sure that the ignition is OFF and all vehicle doors are closed.

Automatic door locks can be turned on/off with the keyless entry keypad through the following procedure:

You must complete steps 1-5 within 30 seconds or the procedure will have to be repeated. If the procedure needs to be repeated, you must wait 30 seconds.

1. Enter the keyless entry keypad factory code.
2. Within 5 seconds, press and hold control 7/8.
3. Within 5 seconds (while holding down control 7/8), press and release control 3/4.
4. Release control 7/8.

The door will lock/unlock to confirm the feature has been disabled. Once disabled, the feature can be enabled by repeating the same sequence.

Automatic door locks can also be turned on/off through the following procedure:

## Controls and features

You must complete steps 1-7 within 30 seconds or the procedure will have to be repeated. If the procedure needs to be repeated, you must wait 30 seconds.

1. Turn the ignition key to ON.
2. Press the power door unlock control on the door panel three times.
3. Turn the ignition key from ON to OFF.
4. Press the power door unlock control three times.
5. Turn the ignition back to ON.
6. Press the unlock control once. After a five to ten second delay, the door will lock/unlock to confirm successful programming.
7. Turn the ignition to OFF.

### Opening the trunk

Press the control once to open the trunk.

Ensure that the trunk is closed and latched before driving your vehicle. Failure to latch the trunk may cause objects to fall out of the trunk or block the rear view.

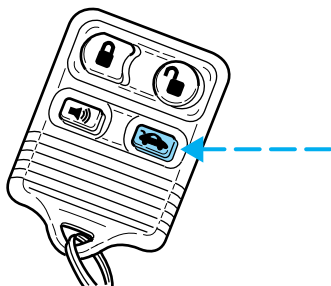

### Sounding a panic alarm

Press this control to activate the alarm.

To deactivate the alarm, press the control again or turn the ignition to ACC or ON.

This device complies with part 15 of the FCC rules and with RS-210 of Industry Canada. Operation is subject to the following two conditions: (1) This device may not cause harmful interference, and (2) This device must accept any interference received, including interference that may cause undesired operation.

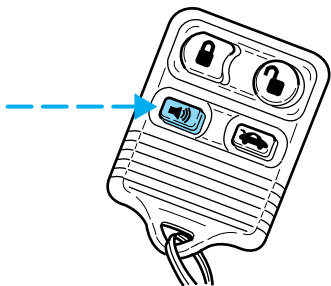

## Controls and features

**Changes or modifications not expressly approved by the party responsible for compliance could void the user's authority to operate the equipment.**

### Illuminated entry

The interior lamps illuminate when the remote entry system is used to unlock the door(s) or sound the personal alarm.

The system automatically turns off after 25 seconds or when the ignition is turned to the START or ACC position. The dome lamp control (if equipped) must **not** be set to the OFF position for the illuminated entry system to operate.

The inside lights will not turn off if:

- they have been turned on with the dimmer control or
- any door is open.

The battery saver will shut off the interior lamps 30 minutes after the last door is closed or after 10 minutes if the door is left open.

### Replacing the battery

The remote transmitter is powered by one coin type three-volt lithium battery CR2032 or equivalent. Typical operating range will allow you to be up to 10 meters (33 feet) away from your vehicle. A decrease in operating range can be caused by:

- weather conditions
- nearby radio towers
- structures around the vehicle
- other vehicles parked next to the vehicle

To replace the battery:

1. Twist a thin coin between the two halves of the transmitter near the key ring. **DO NOT TAKE THE FRONT PART OF THE TRANSMITTER APART.**
2. Place the positive (+) side of new battery in the same orientation. Refer to the diagram inside the transmitter unit.

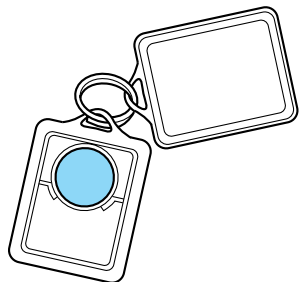

## Controls and features

3. Snap the two halves back together.

Replacement of the battery will **not** cause the remote transmitter to become deprogrammed from your vehicle. The remote transmitter should operate normally after battery replacement.

### Replacing lost transmitters

Take all your vehicle's transmitters to your dealer if service is required.

If you purchase additional transmitters (up to four may be programmed), perform the following procedure:

To reprogram the transmitters yourself, place the key in the ignition and turn from OFF to ON four times in rapid succession within 3 seconds. After doors lock/unlock, press any control on all transmitters (up to four). When completed, turn the ignition to OFF.

All transmitters must be programmed at the same time.



### SECURILOCK™ PASSIVE ANTI-THEFT SYSTEM

Your vehicle is equipped with a coded-key anti-theft system. Only the correct key will be able to start your vehicle. If your keys are lost or stolen, you must take your vehicle to your dealership for key reprogramming.

The SecuriLock™ passive anti-theft system provides an advanced level of vehicle theft protection. Your vehicle's engine can only be started with the two special SecuriLock™ electronically coded keys provided with your vehicle. Each time you start your vehicle, the SecuriLock™ key is read by the SecuriLock™ passive anti-theft system. If the SecuriLock™ key identification code matches the code stored in the SecuriLock™ passive anti-theft system, the vehicle's engine is allowed to start. If the SecuriLock™ key identification code does not match the code stored in the system or if a SecuriLock™ key is not detected (vehicle theft situation), the vehicle's engine will not operate.

The SecuriLock™ passive anti-theft system is not compatible with aftermarket remote start systems. Use of these systems may result in vehicle starting problems and a loss of security protection. Large metallic objects or devices such as the Mobil Speedpass™ on the same key ring

## Controls and features

as your SecuriLock™ key may cause vehicle starting problems. These objects and devices cannot damage the SecuriLock™ key, but can cause a momentary problem if they are too close to the key when starting the engine. If a problem occurs, turn ignition off and restart the engine with all other objects on the key ring held away from the SecuriLock™ ignition key.

Spare SecuriLock™ keys can be purchased from your dealership and programmed to your SecuriLock™ passive anti-theft system. Refer to *Programming spare SecuriLock™ keys* for more information.

If one or both of your SecuriLock™ keys are lost or stolen and you want to ensure the lost or stolen key will not operate your vehicle, bring your vehicle and all available SecuriLock™ keys to your dealership for reinitialization.

### Theft indicator

The theft indicator on top of the instrument panel will operate as follows:

- When the ignition is OFF, the theft indicator will flash briefly every 2 seconds to indicate the SecuriLock™ system is protecting your vehicle.
- When the ignition is turned to ON or START, the theft indicator will light for 3 seconds and then go out. If the theft indicator stays on for an extended period of time or flashes rapidly, have the system serviced by your dealership or a qualified technician.

### Programming spare SecuriLock™ keys

Spare SecuriLock™ keys can be purchased from your dealership and programmed to your SecuriLock™ anti-theft system (up to a total of 8 keys). Your dealership can program your new SecuriLock™ key(s) to your vehicle or you can do it yourself using the following simple procedure. To program a new SecuriLock™ key yourself, you will need two previously programmed SecuriLock™ keys (keys that already operate your vehicle's engine). If two previously programmed SecuriLock™ keys are not available (one or both of your original keys were lost or stolen), you must bring your vehicle to your dealership to have the spare SecuriLock™ key(s) programmed.

## Controls and features

### KEYLESS ENTRY SYSTEM

With the keyless entry keypad, you can:

- lock or unlock the vehicle doors without using the key.
- open trunk
- disable/enable horn chirp.
- disable/enable autolock

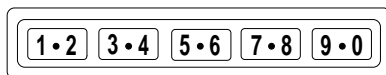

See also *Remote entry system* in this chapter for more information.

Your vehicle has a factory-set 5–digit code that operates the keyless entry system. You can also program your own 5–digit personal entry code.

The factory-set code is located:

- on the owner’s wallet card in the glove compartment
- taped to the computer module

When pressing the controls on the keyless entry keypad, press the middle of the controls to ensure a good activation.

### Programming your own entry code

1. Enter the factory-set code (keypad will illuminate when pressed).
2. Press the 1/2 control within five seconds of step 1.
3. Enter your personal 5 digit code. Enter each digit within five seconds of the previous one.

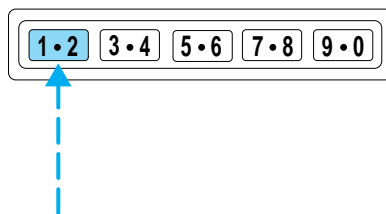

All of the vehicle doors will lock and unlock to confirm programming of the new code.

Do not set a code that includes five of the same number or presents them in sequential order. Thieves can easily figure out these types of codes.



## Controls and features

You can program up to three personal codes to unlock your vehicle. These codes do not replace the permanent code that the dealership gave you.

### **Erasing personal code**

To erase all of the personal entry codes programmed to a vehicle:

1. Enter the factory-set code.
2. Press 1/2 within 5 seconds of step 1.
3. Press and hold 1/2 for two seconds. All of the vehicle doors will lock and then unlock to confirm erasure.

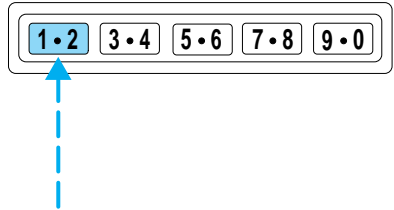

### **Unlocking the doors and releasing the trunk with the keyless entry system**

To unlock the driver door, enter either the factory-set code or personal code (each digit pressed within 5 seconds of prior digit). The interior lamps will illuminate.

To unlock all doors, enter the factory-set code or personal code (driver door unlocks) and press 3/4 within 5 seconds.

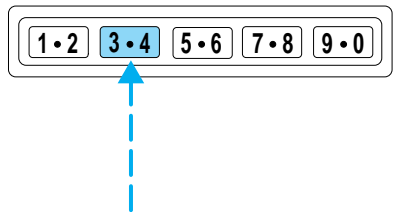

To release the trunk, enter the factory-set code or personal code (driver door unlocks) and press 5/6 within 5 seconds.

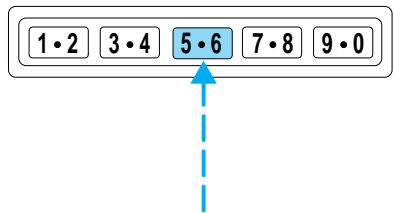

After the factory-set code or personal code has been entered, you can unlock all doors (press 3/4) and release the trunk (press 5/6) as long as the controls are pressed within 5 seconds of each other.

## Controls and features

### ***Locking doors with the keyless entry system***

It is not necessary to enter the factory-set code prior to locking all doors. To lock the doors:

1. Press 7/8 and 9/0 at the same time.

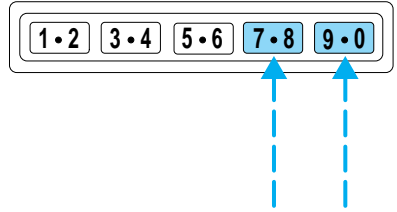

## Seating and safety restraints

### SEATING

#### Head restraints

Your vehicle's seats may be equipped with head restraints which are vertically adjustable. The purpose of these head restraints is to help limit head motion in the event of a rear collision. To properly adjust your head restraints, lift the head restraint so that it is located directly behind your head or as close to that position as possible. Refer to the following to raise and lower the head restraints.

Push or pull the head rests to the desired position.

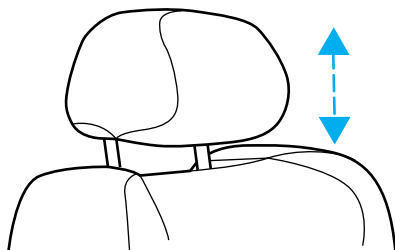

#### Adjusting the front manual seat



Never adjust the driver's seat or seatback when the vehicle is moving.



Do not pile cargo higher than the seatbacks to avoid injuring people in a collision or sudden stop.



Always drive and ride with your seatback upright and the lap belt snug and low across the hips.

## Seating and safety restraints

Lift handle to move seat forward or backward.

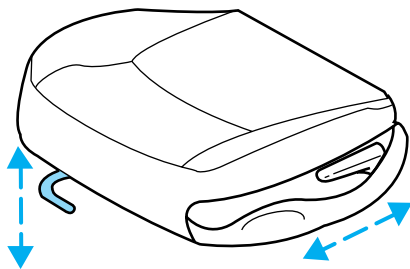

Pull lever up to adjust seatback.

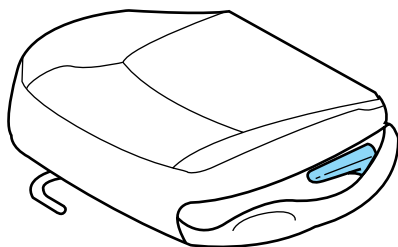

### **Using the manual recline function (if equipped)**



Never adjust the driver's seat or seatback when the vehicle is moving.



Do not pile cargo higher than the seatbacks to avoid injuring people in a collision or sudden stop.



Always drive and ride with your seatback upright and the lap belt snug and low across the hips.

To adjust the front seatback using the manual recliner:

- Lift and hold the handle located on the side of the seat.
- Lean against the seatback to adjust it to your desired position. You can recline the seat back or bring it forward.

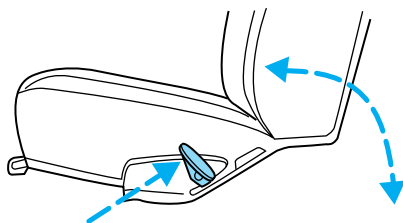

## Seating and safety restraints

- Release the handle when the desired position has been reached.

### Adjusting the power front seats – door mounted controls

The controls for the power seats are located on the inside of each front door.



Never adjust the driver's seat or seatback when the vehicle is moving.



Do not pile cargo higher than the seatbacks to avoid injuring people in a collision or sudden stop.



Always drive and ride with your seatback upright and the lap belt snug and low across the hips.

Press the control to recline the seatback forward or backward.

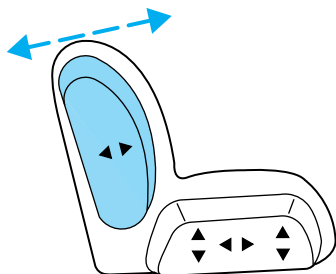

Press to move the seat forward or backward.

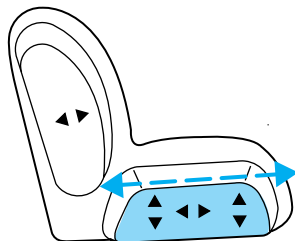

## Seating and safety restraints

Press to move the front portion of the seat cushion up or down.

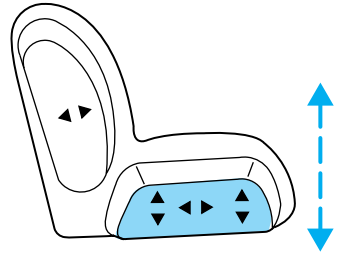

Press to move the rear portion of the seat cushion up or down.

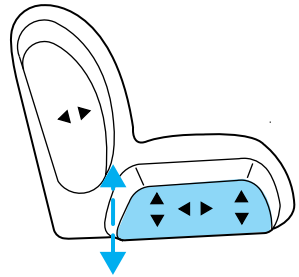

### ***Adjusting the power seats – seat mounted controls***



Never adjust the driver's seat or seatback when the vehicle is moving.

The power seat controls are located on the side of the driver's seat.

Press to raise or lower the seat, or to move the seat forward or backward.

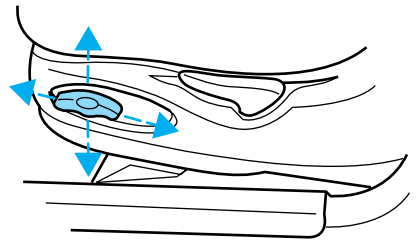

## Seating and safety restraints

### Using the power lumbar support (if equipped)

The power lumbar control is located on the outboard side of the seat.

Press one side of the control to adjust firmness.

Press the other side of the control to adjust softness.

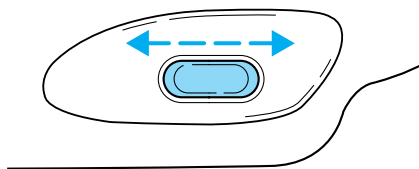

## SAFETY RESTRAINTS

### Safety restraints precautions



Always drive and ride with your seatback upright and the lap belt snug and low across the hips.



To prevent the risk of injury, make sure children sit where they can be properly restrained.



Never let a passenger hold a child on his or her lap while the vehicle is moving. The passenger cannot protect the child from injury in a collision.



All occupants of the vehicle, including the driver, should always properly wear their safety belts, even when an air bag SRS is provided.



It is extremely dangerous to ride in a cargo area, inside or outside of a vehicle. In a collision, people riding in these areas are more likely to be seriously injured or killed. Do not allow people to ride in any area of your vehicle that is not equipped with seats and safety belts. Be sure everyone in your vehicle is in a seat and using a safety belt properly.

## Seating and safety restraints



Each seating position in your vehicle has a specific safety belt assembly which is made up of one buckle and one tongue that are designed to be used as a pair. 1) Use the shoulder belt on the outside shoulder only. Never wear the shoulder belt under the arm. 2) Never swing the safety belt around your neck over the inside shoulder. 3) Never use a single belt for more than one person.

### Combination lap and shoulder belts

1. Insert the belt tongue into the proper buckle (the buckle closest to the direction the tongue is coming from) until you hear a snap and feel it latch. Make sure the tongue is securely fastened in the buckle.

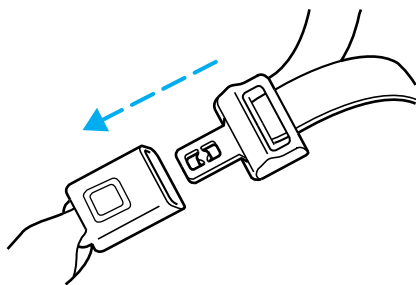

2. To unfasten, push the release button and remove the tongue from the buckle.

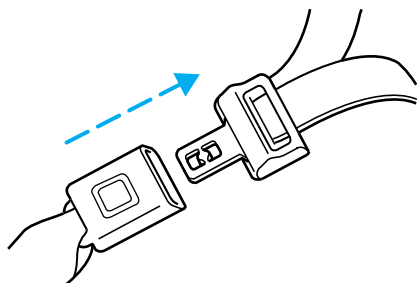

The front and rear outboard safety restraints in the vehicle are combination lap and shoulder belts. The front and rear seat passenger outboard safety belts have two types of locking modes described below:

### Vehicle sensitive mode

The vehicle sensitive mode is the normal retractor mode, allowing free shoulder belt length adjustment to your movements and locking in response to vehicle movement. For example, if the driver brakes suddenly or turns a corner sharply, or the vehicle receives an impact of 8 km/h (5 mph) or more, the combination safety belts will lock to help reduce forward movement of the driver and passengers.



## Seating and safety restraints

### Automatic locking mode

In this mode, the shoulder belt is automatically pre-locked. The belt will still retract to remove any slack in the shoulder belt.

The automatic locking mode is not available on the driver safety belt.

### When to use the automatic locking mode

- When a tight lap/shoulder fit is desired.
- **Anytime** a child safety seat is installed in a passenger front or outboard rear seating position (if equipped). Refer to *Safety Restraints for Children* or *Safety Seats for Children* later in this chapter.

### How to use the automatic locking mode

- Buckle the combination lap and shoulder belt.

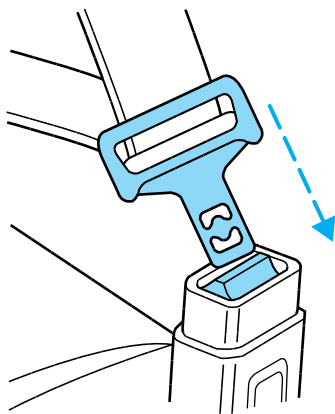

- Grasp the shoulder portion and pull downward until the entire belt is extracted.



## Seating and safety restraints

- Allow the belt to retract. As the belt retracts, you will hear a clicking sound. This indicates the safety belt is now in the automatic locking mode.

### ***How to disengage the automatic locking mode***

Disconnect the combination lap/shoulder belt and allow it to retract completely to disengage the automatic locking mode and activate the vehicle sensitive (emergency) locking mode.

### **Front safety belt height adjustment**

Your vehicle has safety belt height adjustments for the driver and front passenger. Adjust the height of the shoulder belt so the belt rests across the middle of your shoulder.

To lower the shoulder belt height, push the button and slide the height control down. To raise the height of the shoulder belt, slide the height adjuster up. Pull down on the height adjustment assembly to make sure it is locked in place.

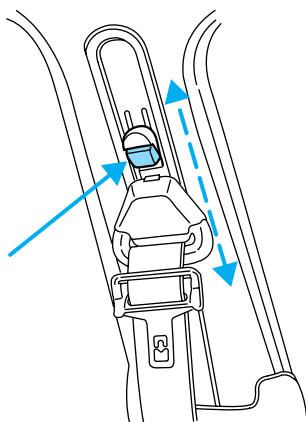

Position the shoulder belt height adjuster so that the belt rests across the middle of your shoulder. Failure to adjust the safety belt properly could reduce the effectiveness of the safety belt and increase the risk of injury in a collision.

### **Lap belts**

#### ***Adjusting the lap belt***

The lap belt does not adjust automatically.



The lap belts should fit snugly and as low as possible around the hips, not around the waist.

## Seating and safety restraints

Insert the tongue into the correct buckle (the buckle closest to the direction the tongue is coming from). To lengthen the belt, turn the tongue at a right angle to the belt and pull across your lap until it reaches the buckle. To tighten the belt, pull the loose end of the belt through the tongue until it fits snugly across the hips.

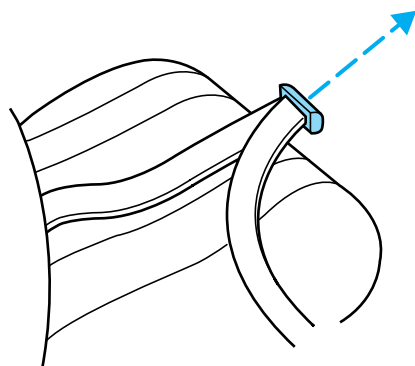

Shorten and fasten the belt when not in use.

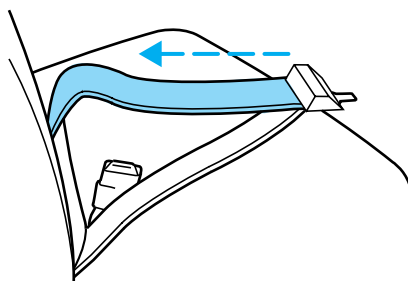

### Safety belt extension assembly

If the safety belt assembly is too short, even when fully extended, 20 cm (8 inches) can be added to the safety belt assembly by adding a safety belt extension assembly (part number 611C22). Safety belt extension assemblies can be obtained from your dealer at no cost.

Use only extensions manufactured by the same supplier as the safety belt. Manufacturer identification is located at the end of the webbing on the label. Also, use the safety belt extension only if the safety belt is too short for you when fully extended. Do not use extensions to change the fit of the shoulder belt across the torso.

### Safety belt warning light and indicator chime

The seat belt warning light illuminates in the instrument cluster and a chime sounds to remind the occupants to fasten their safety belts.

## Seating and safety restraints

### Conditions of operation

If...	Then...
The driver's safety belt is not buckled before the ignition switch is turned to the ON position...	The safety belt warning light illuminates for one to two minutes and the warning chime sounds for four to eight seconds.
The driver's safety belt is buckled while the indicator light is illuminated and the warning chime is sounding...	The safety belt warning light and warning chime turn off.
The driver's safety belt is buckled before the ignition switch is turned to the ON position...	The safety belt warning light and indicator chime remain off.

### Safety belt maintenance

Inspect the safety belt systems periodically to make sure they work properly and are not damaged. Inspect the safety belts to make sure there are no nicks, wears or cuts, replacing if necessary. All safety belt assemblies, including retractors, buckles, front seat belt buckle assemblies (slide bar)(if equipped), shoulder belt height adjusters (if equipped), child safety seat tether bracket assemblies (if equipped), and attaching hardware, should be inspected after a collision. Ford recommends that all safety belt assemblies used in vehicles involved in a collision be replaced. However, if the collision was minor and a qualified technician finds that the belts do not show damage and continue to operate properly, they do not need to be replaced. Safety belt assemblies not in use during a collision should also be inspected and replaced if either damage or improper operation is noted.



Failure to inspect and if necessary replace the safety belt assembly under the above conditions could result in severe personal injuries in the event of a collision.

Refer to *Cleaning and maintaining the safety belts* in the *Maintenance and care* section.

## Seating and safety restraints

### AIR BAG SUPPLEMENTAL RESTRAINT SYSTEM (SRS)

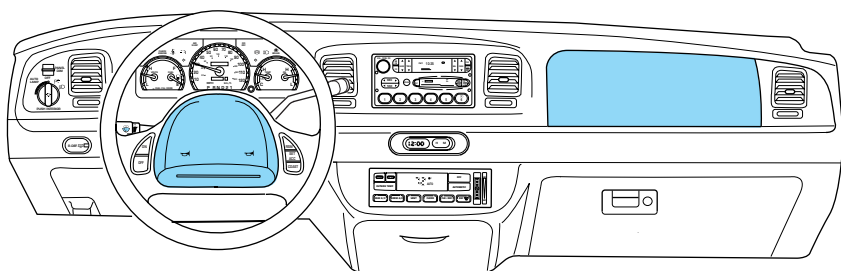



### Important supplemental restraint system (SRS) precautions

The supplemental restraint system is designed to work with the safety belt to help protect the driver and right front passenger from certain upper body injuries.

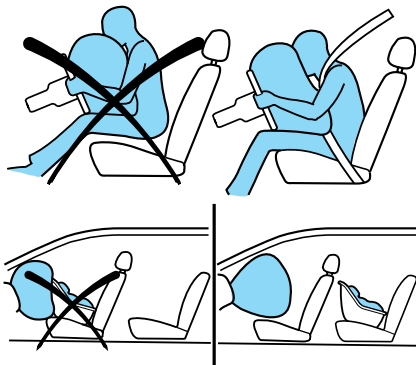
Air bags DO NOT inflate slowly or gently and the risk of injury from a deploying air bag is greatest close to the trim covering the air bag module.



 All occupants of the vehicle including the driver should always properly wear their safety belts even when air bag SRS is provided.

 Always transport children 12 years old and under in the back seat and always use appropriate child restraints.

 NHTSA recommends a minimum distance of at least 25 cm (ten [10] inches) between an occupant's chest and the air bag module.

## Seating and safety restraints

Steps you can take to properly position yourself away from the airbag:

- Move your seat to the rear as far as you can while still reaching the pedals comfortably.
- Recline the seat slightly (one or two degrees) from the upright position.



Do not put anything on or over the air bag module. Placing objects on or over the air bag inflation area may cause those objects to be propelled by the air bag into your face and torso causing serious injury.



Do not attempt to service, repair, or modify the Air Bag Supplemental Restraint System or its fuses. See your Ford or Lincoln-Mercury dealer.

### Children and air bags

For additional important safety information, read all information on safety restraints in this guide.

Children must always be properly restrained. Accident statistics suggest that children are safer when properly restrained in the rear seating positions than in the front seating position. Failure to follow these instructions may increase the risk of injury in a collision.



Air bags can kill or injure a child in a child seat.

**NEVER** place a rear-facing child seat in front of an active air bag. If you must use a forward-facing child seat in the front seat, move the seat all the way back.

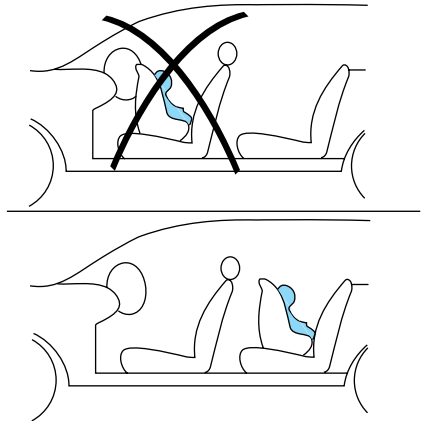

## Seating and safety restraints

### How does the air bag supplemental restraint system work?

The air bag SRS is designed to activate when the vehicle sustains sufficient longitudinal deceleration sufficient to cause the sensors to close an electrical circuit that initiates air bag inflation.

The fact that the air bags did not inflate in a collision does not mean that something is wrong with the system. Rather, it means the forces were not of the type sufficient to cause activation. Air bags are designed to inflate in frontal and near-frontal collisions, not rollover, side-impact, or rear-impacts.

The air bags inflate and deflate rapidly upon activation. After air bag deployment, it is normal to notice a smoke-like, powdery residue or smell the burnt propellant. This may consist of cornstarch, talcum powder (to lubricate the bag) or sodium compounds (e.g., baking soda) that result from the combustion process that inflates the air bag. Small amounts of sodium hydroxide may be present which may irritate the skin and eyes, but none of the residue is toxic.

While the system is designed to help reduce serious injuries, it may also cause minor burns, abrasions, swelling or temporary hearing loss. Because air bags must inflate rapidly and with considerable force, there is the risk of death or serious injuries such as fractures, facial and eye injuries or internal injuries, particularly to occupants who are not properly restrained or are otherwise out of position at the time of air bag deployment. Thus, it is extremely important that occupants be properly restrained as far away from the air bag module as possible while maintaining vehicle control.

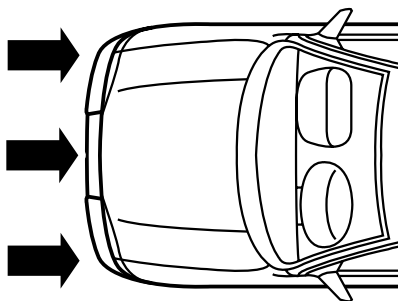

## Seating and safety restraints



Several air bag system components get hot after inflation. Do not touch them after inflation.



If the air bag is deployed, **the air bag will not function again and must be replaced immediately.** If the air bag is not replaced, the unrepaired area will increase the risk of injury in a collision.

The SRS consists of:

- driver and passenger air bag modules (which include the inflators and air bags),
- one or more impact and safing sensors,
- a readiness light and tone
- and the electrical wiring which connects the components.

The diagnostic module monitors its own internal circuits and the supplemental air bag electrical system warning (including the impact sensors), the system wiring, the air bag system readiness light, the air bag back up power and the air bag ignitors.

### Determining if the system is operational

The SRS uses a readiness light in the instrument cluster or a tone to indicate the condition of the system. Refer to the *Air bag readiness* section in the *Instrumentation* chapter. Routine maintenance of the air bag is not required.

A difficulty with the system is indicated by one or more of the following:

- The readiness light will either flash or stay lit.
- The readiness light will not illuminate immediately after ignition is turned on.
- A series of five beeps will be heard. The tone pattern will repeat periodically until the problem and light are repaired.

**AIR  
BAG**

If any of these things happen, even intermittently, have the SRS serviced at your dealership or by a qualified technician immediately. Unless serviced, the system may not function properly in the event of a collision.



## Seating and safety restraints

### Disposal of air bags and air bag equipped vehicles

For disposal of air bags or air bag equipped vehicles, see your local dealership or qualified technician. Air bags **MUST BE** disposed of by qualified personnel.

### SAFETY RESTRAINTS FOR CHILDREN

See the following sections for directions on how to properly use safety restraints for children. Also see *Air Bag Supplemental Restraint System (SRS)* in this chapter for special instructions about using air bags.

### Important child restraint precautions

You are required by law to use safety restraints for children in the U.S. and Canada. If small children ride in your vehicle (generally children who are four years old or younger and who weigh 18 kg [40 lbs] or less), you must put them in safety seats made especially for children. Check your local and state or provincial laws for specific requirements regarding the safety of children in your vehicle.



Never let a passenger hold a child on his or her lap while the vehicle is moving. The passenger cannot protect the child from injury in a collision.

Always follow the instructions and warnings that come with any infant or child restraint you might use.

When possible, always place children under age 12 in the rear seat of your vehicle. Accident statistics suggest that children are safer when properly restrained in the rear seating positions than in the front seating position.

### Children and safety belts

If the child is the proper size, restrain the child in a safety seat.

Children who are too large for child safety seats (as specified by your child safety seat manufacturer) should always wear safety belts.

Follow all the important safety restraint and air bag precautions that apply to adult passengers in your vehicle.

If the shoulder belt portion of a combination lap and shoulder belt can be positioned so it does not cross or rest in front of the child's face or neck, the child should wear the lap and shoulder belt. Moving the child closer to the center of the vehicle may help provide a good shoulder belt fit.

## Seating and safety restraints



Do not leave children, unreliable adults, or pets unattended in your vehicle.

To improve the fit of lap and shoulder belts on children who have outgrown child safety seats, Ford recommends use of a belt-positioning booster seat that is labelled as conforming to all Federal motor vehicle safety standards. Belt-positioning booster seats raise the child and provide a shorter, firmer seating cushion that encourages safer seating posture and better fit of lap and shoulder belts on the child.

A belt-positioning booster should be used if the shoulder belt rests in front of the child's face or neck, or if the lap belt does not fit snugly on both thighs, or if the thighs are too short to let the child sit all the way back on the seat cushion when the lower legs hang over the edge of the seat cushion. You may wish to discuss the special needs of your child with your pediatrician.

### SAFETY SEATS FOR CHILDREN



## Seating and safety restraints

### Child and infant or child safety seats

Use a safety seat that is recommended for the size and weight of the child. Carefully follow all of the manufacturer's instructions with the safety seat you put in your vehicle. If you do not install and use the safety seat properly, the child may be injured in a sudden stop or collision.

When installing a child safety seat:

- Review and follow the information presented in the *Air Bag Supplemental Restraint System* section in this chapter.
- Use the correct safety belt buckle for that seating position.
- Insert the belt tongue into the proper buckle until you hear a snap and feel it latch. Make sure the tongue is securely fastened in the buckle.
- Keep the buckle release button pointing up and away from the safety seat, with the tongue between the child seat and the release button, to prevent accidental unbuckling.
- Place seat back in upright position.
- Put the safety belt in the automatic locking mode. Refer to *Automatic locking mode* (passenger side front and outboard rear seating positions)(if equipped).

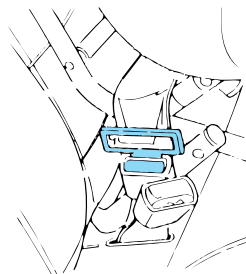

Ford recommends the use of a child safety seat having a top tether strap. Install the child safety seat in a seating position which is capable of providing a tether anchorage. For more information on top tether straps, refer to *Attaching safety seats with tether straps*.



Carefully follow all of the manufacturer's instructions included with the safety seat you put in your vehicle. If you do not install and use the safety seat properly, the child may be injured in a sudden stop or collision.

## Seating and safety restraints

### Installing child safety seats in combination lap and shoulder belt seating positions

1. Position the child safety seat in a seat with a combination lap and shoulder belt.

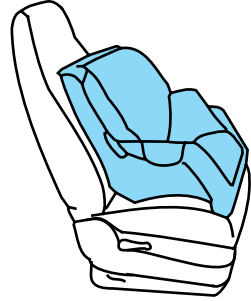

An air bag can kill or injure a child in a child seat. If you must use a forward-facing child seat in the front seat, move seat all the way back.



Children 12 and under should be properly restrained in the rear seat whenever possible.

2. Pull down on the shoulder belt and then grasp the shoulder belt and lap belt together.

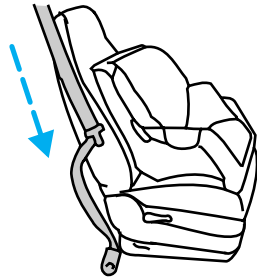

## Seating and safety restraints

3. While holding the shoulder and lap belt portions together, route the tongue through the child seat according to the child seat manufacturer's instructions. Be sure the belt webbing is not twisted.

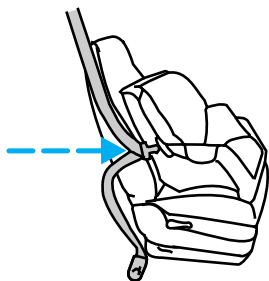

4. Insert the belt tongue into the proper buckle (the buckle closest to the direction the tongue is coming from) for that seating position until you hear a snap and feel the latch engage. Make sure the tongue is latched securely by pulling on it.

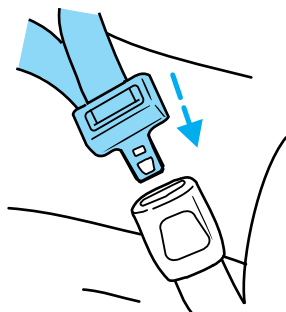

5. To put the retractor in the automatic locking mode, grasp the shoulder portion of the belt and pull downward until all of the belt is extracted and a click is heard.

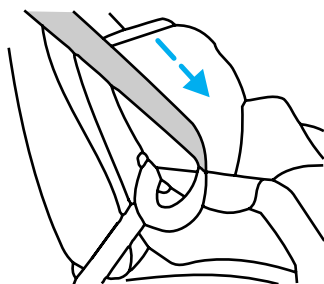

6. Allow the belt to retract. The belt will click as it retracts to indicate it is in the automatic locking mode.

## Seating and safety restraints

7. Pull the lap belt portion across the child seat toward the buckle and pull up on the shoulder belt while pushing down with your knee on the child seat.

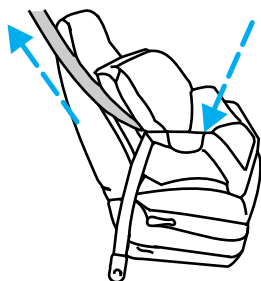

8. Allow the safety belt to retract to remove any slack in the belt.

9. Before placing the child in the seat, forcibly tilt the seat forward and back to make sure the seat is securely held in place.

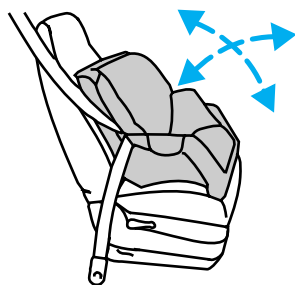

10. Try to pull the belt out of the retractor to make sure the retractor is in the automatic locking mode (you should not be able to pull more belt out). If the retractor is not locked, unbuckle the belt and repeat steps two through nine.

Check to make sure the child seat is properly secured before each use.

### Installing child safety seats in the lap belt seating positions

1. Lengthen the lap belt. To lengthen the belt, hold the tongue so that its bottom is perpendicular to the direction of webbing while sliding the tongue up the webbing.

2. Place the child safety seat in the center seating position.

3. Route the tongue and webbing through the child seat according to the child seat manufacturer's instructions.

4. Insert the belt tongue into the proper buckle for the center seating position until you hear a snap and feel it latch. Make sure the tongue is securely fastened to the buckle by pulling on tongue.

## Seating and safety restraints

5. Push down on the child seat while pulling on the loose end of the lap belt webbing to tighten the belt.
6. Before placing the child into the child seat, forcibly tilt the child seat from side to side and in forward direction to make sure that the seat is held securely in place. If the child seat moves excessively, repeat steps 5 through 6, or properly install the child seat in a different position.

### Attaching safety seats with tether straps

Some manufacturers make safety seats that include a tether strap that goes over the back of the vehicle seat and attaches to an anchoring point. Other manufacturers offer the tether strap as an accessory. Contact the manufacturer of your child safety seat for information about ordering a tether strap.

### Tether anchorage hardware

Attachment holes (at each rear seating position) have been provided in your vehicle to attach anchor hardware, if desired. Tether anchorage hardware kits (part number 613D74) including instructions, may be obtained at no charge from any Ford or Lincoln-Mercury dealer. All vehicles built for sale in Canada include a tether anchor hardware kit.

Be sure to follow the child safety seat manufacturer's instructions.



Tighten the anchor according to specifications. Otherwise, the safety seat may not be properly secured and the child may be injured in a sudden stop or collision.

## Starting

### PREPARING TO START YOUR VEHICLE

Engine starting is controlled by the ignition system. This system meets all Canadian Interference-Causing Equipment standard requirements regulating the impulse electrical field strength of radio noise.

When starting a fuel-injected engine, avoid pressing the accelerator before or during starting. Only use the accelerator when you have difficulty starting the engine. For more information on starting the vehicle, refer to *Starting the engine* in this chapter.



Extended idling at high engine speeds can produce very high temperatures in the engine and exhaust system, creating the risk of fire or other damage.



Do not park, idle, or drive your vehicle in dry grass or other dry ground cover. The emission system heats up the engine compartment and exhaust system, which can start a fire.



Do not start your vehicle in a closed garage or in other enclosed areas. Exhaust fumes can be toxic. Always open the garage door before you start the engine. See *Guarding against exhaust fumes* in this chapter for more instructions.



If you smell exhaust fumes inside your vehicle, have your dealer inspect your vehicle immediately. Do not drive if you smell exhaust fumes.

### Important safety precautions

A computer system controls the engine's idle revolutions per minute (RPM). When the engine starts, the idle RPM runs faster to warm the engine. If the engine idle speed does not slow down automatically, have the vehicle checked. Do not allow the vehicle to idle for more than ten minutes.

Before starting the vehicle:

1. Make sure all vehicle occupants have buckled their safety belts. For more information on safety belts and their proper usage, refer to the *Seating and safety restraints* chapter.



## Starting

2. Make sure the headlamps and vehicle accessories are off.
3. Make sure the parking brake is set.

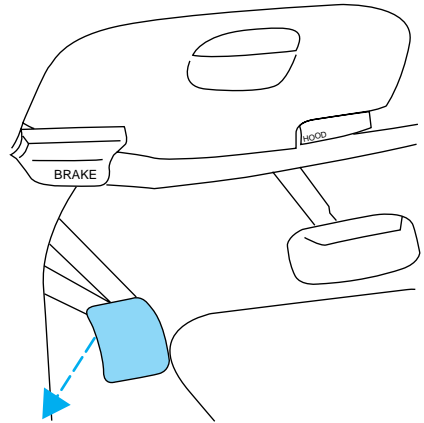

4. Make sure the gearshift is in P (Park).



5. Turn the key to 4 (ON) without turning the key to 5 (START).

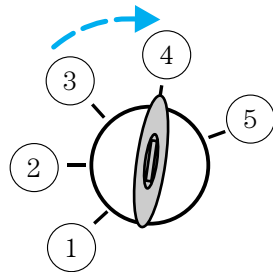

# Starting

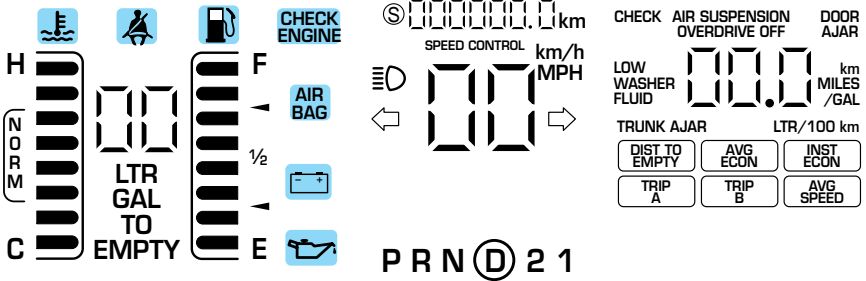
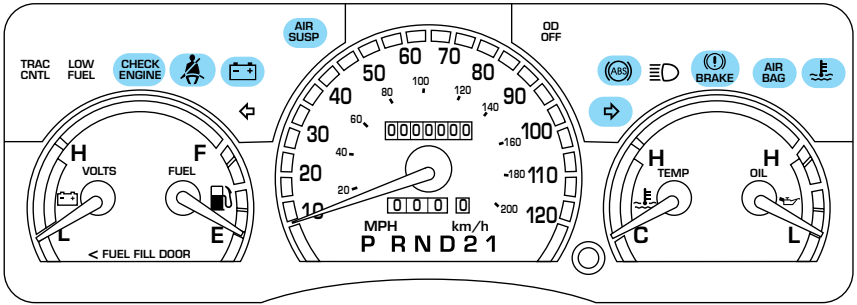

Make sure the corresponding lights illuminate briefly. If a light fails to illuminate, have the vehicle serviced.

- If the driver's safety belt is fastened, the light (  ) will not illuminate.

## STARTING THE ENGINE

1. Turn the key to 5 (START) without pressing the accelerator pedal and release as soon as the engine starts. The key will return to 4 (ON).

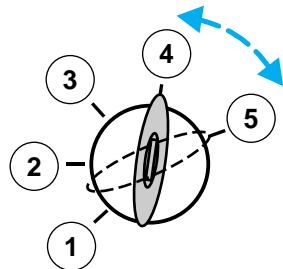

2. If the temperature is above  $-12^{\circ}\text{C}$  ( $10^{\circ}\text{F}$ ) and the engine does not start within five seconds on the first try, turn the key to OFF, wait ten seconds and try again.
3. If the temperature is below  $-12^{\circ}\text{C}$  ( $10^{\circ}\text{F}$ ) and the engine does not start in fifteen seconds on the first try, turn the key OFF and wait ten seconds and try again. If the engine does not start in two attempts, depress the accelerator and start the engine while holding the accelerator down to the floor. Release the accelerator when the engine starts.
4. After idling for a few seconds, apply the brake and release the parking brake.

### Using the engine block heater (if equipped)

An engine block heater warms the engine coolant, which improves starting, warms up the engine faster and allows the heater-defroster system to respond quickly. Use of an engine block heater is strongly recommended if you live in a region where temperatures reach  $-23^{\circ}\text{C}$  ( $-10^{\circ}\text{F}$ ) or below.

For best results, plug the heater in at least three hours before starting the vehicle. Using the heater for longer than three hours will not harm the engine, so the heater can be plugged in the night before starting the vehicle.



To prevent electrical shock, do not use your heater with ungrounded electrical systems or two-pronged (cheater) adapters.

## Starting

### Guarding against exhaust fumes

Although odorless and colorless, carbon monoxide is present in exhaust fumes. Take precautions to avoid its dangerous effects.

 If you ever smell exhaust fumes of any kind inside your vehicle, have your dealer inspect and fix your vehicle immediately. Do not drive if you smell exhaust fumes. These fumes are harmful and could kill you.

Have the exhaust and body ventilation systems checked whenever:

- the vehicle is raised for service.
- the sound of the exhaust system changes.
- the vehicle has been damaged in a collision.

 Engine exhaust, some of its constituents, and certain vehicle components contain or emit chemicals known to the State of California to cause cancer, and birth defects or other reproductive harm.

### Important ventilating information

If the engine is idling while the vehicle is stopped in an open area for long periods of time, open the windows at least 2.5 cm (one inch).

Adjust the heating or air conditioning (if equipped) to bring in fresh air.

Improve vehicle ventilation by keeping all air inlet vents clear of snow, leaves and other debris.

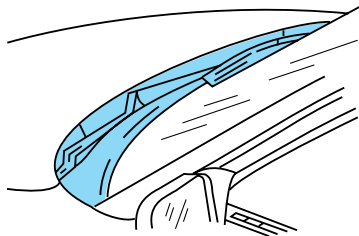

## BRAKES

Your service brakes are self-adjusting. Refer to the scheduled maintenance guide for scheduled maintenance.

Occasional brake noise is normal and often does not indicate a performance concern with the vehicle's brake system. In normal operation, automotive brake systems may emit occasional or intermittent squeal or groan noises when the brakes are applied. Such noises are usually heard during the first few brake applications in the morning; however, they may be heard at any time while braking and can be aggravated by environmental conditions such as cold, heat, moisture, road dust, salt or mud. If a "metal-to-metal," "continuous grinding" or "continuous squeal" sound is present while braking, the brake linings may be worn-out and should be inspected by a qualified service technician.

### Anti-lock brake system (ABS) (if equipped)

On vehicles equipped with an anti-lock braking system (ABS), a noise from the hydraulic pump motor and pulsation in the pedal may be observed during ABS braking events. Pedal pulsation coupled with noise while braking under panic conditions or on loose gravel, bumps, wet or snowy roads is normal and indicates proper functioning of the vehicle's anti-lock brake system. The ABS performs a self-check at 17 km/h (10 mph) after you start the engine and begin to drive away. A brief mechanical noise may be heard during this test. This is normal. If a malfunction is found, the ABS warning light will come on. If the vehicle has continuous vibration or shudder in the steering wheel while braking, the vehicle should be inspected by a qualified service technician.

The ABS operates by detecting the onset of wheel lockup during brake applications and compensating for this tendency. The wheels are prevented from locking even when the brakes are firmly applied. The accompanying illustration depicts the advantage of an ABS equipped vehicle (on bottom) to a non-ABS equipped vehicle (on top) during hard braking with loss of front braking traction.

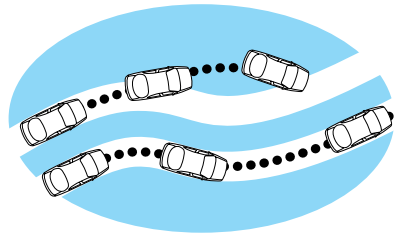

## Driving

### ABS warning lamp

The (ABS) warning lamp in the instrument cluster momentarily illuminates when the ignition is turned on and the engine is off. If the light does not illuminate momentarily at start up, remains on or continues to flash, the ABS needs to be serviced.

With the ABS light on, the anti-lock brake system is disabled and normal braking is still effective unless the brake warning light also remains illuminated with parking brake released. (If your brake warning lamp illuminates, have your vehicle serviced immediately).



### Using ABS

- In an emergency or when maximum efficiency from the ABS is required, apply continuous full force on the brake. The ABS will be activated immediately, thus allowing you to retain full steering control of your vehicle and, providing there is sufficient space, will enable you to avoid obstacles and bring the vehicle to a controlled stop.
- The Anti-Lock system does not decrease the time necessary to apply the brakes or always reduce stopping distance. Always leave enough room between your vehicle and the vehicle in front of you to stop.
- We recommend that you familiarize yourself with this braking technique. However, avoid taking any unnecessary risks.

### Parking brake with auto-release

Apply the parking brake whenever the vehicle is parked.

To set the parking brake:

1. Move the gearshift to P (Park).
2. Push pedal downward.

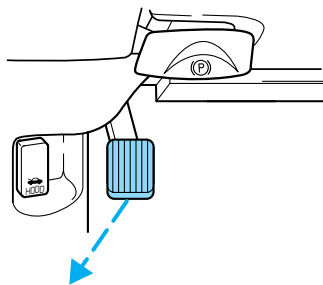

The BRAKE warning lamp in the instrument cluster illuminates and remains illuminated (when the ignition is turned ON) until the parking brake is fully released.



Always set the parking brake fully and make sure the gearshift is latched in P (Park). Turn off the ignition whenever you leave your vehicle.

The parking brake is not recommended to stop a moving vehicle. However, if the normal brakes fail, the parking brake can be used to stop your vehicle in an emergency. Since the parking brake applies only the rear brakes, the vehicle's stopping distance will increase greatly and the handling of your vehicle will be adversely affected.

Your vehicle has an automatic parking brake release. To release the parking brake:

1. Turn the ignition to the RUN position.
2. Press the brake pedal.
3. Move the gearshift from the P (Park) position to one of the forward gears (the parking brake will not release automatically when you shift into reverse). The brake pedal must remain pressed while the gearshift is moved.

If the parking brake fails to release after completing this procedure, use the manual parking brake release lever.

Pull the lever to manually release the parking brake.

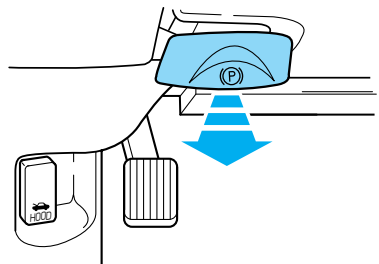

### TRACTION CONTROL™ (IF EQUIPPED)

Your vehicle may be equipped with the optional Traction Control™ system. This system helps you maintain the stability and steerability of your vehicle. It is especially useful on slippery and/or hilly road surfaces. The system operates by detecting and controlling wheel spin. The system borrows many of the electronic and mechanical elements already present in the anti-lock braking system (ABS).

Wheel-speed sensors allow excess rear wheel spin to be detected by the Traction Control™ portion of the ABS computer. Any excessive wheel spin is controlled by automatically applying and releasing the rear brakes in conjunction with engine torque reductions. Engine torque reduction is realized via the fully electronic spark and fuel injection systems. This process is very sensitive to driving conditions and very fast acting. The rear wheels “search” for optimum traction several times a second and adjustments are made accordingly.

The Traction Control™ system will allow your vehicle to make better use of available traction on slippery surfaces. The system is a driver aid which makes your vehicle easier to handle primarily on snow and ice covered roads.

During Traction Control™ operation you may hear an electric motor type of sound coming from the engine compartment and the engine will not “rev-up” when you push further on the accelerator. This is normal system behavior.

If you should become stuck in snow or ice or on a very slippery road surface, try switching the Traction Control™ system off. This may allow excess wheel spin to “dig” the vehicle out and enable a successful “rocking” maneuver.

If the Traction Control™ system is cycled excessively, the brake portion of the system will shut down to prevent the rear brakes from overheating. A limited Traction Control™ function using only engine torque reduction will still control wheels from over-spinning. When the rear brakes have cooled down, the system will again function normally. Anti-lock braking is not affected by this condition and will function normally during the cool down period.

If the engine coolant temperature is below  $-23^{\circ}\text{C}$  ( $-10^{\circ}\text{F}$ ) the engine torque reduction portion of the Traction Control™ system is **NOT** active. The system will operate normally when the engine coolant warms up.



The traction control indicator flashes during a Traction Control™ system event.

**TRAC  
CNTL**

If the traction control indicator comes on and stays lit, either:

- the Traction Control™ system requires service, or
- the customer has disabled the system using the traction control switch located on the left side of the glove compartment.

The Traction Control™ system will be on every time you turn the ignition key from OFF to ON until you deactivate the system using the traction control switch in the glove compartment.

The traction control must be turned off if you are using a mini-spare tire in a rear tire position.

### **STEERING**

Your vehicle is equipped with power steering. Power steering uses energy from the engine to help steer the vehicle.

To prevent damage to the power steering pump:

- Never hold the steering wheel to the extreme right or the extreme left for more than a few seconds when the engine is running.
- Do not operate the vehicle with a low power steering pump fluid level.

If the power steering system breaks down (or if the engine is turned off), you can steer the vehicle manually, but it takes more effort.

If the steering wanders or pulls, the condition could be caused by any of the following:

- underinflated tire(s) on any wheel(s)
- high crown in center of road
- high crosswinds
- wheels out of alignment
- loose or worn components in steering linkage

## Driving

### Speed sensitive steering

The steering in your vehicle is speed sensitive. At high speeds, steering assist will decrease to improve steering feel. At lower speeds, maneuverability will be increased.

If the amount of effort required to steer your vehicle changes at a constant vehicle speed, have the power steering system checked by your dealer or a qualified service technician.

### AIR SUSPENSION SYSTEM (IF EQUIPPED)

The air suspension system is designed to improve ride, handling and general vehicle performance during:

- certain road conditions
- steering maneuvers
- braking
- accelerations

This system keeps the rear of your vehicle at a constant level by automatically adding air or releasing air from the springs.

The air suspension shut-off switch is located on the left side of the trunk. If this switch is in the OFF position, the rear air suspension will not operate.



On vehicles equipped with Air Suspension, turn OFF the Air Suspension switch prior to jacking, hoisting or towing your vehicle.

Normal vehicle operation does not require any action by the driver.



## TRANSMISSION OPERATION

### Brake-shift interlock

This vehicle is equipped with a brake-shift interlock feature that prevents the gearshift from being moved from P (Park) unless the brake pedal is depressed.

If you cannot move the gearshift out of P (Park) with the brake pedal depressed:

1. Apply the parking brake, turn ignition key to LOCK, then remove the key.
2. Insert the key and turn it to OFF. Apply the brake pedal and shift to N (Neutral).
3. Start the vehicle.

If it is necessary to use the above procedure to move the gearshift, it is possible that a fuse has blown or the vehicle's brakelamps are not operating properly. Refer to *Fuses and relays* in the *Roadside emergencies* chapter.



Do not drive your vehicle until you verify that the brakelamps are working.

If your vehicle gets stuck in mud or snow it may be rocked out by shifting from forward and reverse gears, stopping between shifts, in a steady pattern. Press lightly on the accelerator in each gear.

**Do not rock the vehicle for more than a few minutes. The transmission and tires may be damaged or the engine may overheat.**



Always set the parking brake fully and make sure the gearshift is latched in P (Park). Turn off the ignition whenever you leave your vehicle.



If the parking brake is fully released, but the brake warning lamp remains illuminated, the brakes may not be working properly. See your dealer or a qualified service technician.

## Driving

### Driving with a 4-speed automatic transmission

#### *Understanding gearshift positions*

Pull the gearshift lever towards you and downward to move the automatic gearshift.



Hold the brake pedal down while you move the gearshift lever from P (Park) to another position. If you do not hold the brake pedal down, your vehicle may move unexpectedly and injure someone.

#### **P (Park)**

Always come to a complete stop before shifting into P (Park). Make sure the gearshift is securely latched in P (Park). This position locks the transmission and prevents the rear wheels from turning.



Always set the parking brake fully and make sure the gearshift is securely latched in P (Park).



Never leave your vehicle unattended while it is running.

#### **R (Reverse)**

With the gearshift in R (Reverse), the vehicle will move backward. Always come to a complete stop before shifting into and out of R (Reverse).



#### **N (Neutral)**

With the gearshift in N (Neutral), the vehicle can be started and is free to roll. Hold the brake pedal down while in this gear.



## Overdrive

The normal driving position for the best fuel economy. Transmission operates in gears one through four.



Overdrive can be deactivated by pressing the transmission control switch on the gearshift lever.

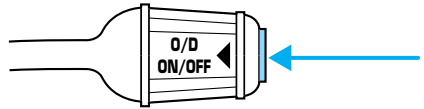

The transmission control indicator light (TCIL) will illuminate on the instrument cluster.

O/D  
OFF

## Drive

Not shown on the display. Activate by pressing the transmission control switch on the gearshift lever with the gearshift in the Drive position. The O/D OFF indicator will illuminate in the instrument cluster. Transmission operates in gears one through three. Drive provides more engine braking than Overdrive and is useful when:

- driving with a heavy load
- towing a trailer up or down steep hills
- additional engine braking is desired. If towing a trailer, refer to *Driving while you tow* in the *Trailer Towing* chapter.

To return to Overdrive mode, press the transmission control switch. The O/D OFF indicator light will no longer be illuminated.

Each time the vehicle is started, the transmission will automatically return to normal Overdrive mode.

Every time the vehicle is shut off and restarted, you must press the transmission control switch to cancel overdrive operation if the Overdrive mode is not desired.

## 2 (Second)

Use 2 (Second) to start-up on slippery roads or to provide additional engine braking on downgrades.



## Driving

### 1 (First)

Use 1 (Low) to provide maximum engine braking on steep downgrades. Upshifts can be made by shifting to 2 (Second) or to Overdrive. Selecting 1 (Low) at

higher speeds causes the transmission to shift to a lower gear, and will shift to 1 (Low) after vehicle decelerates to the proper speed.



### TRACTION-LOK AXLE (IF EQUIPPED)

This axle provides added traction on slippery surfaces, particularly when one wheel is on a poor traction surface. Under normal conditions, the Traction-Lok axle functions like a standard rear axle.

Extended use of other than the manufacturer's specified size tires on a Traction-Lok rear axle could result in a permanent reduction in effectiveness. This loss of effectiveness does not affect normal driving and should not be noticeable to the driver.



To avoid injury, never run the engine with one wheel off the ground, such as when changing a tire.

## VEHICLE LOADING

Before loading a vehicle, familiarize yourself with the following terms:

- **Base Curb Weight** : Weight of the vehicle including any standard equipment, fluids, lubricants, etc. It does not include passengers or aftermarket equipment.
- **Payload** : Combined maximum allowable weight of cargo, passengers and optional equipment. The payload equals the gross vehicle weight rating minus base curb weight.
- **GVW (Gross Vehicle Weight)** : Base curb weight plus payload weight. The GVW is not a limit or a specification.
- **GVWR (Gross Vehicle Weight Rating)** : Maximum total weight of the base vehicle, passengers, optional equipment and cargo. The GVWR is specific to each vehicle and is listed on the Safety Compliance Label on the driver's door pillar.
- **GAWR (Gross Axle Weight Rating)** : Carrying capacity for each axle system. The GAWR is specific to each vehicle and is listed on the Safety Compliance Label on the driver's door pillar.

- **GCW (Gross Combined Weight)** : The combined weight of the towing vehicle (including passengers and cargo) and the trailer.
- **GCWR (Gross Combined Weight Rating)** : Maximum combined weight of the towing vehicle (including passengers and cargo) and the trailer. The GCWR indicates the maximum loaded weight that the vehicle is designed to tow.
- **Maximum Trailer Weight Rating** : Maximum weight of a trailer the vehicle is permitted to tow. The maximum trailer weight rating is determined by subtracting the vehicle curb weight for each engine/transmission combination, any required option weight for trailer towing and the weight of the driver from the GCWR for the towing vehicle.
- **Maximum Trailer Weight** : maximum weight of a trailer the loaded vehicle (including passengers and cargo) is permitted to tow. It is determined by subtracting the weight of the loaded trailer towing vehicle from the GCWR for the towing vehicle.
- **Trailer Weight Range** : Specified weight range that the trailer must fall within that ranges from zero to the maximum trailer weight rating.

Remember to figure in the tongue load of your loaded trailer when figuring the total weight.



Do not exceed the GVWR or the GAWR specified on the Safety Compliance Certification Label.

Do not use replacement tires with lower load carrying capacities than the originals because they may lower the vehicle's GVWR and GAWR limitations. Replacement tires with a higher limit than the originals do not increase the GVWR and GAWR limitations.

The Certification Label, found on the inside pillar of the driver's door, lists several important vehicle weight rating limitations. Before adding any additional equipment, refer to these limitations. If you are adding weight to the front of your vehicle, (potentially including weight added to the cab), the weight added should not exceed the Front Axle Reserve Capacity (FARC). Additional frontal weight may be added to the front axle reserve capacity provided you limit your payload in other ways (i.e. restrict the number of passengers or amount of cargo carried).

You may add equipment throughout your vehicle if the total weight added is equal to or less than the Total Axle Reserve Capacity (TARC) weight. You should NEVER exceed the Total Axle Reserve Capacity.

## Driving

Always ensure that the weight of passengers, cargo and equipment being carried is within the weight limitations that have been established for your vehicle including both Gross Vehicle Weight and Front and Rear Gross Axle Weight Rating limits. Under no circumstance should these limitations be exceeded. Exceeding any vehicle weight rating limitation could result in serious damage to the vehicle and/or personal injury.

The weight of your loaded trailer should not exceed 907 kg (2 000 lbs). The GCW of your vehicle and trailer should not exceed 2 993 kg (6 600 lbs).

### TRAILER TOWING

Your vehicle is classified as a light duty towing vehicle. Do not tow a trailer until your vehicle has been driven at least 3 200 km (2 000 miles).

Towing a trailer places an additional load on your vehicle's engine, transmission, brakes, tires and suspension. Inspect these components carefully after towing.

Your loaded trailer should weigh no more than 907 kg (2 000 lbs.).



Do not exceed the GVWR or the GAWR specified on the Safety Compliance Certification Label.



Towing trailers beyond the maximum recommended gross trailer weight could result in engine damage, transmission/axle damage, structural damage, loss of control, and personal injury.

### Preparing to tow

Use the proper equipment for towing a trailer, and make sure it is properly attached to your vehicle. See your dealer or a reliable trailer dealer if you require assistance.

#### **Hitches**

Do not use hitches that clamp onto the vehicle bumper. Use a load carrying hitch. You must distribute the load in your trailer so that 10% of the total weight of the trailer is on the tongue.

#### **Safety chains**

Always connect the trailer's safety chains to the vehicle. To connect the trailer's safety chains, cross the chains under the trailer tongue and allow slack for turning corners.



If you use a rental trailer, follow the instructions that the rental agency gives to you.

Do not attach safety chains to the bumper.

### **Trailer brakes**

Electric brakes and manual, automatic or surge-type brakes are safe if installed properly and adjusted to the manufacturer's specifications. The trailer brakes must meet local and Federal regulations.



Do not connect a trailer's hydraulic brake system directly to your vehicle's brake system. Your vehicle may not have enough braking power and your chances of having a collision greatly increase.

The braking system of the tow vehicle is rated for operation at the GVWR not GCWR.

### **Trailer lamps**

Trailer lamps are required on most towed vehicles. Make sure your trailer lamps conform to local and Federal regulations. See your dealer or trailer rental agency for proper instructions and equipment for hooking up trailer lamps.

### **Driving while you tow**

Do not drive faster than 88 km/h (55 mph) when towing a trailer.

Speed control may shut off if you are towing on long, steep grades.

When towing a trailer:

- Use a lower gear when towing up or down steep hills. This will eliminate excessive downshifting and upshifting for optimum fuel economy and transmission cooling.
- Anticipate stops and brake gradually.

**Exceeding the GCWR rating may cause internal transmission damage and void your warranty coverage.**

### **Servicing after towing**

If you tow a trailer for long distances, your vehicle will require more frequent service intervals. Refer to your Scheduled Maintenance guide for more information.

## Driving

### Trailer towing tips

- Practice turning, stopping and backing up in an area before starting on a trip to get the feel of the vehicle trailer combination. When turning, make wider turns so the trailer wheels will clear curbs and other obstacles.
- Allow more distance for stopping with a trailer attached.
- The trailer tongue weight should be 10% of the loaded trailer weight.
- After you have traveled 80 km (50 miles), thoroughly check your hitch, electrical connections and trailer wheel lug nuts.
- When stopped in traffic for long periods of time in hot weather, place the gearshift in P (Park) and increase idle speed. This aids engine cooling and air conditioner efficiency.
- Vehicles with trailers should not be parked on a grade. If you must park on a grade, place wheel chocks under the trailer's wheels.

### Launching or retrieving a boat

When backing down a ramp during boat launching or retrieval,

- Do not allow the static water level to rise above the bottom edge of the rear bumper and
- Do not allow waves to break higher than 15 cm (six inches) above the bottom edge of the rear bumper.

Exceeding these limits may allow water to enter critical vehicle components, adversely affecting driveability, emissions, reliability and causing internal transmission damage.

Replace the rear axle lubricant anytime the axle has been submerged in water. Rear axle lubricant quantities are not to be checked or changed unless a leak is suspected or repair required.

Disconnect the wiring to the trailer before backing the trailer into the water. Reconnect the wiring to the trailer after the trailer is removed from the water.

### DRIVING THROUGH WATER

Do not drive quickly through standing water, especially if the depth is unknown. Traction or brake capability may be limited and if the ignition system gets wet, your engine may stall. Water may also enter your engine's air intake and severely damage your engine.

If driving through deep or standing water is unavoidable, proceed very slowly. Never drive through water that is higher than the bottom of the hubs.

Once through the water, always try the brakes. Wet brakes do not stop the vehicle as effectively as dry brakes. Drying can be improved by moving your vehicle slowly while applying light pressure on the brake pedal.

**Driving through deep water where the transmission is submerged may allow water into the transmission and cause internal transmission damage.**

## Roadside emergencies

### HAZARD FLASHER

Use only in an emergency to warn traffic of vehicle breakdown, approaching danger, etc. The hazard flashers can be operated when the ignition is off.

- The hazard lights control is located on top of the steering column.
- Depress hazard lights control to activate all hazard flashers simultaneously.
- Depress control again to turn the flashers off.

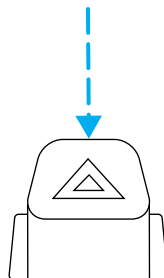

### RESETTING THE FUEL PUMP SHUT-OFF SWITCH

After a collision, if the engine cranks but does not start, the fuel pump shut-off switch may have been activated. The shut-off switch is a device intended to stop the electric fuel pump when your vehicle has been involved in a substantial jolt.

## Roadside emergencies

The fuel pump shut-off switch is located on the left side of the trunk behind the trunk liner.

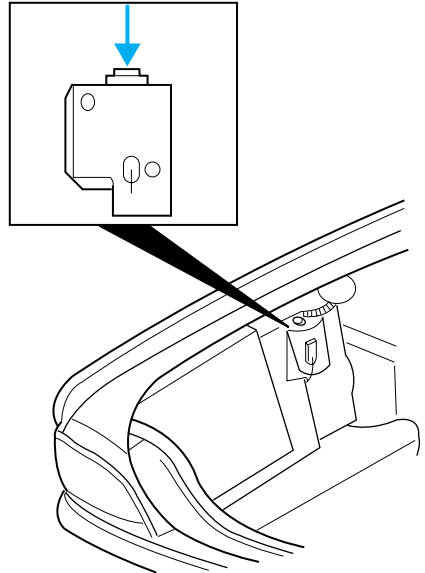

Use the following procedure to reset the fuel pump shut-off switch.

1. Turn the ignition to the OFF position.
2. Check the fuel system for leaks.
3. If no fuel leak is apparent, reset the fuel pump shut-off switch by pushing in the reset button.
4. Turn the ignition to the ON position. Pause for a few seconds and return the key to the OFF position.
5. Make a further check for leaks in the fuel system.

## FUSES AND RELAYS

### Fuses

If electrical components in the vehicle are not working, a fuse may have blown. Blown fuses are identified by a broken wire within the fuse. Check the appropriate fuses before replacing any electrical components.

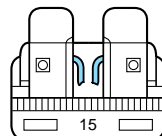

## Roadside emergencies



Always replace a fuse with one that has the specified amperage rating. Using a fuse with a higher amperage rating can cause severe wire damage and could start a fire.

### *Standard fuse amperage rating and color*

COLOR					
Fuse Rating	Mini Fuses	Standard Fuses	Maxi Fuses	Cartridge Maxi Fuses	Fuse Link Cartridge
2A	Grey	Grey	—	—	—
3A	Violet	Violet	—	—	—
4A	Pink	Pink	—	—	—
5A	Tan	Tan	—	—	—
7.5A	Brown	Brown	—	—	—
10A	Red	Red	—	—	—
15A	Blue	Blue	—	—	—
20A	Yellow	Yellow	Yellow	Blue	Blue
25A	Natural	Natural	—	—	—
30A	Green	Green	Green	Pink	Pink
40A	—	—	Orange	Green	Green
50A	—	—	Red	Red	Red
60A	—	—	Blue	—	Yellow
70A	—	—	Tan	—	Brown
80A	—	—	Natural	—	Black

### **Passenger compartment fuse panel**

The fuse panel is located below and to the left of the steering wheel by the brake pedal. Remove the panel cover to access the fuses.

To remove a fuse use the fuse puller tool provided on the fuse panel cover.

## Roadside emergencies

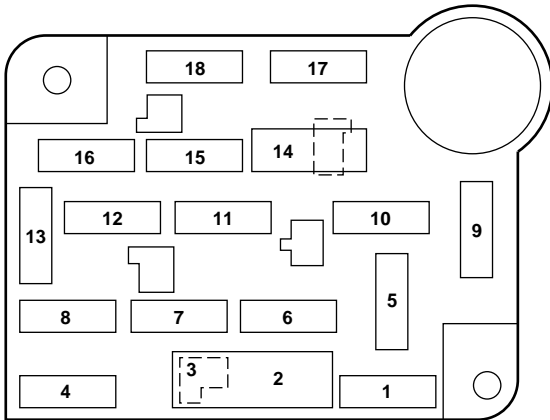

The fuses are coded as follows.

Fuse/Relay Location	Fuse Amp Rating	Description
1	15A	Brake Pedal Position (BPP) Switch, Multi-Function Switch, Speed Control
2	30A	Wiper Control Module, Windshield Wiper Motor
3	—	Not Used
4	15A	Lighting Control Module, Main Light Switch
5	15A	Backup Lamps, Variable Assist Power Steering (VAPS), Turn Signals, Air Suspension, Daytime Running Lamps, Electronic Day/Night Mirror, Shift Lock, EATC, Speed Chime Warning
6	15A	Speed Control, Main Light Switch, Lighting Control Module, Clock, Police Power Relay
7	25A	Powertrain Control Module (PCM) Power Diode, Ignition Coils
8	15A	Lighting Control Module, Power Mirrors, PATS Module, Keyless Entry, Clock Memory, Electronic Automatic Temperature Control (EATC), Power Windows, Police Spot Light, SecuriLock

## Roadside emergencies

Fuse/Relay Location	Fuse Amp Rating	Description
9	30A	Blower Motor, A/C-Heater Mode Switch
10	10A	Air Bag Module
11	5A	Radio
12	18A CB	Lighting Control Module, Flash-to-Pass, Main Light Switch
13	15A	Warning Lamps, Analog Cluster Gauges and Indicators, Electronic Automatic Transmission, Lighting Control Module
14	20A CB	Window/Door Lock Control, Driver's Door Module, One Touch Down
15	10A	Anti-Lock Brakes, Instrument Cluster, Transmission Control Switch
16	20A	Cigar Lighter
17	10A	Rear Defrost
18	10A	Air Bag Module

### Power distribution box

The power distribution box is located in the engine compartment. The power distribution box contains high-current fuses that protect your vehicle's main electrical systems from overloads.



Always disconnect the battery before servicing high current fuses.



Always replace the cover to the Power Distribution Box before reconnecting the battery or refilling fluid reservoirs.

If the battery has been disconnected and reconnected, refer to the *Battery* section of the *Maintenance and Care* chapter.



## Roadside emergencies

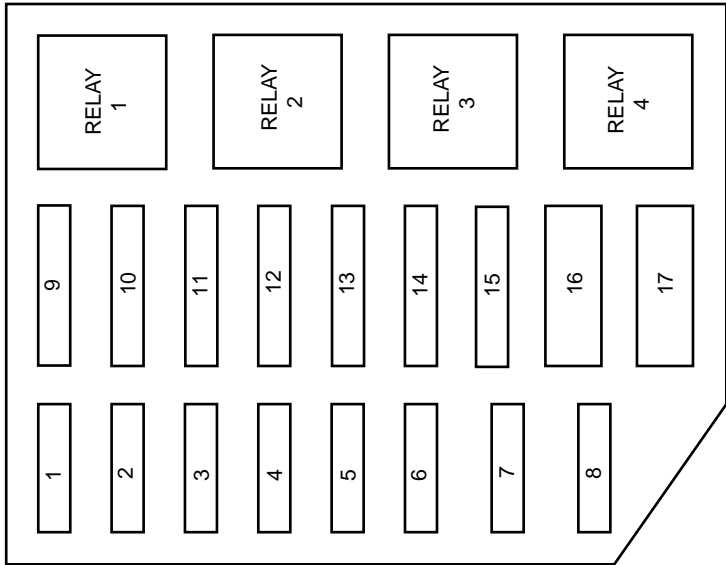

The high-current fuses are coded as follows.

Fuse/Relay Location	Fuse Amp Rating	Description
1	20A*	Electric Fuel Pump Relay
2	30A*	Generator, Starter Relay, Fuses 15 and 18
3	25A*	Radio, CD Changer, Subwoofer Amplifier
4	30A*	Police Power Relay
5	15A*	Horn Relay
6	20A*	DRL Module
7	20A CB	Power door Locks, Power Seats, Trunk Lid Release
8	30A**	Air Suspension System
9	50A**	See Fuses 5 and 9
10	50A**	See Fuses 1, 2, 6, 7, 10, 11, 13 and Circuit Breaker 14
11	40A**	See Fuses 4, 8, 16 and Circuit Breaker 12

## Roadside emergencies

Fuse/Relay Location	Fuse Amp Rating	Description
12	30A**	PCM Power Relay, PCM, Natural Gas Vehicle Module
13	50A**	High Speed Cooling Fan Relay
14	40A**	Rear Window Defrost Relay, Also see Fuse 17
15	50A**	Anti-Lock Brake Module
16	50A**	Police Option Fuse Holder
17	30A CB	Cooling Fan Relay
Relay 1	—	Rear Defrost Relay
Relay 2	—	Horn Relay
Relay 3	—	Cooling Fan Relay
Relay 4	—	Air Suspension Pump Relay, Police Power Relay

\* Mini Fuses \*\* Maxi Fuses

### Relays

Relays are located in the power distribution box and should be replaced by qualified technicians.

### CHANGING THE TIRES

If you get a flat tire while driving, do not apply the brake heavily. Instead, gradually decrease your speed. Hold the steering wheel firmly and slowly move to a safe place on the side of the road.

### Temporary spare tire information

Your vehicle may have a temporary or full-size spare tire. The temporary spare tire for your vehicle is labeled as such. It is smaller than a regular tire and is designed for emergency use only. Replace this tire with a full-size tire as soon as possible.



If you use the temporary spare tire continuously or do not follow these precautions, the tire could fail, causing you to lose control of the vehicle, possibly injuring yourself or others.

## Roadside emergencies

When driving with the temporary spare tire **do not:**

- exceed 80 km/h (50 mph) under any circumstances
- load the vehicle beyond maximum vehicle load rating listed on the Safety Compliance Label
- tow a trailer
- use tire chains
- drive through an automatic car wash, because of the vehicle's reduced ground clearance
- try to repair the temporary spare tire or remove it from its wheel
- use the wheel for any other type of vehicle

If the mini-spare tire is used as a replacement for a rear wheel:

- Turn off the traction control switch (if equipped).

### Tire change procedure



To prevent the vehicle from moving when you change a tire, be sure the parking brake is set, then block (in both directions) the wheel that is diagonally opposite (other side and end of the vehicle) to the tire being changed.



If the vehicle slips off the jack, you or someone else could be seriously injured.

1. Park on a level surface, activate hazard flashers and set parking brake.
2. Place gearshift lever in P (Park) and turn engine OFF.
3. Remove the spare tire, jack and lug wrench.
4. Locate pry off notch (if equipped) and remove the center ornament from the aluminum wheel with the tapered end of the wheel nut wrench that came with your vehicle. Insert and twist the handle, then pry against the wheel.

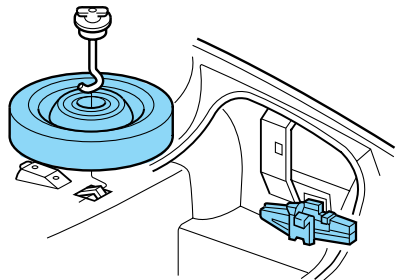

## Roadside emergencies

5. Loosen each wheel lug nut one-half turn counterclockwise but do not remove them until the wheel is raised off the ground. Refer to *Anti-theft lug nuts* for information on removing anti-theft lug nuts.

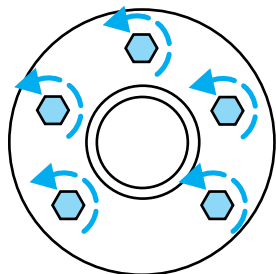

On vehicles equipped with Air Suspension, turn OFF the Air Suspension switch prior to jacking, hoisting or towing your vehicle.

Refer to *Air suspension system* in the *Driving* chapter for more information.



6. Put the jack in the jack notch next to the door closest to the tire you are changing. Turn the jack handle clockwise until the wheel is completely off the ground.

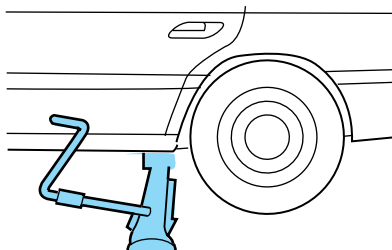

## Roadside emergencies



To lessen the risk of personal injury, do not put any part of your body under the vehicle while changing a tire. Do not start the engine when your vehicle is on the jack. The jack is only meant for changing the tire.

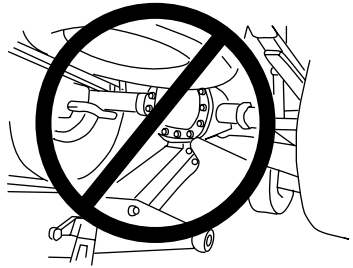

- **Never use the rear differential as a jacking point.**

7. Remove the lug nuts with the lug wrench.
8. Replace the flat tire with the spare tire, making sure the valve stem is facing outward. Reinstall lug nuts until the wheel is snug against the hub. Do not fully tighten the lug nuts until the wheel has been lowered.
9. Lower the wheel by turning the jack handle counterclockwise.
10. Remove the jack and fully tighten the lug nuts in the order shown.
11. Put flat tire, jack and lug wrench away.
12. If using a mini-spare tire, turn off the traction control switch (if equipped).
13. Turn on the air suspension switch (if equipped).

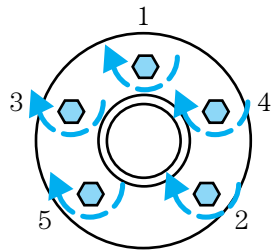

### Anti-theft lug nuts (if equipped)

If your vehicle is equipped with this feature, one of the lug nuts on each wheel must be removed and replaced with a special key. The key and registration card are attached to the lug wrench and stored with the spare tire.

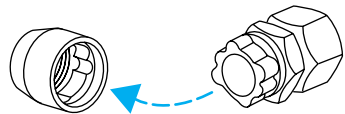

If you lose the key, send the registration card to the manufacturer (not the dealer) to get a replacement key. If the lug wrench/lug nut key assembly is lost, see your nearest Ford or Lincoln/Mercury dealer who has access to the master set of keys. **Do not use an impact wrench with the anti-theft key.**

## Roadside emergencies

### ***Removing the anti-theft lug nut***

1. Insert the key over the locking lug nut. Make sure you hold the key square to the lug nut. If you hold the key at an angle, you could damage the key and the lug nut.
2. Place the lug nut wrench over the lug nut key and apply pressure on the key with the wrench.
3. Turn the wrench in a counterclockwise direction to remove the lug nut.

### ***Reinstalling the anti-theft lug nut***

1. Insert the key over the locking lug nut.
2. Place the lug nut wrench over the lug nut key and apply pressure on the key with the wrench.
3. Install the lug nut.

## **JUMP STARTING YOUR VEHICLE**



The gases around the battery can explode if exposed to flames, sparks, or lit cigarettes. An explosion could result in injury or vehicle damage.



Do not push start your vehicle. You could damage the catalytic converter.



Batteries contain sulfuric acid which can burn skin, eyes, and clothing, if contacted.

**Do not attempt to push start your vehicle. Automatic transmissions do not have push-start capability.**

### **Preparing your vehicle**

1. **Use only a 12-volt supply to start your vehicle.**
2. Do not disconnect the battery of the disabled vehicle as this could damage the vehicle's electrical system.

## Roadside emergencies

3. Park the booster vehicle close to the hood of the disabled vehicle making sure the two vehicles **do not** touch. Set the parking brake on both vehicles and stay clear of the engine cooling fan and other moving parts.
4. Check all battery terminals and remove any excessive corrosion before you attach the battery cables. Ensure that vent caps are tight and level.
5. Turn the heater fan on in both vehicles to protect any electrical surges. Turn all other accessories off.

### Connecting the jumper cables

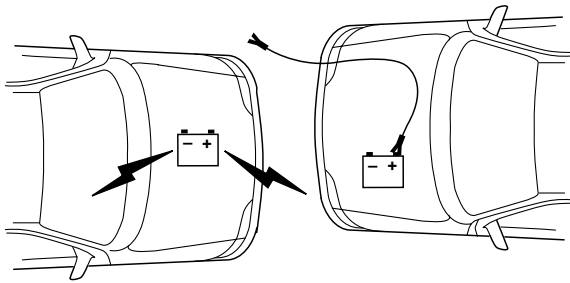

1. Connect the positive (+) booster cable to the positive (+) terminal of the discharged battery.

**Note:** In the illustrations, *lightning bolts* are used to designate the assisting (boosting) battery.

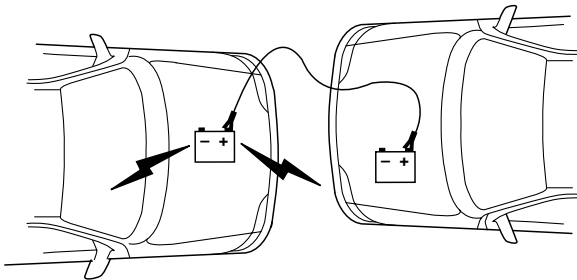

2. Connect the other end of the positive (+) cable to the positive (+) terminal of the assisting battery.

## Roadside emergencies

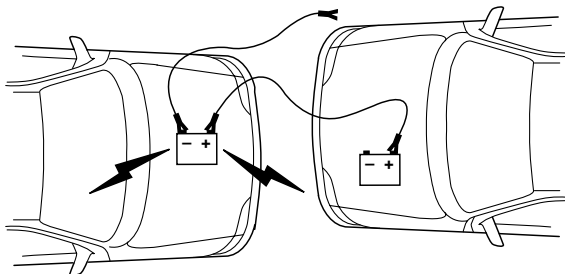

3. Connect the negative (-) cable to the negative (-) terminal of the assisting battery.

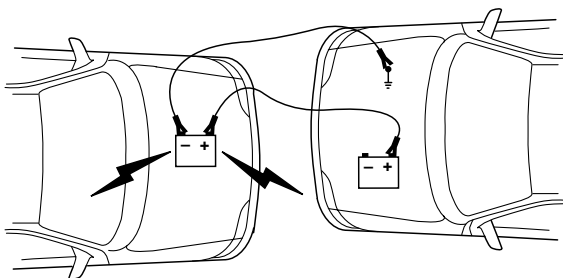

4. Make the final connection of the negative (-) cable to an exposed metal part of the stalled vehicle's engine, away from the battery and the carburetor/fuel injection system.

The preferred locations of an exposed metal part (to *ground* the circuit) are the alternator mounting brackets or an engine lifting *eye*. **Do not** use fuel lines, engine rocker covers or the intake manifold as *grounding* points.



Do not connect the end of the second cable to the negative (-) terminal of the battery to be jumped. A spark may cause an explosion of the gases that surround the battery.

5. Be sure that the cables are clear of fan blades, belts and other moving parts of both engines.



## Roadside emergencies

### Jump starting

1. Start the engine of the booster vehicle and run the engine at moderately increased speed.
2. Start the engine of the disabled vehicle.
3. Once the disabled vehicle has been started, run both engines for a further three minutes before disconnecting the jumper cables.

### Removing the jumper cables

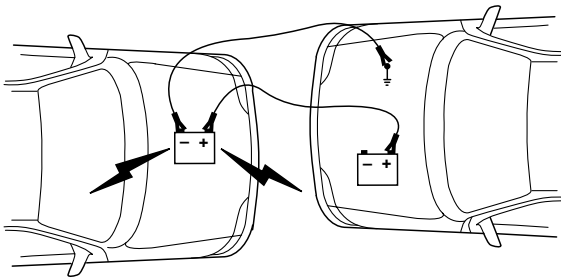

### Remove the jumper cables in the reverse order that they were connected.

1. Remove the jumper cable from the *ground* metal surface.

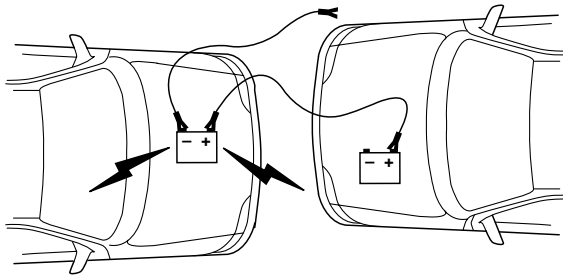

2. Remove the jumper cable on the negative (-) connection of the booster vehicle's battery.

## Roadside emergencies

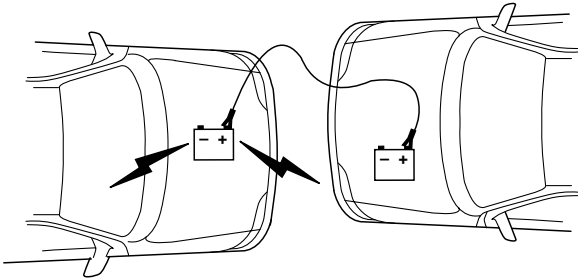

3. Remove the jumper cable from the positive (+) terminal of the booster vehicle's battery.

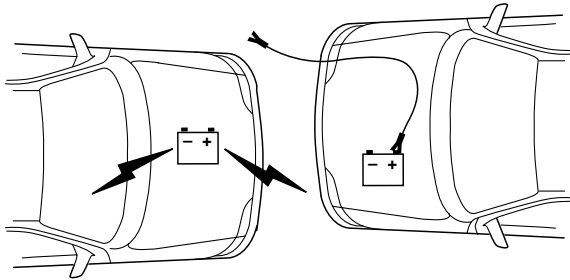

4. Remove the jumper cable from the positive (+) terminal of the disabled vehicle's battery.

After the disabled vehicle has been started and the jumper cables removed, allow it to idle for several minutes so the engine computer can *relearn* its idle conditions.

### WRECKER TOWING

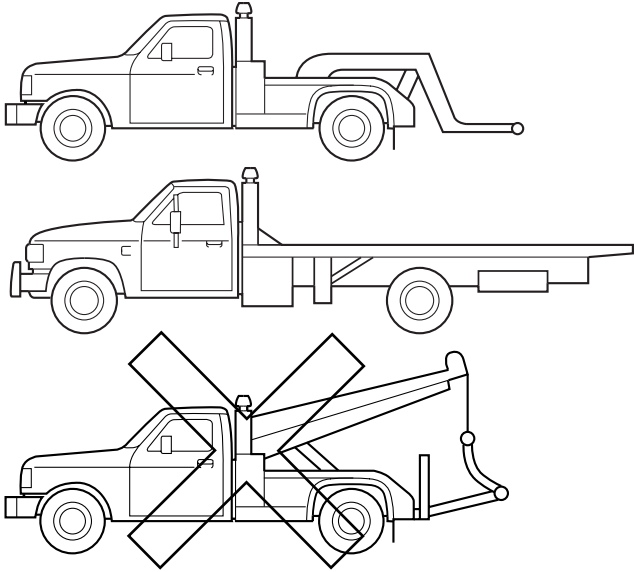

If you need to have your vehicle towed, contact a professional towing service or, if you are a member, your roadside assistance center.

It is recommended that your vehicle be towed with a wheel lift or flatbed equipment. Do not tow with a slingbelt. Ford Motor Company has not approved a slingbelt towing procedure.

Before your vehicle can be towed, the air suspension control in the luggage compartment must be turned to the OFF position (if equipped).

Ford Motor Company provides a towing manual for all authorized tow truck operators. Have your tow truck operator refer to this manual for proper hook-up and towing procedures for your vehicle.

# Maintenance and care

## SERVICE RECOMMENDATIONS

To help you service your vehicle:

- We highlight do-it-yourself items in the engine compartment for easy location.
- We provide a Scheduled Maintenance Guide which makes tracking routine service easy.

If your vehicle requires professional service, your dealership can provide necessary parts and service. Check your “Warranty Guide” to find out which parts and services are covered.

Use only recommended fuels, lubricants, fluids and service parts conforming to specifications. Motorcraft parts are designed and built to provide the best performance in your vehicle.

## PRECAUTIONS WHEN SERVICING YOUR VEHICLE

Be especially careful when inspecting or servicing your vehicle.

- Do not work on a hot engine.
- When the engine is running, keep loose clothing, jewelry or long hair away from moving parts.
- Do not work on a vehicle with the engine running in an enclosed space, unless you are sure you have enough ventilation.
- Keep all lit cigarettes, open flames and other lit material away from the battery and all fuel related parts.

If you disconnect the battery, the engine must “relearn” its idle conditions before your vehicle will drive properly, as explained in the *Battery* section in this chapter.

### Working with the engine off

1. Set the parking brake and ensure the gearshift is securely latched in P (Park).
2. Turn off the engine and remove the key.
3. Block the wheels to prevent the vehicle from moving unexpectedly.

### Working with the engine on

1. Set the parking brake and ensure the gearshift is securely latched in P (Park).
2. Block the wheels to prevent the vehicle from moving unexpectedly.

## Maintenance and care



Do not start your engine with the air cleaner removed and do not remove it while the engine is running.

### OPENING THE HOOD

1. Inside the vehicle, pull the hood release handle located under the instrument panel.
2. Go to the front of the vehicle and release the auxiliary latch that is located under the front of the hood.
3. Lift the hood until the lift cylinders hold it open.

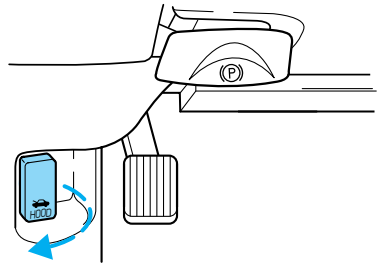

# Maintenance and care

## IDENTIFYING COMPONENTS IN THE ENGINE COMPARTMENT

### 4.6L SOHC V8 engine

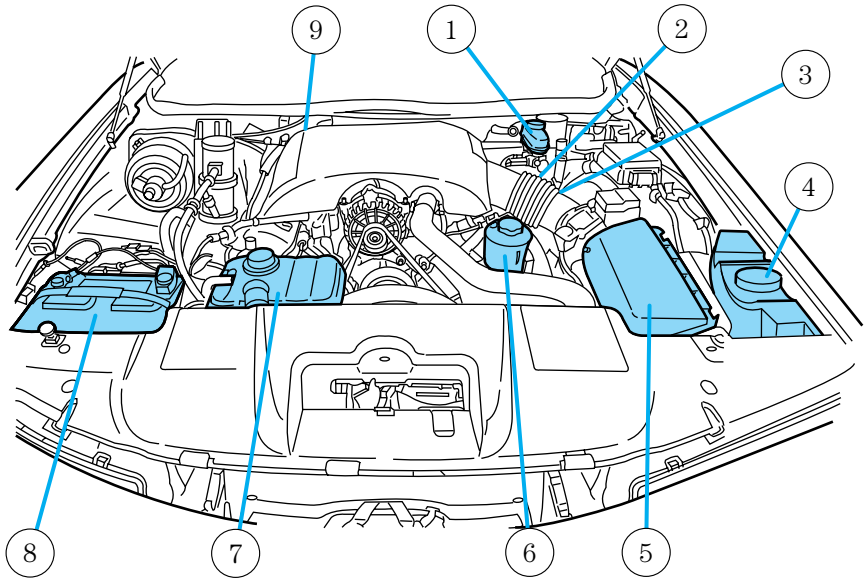

1. Brake fluid reservoir
2. Engine oil dipstick
3. Engine oil filler cap
4. Windshield washer fluid reservoir
5. Air filter assembly
6. Power steering fluid reservoir
7. Engine coolant reservoir
8. Battery
9. Automatic transmission fluid dipstick

## ENGINE OIL

### Checking the engine oil

Refer to the Scheduled Maintenance Guide for the appropriate intervals for checking the engine oil .

1. Make sure the vehicle is on level ground.
2. Turn the engine off and wait a few minutes for the oil to drain into the oil pan.
3. Set the parking brake and ensure the gearshift is securely latched in P (Park).
4. Open the hood. Protect yourself from engine heat.
5. Locate and carefully remove the engine oil level indicator (dipstick).

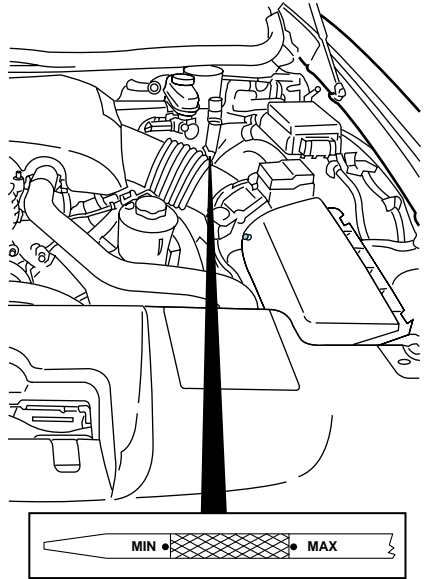

6. Wipe the indicator clean. Insert the indicator fully, then remove it again.

- If the oil level is **between the MIN and MAX marks**, the oil level is acceptable. **DO NOT ADD OIL.**

## Maintenance and care

- If the oil level is below the MIN mark, add enough oil to raise the level within the MIN-MAX range.

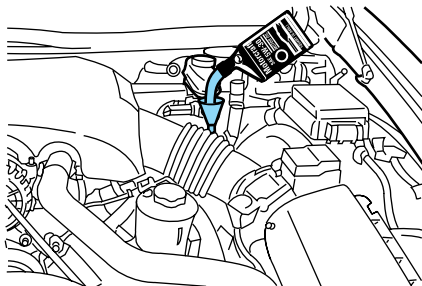

- Oil levels above the MAX mark may cause engine damage. Some oil must be removed from the engine by a service technician.

7. Put the indicator back in and ensure it is fully seated.

### Adding engine oil

1. Check the engine oil. For instructions, refer to *Checking the engine oil* in this chapter.
2. If the engine oil level is not within the MIN and MAX ranges, add only certified engine oil of the recommended viscosity. Remove the engine oil filler cap and use a funnel to pour the engine oil into the opening.
3. Recheck the engine oil level. Make sure the oil level is not above the MAX mark on the dipstick.

### Engine oil and filter recommendations

Look for this certification mark.

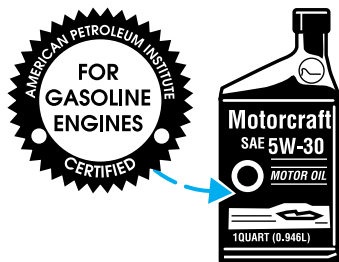

Ford oil specification is WSS-M2C153-G.

Use SAE 5W-30 motor oil certified for gasoline engines by the American Petroleum Institute.



## Maintenance and care

Do not use supplemental engine oil additives, oil treatments or engine treatments. They are unnecessary and could, under certain conditions, lead to engine damage which is not covered by your warranty.

Change your engine oil and filter according to the appropriate schedule listed in the Scheduled Maintenance Guide.

Ford production and aftermarket (Motorcraft) oil filters are designed for added engine protection and long life. If a replacement oil filter is used that does not meet Ford material and design specifications, startup engine noises or knock may be experienced.

It is recommended you use the appropriate Motorcraft oil filter (or another brand meeting Ford specifications) for your engine application.

### BRAKE FLUID

#### Checking and adding brake fluid

Brake fluid should be checked and refilled as needed. Refer to the Scheduled Maintenance Guide for the service interval schedules:

1. Clean the reservoir cap before removal to prevent dirt or water from entering the reservoir.
2. Visually inspect the fluid level.
3. If necessary, add brake fluid until the level reaches MAX. Do not fill above this line.
4. Use only a DOT 3 brake fluid certified to meet Ford specifications. Refer to *Lubricant specifications* in the *Capacities and specifications* chapter.

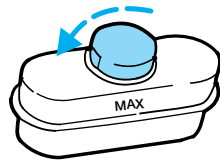
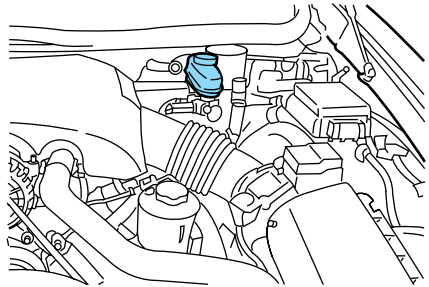

Brake fluid is toxic.

## Maintenance and care



If you use a brake fluid that is not DOT 3, you will cause permanent damage to your brakes.



Do not let the reservoir for the master cylinder run dry. This may cause the brakes to fail.

## WINDSHIELD WASHER FLUID

### Checking and adding washer fluid

Check the washer fluid whenever you stop for fuel. The reservoir is highlighted with a  symbol.

If the level is low, add enough fluid to fill the reservoir. In very cold weather, do not fill the reservoir all the way.

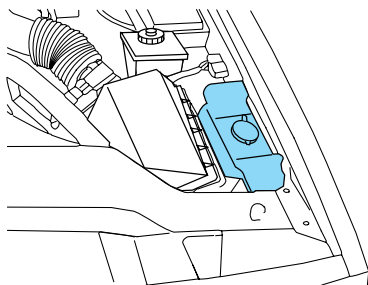

Do not put engine coolant in the container for the windshield washer fluid.

## ENGINE COOLANT

Check the level of the engine coolant in the reservoir. Refer to the Scheduled Maintenance Guide for service interval schedules. Be sure to read and understand *Precautions when servicing your vehicle* in this chapter.

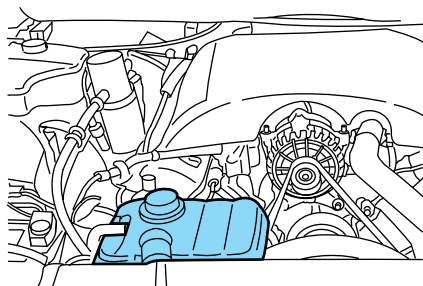

If the engine coolant has not been checked at the recommended interval, the engine coolant reservoir may become empty. If this occurs, add engine coolant to the reservoir. For more information on engine coolant

## Maintenance and care

maintenance, refer to *Adding engine coolant* in this chapter.

Automotive fluids are not interchangeable; do not use engine coolant, antifreeze or windshield washer fluid outside of its specified function and vehicle location.

### Adding engine coolant



Do not put engine coolant in the container for the windshield washer fluid.

**Do not mix conventional green coolant, orange coolant or recycled coolants together in your vehicle. Use only the type of coolant with which your vehicle was originally equipped. If you are unsure which type of coolant your vehicle requires, contact your local dealer.**

If sprayed on the windshield, engine coolant could make it difficult to see through the windshield.

When the engine is cool, add a 50/50 mixture of engine coolant and water to the engine coolant reservoir. **DO NOT ADD ENGINE COOLANT DIRECTLY TO THE RADIATOR.**

Plain water may be added in an emergency, but you **MUST** replace it with a 50/50 mixture of coolant and distilled water as soon as possible.

Check the coolant level in the coolant reservoir the next few times you drive the vehicle. If necessary, add enough of a 50/50 mixture of coolant and water to bring the liquid level to the fill line on the reservoir.



Never remove the coolant reservoir cap while the engine is running or hot.

If you must remove the coolant reservoir cap, follow these steps to avoid personal injury:

1. Before you remove the cap, turn the engine off and let it cool.
2. When the engine is cool, wrap a thick cloth around the cap. Slowly turn cap counterclockwise until pressure begins to release.
3. Step back while the pressure releases.
4. When you are sure that all the pressure has been released, use the cloth to turn it counterclockwise and remove the cap.

## Maintenance and care

Change your engine coolant according to the appropriate schedule listed in the Scheduled Maintenance Guide.

Use Ford Premium Engine Coolant E2FZ-19549-AA (in Oregon, F5FZ-19549-CC, in Canada, Motorcraft CXC-10) or an equivalent premium engine coolant that meets Ford specification ESE-M97B44-A.

**DO NOT USE Ford Extended Life Engine Coolant F6AZ-19544-AA, meeting Ford specification WSS-M97B44-D (orange in color). Do not add recycled coolant to your vehicle.**

Do not use alcohol or methanol antifreeze or any engine coolants mixed with alcohol or methanol antifreeze. Do not use supplemental coolant additives in your vehicle. These additives may harm your engine cooling system. The use of an improper coolant may void the warranty of your vehicle's engine cooling system.

### Recycled engine coolant

Ford Motor Company recommends that Ford and Lincoln-Mercury dealers use recycled engine coolant produced by Ford-approved processes.

Not all coolant recycling processes produce coolant which meets Ford specification ESE-M97B44-A, and use of such coolant may harm engine and cooling system components.



Always dispose of used automotive fluids in a responsible manner. Follow your community's regulations and standards for recycling and disposing of automotive fluids.

### Coolant refill capacity

To find out how much fluid your vehicle's cooling system can hold, refer to *Refill capacities* in the *Capacities and specifications* chapter.

Have your dealer check the engine cooling system for leaks if you have to add more than 1.0 liter (1.0 quart) of engine coolant per month.

### Severe winter climate

If you drive in extremely cold climates (less than  $-36^{\circ}\text{C}$  [ $-34^{\circ}\text{F}$ ]), it may be necessary to increase the coolant concentration above 50%. Refer to the chart on the coolant container to ensure the coolant concentration in your vehicle is such that the coolant will not freeze at the temperature level in which you drive during winter months. Never increase the engine coolant concentration above 60%. Leave a 50/50 mixture of engine coolant and water in your vehicle year-round in non-extreme climates.

### What you should know about fail-safe cooling

If the engine coolant supply is depleted, this feature allows the vehicle to be driven temporarily before incremental component damage is incurred. The “fail-safe” distance depends on ambient temperatures, vehicle load and terrain.

### How fail-safe cooling works

- Standard cluster

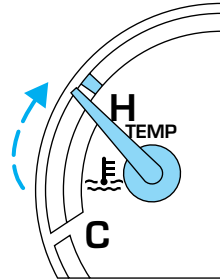

- Optional cluster



If the engine begins to overheat:

- the engine coolant temperature gauge will move to the H (hot) area (if your vehicle is equipped with analog gauges).
- the engine coolant temperature gauge will illuminate all eight bars and a tone will sound every five seconds for one minute (if your vehicle is equipped with digital gauges).
- the  symbol will illuminate.
- the *Check Engine* indicator light will illuminate.

If the engine reaches a preset over-temperature condition, the engine will automatically switch to alternating cylinder operation. Each disabled cylinder acts as an air pump and cools the engine.

## Maintenance and care

When this occurs the vehicle will still operate, however:

- the engine power will be limited.
- the air conditioning system will be disabled.

Continued operation will increase the engine temperature:

- the  symbol will begin to flash.
- if your vehicle is equipped with digital gauges, the gauge bars will flash and a tone will sound every five seconds for one minute.
- the engine will completely shut down, causing steering and braking effort to increase.

Once the engine temperature cools, the engine can be re-started. Take your vehicle to a service facility as soon as possible to minimize engine damage.

### ***When fail-safe mode is activated***

You have limited engine power when in the fail-safe mode, so drive the vehicle with caution. The vehicle will not be able to maintain high-speed operation and the engine will run rough. Remember that the engine is capable of completely shutting down automatically to prevent engine damage, therefore:

1. Pull off the road as soon as safely possible and turn off the engine.
2. Arrange for the vehicle to be taken to a service facility.
3. If this is not possible, wait a short period for the engine to cool.
4. Check the coolant level and replenish if low.



Never remove the coolant reservoir cap while the engine is running or hot.

5. Re-start the engine and take your vehicle to a service facility.



Driving the vehicle without repairing the engine problem increases the chance of engine damage. Take your vehicle to a service facility as soon as possible.

### CHECKING AND ADDING POWER STEERING FLUID

Check the power steering fluid. Refer to the Scheduled Maintenance Guide for the service interval schedules. If adding fluid is necessary, use only MERCON® ATF.

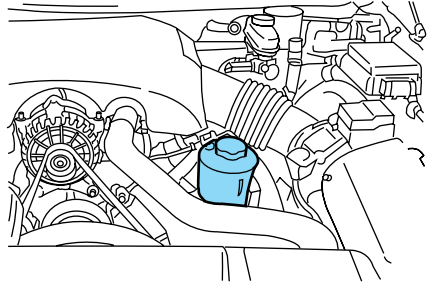

1. Start the engine and let it run until it reaches normal operating temperature (the engine coolant temperature gauge indicator will be near the center of the normal area between H and C).
2. While the engine idles, turn the steering wheel left and right several times.
3. Turn the engine off.
4. Check the fluid level in the reservoir. It should be between the MIN and MAX lines. Do not add fluid if the level is in this range.

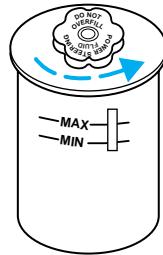

5. If the fluid is low, add fluid in small amounts, continuously checking the level until it reaches the range between the MIN and MAX lines. Be sure to put the cap back on the reservoir.

### TRANSMISSION FLUID

#### Checking automatic transmission fluid

Refer to your Scheduled Maintenance Guide for scheduled intervals for fluid checks and changes. Your transmission does not consume fluid. However, the fluid level should be checked if the transmission is not working properly, i.e., if the transmission slips or shifts slowly or if you notice some sign of fluid leakage.

## Maintenance and care

Automatic transmission fluid expands when warmed. To obtain an accurate fluid check, drive the vehicle until it is at normal operating temperature (approximately 30 km [20 miles]). If your vehicle has been operated for an extended period at high speeds, in city traffic during hot weather or pulling a trailer, the vehicle should be turned off for about 30 minutes to allow fluid to cool before checking.

1. Drive the vehicle 30 km (20 miles) or until it reaches normal operating temperature.
2. Park the vehicle on a level surface and engage the parking brake.
3. With the parking brake engaged and your foot on the brake pedal, start the engine and move the gearshift lever through all of the gear ranges. Allow sufficient time for each gear to engage.
4. Latch the gearshift lever in P (Park) and leave the engine running.
5. Remove the dipstick, wiping it clean with a clean, dry lint free rag.
6. Install the dipstick making sure it is fully seated in the filler tube.
7. Remove the dipstick and inspect the fluid level. The fluid should be in the designated area for normal operating temperature (H) or ambient temperature (C).

### **Low fluid level**

Do not drive the vehicle if the fluid level is at the bottom of the dipstick and the ambient temperature is above 10°C (50°F).

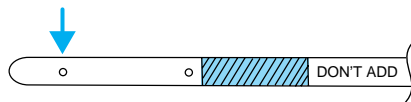

### **Correct fluid level**

The transmission fluid should be checked at normal operating temperature 66°C-77°C (150°F-170°F) on a level surface. The normal operating temperature can be reached after approximately 30 km (20 miles) of driving.

You can check the fluid without driving if the ambient temperature is above 10°C (50°F). However, if fluid is added at this time, an overfill condition could result when the vehicle reaches normal operating temperature.

The transmission fluid should be in this range if at normal operating temperature (66°C-77°C [150°F-170°F]).

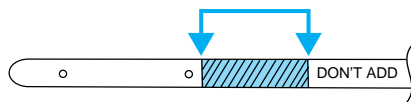



## Maintenance and care

The transmission fluid should be in this range if at ambient temperature (10°C-35°C [50°F-95°F]).

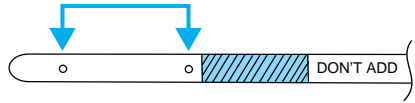

### **High fluid level**

Fluid levels above the safe range may result in transmission failure. An overfill condition of transmission fluid may cause shift and/or engagement concerns and/or possible damage.

High fluid levels can be caused by an overheating condition.

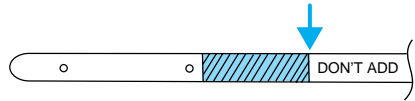

### **Adjusting automatic transmission fluid levels**

Before adding any fluid, make sure the correct type is used. The type of fluid used is normally indicated on the dipstick and/or dipstick handle and also in the *Lubricant specifications* section in the *Capacities and specifications* chapter.

**Use of a non-approved automatic transmission fluid may cause internal transmission component damage.**

If necessary, add fluid in 250 mL (1/2 pint) increments through the filler tube until the level is correct.

If an overfill occurs, excess fluid should be removed by a qualified technician.

**An overfill condition of transmission fluid may cause shift and/or engagement concerns and/or possible damage.**

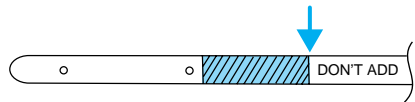

## Maintenance and care

### BATTERY

Your vehicle is equipped with a Motorcraft maintenance-free battery which normally does not require additional water during its life of service.

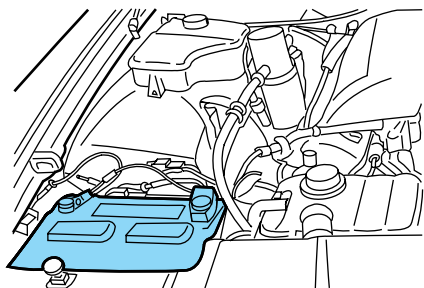

However, for severe usage or in high temperature climates, check the battery electrolyte level. Refer to the Scheduled Maintenance Guide for the service interval schedules.

**Keep the electrolyte level in each cell up to the “level indicator”. Do not overfill the battery cells.**

If the electrolyte level in the battery is low, you can add plain tap water to the battery, as long as you do not use hard water (water with a high mineral or alkali content). If possible, however, try to only fill the battery cells with distilled water. If the battery needs water often, have the charging system checked.

**If your battery has a cover/shield, make sure it is reinstalled after the battery has been cleaned or replaced.**

For longer, trouble-free operation, keep the top of the battery clean and dry. Also, make certain the battery cables are always tightly fastened to the battery terminals.

If you see any corrosion on the battery or terminals, remove the cables from the terminals and clean with a wire brush. You can neutralize the acid with a solution of baking soda and water.



Batteries normally produce explosive gases which can cause personal injury. Therefore, do not allow flames, sparks or lighted substances to come near the battery. When working near the battery, always shield your face and protect your eyes. Always provide proper ventilation.

## Maintenance and care



When lifting a plastic-cased battery, excessive pressure on the end walls could cause acid to flow through the vent caps, resulting in personal injury and/or damage to the vehicle or battery. Lift the battery with a battery carrier or with your hands on opposite corners.



Keep batteries out of reach of children. Batteries contain sulfuric acid. Avoid contact with skin, eyes or clothing. Shield your eyes when working near the battery to protect against possible splashing of acid solution. In case of acid contact with skin or eyes, flush immediately with water for a minimum of 15 minutes and get prompt medical attention. If acid is swallowed, call a physician immediately.

Because your vehicle's engine is electronically controlled by a computer, some control conditions are maintained by power from the battery. When the battery is disconnected or a new battery is installed, the engine must relearn its idle and fuel trim strategy for optimum driveability and performance. To begin this process:

1. Set your parking brake.
  2. Put the gearshift in P (Park), turn off all accessories and start the engine.
  3. Let the engine idle for at least one minute.
  4. The relearning process will automatically complete as you drive the vehicle.
- The vehicle may need to be driven 16 km (10 miles) or more to relearn the idle and fuel trim strategy.
  - If you do not allow the engine to relearn its idle trim, the idle quality of your vehicle may be adversely affected until the idle trim is eventually relearned.

If the battery has been disconnected or a new battery has been installed, the clock and the preset radio stations must be reset once the battery is reconnected.

## Maintenance and care

- Always dispose of automotive batteries in a responsible manner. Follow your local authorized standards for disposal. Call your local authorized recycling center to find out more about recycling automotive batteries.

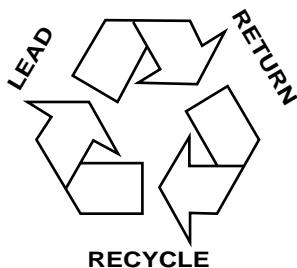

### WINDSHIELD WIPER BLADES

Check the wiper blades at least twice a year or when they seem less effective. Substances such as tree sap and some hot wax treatments used by commercial car washes reduce the effectiveness of wiper blades.

#### Checking the wiper blades

If the wiper blades do not wipe properly, clean both the windshield and wiper blades using undiluted windshield wiper solution or a mild detergent. Rinse thoroughly with clean water. To avoid damaging the blades, do not use fuel, kerosene, paint thinner or other solvents.

#### Changing the wiper blades

To replace the wiper blades:

1. Pull the wiper arm away from the windshield and lock into the service position.
2. Turn the blade at an angle from the wiper arm. Push the lock pin manually to release the blade and pull the wiper blade down toward the windshield to remove it from the arm.
3. Attach the new wiper to the wiper arm and press it into place until a click is heard.

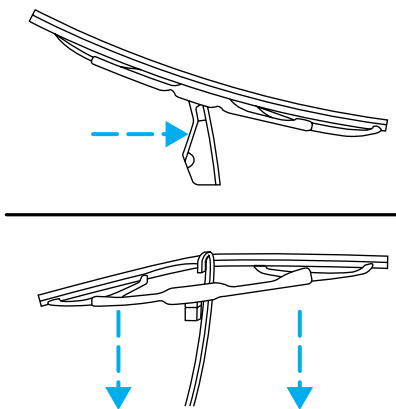

### INFORMATION ABOUT TIRE QUALITY GRADES

New vehicles are fitted with tires that have their Tire Quality Grade (described below) molded into the tire's sidewall. These Tire Quality Grades are determined by standards that the United States Department of Transportation has set.

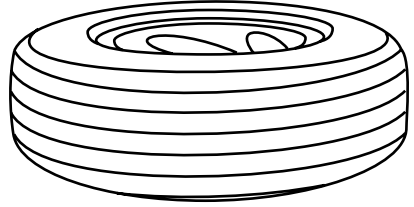

Tire Quality Grades apply to new pneumatic tires for use on passenger cars. They do not apply to deep tread, winter-type snow tires, space-saver or temporary use spare tires, tires with nominal rim diameters of 10 to 12 inches or limited production tires as defined in Title 49 Code of Federal Regulations Part 575.104(c)(2).

**U.S. Department of Transportation-Tire quality grades:** The U.S. Department of Transportation requires Ford to give you the following information about tire grades exactly as the government has written it.

#### Treadwear

The treadwear grade is a comparative rating based on the wear rate of the tire when tested under controlled conditions on a specified government test course. For example, a tire graded 150 would wear one and one-half (1 1/2) times as well on the government course as a tire graded 100. The relative performance of tires depends upon the actual conditions of their use, however, and may depart significantly from the norm due to variations in driving habits, service practices, and differences in road characteristics and climate.

#### Traction AA A B C

The traction grades, from highest to lowest are AA, A, B, and C. Those grades represent the tire's ability to stop on wet pavement as measured under controlled conditions on specified government test surfaces of asphalt and concrete. A tire marked C may have poor traction performance.



The traction grade assigned to this tire is based on straight-ahead braking traction tests, and does not include acceleration, cornering, hydroplaning or peak traction characteristics.

## Maintenance and care

### Temperature A B C

The temperature grades are A (the highest), B, and C, representing the tire's resistance to the generation of heat and its ability to dissipate heat when tested under controlled conditions on a specified indoor laboratory test wheel. Sustained high temperature can cause the material of the tire to degenerate and reduce tire life, and excessive temperature can lead to sudden tire failure. The grade C corresponds to a level of performance which all passenger car tires must meet under the Federal Motor Vehicle Safety Standard No. 109. Grades B and A represent higher levels of performance on the laboratory test wheel than the minimum required by law.



The temperature grade for this tire is established for a tire that is properly inflated and not overloaded. Excessive speed, underinflation, or excessive loading, either separately or in combination, can cause heat buildup and possible tire failure.

### SERVICING YOUR TIRES

#### Checking the tire pressure

- Use an accurate tire pressure gauge.
- Check the tire pressure when tires are cold, after the vehicle has been parked for at least one hour or has been driven less than 5 km (3 miles).
- Adjust tire pressure to recommended specifications found on the Certification Label.



Improperly inflated tires can affect vehicle handling and can fail suddenly, possibly resulting in loss of vehicle control.

#### Tire rotation

Because your vehicle's tires perform different jobs, they often wear differently. To make sure your tires wear evenly and last longer, rotate them as indicated in the Scheduled Maintenance Guide. If you notice that the tires wear unevenly, have them checked.

## Maintenance and care

- Four tire rotation (for vehicles with aluminum wheels)

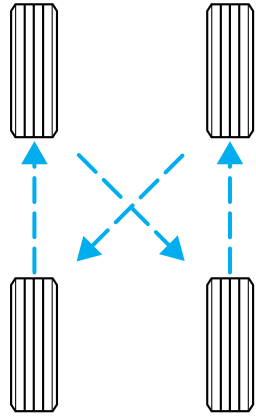

- Five tire rotation (for vehicles with steel wheels and full size spare tires)

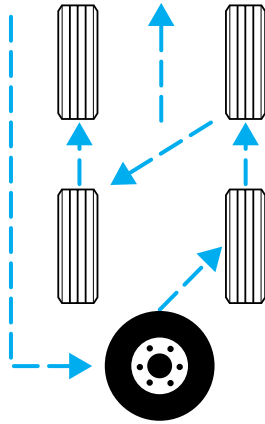



## Maintenance and care

### Replacing the tires

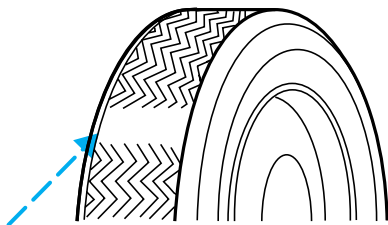
Replace the tires when the wear band is visible through the tire treads.



 When replacing full size tires, never mix radial bias-belted, or bias-type tires. Use only the tire sizes that are listed on the Certification Label. Make sure that all tires are the same size, speed rating, and load-carrying capacity. Use only the tire combinations recommended on the label. If you do not follow these precautions, your vehicle may not drive properly and safely.

 Make sure that all replacement tires are of the same size, type, load-carrying capacity and tread design (e.g., “All Terrain”, etc.), as originally offered by Ford.

 Failure to follow these precautions may adversely affect the handling of the vehicle and make it easier for the driver to lose control and roll over.

Tires that are larger or smaller than your vehicle’s original tires may also affect the accuracy of your speedometer.



### SNOW TIRES AND CHAINS



Snow tires must be the same size and grade as the tires you currently have on your vehicle.

The tires on your vehicle have all weather treads to provide traction in rain and snow. However, in some climates, you may need to use snow tires and chains. If you need to use chains, it is recommended that steel wheels (of the same size and specifications) be used as chains may chip aluminum wheels.

Follow these guidelines when using snow tires and chains:

- Use only SAE Class S chains.
- Install chains securely, verifying that the chains do not touch any wiring, brake lines or fuel lines.
- Drive cautiously. If you hear the chains rub or bang against your vehicle, stop and re-tighten the chains. If this does not work, remove the chains to prevent damage to your vehicle.
- If possible, avoid fully loading your vehicle.
- Remove the tire chains when they are no longer needed. Do not use tire chains on dry roads.
- The suspension insulation and bumpers will help prevent vehicle damage. Do not remove these components from your vehicle when using snow tires and chains.

### WHAT YOU SHOULD KNOW ABOUT AUTOMOTIVE FUELS

#### Important safety precautions



Do not overfill the fuel tank. The pressure in an overfilled tank may cause leakage and lead to fuel spray and fire.



If you do not use the proper fuel cap, the pressure in the fuel tank can damage the fuel system or cause it to work improperly in a collision.

## Maintenance and care



The fuel system may be under pressure. If the fuel cap is venting vapor or if you hear a hissing sound, wait until it stops before completely removing the cap.



Automotive fuels can cause serious injury or death if misused or mishandled.

Observe the following guidelines when handling automotive fuel:

- Extinguish all smoking materials and any open flames before fueling your vehicle.
- Always turn off the vehicle before fueling.
- Automotive fuels can be harmful or fatal if swallowed. Fuel such as gasoline is highly toxic and if swallowed can cause death or permanent injury. If fuel is swallowed, call a physician immediately, even if no symptoms are immediately apparent. The toxic effects of fuel may not be visible for hours.
- Avoid inhaling fuel vapors. Inhaling too much fuel vapor of any kind can lead to eye and respiratory tract irritation. In severe cases, excessive or prolonged breathing of fuel vapor can cause serious illness and permanent injury.
- Avoid getting fuel liquid in your eyes. If fuel is splashed in the eyes, remove contact lenses (if worn), flush with water for 15 minutes and seek medical attention. Failure to seek proper medical attention could lead to permanent injury.
- Fuels can also be harmful if absorbed through the skin. If fuel is splashed on the skin and/or clothing, promptly remove contaminated clothing and wash skin thoroughly with soap and water. Repeated or prolonged skin contact with fuel liquid or vapor causes skin irritation.
- Be particularly careful if you are taking “Antabuse” or other forms of disulfiram for the treatment of alcoholism. Breathing gasoline vapors, or skin contact could cause an adverse reaction. In sensitive individuals, serious personal injury or sickness may result. If fuel is

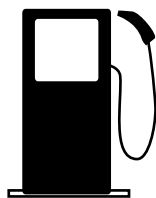

## Maintenance and care

splashed on the skin, promptly wash skin thoroughly with soap and water. Consult a physician immediately if you experience an adverse reaction.

### Fuel Filler Cap

Your fuel tank filler cap has an indexed design with a one-eighth turn on/off feature.

When fueling your vehicle:

1. Turn the engine off.
2. Carefully turn the filler cap counterclockwise 1/8 of a turn until it stops.
3. Pull to remove the cap from the fuel filler pipe.
4. To install the cap, align the tabs on the cap with the notches on the filler pipe.
5. Turn the filler cap clockwise 1/8 of a turn until it stops.

If the “Service Engine Soon/Check Engine” indicator comes on and stays on when you start the engine, the fuel filler cap may not be properly installed. Turn off the engine, remove the fuel filler cap and reinstall it being careful to align the cap properly.

**If you must replace the fuel filler cap, replace it with a genuine Ford or Motorcraft part. The customer warranty may be void for any damage to the fuel tank or fuel system if a genuine Ford or Motorcraft fuel filler cap is not used.**



The fuel system may be under pressure. If the fuel filler cap is venting vapor or if you hear a hissing sound, wait until it stops before completely removing the fuel filler cap. Otherwise, fuel may spray out and injure you or others.



If you do not use the proper fuel filler cap, the pressure in the fuel tank can damage the fuel system or cause it to work improperly in a collision.

### Choosing the right fuel

Use only UNLEADED FUEL. The use of leaded fuel is prohibited by law and could damage your vehicle.

## Maintenance and care

Do not use gasolines containing methanol. It can damage critical fuel systems components.

Vehicles certified to meet California emission standards (indicated on the underhood Vehicle Emissions Control Information label) are designed to operate on California cleaner-burning, low-sulfur gasolines. If you have a California-certified vehicle and California cleaner-burning gasoline is not available when you refuel, your engine should perform adequately.

However, the performance of the emission control devices and systems may be adversely affected. In New York and Massachusetts, which have adopted California's emission standards without requiring the sale of California cleaner-burning gasoline, repairs to correct the effects of using non-California fuel may not be covered by the emissions warranty.

Your vehicle was not designed to use fuel or fuel additives with metallic compounds, including manganese-based compounds containing (MMT).

Repairs to correct the effects of using a fuel for which your vehicle was not designed may not be covered by your warranty.

### Octane recommendations

Your vehicle is designed to use "Regular" unleaded gasoline with an (R+M)/2 octane rating of 87. We do not recommend the use of gasolines labeled as "Regular" that are sold with octane ratings of 86 or lower in high altitude areas.

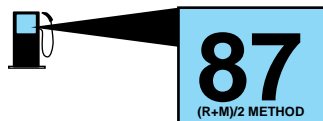

Do not be concerned if your engine sometimes knocks lightly. However, if it knocks heavily under most driving conditions while you are using fuel with the recommended octane rating, see your dealer or a qualified service technician to prevent any engine damage.

### Fuel quality

If you are experiencing starting, rough idle or hesitation driveability problems during a cold start, try a different brand of "Regular" unleaded gasoline. "Premium" unleaded gasoline is not recommended (particularly in the United States) because it may cause these problems to become more pronounced. If the problems persist, see your dealer or a qualified service technician.

It should not be necessary to add any aftermarket products to your fuel tank if you continue to use a high-quality fuel.

### Cleaner air

Ford approves the use of gasolines to improve air quality, including reformulated gasolines that contain oxygenates up to 10% ethanol or 15% MTBE.

### Running out of fuel

Avoid running out of fuel because this situation may have an adverse affect on powertrain components.

If you have run out of fuel:

- You may need to crank the engine several times before the system starts to pump fuel from the tank to the engine.
- Your “Check Engine” light may come on. For more information on the “Check Engine” light, refer to the *Instrumentation* chapter.

### Fuel Filter

Your vehicle is equipped with a fuel filter that is mounted on the underbody.

For fuel filter replacement, see your dealer or a qualified service technician. Refer to the Scheduled Maintenance Guide for the appropriate intervals for changing the fuel filter.

**If you replace the fuel filter, replace it with an authorized Motorcraft part. The customer warranty may be void for any damage to the fuel system if an authorized Motorcraft fuel filter is not used.**

## ESSENTIALS OF GOOD FUEL ECONOMY

### Measuring techniques

Your best source of information about actual fuel economy is you, the driver. You must gather information as accurately and consistently as possible. Fuel expense, frequency of fillups or fuel gauge readings are NOT accurate as a measure of fuel economy. We do not recommend taking fuel economy measurements during the first 1 600 km (1 000 miles) of driving (engine break-in period). You will get a more accurate measurement after 3 000 km–5 000 km (2 000 miles–3 000 miles).

The advertised fuel capacity of the fuel tank on your vehicle is equal to the rated refill capacity of the fuel tank as listed in the Refill Capacities chart in this “Owner Guide.” The advertised capacity is the amount of

## Maintenance and care

the Indicated Capacity and the Empty Reserve combined. Indicated Capacity is the difference in the amount of fuel in a full tank and a tank when the fuel gauge indicates empty. Empty Reserve is the small amount of usable fuel remaining in the fuel tank after the fuel gauge indicates empty.

**The amount of Empty Reserve varies and should not be relied upon to increase driving range. When refueling your vehicle after the fuel gauge indicates empty, you might not be able to refuel the full amount of the advertised capacity of the fuel tank due to the empty reserve still present in the tank.**

### Filling the tank

For consistent results:

- Use the same filling rate setting (low — medium — high) each time the tank is filled.
- Allow three automatic click-offs when filling.
- Always use the recommended octane rating of a known quality gasoline, preferably a national brand.
- Use the same side of the same pump and have the vehicle facing the same direction each time you fill up.
- Have the vehicle loading and distribution the same every time.

Your results will be most accurate if your filling method is consistent.

### Calculating fuel economy

1. Fill the fuel tank completely and record the initial odometer reading.
2. Each time you fill the tank, record the amount of fuel added (in liters or gallons).
3. After at least three to five tank fill-ups, fill the fuel tank and record the current kilometer (mileage) reading.
4. Follow one of the simple calculations in order to determine fuel economy:

**Multiply liters used by 100, then divide by total kilometers traveled.**

**Divide total miles traveled by total gallons used.**

Keep a record for at least one month and record the type of driving (city or highway). This will provide an accurate estimate of the vehicle's fuel

economy. Additionally, keeping records during summer and winter will show how temperature impacts fuel economy. In general, lower temperatures give lower fuel economy.

### **Driving style — good driving and fuel economy habits**

Give consideration to the lists that follow and you may be able to change a number of variables and improve your fuel economy.

#### ***Habits***

- Smooth, moderate operation can yield up to 10% savings in fuel.
- Steady speeds without stopping will usually give the best fuel economy.
- Idling for long periods of time (greater than one minute) may waste fuel.
- Anticipate stopping; slowing down may eliminate the need to stop.
- Sudden or hard accelerations may reduce fuel economy.
- Slow down gradually.
- Drive at reasonable speeds (traveling at 105 km/h [65 mph] uses 15% more fuel than traveling at 88 km/h [55 mph]).
- Revving the engine before turning it off may reduce fuel economy.
- Use of the air conditioner or defroster may reduce fuel economy.
- Use of speed control (if equipped) may improve fuel economy. Speed control can help maintain a constant speed and reduce speed changes. You may want to turn off the speed control in hilly terrain as unnecessary shifting between third and fourth gears may occur and could result in reduced fuel economy.
- Warming up a vehicle on cold mornings is not required and may reduce fuel economy.
- Resting your foot on the brake pedal while driving may reduce fuel economy.
- Combine errands and minimize stop-and-go driving.

#### ***Maintenance***

- Keep tires properly inflated and use only recommended size.
- Operating a vehicle with the wheels out of alignment will reduce fuel economy.

## Maintenance and care

- Use recommended engine oil. Refer to *Lubricant Specifications*.
- Perform all regularly scheduled maintenance items. Follow the recommended maintenance schedule and owner maintenance checks found in your vehicle Scheduled Maintenance Guide.

### Conditions

- Heavily loading a vehicle or towing a trailer may reduce fuel economy at any speed.
- Carrying unnecessary weight may reduce fuel economy (approximately 2 km/h [1 mpg] is lost for every 180 kg [400 lb] of weight carried).
- Adding certain accessories to your vehicle (for example bug deflectors, rollover/light bars, running boards, ski/luggage racks) may reduce fuel economy.
- Use of fuel blended with alcohol may lower fuel economy.
- Fuel economy may decrease with lower temperatures during the first 12–16 km (8–10 miles) of driving.
- Driving on flat terrain offers improved fuel economy as compared to driving over hilly terrain.
- Transmissions give their best fuel economy when operated in the top cruise gear and with steady pressure on the gas pedal.
- Close windows for high speed driving.

### EPA window sticker

Every new vehicle should have the EPA window sticker. Contact your dealer if the window sticker is not supplied with your vehicle. The EPA window sticker should be your guide for the fuel economy comparisons with other vehicles.

It is important to note the box in the lower left corner of the window sticker. These numbers represent the Range of Km/L (MPG) expected on the vehicle, depending upon the driver's method of operation and conditions.

### EMISSION CONTROL SYSTEM

Your vehicle is equipped with various emission control components and a catalytic converter which will enable your vehicle to comply with applicable exhaust emission standards. To make sure that the catalytic converter and other emission control components continue to work properly:



## Maintenance and care

- Use only unleaded fuel.
- Avoid running out of fuel.
- Do not turn off the ignition while your vehicle is moving, especially at high speeds.
- Have the items listed in your Scheduled Maintenance Guide performed according to the specified schedule.

The scheduled maintenance items listed in the Scheduled Maintenance Guide are essential to the life and performance of your vehicle and to its emissions system.

If other than Ford, Motorcraft or Ford-authorized parts are used for maintenance replacements or for service of components affecting emission control, such non-Ford parts should be equivalent to genuine Ford Motor Company parts in performance and durability.



Do not park, idle, or drive your vehicle in dry grass or other dry ground cover. The emission system heats up the engine compartment and exhaust system, which can start a fire.

Illumination of the charging system warning light, *Check Engine* indicator light or the temperature warning light, fluid leaks, strange odors, smoke or loss of oil pressure, could indicate that the emission control system is not working properly.



Exhaust leaks may result in entry of harmful and potentially lethal fumes into the passenger compartment.

Do not make any unauthorized changes to your vehicle or engine. By law, vehicle owners and anyone who manufactures, repairs, services, sells, leases, trades vehicles, or supervises a fleet of vehicles are not permitted to intentionally remove an emission control device or prevent it from working. Information about your vehicle's emission system is on the Vehicle Emission Control Information Decal located on or near the engine. This decal identifies engine displacement and gives some tune up specifications.

Please consult your "Warranty Guide" for complete emission warranty information.

## Maintenance and care

### Readiness for Inspection/Maintenance (I/M) testing

In some localities, it may be a legal requirement to pass an I/M test of the on-board diagnostics system. If your “Check Engine/Service Engine Soon” light is on, refer to the description in the *Warning Lights and Chimes* section of the *Instrumentation* chapter. Your vehicle may not pass the I/M test with the “Check Engine/Service Engine Soon” light on.

If the vehicle’s powertrain system or its battery has just been serviced, the on-board diagnostics system is reset to a “not ready for I/M test” condition. To ready the on-board diagnostics system for I/M testing, a minimum of 30 minutes of city and highway driving is necessary as described below:

- First, at least 10 minutes of driving on an expressway or highway.
- Next, at least 20 minutes driving in stop-and-go, city-type traffic with at least four idle periods.

Allow the vehicle to sit for at least eight hours without starting the engine. Then, start the engine and complete the above driving cycle. The engine must warm up to its normal operating temperature. Once started, do not turn off the engine until the above driving cycle is complete.

### EXTERIOR BULBS

#### Replacing exterior bulbs

Check the operation of the following lamps frequently:

- Headlamps
- Tail lamps
- Brakelamps
- High-mount brakelamp
- Turn signals
- Backup lamps
- License plate lamp

Do not remove lamp bulbs unless they will be replaced immediately. If a bulb is removed for an extended period of time, contaminants may enter the lamp housings and affect performance.

### Replacing headlamp bulbs



Handle a halogen headlamp bulb carefully and keep out of children's reach. Grasp the bulb only by its plastic base and do not touch the glass. The oil from your hand could cause the bulb to break the next time the headlamps are operated.

To remove the headlamp bulb:

1. Make sure headlamp switch is in OFF position, then open the hood.
2. Remove the protective cover by turning the three knobs to the unlock position.
3. Disengage the safety snap on the connector by pulling upward slightly on the clip.
4. Release clip and disconnect the electrical connector from the bulb.

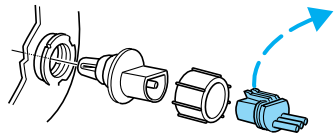

5. Remove the bulb retaining ring by rotating it counterclockwise (when viewed from the rear) about 1/8 turn to free it from the bulb socket, and slide the ring off the plastic base. Keep the ring to retain the new bulb.

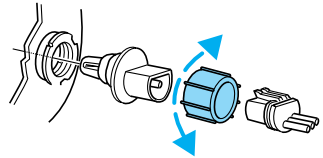

6. Without turning, remove the old bulb from the lamp assembly by gently pulling it straight back out of the lamp assembly.

To install the new bulb:

1. With the flat side of the new bulb's plastic base facing upward, insert the glass end of the bulb into the lamp assembly. Turn the bulb left or right to align the grooves in the plastic base with the tabs in the lamp assembly. When the grooves are aligned, push the bulb into the lamp assembly until the plastic base contacts the rear of the lamp assembly.

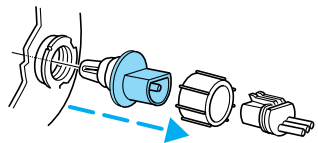

## Maintenance and care

2. Install the bulb retaining ring over the plastic base until it contacts the rear of the socket by rotating it clockwise until you feel a “stop.”
3. Connect the electrical connector into the rear of the plastic base until it snaps, locking it into position.
4. Install the protective cover over headlamps locking it in place with three knobs.
5. Turn the headlamps on and make sure they work properly. If the headlamp was correctly aligned before you changed the bulb, you should not need to align it again.

### **Replacing front parking lamp/turn signal bulbs**

1. Make sure headlamp switch is in OFF position, then open the hood.
2. Remove the protective cover by turning the three knobs to the unlock position.
3. Disengage the safety snap on the connector by pulling upward slightly on the clip.
4. Disconnect the electrical connector from the bulb socket.
5. Rotate the bulb socket counterclockwise about  $\frac{1}{4}$  turn and remove from lamp assembly.

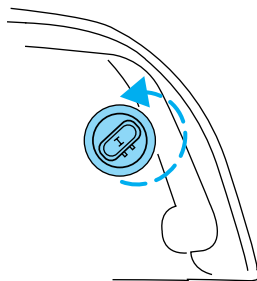

6. Carefully pull bulb straight out of the socket and push in the new bulb.
7. To complete installation, follow the removal procedure in reverse order.

### **High-mount brakelamp bulbs**

1. Open trunk.
2. Inside trunk, locate access hole under the rear window
3. Remove the bulb socket by rotating it 45 degrees and pulling it out of the lamp assembly.
4. Carefully pull bulb straight out of socket and push in new bulb.
5. To complete installation, follow the removal procedure in reverse order.

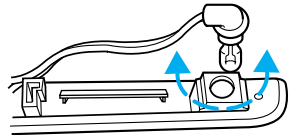
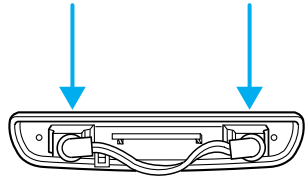

### **Replacing tail lamp/backup bulbs**

For bulb replacement, see a dealer or qualified technician.

### **Replacing sidemarker and cornering lamp bulbs**

For bulb replacement, see a dealer or qualified technician.

### **Replacing license plate lamp bulbs**

For bulb replacement, see a dealer or qualified technician.

### **Replacing the interior bulbs**

Check the operation of the following interior bulbs frequently:

- interior overhead lamp
- map lamp

## Maintenance and care

### Using the right bulbs

Function	Trade Number
Headlamp	9007
Park lamp and turn lamp (front)	3457 NAK
Side marker (front)	194 NA
Cornering lamp (front)	3156K
Tail, stop, turn (rear)	3157 K
Side marker (rear)	194
Backup lamp	3156K
License plate lamp	168
High-mount brakelamp	912
Luggage compartment lamp	212-2
Dome lamp	906
Rear reading lamp	211-2
Map lamp	168
Illuminated visor mirror	168
Dual floorwell lamp	906
Glove compartment	168
To replace all instrument panel lights - see your dealer.	

### AIMING THE HEADLAMPS

The alignment of your headlamps should be checked by a qualified service technician if:

- Oncoming motorists frequently signal you to deactivate your high beams, and your high beams are not activated.
- The headlamps do not seem to provide enough light for clear night vision.
- The headlamp beams are pointed substantially away from a slightly down and to the right position.

### CLEANING AND CARING FOR YOUR VEHICLE

Refer to the Customer Assistance chapter for a list of Ford-approved cleaners, polishes and waxes.

### Washing your vehicle

Wash your vehicle regularly with cold or lukewarm water. Never use strong detergents or soap. If your vehicle is particularly dirty, use a quality car wash detergent. Always use a clean sponge, washing glove or similar device and plenty of water for best results. To avoid spots, avoid washing when the hood is still warm, immediately after or during exposure to strong sunlight.

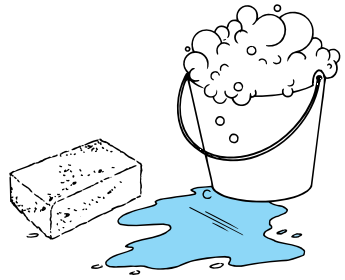

During winter months, it is especially important to wash the vehicle on a regular basis. Large quantities of dirt and road salt are difficult to remove and also cause damage to the vehicle.

Remove any exterior accessories, such as antennas, before entering a car wash. If you have wax applied to the vehicle at a commercial car wash, it is recommended that you clean the wiper blades and windshield as described in *Cleaning the wiper blades and windshield*.

After washing, apply the brakes several times to dry them.

### Waxing your vehicle

Wax when water stops beading on the surface. This could be every three or four months, depending on operating conditions.

Use only carnauba or synthetic-based waxes. Use cleaning fluid or alcohol with a clean cloth to remove any bugs and tar before waxing vehicle. Use tar remover to remove any tar spots.

Avoid getting wax on the windshield. If you have wax applied at a commercial car wash, it is recommended that you clean the wiper blades and windshield as described in *Cleaning the wiper blades and windshield*.

### Repairing paint chips

Minor scratches or paint damage from road debris may be repaired with touch-up paint, repair foil or aerosol paint spray from the Ford Car Care Chemicals line. Observe the application instructions on the products.

Remove particles such as bird droppings, tree sap, insect remains, tar spots, road salt and industrial fallout immediately.

## Maintenance and care

### Cleaning the wheels

Wash with the same detergent as the body of your vehicle. Do not use acid-based or alcohol-based wheel cleaners, steel wool, fuel or strong detergents. Never use abrasives that will damage the finish of special wheel surfaces. Use a tar remover to remove grease and tar.

The brushes used in some automatic car washes may damage the finish on your wheels. Before going to a car wash, find out if the brushes are abrasive.

### Cleaning the engine

Engines are more efficient when they are clean because grease and dirt buildup keep the engine warmer than normal. When washing:

- Take care when using a power washer to clean the engine. The high pressure fluid could penetrate the sealed parts and cause damage.
- Do not spray with cold water to avoid cracking the engine block or other engine components.
- Never apply anything to the drive belt (including belt dressing).

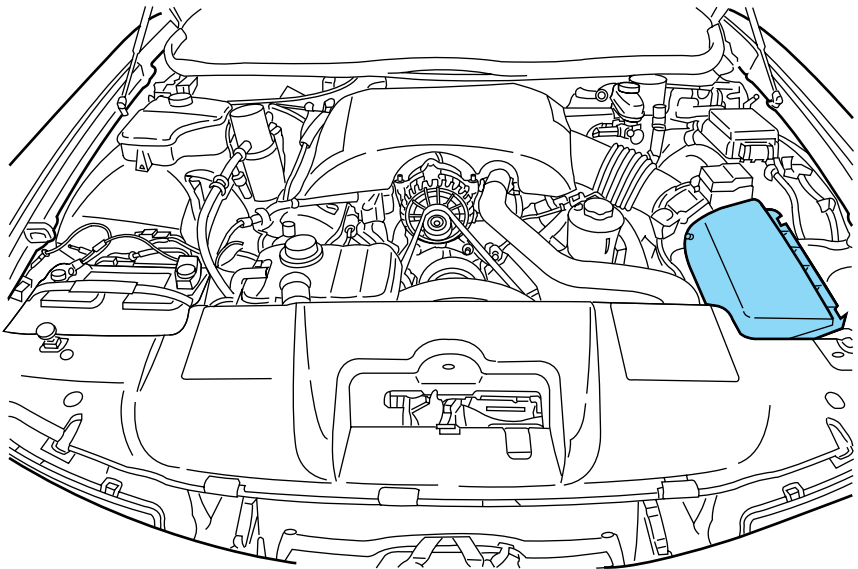



## Maintenance and care

- Cover the highlighted areas to prevent water damage when cleaning the engine.
- Never wash or rinse the engine while it is running; water in the running engine may cause internal damage.

### Cleaning plastic exterior parts

Use vinyl cleaner for routine cleaning. Clean with a tar remover if necessary. Do not clean plastic parts with thinners, solvents or petroleum-based cleaners.

### Cleaning the exterior lamps

Wash with the same detergent as the exterior of your vehicle. Use glass cleaner or tar remover if necessary.

To avoid scratching the lamps, do not use a dry paper towel, chemical solvents or abrasive cleaners.

### Cleaning the wiper blades and windshield

If the wiper blades do not wipe properly, clean the wiper blade rubber element with undiluted windshield washer solution or a mild detergent. To avoid damaging the blades, do not use fuel, kerosene, paint thinner or other solvents.

If the wiper still does not wipe properly, this could be caused by substances on the windshield such as tree sap and some hot wax treatments used by commercial car washes. Clean the outside of the windshield with a non-abrasive cleanser such as the non-abrasive Bon-Ami® powder. Rinse thoroughly with clean water. **Do not** use abrasive cleansers on glass as they may cause scratches. The windshield is clean if beads do not form when you rinse it with water. The windshield and wiper blades should be cleaned on a regular basis, and blades or rubber elements replaced when worn.

### Cleaning the instrument panel

Clean with a damp cloth, then dry with a dry cloth.

Avoid cleaner or polish that increases the gloss of the upper portion of the instrument panel. The dull finish in this area helps protect the driver from undesirable windshield reflection.

## Maintenance and care

### Cleaning the interior fabric

Remove dust and loose dirt with a whisk broom or a vacuum cleaner. Remove fresh spots immediately. Do not use household or glass cleaners. These agents can stain and discolor the fabric. Use a mild soap and water solution if necessary.

### Cleaning and maintaining the safety belts

Clean the safety belts with a mild soap solution recommended for cleaning upholstery or carpets. Do not bleach or dye the belts, because these actions may weaken the belt webbing.

Check the safety belt system periodically to make sure there are no nicks, wear or cuts. If your vehicle has been involved in an accident, refer to the *Safety belt maintenance* section in the *Seating and safety restraints* chapter.

### Underbody

Flush the complete underside of vehicle frequently. Keep body drain holes unplugged. Inspect for road damage.

### Cleaning leather seats (if equipped)

To clean, simply use a soft cloth dampened with water and a mild soap. Wipe the leather again with a damp cloth to remove soap residue. Dry with a soft cloth. For tougher soiling concerns, Ford recommends using the Deluxe Leather Care Kit F8AZ-19G253-AA, which is available from your Ford Dealer. This mild cleaner and special pad, cleans the leather and maintains its natural beauty. Follow the instructions on the cleaner label. Regular cleaning of your leather upholstery helps maintain its resiliency and color.

**Do not use household cleaning products, alcohol solutions, solvents or cleaners intended for rubber, vinyl or plastics.**

### Inside windows

Use glass cleaner for the inside windows if they become fogged.

## Capacities and specifications

### MOTORCRAFT PART NUMBERS

Component	4.6L SOHC V8 engine
Air filter element	FA-1668
Fuel filter	FG-986B
Battery (standard)	BXT-59
Battery (optional)	BXT-65-650
Oil filter	FL-820-S
PCV valve	EV-98
Spark plugs*	AWSF-32P

\* Refer to Vehicle Emissions Control Information (VECI) decal for spark plug gap information.

### REFILL CAPACITIES

Fluid	Ford Part Name	Capacity
Engine oil (includes filter change)	Motorcraft 5W-30 Super Premium Motor Oil	4.7L (5.0 quarts)
Brake fluid	High Performance DOT 3 Motor Vehicle Brake Fluid	Fill to line on reservoir
Power steering fluid	Motorcraft MERCON® ATF	Fill to line on reservoir
Transmission fluid	Motorcraft MERCON®V ATF	13.1L (13.9 quarts)
Engine coolant <sup>1</sup>	Premium Engine Coolant	15.0L (15.8 quarts)
Fuel tank	N/A	71.9L (19.0 gallons)
Rear axle lubricant <sup>2</sup>	Motorcraft SAE 80W90 Premium Rear Axle Lubricant	1.8-1.9L (3.75-4.0 pints)
Windshield washer fluid	Ultra-Clear Windshield Washer Concentrate	Fill to line on reservoir

<sup>1</sup> Use Ford Premium Engine Coolant (green in color). DO NOT USE Ford Extended Life Engine Coolant (orange in color). Refer to *Adding engine coolant, in the Maintenance and Care chapter.*

<sup>2</sup> Rear axles are considered lubricated for life when the vehicle is used for normal service. See your Scheduled Maintenance Guide for Severe Duty requirements. Traction-Lok axles use 2.2–2.4L (4.75–5.0 pints) of

## Capacities and specifications

rear axle lubricant. Service refill capacities are determined by filling the rear axle 6 mm to 14 mm (1/4 inch to 9/16 inch) below the bottom of the filler hole. Add 118 ml (4 oz.) of additive friction modifier C8AZ-19B546-A, Ford specification EST-M2C118-A for complete refill of Traction-Lok axles.

### LUBRICANT SPECIFICATIONS

Item	Ford part name	Ford part number	Ford specification
Brake fluid	High Performance DOT 3 Motor Vehicle Brake Fluid	C6AZ-19542-AB	ESA-M6C25-A and DOT 3
Door weatherstrips	Silicone Lubricant	F7AZ-19G208-BA and F5AZ-19553-AA	ESR-M13P4-A
Engine coolant	Ford Premium Engine Coolant	E2FZ-19549-AA (in Oregon, F5FZ-19549-CC, in Canada, Motorcraft CXC-10)	ESE-M97B44-A
Engine oil	Motorcraft 5W-30 Super Premium Motor Oil	XO-5W30-QSP	WSS-M2C153-G with API Certification Mark
Hinges, latches, striker plates, fuel filler door hinge and seat tracks	Multi-Purpose Grease	DOAZ-19584-AA or F5AZ-19G209-AA	ESB-M1C93-B or ESR-M1C159-A
Lock cylinders	Penetrating and Lock Lubricant	E8AZ-19501-B	none
Power steering fluid	Motorcraft MERCON® ATF	XT-2-QDX	MERCON®
Automatic transmission (4R70W)	Motorcraft MERCON®V ATF	XT-5-QM	MERCON®V

## Capacities and specifications

Item	Ford part name	Ford part number	Ford specification
Rear axle lubricant <sup>1</sup>	Motorcraft SAE 80W90 Premium Rear Axle Lubricant	XY-80W90-QL	WSP-M2C197_A
Windshield washer fluid	Ultra-Clear Windshield Washer Concentrate	C9AZ-19550-AC	ESR-M17P5-A

<sup>1</sup> Add 118 ml (4 oz.) of additive friction modifier C8AZ-19B546-A, Ford specification EST-M2C118-A for complete refill of Traction-Lok axles.

### ENGINE DATA

Engine	4.6L V8 engine
Cubic inches	281
Horsepower-single exhaust	200 @ 4250 rpm
Horsepower-dual exhaust	215 @ 4500 rpm
Torque-single exhaust	275 lb.-ft. @ 3000 rpm
Torque-dual exhaust	285 lb.-ft. @ 3000 rpm
Recommended fuel	87 octane
Firing order	1-3-7-2-6-5-4-8
Spark plug gap	1.3-1.4 mm (0.052-0.056 inch)
Ignition system	Coil on plug
Compression ratio	9.0:1

### VEHICLE DIMENSIONS

Vehicle dimensions	mm (in)
(1) Overall length	5 382 (211.9)
(2) Overall width	1 987 (78.2)
(3) Overall height	1 443 (56.8)
(4) Wheelbase	2 913 (114.4)
(5) Track - Front	1 611 (63.4)
(5) Track - Rear	1 659 (65.3)

# Capacities and specifications

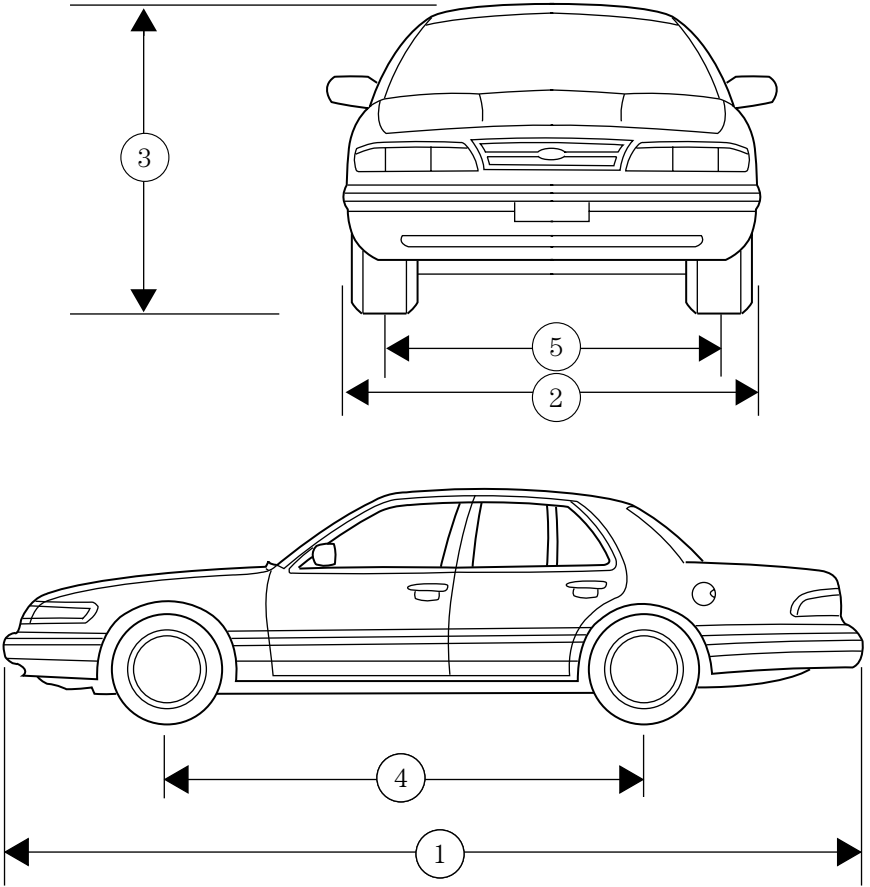

# Capacities and specifications

## IDENTIFYING YOUR VEHICLE

### Certification label

The National Highway Traffic Safety Administration Regulations require that a Certification Label be affixed to a vehicle and prescribe where the Certification Label may be located. The Certification Label is located on the front door latch pillar on the driver's side.

<b>MFD. BY FORD MOTOR CO. IN U.S.A.</b>			
DATE: XXXXX	GVWR: XXXXX LB/ XXXXX KG		
FGAWR: XXXXXX/XXXXXXXX	RGAWR: XXXXXX/XXXXXXXX		
THIS VEHICLE CONFORMS TO ALL APPLICABLE FEDERAL MOTOR VEHICLE SAFETY STANDARDS IN EFFECT ON THE DATE OF MANUFACTURE SHOWN ABOVE.			
VIN: XXXXXXXXXXXXXXXXX	TYPE: XXXXXXXXXXXXXXXXX		
			
MAXIMUM LOAD=OCCUPANTS + LUGGAGE=XXXKG/XXXLB			
OCCUPANTS: X TOTAL X FR X 2ND X RR OCCUPANTS LUGGAGE			
TIRE: XXXX/XXXXX XXX			
PRESSURE (FR) XXX kPa/33 PSI COLD			
PRESSURE (RR) XXX kPa/33 PSI COLD			
TRAILER TOWING - SEE OWNER GUIDE			
EXT PNT: XXXXXX XXXXXX	RC: XX	DSO: XXXX	F0000
BAR   INT TR   TP/PS   R	AXLE   TR   SPR	T0000	
X XX XXX X	XX X XXX		
UTC VFOHT-15294A10-GA			

### Vehicle identification number

The vehicle identification number is attached to a metal tag and is located on the driver side instrument panel.

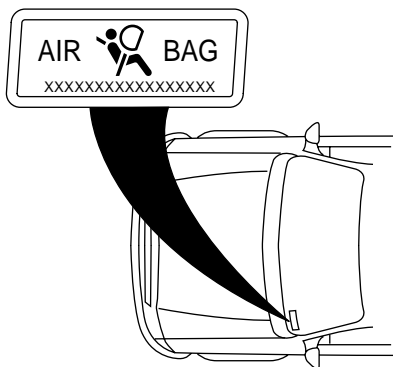

### Engine number

The engine number (the last eight numbers of the vehicle identification number) is stamped on the engine block, transmission, frame and transfer case (if equipped).

## Customer assistance

### GETTING ROADSIDE ASSISTANCE

To fully assist you should you have a vehicle concern, Ford offers a complimentary roadside assistance program. This program is separate from the New Vehicle Limited Warranty. The service is available:

- 24-hours, seven days a week
- for the Basic warranty period (Canada) or New Vehicle Limited Warranty period (U.S.) of three years or 60,000 km (36,000 miles), whichever comes first on Ford and Mercury vehicles, and four years or 80,000 km (50,000 miles) on Lincoln vehicles

In the United States, you may purchase additional roadside assistance coverage beyond this period through the Ford Auto Club by contacting your Ford or Lincoln-Mercury dealer.

Roadside assistance will cover:

- changing a flat tire
- jump-starts
- lock-out assistance
- fuel delivery
- towing to the nearest Ford of Canada or Ford Motor Company dealership, or towing to your selling dealership if within 56 km (35 miles). Even non-warranty related tows, like accidents or getting stuck in the mud or snow, are covered (some exclusions apply, such as impound towing or repossession).

### Using roadside assistance

Complete the roadside assistance identification card and place it in your wallet for quick reference. In the United States, this card is found in the Owner Guide portfolio in the glove compartment in Ford vehicles and is mailed to you if you own a Mercury or Lincoln. In Canada, it's found in the Roadside Assistance book in the glove compartment.

To receive roadside assistance in the United States for Ford or Mercury vehicles, call 1-800-241-3673 or if you own a Lincoln vehicle, call 1-800-521-4140. In Canada call 1-800-665-2006.

Should you need to arrange assistance for yourself, Ford will reimburse a reasonable amount. To obtain information about reimbursement, call 1-800-241-3673 in the United States for Ford or Mercury vehicles; or if you own a Lincoln vehicle, call 1-800-521-4140. Call 1-800-665-2006 in Canada.



### Ford extended service plan

You can get more protection for your new car or light truck by purchasing Ford Extended Service Plan (Ford ESP) coverage. Ford ESP is an optional service contract which is backed by Ford Motor Company or Ford Motor Service Company (in the U.S.) and Ford of Canada (in Canada). It provides:

- Protection against repair costs after your New Vehicle Limited Warranty period expires;

and

- Other benefits during the warranty period (such as reimbursement for rentals and towing.)

You may purchase Ford ESP from any participating Ford or Lincoln-Mercury or Ford of Canada dealer. There are several plans available in various time, distance and deductible combinations which can be tailored to fit your own driving needs. Ford ESP also offers reimbursement benefits for towing and rental coverage. (In Hawaii, rules vary. See your dealer for details.)

When you buy Ford ESP, you receive Peace-of-Mind protection throughout the United States and Canada, provided by a network of more than 5,200 participating Ford, Lincoln-Mercury and Ford of Canada dealers.

If you did not take advantage of the Ford Extended Service Plan at the time of purchasing your vehicle, you may still be eligible. Please contact your dealer for further information. Since this information is subject to change, please ask your dealer for complete details about Ford Extended Service Plan coverage options.

Also, please be aware that some dealers offer service contracts that are not backed by Ford Motor Company or Ford of Canada. On the surface, many independent plans appear to be like Ford's. The problem is that they can often require the use of non-factory approved parts and have much more complex and restrictive claims coverage terms than Ford.

At Ford Motor Company and Ford of Canada, we are dedicated to providing Ford, Lincoln and Mercury vehicle owners with programs that will enhance your ownership experience and protect you from unexpected repair bills. Genuine Ford ESP is the only Extended Service Plan that enables us to provide that service.

## Customer assistance

### Getting the service you need

#### At home

Ford Motor Company and Ford of Canada have authorized dealerships to service your vehicle. When you need warranty repairs your selling dealer would like you to return to it for that service, but you may also take your vehicle to another Ford Motor Company dealership authorized for warranty repairs. Certain warranty repairs require special training though, so not all dealers are authorized to perform all warranty repairs. That means that depending on the warranty repair needed, the vehicle may need to be taken to another dealer. If a particular dealership can not assist you, then contact the Customer Assistance Center.

If you are not satisfied with the service you receive at the dealership, speak with the service manager. If you are still not satisfied, speak with the owner or general manager of the dealership. In most cases, your concern will be resolved at this level.

Ford Motor Company and Ford of Canada dealerships also carry genuine Ford parts and accessories, providing you with original equipment reliability.

#### Away from home

If you are away from home when your vehicle needs service, or if you need more help than the dealership could provide, contact the Ford Customer Assistance Center to find an authorized dealership to help you. In the United States:

Ford Motor Company  
Customer Assistance Center  
16800 Executive Plaza Drive  
P.O. Box 6248  
Dearborn, Michigan 48121  
1-800-392-3673 (FORD)  
(TDD for the hearing impaired: 1-800-232-5952)

In Canada:  
Customer Assistance Centre  
Ford Motor Company of Canada, Limited  
P.O. Box 2000  
Oakville, Ontario L6J 5E4  
1-800-565-3673 (FORD)

## Customer assistance

Please have the following information available when contacting Ford Customer Assistance:

- Your telephone number (home and business)
- The name of the dealer and the city where the dealership is located
- The year and make of your vehicle
- The date of vehicle purchase
- The current odometer reading
- The vehicle identification number (VIN)

If you still have a complaint involving a warranty dispute, you may wish to contact the Dispute Settlement Board (U.S.) or the Mediation/Arbitration Program (Canada).

In the United States, a warranty dispute must be submitted to the Dispute Settlement Board before taking action under the Magnuson-Moss Warranty Act, or to the extent allowed by state law, before pursuing replacement or repurchase remedies provided by certain state laws. This dispute handling procedure is not required prior to enforcing state created rights or other rights which are independent of the Magnuson-Moss Warranty Act or state replacement or repurchase laws.

### **THE DISPUTE SETTLEMENT BOARD**

The Dispute Settlement Board is:

- an independent, third-party arbitration program for warranty disputes
- available free to owners and lessees of qualifying Ford Motor Company vehicles

The Dispute Settlement Board may not be available in all states. Ford Motor Company reserves the right to change eligibility limitations, modify procedures and/or to discontinue this service without notice and without incurring obligations per applicable state law.

### **What kinds of cases does the Board review?**

Unresolved warranty repair concerns or vehicle performance as designed concerns on Ford, Mercury and Lincoln cars and Ford or Mercury light trucks which are within the terms of any applicable written new vehicle warranty are eligible for review, except those involving:

- a non-Ford product
- a non-Ford dealership

## Customer assistance

- sales disputes between customer and dealer except those associated with warranty repairs or concerns with the vehicle's performance as designed
- a request for reimbursement of consequential expenses unless a service or product concern being reviewed
- items not covered by the New Vehicle Limited Warranty (including maintenance and wear items)
- alleged personal injury/property damage claims
- cases currently in litigation
- vehicles not used primarily for family, personal or household purposes (except in states where the Dispute Settlement Board is required to review commercial vehicles)
- vehicles with non-U.S. warranties

Concerns are ineligible for review if the New Vehicle Limited Warranty has expired at receipt of your application and, in certain states of eligibility is dependent upon the customer's possession of the vehicle.

Eligibility may differ according to state law. For example, see the unique brochures for California, West Virginia, Georgia and Wisconsin purchasers/lessees.

### Board membership

The Board consists of:

- three consumer representatives
- a Ford or Lincoln/Mercury dealership representative

Consumer candidates for Board membership are recruited and trained by an independent consulting firm. The dealership Board member is chosen from Ford and Lincoln-Mercury dealership management, recognized for their business leadership qualities.

### What the Board needs

To have your case reviewed you must complete the application in the DSB brochure and mail it to the address provided on the application form.

Your application is reviewed and, if it is determined to be eligible, you will receive an acknowledgment indicating:

- the file number assigned to your application

## Customer assistance

- the toll-free phone number of the DSB's independent administrator

Your dealership and a Ford Motor Company representative are asked to submit statements at this time.

To properly review your case, the Board needs the following information:

- legible copies of all documents and maintenance or repair orders relevant to the case
- the year, make, model, and Vehicle Identification Number (VIN) listed on your vehicle ownership license
- the date of repair(s) and mileage at the time of occurrence(s)
- the current mileage
- the name of the dealer who sold or serviced the vehicle
- a brief description of your unresolved concern
- a brief summary of the action taken by the dealer(s) and Ford Motor Company
- the names (if known) of all the people you contacted at the dealership(s)
- a description of the action you expect to resolve your concern

You will receive a letter of explanation if your application does not qualify for Board review.

### Oral presentations

If you would like to make an oral presentation, indicate YES to question #6 on the application. While it is your right to make an oral presentation before the Board, this is not a requirement and the Board will decide the case whether or not an oral presentation is made. Oral presentation may be requested Board as well.

### Making a decision

Board members review all available information related to each complaint, including oral presentations, and arrive at a fair and impartial decision.

Every effort is made to decide the case within 40 days of the date that all requested information is received by the Board. Since the Board generally meets once a month, it may take more than a month before the Board can consider some cases.

## Customer assistance

After a case is reviewed, the Board mails you a decision letter and a form on which to accept or reject the Board's decision. The decisions of the Board are binding on Ford (and, in some cases, on the dealer) but not on consumers who are free to pursue other remedies available to them under state or federal law.

### To Request a DSB Brochure/Application

For a brochure/application, speak to your dealer or write/call to the Board at the following address/phone number:

Dispute Settlement Board  
P.O. Box 5120  
Southfield, MI 48086-5120  
1-800-428-3718

You may also contact the North American Customer Assistance Center at 1-800-392-3673 (Ford), TDD for the hearing impaired: 1-800-232-5952 or by writing to the Center at the following address:

Ford Motor Company  
Customer Assistance Center  
16800 Executive Plaza Drive  
P.O. Box 6248  
Dearborn, Michigan 48121

### GETTING ASSISTANCE OUTSIDE THE U.S. AND CANADA

Before exporting your vehicle to a foreign country, contact the appropriate foreign embassy or consulate. These officials can inform you of local vehicle registration regulations and where to find unleaded fuel.

If you cannot find unleaded fuel or can only get fuel with an anti-knock index lower than is recommended for your vehicle, contact a district or owner relations/customer assistance office.

The use of leaded fuel in your vehicle without proper conversion may damage the effectiveness of your emission control system and may cause engine knocking or serious engine damage. Ford Motor Company/Ford of Canada is not responsible for any damage caused by use of improper fuel.

In the United States, using leaded fuel may also result in difficulty importing your vehicle back into the U.S.

## Customer assistance

If your vehicle must be serviced while you are traveling or living in Central or South America, the Caribbean, or the Middle East, contact the nearest Ford dealership. If the dealership cannot help you, write or call:

FORD MOTOR COMPANY  
WORLDWIDE DIRECT MARKET OPERATIONS

1555 Fairlane Drive  
Fairlane Business Park #3  
Allen Park, Michigan 48101  
U.S.A.

Telephone: (313) 594-4857  
FAX: (313) 390-0804

If you are in another foreign country, contact the nearest Ford dealership. If the dealership employees cannot help you, they can direct you to the nearest Ford affiliate office.

If you buy your vehicle in North America and then relocate outside of the U.S. or Canada, register your vehicle identification number (VIN) and new address with Ford Motor Company Worldwide Direct Market Operations.

### **FORD ACCESSORIES FOR YOUR VEHICLE**

Ford has many quality products available from your dealer to clean your vehicle and protect its finishes. For best results, use the following or products of equivalent quality:

Ford Custom Clearcoat Polish\*

Ford Custom Silicone Gloss Polish

Ford Custom Vinyl Protectant\*

Ford Deluxe Leather and Vinyl Cleaner

Ford Extra Strength Tar and Road Oil Remover\*

Ford Extra Strength Upholstery Cleaner

Ford Metal Surface Cleaner

Ford Multi-Purpose Cleaner\*

Motorcraft Car Wash Concentrate

Motorcraft Carlite Glass Cleaner

Ford Spot and Stain Remover\*

Ford Super Premium Tire and Trim Dressing

## Customer assistance

Ford Triple Clean

Ford Ultra-Clear Spray Glass Cleaner

\* May be sold with the Motorcraft name

A wide selection of accessories is available through your local authorized Ford, Lincoln-Mercury or Ford of Canada dealer. These quality accessories have been specifically engineered to fulfill your automotive needs; they are custom designed to complement the style and aerodynamic appearance of your vehicle. In addition, each accessory is made from high quality materials and meets or exceeds Ford's rigid engineering and safety specifications. Ford accessories are warranted for up to 12 months or 20,000 km (12,000 miles) on all cars and light trucks and 12 months with unlimited distance on medium/heavy duty trucks unless the accessory is installed on a new vehicle, then the warranty becomes the balance of the new vehicle's warranty or the accessories warranty, whichever is greater. See your dealer for complete warranty information and availability.

**Not all accessories are available for all models.**

### Vehicle Security

Remote keyless entry

Styled wheel protector locks

Vehicle security systems

### Comfort and convenience

Air conditioner

Air filtration systems

Cargo nets

Cargo organizers

Cargo shades

Cargo trays

Dash trim

Engine block heaters

Gear shift knob

Luggage presenter (Continental only)

Manual sliding rear window

Tire step



### **Travel equipment**

Console

Console armrest

Daytime running lights

Factory luggage rack

Factory luggage rack adaptors

Fog lights

Framed luggage covers

Heavy-duty battery

Neutral towing transfer case kit (Explorer 4.0L only)

Off road lights

Pickup box rails

Removable luggage rack

Removable luggage rack adapters

Retractable bed hooks and loops

Running boards

Snow traction cables

Soft luggage cover

Speed control

Towing mirrors

Trailer hitch

Trailer hitch bars and balls

Trailer hitch wiring adaptor

### **Protection and appearance equipment**

Air bag anti-theft locks

Bed mat/bedliner tailgate covers

Bed mats

Bedliners

Car/truck covers

Cargo liners, interior

## Customer assistance

Carpet floor mats  
Cleaners, waxes and polishes  
Flat splash guards  
Front end covers (full and mini)  
Hood deflectors  
Locking gas cap  
Lubricants and oils  
Molded splash guards  
Molded vinyl floor mats  
Rallye bars  
Rear air deflectors  
Rear decklid spoilers  
Side window air deflectors  
Spare tire lock  
Step bumpers  
Step/sill plates  
Tailgate covers  
Tailgate lock  
Tailgate protector  
Tonneau covers  
Touch-up paint  
Universal floor mats

For maximum vehicle performance, keep the following information in mind when adding accessories or equipment to your vehicle:

- When adding accessories, equipment, passengers and luggage to your vehicle, do not exceed the total weight capacity of the vehicle or of the front or rear axle (GVWR or GAWR as indicated on the Safety compliance certification label). Consult your dealer for specific weight information.

## Customer assistance

- The Federal Communications Commission (FCC) and Canadian Radio Telecommunications Commission (CRTC) regulate the use of mobile communications systems - such as two-way radios, telephones and theft alarms - that are equipped with radio transmitters. Any such equipment installed in your vehicle should comply with FCC or CRTC regulations and should be installed only by a qualified service technician.
- Mobile communications systems may harm the operation of your vehicle, particularly if they are not properly designed for automotive use or are not properly installed. When operated, such systems may cause the engine to stumble or stall. In addition, such systems may be damaged or their performance may be affected by operating your vehicle. (Citizens band [CB] transceivers, garage door openers and other transmitters with outputs of five watts or less will not ordinarily affect your vehicle's operation.)
- Ford cannot assume responsibility for any adverse effects or damage that may result from the use of such equipment.

### ORDERING ADDITIONAL OWNER'S LITERATURE

To order the publications in this portfolio in the United States:

Make checks payable to:

HELM, INCORPORATED  
P.O. Box 07150  
Detroit, Michigan 48207

**For a free publication catalog, order toll free: 1-800-782-4356**

Monday-Friday 8:00 a.m. - 6:00 p.m. EST,  
for credit card holders only

To order the publications in this portfolio in Canada:

Make cheques payable to:  
Ford Motor Company of Canada, Ltd.

Service Publications  
P.O. Box 1580, Station B  
Mississauga, Ontario, Canada L4Y 4G3

**or order toll free: 1-800-387-4966**

Monday-Friday 8:00 a.m. - 6:00 p.m. EST,  
for credit card holder orders only

## Reporting safety defects

### REPORTING SAFETY DEFECTS (U.S. ONLY)

If you believe that your vehicle has a defect that could cause a crash, or could cause injury or death, you should immediately inform the National Highway Traffic Safety Administration (NHTSA) in addition to notifying Ford Motor Company.



If NHTSA receives similar complaints, it may open an investigation, and if it finds that a safety defect exists in a group of vehicles, it may order a recall and remedy campaign. However, NHTSA cannot become involved in individual problems between you, your dealer or Ford Motor Company.

To contact NHTSA, you may either call the Auto Safety Hotline toll-free at 1-800-424-9393 (202-366-0123 in the Washington D.C. area) or write to:

NHTSA  
U.S. Department of Transportation  
400 Seventh Street  
Washington D.C. 20590

You can also obtain other information about motor vehicle safety from the Hotline.

- Air bag supplemental restraint system .....101
  - and child safety seats .....102
  - description .....101
  - disposal .....105
  - indicator light .....104
  - passenger air bag .....103
- Air conditioning
  - automatic temperature control system .....27,28,29,30,32
- Air suspension .....122
- Anti-theft system .....87
- Automatic transmission
  - driving an automatic overdrive .....124,125,126
- Axle
  - refill capacities .....187
- Brakes .....117
  - anti-lock .....117,118
  - anti-lock brake system (ABS) warning light .....118
  - fluid, checking and adding ....153
  - shift interlock .....123
- Break-in period .....2
- CD changer .....61,63,64,65
- Child safety seats
  - attaching with tether straps ..111
  - in rear seat .....108,110
  - tether anchorage hardware ...111
- Cleaning your vehicle .....182
  - engine compartment .....184
  - exterior .....183,186
  - exterior lamps .....185
  - interior .....186
  - plastic parts .....185
  - washing .....183
  - waxing .....183
  - wheels .....184
  - windows .....186
  - wiper blades .....185
- Clock .....33
- Compass, electronic .....76
  - calibration .....77
  - set zone adjustment .....77
- Controls .....72,73,74,75
  - power seat .....93,94
- Coolant .....156
  - checking and adding .....155
  - refill capacities .....156
- Customer Assistance
  - Ford accessories for your vehicle .....199,200,201
  - Ford Extended Service Plan .193
  - Getting assistance outside the U.S. and Canada .....198
  - Getting roadside assistance ...192
  - Getting the service you need .....194
  - Ordering additional owner's literature .....203
  - The Dispute Settlement Board .....195,196,197,198
- Defrost
  - rear window .....24
- Emission control system .....176
- Engine
  - check engine/ service engine soon light .....7
  - coolant .....154
  - idle speed control .....162
  - service points .....150
  - starting after a collision .....132
- Engine block heater .....115
- Engine oil
  - checking and adding .....152
  - dipstick .....151
  - specifications .....151,152
- Exhaust fumes .....116
- Fail safe cooling .....157,158
- Floor mats .....81
- Fuel
  - choosing the right fuel .....171
  - comparisons with EPA fuel economy estimates .....176

# Index

- detergent in fuel .....173
- filling your vehicle
  - with fuel .....169,171
  - quality .....172
  - running out of fuel .....173
  - safety information relating to automotive fuels .....169
- Fuses .....133,134
- Gas mileage (see Fuel economy) .....173,174,175,176
- Gauges .....11,12
  - battery voltage gauge .....16
  - engine coolant temperature gauge .....15
  - engine oil pressure gauge .....16
  - fuel gauge .....12
  - odometer .....14
  - speedometer .....13
  - trip odometer .....14
- Hazard flashers .....132
- Head restraints .....91,92
- Headlamps
  - aiming .....182
  - bulb specifications .....182
  - high beam .....9,23
- Heating .....25
  - heating and air conditioning system .....25,27
- Hood .....149
- Ignition .....189
- Inspection/maintenance (I/M) testing .....178
- Instrument panel .....6
  - cleaning .....185
- Keyless entry system
  - keypad .....88
  - programming
    - entry code .....88,89,90
- Keys
  - positions of the ignition .....67
- Lamps
  - autolamp system .....24
  - daytime running light .....24
  - headlamps .....23
  - headlamps, flash to pass .....23
  - instrument panel, dimming .....23
  - interior lamps .....181
  - replacing bulbs ..178,179,180,181
- Lane change indicator (see Turn signal) .....66
- Lights, warning and indicator .....6
  - air bag .....8
  - air suspension .....10
  - anti-lock brakes (ABS) .....8,22
  - brake .....8,22
  - charging system .....9
  - low coolant .....9
  - low fuel .....6
  - oil pressure .....9
  - overdrive off .....10
  - safety belt .....8
  - speed control .....72
  - traction control active .....10,21
  - turn signal indicator .....9
- Locks
  - childproof .....81
- Lumbar support, seats .....95
- Message center .....16
  - reset button .....17
  - select button .....17
- Mirrors
  - automatic dimming
    - rearview mirror .....76
    - side view mirrors (power) .....80
- Motorcraft parts .....173
- Octane rating .....172
- Overdrive .....68
- Parking brake .....118
- Power distribution box (see Fuses) .....136
- Power door locks .....80,83
- Power steering .....121,122
  - fluid, checking and adding ....159

- Radio ....34,35,36,37,38,39,40,41,42  
43,44,45,46,47,48,49,50,51  
52,53,54,55,56,57,58,59,60
- Relays .....133,138
- Remote entry system .....81,84
  - illuminated entry .....85
  - locking/unlocking doors .....82
  - replacement/additional  
transmitters .....86
  - replacing the batteries .....85
- Safety Compliance
  - Certification Label .....191
  - Safety defects, reporting .....204
  - Safety restraints .....95,96,97,98
    - cleaning the safety belts .100,186
    - extension assembly .....99
    - for children .....105
    - lap belt .....98
    - warning light and chime ...99,100
  - Seat belts  
(see Safety restraints) .....95
  - Seats .....91
    - child safety seats .....106,107
    - cleaning .....186
  - Servicing your vehicle .....148
  - Spark plugs, specifications .....187
  - Special notice .....3
  - Specification chart, lubricants .188
  - Speed control .....68
  - Starting your vehicle .....112,114
    - jump starting .....142,143,145
    - preparing to start your  
vehicle .....86
  - Steering wheel
    - tilting .....67
- Tires .....165,166
  - changing .....138,139
  - checking the pressure .....166
  - replacing .....168
  - rotating .....166
  - snow tires and chains .....169
  - tire grades .....166
  - treadwear .....165
- Towing .....128,129,130
  - wrecker .....147
- Traction control .....120
- Traction-lok rear axle .....126
- Transmission .....123
  - fluid, checking and adding  
(automatic) .....159,160,161
- Trunk .....84
  - remote release .....78
- Vehicle dimensions .....189
- Vehicle Identification Number  
(VIN) .....191
- Vehicle loading .....126
- Ventilating your vehicle .....116
- Warning chimes .....11,21
- Washer fluid .....154
- Water, Driving through .....130
- Wheels
  - anti-theft lug nuts .....141,142
- Windows .....78,79
- Windshield washer fluid and  
wipers
  - checking and cleaning .....164
  - operation .....66
  - replacing wiper blades .....164

## Filling station information

Recommended fuel	Unleaded fuel only - 87 octane
Fuel tank capacity	71.9L (19.0 gallons)
Engine oil capacity (includes filter change)	4.7L (5.0 quarts). Use Motorcraft 5W30 Super Premium Motor Oil, Ford specification WSS-M2C153-G.
Tire pressure and size	Refer to the Certification Label located on the driver's door.
Hood release	Pull handle under the left side of the instrument panel.
Coolant capacity <sup>1</sup>	15.0L (15.8 quarts)
Automatic transmission fluid capacity	13.1L (13.9 quarts). Use Motorcraft MERCON®V ATF.
Power steering fluid capacity <sup>2</sup>	Fill to line on reservoir. Use Motorcraft MERCON® ATF.

<sup>1</sup> Use Ford Premium Engine Coolant (green in color). DO NOT USE Ford Extended Life Engine Coolant (orange in color). Refer to *Adding engine coolant*, in the *Maintenance and Care* chapter.

<sup>2</sup> Ensure correct automatic transmission fluid is used for a specific application. Check the container to verify the fluid is MERCON® and/or MERCON® V approved. Some fluids have been approved as meeting both MERCON® and MERCON® V requirements and will be labeled as such. Fluids labeled as meeting only MERCON® or only MERCON® V requirements must not be used interchangeably. DO NOT mix MERCON® and MERCON® V. Transmission fluid requirements are indicated on the dipstick or on the dipstick handle. Refer to your Scheduled Maintenance Guide to determine the correct service interval.