

# Contents

## Before driving

Introduction	2
Instrumentation	3
Controls and features	17
Seating and safety restraints	47

## Starting and driving

Starting	80
Driving	87
Roadside emergencies	104

## Servicing

Maintenance and care	123
Capacities and specifications	180
Reporting safety defects	187
Index	188

All rights reserved. Reproduction by any means, electronic or mechanical including photocopying, recording or by any information storage and retrieval system or translation in whole or part is not permitted without written authorization from Ford Motor Company.

# Introduction

## ICONS

Indicates a warning. Read the following section on *Warnings* for a full explanation.



Indicates vehicle information related to recycling and other environmental concerns will follow.



Correct vehicle usage and the authorized disposal of waste cleaning and lubrication materials are significant steps towards protecting the environment.

## WARNINGS

Warnings provide information which may reduce the risk of personal injury and prevent possible damage to others, your vehicle and its equipment.

## BREAKING-IN YOUR VEHICLE

There are no particular breaking-in rules for your vehicle. During the first 1 600 km (1 000 miles) of driving, vary speeds frequently. This is necessary to give the moving parts a chance to break in.

If possible, you should avoid full use of the brakes for the first 1 600 km (1 000 miles).

## INFORMATION ABOUT THIS GUIDE

The information found in this guide was in effect at the time of printing. Ford may change the contents without notice and without incurring obligation.



# Instrumentation

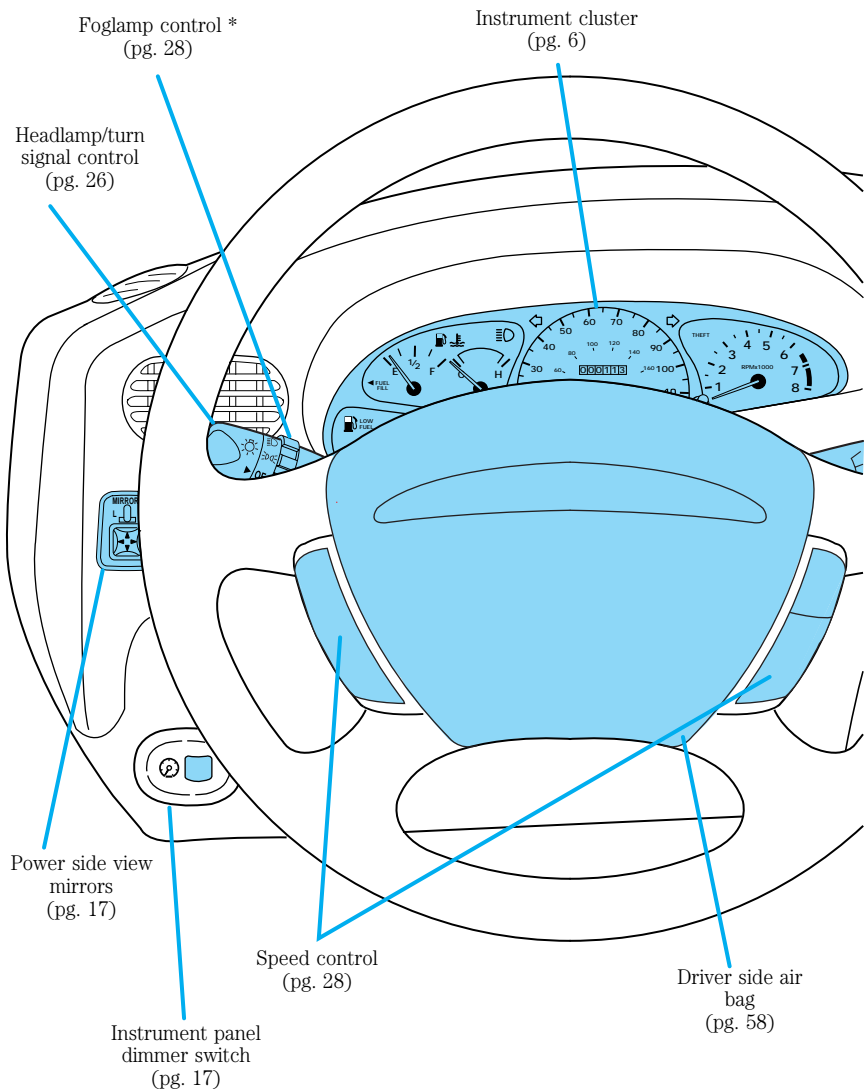

# Instrumentation

Passenger side air bag  
(pg. 58)

Windshield wiper/washer  
control  
(pg. 34)

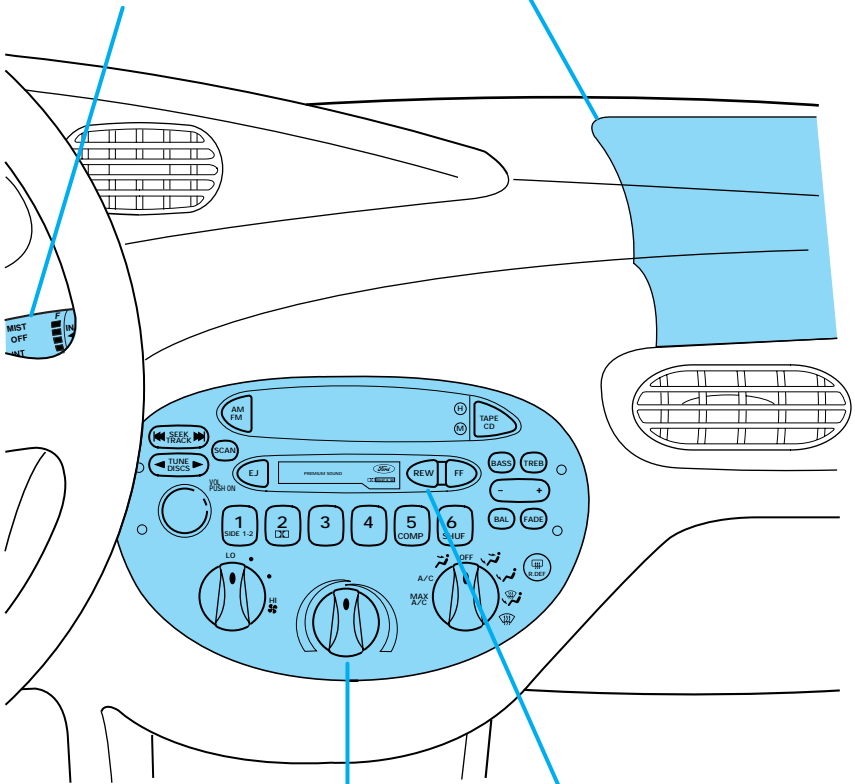

Climate controls  
(pg. 18)

Electronic sound  
system; refer to  
Audio Guide  
(pg. 18)

# Instrumentation

## WARNING LIGHTS AND CHIMES

### Base instrument cluster

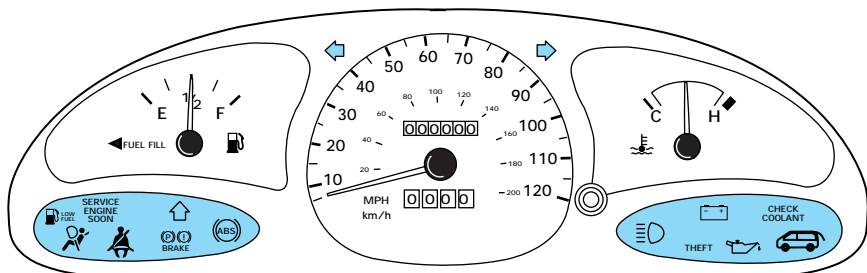

### Sport instrument cluster

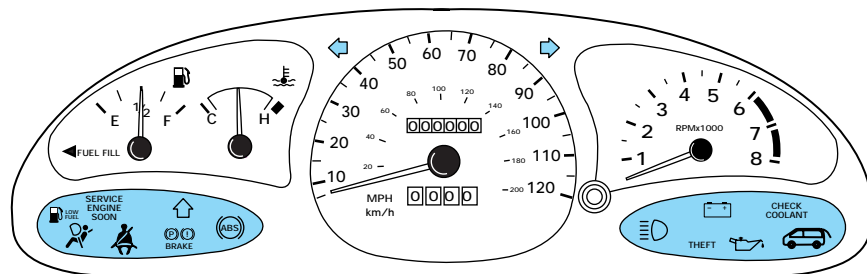

## ZX2 coupe instrument cluster

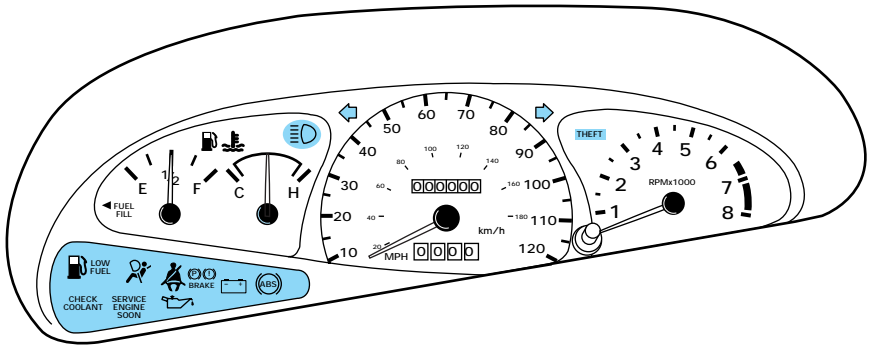

### Low fuel

Illuminates when the fuel tank has approximately eight liters (two gallons) remaining. The lamp will also illuminate when the ignition key is turned to ON and the engine is off.



### Service engine soon

Your vehicle is equipped with a computer that monitors the engine's emission control system. This system is commonly known as the On Board Diagnostics System (OBD II). This OBD II system protects the environment by ensuring that your vehicle continues to meet government emission standards. The OBD II system also assists the service technician in properly servicing your vehicle.



The *Service Engine Soon* indicator light illuminates when the ignition is first turned to the ON

## Instrumentation

position to check the bulb. If it comes on after the engine is started, one of the engine's emission control systems may be malfunctioning. The light may illuminate without a driveability concern being noted. The vehicle will usually be drivable and will not require towing.

### ***What you should do if the Service Engine Soon light illuminates***

#### **Light turns on solid:**

This means that the OBD II system has detected a malfunction.

Temporary malfunctions may cause your *Service Engine Soon* light to illuminate. Examples are:

1. The vehicle has run out of fuel. (The engine may misfire or run poorly.)
2. Poor fuel quality or water in the fuel.
3. The fuel cap may not have been properly installed and securely tightened.

These temporary malfunctions can be corrected by filling the fuel tank with good quality fuel and/or properly installing and securely tightening the gas cap. After three driving cycles without these or any other temporary malfunctions present, the *Service Engine Soon* light should turn off. (A driving cycle consists of a cold engine startup followed by mixed city/highway driving.) No



additional vehicle service is required.

If the *Service Engine Soon* light remains on, have your vehicle serviced at the first available opportunity.

### **Light is blinking:**

Engine misfire is occurring which could damage your catalytic converter. You should drive in a moderate fashion (avoid heavy acceleration and deceleration) and have your vehicle serviced at the first available opportunity.



Under engine misfire conditions, excessive exhaust temperatures could damage the catalytic converter, the fuel system, interior floor coverings or other vehicle components, possibly causing a fire.

### **Air bag readiness**

Momentarily illuminates when the ignition is turned ON. If the light fails to illuminate, continues to flash or remains on, have the system serviced immediately.



### **Safety belt**

Momentarily illuminates when the ignition is turned ON to remind you to fasten your safety belts. For more information, refer to the *Seating and safety restraints* chapter.



## Instrumentation

### Brake system warning

Momentarily illuminates when the ignition is turned ON and the engine is off. Also illuminates when the parking brake is engaged. Illumination after releasing the parking brake indicates low brake fluid level.



### Anti-lock brake system (ABS) (If equipped)

Momentarily illuminates when the ignition is turned on and the engine is off. If the light remains on or continues to flash, the ABS needs to be serviced.



### Turn signal

Illuminates when the left or right turn signal or the hazard lights are turned on. If one or both of the indicators stay on continuously or flash faster, check for a burned-out turn signal bulb. Refer to *Exterior bulbs* in the *Maintenance and care* chapter.

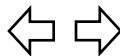

### High beams

Illuminates when the high beam headlamps are turned on.



### Anti-theft system (if equipped)

Refer to *Anti-theft system* in the *Controls and features* chapter.

THEFT

### Charging system

Momentarily illuminates when the ignition is turned ON and the engine is off. The light also illuminates when the battery is not charging properly, requiring electrical system service.

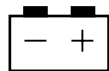

### Engine oil pressure

Illuminates when the oil pressure falls below the normal range. Switch off the engine immediately. Check the oil level and add oil if needed. Refer to *Engine oil* in the *Maintenance and Care* chapter.

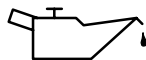

This lamp also illuminates when the ignition is turned to ON and the engine is off.

### Check coolant

Illuminates when the coolant level in the coolant reservoir is low and more needs to be added. This lamp will also illuminate when the ignition is turned to ON and the engine is off. For more information on adding engine coolant, refer to *Engine coolant* in the *Maintenance and care* chapter.

**CHECK  
COOLANT**

### Liftgate ajar (if equipped)

Illuminates when the ignition is in the ON position and the liftgate is open.

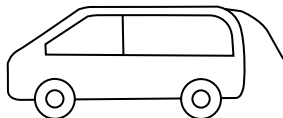

### Safety belt warning chime

Chimes to remind you to fasten your safety belts.

## Instrumentation

For information on the safety belt warning chime, refer to the *Seating and safety restraints* chapter.

### **Supplemental restraint system (SRS) warning chime**

For information on the SRS warning chime, refer to the *Seating and safety restraints* chapter.

### **Key-in-ignition warning chime**

Sounds when the key is left in the ignition in the OFF/LOCK or ACC position and either front door is opened.

### **Headlamps on warning chime**

Sounds when the headlamps or parking lamps are on, the ignition is off (and the key is not in the ignition) and either front door is opened.

# Instrumentation

## GAUGES

### Base instrument cluster gauges

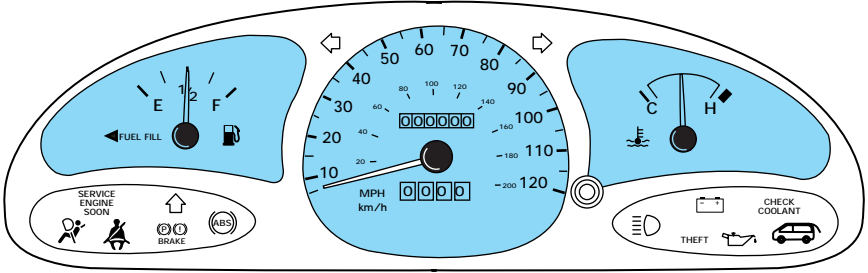

### Sport instrument cluster gauges

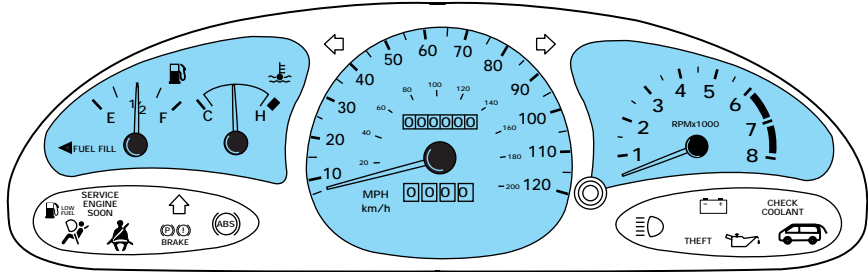

### ZX2 coupe instrument cluster gauges

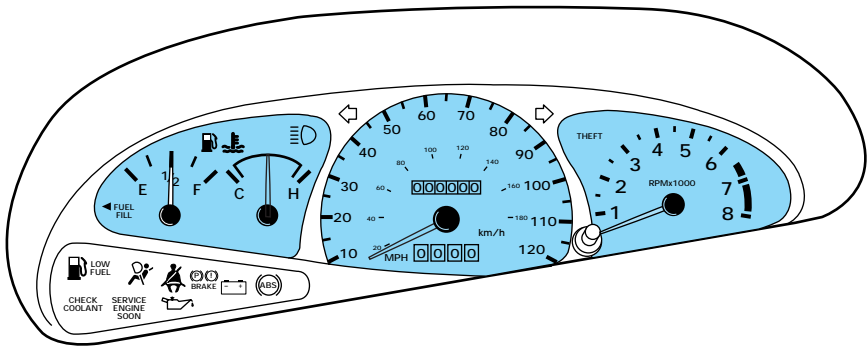

## Instrumentation

### Fuel gauge

Displays approximately how much fuel is in the fuel tank (when the key is in the ON position). The fuel gauge may vary slightly when the vehicle is in motion. The ignition should be in the OFF position while the vehicle is being refueled. When the gauge first indicates empty, there is a small amount of reserve fuel in the tank. When refueling the vehicle from empty indication, the amount of fuel that can be added will be less than the advertised capacity due to the reserve fuel.

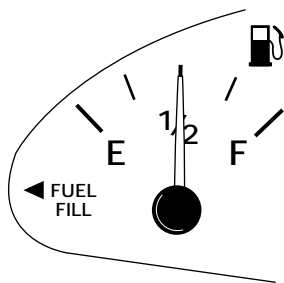

### Engine coolant temperature gauge

Indicates the temperature of the engine coolant. At normal operating temperature, the needle remains within the normal area (the area between the “H” and “C”). If it enters the red section, the engine is overheating. Stop the vehicle, switch off the ignition and let the engine cool. Refer to *Engine coolant* in the *Maintenance and care* chapter.

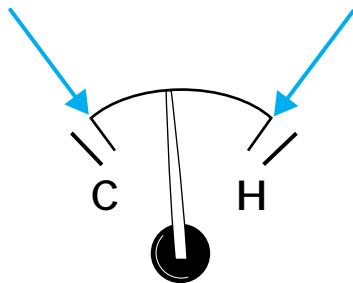

Never remove the coolant recovery cap while the engine is running or hot.

This gauge indicates the temperature of the engine coolant, not the coolant level. If the coolant is not at its proper level or mixture, the gauge indication will not be accurate.

## Speedometer

Indicates the current vehicle speed.

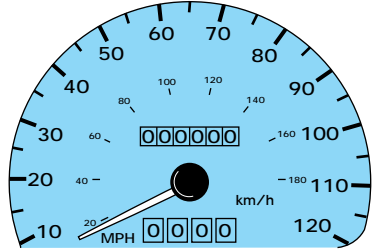

## Odometer

Registers the total kilometers (miles) of the vehicle.

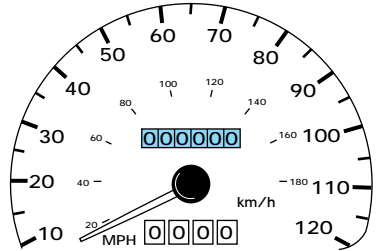

## Trip odometer

Registers the kilometers (miles) of individual journeys. To reset, depress the control.

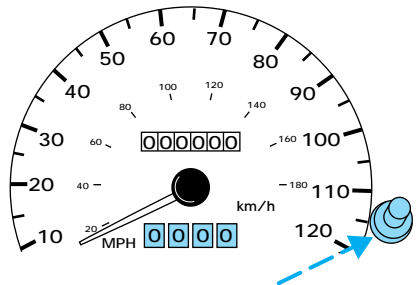

## Instrumentation

### Tachometer (if equipped)

Indicates the engine speed in revolutions per minute.

Driving with your tachometer pointer in the red zone may damage the engine.

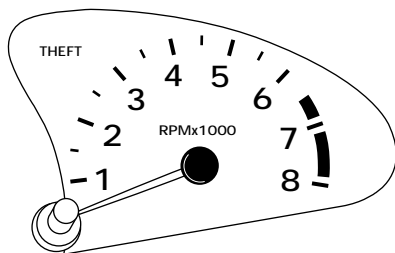



## Controls and features

### PANEL DIMMER CONTROL

Use to adjust the brightness of the instrument panel.

- Rotate left to brighten.
- Rotate right to dim.

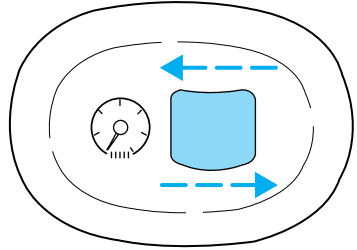

### POWER SIDE VIEW MIRRORS

To adjust your mirrors:

1. Select L to adjust the left mirror or R to adjust the right mirror.

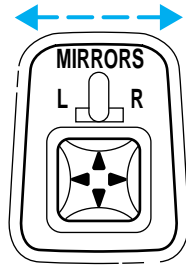

2. Move the control in the direction you wish to tilt the mirror.

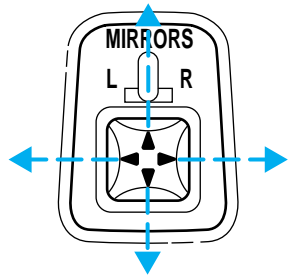

3. Return to the center position to lock mirrors in place.

The ignition key must be in ACC or ON to adjust the power side view mirrors.

# Controls and features

## AUDIO SYSTEM

Refer to the “Audio Guide” for instructions on how to operate the audio system.

## CLIMATE CONTROL SYSTEM

**Heater only system  
(if equipped)**



## Controls and features

### **Fan speed control**

Controls the volume of air circulated in the vehicle.

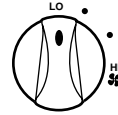

### **Temperature control knob**



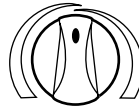

Controls the temperature of the airflow inside the vehicle. On heater-only systems, the air cannot be cooled below the outside temperature.



### **Mode selector control**

Controls the direction of the airflow to the inside of the vehicle.



-  (Vent)-Distributes outside air through the instrument panel registers.
- OFF-Outside air is shut out and the fan will not operate.
-  (Panel and floor)-Distributes outside air through the instrument panel registers and the floor ducts.
-  (Floor)-Allows for maximum heating. Distributes outside air through the floor ducts.
-  (Floor and defrost)-Distributes outside air through the floor ducts and the windshield defroster ducts.
-  -Distributes outside air through the windshield defroster

## Controls and features

ducts. It can be used to clear ice or fog from the windshield.

### **Operating tips**

- In humid weather, select  before driving. This will help to prevent your windshield from fogging. After a few minutes, select any desired position.
- To prevent humidity buildup inside the vehicle, don't drive with the climate control system in the OFF position.
- Don't put objects under the front seat that will interfere with the airflow to the back seats.
- Remove any snow, ice or leaves from the air intake area (at the bottom of the windshield under the hood).
- When placing objects on top of your instrument panel, be careful to not place them over the defroster outlets. These objects can block airflow and reduce your ability to see through your windshield. Also, avoid placing small objects on top of your instrument panel. These objects can fall down into the defroster outlets and block airflow and possibly damage your climate control system.

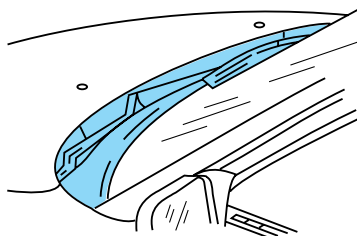

# Controls and features

## Manual heating and air conditioning system (if equipped)

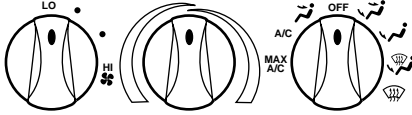

### **Fan speed control**

Controls the volume of air circulated in the vehicle.

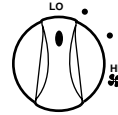

### **Temperature control knob**



Controls the temperature of the airflow inside the vehicle.

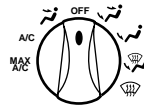

### **Mode selector control**

Controls the direction of the airflow to the inside of the vehicle.





The air conditioning compressor will operate in all modes except  and . However, the air conditioning will only function if the outside temperature is about 10°C (50°F) or above.

Since the air conditioner removes considerable moisture from the air during operation, it is normal if clear water drips on the ground under the air conditioner drain while the system is working and

## Controls and features



even after you have stopped the vehicle.

Under normal conditions, your vehicle's climate control system should be left in any position other than MAX A/C or OFF when the vehicle is parked. This allows the vehicle to "breathe" through the outside air inlet duct.

- **MAX A/C**-Uses recirculated air to cool the vehicle. MAX A/C is noisier than A/C but more economical and will cool the inside of the vehicle faster. Airflow will be from the instrument panel registers. This mode can also be used to prevent undesirable odors from entering the vehicle.
- **A/C**-Uses outside air to cool the vehicle. It is quieter than MAX A/C but not as economical. Airflow will be from the instrument panel registers.
-  (Vent)-Distributes outside air through the instrument panel registers. However, the air will not be cooled below the outside temperature because the air conditioning does not operate in this mode.
- **OFF**-Outside air is shut out and the fan will not operate. For short periods of time only, use this mode to prevent undesirable odors from entering the vehicle.
-  (Panel and floor)-Distributes outside air

## Controls and features

through the instrument panel registers and the floor ducts. Heating and air conditioning capabilities are provided in this mode. For added customer comfort, when the temperature control knob is anywhere in between the full hot and full cold positions, the air distributed through the floor ducts will be slightly warmer than the air sent to the instrument panel registers.

-  (Floor)-Allows for maximum heating by distributing outside air through the floor ducts. However, the air will not be cooled below the outside temperature because the air conditioning does not operate in this mode.
-  (Floor and defrost)-Distributes outside air through the windshield defroster ducts and the floor ducts. Heating and air conditioning capabilities are provided in this mode. For added customer comfort, when the temperature control knob is anywhere in between the full hot and full cold positions, the air distributed through the floor ducts will be slightly warmer than the air sent to the instrument panel registers. If the temperature is about 10°C (50°F) or higher, the air conditioner will automatically dehumidify the air to prevent fogging.

## Controls and features

-  -Distributes outside air through the windshield defroster ducts. It can be used to clear ice or fog from the windshield. If the temperature is about 10°C (50°F) or higher, the air conditioner will automatically dehumidify the air to prevent fogging.

### **Operating tips**

- In humid weather, select  before driving. This will prevent your windshield from fogging. After a few minutes, select any desired position.
- To prevent humidity buildup inside the vehicle, don't drive with the climate control system in the OFF position.
- Don't put objects under the front seat that will interfere with the airflow to the back seats.
- Remove any snow, ice or leaves from the air intake area (at the bottom of the windshield under the hood).
- If your vehicle has been parked with the windows closed during hot weather, the air conditioner will do a much faster job of cooling if you drive for two or three minutes with the windows open. This will force most of the hot, stale air out of the vehicle.

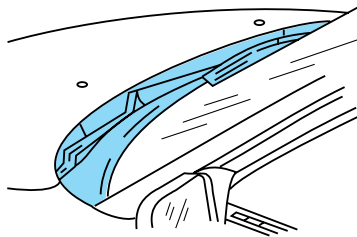



## Controls and features

Then operate your air conditioner as you would normally.

- When placing objects on top of your instrument panel, be careful to not place them over the defroster outlets. These objects can block airflow and reduce your ability to see through your windshield. Also, avoid placing small objects on top of your instrument panel. These objects can fall down into the defroster outlets and block airflow and possibly damage your climate control system.

### REAR WINDOW DEFROSTER

Clears the rear window of thin ice and fog. To operate:

1. Turn the ignition to the ON position.
2. Press and release the control once to turn on. The light will be lit while the rear window defroster is on.
3. Press and release the control again to turn off.

The defroster will automatically turn off after fifteen minutes.

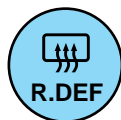

## Controls and features

### POSITIONS OF THE IGNITION

1. LOCK, locks the steering wheel, gearshift lever (automatic transaxle only) and allows key removal. On vehicles with a manual transaxle push the key in while turning to lock.

2. ACCESSORY, allows the electrical accessories such as the radio to operate while the engine is not running.

3. ON, all electrical circuits operational. Warning lights illuminated. Key position when driving.

4. START, cranks the engine. Release the key as soon as the engine starts.

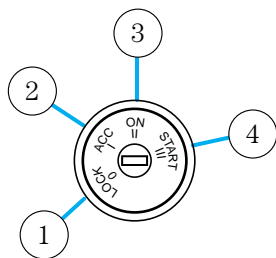

### HEADLAMP CONTROL

Rotate the headlamp control clockwise to the first position to turn on the parking lamps only. Rotate to the second position to also turn on the headlamps.

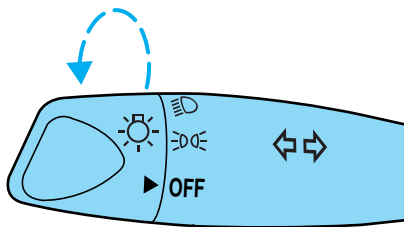

### Daytime running lamps (DRL) (if equipped)

Turns the highbeam headlamps on with a reduced output. To activate:

- the engine must be running
- the gearshift must not be in P (Park)
- the headlamp control is in the OFF or Parking lamps position.

## Controls and features

 The Daytime Running Light (DRL) system will not illuminate the tail lamps and parking lamps. Turn on your headlamps at dusk. Failure to do so may result in a collision.

### High beams

Push forward to activate.

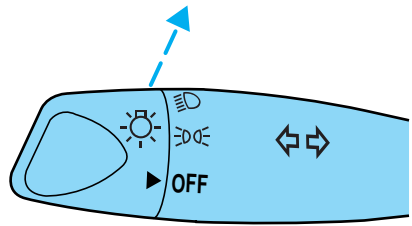

### Flash to pass

Pull toward you to activate and release to deactivate.

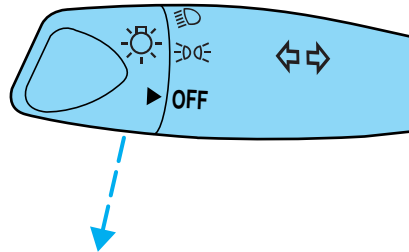

### TURN SIGNAL CONTROL

- Push down to activate the left turn signal.
- Push up to activate the right turn signal.

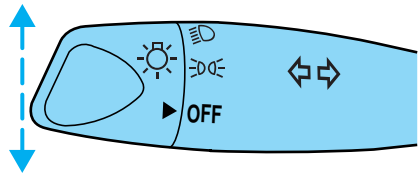

# Controls and features

## FOGLAMPS (IF EQUIPPED)

Rotate forward to activate.

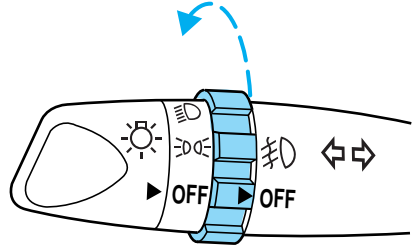

## SPEED CONTROL (IF EQUIPPED)

### To turn speed control on

- Press ON.

Vehicle speed cannot be controlled until the vehicle is traveling at or above 48 km/h (30 mph).

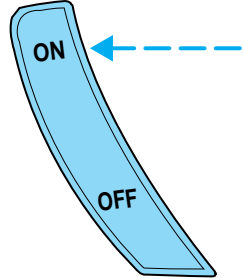

Do not use the speed control in heavy traffic or on roads that are winding, slippery, or unpaved.



Do not shift the gearshift lever into N (Neutral) with the speed control on.

## Controls and features

### To turn speed control off

- Press OFF or
- Turn off the vehicle ignition.

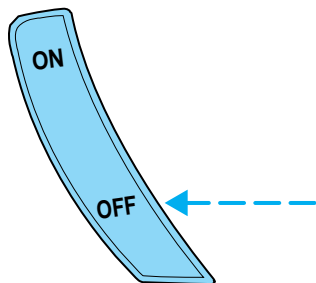

Once speed control is switched off, the previously programmed set speed will be erased.

### To set a speed

- Press SET ACC/SET ACCEL.  
For speed control to operate, the speed control must be ON and the vehicle speed must be greater than 48 km/h (30 mph).

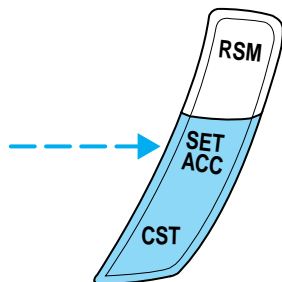

If you drive up or down a steep hill, your vehicle speed may vary momentarily slower or faster than the set speed. This is normal.

Speed control cannot reduce the vehicle speed if it increases above the set speed on a downhill. If your vehicle speed is faster than the set speed while driving on a downhill, you may want to shift to the next lower gear or apply the brakes to reduce your vehicle speed.

## Controls and features

If your vehicle slows down more than 16 km/h (10 mph) below your set speed on an uphill, your speed control will disengage. This is normal. Pressing RES/RSM/RESUME will re-engage it.



Do not use the speed control in heavy traffic or on roads that are winding, slippery, or unpaved.

### To set a higher set speed

- Press and hold SET ACC/SET ACCEL. Release the control when the desired vehicle speed is reached or
- Press and release SET ACC/SET ACCEL. Each press will increase the set speed by 1.6 km/h (1 mph) or
- Accelerate with your accelerator pedal, then press and release SET ACC/SET ACCEL.

You can accelerate with the accelerator pedal at any time during speed control usage. Releasing the accelerator pedal will return your vehicle to the previously programmed set speed.

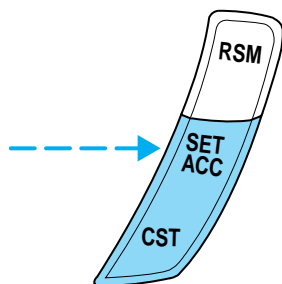

## Controls and features

### To set a lower set speed

- Press and hold CST/COAST. Release the control when the desired speed is reached or
- Press and release CST/COAST. Each press will decrease the set speed by 1.6 km/h (1 mph) or
- Depress the brake pedal. When the desired vehicle speed is reached, press SET ACC/SET ACCEL.

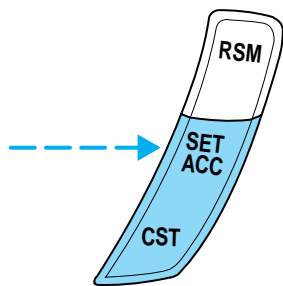
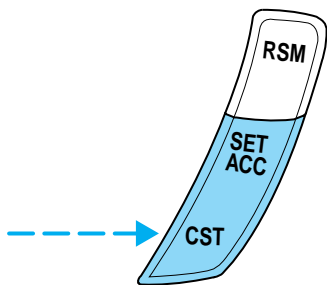

## Controls and features

### To disengage speed control

- Depress the brake pedal or

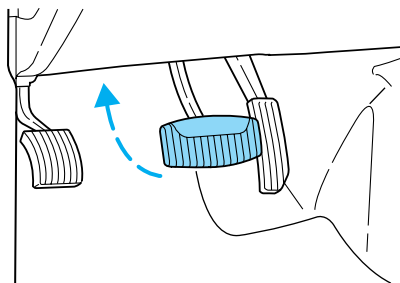

- Depress the clutch pedal (if equipped)

Disengaging the speed control will not erase the previously programmed set speed.

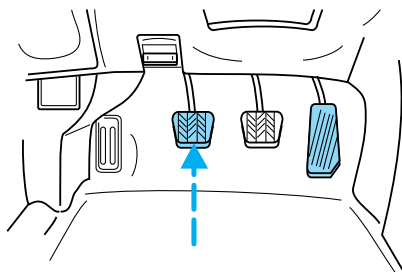

Pressing OFF will erase the previously programmed set speed.

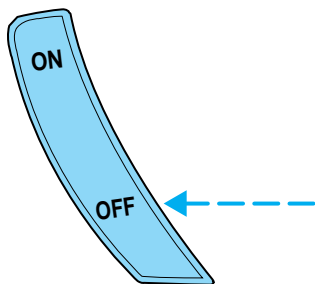



## Controls and features

### To return to a previously set speed

- Press RES/RSM/RESUME. For RES/RSM/RESUME to operate, the vehicle speed must be faster than 48 km/h (30 mph).

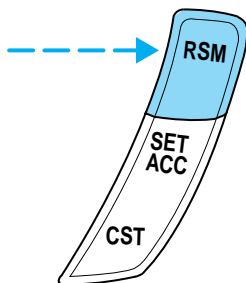

### TILT STEERING (IF EQUIPPED)

Pull the tilt steering control down to move the steering wheel up or down. Hold the control while adjusting the wheel to the desired position, then push the control back up to lock the steering wheel in position.

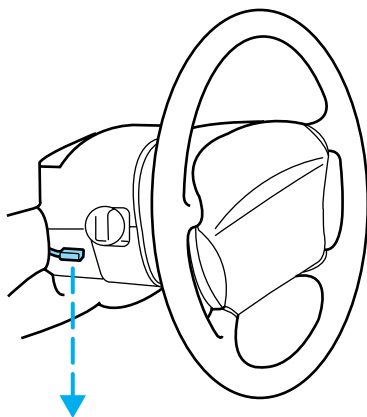

Never adjust the steering wheel when the vehicle is moving.

### HAZARD FLASHER

For information on the hazard flasher control, refer to *Hazard lights control* in the *Roadside emergencies* chapter.

## Controls and features

### WINDSHIELD WIPER AND WASHER

- For intermittent wiping, move the control down one position and rotate the wiper switch to the desired position.

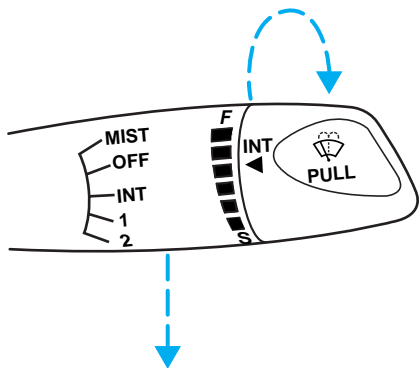

- For low speed wiping, move the control down two positions.
- For high speed wiping, move the control down three positions.

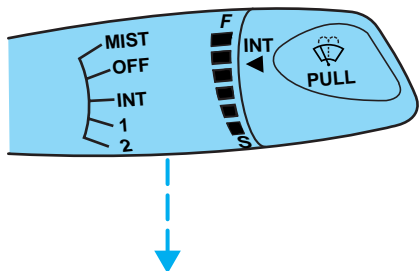

- For mist wiping, move the control up one position.
- To spray the washer fluid, pull the wiper control toward you.

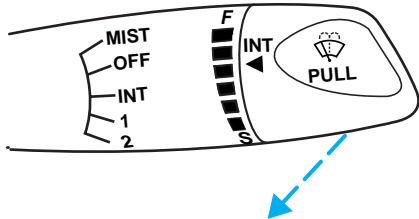



## Controls and features

### Rear window wiper/washer controls (if equipped)

For rear wiper operation, rotate the rear wiper and washer control to the desired position.

- To turn rear wipers on, rotate the rear wiper/washer control upward to the ON position.
- To turn rear wipers off, rotate the rear wiper/washer control downward to the OFF position.

For rear washer fluid operation, rotate the rear wiper/washer control to the desired position.

- To turn rear washers on, rotate the rear wiper/washer control upward to the  position for your desired length of washer time.
- To turn rear washers on briefly (for quick cleaning), rotate the wiper/washer control downward to the  position and release.

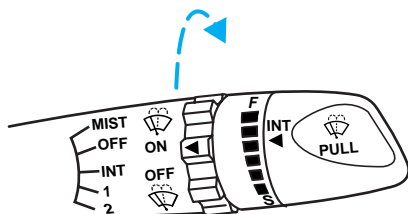

### MOON ROOF (IF EQUIPPED)

- Press OPEN to raise the moon roof to the vent position.
- Press OPEN again to fully open the moon roof.
- Press the opposite end of the toggle control to close the moon roof from either position.

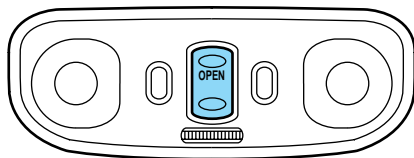

### Sliding shade

The moon roof has a sliding shade that you can open or close when the moon roof is closed.

## Controls and features

### INTERIOR LAMPS

#### Dome lamp (if equipped)

The dome lamp is located overhead between the driver and passenger seats.

The dome lamp will stay on if the control is moved to the ON position. When the control is moved to the DOOR position, the lamp will only come on if a door is opened. If the control is moved to the OFF position, the lamp will not come on at all.

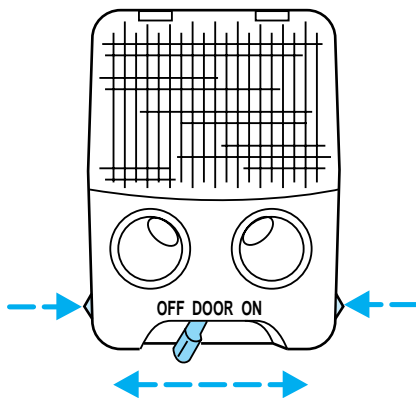

#### Map lamps (if equipped)

The map lamps and controls are located on the dome lamp. Press the controls on either side of the dome lamp to activate the map lamps.

If equipped with a moon roof, the map lamps are located on the moon roof control panel. Press the control next to the map lamp to illuminate the lamp.

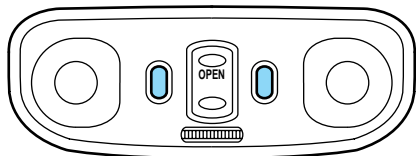

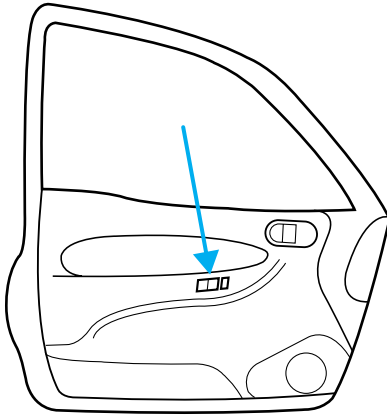

### **POWER WINDOWS (IF EQUIPPED)**

Press and hold the rocker switches to open and close windows.

- Press the top portion of the rocker switch to close.

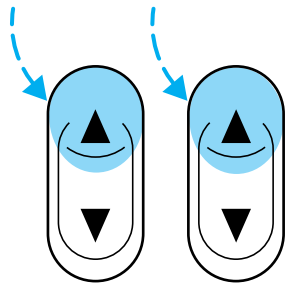

## Controls and features

- Press the bottom portion of the rocker switch to open.

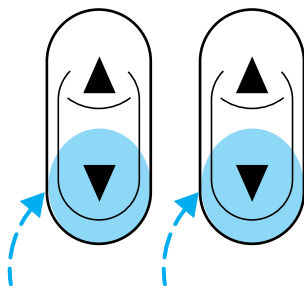

### Express down

To make the driver window open fully without holding the window control, press the driver window control completely down and release quickly. Depress again to stop window operation.

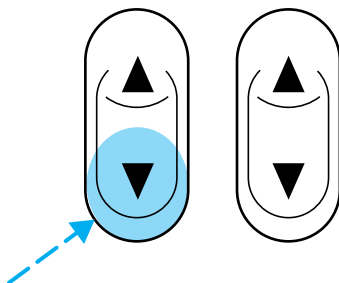

### POSITIVE RETENTION FLOOR MAT

Position the floor mat so that the eyelet is over the pointed end of the retention post and rotate forward to lock in. Make sure that the mat does not interfere with the operation of the accelerator or the brake pedal. To remove the floor mat, reverse the installation procedure.

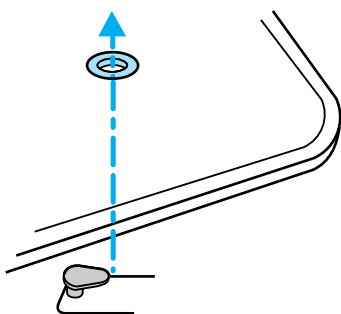

### FUEL PUMP SHUT-OFF SWITCH

Refer to the *Roadside emergencies* chapter for instructions on how to operate the fuel pump shut-off switch.

### CARGO COVER (IF EQUIPPED)

Your vehicle may be equipped with a cargo area shade that covers the luggage compartment of your vehicle.

To install the shade:

1. Fasten the cover into the mounting brackets (make sure the cover is right side up).
2. Pull the end of the shade toward you and hook the sides into the notches in the rear trim panels.

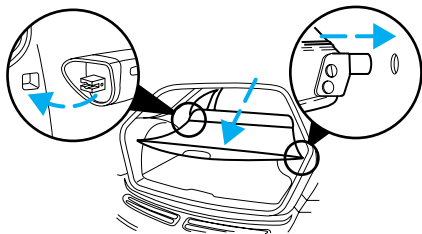

To prevent the possibility of injuries, the fasteners for the cargo area cover must be properly attached to the mounting clips on the rear trim panels.



Do not place any objects on the cargo area cover. They may obstruct your vision or strike occupants of the vehicle in the case of a sudden stop or collision.

### REMOTE ENTRY SYSTEM

Your vehicle may have an all-door remote entry system or a driver's door only remote entry system.

## Controls and features

The all-door remote entry system allows you to:

- lock or unlock all vehicle doors without a key.
- arm and disarm the anti-theft system. (For more information on the anti-theft system, refer to *Anti-theft system* in this chapter.)
- open the trunk.
- activate the panic alarm.

The driver's door only entry system allows you to:

- lock the driver's door and liftgate (wagons)
- unlock the driver's door only without a key.
- activate the panic alarm.
- open the trunk or unlock liftgate (wagons).

The remote entry features only operate with the ignition in the OFF position.

### Unlocking the doors

Press this control to unlock the driver's door. The interior lamps will illuminate.

With the all-door remote entry system, press the control a second time within five seconds to unlock all doors (on wagons, this will not unlock the liftgate).

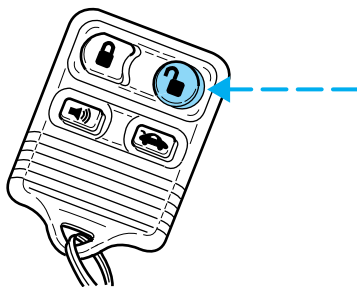



### Locking the doors

Press this control to lock all doors (and liftgate on wagons). On vehicles equipped with the driver's door only remote entry system, only the driver's door will lock.

To confirm doors are closed and locked, press the lock control a second time within five seconds. The door(s) will lock again, the horn will chirp once and the lamps will flash.

If any of the doors are open or ajar, the horn will make two quick chirps, reminding you to properly close the doors.

This process will also arm your anti-theft system (if equipped). For more information on arming the anti-theft system, refer to *Anti-theft system* in this chapter.

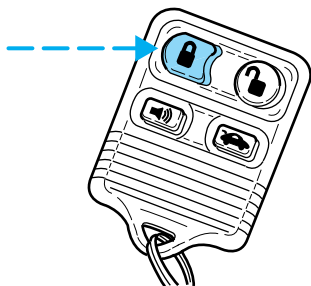

### Opening the trunk

Press the control once to open the trunk. On wagons, pressing the control will unlock (but not open) the liftgate.

Be certain the trunk is closed before driving your vehicle. The trunk may appear closed, but it may not be latched. Failure to do so may cause objects to fall out of the trunk or block rear view vision.

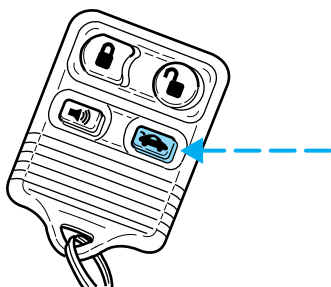

## Controls and features

### Sounding a panic alarm

Press this control to activate the alarm.

To deactivate the alarm, press the control again or turn the ignition to ACC or ON.

This device complies with part 15 of the FCC rules and with RS-210 of Industry Canada. Operation is subject to the following two conditions: (1) This device may not cause harmful interference, and (2) This device must accept any interference received, including interference that may cause undesired operation.

**Changes or modifications not expressly approved by the party responsible for compliance could void the user's authority to operate the equipment.**

### Replacing the batteries

The transmitter is powered by two coin type three-volt lithium batteries. Typical operating range will allow you to be up to 10 meters (33 feet) away from your vehicle. A decrease in operating range can be caused by:

- battery failure
- weather conditions
- nearby radio towers
- structures around the vehicle
- other vehicles parked next to the vehicle

To replace the batteries:

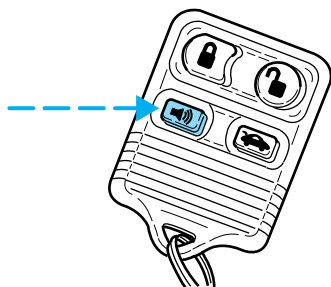

## Controls and features

1. Twist a thin coin between the two halves of the transmitter. **DO NOT TAKE THE FRONT PART OF THE TRANSMITTER APART.**
2. Place the positive (+) side of new batteries down. Refer to the diagram inside the transmitter unit.
3. Snap the two halves back together.

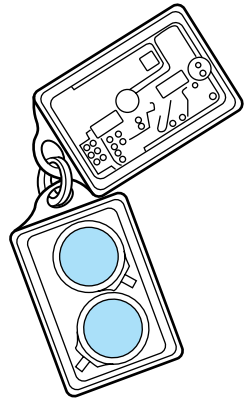

### Replacing lost transmitters

Take all your vehicle's transmitters to your dealer for reprogramming if:

- a transmitter is lost or
- you want to purchase additional transmitters (up to four may be programmed).

To reprogram the transmitters, place the key in the ignition and switch from OFF to ON eight times in rapid succession (within 10 seconds). After doors lock/unlock, press any button on all transmitters (up to four). With each button press of the transmitters, the door should cycle (lock/unlock) to confirm programming. When completed, switch the ignition to OFF. The door locks should cycle (lock/unlock) one last time to confirm completion of programming.

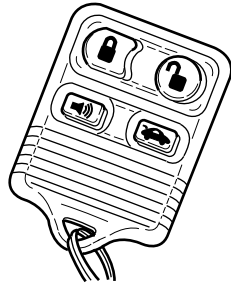

## Controls and features

All transmitters must be programmed at the same time.

### Illuminated entry

Interior lamps will illuminate when UNLOCK is pressed. The lamps will illuminate for approximately 20 seconds or until the key is inserted in the ignition and turned to ON or until LOCK is pressed. The dome lamp must be set to the DOOR position in order for the illuminated entry system to operate.

### ANTI-THEFT SYSTEM (IF EQUIPPED)

When armed, the anti-theft system will help protect your vehicle from unauthorized entry.

### Arming the anti-theft system

Turn the ignition to OFF and press the lock control on the remote entry transmitter.

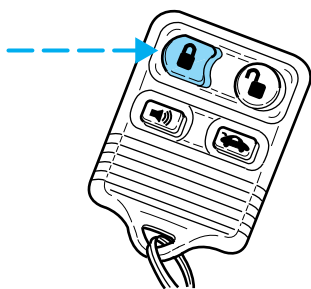

### Identifying an armed system

While the system is arming, the THEFT light in the instrument cluster will illuminate for 30 seconds. After 30 seconds, THEFT will flash, indicating the system is armed.

## Controls and features

If the system is arming with the doors open, the THEFT light will stay illuminated until all the doors are closed and then illuminate for 30 seconds and begin flashing.

When an unauthorized entry occurs, the activated system will:

- flash the parking lamps and the THEFT light
- sound the horn

The flashing parklamps and the honking horn automatically shut off after about three minutes and will remain off unless another unauthorized entry is attempted.

### Disarming the anti-theft system

#### ***Disarming an untriggered anti-theft system***

Press the unlock control to disarm the untriggered system. If the driver armed the system but did not exit the vehicle, disarm the system by inserting the key and turning the ignition to ON/ACC.

Using the ignition key to unlock doors/trunk/liftgate will not disarm the anti-theft system.

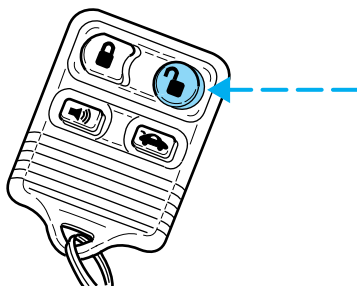

## Controls and features

### ***Disarming a triggered anti-theft system***

Press either the unlock or panic control to disarm the system.

A triggered system may also be disarmed by inserting the key and turning the ignition to ACC or ON.

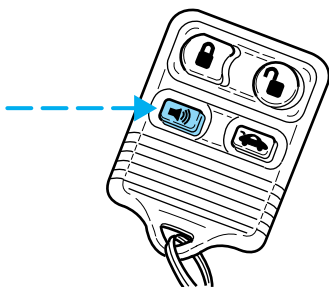

# Seating and safety restraints

## SEATING

### Adjustable head restraints (if equipped)

The head restraints can be moved up and down.

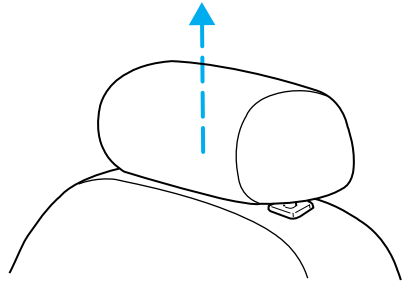

Push control to lower head restraint.

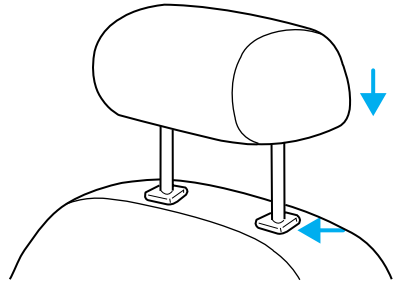

## Front seats



Never adjust the driver's seat or seatback when the vehicle is moving.



Do not pile cargo higher than the seatbacks to avoid injuring people in a collision or sudden stop.

## Seating and safety restraints

 Always drive and ride with your seatback upright and the lap belt snug and low across the hips.

Lift handle to move seat forward or backward.

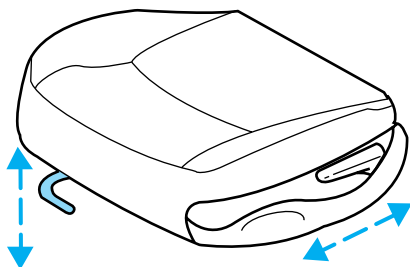

Pull lever up to adjust seatback.

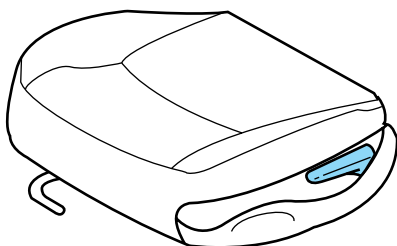



## Seating and safety restraints

### Driver seat memory recliner (if equipped)

- Pull control to adjust seatback.

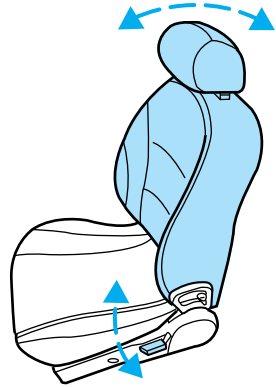

- To retain selected seatback position, release seatback by moving memory recliner control forward to release seatback.

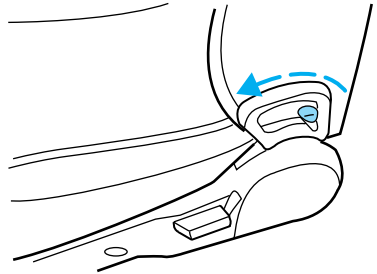

- Push seatback rearward until the seatback latches. This will be the first position selected.

## Seating and safety restraints

### Folding rear seats (if equipped)

#### **Folding down the rear seats**

If your vehicle is equipped with a built-in child seat, the seatback cannot be folded down unless the built-in child seat is fully stowed. See *Built-in child seats* in this chapter for more information.

To fold the seatback down:

- Press the latch control downward or pull up on strap and
- Push the seatback down.

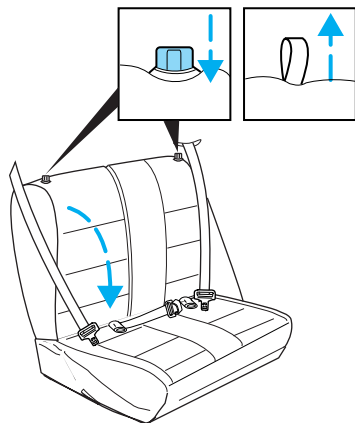

#### **Returning the seat to the upright position**



Check to see that the seat and seatback is latched securely in position. Keep floor area free of objects that would prevent proper seat engagement. Never attempt to adjust the seat while the vehicle is in motion.

To return the seat to the upright/normal seating position:

- Rotate seat upward and latch.

The full rear bench seat is shown. The split-folding rear seat (if equipped) operates in a similar manner.

# Seating and safety restraints

## SAFETY RESTRAINTS

### Safety restraints precautions



Always drive and ride with your seatback upright and the lap belt snug and low across the hips.



To prevent the risk of injury, make sure children sit where they can be properly restrained.



Never let a passenger hold a child on his or her lap while the vehicle is moving. The passenger cannot protect the child from injury in a collision.





All occupants of the vehicle, including the driver, should always wear their safety belts.



It is extremely dangerous to ride in a cargo area, inside or outside of a vehicle. In a collision, people riding in these areas are more likely to be seriously injured or killed. Do not allow people to ride in any area of your vehicle that is not equipped with seats and safety belts. Be sure everyone in your vehicle is in a seat and using a safety belt properly.

## Seating and safety restraints

 Each seating position in your vehicle has a specific safety belt assembly which is made up of one buckle and one tongue that are designed to be used as a pair. 1) Use the shoulder belt on the outside shoulder only. Never wear the shoulder belt under the arm. 2) Never swing it around your neck over the inside shoulder. 3) Never use a single belt for more than one person.

 The ZX2 Coupe was designed to accommodate up to four people. Do not attempt to carry more occupants. All designed seating positions are equipped with safety belts. All occupants should be properly restrained. Failure to follow this warning could result in serious personal injury or death.

### Combination lap and shoulder belts

1. To fasten, insert the tongue into the slot in the buckle.

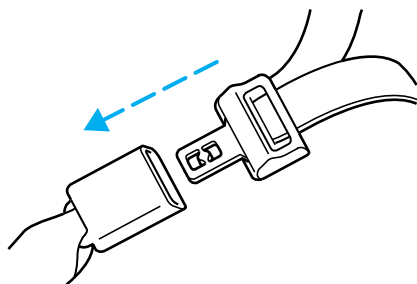

## Seating and safety restraints

2. To unfasten, push the red release button and remove the tongue from the buckle.

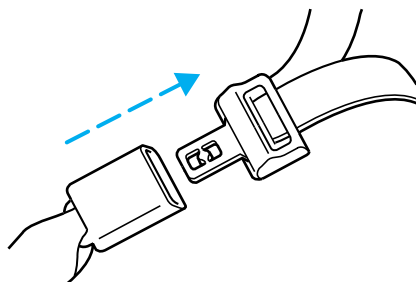

The front and rear outboard safety restraints in the vehicle are combination lap and shoulder belts. The front and rear seat passenger outboard safety belts have two types of locking modes described below:

### **Automatic locking mode**

In this mode, the shoulder belt is automatically pre-locked. The belt will still retract to remove any slack in the shoulder belt.

The automatic locking mode is not available on the driver safety belt.

### ***When to use the automatic locking mode***

- When a tight lap/shoulder fit is desired.
- **Anytime** a child safety seat is installed in the vehicle. Refer to *Safety Restraints for Children* or *Safety Seats for Children* later in this chapter.

## Seating and safety restraints

### ***How to use the automatic locking mode***

- Buckle the combination lap and shoulder belt.

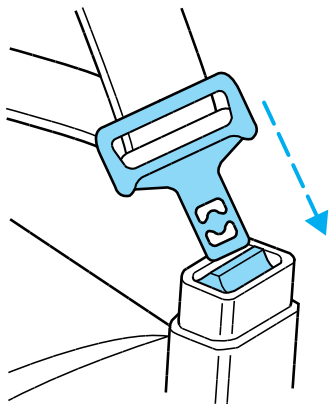

- Grasp the shoulder portion and pull downward until the entire belt is extracted.



- Allow the belt to retract. As the belt retracts, you will hear a clicking sound. This indicates the safety belt is now in the automatic locking mode.

### ***How to disengage the automatic locking mode***

Disconnect the combination lap/shoulder belt and allow it to retract completely to disengage the automatic locking mode and activate the vehicle sensitive (emergency) locking mode.

## Seating and safety restraints

### Front safety belt height adjustment

Your vehicle has safety belt height adjustments for the driver and front passenger. Adjust the height of the shoulder belt so the belt rests across the middle of your shoulder.

To lower the shoulder belt height, push the button and slide the height control down. To raise the height of the shoulder belt, slide the height adjuster up. Pull down on the height adjustment assembly to make sure it is locked in place.

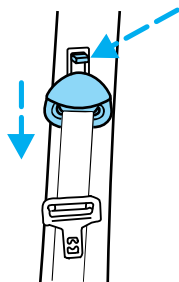

Position the shoulder belt height adjuster so that the belt rests across the middle of your shoulder. Failure to adjust the safety belt properly could reduce the effectiveness of the safety belt and increase the risk of injury in a collision.

### Lap belts

#### *Adjusting the lap belt*

The lap belt does not adjust automatically. Adjust to fit snugly and as low as possible around your hips. Do not wear the lap belt around your waist.

## Seating and safety restraints

Insert the tongue into the correct buckle. To lengthen the belt, turn the tongue at a right angle to the belt and pull across your lap until it reaches the buckle. To tighten the belt, pull the loose end of the belt through the tongue until it fits snugly across the hips.

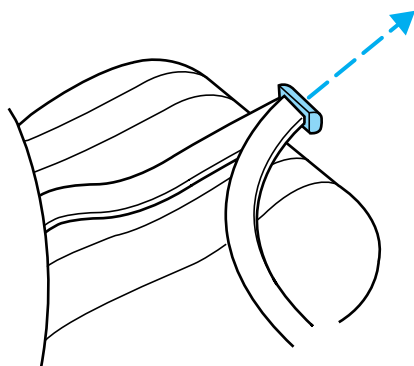

Shorten and fasten the belt when not in use.

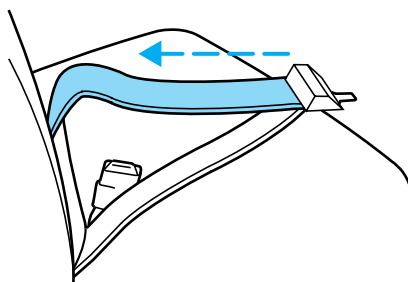

### Safety belt extension assembly

If the safety belt assembly is too short, even when fully extended, 20 cm (8 inches) can be added to the safety belt assembly by adding a safety belt extension assembly (part number 611C22). Safety belt extension assemblies can be obtained from your dealer at no cost.

Use only extensions manufactured by the same supplier as the safety belt. Manufacturer identification is located at the end of the webbing on the label. Also, use the safety



## Seating and safety restraints

belt extension only if the safety belt is too short for you when fully extended. Do not use extensions to change the fit of the shoulder belt across the torso.

### Safety belt warning light and indicator chime

The seat belt warning light illuminates in the instrument cluster and a chime sounds to remind the occupants to fasten their safety belts.

### Conditions of operation

If...	Then...
The driver's safety belt is not buckled before the ignition key is turned to ON...	The safety belt warning light illuminates for one to two minutes and the warning chime sounds for four to eight seconds.
The driver's safety belt is buckled while the indicator light is illuminated and the warning chime is sounding...	The safety belt warning light turns off.
The driver's safety belt is buckled before the ignition key is turned to ON...	The safety belt warning light remains off.

### Safety belt maintenance

Check the safety belt systems periodically to make sure they work properly and are not damaged. Check the safety belts to make sure there are no nicks, wears or cuts. All safety belt assemblies, including retractors, buckles, front seat belt buckle assemblies (slide bar)(if

## Seating and safety restraints

equipped), shoulder belt height adjusters (if equipped), child safety seat tether bracket assemblies (if equipped), and attaching hardware, should be inspected after a collision. Ford recommends that all safety belt assemblies used in vehicles involved in a collision be replaced. However, if the collision was minor and a qualified technician finds that the belts do not show damage and continue to operate properly, they do not need to be replaced. Safety belt assemblies not in use during a collision should also be inspected and replaced if either damage or improper operation is noted.



Failure to replace the safety belt assembly under the above conditions could result in severe personal injuries in the event of a collision.

Refer to *Cleaning and maintaining the safety belts* in the *Maintenance and care* section.

### **AIR BAG SUPPLEMENTAL RESTRAINT SYSTEM (SRS)**

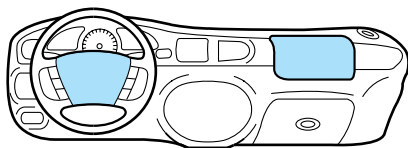

## Seating and safety restraints

### Important supplemental restraint system (SRS) precautions

The supplemental restraint system is designed to:

- work with the safety belt to protect the driver and right front passenger
- reduce certain upper body injuries

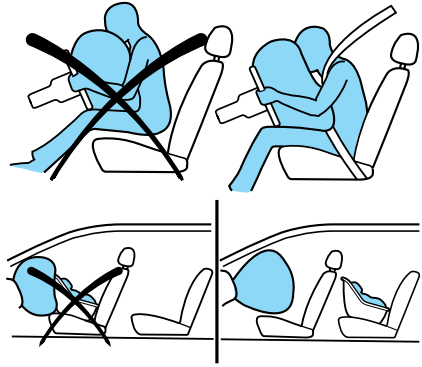

Failure to follow these instructions will affect the performance of the safety belts and increase the risk of personal injury.





The right front passenger air bag is not designed to restrain occupants in the center front seating position.



All occupants of the vehicle including the driver should always wear their safety belts even when air bag SRS is provided.

## Seating and safety restraints

 Do not place objects or mount equipment on or near the air bag cover on the steering wheel or in front seat areas that may come into contact with a deploying air bag. Failure to follow this instruction may increase the risk of personal injury in the event of a collision.

 Do not attempt to service, repair, or modify the Air Bag Supplemental Restraint System or its fuses. See your Ford or Lincoln-Mercury dealer.

### Children and air bags

For additional important safety information, read all information on safety restraints in this guide.

Children should always wear their safety belts. Failure to follow these instructions may increase the risk of injury in a collision.

 Air bag can kill or injure a child in a child seat. If you must use a forward-facing child seat in the front seat, move seat all the way back.

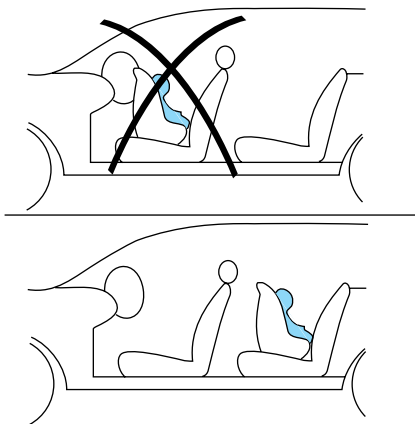

## Seating and safety restraints

### How does the air bag supplemental restraint system work?

The SRS is designed to activate when the vehicle sustains sufficient longitudinal deceleration.

The fact that the air bags did not inflate in a collision does not mean that something is wrong with the system. Rather, it means the forces were not of the type sufficient to cause activation.

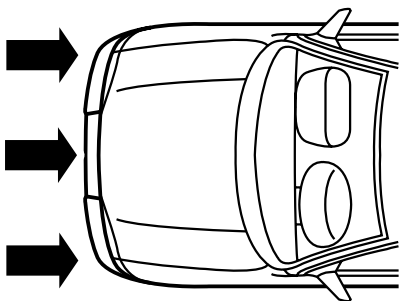

The air bags inflate and deflate rapidly upon activation.

After air bag deployment, it is normal to notice a smoke-like, powdery residue or smell the burnt propellant. This may consist of cornstarch, talcum powder (to lubricate the bag) or sodium compounds (e.g., baking soda) that result from the combustion process that inflates the air bag. Small amounts of sodium hydroxide may be present which may irritate the skin and eyes, but none of the residue is toxic.



Several air bag system components get hot after inflation. Do not touch them after inflation.

## Seating and safety restraints



If the air bag is inflated, **the air bag will not function again and must be replaced immediately**. If the air bag is not replaced, the unrepaired area will increase the risk of injury in a collision.

The SRS consists of:

- driver and passenger air bag modules (which include the inflators and air bags),
- one or more impact and safing sensors,
- a readiness light and tone
- and the electrical wiring which connects the components.

The diagnostic module monitors its own internal circuits and the supplemental air bag electrical system warning (including the impact sensors), the system wiring, the air bag system readiness light, the air bag back up power and the air bag igniters.

### **Determining if the system is operational**

The SRS uses a readiness light in the instrument cluster or a tone to indicate the condition of the system. Refer to the *Air bag readiness* section in the *Instrumentation* chapter. Routine maintenance of the air bag is not required.

## Seating and safety restraints

A difficulty with the system is indicated by one or more of the following:

- The readiness light will either flash or stay lit.
- The readiness light will not illuminate immediately after ignition is turned on.
- A series of five beeps will be heard. The tone pattern will repeat periodically until the problem and light are repaired.



If any of these things happen, even intermittently, have the SRS serviced at your dealership or by a qualified technician immediately. Unless serviced, the system may not function properly in the event of a collision.

### **Disposal of air bags and air bag equipped vehicles**

For disposal of air bags or air bag equipped vehicles, see your local dealership or qualified technician. Air bags **MUST BE** disposed of by qualified personnel.

### **SAFETY RESTRAINTS FOR CHILDREN**

#### **Important child restraint precautions**

You are required by law to use safety restraints for children in the U.S. and Canada. If small children ride in your vehicle (generally children who are four years old or younger and who weigh 18 kg [40 lbs] or less), you must put

## Seating and safety restraints

them in safety seats made especially for children. Check your local and state or provincial laws for specific requirements regarding the safety of children in your vehicle.



Never let a passenger hold a child on his or her lap while the vehicle is moving. The passenger cannot protect the child from injury in a collision.

Always follow the instructions and warnings that come with any infant or child restraint you might use.

When possible, place children in the rear seat of your vehicle. Accident statistics suggest that children are safer when properly restrained in the rear seating positions than in the front seating position.

### Children and safety belts

Children who are too large for child safety seats (as specified by your child safety seat manufacturer) should always wear safety belts.

Follow all the important safety restraint and air bag precautions that apply to adult passengers in your vehicle.

If the shoulder belt portion of a combination lap and shoulder belt can be positioned so it does not cross or rest in front of the child's face or neck, the child should wear the lap and shoulder belt. Moving



## Seating and safety restraints

the child closer to the center of the vehicle may help provide a good shoulder belt fit.

If the shoulder belt cannot be properly positioned:

- move the child to one of the seats with a lap belt only (if equipped)

OR

- if the child is the proper size, restrain the child in a safety seat.



Do not leave children, unreliable adults, or pets unattended in your vehicle.

To improve the fit of lap and shoulder belts on children who have outgrown child safety seats, Ford recommends use of a belt-positioning booster seat that is labelled as conforming to all Federal motor vehicle safety standards. Belt-positioning booster seats raise the child and provide a shorter, firmer seating cushion that encourages safer seating posture and better fit of lap and shoulder belts on the child. A

belt-positioning booster should be used if the shoulder belt rests in front of the child's face or neck, or if the lap belt does not fit snugly on both thighs, or if the thighs are too short to let the child sit all the way back on the seat cushion when the lower legs hang over the edge of the seat cushion. You may wish to discuss the special needs

## Seating and safety restraints

of your child with your pediatrician.

### SAFETY SEATS FOR CHILDREN

#### Child and infant or child safety seats

Use a safety seat that is recommended for the size and weight of the child. Carefully follow all of the manufacturer's instructions with the safety seat you put in your vehicle. If you do not install and use the safety seat properly, the child may be injured in a sudden stop or collision.

When installing a child safety seat:

- Use the correct safety belt buckle for that seating position.
- Make sure the tongue is securely fastened in the buckle.
- Keep the buckle release button pointing up and away from the safety seat, with the tongue between the child seat and the release button, to prevent accidental unbuckling.
- Place seat back in upright position.
- Put the safety belt in the automatic locking mode. Refer to *Automatic locking mode*.

Ford recommends the use of a child safety seat having a top tether strap. Install the child safety seat in a seating position which is capable of providing a tether anchorage. For more information on top tether straps, refer to

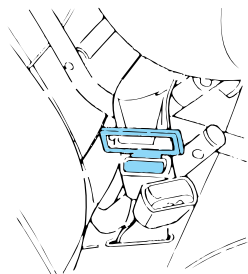

## Seating and safety restraints

*Attaching safety seats with tether straps.*



Carefully follow all of the manufacturer's instructions included with the safety seat you put in your vehicle. If you do not install and use the safety seat properly, the child may be injured in a sudden stop or collision.

### **Installing child safety seats in combination lap and shoulder belt seating positions**

1. Position the child safety seat in a seat with a combination lap and shoulder belt.

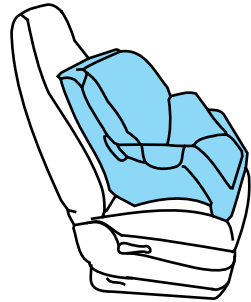

Air bag can kill or injure a child in a child seat. If you must use a forward-facing child seat in the front seat, move seat all the way back.

## Seating and safety restraints

2. Pull down on the shoulder belt and then grasp the shoulder belt and lap belt together.

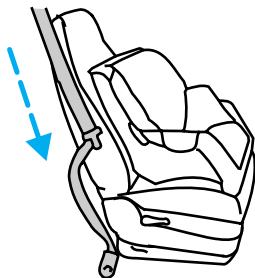

3. While holding the shoulder and lap belt portions together, route the tongue through the child seat according to the child seat manufacturer's instructions. Be sure the belt webbing is not twisted.

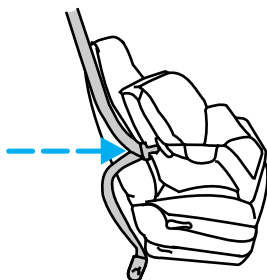

4. Insert the belt tongue into the proper buckle for that seating position until you hear and feel the latch engage. Make sure the tongue is latched securely by pulling on it.

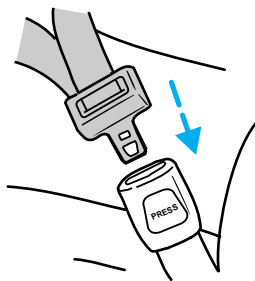

## Seating and safety restraints

5. To put the retractor in the automatic locking mode, grasp the shoulder portion of the belt and pull downward until all of the belt is extracted and a click is heard.

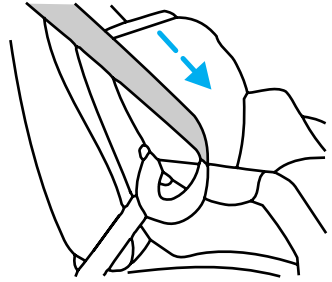

6. Allow the belt to retract. The belt will click as it retracts to indicate it is in the automatic locking mode.

7. Pull the lap belt portion across the child seat toward the buckle and pull up on the shoulder belt while pushing down with your knee on the child seat.

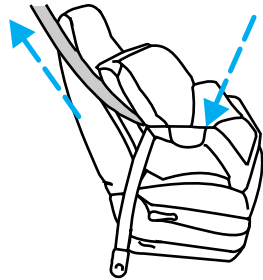

8. Allow the safety belt to retract to remove any slack in the belt.

9. Before placing the child in the seat, forcibly tilt the seat forward and back to make sure the seat is securely held in place.

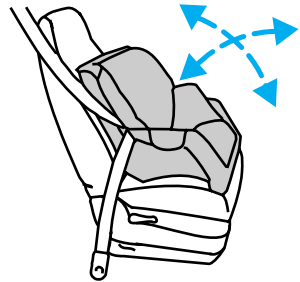

10. Try to pull the belt out of the retractor to make sure the retractor is in the automatic locking mode (you should not be

## Seating and safety restraints

able to pull more belt out). If the retractor is not locked, unbuckle the belt and repeat steps two through nine.

Check to make sure the child seat is properly secured before each use.

### **Attaching safety seats with tether straps**

Some manufacturers make safety seats that include a tether strap that goes over the back of the vehicle seat and attaches to an anchoring point. Other manufacturers offer the tether strap as an accessory. Contact the manufacturer of your child safety seat for information about ordering a tether strap.

### **Tether anchorage hardware (Coupe)**

Attachment holes (at each rear outboard seating position) have been provided in your vehicle to attach anchor hardware, if required. Tether anchorage hardware kits (part number 613D74) including instructions, may be obtained at no charge from any Ford or Lincoln-Mercury dealer. All vehicles built for sale in Canada include a tether anchor hardware kit.

Be sure to follow the child safety seat manufacturer's instructions.

## Seating and safety restraints



Tighten the anchor according to specifications.

Otherwise, the safety seat may not be properly secured and the child may be injured in a sudden stop or collision.

1. Install the child safety seat in the rear right or rear left seat position. For instructions on how to install the seat, refer to *Installing child safety seats in combination lap and shoulder belt seating positions* in this chapter.

2. Refer to the instructions provided in the tether anchor kit.

3. Refer to the instructions provided with your child safety seat to securely attach the child safety seat by tether to the tether strap anchor location.

### **Tether anchorage hardware (Sedan/Wagon)**

Attachment holes (at each rear seating position) have been provided in your vehicle to attach anchor hardware, if required. Tether anchorage hardware kits including instructions, may be obtained at no charge from any Ford or Lincoln-Mercury dealer. All vehicles built for sale in Canada include a tether anchor hardware kit.

Be sure to follow the child safety seat manufacturer's instructions.

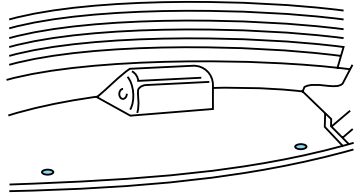

## Seating and safety restraints

 Tighten the anchor according to specifications. Otherwise, the safety seat may not be properly secured and the child may be injured in a sudden stop or collision.

1. Install the child safety seat in the rear right, rear left or rear center seat position. For instructions on how to install the seat, refer to *Installing child safety seats in combination lap and shoulder belt seating positions* in this chapter.
2. Refer to the instructions provided in the tether anchor kit.
3. Refer to the instructions provided with your child safety seat to securely attach the child safety seat by tether to the tether strap anchor location.

- Sedan

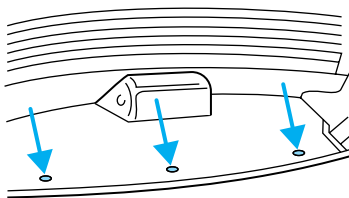

- Wagon

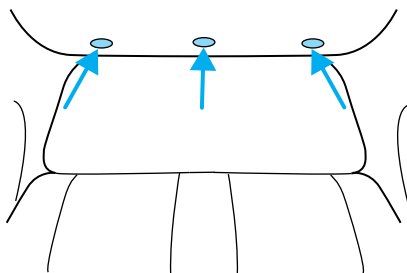



## Seating and safety restraints

### BUILT-IN CHILD SEATS

#### **Built-in child safety seat (if equipped)**

The rear seat may include a built-in child seat. This child seat conforms to all Federal and local motor vehicle safety standards. Read the labels located on the child seat cushion and shoulder belt for information on the built-in child seat.

Use the built-in child seat **only** if the child is at least 9 months old, weighs 9–27 kg (20–60 lb) and the child's shoulders (top) are below the shoulder harness slots in the built-in child seat.

Children not meeting these requirements should be secured in an approved aftermarket seat. Refer to *Children and infant or child safety seats* in this chapter.

#### ***Built-in child seat retractors***

The belts on built-in child seats are equipped with a retractor that locks when both tongues are latched into the crotch safety belt buckle. The retractor will automatically snug the belts around the child. If the belts do not remain snug, take the vehicle to the dealer for child seat repair. The belts will not snug during a collision.

## Seating and safety restraints

### *Placing your child in the built-in child seat*

 Failure to follow all of the instructions on the use of this child restraint system can result in your child striking the vehicle's interior during a sudden stop or crash.

 Never use the Built-In Child Seat as a booster cushion with the adult safety belts. A child using the adult belts could slide forward and out from under the safety belts.

 The rear seatback must be fully locked before operating the child restraint system.

1. Grasp the child seat at the top of the seatback and pull the top forward to release the latch.

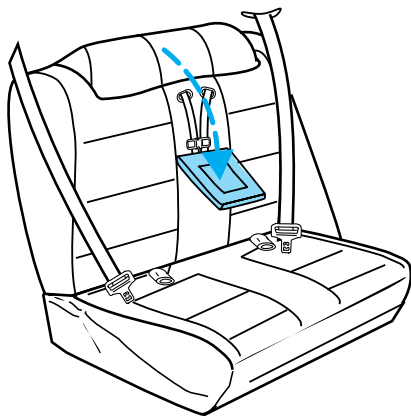

2. Continue to unfold the child seat until it rests on the seat.

## Seating and safety restraints

3. Read all information and warnings on the child seat cushion and shoulder safety belt. Make sure the child is not too large for the child seat.

4. If connected, squeeze the top and the bottom of the right half of the chest clip and pull to separate both halves.

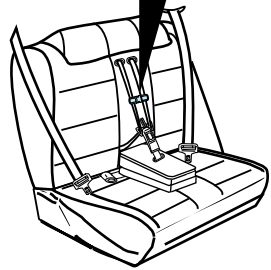
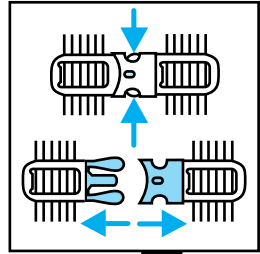

5. Place the child on the child seat and position the shoulder belts over each shoulder.

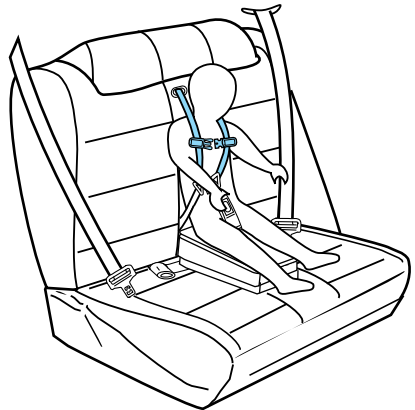

## Seating and safety restraints

6. Insert either the left or the right safety belt tongue into the single opening of the crotch safety belt buckle (it doesn't matter which tongue is inserted first). Insert other tongue. The color green must appear in the indicator window on the crotch safety belt buckle when buckled. Allow belts to retract and fit snugly.

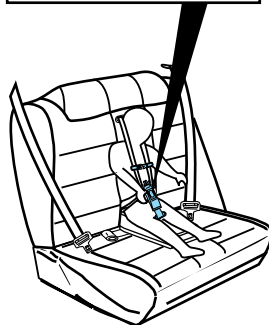
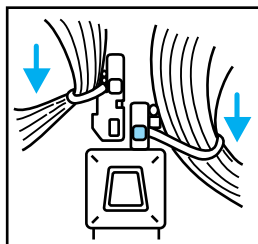

## Seating and safety restraints

7. Fasten both halves of the chest clip below the child's shoulders and adjust it to comfortably hold the shoulder belts in place on the child's chest. The color green must appear in the indicator window when fastened.

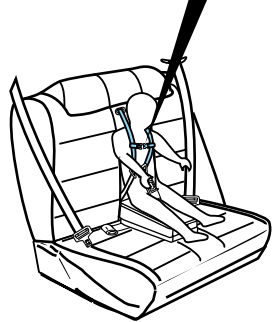
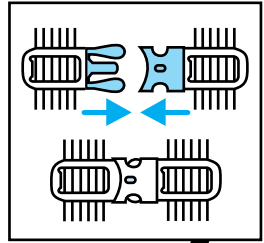

8. Pull the shoulder belts toward you to make sure the crotch safety belt buckle is properly fastened and the retractor is locked.

9. If the belts become too tight, unbuckle the crotch safety belt buckle to unlock the retractors, then reinsert both belt tongues.

## Seating and safety restraints

### ***Removing your child from the built-in child seat***

1. Squeeze the tabs on the top and the bottom of the chest clip and pull the halves apart to open the chest clip.
2. Press the release button on the crotch safety belt buckle.

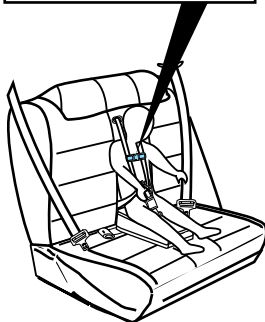
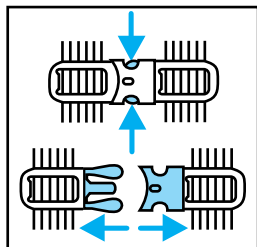

## Seating and safety restraints

3. Slide the shoulder belts off the child's shoulders and remove the child.

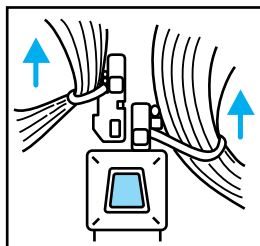

### ***To stow the built-in child seat***

Return the child seat cushion to the upright position, then press firmly in the center and top of the child seat.

### **Inspecting the built-in child seat after a collision**

Inspect all built-in child restraints, including seats, buckles, retractors, seat latches. Interlocks and attaching hardware should be inspected by a qualified technician after any collision. If the child seat was in use during a collision, Ford recommends replacing it. Built-in child restraints not in use during a collision should be inspected and replaced if either damage or improper operation is noted.

## Starting

### PREPARING TO START YOUR VEHICLE

Engine starting is controlled by the spark ignition system. This system meets all Canadian

Interference-Causing Equipment standard requirements regulating the impulse electrical field strength of radio noise.

When starting a fuel-injected engine, avoid pressing the accelerator before or during starting. Only use the accelerator when you have difficulty starting the engine. For more information on starting the vehicle, refer to *Starting the engine* in this chapter.



Extended idling at high engine speeds can produce very high temperatures in the engine and exhaust system, creating the risk of fire or other damage.



Do not park, idle, or drive your vehicle in dry grass or other dry ground cover. The emission system heats up the engine compartment and exhaust system, which can start a fire.





Do not start your vehicle in a closed garage or in other enclosed areas. Exhaust fumes can be toxic. Always open the garage door before you start the engine. See *Guarding against exhaust fumes* in this chapter for more instructions.



If you smell exhaust fumes inside your vehicle, have your dealer inspect your vehicle immediately. Do not drive if you smell exhaust fumes.

### Important safety precautions

A computer system controls the engine's idle revolutions per minute (RPM). When the engine starts, the idle RPM runs faster to warm the engine. If the engine idle speed does not slow down automatically, have the vehicle checked. Do not allow the vehicle to idle for more than ten minutes.

Before starting the vehicle:

1. Make sure all vehicle occupants have buckled their safety belts. For more information on safety belts and their proper usage, refer to the *Seating and safety restraints* chapter.
2. Make sure the headlamps and vehicle accessories are off.

If starting a vehicle with an automatic transaxle:

## Starting

- Make sure the parking brake is set.

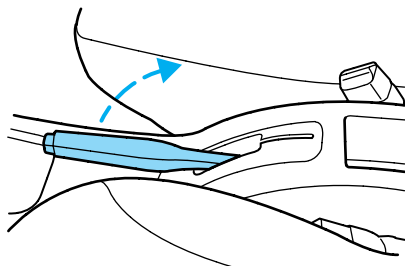

- Make sure the gearshift is in P (Park).

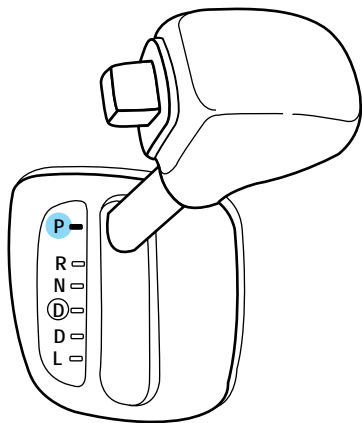

If starting a vehicle with a manual transaxle:

- Make sure the parking brake is set.

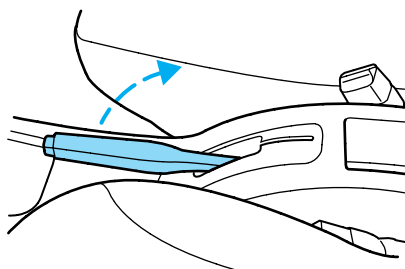

## Starting

- Push the clutch pedal to the floor.

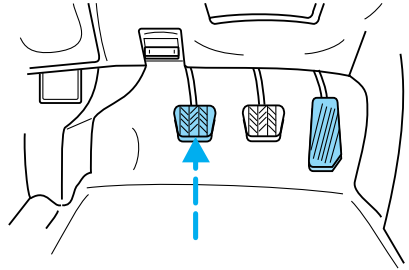

3. Turn the key to 3 (ON) without turning the key to 4 (START).

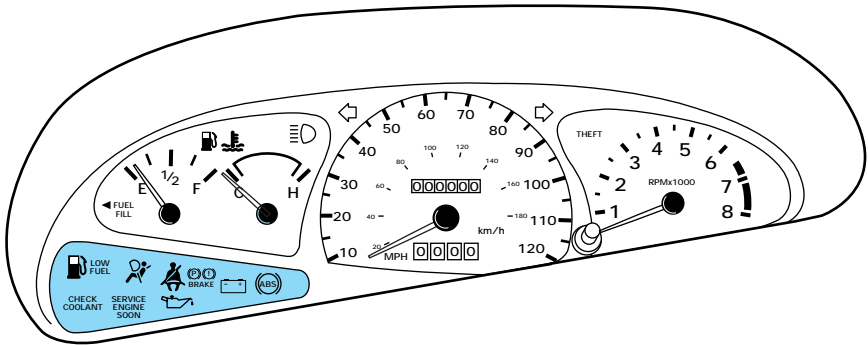
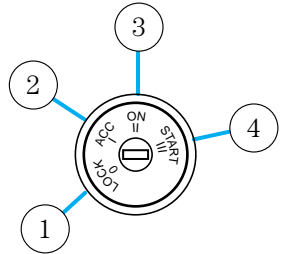

Make sure the corresponding lights illuminate briefly. If a light fails to illuminate, have the vehicle serviced.

## Starting

- If the driver's safety belt is fastened, the light (  ) will not illuminate.

### STARTING THE ENGINE

1. Turn the key to 4 (START) without pressing the accelerator pedal and release as soon as the engine starts. The key will return to 3 (ON).

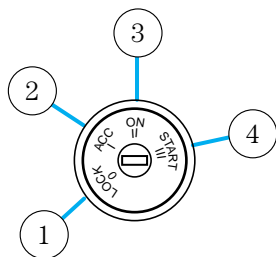

2. If the engine does not start within five seconds, wait ten seconds and try again.

3. If the engine does not start in two attempts OR if the temperature is below  $-12^{\circ}\text{C}$  ( $10^{\circ}\text{F}$ ), depress the accelerator and start the engine while holding the accelerator down. Release the accelerator when the engine starts.

4. After idling for a few seconds, apply the brake and release the parking brake.

### Using the engine block heater (if equipped)

An engine block heater warms the engine coolant, which improves starting, warms up the engine faster and allows the heater-defroster system to respond quickly. They are strongly recommended if you live in a region where temperatures reach  $-23^{\circ}\text{C}$  ( $-10^{\circ}\text{F}$ ) or below.

For best results, plug the heater in at least three hours before starting the vehicle. Using the heater for longer than three hours will not harm the engine, so the heater can be plugged in the night before starting the vehicle.



To prevent electrical shock, do not use your heater with ungrounded electrical systems or two-pronged (cheater) adapters.

### Guarding against exhaust fumes

Although odorless and colorless, carbon monoxide is present in exhaust fumes. Take precautions to avoid its dangerous effects.



If you ever smell exhaust fumes of any kind inside your vehicle, have your dealer inspect and fix your vehicle immediately. Do not drive if you smell exhaust fumes. These fumes are harmful and could kill you.

Have the exhaust and body ventilation systems checked whenever:

- the vehicle is raised for service
- the sound of the exhaust system changes
- the vehicle has been damaged in a collision

## Starting

### Important ventilating information

If the engine is idling while the vehicle is stopped in an open area for long periods of time, open the windows at least 2.5 cm (one inch).

Adjust the heating or air conditioning (if equipped) to bring in fresh air.

Improve vehicle ventilation by keeping all air inlet vents clear of snow, leaves and other debris.

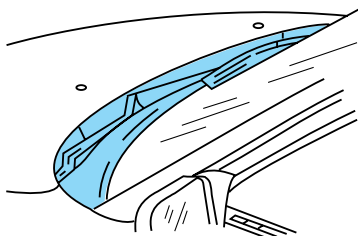

### **BRAKES**

Your brakes are self-adjusting. Refer to the “Service Guide” for scheduled maintenance.

Occasional brake noise is normal and often does not indicate a performance concern with the vehicle’s brake system. In normal operation, automotive brake systems may emit occasional or intermittent squeal or groan noises when the brakes are applied. Such noises are usually heard during the first few brake applications in the morning; however, they may be heard at any time while braking and can be aggravated by environmental conditions such as cold, heat, moisture, road dust, salt or mud. If a “metal-to-metal,” “continuous grinding” or “continuous squeal” sound is present while braking, the brake linings may be worn-out and should be inspected by a qualified service technician.

### **Anti-lock brake system (ABS) (if equipped)**

On vehicles equipped with an anti-lock braking system (ABS), a noise from the hydraulic pump motor and pulsation in the pedal may be observed during ABS braking events. Pedal pulsation coupled with noise while braking under panic conditions or on loose gravel, bumps, wet or snowy roads is normal and indicates proper functioning of the vehicle’s anti-lock brake system. If the

## Driving

vehicle has continuous vibration or shudder while braking, felt mainly in the steering wheel, the vehicle most likely needs service.

The ABS operates by detecting the onset of wheel lock up during brake applications and compensating for this tendency. The front wheels are prevented from locking even when the brakes are firmly applied. The accompanying illustration depicts the advantage of an ABS equipped vehicle (on bottom) to a non-ABS equipped vehicle (on top) during hard braking.

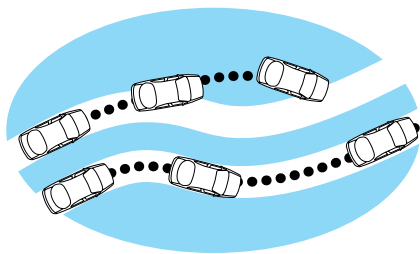

### ABS warning lamp

The  warning lamp in the instrument cluster illuminates for about five seconds when starting the vehicle. If an ABS fault is detected, the light will remain on and your vehicle should be serviced as soon as possible.

Normal braking is still effective unless the BRAKE warning lamp is also illuminated.



### Using ABS

- In an emergency or when maximum efficiency from the ABS is required, apply continuous full force on the brake. The ABS will be activated immediately, thus allowing you to retain full steering control of your vehicle and, providing there is sufficient space, will



enable you to avoid obstacles and bring the vehicle to a controlled stop.

- We recommend that you familiarize yourself with this braking technique. However, avoid taking any unnecessary risks.

### Parking brake

Apply the parking brake whenever the vehicle is parked. To set the parking brake, pull the handle up.

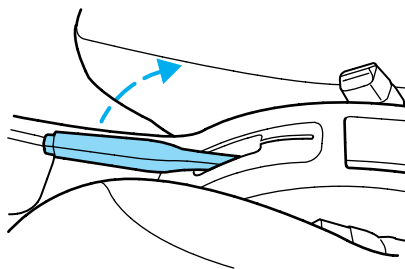

The BRAKE warning lamp in the instrument cluster illuminates and remains illuminated (when the ignition is turned ON) until the parking brake is released.

The parking brake is not designed to stop a moving vehicle. However, if the normal brakes fail, the parking brake can be used to stop your vehicle in an emergency. Since the parking brake applies only the rear brakes, the vehicle's stopping distance will be adversely affected.



**BRAKE**

## Driving

 Always set the parking brake fully and make sure that the gearshift is securely latched in P (Park) (automatic transaxle) or in 1 (First) (manual transaxle).

Push the control on the end of the parking brake and push the handle down to release the brake. Driving with the parking brake on will cause the brakes to wear out quickly and reduce fuel economy.

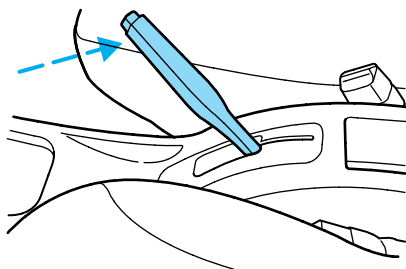

## TRANSAXLE OPERATION

### Manual transaxle (if equipped)

#### *Using the clutch*

Vehicles equipped with a manual transaxle have a starter interrupt interlock that prevents cranking of the engine unless the clutch pedal is depressed.

When starting a vehicle with a manual transaxle, you must:

1. Put the gearshift in the neutral position.

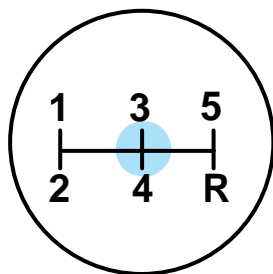

2. Hold down the brake pedal.
3. Depress the clutch pedal.

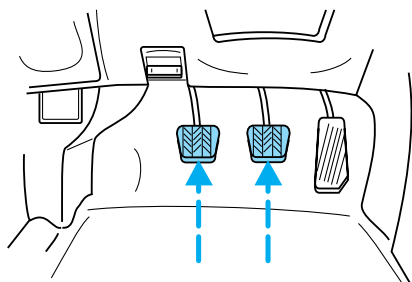

4. Turn the ignition key to 4 (START), then let the engine idle for a few seconds.

5. Release the brake pedal, then slowly release the clutch pedal while pressing down slowly on the accelerator pedal.

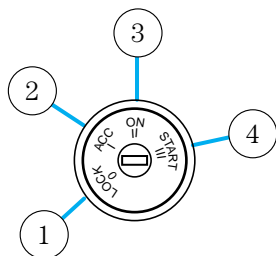

Do not drive with your foot resting on the clutch pedal and do not use the clutch pedal to hold your vehicle at a standstill while waiting on a hill. These actions will seriously reduce clutch life.

### ***Recommended shift speeds***

Upshift according to the following charts for best fuel economy:

<b>Coupe</b>	
<b>Upshifts when accelerating (recommended for best fuel economy)</b>	
1-2	21 km/h (13 mph)
2-3	40 km/h (25 mph)
3-4	53 km/h (33 mph)
4-5	70 km/h (44 mph)

## Driving

Sedan/Wagon	
<b>Upshifts when cruising (recommended for best fuel economy)</b>	
1-2	18 km/h (11 mph)
2-3	32 km/h (20 mph)
3-4	46 km/h (29 mph)
4-5	61 km/h (38 mph)

### ***Parking your vehicle***

1. Apply the brake and shift into the neutral position.

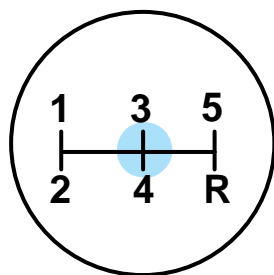

2. Set the parking brake.

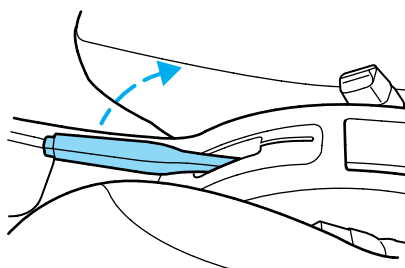

3. Shift into 1 (First).

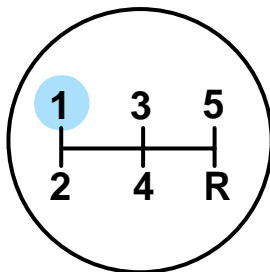

4. Turn engine off and remove the key.

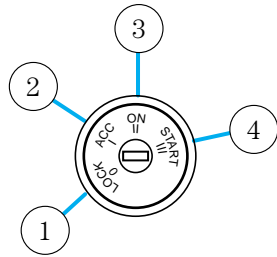

Do not park your vehicle in Neutral, it may move unexpectedly and injure someone. Use 1 (First) gear and set the parking brake fully.

## Reverse

Make sure that your vehicle is at a complete stop before you shift into R (Reverse). Failure to do so may damage the transaxle.

Put the gearshift into the neutral position and wait at least three seconds before shifting into R (Reverse).

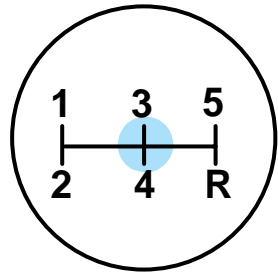

You can shift into R (Reverse) only by moving the gearshift from left of 3 (Third) and 4 (Fourth) gears before you shift into R (Reverse). This is a special lockout feature which prevents you from shifting

## Driving

into R (Reverse) when you downshift from 5 (Fifth).

### Automatic transaxle (if equipped)



Hold the brake pedal down while you move the gearshift lever from position to position. If you do not hold the brake pedal down, your vehicle may move unexpectedly and injure someone.

### **P (Park)**

Always come to a complete stop before shifting into P (Park). Make sure that the gearshift is securely latched in P (Park). This locks the transaxle and prevents the front wheels from rotating.

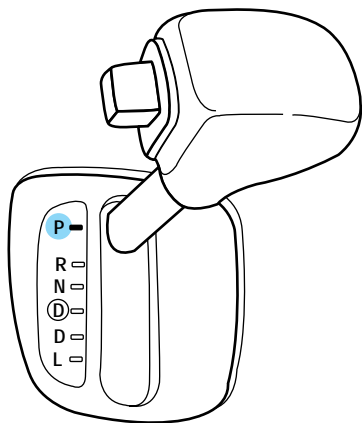

## **R (Reverse)**

With the gearshift in R (Reverse), the vehicle will move backward. You should always come to a complete stop before shifting in and out of R (Reverse).

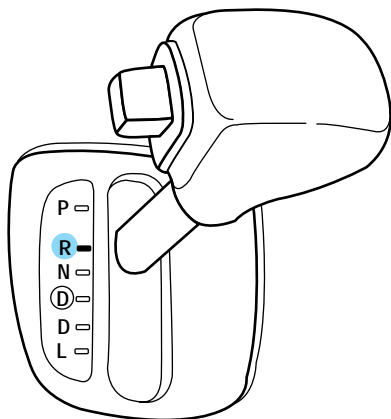

## **N (Neutral)**

With the gearshift in the N (Neutral) position, the vehicle can be started and is free to roll. Hold the brake pedal down while in this position.

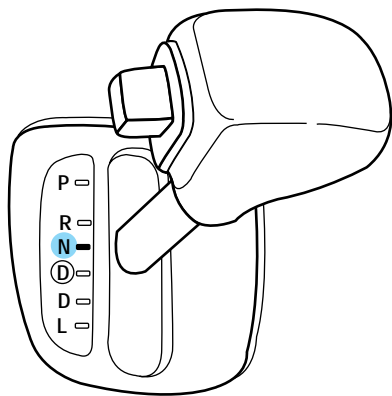

## Driving

### **D (Overdrive)**

The overdrive position is the normal driving position for an automatic overdrive transaxle. It works the same way as D (Drive) but shifts to a fourth gear-an overdrive gear-when your vehicle cruises at a constant speed for any length of time. This fourth gear will increase your fuel economy when you travel at cruising speeds

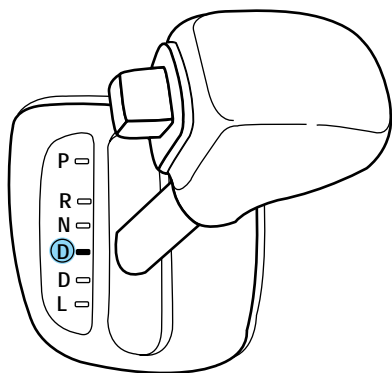

Overdrive may not be appropriate for certain terrains. If the transaxle shifts back and forth between third and fourth gears while you are driving hilly roads or if your vehicle requires additional power for climbing hills, shift into D (Drive).

### **D (Drive)**

D (Drive) eliminates the needless shifting between third and fourth gears that your vehicle may do when driving in hilly terrain. It also gives more engine braking than overdrive to slow your vehicle on downgrades.

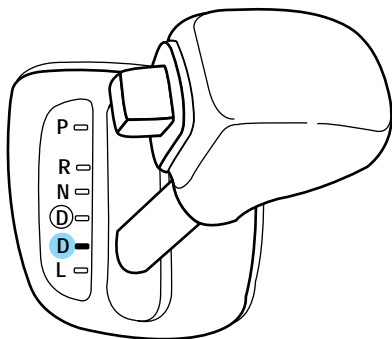



### **L (Low)**

Use L (Low) when added engine braking is desired or when descending steep hills.

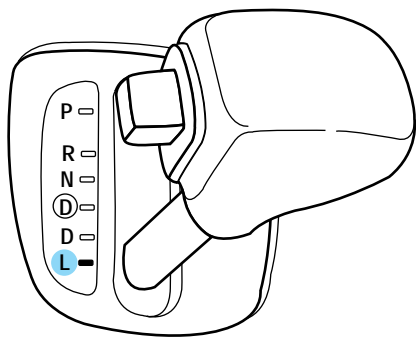

The automatic transaxle will shift into the proper gear to ascend any grade without any need to shift to L (Low).

Do not go faster than 61 km/h (38 mph) when in this gear. You can upshift from L (Low) to **D** (overdrive) at any time.



When parking, do not use the gearshift in place of the parking brake. Always set the parking brake fully and make sure that the gearshift is securely latched in Park (P). Turn off the ignition whenever you leave your vehicle. Never leave your vehicle unattended while it is running. If you do not take these precautions, your vehicle may move unexpectedly and injure someone.

### **VEHICLE LOADING**

Before loading a vehicle, familiarize yourself with the following terms:

## Driving

- **Base Curb Weight:** Weight of the vehicle including any standard equipment, fluids, lubricants, etc. It does not include passengers or aftermarket equipment.
- **Payload:** Combined maximum allowable weight of cargo, passengers and optional equipment. The payload equals the gross vehicle weight rating minus base curb weight.
- **GVW (Gross Vehicle Weight):** Base curb weight plus payload weight. The GVW is not a limit or a specification.
- **GVWR (Gross Vehicle Weight Rating):** Maximum total weight of the base vehicle, passengers, optional equipment and cargo. The GVWR is specific to each vehicle and is listed on the Safety Compliance Label on the driver's door pillar.
- **GAWR (Gross Axle Weight Rating):** Carrying capacity for each axle system. The GAWR is specific to each vehicle and is listed on the Safety Compliance Label on the driver's door pillar.
- **GCWR (Gross Combined Weight Rating):** Maximum combined weight of towing vehicle (including passengers and cargo) and the trailer. The GCWR indicates the maximum loaded weight that the vehicle is allowed to tow.

- **Maximum Trailer Weight Rating:** Maximum weight of a trailer the vehicle is permitted to tow. The maximum trailer weight rating equals the vehicle curb weight for each engine/transmission combination, any required option weight for trailer towing and the weight of the driver from the GCWR for the towing vehicle.
- **Maximum Trailer Weight:** maximum weight of a trailer the loaded vehicle (including passengers and cargo) is permitted to tow. It is determined by subtracting the weight of the loaded trailer towing vehicle from the GCWR for the towing vehicle.
- **Trailer Weight Range:** Specified weight range that the trailer must fall within that ranges from zero to the maximum trailer weight rating.

Remember to figure in the tongue load of your loaded trailer when figuring the total weight.



Do not exceed the GVWR or the GAWR specified on the Safety Compliance Certification Label.

Do not use replacement tires with lower weight capacities than the originals because they may lower the vehicle's GVWR and GAWR limitations. Replacement tires with

## Driving

a higher weight limit than the originals do not increase the GVWR and GAWR limitations.

### TRAILER TOWING

Your vehicle is capable of towing a trailer up to 454 kg (1 000 lbs.) gross trailer weight with a maximum tongue load of 45 kg (100 lbs.). Do not tow a trailer until your vehicle has been driven at least 800 km (500 miles).

Towing a trailer places an additional load on your vehicle's engine, transaxle, brakes, tires and suspension. Inspect these components carefully after towing.



Do not exceed the GVWR or the GAWR specified on the Safety Compliance Certification Label.



Towing trailers beyond the maximum recommended gross trailer weight exceeds the limit of the vehicle and could result in engine damage, transaxle damage, structural damage, loss of control, and personal injury.

### Preparing to tow

Use the proper equipment for towing a trailer, and make sure it is properly attached to your vehicle. See your dealer or a reliable trailer dealer if you require assistance.

### **Hitches**

Do not use hitches that clamp onto the vehicle bumper. Use a load carrying hitch. You must distribute the load in your trailer so that 10 – 15% of the total weight of the trailer is on the tongue.

### **Safety chains**

Always connect the trailer's safety chains to the vehicle. To connect the trailer's safety chains, cross the chains under the trailer tongue and allow slack for turning corners.

If you use a rental trailer, follow the instructions that the rental agency gives to you.

### **Trailer brakes**

Electric brakes and manual, automatic or surge-type brakes are safe if installed properly and adjusted to the manufacturer's specifications. The trailer brakes must meet local and Federal regulations.



Do not connect a trailer's hydraulic brake system directly to your vehicle's brake system. Your vehicle may not have enough braking power and your chances of having a collision greatly increase.

### **Trailer lamps**

Trailer lamps are required on most towed vehicles. Make sure your trailer lamps conform to local and Federal regulations. See your

## Driving

dealer or trailer rental agency for proper instructions and equipment for hooking up trailer lamps.

### **Driving while you tow**

Do not drive faster than 88 km/h (55 mph) when towing a trailer.

Speed control may shut off if you are towing on long, steep grades.

When towing a trailer:

- Use D (Drive) or a lower gear when towing up or down steep hills. This will eliminate excessive downshifting and upshifting for optimum fuel economy and transmission cooling.
- Anticipate stops and brake gradually.

### ***Servicing after towing***

If you tow a trailer for long distances, your vehicle will require more frequent service intervals. Refer to the Severe Duty Schedule in your “Service Guide” for more information.

### **Trailer towing tips**

- Practice turning, stopping and backing up in an area before starting on a trip to get the feel of the vehicle trailer combination. When turning, make wider turns so the trailer wheels will clear curbs and other obstacles.
- Allow more distance for stopping with a trailer attached.

- The trailer tongue weight should be 10–15% of the loaded trailer weight.
- After you have traveled 80 km (50 miles), thoroughly check your hitch, electrical connections and trailer wheel lug nuts.
- When stopped in traffic for long periods of time in hot weather, place the gearshift in P (Park) and increase idle speed. This aids engine cooling and air conditioner efficiency.
- Vehicles with trailers should not be parked on a grade. If you must park on a grade, place wheel chocks under the trailer's wheels.

### **LUGGAGE RACK (IF EQUIPPED)**

Load luggage as far back as it will safely go on the rack without causing the vehicle to exceed the gross vehicle weight rating (GVWR) or gross axle weight rating (GAWR).

### **FUEL CONSUMPTION**

Fuel economy can be improved by avoiding:

- lack of regular, scheduled maintenance
- excessive speed
- rapid acceleration
- extended idle

## Roadside emergencies

### HAZARD FLASHER

Use only in an emergency to warn traffic of vehicle breakdown, approaching danger, etc. The hazard flashers can be operated when the ignition is off.

- Slide the hazard flasher control to the right to activate the hazard flashers simultaneously.
- Slide the control to the left to turn the flashers off.

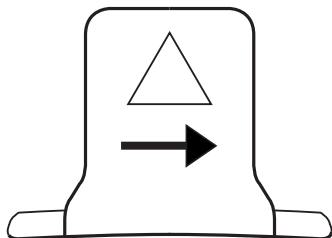

### FUEL PUMP SHUT-OFF SWITCH

If the engine cranks but does not start after a collision, the fuel pump shut-off switch may have been activated. The shut-off switch is a device intended to stop the electric fuel pump when your vehicle has been involved in a substantial jolt.

1. Turn the ignition switch to the OFF position.
2. Check the fuel system for leaks.
3. If no fuel leak is apparent, reset the fuel pump shut-off switch by pushing in the button on the switch.
4. Turn the ignition switch to the ON position. Pause for a few seconds and return the key to the OFF position.
5. Make a further check for leaks in the fuel system.



## Roadside emergencies

If your vehicle is a coupe, the fuel pump shut-off switch is located on the right side of the trunk behind the trunk liner.

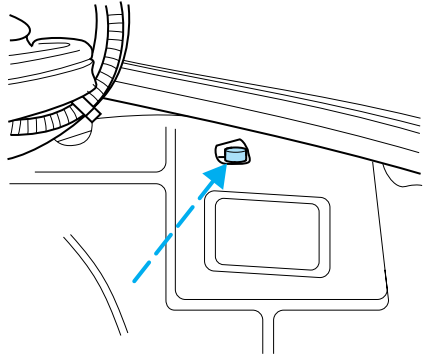

If your vehicle is a sedan or wagon, the fuel pump shut-off switch is located in the driver's foot well, behind the kick panel.

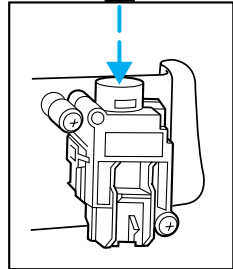
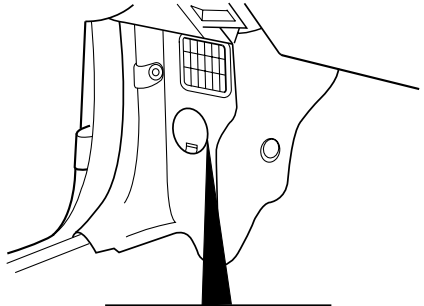

# Roadside emergencies

## FUSES AND RELAYS

### Fuses

If electrical components in the vehicle are not working, a fuse may have blown. Blown fuses are identified by a broken wire within the fuse. Check the appropriate fuses before replacing any electrical components.

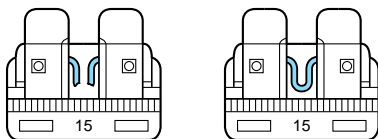

Always replace a fuse with one that has the specified amperage rating. Using a fuse with a higher amperage rating can cause severe wire damage and could start a fire.

### ***Standard fuse amperage rating and color***

<b>Fuse rating</b>	<b>Color</b>
5 amp	Tan
7.5 amp	Brown
10 amp	Red
15 amp	Light blue
20 amp	Yellow
20 amp fuse link	Light blue
25 amp	Natural
30 amp	Light green
30 amp fuse link	Pink
40 amp fuse link	Green
50 amp fuse link	Red
60 amp fuse link	Yellow
80 amp fuse link	Black
100 amp fuse link	Dark blue

## Roadside emergencies

### Coupe

The fuses are coded as follows:

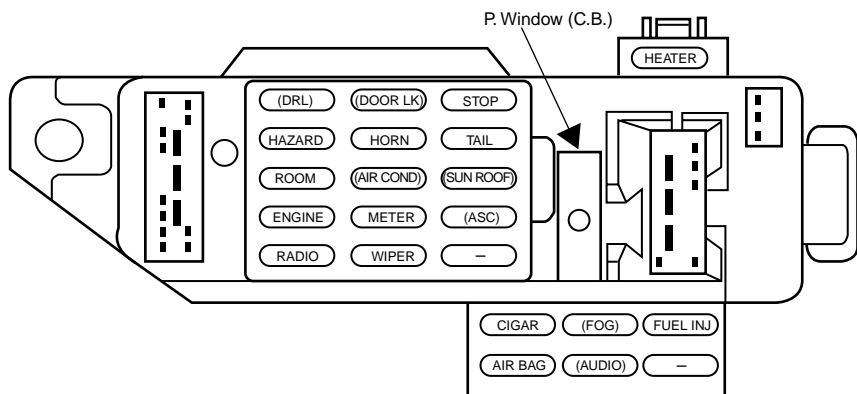

Fuse/Relay Location	Fuse Amp Rating	Description
DRL	10A	Daytime Running Lamps
HAZARD	15A	Hazard Flasher
ROOM	10A	Engine Controls, RAP System, Radio, Shift Lock, Courtesy Lamps, Starting System, Warning Chime, Instrument Cluster
ENGINE	15A	Electronic Automatic Transaxle, Ignition System, Constant Control Relay Module (PCM Relay)
RADIO	5A	Power Mirrors, Radio, RAP System
DOOR LOCK	30A	Power Door Locks
HORN	15A	Horn, Shift Lock
AIR COND	15A	A/C-Heater, ABS

## Roadside emergencies

<b>Fuse/Relay Location</b>	<b>Fuse Amp Rating</b>	<b>Description</b>
METER	10A	Backup Lamps, Engine Coolant Level Switch, Instrument Cluster, Rear Window Defrost, Shift Lock, Warning Chime, Turn Signal Switch
WIPER	20A	Wiper/Washer, Blower Motor Relay
STOP	20A	Stop Lamps, Brake Pressure Switch
TAIL	15A	Exterior Lamps, Instrument Illumination
SUN ROOF	15A	Power Moonroof
ASC	10A	Speed Control
P. WINDOW	30A CB	Power Windows
CIGAR	20A	Cigar Lighter
AIR BAG	10A	Air Bags
FOG	10A	Fog Lamps, Daytime Running Lamps (DRL)
AUDIO	15A	Premium Sound Amplifier, CD Changer
FUEL INJ.	10A	H02S, Evaporative Emission Purge Flow Sensor
BLOWER	30A CB	Blower Motor Relay

### Sedan/Wagon

The fuses are coded as follows:

## Roadside emergencies

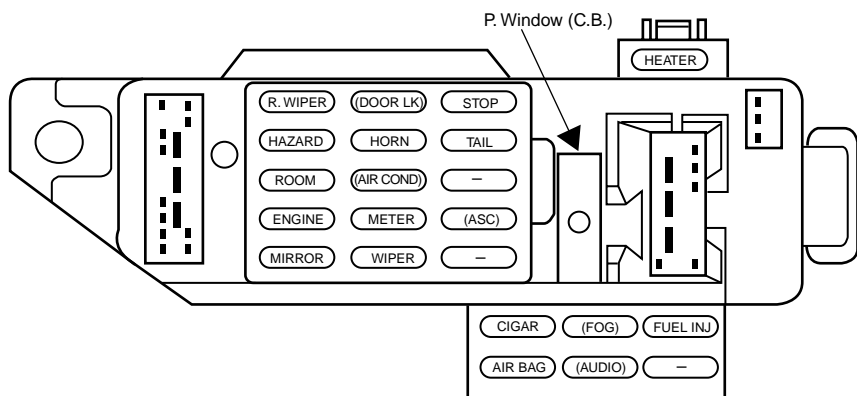

Fuse/Relay Location	Fuse Amp Rating	Description
R. WIPER	10A	Daytime Running Lamps, Liftgate Wiper/Washer
HAZARD	15A	Hazard Lamps
ROOM	10A	Engine Controls, Remote Anti-Theft Personality (RAP) Module, Radio, Shift Lock, Courtesy Lamps, Starting System, Warning Chime
ENGINE	15A	Air Bag, Engine Controls, TR Sensor
MIRROR	5A	Power Mirrors, Radio, Remote Keyless Entry (RKE)
DOOR LOCK	30A	Power Door Locks
HORN	15A	Horn
AIR COND	15A	A/C-Heater, ABS

## Roadside emergencies

<b>Fuse/Relay Location</b>	<b>Fuse Amp Rating</b>	<b>Description</b>
METER	10A	Backup Lamps, Engine Controls, Instrument Cluster, Rear Window Defrost, Shift Lock, Warning Chime, Turn Signal Switch
WIPER	20A	Wiper/Washer, Blower Relay
STOP	15A	Stop Lamps
TAIL	15A	Exterior Lamps, Instrument Illumination
ASC	10A	Speed Control
CIGAR	20A	Cigar Lighter
AIR BAG	10A	Joint Connector, Air Bag Diagnostic Monitor
FOG	10A	Fog Lamps, Daytime Running Lamps (DRL)
AUDIO	15A	Radio
FUEL INJECTOR	10A	H02S, Evaporative Emission Purge Flow Sensor
P. WINDOW	30A CB	Power Windows
BLOWER	30A CB	A/C-Heater

### Coupe

The high-current fuses are coded as follows.

## Roadside emergencies

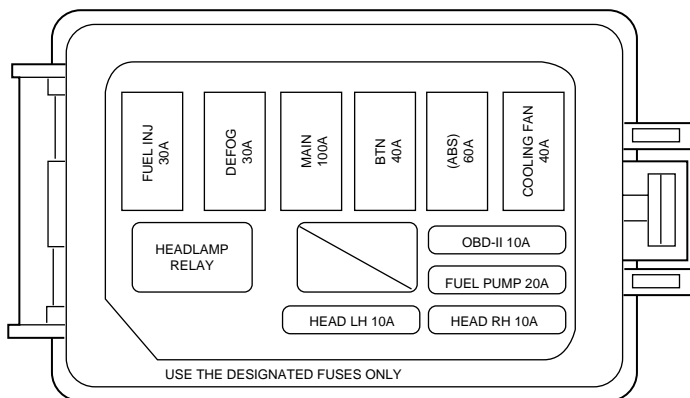

Fuse/Fuse Link Cartridge Location	Fuse Amp Rating	Description
FUEL INJ.	30A*	Air Bags, Constant Control Relay Module (PCM Relay), Generator
DEFOG	30A*	Rear Window Defrost
MAIN	100A*	Overall Circuit Protection
BTN	40A*	Hazard, Stop, Door Lock, Tail, Room and Horn Fuses of the I/P Fuse Panel
ABS	60A*	ABS Main Relay
COOLING FAN	40A*	Constant Control Relay Module (Cooling Fan)
OBD-II	10A*	Data Link Connector (DLC), Instrument Cluster
FUEL PUMP	20A**	Constant Control Relay Module (Fuel Pump)
HEAD RH	10A**	Headlamps
HEAD LH	10A**	Headlamps
* Fuse Link Cartridge **Fuse		

## Roadside emergencies

### Sedan/Wagon

The high-current fuses are coded as follows.

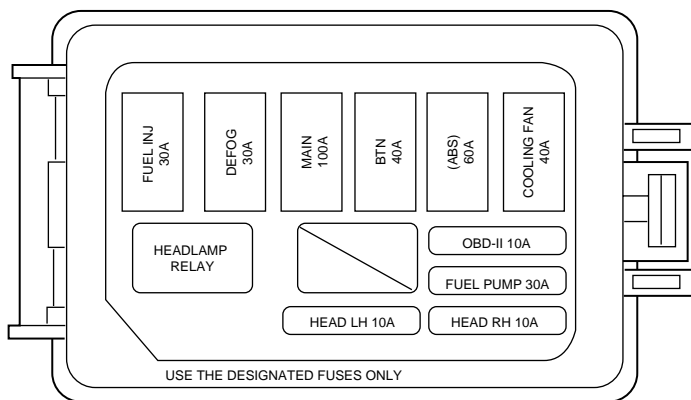

Fuse/Fuse Link Cartridge Location	Fuse Amp Rating	Description
FUEL INJ.	30A*	Air Bags, Engine Controls, Generator
DEFOG	30A*	Rear Window Defrost



## Roadside emergencies

<b>Fuse/Fuse Link Cartridge Location</b>	<b>Fuse Amp Rating</b>	<b>Description</b>
MAIN	100A*	Charging System, BTN, Cooling Fan, Fuel Pump, OBD-II, ABS Fuses, Ignition Switch, Headlamps
BTN	40A*	Hazard
ABS	60A*	ABS Main Relay
COOLING FAN	40A*	Constant Control Relay Module
OBD-II	10A**	Data Link Connector (DLC), Instrument Cluster
FUEL PUMP	30A**	Engine Controls
HEAD RH	10A**	Headlamps
HEAD LH	10A**	Headlamps
* Fuse Link Cartridge ** Fuse		

### Relays

Relays are located in the power distribution box and should be replaced by qualified technicians.

### CHANGING THE TIRES

If you get a flat tire while driving, do not apply the brake heavily. Instead, gradually decrease your speed. Hold the steering wheel firmly and slowly move to a safe place on the side of the road.

## Roadside emergencies

### Temporary spare tire information

The temporary spare tire for your vehicle is labeled as such. It is smaller than a regular tire and is designed for emergency use only.

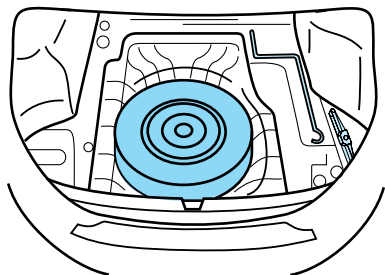

If you use the temporary spare tire continuously or do not follow these precautions, the tire could fail, causing you to lose control of the vehicle, possibly injuring yourself or others.

When driving with the temporary spare tire **do not:**

- exceed 80 km/h (50 mph) under any circumstances
- load the vehicle beyond maximum vehicle load rating listed on the Safety Compliance Label
- tow a trailer
- use tire chains
- drive through an automatic car wash, because of the vehicle's reduced ground clearance
- try to repair the temporary spare tire or remove it from its wheel

## Roadside emergencies

- use the wheel for any other type of vehicle

### Tire change procedure

1. Park on a level surface, activate hazard flashers and set the parking brake.

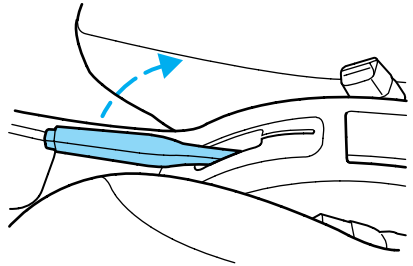

When one of the front wheels is off the ground, the transaxle alone will not prevent the vehicle from moving or slipping off the jack, even if the vehicle is in P (Park) (automatic transaxle) or R (Reverse) (manual transaxle).



To prevent the vehicle from moving when you change a tire, be sure the parking brake is set, then block (in both directions) the wheel that is diagonally opposite (other side and end of the vehicle) to the tire being changed.



If the vehicle slips off the jack, you or someone else could be seriously injured.

2. Place gearshift lever in P (Park) (automatic transaxle) or R (Reverse) (manual transaxle) and

## Roadside emergencies

block the diagonally opposite wheel.

- Automatic

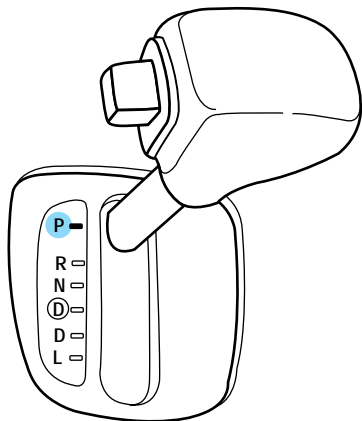

- Manual

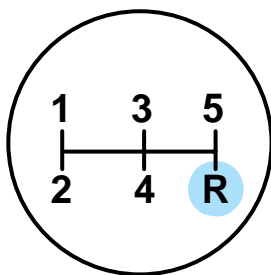

3. Remove the jack, jack handle and spare tire.

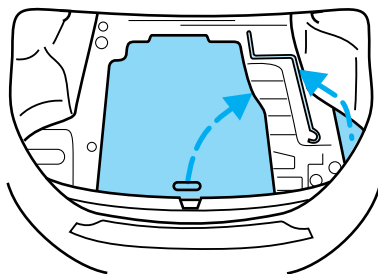

## Roadside emergencies

4. Loosen each wheel lug nut one-half turn counterclockwise but do not remove them until the wheel is raised off the ground.

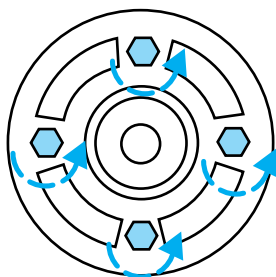

5. Put the jack in the jack notch next to the door of the tire you are changing. Turn the handle clockwise until the wheel is completely off the ground.

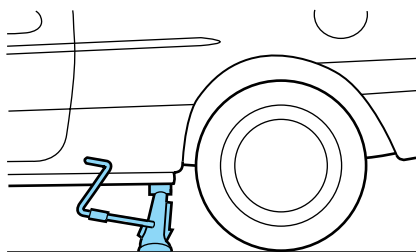

6. Remove the lug nuts with the lug wrench.

7. Replace the flat tire with the spare tire, making sure the valve stem is facing outward. Reinstall the lug nuts until the wheel is snug against the hub. Do not fully tighten the lug nuts until the wheel has been lowered.

8. Lower the wheel by turning the jack handle counterclockwise.

## Roadside emergencies

9. Remove the jack and fully tighten the lug nuts in the order shown.

10. Put flat tire, jack and lug wrench away. Make sure the jack is fastened so it does not rattle when you drive. Unblock the wheels.

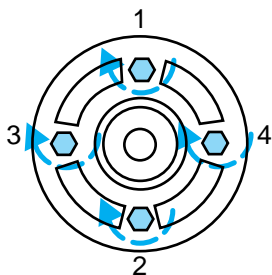

## JUMP STARTING YOUR VEHICLE

 The gases around the battery can explode if exposed to flames, sparks, or lit cigarettes. An explosion could result in injury or vehicle damage.

 Do not push start your vehicle. You could damage the catalytic converter.

 Batteries contain sulfuric acid which burns skin, eyes, and clothing.

## Preparing your vehicle

Also see the label on the battery.

1. Use only a 12-volt supply to start your vehicle. If you connect your battery to a 24-volt power supply you can damage your starter, ignition system and other electrical components.

## Roadside emergencies

2. Do not disconnect the battery of the disabled vehicle as this could damage the vehicle's electrical system.
3. Park the booster vehicle close to the hood of the disabled vehicle making sure they **do not** touch. Set the parking brake on both vehicles and stay clear of the engine cooling fan and other moving parts.
4. Check all battery terminals and remove any excessive corrosion before you attach the battery cables.
5. Turn the heater fan on in both vehicles to protect any electrical surges. Turn all other accessories off.

### Connecting the jumper cables

1. Position the vehicles so that they do not touch one another.
2. Switch off the engine. Switch off any unnecessary electrical equipment.
3. Connect the positive (+) terminal of the discharged battery (1) to the positive (+) terminal of the booster battery (2).
4. Connect one end of the second lead to the negative (-) terminal of the booster battery (3) and the other end to a metal part of the engine to be started (4), not to the negative (-) terminal of the discharged battery.

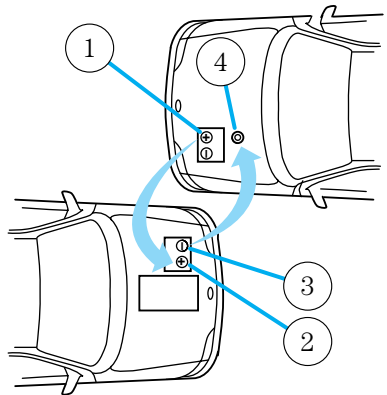

## Roadside emergencies

5. Make sure that the jump leads are clear of moving parts of the engine.

 Do not connect the end of the second cable to the negative (-) terminal of the battery to be jumped. A spark may cause an explosion of the gases that surround the battery.

### Jump starting

1. Start the booster vehicle and run the engine at moderately increased speed.
2. Start the engine of the vehicle with the discharged battery.
3. Once the engine has been started, run both vehicles for a further three minutes before disconnecting the leads.

### Removing the jumper cables

1. Remove the jumper cables in reverse order. Take the cable off the metallic surface (1) first, followed by the cable on the negative (-) booster battery terminal (2).
2. Remove the cable from the positive (+) terminal of the booster battery (3) and then the discharged battery (4).
3. After the disabled vehicle has been started, allow it to idle for a while so the engine can “relearn” its idle conditions.

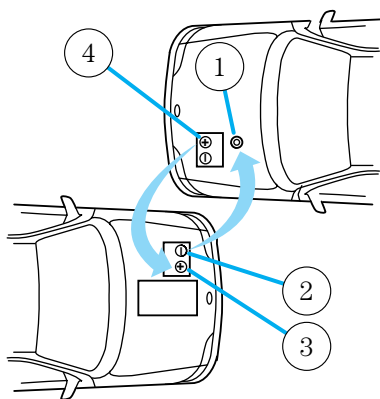



# Roadside emergencies

## WRECKER TOWING

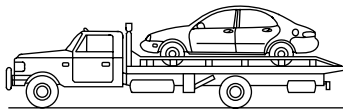
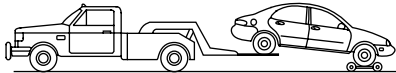
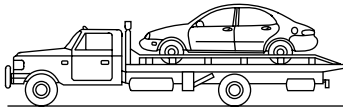
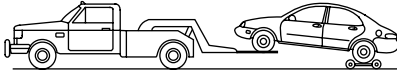

If you need to have your vehicle towed, contact a professional towing service or, if you are a member, your roadside assistance center. It is recommended that your vehicle be towed with a wheel lift or flatbed equipment.

When calling for a tow truck, tell the operator what kind of vehicle you have. A towing manual is available from Ford Motor Company for all authorized tow truck operators. Have your tow truck driver refer to this manual for proper hook-up and towing procedures for your vehicle.

## Roadside emergencies

### **TOWING BEHIND ANOTHER VEHICLE**

Do not tow your vehicle behind another vehicle, such as an RV, unless front wheel dollies are used.

Your vehicle cannot be flat towed with all wheels on the ground.

### SERVICE RECOMMENDATIONS

To help you service your vehicle:

- We highlight do-it-yourself items in the engine compartment for easy location.
- We provide a “Service Guide” which makes tracking routine service easy.

If your vehicle requires professional service, your dealership can provide necessary parts and service. Check your “Warranty Guide” to find out which parts and services are covered.

Use only recommended fuels, lubricants, fluids and service parts conforming to specifications. Motorcraft parts are designed and built to provide the best performance in your vehicle.

### PRECAUTIONS WHEN SERVICING YOUR VEHICLE

Be especially careful when inspecting or servicing your vehicle.

- Do not work on a hot engine.



The cooling fan is automatic and may come on at any time. Always disconnect the negative terminal of the battery before working near the fan.

- When the engine is running, avoid wearing loose clothing, jewelry or long hair that could get caught up in moving parts.

## Maintenance and care

- Do not work on a vehicle with the engine running in an enclosed space, unless you are sure you have enough ventilation.
- Keep all lit cigarettes, open flames and other lit material away from the battery and all fuel related parts.

If you disconnect the battery, the engine must “relearn” its idle conditions before your vehicle will drive properly, as explained in the *Battery* section in this chapter.

### Working with the engine off

- Automatic transaxle:
  1. Set the parking brake and

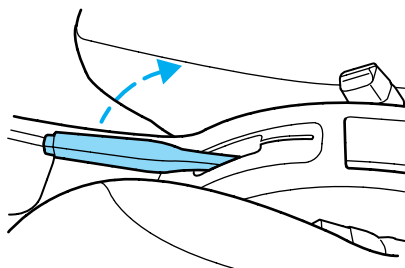

## Maintenance and care

ensure the gearshift is securely latched in P (Park).

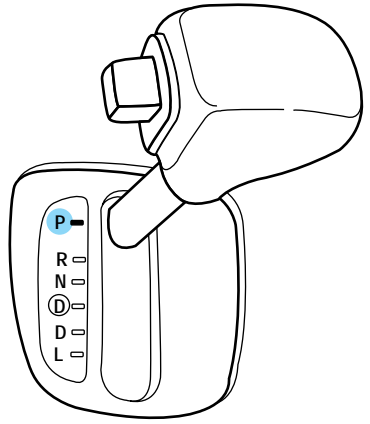

2. Turn off the engine and remove the key.

3. Block the wheels to prevent the vehicle from moving unexpectedly.

- Manual transaxle:

1. Set the parking brake,

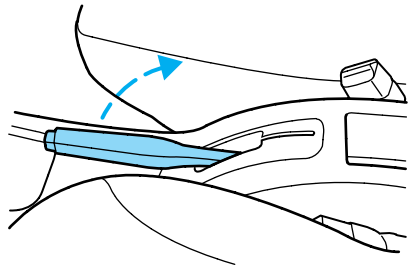

## Maintenance and care

depress the clutch and place the gearshift in 1 (First).

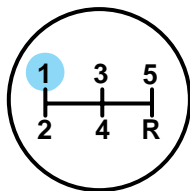
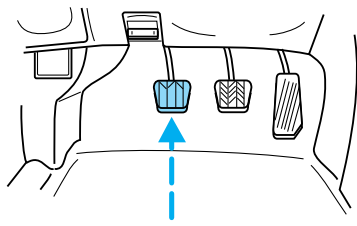

2. Turn off the engine and remove the key.

3. Block the wheels to prevent the vehicle from moving unexpectedly.

### Working with the engine on

- Automatic transaxle:

1. Set the parking brake and

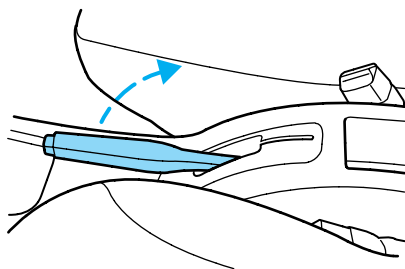

## Maintenance and care

ensure the gearshift is securely latched in P (Park).

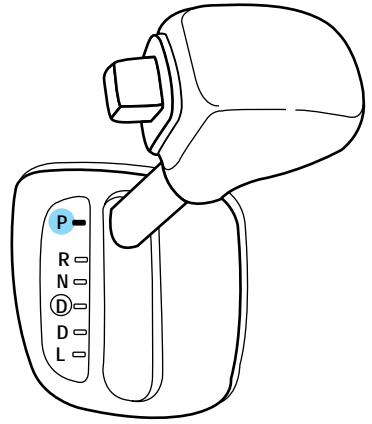

2. Block the wheels to prevent the vehicle from moving unexpectedly.



Do not start your engine with the air cleaner removed and do not remove it while the engine is running.

• Manual transaxle:

1. Set the parking brake,

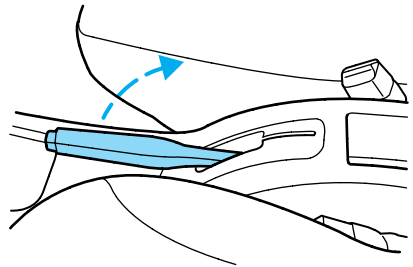

## Maintenance and care

depress the clutch and place the gearshift in N (Neutral).

2. Block the wheels to prevent the vehicle from moving unexpectedly.

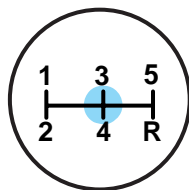
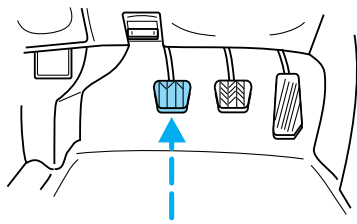

Do not start your engine with the air cleaner removed and do not remove it while the engine is running.

### OPENING THE HOOD

1. Inside the vehicle, pull the hood release handle located under the bottom left corner of the instrument panel.

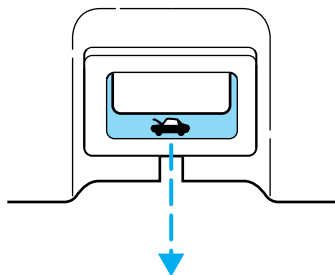

2. Go to the front of the vehicle and release the auxiliary latch that is located under the front center of the hood.



## Maintenance and care

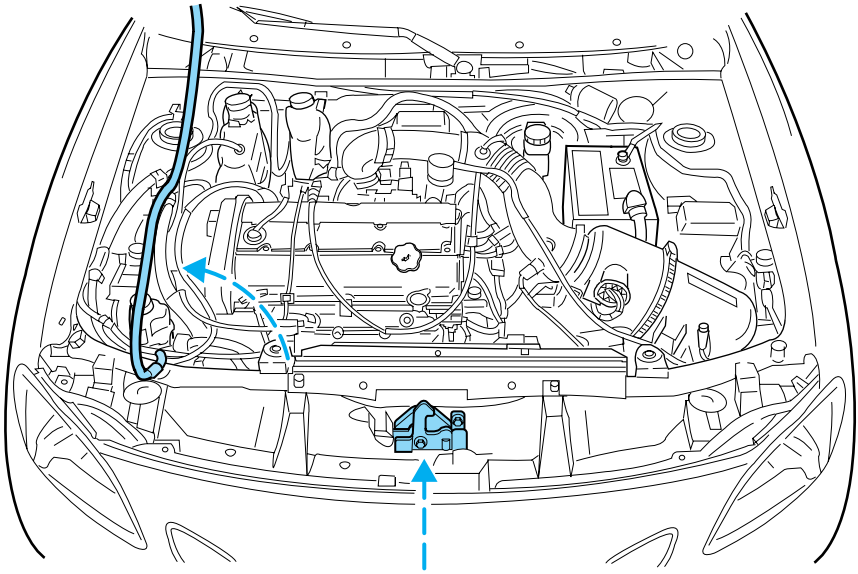

3. Lift the hood and secure it with the prop rod.

## Maintenance and care

### IDENTIFYING COMPONENTS IN THE ENGINE COMPARTMENT

#### 2.0L SOHC engine

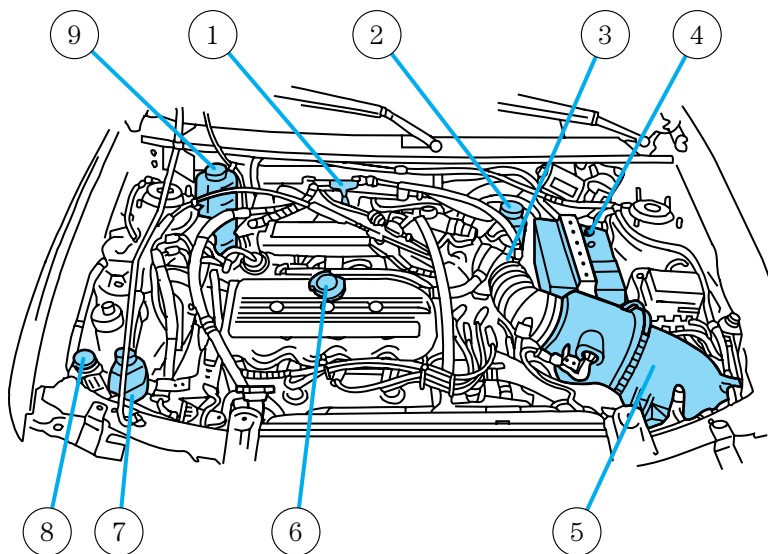

1. Engine oil dipstick
2. Brake fluid reservoir
3. Transmission fluid dipstick (automatic transaxle only)
4. Battery
5. Air filter assembly
6. Engine oil fill cap
7. Power steering fluid reservoir
8. Engine coolant reservoir
9. Windshield washer fluid reservoir

### 2.0L DOHC Zetec engine

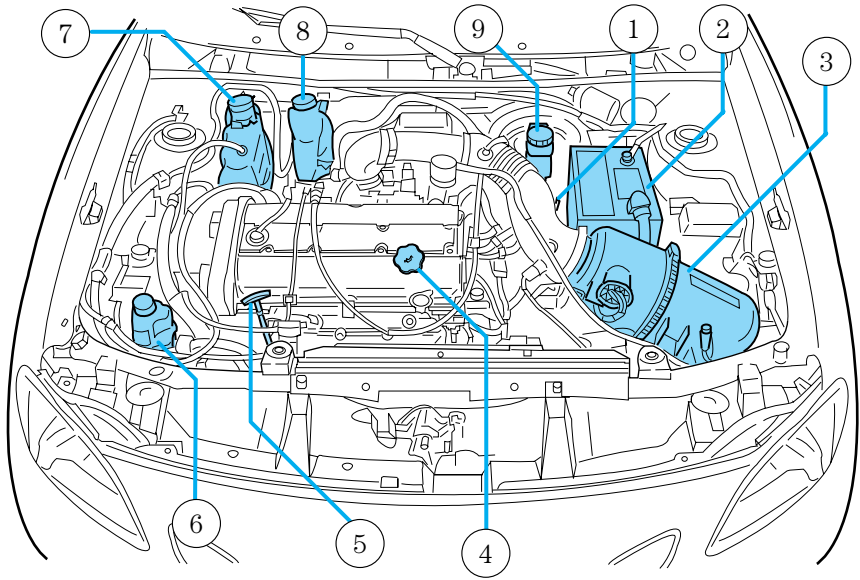

1. Transmission fluid dipstick  
(automatic transaxle only)
2. Battery
3. Air filter assembly
4. Engine oil fill cap
5. Engine oil dipstick
6. Power steering fluid reservoir
7. Engine coolant reservoir
8. Windshield washer fluid reservoir
9. Brake fluid reservoir

# Maintenance and care

## ENGINE OIL

### Checking the engine oil

Check the engine oil each time you fuel your vehicle.

1. Make sure the vehicle is on level ground.
  2. Turn the engine off and wait a few minutes for the oil to drain into the oil pan.
  3. Set the parking brake and ensure the gearshift is securely latched in P (automatic transaxle) or 1st (manual transaxle).
  4. Open the hood. Protect yourself from engine heat.
  5. Locate and carefully remove the engine oil indicator (dipstick).
- 2.0L SOHC engine

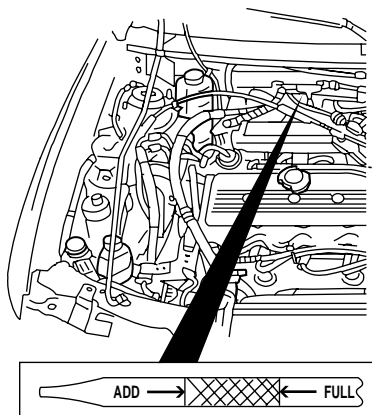

## Maintenance and care

- 2.0L DOHC Zetec engine

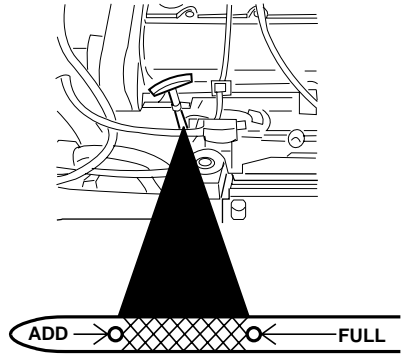

6. Wipe the indicator clean. Insert the indicator fully, then remove it again.

- If the oil level is **between the ADD and FULL marks**, the oil level is acceptable. **DO NOT ADD OIL.**
- If the oil level is below the ADD mark, add enough oil to raise the level within the ADD-FULL range.

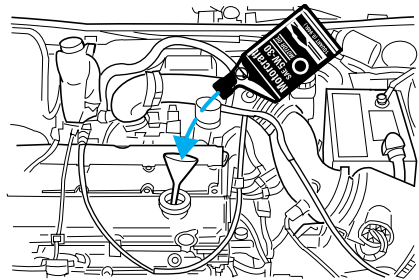

- Oil levels above the F in FULL may cause engine damage. Some oil must be removed from the engine by a service technician.

7. Put the indicator back in and ensure it is fully seated.

## Maintenance and care

### Adding engine oil

1. Check the engine oil. For instructions, refer to *Checking the engine oil* in this chapter.
2. If the fluid level is not within the normal range, add only certified engine oil of the preferred viscosity. Add engine oil through the oil filler cap. Remove the filler cap and use a funnel to pour oil in the opening.
3. Recheck the oil level. Make sure the oil level is not above the F in FULL mark on the dipstick.

### Engine oil recommendations

Look for this certification mark.

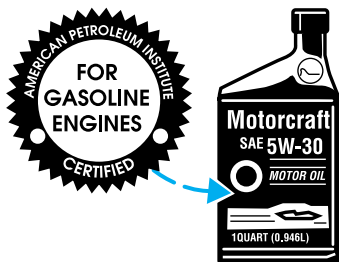

Ford oil specification is WSS-M2C153-G.

Use SAE 5W-30 motor oil certified for gasoline engines by the American Petroleum Institute.

Do not use supplemental engine oil additives, oil treatments or engine treatments. They are unnecessary and could, under certain conditions, lead to engine damage which is not covered by your warranty.

### Changing the engine oil and filter

Change your engine oil and filter according to the following mileage and time requirements, whichever occurs first:

- Normal Schedule – 8,000 km (5,000 miles) or six months.
- Severe Duty Schedule - 5,000 km (3,000 miles) or three months. Severe duty operation would include extensive idling, trailer towing, driving in severe dust and police, taxi or delivery service.

Ford production and aftermarket (Motorcraft) oil filters are designed for added engine protection and long life. If a replacement oil filter is used that does not meet Ford material and design specifications, startup engine noises or knock may be experienced.

It is recommended you use the appropriate Motorcraft oil filter (or another brand meeting Ford specifications) for your engine application.

## Maintenance and care

### BRAKE FLUID

#### Checking and adding brake fluid

Brake fluid should be checked and refilled as needed at least once each year:

- Clean the reservoir cap before removal to prevent dirt or water from entering the reservoir.
- Visually inspect the fluid level.
- If necessary, add brake fluid until the level reaches MAX. Do not fill above this line.
- Use only a DOT 3 brake fluid certified to meet Ford specifications. Refer to *Lubricant specifications* in the *Capacities and specifications* chapter.

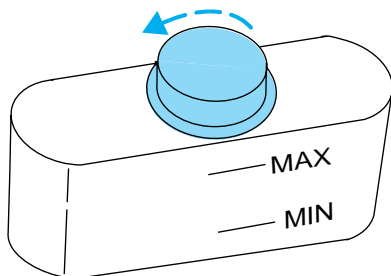
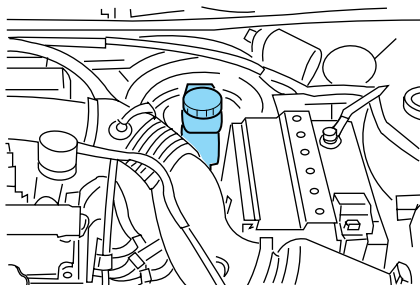

Brake fluid is toxic.



If you use a brake fluid that is not DOT 3, you will cause permanent damage to your brakes.



Do not let the reservoir for the master cylinder run dry. This may cause the brakes to fail.



## Maintenance and care

### CLUTCH FLUID (IF EQUIPPED)

The clutch master cylinder and brake master cylinder are part of the same system; both are refillable through the brake master cylinder with brake fluid. During normal operation, the fluid level in the brake fluid reservoir will rise slowly. For more information on brake fluid maintenance, refer to *Brake fluid* in this chapter.

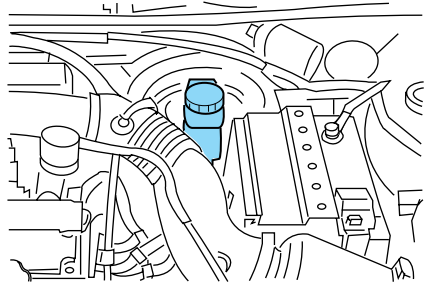

### WINDSHIELD WASHER FLUID

#### Checking and adding washer fluid

Check the washer fluid whenever you stop for fuel. The reservoir is highlighted with a  symbol.

If the level is low, add enough fluid to fill the reservoir. In very cold weather, do not fill the reservoir all the way.

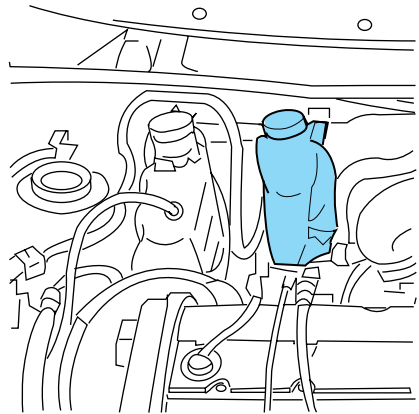

Do not put engine coolant in the container for the windshield washer fluid.

## Maintenance and care

### ENGINE COOLANT

- Coupe

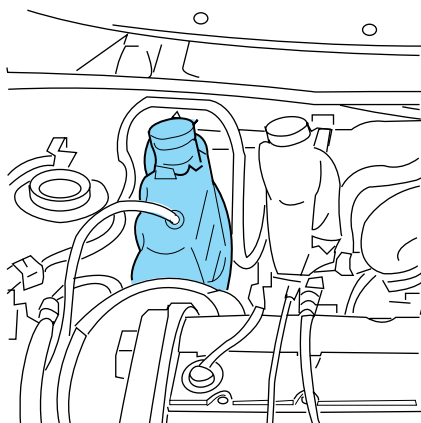

- Sedan/Wagon

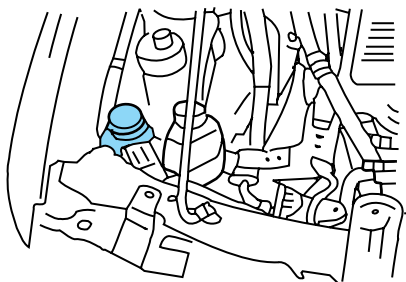

Check the level of the coolant in the reservoir at least once a month. Be sure to read and understand *Precautions when servicing your vehicle* in this chapter.

If the engine coolant has not been checked for a long period of time, the engine coolant reservoir may eventually empty. If this occurs, add engine coolant to the coolant reservoir. For more information on engine coolant maintenance, refer

to *Adding engine coolant* in this chapter.

Automotive fluids are not interchangeable; do not use engine coolant, antifreeze or windshield washer fluid outside of its specified function and vehicle location.

### Adding engine coolant



Do not put engine coolant in the container for the windshield washer fluid.

If sprayed on the windshield, engine coolant could make it difficult to see through the windshield.

When the engine is cool, add a 50/50 mixture of engine coolant and water to the engine coolant recovery reservoir-DO NOT ADD DIRECTLY TO THE RADIATOR. Add straight water only in an emergency, but you should replace it with a 50/50 mixture of coolant and distilled water as soon as possible.

Check the coolant level in the coolant recovery reservoir the next few times you drive the vehicle. If necessary, add enough of a 50/50 mixture of coolant and water to bring the liquid level to the fill line on the reservoir.



Never remove the coolant recovery cap while the engine is running or hot.

## Maintenance and care

If you must remove the coolant recovery cap, follow these steps to avoid personal injury:

1. Before you remove the cap, turn the engine off and let it cool.
2. When the engine is cool, wrap a thick cloth around the cap. Slowly turn cap counterclockwise to the first stop.
3. Step back while the pressure releases.
4. When you are sure that all the pressure has been released, use the cloth to press the cap down, turn it counterclockwise and remove it.

Use Ford Premium Cooling System Fluid E2FZ-19549-AA (in Canada, Motorcraft CXC-8-B) or an equivalent premium engine coolant that meets Ford specification ESE-M97B44-A. Ford Premium Engine Coolant is an optimized formula that will protect all metals and rubber elastomers used in Ford cooling systems for four years or 80,000 km (50,000 miles).

Do not use alcohol or methanol antifreeze or any engine coolants mixed with alcohol or methanol antifreeze. Do not use supplemental coolant additives in your vehicle. These additives may harm your engine cooling system. The use of an improper coolant may void your warranty of your vehicle's engine cooling system.

### Recycled engine coolant

Ford Motor Company recommends that Ford and Lincoln-Mercury dealers use recycled engine coolant produced by Ford-approved processes. Not all coolant recycling processes produce coolant which meets Ford specification ESE-M97B44-A, and use of such coolant may harm engine and cooling system components.



Always dispose of used automotive fluids in a responsible manner. Follow your community's regulations and standards for recycling and disposing of automotive fluids.

### Coolant refill capacity

To find out how much fluid your vehicle's cooling system can hold, refer to *Refill capacities* in the *Capacities and specifications* chapter.

Have your dealer check the engine cooling system for leaks if you have to add more than a liter (quart) of engine coolant per month.

### Severe winter climate

If you drive in extremely cold climates (less than  $-36^{\circ}\text{C}$  [ $-34^{\circ}\text{F}$ ]), it may be necessary to increase the coolant concentration above 50%. Refer to the chart on the coolant container to ensure the coolant concentration in your vehicle is

## Maintenance and care

such that the coolant will not freeze at the temperature level in which you drive during winter months. Never increase the engine coolant concentration above 60%. Leave a 50/50 mixture of engine coolant and water in your vehicle year-round in non-extreme climates.

### CHECKING AND ADDING POWER STEERING FLUID

Check the power steering fluid at least twice a year. If adding fluid is necessary, use only MERCON® ATF power steering fluid.

- Coupe

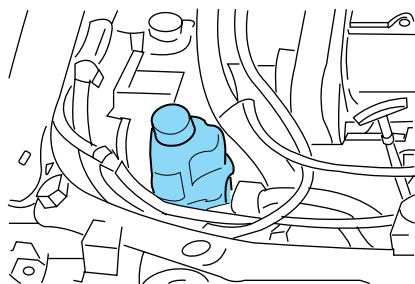

- Sedan/Wagon

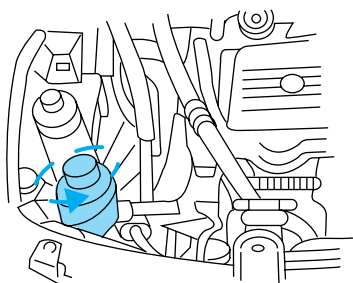

1. Start the engine and let it run until it reaches normal operating temperature (the engine coolant temperature gauge will be near the

- center of the NORMAL band).
2. While the engine idles, turn the steering wheel left and right several times.
  3. Turn the engine off.
  4. Check the fluid level in the reservoir. It should be between the MIN and MAX lines. Do not add fluid if the level is in this range.
  5. If the fluid is low, add fluid in small amounts, continuously checking the level until it reaches the range between the MIN and MAX lines. Be sure to put the cap back on the reservoir.

### TRANSMISSION FLUID

#### Checking and adding automatic transmission fluid

Follow the scheduled service intervals outlined in the “Service Guide.”

Before adding any fluid, make sure the correct type is used. The type of fluid used is normally indicated on the dipstick and/or dipstick handle and also in the *Lubricant specifications* section in the *Capacities and specifications* chapter.

Do not drive the vehicle if the fluid level is below the hole at the bottom of the dipstick and outside temperatures are above 10°C (50°F).

Your transaxle does not use up fluid. However, it is recommended that you check the transmission

## Maintenance and care

fluid at least twice a year. The fluid level should be checked if the transmission is not working properly, i.e., if the transaxle slips or shifts slowly or if you notice some sign of fluid leakage.

Transmission fluid should be checked at normal operating temperatures 66°C-77°C (150°F-170°F) on a level surface. The normal operating temperature can be reached after approximately 32 km (20 miles) of driving.

If your vehicle has been operated for an extended period at high speeds, in city traffic during hot weather or pulling a trailer, the vehicle should be turned off for about 30 minutes to allow the fluid to cool before checking.

1. Park the vehicle on a level surface and engage the parking brake.
2. With the parking brake engaged and your foot on the brake pedal, start the engine and move the gearshift lever through all of the gear ranges. Allow sufficient time for each gear to engage.
3. Latch the gearshift lever in P (Park) and leave the engine running.
4. Remove the dipstick, wiping it clean with a clean, dry lint free rag.
5. Install the dipstick making sure it is fully seated in the filler tube.

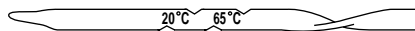



6. Remove the dipstick and inspect the fluid level. The fluid level should be between the notches on the dipstick.
7. If necessary, add fluid in .25L (1/2 pint) increments through the filler tube until the level is correct.
8. If an overfill occurs, excess fluid should be removed by a qualified technician.

### Checking and adding manual transmission fluid

The lubricant level and quality should not deteriorate under normal conditions. However, you should have the fluid checked occasionally. If lubricant is required, refer to *Lubricant specifications* in this section.

### BATTERY

Your vehicle may be equipped with a Motorcraft maintenance-free battery. If the original equipment battery needs replacing, it may be replaced with a low-maintenance battery. The low-maintenance battery normally does not require additional water during its life of service. However, for severe usage or in high temperature climates, check your battery electrolyte level, at least every 24 months or 40,000 km (24,000 miles). Keep the electrolyte in each cell up to the “level” indicator. Do not overfill the battery cells.

If the electrolyte level in the battery is low, you can add plain

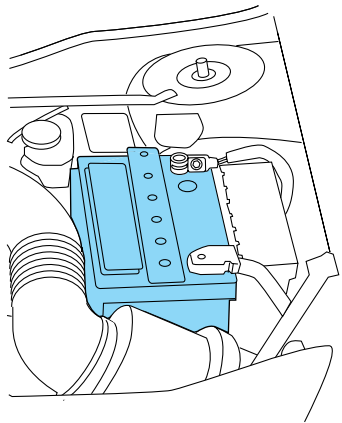

## Maintenance and care

tap water to the battery, as long as you do not use hard water (water with a high alkali content). If possible, however, try to only fill the battery cells with distilled water. If the battery needs water often, have the charging system checked.

For longer, trouble-free operation, keep the top of the battery clean and dry. Also, make certain the battery cables are always tightly fastened to the battery terminals.

If you see any corrosion on the battery or terminals, remove the cables from the terminal(s) and clean with a wire brush. You can neutralize the acid with a solution of baking soda and water. Reinstall the cables when you are done cleaning them, and apply a small quantity of grease to the top of each battery terminal to help prevent corrosion.

**If your battery has a cover/shield, make sure it is reinstalled after the battery is replaced.**

Because your vehicle's engine is electronically controlled by a computer, some control conditions are maintained by power from the battery. When the battery is disconnected or a new battery is installed, the engine must relearn its idle conditions before your vehicle will drive properly. To begin this process:

1. Put the gearshift in P (Park) (automatic transaxles) or the

## Maintenance and care

neutral position (manual transaxles), turn off all accessories and start the vehicle.

2. Let the engine idle for at least one minute.

3. The relearning process will automatically complete as you drive the vehicle.

- If you do not allow the engine to relearn its idle, the idle quality of your vehicle may be adversely affected until the idle is eventually relearned.
- If the battery has been disconnected or a new battery has been installed, the clock and the preset radio stations must be reset once the battery is reconnected.
- Always dispose of automotive batteries in a responsible manner. Follow your communities standards for disposal. Call your local recycling center to find out more about recycling automotive batteries.



## Maintenance and care

### AIR FILTER

To replace your air filter, release the clamp locking clip on the front portion of the air filter housing, then swing the left side open and remove the air filter. When installing the air filter, ensure the nubs on the air filter and the air filter housing are aligned. Swing the left side of the air filter housing closed and secure the clamp.

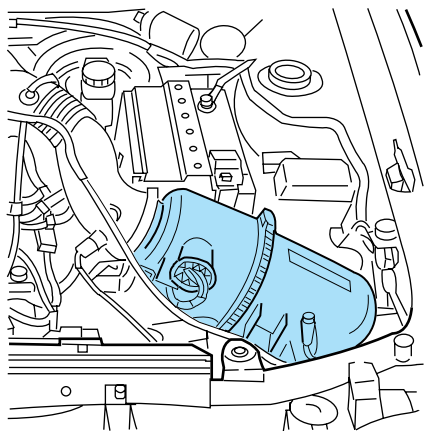

### WINDSHIELD WIPER BLADES

Check the wiper blades at least twice a year or when they seem less effective. Substances such as tree sap and some hot wax treatments used by commercial car washes reduce the effectiveness of wiper blades.

#### Checking the wiper blades

If the wiper blades do not wipe properly, clean both the windshield and wiper blades using undiluted windshield wiper solution or a mild detergent. Rinse thoroughly with clean water. To avoid damaging the blades, do not use fuel, kerosene, paint thinner or other solvents.

#### Changing the wiper blades

When replacing wiper blade assemblies, always use a Motorcraft part or equivalent. To

## Maintenance and care

make replacing the wipers easy, turn the ignition to ACC, then turn the wipers on. When the wipers reach the vertical position, turn the ignition to LOCK.

To replace the wiper blades:

1. Pull the wiper arm away from the windshield and lock into the service position.
2. Turn the blade at an angle from the wiper arm. Push the lock pin with a screwdriver to release the blade and pull the wiper blade down toward the windshield to remove it from the arm.
3. Attach the new wiper to the wiper arm and press it into place until a click is heard.

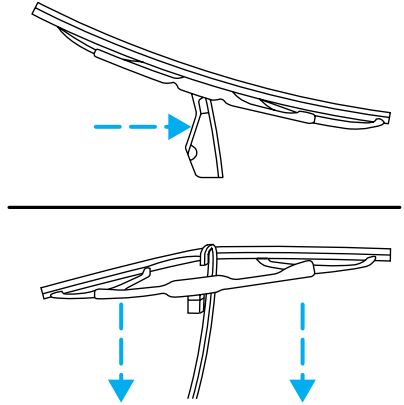

### INFORMATION ABOUT TIRE QUALITY GRADES

New vehicles are fitted with tires that have their Tire Quality Grade (described below) molded into the tire's sidewall. These Tire Quality Grades are determined by standards that the United States Department of Transportation has set.

Tire Quality Grades apply to new pneumatic tires for use on passenger cars. They do not apply to deep tread, winter-type snow tires, space-saver or temporary use spare tires, tires with nominal rim diameters of 10 to 12 inches or limited production tires as defined

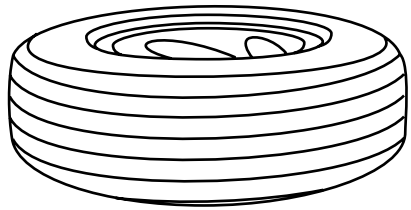

## Maintenance and care

in Title 49 Code of Federal Regulations Part 575.104(c)(2).

**U.S. Department of Transportation-Tire quality grades:** The U.S. Department of Transportation requires Ford to give you the following information about tire grades exactly as the government has written it.

### **Treadwear**

The treadwear grade is a comparative rating based on the wear rate of the tire when tested under controlled conditions on a specified government test course. For example, a tire grade 150 would wear one and one-half (1 1/2) times as well on the government course as a tire grade 100. The relative performance of tires depends upon the actual conditions of their use, however, and may depart significantly from the norm due to variations in driving habits, service practices, and differences in road characteristics and climate.

### **Traction A B C**

The traction grades, from highest to lowest are A, B, and C, and they represent the tire's ability to stop on wet pavement as measured under test surfaces of asphalt and concrete. A tire marked C may have poor traction performance.



The traction grade assigned to this tire is based on braking (straight ahead) traction tests and does not include cornering (turning) traction.

### Temperature A B C

The temperature grades are A (the highest), B, and C, representing the tire's resistance to the generation of heat and its ability to dissipate heat when tested under controlled conditions on a specified indoor laboratory test wheel. Sustained high temperature can cause the material of the tire to degenerate and reduce tire life, and excessive temperature can lead to sudden tire failure. The grade C corresponds to a level of performance which all passenger car tires must meet under the Federal Motor Vehicle Safety Standard No. 109. Grades B and A represent higher levels of performance on the laboratory test wheel than the minimum required by law.



The temperature grade for this tire is established for a tire that is properly inflated and not overloaded. Excessive speed, underinflation, or excessive loading, either separately or in combination, can cause heat buildup and possible tire failure.

# Maintenance and care

## SERVICING YOUR TIRES

### Checking the tire pressure

- Use an accurate tire pressure gauge.
- Check the tire pressure when tires are cold, after the vehicle has been parked for at least one hour or has been driven less than 5 km (3 miles).
- Adjust tire pressure to recommended specifications found on the Safety Compliance Certification Label.



Improperly inflated tires can affect vehicle handling and can fail suddenly, possibly resulting in loss of vehicle control.

### Tire rotation

Because your vehicle's tires perform different jobs, they often wear differently. To make sure your tires wear evenly and last longer, rotate them as indicated in the "Service Guide." If you notice that the tires wear unevenly, have them checked.



## Maintenance and care

- Four tire rotation

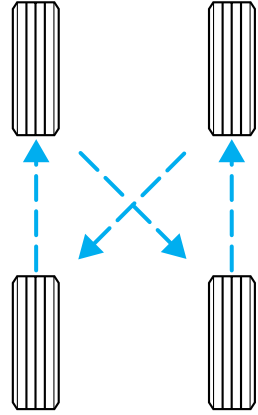

### Replacing the tires

Replace the tires when the wear band is visible through the tire treads.

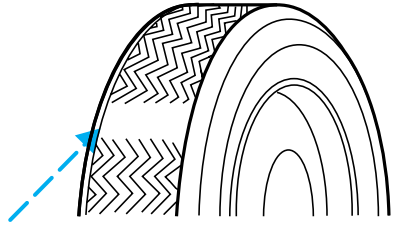

Failure to follow these precautions may adversely affect the handling of the vehicle and make it easier to lose control and roll over.

Tires that are larger or smaller than your vehicle's original tires may also affect the accuracy of your speedometer.

## Maintenance and care

### SNOW TIRES AND CHAINS



Snow tires must be the same size and grade as the tires you currently have on your vehicle.

The tires on your vehicle have all weather treads to provide traction in rain and snow. However, in some climates, you may need to use snow tires and chains. If you need to use snow tires and chains, you must install steel wheels of the same size and specifications as those originally installed.

Follow these guidelines when using snow tires and chains:

- Use only SAE Class S chains.
- Install chains securely, verifying that the chains do not touch any wiring, brake lines or fuel lines.
- Drive cautiously. If you hear the chains rub or bang against your vehicle, stop and re-tighten the chains. If this does not work, remove the chains to prevent damage to your vehicle.
- If possible, avoid fully loading your vehicle.
- Do not use tire chains on aluminum wheels. Chains may chip the wheels.
- Do not use tire chains with 38 cm (15 inch) wheel/tire options. Using chains on this size tire may cause damage to steering, suspension and/or body components.

## Maintenance and care

- Remove the tire chains when they are no longer needed. Do not use tire chains on dry roads.
- The suspension insulation and bumpers will help prevent vehicle damage. Do not remove these components from your vehicle when using snow tires and chains.

### WHAT YOU SHOULD KNOW ABOUT AUTOMOTIVE FUELS

#### Important safety precautions



Do not overfill the fuel tank. The pressure in an overfilled tank may cause leakage and lead to fuel spray and fire.



If you do not use the proper fuel cap, the pressure in the fuel tank can damage the fuel system or cause it to work improperly in a collision.



The fuel system may be under pressure. If the fuel cap is venting vapor or if you hear a hissing sound, wait until it stops before completely removing the cap.



Automotive fuels can cause serious injury or death if misused or mishandled.

## Maintenance and care

Observe the following guidelines when handling automotive fuel:

- Extinguish all smoking materials and any open flames before fueling your vehicle.
- Always turn off the vehicle before fueling.
- Automotive fuels can be harmful or fatal if swallowed. If fuel is swallowed, call a physician immediately, even if no symptoms are immediately apparent. The toxic effects of fuel may not be visible for hours.
- Fuels can also be harmful if absorbed through the skin. If fuel is splashed on the skin, promptly remove contaminated clothing and wash skin thoroughly with soap and water.
- If fuel is splashed in the eyes, remove contact lenses, flush with water for 15 minutes and seek medical attention.
- Be particularly careful if you are taking “Antabuse” or other forms of disulfiram for the treatment of alcoholism. Breathing gasoline vapors or skin contact could cause an adverse reaction. Consult a physician immediately.

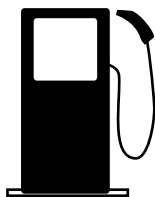

### Choosing the right fuel

Use only UNLEADED FUEL. The use of leaded fuel is prohibited by law and could damage your vehicle.

Your vehicle was not designed to use fuel or fuel additives with metallic compounds, including manganese-based compounds containing MMT.

Vehicles certified to California emission standards (indicated on the underhood Vehicle Emissions Control Information label) are designed to operate on California reformulated gasolines. If California reformulated gasoline is not available when you refuel, your vehicle can be operated on non-California fuels. However, even though your engine will perform adequately on other gasolines, the performance of the emission control devices and systems may be adversely affected.

Repair of damage caused by using a fuel that your vehicle was not designed for may not be covered by your warranty.

### Octane recommendations

Your vehicle is designed to use regular unleaded with an (R+M)/2 octane rating of 87. We do not recommend gasolines labeled as “regular” in high altitude areas that are sold with octane ratings of 86 or even less.

Do not be concerned if your vehicle sometimes knocks lightly. However, if it knocks heavily under most driving conditions on fuel with the recommended octane, see your dealer or a qualified service

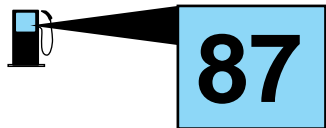

## Maintenance and care

technician to prevent any engine damage.

### Fuel quality

If you are experiencing starting, rough idle or hesitation problems try a different brand of fuel. If the condition persists, see your dealer or a qualified service technician.

The American Automobile Manufacturers Association (AAMA) issued a gasoline specification to provide information on high quality fuels that optimize the performance of your vehicle. We recommend the use of gasolines that meet the AAMA specification if they are available.

It should not be necessary to add any aftermarket products to your fuel tank if you continue to use a high-quality fuel.

### Cleaner air

Ford approves the use of gasolines to improve air quality, including reformulated gasolines that contain oxygenates up to 10% ethanol or 15% MTBE.

Do not use gasolines containing methanol, which can damage critical fuel system components. Damage resulting from the use of methanol may not be covered by your warranty.

### Running out of fuel

Avoid running out fuel because this situation may have an adverse

affect on modern powertrain components.

You may need to crank the engine several times before the system starts to pump fuel from the tank to the engine. If you run out of fuel, your Service Engine Soon light may come on. For more information on the Service Engine Soon light, refer to the *Instrumentation* chapter.

### Calculating fuel economy

To accurately calculate your vehicle's fuel economy:

1. Fill the tank completely and record the initial odometer reading.
2. Each time you fill the tank, record the amount of fuel added (in liters or gallons).
3. After at least three to five fuel tank fill-ups, fill the fuel tank and record the current mileage reading.
4. Use one of the following equations to calculate fuel economy.

Liters used  $\times$  100  $\div$  Total kilometers traveled

Total miles traveled  $\div$  Total gallons used

Keep a record for at least one month. This will provide an accurate estimate of the vehicle's fuel economy.

## Maintenance and care

### EMISSION CONTROL SYSTEM

Your vehicle is equipped with various emission control components and a catalytic converter which will enable your vehicle to comply with applicable exhaust emission standards. To make sure that the catalytic converter and other emission control components continue to work properly:

- Use only unleaded fuel.
- Avoid running out of fuel.
- Do not turn off the ignition while your vehicle is moving, especially at high speeds.
- Have the services listed in your “Service Guide” performed according to the specified schedule.

The Scheduled Maintenance Services listed in the “Service Guide” are required because they are considered essential to the life and performance of your vehicle and to its emissions system.

If other than Ford, Motorcraft or Ford authorized parts are used for maintenance replacements or for service of components affecting emission control such non-Ford parts should be equivalent to genuine Ford Motor Company parts in performance and durability.



## Maintenance and care



Do not park, idle, or drive your vehicle in dry grass or other dry ground cover. The emission system heats up the engine compartment and exhaust system, which can start a fire.

Watch for fluid leaks, strange odors, smoke, loss of oil pressure, the charging system warning light, the “Service Engine Soon” light or the temperature warning light. These events could indicate that the emission control system is not working properly.



If you smell exhaust fumes of any kind inside your vehicle, have the dealer inspect and fix your vehicle immediately. Do not drive if you smell exhaust fumes. These fumes are harmful and could kill you.

Do not make any unauthorized changes to your vehicle or engine. By law, vehicle owners and anyone who manufactures, repairs, services, sells, leases, trades vehicles, or supervises a fleet of vehicles are not permitted to intentionally remove an emission control device or prevent it from working. Information about your vehicle’s emission system is on the Vehicle Emission Control Information Decal located on or near the engine. This decal identifies engine displacement and gives some tune up specifications.

## Maintenance and care

Please consult your “Warranty Guide” for complete emission warranty information.

### **Readiness for inspection/maintenance (I/M) testing**

In some localities, it may be a legal requirement to pass an I/M test of the on-board diagnostic (OBD-II) system. If your “check engine/service engine soon” light is on, reference the applicable light description in the *Warning Lights and Chimes* section of your owners guide. Your vehicle may not pass the I/M test with the “check engine/service engine soon” light on.

If the vehicle’s powertrain system or its battery has just been serviced, the OBD-II system is reset to a “not ready for I/M test” condition. To ready the OBD-II system for I/M testing, a minimum of 30 minutes of city and highway driving is necessary as described below:

- First, at least 10 minutes of driving on an expressway or highway.
- Next, at least 20 minutes driving in stop and go, city type traffic with at least four idle periods.

Allow the vehicle to sit for at least eight hours without starting the engine. Then, start the engine and complete the above driving cycle. The engine must warm up to its normal operating temperature.

## Maintenance and care

Once started, do not turn off the engine until the above driving cycle is complete.

### EXTERIOR BULBS

It is a good idea to check the operation of the following lights frequently:

- Headlamps
- Turn signals
- Foglamps (if equipped)

Coupe

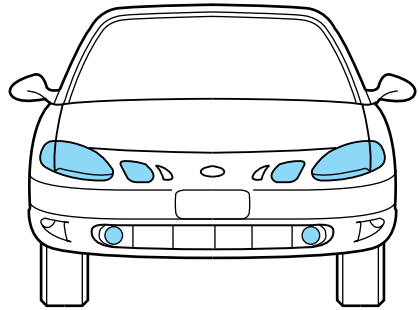

Sedan/wagon

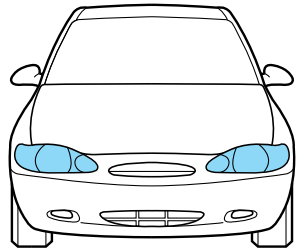

- High-mount brake lamp
- Tail lamps
- Brake lamps
- Backup lamps
- License plate lamp

## Maintenance and care

Sedan

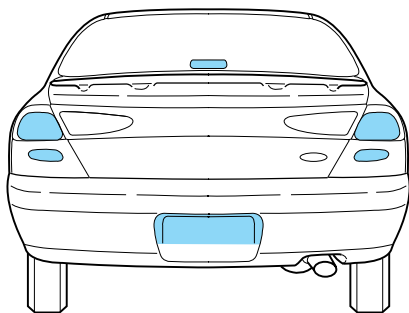

Wagon

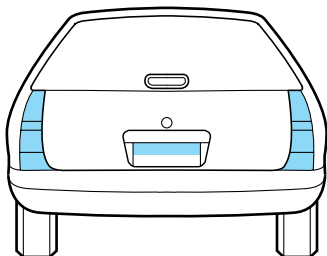

Coupe

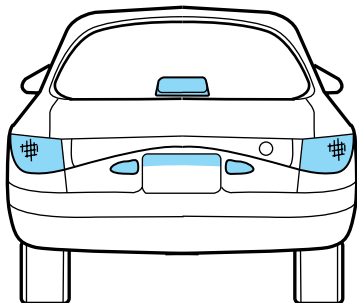

- Hazard flashers
- Interior overhead lamps

Do not remove lamp bulbs unless they will be replaced immediately. If a bulb is removed for an extended period of time, contaminants may enter the lamp housings and affect performance.

## Maintenance and care



Handle a halogen bulb carefully and keep out of children's reach. Grasp the bulb only by its plastic base and do not touch the glass; the oil from your hand could cause the bulb to break the next time that the headlamps are operated.

### Replacing headlamp bulbs

1. Make sure that the headlamps are turned OFF.

Coupe

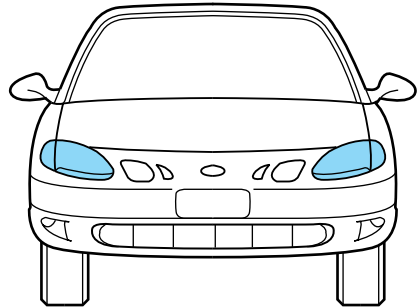

Sedan/wagon

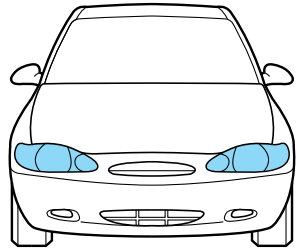

2. Open the hood and find the headlamp wiring socket and disconnect from the in-line connector. This will make it easier to change the bulb.

## Maintenance and care

3. Remove the protective dust shield from the housing by turning the dust shield counterclockwise (when viewed from the rear).

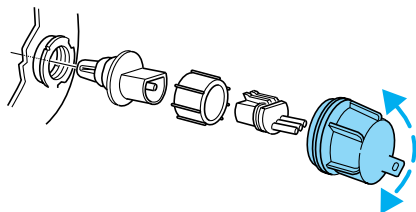

4. Disconnect the electrical connector from the bulb by pulling it straight out.

5. Remove the bulb retaining ring by rotating it counterclockwise (when viewed from the rear).

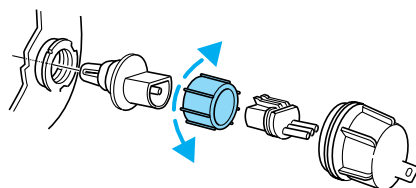

6. Remove the old bulb from its socket by pulling it straight back out of the socket. Do not turn the bulb while removing it.

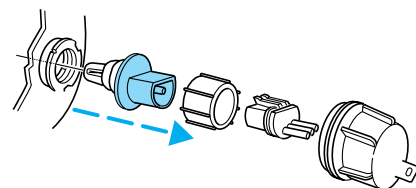

7. Replace the bulb by pushing a new one straight in with the bulb's plastic base facing upward. You may need to turn the bulb slightly to align the grooves in the plastic base with the tabs in the bulb socket.

8. Slip the bulb retaining ring over the plastic base and lock the ring by rotating it clockwise until it snaps into place.

9. Reconnect the electrical connector to the bulb.

## Maintenance and care

10. Replace the protective dust shield and lock the shield by rotating it clockwise until it locks into position.
11. Reconnect the headlamp wiring socket to the in-line connector.

### Foglamps (if equipped)

To change the foglamp bulbs:

1. Disconnect the electrical connector from the back of the foglamp assembly.
2. Twist, then pull the bulb from the foglamp assembly.
3. Install the new bulb.
4. Connect the electrical connector to the back of the foglamp assembly.

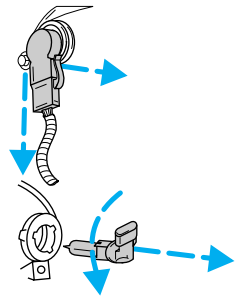
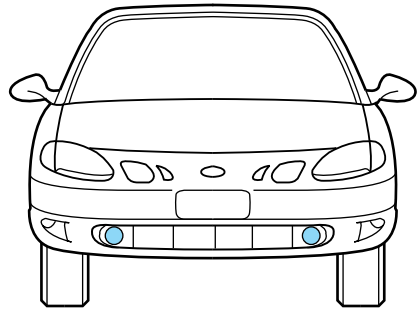

### High-mount brake lamp

The brake lamp is mounted with two fastener clips and an assembly cover on the package tray.

## Maintenance and care

Coupe

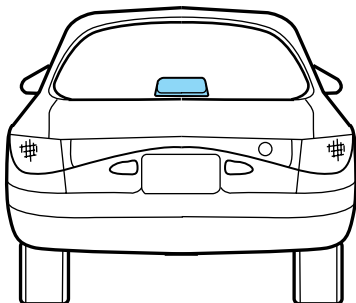

Sedan

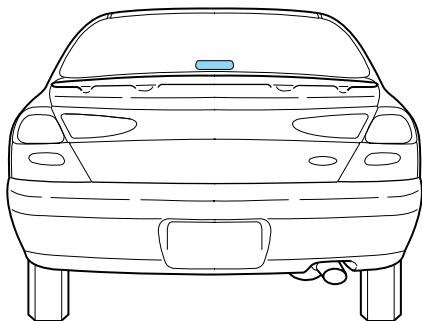

Wagon

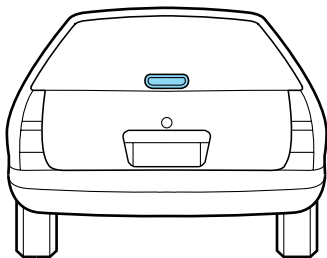

1. Remove the push pins and cover from the package tray.
2. Detach the socket from the housing and remove the bulb.
3. Replace the bulb and ease the socket back into the housing.



## Maintenance and care

4. Replace the housing cover and secure with the push pins.

### Tail lamps/Backup lamps

The tail lamp assemblies and the backup bulb assemblies are located in the same portion of the vehicle rear, one just below the other. Follow the same steps to replace either bulb.

Coupe

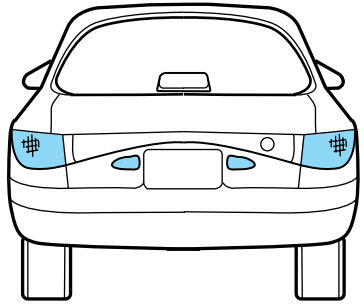

Sedan

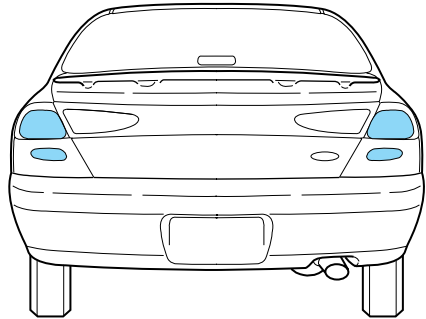

## Maintenance and care

### Wagon

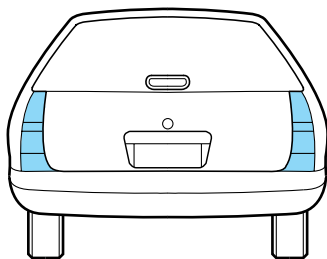

1. Open trunk to expose the tail lamp assembly. Remove the two screws from the front of the lamp.
2. The tail lamp has hidden fasteners which can be disengaged by hitting the lamp, with the side of your hand, toward the side of the vehicle.
3. Remove the socket that contains the burned-out bulb by rotating it counterclockwise, then pulling it out of the lamp assembly.
4. Pull the burned-out bulb from the socket and install the new bulb.
5. Push the socket into the lamp, then secure it by rotating it clockwise.
6. Position the tail lamp on the vehicle and gently tap the lens to engage the clips. Install the screws.

## Maintenance and care

### License plate lamps

To change the license plate bulbs:

1. Carefully remove screws and pull the license plate lamp assembly from the rear bumper.
2. Carefully pull the lamp lens from the assembly.
3. Remove the bulb to be replaced and install a new bulb.
4. Replace the lamp lens, assembly and screws.

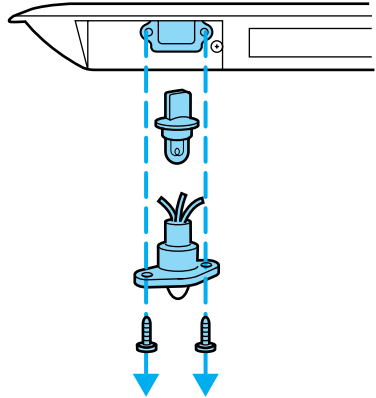

### INTERIOR BULBS

#### Dome lamp

1. Remove the lamp lens by applying pressure to both tabs at the top of the lamp and pulling lens downward.
2. Pull out the burned-out bulb and install a new one.
3. Install the lamp lens by applying pressure to both sides of the lamp lens and popping the lamp lens up on the assembly.

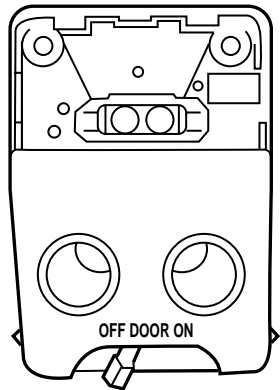

# Maintenance and care

## Using the right bulbs

Function	Trade Number
Front park/turn lamps	3457 NAK
Foglamps (if equipped)	881
Headlamps-aero high and low beam	9007
Rear license plate lamps	168
High-mount brake lamp	921
Backup lamps	3156K
Brake lamps	3157K
Interior overhead lamp	12V/10W
Warning lights	37
Instrument panel gauge	194

## Map lamps

For bulb replacement, see a qualified service technician or your dealer.

## AIMING THE HEADLAMPS

Your vehicle is equipped with a Vehicle Headlamp Aim Device (VHAD) on each headlamp. Each headlamp may be properly aimed in the vertical (up/down) and the horizontal (left/right) directions using your VHAD system. The headlamps on your vehicle are properly aimed at the assembly plant, and vertical and horizontal indicators of the VHAD system are calibrated.

A bubble (vertical indicator) that is not centered between the two red lines does not necessarily indicate out-of-aim headlamps. If your vehicle is not positioned on a level surface, the slope will be

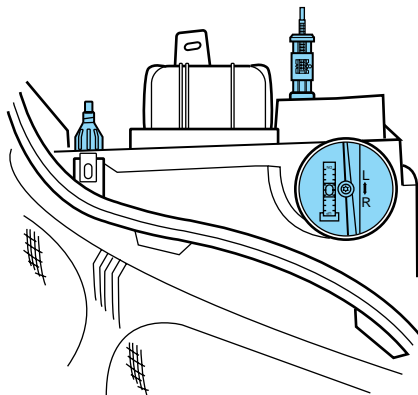

included in the vertical indication. Therefore, vertical and horizontal headlamp adjustment should be performed only when the beam direction appears to be incorrect.

You will need one 4 mm wrench or socket with ratchet to make the adjustments.

The following procedure assumes that the factory set horizontal indicator reference has not changed and the vehicle's front structure is in its factory alignment condition. If the vehicle has been in an accident requiring the front end of the vehicle to be repaired, the horizontal indicator should be recalibrated by the servicing facility according to instructions in the vehicle's Service Manual.

### Horizontal aim adjustment

1. With the hood open, locate the horizontal indicator and adjusting screw. They are located below the viewing window at the rear of the headlamp assembly.

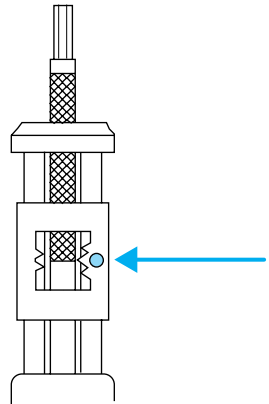

2. The “L” and “R” under the viewing window on the top of the

## Maintenance and care

headlamp refer to the directional change (left or right) of the horizontal aim.

3. Use a 4 mm wrench or socket to turn the horizontal adjusting screw until the forward edge of the knurled portion of the screw is aligned with the “0” reference mark (as shown) on the plastic slider when viewed directly from above.

### Vertical aim adjustment

1. Park the vehicle on a level surface.

2. With the hood open, locate the bubble level and vertical adjustment screw. The adjustment screw is located on the outboard side of the headlamp below the headlamp upper attachment.

3. The “UP” and “DN” on the bubble indicate the directional change (up or down) of the vertical aim.

4. Use a 4 mm wrench or socket to turn the vertical adjusting screw clockwise or counterclockwise until the bubble is centered.

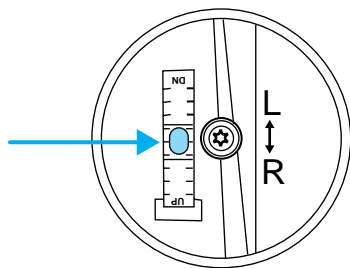
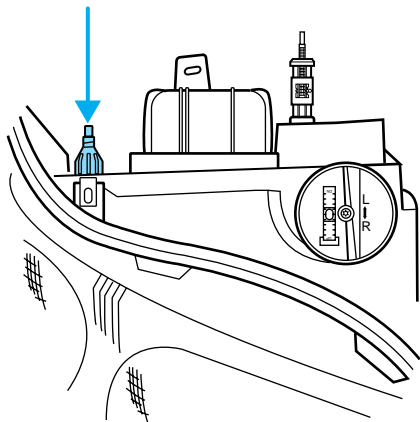

Repeat the above process to the other headlamp, if necessary.

### **CLEANING AND CARING FOR YOUR VEHICLE**

Refer to the “Customer Assistance Guide” for a list of Ford-approved cleaners, polishes and waxes.

#### **Washing your vehicle**

Wash your vehicle regularly with cold or lukewarm water. Never use strong detergents or soap. If your vehicle is particularly dirty, use a quality car wash detergent. Always use a clean sponge, washing glove or similar device and plenty of water for best results. To avoid spots, avoid washing when the hood is still warm, immediately after or during exposure to strong sunlight.

During winter months, it is especially important to wash the vehicle on a regular basis. Large quantities of dirt and road salt are difficult to remove and also cause damage to the vehicle. Remove any exterior accessories, such as antennas, before entering a car wash.

After washing, apply the brakes several times to dry them.

#### **Waxing your vehicle**

Wax when water stops beading on the surface. This could be every three or four months, depending on operating conditions.

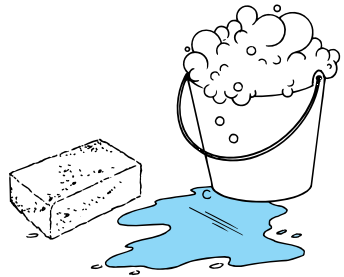

## Maintenance and care

Use only carnauba or synthetic-based waxes. Remove any bugs and tar before waxing vehicle. Use cleaning fluid or alcohol with a clean cloth to remove. Use tar remover to remove any tar spots.

### Repairing paint chips

Minor scratches or paint damage from road debris may be repaired with touch-up, paint repair foil or aerosol paint spray from the Ford accessory line. Observe the application instructions on the products.

Remove particles such as bird droppings, tree sap, insect remains, tar spots, road salt and industrial fallout immediately.

### Cleaning the wheels

Wash with the same detergent as the body of your vehicle. Do not use acid-based wheel cleaners, steel wool, fuel or strong detergents. Never use abrasives that will damage the finish of special wheel surfaces. Use a tar remover to remove grease and tar.

### Cleaning the engine

Engines are more efficient when they are clean because grease and dirt buildup keep the engine warmer than normal. When washing:

- Take care when using a power washer to clean the engine. The



## Maintenance and care

high pressure fluid could penetrate the sealed parts and cause damage.

- Do not spray with cold water to avoid cracking the engine block or other engine components.

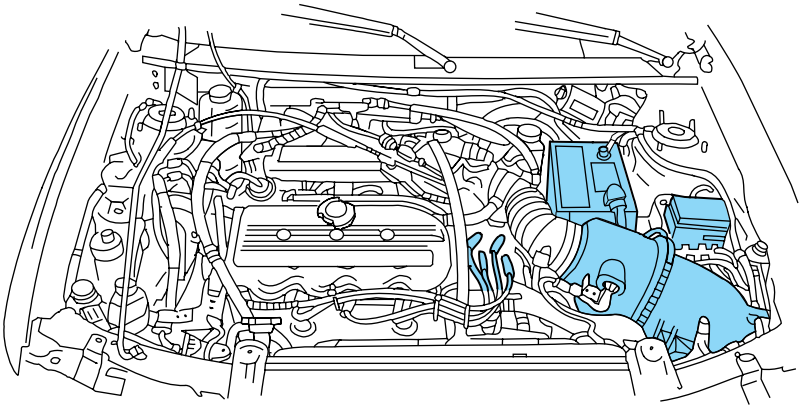

- Cover the highlighted areas to prevent water damage when cleaning the engine.
- Never wash or rinse the engine while it is running; water in the running engine may cause internal damage.

### **Cleaning plastic exterior parts**

Use vinyl cleaner for routine cleaning. Clean with a tar remover if necessary. Do not clean plastic parts with thinners, solvents or petroleum-based cleaners.

## Maintenance and care

### Cleaning the exterior lamps

Wash with the same detergent as the exterior of your vehicle. Use glass cleaner or tar remover if necessary.

To avoid scratching the lamps, do not use a dry paper towel, chemical solvents or abrasive cleaners.

### Cleaning the wiper blades

If the wiper blades do not wipe properly, clean the windshield and wiper blades with undiluted windshield wiper solution or a mild detergent. Rinse thoroughly with clean water. To avoid damaging the blades, do not use fuel, kerosene, paint thinner or other solvents.

### Cleaning the instrument panel

Clean with a damp cloth, then dry with a dry cloth.

Avoid cleaner or polish that increases the gloss of the upper portion of the instrument panel. The dull finish in this area helps protect the driver from undesirable windshield reflection.

### Cleaning the interior fabric

Remove dust and loose dirt with a whisk broom or a vacuum cleaner. Remove fresh spots immediately. Follow the directions that come with the cleaner.

### **Cleaning and maintaining the safety belts**

Clean the safety belts with a mild soap solution recommended for cleaning upholstery or carpets. Do not bleach or dye the belts, because these actions may weaken the belt webbing.

Check the safety belt system periodically to make sure there are no nicks, wear or cuts. If your vehicle has been involved in an accident, refer to the *Safety belt maintenance* section in the *Seating and safety restraints* chapter.

### **Cleaning the built-in child seat (if equipped)**

Clean with mild soap and water. Do not use household cleaning products because they may weaken the safety belt webbing or damage the vinyl parts of the seat.

The child seat liner is removable and may be machine-washed and air dried.

## Capacities and specifications

### MOTORCRAFT PART NUMBERS

Component	2.0L SOHC engine	2.0L DOHC Zetec engine
Air filter	FA-1643	FA-1643
Fuel filter	FG-862	FG-862
Battery	BX-58C	BXT-58
Oil filter	FL-400-A	FL-2005
PCV Valve	EV-229	EV-224
Spark plugs*	AGSF-34EE**	AZFS-22FE***
* Refer to Vehicle Emissions Control Information (VECI) decal for spark plug gap information.		
**Replacement double platinum spark plug "EE" will replace "E" and "EG" and "P" will replace "P" and "PG" suffixed plugs. Refer to the Engine Data chart for spark plug gap specifications.		
*** If a spark plug is removed for inspection, it must be reinstalled in the same cylinder. Cylinders No. 1 and 2 have a "FE" suffix. Cylinders No. 3 and 4 have a F suffix. If a spark plug needs to be replaced, use only spark plugs with the same service part number suffix letter "FE" as shown on the engine decal.		

### REFILL CAPACITIES

Fluid	Ford Part Name	Application	Capacity
Brake fluid	Ford High Performance DOT 3 Brake Fluid	All	Fill to line in reservoir
Engine coolant	Ford Premium Cooling System Fluid	Automatic transaxles	6.0L (6.3 quarts)
		Manual transaxles	5.0L (5.3 quarts)

## Capacities and specifications

<b>Fluid</b>	<b>Ford Part Name</b>	<b>Application</b>	<b>Capacity</b>
Engine oil (includes filter change)	Motorcraft 5W30 Super Premium Motor Oil	ZX2	4.25L (4.5 quarts)
		Sedan/wagon	3.8L (4.0 quarts)
Fuel tank capacity	N/A	All	48.5L (12.8 gallons)
Power steering fluid	Motorcraft MERCON® ATF	All	Fill to line in reservoir
Transmission fluid	Motorcraft MERCON® ATF	Automatic transaxles	3.9L (4.1 quarts)
		Manual transaxles	3.35L (3.55 quarts)
Windshield washer fluid	Ultra-Clear Windshield Washer Concentrate	All	2.2L (2.32 quarts)

## LUBRICANT SPECIFICATIONS

<b>Fluid</b>	<b>Ford Part Name or Equivalent</b>	<b>Ford Part Number</b>	<b>Ford Specification</b>
Brake master cylinder	High Performance DOT 3 Motor Vehicle Brake Fluid	C6AZ-19542-AB	ESA-M6C25-A
Door latch, hood latch, auxiliary hood latch, trunk latch	Multi-Purpose Grease	DOAZ-19584-AA	ESR-M1C159-A and ESA-M1C93-A

## Capacities and specifications

<b>Fluid</b>	<b>Ford Part Name or Equivalent</b>	<b>Ford Part Number</b>	<b>Ford Specification</b>
Lock cylinder	Penetrating lubricant	E8AZ-19A501-B	N/A
Automatic transmission	Motorcraft MERCON® ATF	XT-2-QDX	MERCON®
Manual transmission	Motorcraft MERCON® ATF	XT-2-QDX	MERCON®
Engine oil	Motorcraft 5W30 Super Premium Motor Oil	XO-5W30-QSP	WSS-M2C153-G and API Certification Mark
Constant velocity joints	CV Joint Grease (High Temp.)	E43Z-19590-A	ESP-M1C207-A
Engine coolant	Ford Premium Cooling System Fluid	E2FZ-19549-AA	ESE-M97B44-A
Power steering reservoir	Motorcraft MERCON® ATF	XT-2-QDX	MERCON®

## ENGINE DATA

<b>Engine</b>	<b>2.0L-2V engine</b>	<b>2.0L-4V Zetec engine</b>
Cubic inches	121	121
Horsepower	110 @ 5000 rpm	130 @ 5750 rpm
Torque	125 lb. ft. @ 3750 rpm	127 lb-ft. @ 4250 rpm
Required fuel grade	87 octane	87 octane
Firing order	1-3-4-2	1-3-4-2
Spark plug gap	1.3-1.4 mm (0.052-.056 inch)	1.22-1.32 mm (0.048-.052 inch)
Ignition system	DIS	DIS

## Capacities and specifications

Engine	2.0L-2V engine	2.0L-4V Zetec engine
Compression ratio	9.2:1	9.6:1

### VEHICLE DIMENSIONS

Vehicle dimensions	Coupe mm (in)	Sedan mm (in)	Wagon mm (in)
(1) Overall length	4 451.0 (175.2)	4 432.3 (174.5)	4 392.0 (172.9)
(2) Overall width	1 712.0 (67.4)	1 681.0 (66.2)	1 701.0 (67.0)
(3) Overall height	1 328.4 (52.3)	1 351.0 (53.2)	1 369.1 (53.9)
(4) Wheelbase	2 499.0 (98.4)	2 499.0 (98.4)	2 499.0 (98.4)
(5) Track - Front	1 435.1 (56.5)	1 435.1 (56.5)	1 435.1 (56.5)
(5) Track - Rear	1 435.1 (56.5)	1 435.1 (56.5)	1 435.1 (56.5)

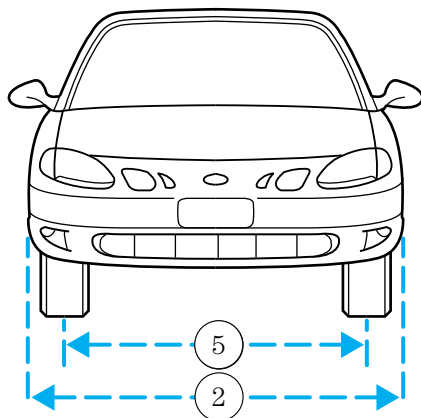

- Coupe and Sedan models

## Capacities and specifications

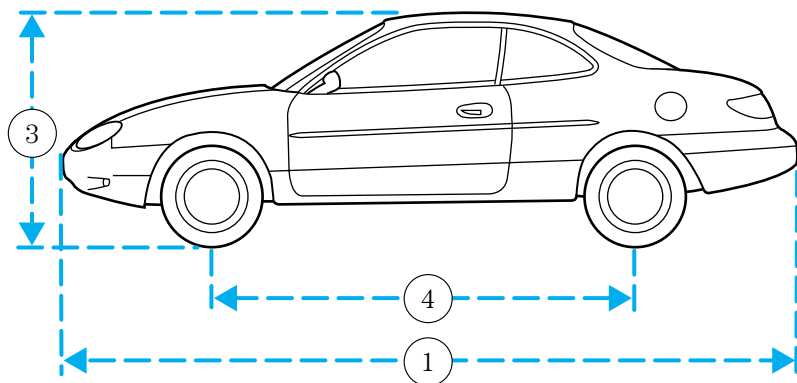

- Coupe model

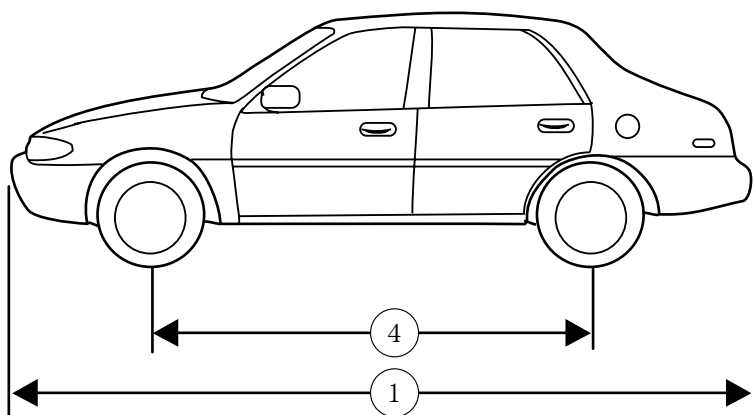

- Sedan model



## Capacities and specifications

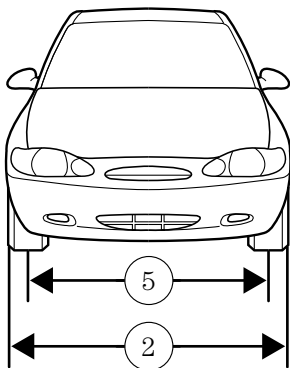

- Wagon model

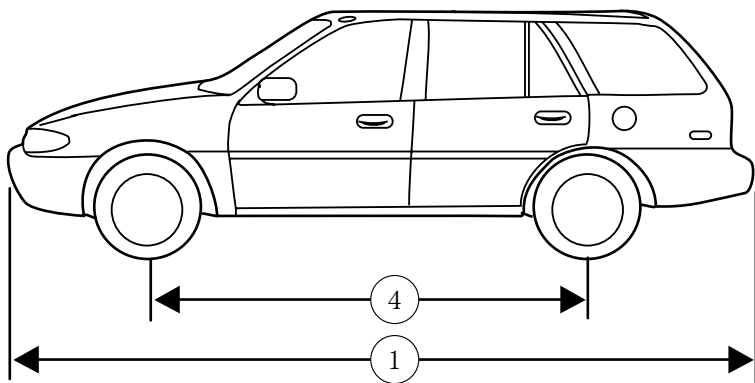

- Wagon model

# Capacities and specifications

## IDENTIFYING YOUR VEHICLE

### Safety compliance label

The National Highway Traffic Safety Administration Regulations require that a Safety Compliance Certification Label be affixed to a vehicle and prescribe where the Safety Compliance Certification Label may be located. The Safety Compliance Certification Label is located on the front door latch pillar on the driver's side.

<b>MFD. BY FORD MOTOR CO. IN U.S.A.</b>			
DATE: XXXXX	GVWR: XXXXX LB/ XXXXX KG		
FGAWR: XXXXXX/XXXXXXXX	RGAWR: XXXXXX/XXXXXXXX		
THIS VEHICLE CONFORMS TO ALL APPLICABLE FEDERAL MOTOR VEHICLE SAFETY STANDARDS IN EFFECT ON THE DATE OF MANUFACTURE SHOWN ABOVE.			
VIN: XXXXXXXXXXXXXXXXXXXX TYPE: XXXXXXXXXXXXXXXXXXXX			
			
MAXIMUM LOAD=OCCUPANTS + LUGGAGE=XXXKG/XXXLB			
OCCUPANTS: X TOTAL X FR X 2ND X RR OCCUPANTS LUGGAGE			
XX XXKG/XXXLB			
X XXXKG/XXXLB			
TIRE: XXXX/XXXX XXX			
PRESSURE (FR) XXX kPa/33 PSI COLD			
PRESSURE (RR) XXX kPa/33 PSI COLD			
TRAILER TOWING - SEE OWNER GUIDE			
EXT PNT: XXXXXX XXXXXX	RC: XX	DSO: XXXX	F0000
BAR   INT TR   TP/PS   R	AXLE   TR   SPR	T0000	
X XX XXX X XX X XXX			
UTC VFOHT-15294A10-GA			

### Vehicle identification number

The vehicle identification number is attached to a metal tag and is located on the driver side instrument panel.



### Engine number

The engine number (the last eight numbers of the vehicle identification number) is stamped on the engine block, transmission, frame and transfer case (if so equipped).

## Reporting safety defects

### REPORTING SAFETY DEFECTS (U.S. ONLY)

If you believe that your vehicle has a defect that could cause a crash, or could cause injury or death, you should immediately inform the National Highway Traffic Safety Administration (NHTSA) in addition to notifying Ford Motor Company.



If NHTSA receives similar complaints, it may open an investigation, and if it finds that a safety defect exists in a group of vehicles, it may order a recall and remedy campaign. However, NHTSA cannot become involved in individual problems between you, your dealer or Ford Motor Company.

To contact NHTSA, you may either call the Auto Safety Hotline toll-free at 1-800-424-9393 (202-366-0123 in the Washington D.C. area) or write to:

NHTSA  
U.S. Department of Transportation  
400 Seventh Street  
Washington D.C. 20590

You can also obtain other information about motor vehicle safety from the Hotline.

## Index

- Air bag supplemental restraint system .....58
  - and child safety seats .....60
  - description .....59
  - disposal .....63
  - indicator light .....62
  - passenger air bag .....61
- Air cleaner filter .....148
- Air conditioning
  - manual heating and air conditioning system .....21,24
- Anti-lock brake system (ABS)
  - description .....88
- Anti-theft system .....44
  - arming the system .....44
  - disarming a triggered system ..46
  - disarming an untriggered system .....45
- Battery .....145
- Brake fluid
  - checking and adding .....136
- Brakes .....87
  - anti-lock .....87
  - anti-lock brake system (ABS)
    - warning light .....88
  - fluid, checking and adding ....136
- Break-in period .....2
- Bulbs, replacing .....163
  - specifications .....172
- Cargo cover .....39
- Changing a tire .....113
- Child safety seats .....66
- Chime
  - headlamps on .....12
- Cleaning your vehicle .....175
  - built-in child seat .....179
  - engine compartment .....176
  - fabric .....178
  - instrument panel .....178
  - plastic parts .....177
  - safety belts .....179
  - tail lamps .....178
  - washing .....175
  - waxing .....175
  - wheels .....176
- Clutch
  - fluid .....137
- Defrost
  - rear window .....25
- Emission control system .....160
- Engine
  - service points .....130,131
- Engine block heater .....84
- Engine coolant
  - checking and adding .....138,139
  - disposal .....141
  - refill capacities .....141
- Engine oil .....132,134
  - changing oil and oil filter .....135
  - checking and adding .....132,134
- Exhaust fumes .....85
- Floor mats .....38
- Foglamps .....28
- Fuel
  - calculating fuel economy .....159
  - improving fuel economy .....103
  - octane rating .....157
  - quality .....158
  - running out of fuel .....158
  - safety information relating to automotive fuels .....155
- Fuel gauge .....14
- Fuel pump shut-off switch ..39,104
- Fuses .....106,107,108,110,112
- Gauges, Mechanical .....13
  - engine coolant temperature gauge .....14
- Hazard flashers .....104
- Headlamps .....26
  - daytime running lights .....26
  - flashing .....27
  - high beam .....27
- Heating .....18

- High beams
  - indicator light .....10
- Hood
  - release lever .....128
- Ignition
  - positions of the ignition .....26
- Instrument panel
  - lighting up panel and interior .....17
- Jump-starting your vehicle .....118,120
  - attaching cables .....119
  - disconnecting cables .....120
- Keys
  - key in ignition chime .....12
- Lamps
  - dome lamps .....36,171
  - fog lamps .....167
  - headlamps .....165
  - high-mount brakelamp .....167
  - interior lamps .....36,171
  - map lamps .....36,172
  - tail lamps .....169
- License plate lamps .....171
- Lights, warning and indicator
  - air bag .....9
  - anti-lock brakes (ABS) .....10
  - anti-theft .....10
  - brake .....10
  - charging system .....11
  - check coolant .....11
  - liftgate ajar .....11
  - low fuel .....7
  - oil pressure .....11
  - safety belt .....9
  - service engine soon .....7,8
  - turn signal indicator .....10
- Lubricant specifications .....181
- Luggage rack .....103
- Mirrors
  - side view mirrors (power) .....17
- Moon roof .....35
- Odometer .....15
- Panic alarm feature, remote entry system .....42
- Parking brake .....89
- Parts (see Motorcraft parts) ....180
- Power steering
  - fluid, checking and adding ....142
- Rear window
  - wiper .....35
- Refill capacities for fluids .....180
- Relays .....106,113
- Remote entry system .....39
  - illuminated entry .....44
  - locking/unlocking doors .....40,41
  - replacement/additional transmitters .....43
  - replacing the batteries .....42
- Reporting safety defects .....187
- Safety restraints
  - automatic locking mode (retractor) .....53,54
  - extension assembly .....56
  - for children .....63
  - for second row bench seats .....73,74,78,79
  - lap and shoulder belts .....52
  - maintenance .....57
  - proper use .....51
  - warning light and chime ....11,57
- Safety seats for children
  - attaching with tether straps ....70
  - automatic locking mode (retractor) .....67
  - tether anchorage hardware .....70,71
- Seats .....47
  - adjusting the seat, manual .....47
  - folding rear seats .....50
  - head restraints .....47
- Servicing your vehicle .....123
  - precautions when servicing ...123

## Index

- Sliding moon roof (see Moonroof) .....35
- Speed control .....28
  - canceling a set speed .....32
  - resuming a set speed .....33
  - tap up/tap down .....30,31
  - turning off .....29
- Speedometer .....15
- Starting your vehicle .....80,81,84
- Tachometer
  - mechanical cluster .....16
- Tilt steering wheel .....33
- Tires .....149,152
  - checking the pressure .....152
  - replacing .....153
  - rotating .....152
  - snow tires and chains .....154
  - treadwear .....150
- Trailer towing .....100
  - tips .....102,122
- Transaxle .....90
  - automatic operation ..94,95,96,97
  - manual operation .....90,91,92,93
- Transmission .....143
  - fluid, checking and adding (automatic) .....143,145
- Trip odometer .....15
- Trunk
  - using the remote entry system to open .....41
- Turn signal
  - lever .....27
- Vehicle dimensions .....183
- Vehicle headlamp aiming device (VHAD) .....172
- Vehicle Identification Number (VIN) .....186
- Vehicle loading .....97
- Ventilating your vehicle .....86
- Warning chimes .....6
- Windows
  - power windows, operating .....37
- Windshield washer fluid and wipers
  - checking and adding fluid .....137
  - checking and replacing wiper blades .....148
  - operation .....34
- Wrecker towing .....121

## Filling station information

Recommended fuel	Unleaded fuel only - 87 octane
Fuel tank capacity	48.5L (12.8 gallons)
Engine oil	Use Motorcraft 5W30 Super Premium Motor Oil, Ford Specification WSS-M2C153-G
Tire size and pressure	Refer to Tire Pressure Decal on passenger's door panel
Hood release	Pull handle under the left side of the instrument panel
Oil capacity (with filter change)	Sedan/wagon-3.8L (4.0 quarts)
	ZX2-4.25L (4.5 quarts)
Coolant capacity	Automatic transaxle-6.0L (6.3 quarts)
	Manual transaxle-5.0L (5.3 quarts)
Power steering fluid capacity	Fill to line on reservoir
Automatic transmission capacity	3.9L (4.1 quarts)
Manual transmission capacity	3.35L (3.55 quarts)