

# Contents

## Before driving

Introduction	2
Instrumentation	3
Controls and features	23
Seating and safety restraints	58

## Starting and driving

Starting	78
Driving	83
Roadside emergencies	95

## Servicing

Maintenance and care	109
Capacities and specifications	145
Reporting safety defects	151
Index	152

All rights reserved. Reproduction by any means, electronic or mechanical including photocopying, recording or by any information storage and retrieval system or translation in whole or part is not permitted without written authorization from Ford Motor Company.

# Introduction

## ICONS

Indicates a warning. Read the following section on *Warnings* for a full explanation.



Indicates vehicle information related to recycling and other environmental concerns will follow.



Correct vehicle usage and the authorized disposal of waste cleaning and lubrication materials are significant steps towards protecting the environment.

## WARNINGS

Warnings provide information which may reduce the risk of personal injury and prevent possible damage to others, your vehicle and its equipment.

## BREAKING-IN YOUR VEHICLE

There are no particular breaking-in rules for your vehicle. During the first 1 600 km (1 000 miles) of driving, vary speeds frequently. This is necessary to give the moving parts a chance to break in.

If possible, you should avoid full use of the brakes for the first 1 600 km (1 000 miles).

## INFORMATION ABOUT THIS GUIDE

The information found in this guide was in effect at the time of printing. Ford may change the contents without notice and without incurring obligation.



# Instrumentation

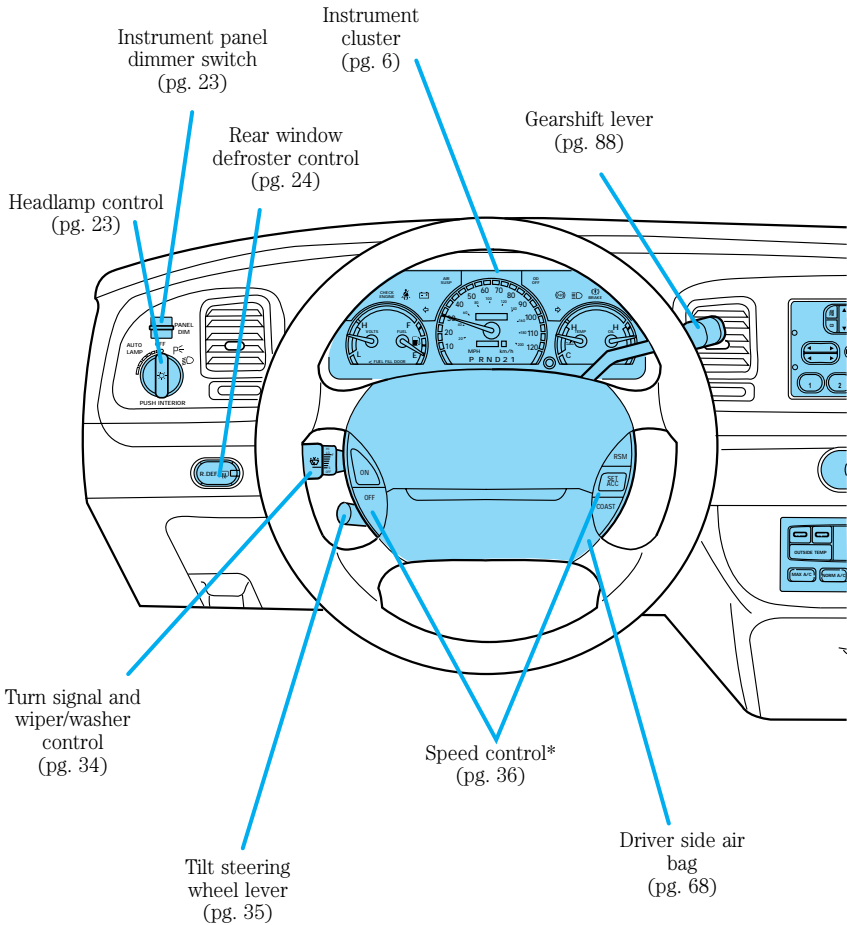

\*if equipped

# Instrumentation

Electronic sound  
system  
(pg. 33)

Passenger side air  
bag  
(pg. 68)

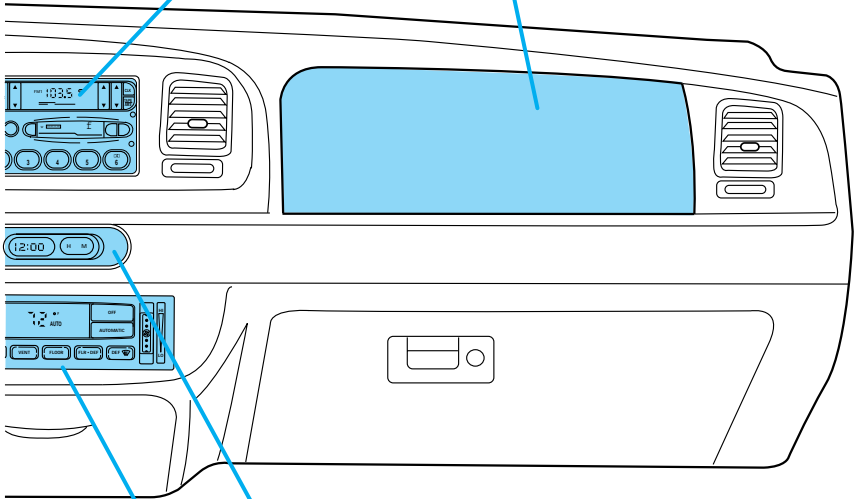

Clock  
(pg. 33)

Climate control  
systems  
(pg. 25)

# Instrumentation

## WARNING LIGHTS AND CHIMES

### Standard instrument cluster

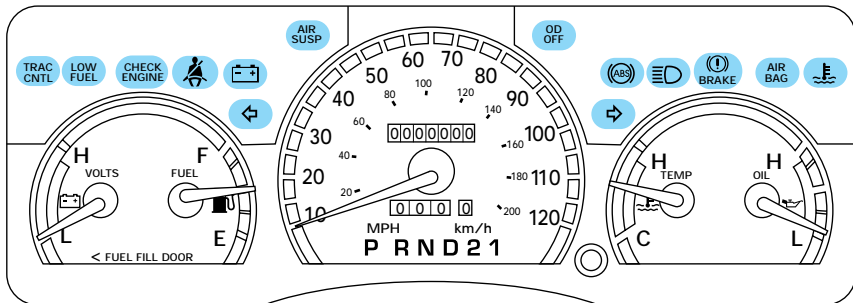

### Optional instrument cluster

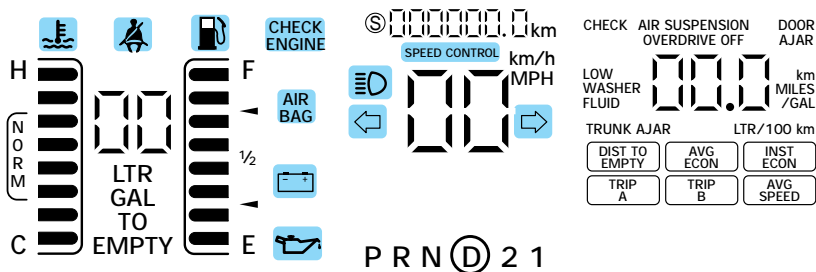

### Low fuel

Illuminates when the fuel tank has approximately eight liters (two gallons) remaining. The lamp will also illuminate when the ignition key is turned to ON and the engine is off.



### Check engine

Your vehicle is equipped with a computer that monitors the engine's emission control system. This system is commonly known as the On Board Diagnostics System (OBD

II). This OBD II system protects the environment by ensuring that your vehicle continues to meet government emission standards. The OBD II system also assists the service technician in properly servicing your vehicle.

The *Check Engine* indicator light illuminates when the ignition is first turned to the ON position to check the bulb. If it comes on after the engine is started, one of the engine's emission control systems may be malfunctioning. The light may illuminate without a driveability concern being noted. The vehicle will usually be drivable and will not require towing.

## CHECK ENGINE

### ***What you should do if the check engine light illuminates***

#### **Light turns on solid:**

This means that the OBD II system has detected a malfunction.

Temporary malfunctions may cause your *Check Engine* light to illuminate. Examples are:

1. The vehicle has run out of fuel. (The engine may misfire or run poorly.)
2. Poor fuel quality or water in the fuel.
3. The fuel cap may not have been properly installed and securely tightened.

These temporary malfunctions can be corrected by filling the fuel tank with good quality fuel and/or properly installing and securely tightening the gas cap. After three driving cycles without these or any other temporary malfunctions present, the *Check Engine* light should turn off. (A driving cycle consists of a cold engine startup followed by mixed city/highway driving.) No additional vehicle service is required.

If the *Check Engine* light remains on, have your vehicle serviced at the first available opportunity.

## Instrumentation

### Light is blinking:

Engine misfire is occurring which could damage your catalytic converter. You should drive in a moderate fashion (avoid heavy acceleration and deceleration) and have your vehicle serviced at the first available opportunity.



Under engine misfire conditions, excessive exhaust temperatures could damage the catalytic converter, the fuel system, interior floor coverings or other vehicle components, possibly causing a fire.

### Air bag readiness

Momentarily illuminates when the ignition is turned ON. If the light fails to illuminate, continues to flash or remains on, have the system serviced immediately.

AIR  
BAG

### Safety belt

Momentarily illuminates when the ignition is turned to the ON position to remind you to fasten your safety belts. For more information, refer to the *Seating and safety restraints* chapter.



### Brake system warning (if equipped)

Momentarily illuminates when the ignition is turned to the ON position and the engine is off. If brake warning lamp does not illuminate at this time, seek service immediately.

Also illuminates when the parking brake is engaged. Illumination after releasing the parking brake indicates low brake fluid level and the brake system should be inspected immediately.

(!)  
BRAKE



### Anti-lock brake system (ABS) (If equipped)

Momentarily illuminates when the ignition is turned on and the engine is off. If the light does not illuminate momentarily at start up, remains on or continues to flash, the ABS needs to be serviced. With the ABS light on, the anti-lock brake system is disabled and normal braking is still effective unless the brake warning light also remains illuminated with parking brake released.



### Turn signal

Illuminates when the left or right turn signal or the hazard lights are turned on. If one or both of the indicators stay on continuously or flash faster, check for a burned-out turn signal bulb. Refer to *Exterior bulbs* in the *Maintenance and care* chapter.

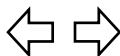

### High beams

Illuminates when the high beam headlamps are turned on.



### Charging system

Illuminates when the ignition is turned to the ON position and the engine is off. The light also illuminates when the battery is not charging properly, requiring electrical system service.

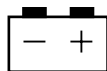

## Instrumentation

### Engine oil pressure (if equipped)

Illuminates when the oil pressure falls below the normal range. Stop the vehicle as soon as safely possible and switch off the engine immediately. Check the oil level and add oil if needed. Refer to *Engine oil* in the *Maintenance and Care* chapter.

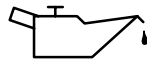

This lamp also illuminates when the ignition is turned to ON and the engine is off.

### Engine coolant temperature

Illuminates when the engine coolant temperature is high. Stop the vehicle as soon as safely possible, switch off the engine and let it cool.



Never remove the coolant recovery cap while the engine is running or hot.

Refer to *Engine coolant* in the *Maintenance and care* chapter. If light stays on or continues to turn on after the vehicle warms up, have your vehicle serviced.

This light also illuminates briefly when the ignition key is turned to ON.

### Air suspension (if equipped)

This light tells you if the air suspension needs repair or if the air suspension switch is OFF. For information on the air suspension system, refer to the *Driving* chapter.

AIR  
SUSP

### **O/D off**

Illuminates when the transmission control switch has been pushed.

When the light is on, the

transmission does not shift into

overdrive. If the light does not come

on when the transmission control switch is depressed or if the light flashes when you are driving, have your vehicle serviced.

**O/D  
OFF**

### **Traction Control™ active (if equipped)**

Flashes when the Traction Control™ system begins applying and

releasing the brakes and adjusting

the engine characteristics to limit a

wheelspin condition. It will be lit for

a minimum of four seconds or for

the duration of the Traction

Control™ event.

**TRAC  
CNTL**

If the Traction Control™ indicator comes on or stays lit, either:

- the Traction Control™ system needs service, or
- the customer has disabled the system using the traction control switch.

For more information, refer to the *Driving* chapter.

### **Safety belt warning chime**

Chimes to remind you to fasten your safety belts.

For information on the safety belt warning chime, refer to the *Seating and safety restraints* chapter.

### **Supplemental restraint system (SRS) warning chime**

For information on the SRS warning chime, refer to the *Seating and safety restraints* chapter.

### **Key-in-ignition warning chime**

Sounds when the key is left in the ignition in the OFF/LOCK or ACC position and either front door is opened.

# Instrumentation

## Headlamps on warning chime

Sounds when the headlamps or parking lamps are on, the ignition is off (and the key is not in the ignition) and either front door is opened.

## Turn signal chime

Sounds when the turn signal lever has been activated to signal a turn.

## GAUGES

### Standard instrument cluster gauges

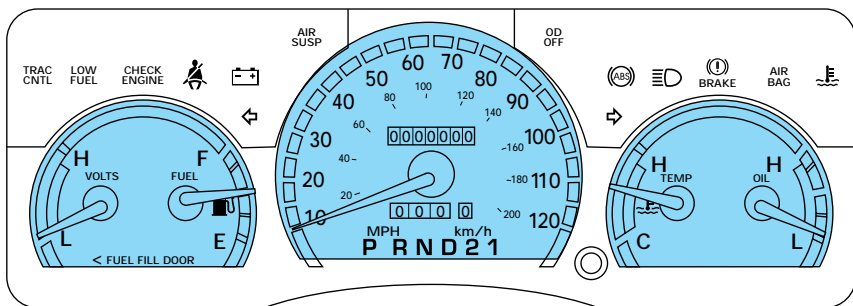

### Optional instrument cluster gauges

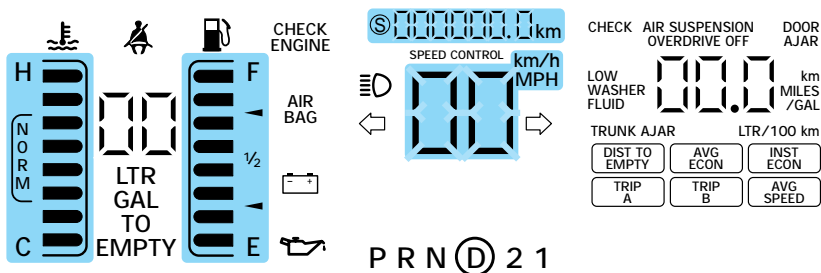

## Fuel gauge

Displays approximately how much fuel is in the fuel tank (when the key is in the ON position). The fuel gauge may vary slightly when the vehicle is in motion. The ignition should be in the OFF position while the vehicle is being refueled. When the gauge first indicates empty, there is a small

# Instrumentation

amount of reserve fuel in the tank. When refueling the vehicle from empty indication, the amount of fuel that can be added will be less than the advertised capacity due to the reserve fuel.

- Standard instrument cluster

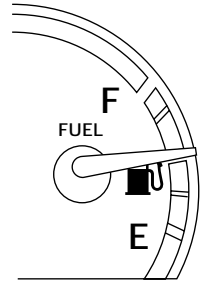

- Optional instrument cluster



## Speedometer

Indicates the current vehicle speed.

- Standard instrument cluster

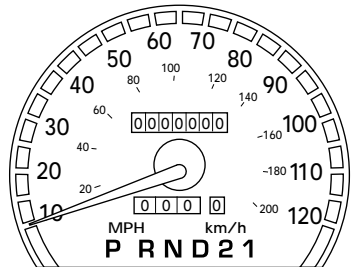

## Instrumentation

- Optional instrument cluster

Ⓢ 000000.0 km

00 km/h  
MPH

### Odometer

Registers the total kilometers (miles) of the vehicle.

- Standard instrument cluster

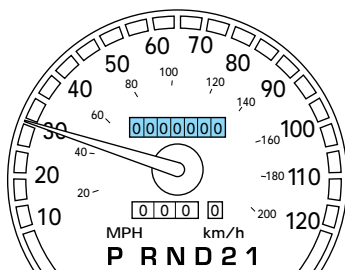

- Optional instrument cluster

Ⓢ 000000.0 km

00 km/h  
MPH

Refer to *Electronic Message Center* for information on how to switch the display from metric to English measurements.

## Trip odometer

Registers the kilometers (miles) of individual journeys. To reset, depress the control.

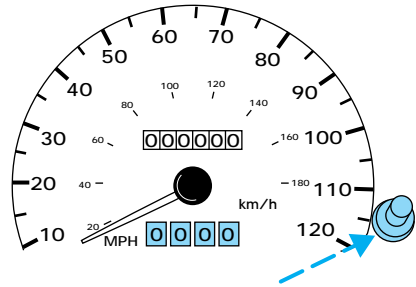

Refer to electronic message center for Trip A and Trip B features on the optional instrument cluster.

## Engine coolant temperature gauge

Indicates the temperature of the engine coolant. At normal operating temperature, the needle remains within the normal area (the area between the “H” and “C”). If it enters the red section, the engine is overheating. Stop the vehicle as soon as safely possible, switch off the ignition and let it cool. Refer to *Engine coolant* in the *Maintenance and care* chapter.



Never remove the coolant recovery cap while the engine is running or hot.

- Standard instrument cluster

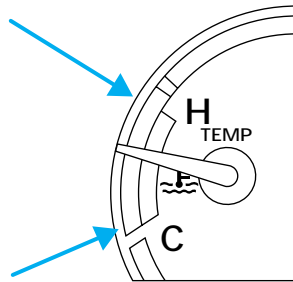

## Instrumentation

- Optional instrument cluster



This gauge indicates the temperature of the engine coolant, not the coolant level. If the coolant is not at its proper level or mixture, the gauge indication will not be accurate.

### Battery voltage gauge (if equipped)

This gauge shows the battery voltage when the ignition is in the ON position. If the pointer moves and stays outside the normal operating range (as indicated), have the vehicle's electrical system checked as soon as possible.

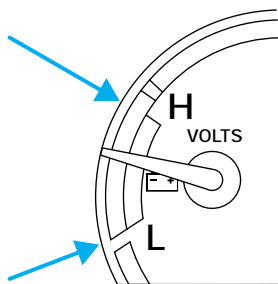

### Engine oil pressure gauge (if equipped)

This shows the engine oil pressure in the system. Sufficient pressure exists as long as the needle remains in the normal range (the area between the "H" and "L").

If the gauge indicates low pressure, stop the vehicle as soon as safely possible and switch off the engine immediately. Check the oil level.

Add oil if needed (refer to

*Checking and adding engine oil* in the *Maintenance and care*

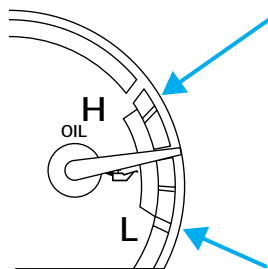



chapter). If the oil level is correct, have your vehicle checked at your dealership or by a qualified technician.

## ELECTRONIC MESSAGE CENTER

The electronic message center only works when the ignition is in the ON position.

The message center allows you to:

- see problems such as door ajar, air suspension, trunk ajar, washer fluid low
- see how many kilometers/miles you can drive before running out of fuel
- see when overdrive has been deactivated
- monitor the average fuel economy
- monitor the instantaneous fuel economy
- check the distance traveled during a trip on either Trip A or Trip B
- monitor the average speed

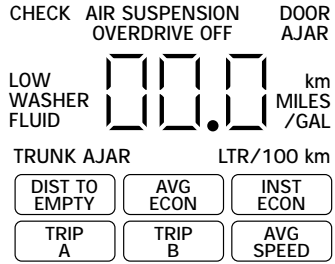

## Selectable features

### Reset

Press this control to reset the selected message center function to zero. The only functions which can be reset are:

- AVG ECON
- TRIP A or TRIP B
- AVG SPEED



# Instrumentation

## **E/M**

Press this control to switch the electronic instrument cluster display and the message center display from metric to English units.

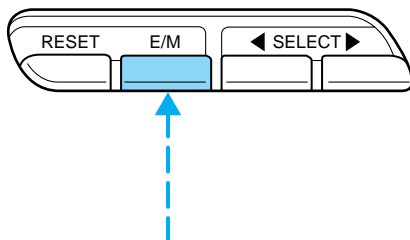

## **Select**

Each press of the SELECT control will select a different function.

Press the right side of the control to advance the function to the right, and press the left side of the control to advance the function to the left.

To reset any function:

1. Push either the right or left side of the SELECT control to choose the desired function.
2. Press the RESET control and the selected message center function will be reset to zero.

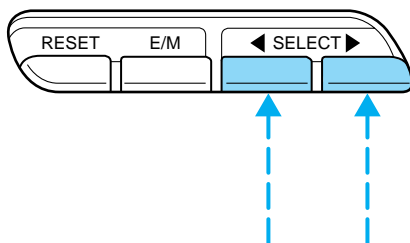

## **Message center functions**

### ***DIST TO EMPTY (DTE)***

This function estimates approximately how far you can drive with the fuel remaining in your tank under normal driving conditions.

<b>DIST TO EMPTY</b>	<b>AVG ECON</b>	<b>INST ECON</b>
<b>TRIP A</b>	<b>TRIP B</b>	<b>AVG SPEED</b>

## Instrumentation

Remember to turn the ignition OFF when refueling your vehicle. Otherwise, the display will not show the addition of fuel for a few miles. At least 9.5 liters (2.5 gallons) of fuel must be added for the fuel gauge to immediately show the new fuel level.

The DTE function will flash for 5 seconds and sound a tone for 1 second when you have approximately:

- 80 km (50 miles) left before you run out of fuel
- 40 km (25 miles)
- 16 km (10 miles)

The message center will remain in the DTE function until the SELECT control is pressed to change functions.

Displayed DTE will not be equal to AVG ECON multiplied by the FUEL REMAIN value. DTE is calculated using a method that considers the fuel economy of the last 800 km (500 miles) driven.

If “CO” or “CS” is displayed, there is a problem with the fuel indication system and you should contact your dealer for service as soon as possible.

### **AVG ECON (average fuel economy)**

Select this function to display your average fuel economy in liters/100 km or miles/gallon.

If you calculate your average fuel economy by dividing miles traveled by gallons used, your figure may be different than displayed for the following reasons:

- your vehicle was not perfectly level during fill-up
- differences in the automatic shut-off points on the fuel pumps at service stations
- variations in top-off procedure from one fill-up to another
- rounding of the displayed values to the nearest 0.1 liter (gallons)

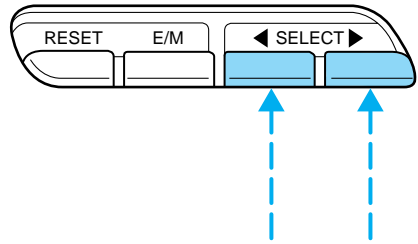

DIST TO EMPTY	<b>AVG ECON</b>	INST ECON
TRIP A	TRIP B	AVG SPEED

## Instrumentation

Press the RESET control while AVG ECON is displayed to reset the function.

The average displayed is the average since the last reset.

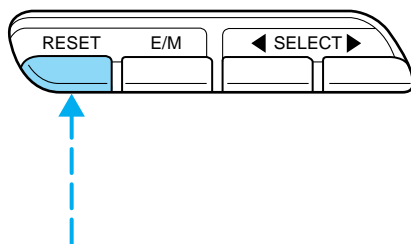

### **INST ECON (instantaneous fuel economy)**

Select this function to calculate the instantaneous fuel economy of your running vehicle. For example, you can see what your fuel economy is in heavy traffic or on an open highway.

Your vehicle must be moving to calculate instantaneous fuel economy. When your vehicle is not moving, instantaneous fuel economy is displayed at 99 liters per 100 kilometers (or 0 miles per gallon). Instantaneous fuel economy cannot be reset.

DIST TO EMPTY	AVG ECON	<b>INST ECON</b>
TRIP A	TRIP B	AVG SPEED

### **TRIP A and TRIP B**

These two functions allow you to see how far you have traveled since you last reset. Trip A and Trip B are completely independent and must be reset individually.

To reset either trip feature to zero, press the RESET control while the appropriate trip distance feature (TRIP A or TRIP B) is displayed.

DIST TO EMPTY	AVG ECON	INST ECON
TRIP A	<b>TRIP B</b>	AVG SPEED



## AVG SPEED (average speed)

Select this function to display your average speed in miles per hour or kilometers per hour.

Your vehicle must be moving to calculate your average speed. When your vehicle is not moving, the average speed is displayed at 0 kilometers (0 miles) per hour.



## Message center indicator lights

### Check air suspension

Briefly illuminates when the ignition is turned ON. This light will remain on to indicate that the air suspension switch is off or to indicate a possible system fault. For more information on the air suspension system, refer to the *Driving* chapter.

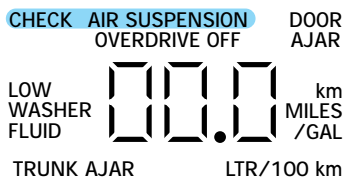

### Overdrive off

Illuminates when the transmission control switch (TCS) has been pushed. When the light is on, the transmission does not shift into overdrive. If the light does not come on when the TCS is depressed or if the light flashes when you are driving, have your vehicle serviced.

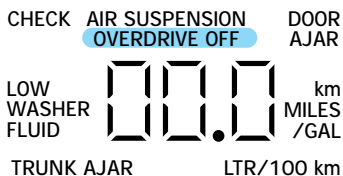

### Door ajar

Illuminates when one of the doors is not completely shut and the ignition is turned to ON. With the ignition ON, this light will flash five times and sound a tone for one second, then remain on (if a door is open).

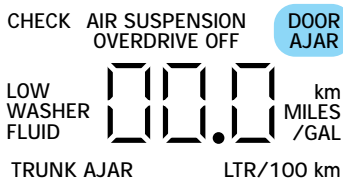

# Instrumentation

## Low washer fluid

Momentarily illuminates when the ignition is turned to ON and will stay on when the windshield washer fluid is low.

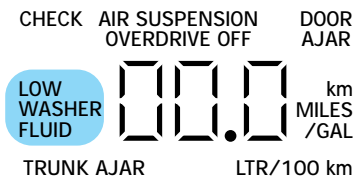

## Trunk ajar

If the trunk is not completely closed, this light comes on when you turn the ignition to ON. With the ignition ON, this light will flash five times and sound a tone for one second, then remain on (if the trunk is open).

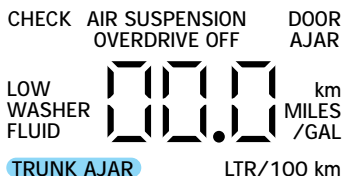

## INDICATOR LAMP MODULE

The indicator lamp module contains the following lamps:

### Anti-lock brake system (ABS) (If equipped)

Momentarily illuminates when the ignition is turned on and the engine is off. If the light does not illuminate momentarily at start up, remains on or continues to flash, the ABS needs to be serviced. With the ABS light on, the anti-lock brake system is disabled and normal braking is still effective unless the brake warning light also remains illuminated with parking brake released.



### Brake system warning

Momentarily illuminates when the ignition is turned to the ON position and the engine is off. If brake warning lamp does not illuminate at this time, seek service immediately. Also illuminates when the parking brake is engaged. Illumination after releasing the parking brake indicates low brake fluid level and the brake system should be inspected immediately.



## Controls and features

### PANEL DIMMER CONTROL

Use to adjust the brightness of the instrument panel during headlight and parklamp operation.

- Push up to brighten.
- Push down to dim.

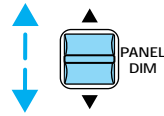

### HEADLAMP CONTROL

Rotate the headlamp control to the first position to turn on the parking lamps only. Rotate to the second position to also turn on the headlamps.

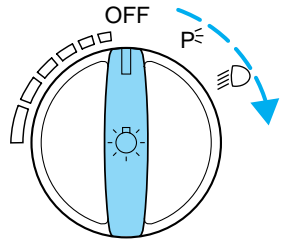

### High beams

Push forward to activate.

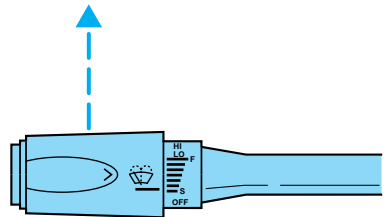

### Flash to pass

Pull toward you to activate and release to deactivate.

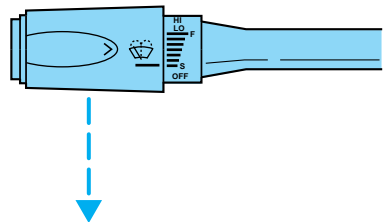

## Controls and features

### Autolamp control (if equipped)

The autolamp system provides light sensitive automatic on-off control of the exterior lights normally controlled by the headlamp control.

The autolamp system also keeps the lights on for a preselected period of time after the ignition switch is turned to OFF.

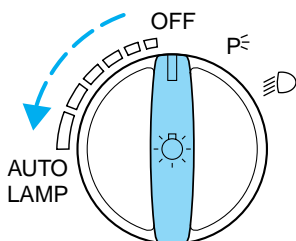

- To turn autolamps on, rotate the control counterclockwise. The preselected time lapse is adjustable up to approximately three minutes by continuing to rotate the control counterclockwise.
- To turn autolamps off, rotate the control clockwise to OFF.
- A small LED illuminates under the autolamp control to indicate that the headlamps have been turned on by the autolamps.

### Daytime running lamps (DRL) (if equipped)

Turns the highbeam headlamps on with a reduced output. To activate:

- the engine must be running,
- the parking brake released, and
- the headlamp control is in the OFF or Parking lamps position.



The Daytime Running Light (DRL) system will not illuminate the tail lamps and parking lamps. Turn on your headlamps at dusk. Failure to do so may result in a collision.

### REAR WINDOW DEFROSTER

The rear defroster control is located on the instrument panel.

Press the defroster control to clear the rear window of thin ice and fog.



- The small LED will illuminate when the defroster is activated.

The ignition must be in the ON position to operate the rear window defroster.



## Controls and features

The defroster turns off automatically after 10 minutes or when the ignition is turned to the OFF position. To manually turn off the defroster before ten minutes have passed, push the control again.

### CLIMATE CONTROL SYSTEM

#### Manual heating and air conditioning system (if equipped)



#### **Fan speed control**

Controls the volume of air circulated in the vehicle.

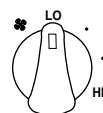

#### **Temperature control knob**

Controls the temperature of the airflow inside the vehicle.



#### **Mode selector control**

Controls the direction of the airflow to the inside of the vehicle.

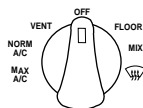

The air conditioning compressor will operate in all modes except VENT and FLR. However, the air conditioning will only function if the outside temperature is about 10°C (50°F) or above.

Since the air conditioner removes considerable moisture from the air during operation, it is normal if clear water drips on the ground under the air conditioner drain while the system is working and even after you have stopped the vehicle.

## Controls and features

Under normal conditions, your vehicle's climate control system should be left in any position other than MAX A/C or OFF when the vehicle is parked. This allows the vehicle to "breathe" through the outside air inlet duct.

- **MAX A/C**-Uses recirculated air to cool the vehicle. MAX A/C is noisier than NORM A/C but more economical and will cool the inside of the vehicle faster. Airflow will be from the instrument panel registers. This mode can also be used to prevent undesirable odors from entering the vehicle.
- **NORM A/C**-Uses outside air to cool the vehicle. It is quieter than MAX A/C but not as economical. Airflow will be from the instrument panel registers.
- **VENT**-Distributes outside air through the instrument panel registers. However, the air will not be cooled below the outside temperature because the air conditioning does not operate in this mode.
- **OFF**-Outside air is shut out and the fan will not operate. For short periods of time only, use this mode to prevent undesirable odors from entering the vehicle.
- **FLR**-Allows for maximum heating by distributing outside air through the floor ducts. However, the air will not be cooled below the outside temperature because the air conditioning does not operate in this mode.
- **MIX**-Distributes outside air through the windshield defroster ducts and the floor ducts. Heating and air conditioning capabilities are provided in this mode. For added customer comfort, when the temperature control knob is anywhere in between the full hot and full cold positions, the air distributed through the floor ducts will be slightly warmer than the air sent to the windshield defroster ducts. If the temperature is about 10°C (50°F) or higher, the air conditioner will automatically dehumidify the air to prevent fogging.
-  -Distributes outside air through the windshield defroster ducts. It can be used to clear ice or fog from the windshield. If the temperature is about 10°C (50°F) or higher, the air conditioner will automatically dehumidify the air to prevent fogging.

### **Operating tips**

- In humid weather, select  before driving. This will prevent your windshield from fogging. After a few minutes, select any desired position.

## Controls and features

- To prevent humidity buildup inside the vehicle, don't drive with the climate control system in the OFF position.
- Don't put objects under the front seat that will interfere with the airflow to the back seats.
- Remove any snow, ice or leaves from the air intake area (at the bottom of the windshield).

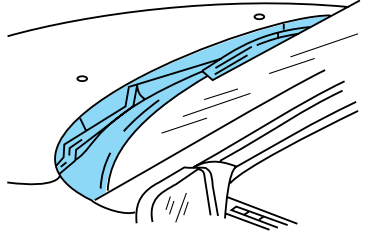

- If your vehicle has been parked with the windows closed during hot weather, the air conditioner will do a much faster job of cooling if you drive for two or three minutes with the windows open. This will force most of the hot, stale air out of the vehicle. Then operate your air conditioner as you would normally.
- When placing objects on top of your instrument panel, be careful to not place them over the defroster outlets. These objects can block airflow and reduce your ability to see through your windshield. Also, avoid placing small objects on top of your instrument panel. These objects can fall down into the defroster outlets and block airflow and possibly damage your climate control system.

### Electronic Automatic Temperature Control (EATC) system (if equipped)

The EATC system will maintain a selected temperature and automatically control airflow. You can override automatic operation with any of the override controls or the fan speed control.

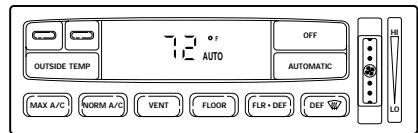

## Controls and features

### **Turning the EATC on**

Press AUTOMATIC, any of the override controls or the fan speed control. The EATC will only operate when the ignition is in the ON position.

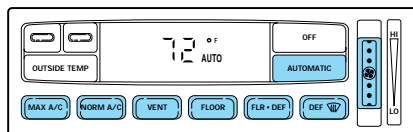

### **Turning the EATC off**

Press OFF. The Outside Temperature function will continue to operate until the ignition is turned off.

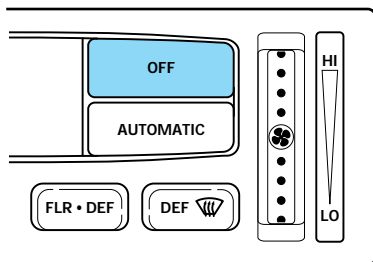

### **Automatic operation**

Press AUTOMATIC and select the desired temperature. The selected temperature and the word AUTO will appear in the display window. The EATC system will either heat or cool to achieve the selected temperature. The system will automatically determine fan speed, airflow location and if fresh outside air or recirculated air is required. Fan speed remains automatic unless the fan speed thumbwheel is turned.

When in AUTOMATIC and weather conditions require heat, air will be sent to the floor. However, if the engine is not warm enough to provide heat, the fan will be at a low speed and the air will be directed to the windshield. In 3½ minutes or less, the fan speed will start to increase and the airflow location will change to the floor area.

If unusual conditions exist (i.e.-window fogging, etc.), the manual override controls allow you to select airflow locations and the fan control allows you to adjust fan speed as necessary.

## Controls and features

### Temperature selection

The display window indicates the selected temperature, function (AUTO or one of the override controls) and manual control of fan speed (🌀) if automatic fan speed is not desired.



To control the temperature, select any temperature between 18°C (65°F) and 29°C (85°F) by pressing the blue (cooler) or red (warmer) buttons.

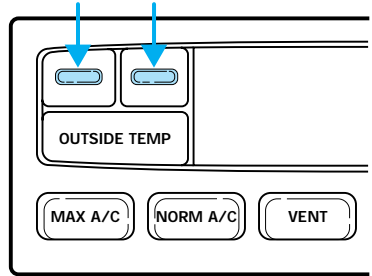

For continuous maximum cooling, push the blue button until 16°C (60°F) is shown in the display window. The EATC will continue maximum cooling (disregarding the displayed temperature) until a warmer temperature is selected by pressing the red button.

For continuous maximum heating, push the red button until 32°C (90°F) is shown in the display window. The EATC will continue maximum heating (disregarding the displayed temperature) until a cooler temperature is selected by pressing the blue button.

### Temperature conversion

Press MAX A/C and DEF 🌨️ at the same time (for one second) to switch between Fahrenheit and Celsius.

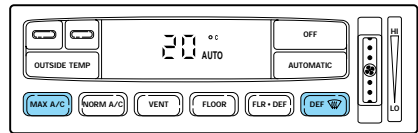



If your vehicle has an English/Metric (E/M) control to change your electronic instrument cluster display (if equipped) and the message center display (if equipped) from English to Metric, this control will also change the temperature display. Refer to *Electronic Message Center* in the *Instrumentation Chapter*.

## Controls and features

### Fan speed ( )

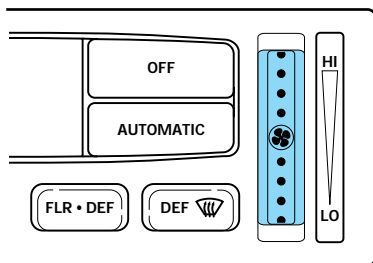
When AUTOMATIC is pressed, fan speed is adjusted automatically for existing conditions. You can override fan speed at any time. To control fan speed manually, use the thumbwheel to cancel automatic fan speed operation. Rotate the thumbwheel up for higher fan speed or down for lower fan speed.



The display will show  to indicate manual fan operation.



To return to automatic fan operation, press AUTOMATIC.

### Manual override controls

The override controls are located at the bottom of the EATC and allow you to determine where airflow is directed. To return to full automatic control, press AUTOMATIC.

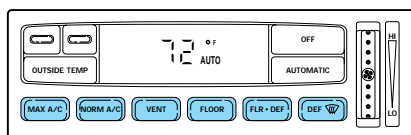

The air conditioning compressor will operate in all modes except FLOOR and VENT. It will also operate only when required when AUTOMATIC has been selected. However, the air conditioning will only function if the outside temperature is about 10°C (50°F) or above.

Since the air conditioner removes considerable moisture from the air during operation, it is normal if clear water drips on the ground under the air conditioner drain while the system is working and even after you have stopped the vehicle.

Under normal conditions, your vehicle's climate control system should be left in any position other than MAX A/C or OFF when the vehicle is parked. This allows the vehicle to "breathe" through the outside air inlet duct.

- **MAX A/C**-Uses recirculated air to cool the vehicle. The temperature display will remain the same and air will be cooled based on the selected temperature. To exit, press AUTOMATIC or any other override controls. MAX A/C is noisier than NORM A/C but more

## Controls and features

economical and will cool the inside of the vehicle faster. Airflow is from the instrument panel registers. This mode can also be used to prevent undesirable odors from entering the vehicle.

- **NORM A/C**-Uses outside air to cool the vehicle. The temperature display will remain the same and air will be cooled based on the selected temperature. It is quieter than MAX A/C but not as economical. Fan speed will remain automatic. Airflow is from the instrument panel registers.
- **VENT**-Distributes outside air through the instrument panel registers. However, the air cannot be cooled below the outside temperature because the air conditioning does not operate in this mode.
- **FLOOR**-Allows for maximum heating by distributing outside air through the floor ducts. However, the air cannot be cooled below the outside temperature because the air conditioning does not operate in this mode.
- **FLR•DEF**-Distributes outside air through the windshield defroster ducts and the floor ducts. Heating and air conditioning capabilities are provided in this mode. The air will be heated or cooled based on the temperature selection. For added customer comfort, the air distributed through the floor ducts will be slightly warmer than the air sent to the windshield defroster ducts. If the temperature is about 10°C (50°F) or higher, the air conditioner will automatically dehumidify the air to prevent fogging.
- **DEF**  -Distributes outside air through the windshield defroster ducts. It can be used to clear ice or fog from the windshield. If the outside air temperature is about 10°C (50°F) or higher, the air conditioner will automatically dehumidify the air to prevent fogging.
- **OFF**-Outside air is shut out and the fan will not operate. For short periods of time, use this mode to prevent undesirable odors from entering the vehicle. For short periods of time only, use this mode to prevent undesirable odors from entering the vehicle.

## Controls and features

### **Displaying outside temperature**

Press OUTSIDE TEMP to display the outside air temperature. It will be displayed until OUTSIDE TEMP is pressed again.

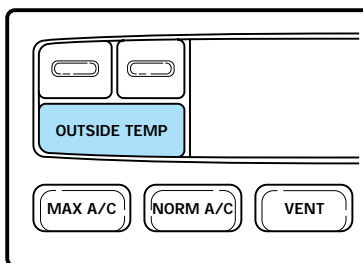

If the selected temperature is changed while the outside temperature is displayed, the new temperature will be displayed for four seconds after it is changed, then the outside temperature will return to the window.

If a manual override function is selected while the outside temperature is displayed, the new function will be displayed for four seconds after it is changed, then the outside temperature will return to the window along with the override selection.

The outside temperature reading is most accurate when the vehicle is moving. Higher readings may be obtained when the vehicle is not moving. The readings that you get may not agree with temperatures given on the radio due to differences in vehicle and station locations.

### **Operating tips**

- In humid weather, select DEF  before driving. This will prevent your windshield from fogging. After a few minutes, select any desired position.
- To prevent humidity buildup inside the vehicle, don't drive with the climate control system in the OFF position.
- Don't put objects under the front seat that will interfere with the airflow to the back seats.



## Controls and features

- Remove any snow, ice or leaves from the air intake area (at the bottom of the windshield).

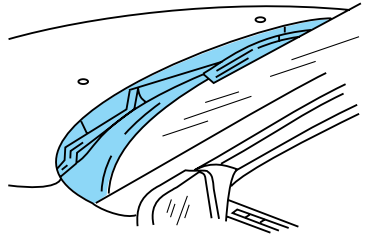

- If your vehicle has been parked with the windows closed during hot weather, the air conditioner will do a much faster job of cooling if you drive for two or three minutes with the windows open. This will force most of the hot, stale air out of the vehicle. Then operate the air conditioner as you would normally.
- When placing objects on top of your instrument panel, be careful to not place them over the defroster outlets. These objects can block airflow and reduce your ability to see through your windshield. Also, avoid placing small objects on top of your instrument panel. These objects can fall down into the defroster outlets and block airflow and possibly damage your climate control system.

### CLOCK

Press H to set the hour.

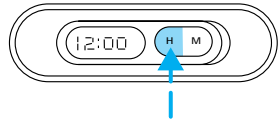

Press M to set the minute.

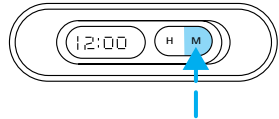

### AUDIO SYSTEM

Refer to the "Audio Guide" in your owner portfolio.

## Controls and features

### TURN SIGNAL CONTROL

- Push down to activate the left turn signal.
- Push up to activate the right turn signal.

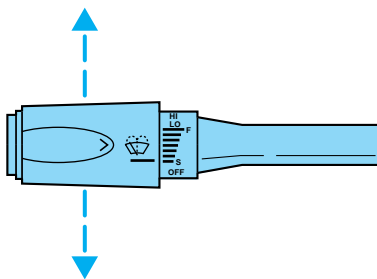

The flash rate of the turn signal will speed up considerably if the Lighting Control Module detects a left or right turn lamp bulb (front or rear) is burned out.

### WINDSHIELD WIPER/WASHER CONTROLS

Rotate the windshield wiper control to the desired interval, low or high speed position.

The bars of varying length are for intermittent wipers. When in this position rotate the control upward for fast intervals and downward for slow intervals.

Push the control on the end of the stalk to activate washer. Push and hold for a longer wash cycle. The washer will automatically shut off after ten seconds of continuous use.

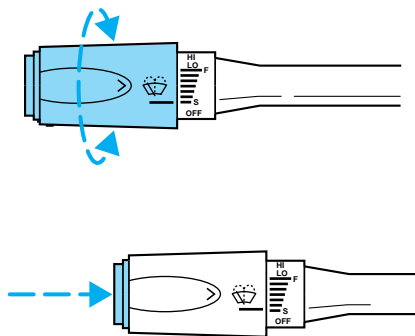

## Controls and features

### POSITIONS OF THE IGNITION

1. **ACCESSORY**, allows the electrical accessories such as the radio to operate while the engine is not running.
2. **LOCK**, locks the steering wheel, automatic transmission gearshift lever and allows key removal.
3. **OFF**, shuts off the engine and all accessories without locking the steering wheel.
4. **ON**, all electrical circuits operational. Warning lights illuminated. Key position when driving.
5. **START**, cranks the engine. Release the key as soon as the engine starts.

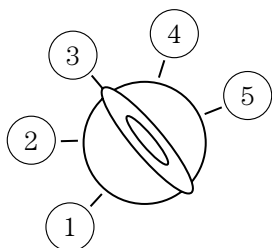

### TILT STEERING

Pull the tilt steering control toward you to move the steering wheel up or down. Hold the control while adjusting the wheel to the desired position, then release the control.

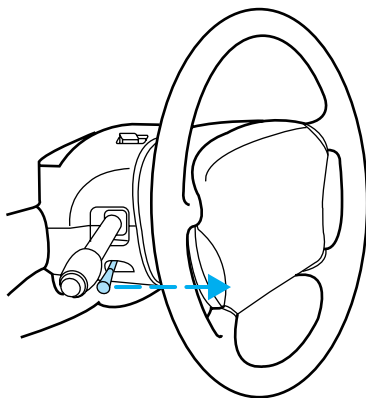

Never adjust the steering wheel when the vehicle is moving.

## Controls and features

### SPEED CONTROL (IF EQUIPPED)

#### To turn speed control on

- Press ON.

Vehicle speed cannot be controlled until the vehicle is traveling at or above 48 km/h (30 mph).

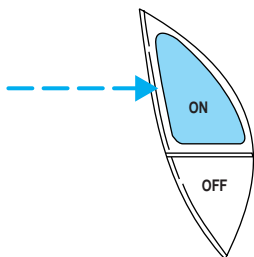

Do not use the speed control in heavy traffic or on roads that are winding, slippery, or unpaved.



Do not shift the gearshift lever into N (Neutral) with the speed control on.

#### To turn speed control off

- Press OFF or
- Turn off the vehicle ignition.

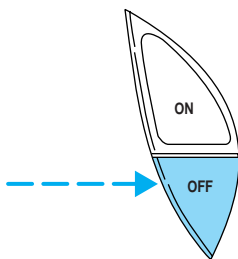

Once speed control is switched off, the previously programmed set speed will be erased.

## Controls and features

### To set a speed

- Press SET ACC/SET ACCEL. For speed control to operate, the speed control must be ON and the vehicle speed must be greater than 48 km/h (30 mph).

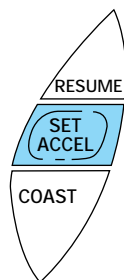

If you drive up or down a steep hill, your vehicle speed may vary momentarily slower or faster than the set speed. This is normal.

Speed control cannot reduce the vehicle speed if it increases above the set speed on a downhill. If your vehicle speed is faster than the set speed while driving on a downhill, you may want to shift to the next lower gear or apply the brakes to reduce your vehicle speed.

If your vehicle slows down more than 16 km/h (10 mph) below your set speed on an uphill, your speed control will disengage. This is normal. Pressing RES/RSM/RESUME will re-engage it.



Do not use the speed control in heavy traffic or on roads that are winding, slippery, or unpaved.

### To set a higher set speed

- Press and hold SET ACC/SET ACCEL. Release the control when the desired vehicle speed is reached or
- Press and release SET ACC/SET ACCEL. Each press will increase the set speed by 1.6 km/h (1 mph) or
- Accelerate with your accelerator pedal. When the desired vehicle speed is reached, press and release SET ACC/SET ACCEL.

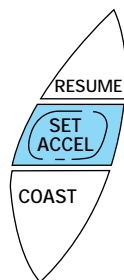

## Controls and features

You can accelerate with the accelerator pedal at any time during speed control usage. Releasing the accelerator pedal will return your vehicle to the previously programmed set speed.

### To set a lower set speed

- Press and hold CST/COAST. Release the control when the desired speed is reached or
- Press and release CST/COAST. Each press will decrease the set speed by 1.6 km/h (1 mph) or

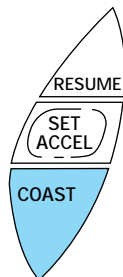

- Depress the brake pedal. When the desired vehicle speed is reached, press SET ACC/SET ACCEL.

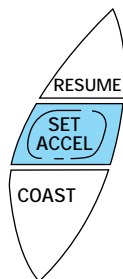

### To disengage speed control

- Depress the brake pedal.

Disengaging the speed control will not erase the previously programmed set speed.

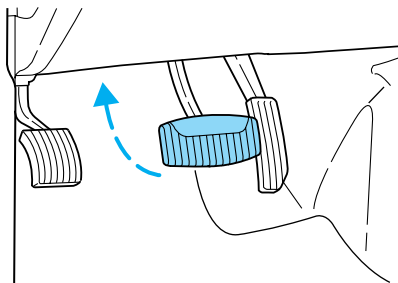

## Controls and features

Pressing OFF will erase the previously programmed set speed.

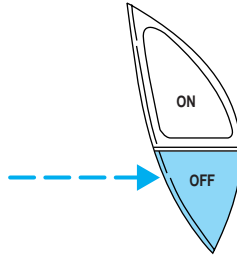

### To return to a previously set speed

- Press RES/RSM/RESUME. For RES/RSM/RESUME to operate, the vehicle speed must be faster than 48 km/h (30 mph).

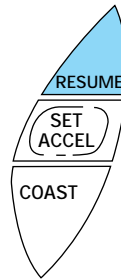

### Indicator light

This light comes on when either the SET ACC/SET ACCEL or RES/RSM/RESUME controls are

pressed. It turns off when the speed control OFF control is pressed, the brake is applied or the ignition is turned to the OFF position.

## SPEED CONTROL

### HOMELINK® UNIVERSAL TRANSMITTER (IF EQUIPPED)

The HomeLink® Universal Transmitter, located underneath the driver's visor, provides a convenient way to replace up to three hand-held transmitters with a single built-in device. This feature will learn the radio frequency codes of most current transmitters to operate garage doors and gates, and can also control home or office lighting and security systems (with the available accessory package).

## Controls and features



When programming your HomeLink® Universal Transmitter, you will be operating the garage door or gate. Be sure that people and objects are out to the way to prevent potential harm or damage.

Do not use the HomeLink® Universal Transmitter with any garage door opener that lacks safety stop and reverse features as required by U.S. federal safety standards (this includes any garage door opener model manufactured before April 1, 1982). A garage door which cannot detect an object, signaling the door to stop and reverse, does not meet current U.S. federal safety standards. For more information on this matter, call toll-free: 1-800-355-3515.

### Programming

1. Prepare for programming the HomeLink® Universal Transmitter by erasing all three of the factory default channels by holding down the two outside controls until the red light begins to flash (20-30 seconds). Release both controls.

2. Hold the end of your hand-held transmitter against the HomeLink® Universal Transmitter (located on your visor) while keeping the red light in view.

3. Using both hands, press the hand-held transmitter control and the desired channel control on the HomeLink® Universal Transmitter. Do not release the controls until step 4 has been completed.

4. Hold down both controls until the red light begins to flash slowly and then rapidly. Rapid flashing indicates successful programming of the new frequency signal.

5. Follow steps 2 through 4 to program the remaining two channels.

If you do not successfully program the HomeLink® Universal Transmitter after repeated attempts, refer to *Training a rolling code* which follows or call toll-free customer assistance: 1-800-355-3515.

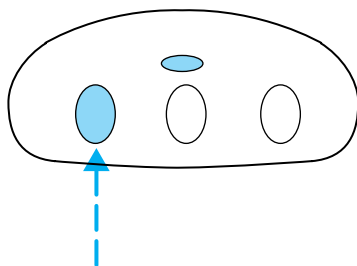
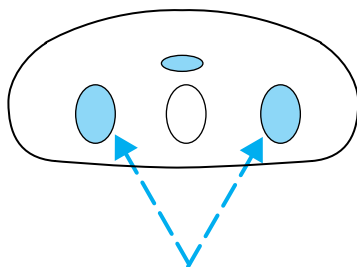



## Controls and features

### Note to Canadian residents

During programming, your hand-held transmitter may automatically stop transmitting after two seconds which may not be long enough to program the HomeLink® Universal Transmitter.

If you are programming from one of these hand-held transmitters:

- continue to hold the control on the HomeLink® Universal Transmitter
- re-press the hand-held transmitter every two seconds

You may have to repeat this function several times while programming.

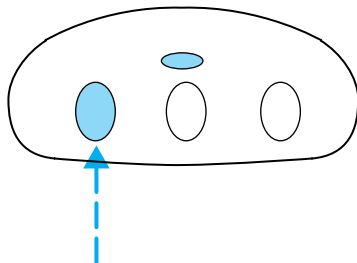

### Operating the HomeLink® Universal Transmitter

Once programmed, the HomeLink® Universal Transmitter can be used in place of hand-held transmitters. To operate, simply press the appropriate channel control on the transmitter (the red light will illuminate, indicating the signal is being transmitted).

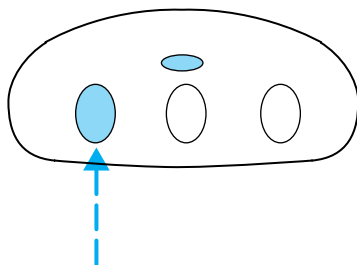

### Training a rolling code system

Rolling code systems (garage door openers which are “code protected”) may be determined by the following:

- The hand-held transmitter appears to program the HomeLink® Universal Transmitter but does not activate the garage door.
- The garage door opener was manufactured after 1995.

Follow these steps to train a garage door with the rolling code feature:

1. Locate the training control on the garage door opener receiver. Refer to the garage door opener manual or call 1-800-355-3515 if there is difficulty locating the training control.

## Controls and features

2. Press the training control on the garage door opener receiver until the training light (next to the control) begins to flash (1-2 seconds).

3. Press the programmed HomeLink® control in the vehicle until the training light on the garage door receiver turns solid (1-2 seconds). Release the HomeLink® control and repress to turn off the training light.

4. Press the HomeLink® control again. If the garage door activates, the HomeLink® Universal Transmitter has been trained to the receiver.

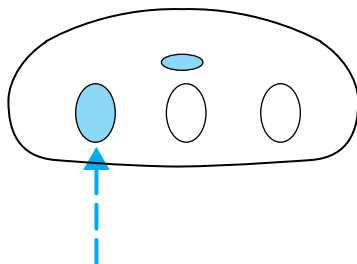

### Erasing channels

To erase all three programmed channels:

1. Hold down the two outside controls until the red light begins to flash.

2. Release both controls.

Channels cannot be erased individually, but can be reprogrammed. Refer to *Programming* for instructions.

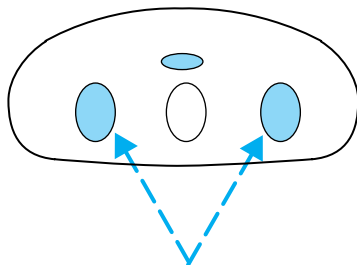

### AUTOMATIC DIMMING INSIDE REAR VIEW MIRROR (IF EQUIPPED)

Your vehicle is equipped with an inside rear view mirror which has an auto-dimming function. The electronic day/night mirror will change from the normal state to the non-glare state when bright lights (glare) reach the mirror. When the mirror detects bright light from front or behind, it will automatically adjust (darken) to minimize glare.

Do not block the sensor on the backside of the mirror since this may impair proper mirror performance.

## Controls and features

Press the control to turn the mirror on or off.

The mirror will automatically return to the normal state whenever the vehicle is placed in R (Reverse)(when the mirror is on) to ensure a bright clear view when backing up.

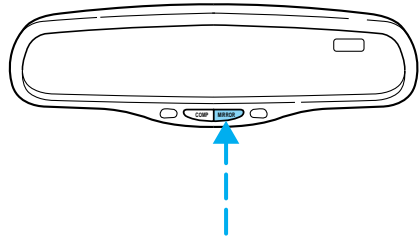

### **ELECTRONIC COMPASS (IF EQUIPPED)**

The compass reading will remain accurate during most driving conditions. Unknown to the driver, the compass is continuously recalibrating due to magnetic fields and subtle, slow changes in vehicle magnetics which can occur over the life of the vehicle.

The compass reading will remain fixed when significant levels are experienced (such as steel bridges). The compass will return to normal operation upon leaving the magnetized area.

If highly magnetized items (such as magnetic mount antennas) are placed very near the compass the display will change to "C" for 15 seconds, then display all segments until the magnetized item is removed.

Most geographic areas (zones) have a magnetic north compass point that varies slightly from the northerly direction on maps. This variation is four degrees between adjacent zones and will become noticeable as the vehicle crosses multiple zones. A correct zone setting will eliminate this error. Refer to *Compass zone adjustment*.

## Controls and features

### Compass zone adjustment

1. Determine which compass zone you are in by referring to the zone map.

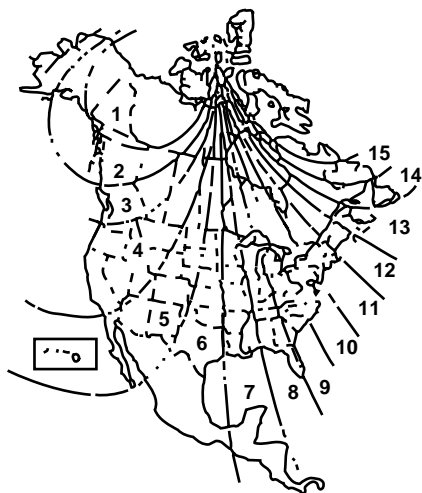

2. With the compass display turned on, press and hold the COMP side of the control until the zone selection number appears in the mirror display window.

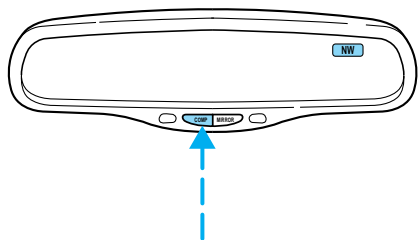

3. Release the COMP side of the control, then press it down again.

4. Continue to press until your zone number is shown in the mirror display, then release.

5. The display will show all segments, then return to normal compass mode within ten seconds.

## Controls and features

### Compass calibration adjustment

Perform this adjustment in an open area free from steel structures and high voltage lines.

1. Start the vehicle.
2. Press and hold the COMP side of the control for approximately six seconds until “C” appears in the mirror display.
3. Drive the vehicle slowly (less than 5 km/h [3 mph]) in circles or on your everyday routine until the display reads a direction.
4. The compass is now calibrated.

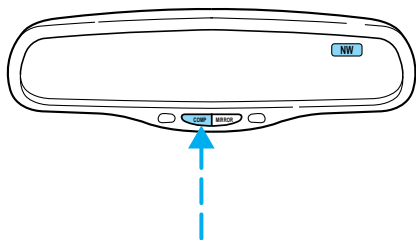

### TRUNK REMOTE CONTROL

The remote trunk release control is located on the driver's door trim panel and can be operated at any time.

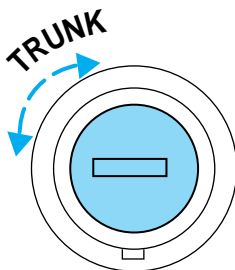

### POWER WINDOWS

Press and hold the rocker switches to open and close windows.

- Press the top portion of the rocker switch to close.

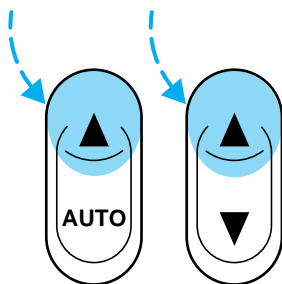

## Controls and features

- Press the bottom portion of the rocker switch to open.

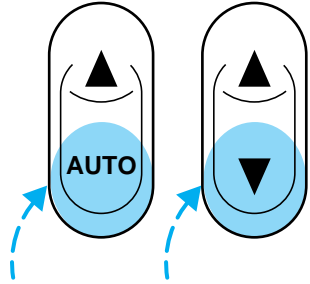

### Express down

- Press AUTO and release quickly. The window will open fully. Depress again to stop window operation.

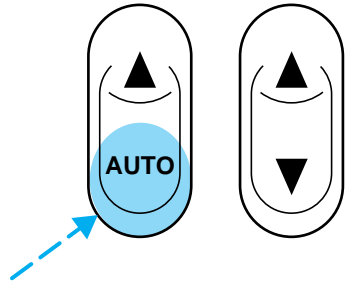

### Window lock

The window lock feature allows only the driver to operate the power windows.

To lock out all the window controls except for the driver's press the right side of the control. Press the left side to restore the window controls.

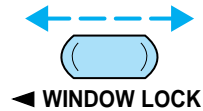

## Controls and features

### POWER DOOR LOCKS (IF EQUIPPED)

Press U to unlock all doors and L to lock all doors.

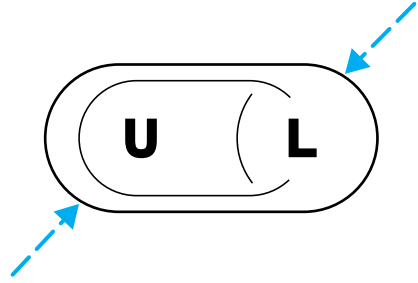

### POWER SIDE VIEW MIRRORS

The ignition must be in ACC or ON position to adjust the power side view mirrors.

To adjust your mirrors:

1. Select L to adjust the left mirror or R to adjust the right mirror.

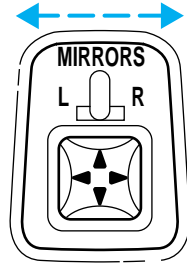

2. Move the control in the direction you wish to tilt the mirror.

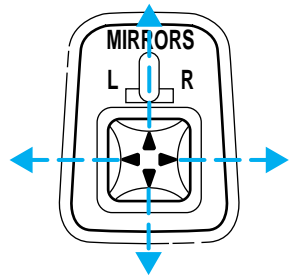

3. Return to the center position to lock mirrors in place.

## Controls and features

### CHILDPROOF DOOR LOCKS

When these locks are set, the rear doors cannot be opened from the inside. The rear doors can be opened from the outside when the doors are unlocked.

The childproof locks are located on rear edge of each rear door and must be set separately for each door. Setting the lock for one door will not automatically set the lock for both doors.

Move lock control up to engage the lock. Move control down to disengage childproof locks.

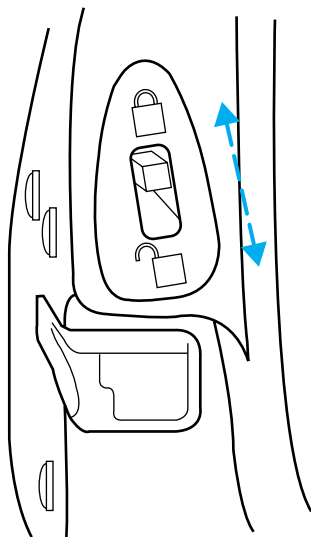

### POSITIVE RETENTION FLOOR MAT

Position the floor mat so that the eyelet is over the pointed end of the retention post and rotate forward to lock in. Make sure that the mat does not interfere with the operation of the accelerator or the brake pedal. To remove the floor mat, reverse the installation procedure.

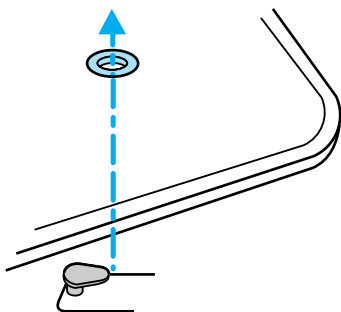

### REMOTE ENTRY SYSTEM (IF EQUIPPED)

The remote entry system allows you to lock or unlock all vehicle doors without a key.

The remote entry features only operate with the ignition in the OFF position.



## Controls and features

### Unlocking the doors

Press this control to unlock the driver's door. The interior lamps will illuminate.

Press the control a second time within five seconds to unlock all doors.

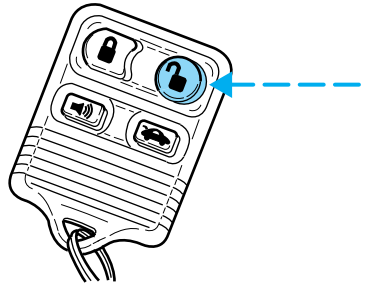

### Locking the doors

Press this control to lock all doors.

The horn will chirp and the parklamps/taillamps will flash to confirm the control was pressed. This feature can be turned on/off through the following procedure:

You must complete steps 1-7 within 30 seconds or the procedure will have to be repeated. If the procedure needs to be repeated, you must wait 30 seconds.

1. Turn the ignition key to ON.
2. Press the power door unlock control three times.
3. Turn the ignition key from ON to OFF.
4. Press the power door unlock control three times.
5. Turn the ignition back to ON. The horn will chirp.
6. Press the unlock control, then press the lock control. The horn will chirp once if autolock was deactivated or twice (one short and one long chirp) if autolock was activated.
7. Turn the ignition to OFF. The horn will chirp once to confirm the procedure is complete.

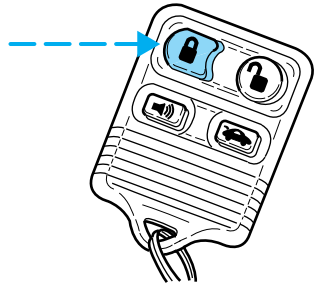

## Controls and features

### **Autolock**

This feature automatically locks all doors when:

- all vehicle doors are closed
- the ignition is in the ON position
- you shift into or through R (Reverse)
- the brake pedal is released.

### **Relock**

The autolock feature repeats when:

- any door is opened and closed
- the brake pedal is released.

### ***Deactivating/activating the autolock feature***

Before following the procedure, make sure that the ignition is OFF and all vehicle doors are closed.

Automatic door locks can be turned on/off with the keyless entry keypad through the following procedure:

You must complete steps 1-5 within 30 seconds or the procedure will have to be repeated. If the procedure needs to be repeated, you must wait 30 seconds.

1. Enter the keyless entry keypad factory code.
2. Within 5 seconds, press and hold control 7/8.
3. Within 5 seconds (while holding down control 7/8), press and release control 3/4.
4. Release control 7/8.

The door will lock/unlock to confirm the horn chirp feature has been disabled. Once disabled, the feature can be enabled by repeating the same sequence.

## Controls and features

### Opening the trunk

Press the control once to open the trunk.

Ensure that the trunk is closed and latched before driving your vehicle. Failure to latch the trunk may cause objects to fall out of the trunk or block the rear view.

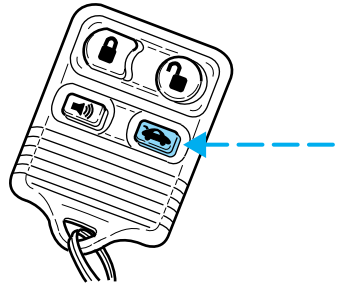

### Sounding a panic alarm

Press this control to activate the alarm.

To deactivate the alarm, press the control again or turn the ignition to ACC or ON.

This device complies with part 15 of the FCC rules and with RS-210 of Industry Canada. Operation is subject to the following two conditions: (1) This device may not cause harmful interference, and (2) This device must accept any interference received, including interference that may cause undesired operation.

**Changes or modifications not expressly approved by the party responsible for compliance could void the user's authority to operate the equipment.**

### Illuminated entry

The interior lamps illuminate when the remote entry system is used to unlock the door(s) or sound the personal alarm.

The system automatically turns off after 25 seconds or when the ignition is turned to the START or ACC position. The dome lamp control (if equipped) must **not** be set to the OFF position for the illuminated entry system to operate.

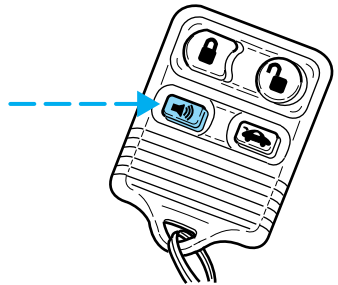

## Controls and features

The inside lights will not turn off if:

- they have been turned on with the dimmer control or
- any door is open.

The battery saver will shut off the interior lamps 30 minutes after the last door is closed or after 10 minutes if the door is left open.

### Replacing the battery

The transmitter is powered by one coin type three-volt lithium battery CR2032 or equivalent. Typical operating range will allow you to be up to 10 meters (33 feet) away from your vehicle. A decrease in operating range can be caused by:

- battery weakness due to time and use
- weather conditions
- nearby radio towers
- structures around the vehicle
- other vehicles parked next to the vehicle

To replace the battery:

1. Twist a thin coin between the two halves of the transmitter near the key ring. **DO NOT TAKE THE FRONT PART OF THE TRANSMITTER APART.**

2. Place the positive (+) side of new battery in the same orientation. Refer to the diagram inside the transmitter unit.

3. Snap the two halves back together.

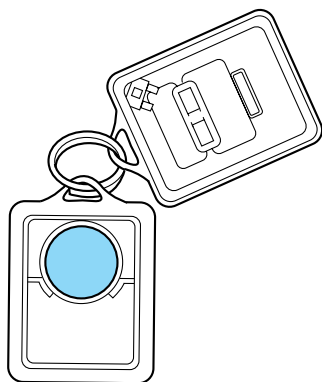

Replacement of the battery will **not** cause the remote transmitter to become deprogrammed from your vehicle. The remote transmitter should operate normally after battery replacement.

## Controls and features

### Replacing lost transmitters

Take all your vehicle's transmitters to your dealer for reprogramming if:

- a transmitter is lost or
- you want to purchase additional transmitters (up to four may be programmed).

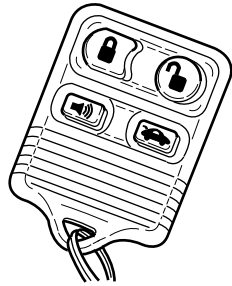

### SECURILOCK™ ANTI-THEFT SYSTEM

The SecuriLock™ anti-theft system provides an advanced level of vehicle theft protection. Your vehicle's engine can only be started with the two special SecuriLock™ electronically coded keys provided with your vehicle. Each time you start your vehicle, the SecuriLock™ key is read by the SecuriLock™ anti-theft system. If the SecuriLock™ key identification code matches the code stored in the SecuriLock™ anti-theft system, the vehicle's engine is allowed to start. If the SecuriLock™ key identification code does not match the code stored in the system or if a SecuriLock™ key is not detected (vehicle theft situation), the vehicle's engine will not operate.

Spare SecuriLock™ keys can be purchased from your dealership and programmed to your SecuriLock™ anti-theft system. Refer to *Programming spare SecuriLock™ keys* for more information.

If one or both of your SecuriLock™ keys are lost or stolen and you want to ensure the lost or stolen key will not operate your vehicle, bring your vehicle and all available SecuriLock™ keys to your dealership for reinitialization.

## Controls and features

### Theft indicator

The theft indicator on top of the instrument panel will operate as follows:

- When the ignition is OFF, the theft indicator will flash briefly every 2 seconds to indicate the SecuriLock™ system is protecting your vehicle.
- When the ignition is turned to RUN or START, the theft indicator will light for 3 seconds and then go out. If the theft indicator stays on for an extended period of time or flashes rapidly, have the system serviced by your dealership or a qualified technician.

### Programming spare SecuriLock™ keys

Spare SecuriLock™ keys can be purchased from your dealership and programmed to your SecuriLock™ anti-theft system (up to a total of 8 keys). Your dealership can program your new SecuriLock™ key(s) to your vehicle or you can do it yourself using the following simple procedure. To program a new SecuriLock™ key yourself, you will need two previously programmed SecuriLock™ keys (keys that already operate your vehicle's engine). If two previously programmed SecuriLock™ keys are not available (one or both of your original keys were lost or stolen), you must bring your vehicle to your dealership to have the spare SecuriLock™ key(s) programmed.

### Procedure to program spare SecuriLock™ keys to your vehicle

New SecuriLock™ keys must have the correct mechanical key cut for your vehicle.

Conventional (non-SecuriLock™) keys **cannot** be programmed to your vehicle.

You will need to have two previously programmed SecuriLock™ keys and the new unprogrammed SecuriLock™ key readily accessible for timely implementation of each step in the procedure. Please read and understand the entire procedure before you begin.

1. Insert the first previously programmed SecuriLock™ key into the ignition and turn the ignition from OFF to RUN (maintain ignition in RUN for at least one second).
2. Turn ignition to OFF and remove the first SecuriLock™ key from the ignition.

## Controls and features

3. Within five seconds of turning the ignition to OFF, insert the second previously programmed SecuriLock™ key into the ignition and turn the ignition from OFF to RUN (maintain ignition in RUN for at least one second but no more than 5 seconds).
4. Turn the ignition to OFF and remove the second SecuriLock™ key from the ignition.
5. Within 10 seconds of turning the ignition to OFF, insert the unprogrammed SecuriLock™ key (new key) into the ignition and turn the ignition from OFF to RUN (maintain ignition in RUN for at least one second). This step will program your new SecuriLock™ key.
6. To program additional SecuriLock™ key(s), repeat this procedure from step 1.

If the programming procedure was successful, the new SecuriLock™ key(s) will start the vehicle's engine. The theft indicator (located on the instrument panel) will light for three seconds and then go out.

If the programming procedure was not successful, the new SecuriLock™ key(s) will not operate the vehicle's engine. The theft indicator will flash on and off. Wait at least one minute and then repeat the procedure from step 1. If failure repeats, bring your vehicle to your dealership to have the spare SecuriLock™ key(s) programmed.

### KEYLESS ENTRY SYSTEM

With the keyless entry keypad, you can:

- lock or unlock the vehicle doors without using the key
- open trunk
- disable/enable horn chirp
- disable/enable autolock

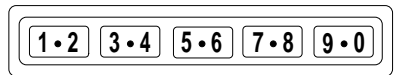

See also *Remote entry system* in this chapter for more information.

Your vehicle has a factory-set 5-digit code that operates the keyless entry system. You can also program your own 5-digit personal entry code.

## Controls and features

The factory-set code is located:

- on the owner's wallet card in the glove compartment
- taped to the computer module

When pressing the controls on the keyless entry keypad, press the middle of the controls to ensure a good activation.

### Programming your own entry code

1. Enter the factory-set code (keypad will illuminate when pressed).
2. Press the 1/2 control within five seconds of step 1.
3. Enter your personal 5 digit code. Enter each digit within five seconds of the previous one.

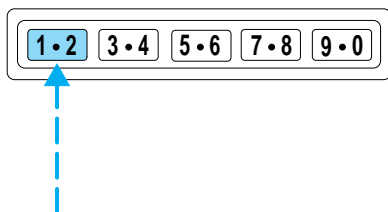

All of the vehicle doors will lock and unlock to confirm programming of the new code.

Do not set a code that includes five of the same number or presents them in sequential order. Thieves can easily figure out these types of codes.

You can program up to three personal codes to unlock your vehicle. These codes do not replace the permanent code that the dealership gave you.

### Erasing personal code

To erase all of the personal entry codes programmed to a vehicle:

1. Enter the factory-set code.
2. Press 1/2 within 5 seconds of step 1.
3. Press and hold 1/2 for two seconds. All of the vehicle doors will lock and then unlock to confirm erasure.

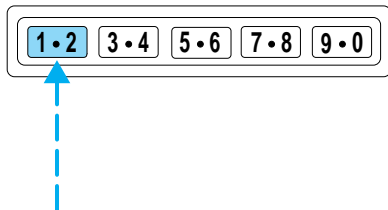



## Controls and features

### **Unlocking the doors and releasing the trunk with the keyless entry system**

To unlock the driver door, enter either the factory-set code or personal code (each digit pressed within 5 seconds of prior digit). The interior lamps will illuminate.

To unlock all doors, enter the factory-set code or personal code (driver door unlocks) and press 3/4 within 5 seconds.

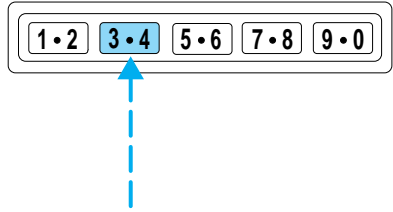

To release the trunk, enter the factory-set code or personal code (driver door unlocks) and press 5/6 within 5 seconds.

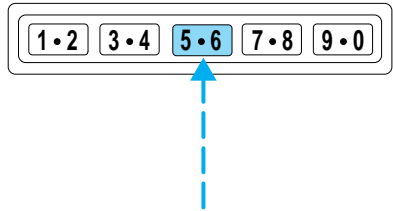

After the factory-set code or personal code has been entered, you can unlock all doors (press 3/4) and release the trunk (press 5/6) as long as the controls are pressed within 5 seconds of each other.

### **Locking doors with the keyless entry system**

It is not necessary to enter the factory-set code prior to locking all doors. To lock the doors:

1. Press 7/8 and 9/0 at the same time.

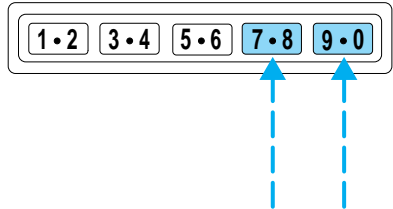

## Seating and safety restraints

### SEATING

#### Head restraints

Push or pull the head rests to the desired position.

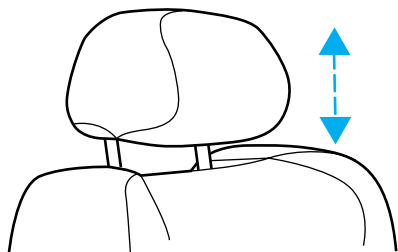

#### Front seats



Never adjust the driver's seat or seatback when the vehicle is moving.



Do not pile cargo higher than the seatbacks to avoid injuring people in a collision or sudden stop.



Always drive and ride with your seatback upright and the lap belt snug and low across the hips.

Lift handle to move seat forward or backward.

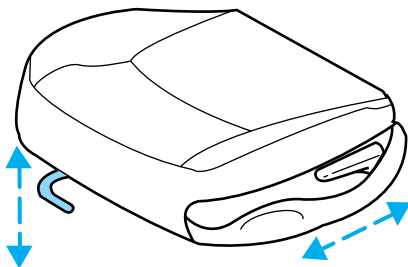

## Seating and safety restraints

Pull lever up to adjust seatback.

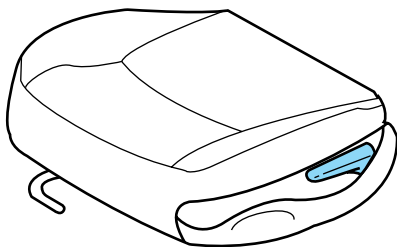

### **Using the manual recline function (if equipped)**



Never adjust the driver's seat or seatback when the vehicle is moving.



Do not pile cargo higher than the seatbacks to avoid injuring people in a collision or sudden stop.



Always drive and ride with your seatback upright and the lap belt snug and low across the hips.

To adjust the front seatback using the manual recliner:

- Lift and hold the handle located on the side of the seat.
- Lean against the seatback to adjust it to your desired position. You can recline the seat back or bring it forward.
- Release the handle when the desired position has been reached.

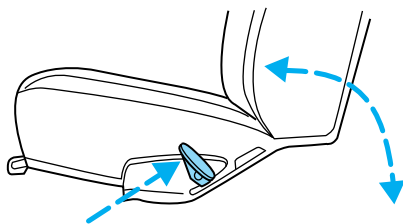

### **Adjusting the power front seats – door mounted controls**

The controls for the power seats are located on the inside of each front door.



Never adjust the driver's seat or seatback when the vehicle is moving.

# Seating and safety restraints



Do not pile cargo higher than the seatbacks to avoid injuring people in a collision or sudden stop.



Always drive and ride with your seatback upright and the lap belt snug and low across the hips.

Press the control to recline the seatback forward or backward (if equipped).

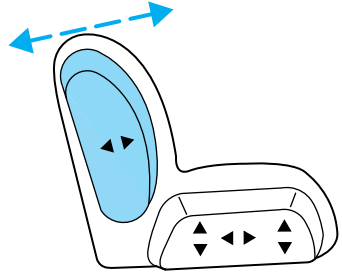

Press to move the seat forward or backward.

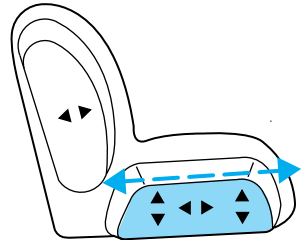

Press to move the front portion of the seat cushion up or down.

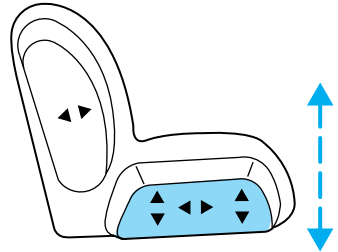

## Seating and safety restraints

Press to move the rear portion of the seat cushion up or down.

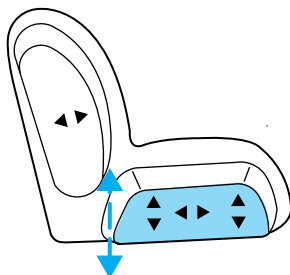

### **Adjusting the power seats – seat mounted controls**



Never adjust the driver's seat or seatback when the vehicle is moving.

The power seat controls are located on the side of the driver's seat.

Press to raise or lower the seat, or to move the seat forward or backward.

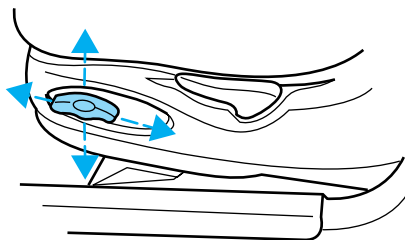

### **Using the power lumbar support**

The power lumbar control is located on the outboard side of the seat.

Press one side of the control to adjust firmness.

Press the other side of the control to adjust softness.

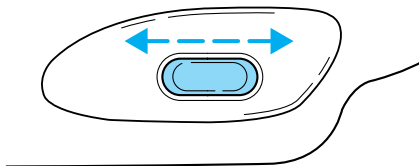

## **SAFETY RESTRAINTS**

### **Safety restraints precautions**



Always drive and ride with your seatback upright and the lap belt snug and low across the hips.

## Seating and safety restraints



To prevent the risk of injury, make sure children sit where they can be properly restrained.



Never let a passenger hold a child on his or her lap while the vehicle is moving. The passenger cannot protect the child from injury in a collision.



All occupants of the vehicle, including the driver, should always properly wear their safety belts, even when an air bag SRS is provided.



It is extremely dangerous to ride in a cargo area, inside or outside of a vehicle. In a collision, people riding in these areas are more likely to be seriously injured or killed. Do not allow people to ride in any area of your vehicle that is not equipped with seats and safety belts. Be sure everyone in your vehicle is in a seat and using a safety belt properly.



Each seating position in your vehicle has a specific safety belt assembly which is made up of one buckle and one tongue that are designed to be used as a pair. 1) Use the shoulder belt on the outside shoulder only. Never wear the shoulder belt under the arm. 2) Never swing it around your neck over the inside shoulder. 3) Never use a single belt for more than one person.

### Combination lap and shoulder belts

1. Insert the belt tongue into the proper buckle until you hear a snap and feel it latch. Make sure the tongue is securely fastened in the buckle.

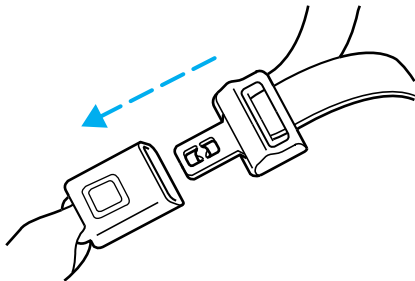

## Seating and safety restraints

2. To unfasten, push the release button and remove the tongue from the buckle.

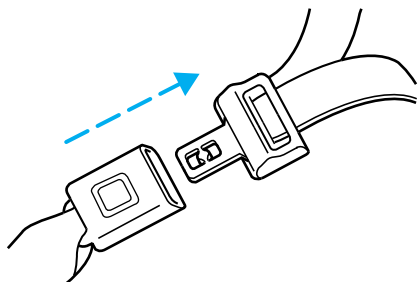

The front and rear outboard safety restraints in the vehicle are combination lap and shoulder belts. The front and rear seat passenger outboard safety belts have two types of locking modes described below:

### Vehicle sensitive mode

The vehicle sensitive mode is the normal retractor mode, allowing free shoulder belt length adjustment to your movements and locking in response to vehicle movement. For example, if the driver brakes suddenly or turns a corner sharply, or the vehicle receives an impact of 8 km/h (5 mph) or more, the combination safety belts will lock to help reduce forward movement of the driver and passengers.

### Automatic locking mode

In this mode, the shoulder belt is automatically pre-locked. The belt will still retract to remove any slack in the shoulder belt.

The automatic locking mode is not available on the driver safety belt.

### When to use the automatic locking mode

- When a tight lap/shoulder fit is desired.
- **Anytime** a child safety seat is installed in the vehicle. Refer to *Safety Restraints for Children* or *Safety Seats for Children* later in this chapter.

## Seating and safety restraints

### ***How to use the automatic locking mode***

- Buckle the combination lap and shoulder belt.

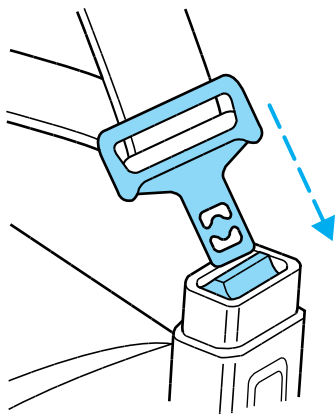

- Grasp the shoulder portion and pull downward until the entire belt is extracted.



- Allow the belt to retract. As the belt retracts, you will hear a clicking sound. This indicates the safety belt is now in the automatic locking mode.

### ***How to disengage the automatic locking mode***

Disconnect the combination lap/shoulder belt and allow it to retract completely to disengage the automatic locking mode and activate the vehicle sensitive (emergency) locking mode.





## Seating and safety restraints

### Front safety belt height adjustment

Your vehicle has safety belt height adjustments for the driver and front passenger. Adjust the height of the shoulder belt so the belt rests across the middle of your shoulder.

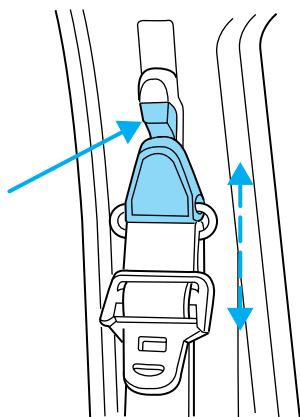
To lower the shoulder belt height, push the button and slide the height control down. To raise the height of the shoulder belt, slide the height adjuster up. Pull down on the height adjustment assembly to make sure it is locked in place.



 Position the shoulder belt height adjuster so that the belt rests across the middle of your shoulder. Failure to adjust the safety belt properly could reduce the effectiveness of the safety belt and increase the risk of injury in a collision.

### Lap belts

#### *Adjusting the lap belt*

The lap belt does not adjust automatically.

 The lap belts should fit snugly and as low as possible around the hips, not around the waist.

## Seating and safety restraints

Insert the tongue into the correct buckle. To lengthen the belt, turn the tongue at a right angle to the belt and pull across your lap until it reaches the buckle. To tighten the belt, pull the loose end of the belt through the tongue until it fits snugly across the hips.

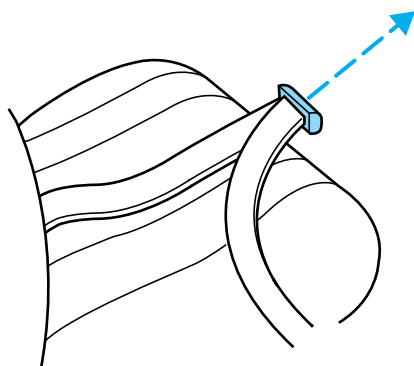

Shorten and fasten the belt when not in use.

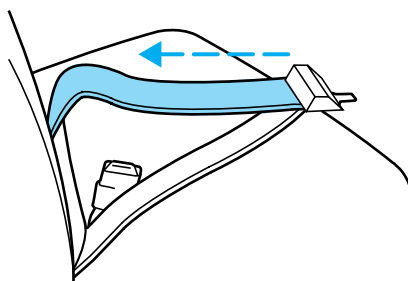

### Safety belt extension assembly

If the safety belt assembly is too short, even when fully extended, 20 cm (8 inches) can be added to the safety belt assembly by adding a safety belt extension assembly (part number 611C22). Safety belt extension assemblies can be obtained from your dealer at no cost.

Use only extensions manufactured by the same supplier as the safety belt. Manufacturer identification is located at the end of the webbing on the label. Also, use the safety belt extension only if the safety belt is too short for you when fully extended. Do not use extensions to change the fit of the shoulder belt across the torso.

### Safety belt warning light and indicator chime

The seat belt warning light illuminates in the instrument cluster and a chime sounds to remind the occupants to fasten their safety belts.

## Seating and safety restraints

### Conditions of operation

If...	Then...
The driver's safety belt is not buckled before the ignition switch is turned to the ON position...	The safety belt warning light illuminates for one to two minutes and the warning chime sounds for four to eight seconds.
The driver's safety belt is buckled while the indicator light is illuminated and the warning chime is sounding...	The safety belt warning light and warning chime turn off.
The driver's safety belt is buckled before the ignition switch is turned to the ON position...	The safety belt warning light and indicator chime remain off.

### Safety belt maintenance

Inspect the safety belt systems periodically to make sure they work properly and are not damaged. Inspect the safety belts to make sure there are no nicks, wears or cuts, replacing if necessary. All safety belt assemblies, including retractors, buckles, front seat belt buckle assemblies (slide bar)(if equipped), shoulder belt height adjusters (if equipped), child safety seat tether bracket assemblies (if equipped), and attaching hardware, should be inspected after a collision. Ford recommends that all safety belt assemblies used in vehicles involved in a collision be replaced. However, if the collision was minor and a qualified technician finds that the belts do not show damage and continue to operate properly, they do not need to be replaced. Safety belt assemblies not in use during a collision should also be inspected and replaced if either damage or improper operation is noted.



Failure to inspect and if necessary replace the safety belt assembly under the above conditions could result in severe personal injuries in the event of a collision.

Refer to *Cleaning and maintaining the safety belts* in the *Maintenance and care* section.

## Seating and safety restraints

### AIR BAG SUPPLEMENTAL RESTRAINT SYSTEM (SRS)

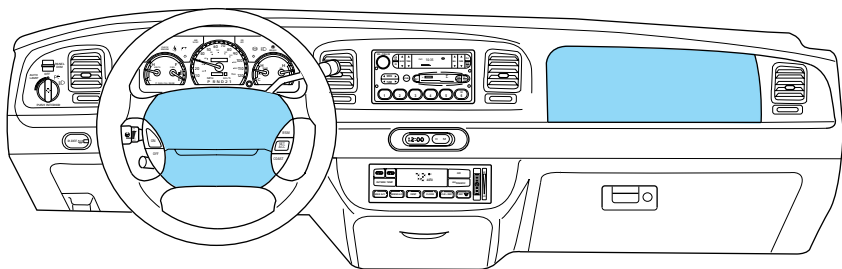

### Important supplemental restraint system (SRS) precautions

The supplemental restraint system is designed to work with the safety belt to help protect the driver and right front passenger from certain upper body injuries.

Air bags DO NOT inflate slowly or gently and the risk of injury from a deploying air bag is greatest close to the trim covering the air bag module.

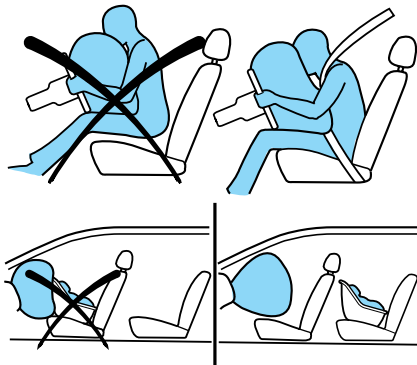

All occupants of the vehicle including the driver should always properly wear their safety belts even when air bag SRS is provided.



Always transport children 12 years old and under in the back seat and always use appropriate child restraints.



NHTSA recommends a minimum distance of at least 25.4 cm (ten [10] inches) between an occupant's chest and the air bag module.

## Seating and safety restraints

Steps you can take to properly position yourself away from the airbag:

- Move your seat to the rear as far as you can while still reaching the pedals comfortably.
- Recline the seat one or two notches from the upright position.



The right front passenger air bag is not designed to restrain occupants in the center front seating position.



Do not put anything on or over the air bag module. Placing objects on or over the air bag inflation area may cause those objects to be propelled by the air bag into your face and torso causing serious injury.



Do not attempt to service, repair, or modify the Air Bag Supplemental Restraint System or its fuses. See your Ford or Lincoln-Mercury dealer.

### Children and air bags

For additional important safety information, read all information on safety restraints in this guide.

Children must always be properly restrained. Accident statistics suggest that children are safer when properly restrained in the rear seating positions than in the front seating position. Failure to follow these instructions may increase the risk of injury in a collision.



Air bags can kill or injure a child in a child seat.

**NEVER** place a rear-facing child seat in front of an active air bag. If you must use a forward-facing child seat in the front seat, move the seat all the way back.

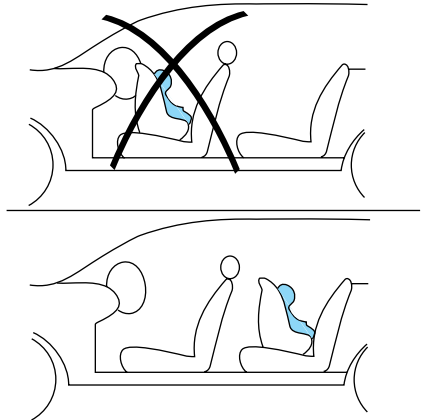

## Seating and safety restraints

### How does the air bag supplemental restraint system work?

The air bag SRS is designed to activate when the vehicle sustains sufficient longitudinal deceleration sufficient to cause the sensors to close an electrical circuit that initiates air bag inflation.

The fact that the air bags did not inflate in a collision does not mean that something is wrong with the system. Rather, it means the forces were not of the type sufficient to cause activation. Air bags are designed to inflate in frontal and near-frontal collisions, not rollover, side-impact, or rear-impacts.

The air bags inflate and deflate rapidly upon activation. After air bag deployment, it is normal to notice a smoke-like, powdery residue or smell the burnt propellant. This may consist of cornstarch, talcum powder (to lubricate the bag) or sodium compounds (e.g., baking soda) that result from the combustion process that inflates the air bag. Small amounts of sodium hydroxide may be present which may irritate the skin and eyes, but none of the residue is toxic.

While the system is designed to help reduce serious injuries, it may also cause minor burns, abrasions, swelling or temporary hearing loss. Because air bags must inflate rapidly and with considerable force, there is the risk of death or serious injuries such as fractures, facial and eye injuries or internal injuries, particularly to occupants who are not properly restrained or are otherwise out of position at the time of air bag deployment. Thus, it is extremely important that occupants be properly restrained as far away from the air bag module as possible while maintaining vehicle control.

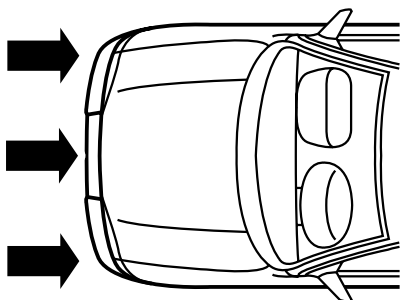

## Seating and safety restraints



Several air bag system components get hot after inflation. Do not touch them after inflation.



If the air bag is inflated, **the air bag will not function again and must be replaced immediately**. If the air bag is not replaced, the unrepaired area will increase the risk of injury in a collision.

The SRS consists of:

- driver and passenger air bag modules (which include the inflators and air bags),
- one or more impact and safing sensors,
- a readiness light and tone
- and the electrical wiring which connects the components.

The diagnostic module monitors its own internal circuits and the supplemental air bag electrical system warning (including the impact sensors), the system wiring, the air bag system readiness light, the air bag back up power and the air bag ignitors.

### Determining if the system is operational

The SRS uses a readiness light in the instrument cluster or a tone to indicate the condition of the system. Refer to the *Air bag readiness* section in the *Instrumentation* chapter. Routine maintenance of the air bag is not required.

A difficulty with the system is indicated by one or more of the following:

- The readiness light will either flash or stay lit.
- The readiness light will not illuminate immediately after ignition is turned on.
- A series of five beeps will be heard. The tone pattern will repeat periodically until the problem and light are repaired.

**AIR  
BAG**

If any of these things happen, even intermittently, have the SRS serviced at your dealership or by a qualified technician immediately. Unless serviced, the system may not function properly in the event of a collision.

## Seating and safety restraints

### Disposal of air bags and air bag equipped vehicles

For disposal of air bags or air bag equipped vehicles, see your local dealership or qualified technician. Air bags **MUST BE** disposed of by qualified personnel.

### SAFETY RESTRAINTS FOR CHILDREN

See the following sections for directions on how to properly use safety restraints for children. Also see *Air Bag Supplemental Restraint System (SRS)* in this chapter for special instructions about using air bags.

#### Important child restraint precautions

You are required by law to use safety restraints for children in the U.S. and Canada. If small children ride in your vehicle (generally children who are four years old or younger and who weigh 18 kg [40 lbs] or less), you must put them in safety seats made especially for children. Check your local and state or provincial laws for specific requirements regarding the safety of children in your vehicle.



Never let a passenger hold a child on his or her lap while the vehicle is moving. The passenger cannot protect the child from injury in a collision.

Always follow the instructions and warnings that come with any infant or child restraint you might use.

When possible, place children in the rear seat of your vehicle. Accident statistics suggest that children are safer when properly restrained in the rear seating positions than in the front seating position.

#### Children and safety belts

If the child is the proper size, restrain the child in a safety seat.

Children who are too large for child safety seats (as specified by your child safety seat manufacturer) should always wear safety belts.

Follow all the important safety restraint and air bag precautions that apply to adult passengers in your vehicle.

If the shoulder belt portion of a combination lap and shoulder belt can be positioned so it does not cross or rest in front of the child's face or neck, the child should wear the lap and shoulder belt. Moving the child closer to the center of the vehicle may help provide a good shoulder belt fit.



## Seating and safety restraints



Do not leave children, unreliable adults, or pets unattended in your vehicle.

To improve the fit of lap and shoulder belts on children who have outgrown child safety seats, Ford recommends use of a belt-positioning booster seat that is labelled as conforming to all Federal motor vehicle safety standards. Belt-positioning booster seats raise the child and provide a shorter, firmer seating cushion that encourages safer seating posture and better fit of lap and shoulder belts on the child.

A belt-positioning booster should be used if the shoulder belt rests in front of the child's face or neck, or if the lap belt does not fit snugly on both thighs, or if the thighs are too short to let the child sit all the way back on the seat cushion when the lower legs hang over the edge of the seat cushion. You may wish to discuss the special needs of your child with your pediatrician.

### SAFETY SEATS FOR CHILDREN

#### Child and infant or child safety seats

Use a safety seat that is recommended for the size and weight of the child. Carefully follow all of the manufacturer's instructions with the safety seat you put in your vehicle. If you do not install and use the safety seat properly, the child may be injured in a sudden stop or collision.

When installing a child safety seat:

- Use the correct safety belt buckle for that seating position.
- Insert the belt tongue into the proper buckle until you hear a snap and feel it latch. Make sure the tongue is securely fastened in the buckle.
- Keep the buckle release button pointing up and away from the safety seat, with the tongue between the child seat and the release button, to prevent accidental unbuckling.

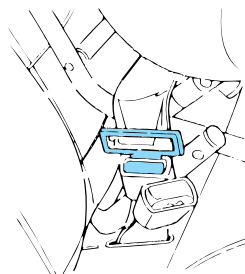

## Seating and safety restraints

- Place seat back in upright position.
- Put the safety belt in the automatic locking mode. Refer to *Automatic locking mode*.

Ford recommends the use of a child safety seat having a top tether strap. Install the child safety seat in a seating position which is capable of providing a tether anchorage. For more information on top tether straps, refer to *Attaching safety seats with tether straps*.



Carefully follow all of the manufacturer's instructions included with the safety seat you put in your vehicle. If you do not install and use the safety seat properly, the child may be injured in a sudden stop or collision.

### Installing child safety seats in combination lap and shoulder belt seating positions

1. Position the child safety seat in a seat with a combination lap and shoulder belt.

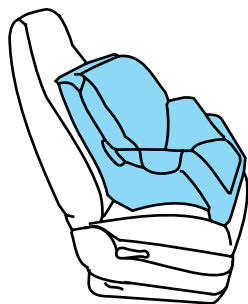

An air bag can kill or injure a child in a child seat. If you must use a forward-facing child seat in the front seat, move seat all the way back.



Rear facing child seats should NEVER be placed in the front seats.

## Seating and safety restraints

2. Pull down on the shoulder belt and then grasp the shoulder belt and lap belt together.

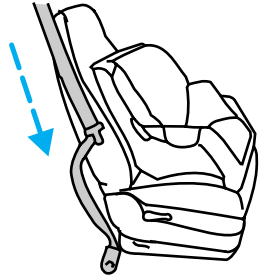

3. While holding the shoulder and lap belt portions together, route the tongue through the child seat according to the child seat manufacturer's instructions. Be sure the belt webbing is not twisted.

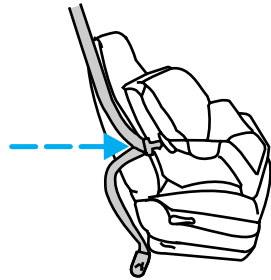

4. Insert the belt tongue into the proper buckle for that seating position until you hear and feel the latch engage. Make sure the tongue is latched securely by pulling on it.

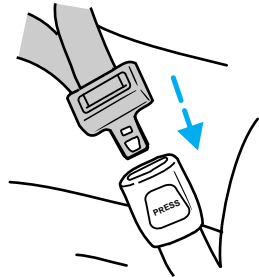

## Seating and safety restraints

5. To put the retractor in the automatic locking mode, grasp the shoulder portion of the belt and pull downward until all of the belt is extracted and a click is heard.

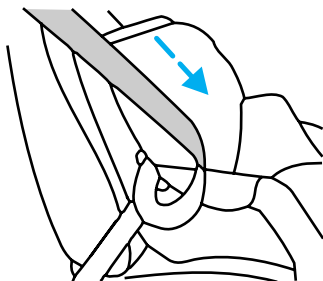

6. Allow the belt to retract. The belt will click as it retracts to indicate it is in the automatic locking mode.

7. Pull the lap belt portion across the child seat toward the buckle and pull up on the shoulder belt while pushing down with your knee on the child seat.

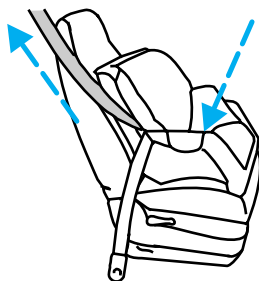

8. Allow the safety belt to retract to remove any slack in the belt.

9. Before placing the child in the seat, forcibly tilt the seat forward and back to make sure the seat is securely held in place.

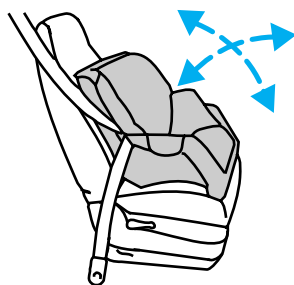

10. Try to pull the belt out of the retractor to make sure the retractor is in the automatic locking mode (you should not be able to pull more belt out). If the retractor is not locked, unbuckle the belt and repeat steps two through nine.

Check to make sure the child seat is properly secured before each use.

## Seating and safety restraints

### Installing a child safety seat in the center rear seating position with adjustable lap belt

1. Lengthen the lap belt. To lengthen the belt, hold the tongue so that its bottom is perpendicular to the direction of webbing while sliding the tongue up the webbing.
2. Place the child safety seat in the center seating position.
3. Route the tongue and webbing through the child seat according to the child seat manufacturer's instructions.
4. Insert the belt tongue into the proper buckle for the center seating position until you hear a snap and feel it latch. Make sure the tongue is securely fastened to the buckle by pulling on tongue.
5. Push down on the child seat while pulling on the loose end of the lap belt webbing to tighten the belt.
6. Before placing the child into the child seat, forcibly tilt the child seat from side to side and in forward direction to make sure that the seat is held securely in place. If the child seat moves excessively, repeat steps 5 through 6, or properly install the child seat in a different position.

### Attaching safety seats with tether straps

Some manufacturers make safety seats that include a tether strap that goes over the back of the vehicle seat and attaches to an anchoring point. Other manufacturers offer the tether strap as an accessory. Contact the manufacturer of your child safety seat for information about ordering a tether strap.

### Tether anchorage hardware

Attachment holes (at each rear seating position) have been provided in your vehicle to attach anchor hardware, if required. Tether anchorage hardware kits (part number 613D74) including instructions, may be obtained at no charge from any Ford or Lincoln-Mercury dealer. All vehicles built for sale in Canada include a tether anchor hardware kit.

Be sure to follow the child safety seat manufacturer's instructions.



Tighten the anchor according to specifications. Otherwise, the safety seat may not be properly secured and the child may be injured in a sudden stop or collision.

## Starting

### PREPARING TO START YOUR VEHICLE

Engine starting is controlled by the ignition system. This system meets all Canadian Interference-Causing Equipment standard requirements regulating the impulse electrical field strength of radio noise.

When starting a fuel-injected engine, avoid pressing the accelerator before or during starting. Only use the accelerator when you have difficulty starting the engine. For more information on starting the vehicle, refer to *Starting the engine* in this chapter.



Extended idling at high engine speeds can produce very high temperatures in the engine and exhaust system, creating the risk of fire or other damage.



Do not park, idle, or drive your vehicle in dry grass or other dry ground cover. The emission system heats up the engine compartment and exhaust system, which can start a fire.



Do not start your vehicle in a closed garage or in other enclosed areas. Exhaust fumes can be toxic. Always open the garage door before you start the engine. See *Guarding against exhaust fumes* in this chapter for more instructions.



If you smell exhaust fumes inside your vehicle, have your dealer inspect your vehicle immediately. Do not drive if you smell exhaust fumes.

### Important safety precautions

A computer system controls the engine's idle revolutions per minute (RPM). When the engine starts, the idle RPM runs faster to warm the engine. If the engine idle speed does not slow down automatically, have the vehicle checked. Do not allow the vehicle to idle for more than ten minutes.

Before starting the vehicle:

1. Make sure all vehicle occupants have buckled their safety belts. For more information on safety belts and their proper usage, refer to the *Seating and safety restraints* chapter.

## Starting

2. Make sure the headlamps and vehicle accessories are off.
3. Make sure the parking brake is set.

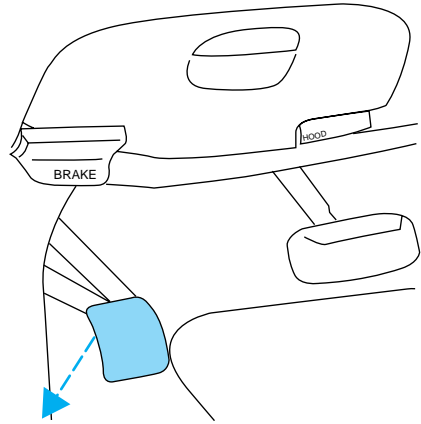

4. Make sure the gearshift is in P (Park).



5. Turn the key to 4 (ON) without turning the key to 5 (START).

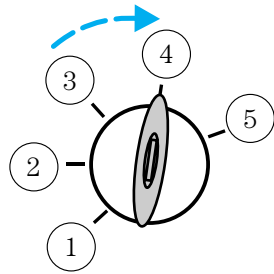

# Starting

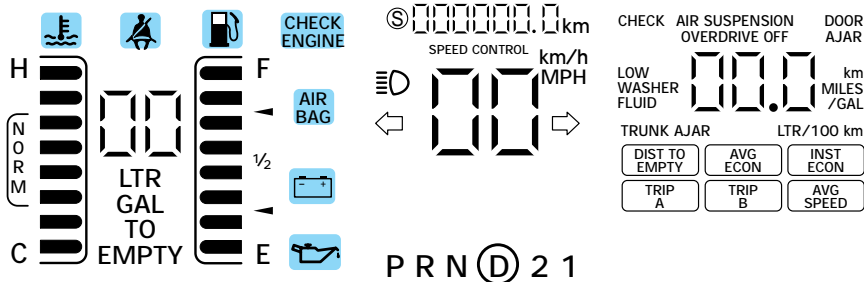
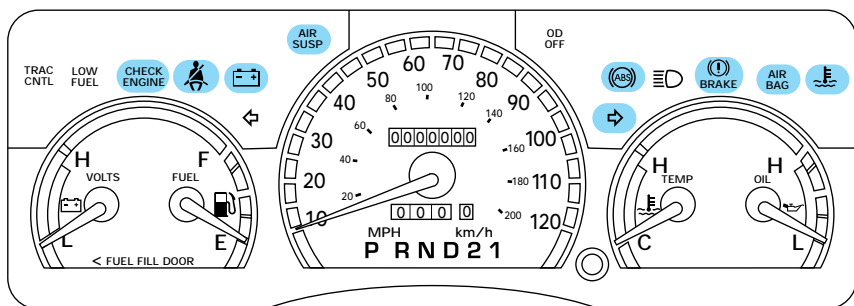

Make sure the corresponding lights illuminate briefly. If a light fails to illuminate, have the vehicle serviced.

- If the driver's safety belt is fastened, the light (  ) will not illuminate.



## STARTING THE ENGINE

1. Turn the key to 5 (START) without pressing the accelerator pedal and release as soon as the engine starts. The key will return to 4 (ON).

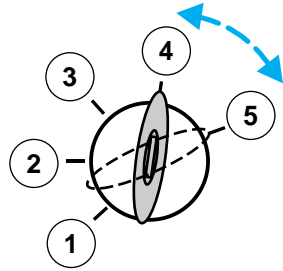

2. If the temperature is above 12° C (10° F) and the engine does not start within five seconds on the first try, turn the key to OFF, wait ten seconds and try again.

3. If the temperature is below -12°C (10°F) and the engine does not start in fifteen seconds on the first try, turn the key OFF and wait ten seconds and try again. If the engine does not start in two attempts, depress the accelerator and start the engine while holding the accelerator down to the floor. Release the accelerator when the engine starts.

4. After idling for a few seconds, apply the brake and release the parking brake.

## Using the engine block heater (if equipped)

An engine block heater warms the engine coolant, which improves starting, warms up the engine faster and allows the heater-defroster system to respond quickly. Use of an engine block heater is strongly recommended if you live in a region where temperatures reach -23°C (-10°F) or below.

For best results, plug the heater in at least three hours before starting the vehicle. Using the heater for longer than three hours will not harm the engine, so the heater can be plugged in the night before starting the vehicle.



To prevent electrical shock, do not use your heater with ungrounded electrical systems or two-pronged (cheater) adapters.

## Starting

### Guarding against exhaust fumes

Although odorless and colorless, carbon monoxide is present in exhaust fumes. Take precautions to avoid its dangerous effects.



If you ever smell exhaust fumes of any kind inside your vehicle, have your dealer inspect and fix your vehicle immediately. Do not drive if you smell exhaust fumes. These fumes are harmful and could kill you.

Have the exhaust and body ventilation systems checked whenever:

- the vehicle is raised for service.
- the sound of the exhaust system changes.
- the vehicle has been damaged in a collision.



Engine exhaust, some of its constituents, and certain vehicle components contain or emit chemicals known to the State of California to cause cancer, and birth defects or other reproductive harm.

### Important ventilating information

If the engine is idling while the vehicle is stopped in an open area for long periods of time, open the windows at least 2.5 cm (one inch).

Adjust the heating or air conditioning (if equipped) to bring in fresh air.

Improve vehicle ventilation by keeping all air inlet vents clear of snow, leaves and other debris.

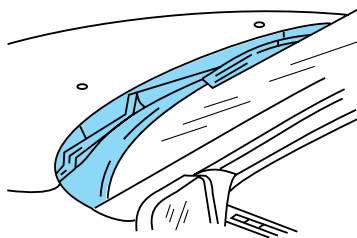

## BRAKES

Your brakes are self-adjusting. Refer to the “Service Guide” for scheduled maintenance.

Occasional brake noise is normal and often does not indicate a performance concern with the vehicle’s brake system. In normal operation, automotive brake systems may emit occasional or intermittent squeal or groan noises when the brakes are applied. Such noises are usually heard during the first few brake applications in the morning; however, they may be heard at any time while braking and can be aggravated by environmental conditions such as cold, heat, moisture, road dust, salt or mud. If a “metal-to-metal,” “continuous grinding” or “continuous squeal” sound is present while braking, the brake linings may be worn-out and should be inspected by a qualified service technician.

### Anti-lock brake system (ABS) (if equipped)

On vehicles equipped with an anti-lock braking system (ABS), a noise from the hydraulic pump motor and pulsation in the pedal may be observed during ABS braking events. Pedal pulsation coupled with noise while braking under panic conditions or on loose gravel, bumps, wet or snowy roads is normal and indicates proper functioning of the vehicle’s anti-lock brake system. If the vehicle has continuous vibration or shudder in the steering wheel while braking, the vehicle should be inspected by a qualified service technician.

The ABS operates by detecting the onset of wheel lockup during brake applications and compensating for this tendency. The wheels are prevented from locking even when the brakes are firmly applied. The accompanying illustration depicts the advantage of an ABS equipped vehicle (on bottom) to a non-ABS equipped vehicle (on top) during hard braking with loss of front braking traction.

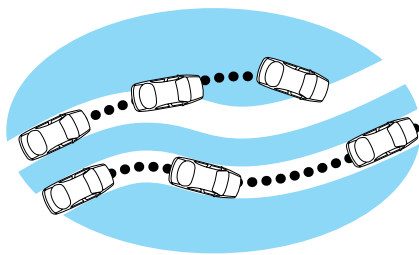

## Driving

### ABS warning lamp

The (ABS) warning lamp in the instrument cluster illuminates for about five seconds when starting the vehicle. If an ABS fault is detected, the light will remain on, the ABS system is disabled with normal braking still effective, and your vehicle should be serviced as soon as possible.

Normal braking is still effective unless the BRAKE warning lamp is also illuminated.



### Using ABS

- In an emergency or when maximum efficiency from the ABS is required, apply continuous full force on the brake. The ABS will be activated immediately, thus allowing you to retain full steering control of your vehicle and, providing there is sufficient space, will enable you to avoid obstacles and bring the vehicle to a controlled stop.
- The Anti-Lock system does not decrease the time necessary to apply the brakes or always reduce stopping distance. Always leave enough room between your vehicle and the vehicle in front of you to stop.
- We recommend that you familiarize yourself with this braking technique. However, avoid taking any unnecessary risks.

### Parking brake with auto-release

Apply the parking brake whenever the vehicle is parked.

To set the parking brake:

1. Move the gearshift to P (Park).
2. Push pedal downward.

The BRAKE warning lamp in the instrument cluster illuminates and remains illuminated (when the ignition is turned ON) until the parking brake is fully released.

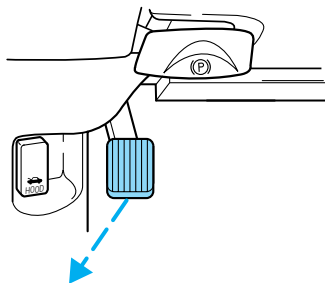

Always set the parking brake fully and make sure the gearshift is latched in P (Park). Turn off the ignition whenever you leave your vehicle.

The parking brake is not designed to stop a moving vehicle. However, if the normal brakes fail, the parking brake can be used to stop your vehicle in an emergency. Since the parking brake applies only the rear brakes, the vehicle's stopping distance will increase greatly and the handling of your vehicle will be adversely affected.

Your vehicle has an automatic parking brake release. To release the parking brake:

1. Turn the ignition to the RUN position.
2. Press the brake pedal.
3. Move the gearshift from the P (Park) position to one of the forward gears (the parking brake will not release automatically when you shift into reverse). The brake pedal must remain pressed while the gearshift is moved.

If the parking brake fails to release after completing this procedure, use the manual parking brake release lever.

Pull the lever to manually release the parking brake.

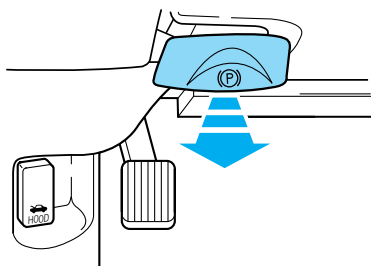

### **TRACTION CONTROL™ (IF EQUIPPED)**

Your vehicle may be equipped with the optional Traction Control™ system. This system helps maintain the stability and steerability of your vehicle. It is especially useful on slippery and/or hilly road surfaces. The system operates by detecting and controlling wheel spin. The system borrows many of the electronic and mechanical elements already present in the anti-lock braking system (ABS).

Wheel-speed sensors allow excess rear wheel spin to be detected by the Traction Control™ portion of the ABS computer. Any excessive wheel spin is controlled by automatically applying and releasing the rear brakes in conjunction with engine torque reductions. Engine torque reduction is realized via the fully electronic spark and fuel injection systems. This process is very sensitive to driving conditions and very fast acting. The rear wheels “search” for optimum traction several times a second and adjustment are made accordingly.

## Driving

The Traction Control™ system will allow your vehicle to make better use of available traction on slippery surfaces. The system is a driver aid which makes your vehicle easier to handle primarily on snow and ice covered roads.

During Traction Control™ operation you may hear an electric motor type of sound coming from the engine compartment and the engine will not “rev-up” when you push further on the accelerator. This is normal system behavior.

If you should become stuck in snow or ice or on a very slippery road surface, try switching the Traction Control™ system off. This may allow excess wheel spin to “dig” the vehicle out and enable a successful “rocking” maneuver.

If the Traction Control™ system is cycled excessively, the brake portion of the system will shut down to prevent the rear brakes from overheating. A limited Traction Control™ function using only engine torque reduction will still control wheels from over-spinning. When the rear brakes have cooled down, the system will again function normally. Anti-lock braking is not affected by this condition and will function normally during the cool down period.

If the engine coolant temperature is below  $-23^{\circ}\text{C}$  ( $-10^{\circ}\text{F}$ ) the engine torque reduction portion of the Traction Control™ system is **NOT** active. The system will operate normally when the engine coolant warms up.

The traction control indicator flashes during a Traction Control™ system event.

TRAC  
CNTL

If the traction control indicator comes on and stays lit, either:

- the Traction Control™ system requires service, or
- the customer has disabled the system using the traction control switch.

The Traction Control™ system will be on every time you turn the ignition key from OFF to ON until you deactivate the system using the traction control switch in the glove compartment.

## STEERING

Your vehicle is equipped with power steering. Power steering uses energy from the engine to help steer the vehicle.

Never hold the steering wheel to the extreme right or the extreme left for more than a few seconds when the engine is running. This action could damage the power steering pump.

### Speed sensitive steering

The steering in your vehicle is speed sensitive. At high speeds, steering assist will decrease to improve steering feel. At lower speeds, maneuverability will be increased.

If the amount of effort required to steer your vehicle changes at a constant vehicle speed, have the power steering system checked by your dealer or a qualified service technician.

### AIR SUSPENSION SYSTEM (IF EQUIPPED)

The air suspension system is designed to improve ride, handling and general vehicle performance during:

- certain road conditions
- steering maneuvers
- braking
- accelerations

This system keeps the rear of your vehicle at a constant level by automatically adding air or releasing air from the springs.

The air suspension shut-off switch is located on the left side of the trunk. If this switch is in the OFF position, the rear air suspension will not operate.



On vehicles equipped with Air Suspension, turn OFF the Air Suspension switch prior to jacking, hoisting or towing your vehicle.

Normal vehicle operation does not require any action by the driver.



# Driving

## TRANSMISSION OPERATION

### Brake-shift interlock

This vehicle is equipped with a brake-shift interlock feature that prevents the gearshift from being moved from P (Park) unless the brake pedal is depressed.

If you cannot move the gearshift out of P (Park) with the brake pedal depressed:

1. Apply the parking brake, turn ignition key to LOCK, then remove the key.
2. Insert the key and turn it to OFF. Apply the brake pedal and shift to N (Neutral).
3. Start the vehicle.

If it is necessary to use the above procedure to move the gearshift, it is possible that a fuse has blown and the vehicle's brakelamps may not be operating properly. Refer to *Fuses and relays* in the *Roadside emergencies* chapter.



Do not drive your vehicle until you verify that the brakelamps are working.

If your vehicle gets stuck in mud or snow it may be rocked out by shifting from forward and reverse gears, stopping between shifts, in a steady pattern. Press lightly on the accelerator in each gear.

**Do not rock the vehicle for more than a few minutes. The transmission and tires may be damaged or the engine may overheat.**



Always set the parking brake fully and make sure the gearshift is latched in P (Park). Turn off the ignition whenever you leave your vehicle.

## Driving with a 4-speed automatic transmission

### Understanding gearshift positions

Pull the gearshift lever towards you and downward to move the automatic gearshift.





Hold the brake pedal down while you move the gearshift lever from position to position. If you do not hold the brake pedal down, your vehicle may move unexpectedly and injure someone.

### **P (Park)**

Always come to a complete stop before shifting into P (Park). Make sure the gearshift is securely latched in P (Park). This position locks the transmission and prevents the rear wheels from turning.



Always set the parking brake fully and make sure the gearshift is securely latched in P (Park).



Never leave your vehicle unattended while it is running.

### **R (Reverse)**

With the gearshift in R (Reverse), the vehicle will move backward. Always come to a complete stop before shifting into and out of R (Reverse).



### **N (Neutral)**

With the gearshift in N (Neutral), the vehicle can be started and is free to roll. Hold the brake pedal down while in this gear.



### **Overdrive**

The normal driving position for the best fuel economy. Transmission operates in gears one through four.



## Driving

Overdrive can be deactivated by pressing the transmission control switch on the gearshift lever.

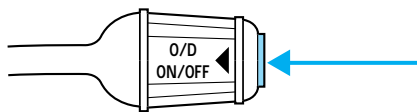

The transmission control indicator light (TCIL) will illuminate on the instrument cluster.

O/D  
OFF

### Drive

Not shown on the display. Activate by pressing the transmission control switch on the gearshift lever with the gearshift in the Drive position. The O/D OFF indicator will illuminate in the instrument cluster. Transmission operates in gears one through three. Drive provides more engine braking than Overdrive and is useful when:

- driving with a heavy load
- towing a trailer up or down steep hills
- additional engine braking is desired. If towing a trailer, refer to *Driving while you tow* in the *Towing a trailer* chapter.

To return to Overdrive mode, press the transmission control switch. The O/D OFF indicator light will no longer be illuminated.

Each time the vehicle is started, the transmission will automatically return to normal Overdrive mode.

Every time the vehicle is shut off and restarted, you must press the transmission control switch to cancel overdrive operation if the Overdrive mode is not desired.

### 2 (Second)

Use 2 (Second) to start-up on slippery roads or to provide additional engine braking on downgrades.



### 1 (First)

Use 1 (Low) to provide maximum engine braking on steep downgrades. Upshifts can be made by shifting to 2 (Second) or to



Overdrive. Selecting 1 (Low) at higher speeds causes the transmission to shift to a lower gear, and will shift to 1 (Low) after vehicle decelerates to the proper speed.

### VEHICLE LOADING

Before loading a vehicle, familiarize yourself with the following terms:

- **Base Curb Weight** : Weight of the vehicle including any standard equipment, fluids, lubricants, etc. It does not include passengers or aftermarket equipment.
- **Payload** : Combined maximum allowable weight of cargo, passengers and optional equipment. The payload equals the gross vehicle weight rating minus base curb weight.
- **GVW (Gross Vehicle Weight)** : Base curb weight plus payload weight. The GVW is not a limit or a specification.
- **GVWR (Gross Vehicle Weight Rating)** : Maximum total weight of the base vehicle, passengers, optional equipment and cargo. The GVWR is specific to each vehicle and is listed on the Safety Compliance Label on the driver's door pillar.
- **GAWR (Gross Axle Weight Rating)** : Carrying capacity for each axle system. The GAWR is specific to each vehicle and is listed on the Safety Compliance Label on the driver's door pillar.



Do not exceed the GVWR or the GAWR specified on the Safety Compliance Certification Label.

Do not use replacement tires with lower weight capacities than the originals because they may lower the vehicle's GVWR and GAWR limitations. Replacement tires with a higher weight limit than the originals do not increase the GVWR and GAWR limitations.

### TRAILER TOWING

Your vehicle is classified as a light duty towing vehicle. It does not come from the factory fully equipped to tow. No towing packages are available through Ford or Mercury/Lincoln dealers. Do not tow a trailer until your vehicle has been driven at least 3 200 km (2 000 miles).

Towing a trailer places an additional load on your vehicle's engine, transmission, brakes, tires and suspension. Inspect these components carefully after towing.

## Driving

The amount of weight your loaded trailer should be no more than 907 kg (2 000 lbs.).



Do not exceed the GVWR or the GAWR specified on the Safety Compliance Certification Label.



Towing trailers beyond the maximum recommended gross trailer weight could result in engine damage, transmission/axle damage, structural damage, loss of control, and personal injury.

### Preparing to tow

Use the proper equipment for towing a trailer, and make sure it is properly attached to your vehicle. See your dealer or a reliable trailer dealer if you require assistance.

### Hitches

Do not use hitches that clamp onto the vehicle bumper. Use a load carrying hitch. You must distribute the load in your trailer so that 10 – 15% of the total weight of the trailer is on the tongue.

### Safety chains

Always connect the trailer's safety chains to the vehicle. To connect the trailer's safety chains, cross the chains under the trailer tongue and allow slack for turning corners.

If you use a rental trailer, follow the instructions that the rental agency gives to you.

### Trailer brakes

Electric brakes and manual, automatic or surge-type brakes are safe if installed properly and adjusted to the manufacturer's specifications. The trailer brakes must meet local and Federal regulations.



Do not connect a trailer's hydraulic brake system directly to your vehicle's brake system. Your vehicle may not have enough braking power and your chances of having a collision greatly increase.

The braking system of the tow vehicle is rated for operation at the GVWR not GCWR.

### ***Trailer lamps***

Trailer lamps are required on most towed vehicles. Make sure your trailer lamps conform to local and Federal regulations. See your dealer or trailer rental agency for proper instructions and equipment for hooking up trailer lamps.

### **Driving while you tow**

Do not drive faster than 88 km/h (55 mph) when towing a trailer. Speed control may shut off if you are towing on long, steep grades.

When towing a trailer:

- Use a lower gear when towing up or down steep hills. This will eliminate excessive downshifting and upshifting for optimum fuel economy and transmission cooling.
- Anticipate stops and brake gradually.

### ***Servicing after towing***

If you tow a trailer for long distances, your vehicle will require more frequent service intervals. Refer to the Severe Duty Schedule in your “Service Guide” for more information.

### **Trailer towing tips**

- Practice turning, stopping and backing up in an area before starting on a trip to get the feel of the vehicle trailer combination. When turning, make wider turns so the trailer wheels will clear curbs and other obstacles.
- Allow more distance for stopping with a trailer attached.
- The trailer tongue weight should be 10–15% of the loaded trailer weight.
- After you have traveled 80 km (50 miles), thoroughly check your hitch, electrical connections and trailer wheel lug nuts.
- When stopped in traffic for long periods of time in hot weather, place the gearshift in P (Park) and increase idle speed. This aids engine cooling and air conditioner efficiency.
- Vehicles with trailers should not be parked on a grade. If you must park on a grade, place wheel chocks under the trailer’s wheels.

# Driving

## Launching or retrieving a boat

When backing down a ramp during boat launching or retrieval,

- Do not allow the static water level to rise above the bottom edge of the rear bumper and
- Do not allow waves to break higher than 15 cm (six inches) above the bottom edge of the rear bumper.

Exceeding these limits may allow water to enter critical vehicle components, adversely affecting driveability, emissions and reliability.

If the rear axle is submerged in water, the rear axle lubricant should be changed. Axle lubricant quantities are not to be checked unless a leak is suspected.

## DRIVING THROUGH WATER

Do not drive quickly through standing water, especially if the depth is unknown. Traction or brake capability may be limited and if the ignition system gets wet, your engine may stall. Water may also enter your engine's air intake and severely damage your engine.

If driving through deep or standing water is unavoidable, proceed very slowly. Never drive through water that is higher than the bottom of the hubs (truck)/wheel rims (car).

Once through the water, always try the brakes. Wet brakes do not stop the vehicle as effectively as dry brakes. Drying can be improved by moving your vehicle slowly while applying light pressure on the brake pedal.

## FUEL CONSUMPTION

Fuel economy can be improved by avoiding:

- lack of regular, scheduled maintenance.
- excessive speed.
- rapid acceleration.
- extended idle.

## Roadside emergencies

### HAZARD LIGHTS CONTROL

Use only in an emergency to warn traffic of vehicle breakdown, approaching danger, etc. The hazard flashers can be operated when the ignition is off.

- The hazard lights control is located on top of the steering column.
- Depress hazard lights control to activate all hazard flashers simultaneously.
- Depress control again to turn the flashers off.

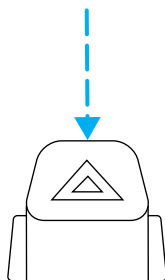

### FUEL PUMP SHUT-OFF SWITCH

After a collision, if the engine cranks but does not start, the fuel pump shut-off switch may have been activated. The shut-off switch is a device intended to stop the electric fuel pump when your vehicle has been involved in a substantial jolt.

1. Turn the ignition to the OFF position.
2. Check the fuel system for leaks.
3. If no fuel leak is apparent, reset the fuel pump shut-off switch by pushing in the button on the switch.
4. Turn the ignition to the ON position. Pause for a few seconds and return the key to the OFF position.
5. Make a further check for leaks in the fuel system.

## Roadside emergencies

The fuel pump shut-off switch is located on the left side of the trunk behind the trunk liner.

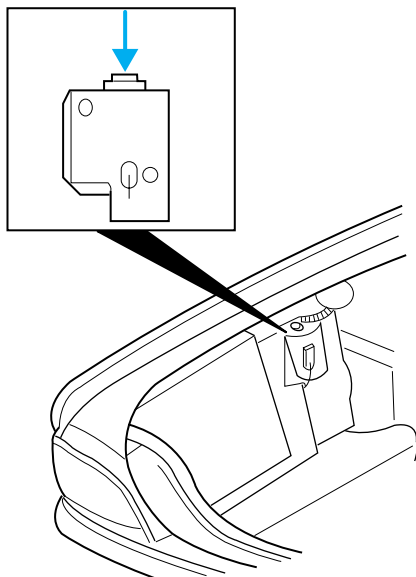

## FUSES AND RELAYS

### Fuses

If electrical components in the vehicle are not working, a fuse may have blown. Blown fuses are identified by a broken wire within the fuse. Check the appropriate fuses before replacing any electrical components.

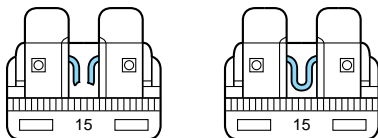

Always replace a fuse with one that has the specified amperage rating. Using a fuse with a higher amperage rating can cause severe wire damage and could start a fire.



## Roadside emergencies

### ***Standard fuse amperage rating and color***

<b>Fuse rating</b>	<b>Color</b>
5 amp	Tan
7.5 amp	Brown
10 amp	Red
15 amp	Light blue
20 amp	Yellow
20 amp fuse link	Light blue
25 amp	Natural
30 amp	Light green
30 amp fuse link	Pink
40 amp fuse link	Green
50 amp fuse link	Red
60 amp fuse link	Yellow
80 amp fuse link	Black
100 amp fuse link	Dark blue

### **Passenger compartment fuse panel**

The fuse panel is located below and to the left of the steering wheel by the brake pedal. Remove the panel cover to access the fuses.

To remove a fuse use the fuse puller tool provided on the fuse panel cover.

## Roadside emergencies

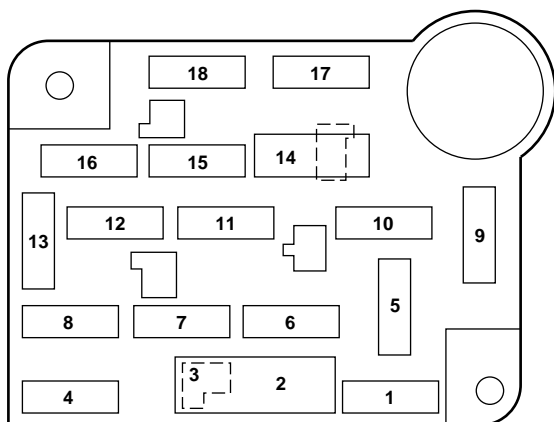

The fuses are coded as follows.

Fuse/Relay Location	Fuse Amp Rating	Description
1	15A	Brake Pedal Position (BPP) Switch, Multi-Function Switch, Speed Control
2	30A	Wiper Control Module, Windshield Wiper Motor
3	—	Not Used
4	15A	Lighting Control Module, Main Light Switch
5	15A	Backup Lamps, Variable Assist Power Steering (VAPS), Turn Signals, Air Suspension, Daytime Running Lamps, Electronic Day/Night Mirror, Shift Lock, EATC, Speed Chime Warning
6	15A	Speed Control, Main Light Switch, Lighting Control Module, Clock, Police Power Relay
7	25A	Powertrain Control Module (PCM) Power Diode, Ignition Coils

## Roadside emergencies

Fuse/Relay Location	Fuse Amp Rating	Description
8	15A	Lighting Control Module, Power Mirrors, PATS Module, Keyless Entry, Clock Memory, Electronic Automatic Temperature Control (EATC), Power Windows, Police Spot Light, SecuriLock
9	30A	Blower Motor, A/C-Heater Mode Switch
10	10A	Air Bag Module
11	5A	Radio
12	18A CB	Lighting Control Module, Flash-to-Pass, Main Light Switch
13	15A	Warning Lamps, Analog Cluster Gauges and Indicators, Electronic Automatic Transmission, Lighting Control Module
14	20A CB	Window/Door Lock Control, Driver's Door Module, One Touch Down
15	10A	Anti-Lock Brakes, Instrument Cluster, Transmission Control Switch
16	20A	Cigar Lighter
17	10A	Rear Defrost
18	10A	Air Bag Module

### Power distribution box

The power distribution box is located in the engine compartment. The power distribution box contains high-current fuses that protect your vehicle's main electrical systems from overloads.



Always disconnect the battery before servicing high current fuses.



Always replace the cover to the Power Distribution Box before reconnecting the battery or refilling fluid reservoirs.

## Roadside emergencies

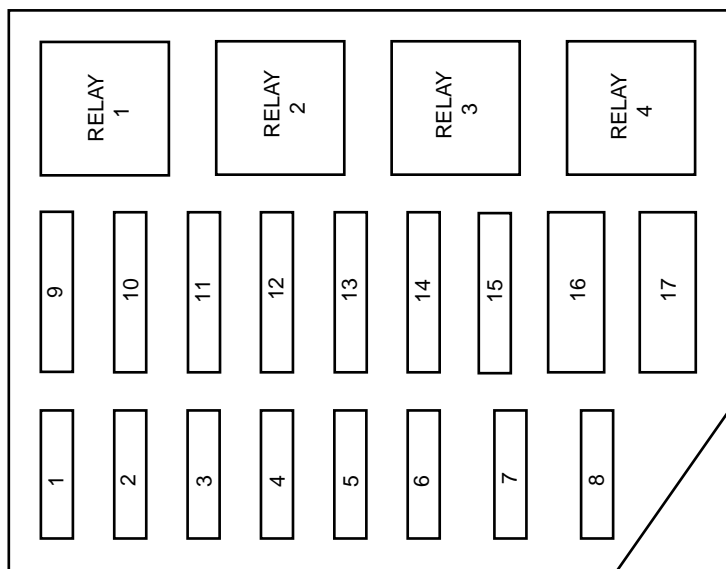

The high-current fuses are coded as follows.

Fuse/Relay Location	Fuse Amp Rating	Description
1	20A*	Electric Fuel Pump Relay
2	30A*	Generator, Starter Relay, Fuses 15 and 18
3	25A*	Radio, CD Changer, Subwoofer Amplifier
4	30A*	Police Power Relay
5	15A*	Horn Relay
6	20A*	DRL Module
7	20A CB	Power door Locks, Power Seats, Trunk Lid Release
8	30A**	Air Suspension System
9	50A**	See Fuses 5 and 9

## Roadside emergencies

Fuse/Relay Location	Fuse Amp Rating	Description
10	50A**	See Fuses 1, 2, 6, 7, 10, 11, 13 and Circuit Breaker 14
11	40A**	See Fuses 4, 8, 16 and Circuit Breaker 12
12	30A**	PCM Power Relay, PCM, Natural Gas Vehicle Module
13	50A**	High Speed Cooling Fan Relay
14	40A**	Rear Window Defrost Relay, Also see Fuse 17
15	50A**	Anti-Lock Brake Module
16	50A**	Police Option Fuse Holder
17	30A**	Cooling Fan Relay
Relay 1	—	Rear Defrost Relay
Relay 2	—	Horn Relay
Relay 3	—	Cooling Fan Relay
Relay 4	—	Air Suspension Pump Relay, Police Power Relay

\* Mini Fuses \*\* Maxi Fuses

### Relays

Relays are located in the power distribution box and should be replaced by qualified technicians.

### CHANGING THE TIRES

If you get a flat tire while driving, do not apply the brake heavily. Instead, gradually decrease your speed. Hold the steering wheel firmly and slowly move to a safe place on the side of the road.

### Temporary spare tire information

Your vehicle may have a temporary or full-size spare tire. The temporary spare tire for your vehicle is labeled as such. It is smaller than a regular tire and is designed for emergency use only. Replace this tire with a full-size tire as soon as possible.

## Roadside emergencies



If you use the temporary spare tire continuously or do not follow these precautions, the tire could fail, causing you to lose control of the vehicle, possibly injuring yourself or others.

When driving with the temporary spare tire **do not:**

- exceed 80 km/h (50 mph) under any circumstances
- load the vehicle beyond maximum vehicle load rating listed on the Safety Compliance Label
- tow a trailer
- use tire chains
- drive through an automatic car wash, because of the vehicle's reduced ground clearance

- try to repair the temporary spare tire or remove it from its wheel
- use the wheel for any other type of vehicle

If the mini-spare tire is used as a replacement for a rear wheel:

- Turn off the traction control switch (if equipped).
- Turn off the air suspension switch (if equipped).

### Anti-theft lug nuts (if equipped)

If your vehicle is equipped with this feature, one of the lug nuts on each wheel must be removed and replaced with a special key. The key and registration card are attached to

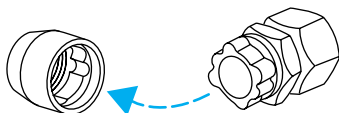

the lug wrench and stored with the spare tire. If you lose the key, send the registration card to the manufacturer (not the dealer) to get a replacement key. If the lug wrench/lug nut key assembly is lost, see your nearest Ford or Lincoln/Mercury dealer who has access to the master set of keys. **Do not use an impact wrench with the anti-theft key.**

### Removing the anti-theft lug nut

1. Insert the key over the locking lug nut. Make sure you hold the key square to the lug nut. If you hold the key at an angle, you could damage the key and the lug nut.
2. Place the lug nut wrench over the lug nut key and apply pressure on the key with the wrench.
3. Turn the wrench in a counterclockwise direction to remove the lug nut.

## Roadside emergencies

### Reinstalling the anti-theft lug nut

1. Insert the key over the locking lug nut.
2. Place the lug nut wrench over the lug nut key and apply pressure on the key with the wrench.
3. Install the lug nut.

### Tire change procedure

 To prevent the vehicle from moving when you change a tire, be sure the parking brake is set, then block (in both directions) the wheel that is diagonally opposite (other side and end of the vehicle) to the tire being changed.

 If the vehicle slips off the jack, you or someone else could be seriously injured.

1. Park on a level surface, activate hazard flashers and set parking brake.
2. Place gearshift lever in P (Park).
3. Remove the spare tire, jack and lug wrench.

4. Locate pry off notch (if equipped) and remove the center ornament from the aluminum wheel with the tapered end of the wheel nut wrench that came with your vehicle. Insert and twist the handle, then pry against the wheel.

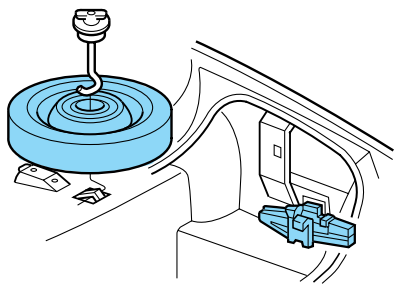

5. Loosen each wheel lug nut one-half turn counterclockwise but do not remove them until the wheel is raised off the ground. Refer to *Anti-theft lug nuts* for information on removing anti-theft lug nuts.

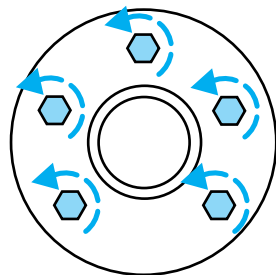

## Roadside emergencies



On vehicles equipped with Air Suspension, turn OFF the Air Suspension switch prior to jacking, hoisting or towing your vehicle.

Refer to *Air suspension system* in the *Driving* chapter for more information.



6. Put the jack in the jack notch next to the door closest to the tire you are changing. Turn the jack handle clockwise until the wheel is completely off the ground.

7. Remove the lug nuts with the lug wrench. Replace the flat tire with the spare tire, making sure the valve stem is facing outward. Reinstall lug nuts until the wheel is snug against the hub. Do not fully tighten the lug nuts until the wheel has been lowered.

8. Lower the wheel by turning the jack handle counterclockwise.

9. Remove the jack and fully tighten the lug nuts in the order shown.

10. Put flat tire, jack and lug wrench away.

11. Turn on the air suspension switch.

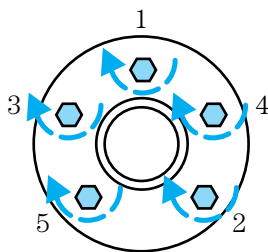
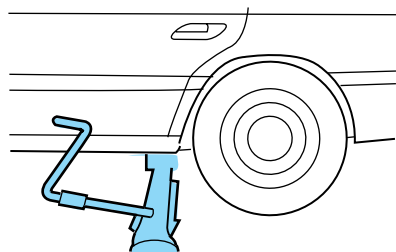



## Roadside emergencies

### JUMP STARTING YOUR VEHICLE



The gases around the battery can explode if exposed to flames, sparks, or lit cigarettes. An explosion could result in injury or vehicle damage.



Do not push start your vehicle. You could damage the catalytic converter.



Batteries contain sulfuric acid which burns skin, eyes, and clothing.

### Preparing your vehicle

Also see the label on the battery.

1. Use only a 12-volt supply to start your vehicle. **If you connect your battery to a 24-volt power supply you can damage your starter, ignition system and other electrical components.**
2. Do not disconnect the battery of the disabled vehicle as this could damage the vehicle's electrical system.
3. Park the booster vehicle close to the hood of the disabled vehicle making sure they **do not** touch. Set the parking brake on both vehicles and stay clear of the engine cooling fan and other moving parts.
4. Check all battery terminals and remove any excessive corrosion before you attach the battery cables.
5. Turn the heater fan on in both vehicles to protect any electrical surges. Turn all other accessories off.

## Roadside emergencies

### Connecting the jumper cables

1. Position the vehicles so that they do not touch one another.
2. Switch off the engine. Switch off any unnecessary electrical equipment.
3. Connect the positive (+) terminal of the discharged battery (1) to the positive (+) terminal of the booster battery (2).
4. Connect one end of the second lead to the negative (-) terminal of the booster battery (3) and the other end to a metal part of the engine to be started (4), **not to the negative (-) terminal of the discharged battery**.
5. Make sure that the jump leads are clear of moving parts of the engine.

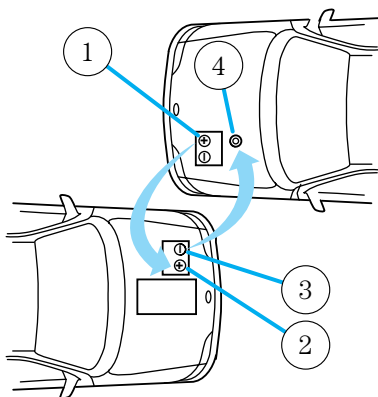

Do not connect the end of the second cable to the negative (-) terminal of the battery to be jumped. A spark may cause an explosion of the gases that surround the battery.

### Jump starting

1. Start the booster vehicle and run the engine at moderately increased speed.
2. Start the engine of the vehicle with the discharged battery.
3. Once the engine has been started, run both engines for a further three minutes before disconnecting the leads.

## Roadside emergencies

### Removing the jumper cables

1. Remove the jumper cables in reverse order. Take the cable off the metallic engine surface (1) first, followed by the cable on the negative (-) booster battery terminal (2).
2. Remove the cable from the positive (+) terminal of the booster battery (3) and then the discharged battery (4).
3. After the disabled vehicle has been started, allow it to idle for a while so the engine can “relearn” its idle conditions.

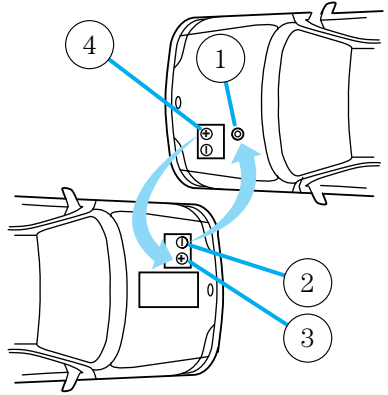

## Roadside emergencies

### WRECKER TOWING

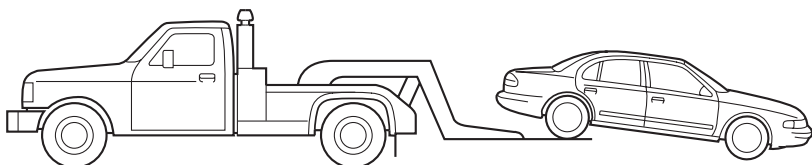
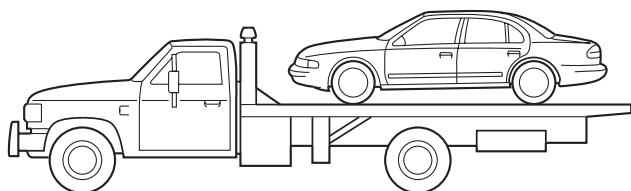
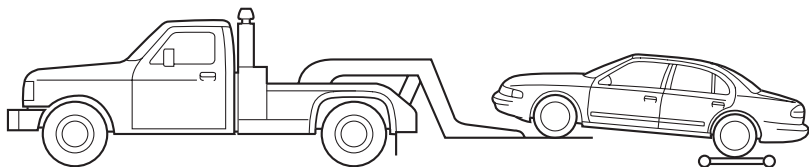

If you need to have your vehicle towed, contact a professional towing service or, if you are a member, your roadside assistance center.

It is recommended that your vehicle be towed with a wheel lift or flatbed equipment. Do not tow with slingbelt equipment. Ford Motor Company has not developed or approved a T-hook or slingbelt towing procedure.

Before your vehicle can be towed, the air suspension control in the luggage compartment must be turned to the OFF position (if equipped).

When calling for a tow truck, tell the operator what kind of vehicle you have. A towing manual is available from Ford Motor Company for all authorized tow truck operators. Have your tow truck driver refer to this manual for proper hook-up and towing procedures for your vehicle.

### SERVICE RECOMMENDATIONS

To help you service your vehicle:

- We highlight do-it-yourself items in the engine compartment for easy location.
- We provide a “Service Guide” which makes tracking routine service easy.

If your vehicle requires professional service, your dealership can provide necessary parts and service. Check your “Warranty Guide” to find out which parts and services are covered.

Use only recommended fuels, lubricants, fluids and service parts conforming to specifications. Motorcraft parts are designed and built to provide the best performance in your vehicle.

### PRECAUTIONS WHEN SERVICING YOUR VEHICLE

Be especially careful when inspecting or servicing your vehicle.

- Do not work on a hot engine.
- When the engine is running, avoid wearing loose clothing, jewelry or long hair that could get caught up in moving parts.
- Do not work on a vehicle with the engine running in an enclosed space, unless you are sure you have enough ventilation.
- Keep all lit cigarettes, open flames and other lit material away from the battery and all fuel related parts.

If you disconnect the battery, the engine must “relearn” its idle conditions before your vehicle will drive properly, as explained in the *Battery* section in this chapter.

### Working with the engine off

1. Set the parking brake and ensure the gearshift is securely latched in P (Park).
2. Turn off the engine and remove the key.
3. Block the wheels to prevent the vehicle from moving unexpectedly.

## Maintenance and care

### Working with the engine on

1. Set the parking brake and ensure the gearshift is securely latched in P (Park).
2. Block the wheels to prevent the vehicle from moving unexpectedly.



Do not start your engine with the air cleaner removed and do not remove it while the engine is running.

### OPENING THE HOOD

1. Inside the vehicle, pull the hood release handle located under the instrument panel.
2. Go to the front of the vehicle and release the auxiliary latch that is located under the front of the hood.
3. Lift the hood until the lift cylinders hold it open.

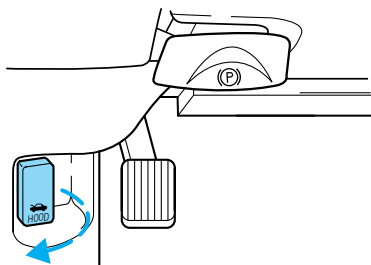

### IDENTIFYING COMPONENTS IN THE ENGINE COMPARTMENT

#### 4.6L SOHC V8 engine

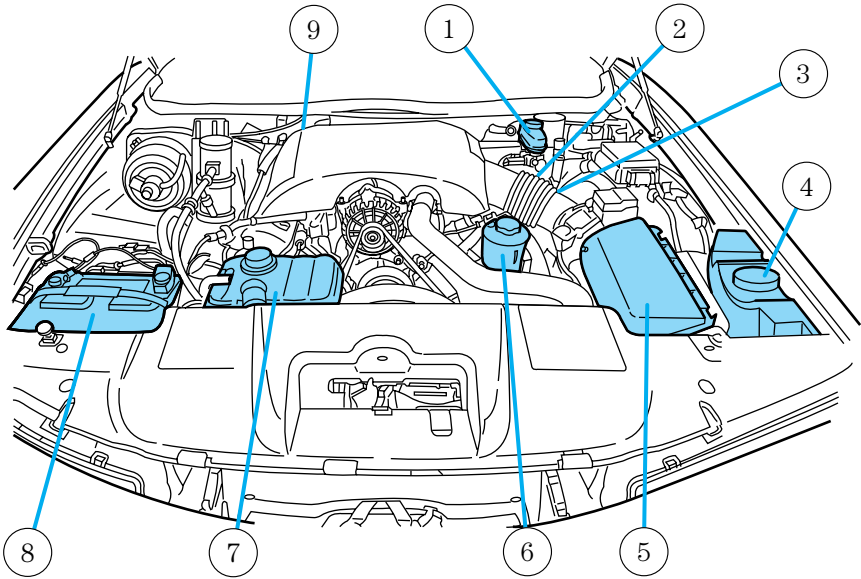

1. Brake fluid reservoir
2. Engine oil dipstick
3. Engine oil filler cap
4. Windshield washer fluid reservoir
5. Air filter assembly
6. Power steering fluid reservoir
7. Engine coolant reservoir
8. Battery
9. Automatic transmission fluid dipstick

## Maintenance and care

### ENGINE OIL

#### Checking the engine oil

Refer to the "Service Guide" for the appropriate intervals for checking the engine oil.

1. Make sure the vehicle is on level ground.
2. Turn the engine off and wait a few minutes for the oil to drain into the oil pan.
3. Set the parking brake and ensure the gearshift is securely latched in P (Park).
4. Open the hood. Protect yourself from engine heat.
5. Locate and carefully remove the engine oil level indicator (dipstick).

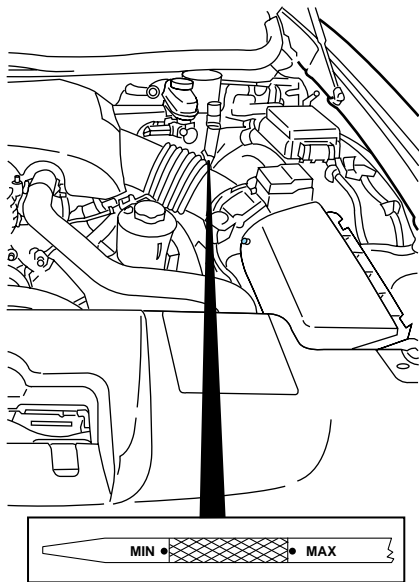

6. Wipe the indicator clean. Insert the indicator fully, then remove it again.

- If the oil level is **between the MIN and MAX marks**, the oil level is acceptable. **DO NOT ADD OIL.**



## Maintenance and care

- If the oil level is below the MIN mark, add enough oil to raise the level within the MIN-MAX range.

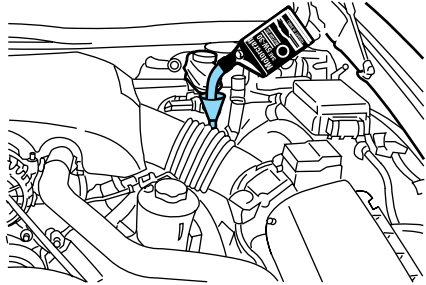

- Oil levels above the MAX mark may cause engine damage. Some oil must be removed from the engine by a service technician.
7. Put the indicator back in and ensure it is fully seated.

### Adding engine oil

1. Check the engine oil. For instructions, refer to *Checking the engine oil* in this chapter.
2. If the engine oil level is not within the MIN and MAX ranges, add only certified engine oil of the recommended viscosity. Remove the engine oil filler cap and use a funnel to pour the engine oil into the opening.
3. Recheck the engine oil level. Make sure the oil level is not above the MAX mark on the dipstick.

### Engine oil and filter recommendations

Look for this certification mark.

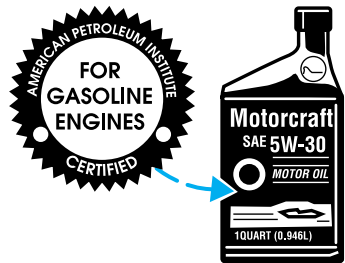

Ford oil specification is WSS-M2C153-G.

Use SAE 5W-30 motor oil certified for gasoline engines by the American Petroleum Institute.

## Maintenance and care

Do not use supplemental engine oil additives, oil treatments or engine treatments. They are unnecessary and could, under certain conditions, lead to engine damage which is not covered by your warranty.

Change your engine oil and filter according to the appropriate schedule listed in the “Service Guide”.

Ford production and aftermarket (Motorcraft) oil filters are designed for added engine protection and long life. If a replacement oil filter is used that does not meet Ford material and design specifications, startup engine noises or knock may be experienced.

It is recommended you use the appropriate Motorcraft oil filter (or another brand meeting Ford specifications) for your engine application.

### Changing the engine oil and filter

Change your engine oil and filter according to the appropriate schedule listed in the “Service Guide”.

Ford production and aftermarket (Motorcraft) oil filters are designed for added engine protection and long life. If a replacement oil filter is used that does not meet Ford material and design specifications, startup engine noises or knock may be experienced.

It is recommended you use the appropriate Motorcraft oil filter (or another brand meeting Ford specifications) for your engine application.

## BRAKE FLUID

### Checking and adding brake fluid

Brake fluid should be checked and refilled as needed at least once each year:

1. Clean the reservoir cap before removal to prevent dirt or water from entering the reservoir.

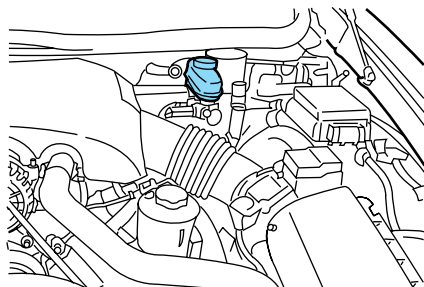

## Maintenance and care

2. Visually inspect the fluid level.
3. If necessary, add brake fluid until the level reaches MAX. Do not fill above this line.
4. Use only a DOT 3 brake fluid certified to meet Ford specifications. Refer to *Lubricant specifications* in the *Capacities and specifications* chapter.

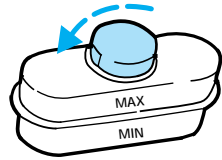

Brake fluid is toxic.



If you use a brake fluid that is not DOT 3, you will cause permanent damage to your brakes.



Do not let the reservoir for the master cylinder run dry. This may cause the brakes to fail.

## WINDSHIELD WASHER FLUID

### Checking and adding washer fluid

Check the washer fluid whenever you stop for fuel. The reservoir is highlighted with a  symbol.

If the level is low, add enough fluid to fill the reservoir. In very cold weather, do not fill the reservoir all the way.

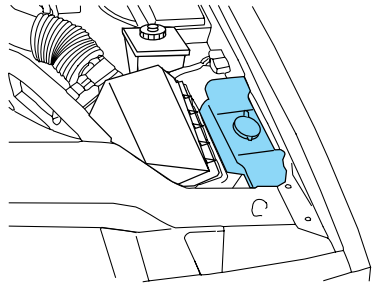

Do not put engine coolant in the container for the windshield washer fluid.

## Maintenance and care

### ENGINE COOLANT

Check the level of the engine coolant in the reservoir. Refer to the “Service Guide” for service interval schedules. Be sure to read and understand *Precautions when servicing your vehicle* in this chapter.

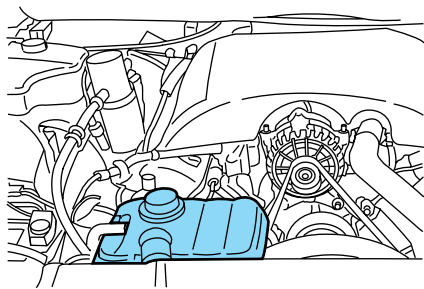

If the engine coolant has not been checked at the above recommended interval, the engine coolant reservoir may become empty. If this occurs, add engine coolant to the reservoir. For more information on engine coolant maintenance, refer to *Adding engine coolant* in this chapter.

Automotive fluids are not interchangeable; do not use engine coolant, antifreeze or windshield washer fluid outside of its specified function and vehicle location.

### Adding engine coolant



Do not put engine coolant in the container for the windshield washer fluid.

**Do not mix conventional green coolant, orange coolant or recycled coolants together in your vehicle. Use only the type of coolant that your vehicle was originally equipped with . If you are unsure which type of coolant your vehicle requires, contact your local dealer.**

If sprayed on the windshield, engine coolant could make it difficult to see through the windshield.

When the engine is cool, add a 50/50 mixture of engine coolant and water to the engine coolant reservoir-DO NOT ADD DIRECTLY TO THE RADIATOR. Add straight water only in an emergency, but you should replace it with a 50/50 mixture of coolant and distilled water as soon as possible.

Check the coolant level in the coolant reservoir the next few times you drive the vehicle. If necessary, add enough of a 50/50 mixture of coolant and water to bring the liquid level to the fill line on the reservoir.

## Maintenance and care



Never remove the coolant reservoir cap while the engine is running or hot.

If you must remove the coolant reservoir cap, follow these steps to avoid personal injury:

1. Before you remove the cap, turn the engine off and let it cool.
2. When the engine is cool, wrap a thick cloth around the cap. Slowly turn cap counterclockwise until pressure begins to release.
3. Step back while the pressure releases.
4. When you are sure that all the pressure has been released, use the cloth to turn it counterclockwise and remove the cap.

Change your engine coolant according to the appropriate schedule listed in the “Service Guide”.

Before adding engine coolant, check the color of the coolant in your vehicle.

**For vehicles with green coolant,** use Ford Premium Cooling System Fluid E2FZ-19549-AA (in Canada, Motorcraft CXC-8-B) or an equivalent premium engine coolant that meets Ford specification ESE-M97B44-A.

**Do not add orange coolant or recycled coolant to your vehicle originally equipped with conventional green coolant.**

**For vehicles with orange coolant,** use Ford Extended Life Engine Coolant F6AZ-19544-AA or a DEX-COOL® equivalent that meets Ford specification WSS-M97B44-D.

**Do not add conventional green coolant or recycled coolant to your vehicle originally equipped with orange coolant.**

Do not use alcohol or methanol antifreeze or any engine coolants mixed with alcohol or methanol antifreeze. Do not use supplemental coolant additives in your vehicle. These additives may harm your engine cooling system. The use of an improper coolant may void your warranty of your vehicle's engine cooling system.

### Recycled engine coolant

Ford Motor Company recommends that Ford and Lincoln-Mercury dealers use recycled engine coolant produced by Ford-approved processes.

## Maintenance and care

**For vehicles with green coolant,** not all coolant recycling processes produce coolant which meets Ford specification ESE-M97B44-A, and use of such coolant may harm engine and cooling system components.

**For vehicles with orange coolant,** no recycling process has been approved at this time and use of such coolant may harm engine and cooling system components.



Always dispose of used automotive fluids in a responsible manner. Follow your community's regulations and standards for recycling and disposing of automotive fluids.

### Coolant refill capacity

To find out how much fluid your vehicle's cooling system can hold, refer to *Refill capacities* in the *Capacities and specifications* chapter.

Have your dealer check the engine cooling system for leaks if you have to add more than 1.0 liter (1.0 quart) of engine coolant per month.

### Severe winter climate

If you drive in extremely cold climates (less than  $-36^{\circ}\text{C}$  [ $-34^{\circ}\text{F}$ ]), it may be necessary to increase the coolant concentration above 50%. Refer to the chart on the coolant container to ensure the coolant concentration in your vehicle is such that the coolant will not freeze at the temperature level in which you drive during winter months. Never increase the engine coolant concentration above 60%. Leave a 50/50 mixture of engine coolant and water in your vehicle year-round in non-extreme climates.

## Maintenance and care

### How fail-safe cooling works

- Standard cluster

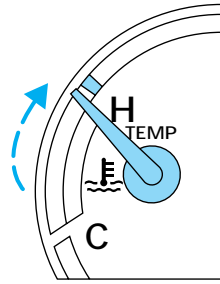

- Optional cluster



If the engine overheats, the engine will automatically switch to alternating cylinder operation. Each disabled cylinder acts as an air pump and cools the engine.

When this occurs:

- if your vehicle is equipped with analog gauges, the engine coolant temperature gauge will move to the H (hot) area
- if your vehicle is equipped with digital gauges, the engine coolant temperature gauge will illuminate all eight bars and a tone will sound every five seconds for a minute
- the  symbol will illuminate
- the *Check Engine* indicator light will illuminate.

The vehicle will still operate, however:

- the engine power will be limited.
- the air conditioning system will be disabled.

Continued operation will increase the engine temperature:

## Maintenance and care

- the  symbol will begin to flash.
- if your vehicle is equipped with digital gauges, the gauge bars will flash and a tone will sound continuously for thirty seconds.
- the engine will completely shut down, causing steering and braking effort to increase.

Once the engine temperature cools, the engine can be re-started. Take your vehicle to a service facility as soon as possible to minimize engine damage.

### ***When fail-safe mode is activated***

You have limited engine power when in the fail-safe mode, so drive the vehicle with caution. The vehicle will not be able to maintain high-speed operation and the engine will run rough. Remember that the engine is capable of completely shutting down automatically to prevent engine damage, therefore:

1. Pull off the road as soon as possible and turn off the engine.
2. Arrange for the vehicle to be taken to a service facility.
3. If this is not possible, wait a short period for the engine to cool.
4. Check the coolant level and replenish if low.



Never remove the coolant reservoir cap while the engine is running or hot.

5. Re-start the engine and take your vehicle to a service facility.



Driving the vehicle without repairing the engine problem increases the chance of engine damage. Take your vehicle to a service facility as soon as possible.



## Maintenance and care

### CHECKING AND ADDING POWER STEERING FLUID

Check the power steering fluid. Refer to the “Service Guide” for the service interval schedules. If adding fluid is necessary, use only MERCON® ATF.

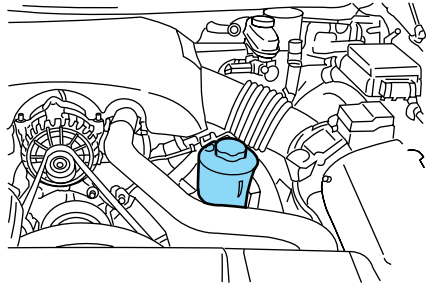

1. Start the engine and let it run until it reaches normal operating temperature (the engine coolant temperature gauge indicator will be near the center of the normal area between H and C).
2. While the engine idles, turn the steering wheel left and right several times.
3. Turn the engine off.
4. Check the fluid level in the reservoir. It should be between the MIN and MAX lines. Do not add fluid if the level is in this range.

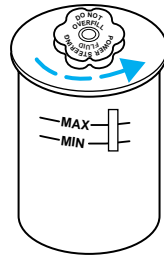

5. If the fluid is low, add fluid in small amounts, continuously checking the level until it reaches the range between the MIN and MAX lines. Be sure to put the cap back on the reservoir.

# Maintenance and care

## TRANSMISSION FLUID

### Checking and adding automatic transmission fluid

Follow the scheduled service intervals outlined in the “Service Guide.”

Before adding any fluid, make sure the correct type is used. The type of fluid used is normally indicated on the dipstick and/or dipstick handle and also in the *Lubricant specifications* section in the *Capacities and specifications* chapter.

**An overfill condition of transmission fluid may cause shift and/or engagement concerns and/or possible damage.**

Do not drive the vehicle if the fluid level is below the bottom hole on the dipstick and outside temperatures are above 10°C (50°F) (see figure to the right).

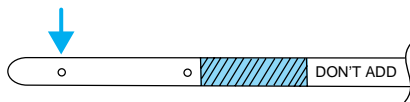

Your transmission does not use up fluid. However, it is recommended that you check the transmission fluid at least twice a year. The fluid level should be checked if the transmission is not working properly, i.e., if the transmission slips or shifts slowly or if you notice some sign of fluid leakage.

Transmission fluid should be checked at normal operating temperatures 66°C-77°C (150°F-170°F) on a level surface. The normal operating temperature can be reached after approximately 32 km (20 miles) of driving.

The transmission fluid should be in this range if at normal operating temperature (66°C-77°C [150°F-170°F]) (see figure to the right).

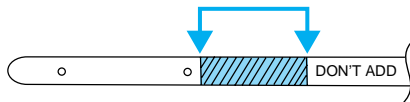

The transmission fluid should be in this range if at room temperature (10°C-35°C [50°F-95°F]) (see figure to the right).

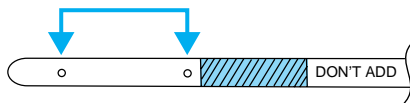

## Maintenance and care

If your vehicle has been operated for an extended period at high speeds, in city traffic during hot weather or pulling a trailer, the vehicle should be turned off for about 30 minutes to allow the fluid to cool before checking.

1. Park the vehicle on a level surface and engage the parking brake.
2. With the parking brake engaged and your foot on the brake pedal, start the engine and move the gearshift lever through all of the gear ranges. Allow sufficient time for each gear to engage.



3. Latch the gearshift lever in P (Park) and leave the engine running.
4. Remove the dipstick, wiping it clean with a clean, dry lint free rag.
5. Install the dipstick making sure it is fully seated in the filler tube.
6. Remove the dipstick and inspect the fluid level. The fluid level should be within the top hole area on the dipstick.
7. If necessary, add fluid in 250ml (1/2 pint) increments through the filler tube until the level is correct.
8. If an overfill occurs, excess fluid should be removed by a qualified technician.

**An overfill condition of transmission fluid may cause shift and/or engagement concerns and/or possible damage.**

If the fluid level is above the crosshatch (hot operating range) area after driving the vehicle for approximately 30 km (20 miles), excess transmission fluid should be removed by a qualified technician.

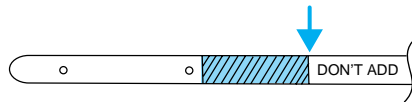

## Maintenance and care

### BATTERY

Your vehicle is equipped with a Motorcraft maintenance-free battery which normally does not require additional water during its life of service.

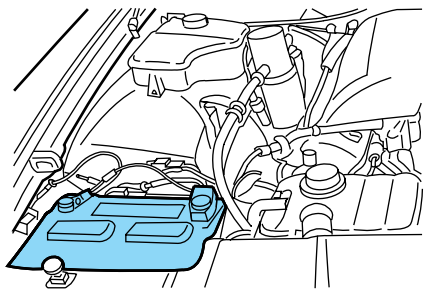

However, for severe usage or in high temperature climates, check the battery electrolyte level. Refer to the “Service Guide” for the service interval schedules.

If the electrolyte level in the battery is low, you can add plain tap water to the battery, as long as you do not use hard water (water with a high mineral or alkali content). If possible, however, try to only fill the battery cells with distilled water. If the battery needs water often, have the charging system checked.

**Keep the electrolyte level in each cell up to the “level indicator”. Do not overfill the battery cells.**

For longer, trouble-free operation, keep the top of the battery clean and dry. Also, make certain the battery cables are always tightly fastened to the battery terminals.

If you see any corrosion on the battery or terminals, remove the cables from the terminals and clean with a wire brush. You can neutralize the acid with a solution of baking soda and water. Reinstall the cables when you are done cleaning them, and apply a small quantity of grease to the top of each battery terminal to help prevent corrosion.

**If your battery has a cover/shield, make sure it is reinstalled after the battery has been cleaned or replaced.**



Batteries normally produce explosive gases which can cause personal injury. Therefore, do not allow flames, sparks or lighted substances to come near the battery. When working near the battery, always shield your face and protect your eyes. Always provide proper ventilation.

## Maintenance and care



When lifting a plastic-cased battery, excessive pressure on the end walls could cause acid to flow through the vent caps, resulting in personal injury and/or damage to the vehicle or battery. Lift the battery with a battery carrier or with your hands on opposite corners.



Keep batteries out of reach of children. Batteries contain sulfuric acid. Avoid contact with skin, eyes or clothing. Shield your eyes when working near the battery to protect against possible splashing of acid solution. In case of acid contact with skin or eyes, flush immediately with water for a minimum of 15 minutes and get prompt medical attention. If acid is swallowed, call a physician immediately.

Because your vehicle's engine is electronically controlled by a computer, some control conditions are maintained by power from the battery. When the battery is disconnected or a new battery is installed, the engine must relearn its idle conditions before your vehicle will drive properly. To begin this process:

1. Set your parking brake.
  2. Put the gearshift in P (Park), turn off all accessories and start the engine.
  3. Let the engine idle for at least one minute.
  4. The relearning process will automatically complete as you drive the vehicle.
- If you do not allow the engine to relearn its idle, the idle quality of your vehicle may be adversely affected until the idle is eventually relearned.
  - If the battery has been disconnected or a new battery has been installed, the clock and the preset radio stations must be reset once the battery is reconnected.

## Maintenance and care

- Always dispose of automotive batteries in a responsible manner. Follow your local standards for disposal. Call your local recycling center to find out more about recycling automotive batteries.

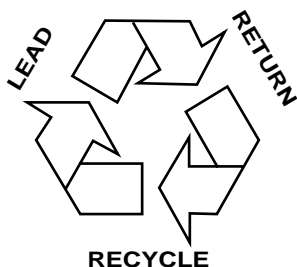

### WINDSHIELD WIPER BLADES

Check the wiper blades at least twice a year or when they seem less effective. Substances such as tree sap and some hot wax treatments used by commercial car washes reduce the effectiveness of wiper blades.

#### Checking the wiper blades

If the wiper blades do not wipe properly, clean both the windshield and wiper blades using undiluted windshield wiper solution or a mild detergent. Rinse thoroughly with clean water. To avoid damaging the blades, do not use fuel, kerosene, paint thinner or other solvents.

#### Changing the wiper blades

To replace the wiper blades:

1. Pull the wiper arm away from the windshield and lock into the service position.
2. Turn the blade at an angle from the wiper arm. Push the lock pin manually to release the blade and pull the wiper blade down toward the windshield to remove it from the arm.
3. Attach the new wiper to the wiper arm and press it into place until a click is heard.

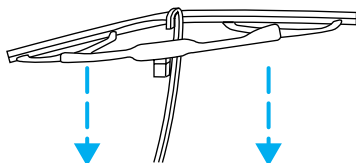
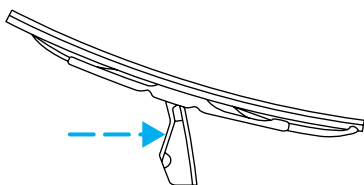

## Maintenance and care

### INFORMATION ABOUT TIRE QUALITY GRADES

New vehicles are fitted with tires that have their Tire Quality Grade (described below) molded into the tire's sidewall. These Tire Quality Grades are determined by standards that the United States Department of Transportation has set.

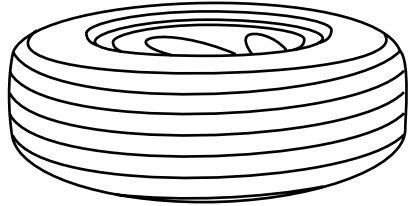

Tire Quality Grades apply to new pneumatic tires for use on passenger cars. They do not apply to deep tread, winter-type snow tires, space-saver or temporary use spare tires, tires with nominal rim diameters of 10 to 12 inches or limited production tires as defined in Title 49 Code of Federal Regulations Part 575.104(c)(2).

**U.S. Department of Transportation-Tire quality grades:** The U.S. Department of Transportation requires Ford to give you the following information about tire grades exactly as the government has written it.

#### Treadwear

The treadwear grade is a comparative rating based on the wear rate of the tire when tested under controlled conditions on a specified government test course. For example, a tire grade 150 would wear one and one-half (1 1/2) times as well on the government course as a tire grade 100. The relative performance of tires depends upon the actual conditions of their use, however, and may depart significantly from the norm due to variations in driving habits, service practices, and differences in road characteristics and climate.

#### Traction A B C

The traction grades, from highest to lowest are A, B, and C, and they represent the tire's ability to stop on wet pavement as measured under test surfaces of asphalt and concrete. A tire marked C may have poor traction performance.



The traction grade assigned to this tire is based on braking (straight ahead) traction tests and does not include cornering (turning) traction.

## Maintenance and care

### Temperature A B C

The temperature grades are A (the highest), B, and C, representing the tire's resistance to the generation of heat and its ability to dissipate heat when tested under controlled conditions on a specified indoor laboratory test wheel. Sustained high temperature can cause the material of the tire to degenerate and reduce tire life, and excessive temperature can lead to sudden tire failure. The grade C corresponds to a level of performance which all passenger car tires must meet under the Federal Motor Vehicle Safety Standard No. 109. Grades B and A represent higher levels of performance on the laboratory test wheel than the minimum required by law.



The temperature grade for this tire is established for a tire that is properly inflated and not overloaded. Excessive speed, underinflation, or excessive loading, either separately or in combination, can cause heat buildup and possible tire failure.

## SERVICING YOUR TIRES

### Checking the tire pressure

- Use an accurate tire pressure gauge.
- Check the tire pressure when tires are cold, after the vehicle has been parked for at least one hour or has been driven less than 5 km (3 miles).
- Adjust tire pressure to recommended specifications found on the Tire Pressure Label.



Improperly inflated tires can affect vehicle handling and can fail suddenly, possibly resulting in loss of vehicle control.

### Tire rotation

Because your vehicle's tires perform different jobs, they often wear differently. To make sure your tires wear evenly and last longer, rotate them as indicated in the "Service Guide." If you notice that the tires wear unevenly, have them checked.



## Maintenance and care

- Four tire rotation (for vehicles with aluminum wheels)

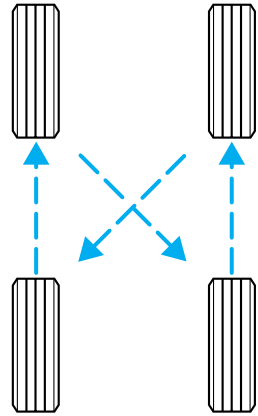

- Five tire rotation (for vehicles with steel wheels and full size spare tires)

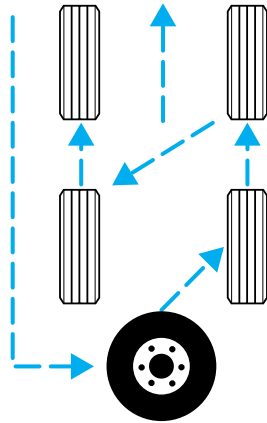

## Maintenance and care

### Replacing the tires

Replace the tires when the wear band is visible through the tire treads.

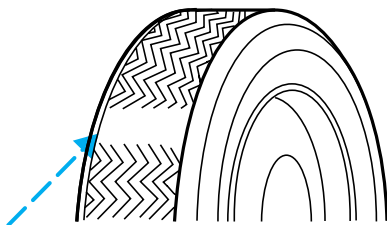

Failure to follow these precautions may adversely affect the handling of the vehicle and make it easier to lose control and roll over.

Tires that are larger or smaller than your vehicle's original tires may also affect the accuracy of your speedometer.

### SNOW TIRES AND CHAINS



Snow tires must be the same size and grade as the tires you currently have on your vehicle.

The tires on your vehicle have all weather treads to provide traction in rain and snow. However, in some climates, you may need to use snow tires and chains. If you need to use chains, it is recommended that steel wheels (of the same size and specifications) be used as chains may chip aluminum wheels.

Follow these guidelines when using snow tires and chains:

- Use only SAE Class S chains.
- Install chains securely, verifying that the chains do not touch any wiring, brake lines or fuel lines.
- Drive cautiously. If you hear the chains rub or bang against your vehicle, stop and re-tighten the chains. If this does not work, remove the chains to prevent damage to your vehicle.
- If possible, avoid fully loading your vehicle.

## Maintenance and care

- Remove the tire chains when they are no longer needed. Do not use tire chains on dry roads.
- The suspension insulation and bumpers will help prevent vehicle damage. Do not remove these components from your vehicle when using snow tires and chains.

### WHAT YOU SHOULD KNOW ABOUT AUTOMOTIVE FUELS

#### Important safety precautions



Do not overfill the fuel tank. The pressure in an overfilled tank may cause leakage and lead to fuel spray and fire.



If you do not use the proper fuel cap, the pressure in the fuel tank can damage the fuel system or cause it to work improperly in a collision.



The fuel system may be under pressure. If the fuel cap is venting vapor or if you hear a hissing sound, wait until it stops before completely removing the cap.



Automotive fuels can cause serious injury or death if misused or mishandled.

Observe the following guidelines when handling automotive fuel:

- Extinguish all smoking materials and any open flames before fueling your vehicle.
- Always turn off the vehicle before fueling.
- Automotive fuels can be harmful or fatal if swallowed. Fuel such as gasoline is highly toxic and if swallowed can cause death or permanent injury. If fuel is swallowed, call a physician immediately, even if no symptoms are immediately apparent. The toxic effects of fuel may not be visible for hours.

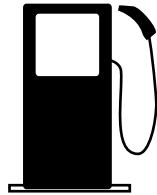

## Maintenance and care

- Avoid inhaling fuel vapors. Inhaling too much fuel vapor of any kind can lead to eye and respiratory tract irritation. In severe cases, excessive or prolonged breathing of fuel vapor can cause serious illness and permanent injury.
- Avoid getting fuel liquid in your eyes. If fuel is splashed in the eyes, remove contact lenses (if worn), flush with water for 15 minutes and seek medical attention. Failure to seek proper medical attention could lead to permanent injury.
- Fuels can also be harmful if absorbed through the skin. If fuel is splashed on the skin and/or clothing, promptly remove contaminated clothing and wash skin thoroughly with soap and water. Repeated or prolonged skin contact with fuel liquid or vapor causes skin irritation.
- Be particularly careful if you are taking “Antabuse” or other forms of disulfiram for the treatment of alcoholism. Breathing gasoline vapors, or skin contact could cause an adverse reaction. In sensitive individuals, serious personal injury or sickness may result. If fuel is splashed on the skin, promptly wash skin thoroughly with soap and water. Consult a physician immediately if you experience an adverse reaction.

### Choosing the right fuel

Use only UNLEADED FUEL. The use of leaded fuel is prohibited by law and could damage your vehicle.

Your vehicle was not designed to use fuel or fuel additives with metallic compounds, including manganese-based compounds containing (MMT).

Vehicles certified to meet California emission standards (indicated on the underhood Vehicle Emissions Control Information label) are designed to operate on California reformulated gasolines. If California reformulated gasoline is not available when you refuel, your vehicle can be operated on non-California fuels. However, even though your engine will perform adequately on other gasolines, the performance of the emission control devices and systems may be adversely affected.

Repair of damage caused by using a fuel for which your vehicle was not designed may not be covered by your warranty.

### Octane recommendations

Your vehicle is designed to use “Regular” unleaded gasoline with an (R+M)/2 octane rating of 87. We do not recommend gasolines labeled as “Regular” that are sold with octane ratings of 86 or lower in high altitude areas.



Do not be concerned if your engine sometimes knocks lightly. However, if it knocks heavily under most driving conditions while you are using fuel with the recommended octane rating, see your dealer or a qualified service technician to prevent any engine damage.

### Fuel quality

If you are experiencing starting, rough idle or hesitation driveability problems during a cold start, try a different brand of “Regular” unleaded gasoline. “Premium” unleaded gasoline is not recommended (particularly in the United States) because it may cause these problems to become more pronounced. If the problems persist, see your dealer or a qualified service technician.

The American Automobile Manufacturers Association (AAMA) issued a fuel specification to provide information on high quality fuels that optimize the performance of your vehicle. We recommend the use of fuels that meet the AAMA specification if they are available.

It should not be necessary to add any aftermarket products to your fuel tank if you continue to use a high-quality fuel.

### Cleaner air

Ford approves the use of gasolines to improve air quality, including reformulated gasolines that contain oxygenates up to 10% ethanol or 15% MTBE.

Do not use gasolines containing methanol, which can damage critical fuel system components. Damage resulting from the use of methanol may not be covered by your warranty.

## Maintenance and care

### Running out of fuel

Avoid running out of fuel because this situation may have an adverse effect on powertrain components.

If you have run out of fuel:

- You may need to crank the engine several times before the system starts to pump fuel from the tank to the engine.
- Your “Check Engine” light may come on. For more information on the “Check Engine” light, refer to the *Instrumentation* chapter.

### Calculating fuel economy

To accurately calculate your vehicle’s fuel economy:

1. Fill the tank completely and record the initial odometer reading.
2. Each time you fill the tank, record the amount of fuel added (in liters or gallons).
3. After at least three to five fuel tank fill-ups, fill the fuel tank and record the current mileage reading.
4. Use one of the following equations to calculate fuel economy.

Liters used  $\times 100 \div$  Total kilometers traveled

Total miles traveled  $\div$  Total gallons used

Keep a record for at least one month. This will provide an accurate estimate of the vehicle’s fuel economy.

### EMISSION CONTROL SYSTEM

Your vehicle is equipped with various emission control components and a catalytic converter which will enable your vehicle to comply with applicable exhaust emission standards. To make sure that the catalytic converter and other emission control components continue to work properly:

- Use only unleaded fuel.
- Avoid running out of fuel.
- Do not turn off the ignition while your vehicle is moving, especially at high speeds.
- Have the items listed in your “Service Guide” performed according to the specified schedule.

## Maintenance and care

The scheduled maintenance items listed in the “Service Guide” are essential to the life and performance of your vehicle and to its emissions system.

If other than Ford, Motorcraft or Ford-authorized parts are used for maintenance replacements or for service of components affecting emission control, such non-Ford parts should be equivalent to genuine Ford Motor Company parts in performance and durability.



Do not park, idle, or drive your vehicle in dry grass or other dry ground cover. The emission system heats up the engine compartment and exhaust system, which can start a fire.

Lumination of the charging system warning light, “Check Engine” light or the temperature warning light, fluid leaks, strange odors, smoke or loss of oil pressure, could indicate that the emission control system is not working properly.



If you smell exhaust fumes of any kind inside your vehicle, have the dealer inspect and fix your vehicle immediately. Do not drive if you smell exhaust fumes. These fumes are harmful and could kill you.

Do not make any unauthorized changes to your vehicle or engine. By law, vehicle owners and anyone who manufactures, repairs, items, sells, leases, trades vehicles, or supervises a fleet of vehicles are not permitted to intentionally remove an emission control device or prevent it from working. Information about your vehicle’s emission system is on the Vehicle Emission Control Information Decal located on or near the engine. This decal identifies engine displacement and gives some tune up specifications.

Please consult your “Warranty Guide” for complete emission warranty information.

### Readiness for inspection/maintenance (I/M) testing

In some localities, it may be a legal requirement to pass an I/M test of the on-board diagnostic (OBD-II) system. If your “Check Engine/Service Engine Soon” light is on, refer to the description in the *Warning Lights and Chimes* section of the *Instrumentation* chapter. Your vehicle may not pass the I/M test with the “Check Engine/Service Engine Soon” light on.

## Maintenance and care

If the vehicle's powertrain system or its battery has just been serviced, the OBD-II system is reset to a "not ready for I/M test" condition. To ready the OBD-II system for I/M testing, a minimum of 30 minutes of city and highway driving is necessary as described below:

- First, at least 10 minutes of driving on an expressway or highway.
- Next, at least 20 minutes driving in stop-and-go, city-type traffic with at least four idle periods.

Allow the vehicle to sit for at least eight hours without starting the engine. Then, start the engine and complete the above driving cycle. The engine must warm up to its normal operating temperature. Once started, do not turn off the engine until the above driving cycle is complete.

### EXTERIOR BULBS

#### Replacing exterior bulbs

Check the operation of the following lamps frequently:

- Headlamps
- Tail lamps
- Brakelamps
- High-mount brakelamp
- Turn signals
- Backup lamps
- License plate lamp

Do not remove lamp bulbs unless they will be replaced immediately. If a bulb is removed for an extended period of time, contaminants may enter the lamp housings and affect performance.

#### Replacing headlamp bulbs



Handle a halogen headlamp bulb carefully and keep out of children's reach. Grasp the bulb only by its plastic base and do not touch the glass. The oil from your hand could cause the bulb to break the next time the headlamps are operated.

To remove the headlamp bulb:

1. Make sure headlamp switch is in OFF position, then open the hood.



## Maintenance and care

2. Remove the protective cover by turning the three knobs to the unlock position.
3. Disengage the safety snap on the connector by pulling upward slightly on the clip.
4. Release clip and disconnect the electrical connector from the bulb.

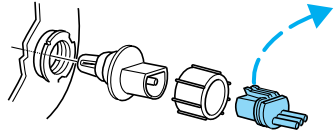

5. Remove the bulb retaining ring by rotating it counterclockwise (when viewed from the rear) about 1/8 turn to free it from the bulb socket, and slide the ring off the plastic base. Keep the ring to retain the new bulb.

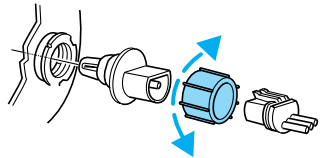

6. Without turning, remove the old bulb from the lamp assembly by gently pulling it straight back out of the lamp assembly.

To install the new bulb:

1. With the flat side of the new bulb's plastic base facing upward, insert the glass end of the bulb into the lamp assembly. Turn the bulb left or right to align the grooves in the plastic base with the tabs in the lamp assembly. When the grooves are aligned, push the bulb into the lamp assembly until the plastic base contacts the rear of the lamp assembly.

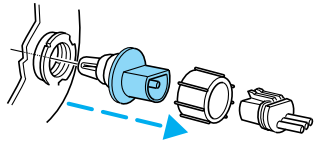

2. Install the bulb retaining ring over the plastic base until it contacts the rear of the socket by rotating it clockwise until you feel a "stop."
3. Connect the electrical connector into the rear of the plastic base until it snaps, locking it into position.
4. Install the protective cover over headlamps locking it in place with three knobs.
5. Turn the headlamps on and make sure they work properly. If the headlamp was correctly aligned before you changed the bulb, you should not need to align it again.

## Maintenance and care

### **Replacing front parking lamp/turn signal bulbs**

1. Make sure headlamp switch is in OFF position, then open the hood.
2. Remove the protective cover by turning the three knobs to the unlock position.
3. Disengage the safety snap on the connector by pulling upward slightly on the clip.
4. Disconnect the electrical connector from the bulb socket.
5. Rotate the bulb socket counterclockwise about  $\frac{1}{4}$  turn and remove from lamp assembly.

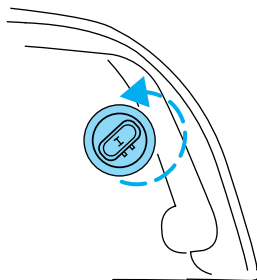

6. Carefully pull bulb straight out of the socket and push in the new bulb.
7. To complete installation, follow the removal procedure in reverse order.

### **Replacing tail lamp/backup bulbs**

For bulb replacement, see a dealer or qualified technician.

### **High-mount brakelamp bulbs**

For bulb replacement, see a dealer or qualified technician.

### **Replacing sidemarker and cornering lamp bulbs**

For bulb replacement, see a dealer or qualified technician.

### **Replacing license plate lamp bulbs**

For bulb replacement, see a dealer or qualified technician.

## **AIMING THE HEADLAMPS**

The alignment of your headlamps should be checked by a qualified service technician if:

- Oncoming motorists frequently signal you to deactivate your high beams, and your high beams are not activated.

## Maintenance and care

- The headlamps do not seem to provide enough light for clear night vision.
- The headlamp beams are pointed substantially away from a slightly down and to the right position.

### REPLACING THE INTERIOR BULBS

Check the operation of the following interior bulbs frequently:

- interior overhead lamp
- map lamp

### Using the right bulbs

Function	Trade Number
Headlamp	9007
Park lamp and turn lamp (front)	3457 NAK
Side marker (front)	194 NA
Cornering lamp (front)	3156K
Tail, stop, turn (rear)	3157 K
Side marker (rear)	194
Backup lamp	3156K
License plate lamp	168
High-mount brakelamp	912
Luggage compartment lamp	212-2
Dome lamp	906
Rear reading lamp	211-2
Map lamp	168
Illuminated visor mirror	168
Dual floorwell lamp	906
Glove compartment	168
To replace all instrument panel lights - see your dealer.	

## Maintenance and care

### CLEANING AND CARING FOR YOUR VEHICLE

Refer to the “Customer Assistance Guide” for a list of Ford-approved cleaners, polishes and waxes.

#### Washing your vehicle

Wash your vehicle regularly with cold or lukewarm water. Never use strong detergents or soap. If your vehicle is particularly dirty, use a quality car wash detergent. Always use a clean sponge, washing glove or similar device and plenty of water for best results. To avoid spots, avoid washing when the hood is still warm, immediately after or during exposure to strong sunlight.

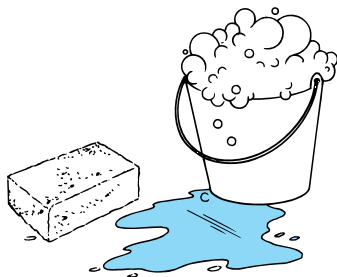

During winter months, it is especially important to wash the vehicle on a regular basis. Large quantities of dirt and road salt are difficult to remove and also cause damage to the vehicle.

Remove any exterior accessories, such as antennas, before entering a car wash. If you have wax applied to the vehicle at a commercial car wash, it is recommended that you clean the wiper blades and windshield as described in *Cleaning the wiper blades and windshield*.

After washing, apply the brakes several times to dry them.

#### Waxing your vehicle

Wax when water stops beading on the surface. This could be every three or four months, depending on operating conditions.

Use only carnauba or synthetic-based waxes. Use cleaning fluid or alcohol with a clean cloth to remove any bugs and tar before waxing vehicle. Use tar remover to remove any tar spots.

Avoid getting wax on the windshield. If you have wax applied at a commercial car wash, it is recommended that you clean the wiper blades and windshield as described in *Cleaning the wiper blades and windshield*.

#### Repairing paint chips

Minor scratches or paint damage from road debris may be repaired with touch-up paint, repair foil or aerosol paint spray from the Ford accessory line. Observe the application instructions on the products.

## Maintenance and care

Remove particles such as bird droppings, tree sap, insect remains, tar spots, road salt and industrial fallout immediately.

### Cleaning the wheels

Wash with the same detergent as the body of your vehicle. Do not use acid-based or alcohol-based wheel cleaners, steel wool, fuel or strong detergents. Never use abrasives that will damage the finish of special wheel surfaces. Use a tar remover to remove grease and tar.

### Cleaning the engine

Engines are more efficient when they are clean because grease and dirt buildup keep the engine warmer than normal. When washing:

- Take care when using a power washer to clean the engine. The high pressure fluid could penetrate the sealed parts and cause damage.
- Do not spray with cold water to avoid cracking the engine block or other engine components.

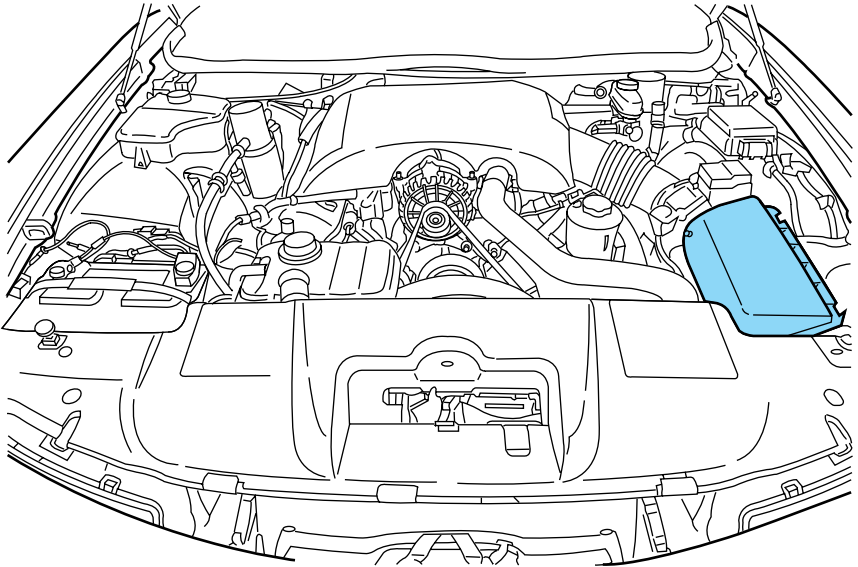

## Maintenance and care

- Cover the highlighted areas to prevent water damage when cleaning the engine.
- Never wash or rinse the engine while it is running; water in the running engine may cause internal damage.

### Cleaning plastic exterior parts

Use vinyl cleaner for routine cleaning. Clean with a tar remover if necessary. Do not clean plastic parts with thinners, solvents or petroleum-based cleaners.

### Cleaning the exterior lamps

Wash with the same detergent as the exterior of your vehicle. Use glass cleaner or tar remover if necessary.

To avoid scratching the lamps, do not use a dry paper towel, chemical solvents or abrasive cleaners.

### Cleaning the wiper blades and windshield

If the wiper blades do not wipe properly, clean the wiper blade rubber element with undiluted windshield washer solution or a mild detergent. To avoid damaging the blades, do not use fuel, kerosene, paint thinner or other solvents.

If the wiper still does not wipe properly, this could be caused by substances on the windshield such as tree sap and some hot wax treatments used by commercial car washes. Clean the outside of the windshield with a non-abrasive cleanser such as the non-abrasive Bon-Ami® powder. Rinse thoroughly with clean water. **Do not** use abrasive cleansers on glass as they may cause scratches. The windshield is clean if beads do not form when you rinse it with water. The windshield and wiper blades should be cleaned on a regular basis, and blades or rubber elements replaced when worn.

## Maintenance and care

### Cleaning the instrument panel

Clean with a damp cloth, then dry with a dry cloth.

Avoid cleaner or polish that increases the gloss of the upper portion of the instrument panel. The dull finish in this area helps protect the driver from undesirable windshield reflection.

### Cleaning the interior fabric

Remove dust and loose dirt with a whisk broom or a vacuum cleaner. Remove fresh spots immediately. Do not use household or glass cleaners. These agents can stain and discolor the fabric. Use a mild soap and water solution if necessary.

### Cleaning and maintaining the safety belts

Clean the safety belts with a mild soap solution recommended for cleaning upholstery or carpets. Do not bleach or dye the belts, because these actions may weaken the belt webbing.

Check the safety belt system periodically to make sure there are no nicks, wear or cuts. If your vehicle has been involved in an accident, refer to the *Safety belt maintenance* section in the *Seating and safety restraints* chapter.

### Underbody

Flush the complete underside of vehicle frequently. Keep body drain holes unplugged. Inspect for road damage.

### Cleaning leather seats (if equipped)

For routine cleaning, wipe the surface with a soft, damp cloth. For more thorough cleaning, wipe the surface with a mild soap.

If the leather cannot be completely cleaned using a mild soap and water solution, the leather may be cleaned using a commercially available cleaning product “Tanners Preserve Leather Cleaner” and a 3M “Type T” scrubbing pad by using the following steps;

**The type of scrubbing pad is very critical because the common 3M “Scotch Brite” green pad is too aggressive and will damage the leather surface**

- Spray a small amount of the leather cleaner on the pad and rub the area to be cleaned with the pad using a circular motion. Only clean 1/4

## Maintenance and care

of the area at a time. For heavily soiled areas, spray the cleaner directly onto the leather (two squirts should be adequate) and rub with the pad. Repeat if necessary.

- Use a soft, damp cloth to remove the loosened dirt and foam.
- Dry with a soft cloth.

**Do not use household cleaners, glass cleaner, alcohol solutions or cleaner intended for vinyl, rubber or plastics. These products can damage the leather.**

**In some instances, color or dye transfer can occur when wet clothing (wool, denim, leathers or other non-colorfast garments) comes in contact with leather upholstery. If this occurs, the leather should be cleaned immediately to avoid permanent staining.**

“Tanners Preserve Leather Cleaner” (product number AS-300) is available from “First Brands” by calling 1-800-726-1001. This product may also be available at many local automotive after market stores.

3M “Type T” Clean And Finish Scrubbing Pads (UPC 04011-01276) are available through your local 3M distributor. Call 1-800-742-9649 for the nearest distributor in your area.

<b>PART NUMBER</b>	<b>PART NAME</b>
(Obtain Locally)	Tanners Preserve Leather Cleaner
(Obtain Locally)	3M "Type T" Clean and Finish Scrubbing Pads

### Inside windows

Use glass cleaner for the inside windows if they become fogged.



## Capacities and specifications

### MOTORCRAFT PART NUMBERS

<b>Component</b>	<b>4.6L SOHC V8 engine</b>
Air filter	FA-1032
Fuel filter	FG-800A
Battery (standard)	BXT-59
Battery (optional)	BXT-65-650
Oil filter	FL-820-S
PCV valve	EV-98
Spark plugs*	AWSF-32PP

\* Refer to Vehicle Emissions Control Information (VECI) decal for spark plug gap information.

If a spark plug is removed for inspection, it must be reinstalled in the same cylinder. Cylinders No. 1, 2, 3 and 4 have a "PG" suffix and Cylinders No. 5, 6, 7 and 8 have a "P" suffix. If a spark plug needs to be replaced, use only spark plugs with the service number suffix letter as shown on the engine decal.

# Capacities and specifications

## REFILL CAPACITIES

Fluid	Ford Part Name	Capacity
Engine oil (includes filter change)	Motorcraft 5W30 Super Premium Motor Oil	4.7L (5.0 quarts)
Brake fluid	High Performance DOT 3 Motor Vehicle Brake Fluid	Fill to line on reservoir
Power steering fluid	Motorcraft MERCON® ATF	Fill to line on reservoir
Transmission fluid	Motorcraft MERCON®V ATF	13.1L (13.9 quarts)
Engine coolant	<sup>1</sup>	15.0L (15.8 quarts)
Fuel tank	N/A	71.9L (19.0 gallons)
Rear axle fluid <sup>2</sup>	Motorcraft SAE 80W90 Rear Axle Lubricant	1.8-1.9L (3.75-4.0 pints)
Windshield washer fluid	Ultra-Clear Windshield Washer Concentrate	Fill to line on reservoir

<sup>1</sup> If your engine coolant is green in color, use Ford Premium Cooling System Fluid. If your coolant is orange in color, use Ford Extended Life Engine Coolant. Refer to *Lubricant Specifications*.

<sup>2</sup> Add 118 ml (4 oz.) of additive friction modifier C8AZ-19B546-A, Ford specification EST-M2C118-A for complete refill of Traction-Lok axles.

Service refill capacities are determined by filling the rear axle 6 mm to 14 mm (1/4 inch to 9/16 inch) below the bottom of the filler hole.

Rear axles are considered lubricated for life when the vehicle is used for normal service. See your "Service Guide" for Severe Duty requirements.

## Capacities and specifications

### LUBRICANT SPECIFICATIONS

Item	Ford part name	Ford part number	Ford specification
Brake fluid	High Performance DOT 3 Motor Vehicle Brake Fluid	C6AZ-19542-AB	ESA-M6C25-A and DOT 3
Door weatherstrips	Silicone Lubricant	C0AZ-19553-AA and D7AZ-19553-AA	ESR-M13P4-A
Engine coolant	Ford Premium Engine Coolant (green in color)	E2FZ-19549-AA	ESE-M97B44-A
	Ford Extended Life Engine Coolant (orange in color)	F6AZ-19544-AA	WSS-M97B44-D or DEX-COOL® equivalent
Engine oil	Motorcraft 5W30 Super Premium Motor Oil	XO-5W30-QSP	WSS-M2C153-G with API Certification Mark
Hinges, latches, striker plates, fuel filler door hinge and seat tracks	Multi-Purpose Grease	DOAZ-19584-AA or F5AZ-19G209-AA	ESB-M1C93-B or ESR-M1C159-A
Lock cylinders	Penetrating Lubricant	E8AZ-19501-B	none
Power steering fluid	Motorcraft MERCON® ATF	XT-2-QDX	MERCON®
Automatic transmission (4R70W)	Motorcraft MERCON®V ATF	XT-5-QM	MERCON®V

## Capacities and specifications

Item	Ford part name	Ford part number	Ford specification
Rear axle <sup>1</sup>	Motorcraft Premium Rear Axle Lubricant	XY-80W90-QL	WSL-M2C197-A
Windshield washer fluid	Ultra-Clear Windshield Washer Concentrate	C9AZ-19550-AB	ESR-M17P5-A

<sup>1</sup> Add 118 ml (4 oz.) of additive friction modifier C8AZ-19B546-A, Ford specification EST-M2C118-A for complete refill of Traction-Lok axles.

### ENGINE DATA

Engine	4.6L SOHC V8 engine
Cubic inches	281
Horsepower-single exhaust	200 @ 4250 rpm
Horsepower-dual exhaust	215 @ 4500 rpm
Torque-single exhaust	265 lb. ft. @ 3000 rpm
Torque-dual exhaust	275 lb. ft. @ 3000 rpm
Required fuel grade	87 octane
Firing order	1-3-7-2-6-5-4-8
Spark plug gap	1.3-1.4 mm (0.052-.056 inch)
Ignition system	Coil on plug
Compression ratio	9.0:1

### VEHICLE DIMENSIONS

Vehicle dimensions	mm (in)
(1) Overall length	5 382 (211.9)
(2) Overall width	1 987 (78.2)
(3) Overall height	1 443 (56.8)
(4) Wheelbase	2 913 (114.4)
(5) Track - Front	1 611 (63.4)
(5) Track - Rear	1 659 (65.3)

## Capacities and specifications

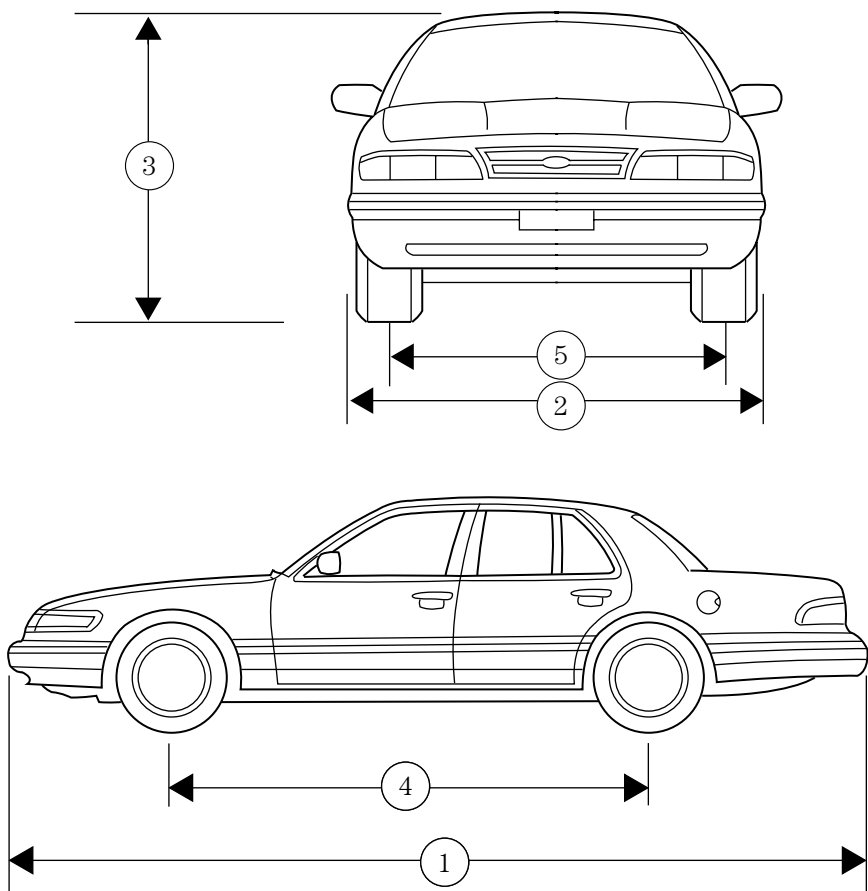

# Capacities and specifications

## IDENTIFYING YOUR VEHICLE

### Safety compliance label

The National Highway Traffic Safety Administration Regulations require that a Safety Compliance Certification Label be affixed to a vehicle and prescribe where the Safety Compliance Certification Label may be located. The Safety Compliance Certification Label is located on the front door latch pillar on the driver's side.

<b>MFD. BY FORD MOTOR CO. IN U.S.A.</b>			
DATE: XXXXX	GVWR: XXXXX LB/ XXXXX KG		
FGAWR: XXXXXX/XXXXXXXX	RGAWR: XXXXXX/XXXXXXXX		
THIS VEHICLE CONFORMS TO ALL APPLICABLE FEDERAL MOTOR VEHICLE SAFETY STANDARDS IN EFFECT ON THE DATE OF MANUFACTURE SHOWN ABOVE.			
VIN: XXXXXXXXXXXXXXXXX		TYPE: XXXXXXXXXXXXXXXXX	
			
MAXIMUM LOAD=OCCUPANTS + LUGGAGE=XXXKG/XXXLB			
OCCUPANTS: X TOTAL X FR X 2ND X RR		OCCUPANTS LUGGAGE	
		XX XXXKG/XXXLB	
TIRE: XXXX/XXXXX XXX		X XXXKG/XXXLB	
PRESSURE (FR) XXX kPa/33 PSI COLD			
PRESSURE (RR) XXX kPa/33 PSI COLD			
TRAILER TOWING - SEE OWNER GUIDE			
EXT PNT: XXXXXX XXXXXX	RC: XX	DSO: XXXX	F0000
BAR   INT TR   TP/PS   R	AXLE   TR   SPR	T0000	
X XX XXX X XX	X XXX		
UTC VFOHT-15294A10-GA			

### Vehicle identification number

The vehicle identification number is attached to a metal tag and is located on the driver side instrument panel.



### Engine number

The engine number (the last eight numbers of the vehicle identification number) is stamped on the engine block, transmission, frame and transfer case (if equipped).

## Reporting safety defects

### REPORTING SAFETY DEFECTS (U.S. ONLY)

If you believe that your vehicle has a defect that could cause a crash, or could cause injury or death, you should immediately inform the National Highway Traffic Safety Administration (NHTSA) in addition to notifying Ford Motor Company.



If NHTSA receives similar complaints, it may open an investigation, and if it finds that a safety defect exists in a group of vehicles, it may order a recall and remedy campaign. However, NHTSA cannot become involved in individual problems between you, your dealer or Ford Motor Company.

To contact NHTSA, you may either call the Auto Safety Hotline toll-free at 1-800-424-9393 (202-366-0123 in the Washington D.C. area) or write to:

NHTSA  
U.S. Department of Transportation  
400 Seventh Street  
Washington D.C. 20590

You can also obtain other information about motor vehicle safety from the Hotline.

# Index

- Aiming headlamps .....138
- Air bag supplemental restraint system .....68
  - and child safety seats .....69
  - description .....68
  - disposal .....72
  - indicator light .....71
  - passenger air bag .....70
- Air conditioning
  - manual heating and air conditioning system .....25,26
- Air suspension
  - description .....87
- Anti-lock brake system (ABS)description
- Battery .....124
  - voltage gauge .....16
- Brake fluid
  - checking and adding .....114
- Brakes .....83
  - anti-lock .....83
  - anti-lock brake system (ABS) warning light .....84
  - fluid, checking and adding ....114
  - traction control .....85
- Brake-shift interlock .....88
- Break-in period .....2
- Bulbs, replacing .....136
  - headlamps .....136
  - specifications .....139
- Changing a tire .....101
- Child safety seats .....73
- Childproof locks .....48
- Chime
  - headlamps on .....12
- Cleaning your vehicle .....140
  - engine compartment .....141,142
  - exterior .....143
  - headlamps .....142
  - plastic parts .....142
  - washing .....140
  - waxing .....140
  - wheels .....141
  - windows .....144
  - wiper blades .....142
- Climate control system
  - automatic temperature control .....27,28,29,30,32
- Clock .....33
- Compass, electronic .....43
  - calibration .....45
  - set zone adjustment .....44
- Coolant (see Engine coolant) temperature gauge .....15
- Defrost
  - rear window .....24
- Emission control system .....134
- Engine
  - service points .....111
- Engine block heater .....81
- Engine coolant
  - checking and adding .....116
  - disposal .....117
  - refill capacities .....118
- Engine oil .....112,113
  - changing oil and oil filter .....114
  - checking and adding .....112,113
- Exhaust fumes .....82
- Floor mats .....48
- Fuel
  - calculating fuel economy .....134
  - improving fuel economy .....94
  - octane rating .....133
  - quality .....133
  - running out of fuel .....134
  - safety information relating to automotive fuels .....131
- Fuel pump shut-off switch .....95
- Fuse panels
  - instrument panel .....97
  - power distribution box .....99
- Fuses .....96,97
- Gauges, Mechanical .....12
  - fuel gauge .....12



- Hazard flashers .....95
- Headlamps .....23
  - autolamp system .....24
  - daytime running lights .....24
  - flashing .....23
  - high beam .....23
- Heating .....25
- High beams
  - indicator light .....9
- Hood
  - release lever .....110
- Ignition
  - positions of the ignition .....35
- Instrument panel
  - cleaning .....143
  - lighting up panel and interior .23
- Keyless entry system
  - autolock .....50
  - keypad .....55
  - programming entry code ....56,57
- Keys
  - key in ignition chime .....11
- Lamps
  - headlamps .....136
  - high-mount brakelamp .....138
  - interior lamps .....139
  - parking lamps .....138
  - tail lamps .....138
- License plate lamps .....138
- Lights, warning and indicator
  - air bag .....8
  - air suspension .....10
  - anti-lock brakes (ABS) .....9,22
  - brake .....8,22
  - charging system .....9
  - check engine .....7
  - fuel reset .....6
  - low coolant .....10
  - oil pressure .....10
  - overdrive off .....11
  - safety belt .....8
  - turn signal indicator .....9
- Lubricant specifications .....147
- Message center .....17
  - reset button .....17,18
  - select button .....18
- Mirrors
  - automatic dimming rearview
    - mirror .....42
  - side view mirrors (power) .....47
- Motorcraft parts .....145
- Odometer .....14
- Panic alarm feature, remote
  - entry system .....51
- Parking brake .....84
- Power door locks .....47
- Power steering
  - fluid, checking and adding ....121
- Radio .....33
- Refill capacities for fluids .....146
- Relays .....96,101
- Remote entry system .....48
  - illuminated entry .....51
  - locking/unlocking doors .....49
  - replacement/additional
    - transmitters .....53
    - replacing the batteries .....52
- Reporting safety defects .....151
- Safety restraints
  - center front lap belt .....65
  - cleaning the safety belts .....143
  - extension assembly .....66
  - for children .....72
  - warning light and
    - chime .....11,66,67
- Safety seats for children
  - attaching with tether straps ....77
  - in rear seat .....77
  - tether anchorage hardware ....77
- Seat belts (see Safety
  - restraints) .....61
- Seats .....58
  - adjusting the seat, manual ..58,59
  - adjusting the seat, power ....59,61

# Index

- cleaning upholstery .....143
- head restraints .....58
- lumbar support .....61
- Service your vehicle .....109
  - precautions when servicing ...109
- Speed control .....36
  - canceling a set speed .....38
  - indicator light .....39
  - resuming a set speed .....39
  - tap up/tap down .....37,38
  - turning off .....36
- Speed sensitive steering .....87
- Speedometer .....13
- Starting your vehicle .....78,81
  - starting your vehicle if the battery is disabled ....105,106,107
- Steering, power .....86
- Tilt steering wheel .....35
- Tires .....127,128
  - changing .....103
  - checking the pressure .....128
  - replacing .....130
  - rotating .....128
  - snow tires and chains .....130
  - treadwear .....127
- Traction control
  - active light .....11
- Trailer towing .....91
  - tips .....93
- Transmission .....122
  - automatic operation .....88,89,90
  - fluid, checking and adding
    - (automatic) .....122
- Trip odometer .....15
- Trunk
  - remote release lever .....45
  - using the remote entry system to open .....51
- Turn signal
  - lever .....34
- Universal transmitter .....39
  - erasing channels .....42
  - operating .....41
  - programming .....40
- Vehicle dimensions .....148
- Vehicle Identification Number (VIN) .....150
- Vehicle loading .....91
- Ventilating your vehicle .....82
- Warning chimes .....6,22
- Wheels
  - anti-theft lug nuts .....102,103
- Windows
  - power windows, operating .....45
- Windshield washer fluid and wipers
  - checking and adding fluid ....115
  - checking and replacing wiper blades .....126
  - operation .....34
- Wrecker towing .....108











## Filling station information

Recommended fuel	Unleaded fuel only - 87 octane
Fuel tank capacity	71.9L (19.0 gallons)
Engine oil capacity (includes filter change)	4.7L (5.0 quarts). Use Motorcraft 5W30 Super Premium Motor Oil, Ford Specification WSS-M2C153-G.
Automatic transmission fluid capacity	13.1L (13.9 quarts). Use Motorcraft MERCON®V ATF.
Tire pressure and size	Refer to Tire Pressure Label located on the front face of the rear passenger door jamb.
Hood release	Pull handle under the left side of the instrument panel.
Coolant capacity <sup>1</sup>	15.0L (15.8 quarts)
Power steering fluid capacity	Fill to line on reservoir. Use Motorcraft MERCON® ATF.

<sup>1</sup> If your engine coolant is green in color, use Ford Premium Cooling System Fluid. If your engine coolant is orange in color, use Ford Extended Life Engine Coolant. Refer to *Lubricant Specifications*.

Ensure correct automatic transmission fluid is used for a specific application. Check the container to verify the fluid is MERCON® and/or MERCON® V approved. Some fluids have been approved as meeting both MERCON® and MERCON® V requirements and will be labeled as such. Fluids labeled as meeting only MERCON® or only MERCON® V requirements must not be used interchangeably. DO NOT mix MERCON® and MERCON® V. Transmission fluid requirements are indicated on the dipstick or on the dipstick handle. Refer to your “Service Guide” to determine the correct service interval.