

Contents

Before driving

Introduction	2
Instrumentation	3
Controls and features	14
Seating and safety restraints	35

Starting and driving

Starting	78
Driving	84
Roadside emergencies	99

Servicing

Maintenance and care	118
Capacities and specifications	156
Reporting safety defects	168
Index	169

Introduction

ICONS

Indicates a warning. Read the following section on *Warnings* for a full explanation of them.



Indicates that vehicle information related to recycling and other environmental concerns will follow.



We must all play our part in protecting the environment. Correct vehicle usage and the authorized disposal of waste cleaning and lubrication materials are significant steps towards this aim.

WARNINGS

How can you reduce the risk of personal injury and prevent possible damage to others, your vehicle and its equipment?

In this owner's guide, answers to such questions are contained in comments highlighted by the warning triangle symbol.

BREAKING-IN YOUR VEHICLE

There are no particular breaking-in rules for your vehicle. Simply avoid driving too briskly during the first 1,600 km (1,000 miles) of driving. Vary speeds frequently. This is necessary to give the moving parts a chance to break in.

If possible, you should avoid full use of the brakes for the first 1,600 km (1,000 miles).

From 1,600 km (1,000 miles) onwards you can gradually increase the performance of your vehicle up to the permitted maximum speeds.

INFORMATION ABOUT THIS GUIDE

The information found in this guide was in effect at the time of printing. Ford may change the contents without notice and without incurring obligation.

Instrumentation

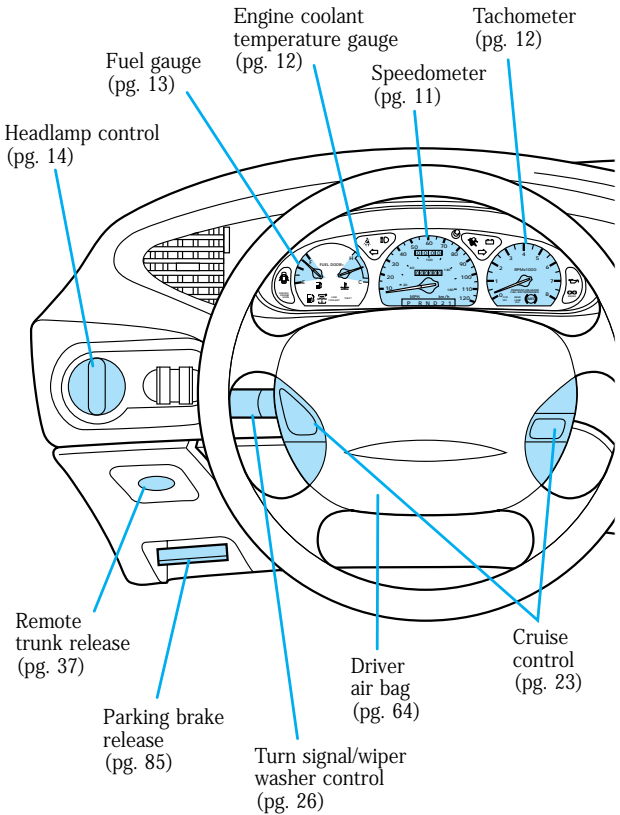

* if equipped

Instrumentation

Electronic sound system;
refer to Audio Guide
(pg. 22)

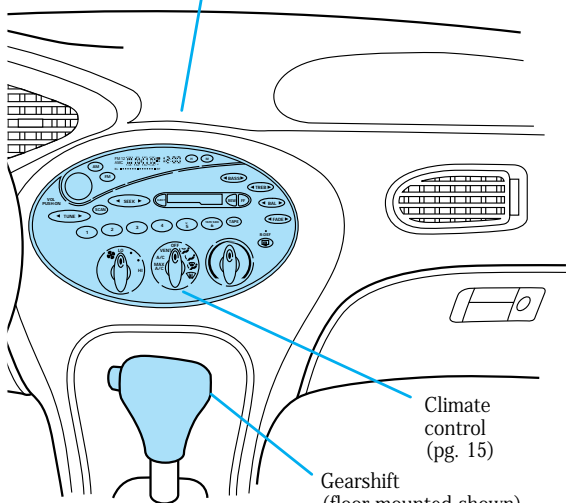

Climate
control
(pg. 15)

Gearshift
(floor-mounted shown)
(pg. 86)

Instrumentation

WARNING LIGHTS AND GAUGES

Standard instrument cluster

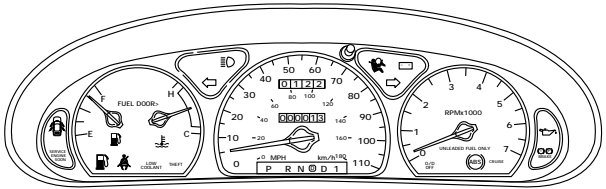

Optional Instrument cluster

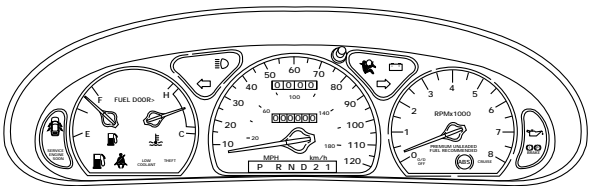

SHO cluster (if equipped)

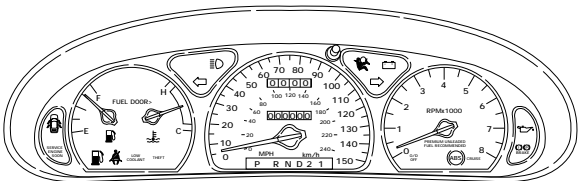

Instrumentation

Turn signal

Illuminates when the left or right turn signal or the hazard lights are turned on.



High beams

Illuminates when the headlamp high beams are on.



Safety belt

Illuminates when the ignition is switched on to remind you to fasten your safety belts. For more information, refer to *Using the safety restraints properly* in the *Seating and safety restraints* chapter.



Door ajar

Illuminates when the ignition switch is in the ON or START position and any door is open.



Service engine soon

This light illuminates when the engine's Emission Control System requires service. It will also illuminate when the ignition key is in the ON position and the engine is off.



Low fuel

If the fuel gauge reaches approximately 1/16th of a tank, this



Instrumentation

lamp will illuminate. The ignition must be turned on for this lamp to illuminate.

Low coolant (if equipped)

This lamp will illuminate when the engine coolant inside the reservoir is low.

LOW
COOLANT

This lamp will come on when the ignition is first turned on, but then should turn off. If the lamp stays on and a chime sounds, you should check the coolant level inside the reservoir. For instructions on adding coolant, see *Engine coolant* in the index.

Anti-theft alarm light (if equipped)

This light is used when you set the anti-theft alarm system. See *Anti-theft system* in the index.

THEFT

O/D off (if equipped)

Illuminates when the transaxle control switch (TCS) has been pushed. When the light

O/D
OFF

is on, the transaxle does not shift into overdrive. If the light does not come on when the TCS is depressed or if the light flashes when you are driving, have your vehicle serviced.

Anti-lock brake system (ABS) (if equipped)

Momentarily illuminates when the ignition is turned on and the engine is off. If the



light stays on or continues to flash, the ABS needs to be serviced.

Instrumentation

Cruise control (if equipped)

This light comes on when the cruise control ON button is pressed.

CRUISE

It turns off when the cruise control OFF

button is pressed or when the ignition is turned to the OFF position.

Brake system warning

Extinguishes when the parking brake is released. Illumination



after releasing the

BRAKE

parking brake indicates low brake fluid level.

Engine oil pressure

When the oil pressure is below the normal operating range, this lamp will illuminate.



The engine oil level being too high or too low could cause this lamp to illuminate. This lamp will come on when the ignition is first turned on but then should turn off. If the lamp stays on, continued operation will cause severe engine damage.

Charging system

Briefly illuminates when the ignition is turned on and the engine is off. The light



also illuminates when the battery is not charging properly, requiring electrical system service.

Air bag readiness

Briefly illuminates when the ignition is turned on and the engine is off. If the



Instrumentation

light fails to illuminate, continue to flash or remains on, have the system serviced immediately.

Headlamps on warning chime

Sounds when the headlamps are on, the ignition is off (and the key is not in the ignition) and the driver's door is opened.

Key-in-ignition warning chime

Sounds when the key is left in the ignition in the OFF/LOCK or ACC position and the driver's door is opened.

Low coolant chime

Sounds when the engine coolant in the coolant reservoir is low.

Safety belt warning chime

For information on the safety belt warning chime, refer to the *Seating and safety restraints* chapter.

Supplemental restraint system (SRS) warning chime

For information on the SRS warning chime, refer to the *Seating and safety restraints* chapter.

Instrumentation

Speedometer

Indicates the current vehicle speed.

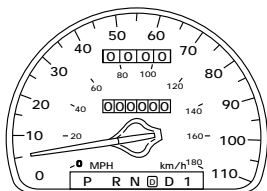

(Optional instrument cluster)

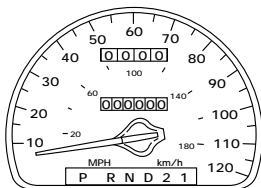

(Taurus SHO cluster)

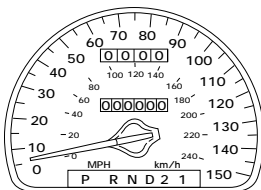

Instrumentation

Tachometer

Indicates the engine speed in revolutions per minute.

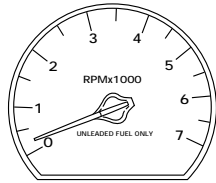

(Optional cluster and Taurus SHO cluster)

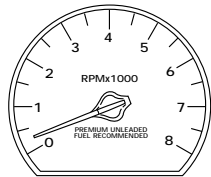

Engine coolant temperature gauge

Indicates the temperature of the engine coolant. At normal operating temperature, the needle remains within the normal area. If it enters the red section, the engine is

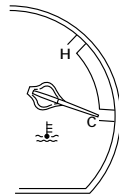

overheating. Switch off the ignition and let it cool. Refer to *Checking and adding engine coolant* in the *Maintenance and care* chapter.

Instrumentation

Odometer

Registers the total kilometers (mileage) of the vehicle.

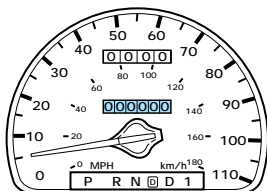

Trip odometer

Can register the kilometers (mileage) of individual journeys. To reset, depress the control.



Fuel gauge

Displays approximately how much fuel is in the fuel tank (when the key is in the ON position). The fuel gauge may vary slightly when the vehicle is in motion. The ignition should be in the OFF position while the vehicle is being refueled.

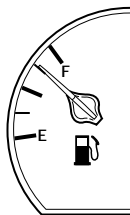

Controls and features

TURNING ON THE INTERIOR AND EXTERIOR LAMPS

Panel dimmer control

Instrument panel illumination, interior lamps and cargo lamp brightness can be adjusted with this control. Move the thumbwheel up to brighten the lamps or down to dim the lamps.

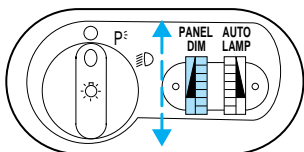

Headlamp control

Turn the headlamp control one turn to turn on the parking lamps. Turn it all the way to turn on the headlamps.

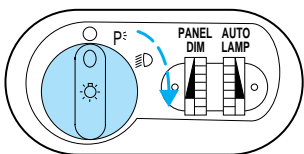

Autolamp delay system (if equipped)

The autolamp system sets the headlamps to turn on and off automatically. You can use the autolamps to:

- Turn on the lamps automatically at night.
- Turn off the lamps automatically in daylight.
- Keep the lamps on for up to three minutes after the ignition is turned off.

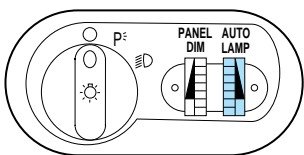

Setting autolamp

1. Make sure headlamp control is in the OFF position, then turn the key to ON or start the vehicle.

Controls and features

2. Locate autolamp thumbwheel and turn thumbwheel to beginning of MAX position. The indicator light will come on if it is dark enough to

activate the light sensor. The closer the thumbwheel is to the MAX mark, the longer the lamps will stay on after leaving the vehicle.

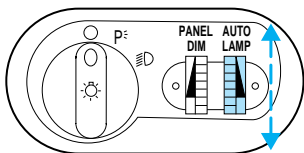

The autolamps will now automatically turn the headlamps on and off for you. To turn the autolamps off, move thumbwheel back to the OFF position.

Daytime running lights (Canadian vehicles only)

The daytime running light system turns the headlamps on, with a reduced light output, when:

- the engine is running
- the parking brake is released
- the headlamp system is in the OFF position.



The Daytime Running Light (DRL) system will not illuminate the tail lamps and parking lamps. Turn on your headlamps at dusk. Failure to do so may result in a collision.

CLIMATE CONTROL SYSTEM

Manual heating and air conditioning system

Fan speed control

Controls the volume of air circulated in the vehicle.







Controls and features

Mode selector control

Controls the direction of the airflow to the inside of the vehicle.



- **MAX A/C** - Uses recirculated air to cool the vehicle. It allows for faster cooling but is noisier than A/C. The air conditioning compressor will operate in this mode.
- **A/C** - Uses outside air to cool the vehicle. It is quieter than MAX A/C but not as economical. The air conditioning compressor will operate in this mode.
- **VENT** - Distributes outside air through the instrument panel registers.
- **OFF** - Outside air is shut out and the fan will not operate.
-  (Panel and floor) - Distributes outside air through the instrument panel registers and the front and rear floor ducts. The air conditioning compressor will operate in this mode.
-  (Floor) - Allows for maximum heating. The airflow is from the front and rear floor ducts.
-  (Floor and defrost) - Distributes outside air through the floor ducts and the windshield defroster ducts. The air conditioning compressor will operate in this mode.
-  (Front defrost) - Distributes outside air through the windshield defroster ducts. It can be used to clear ice or fog from the windshield. The air conditioning compressor will operate in this mode.

Temperature control knob

Turn the dial to the desired mix of warm (red) and cool (blue) air.



Controls and features

Operating tips

- In humid weather, select  before driving. This will prevent your windshield from fogging. After a few minutes, select any desired position.
- To prevent humidity buildup inside the vehicle, don't drive with the climate control system in the OFF position.
- Don't put objects under the front seat that will interfere with the airflow to the back seats.
- Remove any snow, ice or leaves from the air intake area (at the bottom of the windshield under the hood) on the passenger side of your vehicle.
- If the air conditioner works well in MAX A/C but not in A/C, this may indicate that the passenger compartment air filter (if equipped) needs to be replaced.

Electronic Automatic Temperature Control (EATC) system (if equipped)

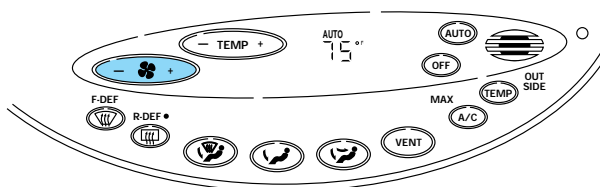

The EATC system will maintain a selected temperature and automatically control airflow. You can override automatic operation with any of the six override controls at the bottom of the control panel.

Controls and features

To turn on the EATC

Press AUTO or any of the six manual override buttons along the bottom of the control. The control will operate only when the ignition is turned to the ON position.

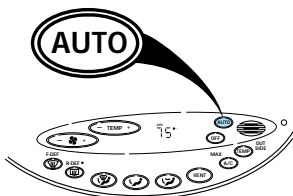

To turn off the EATC

Press OFF. When the system is off, the display window will be blank (dark).

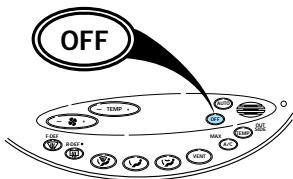

Automatic operation

Press AUTO and select the desired temperature. The system will automatically determine fan speed and airflow location. Fan speed remains automatic unless you press FAN. The selected temperature will be shown on the display.

Temperature selection

TEMP will increase or decrease the set temperature. Pressing TEMP will change the temperature one degree in either direction. Pressing and holding TEMP will rapidly change the temperature (in one degree increments) in either direction until either 18°C (65°F) or 29°C (85°F). The temperature will then jump -15°C (5°F) and stop at either 16°C (60°F) which is maximum cooling or 32°C (90°F) which is maximum heating.

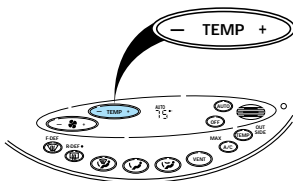

Controls and features

Changing modes (Temperature conversion)

Press MAX A/C and the  F-DEF button at the same time to switch between Fahrenheit and Celsius. If the battery is disconnected, the display will revert to Fahrenheit.

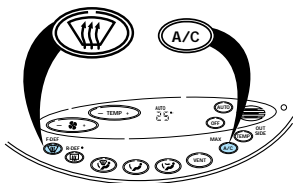

(fan speed)

Once AUTO is pressed, fan speed is adjusted automatically for existing conditions.

You can override automatic fan speed (at any time) by pressing FAN. The display window will show FAN  and a series of dots indicating fan speed. To return to automatic fan control, press AUTO.

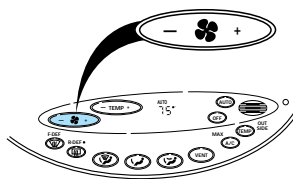

Manual override controls

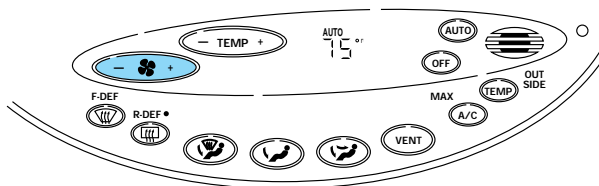





The override controls are located on the bottom of the EATC and allow you to determine where airflow is directed. To return to full automatic control, press AUTO.

- MAX A/C - Uses recirculated air to cool the vehicle. The temperature will display 16°C

Controls and features

(60°F). To exit, press AUTO or any of the other override controls. MAX A/C is noisier but more economical than A/C. The airflow will be from the instrument panel registers. The air conditioning compressor will operate in this mode.

- VENT - Distributes outside air through the instrument panel registers. However, the air will not be cooled below the outside temperature.
-  (Panel and floor) - Distributes outside air through the instrument panel registers and the front and rear seat floor ducts. The air will be heated or cooled based on temperature selection. The air conditioning compressor will operate in this mode.
-  (Floor) - Allows for maximum heating through the front and rear seat floor ducts.
-  (Floor and defrost) - Distributes outside air through the floor ducts and the windshield defroster ducts. If the outside temperature is about 10°C (50°F) or higher, the air conditioner will dehumidify the air to prevent fogging. The air conditioning compressor will operate in this mode.
-  F-DEF (Defrost) - Distributes outside air through the windshield defroster ducts. It can be used to clear ice or fog from the windshield. If the outside temperature is about 10°C (50°F) or higher, the air conditioner will dehumidify the air to prevent fogging. The air conditioning compressor will operate in this mode.
- OFF - Outside air is shut out and the fan will not operate.

Displaying outside temperature

- OUTSIDE TEMP - Outside air temperature will be displayed. If the EATC is off, the display will go blank after four seconds. If the EATC is on, the display will show the outside temperature until the button is pressed again.

Controls and features

The outside temperature reading is most accurate when the vehicle is moving. Higher readings may be obtained when the vehicle is not moving. The readings that you get may not agree with temperatures given on the radio due to differences in vehicle and station locations.

Operating tips

- In humid weather, select  F-DEF before driving. This will prevent your windshield from fogging. After a few minutes, select any desired position.
- To prevent humidity buildup inside the vehicle, don't drive with the climate control system in the OFF position.
- Don't put objects under the front seat that will interfere with the air circulation to the back seats.
- Remove any snow, ice or leaves from the air intake area (at the bottom of the windshield under the hood) on the passenger side of your vehicle.
- If the air conditioner works well in MAX A/C but not in A/C, this may indicate that the passenger compartment air filter (if equipped) needs to be replaced.

Rear window defroster and heated outside rear view mirrors

The defroster clears away fog, frost and thin ice from the rear window and outside rear view mirrors.

Clear away snow from rear window and mirrors. The defroster operates for 10 minutes then shuts off. If more defrosting is required, press the control again.

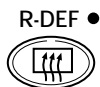

Controls and features

Liftgate wiper and washer (wagon only)

The liftgate wiper/washer control is located under the headlamp controls. Press the wiper control to activate the rear wiper. Press control again to turn off the wiper.

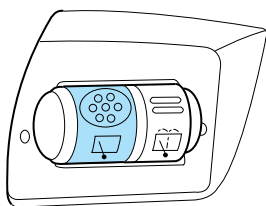

Press the washer control to activate rear washer. The wiper will come on when the washer control is pressed, if not already on.

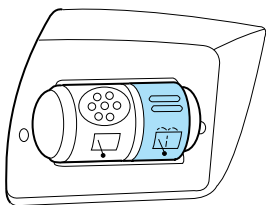

AUDIO SYSTEM

Refer to the *Audio Guide* for instructions on how to operate the audio system.

FUEL PUMP SHUT-OFF SWITCH

Refer to the *Roadside emergencies* chapter for instructions on how to operate the fuel pump shut-off switch.

POSITIONS OF THE IGNITION

1. ACCESSORY allows the electrical accessories such as the radio and wipers/washer to operate while the engine is not running.

2. LOCK locks the steering wheel and gearshift lever and allows key removal.

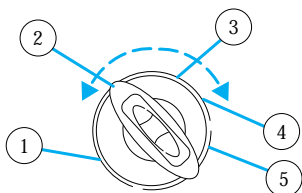

Controls and features

3. OFF shuts off the ignition and accessories and allows the gearshift and steering wheel to move.
4. ON tests the warning lights. The key must remain here when the engine is running.
5. START cranks the engine. The key must return to ON when running.

CRUISE CONTROL

To turn cruise control on

Press ON.

Vehicle speed cannot be controlled until the vehicle is travelling at or above 48 km/h (30 mph).

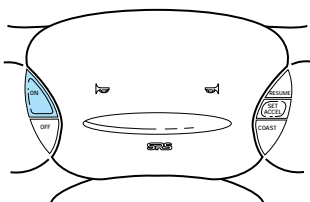

Do not use the cruise control in heavy traffic or winding, slippery or unpaved roads.

Do not shift into N (Neutral) while the cruise control is on.

To turn cruise control off

Press OFF or turn off the vehicle ignition.

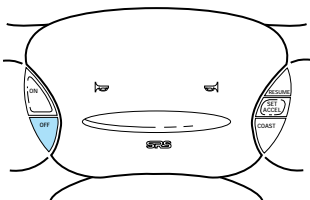

Once cruise control is switched off, the previously programmed set speed will be erased.

Controls and features

To set a speed

Press SET ACCEL. For cruise control to operate, the cruise control must be ON and the vehicle speed must be greater than 48 km/h (30 mph).

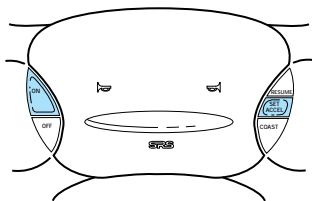

If you drive up or down a steep hill, your vehicle speed may vary momentarily slower or faster than the set speed. This is normal.

Cruise control cannot reduce the vehicle speed if it increases above the set speed on a downhill. If your vehicle speed is faster than the set speed while driving on a downhill in Overdrive, you may want to shift to the next lower gear to reduce your vehicle speed.

If your vehicle slows down more than 16 km/h (10 mph) below your set speed on an uphill, your cruise control will disengage. This is normal. Pressing RESUME will re-engage it.

Do not use your cruise control in heavy traffic or roads that are winding, slippery or unpaved.

To set a higher set speed

- Press and hold SET ACCEL. Release the control when the desired vehicle speed is reached or
- Press and release SET ACCEL. Each press will increase the set speed by 1.6 km/h (1 mph) or
- Accelerate with your accelerator pedal, then press and release SET ACCEL.

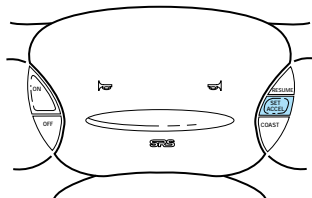

Controls and features

You can accelerate with the accelerator pedal at any time during cruise control usage. Releasing the accelerator pedal will return your vehicle to the previously programmed set speed.

To set a lower set speed

- Press and hold COAST. Release the control when the desired speed is reached or
- Press and release COAST. Each press will decrease the set speed by 1.6 km/h (1 mph) or
- Depress the brake pedal. When the desired vehicle speed is reached, press SET ACCEL.

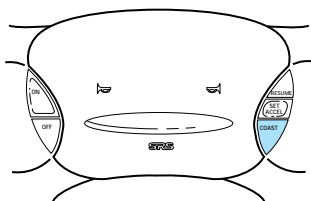

To disengage cruise control

- Depress the brake pedal.

Disengaging the cruise control will not erase the previously programmed set speed.

Pressing OFF will erase the previously programmed set speed.

To return to a set speed

- Press RESUME. For RESUME to operate, the vehicle speed must be faster than 48 km/h (30 mph).

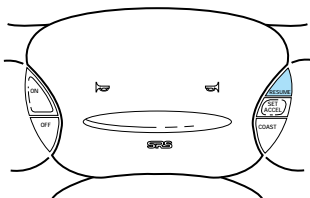

Controls and features

Indicator light

Lights when the cruise control is turned on and remains lit until either the cruise control or the ignition is turned off.

CRUISE

TURN SIGNAL CONTROL

Turn signals

Push the control down to activate the left turn signal. Push control up to activate the right turn signal.

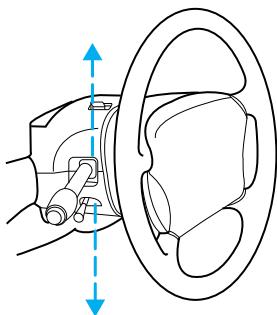

High beams

Push the control forward to activate the high beams.

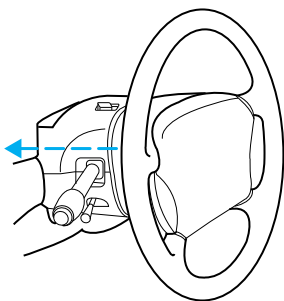

Controls and features

Flash-to-pass

Pull the control toward you to activate the flash-to-pass function.

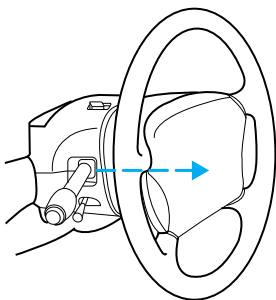

WINDSHIELD WIPERS AND WASHER

Push the control on the end of the turn signal control to activate washer. Push the control once for a single wipe. Push and hold for a longer wash cycle.

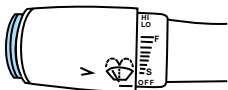

Turn the dial at end of the turn signal control to adjust wiper interval and speed.

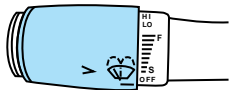

HAZARD FLASHER

Push the control located on top of the steering column to activate four-way flashers. Push control again to turn flashers off.

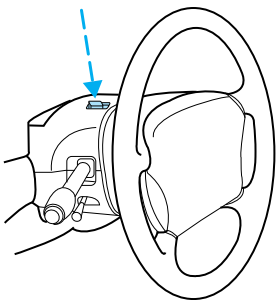

Controls and features

TILT STEERING

Pull the tilt steering control toward you to move the steering wheel up or down. Hold the control while adjusting the wheel to the desired position, then release the control.

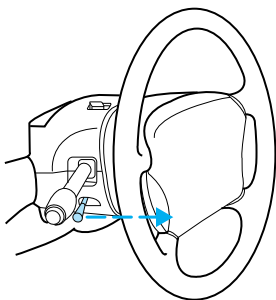

Never adjust the steering wheel when the vehicle is moving.

MOON ROOF (IF EQUIPPED)

Press SLIDE to open and close moon roof. Press AUTO and release to open completely with one touch.

Press UP or DN on the TILT control to tilt moon roof when closed.

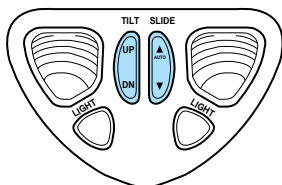

Sliding shade

The moon roof has a sliding shade that you can open or close when the moon roof is closed.

DOMES LAMPS AND MAP LAMPS

The front dome lamp is located overhead between the driver and passenger seats. If the vehicle is equipped with a moon roof, the dome lamp is located behind the moon roof.

Controls and features

The dome lamp will stay on if the control is moved to the ON position. When the control is in the DOOR position, the lamp will only come on when a door is opened. If the control is moved to the OFF position, the lamp will not come on at all.

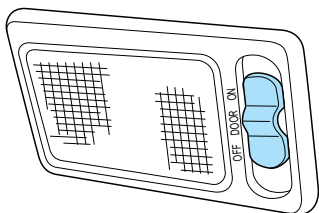

The dome lamp will illuminate whenever a front door is opened. If either front door has been opened from the outside, the lamp will remain on for 25 seconds after the door is shut. If any other door has been opened from the inside, the lamp will shut off immediately after the door is closed.

The map lamps and controls are located on the dome lamp. Press the controls on either side of each map lamp to activate the lamps.

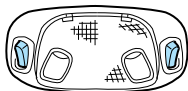

If equipped with a moon roof, the map lamps are located on the moon roof control panel. Press LIGHT to illuminate the map lamp.

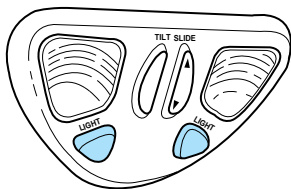

Controls and features

POWER WINDOWS

Press and hold the rocker switches to open and close windows. When AUTO is pressed and released quickly, the driver's window will open completely without holding the switch down. Each passenger has window controls.

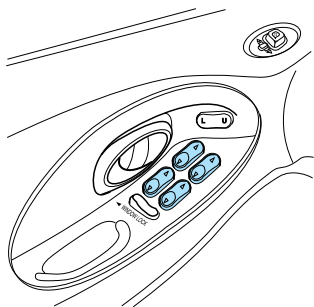

The window lock feature allows only the driver to operate the power windows.

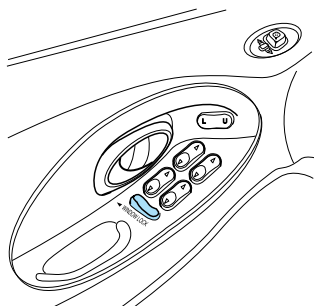

POWER DOOR LOCKS (IF EQUIPPED)

Press U to unlock all doors and L to lock all doors.

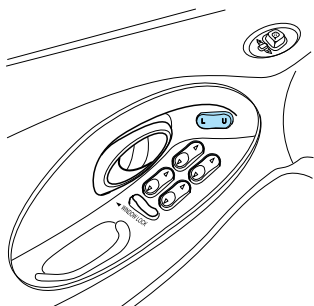

Controls and features

Central locking/Two step unlocking

When unlocking the driver or front passenger door with the key, turn it once toward the front of the vehicle to unlock that door only. Turn the key a second time to unlock all doors. When locking, turn the key toward the back of the vehicle to lock all doors.

Liftgate (wagon only)

The power liftgate lock is located on the right inside trim panel in the cargo area. When this lock is pressed, all doors and the liftgate will lock.

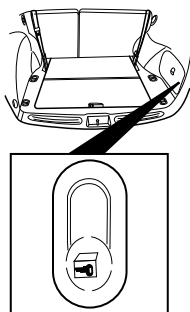

POWER SIDE VIEW MIRRORS

To change mirror position, first select a mirror by moving the selector control left (◀) or right (▶), then moving the control to set the desired position.

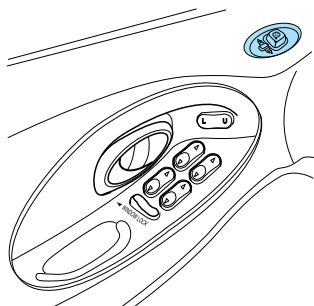

Power heated side view mirrors (if equipped)

The heated mirrors will melt frost, thin ice or remove fog when the rear window defroster is activated.

Controls and features

CHILDPROOF DOOR LOCKS

When these locks are set, the rear doors cannot be opened from the inside. The rear doors can be opened from the outside when the doors are unlocked.

Move lock control up to engage the lock.
Move control down to disengage childproof locks.

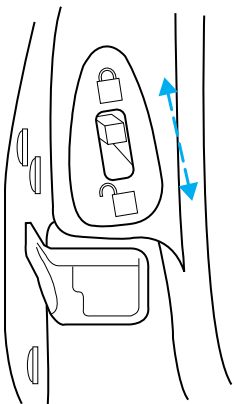

CONSOLE

If your vehicle is equipped with a floor mounted gearshift, it will have a full console with the following features:

- cup holders (push to open)

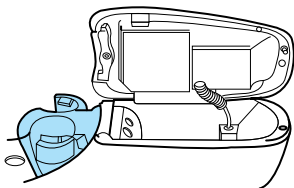
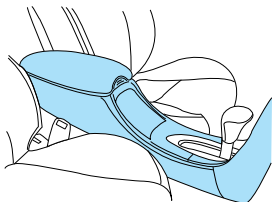

Controls and features

- coin holder and utility bin

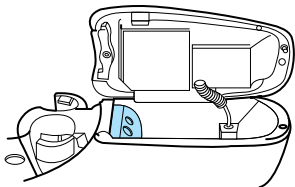

- cassette/CD storage

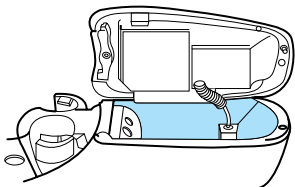

- cellular phone (if equipped)

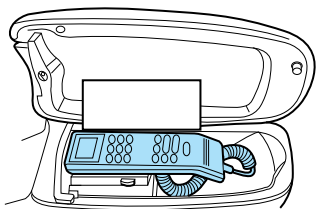

- ashtray (push to open)

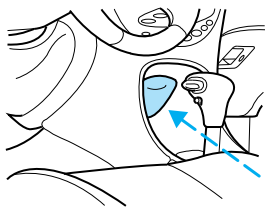

The release for the utility compartment is on the front of the console, just below the armrest. Press and release at the ridges to open.

Controls and features

If your vehicle is equipped with a cellular phone, press the latch release located on the driver's side edge of the console lid to access the phone.

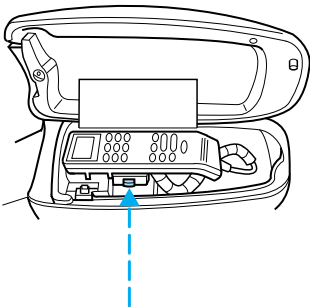

If your vehicle is equipped with the column shift, it has a center console in the center front seating position.

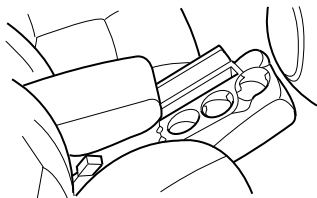

The center console has the same features as the full console. To open the storage compartment, raise the armrest and pull the strap on the seat up and toward the front of the vehicle. The cupholders in the center console can be removed for cleaning.

Cellular phone

Refer to the cellular phone user's manual for instruction on operation.

Seating and safety restraints

CONSOLE

If your vehicle is equipped with a floor mounted gearshift, it will have a full console with the following features:

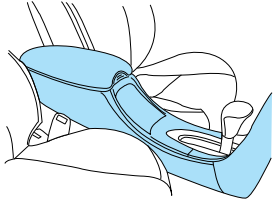

- cup holders (push to open)

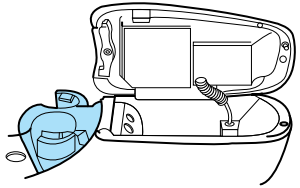

- coin holder and utility bin

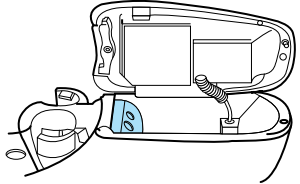

- cassette/CD storage

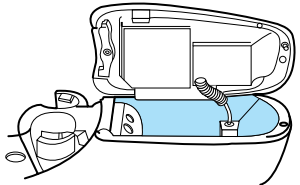

Seating and safety restraints

- ashtray (push to open)

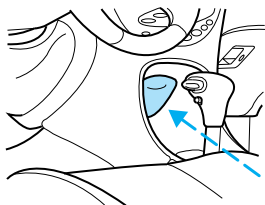

The release for the utility compartment is on the front of the console, just below the armrest. Press and release at the ridges to open.

If your vehicle is equipped with the column shift, it has a center console in the center front seating position.

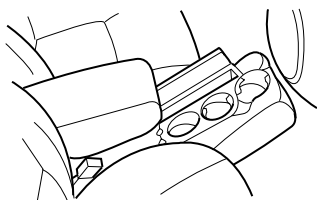

The center console has the same features as the full console. To open the storage compartment, raise the armrest and pull the strap on the seat up and toward the front of the vehicle. The cupholders in the center console can be removed for cleaning.

POSITIVE RETENTION FLOOR MAT (IF EQUIPPED)

Position the floor mat so that the eyelet is over the pointed end of the retention post and rotate forward to lock in. Make sure the mat does not interfere with the operation of the accelerator and brake pedal. To remove the floor mat, reverse the installation procedure.

Seating and safety restraints

OPENING THE TRUNK WITH REMOTE CONTROL (IF EQUIPPED)

Press the remote release control on the instrument panel to the left of the steering wheel.

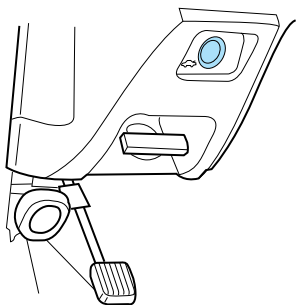

LIFTGATE (WAGON ONLY)

You can open the entire liftgate or just the liftgate window. To open the entire liftgate, press the release button hidden under the exterior trim panel just above the license plate.

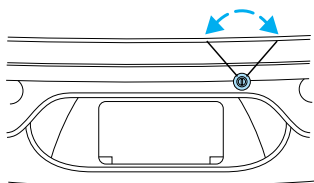

You must lock the liftgate with the key or power lock control; it does not lock automatically.

The window locks when the liftgate is locked. To open the window, make sure the liftgate and window are unlocked, then press the outside lock cylinder. The window can only be opened from the outside.

To prevent any damage to the liftgate and window, close them completely before driving.

Seating and safety restraints

STORAGE COMPARTMENT (WAGON ONLY)

Your vehicle comes equipped with a storage compartment in the floor of the cargo area. An additional compartment is in the rear trim panel on the right. Always put the load you are carrying as far forward as possible.

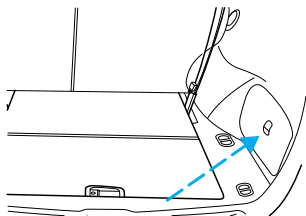

CARGO NET (IF EQUIPPED)

The cargo net secures lightweight objects in the cargo area. Attach the net to the anchors provided. Do not put more than 22 kg (50 lbs.) in the net. This net is not designed to restrain objects during a collision.

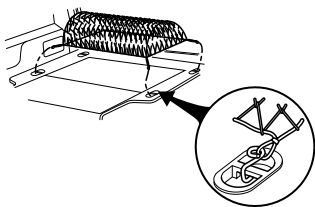

CARGO COVER (WAGON - IF EQUIPPED)

You can cover the rear compartment by fastening the cover into the pockets in the trim panel (make sure the cover is right side up so it unrolls from the top), then pulling and hooking the cover into the pockets into the trim panel.

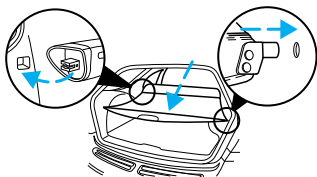

REWINDING THE SLIDING SHADE

If the shade is damaged or loses its spring tension from excessive use, manual rewinding of the shade may be necessary. The following procedure is a two-person operation:

Seating and safety restraints

1. Remove the shade from the mounting brackets by detaching the safety clip and pressure fit plastic knobs from either side of the shade.
2. Wrap the vinyl around the tube twice by twisting the tube away from you. Tuck the edged of the vinyl end cap with each wrap.
3. Fold the vinyl toward the center, making sure the edges clear the end cap slots. Use tape or a rubber band to hold the vinyl on the left side of the tube..
4. Push in the right end cap (marked R) about 6 mm (1/4 inch) to disengage the clutch and hold in while turning the tube toward you fourteen times.
5. Let go of the right end cap and unfold the vinyl. Place the vinyl into the end cap slots.
6. Place the shade back into the vehicle.



The cover may cause injury in a sudden stop or accident if it is not securely installed.

LUGGAGE RACK (WAGON ONLY)

The rear crossbar can be adjusted to fit the item being carried. The front crossbar does not move. No more than 44 kg (100 lbs.) can be loaded on the luggage rack.

To adjust the luggage rack, loosen the adjusting levers by pushing them toward the front of the vehicle, then slide the crossbar forward and lock the adjusting levers by pulling them toward the back of the vehicle.

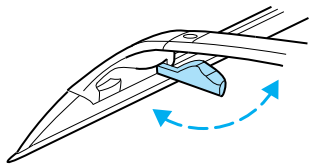

Seating and safety restraints

KEYLESS ENTRY SYSTEM (IF EQUIPPED)

You can lock or unlock the vehicle doors without using a key.



See also *Remote entry system (if equipped)* in this chapter.

The computer code that operates the keyless system is located on your owner's wallet card found in the glove compartment.

Illuminated entry system:

- turns on the interior lights for approximately 25 seconds and
- lights up the keypad controls for five seconds.

Do not push the control keypad with any hard object that could damage the controls.

Programming your own entry code

This code does not replace the permanent code from the dealership.

To program your own code:

1. Select five digits for your personal code.
2. Enter the permanent code that the dealership gave you.
3. Within five seconds, press 1/2.

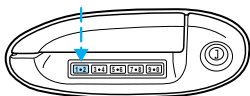

4. Within five seconds of pressing 1/2, enter your personal code, pressing each digit within five seconds of the previous digit.

You can now use either code. The system remembers only one personal code at a time.

To erase your personal code:

1. Enter the original permanent code.

Seating and safety restraints

2. Press 1/2 within five seconds of step one.

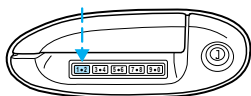

3. Wait six seconds.

For maximum security, do not set a code that presents the numbers in sequential order or uses the same button five times.

Unlocking the doors with the keyless entry system

The driver's door must be unlocked before any other. If more than five seconds pass between pressing numbers, enter the code again. The system has shut down if the keypad light is out. If the keyless entry system does not work, use the key or remote entry transmitter(s).

1. To unlock the driver's door, enter one of the two codes. After pressing the fifth number, the driver's door unlocks.

2. To unlock the passenger's door(s) and liftgate (wagon), press the 3/4 button within five seconds of unlocking the driver's door.

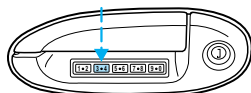

3. To unlock the trunk or liftgate (wagon), enter the five-digit factory code, then press the 5/6 button within five seconds.

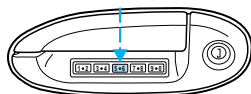

Locking the doors with the keyless entry system

To lock all the doors, press 7/8 and 9/0 at the same time. It is not necessary to first enter the keypad code.

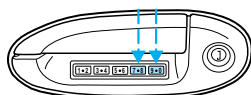

Seating and safety restraints

Operating your perimeter anti-theft system (if equipped) from the keyless entry pad

The keyless entry system arms by pressing 7/8 and 9/0.

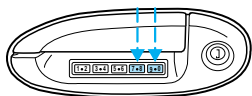

To disarm or reset a triggered anti-theft alarm, enter the five digit code.

All doors must be fully closed for the anti-theft system to arm. Refer to the *Anti-theft system* section, if equipped, in this chapter for more details.

Autolock

The autolock feature is part of your remote keyless entry system which locks all of the doors when:

- all vehicle doors are closed
- the ignition key is turned to the ON position
- the brake pedal is pressed
- you shift through R (reverse)
- one second has elapsed after the brake pedal is released.

The autolock feature repeats when:

- a door is opened and then all doors are closed
- the brake pedal is released.

The doors may not lock automatically if the driver:

- shifts through gears without pressing the brake
- shifts through gears quickly after starting the vehicle
- releases their foot from the brake while someone has stepped out of the vehicle for a moment.

Deactivating the system by using the controls for the keyless entry system:

1. Enter your permanent five-digit entry code (not the user code you may have set).
2. Within five seconds, press and hold 7/8.

Seating and safety restraints

3. Within five more seconds, press and release 3/4.

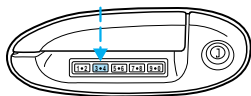

4. Release 7/8.

To reactivate the system, repeat the system deactivating instructions.

You can also deactivate or reactivate the autolock feature by this method:

1. Make sure the anti-theft system is not armed or triggered, ignition is off and all doors are closed.
2. Turn the ignition key from OFF to ON.
3. Press the door power unlock switch three times.
4. Turn the ignition key from ON to OFF.
5. Press the door power unlock switch three times.
6. Turn the ignition key back to ON within 30 seconds of step two.
7. The horn should chirp once. If not, wait 30 seconds and repeat steps one through six.
8. Press the door power unlock switch.
9. Press the door power lock switch.
10. The horn will chirp once if the autolock feature was deactivated, twice (one short chirp followed by a long chirp) if the autolock feature was activated.
11. Turn the ignition key to OFF.
12. The horn will chirp once to confirm you activated or deactivated the autolock feature.

Seating and safety restraints

REMOTE ENTRY SYSTEM (IF EQUIPPED)

The remote entry system allows you to lock or unlock all vehicle doors without a key.

It also arms and disarms the anti-theft system. (For more information on the anti-theft system, refer to *Anti-theft system* in this chapter.) The remote entry features only operate with the ignition in the OFF position.



Unlocking the doors

Press UNLOCK once to unlock the driver and illuminate the interior lamps.

Press UNLOCK a second time, within five seconds, to unlock all doors and liftgate (wagon).

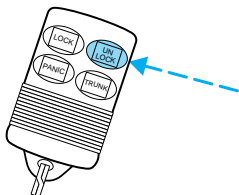

Using the trunk button

Press once to open the trunk (sedan) or unlock the liftgate (wagon).

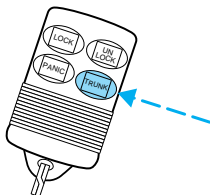

Seating and safety restraints

Locking the doors

Press LOCK to lock all doors and liftgate (wagon).

To confirm all doors are closed and locked, press LOCK a second time. The doors will lock again, the horn will chirp and the lamps will flash.

This process will arm your anti-theft system. For more information on arming the anti-theft system, refer to *Anti-theft system* in this chapter.

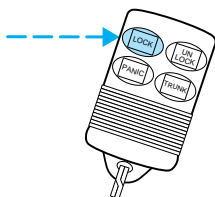

Sounding the PANIC alarm

Press PANIC to activate the alarm.

To deactivate the alarm, press PANIC again or turn the ignition to ACC or ON.

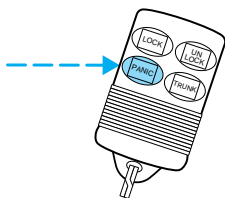

This device complies with part 15 of the FCC rules. Operation is subject to the following two conditions: (1) This device may not cause harmful interference, and (2) This device must accept any interference received, including interference that may cause undesired operation.

Arming and disarming the alarm system

Your remote entry system will:

- automatically arm the factory installed anti-theft system when the doors are locked.
- reset the triggered anti-theft alarm (when the driver's door is unlocked or when PANIC is pressed on a programmed remote entry transmitter).

Seating and safety restraints

Replacing the batteries

The transmitter is powered by two coin type three-volt lithium batteries. A decrease in operating range can be caused by:

- battery failure
- weather conditions
- structures around the vehicle

To replace the batteries:

1. Twist a thin coin between the two halves of the transmitter. **DO NOT TAKE THE FRONT PART OF THE TRANSMITTER APART.**
2. Place the positive (+) side of new batteries down.
3. Snap the two halves back together.

Replacing lost transmitters

Take all your vehicle's transmitters to your dealer for programming if:

- a transmitter is lost or
- you want to purchase additional transmitters (up to four)

ILLUMINATED ENTRY SYSTEM

The interior lamps illuminate when:

- the remote entry system is used to unlock the door or sound the personal alarm.

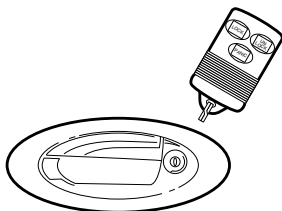

The system automatically turns off after 25 seconds or when the ignition is turned to the START or ACC position.

The inside lights will not turn off if:

- they have been turned on with the dimmer control or

Seating and safety restraints

- any door is open.

PERIMETER ANTI-THEFT SYSTEM (IF EQUIPPED) (TAIWAN AND RUSSIA ONLY)

When armed, this system will protect your vehicle from unauthorized entry. When unauthorized entry occurs, the system will flash the headlamps, parking lamps and the theft indicator lamp and will chirp the horn.

Arming the system

The system is ready to arm whenever the ignition is turned off. Any of the following actions will prearm the alarm system:

- Pressing LOCK on the remote transmitter (doors opened or closed).

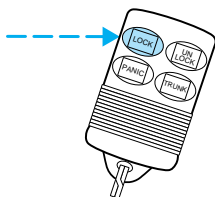

- Pressing 7/8 and 9/0 on the keyless entry pad at the same time to lock the doors (doors opened or closed).

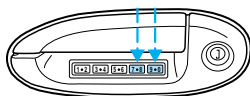

- Opening a door and pressing the power door lock button to lock the doors.
- Using the door key to lock the doors (doors opened or closed).

If a door or the liftgate (wagon) is open, the system is prearmed and is waiting for the door to close or liftgate to close. The THEFT indicator in the instrument cluster will be lit continuously when the system is prearmed.

THEFT

Seating and safety restraints

Once the doors and liftgate (wagon) are closed, the system will arm in 30 seconds.

When the system is armed the THEFT indicator will flash.



When you press the LOCK button twice within 5 seconds on your remote entry transmitter, the horn will chirp once to let you know that the system is armed.

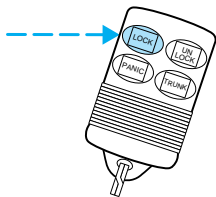

If the doors or liftgate (wagon) are not closed and you press the remote entry transmitter twice to confirm the doors are locked, the horn will chirp twice to warn you that the system is not arming.

Disarming the system

You can disarm the system by any of the following actions:

- Unlock the doors by using your remote entry transmitter.

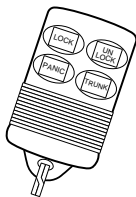

- Unlock the doors by using your keyless entry pad.

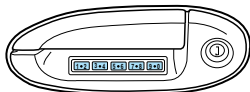

- Unlock the doors or liftgate with a key. Turn the key full travel (toward the front of the vehicle) to make sure the alarm disarms.
- Turn ignition to ACC or ON.

Seating and safety restraints

- Press PANIC on remote entry transmitter. This will disarm the system when alarm is triggered or sounding.

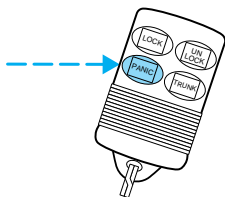

CODED-KEY ANTI-THEFT SYSTEM (IF EQUIPPED)

Your vehicle is equipped with a coded-key anti-theft system. Only the correct key will be able to start your vehicle. If your keys are lost or stolen, you must take your vehicle to a Ford dealership for re-programming.

Programming additional keys

If you need additional keys electronically coded for your vehicle, spares can be purchased (total of 16 keys). To program a new key, perform the following procedure:

1. With the coded key in the ignition, turn the ignition from ON to OFF.
2. Within 15 seconds of turning ignition off, insert new electronic key into the ignition and turn it from OFF to ON or START. If successful, the anti-theft indicator will illuminate for two seconds. Repeat procedure for all new keys.

If key coding fails, the anti-theft indicator will flash.

THEFT



Seating and safety restraints

Coding failure can be caused by any of the following:

- The new key was not inserted into the ignition within 15 seconds.
- 16 keys have already been programmed.
- The new key does not have an electronic code.

Seating and safety restraints

SEATING

Head restraints

The head restraints can be moved up and down.

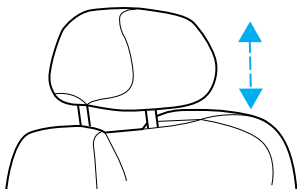

Front seats

Adjusting the manual seats

Lift bar to move seat forward or backward.

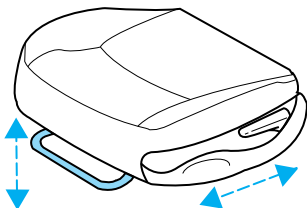

Pull lever up to adjust seatback.

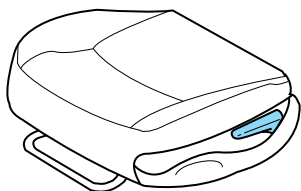

Never adjust the driver's seat or seatback when the vehicle is moving.

Seating and safety restraints

Adjusting the power seats (if equipped)

Press to move front or rear of seat up and down.

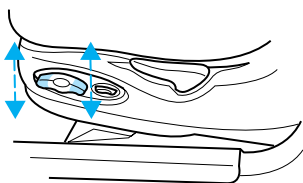

Press in the direction to raise or lower the seat, or to move the seat forward or backward.

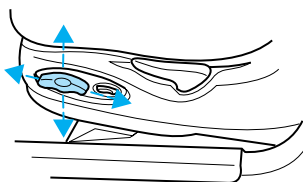

Push to increase or decrease lumbar support.

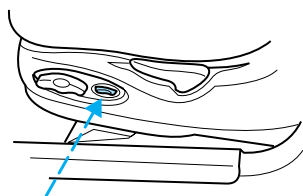

Pull lever up to adjust seatback.

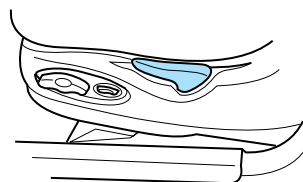

Never adjust the driver's seat or seatback when the vehicle is moving.

Seating and safety restraints

2nd seat/Split-folding rear seat

One or both rear seatbacks can be folded down to provide additional cargo space.

To lower the seatback(s) from inside the vehicle, lift seatback release handle, pull tab, then fold seatback down.

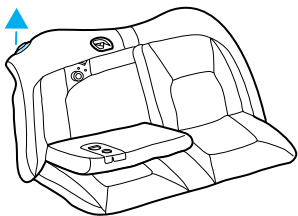

In the sedan, the seatbacks can also be folded down from inside the trunk. Move the release lever on the back of the rear seatback to the OPEN position and fold the seatback down.

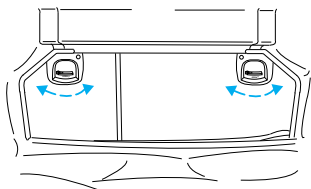

When raising the seatback(s), make sure you hear the seat latch into place.

3rd seat (wagon only)

The third seat faces the rear of the vehicle. For height and weight limits, see the label on the seat cushion. When the seat is down, the back of your wagon has a flat surface for carrying cargo.

Seating and safety restraints

To open up the seat:

1. Unlock the floor panel with the key, then use the handle to fold the floor panel toward the front of the car.

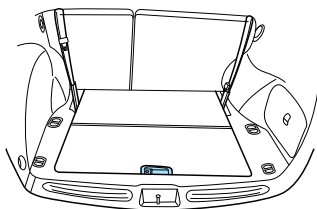

2. Remove the cargo cover. The cargo cover must be removed or the seatback will not latch in the upright position.

3. Lift the remote latch release on the left side of the compartment and fold the remaining floor panel until it latches. Make sure the seatback is locked in the upright position.

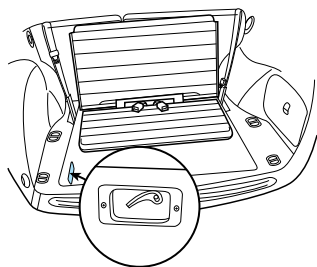

To close the seat, make sure the safety belts are in their correct notches, then lift the remote latch release and push the seat down until it latches. Pull up on the handle and push the floor panel into place.

Seating and safety restraints

SAFETY RESTRAINTS

Safety restraints precautions



Always drive and ride with your seatback upright and the lap belt snug and low across the hips.



To prevent the risk of injury, make sure children sit where they can be properly restrained.



It is extremely dangerous to ride in a cargo area, inside or outside of a vehicle. In a collision, people riding in these areas are more likely to be seriously injured or killed. Do not allow people to ride in any area of your vehicle that is not equipped with seats and safety belts. Be sure everyone in your vehicle is in a seat and using a safety belt properly.

Combination lap and shoulder belts

1. To fasten, insert the tongue into the slot in the buckle.

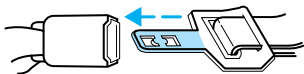

2. To unfasten, push the red release button and remove the tongue from the buckle.

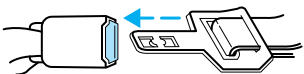

The outboard safety restraints in the vehicle are combination lap and shoulder belts. The front and rear seat passenger outboard safety belts have two types of locking modes described below:

Seating and safety restraints

To test the vehicle sensitive (emergency) locking mode, pull the shoulder belt quickly to lock.



The vehicle sensitive mode is the normal retractor mode, adjusting shoulder belt tightness in response to vehicle movement. For example, if the driver brakes suddenly or turns a corner sharply or the vehicle receives an impact of 8 km/h (5 mph) or more, the combination safety belts would lock to help reduce forward movement of the driver and passengers.

Automatic locking mode

In this mode, the shoulder belt is locked in a certain position by the occupant and **does not** adjust tightness during vehicle movement.

The automatic locking mode is not available on the driver belt.

When to use the automatic locking mode

- When a tight lap/shoulder fit is desired.
- **Any time** a child safety seat is installed in the vehicle. Refer to *Children and infant or Child safety seats* later in this chapter.

Seating and safety restraints

How to use the automatic locking mode

- Buckle the combination lap and shoulder belt.



- Grasp the shoulder portion and pull downward until the entire belt is extracted.

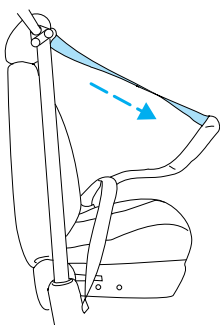

- Allow the belt to retract. As the belt retracts, you will hear a clicking sound. This indicates the safety belt is now in the automatic locking mode.

How to cancel the automatic locking mode

Disconnect the combination lap/shoulder belt and allow it to retract completely to cancel the automatic locking mode and activate the vehicle sensitive (emergency) locking mode.

Safety belts for front outboard passenger and rear outboard seating positions (except wagon rear-facing position)

Your vehicle is equipped with a dual locking mode retractor on the **shoulder** belt portion of the combination lap/shoulder safety belt at these positions.

Seating and safety restraints

Front safety belt height adjustment

Your vehicle has safety belt height adjustments for the driver and front passenger. Adjust the height of the shoulder belt so the belt rests across the middle of your shoulder.

To lower the shoulder belt height, push the button and slide the height control down.

To raise the height of the shoulder belt, slide the height adjuster up. Pull down on the height adjustment assembly to make sure it is locked in place.

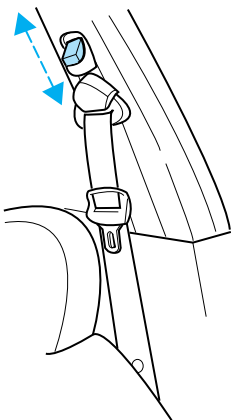

Center rear lap belt (sedan)

The safety belt in the center rear seating position has a detachable shoulder belt.

Seating and safety restraints

To attach the shoulder belt to the lap belt, pull the shoulder belt out from the retractor in the seatback and insert into the lap belt connecting pin into the wide end of the key slot on the shoulder belt. Pull the connecting pin into the narrow end of the key slot until you hear a snap and feel it latch. Make sure the shoulder belt is securely fastened to the lap belt by pulling up on the shoulder belt.

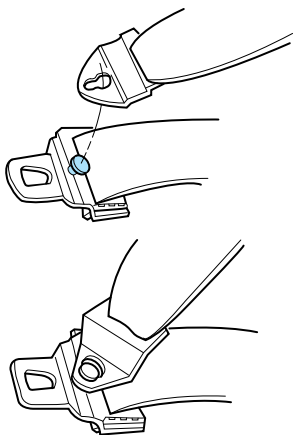

Lap belts

The lap belts in the center front seating position (if equipped) and center rear seating position (wagon) do not adjust automatically. You must adjust them to fit snugly and low as possible around your hips. Do not wear the lap belt around your waist.

Make sure you insert the tongue into the correct buckle. If you need to lengthen the belt, turn the tongue at a right angle to the belt and pull across your lap until it reaches the buckle. If you need to tighten the belt, pull the loose end of the belt through the tongue until it is snugly across the hips. Shorten and fasten the belt when not in use.

Safety belts for rear-facing occupants (wagon only)



Never use child safety seats in the third seat of a wagon.

Seating and safety restraints

Your vehicle is equipped with safety belts containing an adjust tongue at the rear-facing seating positions.

When the adjust tongue of the lap/shoulder combination seat belt is latched into the buckle, the tongue will allow the lap portion to become shorter, but locks the webbing in place to restrict it from becoming longer.

Before you reach and latch a combination lap and shoulder belt having an adjust tongue into the buckle, you may have to lengthen the lap belt portion of it. To lengthen the lap belt, pull some webbing out of the shoulder belt retractor. While holding the webbing below the tongue, grasp the tongue so that it is parallel to the webbing and slide the tongue upward, provide enough length so that the tongue can reach the buckle.

To fasten the belt, pull the combination lap and shoulder belt from the retractor so that the shoulder belt portion of the safety belt crosses your shoulder and chest. Be sure the belt is not twisted. If the belt is twisted, remove the twist. Insert the tongue into the proper buckle for your seating position until you hear a snap and feel it latch. Make sure the tongue is securely fastened to the buckle by pulling on the tongue.



The lap belts should fit snugly and as low as possible around the hips, not around the waist.



Front and rear seat occupants, including pregnant women, should wear safety belts for optimum protection in an accident.

Seating and safety restraints



Each seating position in your vehicle has a specific safety belt assembly which is made up of one buckle and one tongue that are designed to be used as a pair. 1) Use the shoulder belt on the outside shoulder only. Never wear the shoulder belt under the arm. 2) Never swing it around your neck over the inside shoulder. 3) Never use a single belt for more than one person.

Due to folding rear seats, sometimes the buckles and tongues toward the center of the vehicle may be hidden by the rear edge of the seat cushion. Pull them out so they will be accessible.

While you are fastened in the seat belt, the shoulder belt adjusts to your movement. However, if you brake hard, turn hard or your vehicle receives an impact of 8 km/h (5 mph) or more, the safety belt will become locked and help reduce your forward movement.

To unfasten the belt, push the red release button on the end of the buckle. This allows the tongue to unlatch from the buckle. While the belt retracts, guide the tongue to its original position to prevent it from striking you or the vehicle.

Safety belt extension assembly

If the safety belt assembly is too short, even when fully extended, eight inches can be added to the safety belt assembly by adding a safety belt extension assembly (part number 611C22). Safety belt extension assemblies can be obtained from your dealer at no cost. This assembly is not for use in the wagon's rear-facing seat.

Use only extensions manufactured by the same supplier as the safety belt. Manufacturer identification is located at the end of the webbing on the label. Also, use the safety belt extension only if the safety belt is too short for you when fully

Seating and safety restraints

extended. Do not use extensions to change the fit of the shoulder belt across the torso.

Safety belt warning light and indicator chime

The seat belt warning light illuminates in the instrument cluster and a chime sounds to remind the occupants to fasten their safety belts.

Conditions of operation

If...	Then...
The driver's safety belt is not buckled before the ignition key is turned to ON...	The safety belt indicator illuminates for one to two minutes and the warning chime sounds for four to eight seconds.
The driver's side safety belt is buckled while the indicator light is illuminated and the warning chime is sounding...	The safety belt indicator light and warning chime turn off.
The driver's safety belt is buckled before the ignition key is turned to ON...	The safety belt warning light and indicator chime remain off.

Safety belt maintenance

Check the safety belt systems periodically to make sure they work properly and are not damaged. Check the safety belts to make sure there are no nicks, wears or cuts. All safety belt assemblies, including retractors, buckles, front seat belt buckle assemblies (slide bar) (if equipped), shoulder belt height adjusters (if equipped), child safety seat tether bracket assemblies (if equipped), and attaching hardware, should be inspected after a collision. Ford recommends that all safety belt assemblies used in vehicles involved in a collision be

Seating and safety restraints

replaced. However, if the collision was minor and a qualified technician finds that the belts do not show damage and continue to operate properly, they do not need to be replaced. Safety belt assemblies not in use during a collision should also be inspected and replaced if either damage or improper operation is noted.

Refer to *Cleaning and maintaining the safety belts* in the *Maintenance and Care* section.

IMPORTANT SUPPLEMENTAL RESTRAINT SYSTEM (SRS) PRECAUTIONS

The supplemental restraint system is designed to:

- work with the safety belt to protect the driver and right front passenger
- reduce certain upper body injuries

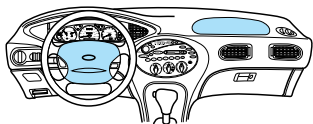

Failure to follow these instructions will affect the performance of the safety belts and increase the risk of personal injury.



The right front passenger air bag is not designed to restrain occupants in the front seating position.



Do not place objects or mount equipment on or near the air bag covers that may come into contact with an inflating air bag.

Seating and safety restraints



Do not attempt to service, repair, or modify the Air Bag Supplemental Restraint System or its fuses. See your Ford or Lincoln-Mercury dealer.

CHILDREN AND AIR BAGS

For additional important safety information, read all information on safety restraints in this guide.

Children should always wear their safety belts. Failure to follow these instructions may increase the risk of injury in a collision.



Rear-facing child seats or infant carriers should never be placed in the front seats.

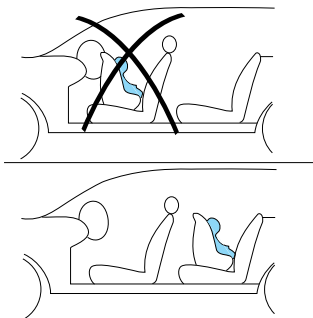

HOW DOES THE AIR BAG SUPPLEMENTAL RESTRAINT SYSTEM WORK?

The SRS is designed to activate when the vehicle sustains sufficient longitudinal deceleration, similar to hitting a fixed barrier head on at 12–24 km/h (8–14 mph).

The fact that the air bags did not inflate in a collision does not mean that something is

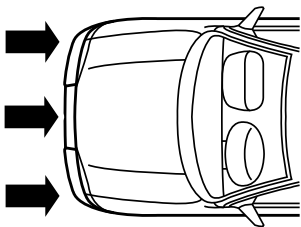

Seating and safety restraints

wrong with the system. Rather, it means the forces were not of the type sufficient to cause activation.

The air bags inflate and deflate rapidly upon activation.

After air bag deployment, it is normal to notice a smoke-like, powdery residue or smell the burnt propellant. This may consist of

cornstarch, talcum powder (to lubricate the bag) or sodium compounds (e.g., baking soda) that result from the combustion process that inflates the air bag. Small amounts of sodium hydroxide may be present which may irritate the skin and eyes, but none of the residue is toxic.



Several air bag system components get hot after inflation. Do not touch them after inflation.



If the air bag is inflated, **the air bag will not function again and must be replaced immediately**. If the air bag is not replaced, the unrepaired area will increase the risk of injury in a collision.

The SRS consists of:

- driver and passenger air bag modules (which include the inflators and air bags),
- one or more impact and safing sensors,
- a readiness light and tone

Seating and safety restraints

- and the electrical wiring which connects the components.

The diagnostic module monitors its own internal circuits and the supplemental air bag electrical system readiness (including the impact sensors), the system wiring, the air bag system readiness light, the air bag back up power and the air bag ignitors.

DETERMINING IF THE SYSTEM IS OPERATIONAL

The SRS uses a readiness light in the instrument cluster or a tone to indicate the condition of the system. Refer to the *Air bag readiness* section in the *Instrumentation* chapter. Routine maintenance of the air bag is not required.

A difficulty with the system is indicated by one or more of the following:

- The readiness light will either flash or stay lit.
- The readiness light will not illuminate immediately after ignition is turned on.
- A group of five beeps will be heard. The tone pattern will repeat periodically until the problem and light are repaired.



If any of these things happen, even intermittently, have the SRS serviced at your dealership or by a qualified technician immediately. Unless serviced, the system may not function properly in the event of a collision.

DISPOSAL OF AIR BAGS AND AIR BAG EQUIPPED VEHICLES

For disposal of air bags or air bag equipped vehicles, see your local dealership or qualified technician. Air bags **MUST BE** disposed of by qualified personnel.

Seating and safety restraints

IMPORTANT CHILD RESTRAINT PRECAUTIONS

You are required by law to use safety restraints for children in the U.S. and Canada. If small children ride in your vehicle (generally children who are four years old or younger and who weigh 18 kg [40 lbs] or less), you must put them in safety seats made especially for children. Check your local and state or provincial laws for specific requirements regarding the safety of children in your vehicle.



Never let a passenger hold a child on his or her lap while the vehicle is moving. The passenger cannot protect the child from injury in a collision.

Always follow the instructions and warnings that come with any infant or child restraint you might use.

When possible, place children in the rear seat of your vehicle. Accident statistics suggest that children are safer when properly restrained in the rear seating positions than in the front seating position.

CHILDREN AND SAFETY BELTS

Children who are too large for child safety seats (as specified by your child safety seat manufacturer) should always wear safety belts.

Follow all the important safety restraint and air bag precautions that apply to adult passengers in your vehicle.

If the shoulder belt portion of a combination lap and shoulder belt can be positioned so it does not cross or rest in front of the child's face or neck, the child should wear the lap and shoulder belt. Moving the child closer to the center of the vehicle may help provide a good shoulder belt fit.

If the shoulder belt cannot be properly positioned:

Seating and safety restraints

- move the child to one of the seats with a lap belt only (if equipped)

OR

- if the child is the proper size, restrain the child in a safety seat.



Do not leave children, unreliable adults, or pets unattended in your vehicle.

To improve the fit of lap and shoulder belts on children who have outgrown child safety seats, Ford recommends use of a belt-positioning booster seat that is labelled as conforming to all Federal motor vehicle safety standards. Belt-positioning booster seats raise the child and provide a shorter, firmer seating cushion that encourages safer seating posture and better fit of lap and shoulder belts on the child. A belt-positioning booster should be used if the shoulder belt rests in front of the child's face or neck, or if the lap belt does not fit snugly on both thighs, or if the thighs are too short to let the child sit all the way back on the seat cushion when the lower legs hang over the edge of the seat cushion. You may wish to discuss the special needs of your child with your pediatrician.

SAFETY SEATS FOR CHILDREN

Child and infant or child safety seats

Use a safety seat that is recommended for the size and weight of the child. Carefully follow all of the manufacturer's instructions with the safety seat you put in your vehicle. If you do not install and use the safety seat properly, the child may be injured in a sudden stop or collision.

When installing a child safety seat:

Seating and safety restraints

- Use the correct safety belt buckle for that seating position.
- Make sure the tongue is securely fastened in the buckle.
- Keep the buckle release button pointing up and away from the safety seat, with the tongue between the child seat and the release button, to prevent accidental unbuckling.
- Place seatback in upright position.
- Put the safety belt in the automatic locking mode. Refer to *Using the automatic locking mode*.

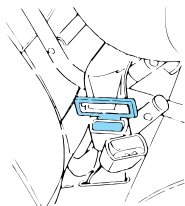

Ford recommends the use of a child safety seat having a top tether strap. Install the child safety seat in a seating position which is capable of providing a tether anchorage. For more information on top tether straps, refer to *Attaching safety seats with tether straps*.



Carefully follow all of the manufacturer's instructions included with the safety seat you put in your vehicle. If you do not install and use the safety seat properly, the child may be injured in a sudden stop or collision.

Seating and safety restraints

Installing child safety seats in combination lap and shoulder belt seating positions

1. Position the child safety seat in a seat with a combination lap and shoulder belt.

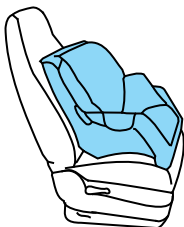

If you choose to install a child safety seat in the front passenger seat, move the seat as far back as possible.



Rear-facing child seats or infant carriers should never be placed in the front seats.

2. Pull down on the shoulder belt and then grasp the shoulder belt and lap belt together.

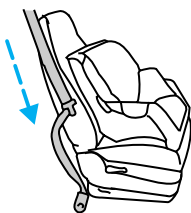

3. While holding the shoulder and lap belt portions together, route the tongue through the child seat according to the child seat manufacturers' instructions. Be sure the belt webbing is not twisted.

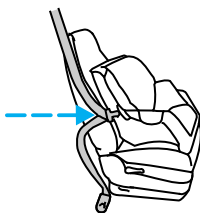

Seating and safety restraints

4. Insert the belt tongue into the proper buckle for that seating position until you hear and feel the latch engage. Make sure the tongue is latched securely by pulling on it.

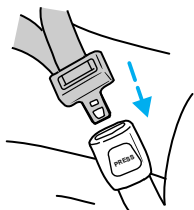

5. To put the retractor in the automatic locking mode, grasp the shoulder portion of the belt and pull downward until all of the belt is extracted and a click is heard.

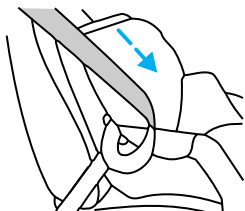

6. Allow the belt to retract. The belt will click as it retracts to indicate it is in the automatic locking mode.

7. Pull the lap belt portion across the child seat toward the buckle and pull up on the shoulder belt while pushing down with knee on the child seat.

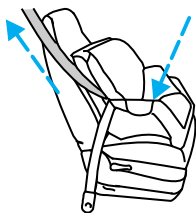

8. Allow the safety belt to retract to remove any slack in the belt.

9. Before placing the child in the seat, forcibly tilt the seat forward and back to make sure the seat is securely held in place.

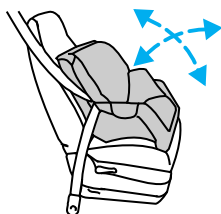

10. Try to pull the belt out of the retractor to make sure the retractor is in the automatic locking mode

Seating and safety restraints

(you should not be able to pull more belt out). If the retractor is not locked, unbuckle the belt and repeat steps two through nine.

Check to make sure the child seat is properly secured before each use.

Attaching safety seats with tether straps

Some manufacturers make safety seats that include a tether strap that goes over the back of the vehicle seat and attaches to an anchoring point. Other manufacturers offer the tether strap as an accessory. Contact the manufacturer of your child safety seat for information about ordering a tether strap.

Front seats

To install a tether from a child safety seat in the front seat:

1. Buckle the lap/shoulder belt (in the seat behind the front passenger seat in which the child safety seat will be installed).
2. Pull all the stored belt out of the rear seat retractor to switch the retractor to automatic locking mode.
3. Let the retractor wind up the slack from the lap/shoulder belt.
4. Install the child safety seat in the front seat. Refer to *Installing child safety seats in combination lap and shoulder belt seating positions*. Hook the tether strap hook around the webbing near the center of the shoulder portion of the locked lap/shoulder belt.
5. Tighten the tether strap.

Rear seats

If you must use a tethered safety seat on one of the rear seats, you can anchor the strap to the appropriate tether anchor directly behind that seat position.

Seating and safety restraints

Tether anchorage hardware

Attachment holes (at each rear outboard seating position) have been provided in your vehicle to attach anchor hardware, if required. Tether anchorage hardware kits (part number 613D74) including instructions, may be obtained at no charge from any Ford or Lincoln-Mercury dealer. All vehicles built for sale in Canada include a tether anchor hardware kit.

Be sure to follow the child safety seat manufacturer's instructions.



Tighten the anchor according to specifications. Otherwise, the safety seat may not be properly secured and the child may be injured in a sudden stop or collision.

If you have a station wagon, tether anchors are already installed for each of the second row seating positions.

1. Behind the second seat, find the plastic snap-on covers for the floor anchors.

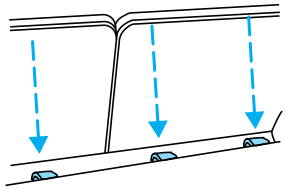

2. Use a screwdriver or coin to snap the covers off the anchor in a rearward and upward direction. Remove the covers completely.

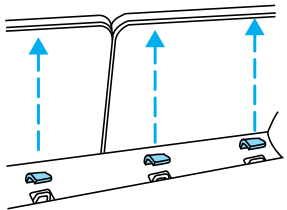

3. Snap the tether strap hook onto the U-shaped tether anchor.

Seating and safety restraints

BUILT-IN CHILD SEATS

Built-in child safety seat (wagon - if equipped)

The second row bench seat may include a built-in child seat. This child seat conforms to all Federal and local motor vehicle safety standards. Read the labels located on the child seat cushion and shoulder belt for information on the built-in child seat.

Use the built-in child seat **only** if the child is at least one year old, weighs 10–27 kg (22–60 lbs.) and the child's shoulders fit below the shoulder harness slots on the built-in child seat.

Children not meeting these requirements should be secured in an approved aftermarket seat. Refer to *Children and infant or child safety seats* in this chapter.

Built-in child seat retractors

The belts on built-in child seats are equipped with a retractor that locks when both tongues are latched into the crotch safety belt buckle. The retractor will automatically snug the belts around the child. If the belts do not remain snug, take the vehicle to the dealer for child seat repair. The belts will not snug during a collision.

Placing your child in the built-in child seat



Failure to follow all of the instructions on the use of this child restraint system can result in your child striking the vehicle's interior during a sudden stop or crash.



Never use the Built-In Child Seat as a booster cushion with the adult safety belts. A child using the adult belts could slide forward and out from under the safety belts.

Seating and safety restraints



The rear seatback must be fully locked before operating the child restraint system.

1. Grasp the child seat at the top of the seatback and pull the top forward to release the latch.

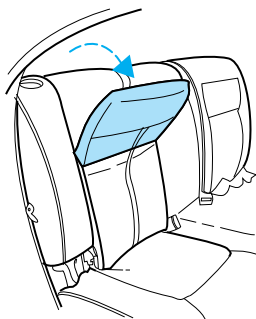

2. Continue to unfold the child seat until it rests on the seat.

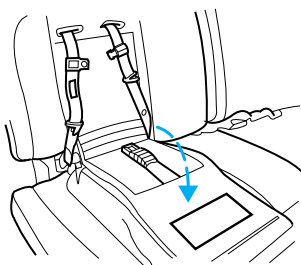

3. Read all information and warnings on the child seat cushion and shoulder safety belt. Make sure the child is not too large for the child seat.

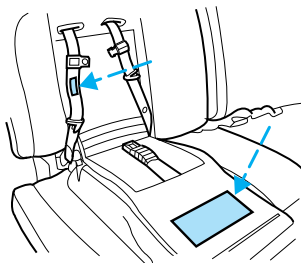

Seating and safety restraints

4. If connected, squeeze the top and the bottom of the right half of the chest clip and pull to separate both halves.
5. Place the child on the child seat and position the shoulder belts over each shoulder.
6. Insert either the left or the right safety belt tongue into the single opening of the crotch safety belt buckle (it doesn't matter which tongue is inserted first). Insert other tongue. The color green must appear in the indicator window on the crotch safety belt buckle when buckled. Allow belts to retract and fit snugly.

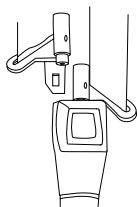

7. Fasten both halves of the chest clip below the child's shoulders and adjust it to comfortably hold the shoulder belts in place on the child's chest. The color green must appear in the indicator window when fastened.

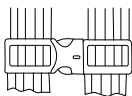

8. Pull the shoulder belts toward you to make sure the crotch safety belt buckle is properly fastened and the retractor is locked.
9. If the belts become too tight, unbuckle the crotch safety belt buckle to unlock the retractors, then reinsert both belt tongues.

Removing your child from the built-in child seat

1. Squeeze the tabs on the top and the bottom of the chest clip and pull the halves apart to open the chest clip.
2. Press the release button on the crotch safety belt buckle.
3. Slide the shoulder belts off the child's shoulders and remove the child.

Seating and safety restraints

To stow the built-in child seat

Return the child seat cushion to the upright position, then press firmly in the center and top of the child seat.

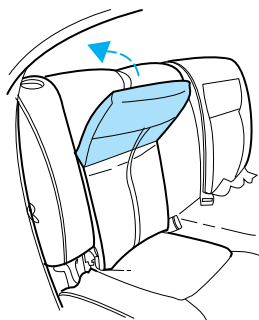

Inspecting the built-in child seat after a collision

All built-in child restraints, including seats, buckles, retractors, seat latches, interlocks and attaching hardware should be inspected by a qualified technician after any collision. If the child seat was in use during a collision, Ford recommends replacing it. Built-in child restraints not in use during a collision should be inspected and replaced if either damage or improper operation is noted.

Starting

PREPARING TO START THE VEHICLE

Engine starting is controlled by the spark ignition system. This system meets all Canadian Interference-Causing Equipment standard requirements regulating the impulse electrical field strength of radio noise.

When starting a fuel-injected engine, avoid pressing the accelerator before or during starting. Only use the accelerator when you have difficulty starting the engine. For more information on starting the vehicle, refer to *Starting the vehicle* in this chapter.

Before starting the vehicle:

1. Make sure all vehicle occupants have buckled their safety belts. For more information on safety belts and their proper usage, refer to the *Seating and safety restraints* chapter.
2. Make sure the headlamps and vehicle accessories are off.

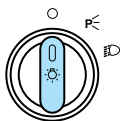

- Make sure the parking brake is set.
- Make sure the gearshift is in P (Park).

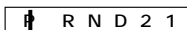
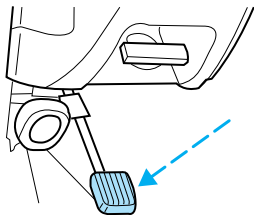

3. Turn the key to the ON position (without turning the key to START.)

Starting

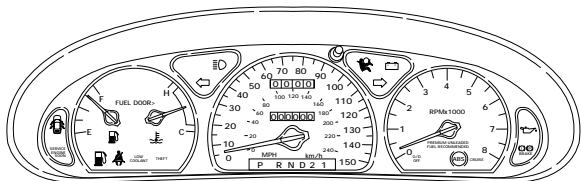
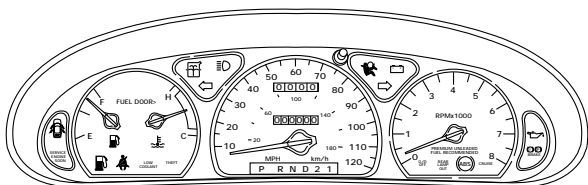
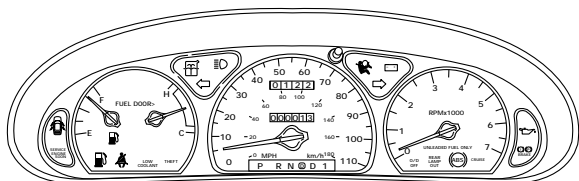

Make sure the corresponding lights illuminate briefly. If a light fails to illuminate, have the vehicle serviced.

- If the driver's safety belt is fastened, the  light does not illuminate.

Important safety precautions

A computer system controls the engine's idle revolutions per minute (RPM). When the engine starts, the idle RPM runs faster to warm the engine.

Starting

If the engine idle speed does not slow down automatically, have the vehicle checked. Do not allow the vehicle to idle for more than ten minutes.



Extended idling at high engine speeds can produce very high temperatures in the engine and exhaust system, creating the risk of fire or other damage.



Do not park, idle, or drive your vehicle in dry grass or other dry ground cover. The emission system heats up the engine compartment and exhaust system, which can start a fire.



Do not start your vehicle in a closed garage or in other enclosed areas. Exhaust fumes can be toxic. Always open the garage door before you start the engine. See *Guarding against exhaust fumes* in this chapter for more instructions.



If you smell exhaust fumes inside your vehicle, have your dealer inspect your vehicle immediately. Do not drive if you smell exhaust fumes.

STARTING THE ENGINE

1. Turn the key to 5 (Start) without pressing the accelerator. The key will return to 4 (On).

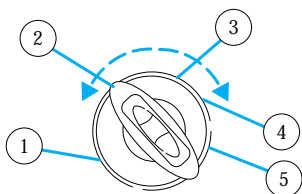

2. If the engine does not start within five seconds, wait ten seconds and try again.

3. If the engine does not start in two attempts OR the temperature is below -12°C (10°F), depress accelerator and start the engine while holding the accelerator down. Release accelerator when engine starts.

4. After idling for a few seconds, apply the brake and release the parking brake.

Using the engine block heater (if equipped)

An engine block heater warms the engine coolant, which improves starting, warms up the engine faster and allows the heater-defroster system to respond quickly. They are strongly recommended if you live in a region where temperatures reach -23°C (-10°F) or below.

For best results, plug the heater in at least three hours before starting the vehicle. Using the heater for longer than three hours will not harm the engine, so the heater can be plugged in the night before starting the vehicle.



To prevent electrical shock, do not use your heater with ungrounded electrical systems or two-pronged (cheater) adapters.

Starting

Guarding against exhaust fumes

Although odorless and colorless, carbon monoxide is present in exhaust fumes. Take precautions to avoid its dangerous effects.



If you ever smell exhaust fumes of any kind inside your vehicle, have your dealer inspect and fix your vehicle immediately. Do not drive if you smell exhaust fumes. These fumes are harmful and could kill you.

Have the exhaust and body ventilation systems checked whenever:

- the vehicle is raised for service
- the sound of the exhaust system changes
- the vehicle has been damaged in a collision

Important ventilating information

If the engine is idling while the vehicle is stopped in an open area for long periods of time, open the windows at least 2.5 cm (one inch).

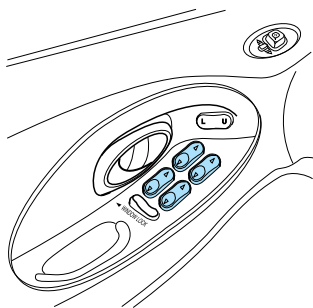

Adjust the heating or air conditioning (if equipped) to bring in fresh air.

Starting

Improve vehicle ventilation by keeping all air inlet vents clear of snow, leaves and other debris.

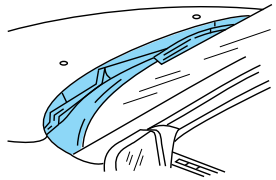

Driving

BRAKES

Your brakes are self-adjusting. Refer to the “Service Guide” for maintenance scheduling.

Anti-lock brake system (ABS) (if equipped)

The ABS operates by detecting the onset of wheel lock up during brake applications and compensating for this tendency. The front wheels are prevented from locking even when the brakes are firmly applied. The accompanying illustration depicts the advantage of an ABS equipped vehicle (on bottom) to a non-ABS equipped vehicle (on top) during hard braking.

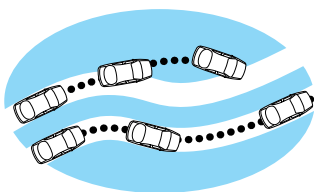

ABS warning lamp

The ABS warning lamp in the instrument cluster illuminates if an ABS fault is detected.



Have your vehicle serviced as soon as possible.

Normal braking operation is still effective unless the BRAKE warning lamp is also illuminated.



Using ABS

- In an emergency, apply full force on the brake. The ABS will be activated immediately, thus allowing you to retain full steering control of your vehicle and, providing there is sufficient space, will enable you to avoid obstacles and bring the vehicle to a quiet stop.

- We recommend that you familiarize yourself with this braking technique. However, avoid taking any unnecessary risks.

Parking brake

The parking brake should be used whenever the vehicle is parked. Push pedal downward to set the parking brake.

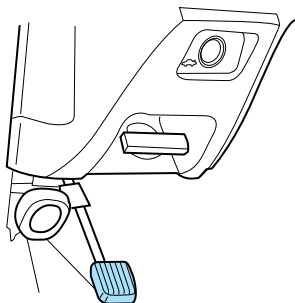

The BRAKE warning lamp in the instrument cluster illuminates and remains illuminated (when the ignition is turned ON) until the parking brake is released.



Always set the parking brake fully and make sure the gearshift is latched in P (Park). Turn off the ignition whenever you leave your vehicle.

The parking brake is not designed to stop a moving vehicle. However, if the normal brakes fail, the parking brake can be used to stop your vehicle in an emergency. Since the parking brake applies only the rear brakes, the vehicle's stopping distance will increase greatly and the handling of your vehicle will be adversely affected.

Driving

Pull release handle toward you to release parking brake. Driving with the parking brake on will cause the brakes to wear out quickly and reduce fuel economy.

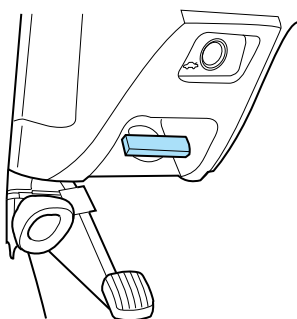

SEMI-ACTIVE RIDE CONTROL (TAURUS SHO ONLY)

Firm shock absorber performance enhances ride and handling during certain road conditions. The shock absorber is returned to a softer performance when driver or road induced motion ceases. This system is automatic and requires no driver input.

TRANSAXLE

Brake-shift interlock

This vehicle is equipped with a brake-shift interlock feature that prevents the gearshift from being moved from P (Park) unless the brake pedal is pressed.

If you cannot move the gearshift out of P (Park) with the brake pedal depressed:

1. Apply the parking brake, turn ignition key to LOCK, then remove the key.
2. Insert the key and turn it to OFF. Apply the brake pedal and shift to N (Neutral).
3. Start the vehicle.

If it is necessary to use the above procedure to move the gearshift, it is possible that a fuse has blown and the vehicle's brake lamps may not be operating properly. Refer to *Fuses and relays* in the *Roadside emergencies* chapter.

Driving



Do not drive your vehicle until you verify that the brakelamps are working.

If your vehicle gets stuck in mud or snow it may be rocked out by shifting from forward and reverse gears in a steady pattern. Press lightly on the accelerator in each gear. Do not rock the vehicle for more than a few minutes, because it could damage the vehicle.



Always set the parking brake fully and make sure the gearshift is latched in P (Park). Turn off the ignition whenever you leave your vehicle.

Driving with an automatic overdrive transaxle (column gearshift without O/D off switch)

Your automatic overdrive transaxle provides fully automatic operation in either **D** (Overdrive) or D (Drive). Driving with the shift selector in **D** gives the best fuel economy for normal driving conditions. For manual control start in 1 (First) and then shift manually.

To put your vehicle in gear, start the engine, depress the brake pedal, then move gearshift out of P (Park).



Hold the brake pedal down while you move the gearshift lever from position to position. If you do not hold the brake pedal down, your vehicle may move unexpectedly and injure someone.

Driving

Driving with an automatic overdrive transaxle (column or console gearshift with O/D off switch)

Your automatic overdrive transaxle provides fully automatic operation in either D (Overdrive) or with the O/D OFF switch depressed. Driving with the shift selector in D (Overdrive) gives the best fuel economy for normal driving conditions. For manual control start in 1 (First) and then shift manually.

If your vehicle is equipped with a console mounted gearshift, you must press the thumb button on the side of the gearshift to move the gearshift from P (Park).

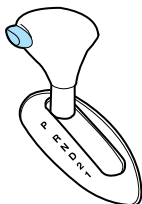
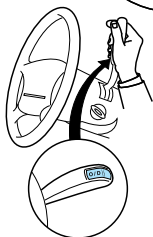
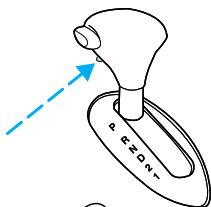

Understanding gearshift positions

P (Park)

Always come to a complete stop before shifting into P (Park). Make sure the gearshift is securely latched in P (Park). This locks the transaxle and prevent the front wheels from rotating.

P R N **D** D 1

P R N D 2 1

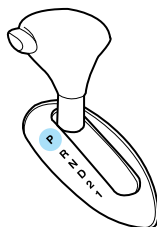

R (Reverse)

With the gearshift in R (Reverse), the vehicle will move backward. You should always come to a complete stop before shifting into and out of R (Reverse).

P R **N** **D** D 1

P **R** N D 2 1

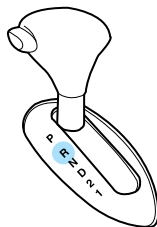

Driving

N (Neutral)

With the gearshift in the N (Neutral) position, the vehicle can be started and is free to roll. Hold the brake pedal down while in this position.

P R **N** D D 1

P R **N** D 2 1

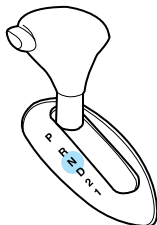

D (Overdrive — column shift without O/D OFF switch) or D (Overdrive — column or console mounted gearshift with O/D off switch)

The overdrive position is the normal driving position for an automatic overdrive transaxle. It works the same way as D (Drive) or D (Overdrive — with the O/D OFF switch **not** depressed) works, but shifts to a fourth gear — an overdrive gear — when your vehicle cruises at a constant speed for any length of time. This fourth gear will increase your fuel economy when you travel at cruising speeds.

P R N **D** D 1

P R N **D** 2 1

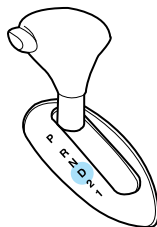

Overdrive may not be appropriate for certain terrains. If the transaxle shifts back and forth between third and fourth gears while you are driving hilly roads or if your vehicle requires additional power for climbing hills, shift into D (Drive) or press the O/D OFF switch (if equipped).

If the O/D OFF indicator light (if equipped) is flashing on and off when the vehicle is started or does not come on when the O/D OFF switch is pressed, it means there is a malfunction in your transaxle's electronic system. Contact your dealer as soon as possible or damage to the transaxle may occur.

When to use D (Drive) or press the O/D OFF switch (if equipped)

D (Drive) eliminates the needless shifting back and forth between third and fourth gears that your vehicle may do when driving on hilly terrain. It also gives more engine braking than overdrive to slow your vehicle on downgrades.

P R N **D** D 1

P R N **D** 2 1

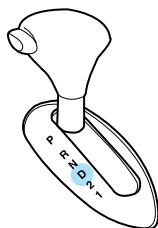

2 (Second - if equipped)

Use 2 (Second) for start-up on slippery roads or to give you more engine braking to slow your vehicle on downgrades.

P R N D **2** 1

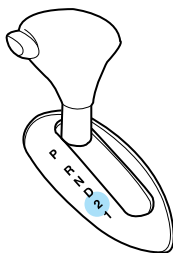

Driving

1 (First)

Use 1 (First) for when added engine braking is desired when descending steep hills.

The automatic transaxle will shift to the proper gear to ascend any grade without any need to shift to 1 (First).

P R N **D** D 1

P R N D 2 1

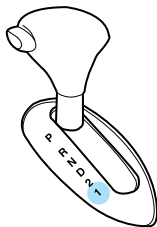

Do not go faster than 61 km/h (38 mph) when in this gear. You can upshift from 1 (First) to overdrive at any time.



When parking, do not use the gearshift in place of the parking brake. Always set the parking brake fully and make sure that the gearshift is securely latched in Park (P). Turn off the ignition whenever you leave your vehicle. Never leave your vehicle unattended while it is running. If you do not take these precautions, your vehicle may move unexpectedly and injure someone.

VEHICLE LOADING

Before loading a vehicle, familiarize yourself with the following terms:

- **Base Curb Weight:** Weight of the vehicle including any standard equipment, fluids, lubricants, etc. It does not include passengers or aftermarket equipment.
- **Payload:** Combined maximum allowable weight of cargo, passengers and optional equipment. The payload equals the gross vehicle weight rating minus base curb weight.

Driving

- **GVW (Gross Vehicle Weight):** Base curb weight plus payload and weight. The GVW is not a limit or a specification.
- **GVWR (Gross Vehicle Weight Rating):** Maximum total weight of the base vehicle, passengers, optional equipment and cargo. The GVWR is specific to each vehicle and is listed on the Safety Compliance Label on the driver's door pillar.
- **GAWR (Gross Axle Weight Rating):** Carrying capacity for each axle system. The GAWR is specific to each vehicle and is listed on the Safety Compliance Label on the driver's door pillar.
- **GCWR (Gross Combined Weight Rating):** Maximum combined weight of towing vehicle (including passengers and cargo) and the trailer. The GCWR indicates the maximum loaded weight that the vehicle is allowed to tow.
- **Maximum Trailer Weight Rating:** Maximum weight of a trailer the vehicle is permitted to tow. The maximum trailer weight rating equals the vehicle curb weight for each engine/transaxle combination, any required option weight for trailer towing and the weight of the driver from the GCWR for the towing vehicle.
- **Maximum Trailer Weight:** maximum weight of a trailer the loaded vehicle (including passengers and cargo) is permitted to tow. It is determined by subtracting the weight of the loaded trailer towing vehicle from the GCWR for the towing vehicle.
- **Trailer Weight Range:** Specified weight range that the trailer must fall within that ranges from zero to the maximum trailer weight rating

Remember to figure in the tongue load of your loaded trailer when figuring the total weight.

Driving



Do not exceed the GVWR or the GAWR specified on the Safety Compliance Certification Label.

Do not use replacement tires with lower weight capacities than the originals because they may lower the vehicle's GVWR and GAWR limitations.

Replacement tires with a higher weight limit than the originals do not increase the GVWR and GAWR limitations.

TRAILER TOWING

Your vehicle is classified as a light duty towing the vehicle. The amount of weight you can safely tow depends on the type of engine you have in your vehicle. Your vehicle does not come from the factory fully equipped to tow. No towing packages are available through Ford or Mercury/Lincoln dealers. Do not tow a trailer until your vehicle has been driven at least 800 km (500 miles). If towing with a station wagon, inflate the rear tires to 35 psi.

Towing a trailer places an additional load on your vehicle's engine, transaxle, brakes, tires and suspension. Inspect these components carefully after towing.

The amount of weight that you can tow depends on the type of engine in your vehicle. See the following charts:

3.0L 2-Valve Vulcan Engine			
Model	Passenger Load #/kg (lbs.)	Luggage Load kg (lbs.)	Max Trailer Wt. kg (lbs.)
Sedan	5/340 (750)	0	365 (800)
	4/270 (600)	70 (150)	365 (800)
	2/135 (300)	70 (150)	500 (1100)
	2/135 (300)	0	565 (1250)

Driving

3.0L 2-Valve Vulcan Engine			
Station Wagon	4/270 (600)	0	365 (800)
	2/135 (300)	70 (150)	430 (950)
	2/135 (300)	0	500 (1100)

The above chart is based on the specified vehicle at a maximum GCW (Vehicle weight + Trailer weight) equal to 2245 kg (4950 lbs.).

3.0L 4-Valve Duratec Engine and SHO Sedan			
Model	Passenger Load #/kg (lbs.)	Luggage Load kg (lbs.)	Max Trailer Wt. kg (lbs.)
Sedan	5/340 (750)	0	590 (1300)
	2/135 (300)	70 (150)	725 (1600)
	2/135 (300)	0	795 (1750)
Station Wagon	5/340 (750)	70 (150)	455 (1000)
	2/135 (300)	70 (150)	660 (1450)
	2/135 (300)	0	725 (1600)

The above chart is based on the specified vehicle at a maximum GCW (Vehicle weight + Trailer weight) equal to 2270 kg (5450 lbs.).



Do not exceed the GVWR or the GAWR specified on the Safety Compliance Certification Label.



Towing trailers beyond the maximum recommended gross trailer weight exceeds the limit of the vehicle and could result in engine damage, transaxle damage, structural damage, loss of control, and personal injury.

Driving

Preparing to tow

Use the proper equipment for towing a trailer, and make sure it is properly attached to your vehicle. See your dealer or a reliable trailer dealer if you require assistance.

Hitches

Your vehicle has a load carrying hitch. This type of hitch places the tongue load of a trailer on the rear wheels of your vehicle. You must distribute the load in your trailer so that 10–15% of the total weight of the trailer is on the tongue.

Safety chains

Always connect the trailer's safety chains to the vehicle. To connect the trailer's safety chains, cross the chains under the trailer tongue and allow slack for turning corners.

If you use a rental trailer, follow the instructions that the rental agency gives to you.

Trailer brakes

Electric brakes and manual, automatic or surge-type brakes are safe if installed properly and adjust them to the manufacturer's specifications. The trailer brakes must meet local and Federal regulations.



Do not connect a trailer's hydraulic brake system directly to your vehicle's brake system. Your vehicle may not have enough braking power and your chances of having a collision greatly increase.

Trailer lamps

Trailer lamps are required on most towed vehicles. Make sure your trailer lamps conform to local and Federal regulations. See your dealer or trailer rental agency for proper instructions and equipment for hooking up trailer lamps.

Driving while you tow

Do not drive faster than 72 km/h (45 mph) with any weight on the trailer while towing on a hot day or in hilly country.

Cruise control may shut off if you are towing on long, steep grades.

When towing a trailer:

- Use 2 (Second) (if equipped) or 1 (First) when towing up or down steep hills. This will eliminate excessive downshifting and upshifting for optimum fuel economy and transaxle cooling.
- Anticipate stops and brake gradually.

Servicing after towing

If you tow a trailer for long distances, your vehicle will require more frequent service intervals. Refer to the *Service Guide* for more information.

Trailer towing tips

- Practice turning, stopping and backing up in an area before starting on a trip to get the feel of the vehicle trailer combination. When turning, drive slightly beyond the normal turning point so the trailer wheels will clear curbs and other obstacles.
- Allow more room for stopping with a trailer attached.
- The trailer tongue weight should be 10–15% of the loaded trailer weight.
- After you have traveled 80 km (50 miles), thoroughly check your hitch, electrical connections and trailer wheel lug nuts.
- When stopped in traffic for long periods of time in hot weather, place the gearshift in P (Park) and increase idle speed. This aids engine cooling and air conditioner efficiency.
- Vehicles with trailers should not be parked on a grade. If you must park on a grade, place wheel chocks under the trailer's wheels.

Driving

FUEL CONSUMPTION

Fuel economy can be improved by avoiding:

- lack of regular, scheduled maintenance
- excessive speed
- rapid acceleration

Roadside emergencies

HAZARD LIGHTS CONTROL

Use only in an emergency to warn traffic of vehicle breakdown, approaching danger, etc. Depress to activate all indicators simultaneously.

Depress again to switch off. The warning lights can be operated when the ignition is off.

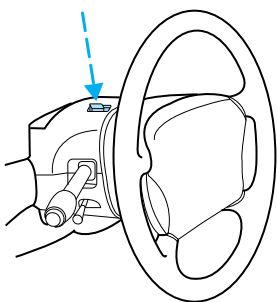

FUEL PUMP SHUT-OFF SWITCH

If the engine cranks but does not start after a collision, the fuel pump shut-off switch may have been activated. The shut-off switch is a device intended to stop the electric fuel pump when your vehicle has been involved in a substantial jolt.

1. Turn the ignition switch to the OFF position.
2. Check the fuel system for leaks.
3. If no fuel leak is apparent, reset the fuel pump shut-off switch by pushing in the button on the switch.
4. Turn the ignition switch to the ON position. Pause for a few seconds and return the key to the OFF position.
5. Make a further check for leaks in the fuel system.

Roadside emergencies

If you have a sedan, the fuel pump shut-off switch is located on the right side of the trunk behind the trunk liner.

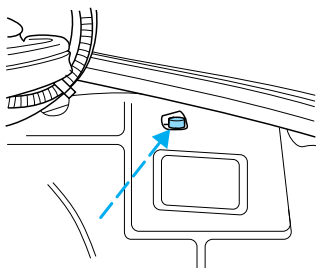

If you have a wagon, the switch is located behind the service panel on the right side of the cargo area.

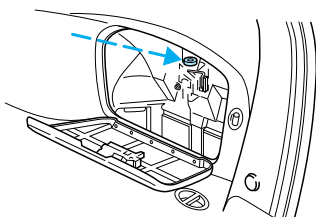

FUSES AND RELAYS

Fuses

If electrical components in the vehicle are not working, a fuse may have blown. Blown fuses are identified by a broken wire. Check the appropriate fuses before replacing any electrical components.

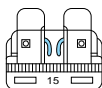

Always replace a fuse with one that has the specified amperage rating. Using a fuse with a higher amperage rating can cause severe wire damage and could start a fire.

Roadside emergencies

Standard fuse amperage rating and color

Fuse rating	Color
10 amp	Red
15 amp	Blue
20 amp	Yellow
30 amp	Light Green
30 amp fuse link	Pink
40 amp	Amber

Passenger compartment fuse panel

The fuse panel is located below and to the left of the steering wheel by the brake pedal. Pull the panel cover outward to access the fuses.

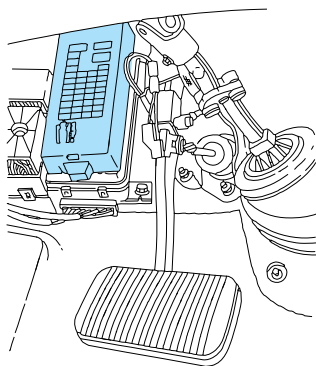

To remove a fuse, use the fuse puller tool provided on the fuse panel cover.

The fuses are coded as follows:

Fuse/Relay Location	Fuse Amp Rating	Description
1	-	Not used
2	5A	Instrument illumination

Roadside emergencies

Fuse/Relay Location	Fuse Amp Rating	Description
3	10A	Left low beam headlamp
4	10A	Right low beam headlamp
5	5A	Brake shift interlock , rear defroster
6	15A	MLPS switch, backup lamps, speed control, climate control
7	10A	MLPS switch, starter relay
8	5A	Power antenna, radio control unit, GEM
9	10A	Anti-lock brakes system, Central Temperature Monitor
10	20A	EEEC relay, ignition coil, passive anti-theft system, radio
11	5A	Air bag indicator, instrument cluster

Roadside emergencies

Fuse/Relay Location	Fuse Amp Rating	Description
12	5A	Instrument cluster, autolamps, transmission control switch, integrated control panel, GEM
13	5A	Air bag, blower motor, electronic automatic temperature control
14	5A	Lamp outage indication, Semi-active suspension (SHO only)
15	10A	Multi-function switch (turn signal)
16	-	Not used
17	30A	Wiper system (front)
18	5A	Headlamp switch
19	15A	Wiper system (rear)
20	5A	Integrated control panel, remote entry, cigar lighter

Roadside emergencies

Fuse/Relay Location	Fuse Amp Rating	Description
21	20A	Cigar lighter
22	5A	Power mirrors, power antenna, decklid lamps, autolamps
23	5A	Wiper system, variable assist steering, remote entry, anti-theft
24	5A	Integrated control panel, speedometer, electronic automatic temperature control module
25	15A	Data link connector
26	15A	Trunklid
27	10A	Battery saver relay
28	15A	Brake lamps, stop control
29	15A	Multi-function switch, hazard flashers
30	15A	High beams, daytime running lamps, instrument cluster
31	5A	Tail lamp feed

Roadside emergencies

Fuse/Relay Location	Fuse Amp Rating	Description
32	10A	Integrated control panel, heated mirrors
33	5A	Power windows, lock illumination
34		Battery saver relay
35		Driver door unlock relay
36		Rear defroster relay
37		Interior lamps relay
38		One touch window down relay
39		Accessory delay relay

Power distribution box

The power distribution box is located in the engine compartment near the battery. The power distribution box contains high-current fuses that protect your vehicle's main electrical systems from overloads.

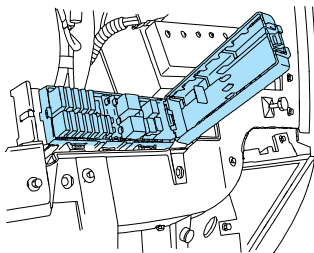

Roadside emergencies

The high-current fuses are coded as follows:

Fuse/Relay Location	Fuse Amp Rating	Circuits protected
1	40A*	Fuse panel
2	30A*	Constant control relay module
3	40A*	Ignition switch, starter relay
4	30A*	Accessory delay relay
5	40A*	Ignition switch
6	30A*	Power seats
7	40A*	Rear window defrost relay
8	30A*	Thermactor air bypass solenoid, EAM solid state relay
9	40A*	Constant control relay module
10	20A*	Constant control relay module
11	40A*	Blower motor relay
12	20A*	Semi-active ride control module
13	40A*	Anti-lock motor module
14	-	Not used

Roadside emergencies

Fuse/Relay Location	Fuse Amp Rating	Circuits protected
15	15A**	Daytime running lamps (DRL) module
16	10A**	Air bag diagnostic monitor
17	20A**	Rear control unit, CD changer
18	30A**	Anti-lock brake module
19	15A**	Horn relay, powertrain control module
20	15A**	Headlamp switch, autolamp park relay
21	-	Not used
22	30A**	Autolamps relay, multi-function switch, headlamp switch
23	-	N/A
24	-	N/A
25	-	N/A
26	30A**	Generator/ Voltage regulator
27	-	N/A

Roadside emergencies

Fuse/Relay Location	Fuse Amp Rating	Circuits protected
28	15A**	Heated oxygen sensors, canister vent
29	-	N/A
30	-	N/A
31	-	N/A
32	-	N/A
33	-	N/A

*Maxi fuses. **Mini fuses



Always disconnect the battery before servicing high current fuses.



Always replace the cover to the Power Distribution Box before reconnecting the battery or refilling fluid reservoirs.

Relays

Relays are located in the power distribution box and should be replaced by qualified technicians.

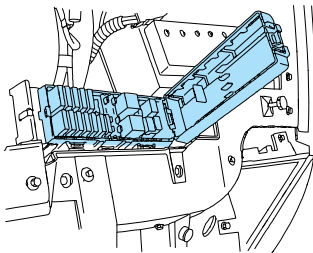

Roadside emergencies

CHANGING THE TIRES

Temporary spare tire information

The temporary spare tire for your vehicle is labeled as such. It is smaller than a regular tire and is designed for emergency use only.

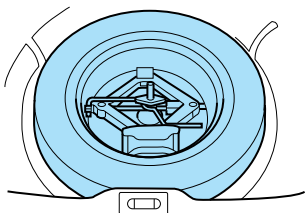

If you use the temporary spare tire continuously or do not follow these precautions, the tire could fail, causing you to lose control of the vehicle, possibly injuring yourself or others.

When driving with the temporary spare tire **DO NOT:**

- exceed 80 km/h (50 mph) under any circumstances
- load the vehicle beyond maximum vehicle load rating listed on the Safety Compliance Label
- tow a trailer
- use tire chains
- drive through an automatic car wash, because of the vehicle's ground clearance
- try to repair the temporary spare tire or remove it from its wheel
- use the wheel for any other type of vehicle

Roadside emergencies

Tire change procedure

1. Park on a level surface, activate hazard flashers and set parking brake.

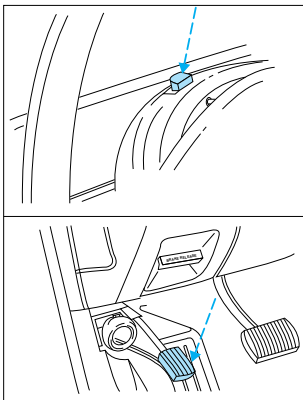

2. Place gearshift lever in P (Park), block the diagonally opposite wheel, then remove the spare tire, jack and lug wrench.

In the sedan, these are located in the trunk under the floor carpet.

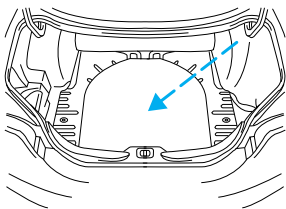

In the wagon, they are stored in the left side rear trim panel.

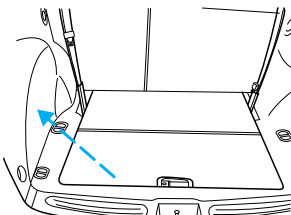

Roadside emergencies

3. Loosen each wheel lug nut one-half turn counterclockwise but do not remove them until the wheel is raised off the ground.

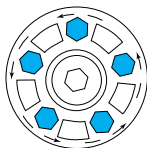

4. Put the jack in the jack notch next to the door of the tire you are changing. Turn the jack handle clockwise until the wheel is completely off the ground.

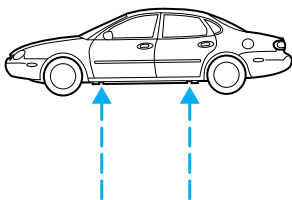

5. Remove the lug nuts with the lug wrench.

6. Replace the flat tire with the spare tire, making sure the valve stem is facing outward. Reinstall lug nuts until the wheel is snug against the hub. Do not fully tighten the lug nuts until the wheel has been lowered.

7. Lower the wheel by turning the jack handle counterclockwise.

8. Remove the jack and fully tighten the lug nuts in the order shown.

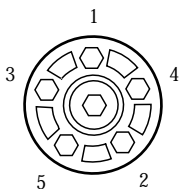

Roadside emergencies

9. Put flat tire, jack and lug wrench away. Make sure jack is fastened so it does not rattle when you drive. Unblock the wheels.

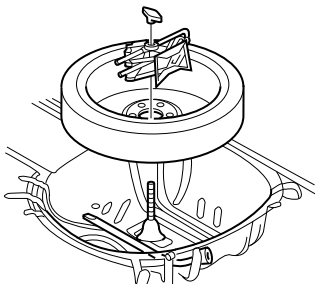

Removing and replacing wheel covers

Full wheel cover

Your vehicle may have wheel covers with a wire retention system. To remove the wheel cover, pry it loose by inserting the tapered end of the jack handle between the wheel cover and wheel.

To replace the wheel cover:

1. One of the windows on the wheel cover is identified with a valve stem logo on the back side of the wheel cover. Install the wheel over the wheel with the window at the valve stem.
2. Hold the wheel cover in this position and press the cover onto the wheel with the palm of your hand. Do not force or hammer the cover.

Center wheel cover

1. Pry the center ornament off the wheel cover with the lug wrench. Pry only at the notch. Do not use a screwdriver or any other tool as this may damage the wheel cover surface finish.

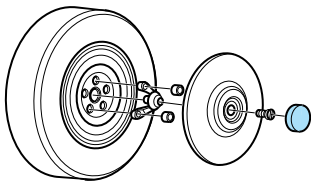

Roadside emergencies

2. Remove the center bolt on the wheel cover with the lug wrench tip.

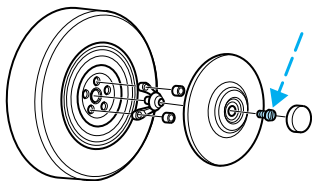

3. To remove the wheel cover, pry it loose by inserting the tapered end of the lug wrench between the wheel cover and wheel.

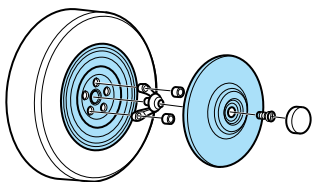

To replace the wheel cover:

1. One of the windows on the wheel cover is identified with a valve stem logo on the back side of the wheel cover. Install the wheel cover over the wheel with the window at the valve stem.

2. Hold the wheel cover in this position and press the cover onto the wheel with the palm of your hand. Do not force or hammer the cover.

3. Attach the bolt to the pedestal through the center hole on the cover with the lug wrench.

4. Align the legs of the center ornament with the slots of the wheel cover. Reinstall the ornament by pressing with the palm of your hand. Do not hammer or force the cover.

Anti-theft lug nuts (if equipped)

If your vehicle is equipped with this feature, one of the lug nuts on each wheel



must be removed and replaced with a special key. The key and registration card are attached to the lug wrench and stored with the spare tire. If you lose

Roadside emergencies

the key, send the registration card to the manufacturer (not the dealer) to get a replacement key. If the lug wrench/lug nut key assembly is lost, see your nearest Ford or Lincoln/Mercury dealer who has access to the master set of keys. **Do not use an impact wrench with the anti-theft key.**

JUMP STARTING YOUR VEHICLE



The gases around the battery can explode if exposed to flames, sparks, or lit cigarettes. An explosion could result in injury or vehicle damage.



Do not push-start your vehicle. You could damage the catalytic converter. For further information, see *Jumper Cables* in the Index.



Batteries contain sulfuric acid which burns skin, eyes, and clothing.

CONNECTING THE JUMPER CABLES

1. Position the vehicles so that they do not touch one another.
2. Switch off the engine. Switch off any unnecessary electrical equipment.

Roadside emergencies

3. Connect the positive (+) terminal of the discharged battery (1) to the positive (+) terminal of the booster battery (2).

4. Connect one end of the second lead to the negative (-) terminal of the booster battery (3) and the other end to a metal part of the

engine to be started (4), not to the negative (-) terminal of the discharged battery.

5. Make sure that the jump leads are clear of moving parts of the engine.

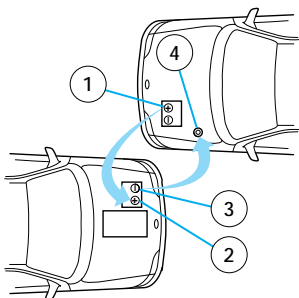

Do not connect the end of the second cable to the negative ([-]) terminal of the battery to be jumped. A spark may cause an explosion of the gases that surround the battery.

JUMP STARTING

1. Start the booster vehicle and run the engine at moderately increased speed.

2. Start the engine of the vehicle with the discharged battery.

3. Once the engine has been started, run both vehicles for a further three minutes before disconnecting the leads.

Roadside emergencies

REMOVING THE JUMPER CABLES

1. Remove the jumper cables in reverse order. Take the cable off the metallic surface (1) first, followed by the cable on the negative (-) booster battery terminal (2).

2. Remove the cable from the positive (+) terminal of the booster battery (3) and then the discharged battery (4).

3. After the disabled vehicle has been started, allow it to idle for a while so the engine can “relearn” its idle conditions.

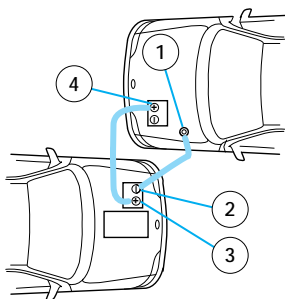

WRECKER TOWING

If you need to have your vehicle towed, contact a professional towing service or, if you are a member, your roadside assistance center. Your vehicle should be towed from the front unless conditions do not allow it. It is recommended that your vehicle be towed with a wheel lift or flatbed equipment.

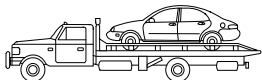

When calling for a tow truck, tell the operator what kind of vehicle you have. A towing manual is available from Ford Motor Company for all authorized tow truck operators. Have your tow truck driver refer to this manual for proper hook-up and towing procedures for your vehicle.

Roadside emergencies

TOWING YOUR VEHICLE BEHIND ANOTHER VEHICLE

At times, you may want to tow your vehicle behind another vehicle, such as a recreational vehicle, car or a truck.

Before you have your vehicle towed:

- Release the parking brake.
- Move the gearshift to N (Neutral).
- Turn the key in the ignition to OFF.
- Unlock the steering wheel.

Do not tow your vehicle at a speed faster than 56 km/h (35 mph) or for a distance greater than 80 km (50 miles), unless the drive wheels are placed on dollies.



Never use a tow bar that attaches to the bumper when you tow your vehicle. This could damage the bumper and cause an accident.

Maintenance and care

SERVICE RECOMMENDATIONS

To help you service your vehicle:

- We highlight do-it-yourself items in the engine compartment for easy location.
- As possible, we design parts that can be replaced without tools.
- We provide you with a “Service Guide” which makes tracking routine service for your vehicle easy.

If your vehicle requires professional service, your dealership can provide necessary parts and service. Check your “Warranty Information Booklet” to find out which parts and services are covered.

Use only recommended fuels, lubricants, fluids and service parts conforming to specifications. Motorcraft parts are designed and built to provide the best performance in your vehicle.

Precautions when servicing your vehicle

Be especially careful when inspecting or servicing your vehicle. Here are some general precautions for your safety:

- Do not work on a hot engine.



The cooling fan is automatic and may come on at any time. Always disconnect the negative terminal of the battery before working near the fan.

- If you must work with the engine running, avoid wearing loose clothing or jewelry that could get caught in moving parts. Take precautions with long hair.
- Do not work on a vehicle with the engine running in an enclosed space, unless you are sure you have enough ventilation.

Maintenance and care

- Keep all lit cigarettes, open flames and other lit material away from the battery and all fuel related parts.

If you disconnect the battery, the engine must “relearn” its idle conditions before your vehicle will drive properly, as explained in *Battery* in this chapter.

Working with the engine off

1. Set the parking brake fully and make sure the gearshift is securely latched in P (Park).
2. Turn off the engine and remove the key.
3. Block the wheels fully to prevent the vehicle from moving unexpectedly.

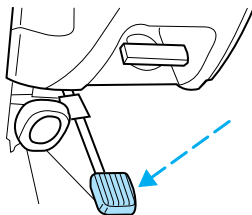

P R N D 2 1

Working with the engine on

1. Set the parking brake fully and make sure the gearshift is securely latched in P (Park).
2. Block the wheels fully to prevent the vehicle from moving unexpectedly.

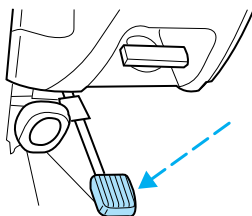

P R N D 2 1

Maintenance and care

Opening the hood

1. Inside the vehicle, pull the hood release handle located under the bottom left corner of the instrument panel.

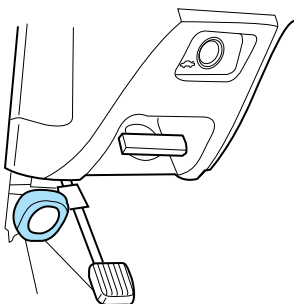

2. Go to the front of the vehicle and release the auxiliary latch that is located under the front center of the hood. Lift the hood until the lift cylinders hold it open.

IDENTIFYING COMPONENTS IN THE ENGINE COMPARTMENT

3.0L Vulcan engine

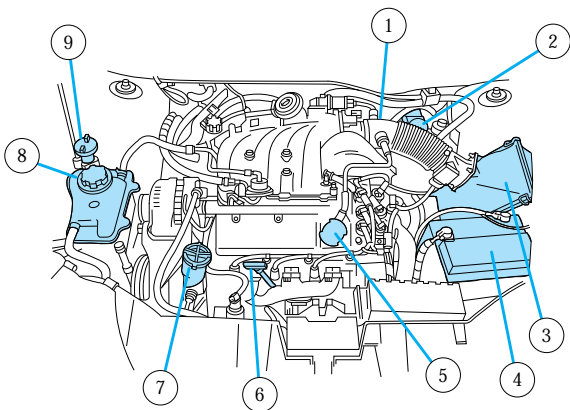

Maintenance and care

1. Automatic transaxle fluid dipstick
2. Brake fluid reservoir
3. Air filter assembly
4. Battery
5. Engine oil filler cap
6. Engine oil dipstick
7. Power steering fluid reservoir
8. Engine coolant reservoir
9. Windshield washer fluid reservoir

3.0L Duratec engine

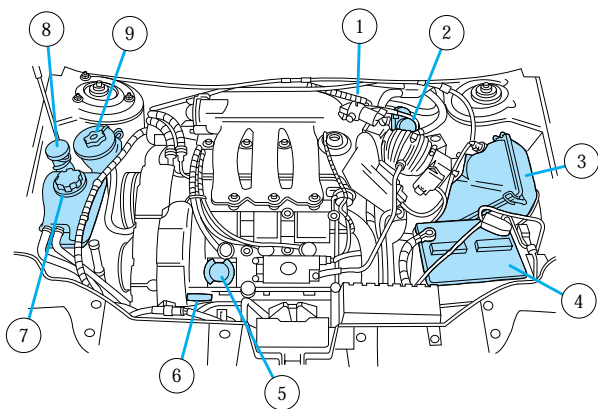

1. Automatic transaxle fluid dipstick
2. Brake fluid reservoir
3. Air filter assembly
4. Battery
5. Engine oil filler cap
6. Engine oil dipstick
7. Engine coolant reservoir

Maintenance and care

8. Windshield washer fluid reservoir

9. Power steering fluid reservoir

3.4L SHO engine

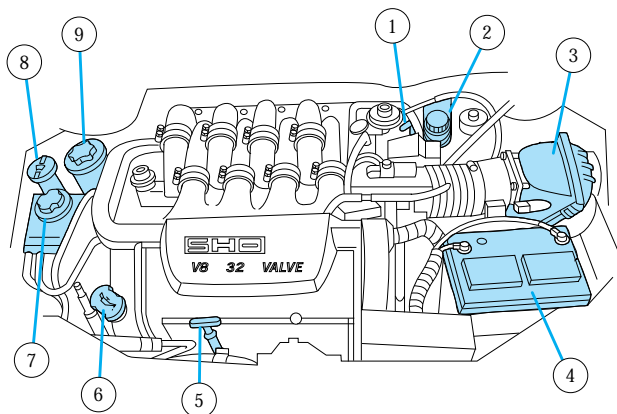

1. Automatic transaxle fluid dipstick

2. Brake fluid reservoir

3. Air filter assembly

4. Battery

5. Engine oil dipstick

6. Engine oil filler cap

7. Engine coolant reservoir

8. Windshield washer fluid reservoir

9. Power steering fluid reservoir

Maintenance and care

CHECKING AND ADDING ENGINE OIL

Checking the engine oil

Check the engine oil each time you fuel your vehicle.

To check the oil:

1. Make sure the vehicle is on level ground. If the engine is warm, turn the engine off and wait a few minutes for the oil to drain into the oil pan.
2. Set the parking brake and ensure the gearshift is securely latched in P (Park).
3. Open the hood. Protect yourself from engine heat.
4. Locate and carefully remove the engine oil dipstick.

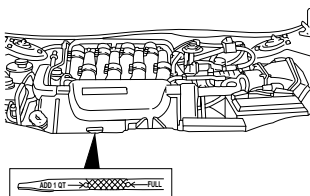

5. Wipe the dipstick clean. Insert the dipstick fully, then remove it again. The oil level should be in the range shown on the dipstick.
6. If the oil level is below the MIN line or the ADD 1 QUART line, add oil as necessary. If the oil level is beyond the MAX or FULL line, engine damage or high engine oil consumption may occur and some oil must be removed from the engine by a service technician.
7. Put the dipstick back in and ensure it is fully seated.

Adding engine oil

1. Check the engine oil. For instructions, refer to *Checking the engine oil* in this chapter.
2. If the fluid level is not within the normal range, add only certified engine oil of the preferred viscosity. Add engine oil through the oil filler cap.

Maintenance and care

Remove the filler cap and use a funnel to pour oil in the opening.

3. Recheck the oil level. Make sure the oil level is not above the MAX or FULL mark on the dipstick.

ENGINE OIL RECOMMENDATIONS

Use SAE 5W-30 motor oil meeting Ford specification WSS-M2C153-F or equivalent. Only use oil certified for gasoline engines by the American Petroleum Institute.

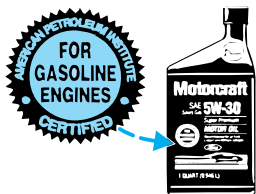

Do not use supplemental engine oil additives, oil treatments or engine treatments. They are unnecessary and could, under certain conditions, lead to engine damage which is not covered by your warranty.

CHANGING THE ENGINE OIL AND FILTER

Change your engine oil and filter according to the following mileage and time requirements, whichever occurs first:

- Normal Schedule – 8,000 km (5,000 miles) or six months.
- Severe Duty Schedule - 5,000 km (3,000 miles) or three months. Severe duty operation would include extensive idling, trailer towing, driving in severe dust and police, taxi or delivery service.

Ford production and aftermarket (Motorcraft) oil filters are designed for added engine protection and long life. If a replacement oil filter is used that does not meet Ford material and design specifications, startup engine noises or knock may be experienced.

It is recommended you use the appropriate Motorcraft oil filter (or another brand meeting Ford specifications) for your engine application.

Maintenance and care

BRAKE FLUID

CHECKING AND ADDING BRAKE FLUID

Brake fluid should be checked and refilled as needed at least once each year:

- Clean the reservoir cap before removal to prevent dirt or water from entering the reservoir.
- Visually inspect the fluid level.
- If necessary, add brake fluid until the level reaches MAX. Do not fill above this line.
- Use only a DOT 3 brake fluid certified to meet Ford specifications. Refer to *Lubricant specifications* in the *Capacities and specifications* chapter.

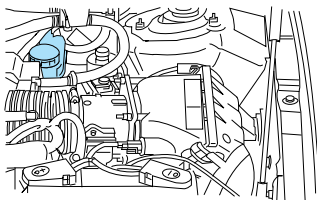

Brake fluid is toxic.



If you use a brake fluid that is not DOT 3, you will cause permanent damage to your brakes.



Do not let the reservoir for the master cylinder run dry. This may cause the brakes to fail.

Maintenance and care

CHECKING AND ADDING WASHER FLUID

Check the washer fluid whenever you stop for fuel. The reservoir is highlighted with a washer symbol.

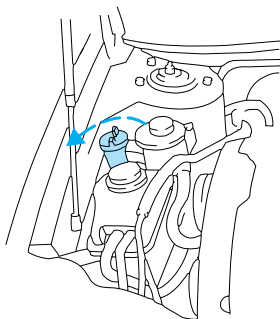

If the level is low, add enough fluid to fill the reservoir. In very cold weather, do not fill the reservoir all the way.

Checking and adding washer fluid for the liftgate (wagon only)

The opening for the reservoir is located on the passenger side under the tail lamp. Refill this reservoir with the same fluid you use for your windshield.

CHECKING AND ADDING ENGINE COOLANT

Check the level of the coolant in the reservoir at least once a month. Be sure to read and understand *Precautions when servicing your vehicle* in this chapter.

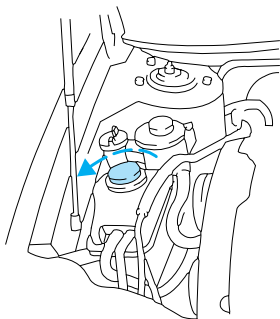

If the engine coolant has not been checked for a long period of time, the engine coolant reservoir may eventually empty. If this occurs, add engine coolant

Maintenance and care

to the coolant reservoir. For more information on engine coolant maintenance, refer to *Adding engine coolant* in this chapter.

Automotive fluids are not interchangeable; do not use engine coolant, antifreeze or windshield washer fluid outside of its specified function and vehicle location.

Adding engine coolant



Do not put engine coolant in the container for the windshield washer fluid.

If sprayed on the windshield, engine coolant could make it difficult to see through the windshield.

When the engine is cool, add a 50/50 mixture of engine coolant and water to the reservoir to the engine coolant recovery reservoir-DO NOT ADD DIRECTLY TO THE RADIATOR. Add straight water only in an emergency, but you should replace it with a 50/50 mixture of coolant and distilled water as soon as possible.

Check the coolant level in the coolant recovery reservoir the next few times you drive the vehicle. If necessary, add enough of a 50/50 mixture of coolant and water to bring the liquid level to the fill line on the reservoir.



Never remove the coolant recovery cap while the engine is running or hot.

If you must remove the coolant recovery cap, follow these steps to avoid personal injury:

1. Before you remove the cap, turn the engine off and let it cool.

Maintenance and care

2. When the engine is cool, wrap a thick cloth around the cap. Slowly turn cap counterclockwise to the first stop.

3. Step back while the pressure releases.

4. When you are sure that all the pressure has been released, use the cloth to press the cap down, turn it counterclockwise and remove it.

Use Ford Premium Cooling System Fluid E2FZ-19549-AA (in Canada, Motorcraft CXC-8-B) or an equivalent premium engine coolant that meets Ford specification ESE-M97B44-A. Ford Premium Engine Coolant is an optimized formula that will protect all metals and rubber elastomers used in Ford cooling systems for four years or 80,000 km (50,000 miles).

Do not use alcohol or methanol antifreeze or any engine coolants mixed with alcohol or methanol antifreeze. Do not use supplemental coolant additives in your vehicle. These additives may harm your engine cooling system. The use of an improper coolant may void your warranty of your vehicle's engine cooling system.

Recycled engine coolant

Ford Motor Company recommends that Ford and Lincoln-Mercury dealers use recycled engine coolant produced by Ford-approved processes. Not all coolant recycling processes produce coolant which meets Ford specification ESE-M97B44-A, and use of such coolant may harm engine and cooling system components.

 Always dispose of used automotive fluids in a responsible manner. Follow your community's regulations and standards for recycling and disposing of automotive fluids.

Maintenance and care

Coolant refill capacity

To find out how much fluid your vehicle's cooling system can hold, refer to *Refill capacities* in the *Capacities and specifications* chapter.

Have your dealer check the engine cooling system for leaks if you have to add more than a liter (quart) of engine coolant per month.

Severe winter climate

If you drive in extremely cold climates [less than -36°C (-34°F)], it may be necessary to increase the coolant concentration above 50%. Refer to the chart on the coolant container to ensure the coolant concentration in your vehicle is such that the coolant will not freeze at the temperature level in which you drive during winter months. Never increase the engine coolant concentration above 60%. Leave a 50/50 mixture of engine coolant and water in your vehicle year-round in non-extreme climates.

CHECKING AND ADDING POWER STEERING FLUID

Check the power steering fluid at least twice a year. If adding fluid is necessary, use only Mercon[®] ATF power steering fluid.

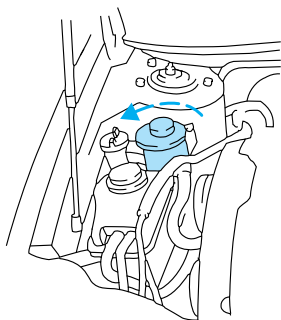

1. Start the engine and let it run until it reaches normal operating temperature (the engine coolant gauge will be near the center of the NORMAL band).
2. While the engine idles, turn the steering wheel left and right several times.
3. Turn the engine off.

Maintenance and care

3.0L Vulcan engine

4. Check the fluid level on the dipstick. It should be between the arrows in the FULL HOT range. Do not add fluid if the level is within this range.

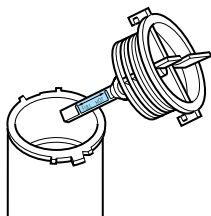

5. If the fluid is low, add fluid in small amounts, continuously checking the level until it reaches the FULL HOT range. Be sure to put the dipstick back in the reservoir.

3.0L Duratec engine and 3.4L SHO engine

4. Check the fluid level in the reservoir. It should be between the MIN and MAX lines. Do not add fluid if the level is within this range.

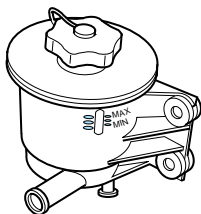

5. If the fluid is low, add fluid in small amounts, continuously checking the level until it reaches the range between the MIN and MAX lines. Be sure to put the cap back on the reservoir.

AUTOMATIC TRANSAXLE FLUID

Under normal circumstances, the transaxle fluid does not need to be checked. Refer to the *Service Guide* for fluid replacement intervals. If the transaxle is not working properly — for instance, the transaxle may slip or shift slowly or even some fluid leakage (red fluid under the vehicle) — the fluid should be checked.

Maintenance and care

Checking the automatic transaxle fluid

Your vehicle should be at normal operating temperature to get an accurate reading on the transaxle fluid dipstick. Normal operating temperature is reached after driving approximately 32 km (20 miles). If the vehicle has been operating for extended periods of time at high speeds, driven in city traffic during hot weather or has been pulling a trailer, the vehicle should be turned off for at least 30 minutes to allow the fluid to cool before checking.

With the vehicle on a level surface and the brake pedal firmly applied, move the gearshift through all the gears. Allow sufficient time for each position to engage. Securely latch the gearshift in P (Park), leave the engine running and set the parking brake.

Wipe off the dipstick cap and pull the dipstick out. Wipe the dipstick clean, put the dipstick back in the filler tube completely, then pull it back out and read the fluid level. The fluid should be in the crosshatched area (not necessarily at the top of the crosshatched area).

Your vehicle should not be driven until some fluid has been added if the fluid level is below the bottom hole on the dipstick and the outside temperature is below 10°C (50°F). Add only enough fluid to bring the level above the bottom hole.

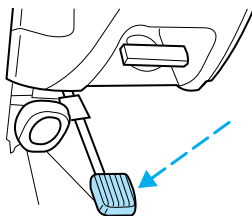

P R N D 2 1



Maintenance and care

Adding transaxle fluid

Before adding any fluid, be sure the correct type is being used (this is indicated on the transaxle dipstick).

Add fluid in 250 ML (1/2 pint) increments through the filler tube to bring the level within the crosshatched area. If the level is above the top hole on the dipstick, a qualified technician should remove the excess fluid.

Always dispose of automotive fluids in a responsible manner. Follow your community's standards for disposing of these types of fluids. Call your local recycling center to find out about recycling automotive fluids.

BATTERY

If the original equipment maintenance-free battery needs replacing, it may be replaced with a low-maintenance battery. For more information on replacement batteries, refer to *Motorcraft part numbers* in the *Capacities and specifications* chapter.

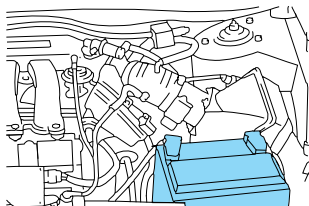

The gases around the battery can explode if exposed to flames, sparks, or lit cigarettes. An explosion could result in injury or vehicle damage.



Batteries contain sulfuric acid which burns skin, eyes, and clothing.

Maintenance and care



Applying too much pressure on the ends when lifting a battery could cause acid to spill. Lift the battery with a carrier or with your hands on the opposite corners.

Servicing your battery

The low-maintenance battery has removable vent caps for checking electrolyte level and adding water. Check electrolyte level every 24 months or 40,000 km (24,000 miles) in an average temperature of 32°C (90°F). Keep the electrolyte level in each cell up to the level indicator. Do not overfill.

If the level gets low, refill the battery with distilled water. If necessary, distilled water may be substituted with tap water that is not hard or has a high mineral or alkali content. If the battery needs water quite often, have the charging system checked for a possible malfunction.

Because your vehicle's engine is electronically controlled by a computer, some control conditions are maintained by power from the battery. When the battery is disconnected or a new battery is installed, the engine must relearn its idle conditions before you vehicle will drive properly. To begin this process:

1. Put the gearshift in P (Park), turn off all accessories and start the vehicle.
 2. Let the engine idle for at least one minute.
 3. The relearning process will automatically complete as you drive the vehicle.
- If you do not allow the engine to relearn its idle, the idle quality of your vehicle may be adversely affected until the idle is eventually relearned.
 - If the battery has been disconnected or a new battery has been installed, the clock and the preset radio stations must be reset once the battery is reconnected.

Maintenance and care

- Always dispose of automotive batteries in a responsible manner. Follow your communities standards for disposal. Call your local recycling center to find out more about recycling automotive batteries.

CHANGING YOUR AIR FILTER

To replace your air filter, unclip the two latches, separate the housing and remove the old filter. Wipe the interior clean before inserting new air filter. Lock the two latches.

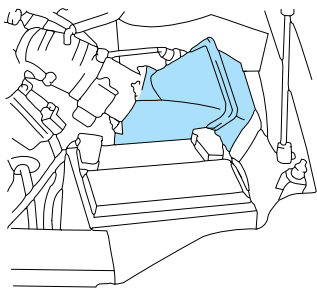

Do not use oil-impregnated air filters. Filters other than the ones specified in this owner guide can cause serious damage. Your warranties may not apply if your vehicle is damaged because you use the wrong air filter. Refer to *Motorcraft part numbers* in the *Capacities and specifications* chapter.

CHECKING AND CHANGING WIPER BLADES

Check the wiper blades at least twice a year or when they seem less effective than usual. Substances such as tree sap and some hot wax treatments used by commercial car washes reduce the effectiveness of wiper blades.

Checking the wiper blades

If the wiper blades do not clean properly, clean the windshield and wipers. Use an undiluted windshield washer solution or a mild detergent, then rinse thoroughly with clear water. Do not use fuel, kerosene, paint thinner or other solvents to clean the wiper blades as these will damage the blades.

Maintenance and care

Changing the wiper blades

When replacing wiper blades assemblies, always use a Motorcraft part or equivalent. To replace the blades, follow the instructions on that come with the new wipers. To make reaching the wipers easy, turn the ignition to the ACC position, then turn the wipers on. When the wipers reach the vertical position, turn the ignition OFF.

INFORMATION ABOUT TIRE QUALITY GRADES

New vehicles are fitted with tires that have their Tire Quality Grade (described below) molded into the tire's sidewall. These Tire Quality Grades are determined by standards that the

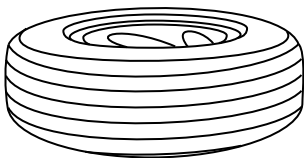

United States Department of Transportation has set.

Tire Quality Grades apply to new pneumatic tires for use on passenger cars. They do not apply to deep tread, winter-type snow tires, space-saver or temporary use spare tires, tires with nominal rim diameters of 10 to 12 inches or limited production tires as defined in Title 49 Code of Federal Regulations Part 575.104(c) (2).

U.S. Department of Transportation-Tire quality grades: The U.S. Department of Transportation requires Ford to give you the following information about tire grades exactly as the government has written it.

Treadwear

The treadwear grade is a comparative rating based on the wear rate of the tire when tested under controlled conditions on a specified government test course. For example, a tire grade 150 would wear one and one-half (1 1/2) times as well on the government course as a tire grade 100. The relative

Maintenance and care

performance of tires depends upon the actual conditions of their use, however, and may depart significantly from the norm due to variations in driving habits, service practices, and differences in road characteristics and climate.

Traction A B C

The traction grades, from highest to lowest are A, B, and C, and they represent the tire's ability to stop on wet pavement as measured under test surfaces of asphalt and concrete. A tire marked C may have poor traction performance. Warning: The traction grade assigned to this tire is based on braking (straightahead) traction tests and does not include cornering (turning) traction.

Temperature A B C

The temperature grades are A (the highest), B, and C, representing the tire's resistance to the generation of heat and its ability to dissipate heat when tested under controlled conditions on a specified indoor laboratory test wheel. Sustained high temperature can cause the material of the tire to degenerate and reduce tire life, and excessive temperature can lead to sudden tire failure. The grade C corresponds to a level of performance which all passenger car tires must meet under the Federal Motor Vehicle Safety Standard No. 109. Grades B and A represent higher levels of performance on the laboratory test wheel than the minimum required by law.



The temperature grade for this tire is established for a tire that is properly inflated and not overloaded. Excessive speed, underinflation, or excessive loading, either separately or in combination, can cause heat buildup and possible tire failure.

Maintenance and care

SERVICING YOUR TIRES

Checking the tire pressure

- Use an accurate tire pressure gauge.
- Check the tire pressure when tires are cold, after the vehicle has been parked for at least one hour or has been driven less than 5 km (3 miles).
- Adjust tire pressure to recommended specifications found on the Safety Compliance Certification Label.



Improperly inflated tires can affect vehicle handling and can fail suddenly, possibly resulting in loss of vehicle control.

Tire rotation

Because your vehicle's tires perform different jobs, they often wear differently. To make sure your tires wear evenly and last longer, rotate them as indicated in the *Service Guide*. If you notice that the tires wear unevenly, have them checked.

Replacing the tires

Replace the tires when the wear band is visible through the tire treads.

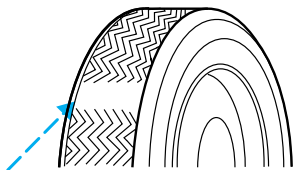

Failure to follow these precautions may adversely affect the handling of the vehicle and make it easier to lose control and roll over.

Maintenance and care

Tires that are larger or smaller than your vehicle's original tires may also affect the accuracy of your speedometer.

SNOW TIRES AND CHAINS

The tires on your vehicle have all weather treads to provide traction in rain and snow. However, in some climates, you may need to use snow tires and chains. Follow these guidelines when using snow tires and chains:

- Use only SAE Class S chains.
- Install chains securely, verifying that the chains do not touch any wiring, brake lines or fuel lines.
- Drive cautiously. If you hear the chains rub or bang against your vehicle, stop and re-tighten the chains. If this does not work, remove the chains to prevent damage to your vehicle.
- If possible, avoid fully loading your vehicle.
- Do not use tire chains on aluminum wheels.
- Do not use tire chains if your vehicle is equipped with P225/55VR16 tires.
- Remove the tire chains when they are no longer needed. Do not use tire chains on dry roads.
- The suspension insulation and bumpers will help prevent vehicle damage. Do not remove these components from your vehicle when using snow tires and chains.

WHAT YOU SHOULD KNOW ABOUT AUTOMOTIVE FUELS

Important safety precautions



Do not overfill the fuel tank. The pressure in an overfilled tank may cause leakage and lead to fuel spray and fire.

Maintenance and care



If you do not use the proper fuel cap, the pressure in the fuel tank can damage the fuel system or cause it to work improperly in a collision.



The fuel system may be under pressure. If the fuel cap is venting vapor or if you hear a hissing sound, wait until it stops before completely removing the cap.



Automotive fuels can cause serious injury or death if misused or mishandled.

Observe the following guidelines when handling automotive fuel:

- Extinguish all smoking materials and any open flames before fueling your vehicle.
- Always turn off the vehicle before fueling.
- Automotive fuels can be harmful or fatal if swallowed. If fuel is swallowed, call a physician immediately, even if no symptoms are immediately apparent. The toxic affects of fuel may not be visible for hours.
- Fuels can also be harmful if absorbed through the skin. If fuel is splashed on the skin, promptly remove contaminated clothing and wash skin thoroughly with soap and water.
- If fuel is splashed in the eyes, remove contact lenses, flush with water for 15 minutes and seek medical attention.



Maintenance and care

- Be particularly careful if you are taking “Antabuse” or other forms of disulfiram for the treatment of alcoholism. Breathing gasoline vapors or skin contact could cause an adverse reaction. Consult a physician immediately.

Choosing the right fuel

Use only UNLEADED FUEL. The use of leaded fuel is prohibited by law and could damage your vehicle. The damage may not be covered by your warranty.

Your vehicle was not designed to use fuel containing manganese-based additives such as MMT.

Additionally, vehicles certified to California emission standards (indicated on the underhood Vehicle Emissions Control Information label) are designed to operate on California reformulated gasolines. If California reformulated gasoline is not available when you refuel, your vehicle can be operated on non-California fuels. However, even though your engine will perform adequately on other gasolines, the performance of the emission control devices and systems may be adversely affected. Repair of damage caused by using a fuel that your vehicle was not designed for may not be covered by your warranty.

Octane recommendations

Your vehicle is designed to use regular gasoline with an (R+M)/2 octane rating of 87. We do not recommend gasolines labeled as “regular” in high altitude areas that are sold with octane ratings of 86 or even less.



Do not be concerned if your vehicle sometimes knocks lightly. However, if it knocks heavily under most driving conditions on the recommended octane

Maintenance and care

fuel, see your dealer or a qualified service technician to prevent any engine damage.

SHO engines

Your vehicle is designed to use premium gasoline for optimum performance



with an $(R + M)/2$ octane rating of 91 or higher. Gasolines with lower octane ratings can be used but performance may decrease. We do not recommend gasolines labeled as “premium” in high altitude areas that are sold with octane ratings less than 91.

Fuel quality

If you are experiencing starting, rough idle or hesitation problems try a different brand of fuel. If the condition persists, see your dealer or a qualified service technician.

The American Automobile Manufacturers Association (AAMA) issued a gasoline specification to provide information on high quality fuels that optimize the performance of your vehicle. We recommend the use of gasolines that meet the AAMA specification if they are available.

It should not be necessary to add any aftermarket products to your fuel tank if you continue to use a high-quality fuel.

Cleaner air

Ford approves the use of gasolines to improve air quality, including reformulated gasolines, that contain oxygenates such as a maximum of 10% ethanol or 15% MTBE. There should be no more than 5% methanol with cosolvents and additives to protect the fuel system.

Calculating fuel economy

To accurately calculate your vehicle’s fuel economy:

Maintenance and care

1. Fill the tank completely and record the initial odometer reading.
2. Each time you fill the tank, record the amount of fuel added (in liters or gallons).
3. After at least three to five fuel tank fill-ups, fill the fuel tank and record the current mileage reading.
4. Use one of the following equations to calculate fuel economy.

Liters used $\times 100 \div$ Total kilometers traveled

Total miles traveled \div Total gallons used

Keep a record for at least one month. This will provide an accurate estimate of the vehicle's fuel economy.

EMISSION CONTROL SYSTEM

Your vehicle is equipped with catalytic converters which enable your vehicle to comply with applicable exhaust emission requirements.



Exhaust leaks may result in the entry of harmful and potentially lethal fumes into the passenger compartment. Under extreme conditions excessive exhaust temperatures could damage the fuel system, the interior floor covering, or other vehicle components, possibly causing a fire.

To make sure that the catalytic converter and the other emission control parts continue to work properly:

- Use only unleaded fuel.
- Avoid running out of fuel.
- Do not turn off the ignition while your vehicle is moving, especially at high speeds.
- Have the services listed in your *Service Guide* performed according to the specified schedule.

Maintenance and care

The Scheduled Maintenance Services listed in the *Service Guide* are required because they are considered essential to the life and performance of your vehicle and to its emissions system.

Ford strongly recommends the use of genuine Ford replacement parts. If other than Ford or Motorcraft parts or Ford authorized parts are used for maintenance replacements or for the service of components affecting emission control, such non-Ford parts should be equivalent to genuine Ford Motor Company parts in performance and durability. It is the owner's responsibility to determine the equivalency of such parts. Please consult your Warranty Information Booklet for complete warranty information.



Do not park, idle, or drive your vehicle in dry grass or other dry ground cover. The emission system heats up the engine compartment and exhaust system, which can start a fire.

Watch for fluid leaks, strange odors, smoke, loss of oil pressure, the charging system warning light, the service engine soon light or the temperature warning light. These sometimes indicate that the emissions system is not working properly.

Do not make any unauthorized changes to your vehicle or engine. Changes that cause more unburned fuel to reach the exhaust system can increase the temperature of the engine or exhaust system.

By law, anyone who manufactures, repairs, services, sells, leases, trades vehicles, or supervises a fleet of vehicles is not permitted to intentionally remove an emission control device or prevent it from working. In some of the United States and Canada, vehicle owners may be liable if their emission control device is removed or prevented from working.

Maintenance and care

Never use a metal exhaust collector when you service your vehicle. If the metal collector contacts any of your vehicle's plastic trim or bumper parts they could melt or deform.

Do not drive your vehicle if it does not operate properly. See your dealer if the engine runs on for more than five seconds after you shut it off or if it misfires, surges, stalls or backfires.

Information about your vehicle's emission system is on the Vehicle Emission Control Information decal located on or near the engine. This decal identifies engine displacement and gives some tune up specifications.

Readiness for inspection/maintenance testing

In some localities, it may become a legal requirement to pass an Inspection/Maintenance (I/M) test of the On-board Diagnostic (OBD) II system. If the vehicle's powertrain system or its battery has just been serviced, the OBD II system is reset to a not ready for I/M testing condition. To prepare for I/M testing, the law specifies that additional mixed city and highway driving is required to complete the check of the OBD II system.

The driving modes required to reach the ready condition consist of a minimum of 30 minutes of city and highway driving as described below:

- At least twenty minutes driving in stop and go, city type traffic with at least four idle periods.
- At least ten minutes of driving on an expressway or highway.

Before completing the above driving modes, the engine must be warmed up and at operating temperature. Once started, the vehicle must not be turned off during these driving modes.

EXTERIOR LAMPS

It is a good idea to check the operation of the following lights frequently:

Maintenance and care

- Headlamps
- High-mount brake lamp
- Tail lamps
- Brake lamps
- Backup lamps
- Hazard flashers
- Turn signals
- License plate lamp
- Interior overhead lamps

Do not remove lamp bulbs unless they will be replaced immediately. If a bulb is removed for an extended period of time, contaminants may enter the lamp housings and affect performance.

High-mount brake lamp - Sedan

To remove the brake lamp:

1. Remove package tray trim, then push attachment toward the rear.
2. Slide brake lamp up and away from the rear window to remove it from the tabs that hold it down.
3. Disconnect bulbs.

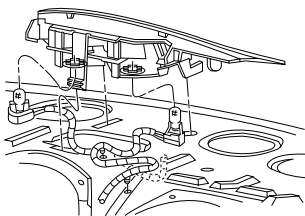

To install brake lamp:

1. Install bulbs, then position the brake lamp over tab slots and line up the tab with the tab slots.
2. Push down and toward the rear window to engage the tabs.
3. Push attachment toward the rear window and line up slot in attachment with the edge of the sheet metal screw.

Maintenance and care

4. Release the attachment slot onto the sheet metal hole. Install the package tray trim.

High-mount brake lamp - Wagon

To remove the brake lamp:

1. Remove interior trim panel, then remove the three attachment nuts that hold brake lamp in place.

2. Lift whole assembly off vehicle from the outside.

3. Disconnect bulbs.

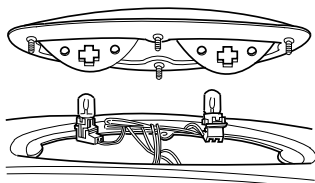

To install brake lamp:

1. Install bulbs, the position brake lamp into tailgate holes.

2. From the inside of the vehicle, stall and tighten the four nuts that hold the brake lamp in place.

3. Install the interior trim panel.

Using the right bulbs

Function	Trade Number
Front side marker lamp	194
Front park/turn lamp	3457NA
Headlamp	9007
Tail lamp/brake lamp	3157
Rear turn lamp	3156
Backup lamp	3156
License plate lamp	168
High-mount brake lamp	912
Rear side marker lamp	168
Cargo lamp (wagon)	211-2
Dome lamp	211-2
Dome/map lamp	578

Maintenance and care

Function	Trade Number
Dome lamp/moon roof	208
Visor vanity lamp (passenger/driver)	74-194
Door courtesy lamp	168
Floor console	194
Luggage compartment lamp	906
Glove compartment	194
Instrument courtesy lamps	168
I/P ashtray lamp	194
Radio illumination	Go to Ford authorized radio service center
Clock	Go to Ford authorized dealer
Warning indicator lights (except THEFT)	Go to Ford authorized dealer
THEFT warning	Go to Ford authorized dealer
Cluster illumination	Go to Ford authorized dealer
Heater-A/C	Go to Ford authorized dealer
Automatic climate control	Go to Ford authorized dealer
Rear window defrost switch	Go to Ford authorized dealer

Maintenance and care

Function	Trade Number
Rear window wiper/washer switch (wagon)	Go to Ford authorized dealer

Headlamps

To remove the headlamp bulb:

1. Make sure headlamp switch is in OFF position, then open the hood. If you are replacing the driver side headlamp, unclip the electronic module on the right side of the battery and move it out of the way.

2. Remove the electrical connector from the bulb by pulling the connector.

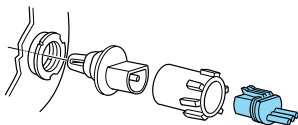

3. Remove the bulb retaining ring by rotating it counterclockwise (when viewed from the rear) about an eighth of a turn to free it from the bulb socket, and by sliding the ring off the plastic base. Keep the ring because it will be used again to retain the new bulb.

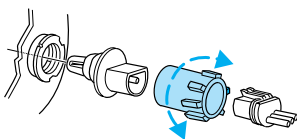

4. Remove the old bulb from its socket by gently pulling it straight back out of the socket. Do not turn the bulb while you are removing it.

To install the new bulb:

Maintenance and care

1. With the flat side of the bulb's plastic base facing upward, insert glass end of the bulb into the socket. You may need to turn the bulb left or right to line up the grooves in the plastic base with the tabs in the socket. When the grooves are aligned, push the bulb into the socket until the plastic base contacts the rear of the socket.

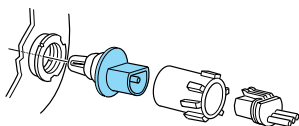

2. Slip the bulb retaining ring over the plastic base until it contacts the rear of the socket by rotating it clockwise until you feel a “stop.”

3. Push the electrical connector into the rear of the plastic base until it snaps, locking it into position.

4. Turn the headlamps on and make sure they work properly. If the headlamp was correctly aligned before you changed the bulb, you should not need to align it again.

AIMING THE HEADLAMPS

Your vehicle is equipped with a Vehicle Headlamp Aim Device (VHAD) on each headlamp body. Each headlamp may be properly aimed in the horizontal direction (left/right) and the vertical position (up/down).

A non-zero bubble reading does not necessarily indicate out-of-aim headlamps. If your vehicle is not positioned on a level surface, the slope will be included in the level indicator. Therefore, vertical headlamp adjustment should be performed only when beam direction appears to be incorrect or a level surface can not be verified.

The horizontal aim must be adjusted first. You will need one 7 mm box wrench or open end wrench.

The following procedure assumes that the vehicle's front structure is properly aligned. If the vehicle has

Maintenance and care

been in an accident requiring the front end of the vehicle to be repaired, the horizontal indicator should be recalibrated by the service facility.

Horizontal aim adjustment

1. With the hood open, locate the horizontal indicator and adjusting screw.

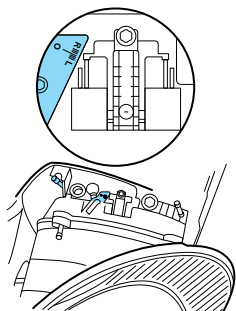

2. Use a 7 mm wrench to turn the horizontal adjusting screw until the reference mark on the reflector extension aligns with the "0" reference mark on the horizontal indicator when viewed directly from above.

3. When the horizontal aim has been adjusted, close the headlamp access panel.

Adjusting the vertical aim

The numbers shown on the vial indicate beam direction in degrees up or down.

1. Do not adjust the vertical aim until after adjusting the horizontal aim.

Maintenance and care

2. With the hood open, locate the bubble level vertical aim indicator. It is visible when viewed from the above rear of the headlamp.

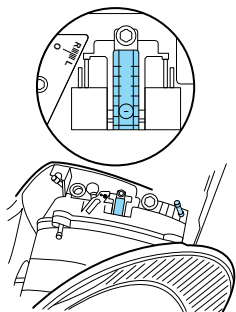

3. Use a 7 mm wrench to turn the vertical adjusting screw until the reference mark on the reflector extension aligns with the “0” reference mark on the vertical indicator when viewed directly from above.

4. Close the hood.

CLEANING AND CARING FOR YOUR VEHICLE

Refer to the “Customer Assistance Guide” for a list of Ford-approved cleaners, polishes and waxes.

Washing your vehicle

Wash your vehicle regularly with cold or lukewarm water. Never use strong detergents or soap. If your vehicle is particularly dirty, use a quality car wash detergent. Always use a clean sponge, washing glove or similar device and plenty of water for best results. To avoid spots, avoid washing when the hood is still warm, immediately after or during exposure to strong sunlight.

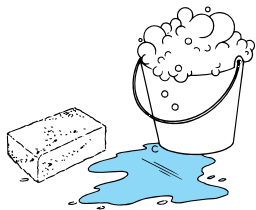

During winter months, it is especially important to wash the vehicle on a regular basis. Large quantities of dirt and road salt are difficult to remove, and they also cause damage to the vehicle. Remove any

Maintenance and care

exterior accessories, such as antennas, before entering a car wash.

- After washing, apply the brakes several times to dry them.

Waxing your vehicle

The best way to determine when the paintwork needs waxing is by noting when water stops beading on the surface. This could be every three or four months, depending on operating conditions.

Use only carnauba or synthetic-based waxes. Remove any bugs and tar before waxing vehicle. Use cleaning fluid or alcohol with a clean cloth to remove. Use tar remover to remove any tar spots.

Repairing paint chips

Minor scratches or paint damage from road debris may be repaired with touch-up paint, paint repair foil or aerosol paint spray from the Ford accessory line. Observe the application instructions on the products.

Remove particles such as bird droppings, tree sap, insect remains, tar spots, road salt and industrial fallout immediately.

Cleaning the wheels

Wash the wheels with the same detergent you use to clean the body of your vehicle. Do not

use acid-based wheel cleaners, steel wool, fuel or strong detergents. Never use abrasives that will damage the finish of special wheel surfaces. Use a tar remover to remove grease and tar.

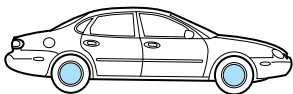

Cleaning the engine

Engines are more efficient when they are clean because grease and dirt buildup act as insulators and keep the engine warmer than normal. Follow these guidelines to clean your engine:

Maintenance and care

- Take care when using a power washer to clean the engine. The high pressure fluid could penetrate the sealed parts and cause damage.
- Do not spray with cold water to avoid cracking the engine block.
- Cover the highlighted areas to prevent water damage when cleaning the engine.

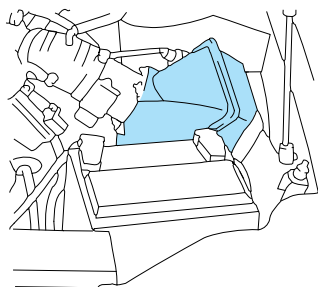

- Never wash or rinse the engine while it is running; water in the running engine may cause internal damage.

Cleaning plastic exterior parts

Use a vinyl cleaner for routine cleaning of plastic. Clean with a tar remover if necessary. Do not clean plastic parts with thinners, solvents or petroleum-based cleaners.

Cleaning the exterior lamps

Wash the exterior lamps with the same detergent you used to wash the exterior of your vehicle. Use glass cleaner or tar remover if necessary.

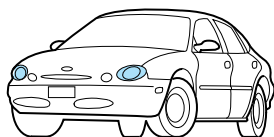

To avoid scratching the lamps, do not use a dry paper towel, chemical solvents or abrasive cleaners to clean the lamps.

Maintenance and care

Cleaning the wiper blades

If the wiper blades do not wipe properly, clean both the windshield and wiper blades using undiluted windshield wiper solution or a mild detergent. Rinse thoroughly with clean water. To avoid damaging the blades, do not use fuel, kerosene, paint thinner or other solvents.

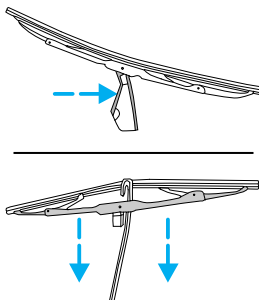

Cleaning the instrument panel

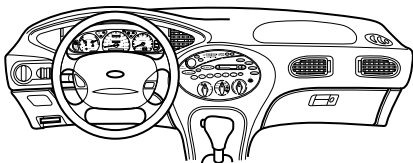

Clean instrument panel with a damp cloth, then dry with a dry cloth.

Any cleaner or polish that increases the gloss of the upper portion of the instrument panel should be avoided. The dull finish in this area is to help protect the driver from undesirable windshield reflection.

Cleaning the interior fabric

Remove dust and loose dirt with a whisk broom or a vacuum cleaner. Remove fresh spots immediately. Follow the directions that come with the cleaner.

Maintenance and care

Cleaning leather seats (if equipped)

For routine cleaning, wipe the surface with a soft, damp cloth. For more thorough cleaning, wipe the surface with a leather and vinyl cleaner or a mild soap.

Cleaning and maintaining the safety belts

Clean the safety belts with a mild soap solution recommended for cleaning upholstery or carpets. Do not bleach or dye the belts, because these actions may weaken the belt webbing.

Check the safety belt system periodically to make sure there are no nicks, wear or cuts. If your vehicle has been involved in an accident, have all the safety restraints examined by a qualified technician.

Cleaning the built-in child seat (if equipped)

Clean the built-in child seat with mild soap and water. Do not use household cleaning products because they may weaken the safety belt webbing or damage the vinyl parts of the seat.

The child seat liner is removable and may be machine-washed and air dried.

Capacities and specifications

MOTORCRAFT PART NUMBERS

3.0L Vulcan engine

Component	Part number
Air filter	FA-1630
Fuel filter	FG-800-A
Battery (standard)	BXT-58R
Battery (optional)	BXT-36R
Fuel filter	FG-800-A
Passenger compartment air filter (if equipped)	FP-6
Oil filter	FL-400-S
PCV valve	EV-228
Spark plug*	AWSF-32PP**
* Refer to Vehicle Emissions Control Information (VECI) decal for spark plug and gap information.	
** If a spark plug is removed for inspection, it must be reinstalled in the same cylinder. Cylinders No. 1, 2 and 3 have a PG suffix. Cylinders No. 4, 5 and 6 have a P suffix. If a spark plug needs to be replaced, use only spark plugs with the service part number suffix letter "PP" as shown on the engine decal.	

3.0L Duratec engine

Component	Part number
Air filter	FA-1630
Fuel filter	FG-800-A
Battery	BXT-36R
Fuel filter	FG-800-A

Capacities and specifications

Component	Part number
Passenger compartment air filter (if equipped)	FP-6
Oil filter	FL-820-S
PCV valve	EV-152
Spark plug	AWSF-32F

3.4L SHO engine

Component	Part number
Air filter	FA-1630
Battery	BXT-36R
Fuel filter	FG-800-A
Passenger compartment air filter (if equipped)	FA1628
Oil filter	FL-400A
PCV valve	EV-234
Spark plug	AWSF-32FM

REFILL CAPACITIES

3.0L Vulcan engine

Fluid	Ford Part Name	Vehicle Type	Capacity
Brake fluid	High performance DOT 3 brake fluid	All	Fill to line in reservoir
Engine coolant	Premium cooling system fluid	All	11.0 (11.6)

Capacities and specifications

Fluid	Ford Part Name	Vehicle Type	Capacity
Engine oil (with filter change)	Motorcraft motor oil 5W30 super premium	All	4.25 (4.5)
Fuel tank capacity	N/A	All	60.6 (16.0 gallons)
Power steering fluid	Motorcraft MERCON® ATF	All	Fill to line in reservoir
Automatic transaxle - AX4N	Motorcraft MERCON® ATF	All	12.8 (13.5)
Automatic transaxle - AX4S	Motorcraft MERCON® ATF	All	11.6 (12.2)
Windshield washer fluid - Front	Ultra-clear windshield washer concentrate	All Wagon	2.7 (90 oz.) 2.1 (70 oz.)

3.0L Duratec engine

Fluid	Ford Part Name	Vehicle Type	Capacity
Brake fluid	High performance DOT 3 brake fluid	All	Fill to line in reservoir
Engine coolant	Premium cooling system fluid	All	10.0 (10.6)

Capacities and specifications

Fluid	Ford Part Name	Vehicle Type	Capacity
Engine oil (with filter change)	Motorcraft motor oil 5W30 super premium	All	5.2 (5.5)
Fuel tank capacity	N/A	All	60.6 (16.0 gallons)
Power steering fluid	Motorcraft MERCON® ATF	All	Fill to line in reservoir
Automatic transaxle - AX4N	Motorcraft MERCON® ATF	All	12.7 (13.4)
Windshield washer fluid - Front	Ultra-clear windshield washer concentrate	All	2.7 (90 oz.)
Windshield washer fluid - Rear	Ultra-clear windshield washer concentrate	Wagon	2.1 (70 oz.)

3.4L SHO engine

Fluid	Ford Part Name	Vehicle Type	Capacity - Liters (Quarts)
Brake fluid	High performance DOT 3 brake fluid	All	Fill to line in reservoir
Engine coolant	Premium cooling system fluid	All	10.0 (10.6)

Capacities and specifications

Fluid	Ford Part Name	Vehicle Type	Capacity - Liters (Quarts)
Engine oil (with filter change)	Motorcraft motor oil 5W30 super premium	All	6.1 (6.5)
Fuel tank capacity	N/A	All	60.6 (16.0 gallons)
Power steering fluid	Motorcraft MERCON® ATF	All	Fill to line in reservoir
Automatic transaxle - AX4N	Motorcraft MERCON® ATF	All	12.7 (13.4)
Windshield washer fluid	Ultra-clear windshield washer concentrate	All	2.7 (90 oz.)

LUBRICANT SPECIFICATIONS

Fluid	Ford Part Name or Equivalent	Ford Part Number	Specification
Brake master cylinder	C6AZ-19542-AB	Ford high performance DOT 3 brake fluid	ESA-M6C25-A
Door latch, hood latch, auxiliary latch, trunk and liftgate latches	D0AZ-19584-AA	Multi-purpose grease	ESR-M1C159-A and ESA-M1C93-A

Capacities and specifications

Fluid	Ford Part Name or Equivalent	Ford Part Number	Specification
Lock cylinders	E8AZ-19A501-B	Penetrating lubricant	N/A
Automatic transaxle	XT-2-QDX	Motorcraft MERCON® ATF	MERCON®
Engine oil (Gasoline engines)	XO-5W30-QSP	Motorcraft 5W30 super premium	WSS-M2C153-F and API Certification Mark
Constant velocity joints	E43Z-19590-A	CV joint grease - high temp.	ESP-M1C207-A
Engine coolant	E2FZ-19549-AA	Ford premium cooling system fluid	ESE-M97B44-A
Power steering pump reservoir	XT-2-QDX	Motorcraft MERCON® ATF	MERCON®

ENGINE DATA

Engine data			
Engine	3.0L SOHC V6	3.0L DOHC V6	3.4L DOHC V8
Cubic inches	182	183	207
Horsepower	145 @ 5250 rpm	200 @ 5750 rpm	235 @ 6100 rpm

Capacities and specifications

Engine data			
Torque	170 @ 3250 rpm	200 @ 4500 rpm	230 @ 4800 rpm
Required fuel grade	87 octane	87 octane	91 octane
Firing order	1-4-2-5-3-6	1-4-2-5-3-6	1-5-4-2-6-3-7-8
Spark plug gap	1.07-1.17 mm (0.042-0.046 inch)	1.07-1.17 mm (0.042-0.046 inch)	1.07-1.17 mm (0.042-0.046 inch)
Ignition system	DIS	DIS	DIS
Valve clearance cold inlet exhaust	0: Maintenance free	0: Maintenance free	Check and adjust as necessary at 160,000 km (100,000 miles)

VEHICLE DIMENSIONS

Vehicle dimensions mm (in.)	Sedan	Wagon
(1) Overall length	5016.5 (197.5)	5069.8 (199.6)
(2) Overall width	1854.2 (73.0)	1854.2 (73.0)
(3) Overall height	1399.5 (55.1)	1463.0 (57.6)
(4) Wheelbase	2755.9 (108.5)	2755.9 (108.5)
(5) Track - Front	1564.6 (61.6)	1564.6 (61.6)

Capacities and specifications

Vehicle dimensions mm (in.)	Sedan	Wagon
(5) Track - Rear	1559.6 (61.4)	1569.7 (61.8)

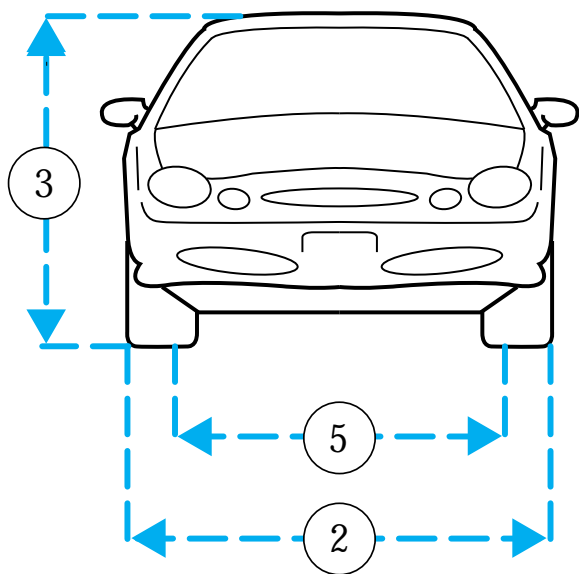

Capacities and specifications

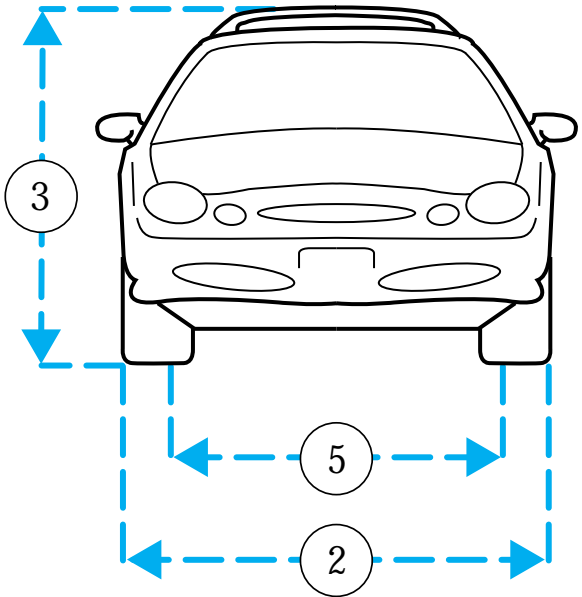

Capacities and specifications

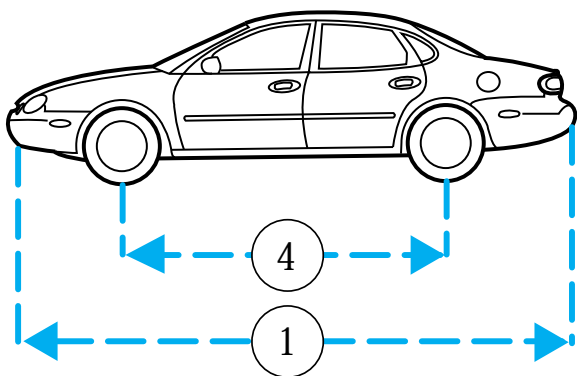

Capacities and specifications

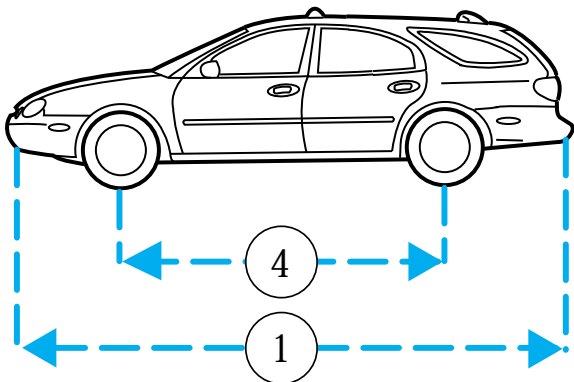

IDENTIFYING YOUR VEHICLE Vehicle identification plate

The vehicle identification plate is located on the front panel of the engine compartment. This plate bears technical information on your vehicle and identifies various components.

Vehicle identification number

The vehicle identification number (VIN) is attached to a metal tag and is located in the following areas

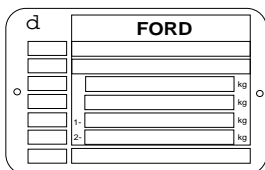

Capacities and specifications

of your vehicle for maximum theft protection:

- left and right front fenders
- hood
- left and right front doors
- front and rear bumpers
- left and right rear quarter panels
- decklid
- liftgate
- engine compartment
- transaxle Engine number

The engine number is stamped on the engine block.

Reporting safety defects

REPORTING SAFETY DEFECTS (U.S. ONLY)

If you believe that your vehicle has a defect that could cause a crash, or could cause injury or death, you should immediately inform the National Highway Traffic Safety Administration



(NHTSA) in addition to Ford Motor Company.

If NHTSA receives similar complaints, it may open an investigation, and if it finds that a safety defect exists in a group of vehicles, it may order a recall and remedy campaign. However, NHTSA cannot become involved in individual problems between you, your dealer or Ford Motor Company.

To contact NHTSA, you may either call the Auto Safety Hotline toll-free at 1-800-424-9393 (202-366-0123 in the Washington D.C. area) or write to:

NHTSA

U.S. Department of Transportation

400 Seventh Street

Washington D.C. 20590

You can also obtain other information about motor vehicle safety from the Hotline.