



PROBE

Your satisfaction is our #1 goal. If you have questions or concerns with your vehicle, we suggest you follow these steps:

1. Contact your Sales Representative or Service Advisor at your selling/servicing dealership.
2. If the inquiry or concern remains unresolved, contact the Sales Manager or Service Manager at the dealership.
3. If the inquiry or concern cannot be resolved at the dealership level, please contact the Ford Customer Assistance Center.

In the United States:

**Ford Motor Company
Customer Assistance Center
300 Renaissance Center
P.O. Box 43360
Detroit, MI 48243
1-800-392-3673 (FORD)
TDD for the hearing impaired: 1-800-232-5952**

In Canada:

**Customer Assistance Centre
Ford Motor Company of Canada, Limited
P.O. Box 2000
Oakville, Ontario L6J 5E4
1-800-565-3673 (FORD)**

Outside the U.S. or Canada:

**FORD MOTOR COMPANY
WORLDWIDE OPERATIONS
1555 Fairlane Drive
Fairlane Business Park #3
Allen Park, Michigan 48101
Telephone: (313) 594-4857
Fax: (313) 390-0804**



All rights reserved. Reproduction by any means, electronic or mechanical, including photocopying, recording, or by any information storage and retrieval system or translation in whole or part is not permitted without written authorization from Ford Motor Company.

Copyright © 1996 Ford Motor Company

Table of Contents

Introduction	1
Instrumentation	7
Electronic Sound Systems	21
Controls and Features	47
Seating and Safety Restraints	89
Starting	125
Driving	133
Roadside Emergencies	155
Maintenance and Care	183
Capacities and Specifications	237
Reporting Safety Defects (U.S. Only)	243
Customer Assistance	245
Accessories	257
Quick Index	265
Index	275
Service Station Information	292

Introductory Information

Ford's Commitment to You

At Ford Motor Company, excellence is the continuous commitment to achieve the best result possible. It is dedication to learning what you want, determination to develop the right concept, and execution of that concept with care, precision, and attention to detail. In short, excellence means being the standard by which others are judged.

Our Guiding Principles

- **Quality comes first.** For your satisfaction, the quality of our products and services must be our number one priority.
- **You are the focus of everything we do.** Our work must be done with you in mind, providing better products and services than our competition.
- **Continuous improvement is essential to our success.** We must strive for excellence in everything we do: in our products — in their safety and value — and in our services, our human relations, our competitiveness, and our profitability.
- **Employee involvement is our way of life.** We are a team. We must treat one another with trust and respect.
- **Dealers and suppliers are our partners.** We must maintain mutually beneficial relationships with dealers, suppliers, and our other business associates.
- **Integrity is never compromised.** Our conduct worldwide must be pursued in a manner that is socially responsible and commands respect for its integrity and for its positive contributions to society.

Things to Know About Using This Guide

Congratulations on the purchase of your new vehicle. This guide has information about the equipment and the options for your new vehicle. You may not have bought all of the options available to you. If you do not know which information applies to your vehicle, talk to your dealer.

This guide describes equipment and gives specifications for equipment that was in effect when this guide was approved for printing. Ford may discontinue models or change specifications or design without any notice and without incurring obligation.

NOTES and WARNINGS

NOTES give you additional information about the subject matter you are referencing.

WARNINGS remind you to be especially careful in those areas where carelessness can cause damage to your vehicle or personal injury to yourself, your passengers or other people. Please read all **WARNINGS** carefully.

 WARNING

Finding Information in This Guide

After you have read this guide once, you will probably return to it when you have a specific question or need additional information. To help you find specific information quickly, you can use the Quick Index, Table of Contents, or the Index.

The **Quick Index** at the end of the book provides a page number following each item which indicates where detailed information can be found.

Introductory Information

To use the **Index**, turn to the back of the book and search in the alphabetical listing for the word that best describes the information you need. If the word you chose is not listed, think of other related words and look them up. We have designed the Index so that you can find information under a technical term.

Canadian Owners — French Version

French Owner Guides can be obtained from your dealer or by writing to Ford Motor Company of Canada, Limited, Service Publications, P.O. Box 1580, Station B, Mississauga, Ontario L4Y 4G3.

Your Maintenance Schedule and Record Booklet

The *Maintenance Schedule and Record* booklet lists the services that are most important for keeping your vehicle in good condition. A record log is also provided to help you keep track of all services performed.

About the Warranties

Your vehicle is covered by three types of warranties: **Basic Vehicle Warranty**, **Extended Warranties** on certain parts, and **Emissions Warranties**.

Read your *Warranty Information Booklet* carefully to find out about your vehicle's warranties and your basic rights and responsibilities.

If you lose your *Warranty Information Booklet*, you can get a new one free of charge. Contact any Ford or Lincoln-Mercury dealer, or refer to the addresses and phone numbers on the first page of this owner guide.

Buying a Ford Extended Service Plan

If you bought your vehicle in the U.S., you can buy a Ford Extended Service Plan for your vehicle. This optional contract provides service protection for a longer period of time than the basic warranty that comes with your vehicle.

You do not have to buy this option when you buy your vehicle. However, your option to purchase the Ford Extended Service Plan runs out after 18 months or 18,000 miles. See your dealer for more details about the Ford Extended Service Plan.

If you purchased a Canadian vehicle and did not take advantage of the Ford Extended Service Plan at the time of purchase, you may still be eligible. See your dealer for the details.

Special Notice

NOTICE TO OWNERS OF UTILITY-TYPE VEHICLES

As with other vehicles of this type, failure to operate this vehicle correctly may result in loss of control or an accident. Be sure to read the *Additional Special Driving Instructions for Utility Vehicles* in this book and the special supplement included with four-wheel drive vehicles entitled *4-Wheeling with Ford*.

Although this special supplement is primarily directed to four-wheel drive vehicle operators, these principles of safe driving also apply to operators of the two-wheel drive Explorer. Even though you may not select a 4WD or AWD option for your Explorer, many of its operating characteristics are similar to those of a four-wheel drive vehicle. For this reason, Ford urges you to read and understand the contents of the *4-Wheeling with Ford* supplement.

Introductory Information

AMBULANCE PACKAGES

 WARNING
--

Do not use this vehicle as an ambulance.

Breaking Your Vehicle In

Your new vehicle goes through an adjustment or break-in period during the first 1,000 miles (1,600 km) that you drive it. During the break-in period, you need to pay careful attention to how you drive your vehicle.

- **Avoid sudden stops.** Because your vehicle has new brake linings, you should take these steps:
 - Watch traffic carefully so that you can anticipate when to stop.
 - Begin braking well in advance.
 - Apply the brakes gradually.

The break-in period for new brake linings lasts for 100 miles (160 km) of city driving or 1,000 miles (1,600 km) of highway driving.

- Wheel lug nuts must be retightened to proper torque specifications at 500 miles/800 km of new vehicle operation. Proper torque specifications are provided in this guide. Also retighten to proper torque specification at 500 miles/800 km after any wheel change or any other time the wheel lug nuts have been loosened.
- **Use only the type of engine oil that Ford recommends.** See *Engine oil recommendations* in the Index. Do not use special “break-in” oils.

Some vehicles are equipped with a Powertrain Control Module that limits engine speeds with a cut-out mode to promote durability.

Cleaning the Outside of Your Vehicle

Pollen, bird droppings and tree sap can damage the paint, especially in hot weather. Wash your vehicle as often as necessary to keep it clean.

Take similar precautions if your vehicle is exposed to chemical industrial fallout.

Paint damage resulting from fallout is not related to a defect in paint materials or workmanship and therefore is not covered by warranty. Ford, however, believes that continual improvement in customer satisfaction is a high priority. For this reason, Ford has authorized its dealers to repair, at no charge to the owner, the surfaces of new vehicles damaged by environmental fallout within 12 months or 12,000 miles (20,000 km) of purchase, whichever comes first. Customers may be required to bring their vehicle in for inspection by a Ford representative.

Washing and Polishing Your Vehicle

Wash the outside of your vehicle, including the underside, with a mild detergent.

DO NOT:

- Wash your vehicle with hot water
- Wash your vehicle while it sits in direct sunlight
- Wash your vehicle while the body is hot

Polish your vehicle to remove harmful deposits and protect the finish.

Introductory Information

Cleaning Chrome and Aluminum Parts

Wash chrome and aluminum parts with a mild detergent. Do not use steel wool, abrasive cleaners, fuel or strong detergents.

Cleaning Plastic Parts

Some of your vehicle's exterior trim parts are plastic. Clean with a tar and road oil remover if necessary. Use a vinyl cleaner for routine cleaning.

Do not clean plastic parts with thinners, solvents or petroleum-based cleaners.

If you have your vehicle rustproofed, remove oversprayed rustproofing with a tar and road oil remover. If rustproofing is not removed from plastic and rubber parts, it can cause deterioration.

Because your vehicle's side mouldings are painted in lacquer, do not use thinners or solvents to clean them.

Instrumentation

The instrument panel (dashboard) on your vehicle is divided into several different sections. The illustrations on the following pages show the major parts of the instrument panel that are described in this chapter. Some items shown may not be on all vehicles.

In your vehicle, the warning lights and gauges are grouped together on the instrument panel. We call this grouping an instrument cluster.

The Mechanical Cluster

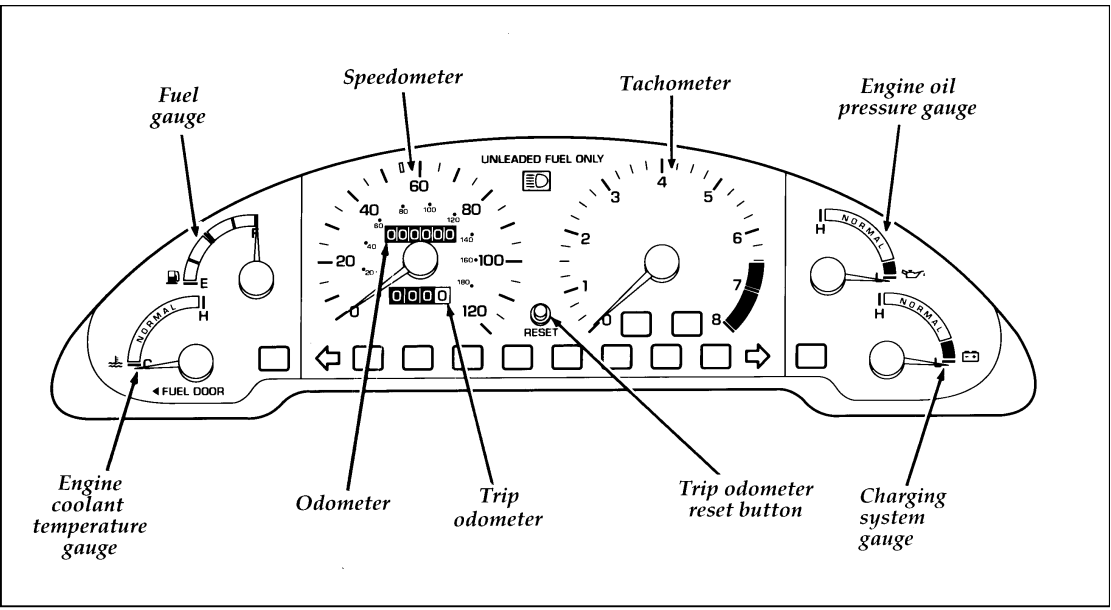

Instrument cluster

Warning light locations on the instrument cluster

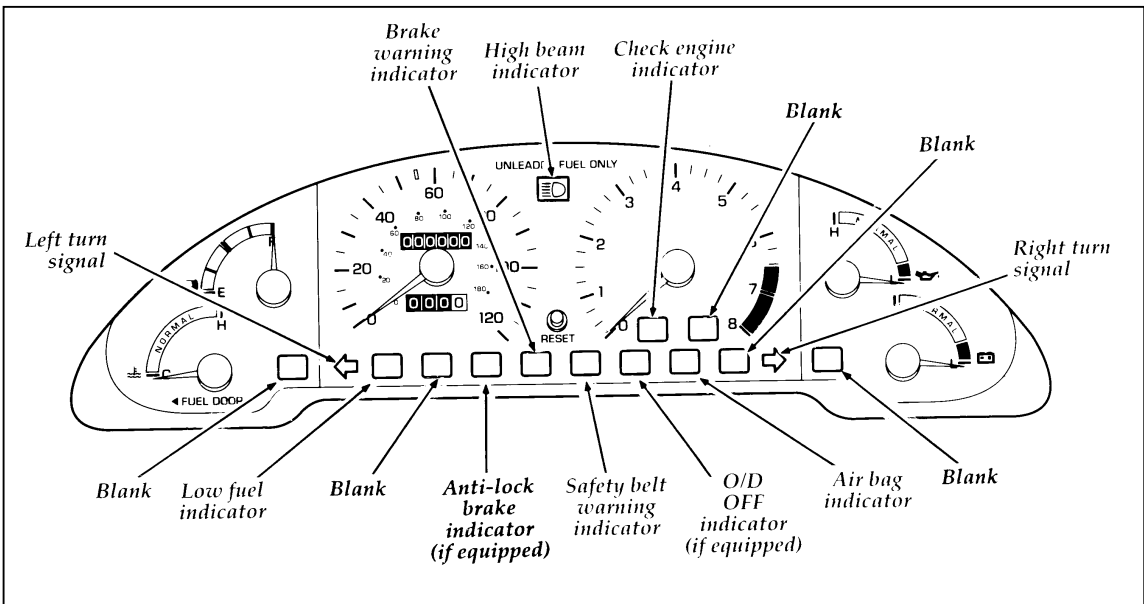

The instrument cluster on the Probe GT model is similar to the one shown. The two exceptions are: the speedometer on the GT model shows 140 mph (225 km/h) and it has a 7,000 rpm red-line tachometer.

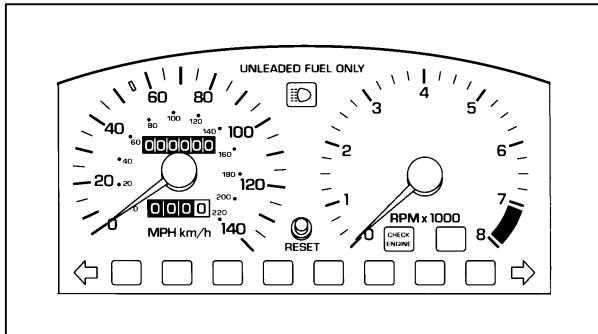

GT model speedometer and tachometer

The following warning lights and gauges are on the cluster. All of the warning lights and gauges alert you to possible problems with your vehicle. The following sections detail what each of these indicators means.

Indicator Lights and Chimes

Safety Belt Warning Light and Chime

This warning light and chime remind you to fasten your safety belt. If you do not fasten your safety belt before the ignition is turned to ON, the chime will sound for 4 to 8 seconds and the warning light will illuminate for 1 to 2 minutes, or until the safety belt is fastened. If you fasten the safety belt before the ignition is turned to ON, neither the light nor chime will activate.



Safety belt light

Air Bag Readiness Light

This light illuminates for six seconds when the ignition is turned to the ON position. If the light fails to illuminate, continues to flash, remains on, or if a series of five beeps is heard, have the system serviced as soon as possible.

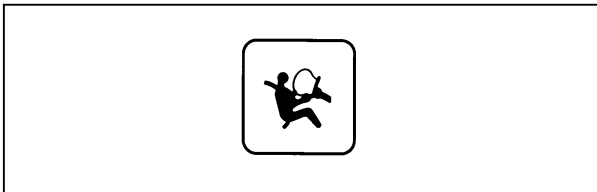

Air bag readiness light

⚠ WARNING

If any of these things happen, even intermittently, have the air bag system serviced at your Ford or Lincoln-Mercury dealer immediately.

Brake System Warning Light

Your vehicle has a divided brake system. If one part isn't working, the other part can still work and stop you. For good braking, though, you need both systems working well. If the warning light illuminates, there could be a problem. Have your brake system inspected right away.

This light should illuminate as you start the vehicle. If it doesn't illuminate then, have it fixed so it will be ready to warn you if there's a problem.

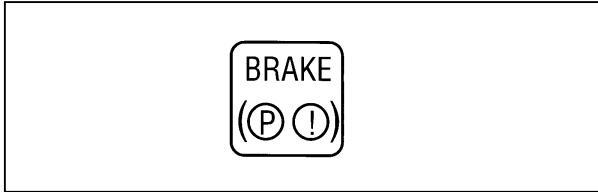

Brake system and parking brake light

This light illuminates briefly when you turn the ignition key to START. It normally goes off shortly after the engine starts and you release the parking brake, but it may stay on for up to 60 seconds. If the light stays on for longer than 60 seconds or comes on after you have fully released the parking brake, have the hydraulic brake system serviced.

This light will also illuminate if the parking brake does not release fully. If it does stay on **after** the parking brake is fully released, it means there may be a brake problem. Pull off the road and stop carefully. You may notice that the pedal is harder to push, the pedal may go closer to the floor, or it may take longer to stop the vehicle. Try the brakes again after you have stopped.

⚠ WARNING

The BRAKE light indicates that the brakes may not be working properly. Have the brakes checked immediately.

Anti-Lock Brake System Warning Light

When the ignition switch is turned to the ON position, the anti-lock brake system warning light will illuminate. When the engine is started, the anti-lock brake system control unit will determine if all components of the system are operating correctly. The warning light could remain on for two to four seconds.

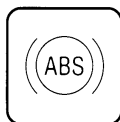

The anti-lock brake system warning light

⚠ WARNING

If the anti-lock brake system warning light remains on or comes on while driving, have the braking system checked by a qualified service technician as soon as possible.

NOTE: If a fault occurs in the anti-lock system, and the brake warning light is not lit, the anti-lock system is disabled but normal brake function remains operational.

NOTE: If your vehicle must be jump-started because of a low battery, the Anti-Lock Brake System warning light could remain on. This is due to low battery voltage and does not indicate a malfunction in the system. Under these circumstances, you should drive your vehicle only after the battery has had time to charge and the light has gone out.

The Low Fuel Light

This light illuminates when fuel level in your tank has reached approximately 2-3 gallons (7-10 liters).

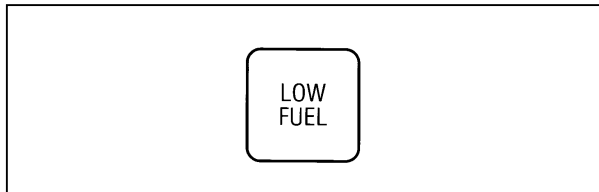

Low fuel light

High Beam Light

This light illuminates when the headlamps are turned to high beam or when you flash the lights.

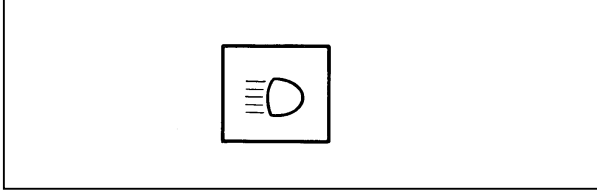

High beam light

Check Engine Warning Light

This light illuminates when the electronic engine control system is not working properly. This is the computer that controls the operating conditions of the engine.

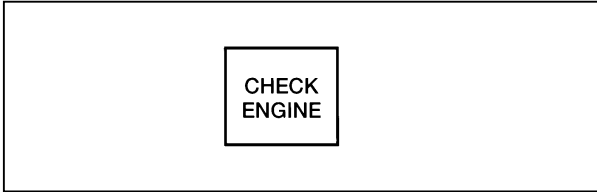

Check engine warning light

This light illuminates briefly when you turn the ignition to the ON position, but should turn off when the engine starts. If the light does not come on when you turn the ignition to the ON position or if it comes on and stays on when you are driving, have your vehicle serviced as soon as possible. This indicates a possible problem with one of the engine's emission control systems. **You do not need to have your vehicle towed in.**

If the light flashes briefly while you are driving, it means that the condition is no longer present.

O/D OFF Light (If equipped)

This light tells you that the overdrive off (O/D OFF) button on the shift selector has been pushed. When the light is on, the transaxle will not shift into overdrive. Depressing the button on the shift selector again will return the vehicle to “overdrive on” mode. The transaxle will be in the “overdrive on” mode when the vehicle is started even if the O/D OFF mode was selected when the vehicle was last shut off. Refer to the *Driving* chapter for more information.

If the light does not illuminate when the O/D OFF button is pressed, or if the light flashes when you are driving, have your vehicle serviced at the first opportunity. If this condition persists, damage could occur to the transaxle.

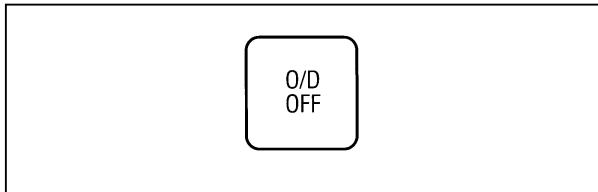

Overdrive OFF light

Gauges

Fuel Gauge

The fuel gauge displays approximately how much fuel you have in the fuel tank.

The ignition must be turned off while putting fuel in the tank in order to get a correct fuel gauge reading after the ignition is turned on.

The fuel gauge indicator may vary slightly while the vehicle is in motion. This is the result of fuel movement within the tank. You can get a more accurate reading with the vehicle on smooth, level ground.

Charging System Gauge

This gauge tells you your battery's voltage when you turn your ignition key to ON. When you start your engine, the pointer should move to the NORMAL range if you are not operating any electrical accessories. (If electrical accessories are operating and the engine is not running, the pointer may move into the red area).

If the pointer moves into the red area when no electrical accessories are operating, have the vehicle's electrical system checked.

Engine Oil Pressure Gauge

The gauge needle should stay in the NORMAL range (indicating normal engine oil pressure). If the needle drops below the NORMAL range into the low range, there is a loss of oil pressure.

If this happens:

1. Pull off the road as soon as safely possible.
2. Shut off the engine immediately or severe engine damage could result.
3. Check the oil level when the vehicle is on level ground.
4. Add only as much oil as the engine needs before you drive the vehicle again. Do not overfill the oil reservoir. For more information, see *Adding engine oil* in the Index.

Engine Coolant Temperature Gauge

This gauge indicates the temperature of the engine coolant, not the coolant level. If the coolant is not at its proper level or mixture, the gauge indication will not be accurate.

The pointer usually moves from C (cold) into the NORMAL band as your vehicle warms up. Under most driving conditions, the pointer should stay in the NORMAL band. If you are driving in heavy traffic or on an extended grade in hot weather, the pointer may reach to the top of the NORMAL band.

If, under any circumstances, the pointer moves above the NORMAL band, the engine is overheating and continued operation may cause engine damage.

If your engine overheats:

1. Pull off the road as soon as it is safely possible.
2. Shut off the engine immediately or severe engine damage could result.
3. Let the engine cool.
4. Check the coolant level following the instructions on checking and adding coolant to your engine. (See *Engine coolant* in the Index.) If you do not follow these instructions, you or others could be injured.

For instructions on checking and adding coolant to your engine, see *Engine coolant* in the Index. If you do not follow these instructions, you or others could be injured.

5. Refer to *Adding Engine Coolant* in the *Maintenance and Care* chapter. Add as much coolant as your engine needs. If the engine continues to overheat, have the cooling system serviced.

Speedometer

The speedometer tells you how many miles (kilometers) per hour your vehicle is moving.

Odometer

The odometer tells you the total number of miles (kilometers) your vehicle has been driven.

Trip Odometer

Use the trip odometer to track your mileage. Simply set the trip odometer to zero by pressing the reset button.

Tachometer

The tachometer indicates approximate engine revolutions per minute, and is located on the right-hand side of the instrument cluster. The tachometer pointer may move slightly when the key is placed in the ACC or ON position, with the engine off. This pointer movement is normal, and will not affect the accuracy of the tachometer once the engine is running.

Electronic Sound Systems

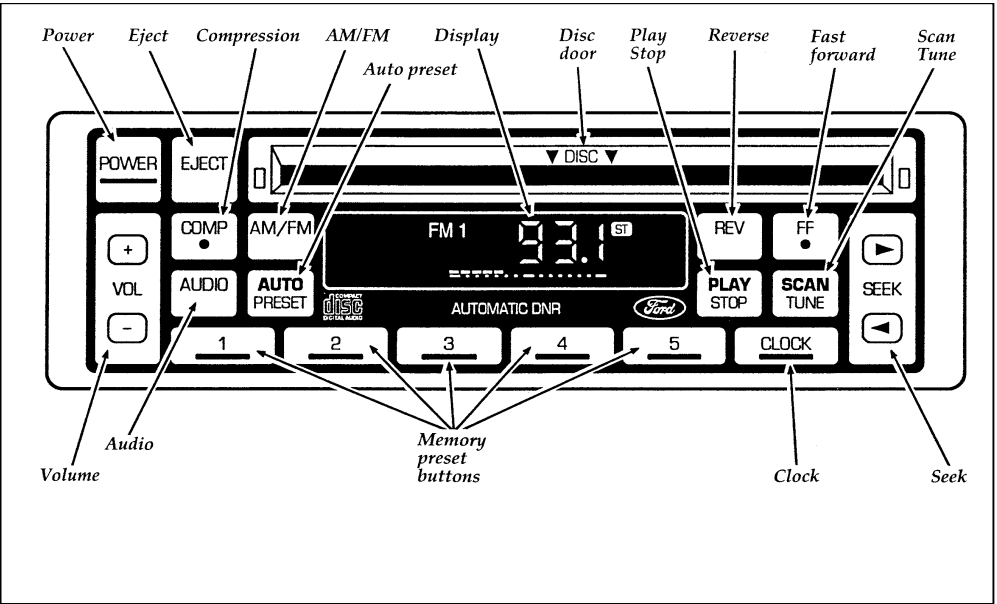

Compact Disc Radio

Compact Disc Radio

The Compact Disc Radio combines the Electronic Stereo Radio with the Ford Compact Disc Player.

Using the Controls on Your New Radio/CD Player

Most of the features of this unit work for both radio and CD operation, depending on which mode the unit is in. Also, some of the buttons control several different functions, so be sure to read all of the operating instructions carefully.

How to turn the radio on and off

Press the “POWER” button to turn the radio on. Press it again to turn it off.

How to adjust the volume

Press the (+/-) side of the “VOL” button to increase/decrease the volume. Bars illuminate in the display to show the relative volume level.

NOTE: If the volume level is set above a certain listening level when the ignition switch is turned off, when the ignition switch is turned back on, the volume will come back to a “nominal” listening level. However, if the radio power is turned off, the volume will remain in the position it was set at when radio power was switched off.

Selecting the AM or FM frequency band

Push the “AM/FM” button to select the desired frequency band. When in the radio mode, pushing the button more than once will alternate between AM, FM1 and FM2. These functions are used with the station memory buttons described under *How to tune radio stations*.

How to tune radio stations

There are four ways for you to tune in a particular station. You can manually locate the station using the “SCAN/TUNE” button, “SEEK” the station, “SCAN” to the station or select the station by using the memory buttons, which you can set to any desired frequency. These four methods are described below.

- Using the “SCAN/TUNE” button to manually tune

You can change the frequency up or down one increment at a time (FM changes in increments of 200kHz; AM changes in increments of 10kHz) by first pressing the “SCAN/TUNE” button twice (display shows “TUNE”), then — **within approximately five seconds** —pressing and releasing either the top (◀) or bottom (▶) half of the “SEEK” button. To change frequencies quickly, press and **hold down** either the top or bottom half of the “SEEK” button.

Manual tuning adjusts your radio to any allowable broadcast frequency, whether or not a station is present on that frequency. (See *All About Radio Frequencies* in this section.)

- Using the “SEEK” function

This feature on your radio allows you to automatically select listenable stations up or down the frequency band. Press the top (▶) half of the “SEEK” button to select the next listenable station up the frequency band. Press the bottom (◀) half of the button to select the next listenable station down the frequency band. By pressing and holding the button, listenable stations can be passed over to reach the desired station.

- Using the “SCAN/TUNE” button to scan radio stations

Pressing the “SCAN/TUNE” button once enters the scan mode (display will indicate “SCN”). Pushing the top (▶) half of the “SEEK” button will begin the scan mode up the frequency band, stopping on each listenable station for approximately five seconds. Pushing the bottom (◀) half of the “SEEK” button will begin the scan mode down the frequency band, again stopping on each listenable station for approximately five seconds.

To stop the scan mode on the presently sampled station, press the “SCAN/TUNE” button again.

- Setting the Station Memory Preset buttons

Your radio is equipped with 5 station memory buttons. These buttons can be used to select up to 5 preset AM stations and 10 FM stations (5 in FM1 and 5 in FM2). Follow the easy steps below to set these buttons to the desired frequencies.

1. Select a band, then select a frequency.
2. Press one of the memory preset buttons and hold the button until the sound returns. That station is now held in memory on that button.
3. Follow the two steps above for each station memory preset button you want to set.

NOTE: If the vehicle’s battery is disconnected, the clock and station memory preset buttons will need to be reset.

❑ Using the Automatic Memory Load feature

You can activate the **Auto Memory Load** feature by pressing and holding the “AUTO PRESET” button for **approximately three seconds**. Auto Memory Load sets all memory buttons in AM, FM1 and FM2 sequentially by seeking out the first five strong stations for the respective band and storing them in memory buttons 1-5. (FM2 will store the second set of strong stations from the FM band.)

With Auto Memory Store, you can continually set strong stations into your memory buttons without losing your existing memory presets, which is especially helpful while traveling. Your radio will automatically set your memory buttons to the strong local stations so you don't have to continually manually tune to existing stations.

Activate Auto Memory Store by pushing the “AUTO PRESET” button once. Your radio will set the first five strong stations of the band you are in (AM, FM1 or FM2) into the memory buttons. The display will show “AUTO,” then run through the frequencies, stopping momentarily on the stations being set into the memory buttons. The radio is now in the “AUTO” mode and the display will show “AUTO” each time a preset is activated.

NOTE: If there are fewer than five strong stations in the frequency band, the remaining unfilled buttons will store the last strong station detected on the band.

After all stations have been filled, the radio will begin playing the station stored on memory button 1.

To deactivate the Auto Memory Store mode and return to the manually-set memory button stations (or those stations set using Auto Memory Load), simply push the “AUTO PRESET” button. Display will show “AUTO” then “OFF.” The next time Auto Memory Store is activated on that band, the radio will store the next set of five strong stations.

Using the “AUDIO” button to adjust the tone balance and speaker output

Increasing or decreasing bass response

Push the “AUDIO” button repeatedly until the display reads “BASS.” Push the “+” side of the “VOL” button to increase bass (more “lows”), and push the “-” side to decrease bass (less “lows”).

Increasing or decreasing treble response

Push the “AUDIO” button repeatedly until the display reads “TREB.” Push the “+” side of the “VOL” button to increase treble (more “highs”), and push the “-” side to decrease treble (less “highs”).

Adjusting speaker balance

Balance control allows you to adjust the sound distribution between the right and left speakers. Push the “AUDIO” button repeatedly until the display reads “BAL.” Push the “+” side of the “VOL” button to shift the sound to the right speakers, and push the “-” side to shift the sound to the left speakers.

□ Adjusting speaker fader

Fade control allows you to adjust the sound distribution between the front and rear speakers. Push the “AUDIO” button repeatedly until the display reads “FADE.” Push the “+” side of the “VOL” button to shift the sound to the front speakers, and push the “-” side to shift the sound to the rear speakers.

NOTE: Illuminated bars in the display show relative levels of bass and treble and positions of speaker balance and fader functions after adjustments are made, then revert to volume level set.

Clock operation

When in the radio mode, push the “CLOCK” button to switch from radio frequency to clock. Only the clock numerals will be displayed in the clock mode — there is no A.M./P.M. indication. When in the clock mode, the time will be displayed until the button is pushed again. However, if you retune the radio while it is in the clock mode, the new radio frequency will be displayed for approximately ten seconds and then change back to clock.

When in the CD mode, push the “CLOCK” button to change the display from elapsed time mode to track number mode to clock mode. If the CD track selection is changed when you are in the clock or elapsed time mode, the new track number will be displayed for approximately ten seconds and then revert back to the previous mode.

To set the clock, simultaneously press the “CLOCK” button and either the bottom (◀) half of the “SEEK” button to set hours, or the top (▶) half of the “SEEK” button to set minutes.

Using the Controls on Your New Compact Disc Player

Your new Ford Compact Disc Player is capable of playing 12 cm *or* 8 cm discs, without an adapter. The player operates when the power is on and a disc is inserted (**label side up**). Handle the disc by its edge only. (Be sure to read and follow all of the care and cleaning instructions under *How To Take Care of and Clean Your CD Player and Discs*.)

NOTE: If after you insert a disc, the disc is ejected and “ERROR” begins scrolling in the display, remove the disc and reinsert it right side up (label side up).

The digital display on your CD player will either show the track (selection) number or the elapsed time. (The display mode can be selected by pressing the “CLOCK” button.) Indicators for play (▶), stop (■) and compression on (“C”) are also in the display. (These features are described later.)

Once a disc is inserted, operation of the CD player will override that of the radio.

NOTE: The volume, bass, treble, balance and fader controls on the radio are also used with the CD player. Refer to earlier operating instructions on these controls.

How to insert a disc and begin play

Insert one disc, **label side up** into the disc opening. When inserted, the disc automatically loads into the unit and play starts at the beginning of the first track (selection).

When the disc reaches the end, the disc player automatically returns to the beginning of the disc and resumes playing.

NOTE: Once a disc is inserted, the disc opening is secured to prevent the accidental insertion of a second disc.

NOTE: The CD player has heat protection circuitry to protect the laser diode. If the temperature of the player reaches 167°F (75°C), the heat detection circuit will shut off the player and “TOO HOT” will scroll in the display for approximately five seconds (radio will resume playing). When the temperature returns to normal operating range, the CD player will again be operational.

How to stop and restart the CD player

When a disc is loaded, the unit automatically enters the play mode and the play indicator (▶) illuminates. To stop temporarily, press the “PLAY/STOP” button or the “AM/FM” button. The stop indicator (■) in the display illuminates and operation returns to the radio mode. To resume CD play, press the “PLAY/STOP” button once again.

NOTE: If the ignition key is turned OFF during play and then is set to the ON or ACCESSORY position, the CD player will resume playing in the mode it was in when ignition was turned off.

Using the “SEEK” feature

The “SEEK” feature allows you to quickly find a particular selection on the disc.

Press the bottom (◀) half of the “SEEK” button once to repeat the current playing selection. Press the top (▶) half of the “SEEK” button to advance to the next selection.

Pressing and holding the bottom (◀) or top (▶) half of the “SEEK” button will scroll backward and forward respectively through the tracks.

How to fast forward or reverse your CD player

To quickly search for a particular point in a selection, press the “FF” button (to fast forward) or the “REV” button (to reverse). While either button is pressed, the disc goes forward or backward at two different speeds depending on how long the button is held down. (Pressing either button for more than three seconds will speed up the process.) Release the button at the desired point (found by watching the elapsed playing time in the display or by listening to the sound during fast forward or reverse). When you have reached the beginning of track 1, the CD player will begin playing.

When you have reached the end of the disc by keeping the fast forward button pressed, the display will show “END” and the player will go into pause mode. Push the “PLAY/STOP” button to begin playing the first track of the disc, press the “REV” button to back up from the end of the disc, or use the “SEEK” function to locate a desired track.

Using the “SCAN” function

Press the “SCAN/TUNE” button to enter the scan mode. Once in the scan mode, press the top (◀) or bottom (▶) half of the “SEEK” button to scan forward or reverse, respectively. The CD player will begin scanning the disc, stopping on each listenable track for approximately an eight-second sampling. This continues until you press the “SCAN/TUNE” button a second time.

How to eject the disc

Push the “EJECT” button to stop play, eject the disc and resume radio operation of your audio system.

NOTE: You can eject the disc while the radio power and/or ignition is on or off.

How To Take Care of and Clean Your CD Player and Discs

To ensure the continued performance of your Ford Compact Disc Player, carefully read the following precautions:

- Always handle the disc by its edge. Never touch the playing surface.
- Before playing, inspect the disc for any contamination. If needed, clean the disc with an approved disc cleaner, such as the Discwasher® Compact Disc Cleaner or the Allsop 3® Compact Disc Cleaner, by wiping from the center out to the edges. **Do not use a circular motion to clean.**
- Do not clean discs with solvents such as benzine, thinner, commercially available cleaners or antistatic spray intended for analog records.

- Do not expose the disc to direct sunlight or heat sources such as defroster and floor heating ducts. Do not leave any discs in a parked car in direct sunlight where there may be a considerable rise in temperature or damage may result.
- After playing, store the disc in its case.
- If a disc has already been inserted, do not try to insert another disc. Doing so may damage the disc player.
- Do not insert anything other than a disc into the disc player.

NOTE: The use of optical instruments with this product will increase eye hazard as the laser beam used in this compact disc player is harmful to the eyes. Do not attempt to disassemble the case. Refer servicing to qualified personnel only.

Common Operating Conditions of Your CD Player

The following information is designed to help you recognize typical situations that could be mistakenly interpreted as mechanical malfunctions of the disc player.

- A disc is already loaded.
- The disc is inserted with the label surface downward.
- The disc is dusty or defective.
- The player's internal temperature is above 140°F (60°C). Allow the player to cool off before operating.

- Different manufacturers of compact discs may produce discs with different dimensions or tolerances, some of which may not be within industry standards or in accordance with the CD format. Because of this, a new disc that is free of dust and scratches could be defective and may not play on your Ford Compact Disc Player.

If play does not begin after the CD button is pushed:

- The radio is not on.
- The unit is in the stop mode.
- Moisture may have condensed on the lenses within the unit. If this occurs, remove the disc and wait approximately an hour until the moisture evaporates.

If the sound skips:

- Badly scratched discs or extremely rough roads will cause the sound to skip. Skipping will not damage the disc player or scratch the discs.

Electronic Stereo and Stereo Cassette Radios

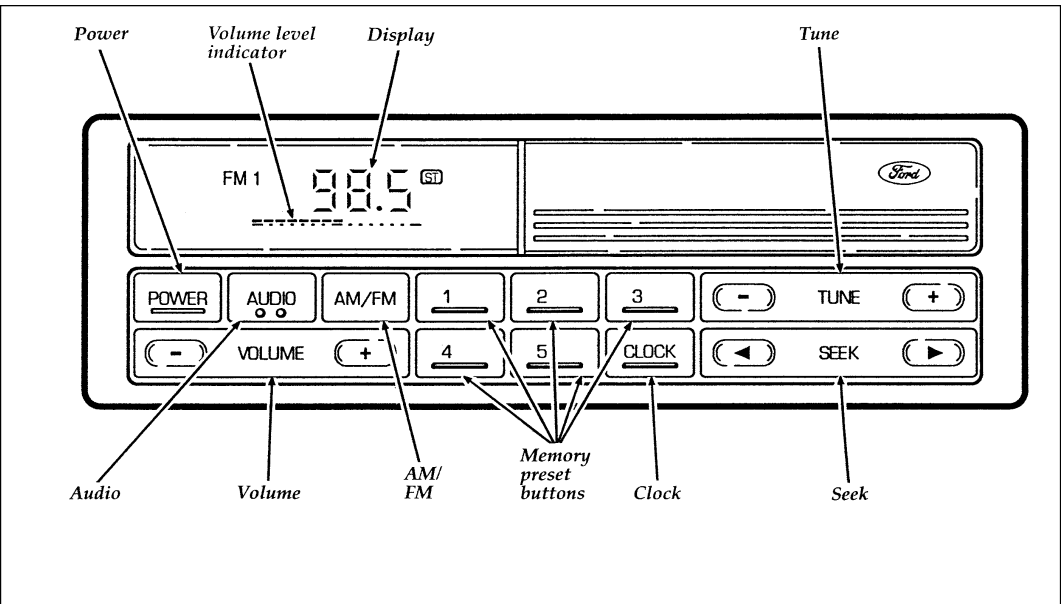

Electronic Stereo Radio

Electronic Stereo Radio with Cassette

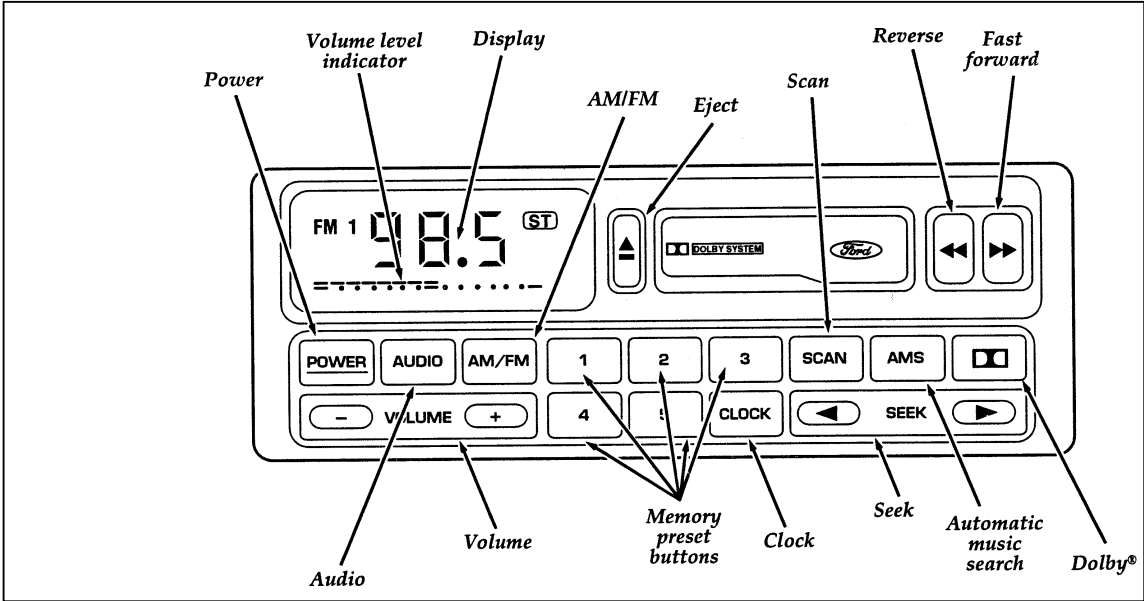

Using the Controls on Your New Radio

How to turn the radio on and adjust the volume

Press the “POWER” button to turn the radio on. Press it again to turn it off.

Press the right (+) side of the “VOLUME” button to increase the volume. Press the left (–) side of the button to decrease the volume. Illuminated bars in the display show the relative volume level.

NOTE: If the volume level is set above a certain listening level when the ignition switch is turned off, when the ignition switch is turned back on, the volume will come back to a “nominal” listening level. However, if the radio power is turned off, the volume will remain in the position it was set at when radio power was switched off.

Selecting the AM or FM frequency band

Push the “AM/FM” button to select the desired frequency band. Pushing the button more than once will alternate between AM, FM1 and FM2. These functions are used with the station memory buttons described under *How to tune radio stations*.

How to tune radio stations (Stereo Radio)

There are three ways for you to tune in to a particular station. You can manually locate the station by using the “TUNE” button, “SEEK” the station or select the station by using the memory preset buttons, which you can set to any desired frequency.

How to tune radio stations (Stereo Cassette Radio)

There are four ways for you to tune in to a particular station. You can manually locate the station by using Automatic Music Search “AMS”, “SEEK” the station, “SCAN” to the station or select the station by using the memory buttons, which you can set to any desired frequency.

Using the “TUNE” function (Stereo Radio)

You can change the frequency up or down one increment at a time by pressing and releasing either the right (+) or left (–) side of the “TUNE” button. To change frequencies quickly, press and hold down either the right or left side of the “TUNE” button.

Manual tuning adjusts your radio to any allowable broadcast frequency, whether or not a station is present on that frequency. (See *All About Radio Frequencies* in this section.)

Using the “AMS” function to manually tune your radio (Stereo Cassette Radio)

You can change the frequency up or down one increment at a time by first pressing the “AMS” button (display shows “TUNE”) then within approximately five seconds pressing and releasing either the right ► or left ◀ side of the “SEEK” button. To change frequencies quickly, press and **hold down** either the right or left side of the “SEEK” button.

Using the “SEEK” function

This feature on your radio allows you to automatically select listenable stations up or down the frequency band. Press the right ► side of the “SEEK” button to select the next listenable station up the frequency band. Press the left ◀ side of the button to select the next listenable station down the frequency band. By holding the button down, listenable stations can be passed over to reach the desired station.

Using the “SCAN” function (Stereo Cassette Radio)

Press the “SCAN” button to enter the scan mode. The radio will begin scanning up the frequency band, stopping on each listenable station for approximately a five-second sampling. This continues until you press the “SCAN” button a second time.

Setting the Station Memory Preset buttons

Your radio is equipped with 5 station memory buttons. These buttons can be used to select up to 5 preset AM stations and 10 preset FM stations (5 in FM1 and 5 in FM2).

Follow the easy steps below to set these buttons to the desired frequencies:

1. Select a band, then select a frequency.
2. Press one of the memory preset buttons and hold the button until the sound returns. That station is now held in memory on that button.
3. Follow the two steps above for each station memory preset button you want to set.

NOTE: If the vehicle's battery is disconnected, the clock and station memory preset buttons will need to be reset.

Adjusting the tone balance and speaker output of your radio

- Increasing or decreasing bass response

Push the "AUDIO" button repeatedly until the display reads "BASS." Push the right (+) side of the "VOLUME" button to increase bass (more "lows"), and push the left (-) side to decrease bass (less "lows").

- Increasing or decreasing treble response

Push the "AUDIO" button repeatedly until the display reads "TREB." Push the right (+) side of the "VOLUME" button to increase the treble (more "highs"), and push the left (-) side to decrease treble (less "highs").

Speaker features and operation

- Adjusting speaker balance

Balance control allows you to adjust the sound distribution between the right and left speakers. Push the "AUDIO" button repeatedly until the display reads "BAL." Push the right (+) side of the "VOLUME" button to shift the sound to the right speakers, and push the left (-) side to shift the sound to the left speakers.

□ Adjusting speaker fader

Fade control allows you to adjust the sound distribution between the front and rear speakers. Push the "AUDIO" button repeatedly until the display reads "FADE." Push the right (+) side of the "VOLUME" button to shift the sound to the front speakers, and push the left (-) side to shift the sound to the rear speakers.

NOTE: Illuminated bars in the display show relative levels of bass and treble and positions of speaker balance and fader functions after adjustments are made, then revert to volume level set.

Using the Controls of Your Cassette Tape Player (If equipped)

How to insert a tape

Insert a cassette (with the open edge to the right) firmly into the tape door opening, making sure the cassette is completely in and "seated."

NOTE: A cassette tape can be loaded with the ignition on whether or not the radio power is on. Inserting a cassette tape with the radio power off will turn the audio system on. After the cassette is ejected, radio play will return.

How to locate a desired track on the tape

NOTE: The tape track or side number indicated in the display does not necessarily correspond to the tape track or side number on the cassette label. It is used only to indicate when the tape mechanism reverses tracks.

- Using the Automatic Music Search (“AMS”) function with cassette tape player

Press and hold the “AMS” button (“AMS” will appear in the display). Then, push the left ◀◀ button to rewind to the beginning of the current selection or press the right ▶▶ button to fast forward to the beginning of the next selection.

- Fast forwarding the tape

Push the right ▶▶ button to fast forward the tape.

- Rewinding the tape

Push the left ◀◀ button to rewind the tape.

- How to change the side of the tape being played

The alternate track (other side) of the tape can be selected at any time by pushing both fast-wind buttons (◀◀ and ▶▶) at the same time. The number in the display will alternate between 1 and 2.

How to eject the tape

To stop the tape and eject the cassette, press the eject (▲) button. The radio will resume playing.

Using the Dolby® B noise reduction feature

NOTE: Noise reduction system manufactured under license from Dolby Labs Licensing Corporation. “Dolby” and double-D symbol are trademarks of Dolby Laboratories Licensing Corporation.

Push station memory button 3 to activate Dolby® B Noise Reduction.

Tips on Caring for the Cassette Player and Tapes

In order to keep your cassette tape player performing the way it was meant to, read and follow these simple precautions:

- Using a Ford or equivalent cassette cleaning cartridge to clean the tape player head after 10-12 hours of play will help maintain the best playback sound and proper tape operation.
- Only cassettes that are 90 minutes long or less should be used. Tapes longer than 90 minutes are thinner and subject to breakage or may jam the tape player mechanism.
- Protect cassettes from exposure to direct sunlight, high humidity and extreme heat or cold. If they are exposed to extreme conditions, allow them to reach a moderate temperature before playing.
- If a tape is loose inside the cassette, tighten it before playing by putting your finger or a pencil into one of the holes and turning the hub until the tape is tight.
- Loose labels on cassette tapes can become lodged in the mechanism. Remove any loose label material before inserting a cassette.
- Do not leave a tape in the cassette tape player when not in use. High heat in the vehicle can cause the cassette to warp.

Clock Operation

How to view the clock mode

Press the “CLOCK” button to alternate the frequency and time in the display. In the clock mode, pressing any radio function will automatically display the radio frequency for approximately ten seconds before changing back to the clock mode.

How to set the clock

1. Turn the radio on.
2. Press and hold in the “CLOCK” button. Press the “SEEK” button left (◀) to advance the hours and right (▶) to advance the minutes.

NOTE: The clock displays 12-hour time with no AM/PM indications.

Radio Antenna

The radio antenna is mounted on the rear passenger side quarter panel of the vehicle. It is a fixed mast antenna and cannot be retracted.

Common Radio Reception Conditions

Several conditions prevent FM reception from being completely clear and noise-free, such as the following:

1. Distance/Strength

The strength of the FM signal is directly related to the distance the signal must travel. The listenable range of an average FM signal is approximately 25 miles (40 kilometers). Beyond this distance, the radio is operating in a fringe area and the signal becomes weaker.

2. Terrain

The terrain (hilly, mountainous, tall buildings) of the area over which the signal travels may prevent the FM signal from being noise-free.

Repeated pops and hisses which are heard during an otherwise clear broadcast can occur near the station because of the “line of sight” characteristic of FM radio waves.

If there is a building or large structure between the antenna and station, some of the signal “bends” around the building, but certain spots receive almost no signal. Moving out of the “shadow” of the structure will allow the station to return to normal.

When the radio waves are reflected off objects or structures, the reflected signal cancels the normal signal, causing the antenna to pick up noise and distortion. Cancellation effects are most prominent in metropolitan areas, but also can become quite severe in hilly terrain and depressed roadways.

To minimize these conditions, a stereo/mono blend circuit has been incorporated into this system. This feature automatically switches a weak stereo signal to a clearer monaural signal, which improves the quality of reception.

Several sources of static are normal conditions on AM frequencies. These can be caused by power lines, electric fences, traffic lights and thunderstorms.

Another reception phenomenon is **Strong Signal Capture and Overload**. This can occur when listening to a weak station and when passing another broadcast tower. The close station may capture the more distant station, although the

displayed frequency does not change. While passing the tower, the station may switch back and forth a few times before returning to the original station.

When several broadcast towers are present (common in metropolitan areas), several stations may overload the receiver, resulting in considerable station changing, mixing and distortion.

Automatic gain control circuitry for both AM and FM bands has been incorporated into this system to reduce strong signal capture and overload.

All About Radio Frequencies

The Federal Communications Commission (FCC) and the Canadian Radio Telecommunications Commission (CRTC) establish the frequencies that AM and FM radio stations may use for their broadcasts. The allowable frequencies are, AM: 530, 540...1600, 1610 kHz in 10 kHz steps; FM: 87.9, 88.1...107.7, 107.9 MHz in 0.2 MHz steps.

Not all frequencies will be assigned to a given area. This radio will tune to each of these frequencies using manual tune and no fine tuning is necessary as radio stations may not use other frequencies.

Some FM radio stations advertise a “rounded-off” frequency which is not the frequency they actually broadcast on. For example, a radio station that is assigned a frequency of 98.7 MHz may call itself “Radio 99” even though 99.0 MHz is not an allowable FM broadcast frequency.

Important Warranty and Service Information

Warranty

Your sound system is warranted for three years or 36,000 miles (60,000 kilometers), whichever comes first. Consult your vehicle warranty booklet for further information. Ask your dealer for a copy of this limited warranty.

Service

At Ford, we stand behind our audio systems with a comprehensive service and repair program. If anything should go wrong with your Ford audio system, return to your dealer for service. There is a nationwide network of qualified Ford authorized repair centers to assist you.

Controls and Features

Your vehicle has a variety of features designed for your comfort, convenience and safety. Read this chapter to find out about standard and optional features.

The main controls for the climate control system, clock, and radio are on the instrument panel.

Instrument panel

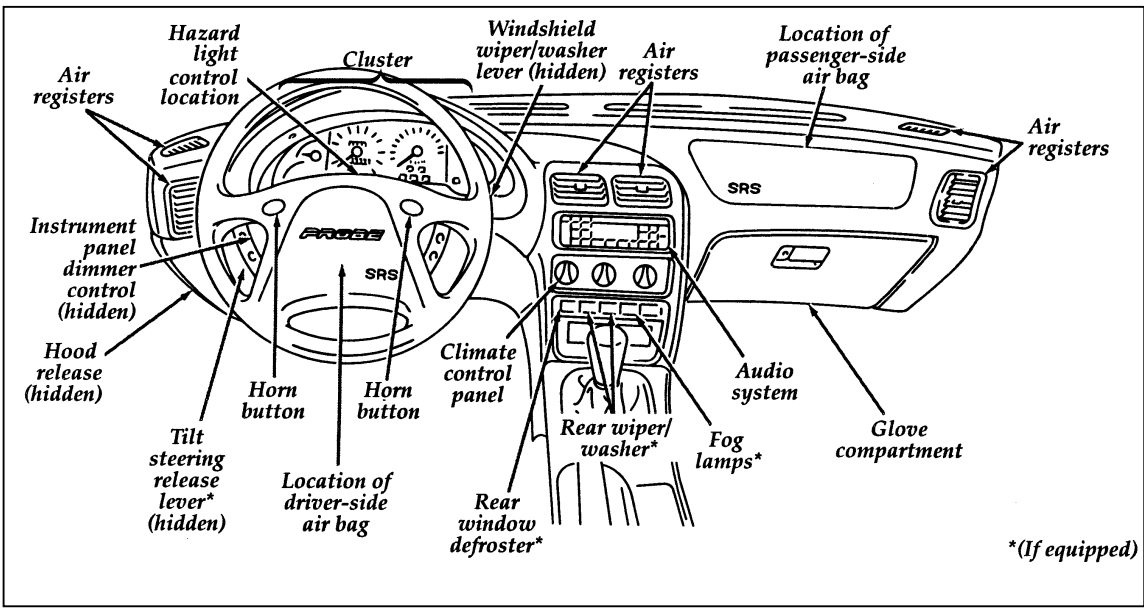

**(If equipped)*

NOTE: Any cleaner or polish that increases the gloss (shine) of the upper part of the instrument panel should be avoided. The dull finish in this area is to help protect the driver from undesirable windshield reflection.

The Climate Control System

Heating Only System (Without Air Conditioning)

Function selection

The heater in your vehicle has three controls used for air direction, temperature and fan speed. The function selector control lets you direct heated or unheated air through the instrument panel registers, or down to the floor. It also allows you to vent your vehicle with outside air.

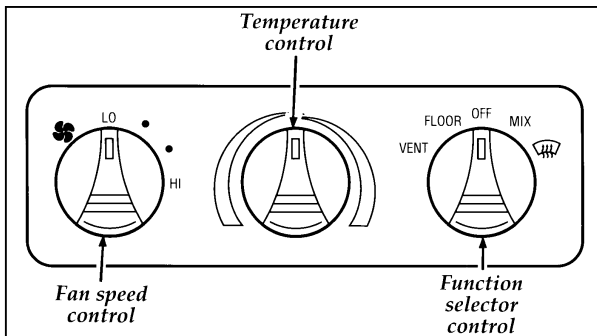

Heating only system control panel

Turning the function selector control all the way to the right (✓) directs air to defroster vents and the side window defoggers only.

With the function selector control in the MIX position, air is directed out the defrosters, side defoggers and the floor heater outlets.

The FLOOR position directs air out the floor outlets and the side window defoggers.

Ventilate your vehicle with outside air by choosing the VENT position.

Temperature control

The air temperature can be adjusted by moving the marker on the temperature control to the red area for warm air, or to the blue area for unheated air. The air will become warmer or cooler depending on how far the control is turned.

Fan speed control

Fan speed can be controlled by turning the control from LO to HI.

Turning On the Heat

To heat the inside of your vehicle:

1. Turn the function selector control to FLOOR.

When FLOOR is selected, air is directed through the floor registers, and a little air is also directed at the windshield and side windows to help prevent fogging.

2. Turn the temperature control all the way to the right in the red area, or to the desired temperature.
3. Set the fan at the desired speed.

Defrosting the Windshield and Side Windows

1. Turn the function selector control to the defrost position.

When ∇ is selected, air is directed to the windshield and side windows.

2. Turn the temperature control to the desired temperature.
3. Set the fan at the desired speed.

Heating and Defrosting at the Same Time

1. Set the function selector control to MIX.
2. Set the temperature and fan speed as desired.

Ventilating Your Vehicle With Outside Air

On mild days, you may want to ventilate your vehicle with outside air. To open the vents:

1. Turn the function selector control to VENT.

When VENT is selected, air is directed out of the panel registers.

2. Turn the temperature control to the desired temperature.
3. Set the H (fan speed) as desired.

Tips for controlling the temperature in your vehicle

- To vary the temperature inside your vehicle, move the temperature selector toward the red area for warmer air and toward the blue area for cooler air.
- If you drive with the fan off and the windows closed, the windows may fog up. To prevent fogging:
 1. Set the function selector control to VENT, MIX, FLOOR or the \vee position.
 2. Set the desired temperature.
 3. Set the H (fan speed) to the desired position.
- Do not put objects under the front seats that will interfere with the flow of air to the back seats.
- Remove any snow, ice, or leaves from the area below the windshield on the outside of your vehicle. They could block the air intake.

Air Conditioning System (If equipped)

Operate the air conditioning by using the climate controls on the center of the instrument panel.

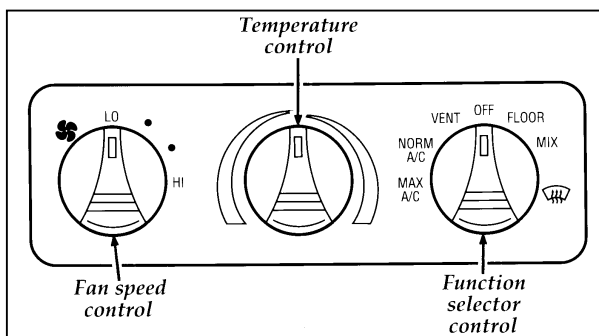

Air conditioning controls

Sometimes you may notice slight engine surging if you have the air conditioner on. This is normal, as the system is designed to cycle the compressor on and off to maintain desired cooling. The reduced compressor operation should benefit fuel economy.

On some vehicles with air conditioning, wide-open throttle acceleration will temporarily cut off the air conditioning.

Since the air conditioner removes a lot of moisture from the air during operation, it is normal for water to drip on the pavement under the air conditioner drain after you have stopped the vehicle.

Action for heating and windshield defrosting are identical for cars equipped with either the *Heating Only System* or the *Heating and Air Conditioning System*. For instructions about these functions, see the previous section, *Heating Only System*. For instructions about using the air conditioning, see the following sections.

If the inside of your vehicle is very warm, drive for a few minutes with the windows down. This forces most of the hot, stale air out of the vehicle and helps the air conditioning cool the vehicle faster.

MAX A/C

When MAX A/C is selected, cooled interior air is recirculated through the system. This position is more efficient than NORM A/C.

To cool your vehicle quickly in warm weather:

1. Turn the function selector control to MAX A/C.
2. Turn the temperature control to the blue (cool) area.
3. Set the fan at the desired speed.

Because MAX A/C uses recirculated air, MAX is usually more efficient than NORM A/C. You can switch to outside air NORM A/C at any time, especially after the vehicle has cooled down.

You may notice a slight odor when using the MAX A/C position. This is normal. If the odor becomes annoying, switch the function selector to NORM A/C.

To provide the most quiet operation when using MAX A/C, reduce the fan speed after a comfortable temperature has been reached.

NORM A/C

When maximum air conditioning is not needed, you can use the NORM A/C position to cool your vehicle with outside air. Cooling your vehicle this way brings in outside air and is quieter, but it is less efficient.

To cool your vehicle using outside air:

1. Turn the function selector control to NORM A/C.
2. Turn the temperature control all the way to left to the blue (cool) area.
3. Set the fan at the desired speed.

In mild weather, setting the function selector control in the VENT position will add cool air to your vehicle without using the air conditioning. You will get better fuel economy without using the air conditioning.

Engine Idle Speed Control System

Genuine Ford air conditioning (either factory-installed or dealer-installed) has an engine idle speed control system that compensates for engine speed loss that may occur when the air conditioning compressor is running. This idle speed control holds the engine idle essentially constant, regardless of whether the air conditioning system is on or off.

NOTE: Whenever service to the air conditioning system is required, make sure the service facility uses a refrigerant recycling system. These systems will capture the refrigerant for reuse. Releasing certain refrigerants into the atmosphere is hazardous to the environment.

Rear Window Defroster (If equipped)

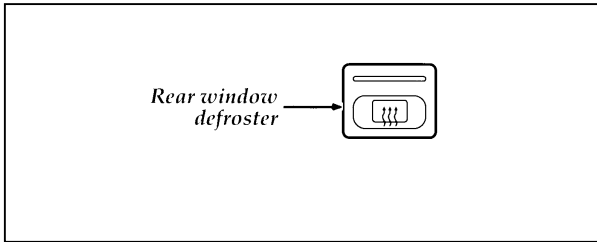

Rear window defroster button

The defroster for the rear window clears frost, fog, or thin ice from both the inside and outside of the rear window. The rear window defroster button is located on the lower right of the instrument panel below the climate control panel. This button is also used to activate your heated power mirrors (if equipped).

To defrost the rear window:

1. Clear any snow and/or ice from the rear window.
2. Get in your vehicle and start the engine.
3. Press the rear defrost button. The indicator light turns on.

The defroster turns off automatically after 15 to 25 minutes. If the window is not clear, turn on the defroster again. It will also automatically shut off any time the engine is shut off.

NOTE: Never use sharp instruments or window cleaners with abrasives to clean the inside of your rear window. If you do, you may damage the heating elements that are bonded to the inside of the rear window and cause damage to the rear window defroster.

Rear Window Wiper and Washer

The rear window wiper and washer buttons are located on the instrument panel below the climate control panel.

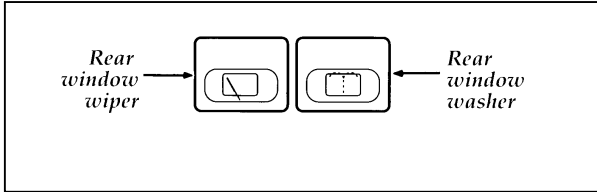

To operate the rear wiper, push the rear window wiper button. Push the button a second time to turn the wiper off. To operate the rear washer, push and hold the rear window washer button in. The washer will spray until the button is released.

Fog Lamps (If equipped)

The fog lamps only operate when the headlamps are on low beam. To activate fog lamps, push the button on the control panel below the climate controls. An indicator light on the button will illuminate. Push the button again to turn the fog lamps off.

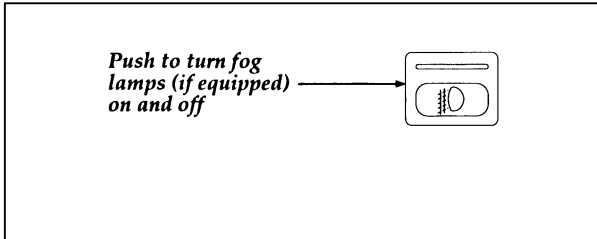

Fog lamp button

Interior Lights

Lighting Up the Interior and Instrument Panel

With the parking lamps or headlamps on, the brightness of the instrument panel lighting can be adjusted.

To brighten or dim the instrument panel lighting, rotate the dimmer control thumbwheel as desired.

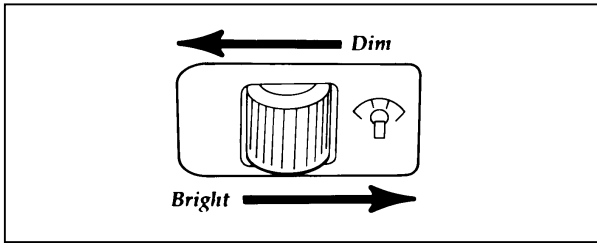

Dimmer control thumbwheel

The dimmer control thumbwheel is located to the left of the steering wheel on the instrument panel.

Dome Lamp

The dome lamp illuminates whenever one of the front doors is opened and turns off automatically when the doors are closed. You may turn the dome lamp on and off while the doors are closed by using the ON/OFF switch located on the interior/map lamp control panel.

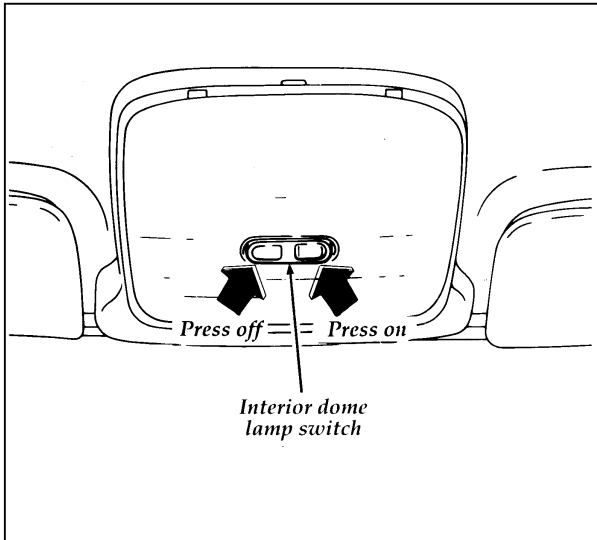

Interior/map lamp control panel

Map lamps (if equipped)

The map lamps can be turned on by using the interior/map lamp control panel located between the sun visors.

There are two map lamps, one for the driver and one for the passenger. To turn on the map lamp, push the button that is next to the lamp. Push the buttons again to turn the map lamps off.

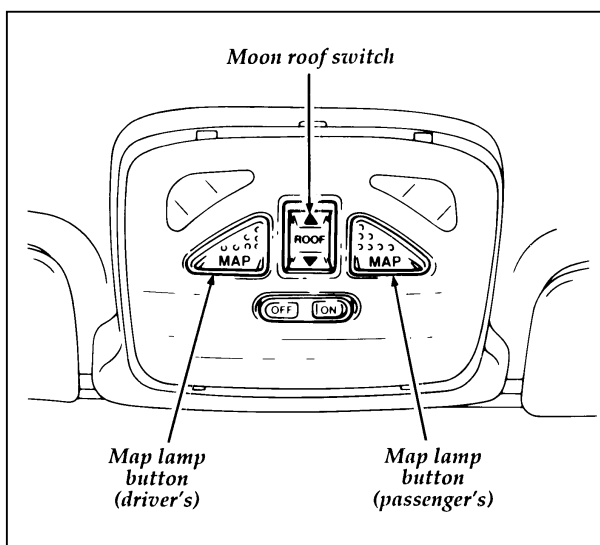

Radio

For information about the radio in your vehicle, refer to the *Electronic Sound Systems* chapter in this Owner Guide.

Clock Controls on Electronic Radios

The electronic radios have a built-in clock. For complete operating instructions, refer to the *Electronic Sound Systems* chapter in this Owner Guide.

Ignition

Understanding the Positions of the Ignition

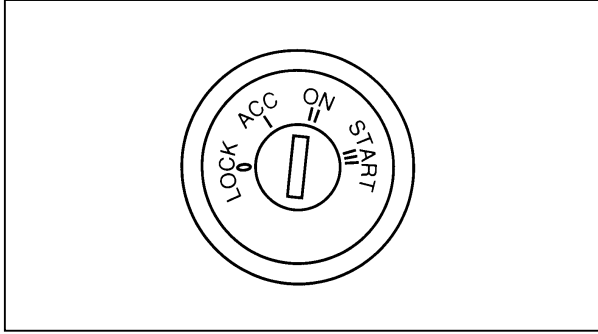

Ignition lock cylinder

LOCK locks the steering wheel. It also locks the gearshift lever in P (Park) (automatic transaxle).

LOCK is the only position that allows you to remove the key. The LOCK feature helps to protect your vehicle from theft.

To remove the key if you have a manual transaxle, push the key in while turning it to the LOCK position.

If your key is stuck in the LOCK position and will not turn, move your steering wheel left or right until the key turns freely.

ACC (Accessory) allows some of your vehicle's electrical accessories to operate while the engine is not running.

ON allows you to test your vehicle's warning lights (except the brake system warning light) to make sure they work before you start the engine. The key returns to the ON position once the engine is started and remains in this position while the engine runs.

START cranks the engine. Release the key once the engine starts so that you do not damage the starter. The key should return to ON when you release it. The START position also allows you to test the brake warning light.

The Turn Signal Lever

You can use the turn signal lever on the left side of the steering column to:

- operate the headlamps and parking lamps
- operate the turn signals and cornering lamps
- turn the high beams on/off
- flash the lamps

Headlamps and Parking Lamps

To turn the parking lamps or headlamps on, twist the knob at the end of the turn signal lever.

FIRST STOP — Turning the knob to the first stop (C) will turn on the license plate lamps, parking lamps, side marker lamps, tail lamps and instrument panel lamps.

SECOND STOP — Turning the knob to the second stop (B) will turn on the headlamps, license plate lamps, parking lamps, side marker lamps, tail lamps, and instrument panel lamps.

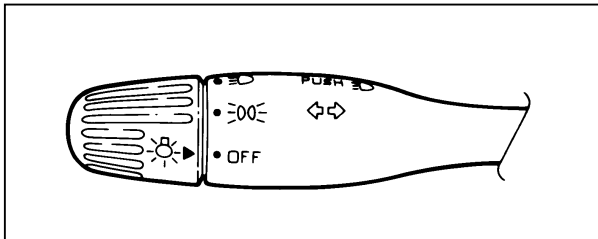

Headlamp control

Daytime Running Light System

(Canadian vehicles only)

In Canada, the lights illuminate during daytime operation. The Daytime Running Light system (DRL) automatically illuminates when the ignition switch is turned to the ON position. The daytime running lights are switched off under the following conditions:

- when the headlamps are switched on
- when the parking brake is applied
- when the flash-to-pass system is used

WARNING
The Daytime Running Light (DRL) system will not illuminate the tail lamps and parking lamps. Turn on your headlamps at dusk. Failure to do so may result in a collision.

Raising the Headlamps Manually

If the power headlamp door system becomes inoperative, your vehicle has a manual retractor system that allows you to raise the headlamps manually (the headlamps will not turn on). The retractors are located under the hood and behind each headlamp. Remove the cap and turn the knob. Each headlamp must be raised separately.

Before using the manual retractors to raise your headlamps, the RETRA fuse must be removed.

Open the main fuse panel. Refer to the underhood fuse panel in *Servicing Your Probe* later in this owner guide. Pull the RETRA (20A) fuse straight out.

Inspect the removed fuse. If it is blown, replace it with a new one of the same rating. If it isn't blown or if a new fuse does not solve the problem, remove it and operate the headlamp manually.

WARNING

<p>Always remove the RETRA (20A) fuse before manually operating a headlamp retractor or attempting to remove anything from the headlamp. Failure to remove the RETRA fuse could cause injury to a hand or fingers.</p>

WARNING

<p>When reinstalling the RETRA fuse, make sure nothing is near the headlamp retractor. It may move suddenly while the fuse is being inserted, causing injury to hands and fingers.</p>

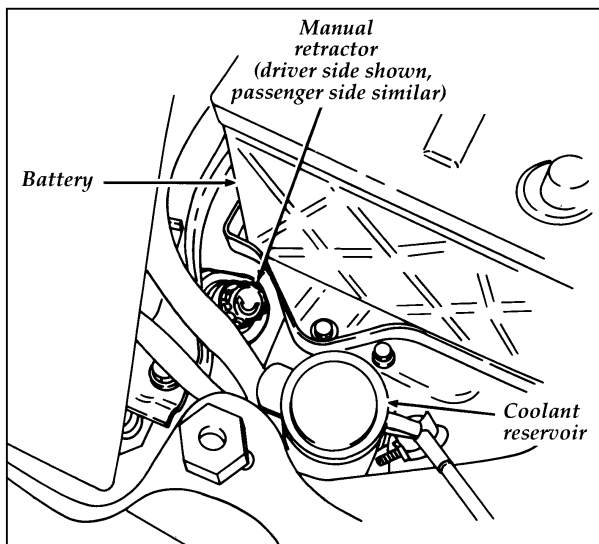

Manual headlamp retractors located behind the headlamps

High Beams and Flashing the Lamps

To turn on the high beams, turn the headlamp control knob to the headlamp ON position and push the turn signal lever away from you until it latches. When the high beams are ON, the high beam indicator light on the instrument panel comes on.

To turn off the high beams, pull the lever toward you until it latches. The high beam indicator light turns off.

Flashing the Lights

To flash the headlamps, pull the lever toward you for a moment and then release it. The headlamps will flash whether the headlamp knob is in the on or off position.

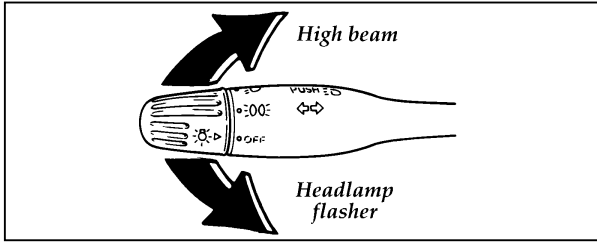

Highbeam and flash-to-pass operation

If the headlamps are retracted when you pull the lever toward you, they will pop up and flash.

Turn Signals

Move the lever up to signal a right turn. Move it down to signal a left turn. The corresponding indicator light in the instrument cluster will flash.

If the turn signal stays on after you turn, move the lever back to the center (OFF) position.

For lane changes, move the lever far enough to signal but not to latch. The lever will return to the off position when you release it.

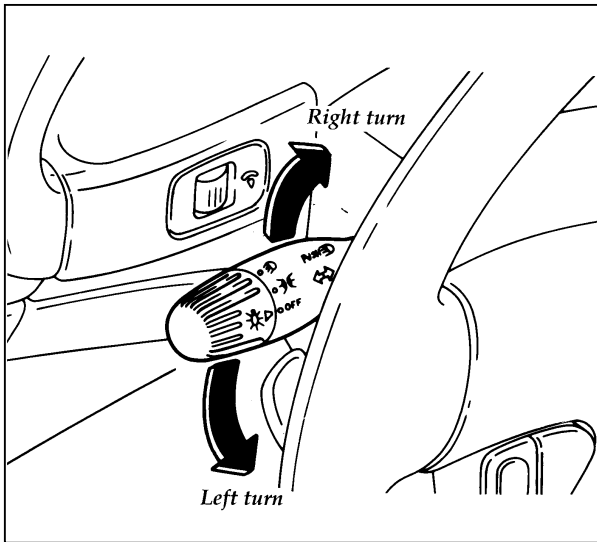

Turn signal

Windshield Wipers and Washer

To operate the windshield wipers and washers, make sure your ignition key is turned to the ON position.

The windshield wipers have two speeds. To operate the wipers, pull down the lever on the right side of your steering column. The first position is LO (Low) and the second position is HI (High). To turn the wipers off, return the lever to the uppermost position.

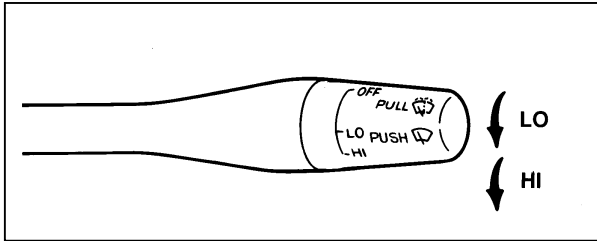

Windshield wiper control

ONE-TOUCH WIPER CONTROL (If equipped)

— For one wiping cycle, push the lever away from you and release it with the lever in the OFF or interval position. The ignition switch must be in the ON position for this operation.

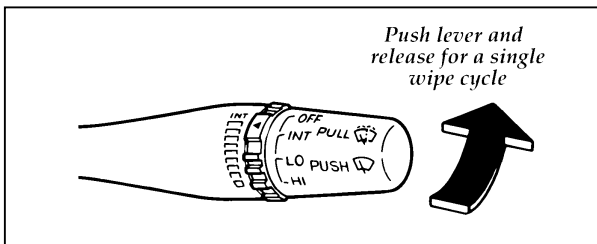

One touch wiper control

Interval Wipers (If equipped)

In addition to two speed wipers, your vehicle may have wipers that you can set to operate at varying intervals. For example, you can set the interval so they wipe less often when it drizzles and more often in heavier rain.

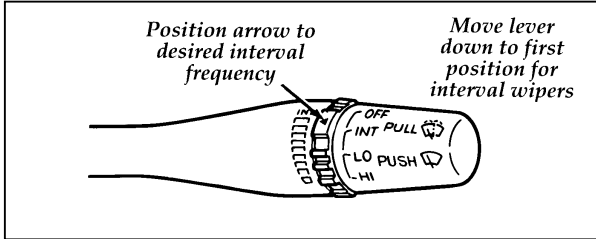

Variable interval wiper control

To set the interval wipers, pull the lever down to the first position. Turn the ring on the lever to the frequency of wiper operation you desire.

Windshield Washer

To clean the windshield, pull the wiper lever toward you. Washer fluid sprays until the lever is released.

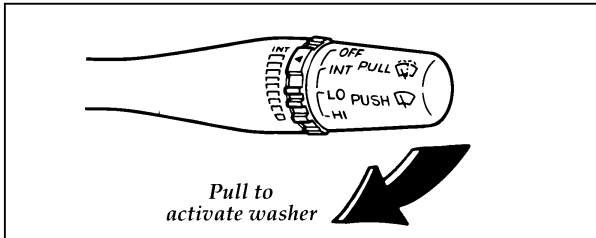

Windshield washer/control

If the washer does not work, check the washer fluid level visually and fill if needed. See *Servicing Your Probe* later in this owner guide. If there is fluid in the reservoir, and your washer doesn't work, consult your Ford or Lincoln-Mercury dealer.

Do not try to clean the windshield when the washer fluid container is empty or activate the washers at any time for more than 15 seconds continuously. This could damage the washer pump system.

WARNING
Always warm up the windshield with the defroster before you use the washer fluid. In freezing weather, the washer solution may freeze on the windshield and obscure your vision.

Tilt Steering Column (If equipped)

WARNING
Never adjust the steering wheel when the vehicle is moving.

To change the position of the steering column/wheel, pull the release lever on the column toward you. Tip the steering wheel to the desired position. Release the lever to lock the steering wheel in place.

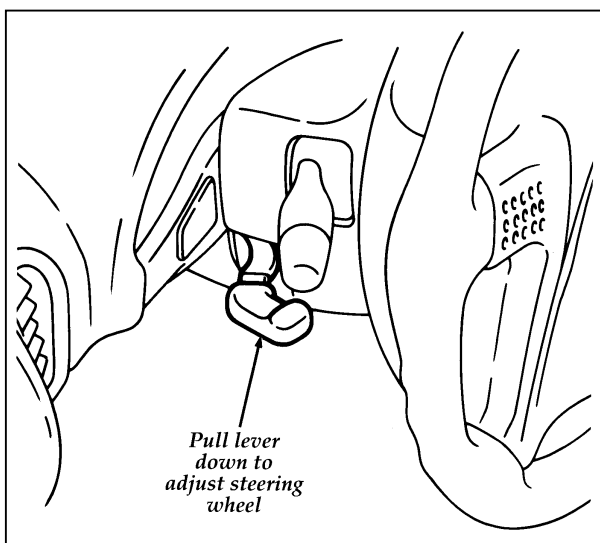

Tilt steering column

Speed Control (If equipped)

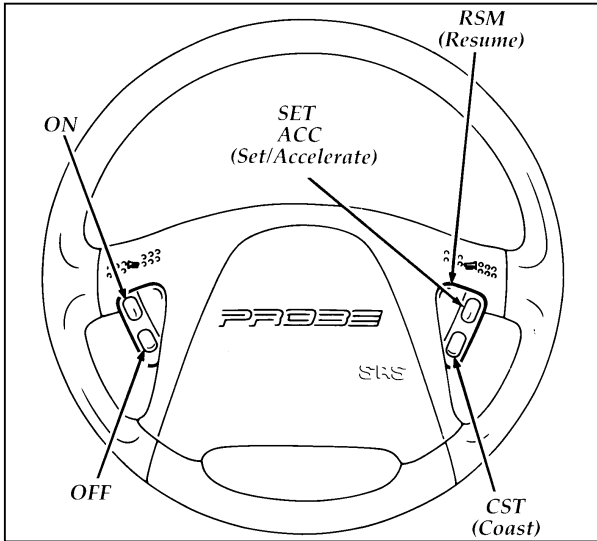

Speed control switches on the steering wheel

To Turn Speed Control Off

Press OFF, or

Turn off the vehicle ignition.

Once speed control is switched off, the previously programmed set speed will be erased.

To Turn Speed Control On

Press ON

To Set a Speed

Press SET ACC. For speed control to operate, the speed control must be ON and the vehicle speed must be greater than 30 mph (48 km/h).

If you drive up or down a steep hill, your vehicle speed may vary slower or faster than the set speed. This is normal.

Speed control cannot reduce the vehicle speed if it increases above the set speed on a downhill. If your vehicle speed is faster than the set speed while driving on a downhill in j (Overdrive), you may want to shift to the next lower gear to reduce your vehicle's speed.

WARNING
To keep your vehicle under control, do not use speed control in heavy traffic or on roads that are winding, slippery, or unpaved.

To Set a Higher Speed

Press and hold SET ACC. Release the switch when the desired vehicle speed is reached, or

Press and release SET ACC. Each press will increase the set speed by 1 mph (1.6 km/h) (2.0L with automatic transmission only), or

Accelerate with your accelerator pedal, then press SET ACC.

You may accelerate with the accelerator pedal at any time during speed control usage. Releasing the accelerator pedal will return your vehicle speed to the previously programmed set speed.

To Set a Lower Set Speed

Press and hold CST. Release the switch when the desired vehicle speed is reached, or

Press and release CST. Each press will decrease the set speed by 1 mph (1.6 km/h) (2.0L with automatic transmission only), or

Depress the brake pedal. When the desired vehicle speed is reached, press SET ACC.

To Disengage Speed Control

Depress the brake pedal, or

Depress the clutch pedal (if equipped).

Disengaging the speed control will not erase the previously programmed set speed.

To Return to a Set Speed

Press RSM. For RSM to operate, the vehicle speed must be faster than 30 mph (48 km/h).

Moon Roof (If equipped)

The control switch for the sliding moon roof is on the interior/map lamp control panel located above the windshield and between the sun visors. The ignition must be in the ON position for the moon roof to be operational.

To open the sliding moon roof to the vent position, push the recessed part of the moon roof switch until the back of the moon roof tilts into the vent position. You must release the switch after opening the vent before pressing it again to slide the moon roof open. To close, push the other side of the switch until the moon roof sets back into place.

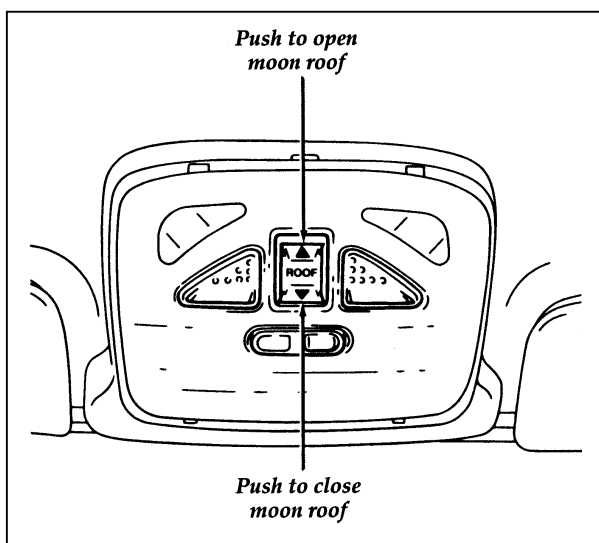

Sliding moon roof control switch

Press the switch until the moon roof is opened to the desired position. When you release the switch, the moon roof will stop sliding open. To close the moon roof, press the other side of the switch and hold it until the roof is closed to the desired position.

Doors

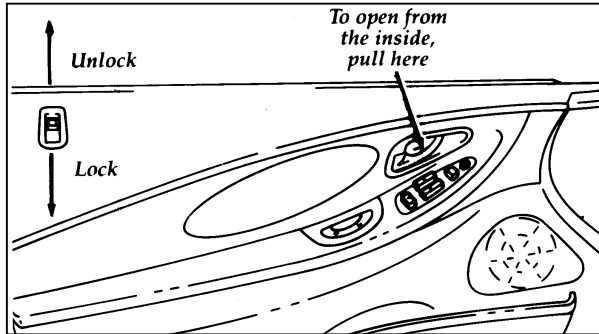

The inside of the door

If you close the door with the lock button depressed, the door will remain locked.

Power Door Locks (If equipped)

If your vehicle has power door locks, the controls to lock the doors are below the inside door handles on each door. When you close the doors after you set the door locks, the doors remain locked. If the power mechanism ever fails, the manual door locks will override the power controls.

NOTE: Vehicles equipped with power locks have a safety feature which allows you to unlock one or both front doors from either door key lock cylinder. To unlock the driver's or passenger door only, insert the key in the door lock cylinder and turn to the left (counterclockwise) to the first position. To unlock the other door at the same time, simply continue turning the key to the left to the second position. Both doors are locked by turning the key to the right (clockwise).

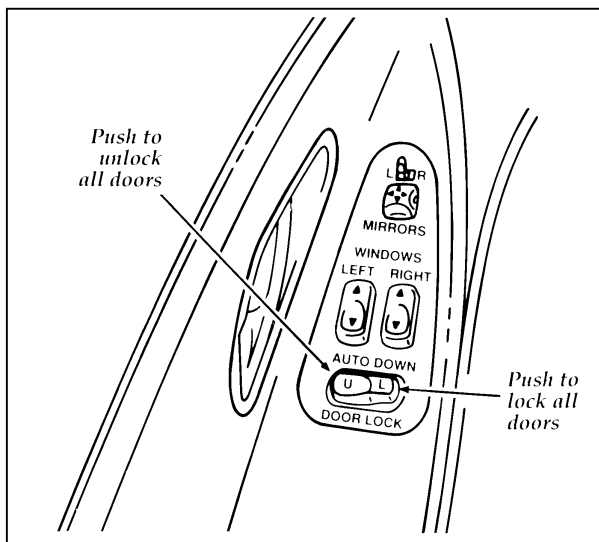

Power locks on the driver's door

Windows

Using the Power Windows (If equipped)

Each door has a power control that opens and closes the window on that door. The driver's door has a master control panel that operates both windows.

To use your power windows, your ignition switch must be placed in the ON position. Press the recessed end of the power window switch to lower a window, press the raised end of the switch to raise a window.

NOTE: Your vehicle is equipped with a “one touch down” feature. This feature allows the driver to fully open the driver's window by firmly pressing the switch and then releasing. The switch will release when the window has fully opened.

WARNING

Do not let children play with the power windows.

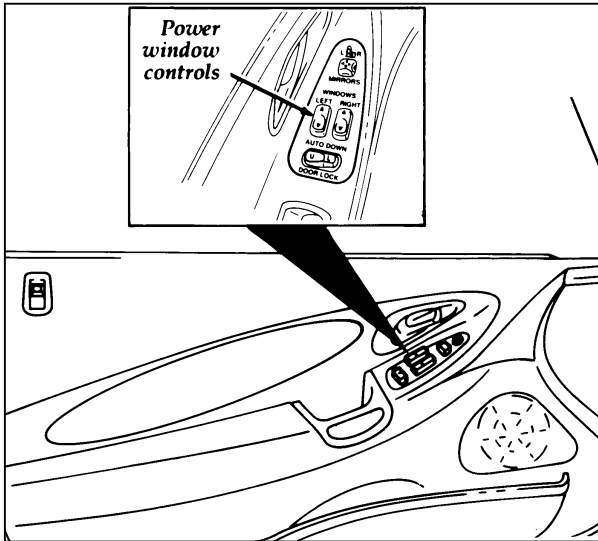

Master window control on the driver's door

Mirrors

WARNING

The right side view mirror makes objects appear smaller and farther away than they actually are.

Dual-Electric Remote Control Mirrors (If equipped)

Dual-electric remote control mirrors are collapsible. The mirror heads can be folded rearward to prevent damage when using an automatic car wash.

To adjust the side mirrors:

1. Locate the control switch in the power control panel on the driver's door.
2. Select the right or left mirror by moving the selector switch right or left.
3. Push the control switch in the direction you want to move the mirror.
4. Return the selector switch to the middle OFF position to keep the mirror in place.

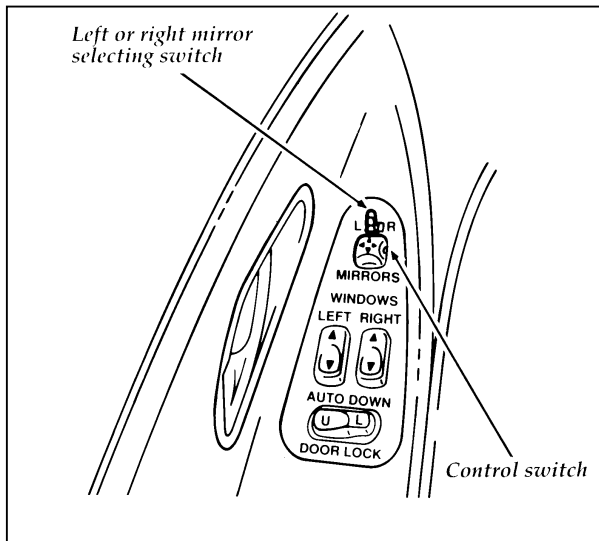

Dual-electric side mirror control switches

Console

A fully-equipped console on your vehicle will include the following items:

- ashtray and lighter
- parking brake lever
- cupholder or storage compartment with cupholder

Storage Compartments

Your vehicle may have several small storage compartments:

- a glove compartment that locks and unlocks using the ignition key
- two map pockets on the door panels (if equipped)
- storage compartment below the climate controls
- a storage bin in the center console

WARNING
Do not put objects on the ledge between the back seat and the rear window, as they can become dangerous projectiles and injure someone.

Center Console Storage (If equipped)

To open the center console storage bin, push the button and slide the lid back. When it is back as far as it will go, push the button and lift the lid.

Cupholders

The cupholders are located inside the center console storage bin. The driver cupholder is integrated in the storage bin. To use the passenger cupholder, rotate it upward then twist the cupholder until it is in a horizontal position. When the passenger cupholder is not in use, twist it back to the vertical position and rotate it into the storage bin.

NOTE: Do not place heavy objects in the cupholders.

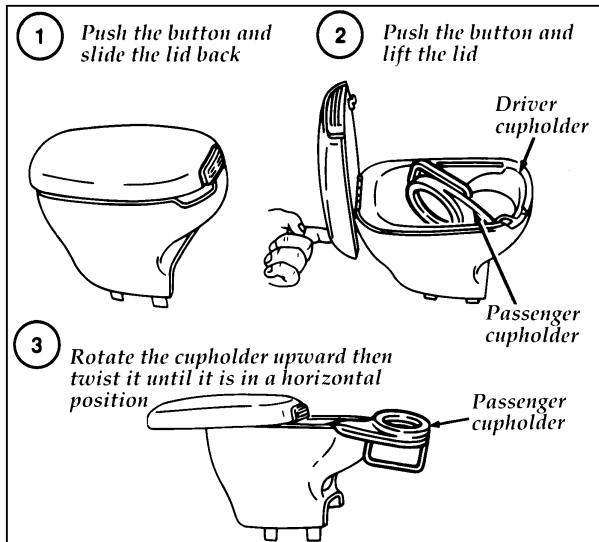

Using the cupholders

Hatchback

Opening and Closing the Hatchback

To open the hatchback from the outside:

1. Put the key into the lock located on the right side, in the tail lamp just above the bumper.
2. Turn the key to the right to unlock.
3. Remove the key before you close the hatchback.

NOTE: When the hatch is unlocked the cargo lamp will illuminate.

4. Using both hands, shut the hatchback completely. Do not slam it.
5. Pull up on the hatchback to make sure it is securely latched.

To prevent premature wear or damage to the hatchback lift cylinders and attaching hardware, the hatchback must be fully closed before you drive your vehicle.

WARNING
If you drive with the hatchback lid open, you will draw dangerous exhaust fumes into your vehicle.

If you must drive like this, keep the vents open so outside air comes into the vehicle.

Using the Remote Control for the Hatchback

To release the hatchback from inside the vehicle, simply pull up on the remote release lever, which is located in front of the driver's seat, near the door.

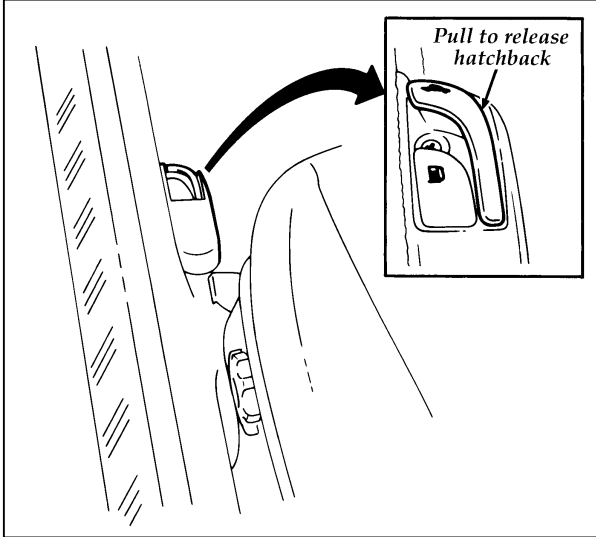

Remote control for the hatchback

Using the Luggage Compartment Cover

This cover lets you conceal cargo in the luggage compartment. The cover will lift automatically when the hatchback lid is opened.

WARNING

Do not put objects on the ledge between the back seat and the rear window, as they can become dangerous projectiles and injure someone.

To remove the luggage compartment cover:

1. Raise the hatchback to the fully open position.
2. Standing outside the vehicle, unfasten the lift cords from the hatchback lid.
3. Disconnect the two front package tray lift cords from the lower trunk side trim.
4. Lower the cover and slide it rearward to disengage it from the sockets and remove it.

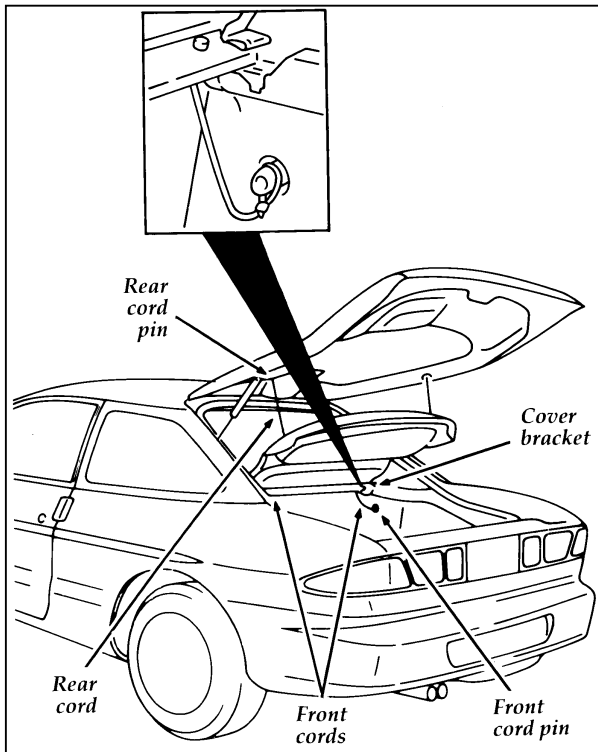

The luggage compartment and cover

WARNING
The cover may cause injury in a sudden stop or accident if it is not securely installed.

To install the luggage compartment cover:

1. Raise the hatchback to the fully open position.
2. From outside the vehicle, position the cover in its sockets.
3. Attach the lift cords to the hatchback lid.
4. Connect the two front luggage compartment cover lift cords to the lower trunk side trim.
5. Close the hatchback.

WARNING
Do not push down on the luggage compartment cover when the lift cords are attached to the open hatchback lid. This could cause the hatchback lid to close unexpectedly.

Remote Keyless Entry System (If equipped)

Your vehicle may be equipped with a remote keyless entry system. This option will allow you to open your vehicle using a remote transmitter from distances of up to 33 feet (10 meters) away. The remote feature will operate only when the ignition is in the OFF position.

The transmitter can unlock the driver's door, unlock all doors, lock all doors, or activate the vehicle's horn and hazard warning lamps for the panic alarm feature.

By pressing the UNLOCK button on the transmitter once, you can unlock the driver side door. Pressing the UNLOCK button a second time within five seconds of unlocking the driver's door will unlock the other doors.

You can lock all your vehicle doors by pressing the LOCK button. If you press the LOCK button a second time within five (5) seconds, the horn will sound briefly to verify that the doors have been locked.

When the PANIC button is pressed, the horn will sound and the hazard warning lamps will flash. This will continue for up to approximately two minutes and 45 seconds unless it is turned off by pressing the PANIC button a second time. The panic mode can also be cancelled by turning the ignition key to ON or ACC.

Up to four transmitters can be programmed for your vehicle. Your vehicle comes with two transmitters. Additional transmitters can be ordered from your dealer.

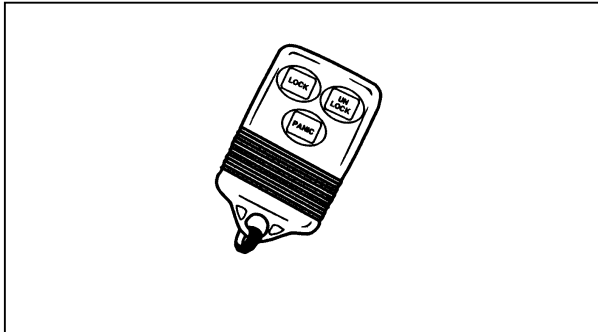

Remote keyless entry transmitter

The remote keyless entry system is equipped with an illuminated entry system.

When the system is activated, the dome lamp will illuminate and will stay lit for approximately 25 seconds. The dome lamp will shut off when the doors are closed.

Replacing the Batteries

The remote entry transmitter is powered by two coin type three-volt lithium 1616 batteries (included) that should last for several years of normal use. If you notice a significant decrease in operating range, the batteries should be replaced. Replacement batteries can be purchased at most pharmacies, watch stores or at your Ford or Lincoln-Mercury dealer.

NOTE: The operating range of the remote entry system can also be affected by weather conditions (such as very cold temperatures) or structures around the vehicle (buildings, other vehicles, radio and TV towers, etc.). Typical operating range will allow you to be up to 33 feet (10 meters) away from your vehicle.

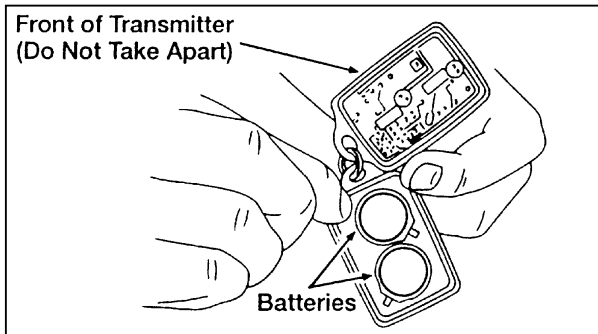

Opening the remote transmitter

The transmitter can be snapped apart to replace the batteries by twisting a thin coin between the two halves of the transmitter. **DO NOT TAKE THE FRONT PART OF THE TRANSMITTER APART.** Carefully remove the old batteries. When installing the new batteries, be sure to place the positive (+) side down as marked. Snap the two halves back together.

Replacement/additional transmitters

In the event a transmitter is lost, return the remaining transmitter(s) to your dealer for reprogramming of your remote entry system. This is necessary to prevent unauthorized use of the lost transmitter.

Additional transmitters may be purchased from your dealer (remote entry system will work with up to four transmitters). Follow the same programming procedure as above.

All transmitters must be programmed (or reprogrammed) at the same time. If the programming mode is entered and the transmitters are not programmed (or reprogrammed) at the same time, they will not operate with the system.

This device complies with Part 15 of the FCC Rules. Operation is subject to the following two conditions: (1) This device may not cause harmful interference, and (2) This device must accept any interference received, including interference that may cause undesired operation.

Seating and Safety Restraints

Seats

⚠ WARNING

Never adjust the driver's seat or seatback when the vehicle is moving.

⚠ WARNING

Always drive and ride with your seatback upright and the lap belt snug and low across the hips.
--

⚠ WARNING

Children should always ride with the seatback in the fully upright position.

Head Restraints

Head restraints help protect your head and neck in a collision. The head restraints on your vehicle are not adjustable.

Manual Seat Adjustments

You can move the front seats forward or backward or tilt the back of the seat forward or backward. The driver's seat also has controls for lumbar support (if equipped) and side bolster support (if equipped).

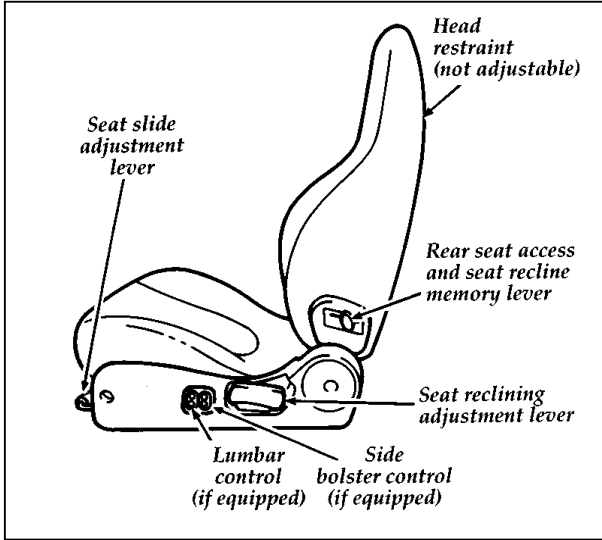

To move the seat forward or backward:

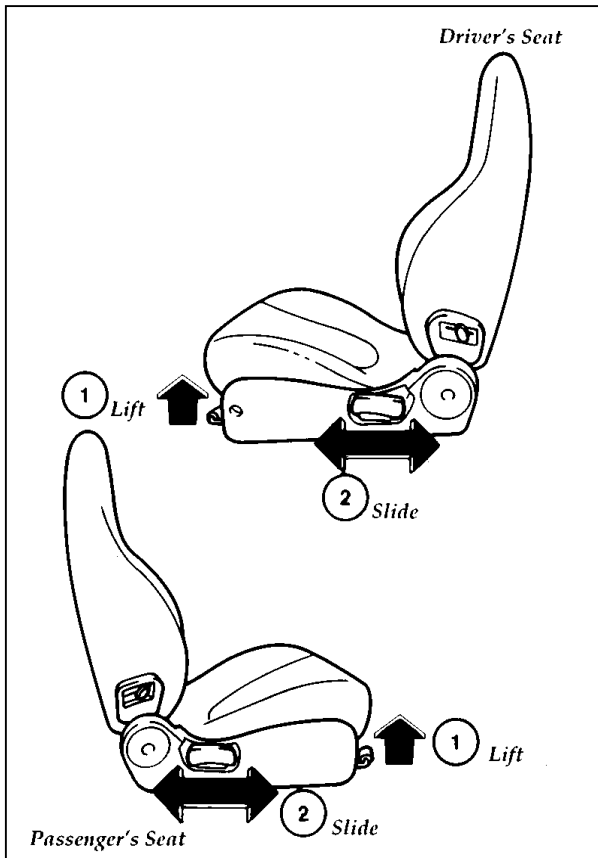

Manual seat controls for front seats

To recline the seatback:

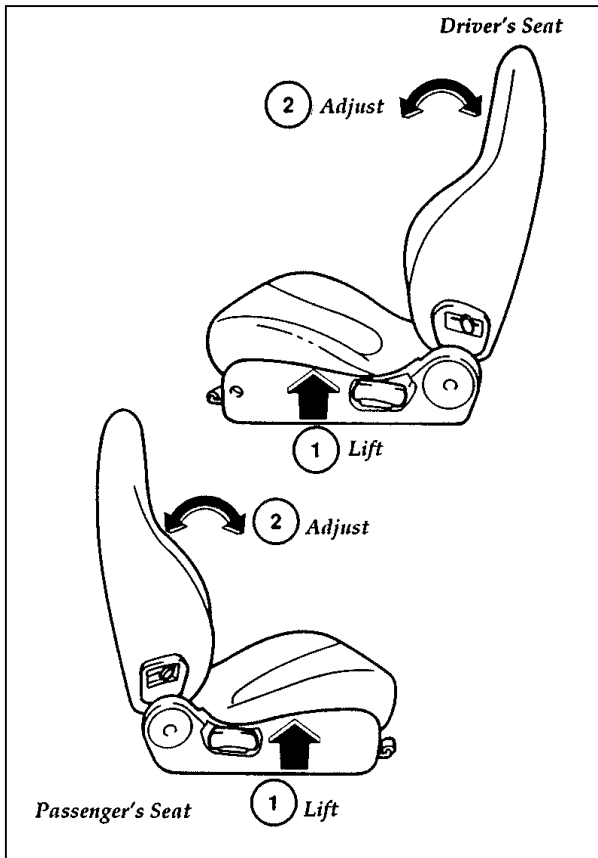

To gain access to the rear seat on the driver's or passenger's side:

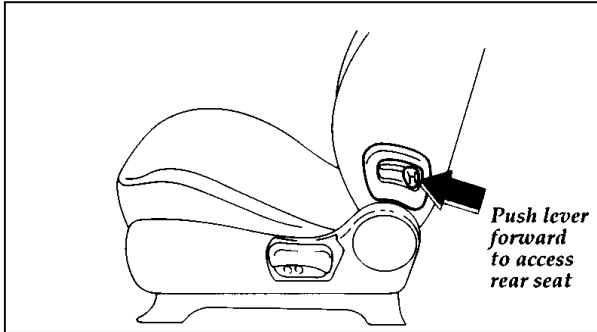

Seatback release lever for rear seat access

The seatback will return to its set reclined position when pushed back.

⚠ WARNING

Check to see that the seat and seatback are latched securely in position. Keep floor area free of objects that would prevent proper seat engagement. Never attempt to adjust the seat while the vehicle is in motion.

To inflate the driver's seatback lumbar support (if equipped) for lower back support, or to inflate the driver's seatback side bolster supports (if equipped):

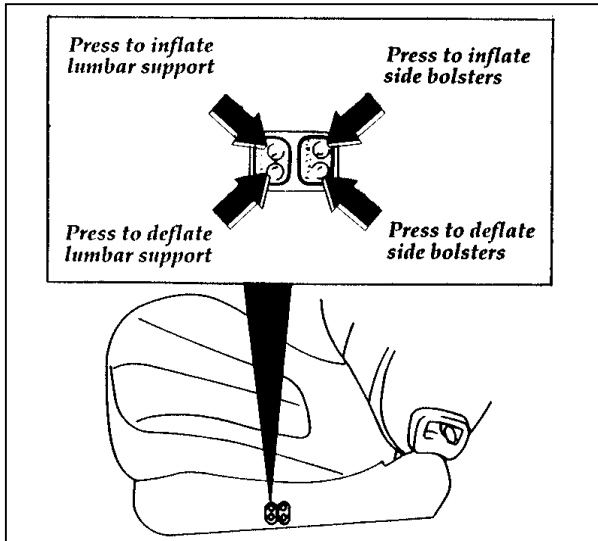

Six-Way Power Seat Adjustment (if equipped)

The six-way power seat control lever is located on the outermost side of the driver's seat.

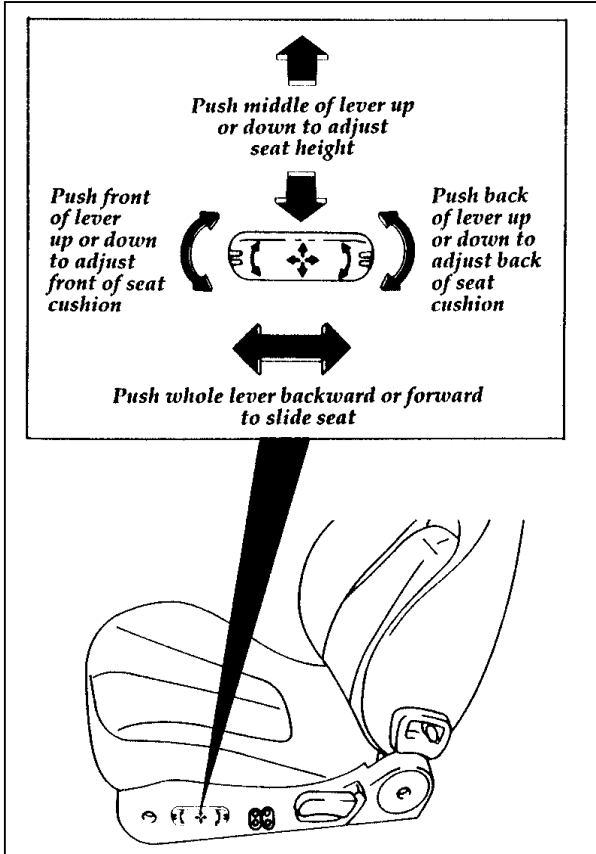

Your seat cushion power adjust lever is operated by a motor. To avoid damage to the motor, you should avoid operating this feature for an extended period of time. You should also avoid using the six-way power adjust lever continuously with the engine stopped. This could run down the battery.

Use the lever to make only one adjustment at a time.

Using the Split-Folding Rear Seat

Your vehicle is equipped with split-folding rear seats. One or both rear seatbacks can be folded down to provide additional cargo space.

NOTE: When folding down the rear seatback, the seat belt tongue should be hanging on the hook of the lower, side trim panel, near the edge of the side of the seat cushion.

To lower the rear seatback:

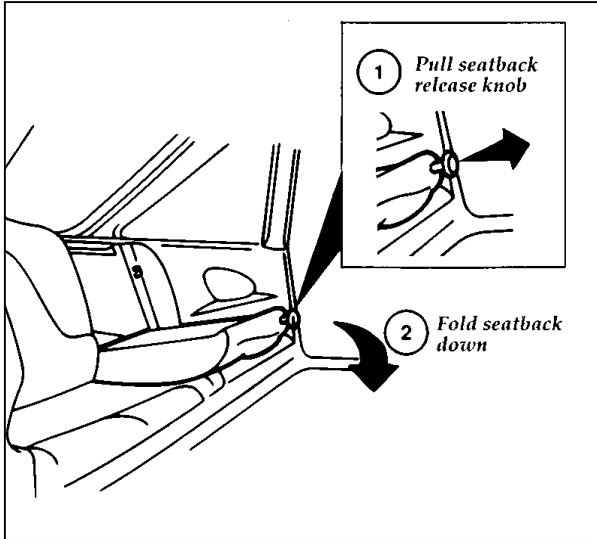

To raise the seatback, lift the seatback rearward until it latches. Make sure the seatback is locked in position by pushing it forward and backward.

⚠ WARNING

Check to see that the seat and seatback are latched securely in position. Keep floor area free of objects that would prevent proper seat engagement. Never attempt to adjust the seat while the vehicle is in motion.

⚠ WARNING

Cargo should always be secured to prevent it from shifting and causing damage to the vehicle or harm to passengers.

⚠ WARNING

Do not remove the floor carpet in your vehicle. Emission controls cause high exhaust temperatures under the floor.

NOTE: When returning the folding seats to the upright position, remember to return rear shoulder belts to their proper position.

NOTE: Your vehicle has stowage hooks on the lower rear side trim panel on which to hook the safety belts when not in use. Simply hook the tongue slot over the stowage hook.

Important Safety Belt Information

The use of safety belts helps to restrain you and your passengers in case of a collision. In most states and in Canada, the law requires their use.

Safety belts provide best restraint when:

- the seatback is upright
- the occupant is sitting upright (not slouched)
- the lap belt is snug and low on the hips
- the shoulder belt is snug against the chest
- the knees are straight forward

To help you remember to fasten your safety belt, a warning light may come on and a chime may sound. See *Safety Belt Warning Light/Chime* in the *Instrumentation* chapter.

See the following sections in this chapter for directions on how to properly use these safety belts. Also see *Safety Restraints for Children* in this chapter for special instructions about using safety belts for children.

⚠ WARNING

Always drive and ride with your seatback upright and the lap belt snug and low across the hips.

⚠ WARNING

Each seating position in your vehicle has a specific safety belt assembly which is made up of one buckle and one tongue that are designed to be used as a pair. 1) Use the shoulder belt on the outside shoulder only. Never wear the shoulder belt under the arm. 2) Never swing it around your neck over the inside shoulder. 3) Never use a single belt for more than one person.

⚠ WARNING

Ford recommends that all safety belt assemblies and attaching hardware should be inspected by a qualified technician after any collision. Safety belt assemblies not in use during a collision should also be inspected and replaced if either damage or improper operation is noted.

⚠ WARNING

Children should always ride with the seatback in the fully upright position.

⚠ WARNING

Never let a passenger hold a child on his or her lap while the vehicle is moving. The passenger cannot protect the child from injury in a collision.

⚠ WARNING

Lock the doors of your vehicle before driving to lessen the risk of the door coming open in a collision.

Combination Lap and Shoulder Belts

While your vehicle is in motion, the combination lap and shoulder belt adjusts to your movement. However, if you brake hard, turn hard, or if your vehicle receives an impact of 5 mph (8 km/h) or more, the lap/shoulder belt locks and helps reduce your forward movement.

After you get into your vehicle, close the door and lock it. Then adjust the driver or passenger seat to the position that suits you best.

Pull the combination lap/shoulder belt from the retractor so that the shoulder portion of the belt crosses your shoulder and chest. Be sure the belt is not twisted. If it is, remove the twist. Insert the belt tongue into the proper buckle until you hear a snap and feel it latch. Make sure the tongue is securely fastened to the buckle by pulling on tongue.

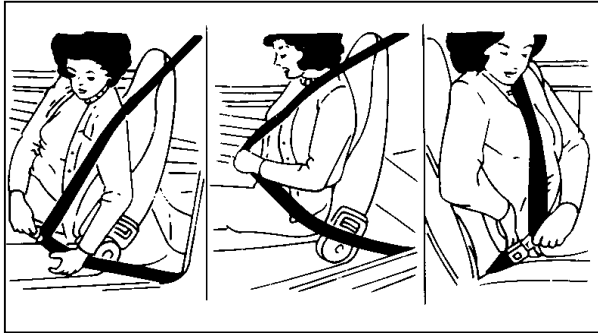

Fastening the front seat combination lap and shoulder belt

NOTE: Be sure to read and understand *Important Safety Belt Information* in this chapter.

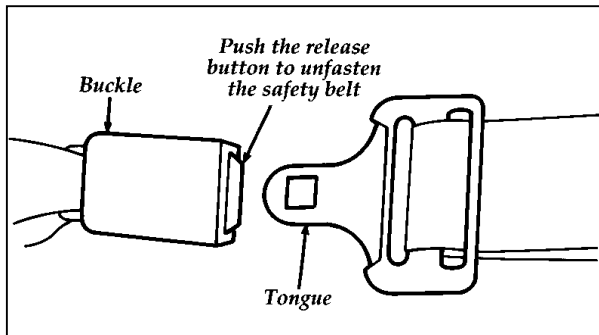

Unfastening the combination lap and shoulder belt — front and rear seating positions

While the belt retracts, guide the tongue to its original position to prevent it from striking you or the vehicle.

Lap/Shoulder Belt Retractors (Dual Locking Modes)

Your vehicle is equipped with a dual locking mode retractor on the shoulder belt portion of the combination lap/shoulder safety belt for passengers.

Dual locking mode retractors operate in two ways:

Vehicle sensitive (emergency) locking mode

In this operating mode, the shoulder belt retractor will allow the occupant freedom of movement, locking tight only on hard braking, hard cornering or impacts of approximately 5 mph (8 km/h) or more. The retractor can also be made to lock by pulling the belt out quickly.

Automatic locking mode

In this operating mode, the shoulder belt retractor will be automatically locked and will remain locked when the combination lap/shoulder safety belt is buckled, and does not allow the occupant freedom of movement. This mode provides the following:

- A tight lap/shoulder belt on the occupant.
- Child safety seat installation.

 WARNING
Rear-facing child seats or infant carriers should never be placed in the front seats.

This mode **must be used** when installing a child seat. To switch the retractor from the emergency locking mode to the automatic locking mode, perform the following steps:

1. Buckle the lap/shoulder combination belt.
2. Pull on the belt until all of the stored belt is out of the retractor and a click is heard.
3. A clicking sound will continue to be heard as the belt is allowed to retract. This indicates that the retractor is in the automatic locking mode.

NOTE: When the combination lap/shoulder belt is unbuckled and allowed to retract completely, the retractor will switch to the vehicle sensitive (emergency) locking mode. See the detailed instructions under *Safety Seats for Children* in this chapter.

Safety Belt Extension Assembly

A safety belt that is too short even when fully extended can be lengthened. You can add about eight inches (20 cm) to the belt length with a safety belt extension assembly. Safety belt extensions are available at no cost from your dealer.

Use only extensions manufactured by the same supplier as the safety belt. Manufacturer identification is located at the end of the webbing on the label. Also, use the safety belt extension only if the safety belt is too short for you when fully extended. Do not use extension to change the fit of the shoulder belt across the torso.

⚠ WARNING

Failure to follow these instructions will affect the performance of the safety belts and increase the risk of personal injury.

Safety Belt Maintenance

Check the safety belt systems periodically to make sure that they work properly and are not damaged.

All safety belt assemblies, including retractors, buckles, front seat belt buckle support assemblies (slide bar) (if equipped), shoulder belt height adjusters (if equipped), child safety seat tether bracket assemblies (if equipped), and attaching hardware, should be inspected after any collision. Ford recommends that all safety belt assemblies used in vehicles involved in a collision be replaced. However, if the collision was minor and a qualified technician finds that the belts do not show damage and continue to operate properly, they do not need to be replaced. Safety belt assemblies not in use during a collision should also be inspected and replaced if either damage or improper operation is noted.

Air Bag Supplemental Restraint System (SRS)

Important Air Bag Precautions

Your vehicle is equipped with a supplemental restraint system designed to work with the safety belts to help protect you and your right front seat passenger in the event of a collision. The Air Bag Supplemental Restraint System is primarily designed to reduce certain upper body injuries.

⚠️ WARNING

All occupants of the vehicle, including the driver, should always wear their safety belts, failure to do so may increase the risk of personal injury in the event of a collision.

⚠️ WARNING

Do not place objects or mount equipment on or near the air bag covers that may come into contact with an inflating air bag. Failure to follow these instructions may increase the risk of personal injury in the event of a collision.

⚠️ WARNING

Do not attempt to service, repair, or modify the air bag Supplemental Restraint System or its fuses. See your Ford or Lincoln-Mercury dealer.

⚠️ WARNING

If you are close to an inflating air bag, it could seriously injure you. Position your seat such that it is as far back from the steering wheel as possible but still allows you to properly control the vehicle.

Children and Air Bags

NOTE: For additional important safety information on the proper use of seat belts, child seats, and infant seats, please read the entire Safety Restraints chapter in this owner guide.

⚠ WARNING

Children should always wear their safety belts. Failure to follow these instructions may increase the risk of personal injury in the event of a collision.

⚠ WARNING

Rear-facing child seats or infant carriers should never be placed in the front seats.
--

How Does the Air Bag Supplemental Restraint System Work?

The Air Bag Supplemental Restraint System is designed to activate when the vehicle is in a collision similar to hitting a fixed barrier head on at 8-14 mph. The fact that the air bags did not inflate in a collision does not mean that something is wrong with the system. Rather, it means the forces were not of the type sufficient to cause activation.

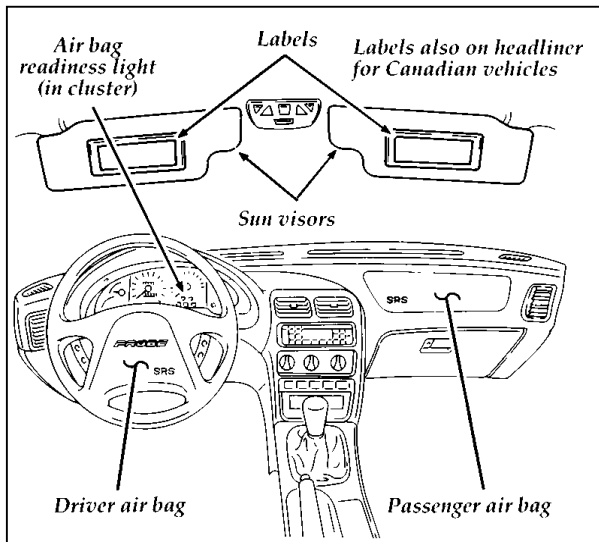

If the vehicle is in a moderate or severe frontal collision, the system is activated and the air bags inflate rapidly. After the air bag inflates, it will quickly deflate. After the air bag deployment, you may notice a smoke-like, powdery residue or smell the burnt propellant. This is normal. The residue may consist of cornstarch or talcum powder (which is used to lubricate the air bag) or sodium compounds, such as sodium carbonates (e.g. baking soda) that result from the combustion process that inflates the air bag. Small amounts of sodium hydroxide may be present which may irritate the skin and eyes, but none of the residue is toxic. The Air Bag Supplemental Restraint System will reduce, but not eliminate all injuries in an accident.

⚠ WARNING

Several air bag system components get hot after inflation. Do not try to touch them after inflation.

⚠ WARNING

The air bag will inflate only once. The system is designed to function on a one-time-only basis. If the air bag is inflated, THE AIR BAG WILL NOT FUNCTION AGAIN AND MUST BE REPLACED IMMEDIATELY. If the air bag is not replaced, this will increase the risk of injury in a subsequent collision.

The Air Bag Supplemental Restraint System consists of:

- driver and passenger air bag modules (which include the inflators and air bags),
- one or more impact and safing sensors,
- a system diagnostic module,
- a readiness light and tone,
- and the electrical wiring which connects the components.

The diagnostic module monitors its own circuits, the air bag electrical system, the air bag readiness light, the air bag power and the air bag inflators.



Inflated driver-side air bag



Inflated passenger-side air bag

Determining if System Is Operational

The Air Bag Supplemental Restraint System uses a readiness light and a tone to indicate the condition of the system. The readiness light is in the instrument cluster. When you turn the ignition key to ON, this light will illuminate for approximately six (6) seconds and then turn off. This indicates that the system is operating normally. NOTE: Routine maintenance of the air bag system is not required.

A problem with the system is indicated by one or more of the following:

- the readiness light will either flash or stay lit,
- the readiness light will not light immediately after ignition is turned on,
- a group of five beeps will be heard. The tone pattern will repeat periodically until the problem and light are repaired.

If any of these things happen, even intermittently, have the Air Bag Supplemental Restraint System serviced at your Ford or Lincoln-Mercury dealer immediately. Unless serviced, the system may not function properly in the event of a collision.

Disposal of Air Bags and Air Bag Equipped Vehicles

For disposal of air bags or air bag equipped vehicles, see your local Ford or Lincoln-Mercury dealer. Air bags **MUST BE** disposed of by qualified personnel.

Safety Restraints for Children

In the U.S. and Canada, you are required by law to use safety restraints for children. If small children ride in your vehicle — this generally includes children who are four years old or younger and who weigh 40 pounds (18 kg) or less — you must put them in safety seats that are made specially for children. Safety belts alone do not provide maximum protection for these children. Check your local and state laws for specific requirements.

⚠️ WARNING

Never let a passenger hold a child on his or her lap while the vehicle is moving. The passenger cannot protect the child from injury in a collision.

⚠️ WARNING

To prevent the risk of injury, make sure children sit where they can be properly restrained.

⚠️ WARNING

It is extremely dangerous to ride in a cargo area, inside or outside of a vehicle. In a collision, people riding in these areas are more likely to be seriously injured or killed. Do not allow people to ride in any area of your vehicle that is not equipped with seats and safety belts. Be sure everyone in your vehicle is in a seat and using a safety belt properly.

When possible, put children in the rear seat of your vehicle. Accident statistics suggest that children are safer when properly restrained in the rear seating positions than in the front seating positions.

⚠️ WARNING

Failure to follow all instructions on the proper use of child seats or the vehicle restraint systems can result in serious injury or death in the event of a sudden stop or collision.

⚠️ WARNING

Carefully follow all of the manufacturer's instructions included with the safety seat you put in your vehicle. If you do not install and use the safety seat properly, the child may be injured in a sudden stop or collision.

⚠️ WARNING

Safety belts and seats can become hot in a vehicle that has been closed up in sunny weather; they could burn a small child. Check seat covers and buckles before you place a child anywhere near them.

⚠️ WARNING

Do not leave children, unreliable adults, or pets unattended in your vehicle.

Safety Seats for Children

Use a safety belt that is recommended for the size and weight of the child. Always follow the safety seat manufacturer's instructions when installing and using the safety seat.

Ford recommends the use of a child safety seat having a top tether strap. Install the child safety seat in a seating position which is capable of providing a tether anchorage. For more information on top tether straps see *Attaching Safety Seats With Tether Straps* in this chapter.

When installing a child safety seat, be sure to use the correct safety belt buckle for that seating position, and make sure the tongue is securely fastened in the buckle. For a shoulder/lap belt combination with a sliding tongue, make sure the retractor is in the automatic locking mode.

WARNING

When using forward-facing child seats move the passenger seat as far back from the instrument panel as possible. Never secure rear-facing child seats or infant carriers in the front seat.

The force of the rapidly inflating passenger air bag could push the top of the rear-facing seat against the vehicle seatback, armrests or console. Rear-facing infant seats must always be secured in the rear seat.

All child restraint systems are designed to be secured in vehicle seats by lap belts or by the lap portion of a lap-shoulder belt.

⚠️ WARNING

If you do not properly secure the safety seat, the child occupying the seat may be injured during a collision or sudden stop. An unsecured safety seat could also injure other passengers.

⚠️ WARNING

Carefully follow all of the manufacturer's instructions included with the safety seat you put in your vehicle. If you do not install and use the safety seat properly, the child may be injured in a sudden stop or collision.

Installing Child Safety Seats

Your vehicle is equipped with a dual locking mode retractor on the shoulder belt portion of the front passenger seat and both rear seats. The automatic locking mode **must be used** when installing a child seat or infant carrier in the front passenger seat or rear seats.

⚠️ WARNING

Rear-facing child seats or infant carriers should never be placed in the front seats.

If you choose to install a child safety seat in the front seat, move the seat as far back as possible.

1. Position the child seat or infant carrier on the passenger seat of the vehicle.
2. Pull down on the shoulder belt, then grasp the shoulder belt and lap belt together.

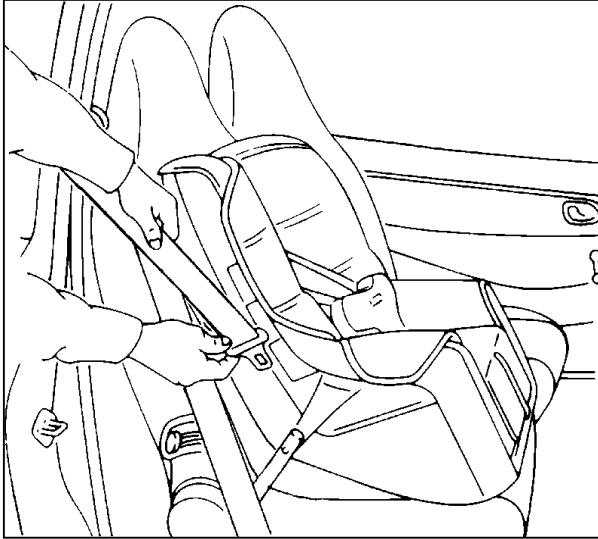

Grasping lap and shoulder belt together

3. While holding the shoulder and lap belt portions together, route the tongue through the child seat according to the child seat manufacturer's instructions. Be sure the belt webbing is not twisted.

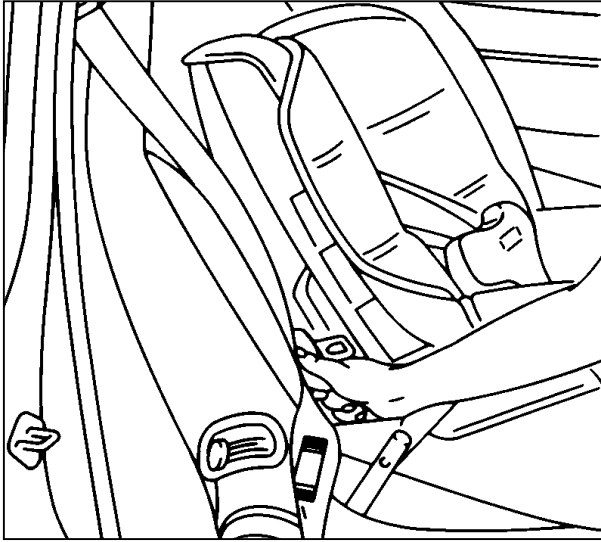

Routing safety belt through child seat or infant carrier

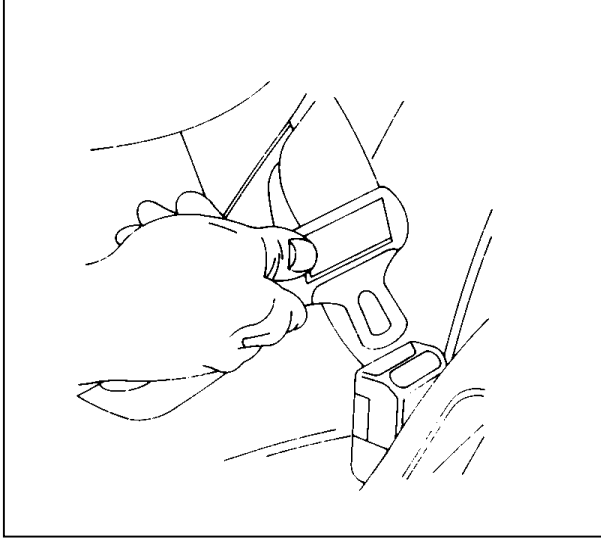

Buckling the belt

4. Grasp the shoulder portion of the belt and pull downward until all of the belt is extracted and a click is heard. At this time, the retractor is in the automatic locking mode (child seat restraint mode).

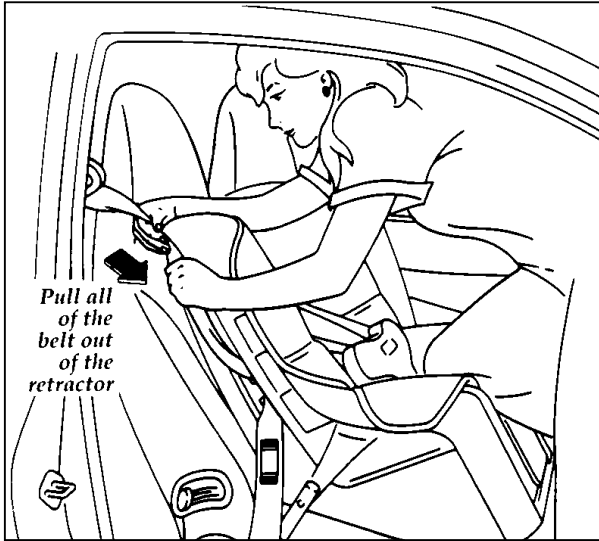

Setting the retractor to automatic locking mode

5. Allow the belt to retract. Pull up on the shoulder webbing. A clicking sound will be heard as the belt retracts. This indicates that the retractor is in the automatic locking mode. Push down on the child seat while you pull up on the belt webbing to remove any slack in the belt.



Removing slack from belt

6. Before placing the child in the child seat or infant carrier, forcibly tilt the seat from side to side, and tug it forward to make sure that the seat is securely held in place.

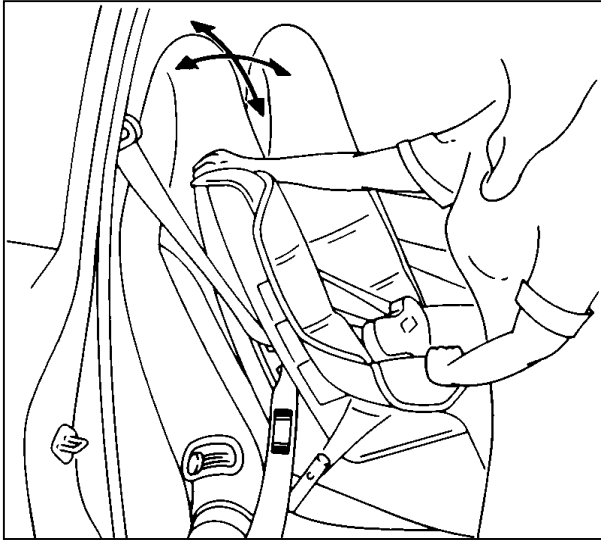

Checking that the seat is secure

7. Double check that the retractor is in the automatic locking mode. Try to pull more belt out of the retractor. If you cannot, the belt is in the automatic locking mode.

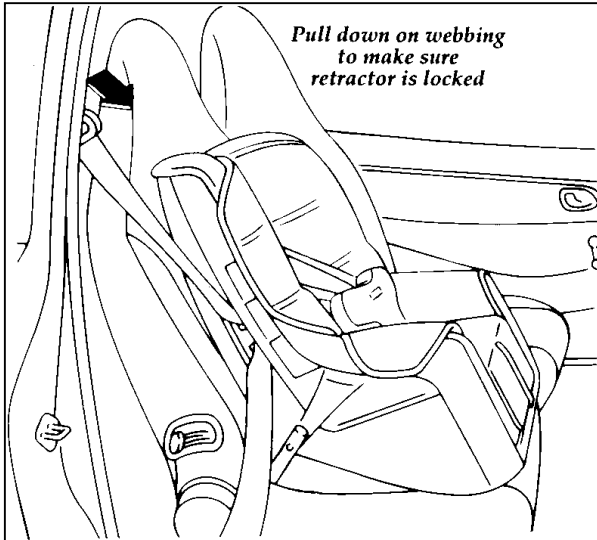

Checking the retractor

8. Check to make sure that the child seat or infant carrier is properly secured prior to each use. If the belt is not locked, repeat steps 4 through 7.

NOTE: To remove the retractor from automatic lock mode, allow seat belt retract fully to its stowed position and the retractor will automatically switch back to the vehicle sensitive locking mode for normal adult usage.

⚠ WARNING

Carefully follow all of the manufacturer's instructions included with the safety seat you put in your vehicle. If you do not install and use the safety seat properly, the child may be injured in a sudden stop or collision.

Attaching Safety Seats With Tether Straps

Some manufacturers make safety seats that include a tether strap that goes over the back of the vehicle seat and attaches to an anchoring point. Other manufacturers offer the tether strap as an accessory. Contact the manufacturer of your child safety seat for information about ordering a tether strap.

Front Seats

To install a tether from a child safety seat in the front seat:

1. Buckle the lap/shoulder belt (in the seat directly behind the front passenger seat in which the child safety seat will be installed).
2. Pull all the stored belt out of the rear seat retractor to switch the retractor to automatic locking mode.
3. Let the retractor wind up the slack from the lap/shoulder belt. A clicking sound should be heard as the belt retracts, indicating that the retractor is in automatic locking mode.
4. Install the child safety seat in the front seat. Refer to the previous section on *Installing Safety Seats*. Hook the tether strap hook around the webbing near the center of the shoulder portion of the locked lap/shoulder belt.
5. Tighten the tether strap.

Rear Seats

If you use a tethered safety seat on one of the rear seats, install a tether anchor bracket to one of the two 0.3 inch (8 mm) weld nuts on the rear of the cargo area below the opening for the liftgate.

Tether Anchorage Hardware

Tether anchor hardware kits can be obtained at no charge from any Ford or Lincoln-Mercury dealer.

Be sure to follow the child safety seat manufacturer's instructions.

⚠ WARNING
Tighten the anchor according to specifications. Otherwise, the safety seat may not be properly secured and the child may be injured in a sudden stop or collision.

Installing the Anchor Bracket

1. Open the liftgate and take out the luggage compartment cover (if equipped).
2. The anchorage nuts used to secure the tether anchor are located in the rear body panel behind the trim at the rear of the luggage compartment. Remove the trim panel. The backside of the panel is scored at the locations of the anchorage nuts. Make a hole the size of the scoring in the trim panel to provide access to the anchor nut. The hole should be made on the same side of the vehicle as the child safety seat will be located. Reinstall the trim panel.

3. Install the hardware for anchoring the tether following the instructions in the tether anchorage hardware kit.
4. Re-install luggage compartment cover.

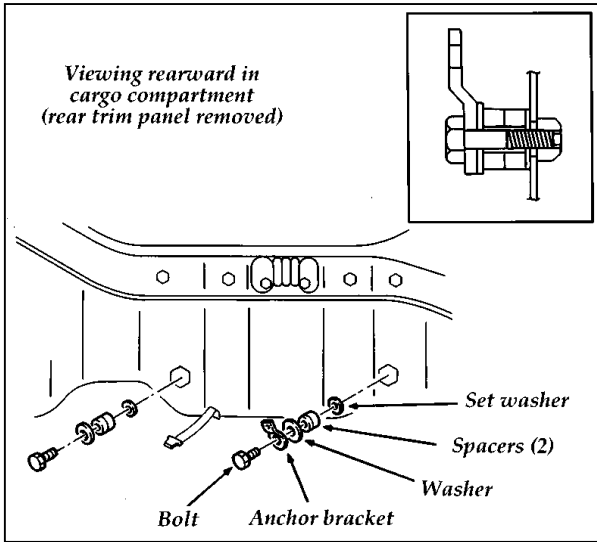

Installing the anchor bracket

Starting

Fuel-Injected Engines

When starting a fuel-injected engine, **the most important thing to remember is to avoid pressing down on the accelerator before or during starting.** Only use the accelerator when you have problems getting your vehicle started. See *Starting Your Engine* in this chapter for details about when to use the accelerator while you start your vehicle.

Starting Your Vehicle

Preparing to Start Your Vehicle

 WARNING
Do not start your vehicle in a closed garage or in other enclosed areas. Exhaust fumes can be toxic. Always open the garage door before you start the engine.

Before you start your vehicle, do the following:

1. Make sure all occupants in the vehicle buckle their safety belts. See *Safety Restraints* in the Index for more details.
2. Make sure the headlamps and other accessories are turned off when starting.

3. **If you have an automatic transaxle**, make sure that the gearshift is in P (Park) and the parking brake is set before you turn the key.

If you have a manual transaxle, make sure that the parking brake is fully set, push the clutch pedal to the floor, and put the gearshift into Neutral before you turn the key. **(Remember, the starter will operate only if the clutch pedal is pushed all the way to the floor.)**

Testing the Warning Lights

Before you start your vehicle, you should test the warning lights on the instrument panel to make sure that they work. Refer to the *Instrumentation* chapter.

Starting Your Engine

To start your engine:

1. Follow the steps under *Preparing to Start Your Vehicle* at the beginning of this section.
2. Keep your foot on the brake pedal and turn the ignition key to the ON position.
3. DO NOT depress the accelerator pedal when starting your engine. DO NOT use the accelerator while the vehicle is parked.
4. Turn the key to the START position (cranking) until the engine starts. Allow the key to return to the ON position after the engine has started.

If you have difficulty in turning the key, rotate the steering wheel slightly because it may be binding.

For a cold engine:

- At temperatures **10°F (-12°C) and below:** If the engine does not start in **fifteen (15) seconds** on the first try, turn the key to OFF, wait approximately ten (10) seconds so you do not flood the engine, then try again.
- At temperatures **above 10°F (-12°C):** If the engine does not start in **five (5) seconds** on the first try, turn the key to OFF, wait approximately ten (10) seconds so you do not flood the engine, then try again.

For a warm engine:

- Do not hold the key in the START position for more than **five (5) seconds** at a time. If the engine does not start within five (5) seconds on the first try, turn the key to the OFF position. Wait a few seconds after the starter stops, then try again.

Whenever you start your vehicle, release the key as soon as the engine starts. Excessive cranking could damage the starter.

After you start the engine, let it idle for a few seconds. Keep your foot on the brake pedal and put the gearshift lever in gear. Release the parking brake. Slowly release the brake pedal and drive away in the normal manner.

NOTE: Automatic transaxle equipped vehicles have an interlock that prevents you from shifting out of P (Park) unless your foot is on the brake pedal.

If the engine does not start after two attempts:

1. Turn the ignition key to the OFF position.
2. Press the accelerator all the way to the floor and hold it.
3. Turn the ignition key to the START position.
4. Release the ignition key when the engine starts.
5. Release the accelerator gradually as the engine speeds up.

If the engine still does not start, the fuel pump shut-off switch may have been activated. For directions on how to reset the switch see *Fuel Pump Shut-Off Switch* in the index.

A computer system controls the engine's idle speed. When you start your vehicle, the engine's idle speed normally runs high. These faster engine speeds will make your vehicle coast slightly faster than its normal idle speed. It should, however, slow down after a short time. If it does not, have the idle speed checked.

If the engine idle speed does not slow down automatically, do not allow your vehicle to idle for more than 10 minutes. Have the vehicle checked.

 WARNING

Extended idling at high engine speeds can produce very high temperatures in the engine and exhaust system, creating the risk of fire or other damage.

⚠ WARNING

Do not park, idle, or drive your vehicle in dry grass or other dry ground cover. The emission system heats up the engine compartment and exhaust system, which can start a fire.

Engine Block Heater (If equipped)

Engine block heaters are strongly recommended if you live in a region where temperatures reach -10°F (-23°C) or below. An engine block heater warms the engine coolant, which improves starting, warms up the engine faster, and allows the heater-defrost system to respond quickly.

To turn the heater on, simply plug it into a grounded 110-volt outlet. Ford recommends that you use a 110-volt circuit that is protected by a ground fault circuit interrupter.

⚠ WARNING

To prevent electrical shock, do not use your heater with ungrounded electrical systems or two-pronged (cheater) adapters.

For best results, plug the heater in at least three hours before you start your vehicle. Using the heater for longer than three hours will not damage the engine, so you can plug it in at night to start your vehicle the following morning.

If the Engine Cranks but Does Not Start or Does Not Start After a Collision

The Fuel Pump Shut-off Switch

If the engine cranks but does not start or does not start even after a small collision, the fuel pump shut-off switch may have been activated. The shut-off switch is a device intended to stop the fuel pump when your vehicle has been involved in a substantial jolt. Refer to *Roadside Emergencies* for more information.

Guarding Against Exhaust Fumes

Carbon monoxide, although colorless and odorless, is present in exhaust fumes. Take precautions to avoid its dangerous effects.

⚠ WARNING

Do not start your vehicle in a closed garage or in other enclosed areas. Exhaust fumes can be toxic. Always open the garage door before you start the engine.
--

⚠ WARNING

If you smell exhaust fumes inside your vehicle, have your dealer inspect your vehicle immediately. Do not drive if you smell exhaust fumes.
--

Have the exhaust and body ventilation systems checked whenever:

- your vehicle is raised for service
- the sound of the exhaust system changes
- your vehicle has been damaged in a collision

Improve your ventilation by keeping all air inlet vents clear of snow, leaves, and other debris.

If the engine is idling while you are stopped in an open area for long periods of time, open the windows at least one inch (2.5 cm). Also, adjust the heating or air conditioning system to bring in outside air.

- If you are using the heater, set the fan speed on MEDIUM or HIGH with the function selector control on VENT.
- If you want to use the air conditioner, set the function selector control in the NORM A/C position which brings in fresh air.

Removing the Key From the Ignition

1. Put the gearshift selector lever in P (Park) (automatic transaxle) or 1 (First) (manual transaxle).
2. Set the parking brake fully.
3. **For a manual transaxle:** Push in on the lock cylinder and turn the key from ACC to LOCK.
For an automatic transaxle: Turn the key to LOCK.
4. Remove the key.

If the driver or passenger door is open while the key is still in the ignition, a warning chime sounds.

 WARNING
--

Always set the parking brake fully and make sure that the gearshift is securely latched in P (Park) (automatic transaxle) or in 1 (First) (manual transaxle).
--

 WARNING

Do not leave children, unreliable adults, or pets unattended in your vehicle.
--

Driving

Brakes

Applying the Brakes

Your vehicle may have four-wheel power anti-lock disc brakes which adjust automatically through everyday use.

Some models have power front disc brakes and rear drum brakes which automatically adjust as the brake pads and linings wear down.

If your vehicle does not have anti-lock brakes, apply the brake pedal gradually. Use the “squeeze” technique — push on the brake pedal with a steadily increasing force. This allows the wheels to continue to roll while you are slowing down, which lets you steer properly.

If your vehicle does not have anti-lock brakes, extreme braking can make the wheels lock and slide, causing you to lose control of the steering. If the wheels lock, release the brake pedal and repeat the “squeeze” technique.

Do not drive with your foot resting on the brake pedal; you will wear out the linings and increase your vehicle’s stopping distance. Brake rotor damage may also eventually occur.

NOTE: If you are driving down a long or steep hill, shift to a lower gear and do not apply your brakes continuously. If you apply your brakes continuously, they may overheat and become less effective.

Occasional brake noise is normal and often does not indicate a performance concern with the vehicle's brake system. In normal operation, automotive brake systems may emit occasional or intermittent squeal or groan noises when the brakes are applied. Such noises are usually heard during the first few brake applications in the morning; however they may be heard at any time while braking and can be aggravated by environmental conditions such as cold, heat, moisture, road dust, salt or mud. If a "metal-to-metal" or "continuous grinding" sound is present while braking, the brake linings may be worn-out and should be inspected by a qualified service technician.

Anti-lock Brake System (If equipped)

If your vehicle is equipped with the anti-lock brake system (ABS), the wheels will not lock and slide when you press down hard on the brake pedal. The ABS automatically starts releasing and reapplying the front brakes independently and the rear brakes together whenever your vehicle's wheels start to lock. When this happens, you will feel the brake pedal pulsate. This is an indication that the ABS is working correctly and is normal.

If the brake pedal is applied while the vehicle is driven over uneven road surfaces, the ABS may cycle and the driver may sense a pulsation in the brake pedal, accompanied by a slight up and down movement of the pedal height and a clicking sound. This may also happen when driving on an inclined surface such as a driveway while making a sharp turn. This is a normal condition.

Each time you turn the ignition key to the ON position, the ABS will function through one test cycle. When this happens, the ABS light will illuminate for up to five seconds. If the light illuminates longer than five seconds, shut off the

engine and restart. If it remains illuminated, it means the ABS is disabled and should be serviced immediately to restore the benefits of the anti-lock feature. Normal braking is not affected unless the red BRAKE system warning light is also illuminated.

ABS has self-check capabilities. As described above, the system turns on the ABS light each time you start your engine. After the engine is started and the ABS light turns off, the system performs another test the first time the vehicle reaches 4-9 mph (6-15 km/h). The system turns on the ABS pump motor for approximately 1/2 second. At this time, a mechanical noise may be heard. This is a normal part of the self-check feature. If a malfunction is found during this check the ABS light will come on.

On vehicles equipped with an antilock braking system (ABS), a noise from the hydraulic pump motor and pulsation in the pedal may be observed during ABS braking events. Pedal pulsation coupled with noise while braking under panic conditions or on loose gravel, wet or snowy roads is normal and indicated proper functioning of the vehicle's antilock brake system. If the vehicle has continuous vibration or shudder while braking, mainly in the steering wheel, the vehicle most likely needs service.

Ford Motor Company has not found any detrimental effects of popular mobile radio transmitting equipment installed on vehicles equipped with the Anti-lock Brake System if normal radio installation practices are rigidly followed. However, if after installing mobile radio transmitting equipment, the Anti-lock Brake System light comes on at any time other than immediately after turning the key to the

ON position, or during a sudden stop, have your mobile radio dealer inspect the radio installation. Proper radio installation procedures to be followed are published by the radio manufacturer.

Parking Brake

The parking brake should be used whenever you park your vehicle.

If the brakes don't operate while the vehicle is in motion, you can make an emergency stop with the parking brake, however, the stopping distance will be much greater than normal.

The parking brake lever is located between the front seats. To set the parking brake, put your foot on the brake pedal while pulling the parking brake handle fully and firmly upward.

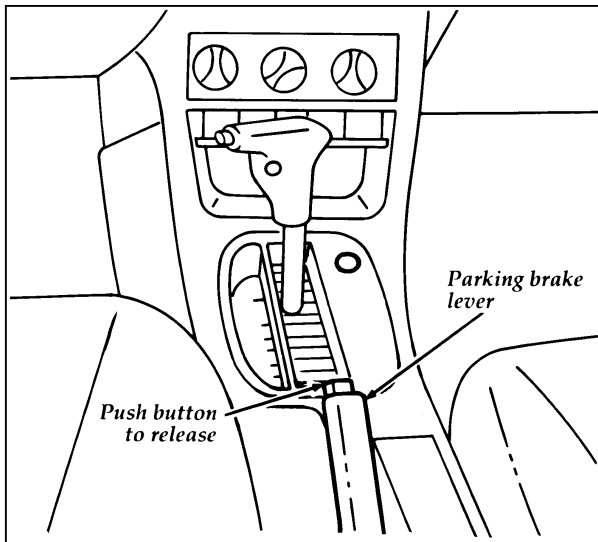

Parking brake (handbrake)

R WARNING

To prevent personal injury, do not release the parking brake while outside the vehicle.

R WARNING

Always set the parking brake fully and make sure that the gearshift is securely latched in P (Park) (automatic transaxle) or in 1 (First) (manual transaxle).

Always check the Brake Warning Light each time you start your engine. Driving with the parking brake on will cause the brakes to wear out quickly and will reduce the fuel economy.

R WARNING

If the parking brake is fully released, but the Brake System light remains on, have the brakes checked immediately. They may not be working properly.

The parking brake is not designed to stop a moving vehicle, but you can use the parking brake to stop your vehicle in an emergency if the normal brakes fail. However, since the parking brake applies only the rear brakes, the stopping distance will increase greatly and the handling of your vehicle will be adversely affected.

Steering Your Vehicle

Your vehicle is equipped with power steering. Power steering uses energy from the engine to help steer your vehicle.

If the amount of effort needed to steer your vehicle changes at a constant vehicle speed, have the power steering system checked. If the power

steering system breaks down (or if the engine is turned off), you can steer the vehicle manually but it takes more effort.

Never hold the steering wheel to the extreme right or left for more than five seconds if the engine is running. This can damage the power steering pump.

Procedures for driving your vehicle will vary depending on which type of *transaxle* your vehicle has. You may be familiar with the term “transmission.” We use *transaxle* because it is a more accurate term for vehicles that have front-wheel drive.

Your vehicle has one of two types of transaxles:

- a manual five-speed overdrive
- an automatic four-speed overdrive

Driving with an Automatic Overdrive Transaxle

Putting Your Vehicle in Gear

The automatic transaxle on your vehicle is an electrically controlled four speed. The highest gear is Overdrive. The Overdrive position is reflected by D in the shift selector indicator.

The automatic transaxle uses the conventional selector lever, and an Overdrive OFF button. All normal driving is done with the selector in the D position.

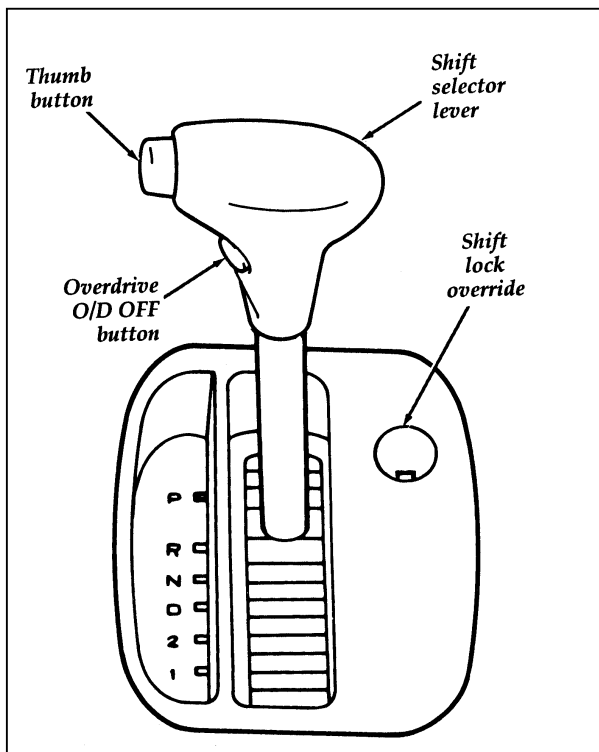

Automatic shift lever

Your automatic transaxle vehicle has a console-mounted shift selector lever. You must step on the brake pedal, start the engine, and then push in the thumb button to move the shift selector lever to the position you choose.

R WARNING

Hold the brake pedal down while you move the gearshift lever from position to position. If you do not hold the brake pedal down, your vehicle may move unexpectedly and injure someone.

Shift-lock System (If equipped)

For your safety, the automatic transaxle has a shift-lock system, which prevents shifting the transaxle out of the P (Park) position without depressing the brake pedal when the ignition key is in the ON position.

To shift the transaxle out of the P (Park) position:

1. Depress and hold the brake pedal.
2. Start the engine.
3. Push in the thumb button and move the shift selector lever.
4. See *Shift Lock Emergency Override* in this section for more information.

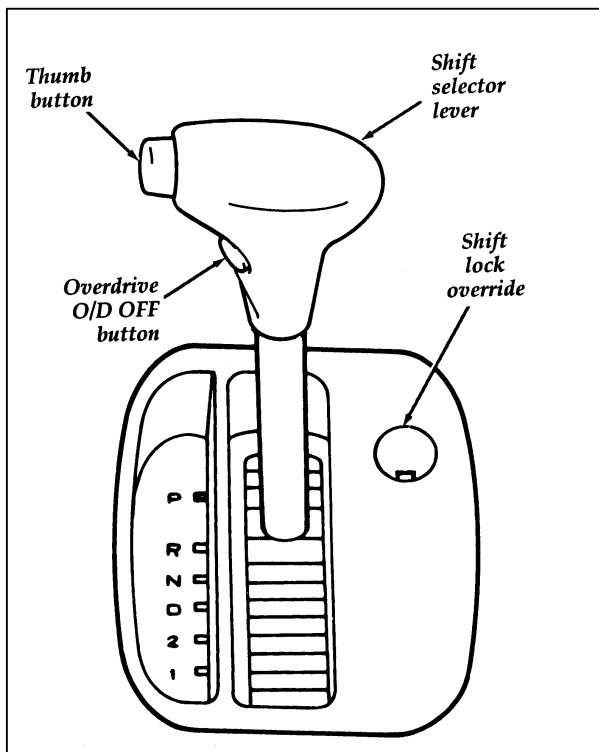

Automatic console-mounted gearshift lever

NOTE: When the ignition key is in the ACC or LOCK position, the transaxle cannot be shifted from the P (Park) position. If the brake pedal is repeatedly depressed and released when the ignition is in the ON position and the selector lever is in the P (Park) position, a chattering near the gearshift lever may be heard. This is not a malfunction.

NOTE: Your vehicle's gearshift lever is securely latched in P (Park) if you cannot move it without pushing in the thumb button. Keep the brake pedal depressed while moving your gearshift lever.

To make the system more effective, the ignition key cannot be removed unless the gearshift selector lever is in the P (Park) position.

Shift lock emergency override

If the gearshift selector lever should fail to move from the P (Park) position with the brake pedal depressed, continue depressing the brake pedal.

1. Remove the shift lock override cover with a screwdriver.
2. Insert the screwdriver into the shift lock override opening and push the screwdriver down.
3. Push and hold the thumb button.
4. Move the shift selector lever.

If you need to shift out of P (Park) by using the alternate procedure described above, it is possible that a fuse has blown and that your brakelamps may also not be functional. Please refer to the chapter titled *Roadside Emergencies* in this Owner Guide for instructions on checking and replacing fuses.

R WARNING
DO NOT DRIVE YOUR VEHICLE UNTIL YOU VERIFY THAT THE BRAKELAMPS ARE WORKING.

Once the gearshift is secure in the desired position, release the brake pedal and use the accelerator as necessary.

Driving

When to use Overdrive (D with Overdrive activated)

Overdrive is the usual driving position for an automatic overdrive transaxle. It works the same way Drive (Overdrive OFF) works, automatically upshifting or downshifting as the vehicle speeds or slows.

However, Overdrive also shifts into a fourth gear —an overdrive gear — when your vehicle cruises at a consistent speed for any length of time. This fourth gear will increase your fuel economy when you travel at cruising speeds.

Canceling Overdrive

Overdrive may not be appropriate for certain terrain. If the transaxle shifts back and forth between third and fourth gears while you are driving on hilly roads, select Drive (Overdrive OFF) by cancelling Overdrive as outlined below.

The Overdrive Off (O/D OFF) button is located on the gearshift. The Overdrive Off (O/D OFF) light is located in the instrument cluster.

The O/D OFF light is not illuminated during normal vehicle operation. This allows the transaxle to upshift and downshift from 1st through 4th gears. When the O/D OFF button is pressed, Overdrive is cancelled and the O/D OFF light in the instrument cluster illuminates. When the O/D OFF light is illuminated, the transaxle will upshift and downshift from 1st through 3rd gears.

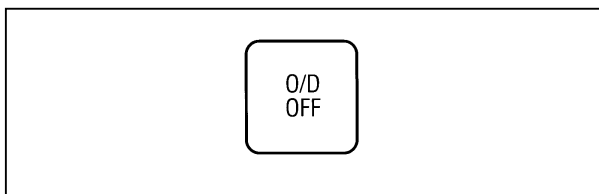

Overdrive OFF indicator light

To return the transaxle to normal operation (1st through 4th gears) press the O/D OFF button again. The O/D OFF button may be used to cancel Overdrive any time the vehicle is being driven. Each time your vehicle is started, the Overdrive system will automatically be in the normal "overdrive on" mode and the light will not be illuminated.

If the light does not illuminate when the O/D OFF button is pressed, or if the light flashes when you are driving, have your vehicle serviced at the first opportunity. If this condition persists, damage could occur to the transaxle.

When to use Drive (D with Overdrive OFF)

In Drive (Overdrive OFF), your vehicle automatically upshifts or downshifts from 1st through 4th gears as the vehicle speeds up or slows down. It also downshifts when you need extra acceleration to pass or when driving up a hill.

Selecting Drive (Overdrive OFF) will eliminate the transaxle's tendency to "hunt" between third and fourth gears while driving over hilly terrain. It also gives your vehicle more engine braking to slow your vehicle than Overdrive does.

When to use 2 (Second)

Use Second (2) to help drive up moderately steep hills or when starting on slick surfaces. It prevents the transaxle from frequently shifting up and down. It also gives more engine braking than Overdrive or Drive when going down hills.

Do not go faster than 64 mph (102 km/h) with the gearshift in the Second (2) position. If you shift from Overdrive or Drive to Second because of hilly terrain, your transaxle will automatically downshift in the proper sequence.

When to use 1 (First)

When your vehicle is in First (1), it gives more engine braking to slow your car than Drive (D with Overdrive OFF) on downgrades.

Do not go faster than 32 mph (50 km/h) in this gear. You can upshift from First (1) into D Position at any speed. If you shift from Overdrive or Drive to First (1) because of hilly terrain, your transaxle will automatically downshift in the proper sequence.

Reverse

In the Reverse (R) position, the vehicle moves only backward. Your vehicle must be stopped before shifting into Reverse (R).

Neutral

In Neutral (N), the wheels of the transaxle are not locked. Your vehicle will roll freely, even on the slightest incline, unless the parking brake or brakes are on.

Parking

Always come to a complete stop before you shift into P (Park). Make sure that the shift selector lever is securely latched in P (Park). This locks the transaxle and prevents the front wheels from rotating.

R WARNING

Always set the parking brake fully and make sure the gearshift is latched in P (Park). Turn off the ignition whenever you leave your vehicle.
--

R WARNING

Never leave your vehicle unattended while it is running.

You can tell the gearshift is securely latched when the thumb button has popped out. In this position the gearshift selector lever cannot be moved unless the button is pushed in.

R WARNING

Hold the brake pedal down while you move the gearshift lever from position to position. If you do not hold the brake pedal down, your vehicle may move unexpectedly and injure someone.
--

Driving with a Manual Transaxle

Using the Clutch

After the engine starts, allow it to idle for a few seconds. Then, hold your right foot on the brake pedal, push the clutch pedal to the floor with your left foot, and move the shift selector lever into 1 (First) or R (Reverse).

To move the vehicle, lift your right foot off the brake pedal and slowly release the clutch pedal. (You need to press down slowly on the accelerator at the same time you release the clutch pedal.)

Do not drive with your foot resting on the clutch pedal and do not use the clutch to hold your vehicle at a standstill while waiting on a hill. These actions will seriously reduce clutch life.

Driving with your foot resting on the clutch may cause the vehicle to jerk sharply when pressing or removing your other foot from the accelerator.

Shifting the Gears

The gearshift for a manual transaxle is mounted on the floor. The gearshift can be in one of seven possible positions, as shown.

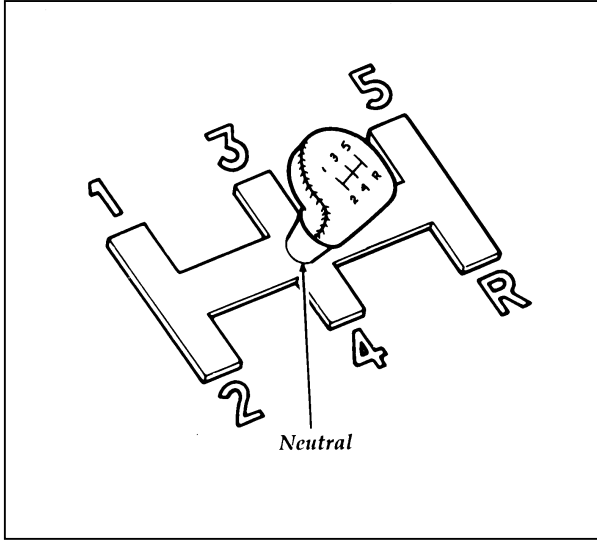

Shift pattern

Always push the clutch pedal all the way in when you shift. You should upshift according to the speeds given in the chart later in this chapter.

Sometimes, you will upshift at higher speeds. For example, you may want to stay in a lower gear to gain more power for passing or for climbing a hill. However, you must stay within the range when you upshift or downshift.

Backing up

To shift into R (Reverse):

1. Bring your vehicle to a **complete** stop.
2. Push the clutch pedal in all the way to the floor and hold it. If you do not hold the clutch pedal in all the way, you may hear a grinding noise when you shift.
3. Put the gearshift in Neutral and wait at least 3 seconds before shifting into R (Reverse) to prevent a grinding noise. Do not release the clutch.
4. Then push the gearshift all the way to the right and pull it down into R (Reverse).

When in 5 (Fifth) gear, you can engage R (Reverse) only by moving the gearshift to Neutral before you shift into R (Reverse). This is a special lockout feature that protects you from accidentally shifting into R (Reverse) when you downshift from 5 (Fifth) gear.

5. Once R (Reverse) is engaged, slowly release the clutch pedal from the floor.

If R (Reverse) is not engaged, continue to push the clutch pedal in while you put the gearshift back into Neutral. Then, release the clutch pedal for a moment and repeat steps 2 through 5.

Upshifting

For normal acceleration, you should upshift at the following speeds:

	2.0 liter engine	2.5 liter engine
1 to 2	13 mph (21 km/h)	14 mph (23 km/h)
2 to 3	24 mph (39 km/h)	25 mph (40 km/h)
3 to 4	34 mph (55 km/h)	33 mph (53 km/h)
4 to 5	47 mph (76 km/h)	43 mph (69 km/h)

For cruising, you should upshift at the following speeds.

	2.0 liter engine	2.5 liter engine
1 to 2	12 mph (19 km/h)	11 mph (18 km/h)
2 to 3	21 mph (34 km/h)	20 mph (32 km/h)
3 to 4	30 mph (48 km/h)	30 mph (48 km/h)
4 to 5	41 mph (66 km/h)	38 mph (61 km/h)

Downshifting

When you slow down or climb a steep hill, always downshift before the engine starts to lose power. Downshifting reduces the chance of stalling and gives your vehicle better acceleration to increase speed again.

When you drive down steep hills, downshifting helps you keep a safe speed and helps prevent unnecessary wear on the brakes.

When you come to a stop, do not downshift through each gear. Disengage the clutch and use the brake as necessary. Downshifting through the gears decreases your vehicle's fuel economy.

Parking

To park your vehicle, shift into 1 (First), set the parking brake fully, and turn off the ignition.

WARNING
Do not park your vehicle in Neutral, it may move unexpectedly and injure someone. Use 1 (First) gear and set the parking brake fully.

Driving With a Heavy Load

There are limits to the amount of weight your vehicle can carry. The total weight of your vehicle, plus the weight of the passengers and cargo, should never be more than the Gross Vehicle Weight Rating (GVWR). Also, the weight that your vehicle carries over each axle should never be more than the Gross Axle Weight Rating (GAWR) for the respective axle.

You can find your vehicle's GVWR and GAWR on the Safety Compliance Certification Label on the left door lock pillar.

The weight limits of your vehicle's tires affect the GVWR or GAWR limitations. Usage of replacement tires with higher weight limits than originals does not increase GVWR or GAWR. Usage of lower capacity replacement tires may lower GVWR and GAWR limitations.

WARNING
Do not exceed the GVWR or the GAWR specified on the Safety Compliance Certification Label.

Limiting Your Vehicle's Load

The load you add to your vehicle must not exceed the maximum load stated on the tire information decal.

To figure the weight of your vehicle's load, add the weights of:

- the driver and passengers
- luggage and any other items that you put in your vehicle
- the weight of any equipment that has been added to your vehicle since it was delivered to your dealer

If you do not know the actual weights of these items, use the following procedure to figure the weight of a load:

1. Weigh your vehicle without the driver, passengers and luggage. You might take your vehicle to a shipping company or an inspection station for trucks.
2. Then weigh your vehicle with the driver, passengers and luggage.
3. Subtract the first reading from the second to figure the total weight of the load.

After determining this load, you must also make sure that the total weight of your vehicle, plus the load it carries, is less than its GVWR. Also, make sure that the weight your vehicle carries over each axle is less than the GAWR for the respective axle.

If your vehicle exceeds the GVWR, remove cargo from your vehicle accordingly. If your vehicle exceeds the GAWR for either axle, shift the load or remove cargo accordingly.

WARNING
Improper distribution of your vehicle's load or carrying weight in excess of the amount shown on the tire decal can cause rapid tire wear or loss of vehicle control.

Towing a Trailer

Do not use your vehicle for towing a trailer.

Towing Behind Another Vehicle — Recreational Vehicle

Towing an automatic transaxle (ATX) equipped vehicle behind another vehicle, such as a Recreational Vehicle (RV), is not recommended unless a front wheel dolly or trailer is used. Do not tow your ATX equipped vehicle with the front wheels on the ground or transaxle damage may occur.

Towing a manual transaxle (MTX) equipped vehicle behind another vehicle, such as a Recreational Vehicle (RV), is allowed only if it is towed forward. The parking brake must be released, the gearshift must be in Neutral, the ignition key must be in the ACC position, the battery must be disconnected to eliminate battery drain, and the steering wheel unlocked. You may tow your MTX equipped vehicle only in a forward direction with the front wheels on the ground without damage to the transaxle.

Do not tow your manual transaxle equipped vehicle at a speed faster than 55 mph (88 km/h). The maximum towing distance is unlimited.

WARNING
Never use a tow bar that attaches to the bumper when you tow your vehicle. This could damage the bumper and cause an accident.

Roadside Emergencies

Hazard Flasher

To alert other drivers to hazardous situations, press the hazard flasher switch on the top of the steering column. All the turn signals will flash on and off at the same time. The flashers will also operate while the brake pedal is applied. To turn the flashers off, press the switch again.

The flashers work whether your vehicle is running or not. The flashers will work for up to two hours when the battery is fully charged and in good condition. They will not drain the battery excessively unless they are left on for an extended period of time.

If the flashers run for longer than 2 hours while your engine is not running, or if your battery is not fully charged, your battery could be drained.

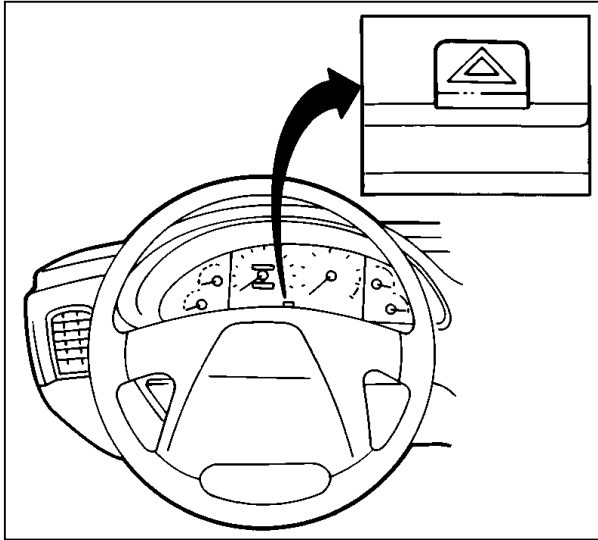

Hazard warning flasher switch

If the Engine Cranks but Does Not Start or Starting After a Collision

The Fuel Pump Shut-off Switch

If the engine cranks but does not start or if you have had a collision, the fuel pump shut-off switch may have been triggered. The shut-off switch is a device that stops the fuel pump when your vehicle has been involved in a substantial jolt.

Once the shut-off switch is activated, you must reset the switch by hand before you can start your vehicle.

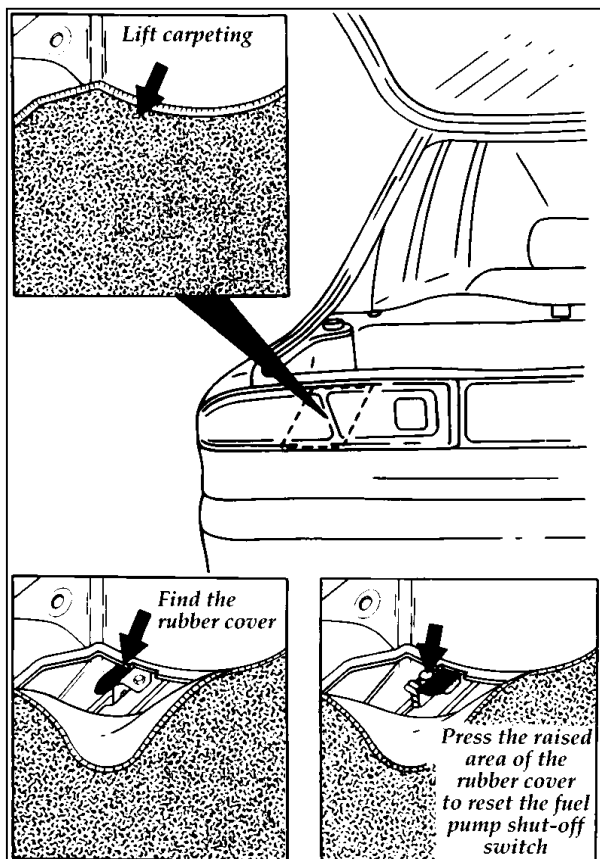

The location of the fuel pump shut-off switch

⚠ WARNING

If you see or smell fuel, do not reset the switch or try to start your vehicle. Have all the passengers get out of the vehicle and call the local fire department or a towing service.

If your engine cranks but does not start after a collision or substantial jolt:

1. Turn the key in the ignition to the LOCK position.
2. Check under the vehicle for leaking fuel.
3. If you do not see or smell fuel, push the red reset button on the fuel pump shut-off switch down.

The reset switch on your vehicle is located on the left side of the luggage compartment under the carpet. The red reset button is under the raised area of the rubber cover.

4. Attempt to start your vehicle. If the vehicle starts, let it run a few seconds, then turn the key to the LOCK position.
5. Check under the vehicle again for leaking fuel. **If you see or smell fuel, do not start your vehicle again.** If you do not see or smell fuel, you can try to start your vehicle again.

Fuses

If electrical parts in your vehicle are not working, the system may have been overloaded and blown a fuse. If a fuse blows, all the parts of your vehicle that use the fuse will not work.

Your vehicle has two fuse panels. The interior fuse panel is below the instrument panel in front of the driver's door. The main panel is under the hood behind the battery.

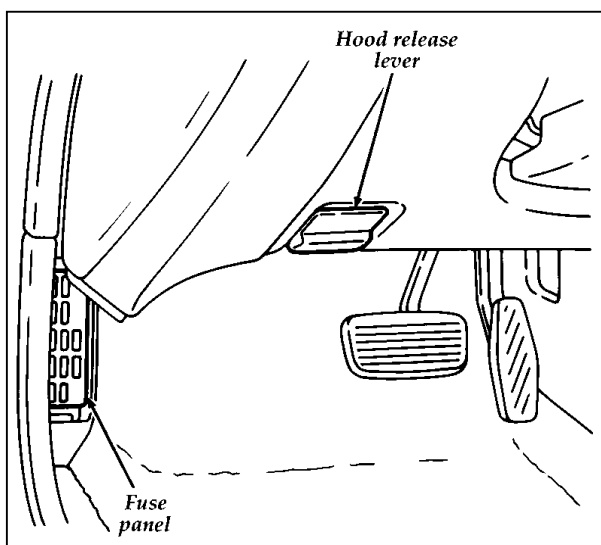

Fuse panel under instrument panel

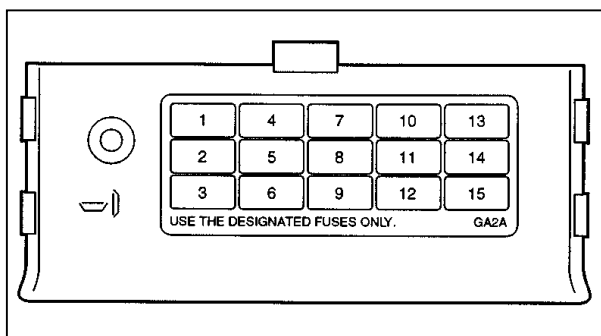

Inside of the instrument fuse panel cover

Location	Amps	Circuits Protected
1	20	Brakelamps, High-Mount Brakelamp, Horn, and Shift-Lock System
2	15	Audio System, Dome and Map Lamps, Door Key Lamps, Illuminated Entry System, Keyless Entry System, Key Reminder, and Luggage Compartment Lamp
3	15	Spare
4	30	Power Door Locks
5	15	Audio System and Power Mirrors
6	15	Moon Roof
7	15	Turn signals
8	15	Audio System and Cigar Lighter
9	15	Backup Lamps, Instrument Cluster, Rear Window Defroster Switch Indicator, Keyless Entry System, Power Door Lock Switch Illumination, Shift-Lock System, and Speed Control System
10	15	Hazard Warning Lamps and Turn Signals
11	15	Air Bag System, Anti-Lock Brake System, Cooling Fan, Emission and Fuel Control System, Rear Window Defroster, and Speed Control System
12	30	Power Windows
13	15	Air Conditioning and Daytime Running Lights
14	20	Wipers and Washers
15	15	-

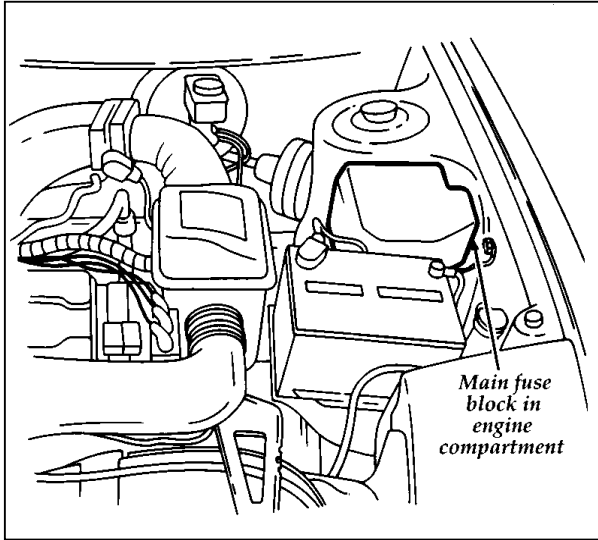

*Main fuse
block in
engine
compartment*

Fuse panel located under hood

Fuses

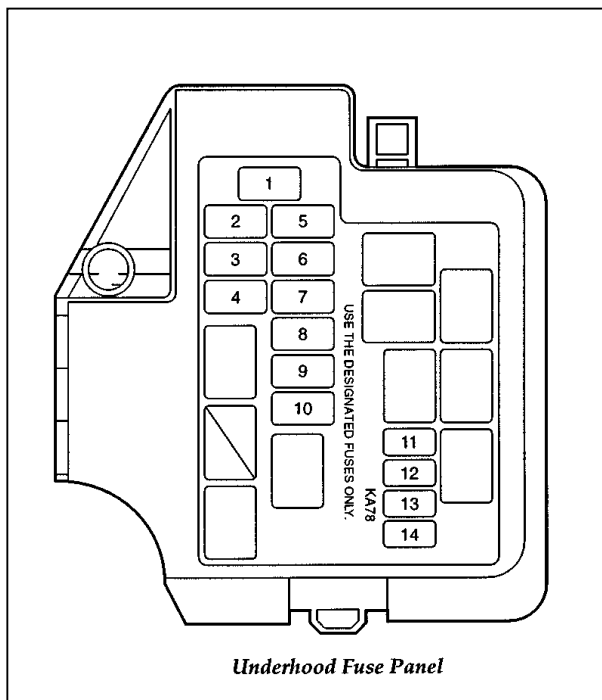

Fuse panel cover located under the hood

Location	Amps	Circuits Protected
1	100	Air Bag System, Air Conditioning, Anti-Lock Brake System, Audio System, Backup Lamps, Brakelamps, Cigar Lighter, Cooling Fan, Daytime Running Lights, Emission and Fuel Control, Fog Lamps, Front and Rear Side Marker Lamps, Front Wipers and Washers, Hazard Warning Lamp, Headlamp Retractors, Headlamps, Heater, High-Mount Brakelamps, Horn, Indicator Lamps (Air Conditioning, Cigar Lighter Switch, Fog Lamp, O/D OFF, Rear Window Defroster), Instrument Cluster, Keyless Entry System, Key Reminder, License Plate Lamps, Moon Roof, Power Door Lock Switch Illumination, Power Seats and Lumbar Support Power Windows, Power Window Switch Illumination, Shift-Lock System, Speed Control System, Starting System, Tail Lamps, and Turn Signals.
2	30	Daytime Running Lights, Fog Lamps, and Headlamps
3	40	Rear Window Defroster
4	30	Air Bag System, Emission and Fuel Control
5	40	Air Bag System, Air Conditioning and Heater, Anti-Lock Brake System, Audio System, Backup Lamps, Cooling Fan, Daytime Running Lights, Emission and Fuel Control System, Front Wiper/Washer, Instrument Cluster, Keyless Entry System, Moon Roof, Power Door Lock Switch Illumination, Power Mirrors, Power Windows, Power Window Switch Illumination, Rear Window Defroster, Rear Window Defroster Indicator, Shift-Lock System, Speed Control System, Starting System, and Turn Signals.

Location	Amps	Circuits Protected
6	60	Air Conditioning Indicator, Audio System, Brakelamps, Cigar Lighter, Cigar Lighter Switch Illumination, Dome and Map Lamps, Door Key Lamp, Fog Lamp Indicator, Front and Rear Side Marker Lamps, Hazard Warning Lamps, Headlamp Retractors, High-Mount Brakelamp, Horn, Ignition Key Lamp, Illuminated Entry System, Keyless Entry System, Key Reminder, License Plate Lamps, Luggage Compartment Lamp, Lumbar Support, O/D OFF Indicator, Power Door Locks, Power Seats, Rear Window Defroster Indicator, Shift-Lock System, Tail Lamps, and Turn Signals.
7	60	Anti-Lock Brake System
8	40	Cooling Fan
9	40	Air Conditioning And Heater
10	40	Air Conditioning
11	15	Front and Rear Side Marker Lamps, Illumination Lights (Air Conditioning, Cigar Lighter Switch, Fog Lamp, O/D OFF, Rear Window Defroster) License Plate Lamps, and Tail Lamps.
12	20	Headlamp Retractors (RETRA)
13	30	Lumbar Support and Power Seats
14	-	-

To remove and replace a fuse, use the fuse puller provided.

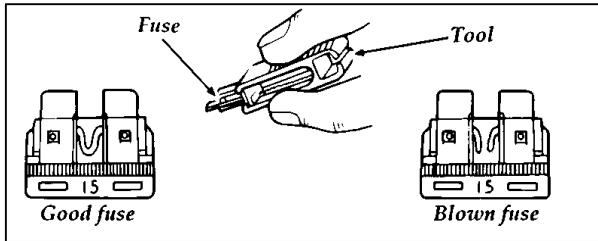

Fuse puller tool and fuse

Relays

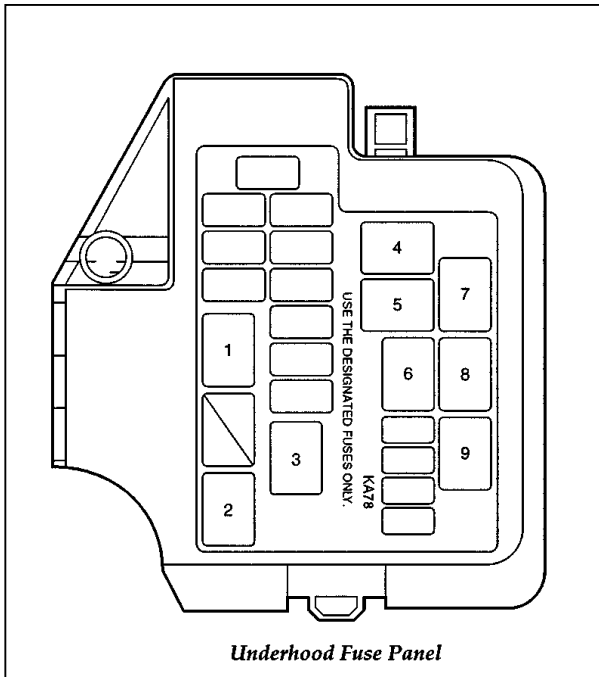

Underhood Fuse Panel

Location	Circuits Protected
1	Headlamps Relay
2	Fog Lamps Relay
3	Air Conditioning Relay
4	Parking Lamps Relay
5	Horn Relay
6	Daytime Running Lights Relay
7	Fuel Pump Relay
8	Powertrain Control Module Power Relay
9	Starter Interrupt Relay

⚠ WARNING

Always replace a fuse with one that has the specified amperage rating. Using a fuse with a higher amperage rating can cause severe wire damage and could start a fire.

To find a fuse's amperage rating, check the number on the fuse or check the color.

Fuse Rating	Color
10 amp	Red
15 amp	Blue
20 amp	Yellow
30 amp	Light Green
30 amp FL	Pink
40 amp	Green
60 amp FL	Yellow
80 amp FL	Black
100 amp FL	Blue

Even after you replace a fuse, it may continue to blow if you do not find what caused the overload. If the fuse continues to blow, have your electrical system checked.

Changing a Tire

If you get a flat tire while you are driving, do not apply the brake heavily. Instead, gradually decrease the speed. Hold the steering wheel firmly and slowly move to a safe place on the side of the road. Park on a level spot, turn off the ignition, set the parking brake, and turn on the hazard flashers.

The Temporary Spare Tire

You may have a high pressure temporary spare tire. This spare tire is smaller than a regular tire and is designed for emergency use only. Use it only when you get a flat tire and replace it as soon as you can. This spare tire is marked with the words “TEMPORARY USE ONLY” so that you can easily identify it.

 WARNING
If you use the temporary spare tire continuously or do not follow these precautions, the tire could fail, causing you to lose control of the vehicle, possibly injuring yourself or others.

When you drive with the temporary spare tire, DO NOT:

- exceed 50 mph (80 km/h) under any circumstances.
- load your vehicle so that it is heavier than the maximum vehicle load rating listed on the tire decal.
- use tire chains on this tire.

- try to repair the temporary spare tire or remove it from its wheel.
- use the wheel for any other type of vehicle.
- drive through an automatic car wash with this tire. Because the temporary spare tire is smaller than a conventional tire, it reduces the ground clearance. Your vehicle may get caught in the rails and it could be damaged.

Spare Tire Location

The temporary spare tire is stored in the luggage compartment, under the mat and floorboard.

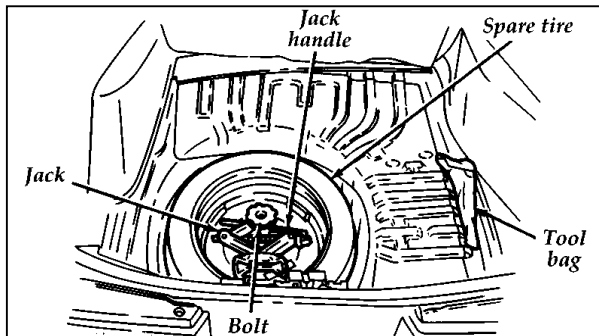

Location of the temporary spare tire and jacking equipment

To remove the jack and the temporary spare, turn the bolt counterclockwise.

Preparing to Change the Tire

1. Make sure that your vehicle will not move or roll. If you have an automatic transaxle, put the gearshift in P (Park). If you have a manual transaxle, put the gearshift in 1 (First). Set the parking brake and block the wheel that is diagonally opposite the tire that you are changing.

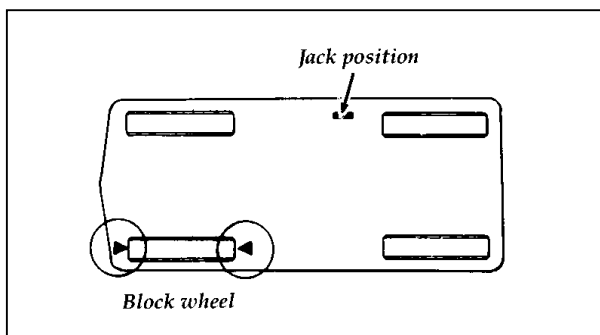

Blocking the wheel diagonally opposite the tire being changed

When one of the front wheels is off the ground, the transaxle alone will not prevent the vehicle from moving or slipping off the jack, even if the vehicle is in P (Park) or 1 (First). To prevent the vehicle from moving when you change one of the front tires, put a block behind the wheel that is diagonally opposite to the tire.

WARNING

If the vehicle slips off the jack, you or someone else could be seriously injured.

2. Get out the spare tire and jack.
3. Remove any wheelcovers or hubcaps with the tapered end of a wheel nut wrench. Insert the handle of the wrench and twist it against the inner wheelcover flange. Remove any chrome nuts or plastic caps covering the wheel lug nuts.
4. Loosen the wheel lug nuts by pulling up on the handle of the wrench one half-turn counterclockwise. Do not remove the wheel lug nuts until you raise the tire off the ground.

Removing and Replacing the Tire

1. Find the jack notch next to the door of the tire that you are changing. Put the jack in the jack notch and turn the handle of the jack clockwise until the wheel is completely off the ground.

 WARNING
To lessen the risk of personal injury, do not put any part of your body under the vehicle while changing a tire. Do not start the engine when your vehicle is on the jack. The jack is only meant for changing the tire.

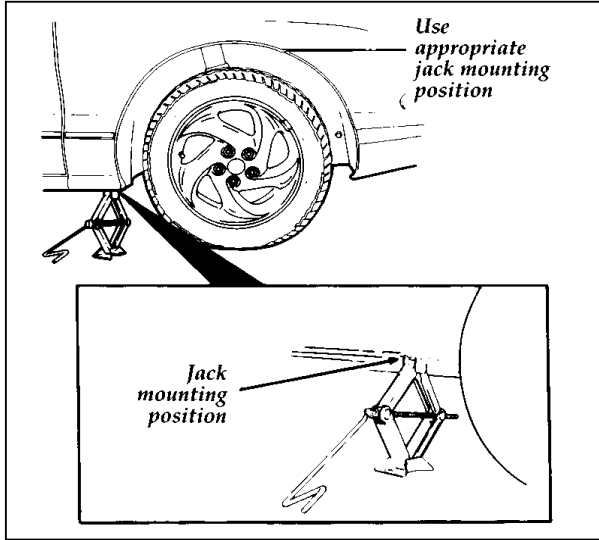

Jack mounting position

2. Remove the lug nuts by using the lug wrench. Never loosen the hub nuts. See the following illustration if you are not sure where to find the lug nuts.

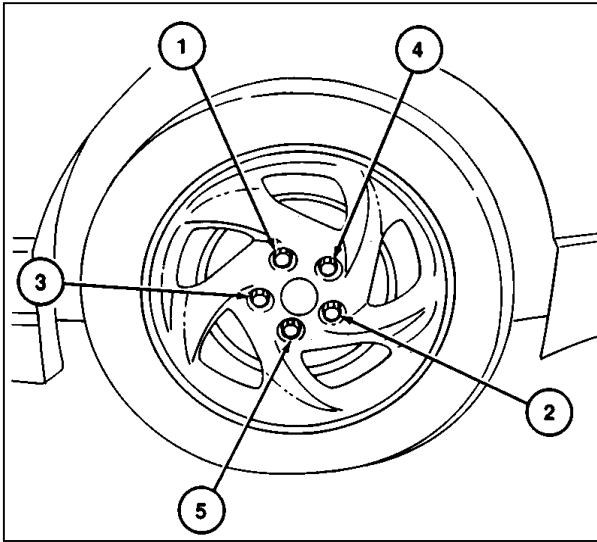

Lug nut positions

3. Replace the flat tire with the spare tire.
4. Replace the lug nuts and tighten snug. The beveled edge faces inward. Do not fully tighten the lug nuts until you lower the vehicle. If you do, you could force the vehicle off the jack.

Your vehicle has metric (12 mm) wheel studs and lug nuts. During wheel removal and replacement, make certain that you use the same lug nuts to reinstall the wheel or replace them with nuts of the same metric size and threading.

⚠ WARNING

Installation of an English thread nut on a metric stud (or vice-versa) will not properly secure the wheel to the hub. Damaged studs may result in wheel separation and possible injury.

5. Lower the vehicle by turning the jack handle counterclockwise.
6. Remove the jack and fully tighten the lug nuts in the order shown in the illustration under step 2.
7. Put the tire, jack, and wrench away.
8. Unblock the wheels.

Jump-Starting Your Vehicle

Your vehicle has a Motorcraft maintenance-free battery. Your vehicle's battery may die if you leave the lights on or any electrical equipment on after you turn the engine off. If this happens, you may be able to jump-start from a booster battery to start your vehicle.

⚠ WARNING

The gases around the battery can explode if exposed to flames, sparks, or lit cigarettes. An explosion could result in injury or vehicle damage.

⚠ WARNING

To protect yourself when charging a battery, always shield your face and eyes. Make sure that you can breathe fresh air.

⚠ WARNING

Applying too much pressure on the ends when lifting a battery could cause acid to spill. Lift the battery with a carrier or with your hands on the opposite corners.

⚠ WARNING

Batteries contain sulfuric acid which burns skin, eyes, and clothing.

If the acid touches someone's skin, eyes, or clothing, immediately flush the area with water for at least 15 minutes. If someone swallows the acid, have him or her drink lots of milk or water first, then Milk of Magnesia, a beaten egg, or vegetable oil. Call a doctor immediately.

⚠ WARNING

Do not push-start your vehicle. You could damage the catalytic converter. For further information, see *Jumper Cables* in the Index.

To avoid damaging your vehicle or your battery, and to avoid injury to yourself, follow these directions for preparing your vehicle to jump-start and connecting the jumper cables in the order they are given. If in doubt, call for road service.

Preparing Your Vehicle

1. Your vehicle has a 12-volt starting system, so you need to use a 12-volt jumper system. You will damage your starting motor, ignition system, and other electrical parts if you connect them to a 24-volt power supply (either two 12-volt batteries in series or a 24-volt generator set).
2. Do not disconnect the battery of the disabled vehicle. You could damage the vehicle's electrical system.
3. Park the booster vehicle close to the hood of the disabled vehicle. **Make sure the vehicles do not touch each other.** Set the parking brake on both vehicles and stay clear of the engine cooling fan and other moving parts.
4. Check all battery terminals and remove any excessive corrosion before you attach the jumper cables.

Connecting the jumper cables

1. Connect one end of the first jumper cable to the positive (+) terminal of the discharged battery. (You can connect either jumper cable to the positive (+) terminal, as long as you use the same cable for both positive terminals.) Most jumper cables have a red cable and a black cable. The red cable is generally used for the positive terminals and the black for the negative ones.
2. Connect the other end of the first cable to the positive (+) terminal of the booster battery.
3. Connect one end of the second cable to the negative (–) terminal of the booster battery — NOT to the discharged battery.

4. Connect the other end of the second cable to a good metallic surface on the engine or frame of the disabled vehicle.

⚠ WARNING

Do not connect the end of the second cable to the negative (-) terminal of the battery to be jumped. A spark may cause an explosion of the gases that surround the battery.

*Make sure vehicles
do not touch*

*Make connections in numerical order
(disconnect in reverse order 4, 3, 2, 1)*

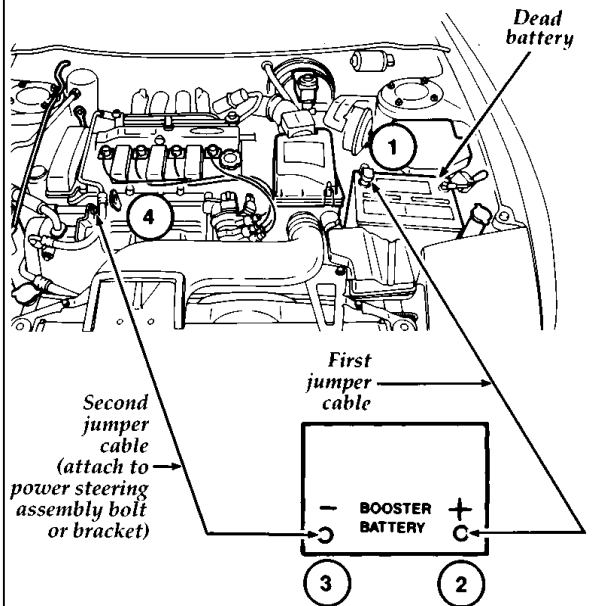

The sequence for connecting the jumper cables

Jump-Starting

1. Make sure that the jumper cables are not in the way of moving engine parts, then start the booster vehicle. Run the engine at a moderate speed.
2. Let the discharged battery charge for a few minutes and then start the disabled vehicle. It may take a couple of tries before the vehicle starts. If the vehicle does not start after several attempts, there may be a different problem.
3. When both vehicles are running, let them idle for a few minutes to charge the discharged battery.

Removing jumper cables

1. **Always remove the jumper cables in reverse order.** Remove the negative (-) end of the jumper cable from the metallic surface on the engine or frame of the disabled vehicle.
2. Remove the negative (-) cable from the booster battery.
3. Remove the positive (+) cable from the booster battery.
4. Remove the other end of the positive (+) cable from the discharged battery.

After the vehicle is started, let it idle for a while to let the engine “relearn” its idle conditions. Drive it around for a while with all electrical accessories turned off to let the battery recharge. Driveability may be deteriorated slightly until all drive modes are “relearned.” **You may need to use a battery charger to fully recharge the battery.**

If you need to replace your battery, see *Battery* in the *Maintenance and Care* chapter.

Towing Your Vehicle

If you need to have your vehicle towed, contact a professional towing service or, if you are a member, your roadside assistance center. Recommended towing options include wheel lift towing or flat bed towing.

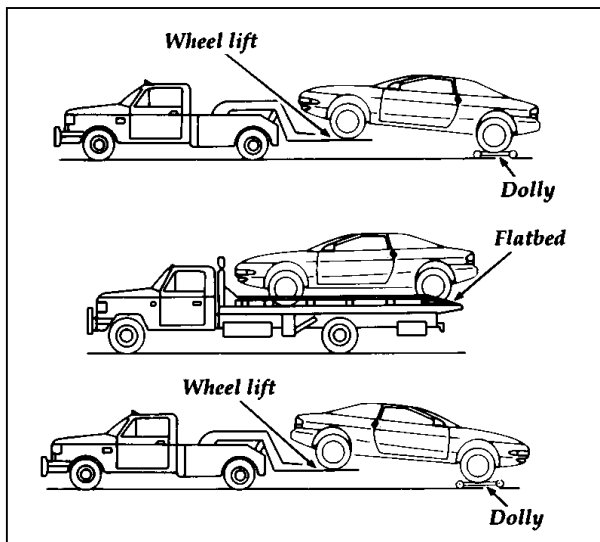

When calling for a tow truck, tell the operator what kind of vehicle you have. A towing manual is available from Ford Motor Company for all authorized tow truck operators. Have your tow truck driver refer to this manual for the proper hook-up and towing procedures for your vehicle.

Towing With the Back Wheels Off the Ground

For automatic and manual transaxle vehicles, if it is necessary to tow your vehicle from the rear (with the rear wheels off the ground), a dolly must be placed under the front tires to prevent transaxle damage.

If the slingbelt towing method must be used, use the following procedure:

1. Place the front wheels on wheel dollies.
2. Place T-hooks into the T-hook slots located on the frame rail behind the rear wheels.
3. Route the tow chain to clear the exhaust pipes.
4. Position the tow bar under the rear bumper.
5. Slowly raise the vehicle off the ground.
6. Attach safety chains around the rear crossmember.

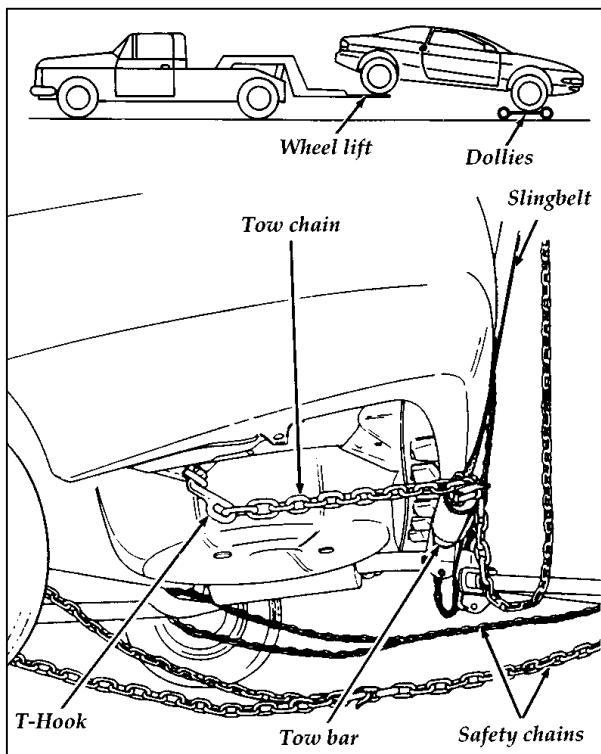

Do not use your vehicle's steering column lock to secure the wheels in a straight-ahead position. Always use a steering wheel clamping device designed for towing service.

Refer to *Towing behind another vehicle* —recreational vehicle in the Index for information on towing behind an RV.

Maintenance and Care

Service Made Easy

Ford has two goals for servicing your vehicle.

1. When we can, we design parts that do not need to be serviced.
2. We want to make servicing your vehicle as easy as possible. To help you:
 - We highlight do-it-yourself items in yellow in the engine compartment so that you can find them easily.
 - When possible, we design parts that can be replaced without tools.
 - We give you a Maintenance Schedule that makes tracking routine service for your vehicle easy. The maintenance schedule is located in the *Maintenance Schedule* booklet.

This chapter tells you about the basic parts that you need to check and service regularly.

If your vehicle needs professional servicing, your dealership can provide the parts and service required. Check your *Warranty Information Booklet* to find out which parts and services are covered. Also see the *Customer Assistance* chapter of this Owner Guide.

Ford Motor Company recommends that you perform the Owner Maintenance Checks listed in the *Maintenance Schedule* booklet. These services are important for the proper operation of your vehicle. In addition to the conditions listed in

the Owner Maintenance Checklist, be alert for any unusual noise, vibration, or other indication that your vehicle may need service. If you do notice something unusual, see that your vehicle is serviced promptly.

Use only recommended fuels, lubricants, fluids, and service parts that meet Ford Motor Company specifications. Motorcraft parts are designed and built to provide the best performance in your vehicle. Using these parts for replacement is your assurance that Ford-built quality stays in your vehicle.

NOTE: Always dispose of used automotive fluids in a responsible manner. Follow your community's standards for disposing of these types of fluids. Call your local recycling center to find out about recycling automotive fluids.

Precautions When Servicing Your Vehicle

Be especially careful when inspecting or servicing your vehicle. Here are some general precautions for your safety:

- Do not work on a hot engine. The engine cooling fan may come on unexpectedly. Always turn the engine off and let it cool.

 WARNING
The cooling fan is automatic and may come on at any time. Always disconnect the negative terminal of the battery before working near the fan.

- If you must work with the engine running, avoid wearing loose clothing or jewelry that could get caught in moving parts. Take appropriate precautions with long hair.

- Do not work on a vehicle in an enclosed space with the engine running, unless you are sure you have enough ventilation.
- Never get under a vehicle while it is supported only by a jack. If you must work under a vehicle, use safety stands.
- Keep all lit cigarettes and other smoking materials away from the battery and all fuel-related parts.

If you disconnect the battery, the engine must “relearn” its idle conditions before your vehicle will drive properly. To find out how the engine does this, see *Battery* in this chapter.

Working with the engine off:

1. Set the parking brake fully and make sure the gearshift is securely latched in P (Park) (automatic transaxle) or Neutral (manual transaxle).
2. Remove the key from the ignition after you turn the engine off.
3. Block the wheels. This will prevent your vehicle from moving unexpectedly.

Working with the engine on:

1. Set the parking brake fully and make sure the gearshift is securely latched in P (Park) (automatic transaxle) or Neutral (manual transaxle).
2. Block the wheels. This will prevent your vehicle from moving unexpectedly.

⚠ WARNING
Do not start your engine with the air cleaner removed and do not remove it while the engine is running.

Opening the Hood

1. Inside the vehicle, pull the hood release handle located under the bottom left corner of the instrument panel.
2. Go to the front of the vehicle and release the auxiliary latch that is located under the hood at the center of the vehicle.
3. Lift the hood and set the prop rod in the hole in the hood marked with an arrow.

When you close the hood, make sure the prop rod is in its retainer and that the hood latches securely.

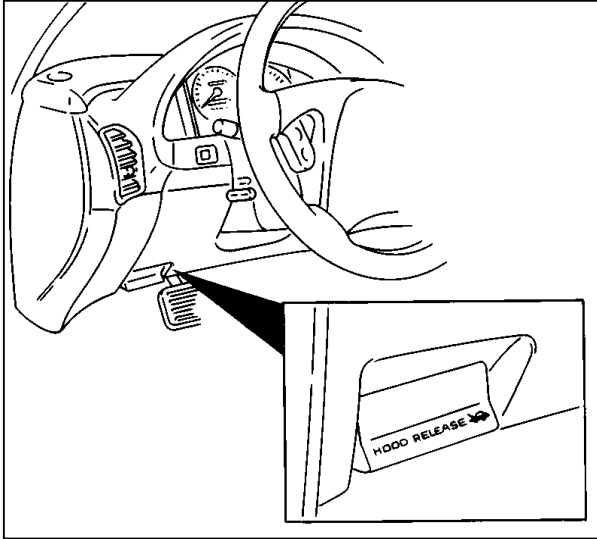

The hood release handle

NOTE: Apply lubricant to the hood latch at six-month intervals to maintain smooth and trouble-free operation.

NOTE: Read and understand *Precautions When Servicing Your Vehicle* at the beginning of this chapter before opening the hood.

Engine Types

Your vehicle has one of these types of engines:

- a 2.0L (121 CID) fuel injected 16-valve four-cylinder engine.
- a 2.5L (152 CID) fuel injected 24-valve six-cylinder engine.

The 2.0L engine

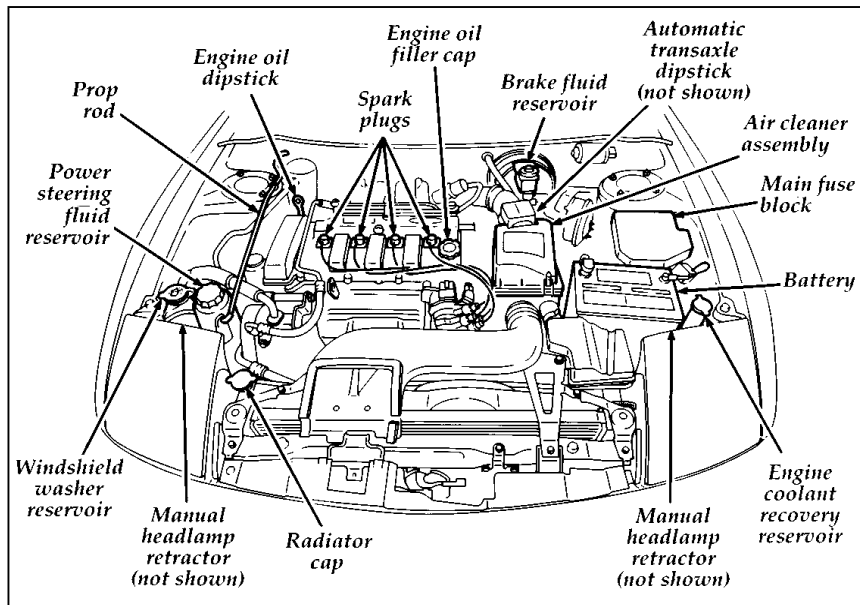

The 2.5L engine

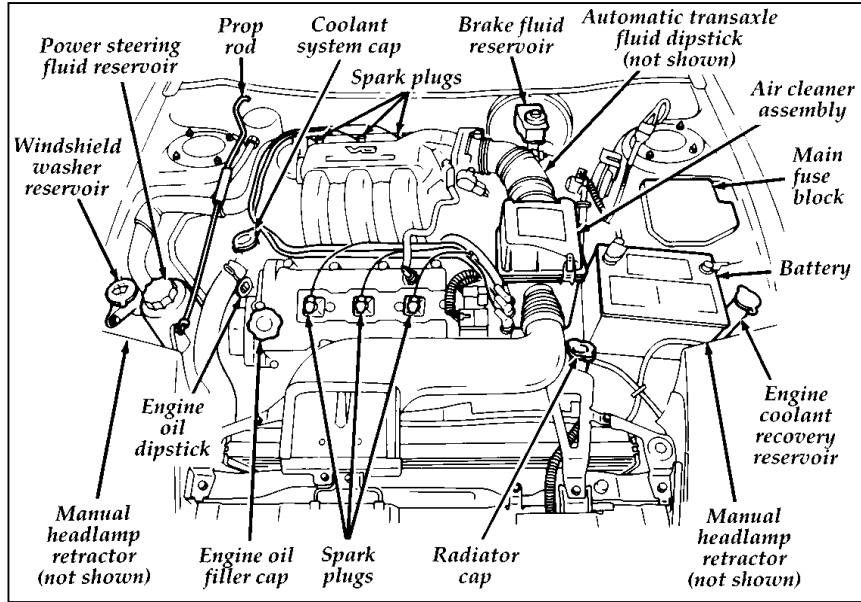

Engine Oil Recommendations

We recommend using Motorcraft oil or an equivalent oil meeting Ford Specification WSS-M2C153-F and displaying the American Petroleum Institute CERTIFICATION MARK on the front of the container.

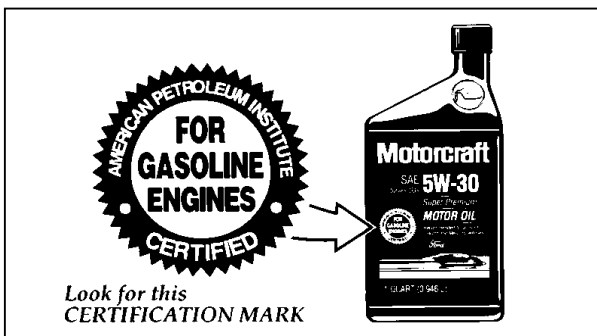

The API Certification Mark

Never use:

- “Non-Detergent” oils
- Oils labeled API SA, SB, SC, SD, SE, SF or SG
- Additional engine oil additives, oil treatments or engine treatments

Engine oils with an SAE **5W-30** viscosity are **PREFERRED** for your vehicle. They provide the best engine performance, fuel economy and engine protection for all climates down to -15°F (-25°C).

Synthetic engine oils which are **CERTIFIED** and of the preferred viscosity may be used in your engine. The engine oil and oil filter must still be changed according to the maintenance schedule.

Checking and Adding Engine Oil

Since the proper amount of engine oil is important for safe engine operation, check the oil using the dipstick each time you put fuel in your vehicle. Remember the engine must be off, the oil must be warm and the vehicle must be parked on level ground.

Checking the engine oil level:

1. Turn the engine off after it has warmed up and allow a few minutes for the engine oil to drain back into the oil pan.
2. Set the parking brake fully and make sure that the gearshift is securely latched in P (Park) (automatic transaxle) or 1 (First) (manual transaxle).
3. Open the hood. Protect yourself from engine heat.
4. Locate the engine oil dipstick (highlighted in yellow) and carefully pull it out of the engine.
5. Wipe the dipstick clean and put it back into position, making sure it is fully seated.

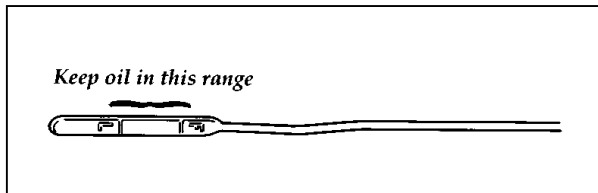

Engine oil dipstick

6. Carefully, pull the dipstick out again. If the oil level is below the L line, add engine oil as necessary. If the oil level is beyond the letter F, engine damage or high oil consumption may occur and some oil must be removed from the engine.
7. Put the dipstick back in and make sure it is fully seated.

Adding engine oil

It may be necessary to add some oil between oil changes. Make sure you use a CERTIFIED engine oil of the preferred viscosity. Your vehicle's warranty coverage may not apply if engine damage is caused by the use of improper engine oil.

Add engine oil through the oil filler cap highlighted in yellow. To add oil, remove the filler cap and use a funnel to pour oil into the opening. Be careful not to overfill the engine. Recheck the oil level after you finish adding oil.

Changing the Engine Oil and the Oil Filter

Change the engine oil and oil filter per the following, whichever occurs first.

<p style="text-align: center;">5,000 MILES (8,000 KM) OR 6 MONTHS NORMAL SCHEDULE</p> <hr/>
<p style="text-align: center;">3,000 MILES (5,000 KM) OR 3 MONTHS SEVERE DUTY SCHEDULE</p> <p style="text-align: center;">EXTENSIVE IDLING TRAILER TOWING DRIVING IN SEVERE DUST POLICE, TAXI, OR DELIVERY</p>

Refer to the *Maintenance Schedule* booklet for additional information.

NOTE: Always dispose of used automotive fluids in a responsible manner. Follow your community's standards for disposing of these types of fluids. Call your local recycling center to find out about recycling automotive fluids.

NOTE: Ford production and aftermarket (Motorcraft) oil filters are designed for added engine protection and long life. If a replacement oil filter is used that does not meet Ford material and design specifications, startup engine noises or knock may be experienced. It is recommended you use the appropriate Motorcraft oil filter (or another brand meeting Ford specifications) for your engine application.

 WARNING
Continuous contact with USED motor oil has caused cancer in laboratory mice.

Protect your skin by washing with soap and water.

Brake Fluid

Under normal circumstances, your vehicle should not use up brake fluid rapidly. However, expect the level of the brake fluid to slowly fall as you put more mileage on your vehicle and the brake pads wear.

Check the brake fluid at least once a year. You can do this by looking at the fluid level in the plastic reservoir on the master cylinder. (See *The Engine Types* earlier in this chapter to locate the master cylinder.) The fluid level should be at or near the MAX mark.

⚠ WARNING

Brake fluid is toxic.

If brake fluid contacts eyes, flush eyes with running water for 15 minutes. Get medical attention if irritation persists. If taken internally, drink water and induce vomiting. Get medical attention immediately.

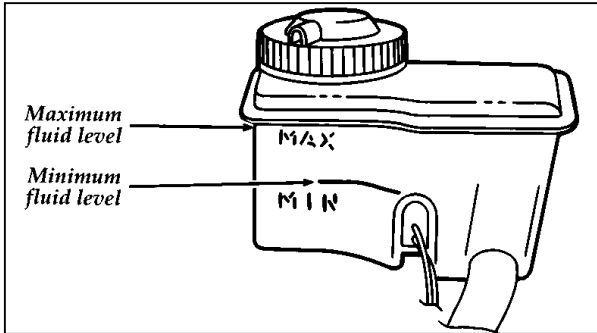

Brake fluid level

If the fluid is low, carefully clean and remove the cap from the reservoir. Fill the reservoir to the MAX line with Ford High Performance DOT 3 Brake Fluid C6AZ-19542-AA or DOT 3 equivalent fluid meeting Ford specification ESA-M6C25-A.

⚠ WARNING

If you use a brake fluid that is not DOT 3, you will cause permanent damage to your brakes.

Do not fill the reservoir above the MAX line.

If you find that the fluid level is excessively low — below the seam or ridge on the outside of the plastic reservoir — have the brake system inspected.

⚠ WARNING

Do not let the reservoir for the master cylinder run dry. This may cause the brakes to fail.

Windshield Washer Fluid

Washer Fluid

Check the level of the windshield washer fluid every time you stop for fuel. The reservoir for the windshield washer fluid is located in the engine compartment. Visual inspection can determine if the washer fluid is adequate. Do not operate the washer when the reservoir is empty.

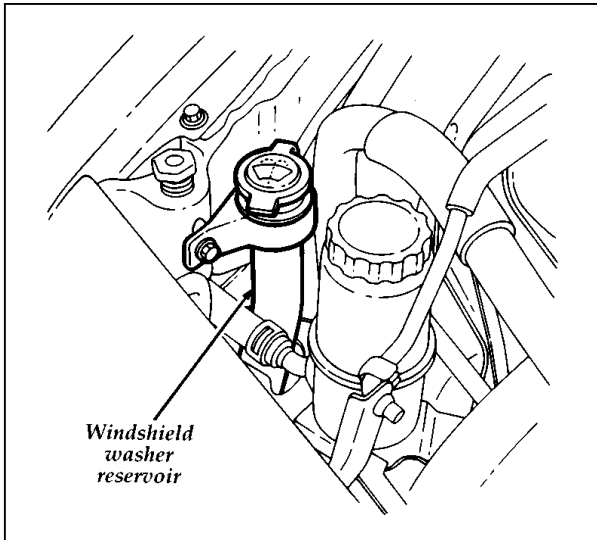

Windshield washer fluid reservoir

⚠ WARNING

Do not put windshield washer fluid in the container for the engine coolant.

Use specially formulated windshield washer fluid rather than plain water, because specially formulated washer fluids contain additives that dissolve road grime. For safety reasons, washer fluids containing an appropriate antifreeze such as methanol should be used in freezing weather (temperatures below 32°F [0°C]). State or local regulations on Volatile Organic Compounds (VOCs) may restrict use of the most common antifreeze, methanol. Washer fluids containing non-methanol antifreeze agents should be used only if they provide cold weather protection without damaging the vehicle's paint finish, wiper blades, and windshield washer system.

Engine Coolant

Adding Engine Coolant

⚠ WARNING

Be careful not to add engine coolant to the windshield washer fluid reservoir. If sprayed on the windshield, engine coolant could make it difficult to see through the windshield.

When the engine is cool, add a 50/50 mixture of engine coolant and water to the engine coolant recovery reservoir — **DO NOT ADD DIRECTLY TO THE RADIATOR**. Add straight water only in an emergency, but you should replace it with a 50/50 mixture of coolant and distilled water as soon as possible.

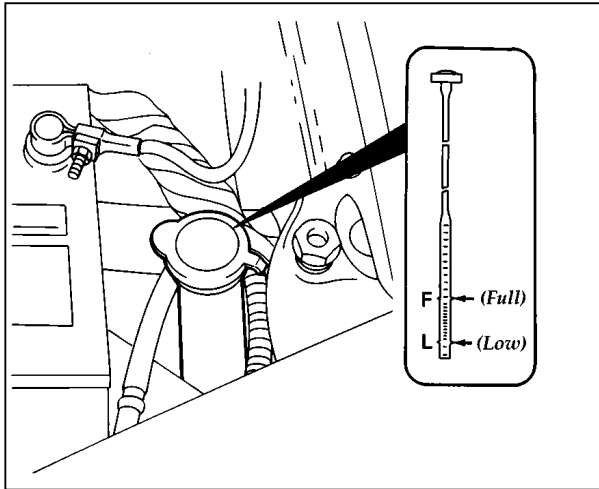

Check the coolant level in the coolant recovery reservoir the next few times you drive the vehicle. If necessary, add enough of a 50/50 mixture of coolant and water to bring the liquid level to the fill line on the reservoir.

⚠ WARNING

Never remove the coolant recovery cap while the engine is running or hot.

If you must remove the coolant recovery cap, follow these steps to avoid personal injury caused by escaping steam or engine coolant:

1. Before you remove the cap, turn the engine off and let it cool.
2. When the engine is cool, wrap a thick cloth around the cap and turn it slowly, counterclockwise to the first stop.
3. Step back while the pressure releases.

4. When you are sure that all the pressure has been released, use the cloth to press the cap down, turn it counterclockwise, and remove it.

Use Ford Premium Engine Coolant E2FZ-19549-AA (in Canada, Motorcraft CXC-8-B) or an equivalent premium engine coolant that meets Ford specification ESE-M97B44-A. Ford Premium Engine Coolant is an optimized formula that will protect all metals and rubber elastomers used in Ford cooling systems for 4 years or 50,000 miles (80,000 km).

Do not use alcohol or methanol antifreeze or any engine coolants mixed with alcohol or methanol antifreeze. Do not use supplemental coolant additives in your vehicle. These additives may harm your engine cooling system. **The use of an improper coolant may void the warranty of your vehicle's engine cooling system.**

Recycled engine coolant

Ford Motor Company recommends that Ford and Lincoln-Mercury dealers use recycled engine coolant produced by Ford-approved processes. Not all coolant recycling processes produce coolant which meets Ford specification ESE-M97B44-A, and use of such coolant may harm engine and cooling system components.

Always dispose of used automotive fluids in a responsible manner. Follow your community's regulations and standards for recycling and disposing of automotive fluids.

Coolant refill capacity

To find out how much fluid your vehicle's cooling system can hold, see *Refill capacities* in the *Capacities and Specifications* chapter.

Have your dealer check the engine cooling system for leaks if you have to add more than a quart (liter) of engine coolant each month.

Severe winter climate

If you drive in extremely cold climates (less than -34°F [-36°C]), it may be necessary to increase the coolant concentration above 50%. Refer to the chart on the coolant container to ensure the coolant concentration in your vehicle is such that the coolant will not freeze at the temperature level in which you drive during winter months. Never increase the engine coolant concentration above 60%. Leave a 50/50 mixture of engine coolant and water in your vehicle year-round in non-extreme climates.

Checking Hoses

Check all engine and heater system hoses and hose connections for deterioration, leaks, and loose hose clamps as specified in the *maintenance schedule*. Repair or replace with Motorcraft hoses or equivalent as necessary.

Power Steering Fluid

Check the level of the power steering fluid at least twice a year (i.e., every Spring and Fall).

Checking and Adding Power Steering Fluid

1. Start the engine and let it run until the power steering fluid reaches normal operating temperature. The power steering fluid will be at the right temperature when the engine coolant temperature gauge in the instrument cluster is near the center of the NORMAL operating temperature range.

2. While the engine idles, turn the steering wheel back and forth several times. Make sure that the cap assembly is installed at this time.
3. Turn the engine off and check the level on the power steering reservoir.

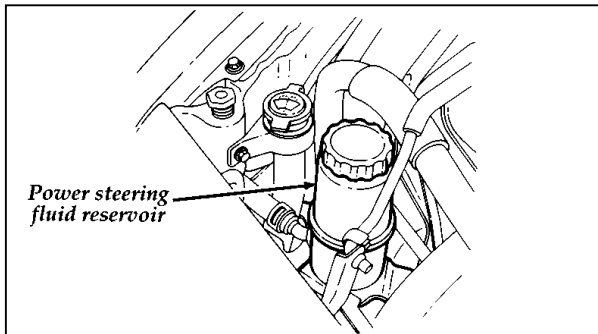

Where to check for power steering fluid

4. Remove the dipstick to read the power steering fluid level. If the power steering fluid is low, add fluid in small amounts, continuously checking the level, until you reach the HIGH line. Do not overfill. To find out how much fluid your vehicle's power steering fluid reservoir will hold, see *Refill capacities for fluids* in the Index.
5. When you are finished, put the dipstick back in and make sure that it fits snugly.

If the power steering fluid is low, do not drive your vehicle for a long period of time before adding fluid. This can damage the power steering pump.

If you must check the power steering fluid before it reaches normal operating temperature, make sure that the fluid reaches the "L" (LOW) line range in the reservoir. The reading will only be accurate if the fluid temperature is approximately 70° to 100°F (21° to 38°C).

Automatic Transaxle Fluid

Under normal circumstances, you do not need to check the fluid level of the transaxle, since your vehicle does not use up transaxle fluid. Refer to the *Maintenance Schedule* booklet for replacement intervals. However, if the transaxle is not working properly — for instance, the transaxle may slip or shift slowly, or you may notice some sign of fluid leakage — the fluid level should be checked.

If you must check the transaxle fluid in an emergency, make sure that your vehicle is on level ground, start the engine, and move the gearshift through all of the gears allowing sufficient time for each position to engage. Securely latch the gearshift in P (Park). Set the parking brake and leave the engine running.

Wipe off the dipstick cap, pull the dipstick out and wipe the indicator end clean. Put the dipstick back into the filler tube. Make sure the dipstick is fully seated in the filler tube; otherwise, you will not get an accurate reading. Pull the dipstick out and read the fluid level.

The fluid level must be above the lower mark. If it is not, you should not drive your vehicle until more fluid is added. Ideally, the fluid level should be within the specified area of the dipstick.

NOTE: The fluid level indication on the dipstick will be different at operating temperature and room temperature. For the correct fluid level reading on the dipstick, follow the appropriate instructions.

At normal operating temperature (approximately 20 miles [32 km] of vehicle operation), the level on the dipstick should be within the specified area on the “Safe level when hot” temperature scale. At room temperature, the level should be within the specified area on the “Safe level when cold” temperature scale. If your vehicle has not been operated for some time and outside temperature is below 50°F (10°C) the fluid must be warmed by running the engine.

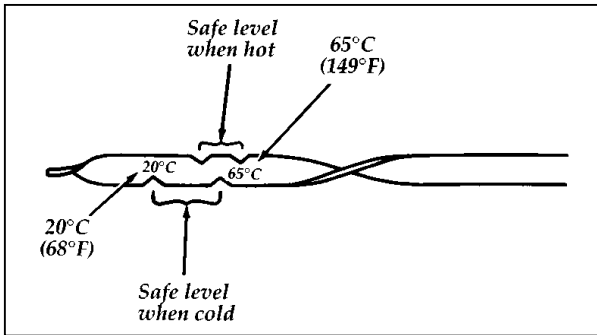

Automatic transaxle fluid dipstick on 2.5L engine vehicles

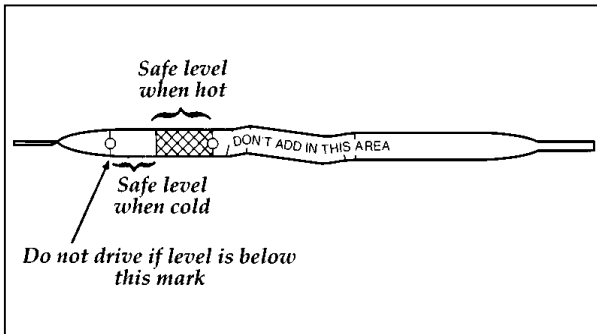

Automatic transaxle fluid dipstick on 2.0L engine vehicles

If you must add transaxle fluid in an emergency, use only MERCON® fluid, such as Motorcraft MERCON® Multi-Purpose ATF. Add the fluid in 1/2-pint increments until you raise the fluid level to within the crosshatched area on the dipstick. Never overfill the transaxle. If the fluid level gets too high, remove the excess fluid as soon as possible; otherwise, you could damage the transaxle.

Manual Transaxle Fluid

The lubricant level and quality should not deteriorate under normal use. However, you should periodically have your Ford Dealer check the fluid level during regular oil changes.

NOTE: Always dispose of used automotive fluids in a responsible manner. Follow your community's standards for disposing of these types of fluids. Call your local recycling center to find out about recycling automotive fluids.

Constant Velocity Joints

Inspect all rubber boots for signs of cracks, tears, or splits. Inspect underneath of your car for any indication of grease splatter in the areas of constant velocity joint boots, outboard and inboard locations; grease splatter is an indication of boot and/or clamp damage.

Battery

The Motorcraft maintenance-free battery does not require additional water during its life of service. The vents are part of the cover and cannot be removed. For longer, trouble-free operation, keep the top of the battery clean and dry. Also, make certain the battery cables are tightly fastened to the battery terminals.

If you see any corrosion on the battery cables or terminals, remove the cables from the terminal and clean them both with a wire brush. You can neutralize the acid with a solution of baking soda and water. Reinstall the cables when you are done cleaning them, and apply a small quantity of grease to the top of each battery terminal to help prevent corrosion.

Battery replacement

When the original equipment maintenance-free battery is replaced under warranty, it may be replaced by a low-maintenance battery.

The low-maintenance battery has removable vent caps for checking the electrolyte level and adding water, if necessary.

The electrolyte level should be checked at least every 24 months or 24,000 miles (40,000 km) in temperatures up to 90°F (32°C) and more in temperatures above 90°F (32°C). Keep the electrolyte level in each cell up to the level indicator. Do not overfill.

If the level gets low, you can add plain tap water to the battery, provided the water isn't hard or doesn't have a high mineral or alkali content. However, if possible, refill with distilled water. If the battery needs water quite often, have the charging system checked for a possible problem.

If you ever disconnect the battery or install a new battery, you must allow the computer to "relearn" its idle condition before your vehicle will drive properly. To begin this process, put the gearshift in P (Park) (automatic transaxle) or N (Neutral) (manual transaxle), set the emergency brake, turn off all the accessories, and start the vehicle. Bring the engine to normal operating temperature.

If you do not let the engine relearn its idle, the idle quality of your vehicle may be adversely affected until the idle is relearned. Your vehicle will eventually relearn its idle while you drive it, but it takes much longer than if you use the previous procedure.

Help Us Protect Our Environment

Ford Motor Company strongly recommends that used lead-acid batteries be returned to an authorized recycling facility for disposal.



Battery recycling symbol

⚠️ WARNING

The gases around the battery can explode if exposed to flames, sparks, or lit cigarettes. An explosion could result in injury or vehicle damage.

⚠️ WARNING

To protect yourself when charging a battery, always shield your face and eyes. Make sure that you can breathe fresh air.

⚠️ WARNING

Batteries contain sulfuric acid which burns skin, eyes, and clothing.

If the acid touches someone's skin, eyes, or clothing, immediately flush the area with water for at least 15 minutes. If someone swallows the acid, have him or her drink lots of milk or water first, then Milk of Magnesia, a beaten egg, or vegetable oil. Call a doctor immediately.

⚠ WARNING

Applying too much pressure on the ends when lifting a battery could cause acid to spill. Lift the battery with a carrier or with your hands on the opposite corners.

Wiper blade maintenance

Check the windshield wiper blades at least twice a year. Also check them whenever they seem less effective than usual. Such substances as tree sap and some hot wax treatments used by commercial car washes reduce the effectiveness of wiper blades.

If the blades do not wipe properly, clean both the windshield and the wiper blades. Use undiluted windshield washer solution or a mild detergent. Rinse thoroughly with clear water. Do not use fuel, kerosene, paint thinner, or other solvents to clean your wiper blades. These will damage your blades.

To make reaching the wiper blades easy, simply turn the ignition switch to ACC and turn your wipers on. Wait for them to reach a vertical position and turn the ignition to OFF. Do not move the wipers manually. Moving the wipers manually may damage them.

Wiper blade replacement

If the wipers still do not work properly after you clean them, you may need to replace the wiper blade assembly. When replacing the wiper blade assembly always use a Motorcraft part or equivalent.

To replace the wiper blades:

1. Pull the wiper arm away from the windshield and into the lock position.
2. Turn the blade at an angle from the wiper arm. Push the lock pin with a screwdriver to release the blade and pull the wiper blade down toward the windshield to remove it from the arm.
3. Attach a new wiper blade to the wiper arm and press it into place until you hear it click.

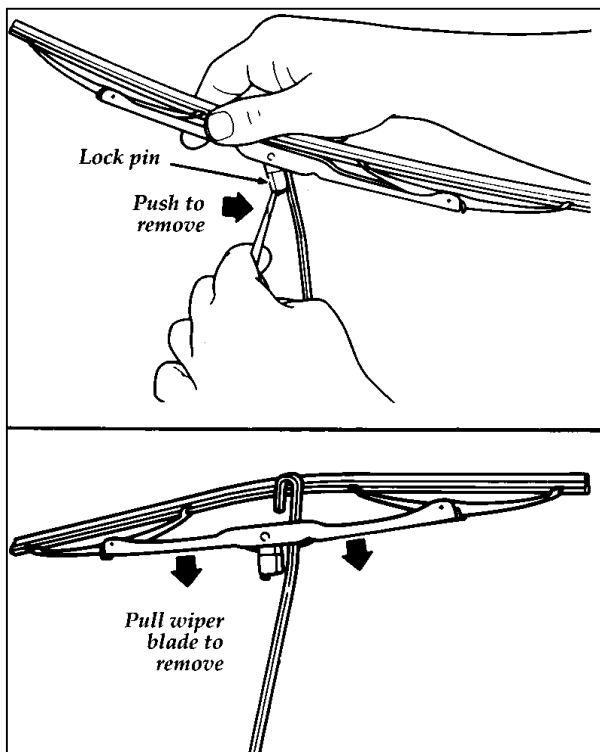

Replacing the wiper blades

Tires

Look at your tires each time you fill your fuel tank. If one tire looks lower than the others, check the pressure in all of them. Always follow these precautions:

- Use an accurate tire pressure gauge.
- Check the tire pressure when tires are cold, after the vehicle has been parked for at least one hour or has been driven less than 3 miles (5 km).

- Make sure the weight of your load is evenly distributed.
- Adjust tire pressure to recommended specifications found on the Safety Compliance Certification Label.

If you do not take these precautions, your tires may fail or go flat.

Ford Motor Company recommends obeying posted speed limits.

 WARNING
Driving too fast for conditions creates the possibility of loss of vehicle control. Driving at very high speeds for extended periods of time may result in damage to vehicle components.

At least once a month, check the pressure in all your vehicle's tires, including the spare. Use an accurate tire pressure gauge. Check the tire pressure when tires are cold, that is, after the vehicle has been parked for at least one hour or has been driven less than 3 miles (5 km).

You can find your vehicle's proper tire inflation pressure on the tire decal on the right door lock pillar.

 WARNING
Improperly inflated tires can affect vehicle handling and can fail suddenly, possibly resulting in loss of vehicle control.

Tire Inspection and Maintenance

Inspect the tire treads, and remove stones, nails, glass or other objects that may be wedged in the tread grooves. Check for holes or cuts that may permit air to leak from the tire, and make the necessary repairs.

Inspect the tire sidewalls for cuts, bruises and other damage. If you suspect internal damage to the tire, have it removed and checked. You may need to repair or replace it.

Tire Rotation

Because your vehicle's front and rear tires perform different jobs, they often wear differently. To make sure your tires wear evenly and last longer, rotate them as indicated in the following diagram.

Do not include the spare tire as part of your rotation.

For tire rotation intervals, see the *Maintenance Schedule* booklet. If you notice the tires wearing unevenly, have them checked.

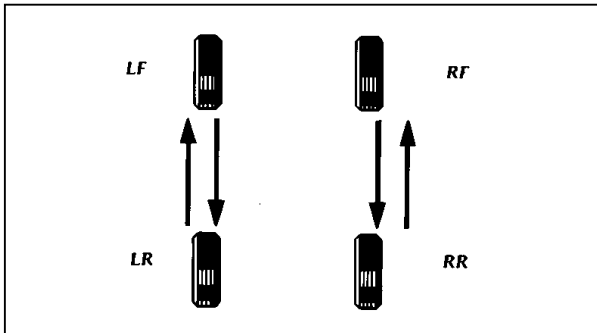

Rotating the tires

Replacing the Tires

We recommend that you use the same size and type when making tire replacements. The standard model uses P195/65 R14 tires, and the GT model is equipped with P225/50VR16 tires. If your standard model vehicle is equipped with a 3-spoke aluminum wheel, you will need P205/55H R15 tires.

Replace any tires that show wear bands. When your tire shows a wear band, it has only 1/16 inch (2 mm) of tread left.

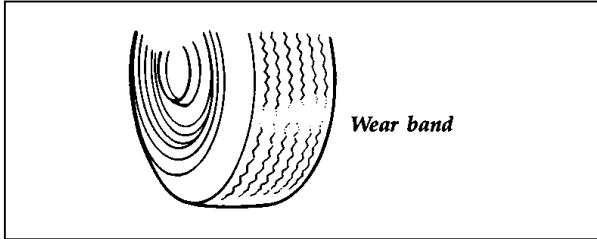

A worn-out tire

Because your vehicle's tires may wear unevenly, you may need to replace them before a wear band appears across the entire tread.

WARNING

When replacing full size tires, never mix radial, bias-belted, or bias-type tires. Use only the tire sizes that are listed on the tire pressure decal. Make sure that all tires are the same size, speed rating, and load-carrying capacity. Use only the tire combinations recommended on the decal. If you do not follow these precautions, your vehicle may not drive properly and safely.

Tires that are larger or smaller than your vehicle's original tires may also affect the accuracy of your speedometer.

Wheel and Tire Matching

See an authorized tire dealer for proper servicing procedures. Wheels and tires must be properly removed, matched and remounted to maintain the best possible ride.

Information About Tire Quality Grades

New vehicles are fitted with tires that have their Tire Quality Grade (described below) molded into the tire's sidewall. These Tire Quality Grades are determined by standards that the United States Department of Transportation has set.

Tire Quality Grades apply to new pneumatic tires for use on passenger cars. They do not apply to deep tread, winter-type snow tires, space-saver or temporary use spare tires, tires with nominal rim diameters of 10 to 12 inches or limited production tires as defined in Title 49 Code of Federal Regulations Part 575.104(c)(2).

U.S. Department of Transportation — Tire quality grades: The U.S. Department of Transportation requires Ford to give you the following information about tire grades exactly as the government has written it.

Treadwear

The treadwear grade is a comparative rating based on the wear rate of the tire when tested under controlled conditions on a specified government test course. For example, a tire graded 150 would wear one and one-half (1 1/2) times as well on the government course as a tire graded 100. The relative performance of tires

depends upon the actual conditions of their use, however, and may depart significantly from the norm due to variations in driving habits, service practices and differences in road characteristics and climate.

Traction A B C

The traction grades, from highest to lowest, are A, B, and C, and they represent the tire's ability to stop on wet pavement as measured under controlled conditions on specified government test surfaces of asphalt and concrete. A tire marked C may have poor traction performance.

⚠ WARNING

The traction grade assigned to this tire is based on braking (straightahead) traction tests and does not include cornering (turning) traction.

Temperature A B C

The temperature grades are A (the highest), B, and C, representing the tire's resistance to the generation of heat and its ability to dissipate heat when tested under controlled conditions on a specified indoor laboratory test wheel. Sustained high temperature can cause the material of the tire to degenerate and reduce tire life, and excessive temperature can lead to sudden tire failure. The grade C corresponds to a level of performance which all passenger car tires must meet under the Federal Motor Vehicle Safety Standard No. 109. Grades B and A represent higher levels of performance on the laboratory test wheel than the minimum required by law.

⚠ WARNING

The temperature grade for this tire is established for a tire that is properly inflated and not overloaded. Excessive speed, underinflation, or excessive loading, either separately or in combination, can cause heat buildup and possible tire failure.

Snow tires

During the winter months in some climates, you may need to use snow tires and occasionally chains for your tires.

⚠ WARNING

Snow tires must be the same size and grade as the tires you currently have on your vehicle.

Use chains on the tires only in an emergency or if the law requires them where you live. If you choose to use chains on your vehicle's tires, be aware of the following:

- Tire chains may scratch or chip aluminum wheels. **IT IS RECOMMENDED THAT TIRE CHAINS ARE INSTALLED ON STEEL WHEELS ONLY.** Be sure to remove wheel covers (if equipped) from steel rims before using tire chains to avoid scratches or damage.
- Do not use tire chains if you have the GT model.
- Local regulations may prohibit or restrict the use of tire chains. Investigate the laws and regulations in your area before installing chains.

- Put the chains on the front tires tightly with the ends held down securely. Retighten the chains after driving 1/2 mile (1 km). Follow the chain manufacturer's instructions.
- Do not drive faster than 30 mph (50 km/h) or the chain manufacturer's recommended speed limit, whichever is lower. Avoid bumps, holes and sharp turns. If you can hear the chains rub or bang against your vehicle, remove the chains to prevent damage to your vehicle.
- Tire chains may affect vehicle handling. Drive carefully and avoid hard braking.
- Do not use chains on temporary spare tires. They may damage the vehicle and the tire.
- Remove tire chains at the first opportunity after using them on snow and ice. Do not use the chains on dry roads.

Filling the Fuel Tank

Fuel filler door release lever

Your vehicle is equipped with a fuel filler door release. To open the fuel filler door, pull up on the release lever which is located in front of the driver's seat and near the door.

Remote Fuel Filler-Lid Release Override

If the release does not operate, open the hatchback, remove the trim on the left rear side, reach into the opening and pull the latch toward the rear (see the service manual for trim removal). You should wear gloves to protect your hands from any sharp edges when you use the fuel filler-lid release override.

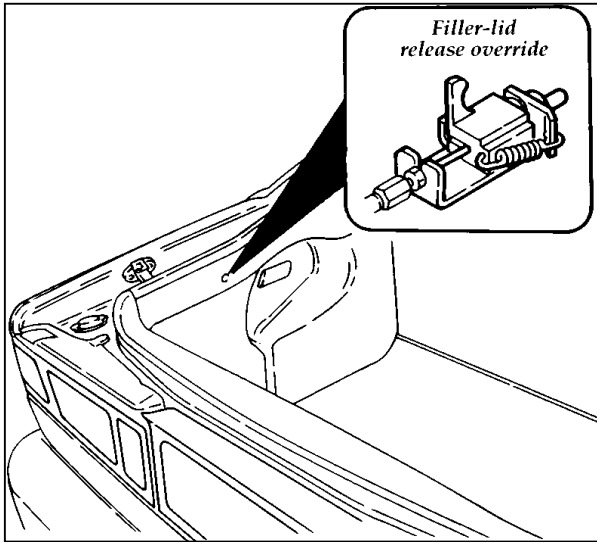

Manual fuel filler-lid override (behind left rear trim panel in hatch)

To fill the fuel tank:

1. After opening the fuel filler door, remove the cap carefully and slowly by turning it counterclockwise $1/2$ to $3/4$ turn.

⚠ WARNING

The fuel system may be under pressure. If the fuel cap is venting vapor or if you hear a hissing sound, wait until it stops before completely removing the cap.

2. Put the nozzle all the way inside the fuel filler pipe before pumping the fuel.

NOTE: If you spill any fuel on the body of your vehicle, clean it off immediately. The fuel may dull or soften the paint if you do not wash it off.

3. Replace the fuel cap completely when you are finished. Turn it clockwise 1/4 turn until it is tight. It will click when it is fully tightened.
4. Push the fuel door closed.

If you lose the fuel cap, replace it with an authorized Motorcraft or equivalent part.

⚠ WARNING

If you do not use the proper fuel cap, the pressure in the fuel tank can damage the fuel system or cause it to work improperly in a collision.

NOTE: If you replace your fuel cap with an aftermarket fuel filler cap, the customer warranty may be void for any damage to the fuel tank and/or fuel system.

Choosing the Right Fuel

Use only UNLEADED FUEL. The use of leaded fuel is prohibited by law and could damage your vehicle. The damage may not be covered by your warranty.

Your vehicle was not designed to use fuel containing manganese-based additives such as MMT. Additionally, vehicles certified to California emission standards (indicated on the underhood Vehicle Emissions Control Information label) are designed to operate on California reformulated gasolines. If California reformulated gasoline is not available when you

refuel, your vehicle can be operated on non-California fuels. However, even though your engine will perform adequately on other gasolines, the performance of the emission control devices and systems may be adversely affected. Repair of damage caused by using a fuel that your vehicle was not designed for may not be covered by your warranty.

Octane Recommendations

Your 2.0L engine is designed to use regular gasoline with an (R+M)/2 octane rating of 87. We do not recommend gasolines labeled as “regular” in high altitude areas that are sold with octane ratings of 86 or even less.

Your 2.5L engine is designed to use premium gasoline for optimum performance with an (R+M)/2 octane rating of 91 or higher. Gasolines with lower octane ratings can be used, but performance may decrease. We do not recommend gasolines labeled as “premium” in high altitude areas that are sold with octane ratings less than 91.

Do not be concerned if your vehicle sometimes knocks lightly. However, if it knocks heavily under most driving conditions on the recommended octane fuel, see your dealer or a qualified service technician to prevent any engine damage.

Fuel Quality

If you are experiencing starting, rough idle or hesitation problems try a different brand of fuel. If the condition persists, see your dealer or a qualified service technician.

The American Automobile Manufacturers Association (AAMA) issued a gasoline specification to provide information on high

quality fuels that optimize the performance of your vehicle. We recommend the use of gasolines that meet the AAMA specification if they are available.

It should not be necessary to add any aftermarket products to your fuel tank if you continue to use a high-quality fuel.

Cleaner Air

Ford approves the use of gasolines to improve air quality, including reformulated gasolines that contain oxygenates such as a maximum of 10% ethanol or 15% MTBE. There should be no more than 5% methanol with cosolvents and additives to protect the fuel system.

Safety Information Relating to Automotive Fuels

 WARNING
--

Automotive fuels can cause serious injury or death if misused or mishandled.

- Turn vehicle off when refueling.
- Do not smoke when refueling. Fuels are extremely flammable.
- Do not siphon any fuel by mouth.

 WARNING
--

Gasoline or gasoline blended with methanol can cause blindness and possible death when swallowed. If any fuel is swallowed, call a physician or poison control center immediately.

- Avoid breathing vapors while refueling.
- If fuel is splashed on the skin, wash with soap and water.
- If fuel is splashed in the eyes, remove contact lenses (if worn), flush with water for 15 minutes, and seek medical attention.

Gasoline and gasoline blends may contain small amounts of carcinogens, such as benzene. Long-term exposure to unleaded gasoline vapors has caused cancer in laboratory animals.

If you are taking the medication “Antabuse” or other forms of disulfiram for the treatment of alcoholism, vapor or skin contact with a gasoline-methanol blend may cause the same kind of adverse reaction as drinking an alcoholic beverage. In sensitive individuals, serious personal injury or sickness could result. Consult a physician promptly if you experience an adverse reaction.

Running Out of Fuel

NOTE: Avoid running out of fuel because this situation may have an adverse effect on modern powertrain components.

You may need to crank the engine several times before the fuel system starts to pump fuel from the tank to the engine.

Fuel Economy

Fuel economy is an estimate of the efficiency of your vehicle and can be calculated as Miles Per Gallon (MPG) or Liters Per 100 Kilometers (L/100K).

Do not calculate fuel economy during your vehicle’s break-in period. This would not be an accurate estimate of how much fuel your vehicle will normally use.

To calculate fuel economy:

1. Fill the tank completely and record the initial odometer reading.
2. Every time you buy fuel record the amount (in gallons or liters) purchased.
3. After at least three to five tankfuls, fill the fuel tank and record the final odometer reading.
4. Use these equations to calculate your fuel economy:

English: $\text{MPG} = \frac{\text{total miles driven}}{\text{gallons used}}$

Metric: $\text{L}/100\text{k} = \frac{\text{liters used}}{100 \text{ kilometers}}$

Comparisons With EPA Estimates

EPA fuel economy figures are obtained from laboratory tests under simulated road conditions and may not reflect the actual conditions you experience or your style of driving. The EPA fuel economy estimate is not a guarantee that you will achieve the fuel economy shown.

The following decrease fuel economy:

- Lack of regular, scheduled maintenance
- Rapid acceleration and excessive speed
- Driving with your foot on the brake
- Sudden stops
- Extended engine idling
- Using speed control in hilly terrain

- Extended use of the A/C, defroster, rear window defroster and other accessories
- Underinflated tires
- Heavy loads
- Aftermarket add-ons such as bike, ski or luggage racks, bug deflectors, etc.

Air Conditioning Refrigerant

Whenever service to the air conditioning system is required, make sure the service facility uses a refrigerant recycling system. These systems will capture the refrigerant for reuse. Releasing certain refrigerants into the atmosphere can damage our environment.

Emission Control System

Your vehicle is equipped with a catalytic converter which enables your vehicle to comply with applicable exhaust emission requirements.

 WARNING
<p>Exhaust leaks may result in the entry of harmful and potentially lethal fumes into the passenger compartment. Under extreme conditions excessive exhaust temperatures could damage the fuel system, the interior floor covering, or other vehicle components, possibly causing a fire.</p>

To make sure that the catalytic converter and the other emission control parts continue to work properly:

- Use only unleaded fuel.
- Avoid running out of fuel.
- Do not turn off the ignition while your vehicle is moving, especially at high speeds.
- Do not push start your vehicle.
- Have the services listed in your *Maintenance Schedule* booklet performed according to the specified schedule.

 **WARNING**

Do not park, idle, or drive your vehicle in dry grass or other dry ground cover. The emission system heats up the engine compartment and exhaust system, which can start a fire.

Watch for fluid leaks, strange odors, smoke, loss of oil pressure, the charge warning light, the check engine light, or the temperature warning light. These sometimes indicate that the emission system is not working properly.

Do not make any unauthorized changes to your vehicle or engine. Changes that cause more unburned fuel to reach the exhaust system can increase the temperature of the engine or exhaust system.

In general, maintenance, replacement, or service of the emission control devices or systems in your new Ford Motor Company vehicle or engine may be performed at your expense by any automotive repair establishment or individual using automotive parts equivalent to those with which your vehicle or engine was originally equipped.

By law, anyone who manufactures, repairs, services, sells, leases, trades vehicles, or supervises a fleet of vehicles is not permitted to intentionally remove an emission control device or prevent it from working. In some of the United States and in Canada, vehicle owners may be liable if their emission control device is removed or is prevented from working.

Never use a metal exhaust collector when you service your vehicle. If the metal collector contacts any of your vehicle's plastic trim or bumper parts they could melt or deform.

Do not drive your vehicle if it does not operate properly. See your dealer if the engine runs on for more than five seconds after you shut it off or if it misfires, surges, stalls, or backfires.

Information about your vehicle's emission control system is on the Vehicle Emission Control Information decal located on or near the engine. This decal identifies engine displacement and gives some tune-up specifications.

How to Prepare Your Vehicle for Inspection/Maintenance (I/M) Testing

In some localities it may become a legal requirement to pass an Inspection/Maintenance (I/M) test of the On-Board Diagnostic (OBD) II system. If the vehicle's powertrain system or its battery has just been serviced, the OBD II system is reset to a not ready for I/M testing condition. To prepare for I/M testing, the law specifies that additional mixed city and highway driving is required to complete the check of the OBD II system.

The driving modes required to reach the ready condition consist of a minimum of 30 minutes of city and highway driving as described below.

- 20 minutes of driving in stop and go city-type traffic with at least four idle periods.
- 10 minutes of driving on an expressway or highway

Before completing the above driving modes, the engine must be warmed up and at operating temperature. Once started, the vehicle must not be turned off during the above driving modes. If the vehicle owner is unable to meet the I/M requirements by using these driving patterns, an authorized service center can perform a detailed OBD II drive cycle as it would any other type of repair work.

Lights and Bulb Replacement

It is a good idea to check the operation of the following lights frequently:

- headlamps
- tail lamps
- brakelamps
- hazard flasher
- turn signals
- side markers
- license plate lamps
- fog lamps (GT model)

The alignment of your headlamps should be checked if:

- oncoming motorists frequently signal you to turn off your vehicle's high beams when you do not have the high beams on
- the headlamps do not seem to give you enough light to see clearly at night
- the headlamp beams are pointed substantially away from a position slightly down and to the right

Headlamp Bulb

Your vehicle has retractable halogen headlamps. If you need to replace a headlamp, have it done by a Ford service technician.

High-Mount Brake Lamp Bulb

To replace the bulb:

1. Remove the two side trim liftgate panels.
2. Remove the liftgate trim clip and the liftgate trim.
3. Remove the bulb from the socket by pushing it in and turning it counterclockwise.
4. Install the bulb by pushing straight into the lamp socket and turning it clockwise until it locks in place.
5. Replace the liftgate trim and trim clip.
6. Replace the two side trim liftgate panels.

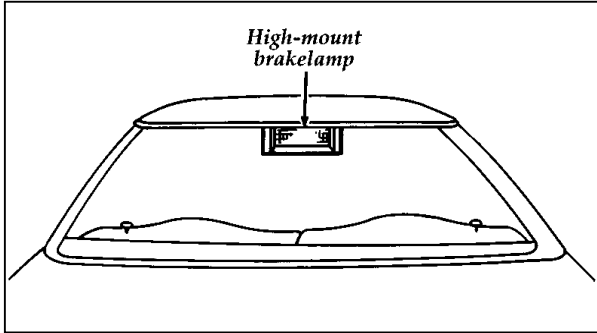

High-mount brakelamp

Rear Lamp Bulbs

To replace a bulb:

1. Remove the attaching screw and the rear lens cover.

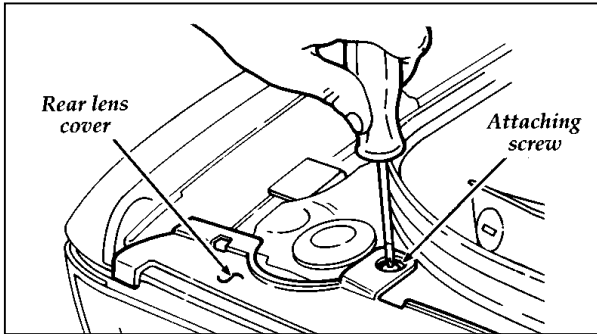

Removing the attaching screw and lens

2. Partially remove the rear lens by pulling the lock tabs out of the slots.

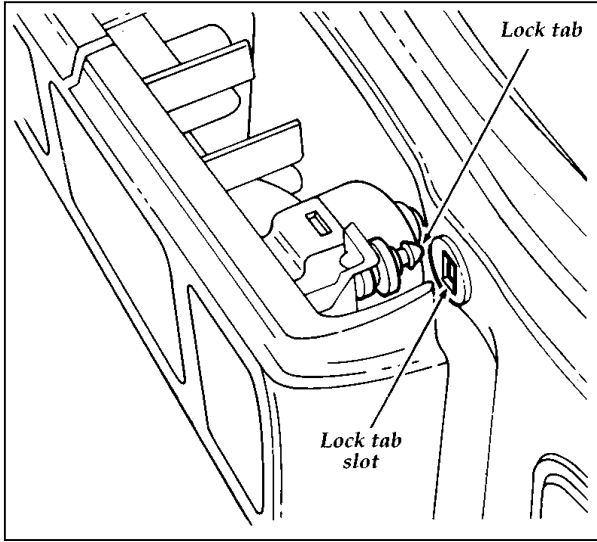

Pulling out the lock tabs

3. Turn the socket counterclockwise to remove it from the lens.
4. Remove the bulb from the socket by pushing it in and turning it counterclockwise.

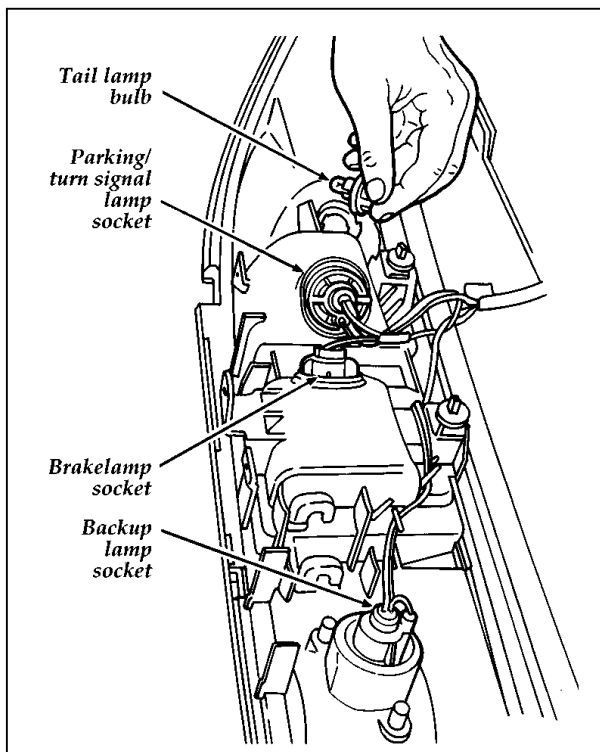

The rear lamps

5. Install the bulb by pushing it into the socket and turning it clockwise.
6. Install the socket by pushing it into its housing and turning it clockwise. The arrow on the socket must align with the arrow on the housing when installed.
7. Replace the rear lens and rear lens cover.

Bulb Specifications

Function	Number of Bulbs	Trade Number
Exterior Illumination		
Backup Lamps	2	1156
Headlamps	2	9004
High-Mount Brakelamp	1	921
Parking Lamps	4	1157NA
Tail and Brakelamps	4	2497
Rear License Plate Lamp	2	168
Rear Turn Signal Lamp	2	3496
Side Marker Lamp–Front	2	194
Side Marker Lamp–Rear	2	168
Instrument Panel Illumination		
Turn Signal Indicator	2	194

Cleaning Your Vehicle

Washing and Polishing Your Vehicle

Wash the outside of your vehicle, including the underside, with a mild detergent.

DO NOT:

- Wash your vehicle with hot water
- Wash your vehicle while it sits in direct sunlight
- Wash your vehicle while the body is hot

Pollen, bird droppings and tree sap can damage the paint, especially in hot weather. Wash your vehicle as often as necessary to keep it clean.

Take similar precautions if your vehicle is exposed to chemical industrial fallout.

Paint damage resulting from fallout is not related to a defect in paint materials or workmanship and therefore is not covered by warranty. Ford, however, believes that continual improvement in customer satisfaction is a high priority. For this reason, Ford has authorized its dealers to repair, at no charge to the owner, the surfaces of new vehicles damaged by environmental fallout within 12 months or 12,000 miles (20,000 km) of purchase, whichever comes first. Customers may be required to bring their vehicle in for inspection by a Ford representative.

Polish your vehicle to remove harmful deposits and protect the finish.

Cleaning Chrome and Aluminum Parts

Wash chrome and aluminum parts with a mild detergent. Do not use steel wool, abrasive cleaners, fuel or strong detergents.

Cleaning Plastic Parts

Some of your vehicle's exterior trim parts are plastic. Clean with a tar and road oil remover if necessary. Use a vinyl cleaner for routine cleaning.

Do not clean plastic parts with thinners, solvents or petroleum-based cleaners.

If you have your vehicle rustproofed, remove oversprayed rustproofing with a tar and road oil remover. If rustproofing is not removed from plastic and rubber parts, it can cause deterioration.

Because your vehicle's side mouldings are painted in lacquer, do not use thinners or solvents to clean them.

Cleaning the Exterior Lamps

Do not use dry paper towel, chemical solvents or abrasive cleaners to clean the lamps, as these may cause scratches or crack the lamps.

Cleaning the Engine

A clean engine is more efficient because the engine is able to cool properly. A build up of grease and dirt acts as an insulator, keeping the engine warmer than normal.

- Extreme care must be used if a power washer is used to clean the engine. The high pressure fluid could penetrate sealed parts and assemblies causing damage or malfunctions.
- In order to avoid possible cracking of the engine block or fuel injection pump, do not spray a hot engine or injection pump with cold water.
- The alternator, distributor and air intake must be covered. Covering these components will help prevent water damage.

Never wash or rinse the engine while it is running. Water getting into the engine may cause internal damage.

Cleaning the Wheels

Wash the wheels with the same detergent you use to wash your vehicle's body. Do not use acid-based wheel cleaners, steel wool, abrasives, fuel, or strong detergents. These substances will damage protective coatings. Use tar and road oil remover to remove grease and tar.

NOTE: Before going to a car wash, find out if the brushes are abrasive.

If you have whitewall tires that are difficult to clean with regular detergent, use whitewall tire cleaner. Follow the directions on the container and rinse the tires with plenty of clean water.

Cleaning the Interior Lamps

Your interior dome lamps and map lamps are plastic and should be cleaned with a mild detergent diluted in water. Rinse them with clear water.

Cleaning the Instrument Panel Lenses

To clean the lenses on your instrument panel, use Ford Glass Cleaner and a soft cloth. Never use paper towels or abrasive cleaners; they can scratch the lenses.

Cleaning the Seats

Leather

For routine cleaning, wipe the surface with a soft, damp cloth. For more thorough cleaning, wipe the surface with a leather and vinyl cleaner or a mild soap.

Fabric

Remove dust and loose dirt with a whisk broom or a vacuum cleaner. Remove fresh spots immediately. Follow the directions that come with the cleaner.

NOTE: Before using any cleaner, test it on a small, hidden area of fabric. If the fabric's color or texture is adversely affected by a particular cleaner, do not use it.

Cleaning the Safety Belts

Clean the safety belts with any mild soap solution that is recommended for cleaning upholstery or carpets. Do not bleach or dye the belt webbing because this may weaken it.

Vehicle Storage

Maintenance Tips

If you plan on storing your vehicle for an extended period of time (60 days or more), refer to the following maintenance recommendations to ensure your vehicle stays in good operating condition.

General

- Store all vehicles in a dry, ventilated place.
- Protect from sunlight, if possible.
- If vehicles are stored outside, they require regular maintenance to protect against rust and damage.

Body

- Wash vehicle thoroughly to remove dirt, grease, oil, tar or mud from exterior surfaces, rear wheel housing and underside of front fenders.
- Periodically wash vehicles stored in exposed locations.
- Touch-up raw or primed metal to prevent rust.
- Cover chrome and stainless steel parts with a thick coat of auto wax to prevent discoloration. Re-wax as necessary when the vehicle is washed.

- Lubricate all hood, door and trunk lid hinges and latches with a light grade oil.
- Cover interior soft trim to prevent fading.
- Keep all rubber parts free from oil and solvents.

Engine

- Start engine every 15 days. Run at fast idle until it reaches normal operating temperature.
- With your foot on the brake, shift through all the gears while the engine is running.

Fuel system

- Fill fuel tank with high-quality unleaded fuel until the first automatic shutoff of the fuel pump nozzle.

NOTE: During extended periods of vehicle storage (60 days or more), fuel may deteriorate due to oxidation. This can damage rubber and other polymers in the fuel system and may also clog small orifices.

Ford Gas Stabilizer should be added whenever actual or expected storage periods exceed 60 days. Follow the instructions on the label. The vehicle should then be operated at idle speed to circulate the additive throughout the fuel system.

A volatile corrosion inhibitor added to the fuel system will protect the fuel system's inner surfaces from corrosion. Follow the instructions packaged with the product.

Cooling system

- Protect against freezing temperatures.

Battery

- Check and recharge as necessary.
- Keep connections clean and covered with a light coat of grease.

Brakes

- Make sure brakes and parking brake are fully released.

Tires

- Maintain recommended air pressure.

Miscellaneous

- Make sure all linkages, cables, levers and clevis pins under vehicle are covered with grease to prevent rust.
- Move vehicles at least 25 feet (10 m) every 15 days to lubricate working parts to prevent corrosion.

Capacities and Specifications

Refill Capacities, Motorcraft Parts, and Lubricant Specifications

Motorcraft Parts

Component	Ford Part Number	
	2.0L Engine	2.5L Engine
Air Filter	FA-1122	FA-1122
Battery	BXT-58R	BXT-58R
Fuel Filter	FG896	FG896
Oil Filter	FL821	FL822
PCV Valve	EV219	EV220
Spark Plug*	AGSP 32C	AGSP 33C
* Refer to Vehicle Emission Control Information (VECI) decal, located on the underside of the hood, for gap specifications.		

Refill Capacities (Approximate)

Fluid	Vehicle Type	Capacity
Brake Fluid	All	¹
Clutch Fluid (if equipped)	All	¹
Engine Coolant ²	2.0L 2.5L	7.4 qts. (7.0 L) 7.9 qts. (7.5 L)
Engine Oil	2.0L 2.5L	3.7 qts. (3.5 L) 4.2 qts. (4.0 L)
Fuel	All	15.5 gal (58.5 L)
Power Steering Fluid	All	1.9 pts. (0.45 L)
Transmission Fluid; Automatic	2.0L 2.5L	9.0 qts. (8.5 L) 9.3 qts. (8.8 L)
Transmission Fluid; Manual	All	5.8 pts. (2.7 L)
Windshield Washer Fluid	Front Rear	³
¹ Fill to MAX line in reservoir. ² Add 50/50 mixture to the Full mark in coolant recovery reservoir for a warm engine, or to the Low mark for a cold engine. ³ Fill to FULL line in reservoirs.		

Lubrication Specifications

The transaxle and steering systems in your vehicle are filled at the factory with high-quality, long-lasting lubricants or fluids that do not require periodic draining or refilling except under severe-duty conditions. However, when refilling or adding is required, it should be with the proper lubricant or fluid meeting Ford technical specifications. See the *Maintenance Schedule* booklet for instructions on maintaining proper fluid levels.

Fluid	Ford Part Name or Equivalent	Ford Part Number	Ford Specification
Brake Fluid and Clutch Fluid	Ford High Performance DOT 3 Motor Vehicle Brake Fluid	C6AZ-19542-AB	ESA-M6C25-A, DOT 3
Engine Coolant	Ford Premium Cooling System Fluid	E2FZ-19549-AA	ESE-M97B44-A
Engine Oil	5W30 Super Premium	XO-5W30-QSP	WSS-M2C153-F with API Certification Mark
Grease; CV Joints	CV Joint Grease – High Temperature	E43Z-19590-A	ESP-M1C207-A
Grease; Hinges and Latches	Multi-Purpose Grease	D0AZ-19584-AA	ESB-M1C93-B
Grease; Rear Wheel Bearings	Motorcraft Premium Long Life Grease	XG-1-C or XG-1-K	ESA-M1C75-B

Fluid	Ford Part Name or Equivalent	Ford Part Number	Ford Specification
Power Steering Fluid	Ford Premium Power Steering Fluid	E6AZ-19582-AA	ESW-M2C33-F
Transaxle Fluid; Automatic	Motorcraft MERCON® Automatic Transmission Fluid	XT-2-QDX	MERCON®
Transaxle Fluid; Manual	Ford SAE 75W/90 Gear Oil	F32Z-19C547-MA	API GL-4
Windshield Washer Fluid	Ultra-Clear Windshield Washer Concentrate	C9AZ-19550-AB or C9AZ-19550-BB	ESR-M17P5

**YOU FOUND
THE RIGHT PLACE.**



**Quality Care is more
than automotive service.**

**It's our goal to make you so
happy with your vehicle
and our service, you'll want
to come back. For service.
And your next vehicle.**

**Quality Care.
It's at your dealer.**

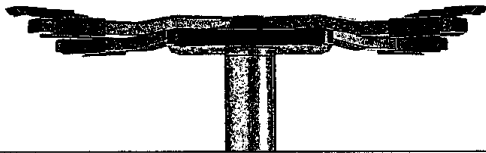

© 1995 Ford Motor Company

Reporting Safety Defects (U.S. Only)

Reporting Safety Defects (U.S. Only)

If you believe that your vehicle has a defect which could cause a crash or could cause injury or death, you should immediately inform the National Highway Traffic Safety Administration (NHTSA) in addition to notifying Ford Motor Company.

If NHTSA receives similar complaints, it may open an investigation, and if it finds that a safety defect exists in a group of vehicles, it may order a recall and remedy campaign. However, NHTSA cannot become involved in individual problems between you, your dealer, or Ford Motor Company.

To contact NHTSA, you may either call the Auto Safety Hotline toll-free at 1-800-424-9393 (or 366-0123 in the Washington, D.C. area) or write to: NHTSA, U.S. Department of Transportation, 400 Seventh Street, Washington D.C. 20590. You can also obtain other information about motor vehicle safety from the Hotline.

Customer Assistance

Roadside Assistance

Ford Motor Company has set up a 24-hour, seven-day-a-week hotline with trained operators who put you in touch with the help you need if you experience a problem with your vehicle. This complimentary service is provided to you throughout your warranty period of 3 years or 36,000 miles (60,000 km), whichever comes first. To purchase Roadside Assistance coverages beyond this period (available through Ford Auto Club in the United States or Ford and Lincoln-Mercury dealers in Canada), contact your Ford or Lincoln-Mercury dealer. Additional Roadside Assistance coverage is unavailable in Puerto Rico and the Virgin Islands.

Roadside Assistance will cover the following:

- Mount your spare if you have a flat tire.
- Jump-start your battery if it is dead.
- Unlock your vehicle if you are locked out.
- Bring you fuel if you run out.
- Tow your vehicle if you are stranded. Even non-warranty related tows, like accidents or getting stuck in mud or snow, are covered (some exclusions apply, such as impound towing and repossession).

How to use Roadside Assistance

Your Roadside Assistance identification card can be found in the Owner Guide portfolio in your glove compartment. Complete the card and place it in your wallet for quick reference.

To receive roadside assistance in the United States call 1-800-241-FORD (in Canada call 1-800-665-2006).

Should you need to arrange for roadside assistance yourself, Ford Motor Company will reimburse the reasonable cost. To obtain information about reimbursement call 1-800-241-FORD (in Canada call 1-800-665-2006).

If You Have a Service Problem

Ford Motor Company has authorized Ford and Lincoln-Mercury dealerships that can service your vehicle for you. This chapter tells you how to get service or maintenance for your vehicle.

Service/Maintenance Concerns (U.S. or Canada)

Ford recommends taking your vehicle to your selling dealer who wants to ensure your continued satisfaction. You may, however, take your vehicle to any authorized Ford or Lincoln-Mercury dealer. In most cases, your dealer will be able to resolve your concern.

If you are not satisfied with the service you received from your dealership's service department, talk to the service manager at the dealership, or if you still are not satisfied, talk to the owner or general manager of the dealership. In most cases, you will have your concern resolved at this level.

If you are away from home when your vehicle needs to be serviced, or if you need more help than the dealer gave you, contact the Ford Customer Assistance Center to find an authorized dealership that may be able to help.

To process your request, the Ford Customer Assistance Center needs the following information:

- your telephone number (both business and home)
- the name of the dealer and the city where the dealership is located
- the year and make of your vehicle
- the date purchased
- the current mileage on your vehicle
- your Vehicle Identification Number (VIN)

<p style="text-align: center;"><i>Ford Motor Company Customer Assistance Center 300 Renaissance Center P.O. Box 43360 Detroit, Michigan 48243 1-800-392-3673 (FORD) TDD for the hearing impaired: 1-800-232-5952</i></p>
--

If you still have a complaint involving a warranty dispute, you may wish to contact the Dispute Settlement Board.

A warranty dispute must be submitted to the Dispute Settlement Board before taking action under the Magnuson-Moss Warranty Act, or to the extent allowed by state law, before pursuing replacement or repurchase remedies provided by certain state laws. This dispute handling

procedure is not required prior to enforcing state created rights or other rights which are independent of the Magnuson-Moss Warranty Act or state replacement or repurchase laws.

The Dispute Settlement Board

The Dispute Settlement Board is:

- an independent, third-party arbitration program for warranty disputes
- available free to owners and lessees of qualifying Ford Motor Company vehicles

The Dispute Settlement Board may not be available in all states. Ford Motor Company reserves the right to change eligibility limitations, modify procedures and/or discontinue this service without notice and without incurring obligations.

What Kinds of Cases Does the Board Review?

The Board reviews all warranty performance complaints on Ford, Mercury and Lincoln cars and Ford and Mercury light trucks under the new vehicle limited warranty that have not been resolved by either a dealer or Ford Motor Company, except those involving:

- a non-Ford product
- a non-Ford dealership
- a vehicle sales transaction
- request for reimbursement of consequential expenses. Expenses incidental to the warranty complaint being reviewed are eligible for consideration
- items not covered by the new vehicle limited warranty

- items covered by a service contract
- alleged liability claims
- property damage where the damage is significant when compared to the economic loss alleged under the warranty dispute
- cases currently in litigation
- vehicles not used primarily for family, personal or household purposes (except in states where the Dispute Settlement Board is required to review commercial vehicles)

Complaints involving vehicles in which applicable new vehicle limited warranties have expired at receipt of your application are not eligible. Eligibility may differ according to state law. For example, see the unique brochures for California and Wisconsin purchasers/lessees.

How Does the Board Work?

The Board consists of:

- three consumer representatives
- a Ford or Lincoln/Mercury dealer

Consumer candidates for Board membership are recruited and trained by an independent consulting firm. Dealers are chosen because of their business leadership qualities.

What the Board needs

To have your case reviewed you must complete the application in the DSB brochure and mail it to the address provided on the application form.

Your application is reviewed and, if it is determined to be eligible, you will receive an acknowledgment indicating:

- the file number assigned to your application
- the toll-free phone number of the DSB's independent administrator

Your dealership and a Ford Motor Company representative are asked to submit statements at this time.

To review your case properly, the Board needs the following information:

- legible copies of all documents and maintenance or repair orders relevant to the case
- the year, make, model and Vehicle Identification Number (VIN) listed on your vehicle ownership license
- the date of repair(s) and mileage at the time of occurrence(s)
- the current mileage
- the name of the dealer who sold or serviced the vehicle
- a brief description of your unresolved concern
- a brief summary of the action taken with the dealer and Ford Motor Company

- the names (if known) of all the people you contacted at the dealership
- a description of the action you expect to resolve your concern

Should your case NOT qualify for review, a letter of explanation will be mailed to you.

Oral presentations

If the involved vehicle is within 36 months and 36,000 miles of the warranty start date, you have the right to make an oral presentation before the Board. Indicate your choice to do so on the application. Oral presentations may also be requested by the Board.

Making a decision

Board members will review all available information related to the complaint, including oral presentations, if necessary. They then arrive at a fair and impartial decision, decided by a simple majority vote.

Because the Board usually meets only once a month, some cases may take longer than 30 days to be reviewed. The Board makes every effort to resolve each case within 40 days of receiving the consumer application form.

After a case is reviewed, the Board mails you a decision letter. The Board also provides a form on which to accept or reject the Board's decision. The decisions of the Board are binding on the dealer and Ford, but not on consumers who may elect to pursue other remedies available to them under state and federal law. Decisions of the Board may be presented as evidence by any party in subsequent legal proceedings that may be initiated, where allowed by law.

To Request a DSB Brochure/Application

For a brochure/application, speak to your dealer or write to the Board at the following address:

*Dispute Settlement Board
P.O. Box 5120
Southfield, MI 48086-5120*

Ford of Canada Customer Assistance

Ford Motor Company of Canada, Limited

If you live in Canada and have any questions or concerns that the dealership cannot answer, contact the Customer Assistance Centre.

*Customer Assistance Centre
Ford Motor Company of Canada, Limited
P.O. Box 2000
Oakville, Ontario L6J 5E4
1-800-565-3673 (FORD)*

Please have the following information available when contacting the Customer Assistance Centre:

- your telephone number (both business and home)
- your Vehicle Identification Number (VIN) listed on your vehicle ownership license
- the year and make of your vehicle
- the date purchased

- the name of the dealer and the city where the dealership is located
- the current mileage on your vehicle

Mediation/Arbitration Program (Canada Only)

In those cases where you continue to feel that the efforts by Ford and the dealer to resolve a factory-related vehicle service concern have been unsatisfactory, Ford of Canada participates in an impartial third party mediation/arbitration program administered by the Canadian Motor Vehicle Arbitration Plan (CAMVAP).

The CAMVAP program is a straight-forward and relatively speedy alternative to resolve a disagreement when all other efforts to produce a settlement have failed. This procedure is without cost to you and is designed to eliminate the need for lengthy and expensive legal proceedings.

In the CAMVAP program, impartial third-party Arbitrators conduct hearings at mutually convenient times and places in an informal environment. These impartial Arbitrators review the positions of the parties, make decisions and, where appropriate, render awards to resolve disputes. CAMVAP decisions are fast, fair and final as the arbitrator's award is binding on both you and Ford of Canada.

CAMVAP services are available in all territories and provinces, except Quebec. For more information, without charge or obligation, call your CAMVAP Provincial Administrator directly at 1-800-207-0685.

This plan is not available in the province of Quebec.

Getting Help Outside the U.S. and Canada

Before you export your vehicle to a foreign country, contact the appropriate foreign embassy or consulate to make sure local regulations do not prevent you from registering your vehicle. Officials at the embassy can also help you decide whether you should import your vehicle to that country.

Officials at the embassy or consulate can tell you where to get unleaded fuel. If you cannot get unleaded fuel or can get only fuel with an anti-knock index that is lower than your vehicle needs, contact a district or owner relations office before you leave the U.S. or Canada.

Use of leaded fuel in your vehicle without a proper conversion may damage the effectiveness of your emissions control system and may cause engine knocking or serious engine damage. Ford Motor Company is not responsible for any damage that is caused by use of improper fuel.

You may also have difficulty importing your vehicle back into the U.S. if you use leaded fuel.

If your vehicle must be serviced while you are traveling or living in Central or South America, the Caribbean, or the Middle East, contact the nearest Ford dealership. If the dealership cannot help you, write to:

*FORD MOTOR COMPANY
WORLDWIDE EXPORT OPERATIONS
1555 Fairlane Drive
Fairlane Business Park #3
Allen Park, Michigan 48101 U.S.A.
Telephone: (313) 594-4857
Fax: (313) 390-0804*

If you are in other foreign countries, contact the nearest Ford dealership. If the dealership cannot help you, they can direct you to the appropriate Ford affiliate office.

If you buy your vehicle in North America and then relocate outside of the U.S. or Canada, register your Vehicle Identification Number and new address with Ford Motor Company Export Operations.

Accessories

Ford Accessories for Your Vehicle

Ford has many fine products available from your dealer to clean your vehicle and protect its finishes. For best results, use the following, or products of equivalent quality:

- Ford Custom Clear Coat Polish
- Ford Custom Silicone Gloss Polish
- Ford Custom Vinyl Protectant
- Ford Deluxe Leather and Vinyl Cleaner
- Ford Extra Strength Spot and Stain Remover
- Ford Extra Strength Tar and Road Oil Remover
- Ford Extra Strength Upholstery Cleaner
- Ford Extra Strength Whitewall Tire Cleaner
- Ford Multi-Purpose Cleaner
- Ford Premium Car Wash Concentrate
- Ford Triple Clean
- Ford Ultra-Clear Spray Glass Cleaner

A wide selection of accessories is available through your local authorized dealer. These fine accessories have been engineered specifically to fulfill your automotive needs. They are custom designed to complement the style and aerodynamic appearance of your Ford-built vehicle. In addition, each accessory is made from high quality materials and meets or exceeds Ford's rigid engineering and safety specifications. That is why Ford brand accessories are warranted for up to 12 months or 12,000 miles (20,000 km), whichever comes first. See your dealer for complete warranty information and accessory availability.

Comfort and Convenience

Travel

Heavy-duty battery

Comfort and convenience

Air-conditioner

Engine block heater

Protection and Appearance

Cleaners, waxes and polishes

Door edge guards

Flat wheel splash guards

Floor mats (carpeted)

Front end covers

Lubricants and oils

Rear deck wing

Remote keyless entry

Super Seal anti-corrosion treatment (US only)

Super Seal fabric protector (US only)

Super Seal undercoating (US only)

Touch-up paints

Vehicle security system

Wheel lug nuts (anti-theft)

NOTE: When adding accessories, equipment, passengers, and luggage to your vehicle, do not exceed the total weight capacity of the vehicle or of the front or rear axle (GVWR, GAWR as shown on the Safety Compliance Certification Label). Consult your dealer for specific weight information.

NOTE: The Federal Communications Commission (FCC) or the Canadian Radio Telecommunications Commission (CRTC) regulates the use of mobile communications systems — such as two-way radios, telephones, and theft alarms — that are equipped with radio transmitters. Any such equipment installed in your vehicle should comply with FCC or CRTC regulations and should be installed only by a qualified technician.

NOTE: Mobile communications systems may harm the operation of your vehicle, particularly if they are not properly designed for automotive use or are not properly installed. For example, when operated, such systems may cause the engine to stumble or stall. In addition, such systems may themselves be damaged or their operation affected by operating your vehicle. (Citizens band [CB] transceivers, garage door openers, and other transmitters whose power output is 5 watts or less will not ordinarily affect your vehicle's operation.)

NOTE: Because we have no control over the installation, design, or manufacture of such systems, Ford cannot assume responsibility for any adverse effects or damage that may result if you use this equipment.

**FOR INFORMATION ON
ORDERING SERVICE
PUBLICATIONS, CONTACT:**

**U.S. RESIDENTS
CALL
HELM, INCORPORATED
1-800-782-4356**

**Monday - Friday 8:00 A.M. - 6:30 P.M. EST
For Credit Card Holder Orders Only**

**CANADIAN RESIDENTS
CALL
Ford Motor Company of Canada, Ltd.
1-800-387-4966**

**Monday - Friday 8:00 A.M. - 6:30 P.M. EST
For Credit Card Holder Orders Only**

All rights reserved. Reproduction by any means, electronic or mechanical including photocopying, recording or by any information storage and retrieval system or translation in whole or part is not permitted without written authorization from Ford Motor Company.

Copyright © 1996 Ford Motor Company

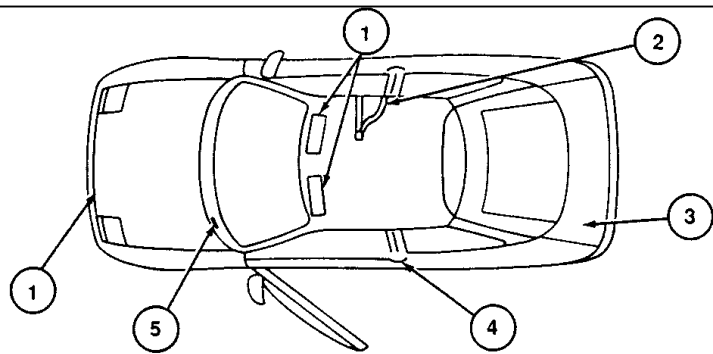

No.	Description	Refer to this label for information regarding:
1	Air Bag Warning Labels	Air bag precautions
2	Child Seat Label	Child seat installation precautions
3	Fuel Pump Shut Off Label	Fuel pump shut off location
4	Safety Compliance Certification Label	Name and date of manufacturer, GVWR*, GAWR**, wheel and tire information
5	Vehicle Identification Number (VIN) Label	Servicing or warranty information specific to your vehicle

* Gross Vehicle Weight Rating

** Gross Axle Weight Rating

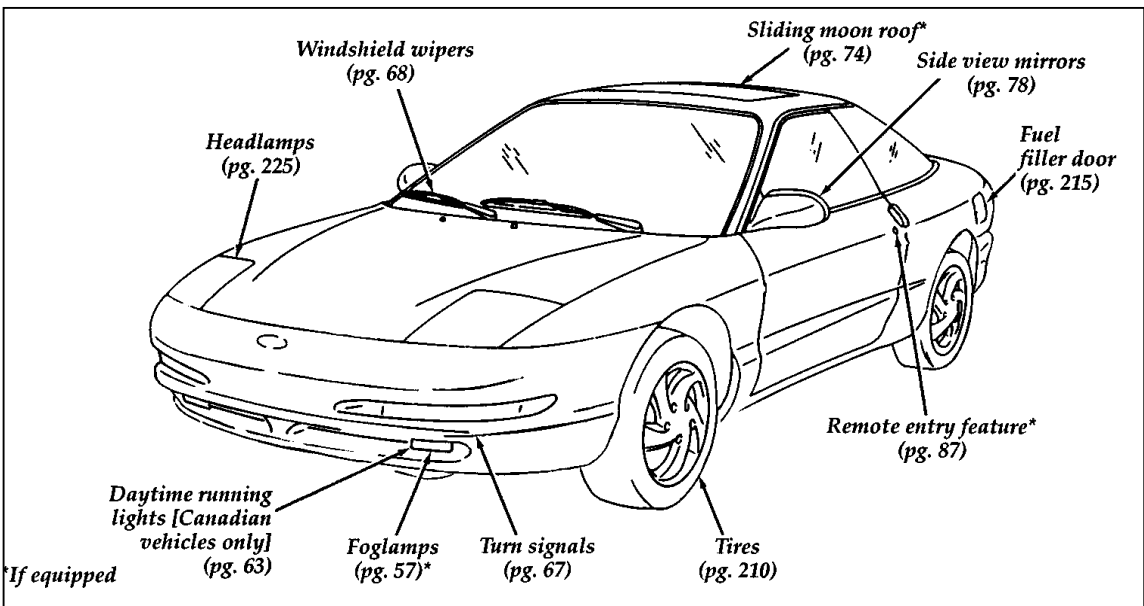

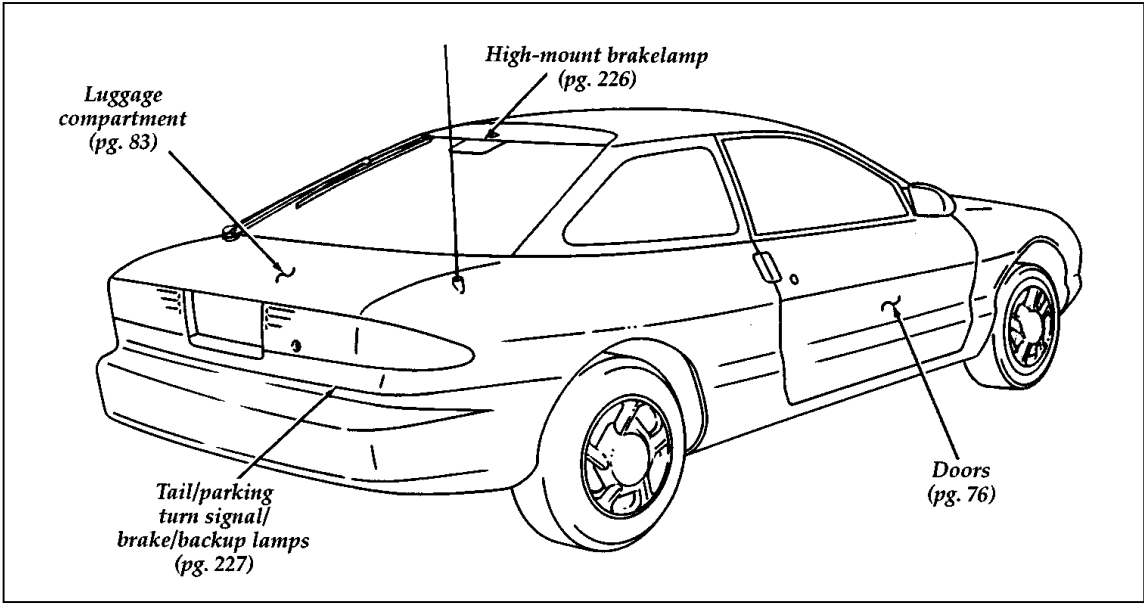

Q U - C K - I - N - D E X

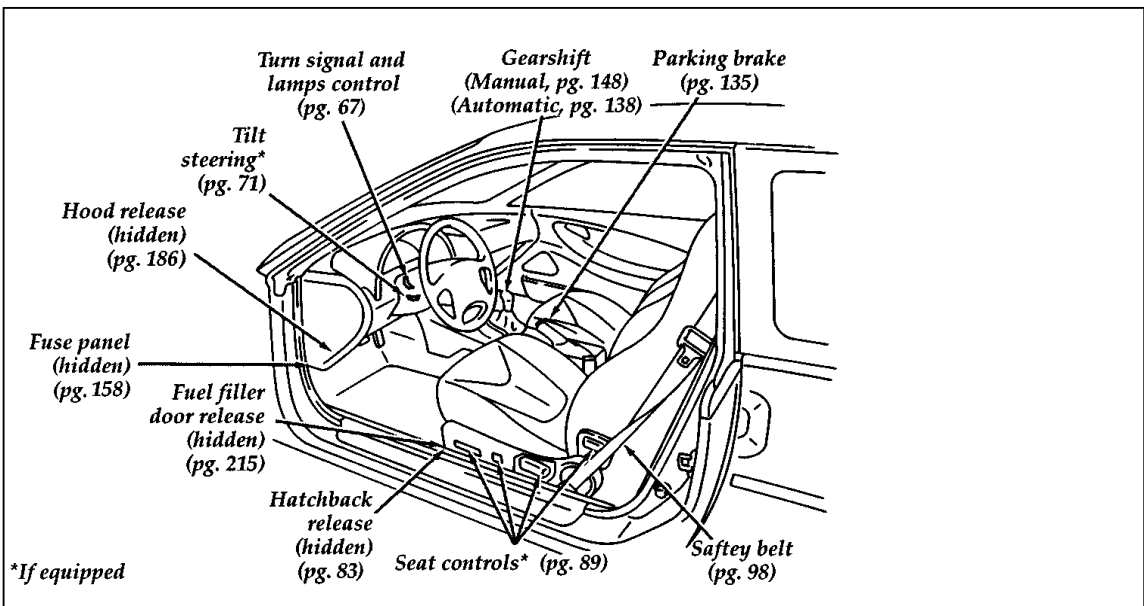

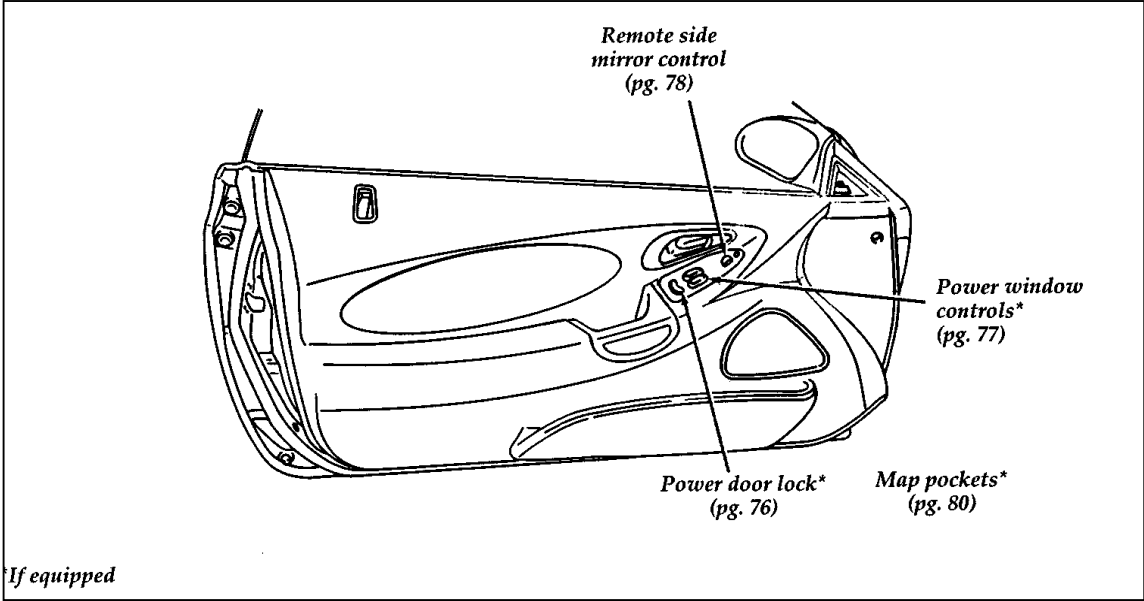

If equipped



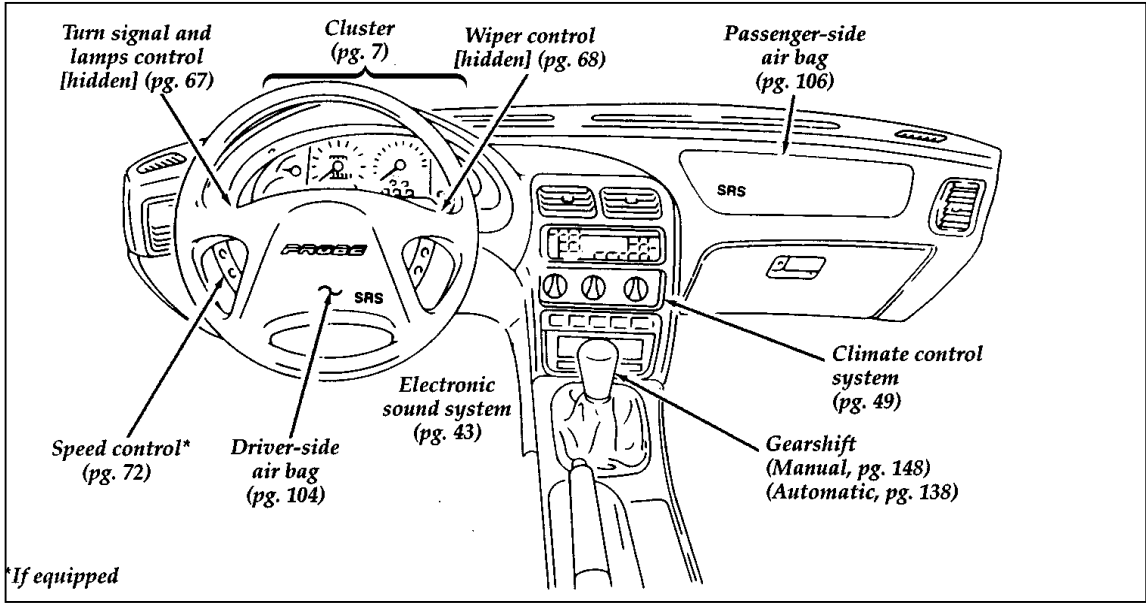

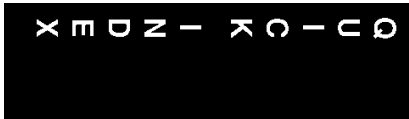
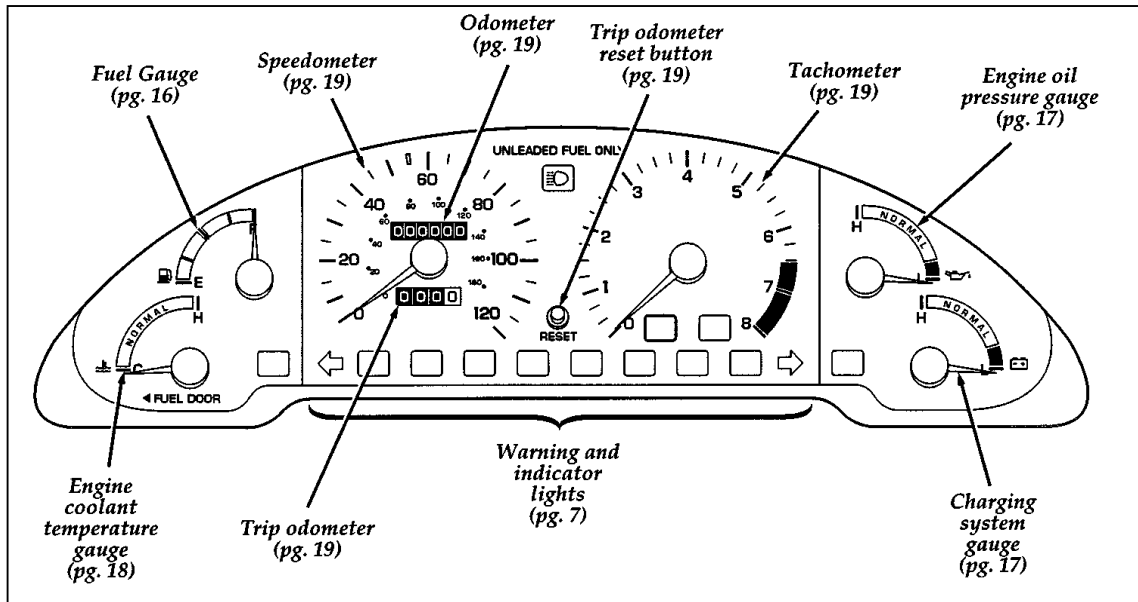

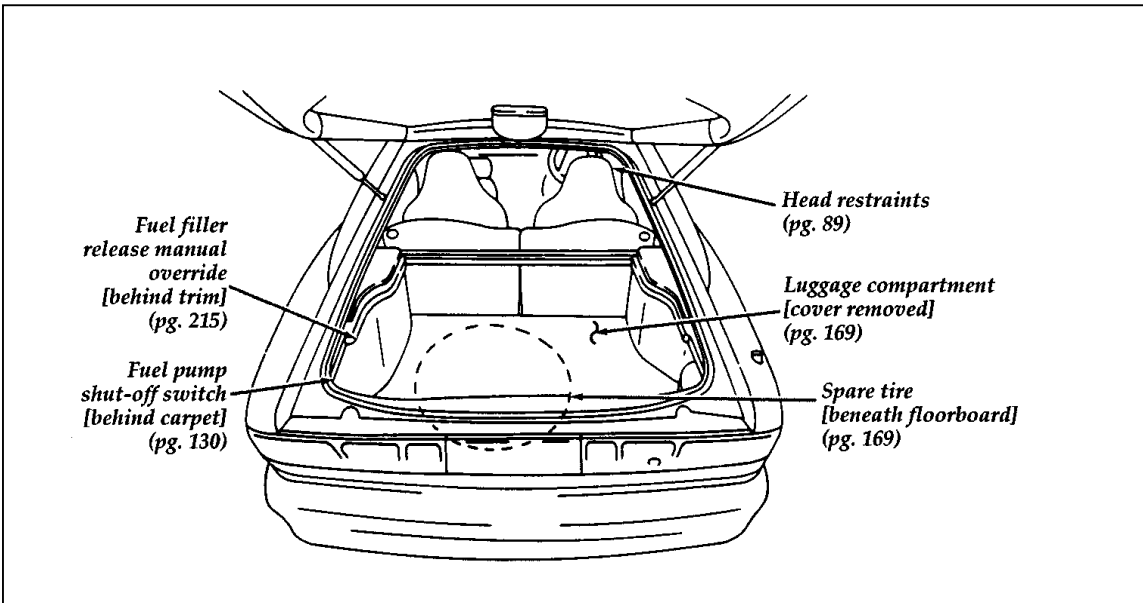

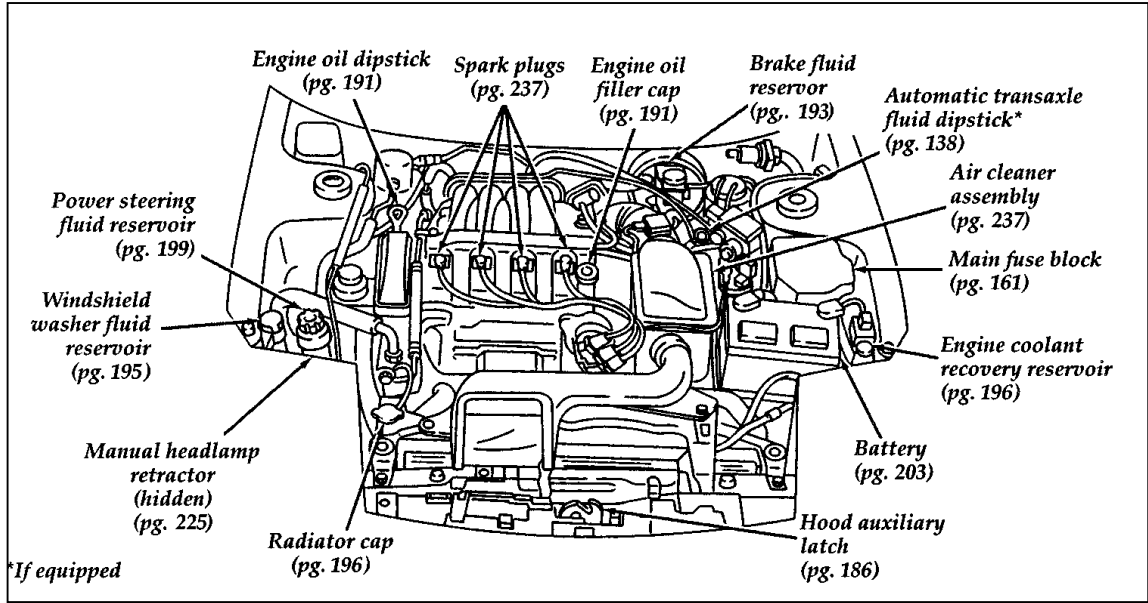

2.5L Engine Compartment

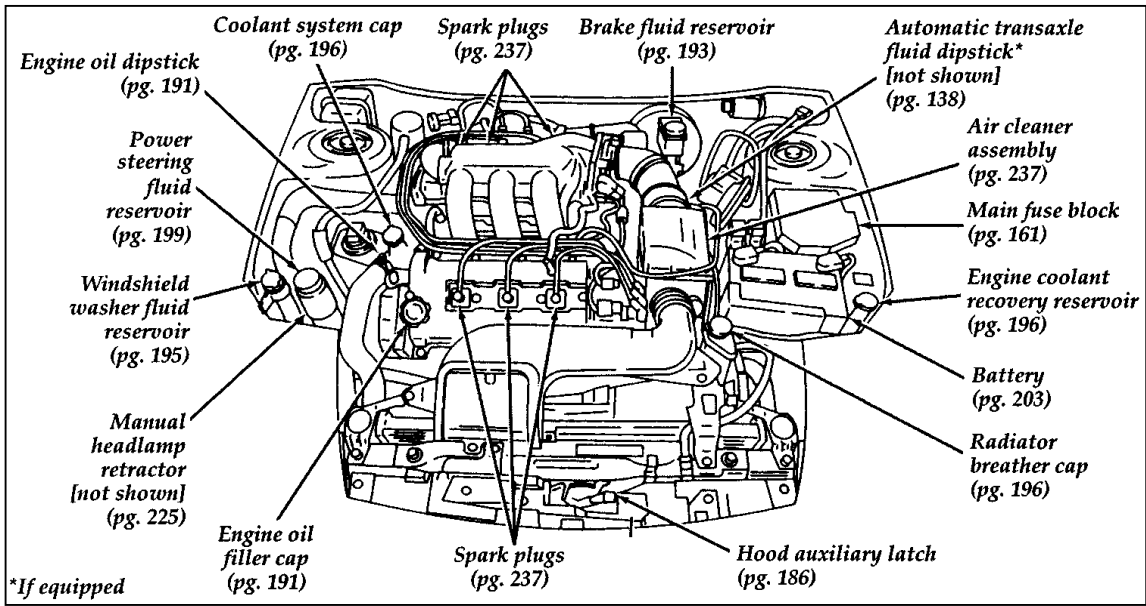

Index

A

ABS warning light (see Anti-lock brake system)	13
Accessory position on the ignition	61
Additives, engine oil	190
Air bag supplemental restraint system	
and child safety seats	113
description	104, 106
driver air bag	104, 106
indicator light	11
operation	106
passenger air bag	106
service and information labels	106
tone generator	110
Air cleaner filter, specifications	237
Air conditioning, electronic automatic temperature control system	49
Aluminum wheels.	214
Antenna, radio (see Electronic sound system)	21, 43
Antifreeze (see Engine coolant)	196
Anti-lock brake system (ABS)	
description	133
see also Brake	133
warning light.	13
warninig light	12
Assistance (see Customer assistance)	245
Audio system (see Electronic sound system)	21
Autolamp system (see Headlamps)	63
Automatic transaxle	
driving with	138
fluid, adding	201
fluid, checking	201

B

Backing up	149
Basic vehicle warranty	4
Battery	
acid, treating emergencies	175, 205
disconnecting	178
how to service	203
jumping a disabled battery	174
maintenance-free	203
proper disposal, recycling	205
replacement, specifications	237
servicing	203
when storing your vehicle	236
Brake fluid	
brake warning light	12
checking and adding	193
description	193
Brakes	
adjustment	133
anti-lock	133
anti-lock brake system (ABS)	
warning light	13
applying the brakes	133
brake warning light	12
fluid, checking and adding	193
fluid, refill capacities	193
front disc	133
if brakes do not grip well	133
master cylinder	193
new brake linings	6
noise	133
parking	135
power braking	133
servicing	193
when storing your vehicle	236
Break-in period	6
Brights (high beams)	15

Bulbs, replacing	
halogen	226
headlamps	226

C

Canada, customer assistance	252
Canada, warranty information	4
Canadian Motor Vehicle Arbitration Plan (CAMVAP).	253
Carbon monoxide in exhaust	130
Car seats for children (see Child safety seats)	113
Cassette tape player (see Electronic sound system)	34
Catalytic converter	222
CD player (see Electronic sound system)	28
Chains, tires	214
Changing a tire	167
Child safety restraints	111
child safety seats	113
Child safety seats	
and air bags	113
attaching with tether straps	122
automatic locking mode (retractor)	102, 113
in front seat	113
in rear outboard seat	113
in rear seat.	113
tether anchorage hardware	122
Chime, safety belt.	11
Cleaning your vehicle	
CD player and discs	31
chrome and aluminum parts.	231
engine compartment	232
exterior	230
exterior lamps	232
fabric	233
headlamps	232
instrument panel	49, 231

Cleaning your vehicle (continued)	
interior	233
interior lamps	233
plastic parts	231
polishing	230
rear windows	56
rustproofing	231
safety belts	234
tail lamps	232
upholstery and interior trim	233
washing	230
waxing	230
wheels	232
windows	56
Clock	27, 43
Clutch	
fluid reservoir	193
operation while driving	147
recommended shift speeds	150
shifting the gears	148
Cold engine starting	127
Combination lap and shoulder belts	98, 100
Compact disc player (see Electronic sound system)	22, 28
Compact disc radio (see Electronic sound system)	22
Console, description	80
Controls, mirrors	78
Convenience kit in cargo area	169
Coolant (see Engine coolant)	
checking and adding	196
preparing for storage	236
temperature gauge	18
warnings	196
Cooling fan	184
Crankcase emission filter	237
Customer Assistance Center, Ford (U.S.)	247
Customer Assistance Centre, Ford of Canada	252

D

Daytime running light system	63
Defects, reporting	243
Dipstick	
automatic transaxle fluid	201
engine oil	191
power steering fluid	199
Disabled vehicle (see Towing)	179
Doors	76
Driving under special conditions	
heavy load	151
towing a trailer.	153

E

Electrical system, relays	165
Electronic radio with cassette (see Electronic sound system)	34
Electronic sound system	
antenna	43
radio reception	43
tuning the radio	23, 37
warranty and service information	46
Electronic stereo cassette radio (see Electronic sound system)	34
Electronic stereo radio (see Electronic sound system)	34
Emergencies, roadside	
assistance	245
battery acid spills.	175, 206
fuel	219
jump-starting.	174
towing.	179
Emergency brake (parking brake).	134
Emission control system	
catalytic converter	222
emissions warranty	4, 222

Engine	
check engine warning light	15
does not start.	128, 130
fuel injected engine, starting	125
fuel pump shut-off switch	130
preparing to start	125
starting.	126
starting after a collision	130
storing your vehicle	234
Engine block heater	129
Engine coolant	
checking and adding	196
checking hoses	199
disposal	184, 193, 203
preparing for storage	236
proper solution	184, 193, 203
temperature gauge	18
Engine coolant temperature gauge	
description	18
mechanical	18
Engine coolant temperature	
gauge:electronic.	18
Engine fan	184
Engine:idle speed control.	128
Engine oil	
changing oil and oil filter	191
checking and adding	191
dipstick	191
disposal	184, 193, 203
engine oil pressure gauge	17
filter, specifications	237
specifications	190
synthetic oil	190
“break-in” oils	6
viscosity	190
Exhaust fumes	130

F

Fan	184
engine fan, avoiding injury	184
Federal Communications Commission	45
Federal Highway Administration	
Regulation	5
Flashers, hazard.	155
Flashing the lights.	66
Flat tire	167
Foglamps.	57
Ford Customer Assistance Center.	247
Ford Motor Company of Canada	252
Ford of Canada Customer	
Assistance Centre	252
Foreign registration	254
French owner guides, how to obtain	3
Fuel	
calculating fuel economy	220
choosing the right fuel	217
filling your vehicle with fuel.	215
filter, specifications	237
fuel filler door release lever	215
fuel gauge	16
octane rating.	217
quality.	217
running out of fuel	220
safety information relating to	
automotive fuels	219
storing your vehicle.	235
treating emergencies	219
Fuel cap	
removing	215
replacing.	215, 217
Fuel filler door	
remote release	215
Fuel filter, specifications	237
Fuel gauge	16

Fuel pump shut-off switch	
engine does not start	130
starting after a collision	130

G

Gas cap (see Fuel cap)	215
Gas mileage (see Fuel economy)	217, 220
Gasoline (see Fuel).	215
Gauges, Electronic	
engine coolant temperature gauge	18
fuel gauge	16
odometer.	19
speedometer	19
Gauges, Mechanical	
engine coolant temperature gauge	18
engine oil pressure gauge	17
fuel gauge	16
odometer.	19
speedometer	19
tachometer	19
trip odometer.	19
GAWR (Gross Axle Weight Rating)	
calculating	152
definition.	151
driving with a heavy load	151
Gearshift	
automatic operation	138
column-mounted	138
downshifting	150
floor-mounted	148
locking the gearshift.	61
positions	138, 148
shifting the gears	138, 148
upshifting	150
Gearshift:shifting the gears	138, 148
GVWR (Gross Vehicle Weight Rating)	
calculating	152
definition.	151
driving with a heavy load	151

H

Hazard flashers	155
Headlamps	
aiming	225
checking alignment	226
cleaning	232
daytime running lights	63
flashing	66
replacing bulbs	225
Head restraints	89
High beams, indicator light	15
Hood	
latch location	186
release lever	186
working under the hood	184
Hoses, checking.	199

I

Identification Number, Vehicle (VIN)	252
Idle	
relearning	178, 184
speed	128
Ignition, positions of the ignition	61
Indicator lights and chimes (see Lights)	7
Infant seats (see Safety seats).	111, 113
Instrument cluster.	8
Instrument panel	47
lighting up panel and interior	58
Interval wipers	68

J

Jack	
operation	170
positioning.	170
storage	169
Jump-starting your vehicle	
attaching cables.	176
disconnecting cables.	178

K

Keys

positions of the ignition	61
stuck in lock position	61

L

Lamps

checking	225
daytime running light system	63
dome lamps	58
flashing the lamps.	66
fog lamps	57
hazard flashers	155
instrument panel, dimming	58
interior lamps.	58
replacing bulbs	225

Lane change indicator

(see Turn signal)	62, 67
-----------------------------	--------

Lights, warning and indicator

air bag	11
anti-lock brakes (ABS)	13
brake	12
check engine	15
engine oil pressure	17
hazard warning light	155
high beam	15
oil pressure.	17
rear ABS	13
safety belt	11
service engine soon	15
testing the warning lights	126
turn signal indicator.	62, 67

Load limits

GAWR	151
GVWR	151
trailer towing	153

Lug nuts	
standard	171
tightening sequence	170

M

Maintenance schedule and record (see separate Maintenance Schedule and Record booklet)	3
Maintenance (see Servicing)	183
Maintenance (see servicing)	183
Manual transaxle	
backing up (reverse)	149
clutch	147
shifting gears.	148
shift speeds	150
Map pockets	80
Master cylinder, brakes	193
Mileage, calculating fuel economy	220
Mirrors	
rearview	78
side view mirrors.	78
Moon roof	74
Motorcraft parts.	237

N

National Highway Traffic Safety Administration	243
New vehicle break-in	6

O

Octane rating	217
Odometer	
description	19
trip odometer	19
Oil filter	192, 237
Oil (see Engine oil)	190

Oil viscosity	190
On-board diagnostic (OBD II) system	224
Order forms, service information	24
Overseas offices	254

P

Parking brake	
operation.	135
warning light	12
Parts (see Motorcraft Parts).	237
PCV valve, specifications.	237
Power door locks	76
Power features	
door locks	76
mirrors.	78
moon roof	74
windows	77
Power steering	
dipstick	199
driving with power steering	137
fluid, checking and adding.	199
servicing	137
Prop rod, hood	186

R

Radio (see Electronic sound systems)	21
Rear window	77
washer reservoir	195
Regulations, National Highway Traffic Safety Administration	243
Relays	165
Remote entry system	
replacement/additional transmitters.	88
replacing the batteries	87
Reporting safety defects	243

Restraints, safety (see Safety restraints)	
adult	89, 98
child.	111
head.	89
infant	111, 113
Roadside assistance	245
Roadside emergencies	155
Rotating the tires	210

S

Safety belts (see Safety restraints).	98
Safety defects, reporting	243
Safety information relating to	
automotive fuels	219
Safety restraints	
adjusting the safety belts	100
automatic locking mode	102
automatic locking mode (retractor)	102
cleaning the safety belts	234
extension assembly	103
for adults	98
for children	111
for infants	111, 113
for pregnant women	89, 98
head.	89
lap and shoulder belts	98, 100
maintenance	104
proper use	98
replacement	104
warning light and chime	11
Safety seats for children	
and air bags	102, 113
attaching with tether straps	122
automatic locking mode	
(retractor)	102, 113
in front seat	113
in rear outboard	113
in rear seat.	113
tether anchorage hardware	122

Seat belts (see Safety restraints)	98
Seats	
child safety seats	113
cleaning upholstery	233
folding rear seats	96
head restraints	89
rear seat access	96
split-folding rear seat	96
Serial number (VIN)	252
Service concerns	246
Servicing your vehicle	
precautions when servicing	184
servicing when you tow	179
Shift positions (see Gearshift)	138, 148
Shoulder and lap belts	
(see Safety restraints)	98, 100
Shoulder belts (see Safety restraints).	100
Side mirrors	78
Sliding moon roof (see Moon roof)	74
Snow tires and chains	214
Spare tire	
changing the tire	167, 170
conventional spare	169
finding the spare	169
removing the spare tire	169
storing the flat tire	169, 171
temporary spare	168
Spark plugs, specifications	237
Speed control, turning off	72
Speedometer	19
Starting your vehicle	
preparing to start your vehicle	125
starting a cold engine	127
starting after a collision	130
starting a warm engine	127
starting your vehicle if the battery is disabled	174
Steering, power	137
Steering wheel, locking.	61
Storage compartments	80

Storage compartments (continued)	
center console	80
map pockets	80
Storing your vehicle	234
Sunroof (moon roof).	74
Supplemental air bag readiness light	11
Supplemental Restraint System (SRS)	104

T

Tachometer	
mechanical cluster	19
Tail lamps	
bulb replacement	225
cleaning	232
Temperature control (see Climate control)	49
Testing the warning lights	126
Tether anchor installation	
(see Child restraints)	122
Tires	
changing.	167
checking the pressure	208
cleaning	232
inspection and maintenance	208, 210
replacing.	211
rotating	210
snow tires and chains	214
spare tire	169
storing your vehicle.	236
tire grades	211
treadwear	211
wear bands	211
wheel and tire matching.	212
Towing a trailer (see Trailer towing)	153
Towing your vehicle	
using wheel dollies	179
with a tow truck	179
Transaxle	
automatic operation.	138
fluid, checking and adding	
(automatic)	201

Transaxle control switch	143
Trip odometer.	19
Tune-up specifications (VECI).	224
Turn signal	
indicator lights	67
lever.	62, 67

U

Upshift speeds	150
Used engine oil, disposal.	184, 193, 203

V

Variable interval wipers	68
VECI (Vehicle Emission Control Information)	
decal.	224
Vehicle Identification Number (VIN)	252
Vehicle loading	
automatic transaxles.	152
calculating the load	152
manual transaxles.	152
understanding loading information	151
Vehicle storage	234
Ventilating your vehicle	
(see Climate control)	49
Viscosity (see Engine oil).	190

W

Warm engine, starting	127
Warning chimes, safety belt	11
Warning lights, testing	126
Warning lights (see Lights).	7
Warranties	
basic.	4
Canada.	4
radio.	46

Warranty Information Booklet	4
Washer fluid	
rear window reservoir	195
reservoir	195
windshield	195
Weight limits (GAWR, GVWR)	151
Wheel and tire matching.	212
Wheel dollies (see Towing).	179
Wheels	
cleaning	232
covers	170
inspection and maintenance	208
lug nuts	170
replacement	212
Windows	
one-touch down	77
power windows, operating	77
Windshield, washing	68
Windshield washer fluid and wipers	
checking and adding fluid.	195
liftgate reservoir	195
operation	68
reservoir	195
specifications	196
variable interval wipers	68
Windshield wipers and washer.	68
Wrecker towing.	179

Service Station Information

Engine Size & Type	2.0 Liter	16V (4 valves per cylinder), Fuel Injected, 4 Cylinder, 121 Cubic Inch Displacement (CID)
	2.5 Liter	24V (4 valves per cylinder), Fuel Injected, 6 Cylinder, 152 Cubic Inch Displacement (CID)
Fuel	UNLEADED FUEL ONLY—Octane 87 (2.0L) or 91 (2.5L) or higher	
Fuel Tank Capacity	15.5 gallons (58.7 liters)	
Engine Oil	Use only engine oil displaying the American Petroleum Institute Certification Mark. SAE 5W-30 is preferred.	
Engine Oil Capacity	2.0 Liter	3.7 quarts (3.5 liters) with filter change
	2.5 Liter	4.2 quarts (4.0 liters) with filter change
Engine Coolant Capacity	2.0 Liter	7.4 quarts (7.0 liters)
	2.5 Liter	7.9 quarts (7.5 liters)
Tire Size & Pressure	Tire size and pressure can be found on the Safety Compliance Certification Label on the driver's door pillar.	
Brake Fluid	Use only brake fluid that meets Ford's Specification ESA-M6C25-A.	
Power Steering Fluid	Use only power steering fluid that meets Ford's Specification ESW-M2C33-F.	
Automatic Transaxle Fluid	Motorcraft MERCON® (ATF)	
Hood Release	Pull handle under the left side of the instrument panel.	