

Contents

Before driving

Introduction	2
Instrumentation	5
Controls and features	18
Seating and safety restraints	53

Starting and driving

Starting	83
Driving	91
Roadside emergencies	135

Servicing

Maintenance and care	154
Capacities and specifications	213
Reporting safety defects	220
Index	221

Introduction

ICONS

Indicates a warning. Read the following section on *Warnings* for a full explanation of them.



Indicates that vehicle information related to recycling and other environmental concerns will follow.



We must all play our part in protecting the environment. Correct vehicle usage and the authorized disposal of waste cleaning and lubrication materials are significant steps towards this aim.

WARNINGS

How can you reduce the risk of personal injury and prevent possible damage to others, your vehicle and its equipment?

In this owner's guide, answers to such questions are contained in comments highlighted by the warning triangle symbol.

BREAKING-IN YOUR VEHICLE

There are no particular breaking-in rules for your vehicle. Simply avoid driving too briskly during the first 1,600 km (1,000 miles) of driving. Vary speeds frequently. This is necessary to give the moving parts a chance to break in.

If possible, you should avoid full use of the brakes for the first 1,600 km (1,000 miles).

From 1,600 km (1,000 miles) onwards you can gradually

increase the performance of your vehicle up to the permitted maximum speeds.

INFORMATION ABOUT THIS GUIDE

The information found in this guide was in effect at the time of printing. Ford may change the contents without notice and without incurring obligation.

Notice to owners of utility type vehicles

Before you drive your vehicle, please read this Owner's Guide carefully. Your vehicle is not a passenger car. As with other vehicles of this type, failure to operate this vehicle correctly may result in loss of control or an accident.

Be sure to read *Driving off road* in the *Driving* chapter as well as the "Four Wheeling" supplement included with 4WD and utility type vehicles.

Using your vehicle with a snowplow

For more information and guidelines for using your vehicle with a snowplow, refer to the *Driving* chapter.

Using your light truck as an ambulance



Do not use this vehicle as an ambulance.

Introduction

Your vehicle is not equipped with the Ford Ambulance Preparation package.

Instrumentation

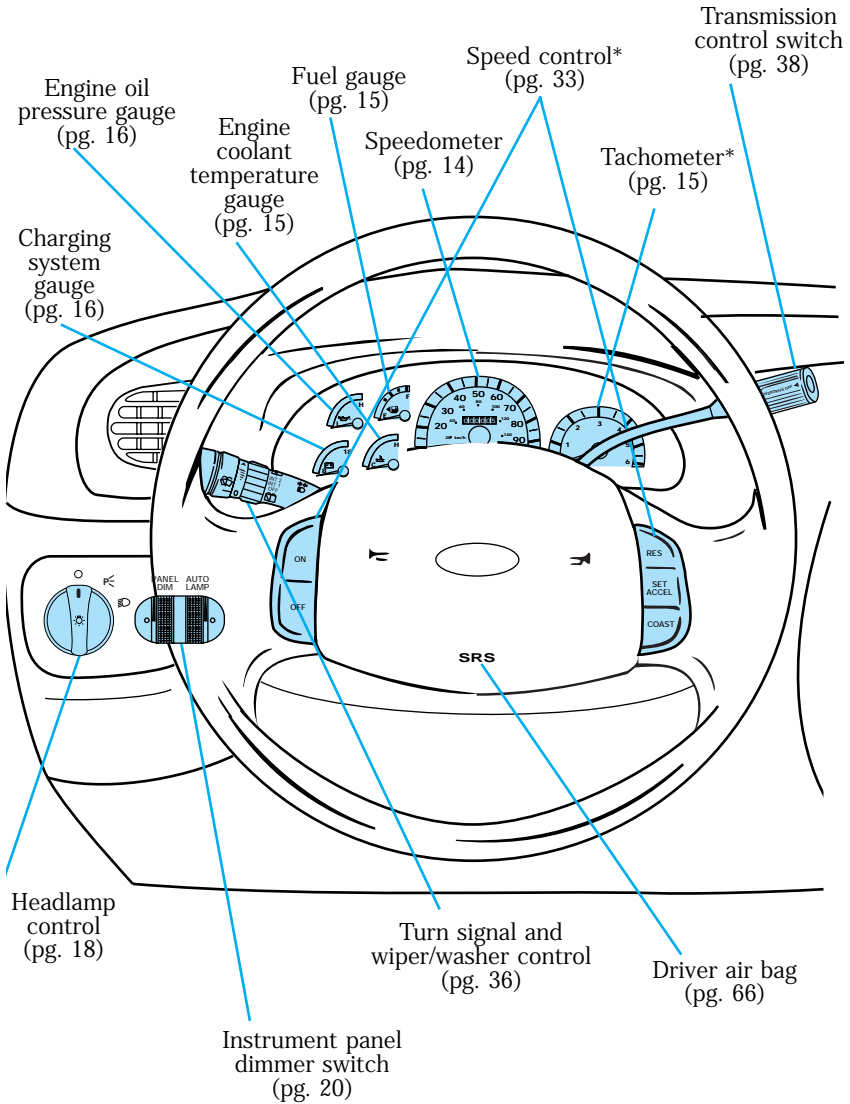

Instrumentation

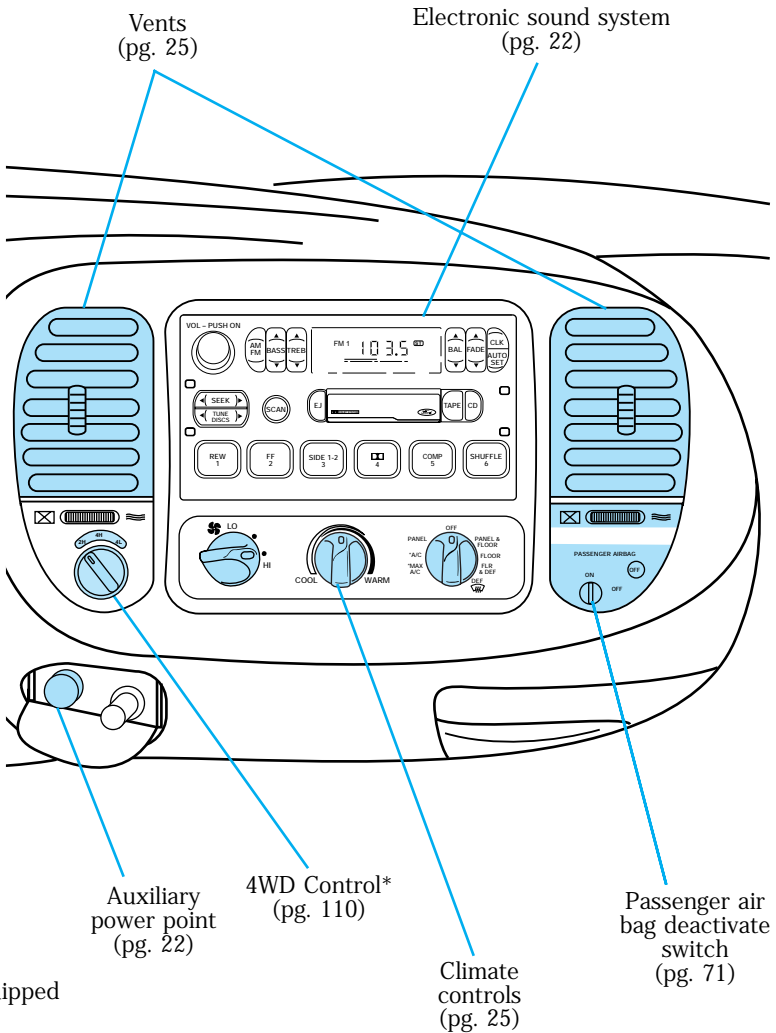

Instrumentation

INSTRUMENT CLUSTER WARNING LIGHTS AND CHIMES

Your vehicle is equipped with one of the following instrument clusters:

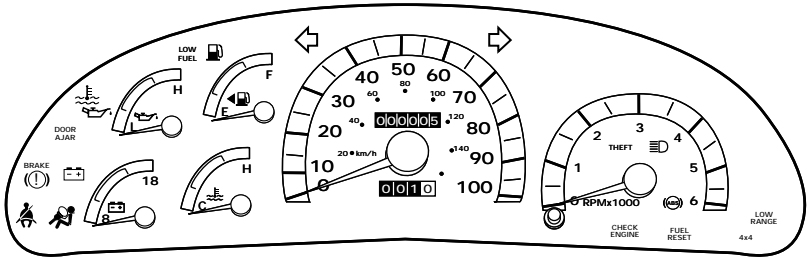
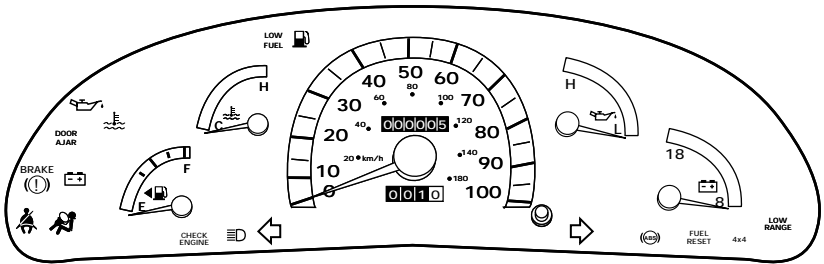

Low fuel

Illuminates when the fuel level is low.



Instrumentation

Engine coolant temperature

Illuminates briefly when the ignition key is turned to On (light from optional cluster shown).

Illuminates when the engine coolant temperature is high. Stop the engine and check the engine coolant temperature level as soon as possible. Refer to *Checking and adding engine coolant* and *What you should know about fail-safe cooling* in the *Maintenance and care* section.

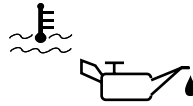

Oil pressure

Illuminates briefly when the ignition key is turned to On (light from base cluster shown).

Illuminates when the oil pressure is low. Stop the engine and check the engine oil level as soon as possible. Refer to *Checking and adding engine oil* in the *Maintenance and care* section.

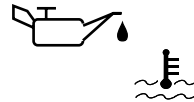

Door ajar

Illuminates when the ignition switch is in the ON or START position and any door is open.

**DOOR
AJAR**

Charging system

Briefly illuminates when the ignition is turned on and the engine is off. The light also illuminates when the battery is not charging properly, requiring electrical system service.

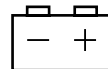

Instrumentation

Brake system warning

Extinguishes when the parking brake is released. Illumination after releasing the parking brake indicates low brake fluid level.

BRAKE



Safety belt

Illuminates when the ignition is switched on to remind you to fasten your safety belts. For more information, refer to *Using the safety restraints properly* in the *Seating and safety restraints* chapter.



Air bag readiness

Briefly illuminates when the ignition is turned to On. If the light fails to illuminate, continues to flash or remains on, have the system serviced. For more information, refer to *Supplemental restraints system (SRS)* in the *Seating and safety restraints* chapter.



Check engine warning light

This light illuminates when the engine's Emission Control System requires service. It will also illuminate when the ignition key is in the On position and the engine is off. Refer to *What you should know about the on-board diagnostic (OBD II) system* in the *Maintenance and care* chapter.

**CHECK
ENGINE**

Instrumentation

Transmission control indicator light (TCIL)

The TCIL (OFF), located on the end of the gearshift lever, may flash steadily if a malfunction has been detected. If the TCIL is flashing, contact your Ford dealer as soon as possible. If this condition persists, damage to the transmission could occur.

For more information, refer to the *Driving* chapter.

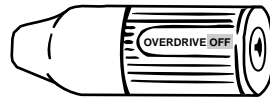

4x4 light (if equipped)

Illuminates when 4H (Four-Wheel Drive) or 4L (Four-Wheel Drive Low) is engaged.

4x4

4x4 low range (if equipped)

Illuminates when 4L (Four-Wheel Drive Low) is engaged.

LOW
RANGE

Anti-lock brake system (ABS)

Momentarily illuminates when the ignition is turned on and the engine is off. If the light stays on or continues to flash, the ABS needs to be serviced.



Fuel reset

Illuminates when the ignition key is turned to the ON position and the fuel pump shut-off switch has been triggered. For more information, refer to *Fuel pump shut-off switch* in the *Roadside emergencies* chapter.

FUEL
RESET

Instrumentation

Anti-theft system (if equipped)

Illuminates when the anti-theft system is arming and flashes when the anti-theft system is armed.

THEFT

High beams

Illuminates when the headlamp high beams are on.



Turn signal

Illuminates when the left or right turn signal or the hazard lights are turned on.

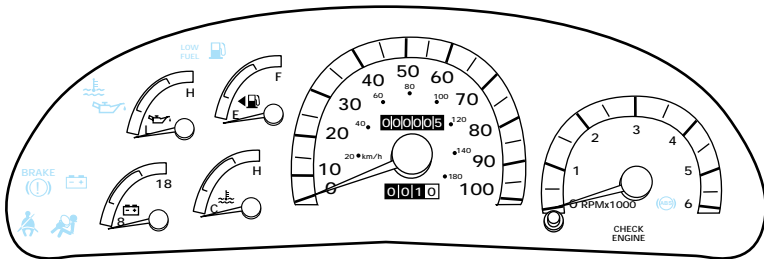
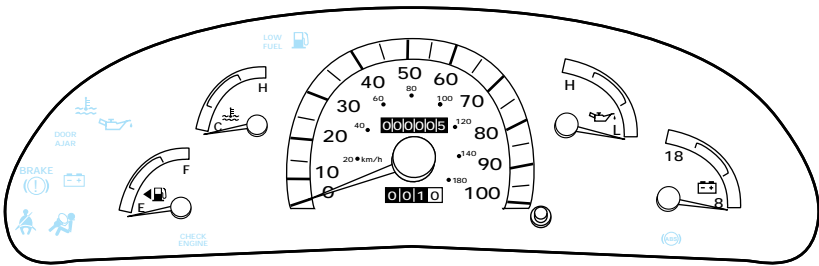
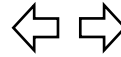

Testing warning lights

Turn the ignition key to On without starting the vehicle. The

warning and indicator lights shown above will illuminate for a brief time. If any of these lights do not illuminate, contact your dealer for service.

Headlamps on warning chime

Sounds when the headlamps are on, the key is out of the ignition and any door is opened.

Key-in-ignition warning chime

Sounds when the key is left in the ignition and any door is opened. The chime is not active when the ignition key is in the On position.

Safety belt warning chime

For information on the safety belt warning chime, refer to the *Seating and safety restraints* chapter.

Supplemental restraint system (SRS) warning chime

For information on the SRS warning chime, refer to the *Seating and safety restraints* chapter.

Instrumentation

INSTRUMENT CLUSTER GAUGES

Your vehicle has one of the following instrument clusters:

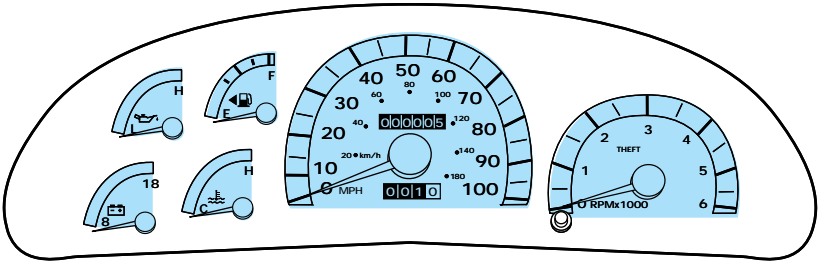
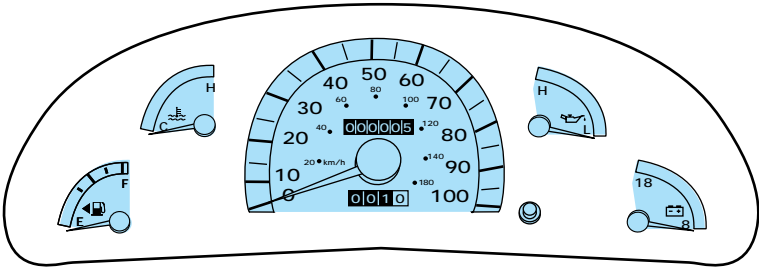

Speedometer

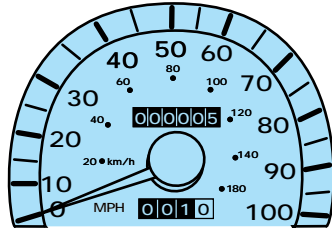

Indicates the current vehicle road speed.

Instrumentation

Tachometer (if equipped)

Indicates the engine speed in revolutions per minute.

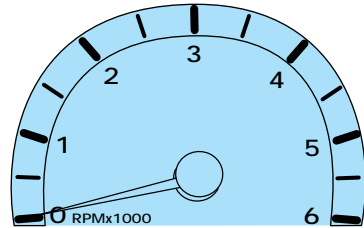

Engine coolant temperature gauge

Indicates the temperature of the engine coolant. At normal operating temperature, the needle remains within the normal area. If it enters the red section, the engine is overheating. Switch off the ignition and let it cool. Refer to *Checking and adding engine coolant* or *What you should know about fail safe cooling* in the *Maintenance and care* chapter.

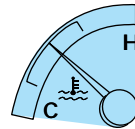

Fuel gauge

Indicates the fuel level.

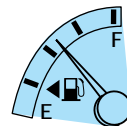

Instrumentation

Voltage gauge

If the pointer moves and stays outside of the normal range, it indicates that the battery is not being charged. Have the vehicle's electrical system checked by your dealer as soon as possible.

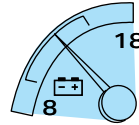

Engine oil pressure gauge

This shows the engine oil pressure in the system. Sufficient pressure exists as long as the needle remains in the normal range. If the gauge indicates constantly low pressure at normal engine speed, refer to *Checking and adding engine oil* in the *Maintenance and care* chapter. If the gauge indicates a low pressure and the engine oil level is correct, switch off the engine immediately and have your vehicle checked at your dealer.

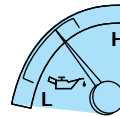

Odometer

Registers the total kilometers (mileage) of the vehicle.

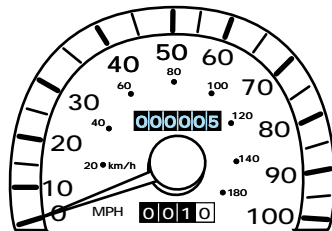

Instrumentation

Trip odometer

Registers the kilometers (miles) of individual journeys. To reset, depress the control.

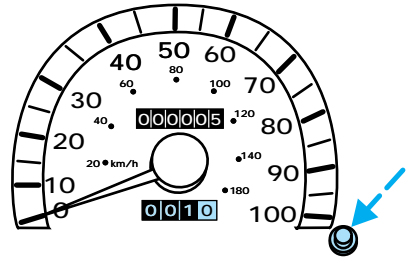

Controls and features

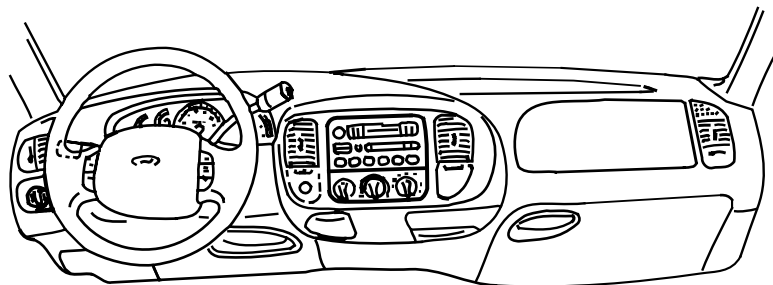

Headlamp/foglamp control

This control operates the headlamps and foglamps.

○ — Off

P — Parking lamps on.

☾ — Headlamps on.

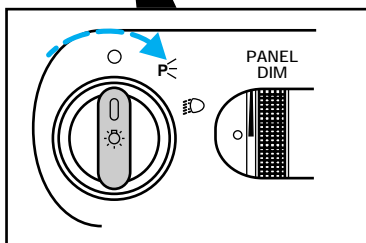

Controls and features

Foglamp control

The headlamp control also operates the foglamps. The foglamps can be turned on only when the headlamps are in the  position.

Pull headlamp control towards you to turn foglamps on. The foglamp indicator light  (located to the right of the control) will illuminate.

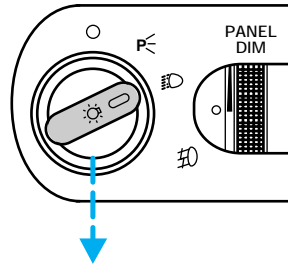

Daytime running lights (Canadian vehicles only)

The daytime running light system turns the headlamps on, with a reduced light output, when:

- the vehicle is running
- the parking brake is released
- the headlamp system is in the  position.



The Daytime Running Light (DRL) system will not illuminate the tail lamps and parking lamps. Turn on your headlamps at dusk. Failure to do so may result in a collision.

Controls and features

Panel dimmer control

Turn control up to brighten panel.
Turn control down to dim panel.

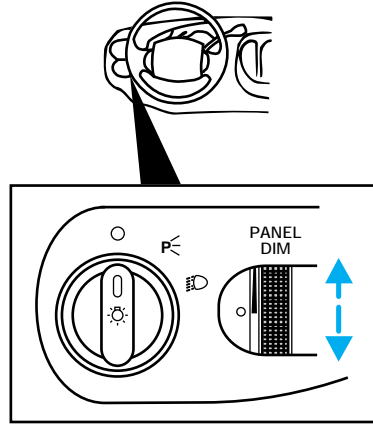

Autolamp delay system (if equipped)

The autolamp delay system sets the headlamp to turn on and off automatically. You can set the autolamp to:

- turn on the exterior lamps automatically at night.
- turn off the lamps automatically during daylight.
- keep the lamps on for up to

Controls and features

three minutes after you turn the key to OFF.

1. Turn control up to increase delay. The indicator light under the autolamp control illuminates when the autolamps are activated.
2. Turn control down to decrease delay.

To turn autolamp system off, turn control down all the way until a click is felt.

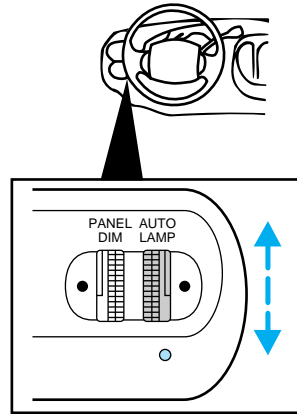

Electronic shift 4WD system (if equipped)

This controls the Electronic Shift 4WD operation. Refer to *Electronic Shift 4WD system* in the *Driving* chapter for more information.

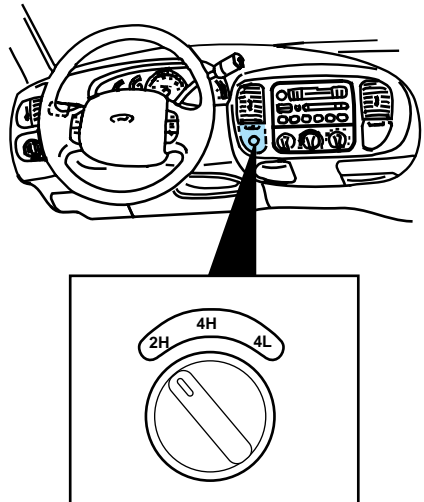

Controls and features

Auxiliary power point

This 12V power point is an additional power source for electrical accessories.

Do not plug optional electrical accessories into the cigarette lighter. Use the power point.

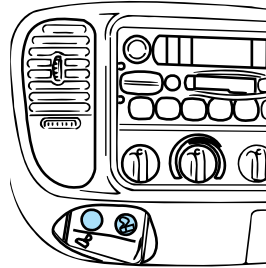

Passenger air bag deactivate switch

This switch must be used to deactivate the passenger air bag whenever a child seat is used in the right front or center front passenger seat position. Refer to *Passenger air bag deactivate switch* in the *Seating and safety restraints* chapter.

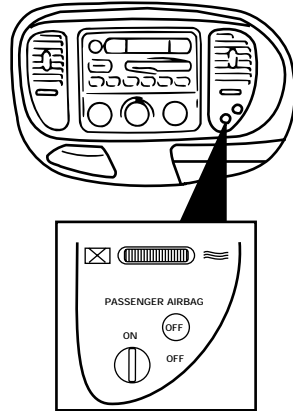

Audio system

Refer to the "Audio Guide" in your Owner's Portfolio.

Controls and features

Fuel pump shut-off switch

Refer to the *Roadside emergencies* chapter for information on operating the fuel pump shut-off switch.

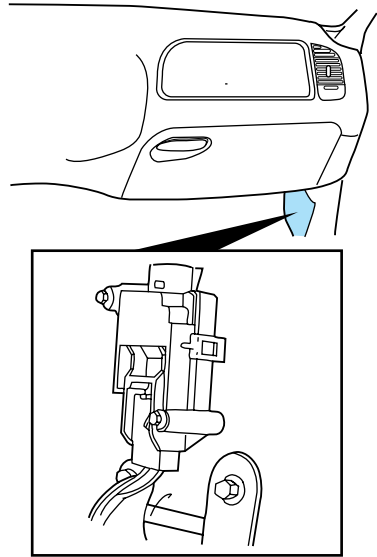

Controls and features

Air suspension load leveling (if equipped)

Your vehicle is equipped with an air suspension system for the rear suspension that levels your vehicle when carrying heavy loads. Refer to *Air suspension load leveling* in the *Driving* chapter for more information.

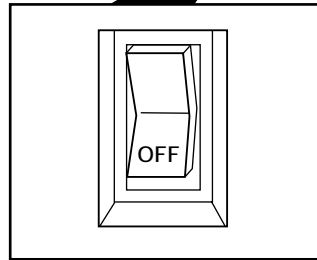
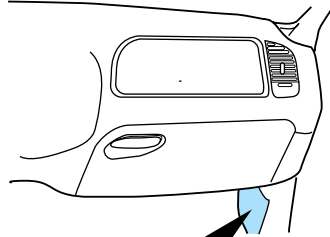

Controls and features

CLIMATE CONTROLS

Operating climate controls

Instrument panel vents

There are four vents on the instrument panel. These vents are equipped with controls to adjust the amount and direction of air passing through them.

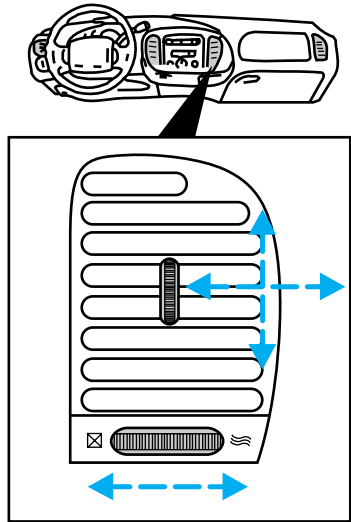

Temperature

Turn temperature control to the desired temperature.

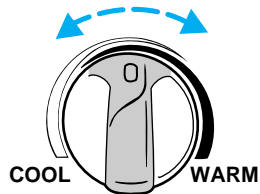

Controls and features

Fan speed

Turn the fan speed control to the desired speed.

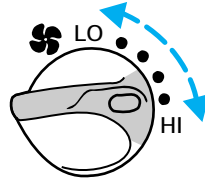

Airflow and air conditioning (if equipped)

Turn the mode control to the desired airflow position.

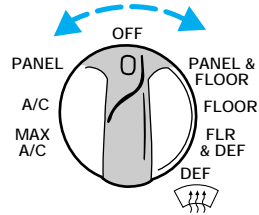

Controlling airflow

Select PANEL for air to flow through these vents:

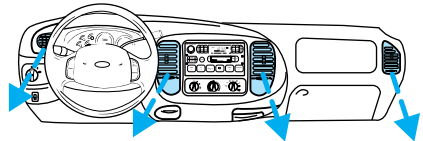

Controls and features

The PANEL position allows outside air to flow through the instrument panel vents.

Select PANEL & FLOOR for air to flow through these vents:

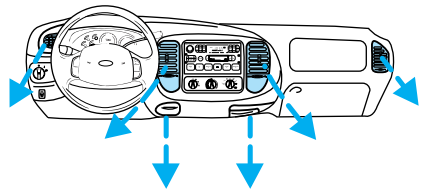

The PANEL & FLOOR position directs outside air to flow between the panel and floor vents. The air conditioning will function to provide cooling and dehumidification when the outside temperature is above 10°C (50°F).

Select FLOOR for air to flow through these vents:

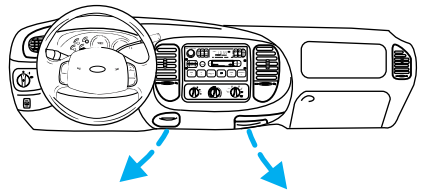

Controls and features

The FLOOR position directs outside air to flow through the floor vents.

Select FLR & DEF for air to flow through these vents:

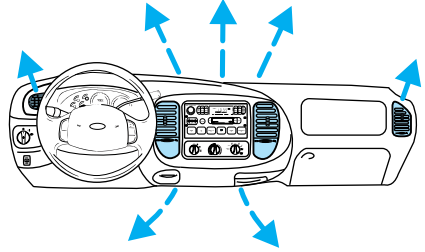

The FLR & DEF position directs outside air to flow through the floor vents and the windshield defroster vents. The air conditioning will function to defog the windows provided the outside temperature is above 10°C (50°F).

Select  for air to flow through these vents:

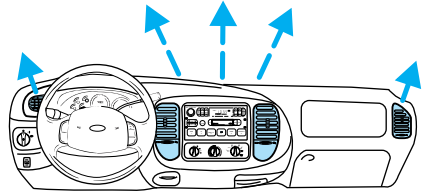

The  position directs outside air to flow through the windshield defroster vents. The air conditioning will function to defog the windows provided the outside temperature is above 10°C (50°F).

Controls and features

Air conditioning

Select A/C for air conditioned air to flow through these vents:

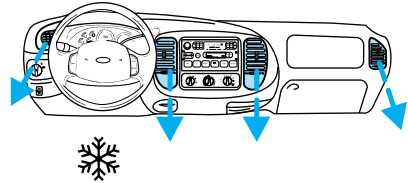

The A/C mode directs outside air conditioned air to flow through the instrument panel vents. The A/C mode can be used for heating, ventilating and defogging the windows or air conditioning. The A/C mode only functions if the outside temperature is above 10°C (50°F).

Select MAX A/C for air to flow through these vents:

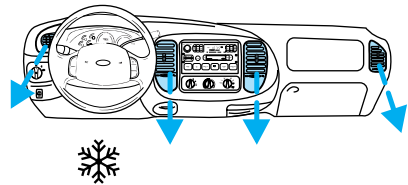

The MAX A/C mode recirculates the cabin air and directs it to flow through the instrument panel vents. The MAX A/C mode can be used for air conditioning or heating. This mode is noisier but more economical than the A/C mode. The MAX A/C mode only functions if the outside temperature is above 10°C (50°F).

Controls and features

OFF position

Select the OFF position for all climate control functions to cease. The outside inlet door will close and the fan is shut off.

Maximum heating

Set mode control to FLOOR, turn temperature control to maximum heat (red) and set fan speed control to HI.

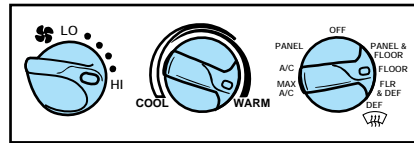

Maximum cooling

Set mode control to MAX A/C, turn the temperature control to maximum cool (blue) and set fan speed control to HI.

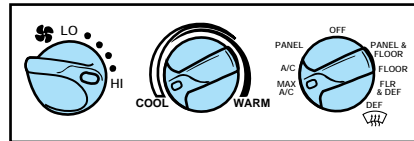

Ventilating with outside air

Set mode control to PANEL & FLOOR or FLOOR, turn the temperature control to the desired temperature and turn fan speed control to the desired speed.

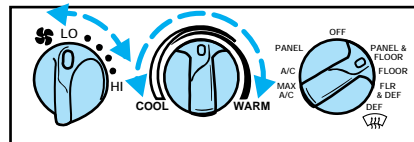

Controls and features

Defrosting windshield

Set mode control to  or FLR & DEF, turn temperature control to maximum heat (red) and set fan speed control to HI.

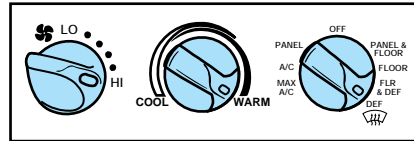

Drive with the climate control system on (in either the heating or air conditioning mode) to reduce humidity in your vehicle.

To prevent air intake restriction, remove any snow, ice or leaves from the air intake area located directly under the windshield.

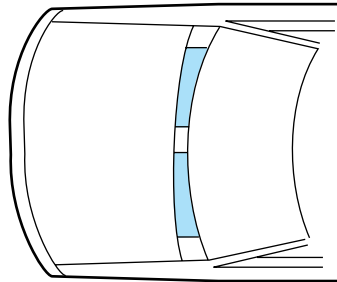

Controls and features

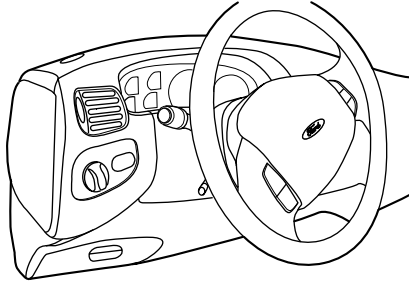

Positions of the ignition

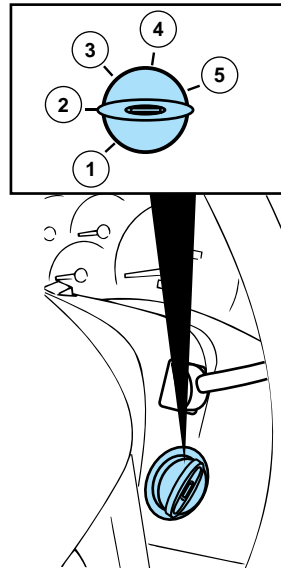

1 (Accessory) - allows electrical accessories such as the audio system and wiper/washer to operate when the engine is not running.

2 (Lock) - locks the steering wheel and automatic gearshift lever (if equipped).

Controls and features

3 (Off) - shuts off the engine and all accessories without locking the steering wheel.

4 (On) - tests the warning lights. Key remains here when engine is running.

5 (Start) - cranks the engine. Key returns to 4 (On) when released.

Speed control (if equipped)

To turn speed control on

- Press ON

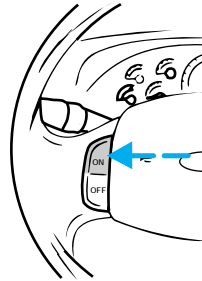

To turn speed control off

- Press OFF or
- Turn off the vehicle ignition.

Once speed control is switched off, the previously programmed set speed will be erased.

To set a speed

Press SET ACCEL. For speed control to operate, the speed control must be ON and the vehicle speed must be greater than 48 km/h (30 mph).

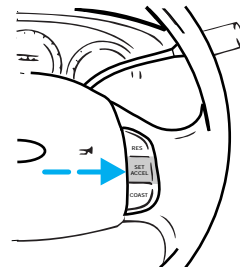

Controls and features

If you drive up or down a steep hill, your vehicle speed may vary momentarily slower or faster than the set speed. This is normal.

Speed control cannot reduce the vehicle speed if it increases above the set speed on a downhill. If your vehicle speed is faster than the set speed while driving on a downhill in Overdrive, you may want to shift to the next lower gear to reduce your vehicle speed.

If your vehicle slows down more than 16 km/h (10 mph) below your set speed on an uphill, your speed control will disengage. This is normal. Pressing RES will re-engage it.



Do not use the speed control in heavy traffic or on roads that are winding, slippery, or unpaved.

To set a higher speed

- Press and hold SET ACCEL. Release the switch when the desired vehicle speed is reached, or
- Press and release SET ACCEL. Each press will increase the set speed by 1.6 km/h (1 mph) or
- Accelerate with your accelerator pedal, then press SET ACCEL.

You may accelerate with the accelerator pedal at any time during speed control usage. Releasing the accelerator pedal will return your vehicle speed to the

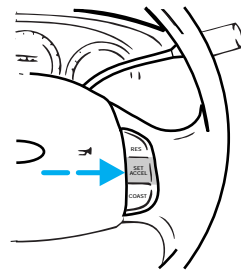

Controls and features

previously programmed set speed.

To set a lower set speed

- Press and hold COAST. Release the switch when the desired vehicle speed is reached, or
- Press and release COAST. Each press will decrease the set speed by 1.6 km/h (1 mph) or
- Depress the brake pedal. When the desired vehicle speed is reached press SET ACCEL.

To return to a set speed

- Press RES. For RES to operate, the vehicle speed must be faster than 48 km/h (30 mph).

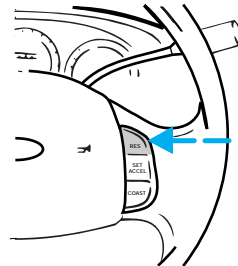
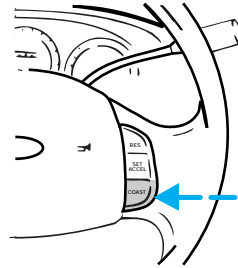

To disengage speed control

- Depress the brake pedal.

Disengaging the speed control will not erase the previously programmed set speed.

Controls and features

Wiper/washer controls

- Push and hold the end to activate the washer.
- Push end briefly for a single wipe.
- Push and hold for a constant cycle.
- Turn the control to adjust intermittent wiper speed.

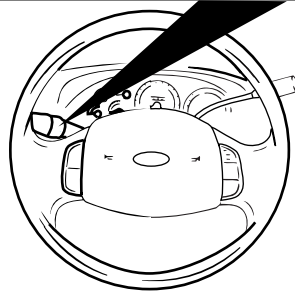
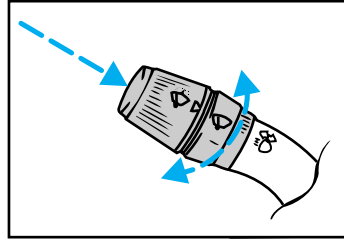

Controls and features

High beam control

- Push the stalk forward to activate the high beam lamps.
- Pull the stalk towards you to activate the “flash to pass” function.

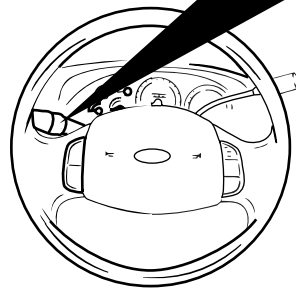
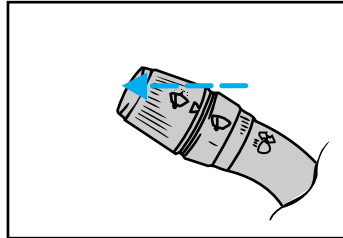

Turn signals

Push the stalk down to activate the left turn signal; push the stalk up to activate the right turn signal.

Controls and features

Overdrive control

Activating overdrive

Ⓧ (Overdrive) is the normal drive position for the best fuel economy.

The overdrive function allows automatic upshifts to second, third and fourth gear.

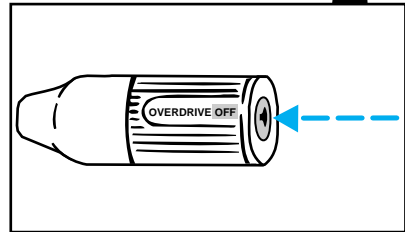
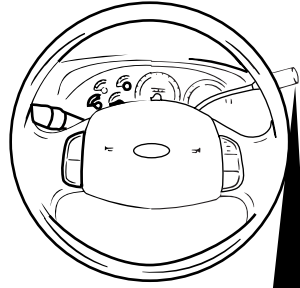

Deactivating overdrive

Press the transmission control switch on the end of the gearshift lever. The transmission control indicator light (TCIL) (OFF) will illuminate on the end of the gearshift lever.

Transmission will operate in gears one through three. To return to normal overdrive mode, press the transmission control switch again. The TCIL (OFF) will no longer be illuminated.

When you shut off and re-start your vehicle, the transmission will automatically return to normal

Ⓧ (Overdrive) mode.

Controls and features

Deactivate overdrive whenever driving conditions (i.e., city traffic, hilly terrain, etc.) cause the transmission to shift excessively between **D** (Overdrive) and D(Drive) ranges. Also deactivate **D** (Overdrive) when:

- driving with a heavy load
- towing a trailer up or down steep hills
- additional engine braking is desired.

Transmission control indicator light (TCIL)

The TCIL (OFF), located on the end of the gearshift lever, may flash steadily if a malfunction has been detected. If the TCIL is flashing, contact your Ford dealer as soon as possible. If this condition persists, damage to the transmission could occur.

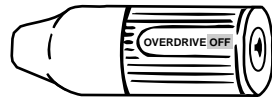

Hazard flasher control

Use only in an emergency to warn traffic of vehicle breakdown, approaching danger, etc. Depress control to activate all indicators simultaneously. Depress control again to turn off. The hazard lights can be operated when the ignition is off.

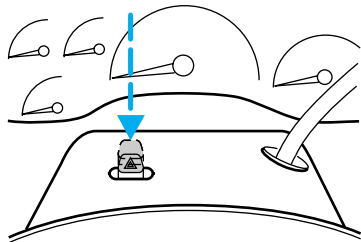

Controls and features

Tilt steering (if equipped)

Pull the lever to adjust the steering column angle. Push the lever back up to lock the steering wheel into position.



Never adjust the steering wheel when the vehicle is moving.

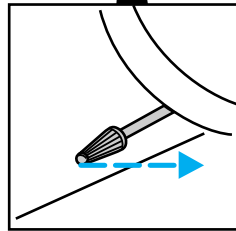
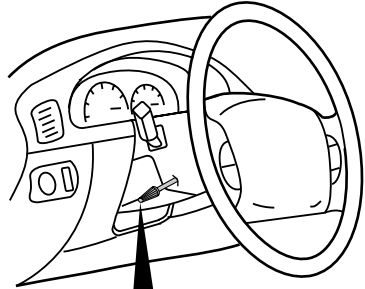

OVERHEAD CONTROLS

Dome/map lamp (if equipped)

Press either the left or right switch to activate the left or right map lamps.

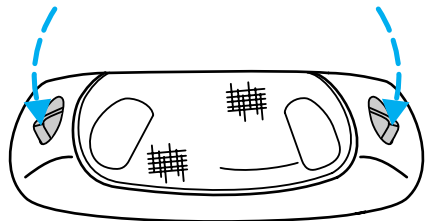

Controls and features

Illuminated entry

The interior lamps illuminate when:

- either front door handle is lifted or
- the remote entry system is used to unlock the door or sound the personal alarm. See *Remote entry system* for more information.

The system automatically turns off after 25 seconds or when the ignition is turned to the Start or Accessory positions.

The inside lights will not turn off if:

- they have been turned on with the dimmer control or
- any door is open.

Battery saver

Battery saver is a feature that automatically shuts off power to these lights after 40 minutes:

- glove box lamp
- engine compartment lamp
- overhead lamps.

Battery saver prevents the battery from being drained if these lights are left on or if a door is not completely closed. Battery power is restored if the remote entry transmitter is used, any door is opened or the ignition key is turned to On.

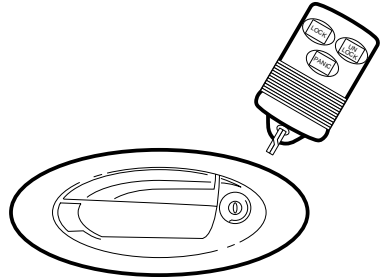

Controls and features

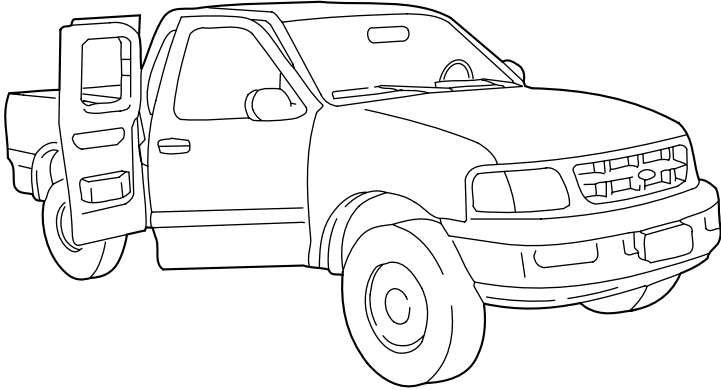

Power windows (if equipped)

Driver-side window control

- Press rear of switch to open window.
- Press front of switch to close window.

The driver-side power window has a one-touch down feature. When AUTO is fully pressed (two clicks will be heard), the driver-side window will move completely down. This feature can be cancelled by pressing the driver-side power window switch again.

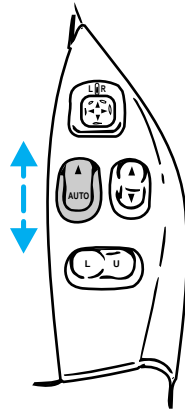

Controls and features

Passenger-side window controls

- Press rear of switches to open passenger window.
- Press front of switches to close passenger window.

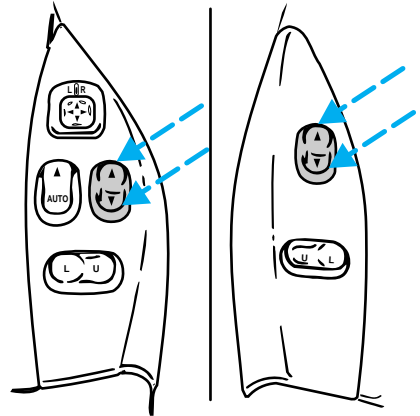

Accessory delay (if equipped)

With accessory delay, the window switches may be used for up to ten minutes after the ignition switch is turned to the Off position or until either door is opened.

Controls and features

Power locks (if equipped)

Driver and passenger controls

- Press L to lock both doors.
- Press U to unlock both doors.

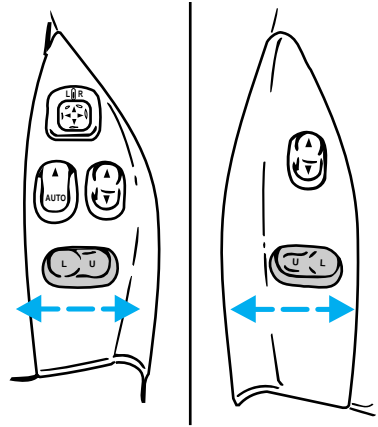

Dual electric remote control mirrors (if equipped)

1. Select driver or passenger mirror by moving selector lever left (L) for driver or right (R) for passenger.
2. Move the mirror control until mirror reaches desired position.
3. Move selector lever to center to "lock" position.

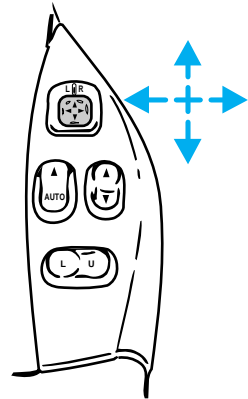

Controls and features

Fold-away mirrors

Pull the side mirrors in carefully when driving through a narrow space, like an automatic car wash.

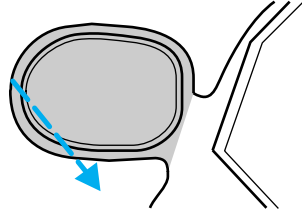

Third door (if equipped)

On SuperCab models a third door is located behind the passenger door. This door allows for improved access to the rear passenger compartment.

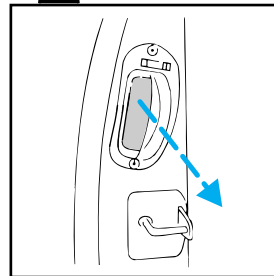
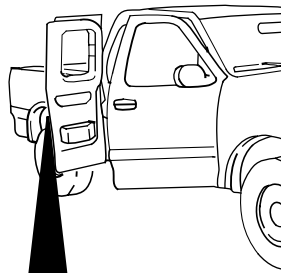

To open the third door (the passenger door must be open) pull either the handle located in the

Controls and features

door jamb or the handle on the interior of the third door.

- To lock the third door, lock the passenger door or press the power lock switch (if equipped).
- When the passenger door is unlocked, the third door cannot be opened until the passenger door is opened. The third door can then be opened.

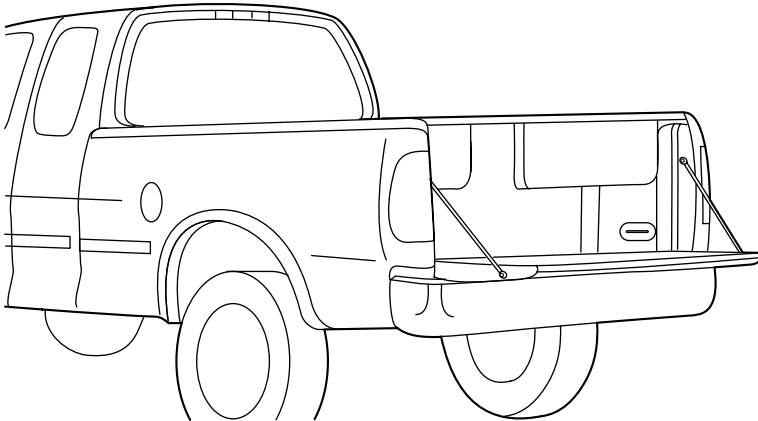
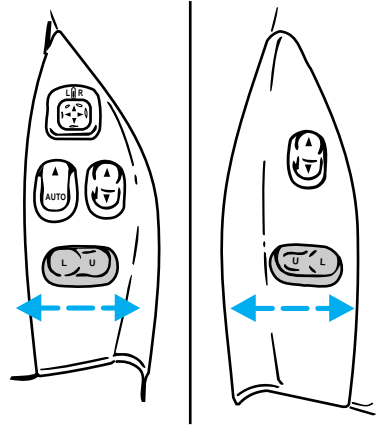

Controls and features

Tailgate lock (if equipped)

Your vehicle is equipped with a tailgate lock designed to prevent theft of the tailgate.

- Insert ignition key and turn to the right to engage lock.
- Turn ignition key to the left to unlock.

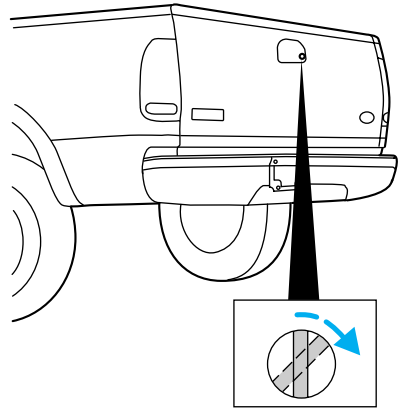

Tailgate removal

Your tailgate is removable to allow more room for loading.

1. Lower the tailgate.
2. Use a screwdriver to pry the spring clip (on each connector) past the head of the support screw. Disconnect cable.
3. Disconnect the other cable.
4. Lift tailgate to a 45 degree angle.
5. Lift right side off of its hinge.
6. Lift left side off of its hinge.

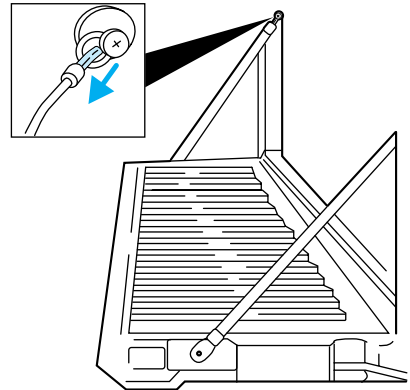

Controls and features

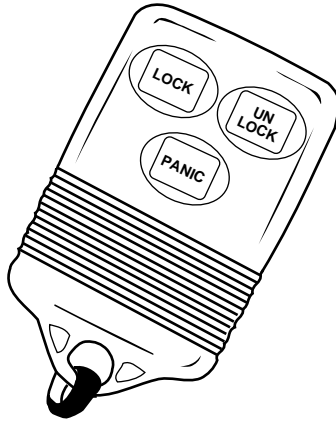

Remote entry system (if equipped)

The remote entry system allows you to lock or unlock all vehicle doors without a key. The remote entry features only operate with the ignition key in the Off position. It also arms and disarms the anti-theft system (for more information on the anti-theft system, refer to *Anti-theft system* in this chapter.)

Unlocking the doors

Press UNLOCK to unlock the driver door. The interior lamps will illuminate.

Press UNLOCK a second time within five seconds to unlock all doors.

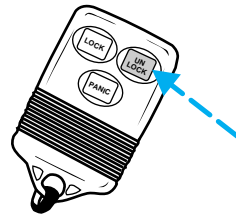

Controls and features

Locking the doors

Press LOCK to lock all doors. To confirm that all doors are closed and locked, press the LOCK control a second time. The doors will lock again, the horn will chirp and the lamps will flash.

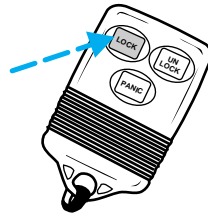

This process will also arm your anti-theft system. If the horn chirps twice, a door is still ajar and the anti-theft system will not arm. For more information on arming the anti-theft system, refer to *Anti-theft system* in this chapter.

Sounding a panic alarm

Press PANIC to activate the alarm. To deactivate the alarm, press the PANIC control again or turn the ignition to the Accessory or On position.

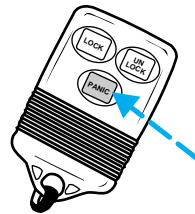

Arming and disarming the alarm system

Your remote entry system will:

- automatically arm the factory installed anti-theft system when the doors are closed and locked.
- reset the triggered anti-theft alarm (when either the UNLOCK or PANIC controls are pressed).

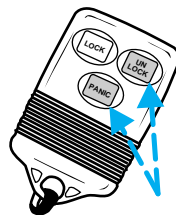

Controls and features

The remote entry system may not arm and disarm non-factory installed anti-theft systems.

Replacing the batteries

The transmitter is powered by two coin type three-volt lithium batteries. A decrease in operating range can be caused by:

- battery failure
- weather conditions
- structures around the vehicle.

Replacement batteries for the remote entry transmitters may be purchased at pharmacies, watch stores or at authorized dealers.

To replace the batteries:

1. Twist a thin coin between the two halves of the transmitter. **DO NOT TAKE THE FRONT PART OF THE TRANSMITTER APART.**
2. Place the positive (+) side of the new batteries down.
3. Snap the two halves back together.

Replacing lost transmitters

Take all your vehicle's transmitters to your dealer for reprogramming if:

- a transmitter is lost or
- you want to purchase additional transmitters (up to four total)

Additional information about remote entry

This device complies with Part 15 of the FCC rules. Operation is

Controls and features

subject to the following two conditions: (1) This device may not cause harmful interference, and (2) This device must accept any interference received, including interference that may cause undesired operation.

Anti-theft system (if equipped)

When armed, the anti-theft system prevents unauthorized entry into your vehicle.

Arming the anti-theft system

Turn the ignition to Off and use one of the following methods to arm the system:

- Press the LOCK control on the remote entry transmitter or
- Open either door and press the power door lock switch.

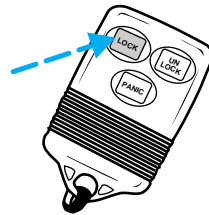

Identifying an armed system

While the system is arming, the THEFT light in the instrument cluster will illuminate for 30 seconds. After 30 seconds, THEFT will flash, indicating the system is armed.

If the system is armed with the doors open, the THEFT light will stay illuminated until all the doors are closed and then illuminate for 30 seconds and begin flashing.

When an unauthorized entry occurs, the activated system will:

- flash the headlamps, parking lamps and the THEFT light

Controls and features

- sound the horn
- prohibit the vehicle from starting.

The flashing headlamps and the honking horn automatically shut off after about three minutes and will remain off unless another unauthorized entry is attempted. However, the vehicle will not start until the system is disarmed.

Disarming an untriggered anti-theft system

Press the UNLOCK control or unlock either door with the key to disarm the untriggered system. If the driver armed the system but did not exit the vehicle, disarm the system by inserting the key and turning the ignition to On.

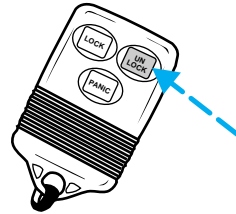

Disarming a triggered anti-theft system

Press either the UNLOCK or PANIC control or unlock either door with the key to disarm the system.

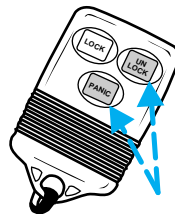

A triggered system may also be disarmed by inserting the key and turning the ignition to Accessory or On.

Seating and safety restraints

SEATING

Full bench seat (if equipped)

- Lift the release bar to move the seat forward or backward. Ensure that the seat is related into place.
- Push down the release lever to quickly fold the seatback forward.

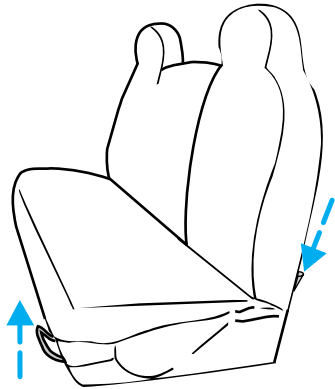

60/40 split bench seat (if equipped)

- Lift the release bar to move the seat forward or backward. Ensure the seat is related into place.

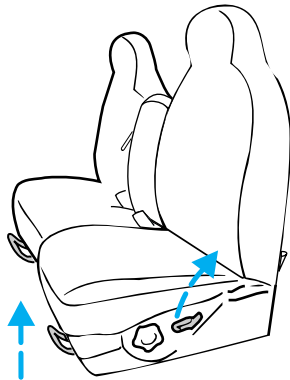

Seating and safety restraints

- Pull the seatback handle up to recline the seat.



- Turn the lumbar support dial to adjust firmness.
- Push down the release lever to quickly fold the seatback forward.

Center armrest (if equipped)

Pull the strap down to move the armrest down.

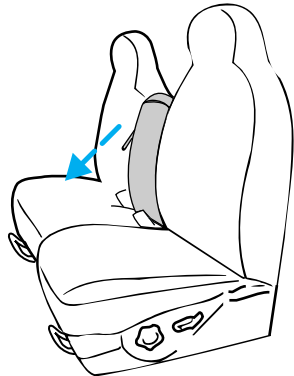

Seating and safety restraints

Captain's chair (if equipped)

- Lift the release bar to move the seat forward or rearward. Ensure that the seat is latched into place.
- Pull the seatback handle up to recline the seat.
- Push the release lever down to quickly fold the seatback forward.

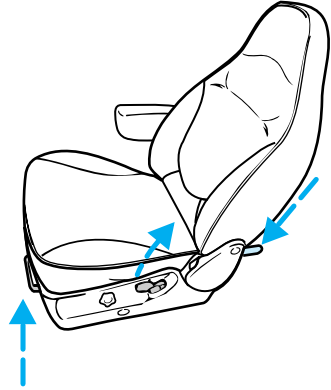

Power seats (if equipped)

- Pull up the seatback handle to recline the seat.
- Push down the release lever to quickly fold the seatback forward.

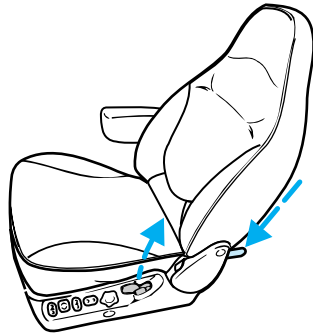

Seating and safety restraints

Press switch to tilt the front of the seat up or down.

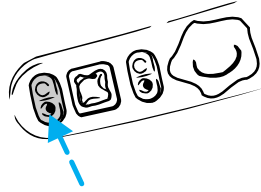

Press switch to tilt the rear of the seat up or down.

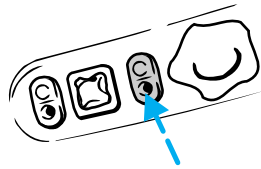

Seating and safety restraints

Press control to move the seat forward, backward, up or down.

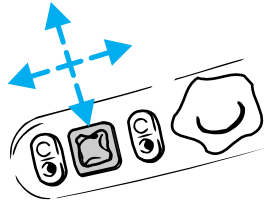

Adjustable lumbar support

Turn the lumbar support dial clockwise to adjust firmness.

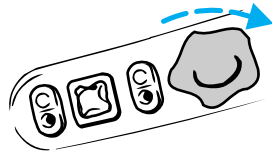

Seating and safety restraints

60/40 split rear seat (if equipped)

When folded down, the rear seats provide a “load floor” of additional storage space. To fold down the rear seats:

1. Pull the straps to lower the seat cushions.
2. Store the center safety belt in the opening on the seat back.

When returning the seats to their normal position:

1. Clear the load floor before folding seat up.
2. Ensure the seat cushion is latched into place.
3. Remove center safety belt from its stowed position.

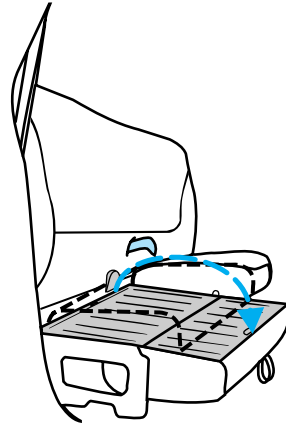

Check to assure that 60/40 Split rear seat cushion is latched by pulling up and forward on lap belt buckles.

SAFETY RESTRAINTS

Safety restraints precautions

The use of safety belts helps to restrain you and your passengers in case of a collision. In most states and Canada, the law requires the use of safety belts.



Always drive and ride with your seatback upright and the lap belt snug and low across the hips.

Seating and safety restraints



All occupants of the vehicle, including the driver, should always wear their safety belts.



To prevent the risk of injury, make sure children sit where they can be properly restrained.



It is extremely dangerous to ride in a cargo area, inside or outside of a vehicle. In a collision, people riding in these areas are more likely to be seriously injured or killed. Do not allow people to ride in any area of your vehicle that is not equipped with seats and safety belts. Be sure everyone in your vehicle is in a seat and using a safety belt properly.

Seating and safety restraints

Using safety restraints properly

Combination lap and shoulder belts

1. To connect the safety belt, insert the tongue into the buckle.
2. To disconnect the safety belt, push the red release button and remove the tongue from the buckle.

The front and rear (if equipped) outboard safety restraints in your vehicle are combination lap and shoulder safety belts. The outboard passenger safety belts have the two types of locking modes described below:

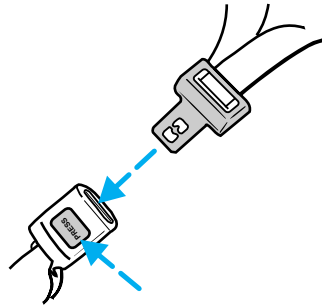

Vehicle sensitive (emergency) locking mode

The vehicle sensitive mode is the normal retractor mode, allowing free shoulder belt length adjustment to your movements and locking in response to vehicle movement. For example, if the driver brakes suddenly or turns a corner sharply, or the vehicle receives an impact of approximately 8 km/h (5 mph) or more the combination safety belts will lock to help reduce forward

Seating and safety restraints

movement of the driver and passengers.

The front seat belt system can also be made to lock manually by quickly pulling on the shoulder belt. Rear seat belts (if equipped) cannot be made to lock up by pulling quickly on the belt.

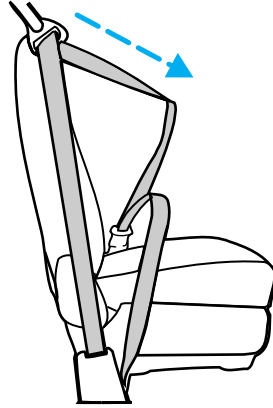

Automatic locking mode

In this mode, the shoulder belt is automatically pre-locked. The belt will still retract to remove any slack in the shoulder belt.

The automatic locking mode is not available on the driver safety belt.

When to use the automatic locking mode

- When a tight lap/shoulder belt fit is desired.
- Any time a child safety seat is installed in the vehicle. Refer to *Children and infant or child safety seats* later in this chapter.

Seating and safety restraints

Using the automatic locking mode

The automatic locking mode must be used when installing a child safety seat in any outboard passenger seat.

1. Buckle the combination lap and shoulder belt.

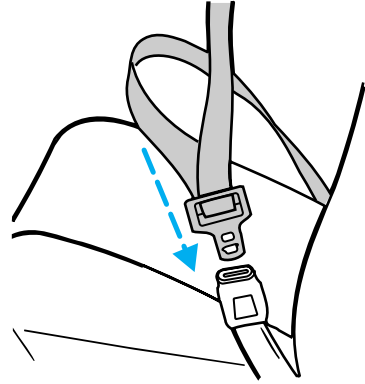

2. Grasp the shoulder belt portion and pull downward until the entire belt is extracted.

3. Allow the belt to retract. As the belt retracts, you will hear a clicking sound. This indicates that the safety belt is now in the automatic locking mode.

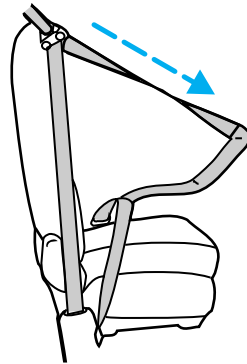

Cancelling the automatic locking mode

Disconnect the combination lap/shoulder belt and allow it to completely retract to cancel the automatic locking mode and activate the vehicle sensitive (emergency) locking mode.

Seating and safety restraints

Front seat safety belt height adjustment

Your vehicle has safety belt height adjustments for the driver and passenger seating positions.

Adjust the height of the shoulder belt so the belt rests across the middle of your shoulder.

1. Push the button and slide down to lower the shoulder belt height.
2. Push the button and slide up to raise the shoulder belt height.
3. Pull down on the height adjustment assembly to make sure it is locked in place.

If you have a SuperCab vehicle, the front passenger seat combination lap and shoulder belt height cannot be adjusted.

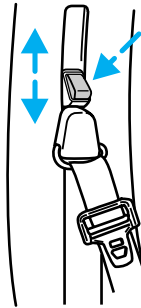

Lap belts

Lap belts are located in the center of the front bench or split bench seat (if equipped) and rear bench seat (SuperCab only).

Adjusting lap belts

The lap belt does not have a retractor to automatically adjust itself during vehicle movement.

Seating and safety restraints

The lap belt must be adjusted before use.

To shorten the belt:

- Buckle the belt.
- Pull the loose end of the belt until snug.

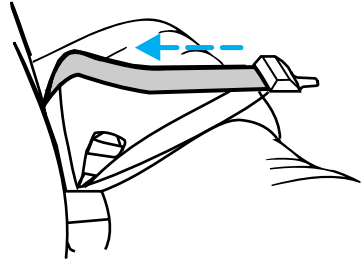

To lengthen the belt:

- Tip and pull the tongue. Do not wear the lap belt around your waist.

Shorten and fasten the belt when not in use.

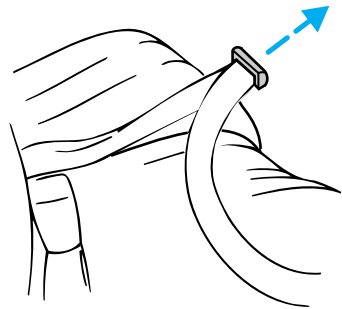

Safety belt warning light and indicator chime

 illuminates in the instrument cluster and a chime sounds to remind the occupants to fasten their safety belts.

Seating and safety restraints

Conditions of operation

If...	Then...
The driver safety belt is not buckled when the ignition key is turned to On...	The safety belt indicator illuminates for 1-2 minutes and the reminder chime sounds for 4-8 seconds.
The driver safety belt is buckled while the indicator light is illuminated and the reminder chime is sounding...	The safety belt indicator light and the reminder chime turn off.
The driver safety belt is buckled before the ignition key is turned to On...	The safety belt indicator light and the safety belt reminder chime remain off.

Safety belt maintenance

Check the safety belt systems periodically to make sure that they work properly and are not damaged. Check the safety belts to make sure that there are no nicks, wear or cuts. If your vehicle has been involved in an accident, have all the safety belts and child seat anchoring brackets (if equipped) examined by a qualified technician.



Failure to replace the safety belt assembly under the above conditions could result in severe personal injuries in the event of a collision.

Safety belt extension assembly

For some people, the safety belt may be too short even when it is fully extended. You can add about 20 cm (8 in.) to the belt length

Seating and safety restraints

with a safety belt extension assembly (part # 611C22). Safety belt extensions are available at no cost from your Ford or Lincoln/Mercury dealer.

Use only extensions manufactured by the same supplier as the safety belt. Manufacturer identification is located at the end of the webbing on the label. Also, use the safety belt extension only if the safety belt is too short for you when fully extended. Do not use extension to change the fit of the shoulder belt across the torso.

SUPPLEMENTAL RESTRAINT SYSTEM (SRS)

Important supplemental restraint system (SRS) precautions

The supplemental restraint system is designed to:

- work with the safety belt to protect the driver and right front passenger
- reduce certain upper body injuries



Failure to follow these instructions will affect the performance of the safety belts and increase the risk of personal injury.

Seating and safety restraints



The right front passenger air bag is not designed to restrain occupants in the front seating position.



Do not place objects or mount equipment on or near the air bag covers that may come into contact with an inflating air bag.



Do not attempt to service, repair, or modify the Air Bag Supplemental Restraint System or its fuses. See your Ford or Lincoln-Mercury dealer.

Children and air bags

For additional important safety information, read all information on safety restraints in this guide.

Seating and safety restraints

Children should always wear their safety belts. Failure to follow these instructions may increase the risk of injury in a collision.



Rear-facing child seats or infant carriers should never be placed in the front seats.

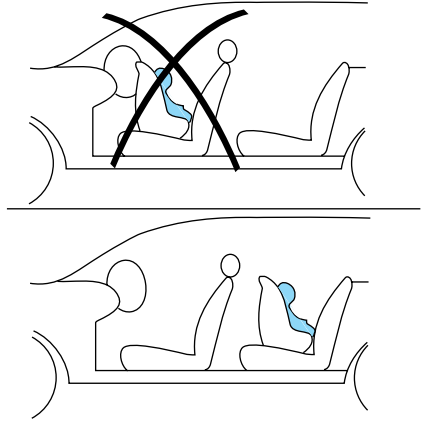

How does the air bag supplemental restraint system work?

The SRS is designed to activate when the vehicle sustains sufficient longitudinal deceleration, similar to hitting a fixed barrier head on at 12–24 km/h (8–14 mph).

The fact that the air bags did not inflate in a collision does not mean that something is wrong with the system. Rather, it means the forces

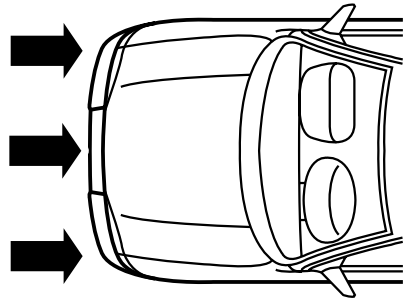

Seating and safety restraints

were not of the type sufficient to cause activation.



The air bags inflate and deflate rapidly upon activation.

After air bag deployment, it is normal to notice a smoke-like, powdery residue or smell the burnt propellant. This may consist of cornstarch, talcum powder (to lubricate the bag) or sodium compounds (e.g., baking soda) that result from the combustion process that inflates the air bag. Small amounts of sodium hydroxide may be present which may irritate the skin and eyes, but none of the residue is toxic.



Several air bag system components get hot after inflation. Do not touch them after inflation.

Seating and safety restraints



If the air bag is inflated, **the air bag will not function again and must be replaced immediately.** If the air bag is not replaced, the unrepaired area will increase the risk of injury in a collision.

The SRS consists of:

- driver and passenger air bag modules (which include the inflators and air bags),
- one or more impact and safing sensors,
- a readiness light and tone
- and the electrical wiring which connects the components.

The diagnostic module monitors its own internal circuits and the supplemental air bag electrical system readiness (including the impact sensors), the system wiring, the air bag system readiness light, the air bag back up power and the air bag ignitors.

Determining if the system is operational

The SRS uses a readiness light in the instrument cluster or a tone to indicate the condition of the system. Refer to the *Air bag readiness* section in the *Instrumentation* chapter. Routine maintenance of the air bag is not required.

Seating and safety restraints

A difficulty with the system is indicated by one or more of the following:

- The readiness light will either flash or stay lit.
- The readiness light will not illuminate immediately after ignition is turned on.
- A group of five beeps will be heard. The tone pattern will repeat periodically until the problem and light are repaired.



If any of these things happen, even intermittently, have the SRS serviced at your dealership or by a qualified technician immediately. Unless serviced, the system may not function properly in the event of a collision.

Passenger air bag deactivate switch

Your vehicle has a passenger air bag deactivate switch. This switch **MUST** be used to activate or deactivate the passenger air bag whenever a rear-facing infant seat is used in the right front or center front passenger seat position.

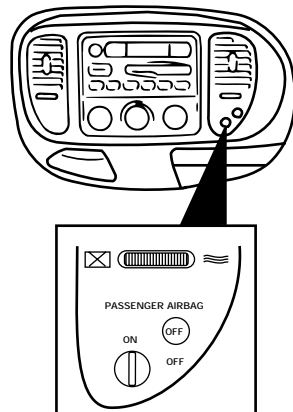

Seating and safety restraints



Keep the passenger air bag turned on unless there is a rear-facing infant seat installed in the front seat. When the passenger air bag switch is turned off, the passenger air bag will not inflate in a collision.

If the passenger air bag switch is turned off, it increases the likelihood of injury to forward facing occupants in the passenger seat.

Turning the passenger air bag off

1. Insert the ignition key, turn the switch to OFF and remove the key.
2. The OFF light illuminates when the key is inserted in the ignition and turned to On. This indicates that the passenger air bag is deactivated.

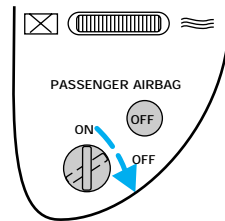

If the light fails to illuminate when the passenger air bag switch is in the OFF position and the ignition switch is in ON, have the passenger air bag switch serviced at your Ford or Lincoln-Mercury dealer immediately.

Seating and safety restraints



In order to avoid inadvertent deployment of the passenger air bag, always remove the ignition key from the passenger air bag deactivate switch.

Turning the passenger air bag back on

The passenger air bag remains off until you turn it back on.

1. Insert the ignition key and turn the switch to ON.
2. The OFF light will not illuminate when the ignition is turned to On.

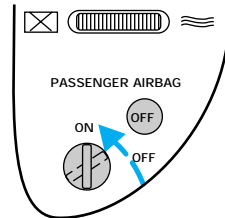

If the light is illuminated when the passenger air bag switch is in the ON position and the ignition switch is in ON, have the passenger air bag switch serviced at your Ford or Lincoln-Mercury dealer immediately.

Seating and safety restraints



Keep the passenger air bag turned on unless there is a rear-facing infant seat installed in the front seat. When the passenger air bag switch is turned off, the passenger air bag will not inflate in a collision.

Disposal of air bags and air bag equipped vehicles

For disposal of air bags or air bag equipped vehicles, see your local dealership or qualified technician. Air bags **MUST BE** disposed of by qualified personnel.

SAFETY RESTRAINTS FOR CHILDREN

Important child restraint precautions

You are required by law to use safety restraints for children in the U.S. and Canada. If small children ride in your vehicle (generally children who are four years old or younger and who weigh 18 kg [40 lbs] or less), you must put them in safety seats made especially for children. Check your local and state laws for specific requirements regarding the safety of children in your vehicle.



Never let a passenger hold a child on his or her lap while the vehicle is moving. The passenger cannot protect the child from injury in a collision.

Seating and safety restraints

Always follow the instructions and warnings that come with any infant or child restraint you might use.

If possible, place children in the rear seat of your vehicle. Accident statistics suggest that children are safer when properly restrained in rear seating positions than when they are restrained in front seating positions.

Children and safety belts

Children who are too large for child safety seats (as specified by your child safety seat manufacturer) should always wear safety belts.

Follow all the important safety restraint and air bag precautions that apply to adult passengers in your vehicle.

If the shoulder belt portion of a combination lap and shoulder belt can be positioned so it does not cross or rest in front of the child's face or neck, the child should wear the lap and shoulder belt. Moving the child closer to the center of the vehicle may help provide a good shoulder belt fit.

If the shoulder belt cannot be properly positioned:

- move the child to one of the seats with a lap belt only (if equipped)

OR

- if the child is the proper size, restrain the child in a safety seat.

Seating and safety restraints



Do not leave children, unreliable adults, or pets unattended in your vehicle.

To improve the fit of lap and shoulder belts on children who have outgrown child safety seats, Ford recommends use of a belt-positioning booster seat that is labelled as conforming to all Federal motor vehicle safety standards. Belt-positioning booster seats raise the child and provide a shorter, firmer seating cushion that encourages safer seating posture and better fit of lap and shoulder belts on the child. A belt-positioning booster should be used if the shoulder belt rests in front of the child's face or neck, or if the lap belt does not fit snugly on both thighs, or if the thighs are too short to let the child sit all the way back on the seat cushion when the lower legs hang over the edge of the seat cushion. You may wish to discuss the special needs of your child with your pediatrician.

Seating and safety restraints

Child and infant or child safety seats



Carefully follow all of the manufacturer's instructions included with the safety seat you put in your vehicle. If you do not install and use the safety seat properly, the child may be injured in a sudden stop or collision.

Ford recommends the use of a child safety seat having a top tether strap. Install the child safety seat in a seating position which is capable of providing a tether anchorage. For more information on top tether straps see *Attaching safety seats with tether straps* in this chapter.

When installing a child safety seat:

- Use the correct safety belt buckle for that seating position.
- Make sure the tongue is securely fastened in the buckle.
- Keep the buckle release button pointing up and away from the safety seat, with the tongue between the child seat and the release button, to prevent accidental unbuckling.
- Place seatbacks in the upright position.
- Put the safety belt in the automatic locking mode. Refer to *Using the automatic locking mode* in this chapter.

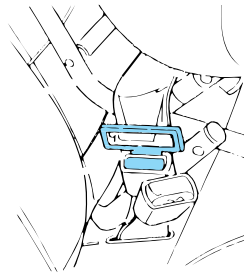

Seating and safety restraints

Installing child safety seats in combination lap and shoulder belt seating positions

1. Position the child safety seat in a seat with a combination lap and shoulder belt.

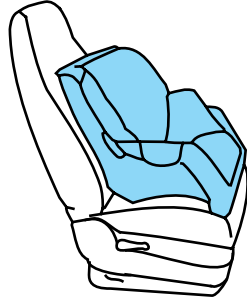

If you choose to install a child safety seat in the front passenger seat, move the seat as far back as possible.

Seating and safety restraints



Keep the passenger air bag turned on unless there is a rear-facing infant seat installed in the front seat. When the passenger air bag switch is turned off, the passenger air bag will not inflate in a collision.

2. Pull down on the shoulder belt and then grasp the shoulder belt and lap belt together.

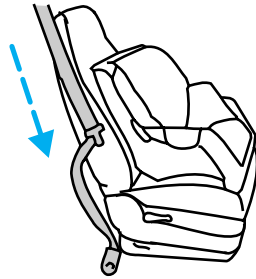

3. While holding the shoulder and lap belt portions together, route the tongue through the child seat according to the child seat manufacturer's instructions. Be

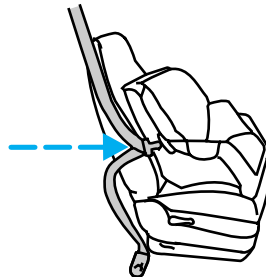

Seating and safety restraints

sure the belt webbing is not twisted.

4. Insert the belt tongue into the proper buckle for that seating position until you hear and feel the latch engage. Make sure the tongue is latched securely by pulling on it.

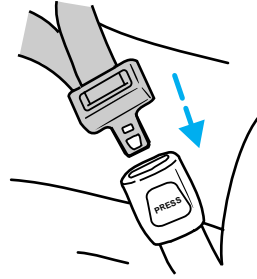

5. To put the retractor in the automatic locking mode, grasp the shoulder portion of the belt and

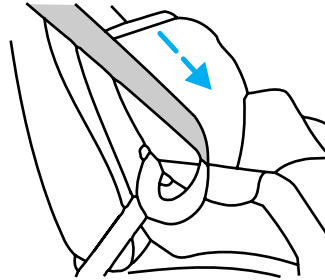

Seating and safety restraints

pull downward until all of the belt is extracted and a click is heard.

6. Allow the belt to retract. The belt will click as it retracts to indicate it is in the automatic locking mode.

7. Pull the lap belt portion across the child seat toward the buckle and pull up on the shoulder belt while pushing down on the child seat.

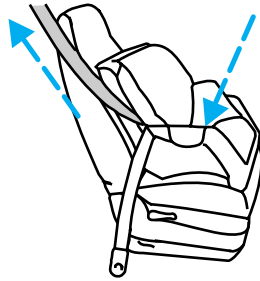

8. Allow the safety belt to retract to remove any slack in the belt.

9. Before placing the child in the seat, forcibly tilt the seat forward and back to make sure the seat is securely held in place.

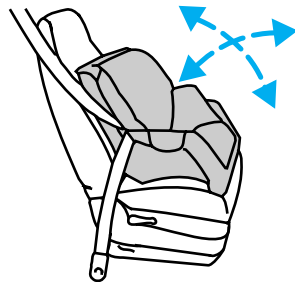

10. Try to pull the belt out of the retractor to make sure the retractor is in the automatic locking mode (you should not be

Seating and safety restraints

able to pull more belt out). If the retractor is not locked, unbuckle the belt and repeat steps two through nine.

Check to make sure the child seat is properly secured before each use.

Using a tether strap

Ford recommends using child safety seats with a top tether strap. Contact the manufacturer of your safety seat for information about ordering a tether strap if one is not provided to you. Contact your Ford dealer for a free tether strap if one is not provided to you. Contact your Ford dealer for a free tether anchor kit (613D74) so you can attach a tether anchor bracket to the back of the seat cushion. If you have a SuperCab, attach the bracket to the inside of the back panel of your vehicle. Carefully follow the instructions provided with the kit.

If you have a SuperCab, Ford recommends you attach tether safety seats in a rear seating position (if possible) with the tether strap attached to the tether anchor bracket as shown in the instructions provided with the tether anchor kit.

If the tethered seat is installed in the front seat, put the tether strap over the seatback and attach it to the anchor bracket installed on the rear edge of the seat cushion as explained in the tether strap instructions.

STARTING YOUR VEHICLE

Important safety precautions

A computer system controls the engine's idle revolutions per minute (RPM). When the engine starts, the idle RPM runs faster to warm the engine. If the engine idle speed does not slow down automatically, have the vehicle checked. Do not allow the vehicle to idle for more than ten minutes.



Extended idling at high engine speeds can produce very high temperatures in the engine and exhaust system, creating the risk of fire or other damage.



Do not park, idle, or drive your vehicle in dry grass or other dry ground cover. The emission system heats up the engine compartment and exhaust system, which can start a fire.



Do not start your vehicle in a closed garage or in other enclosed areas. Exhaust fumes can be toxic. Always open the garage door before you start the engine. See *Guarding against exhaust fumes* in this chapter for more instructions.

Starting



If you smell exhaust fumes inside your vehicle, have your dealer inspect your vehicle immediately. Do not drive if you smell exhaust fumes.

Preparing to start the vehicle

Engine starting is controlled by the spark ignition system. This system meets all Canadian Interference-Causing Equipment standard requirements regulating the impulse electrical field strength of radio noise.

When starting a fuel-injected engine, avoid pressing the accelerator before or during starting. Only use the accelerator when you have difficulty starting the engine. For more information on starting the vehicle, refer to *Starting the vehicle* in this chapter.

Before starting the vehicle:

1. Make sure all vehicle occupants have buckled their safety belts. For more information on safety belts and their proper usage, refer to

Starting

the *Seating and safety restraints* chapter.

2. Make sure the headlamps and vehicle accessories are off.

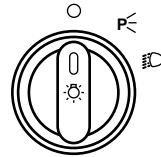

If starting a vehicle with an automatic transmission:

- Make sure the parking brake is set.
- Make sure the gearshift is in P (Park).

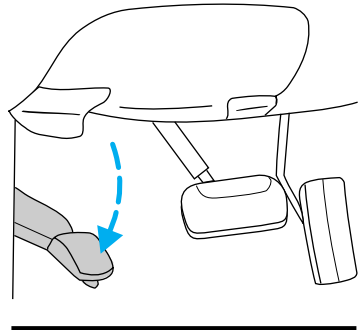

Starting

If starting a vehicle with a manual transmission:

- Make sure the parking brake is set.
- Push the clutch pedal to the floor.

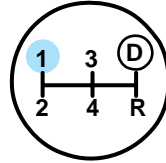
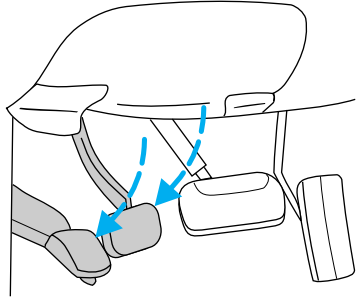

Starting

3. Turn the key to the ON position (without turning the key to START).

Make sure the following lights illuminate briefly. If a light fails to illuminate, have the vehicle serviced.

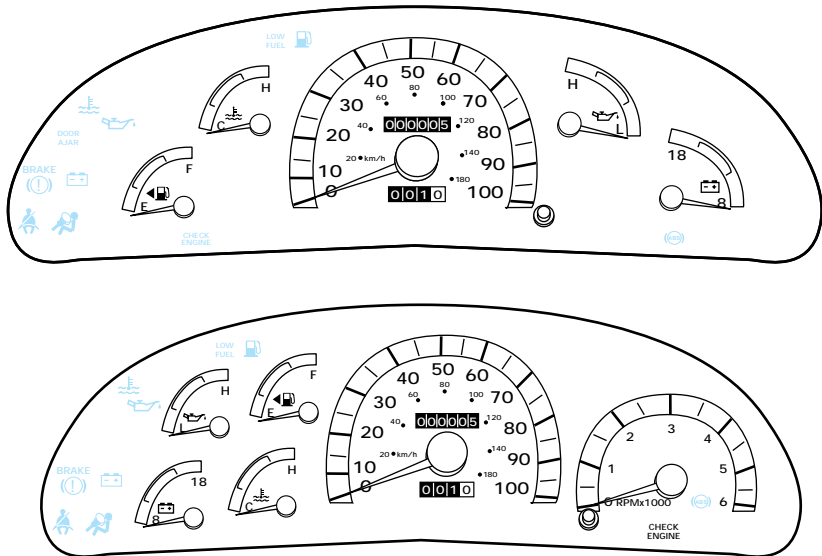

- If the driver's safety belt is fastened, the  light does not illuminate.

Starting

STARTING PROCEDURE

Starting the engine

1. Turn the key to 5 (Start) without pressing the accelerator. The key will return to 4 (On).

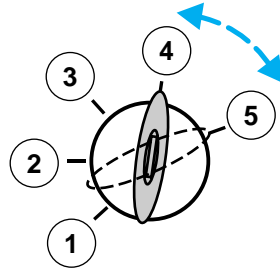

2. If the engine does not start within five seconds, wait ten seconds and try again.

3. If the engine does not start in two attempts OR the temperature is below -12°C (10°F), depress accelerator and start the engine while holding the accelerator down. Release accelerator when engine starts.

4. After idling for a few seconds, apply the brake and release the parking brake.

Using the engine block heater (if equipped)

An engine block heater warms the engine coolant, which improves starting, warms up the engine faster and allows the heater-defroster system to respond quickly. They are strongly recommended if you live in a region where temperatures reach -23°C (-10°F) or below.

For best results, plug the heater in at least three hours before starting

the vehicle. Using the heater for longer than three hours will not harm the engine, so the heater can be plugged in the night before starting the vehicle.



To prevent electrical shock, do not use your heater with ungrounded electrical systems or two-pronged (cheater) adapters.

Guarding against exhaust fumes

Although odorless and colorless, carbon monoxide is present in exhaust fumes. Take precautions to avoid its dangerous effects.



If you ever smell exhaust fumes of any kind inside your vehicle, have your dealer inspect and fix your vehicle immediately. Do not drive if you smell exhaust fumes. These fumes are harmful and could kill you.

Have the exhaust and body ventilation systems checked whenever:

- the vehicle is raised for service
- the sound of the exhaust system changes
- the vehicle has been damaged in a collision

Starting

Important ventilating information

If the engine is idling while the vehicle is stopped in an open area for long periods of time, open the windows at least 2.5 cm (one inch).

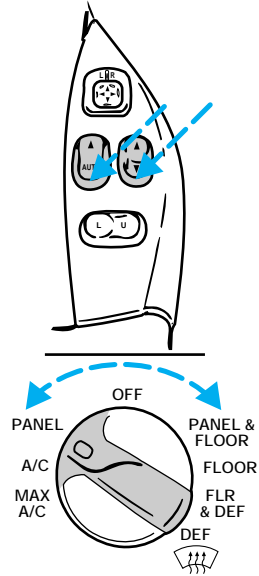

Adjust the heating or air conditioning (if equipped) to bring in fresh air.

Improve vehicle ventilation by keeping all air inlet vents clear of snow, leaves and other debris.

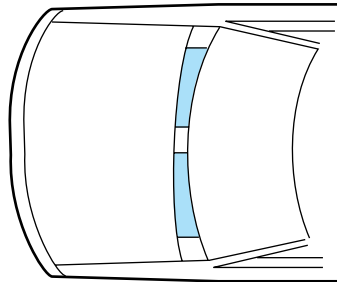

BRAKES

Rear anti-lock brake system (ABS) (if equipped)

This system prevents one or both rear wheels from locking up when the brakes are applied during a sudden stop.

Even with rear ABS, the front brakes may lock up on any surface. Be careful when braking, especially on loose snow or gravel.

Anti-lock brake system (ABS) (if equipped)

The ABS operates by detecting the onset of wheel lock up during brake applications and compensating for this tendency. The front wheels are prevented from locking even when the brakes are firmly applied. The accompanying illustration depicts the advantage of an ABS equipped vehicle (on bottom) to a non-ABS equipped vehicle (on top) during hard braking.

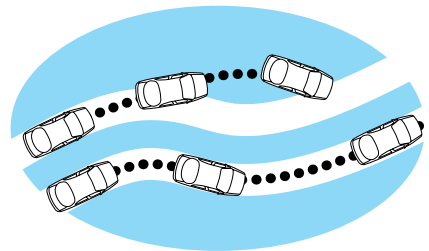

Using ABS

- In an emergency, apply full force on the brake. The ABS will be activated immediately, thus allowing you to retain full steering control of your vehicle and, providing there is sufficient space, will enable you to avoid obstacles and bring the vehicle to a quiet stop.
- We recommend that you familiarize yourself with this

Driving

braking technique. However, avoid taking any unnecessary risks.

Parking brake

The parking brake should be used whenever you park your vehicle. It is not designed to stop a moving vehicle. However, if the normal brakes fail, the parking brake can be used to stop your vehicle in an emergency. Since the parking brake applies only the rear brakes, the vehicle's stopping distance will increase greatly and the handling of your vehicle will be adversely affected.

Setting the parking brake

The ^{BRAKE}  light in the instrument cluster will illuminate and remain illuminated (when the ignition

switch is turned to On) until the parking brake is released.

- Automatic and manual transmissions – Fully depress the parking brake pedal.

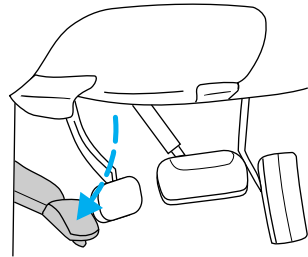
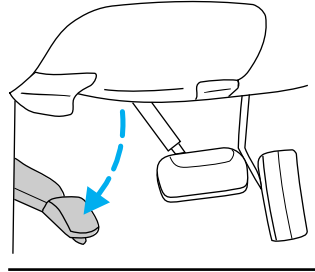

When you leave your vehicle, place the gearshift lever in P (Park). Set the parking brake fully, and shut off the engine. Never park your vehicle in N (Neutral). If you do not take these precautions, your vehicle may move suddenly and injure someone.

With the transfer case in N (Neutral) the vehicle is free to move with either the automatic transmission in P (Park) or with the manual transmission in any driving gear.

Driving



Do not leave the vehicle unattended with the transfer case in the N (Neutral) position. Always set the parking brake fully and turn off the ignition when leaving the vehicle.

Releasing parking brake

Pull the BRAKE lever forward.

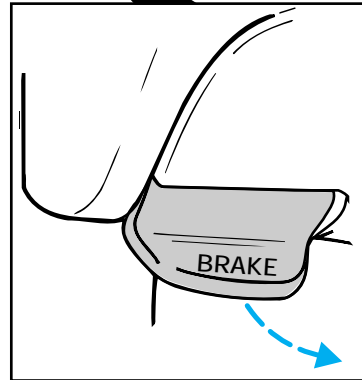
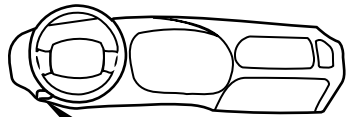

If the parking brake is fully released, but the Brake System light remains on, have the brakes checked immediately. They may not be working properly.

TRACTION LOK® REAR AXLE (IF EQUIPPED)

This axle provides added drive away traction on slippery surfaces,

particularly when one or more wheels are on a surface with poor traction.

AIR SUSPENSION (IF EQUIPPED)

The air suspension system for the rear wheels is designed to keep your vehicle at a constant level by adding or releasing air from the rear springs to compensate for increases or decreases in vehicle load.

Normal vehicle operation does not require any action by the driver.

The air suspension switch is located behind an access panel underneath the passenger side instrument panel.

Press the air suspension switch to OFF when jacking or hoisting your vehicle.



On vehicles equipped with Air Suspension, turn OFF the Air Suspension switch prior to jacking, hoisting or towing your vehicle.

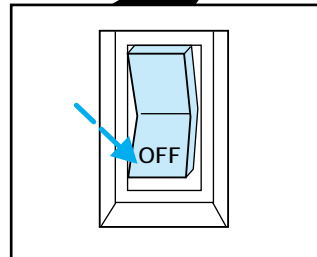
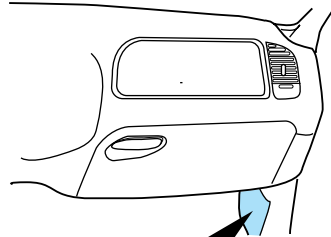

Driving

TRANSMISSION OPERATION

Automatic transmission operation (if equipped)

 Hold the brake pedal down while you move the gearshift lever from position to position. If you do not hold the brake pedal down, your vehicle may move unexpectedly and injure someone.

Pull the gearshift lever towards you and downward to move the automatic gearshift.

P (Park) – Always come to a complete stop before shifting into or out of P (Park).

 When you leave your vehicle, place the gearshift lever in P (Park). Set the parking brake fully, and shut off the engine. Never park your vehicle in N (Neutral). If you do not take these precautions, your vehicle may move suddenly and injure someone.

R (Reverse) – Always come to a complete stop before shifting into or out of R (Reverse).

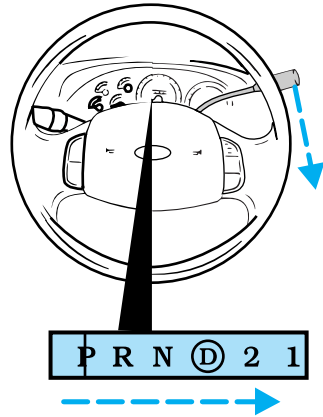

N (Neutral) – Vehicle is free to roll.

Ⓧ (**Overdrive**) – The normal driving position for the best fuel economy. Transmission operates in gears one through four.

Ⓧ (Overdrive) can be deactivated by pressing the transmission control switch on the end of the gearshift lever. The transmission control indicator light (TCIL) (OFF) on the end of the gearshift lever will remain off.

D (Drive) – Not shown on the display. Activate by pressing the transmission control switch on the end of the gearshift lever. The TCIL (OFF) will illuminate on the gearshift lever. Transmission operates in gears one through three. D (Drive) provides more engine braking than

Ⓧ (Overdrive) and is useful whenever driving conditions (i.e., city traffic, hilly terrain, etc.) cause the transmission to excessively shift between Ⓧ (Overdrive) and D (Drive). Also deactivate Ⓧ (Overdrive) when:

- driving with a heavy load
- towing a trailer up or down steep hills
- additional engine braking is desired.

To return to Ⓧ (Overdrive) mode, press the transmission control switch. The TCIL (OFF) will no longer be illuminated.

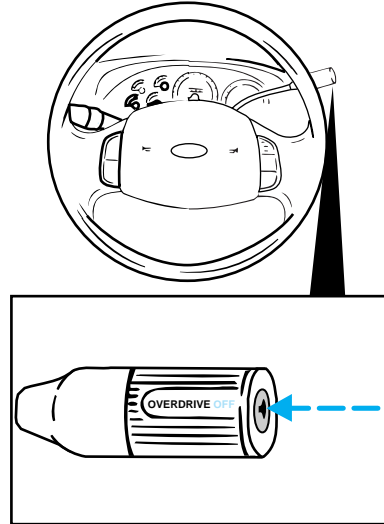

Driving

Each time the vehicle is started, the transmission will automatically return to normal overdrive mode.

2 (Second) – Use 2 (Second) to start-up on slippery roads or to provide additional engine braking on downgrades. Transmission operates in first and second gears.

1 (Low) – Use 1 (Low) to provide maximum engine braking on steep downgrades. Upshifts can be made by shifting to 2 (Second) or to **Ⓧ** (Overdrive). Selecting 1 (Low) at higher speeds causes a shift to 2 (Second), and will shift to 1 (Low) after vehicle decelerates to the proper speed.

Brake-shift interlock

The brake-shift interlock feature prevents you from shifting from P (Park) unless the brake pedal is depressed (with the ignition in the On position). If you cannot move the gearshift out of P (Park) with the brake pedal depressed:

1. Turn ignition key to Off.

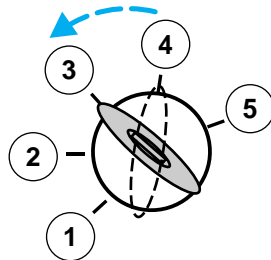

2. Apply the parking brake.

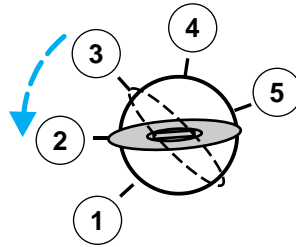

3. Turn ignition key to Lock and remove the key.

4. Re-insert the ignition key and turn it to Off.

5. Shift the transmission to N (Neutral).

6. Start the vehicle.

If you need to use the above procedure, it is possible that a fuse has blown and your brakelamps may not be functioning. Refer to the *Roadside emergencies* chapter for instructions on replacing fuses.



Do not drive your vehicle until you verify that the brakelamps are working.

Manual transmission operation (if equipped)

Using the clutch

Vehicles equipped with a manual transmission have a starter interlock that prevents cranking the engine unless the clutch pedal is fully depressed.

Driving

When starting a vehicle with a manual transmission, you must:

1. Put gearshift in N (Neutral).
2. Hold down brake pedal.

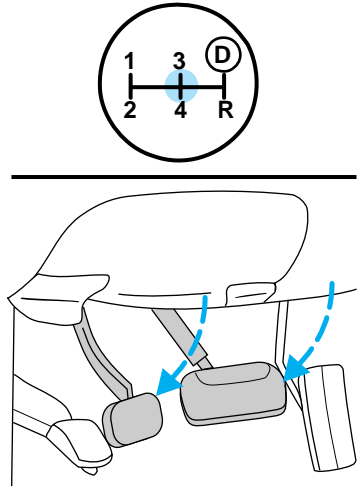

3. Depress clutch pedal.

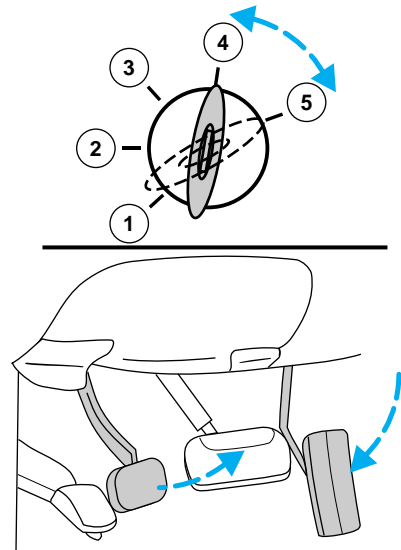

4. Turn ignition key to Start to start the engine and let it idle for a few seconds.

5. Release the brake pedal.

6. Release clutch slowly while pressing down slowly on the accelerator pedal.

- Do not drive with your foot resting on the clutch pedal and do not use the clutch to hold your vehicle at a standstill while waiting on a hill. These actions will seriously reduce clutch life.

Recommended shift speeds

Upshift and downshift according to the following charts for your specific engine/drivetrain combination:

Driving

Upshifts when accelerating (recommended for best fuel economy)		
Shift from:	Transfer case position ¹ (if equipped)	
	2H or 4H	4L
1 - 2	14 km/h (9 mph)	5 km/h (3 mph)
2 - 3	32 km/h (20 mph)	11 km/h (7 mph)
3 - 4	50 km/h (31 mph)	19 km/h (12 mph)
4 - Ⓣ (Overdrive)	71 km/h (44 mph)	27 km/h (17 mph)

Upshifts when cruising (recommended for best fuel economy)		
Shift from:	Transfer case position ¹ (if equipped)	
	2H or 4H	4L
1 - 2	16 km/h (10 mph)	6 km/h (4 mph)
2 - 3	26 km/h (16 mph)	10 km/h (6 mph)
3 - 4	43 km/h (27 mph)	16 km/h (10 mph)
4 - Ⓣ (Overdrive)	68 km/h (42 mph)	26 km/h (16 mph)

Maximum downshift speeds ²		
Shift from:	Transfer case position (if equipped) ¹	
	2H or 4H	4L
Ⓣ (Overdrive) - 4	88 km/h (55 mph)	34 km/h (21 mph)
4 - 3	72 km/h (45 mph)	27 km/h (17 mph)
3 - 2	56 km/h (35 mph)	21 km/h (13 mph)
2 - 1	32 km/h (20 mph)	11 km/h (7 mph)

¹Use 2H or 4H for 4WD equipped vehicles.

²Downshift at lower speeds when driving on slippery surfaces.

Parking your vehicle

1. Apply brake and shift into N (Neutral).

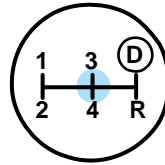
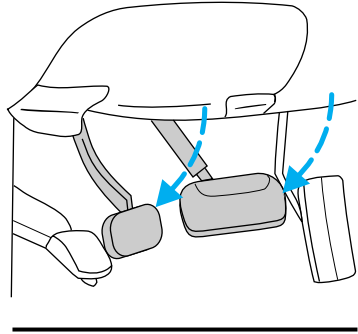

2. Set parking brake.
3. Shift into 1 (First).

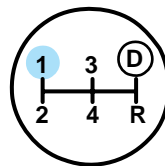
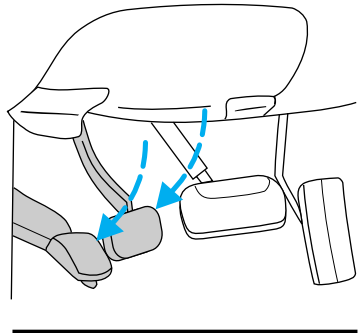

Driving

4. Turn ignition to Off.

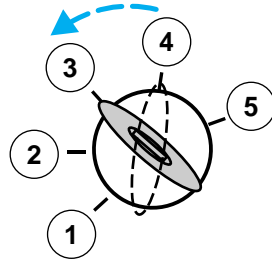

Do not park your vehicle in Neutral, it may move unexpectedly and injure someone. Use 1 (First) gear and set the parking brake fully.

Reverse

Make sure that your vehicle is at a complete stop before you shift into R (Reverse). Failure to do so may damage the transmission.

Put the gearshift in N (Neutral) and wait at least three seconds before shifting into R (Reverse).

You can shift into R (Reverse) only by moving the gearshift from left of 3 (Third) and 4 (Fourth) gears before you shift into R (Reverse). This is a special lockout feature that protects you from accidentally shifting into R (Reverse) when you downshift from **D** (Overdrive).

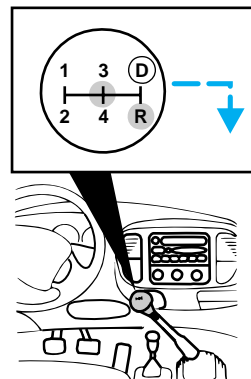

Removing key from ignition

Turn the ignition key to Lock.

Push the release lever forward while removing the key from the ignition.

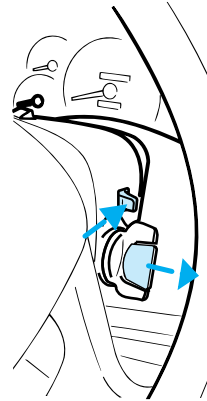

FOUR-WHEEL DRIVE OPERATION (4WD) (IF EQUIPPED)

When Four-wheel drive (4WD) is engaged, power is supplied to all four wheels through a transfer case. 4WD power can be selected when additional driving power is desired.

All utility-type vehicles and 4WD vehicles have special design and equipment features to make them capable of performing in a wide variety of off-road applications. Specific design characteristics give them higher centers of gravity than ordinary passenger cars.

Driving



Utility and four-wheel drive vehicles are **not** designed for cornering at speeds as high as passenger cars any more than low-slung sports cars are designed to perform satisfactorily under off-road conditions. Avoid sharp turns or abrupt maneuvers in these vehicles.

4WD operation is not recommended on dry pavement. Doing so could result in difficult disengagement of the transfer case, increased tire wear and decreased fuel economy.

4WD system indicator lights

The 4WD system indicator lights illuminate only under the following conditions. If these lights illuminate during normal driving, have your vehicle serviced.

4x4 – illuminates when 4H (4WD High) or 4L (4WD Low) is selected.

LOW RANGE – illuminates when 4L (4WD Low) is selected.

Using lever-operated 4WD system (if equipped)

2H (2WD High) – Power to rear axle only.

4H (4WD High) – Power to front and rear axles.

N (Neutral) – No power to either axle.

4L (4WD Low) – Power to front and rear axles at reduced speed.

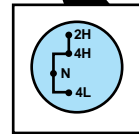
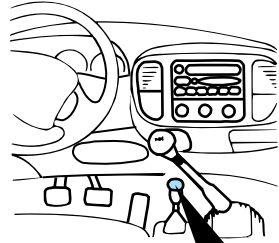

Shifting from 2H (2WD High) to 4H (4WD High)

Move the transfer case lever to 4H (4WD High) at a stop or any forward speed up to 88 km/h (55 mph).

- At temperatures below 0°C (32°F), shifts from 2H (2WD High) to 4H (4WD High) should not be performed above 72 km/h (45 mph).
- Do not shift into 4H (4WD High) with the rear wheels slipping.

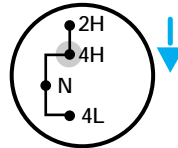

Driving

Shifting from 4H (4WD High) to 2H (2WD High)

Move the transfer case lever to 2H (2WD High) at a stop or any forward speed up to 88 km/h (55 mph).

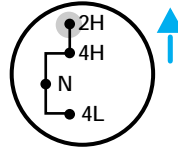

Shifting from 4H (4WD High) to 4L (4WD Low)

1. Depress the brake.
2. Place the gearshift lever in N (Neutral) (automatic transmission) or depress the clutch (manual transmission).
3. Pull the transfer case shift lever through N (Neutral) directly to 4L (4WD Low).

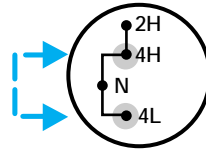

Shifting from N (Neutral) to 4H (4WD High) or 4L (4WD Low)

With the transfer case in N (Neutral) the vehicle is free to move with either the automatic transmission in P (Park) or with the manual transmission in any gear.

1. Stop the vehicle.
2. Depress the brake.

- Place the gearshift in N (Neutral) (automatic transmission) or depress the clutch (manual transmission).
- Place the transfer case lever in the desired gear.

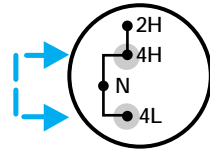

Using the N (Neutral) position

This position should only be used when towing the vehicle. Refer to *Wrecker towing* in the *Roadside emergencies* chapter.



Do not leave the vehicle unattended with the transfer case in the N (Neutral) position. Always set the parking brake fully and turn off the ignition when leaving the vehicle.

Driving

Using the electronic shift 4WD system (if equipped)

Positions of the electronic shift system

2H (2WD High) – Power to rear axle only.

4H (4WD High) – Power delivered to front and rear axles for increased traction.

4L (4WD Low) – Power to front and rear axles at low speeds.

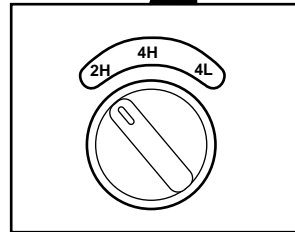
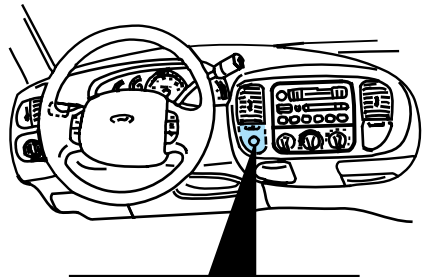

Shifting from 2H (2WD High) to 4H (4WD High)

Move the 4WD control to 4H at a stop or up to 88 km/h (55 mph).

At temperatures below 0°C (32°F), shifts from 2H to 4H should not be performed above 72 km/h (45 mph).

- Do not shift into 4H with the rear wheels slipping.

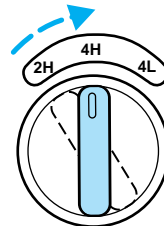

Shifting from 4H (4WD high) to 2H (2WD high)

Move the 4WD control to 2H at any forward speed.

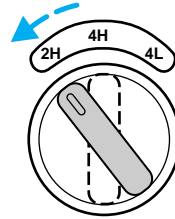

Shifting between 4H (4WD high) and 4L (4WD low)

1. Bring the vehicle to a stop.
2. Depress the brake.
3. Place the gearshift in N (Neutral) (automatic transmission) or depress the clutch (manual transmission).
4. Move the 4WD control to the 4H or 4L position.

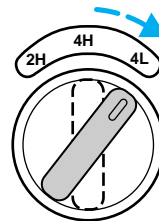

Driving off-road with 4WD

Your vehicle is specially equipped for driving on sand, snow, mud and rough terrain and has operating characteristics that are somewhat different from conventional vehicles, both on and off the road. The following information will help you learn to properly use 4WD.

Driving

When using 4WD, maintain steering wheel control at all times, especially in rough terrain. Since sudden changes in terrain can result in abrupt steering wheel motion, make sure you grip the steering wheel from the outside. Do not grip the spokes.

Drive cautiously to avoid vehicle damage from concealed objects such as rocks and stumps.

You should either know the terrain or examine maps of the area before driving. Map out your route before driving in the area. For more information on driving off-road, read the “Four Wheeling” supplement in your owner’s portfolio.

If your vehicle gets stuck

If the vehicle is stuck, shift the transmission in a steady motion between forward and reverse gears. Allow the transmission to engage, then press lightly on the accelerator. DO NOT rock the vehicle for more than a few minutes. The transmission and tires may be damaged or the engine can overheat.



Do not spin the wheels at over 35 mph (55 km/h). The tires may fail and injure a passenger or bystander.

Sand

When driving over sand, try to keep all four wheels on the most

solid area of the trail. Do not reduce the tire pressures but shift to a lower gear and drive steadily through the terrain. Apply the accelerator slowly and avoid spinning the wheels.

Mud and water

If you must drive through high water, drive slowly. Traction or brake capability may be limited.



When driving through water, determine the depth; avoid water higher than the bottom of the hubs (if possible) and proceed slowly. If the ignition system gets wet, the vehicle may stall.

Once through water, always try the brakes. Wet brakes do not stop the vehicle as effectively as dry brakes. Drying can be improved by moving your vehicle slowly while applying light pressure on the brake pedal.

After driving through mud, clean off residue stuck to rotating driveshafts and tires. Excess mud stuck on tires and rotating driveshafts causes an imbalance

Driving

that could damage drive components.

If the transmission and transfer case are submerged in water, their fluids should be checked and changed, if necessary.

If the rear axle is submerged in water, the rear axle lubricant should be checked and changed, if necessary. The rear axle is filled with a synthetic lubricant and does not normally require a lubricant change for the life of the vehicle. Rear axle lubricant quantities should not need to be checked unless a leak is suspected.

Driving on hill or slope terrain

When driving on a hill, avoid driving crosswise or turning on steep slopes. You could lose traction and slip sideways. Drive straight up, straight down or avoid the hill completely. Know the conditions on the other side of a hill before driving over the crest.

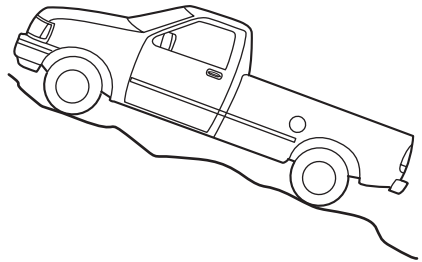

When climbing a steep hill, start in a lower gear rather than downshifting to a lower gear from a higher gear once the ascent has started. This reduces strain on the engine and the possibility of stalling.

When descending a steep hill, avoid sudden braking. Rapid pumping of the brake pedal will help slow the vehicle and still maintain steering control.

When speed control is on and you are driving uphill, your vehicle speed may drop considerably, especially if you are carrying a heavy load.

If vehicle speed drops more than 15–25 km/h (8–14 mph), the speed control will cancel automatically. Resume speed with accelerator pedal.

If speed control cancels after climbing the hill, reset speed by pressing and holding the SET ACCEL button (to resume speeds over 50 km/h (30 mph).

Automatic transmission may shift frequently while driving up steep grades. Eliminate frequent shifting by shifting out of **Ⓧ** (Overdrive) into D (Drive).

Driving on snow and ice

A 4WD vehicle has advantages over 2WD vehicles in snow and ice but can skid like any other vehicle.

Avoid sudden applications of power and quick changes of direction on snow and ice. Apply the accelerator slowly and steadily when starting from a full stop.

When braking, apply the brakes as you normally would. In order to allow the anti-lock brake system (ABS) to operate properly, keep

Driving

steady pressure on the brake pedal.

Allow more stopping distance and drive slower than usual. Consider using one of the lower gears.

VEHICLE LOADING



It is extremely dangerous to ride in a cargo area, inside or outside of a vehicle. In a collision, people riding in these areas are more likely to be seriously injured or killed. Do not allow people to ride in any area of your vehicle that is not equipped with seats and safety belts. Be sure everyone in your vehicle is in a seat and using a safety belt properly.

Before loading a vehicle, familiarize yourself with the following terms:

- **Base Curb Weight:** Weight of the vehicle including any standard equipment, fluids, lubricants, etc. It does not include passengers or aftermarket equipment.
- **Payload:** Combined maximum allowable weight of cargo, passengers and optional equipment. The payload equals gross vehicle weight rating (GVWR) minus base curb weight.
- **Gross vehicle weight (GVW):** Base curb weight plus the payload weight (including passengers, cargo and optional

equipment. Remember, the GVW is not a limit or a specification.

- **Gross vehicle weight rating (GVWR):** Maximum total weight of the base vehicle, passengers, optional equipment and cargo. The GVWR is specific to each particular vehicle and is listed on the Safety Compliance Certification Label on the driver door pillar.
- **Gross axle weight rating (GAWR):** Carrying capacity for each axle system (front and rear). This amount is specific to each particular vehicle and is listed on the Safety Compliance Certification Label on the driver door pillar.
- **Gross combined weight rating (GCWR):** Maximum combined weight of the towing vehicle (including passengers and cargo) and the trailer. The GCWR indicates the maximum loaded weight that the vehicle is allowed to tow.
- **Maximum trailer weight:** Maximum weight of a trailer the loaded vehicle (including passengers and cargo) is permitted to tow. It is determined by subtracting the weight of the loaded towing vehicle from the GCWR of the towing vehicle.
- **Trailer weight range:** Specified weight range that the trailer must fall within that

Driving

ranges from zero to the maximum trailer weight rating.

Remember to figure in the tongue load of your loaded trailer when figuring the total weight.

Do not use replacement tires with lower weight capacities than the original because they may lower the vehicle's GVWR and GAWR limitations. Replacement tires with a higher weight limit than the originals do not increase the GVWR and GAWR limitations.

Calculating the load your vehicle can carry/tow

1. Use the Safety Compliance Certification Label to find the axle code number and engine type for your vehicle.

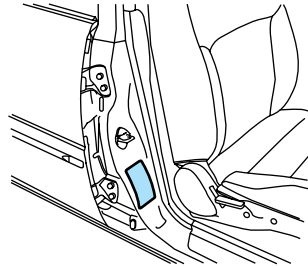

2. Use the appropriate maximum gross combined weight rating (GCWR) chart to find the maximum GCWR for your type engine and rear axle ratio.

3. Weigh your vehicle as you customarily operate the vehicle without cargo. To obtain correct weights, try taking your vehicle to a shipping company or an inspection station for trucks.

4. Subtract your loaded vehicle weight from the maximum GCWR on the following charts. This is the

Driving

maximum trailer weight your vehicle can tow and must fall below the maximum shown under maximum trailer weight on the chart.

Trailer towing table (F-150 4x2 automatic transmission)				
Engine	Rear axle ratio	Maximum GCWR kg (lb)	Maximum trailer weight kg (lb)	Maximum frontal area of trailer m ² (ft ²)
Regular Cab F-150				
4.2L	3.08	4,077 (9,000)	2,177 (4,800)	5.52 (60)
4.2L	3.55	4,530 (10,000)	2,582 (5,800)	5.52 (60)
4.6L	3.08	4,530 (10,000)	2,582 (5,700)	5.52 (60)
4.6L	3.55	5,209 (11,500)	3,261 (7,200)	5.52 (60)
5.4L	3.08	4,983 (11,000)	2,948 (6,500)	5.52 (60)
5.4L	3.55	5,753 (12,700)	3,268 (8,000)	5.52 (60)
SuperCab F-150				
4.2L	3.08	4,077 (9,000)	2,086 (4,600)	5.52 (60)
4.2L	3.08	4,530 (10,000)	2,540 (5,600)	5.52 (60)
4.6L	3.55	4,530 (10,000)	2,491 (5,500)	5.52 (60)
4.6L	3.55	5,209 (11,500)	3,171 (7,000)	5.52 (60)
5.4L	3.08	4,983 (11,000)	2,857 (6,300)	5.52 (60)
5.4L	3.55	5,753 (12,700)	3,628 (8,000)	5.52 (60)

Trailer towing table (F-150 4x2 manual transmission)				
Engine	Rear axle ratio	Maximum GCWR kg (lb)	Maximum trailer weight kg (lb)	Maximum frontal area of trailer m ² (ft ²)
Regular Cab F-150				
4.2L	3.08	2,944 (6,500)	1,041 (2,300)	5.52 (60)
4.2L	3.55	3,533 (7,800)	1,630 (3,600)	5.52 (60)
4.6L	3.08	2,944 (6,500)	997 (2,200)	5.52 (60)

Driving

Trailer towing table (F-150 4x2 manual transmission)				
4.6L	3.55	3,533 (7,800)	1,587 (3,500)	5.52 (60)
SuperCab F-150				
4.2L	3.08	2,944 (6,500)	951 (2,100)	5.52 (60)
4.2L	3.55	3,533 (7,800)	1,540 (3,400)	5.52 (60)
4.6L	3.08	2,944 (6,500)	907 (2,000)	5.52 (60)
4.6L	3.55	3,533 (7,800)	1496 (3,300)	5.52 (60)

Trailer tow table (F-150 4x4 automatic transmission)				
Engine	Rear axle ratio	Maximum GCWR kg (lb)	Maximum trailer weight kg (lb)	Maximum frontal area of trailer m ² (ft ²)
Regular Cab F-150				
4.2L	3.08	4,077 (9,000)	1,995 (4,400)	5.52 (60)
4.2L	3.55	4,530 (10,000)	2,449 (5,400)	5.52 (60)
4.6L	3.08	4,530 (10,000)	2,404 (5,300)	5.52 (60)
4.6L	3.55	5,209 (11,500)	3,084 (6,800)	5.52 (60)
5.4L	3.08	4,983 (11,000)	2,721 (6,000)	5.52 (60)
5.4L	3.55	5,753 (12,700)	3,492 (7,700)	5.52 (60)
SuperCab F-150				
4.6L	3.08	4,530 (10,000)	2,313 (5,100)	5.52 (60)
4.6L	3.55	5,209 (11,500)	2,993 (6,600)	5.52 (60)
5.4L	3.08	4,983 (11,000)	2,721 (6,000)	5.52 (60)
5.4L	3.55	5,753 (12,700)	3,492 (7,700)	5.52 (60)

Trailer towing table (F-150 4x4 manual transmission)				
Engine	Rear axle ratio	Maximum GCWR kg (lb)	Maximum trailer weight kg (lb)	Maximum frontal area of trailer m ² (ft ²)
Regular Cab F-150				
4.2L	3.08	2,944 (6,500)	861 (1,900)	5.52 (60)

Driving

Trailer towing table (F-150 4x4 manual transmission)				
4.2L	3.55	3,533 (7,800)	1,451 (3,200)	5.52 (60)
4.6L	3.08	2,944 (6,500)	816 (1,800)	5.52 (60)
4.6L	3.55	3,533 (7,800)	1,406 (3,100)	5.52 (60)
SuperCab F-150				
4.6L	3.08	2,944 (6,500)	771 (1,700)	5.52 (60)
4.6L	3.55	3,533 (7,800)	1,360 (3,000)	5.52 (60)

Trailer towing table (F-250 4x2 automatic transmission)				
Engine	Rear axle ratio	Maximum GCWR kg (lb)	Maximum trailer weight kg (lb)	Maximum frontal area of trailer m ² (ft ²)
Regular Cab F-250				
4.6L	3.31	4,756 (10,500)	2,630 (5,800)	5.52 (60)
4.6L	3.73	5,436 (12,000)	3,311 (7,300)	5.52 (60)
5.4L	3.31	5,436 (12,000)	3,265 (7,200)	5.52 (60)
5.4L	3.73	6,115 (13,500)	3,946 (8,600)	5.52 (60)
SuperCab F-250				
4.6L	3.31	4,756 (10,500)	2,585 (5,700)	5.52 (60)
4.6L	3.73	5,436 (12,000)	3,265 (7,200)	5.52 (60)
5.4L	3.31	5,436 (12,000)	3,220 (7,100)	5.52 (60)
5.4L	3.73	6,115 (13,500)	3,900 (8,600)	5.52 (60)

Trailer towing table (F-250 4x2 manual transmission)				
Engine	Rear axle ratio	Maximum GCWR kg (lb)	Maximum trailer weight kg (lb)	Maximum frontal area of trailer m ² (ft ²)
Regular Cab F-250				
4.6L	3.31	3,261 (7,200)	1,179 (2,600)	5.52 (60)
4.6L	3.73	3,533 (7,800)	1,451 (3,200)	5.52 (60)
SuperCab F-250				

Driving

Trailer towing table (F-250 4x2 manual transmission)				
4.6L	3.31	3,261 (7,200)	1,133 (2,500)	5.52 (60)
4.6L	3.73	3,533 (7,800)	1,406 (3,100)	5.52 (60)

Trailer towing table (F-250 4x4 automatic transmission)				
Engine	Rear axle ratio	Maximum GCWR kg (lb)	Maximum trailer weight kg (lb)	Maximum frontal area of trailer m ² (ft ²)
Regular Cab F-250				
4.6L	3.31	4,756 (10,500)	2,449 (5,400)	5.52 (60)
4.6L	3.73	5,436 (12,000)	3,129 (6,900)	5.52 (60)
5.4L	3.31	5,436 (12,000)	3,084 (6,800)	5.52 (60)
5.4L	3.73	6,115 (13,500)	3,764 (8,300)	5.52 (60)
SuperCab F-250				
4.6L	3.31	4,756 (10,500)	2,449 (5,400)	5.52 (60)
4.6L	3.73	5,436 (12,000)	3,129 (6,900)	5.52 (60)
5.4L	3.31	5,436 (12,000)	3,084 (6,800)	5.52 (60)
5.4L	3.73	6,115 (13,500)	3,764 (8,300)	5.52 (60)

Trailer towing table (F-250 4x4 manual transmission)				
Engine	Rear axle ratio	Maximum GCWR kg (lb)	Maximum trailer weight kg (lb)	Maximum frontal area of trailer m ² (ft ²)
Regular Cab F-250				
4.6L	3.31	3,261 (7,200)	952 (2,100)	5.52 (60)

Driving

Trailer towing table (F-250 4x4 manual transmission)				
4.6L	3.73	3,533 (7,800)	1,224 (2,700)	5.52 (60)
SuperCab F-250				
4.6L	3.31	3,261 (7,200)	952 (2,100)	5.52 (60)
4.6L	3.73	3,533 (7,800)	1,224 (2,700)	5.52 (60)

TOWING A TRAILER

Your vehicle may tow a class I, II or III trailer provided the maximum trailer weight is less than or equal to the maximum trailer weight listed for your engine and rear axle ratio on the above charts.

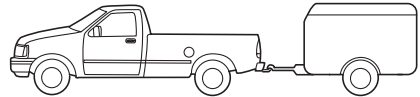

Your vehicle's load capacity is designated by weight, not by volume, so you cannot necessarily use all available space when loading a vehicle.

Towing a trailer places an additional load on your vehicle's engine, transmission, axle, brakes, tires and suspension. Inspect these components carefully after any towing operation.

Driving



Do not exceed the GVWR or the GAWR specified on the Safety Compliance Certification Label.



Towing trailers beyond the maximum recommended gross trailer weight could result in engine damage, transmission/axle damage, structural damage, loss of control, and personal injury.

Preparing to tow

Use the proper equipment for towing a trailer, and make sure it is properly attached to your vehicle. See your dealer or a reliable trailer dealer if you require assistance.

Hitches

Do not use or install hitches that:

- clamp onto the vehicle bumper
- attach to the axle.

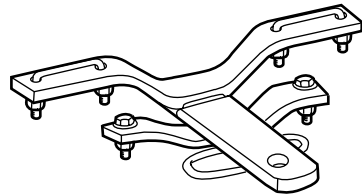

Underbody hitches are acceptable if installed properly.

Distribute the load so that only 10 to 15% of the total is on the tongue. Tie down the load so that it does not shift and change the weight on the hitch.

Using a load-equalizing hitch

When hooking up a trailer using a load-equalizing hitch, always use the following procedure.

1. Park the unloaded vehicle on a level surface. With the ignition on and all doors closed, allow the vehicle to stand for several minutes so that it can level.
2. Turn the air suspension switch to OFF (if equipped).
3. Measure the height of a reference point on the front and rear bumpers at the center of the vehicle.
4. Attach the trailer to the vehicle and adjust the hitch equalizers so that the front bumper height is 0–13 mm (0.5 in). After proper adjustment, the rear bumper should be no higher than in step 3.
5. Turn on the air suspension switch.



Adjusting an equalizing hitch so the rear bumper of the vehicle is lower or higher than it was unloaded will defeat the function of the load equalizing hitch and may cause unpredictable handling.

Step bumper (if equipped)

Step bumpers have a built-in hitch and only require a ball with a 2.5 cm (1 in.) shank diameter. Step bumpers have a Class III capability (2,270 kg [5,000 lb] trailer weight and 91 kg [200 lb] tongue weight).

Driving

If it is necessary to relocate the trailer hitch ball position, a frame-mounted trailer hitch must be installed.

Safety chains

Always use safety chains between your vehicle and trailer. Cross chains under the trailer tongue and allow slack for turning corners. Connect safety chains to the vehicle frame or hook retainers. Never attach chains to the bumper.

Trailer brakes

Trailer brakes are required on most towed vehicles weighing over 680 kg (1,500 lbs).



Do not connect a trailer's hydraulic brake system directly to your vehicle's brake system. Your vehicle may not have enough braking power and your chances of having a collision greatly increase.

Trailer lamps

Trailer lamps are required on most towed vehicles. Make sure your trailer lamps conform to Federal and local regulations. See your dealer or trailer rental agency for the proper instructions and equipment for hooking up trailer lamps.

Driving while you tow

Do not drive faster than 88 km/h (55 mph) while towing a trailer. Do not drive faster than 72 km/h (45

mph) with a trailer while towing in hilly country or on hot days.

Speed control may shut off if you are towing on very long, steep grades.

When towing a trailer

If equipped with an automatic transmission, use D (Drive) rather than  (Overdrive) while towing up or down steep hills. This will eliminate excessive downshifting and upshifting for optimum fuel economy and transmission cooling.

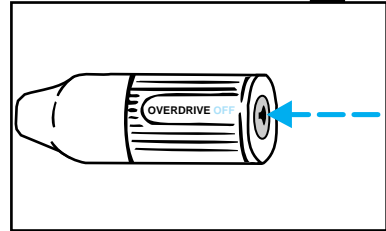
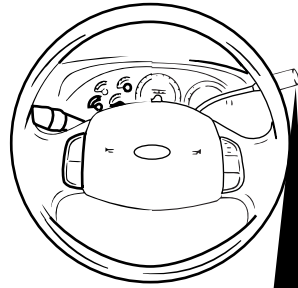

If equipped with a manual transmission, use 4 (Fourth) rather than  (Overdrive).

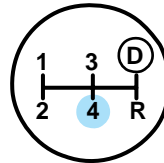

- Anticipate stops and brake gradually.

Driving

- Allow more room for stopping with a trailer attached.
- Practice turning, stopping and backing in an area before starting on a trip to get the feel of the vehicle/trailer combination.
- When turning, drive slightly beyond the normal turning point so the trailer wheels will clear curbs and other obstacles.
- When stopped in traffic for long periods of time in hot weather, place the automatic transmission gearshift in P (Park) to increase idle speed. This aids engine cooling and air conditioner efficiency.
- Vehicles with trailers should not be parked on a grade. If you must park on a grade, place wheel chocks under the trailer's wheels.
- After you have travelled about 80 km (50 miles), thoroughly check your hitch, electrical connections and trailer wheel lug nuts.

Launching or retrieving a boat

When backing down a ramp during boat launching or retrieval,

- Do not allow the static water level to rise above the bottom edge of the rear bumper and
- Do not allow waves to break higher than 15 cm (six inches) above the bottom edge of the rear bumper.

Exceeding these limits may allow water to enter critical vehicle components, adversely affecting driveability, emissions and reliability.

Servicing when towing

If you tow a trailer for long distances, your vehicle will require more frequent service intervals. Refer to the “Service Guide” for more information.

SNOWPLOWING

Ford recommends the following specifications for low speed, personal use snow removal:

- F-150 4WD long wheelbase or F-250 4WD Regular Cab
- 4.6L or 5.4L engine
- Super engine cooling
- Heavy duty front suspension package
- Automatic transmission with auxiliary automatic transmission fluid cooling
- All-terrain tires

Do not install a snowplow and plow with your vehicle until it has been driven at least 800 km (500 miles).

Installing snowplow

Read the following instructions before installing a snowplow:

- Front GAWR must not exceed 63% of the GVW. Add ballast weight to the back of the

Driving

vehicle, if necessary. Refer to the Safety Compliance Certification Label to find Front GAWR.

- The Front Axle Accessory Reserve Capacity and the Total Accessory Reserve Capacity listed on the bottom right of the Safety Compliance Certification Label will determine whether or not the addition of a snowplow will overload your vehicle.
- The weight of the snowplow and supporting components distributed to the front axle must not exceed the front accessory reserve capacity.
- The total weight of the snowplow and aftermarket equipment must not exceed the Total Accessory Reserve Capacity.
- The weight of the installed snowplow and aftermarket equipment must not load the vehicle beyond the GAWR and GVWR listed on the Safety Compliance Certification Label.
- Federal and most local regulations require additional exterior lamps for snowplow-equipped vehicles. Consult your dealer for additional information.
- After installing a snowplow to the vehicle, ensure the vehicle's front toe alignment and front ride height are within specification (reset if required).

These specifications are located in the vehicle's Service Manual. Adherence to the toe and ride height specification is important for proper tire wear, ride, handling and headlight aim.



Do not exceed the GVWR or the GAWR specified on the Safety Compliance Certification Label.

Removing snowplow

Read the following instructions before removing a snowplow:

- After removing a snowplow from the vehicle, ensure the vehicle's front toe alignment and front ride height are within specification (reset if required). These specifications are located in the vehicle's Service Manual. Adherence to the toe and ride height specification is important for proper tire wear, ride, handling and headlight aim.

Snowplowing with your air bag equipped vehicle

Your vehicle is equipped with driver and passenger air bags. The air bags are designed to deploy in a collision with a solid barrier at a range of 13 to 23 km/h (8 to 14 mph) or a parked car at a range of 25 to 45 km/h (16 to 28 mph).



Driving

Careless or high speed driving while plowing snow which results in vehicle decelerations equivalent to or greater than the air bag deployment impact speeds listed above can deploy the air bag. Such driving also increases the risk of accidents.



All occupants of the vehicle, including the driver, should always wear their safety belts.

Never remove or defeat the “tripping mechanisms” designed into the snow removal equipment by its manufacturer. Doing so may cause damage to the vehicle and the snow removal equipment as well as possible air bag deployment.



Do not attempt to service, repair, or modify the Air Bag Supplemental Restraint System or its fuses. See your Ford or Lincoln-Mercury dealer.

Engine temperature while plowing

When driving with a plow, your engine may run at a higher temperature than normal because the attached snowplow blade will restrict airflow to the radiator.

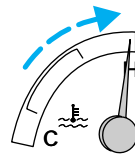

If you are driving more than 24 km (15 miles) at temperatures above freezing, angle the plow blade either full left or full right to provide maximum airflow to the radiator.

If you are driving less than 24 km (15 miles) at speeds up to 64 km/h (40 mph) in cold weather, you will not need to worry about blade position to provide maximum airflow.

Transmission operation while plowing

- Shift transfer case to 4L (4WD Low) when plowing in small areas at speeds below 8 km/h (5 mph).
- Shift transfer case to 4H (4WD High) when plowing larger areas or light snow at higher speeds. Do not exceed 24 km/h (15 mph).
- Do not shift the transmission from a forward gear to R (Reverse) until the engine is at idle and the wheels are stopped.
- If the vehicle is stuck, shift the transmission in a steady motion between forward and reverse gears. Do not rock the vehicle for more than a few minutes. The transmission and tires may be damaged or the engine can overheat.

Driving



Do not spin the wheels at over 35 mph (55 km/h). The tires may fail and injure a passenger or bystander.

FUEL CONSUMPTION

Fuel economy can be improved by avoiding:

- lack of regular, scheduled maintenance
- excessive speed
- rapid acceleration.

Roadside emergencies

HAZARD LIGHTS CONTROL

Use only in an emergency to warn traffic of vehicle breakdown, approaching danger, etc. Depress to activate all indicators simultaneously. Depress again to switch off. The warning lights can be operated when the ignition is off.

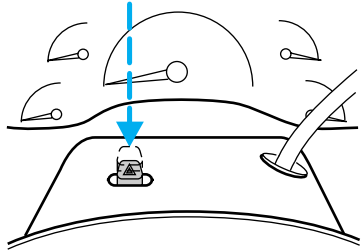

FUEL PUMP SHUT-OFF SWITCH

If the engine cranks but does not start after a collision, the fuel pump shut-off switch may have been activated. The shut-off switch is a device intended to stop the electric fuel pump when your vehicle has been involved in a substantial jolt.

1. Turn the ignition switch to the OFF position.
2. Check fuel system for leaks.
3. If no fuel leak is apparent, reset the fuel pump shut-off switch by pushing in the button on the switch.
4. Turn the ignition switch to the ON position. Pause for a few seconds and return the key to the OFF position.
5. Make a further check for leaks in the fuel system.

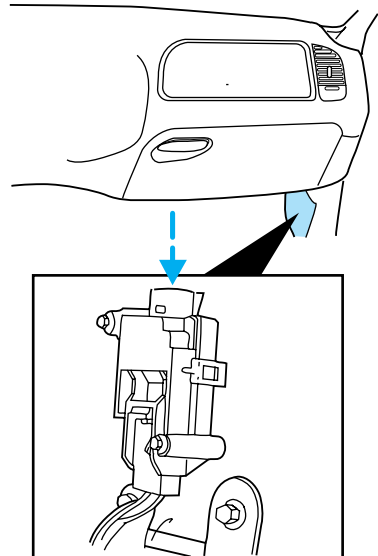

Roadside emergencies

REPLACING BLOWN FUSES

If electrical components in the vehicle are not working, a fuse may have blown. Blown fuses are identified by a broken element. Check the appropriate fuses before replacing any electrical components.

Even after a fuse is replaced, it may continue to blow if the cause of the overload is not identified and corrected. If a fuse continues to blow, have the vehicle's electrical system checked.

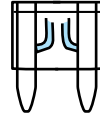
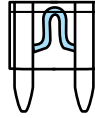

Standard fuse amperage ratings and colors

Fuse rating	Color
7.5 amp	Brown
10 amp	Red
15 amp	Blue
20 amp	Yellow
30 amp	Light green
30 amp fuse link	Pink
40 amp	Green
60 amp fuse link	Yellow
80 amp fuse link	Black
100 amp fuse link	Blue

Roadside emergencies

Instrument panel fuses



Always replace a fuse with one that has the specified amperage rating. Using a fuse with a higher amperage rating can cause severe wire damage and could start a fire.

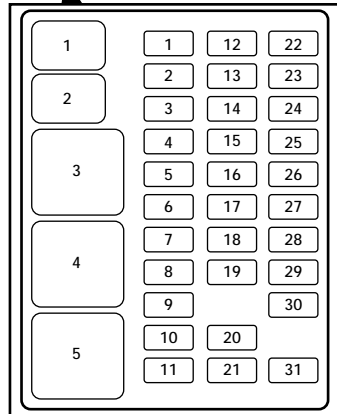
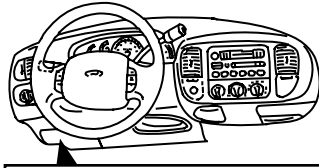

Position	Amps	Description
1	15	Stop/turn lamps and turn indicators
2	5	Instrument cluster
3	25	Cigarette lighter
4	5	Power mirrors, autolamp, remote anti-theft/keyless entry, headlamp relay and parking lamp relay
5	15	Speed control, daytime running lamps, climate control blend door, backup lamps, A/C clutch coil
6	5	Brake-shift interlock, generic electronic module (GEM)/central timer module (CTM) and air suspension module
7	-	Not used
8	5	Radio, remote anti-theft/keyless entry, GEM module/CTM module

Roadside emergencies

Position	Amps	Description
9	-	Not used
10	-	Not used
11	30	Wiper system
12	5	On-board diagnostic (OBD II) data link connector
13	15	Brake ON/OFF switch, rear anti-lock brake module and brake pressure switch
14	15	Interior lamps and accessory delay relay
15	5	GEM module/CTM module
16	20	High beam headlamps
17	-	Not used
18	5	Instrument illumination
19	10	Air bag diagnostic monitor, instrument cluster
20	5	GEM module/CTM module and powertrain control module (PCM)
21	15	Starter relay
22	10	Air bag diagnostic monitor and passenger air bag deactivate switch
23	10	4WD clutch relay, electronic flasher, 4WD/2WD vacuum solenoids and trailer tow battery charge relay
24	10	I/P blower relay
25	5	4WABS module and relay
26	10	Right low beam headlamp and DRL module
27	5	Foglamp relay
28	10	Left low beam headlamp
29	5	Autolamp, instrument cluster, transmission control indicator lamp and switch
30	30	Ignition coils and PCM relay
31	-	Not used

Roadside emergencies

Relays	
Position	Description
1	Interior lamps relay
2	Battery saver relay
3	Not used
4	One touch down relay
5	Accessory delay relay

Power distribution box

Lift cover towards left of vehicle to access the power distribution box.



Always disconnect the battery before servicing high current fuses.



Always replace the cover to the Power Distribution Box before reconnecting the battery or refilling fluid reservoirs.

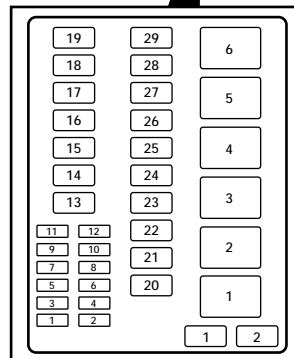
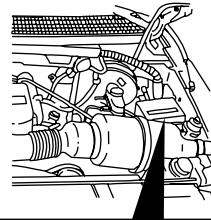

Fuses		
Position	Amps	Description
1	20	Trailer tow back-up and tail lamps
2	10	Air bag diagnostic monitor
3	15	Power locks
4	15	Air suspension
5	20	Horn
6	15	Audio system

Roadside emergencies

Fuses		
Position	Amps	Description
7	15	Parking and tail lamps
8	30	Headlamps
9	15	Daytime running lamps and fog lamps
10	25	Auxiliary power point
11	-	Not used
12	-	Not used
13	-	Not used
14	60/20	4WABS/rear anti-lock brake
15	50	Air suspension compressor
16	40	Trailer tow battery charge and stop/turn lamps
17	30	4WD transfer case shift motor and clutch
18	30	Driver power seat
19	20	Fuel pump
20	50	Instrument panel fuse panel ignition switch feed
21	50	Instrument panel fuse panel ignition switch feed
22	50	I/P fuse panel battery feed
23	40	I/P blower
24	30	PCM power
25	30	Power windows
26	-	Not used
27	-	Not used
28	30	Trailer tow electronic brake
29	-	Not used

Diodes	
Position	Description
1	Rear ABS diode
2	PCM diode

Roadside emergencies

Relays	
Position	Description
1	Windshield wipers HI/LO speed
2	Windshield wipers run/park relay
3	Washer pump relay
4	Fuel pump relay
5	Horn relay
6	PCM power relay

Primary battery fuses (megafuses)

Primary battery fuses are located under the PRIMARY BATTERY FUSE cover next to starter relay.

Ford recommends that megafuses only be serviced by a qualified service technician.

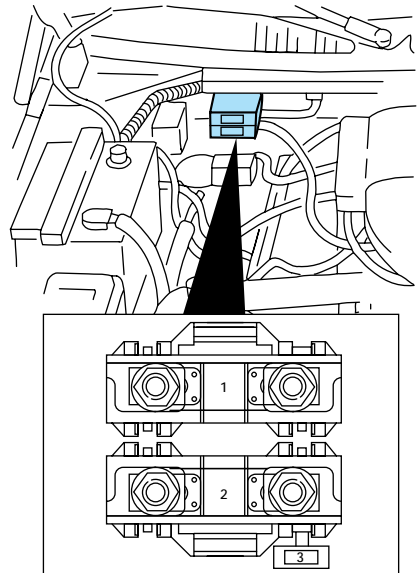

Location	Amperage	Description
1	175	Power network box megafuse
2	175	Alternator megafuse
3	20	Alternator field minifuse

Roadside emergencies

Engine minifuse panel

The minifuse panel is located behind the power distribution box.

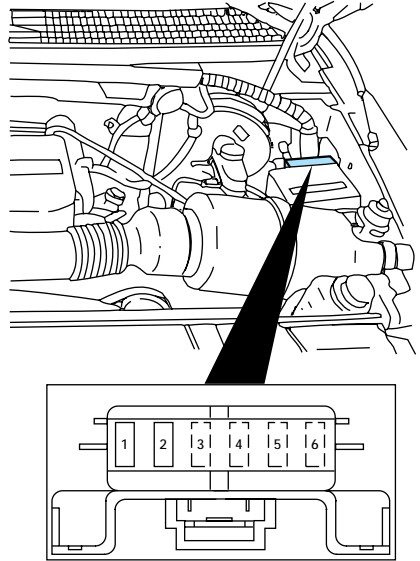

Location	Amperage	Description
1	5	Powertrain control module (PCM)
2	20	Trailer tow stop/turn lamps
3	-	Not used
4	-	Not used
5	-	Not used
6	-	Not used

CHANGING FLAT TIRES

If you get a flat tire while driving, do not apply the brakes heavily. Instead, gradually reduce the speed while holding the steering wheel firmly. Move the vehicle to a safe spot off to the side of the road.

Roadside emergencies

Tire change procedure

1. Park on a level surface.
2. Activate the hazard flashers.
3. Set the parking brake.
4. Place the gearshift in P (Park) (automatic transmission) or R (Reverse) (manual transmission).
For 4WD vehicles equipped with Lever-operated transfer case, make sure that the lever is not in the N (Neutral) position.
5. Block the diagonally opposite wheel.
6. Remove the jack and lug wrench from under the passenger seat.



On vehicles equipped with Air Suspension, turn OFF the Air Suspension switch prior to jacking, hoisting or towing your vehicle.



To avoid injury, never run the engine with one wheel off the ground, such as when changing a tire.

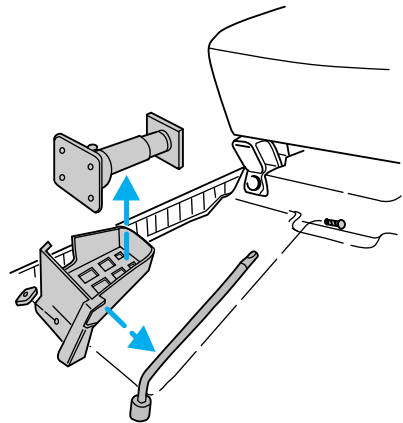

Roadside emergencies

Removing spare from storage

Your vehicle is equipped with a full-size spare tire. To remove the spare tire:

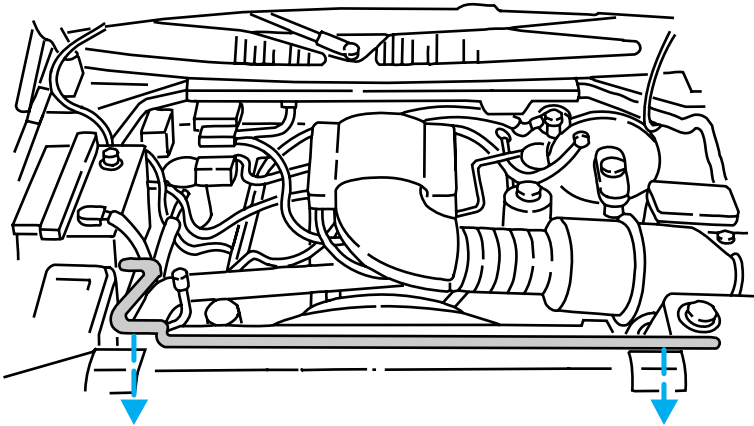
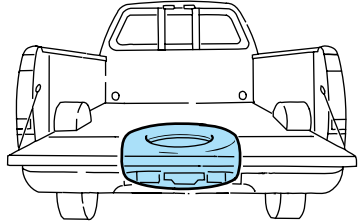

1. Carefully remove the jack handle from the retaining clips (above radiator in engine compartment).

Roadside emergencies

2. To lower the spare tire, insert the jack handle into the rear bumper opening and turn it counterclockwise.

Removing flat tire and installing spare

1. Use the tip of the lug wrench to remove the wheel ornament. Insert the lug wrench tip into the notch in the wheel ornament.

2. Loosen the wheel nuts with the lug wrench. Do not remove the lug nuts yet.

3. Position the jack as shown for your specific vehicle (4WD or 2WD). Use the thumbwheel to raise the jack to the desired height.

- Front (2WD)

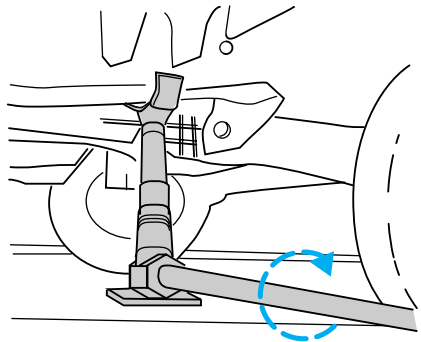
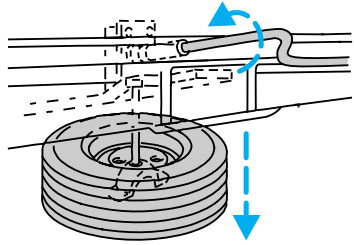

Roadside emergencies

- Front (4WD)

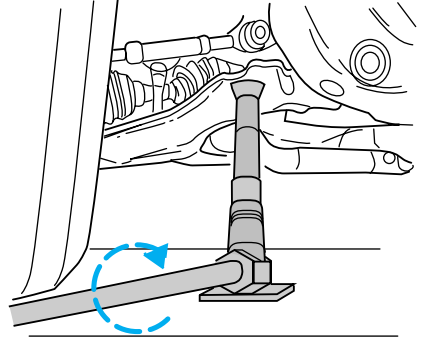

- Rear

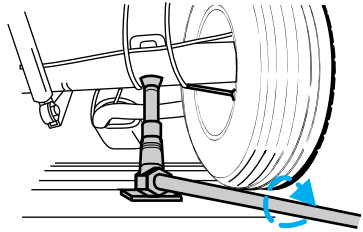

Never use the differential as a jacking point.

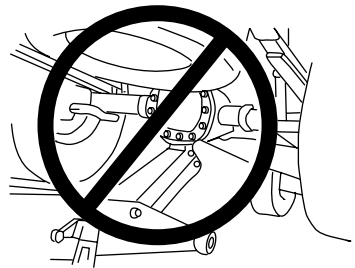

Roadside emergencies

4. Raise the vehicle high enough for the spare tire to clear the ground when installed.
5. Remove the wheel lug nuts.
6. Remove the flat tire and install the spare.
7. Install the lug nuts and tighten until the wheel is seated.



Installing wheels without a good metal-to-metal contact at the wheel mounting surface can cause the wheel lug nuts to loosen and could allow the wheel to come off while the vehicle is in motion.

If your vehicle is equipped with seven-lug hubs, use the following tightening pattern:

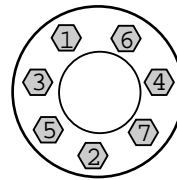

If your vehicle is equipped with five-lug hubs, use the following tightening pattern:

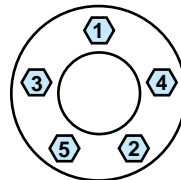

8. Position the wheel ornament on the wheel nuts and secure to the wheel.

Roadside emergencies

9. To stow the flat tire, lay the tire on the ground with the inboard side facing up. Install the retainer through the wheel center and slide the wheel under the vehicle. Turn the spare handle clockwise until the tire is raised to its original position underneath the vehicle. The spare handle ratchets when the tire is raised to the stowed position. It will not allow you to overtighten.
10. Unblock the wheel.
11. Stow the jacking equipment under the passenger seat and stow the jack handle in the engine compartment.
12. As soon as possible, tighten the wheel nuts with a torque wrench to 115–165 Nm (85–115 lb-ft).

JUMP STARTING YOUR VEHICLE



The gases around the battery can explode if exposed to flames, sparks, or lit cigarettes. An explosion could result in injury or vehicle damage.



Do not push-start your vehicle. You could damage the catalytic converter. For further information, see *Jumper Cables* in the Index.

Roadside emergencies



Batteries contain sulfuric acid which burns skin, eyes, and clothing.

CONNECTING THE JUMPER CABLES

1. Position the vehicles so that they do not touch one another.
2. Switch off the engine. Switch off any unnecessary electrical equipment.
3. Connect the positive (+) terminal of the discharged battery (1) to the positive (+) terminal of the booster battery (2).
4. Connect one end of the second lead to the negative (-) terminal of the booster battery (3) and the other end to a metal part of the engine to be started (4), not to the negative (-) terminal of the discharged battery.

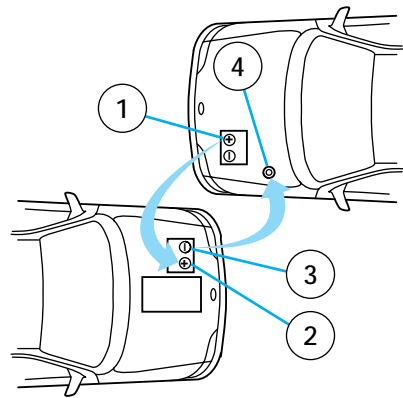

5. Make sure that the jump leads are clear of moving parts of the engine.



Do not connect the end of the second cable to the negative (-) terminal of the battery to be jumped. A spark may cause an explosion of the gases that surround the battery.

Roadside emergencies

JUMP STARTING

1. Start the booster vehicle and run the engine at moderately increased speed.
2. Start the engine of the vehicle with the discharged battery.
3. Once the engine has been started, run both vehicles for a further three minutes before disconnecting the leads.

REMOVING THE JUMPER CABLES

1. Remove the jumper cables in reverse order. Take the cable off the metallic surface (1) first, followed by the cable on the negative (-) booster battery terminal (2).
2. Remove the cable from the positive (+) terminal of the booster battery (3) and then the discharged battery (4).
3. After the disabled vehicle has been started, allow it to idle for a while so the engine can “relearn” its idle conditions.

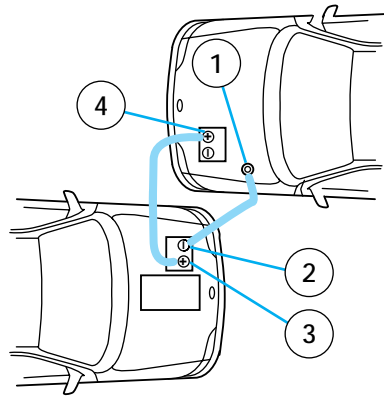

WRECKER TOWING

It is recommended that your vehicle be towed with wheel lift and dollies or flatbed equipment. Do not tow with slingbelt equipment. Ford Motor Company has not developed or approved a T-hook or slingbelt towing procedure.

Roadside emergencies

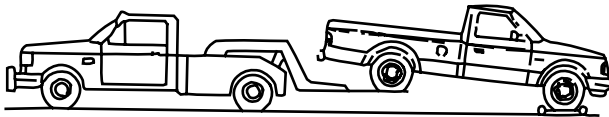
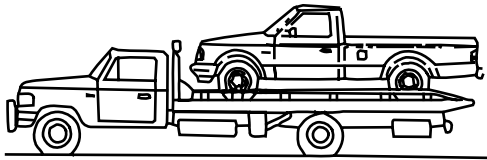
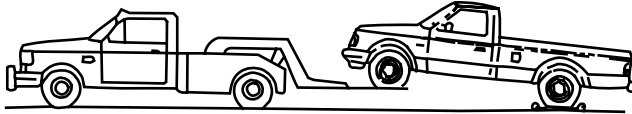

Ford recommends using one of the above methods for towing.

Recreational towing (all wheels on the ground)

Follow these guidelines for your specific powertrain combination to tow your vehicle with all four wheels on the ground (such as behind a recreational vehicle).

These guidelines are designed to ensure that your transmission is not damaged due to insufficient lubrication.

2WD (manual and automatic transmissions)

1. Place transmission in N (Neutral).

Roadside emergencies

2. Maximum speed is 56 km/h (35 mph).
3. Maximum distance is 80 km (50 miles).

If a distance of 80 km (50 miles) or a speed of 56 km/h (35 mph) must be exceeded, you must disconnect the rear driveshaft. With the rear driveshaft disconnected, the maximum speed is 88 km/h (55 mph) and there are no mileage restrictions.

See your dealer for help with disconnecting the driveshaft.

4WD – Lever operated transfer case (manual and automatic transmissions)

1. Place transmission in P (Park).
2. Shift the transfer case to N (Neutral).
3. Lockout the center disconnect by capping off one of the front axle vacuum motor lines. See your Ford dealer for assistance.
4. Vehicle speed should not exceed 88 km/h (55 mph) and there are no mileage restrictions.

4WD – Electronic shift transfer case

1. Place transmission in N (Neutral).
2. Shift the transfer case to 2H (2WD high).
3. Lockout the center disconnect by capping off one of the front axle vacuum motor lines. See your dealer for assistance.

Roadside emergencies

4. Maximum speed is 56 km/h (35 mph).

5. Maximum distance is 80 km (50 miles).

If a distance of 80 km (50 miles) or a speed of 56 km/h (35 mph) must be exceeded, you must disconnect the rear driveshaft.

With the rear driveshaft disconnected, the maximum speed is 88 km/h (55 mph) and there are no mileage restrictions.

See your dealer for help with disconnecting the driveshaft.

Maintenance and care

SERVICING YOUR VEHICLE

Service recommendations

To help you service your vehicle:

- We highlight do-it-yourself items in the engine compartment for easy location.
- As possible, we design parts that can be replaced without tools.
- We provide you with a “Service Guide” which makes tracking routine service for your vehicle easy.

If your vehicle requires professional service, your dealership can provide necessary parts and service. Check your “Warranty Information Booklet” to find out which parts and services are covered.

Use only recommended fuels, lubricants, fluids and service parts conforming to specifications. Motorcraft parts are designed and built to provide the best performance in your vehicle.

Precautions when servicing your vehicle

Be especially careful when inspecting or servicing your vehicle. Here are some general precautions for your safety:

- Do not work on a hot engine.
- If you must work with the engine running, avoid wearing loose clothing or jewelry that

Maintenance and care

could get caught in moving parts. Take precautions with long hair.

- Do not work on a vehicle with the engine running in an enclosed space, unless you are sure you have enough ventilation.
- Keep all lit cigarettes, open flames and other lit material away from the battery and all fuel related parts.

If you disconnect the battery, the engine must “relearn” its idle conditions before your vehicle will drive properly, as explained in *Battery* in this chapter.

Working with the engine off

- Automatic transmission
 1. Set the parking brake fully and ensure the gearshift is securely latched in P (Park).
 2. Turn off the engine and remove the key.
 3. Block the wheels to prevent the vehicle from moving unexpectedly.
- Manual transmission
 1. Set the parking brake, depress the clutch and place the gearshift in 1 (First).
 2. Turn off the engine and remove the key.
 3. Block the wheels to prevent the vehicle from moving unexpectedly.

Working with the engine on

- Automatic transmission

Maintenance and care

1. Set the parking brake fully and ensure the gearshift is securely latched in P (Park).
2. Block the wheels to prevent the vehicle from moving unexpectedly.



Do not start your engine with the air cleaner removed and do not remove it while the engine is running.

- Manual transmission

1. Set the parking brake, depress the clutch and place the gearshift in 1 (First).
2. Block the wheels to prevent the vehicle from moving unexpectedly.

Maintenance and care

Opening the hood

1. Inside the vehicle, pull the hood release handle located under the bottom left corner of the instrument panel.

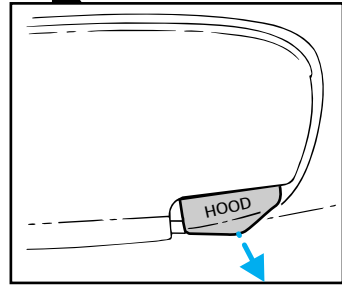
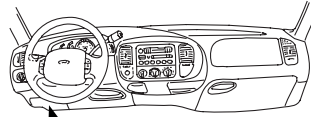

2. While applying downward pressure on the hood, push the hood latch handle located just left of the center of the hood.

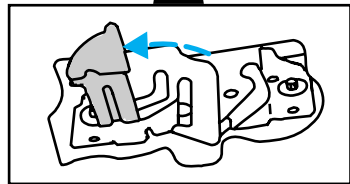
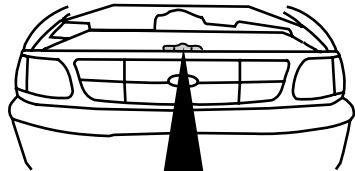

3. Lift the hood.

After closing the hood, try to lift it to be sure that it is closed securely.

Lubricate the hood latch every six months to ensure proper operation.

Maintenance and care

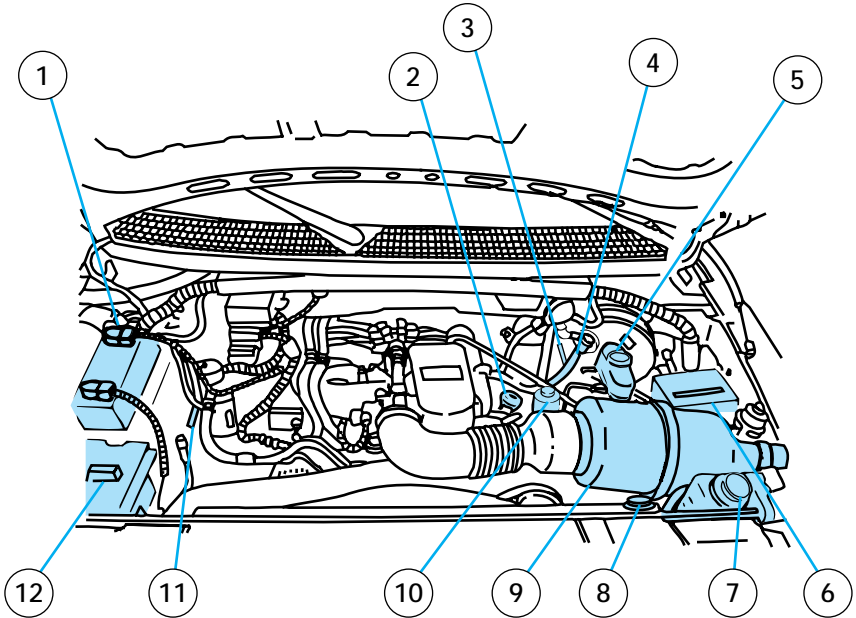

4.2L engine

1. Battery
2. Engine oil filler
3. Engine oil dipstick
4. Clutch fluid reservoir (if equipped)
5. Brake master cylinder
6. Power distribution box
7. Engine coolant recovery reservoir
8. Radiator cap
9. Air cleaner
10. Power steering fluid reservoir
11. Automatic transmission fluid dipstick (if equipped)

Maintenance and care

12. Windshield washer fluid reservoir

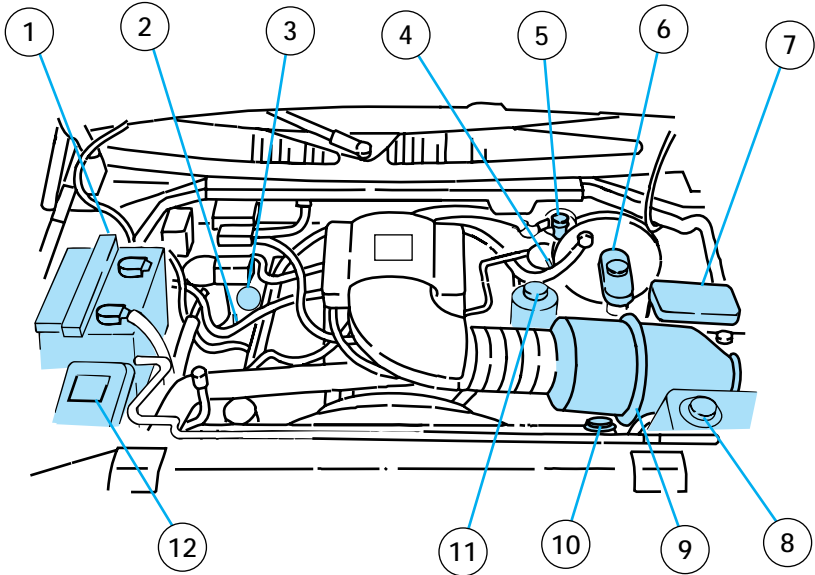

4.6/5.4L engine

1. Battery
2. Automatic transmission dipstick (if equipped)
3. Engine oil filler
4. Engine oil dipstick
5. Clutch fluid reservoir (if equipped)
6. Brake master cylinder
7. Power distribution box
8. Engine coolant recovery reservoir
9. Air cleaner
10. Radiator cap

Maintenance and care

11. Power steering fluid reservoir
12. Windshield washer fluid reservoir

ENGINE OIL

Oil specifications

Use WSS-M2C153-F motor oil CERTIFIED FOR GASOLINE ENGINES by the American Petroleum Institute.

Engine oils with an SAE 5W-30 viscosity and displaying the American Petroleum Institute certification mark are preferred for your vehicle. They provide the best engine performance, fuel economy and engine protection for all climates down to -25°C (-15°F).

Do not use:

- “non-detergent” oils
- oils labeled API SA, SB, SC, SD, SE, SF or SG
- additional engine oil additives, oil treatments or engine treatments

Additional engine oil additives, oil treatments, or engine treatments are never needed and could, under certain conditions, lead to engine damage which is not covered by your Ford warranty.

Synthetic engine oils which are CERTIFIED and of the preferred viscosity may be used in your engine. The engine oil and oil filter must still be changed according to the “Service Guide.”

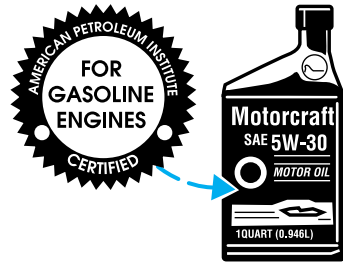

Maintenance and care

Oil filters

Ford production and aftermarket (Motorcraft) oil filters are designed for added engine protection and long life. If a replacement oil filter is used that does not meet Ford material and design specifications, startup engine noises or knock may be experienced. It is recommended that you use the appropriate Motorcraft oil filter (or another brand meeting Ford specifications) for your engine application.

Checking engine oil

Check the engine oil each time you fuel your vehicle.

Check the engine oil level more frequently if the vehicle is carrying a heavy load, towing a trailer, idling for extended periods (like police, taxi or shuttle service vehicles) or driven at high speeds for extended periods of time.

To check the oil:

1. Make sure the vehicle is on level ground. If the engine is warm, turn the engine off and wait a few minutes for the oil to drain into the oil pan.
2. Set the parking brake and ensure the gearshift is latched in P (Park) (automatic transmission) or 1 (First) (manual transmission).
3. Open the hood. Protect yourself from engine heat.
4. Locate and carefully remove the

Maintenance and care

engine oil dipstick (4.2L and 4.6L/5.4L engines shown).

- 4.2L engine

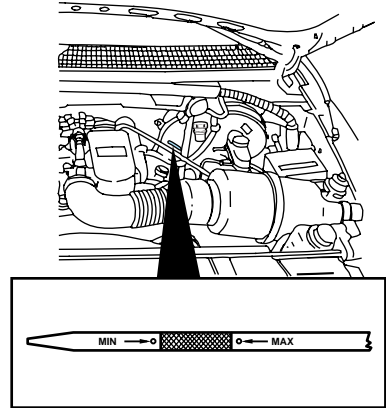

- 4.6L/5.4L engine

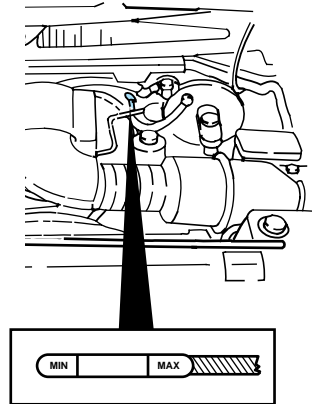

5. Wipe the dipstick clean. Insert the dipstick fully, then remove it again. The oil level should be in the range shown on the dipstick.

6. If the oil level is below the minimum line, add engine oil as necessary. If the oil level is below the MIN line, add engine oil as necessary. If the oil level is above

Maintenance and care

the MAX line, engine damage or high oil consumption may occur and some oil must be removed from the engine by a service technician.

7. Put the dipstick back in and ensure it is fully seated.

Adding engine oil

1. Check the engine oil.
2. If the oil level is below the MIN line, then add engine oil.
3. Remove the yellow oil filler cap.
4. Use a funnel to add oil through the opening.

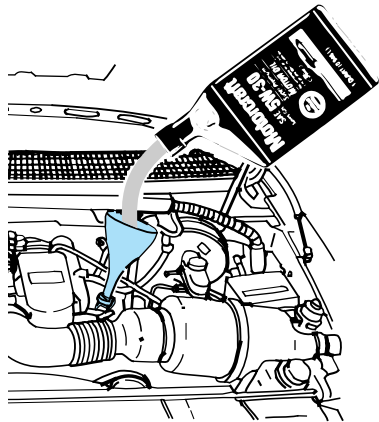

Make sure you use a certified engine oil of the preferred viscosity.

5. Recheck the oil level. Make sure that the oil level is not above the MAX line on the dipstick.



Continuous contact with **used** motor oil has caused cancer in laboratory mice.

Maintenance and care

BRAKE FLUID

CHECKING AND ADDING BRAKE FLUID

Brake fluid should be checked and refilled as needed at least once each year:

- Clean the reservoir cap before removal to prevent dirt or water from entering the reservoir.
- Visually inspect the fluid level.
- If necessary, add brake fluid until the level reaches MAX. Do not fill above this line.
- Use only a DOT 3 brake fluid certified to meet Ford specifications. Refer to *Lubricant specifications* in the *Capacities and specifications* chapter.

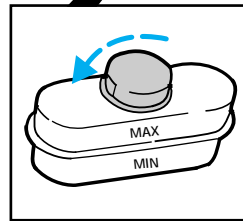
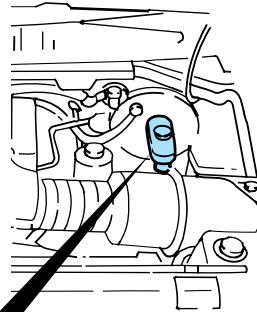

Brake fluid is toxic.



If you use a brake fluid that is not DOT 3, you will cause permanent damage to your brakes.

Maintenance and care



Do not let the reservoir for the master cylinder run dry. This may cause the brakes to fail.

CHECKING AND ADDING CLUTCH FLUID (IF EQUIPPED)

During normal operation, the fluid level in the clutch reservoir will slowly rise. If the fluid level drops, maintain the fluid level at the step in the reservoir.

Use only a DOT 3 brake fluid designed to meet Ford specifications. Refer to *Capacities and specifications*.

1. Clean the reservoir cap before removal to prevent dirt and water from entering the reservoir.
2. Remove cap.
3. Add fluid until the level reaches the FULL line.

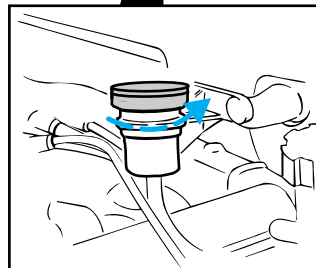
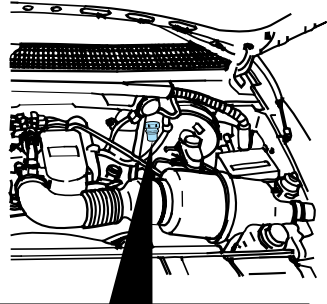

Maintenance and care

CHECKING AND ADDING WINDSHIELD WASHER FLUID

1. Lift the washer fluid reservoir cover.
2. Add washer fluid until the level reaches the FULL line.

Use only fluid that meets Ford Specifications. Refer to *Capacities and specifications*.

The addition of a bug shield to the front of the vehicle may adversely affect the washer system from delivering fluid to the windshield. Devices such as bug shields are not recommended.



Windshield washer fluid contains methanol and it is poisonous. Follow all instructions on the bottle of washer fluid.

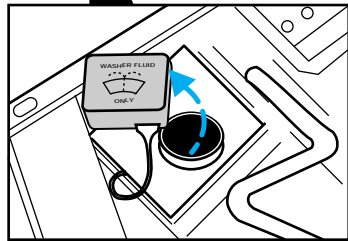
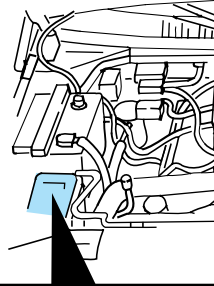

What you should know about washer fluid

In freezing weather [temperatures below 0°C (32°F)], use washer fluid containing a small amount of antifreeze, such as methanol. State or local regulations on volatile organic compounds (VOCs) may restrict the use of methanol, a common type of antifreeze.

Use a non-methanol antifreeze in freezing weather only if the fluid does not damage the paint finish, wiper blades and washer system.

Maintenance and care

CHECKING AND ADDING ENGINE COOLANT

Adding engine coolant



Do not put engine coolant in the container for the windshield washer fluid.

If sprayed on the windshield, engine coolant could make it difficult to see through the windshield.

When the engine is cool, add a 50/50 mixture of engine coolant and water to the engine coolant recovery reservoir – **DO NOT ADD DIRECTLY TO THE RADIATOR.** Add straight water only in an emergency, but you should replace it with a 50/50 mixture of coolant and distilled water as soon as possible.

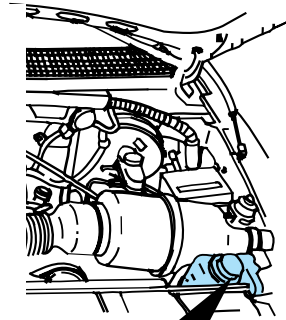

Check the coolant level in the coolant recovery reservoir the next few times you drive the vehicle. If necessary, add enough of a 50/50 mixture of coolant and water to bring the liquid level to the fill line on the reservoir.



Never remove the coolant recovery cap while the engine is running or hot.

Maintenance and care

If you must remove the coolant recovery cap, follow these steps to avoid personal injury:

1. Before you remove the cap, turn the engine off and let it cool.
2. When the engine is cool, wrap a thick cloth around the cap. Slowly turn cap counterclockwise to the first stop.
3. Step back while the pressure releases.
4. When you are sure that all the pressure has been released, use the cloth to press the cap down, turn it counterclockwise and remove it.

Use Ford Premium Cooling System Fluid E2FZ-19549-AA (in Canada, Motorcraft CXC-8-B) or an equivalent premium engine coolant that meets Ford Specification ESE-M97B44-A. Ford Premium Engine Coolant is an optimized formula that will protect all metals and rubber elastomers used in Ford cooling systems for 4 years or 80,000 km (50,000 miles).

Do not use alcohol or methanol antifreeze or any engine coolants mixed with alcohol or methanol antifreeze. Do not use supplemental coolant additives in your vehicle. These additives may harm your engine cooling system. The use of an improper coolant may void the warranty of your vehicle's engine cooling system.

Recycled engine coolant

Ford Motor Company recommends that Ford and Lincoln-Mercury dealers use recycled engine coolant produced by Ford-approved processes. Not all coolant recycling processes produce coolant which meets Ford specification ESE-M97B44-A, and use of such coolant may harm engine and cooling system components.



Always dispose of used automotive fluids in a responsible manner. Follow your community's regulations and standards for recycling and disposing of automotive fluids.

Coolant refill capacity

To find out how much fluid your vehicle's cooling system can hold, refer to *Refill capacities* in the *Capacities and specifications* chapter.

Have your dealer check the engine cooling system for leaks if you have to add more than a liter (quart) of engine coolant per month.

Severe winter climate

If you drive in extremely cold climates [less than 36°C (34°F)], it may be necessary to increase the coolant concentration above 50%. Refer to the chart on the coolant container to ensure the coolant concentration in your vehicle is such that the coolant will not

Maintenance and care

freeze at the temperature level in which you drive during winter months. Never increase the engine coolant concentration above 60%. Leave a 50/50 mixture of engine coolant and water in your vehicle year-round in non-extreme climates.

Checking the cooling system hoses

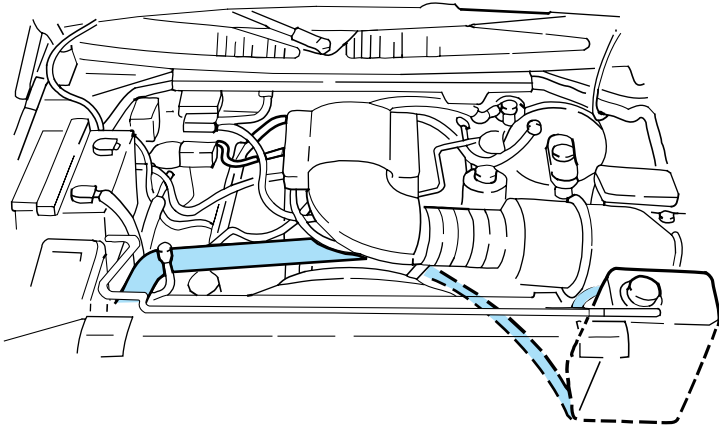

Inspect all engine and heater system hoses and hose connections for:

- deterioration
- leaks
- loose hose clamps

What you should know about fail-safe cooling (if equipped)

Vehicles equipped with 4.6L or 5.4L engines have a fail-safe

Maintenance and care

cooling mode. If the engine coolant supply is depleted, this feature allows the driver to drive the vehicle (with limited power) for a short distance in order to get the vehicle to a service facility. Take your vehicle to a service facility as soon as possible to minimize engine damage.

The actual distance your vehicle can be driven depends on vehicle load, road conditions and outside temperature.

How fail-safe cooling works

If the engine overheats, the engine will automatically switch from eight to alternating four cylinder operation. Each disabled cylinder acts as an air pump and cools the engine.

When this occurs, the engine coolant temperature gauge will move into the red area and the  light illuminates.

The **CHECK ENGINE** light will illuminate, indicating that vehicle service is required.

The vehicle will still operate, but will have limited engine power and no air conditioning capability.

Continued operation will increase engine temperature and cause the engine to completely shut down. The vehicle will coast to a stop.

As the engine temperature cools, the engine may be re-started. Take your vehicle to a service facility as

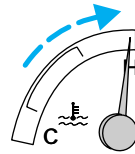

Maintenance and care

soon as possible to minimize engine damage.

When fail-safe mode is activated

- Pull off the road as soon as possible.
- Immediately turn the engine off to prevent severe engine damage.
- Wait for the engine to cool.
- Check the coolant level.

CHECKING AND ADDING POWER STEERING FLUID

Check the power steering fluid level at least twice a year.

1. Start the engine.

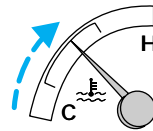

Maintenance and care

2. When the engine coolant temperature gauge reaches the normal zone, turn the engine off.

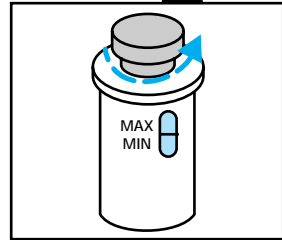
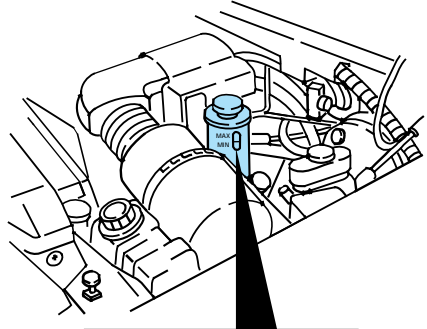

3. Visually inspect the fluid level in the power steering fluid reservoir.

4. Add power steering fluid until the fluid level reaches MAX.

Use only fluid that meets Ford specifications. Refer to *Capacities and specifications*.

CHECKING AND ADDING TRANSMISSION FLUID

Checking and adding automatic transmission fluid (if equipped)

Service the automatic transmission according to the scheduled intervals in the “Service Guide.”

Maintenance and care

Before adding any fluid, make sure the correct type will be used. This information is indicated on the dipstick.

Do not drive the vehicle if the fluid level is below the bottom hole on the blade type dipstick (4R70W transmission) or below the COLD area on the bullet type dipstick (E4OD transmission) and outside temperatures are above 10°C (50°F).

Your vehicle does not use up transmission fluid. However, it is recommended that you check the transmission fluid at least twice a year. The fluid level should be checked if the transmission is not working properly, i.e., if the transmission slips or shifts slowly or if you notice some sign of fluid leakage.

It is preferable to check the transmission fluid level at normal operating temperature, after approximately 32 km (20 miles) of driving. However, you can check the fluid level without driving to obtain a normal operating temperature if the outside temperature is above 10°C (50°F).

If your vehicle has been operated for an extended period at high speeds, in city traffic during hot weather or pulling a trailer, the vehicle should be turned off for about 30 minutes to allow the fluid to cool before checking.

Maintenance and care

1. Park the vehicle on a level surface.
 2. Start the engine and move the gearshift lever through all of the gear ranges. Allow sufficient time for each gear to engage.
 3. Latch the gearshift lever in P (Park), set the parking brake and leave the engine running.
 4. Remove the dipstick, wiping it clean with a clean, dry rag.
 5. Install the dipstick.
 6. Remove the dipstick and inspect the fluid level.
- For 4R70W transmissions, the fluid level should be within the crosshatched area, or if the vehicle has not been driven,

P R N  2 1

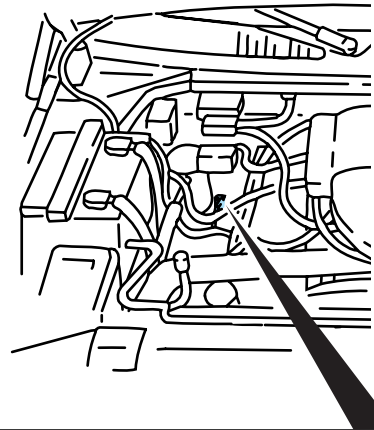

  DON'T ADD IF IN CROSSHATCHED AREA • CHECK WHEN HOT IDLING IN PARK

Maintenance and care

between the holes near the bottom of the indicator.

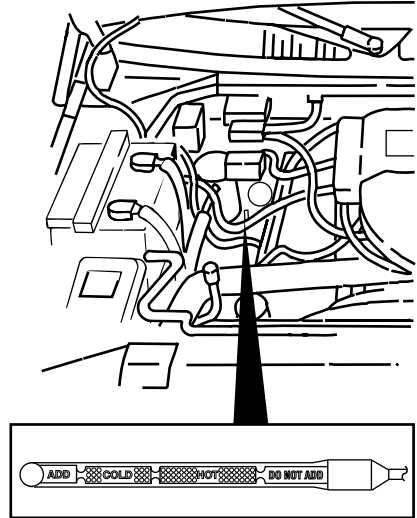

- For E4OD transmissions, the fluid level should be within the HOT area, or if the vehicle has not been driven, within the COLD area.
7. If necessary, add fluid in .25L (1/2 pint) increments through the filler tube until the level is at the correct area on the dipstick. If an overfill occurs, excess fluid should be removed by a qualified technician.

Maintenance and care

Checking and adding manual transmission fluid (if equipped)

1. Clean the filler plug.
2. Remove the filler plug and inspect the fluid level.

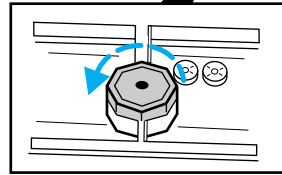
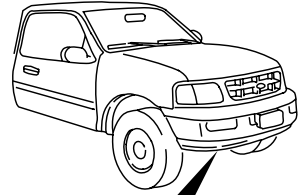

3. Fluid level should be at bottom of the opening.
4. Add only enough fluid through the filler opening so that the fluid level is 6 mm (3/8 in) from the bottom of the opening.

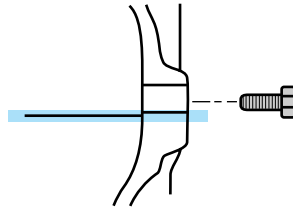

Use only fluid that meets Ford specifications. Refer to the *Capacities and specifications* chapter.

Maintenance and care

Checking and adding transfer case fluid

1. Clean the filler plug.
2. Remove the filler plug and inspect the fluid level.

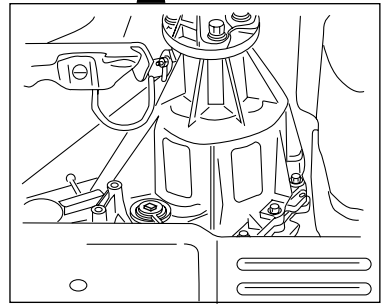
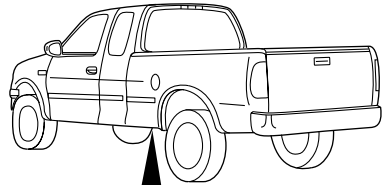

3. Add only enough fluid through the filler opening so that the fluid level is at the bottom of the opening.

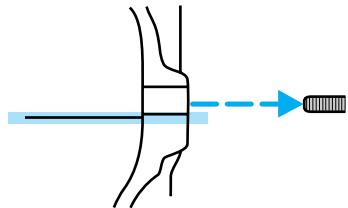

Use only fluid that meets Ford specifications. Refer to the *Capacities and specifications* chapter.

BATTERY

If the original equipment maintenance-free battery needs

Maintenance and care

replacing, it may be replaced with a low-maintenance battery. For information on replacement batteries, refer to *Motorcraft part numbers* in the *Capacities and specifications* chapter.

 The gases around the battery can explode if exposed to flames, sparks, or lit cigarettes. An explosion could result in injury or vehicle damage.

 Batteries contain sulfuric acid which burns skin, eyes, and clothing.

Servicing your battery

A low-maintenance replacement battery has removable vent caps for checking the electrolyte level and adding water. Check the electrolyte level every 24 months or 40,000 km (24,000 miles) in average temperatures below 32°C (90°F).

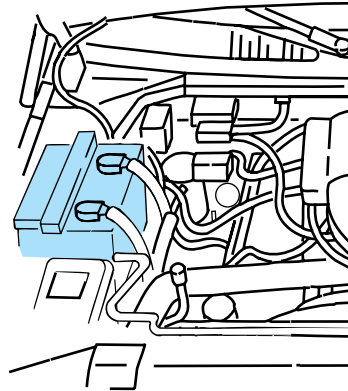

Keep the electrolyte level in each cell up to the level indicator. Do not overfill.

If the level gets low, refill the battery with distilled water. If the battery needs water quite often,

Maintenance and care

have the charging system checked for a possible malfunction.

Your vehicle is equipped with a battery saver feature designed to prevent your battery from accidental wear down due to doors left ajar. For information on this system, refer to the *Controls and features* chapter.

Relearning idle conditions

Because your vehicle's engine is electronically controlled by a computer, some control conditions are maintained by power from the battery. When the battery is disconnected or a new battery is installed, the computer must "relearn" its idle conditions before your vehicle will drive properly. To complete this process:

1. Put the gearshift in P (Park) (automatic transmission) or N (Neutral) (manual transmission).
2. Turn off all accessories, and start the engine.
3. Let the engine idle for at least one minute.
4. **The relearning process will automatically complete as you drive the vehicle.**

- If you do not allow the engine to relearn its idle, the idle quality of your vehicle may be adversely affected until the idle is eventually relearned.
- If the battery has been disconnected or a new battery has been installed, the clock and

Maintenance and care

preset radio stations must be reset once the battery is reconnected.

- Always dispose of used automotive batteries in a responsible manner. Follow your community's standards for disposal. Call your local recycling center to find out more about recycling automotive batteries.

CHANGING THE AIR FILTER

1. Loosen the clamp that secures the air cleaner in place.
2. Separate the two halves of the air cleaner.
3. Remove the air filter element from the open end of the engine air cleaner and replace it with a new element. Be careful not to crimp the filter edges between halves. This could cause filter damage if not properly seated.
4. Replace the two halves of the air cleaner and secure the clamp.

For information on replacement air filter elements, refer to the *Capacities and specifications* chapter.

REPLACING THE WIPER BLADES

If the windshield wiper blades do not work properly after cleaning, replacement of the blade element may be necessary.

To replace the windshield wiper blades:

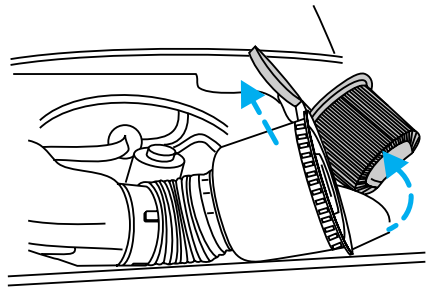

Maintenance and care

1. Pull the arm away from the windshield and lock it into the service position.
2. Turn the blade at an angle from the wiper arm. Depress lock tab and push wiper mounting arm away from wiper blade assembly.
3. Attach new wiper blade by pulling wiper mounting arm down on wiper blade until lock tab is engaged.

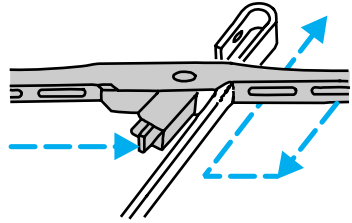

TIRES

Information about tire quality grades

New vehicles are fitted with tires that have their Tire Quality Grade (described below) molded into the tire's sidewall. These Tire Quality Grades are determined by standards that the United States Department of Transportation has set.

Tire Quality Grades apply to new pneumatic tires for use on passenger cars. They do not apply to deep tread, winter-type snow tires, space-saver or temporary use spare tires, tires with nominal rim diameters of 10 to 12 inches or limited production tires as defined in Title 49 Code of Federal Regulations Part 575.104(c) (2).

U.S. Department of Transportation-Tire quality grades: The U.S. Department of Transportation requires Ford to give you the following information

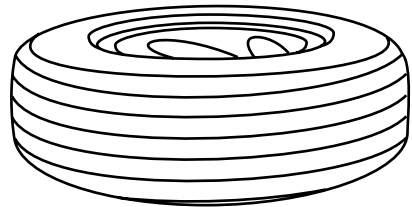

Maintenance and care

about tire grades exactly as the government has written it.

Treadwear

The treadwear grade is a comparative rating based on the wear rate of the tire when tested under controlled conditions on a specified government test course. For example, a tire grade 150 would wear one and one-half (1 1/2) times as well on the government course as a tire grade 100. The relative performance of tires depends upon the actual conditions of their use, however, and may depart significantly from the norm due to variations in driving habits, service practices, and differences in road characteristics and climate.

Traction A B C

The traction grades, from highest to lowest are A, B, and C, and they represent the tire's ability to stop on wet pavement as measured under test surfaces of asphalt and concrete. A tire marked C may have poor traction performance. Warning: The traction grade assigned to this tire is based on braking (straightahead) traction tests and does not include cornering (turning) traction.

Temperature A B C

The temperature grades are A (the highest), B, and C, representing the tire's resistance to the generation of heat and its ability to dissipate heat when tested under

Maintenance and care

controlled conditions on a specified indoor laboratory test wheel. Sustained high temperature can cause the material of the tire to degenerate and reduce tire life, and excessive temperature can lead to sudden tire failure. The grade C corresponds to a level of performance which all passenger car tires must meet under the Federal Motor Vehicle Safety Standard No. 109. Grades B and A represent higher levels of performance on the laboratory test wheel than the minimum required by law.



The temperature grade for this tire is established for a tire that is properly inflated and not overloaded. Excessive speed, underinflation, or excessive loading, either separately or in combination, can cause heat buildup and possible tire failure.

Servicing the tires

Checking the tire pressure

Check the tire pressure at least once a month or after rotating tires and inflate tires as necessary. Tire pressure is most accurate when tires are cold (after vehicle has been parked for at least one

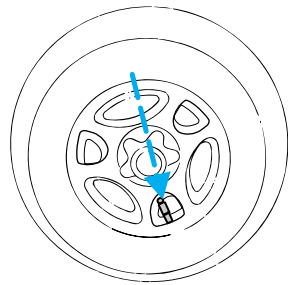

Maintenance and care

hour or driven less than 5 km [3 miles]).

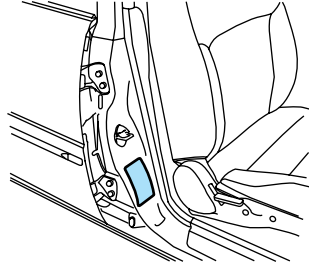

The cold pressure amount is listed on the Safety Compliance Certification Label located on the inside driver door latch pillar.



Improperly inflated tires can affect vehicle handling and can fail suddenly, possibly resulting in loss of vehicle control.

Rotating the tires

Rotate your tires at regular intervals to ensure even wear. Refer to the following diagrams for rotation cycles. Rotation intervals are listed in the “Service Guide.”

Your wheels and tires are match-mounted for improved ride. Before you begin a tire repair, mark the wheel and tire to ensure

Maintenance and care

proper alignment when remounting.

- Four-tire rotation

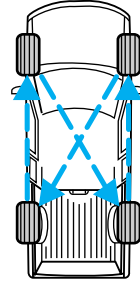

- Five-tire rotation

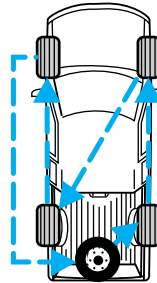

Replacing the tires

Replace the tires when the wear band is visible through the tire treads.



Maintenance and care



When replacing full size tires, never mix radial, bias-belted, or bias-type tires. Use only the tire sizes that are listed on the tire pressure decal. Make sure that all tires are the same size, speed rating, and load-carrying capacity. Use only the tire combinations recommended on the decal. If you do not follow these precautions, your vehicle may not drive properly and safely.



Make sure that all replacement tires are of the same size, type, load-carrying capacity and tread design (e.g., “All Terrain”, etc.), as originally offered by Ford.



Do not replace your tires with “high performance” tires or larger size tires.



Failure to follow these precautions may adversely affect the handling of the vehicle and make it easier to lose control and roll over.

Identifying tire types

Refer to the Safety Compliance Certification Label to determine the specific size tire and wheel Ford Motor Company recommends for use on this vehicle.

Maintenance and care

Snow tires and chains



Snow tires must be the same size and grade as the tires you currently have on your vehicle.

The tires on your vehicle have all weather treads to provide traction in rain and snow.

However, in some climates, you may need to use snow tires and chains.

Follow these guidelines when using snow tires and chains.

- Use only SAE Class “S” chains.
- Install chains securely, verifying that the chains do not touch any wiring, brake lines or fuel lines.
- 4x2: Install tire chains on rear tires (of all sizes) only.
- 4x4: Install tire chains on rear tires (of all sizes), and on front tires of size P235/70R16 only.
- Drive cautiously. If you hear the chains rub or bang against your vehicle, stop and retighten the chains. If this does not work, remove the chains to prevent damage to your vehicle.
- If possible, avoid fully loading your vehicle.
- Remove the tire chains when they are no longer needed. Do not use tire chains on dry roads.
- The suspension insulation and bumpers will help prevent vehicle damage. Do not remove

Maintenance and care

these components from your vehicle when using snow tires and chains.

FUEL

Important safety precautions



Do not overfill the fuel tank. The pressure in an overfilled tank may cause leakage and lead to fuel spray and fire.



If you do not use the proper fuel cap, the pressure in the fuel tank can damage the fuel system or cause it to work improperly in a collision.



The fuel system may be under pressure. If the fuel cap is venting vapor or if you hear a hissing sound, wait until it stops before completely removing the cap.



Automotive fuels can cause serious injury or death if misused or mishandled.

Maintenance and care

Observe the following guidelines when handling automotive fuel:

- Extinguish all smoking materials and any open flames before fueling your vehicle.
- Always turn off the vehicle before fueling.
- Automotive fuels can be harmful or fatal if swallowed. If fuel is swallowed, call a physician immediately, even if no symptoms are immediately apparent. The toxic affects of fuel may not be visible for hours.
- Fuels can also be harmful if absorbed through the skin. If fuel is splashed on the skin, promptly remove contaminated clothing and wash skin thoroughly with soap and water.
- If fuel is splashed in the eyes, remove contact lenses, flush with water for 15 minutes and seek medical attention.
- Be particularly careful if you are taking “Antabuse” or other forms of disulfiram for the treatment of alcoholism. Breathing gasoline vapors or skin contact could cause an adverse reaction. Consult a physician immediately.



Choosing the right fuel

Use only UNLEADED FUEL. The use of leaded fuel is prohibited by law and could damage your

Maintenance and care

vehicle. The damage may not be covered by your warranty.

Your vehicle was not designed to use fuel containing manganese-based additives such as MMT. Additionally, vehicles certified to California emission standards (indicated on the underhood Vehicle Emissions Control Information label) are designed to operate on California reformulated gasolines. If California reformulated gasoline is not available when you refuel, your vehicle can be operated on non-California fuels. However, even though your engine will perform adequately on other gasolines, the performance of the emission control devices and systems may be adversely affected. Repair of damage caused by using a fuel that your vehicle was not designed for may not be covered by your warranty.

Octane recommendations

Your vehicle is designed to use regular gasoline with an (R+M)/2 octane rating of 87. We do not recommend gasolines labeled as “regular” in high altitude areas that are sold with octane ratings of 86 or even less.

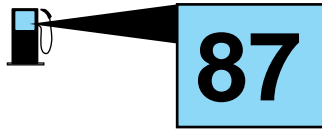

Do not be concerned if your vehicle sometimes knocks lightly. However, if it knocks heavily under most driving conditions on the recommended octane fuel, see

Maintenance and care

your dealer or a qualified service technician to prevent any engine damage.

Fuel quality

If you are experiencing starting, rough idle or hesitation problems try a different brand of fuel. If the condition persists, see your dealer or a qualified service technician.

The American Automobile Manufacturers Association (AAMA) issued a gasoline specification to provide information on high quality fuels that optimize the performance of your vehicle. We recommend the use of gasolines that meet the AAMA specification if they are available.

It should not be necessary to add any aftermarket products to your fuel tank if you continue to use a high-quality fuel.

Cleaner air

Ford approves the use of gasolines to improve air quality, including reformulated gasolines, that contain oxygenates such as a maximum of 10% ethanol or 15% MTBE. There should be no more than 5% methanol with cosolvents and additives to protect the fuel system.

Calculating fuel economy

To accurately calculate your vehicle's fuel economy:

1. Fill the tank completely and record the initial odometer reading.

Maintenance and care

2. Each time you fill the tank, record the amount of fuel added (in liters or gallons).
3. After at least three to five fuel tank fill-ups, fill the fuel tank and record the current mileage reading.
4. Use one of the following equations to calculate fuel economy.

Liters used \times 100 \div Total kilometers traveled = km/liter.

Total miles traveled \div Total gallons used = mpg.

5. Keep a record for at least one month. This will provide an accurate estimate of the vehicle's fuel economy.

Maintenance and care

WHAT YOU SHOULD KNOW ABOUT THE EMISSION CONTROL SYSTEM

Your vehicle is equipped with a catalytic converter which enables your vehicle to comply with applicable exhaust emission requirements. For more information on your vehicle's emission control system, see the Vehicle Emission Control Information decal located on the left side of the engine compartment.

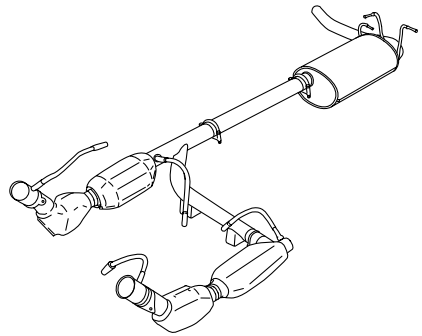

Follow these guidelines to ensure proper emission system operation:

- Use only unleaded fuel.
- Avoid running out of fuel.
- Do not turn off the ignition while the vehicle is in motion.
- Have regular maintenance checks performed according to the intervals in the "Service Guide."

When servicing your vehicle, never use a metal exhaust collector. A metal collector may melt or deform plastic parts.

Maintenance and care



Do not park, idle, or drive your vehicle in dry grass or other dry ground cover. The emission system heats up the engine compartment and exhaust system, which can start a fire.



If you smell exhaust fumes inside your vehicle, have your dealer inspect your vehicle immediately. Do not drive if you smell exhaust fumes.



On vehicles without original equipment floor covering or insulation, do not let passengers ride in your truck in a manner that allows contact between skin and the metal floor.

If you notice one or more of the following, the emissions system may not be working properly. Have your vehicle serviced as soon as possible.

- Fluid leaks
- The  or CHECK ENGINE lights illuminate in the instrument cluster and remain lit
- Strange odors
- Engine runs more than five seconds after shut-off or engine misfires, surges, stalls or backfires
- Loss of oil pressure.

Maintenance and care

Important emission control information

By law, anyone who manufactures, repairs, services, sells, leases, trades vehicles or supervises a fleet of vehicles is not permitted to intentionally remove an emission control device or prevent it from working.

Do not make any unauthorized changes to the vehicle or engine.

Changes that cause more unburned fuel to reach the exhaust system can increase the temperature of the engine or exhaust system.

Preparing your vehicle for inspection/maintenance testing

In some localities it may become a legal requirement to pass an Inspection/Maintenance test of the on-board diagnostic (OBDII) system. If the vehicle's powertrain system or battery has just been serviced, the OBD II system is reset to a "not ready for I/M testing condition." To ready the OBD II system for I/M testing, the law specifies that additional mixed city and highway driving is necessary to complete the check of the OBD II system.

The driving modes required to reach the ready condition consist of a minimum of 30 minutes of city and highway driving as described below:

Maintenance and care

- 20 minutes of driving in stop and go city-type traffic with at least four idle periods.
- 10 minutes of driving on an expressway or highway.

Before completing the above driving modes, the engine must be warmed up and at operating temperature. Once started, the vehicle must not be turned off during the above driving modes.

Maintenance and care

REPLACING BULBS

Replacing exterior bulbs

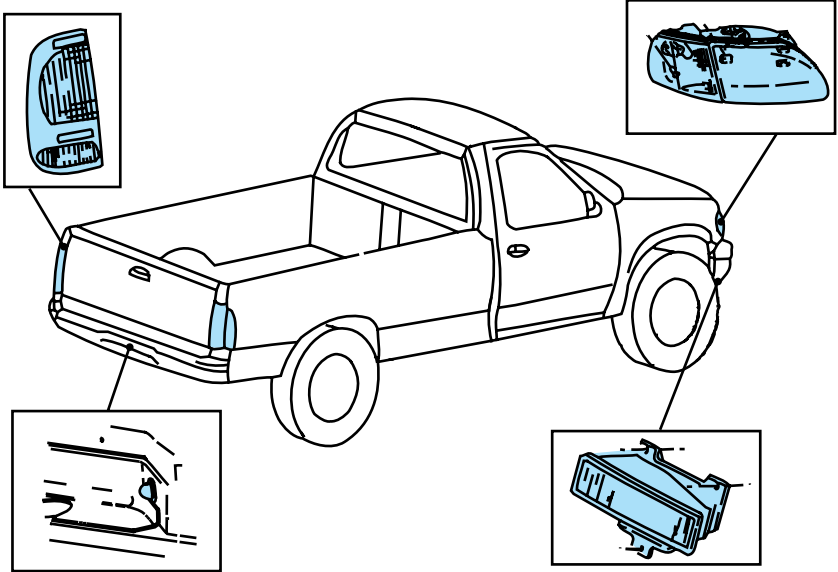

It is a good idea to check the operation of the following lamps frequently:

- Headlamps
- Tail lamps
- Brakelamps
- High-mount brakelamp
- Backup lamps
- Hazard flashers
- Turn signals
- License plate lamp
- Fog lamps
- Interior overhead lamps

Maintenance and care

Do not remove lamp bulbs unless they will be replaced immediately. If a bulb is removed for an extended period of time, contaminants may enter the lamp and affect performance.

Replacing headlamp bulbs



Handle a halogen headlamp bulb carefully and keep out of children's reach. Grasp the bulb only by its plastic base and do not touch the glass. The oil from your hand could cause the bulb to break the next time the headlamps are operated.

1. Make sure that the headlamp control is in the position.
2. Open the hood.
3. At the back of the headlamp, pull clips rearward and up 19 mm (about 3/4 in.) to release the headlamp assembly.

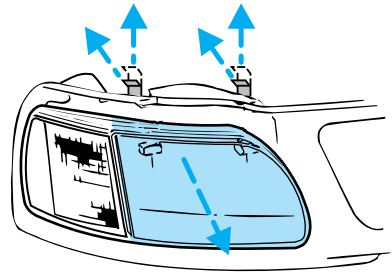

Maintenance and care

4. Slide headlamp assembly forward and off of guide ribs to expose the back of the bulb and wiring connector.

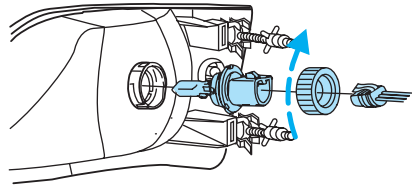

5. Remove the electrical connector from the bulb by grasping the wire and pulling it rearward.

6. Remove bulb retainer ring by turning it counterclockwise about 1/4 turn, then slide the ring off the plastic base.

7. Without turning, carefully pull bulb assembly out of headlamp assembly.

8. Insert the glass end of the new bulb into the headlamp assembly socket. When the grooves in the plastic base are aligned, push the bulb into the socket until the plastic base contacts the rear of the socket.

9. Slip bulb retaining ring over the plastic base and lock the ring into the socket by turning it clockwise until you feel a “stop.”

10. Push the electrical connector into the rear of the plastic base until it “snaps.”

Maintenance and care

11. Straighten alignment pins, making them parallel with the outer edges of the attachment standoff.
12. Carefully insert the headlamp assembly into the vehicle making sure the alignment pins are inserted into the proper holes and into the guide ribs.
13. Hold the headlamp assembly snugly against the vehicle and push down on the clips to lock the lamp into position.

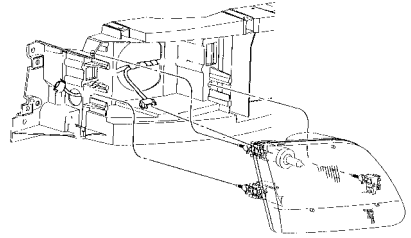

Replacing parking lamp/turn signal bulbs

1. Remove screw from the top of lamp assembly.

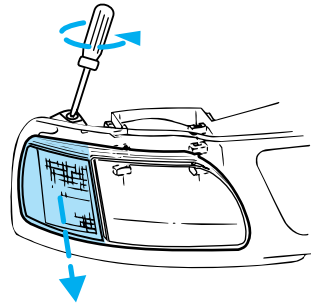

Maintenance and care

2. Disengage lamp assembly (it has a snap fit).

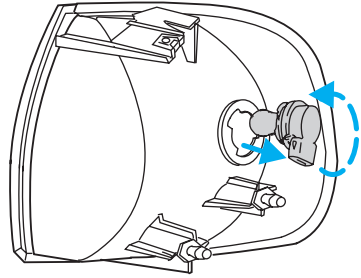

3. Remove the electrical connector from the bulb by grasping the wire and pulling it rearward.

4. Remove bulb retainer ring by turning it counterclockwise about 1/4 turn, then slide the ring off the plastic base.

5. Without turning, carefully pull bulb assembly out of parking lamp assembly.

6. Insert the glass end of the new bulb into the parking lamp assembly socket. When the grooves in the plastic base are aligned, push the bulb into the socket until the plastic base contacts the rear of the socket.

7. Slip bulb retaining ring over the plastic base and lock the ring into the socket by turning it clockwise until you feel a “stop.”

8. Push the electrical connector

Maintenance and care

into the rear of the plastic base until it “snaps.”

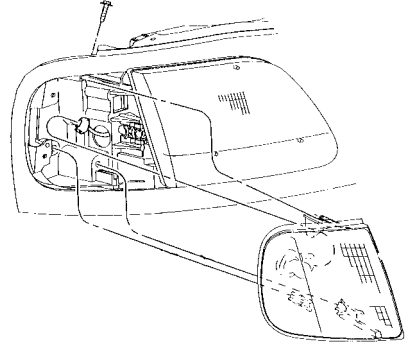

9. Align top and bottom ribs of parking lamp assembly with corresponding slots on front of vehicle.
10. Push gently until parking lamp assembly seats (you will hear a snap).
11. Replace screw removed in step 1.

Replacing foglamp bulbs

1. Disconnect the electrical connector from the back of the foglamp assembly.
2. Twist, then pull the bulb from the foglamp assembly.
3. Install the new bulb.
4. Connect the electrical connector to the back of the foglamp assembly.

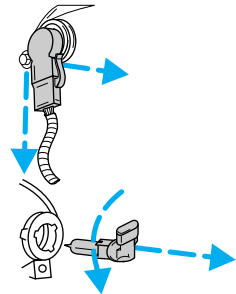

Maintenance and care

Replacing tail lamp/backup lamp bulbs

1. Remove the two bolts from the inside of the tailgate.
2. Carefully pull the tail lamp and backup lamp assembly from the tailgate pillar by releasing the two retaining tabs.
3. Disconnect the bulb connector.
4. Pull out the bulb to be replaced.
5. Install a new bulb.
6. Carefully insert the tail lamp and backup lamp assembly, snapping the two retaining tabs into place.
7. Install the two bolts.

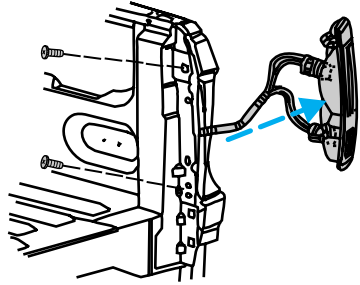

Replacing license plate lamp bulbs

1. Carefully pull the license plate lamp lens from the rear bumper.
2. Remove the bulb to be replaced and install a new bulb.
3. Install the license plate lamp lens.

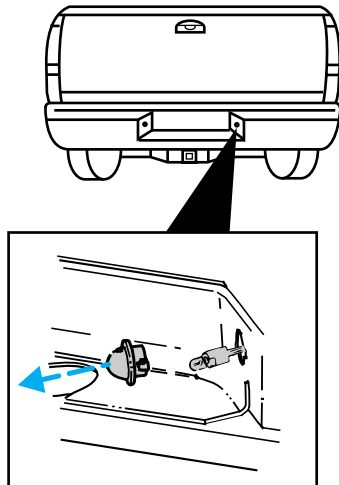

Maintenance and care

Replacing dome lamp bulb (if equipped)

1. Carefully pull the dome lamp lens from the lamp assembly.
2. Remove the dome lamp bulb and replace it with a new bulb.
3. Carefully snap the dome lamp lens into the dome lamp assembly.

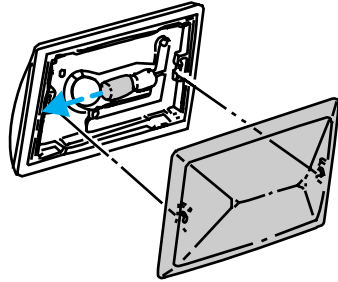

Replacing dome/map lamp bulb (if equipped)

1. Carefully pull the dome/map lamp lens from the lamp assembly.
2. Remove the dome/map lamp bulb and replace it with a new bulb.
3. Carefully snap the dome lamp lens into the dome/map lamp assembly.

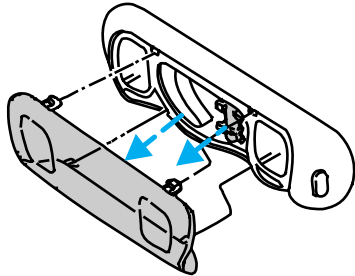

Replacing engine compartment lamp bulb (if equipped)

1. Open the hood.
2. Carefully pull the engine compartment lamp bulb from the lamp assembly and replace with a new bulb.

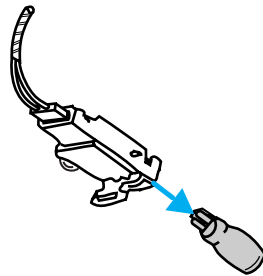

Maintenance and care

Exterior bulb specifications

Function	Number of bulbs	Trade number
Front park/turn lamps	2	3157NAK
Foglamps	2	9006
Headlamps	2	9007
Rear turn/sidemarkers	2	3157NAK

AIMING HEADLAMPS

The alignment of your headlamps should be checked if:

- Oncoming motorists frequently signal you to turn off your vehicle's high beams when you do not have the high beams on.
- The headlamps do not seem to give you enough light to see clearly at night.
- The headlamp beams are pointed substantially away from a position slightly down and to the right.

See your Ford dealer for precise headlamp adjustment.

Cleaning and caring for your vehicle

Refer to the "Customer Assistance Guide" for a list of Ford-approved cleaners, polishes and waxes.

Maintenance and care

Washing your vehicle

Wash your vehicle regularly with cold or lukewarm water. Never use strong detergents or soap. If your vehicle is particularly dirty, use a quality car wash detergent. Always use a clean sponge, washing glove or similar device and plenty of water for best results. To avoid spots, avoid washing when the hood is still warm, immediately after or during exposure to strong sunlight.

During winter months, it is especially important to wash the vehicle on a regular basis. Large quantities of dirt and road salt are difficult to remove, and they also cause damage to the vehicle.

Remove any exterior accessories, such as antennas, before entering a car wash.

- After washing, apply the brakes several times to dry them.

Waxing your vehicle

The best way to determine when the paintwork needs waxing is by noting when water stops beading on the surface. This could be every three or four months, depending on operating conditions.

Use only carnauba or synthetic-based waxes. Remove any bugs and tar before waxing vehicle. Use cleaning fluid or alcohol with a clean cloth to remove. Use tar remover to remove any tar spots.

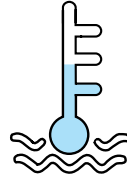

Maintenance and care

Repairing paint chips

Minor scratches or paint damage from road debris may be repaired with touch-up paint, paint repair foil or aerosol paint spray from the Ford accessory line. Observe the application instructions on the products.

Remove particles such as bird droppings, tree sap, insect remains, tar spots, road salt and industrial fallout immediately.

Cleaning the wheels

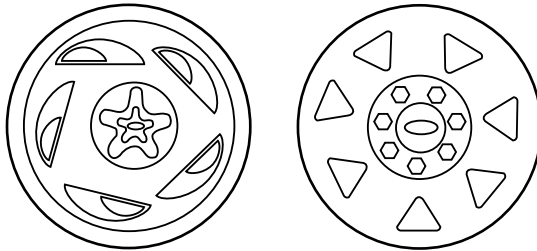

Wash the wheels with the same detergent you use to clean the body of your vehicle. Do not use acid-based wheel cleaners, steel wool, fuel or strong detergents. Never use abrasives that will damage the finish of special wheel surfaces. Use a tar remover to remove grease and tar.

Cleaning the engine

Engines are more efficient when they are clean because grease and

Maintenance and care

dirt buildup act as insulators and keep the engine warmer than normal. Follow these guidelines to clean your engine:

- Take care when using a power washer to clean the engine. The high pressure fluid could penetrate the sealed parts and cause damage.
- Do not spray with cold water to avoid cracking the engine block.
- Cover the highlighted areas to prevent water damage when cleaning the engine.

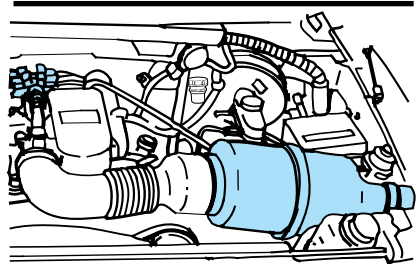
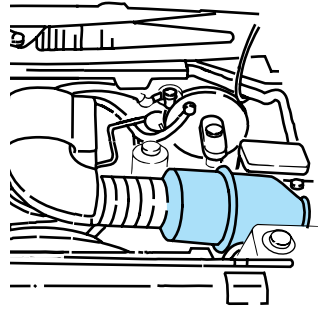

- Never wash or rinse the engine while it is running; water in the running engine may cause internal damage.

Cleaning plastic exterior parts

Use a vinyl cleaner for routine cleaning of plastic. Clean with a tar remover if necessary. Do not clean

Maintenance and care

plastic parts with thinners, solvents or petroleum-based cleaners.

Cleaning the exterior lamps

Wash the exterior lamps with the same detergent you used to wash the exterior of your vehicle. Use glass cleaner or tar remover if necessary.

To avoid scratching the lamps, do not use a dry paper towel, chemical solvents or abrasive cleaners to clean the lamps.

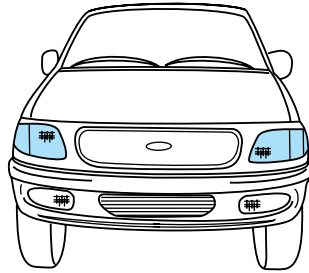

Cleaning the wiper blades

If the wiper blades do not wipe properly, clean both the windshield and wiper blades using undiluted windshield wiper solution or a mild detergent. Rinse thoroughly with clean water. To avoid damaging the blades, do not use fuel, kerosene, paint thinner or other solvents.

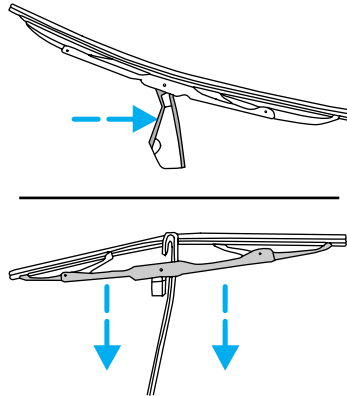

Maintenance and care

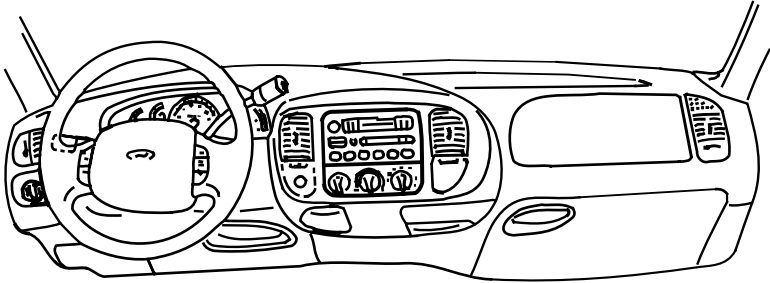

Cleaning the instrument panel

Clean instrument panel with a damp cloth, then dry with a dry cloth.

Any cleaner or polish that increases the gloss of the upper portion of the instrument panel should be avoided. The dull finish in this area is to help protect the driver from undesirable windshield reflection.

Cleaning the interior fabric

Remove dust and loose dirt with a whisk broom or a vacuum cleaner. Remove fresh spots immediately. Follow the directions that come with the cleaner.

Cleaning leather seats (if equipped)

For routine cleaning, wipe the surface with a soft, damp cloth. For more thorough cleaning, wipe the surface with a leather and vinyl cleaner or a mild soap.

Maintenance and care

Cleaning and maintaining the safety belts

Clean the safety belts with a mild soap solution recommended for cleaning upholstery or carpets. Do not bleach or dye the belts, because these actions may weaken the belt webbing.

Check your safety belt system periodically to make sure that it works properly and is not damaged. If the webbing shows any wear, nicks or cuts, have it examined by a qualified technician to determine if replacement is necessary. Always have your safety belt system checked after a collision by a qualified technician. Refer to *Safety belt maintenance* in the *Seating and safety restraints* chapter for more information.

Capacities and specifications

MOTORCRAFT PART NUMBERS

Component	Engine		
	4.2L	4.6L	5.4L
Spark plug-platinum ¹	AWSF-42EE	AWSF-32PP	AWSF-22F
Air filter	FA-1632	FA-1632	FA-1632
Fuel filter	FG-872	FG-872	FG-872
Oil filter	FL-400-S	FL-820-S	FL-820-S
PCV valve	EV-152	EV-98	EV-233
Battery	BXT-59 (manual) BXT-65-750 (automatic)	BXT-59 (manual) BXT-65-750 (automatic)	BXT-59 (manual) BXT-65-750 (automatic)

¹Replacement double platinum spark plug "EE" will replace "E" and "EG" and "P" will replace "P" and "PG" suffixed plugs. Refer to the Engine data chart for spark plug gap specifications.

REFILL CAPACITIES

Fluid	Ford part name	Vehicle type	Capacity
Axle; front	Ford 22.35 cm (8.8 in) Ring Gear	4WD	1.65L (3.5 pts.)
Axle; rear	Ford 22.35 cm (8.8 in) and 24.76 cm (9.75 in) Ring Gear Conventional and Traction-Lok(1)	F-150	2.6L (5.5 pts.)

Capacities and specifications

Fluid	Ford part name	Vehicle type	Capacity
Axle; rear	Ford 26.03 cm (10.25 in) Conventional and Traction Lok (2)	F-250	3.3L (7.0 pts.)
Engine coolant	Premium Cooling System Fluid	4.2L w/o A/C 4.2L with A/C 4.6L w/o A/C 4.6L with A/C 5.4L w/o A/C 5.4L with A/C	14.9L (15.7 qts.) 16.4L (17.3 qts.) 16.9L (17.9 qts.) 18.4L (19.4 qts.) 16.9L (17.9 qts.) 18.3L (19.4 qts.)
Engine oil ¹	Super Premium Motorcraft Motor Oil 5W-30	4.2L 4.6L 5.4L	5.7L (6.0 qts.) 5.7L (6.0 qts.) 5.7L (6.0 qts.)
Fuel	Unleaded 87 octane	4x2 Reg. Cab 4x2 SuperCab 4x4 Reg. Cab 4x4 SuperCab Long Wheelbase	94.6L (25.0 gal) 94.6L (25.0 gal) 92.7L (24.5 gal) 94.6L (25.0 gal) 113.6L (30.0 gal)
Power steering fluid	Motorcraft MERCON® Multi-purpose ATF	All	2.3L (2.4 pts.)
Transfer case fluid ³ (if equipped)	Motorcraft MERCON® Multi-purpose ATF	4-wheel drive transfer case	1.9L (2.0 qts.)
Transmission fluid; automatic	Motorcraft MERCON® Multi-purpose ATF	4R70W E4OD (4x2) E4OD (4x4)	13.1L (13.9 qts.) 15.04L (15.9 qts.) 15.51L (16.4 qts.)

Capacities and specifications

Fluid	Ford part name	Vehicle type	Capacity
Transmission fluid; manual ²	Motorcraft MERCON® Multi-purpose ATF	5-speed manual	3.5L (3.75 qts.)
Windshield washer fluid	Ultra-clear windshield washer fluid concentrate	All	4.0L (4.25 qts.)
<p>(1) Add 118 ml (4 oz.) of additive friction modifier C8AZ-19B546-A, Ford specification EST-M2C118-A, for complete fill of 22.35 cm (8.8 in.) and 24.76 cm (9.75 in) ring gear Traction-Lok axles.</p> <p>(2) Add 236 ml (8 oz.) of additive Friction Modifier C8AZ-19B546-A, Ford Specification EST-M2C118-A, for complete fill of 26.03 cm (10.25 in) Ring Gear Traction-Lok axles.</p>			

¹Includes filter replacement.

²Fill to 6 mm (3/8 in) below bottom of filler hole.

³Fill to bottom of filler hole.

LUBRICANT SPECIFICATIONS

Fluid	Ford part name or equivalent	Ford part number	Ford specification
Axle lubricant; front	SAE 75W90	XY-75W90-QL (Thermally Stable)	WSP-M2C201-A
Axle lubricant; rear	High Performance Rear Axle Lubricant	F1TZ-19580-B	WSL-M2C192-A

Capacities and specifications

Fluid	Ford part name or equivalent	Ford part number	Ford specification
Brake fluid and clutch fluid	High Performance DOT 3 brake fluid	C6AZ-19542-AB	ESA-M6C25-A and DOT 3
Engine coolant	Premium engine coolant	E2FZ-19549-AA or B	ESE-M97B44-A
Engine oil	Super Premium Motorcraft Motor Oil 5W30	XO-5W30-BSP or QSP	WSS-M2C153-F
Grease; body hinges, latches and seat tracks.	Multi-Purpose Grease	D0AZ-19584-AA or D7AZ-19584-AA	ESB-M1C93-A or ESB-M1C106-B
Grease; transmission /steering/parking brake linkages and pivots. Brake and clutch pedal shaft.	Premium Long-Life Grease	XG-1-C	ESA-M1C75-B
Parking brake cable	Speedometer cable lubricant	E6TZ-19581-A	ESF-M1C60-A
Power steering fluid, transfer case fluid and transmission fluid (manual and automatic)	Motorcraft MERCON® Multi-purpose ATF	XT-2-BDX or QDX	MERCON®
Windshield washer fluid	Ultra-clear windshield washer concentrate	C9AZ-19550-AC or BC	ESR-M17P5-A

Capacities and specifications

ENGINE DATA

General Specifications	Engine		
	OHV 4.2L V-6	SOHC 4.6L V8	SOHC 5.4L V8
Displacement	4.2 L (256.2 CID)	4.6 L (280.6 CID)	5.4 L (329.4 CID)
Bore x stroke	96.8 mm x 95.0 mm	90.2 mm x 90 mm	90.2 mm x 105.8 mm
Horsepower	205 @ 4750 RPM	210 @ 4400 RPM	N/A*
Torque	260 ft. lb. @ 3000 RPM	290 ft. lb. @ 3250 RPM	N/A*
Required fuel grade	Unleaded - 87 octane	Unleaded - 87 octane	Unleaded - 87 octane
Induction system	Split port, OHV	Tuned runner and plenum	Tuned runner and plenum
Firing order	1-4-2-5-3-6	1-3-7-2-6-5-4-8	1-3-7-2-6-5-4-8
Spark plug gap	.137 cm (.054 in)	.137 cm (.054 in)	.137 cm (.054 in)
Ignition system	E.I.	E.I.	Coil on plug
Compression ratio	9.2:1	9.0:1	9.0:1

*Not available at time of printing.

Capacities and specifications

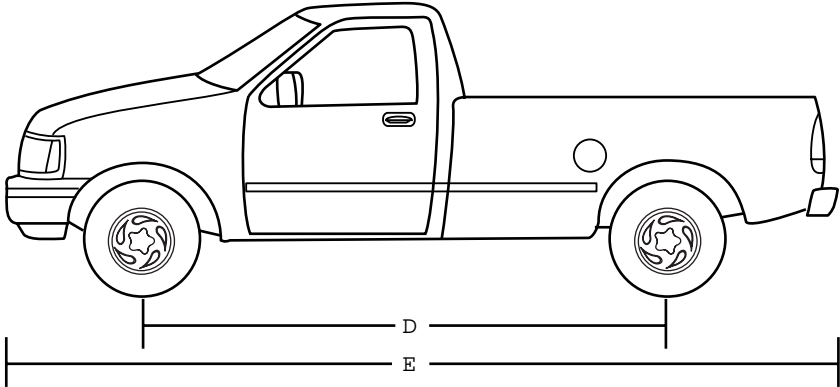

VEHICLE DIMENSIONS

STYLESIDE

Dimension	Body Style			
	Regular Cab 4x2	Regular Cab 4x4	Super Cab 4x2	Super Cab 4x4
A=Overall height	1.84 m (72.7 in) (SWB)	1.91 m (75.5 in) (SWB)	1.84 m (72.7 in) (SWB)	1.91 m (75.5 in) (SWB)
	1.83 m (72.4 in) (LWB)	1.90 m (75.1 in) (LWB)	1.83 m (72.4 in) (LWB)	1.90 m (75.1 in) (LWB)
B=Track front/rear	1.66 m (65.4 in)/1.66 m (65.4 in)	1.66 m (65.4 in)/1.66 m (65.4 in)	1.66 m (65.4 in)/1.66 m (65.4 in)	1.66 m (65.4 in)/1.66 m (65.4 in)
C=Overall width	1.99 m (78.4 in)	1.99 m (78.4 in)	1.99 m (78.4 in)	2.01 m (79.5 in)
D=Wheel base	3.04 m (119.9 in) (SWB)	3.04 m (119.9 in) (SWB)	3.51 m (138.5 in) (SWB)	3.51 m (138.5 in) (SWB)
	3.51 m (138.5 in) (LWB)	3.51 m (138.5 in) (LWB)	3.99 m (157.1 in) (LWB)	3.99 m (157.1 in) (LWB)

Capacities and specifications

Dimension	Body Style			
	Regular Cab 4x2	Regular Cab 4x4	Super Cab 4x2	Super Cab 4x4
E=Overall length	5.13 m (202.2 in)(SWB)	5.13 m (202.2 in)(SWB)	5.6 m (220.8 in)(SWB)	5.6 m (220.8 in)(SWB)
	5.60 m (220.8 in)(LWB)	5.60 m (220.8 in)(LWB)	6.11 m (240.9 in)(LWB)	6.11 m (240.9 in)(LWB)

FLARESIDE

Dimension	Body Style			
	Regular Cab 4x2	Regular Cab 4x4	Super Cab 4x2	Super Cab 4x4
A=Overall height	1.84 m (72.7 in)	1.91 m (75.5 in)	1.84 m (72.7 in)	1.91 m (75.5 in)
B=Track front/rear	1.66 m (65.4 in)	1.66 m (65.4 in)	1.66 m (65.4 in)	1.66 m (65.4 in)
C=Overall width	2.00 m (79.1 in)	2.00 m (79.1 in)	2.00 m (79.1 in)	2.00 m (79.1 in)
D=Wheel base	3.04 m (119.9 in)	3.05 m (120.2 in)	3.51 m (138.5 in)	3.52 m (138.8 in)
E=Overall length	5.22 m (205.9 in)	5.26 m (207.4 in)	5.7 m (224.5 in)	5.74 m (226.0 in)

VEHICLE IDENTIFICATION NUMBER (VIN)

The Vehicle Identification Number (VIN) is attached to a metal tag and is located on the driver side instrument panel (the tag may be read by looking through the windshield from the outside of the vehicle).

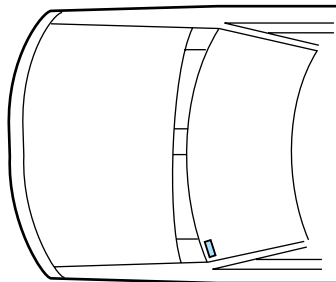

Reporting safety defects

REPORTING SAFETY DEFECTS

If you believe that your vehicle has a defect that could cause a crash, or could cause injury or death, you should immediately inform the National Highway Traffic Safety Administration (NHTSA) in addition to Ford Motor Company.



If NHTSA receives similar complaints, it may open an investigation, and if it finds that a safety defect exists in a group of vehicles, it may order a recall and remedy campaign. However, NHTSA cannot become involved in individual problems between you, your dealer or Ford Motor Company.

To contact NHTSA, you may either call the Auto Safety Hotline toll-free at 1-800-424-9393 (202-366-0123 in the Washington D.C. area) or write to:

NHTSA

U.S. Department of Transportation
400 Seventh Street
Washington D.C. 20590

You can also obtain other information about motor vehicle safety from the Hotline.