

Contents

BEFORE DRIVING

| | |
|-------------------------------|----|
| Introduction | 2 |
| Instrumentation | 4 |
| Controls and Features | 15 |
| Seating and Safety restraints | 53 |

STARTING AND DRIVING

| | |
|----------------------|-----|
| Starting | 85 |
| Driving | 93 |
| Roadside Emergencies | 107 |

SERVICING

| | |
|-------------------------------|-----|
| Maintenance and Care | 124 |
| Capacities and Specifications | 179 |
| Reporting Safety Defects | 186 |
| Index | 187 |

Introduction

ICONS

The following icons appear in this *Owner Guide*:



 indicates a warning. Read the following section on *Warnings* for a full explanation of warnings.

 indicates that vehicle information related to recycling and other environmental concerns will follow.

Warnings

Warnings remind you to be especially careful in those areas where carelessness can cause damage to your vehicle or personal injury to yourself, your passengers, or others. Please read all warnings carefully.

Breaking-in your vehicle

Your new vehicle goes through an adjustment or breaking-in period during the first 1,600 km (1,000 miles) of driving. During this period:

- change your vehicle's speed often as you drive. Do not drive at one speed for a long time.
- use only the type of engine oil Ford recommends. Do not use special "break-in" oils.
- avoid sudden stops. The break-in period for brake linings lasts for 1,600 km (1,000 miles) of highway driving or 160 km (100 miles) of city driving.

Information about this guide

This guide describes equipment and gives specifications for equipment that was in effect when this guide was approved for printing. Ford may discontinue models or change specifications or design without any notice and without incurring obligation.

Instrumentation

Exterior lamps and turn signal lever (pg. 26 and pg. 9)

Foglamp switch (if equipped) (pg. 27)

Instrument panel dimmer switch (pg. 15)

Engine coolant temperature gauge (pg. 13)

Fuel gauge (pg. 13)

Power mirrors control (if equipped) (pg. 16)

Speedometer (pg. 13)

Speed control (if equipped) (pg. 27)

Tachometer (if equipped) (pg. 14)

Warning lights (pg. 6)

Wiper/washer lever (pg. 30)

Rear wiper/washer (if equipped) (pg. 30)

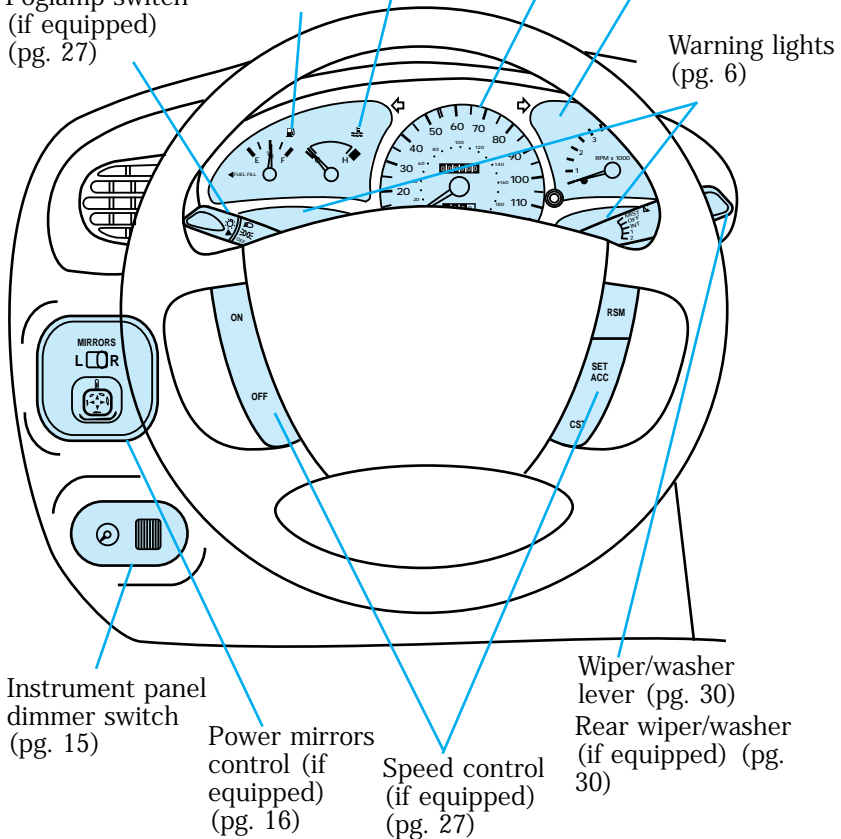

Vents (pg. 18)

Refer to *Audio Guide*
(electronic stereo radio with
cassette shown; others
available) (pg. 17)

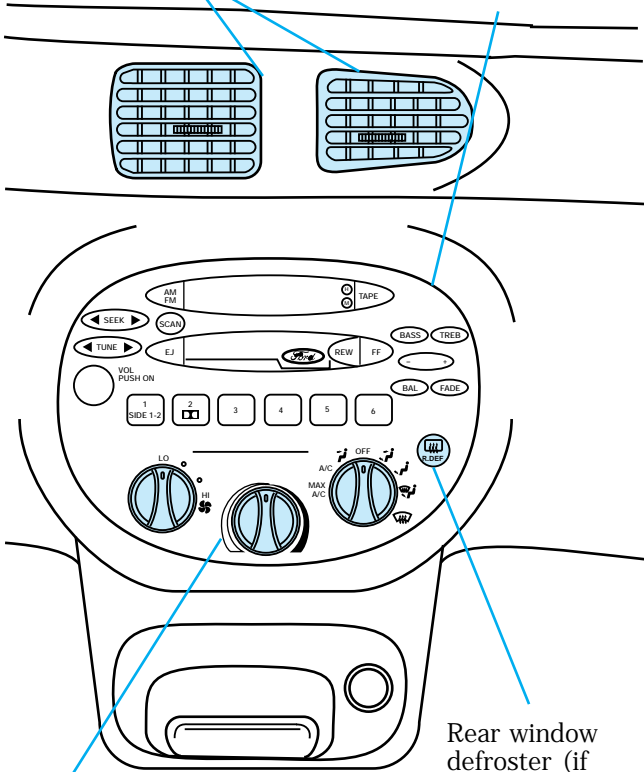

Climate controls
(pg. 17)

Rear window
defroster (if
equipped) (pg. 24)

* if equipped with air conditioning

Instrumentation

INSTRUMENT CLUSTERS

Instrument cluster lights

Base cluster lights

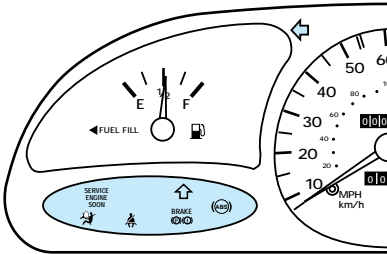

Sport cluster lights

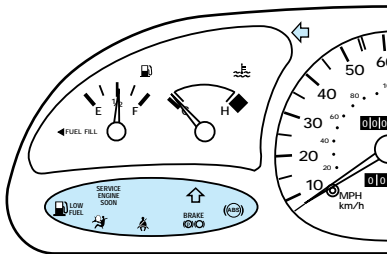

Base cluster lights

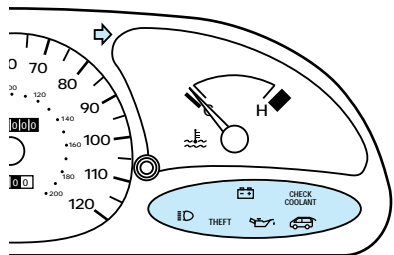

Sport cluster lights

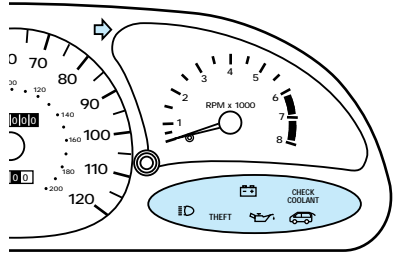

Low fuel

Illuminates when the fuel tank is almost empty (approximately 8 liters [2 gallons] remain). The lights will also briefly illuminate when the ignition key is turned to ON and the engine is off.



Service engine soon

Illuminates when the engine's emissions control system requires service. The light will also illuminate, and will remain illuminated, when the ignition key is turned to ON and the engine is off.



Air bag readiness



Illuminates when the air bag system requires servicing. The light will also briefly illuminate when the ignition key is turned to ON.



Instrumentation

Safety belt

The safety warning light/chime is a reminder to fasten your safety belt. One of the following will take place:

- If the lap/shoulder belt is not buckled before the key is turned to the ON position, the  will illuminate for approximately one minute or until the safety belt is buckled.
- If the lap/shoulder belt is buckled while  is illuminated and the chime is sounding, both will turn off.
- If the lap/shoulder belt is buckled before the key is turned to the ON position, neither light or chime will activate.



Upshift (if equipped)

Illuminates when it is best to shift to the next highest manual transaxle gear for the maximum fuel economy.



Brake

Illuminates when the parking brake is activated and the ignition is keyed to ON or the brake fluid level is low. In addition, with the parking brake off, the light will illuminate when the engine is cranked.



Anti-lock brake system (ABS)

Illuminates when the ABS needs service. The light will also briefly illuminate when the ignition key is turned to ON and the engine is off.



Turn signal

Illuminates when the left hand or right hand turn signal or the hazard lamps are illuminated.



High beams

Illuminates when the headlamp high beams are on.



Anti-theft (if equipped)

Illuminates when the anti-theft system is arming and flashes when the anti-theft system is armed.



Charging

Illuminates when there is a problem with the alternator or charging system and the electrical system requires service. The light will also briefly illuminate when the ignition key is turned to ON and the engine is off.

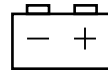

Oil pressure

Illuminates when the oil pressure is low, not the low oil level. However, if your engine's oil level is low, it could affect the oil pressure. Stop the vehicle and check the oil level as soon as possible. Do not drive the vehicle if the light remains on. The light will also briefly illuminate when the ignition key is turned to ON and the engine is off.

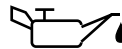

Instrumentation

Engine coolant

Illuminates when there is low coolant level or a problem with the engine coolant system. Stop the vehicle and check the engine coolant level as soon as possible. The light will also briefly illuminate when the ignition key is turned to ON and the engine is off. For more information on engine coolant, refer to *Checking and adding engine coolant* in the *Maintenance and care* chapter.

Liftgate ajar (if equipped)

Illuminates when the ignition is in the ON position and the liftgate is open.

Many of the lights illuminate briefly when you start the vehicle. For more information on warning light illumination, refer to *Preparing to start the vehicle* in the *Starting* chapter.

Warning chimes

Safety belt warning chime

For information on the safety belt warning chime, refer to the *Seating and safety restraints* chapter.

Supplemental restraint system (SRS) warning chime

For information on the SRS warning chime, refer to the *Seating and safety restraints* chapter.

**CHECK
COOLANT**

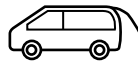

Key-in-ignition warning chime

A warning chime sounds when the key is left in the ignition and any door is opened.

Headlamps-on warning chime

A warning chime sounds when the headlamps are on, the ignition is off, and a door is opened.

Instrumentation

Instrument cluster gauges

Base cluster gauges

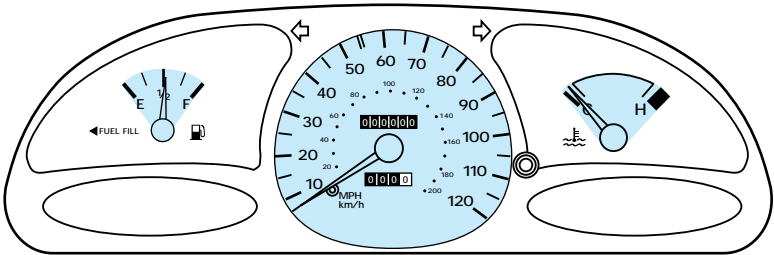

Sport cluster gauges

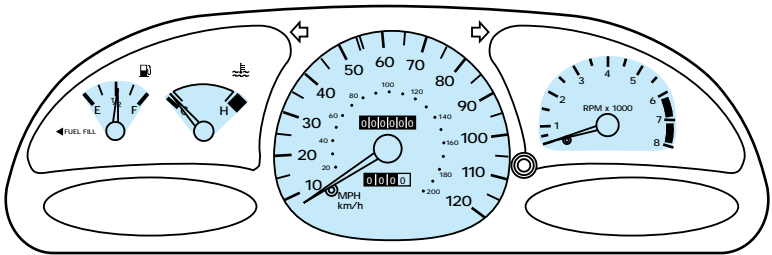

Speedometer

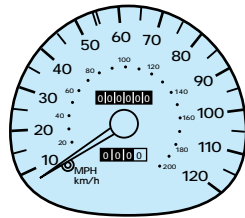

Fuel gauge

When the fuel gauge needle is on the E (empty) portion of the gauge, there are between approximately 2 L (.6 gallons) and 4 L (1 gallon) of usable fuel left in the tank.

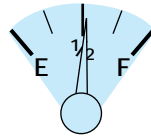

Engine coolant temperature gauge

If the engine coolant temperature gauge moves into the H zone:

1. Pull off the road as soon as is safely possible.
2. Turn off the engine and let it cool.
3. Check and add engine coolant as necessary. Refer to *Checking and adding engine coolant* in the *Maintenance and care* chapter. If the coolant level and mixture is not properly maintained, the engine coolant temperature gauge will not read properly.

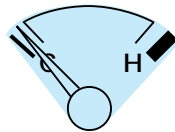

Instrumentation

Odometer

The odometer gives a six digit reading of how many kilometers (miles) your vehicle has traveled.

Trip odometer

The trip odometer gives a four digit reading of how many kilometers (miles) your vehicle has traveled in an individual trip.

Press the reset button to begin an individual trip odometer record.

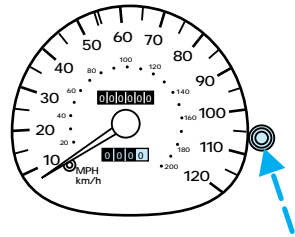

Tachometer

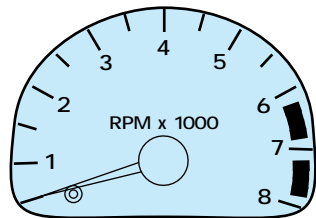

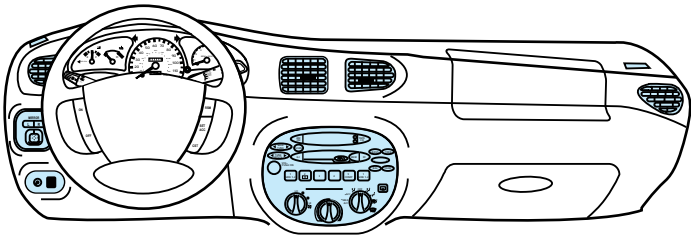

INSTRUMENT PANEL DIMMER SWITCH

To adjust the instrument panel dimmer switch:

- Rotate the switch to the right to dim the instrument panel lighting.
- Rotate the switch to the left to brighten the instrument panel lighting.

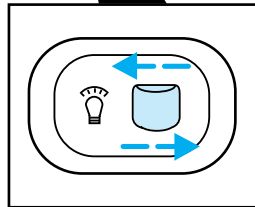
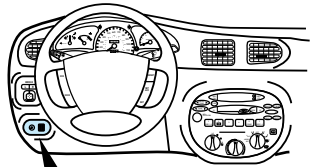

Controls and features

POWER OUTSIDE MIRRORS (IF EQUIPPED)

To adjust the outside mirrors:

1. Select the mirror you want to adjust.

L Driver side mirror

R Passenger side mirror

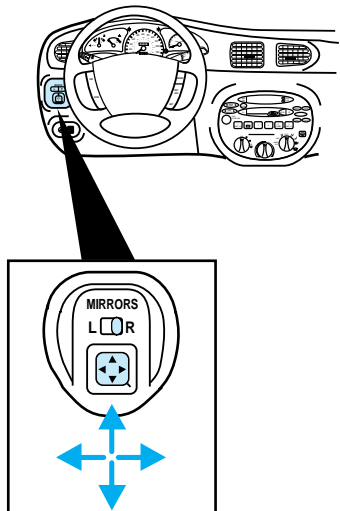

2. Move the mirror control in the desired direction.

3. Lock the mirror by moving the switch to the center position.

Controls and features

AUDIO SYSTEM

For information on the audio system, refer to the *Audio Guide*.

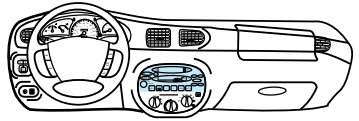

CLIMATE CONTROLS

Your vehicle has one of the following climate control systems:

- Manual heating system
- Manual heating and air conditioning system

In some modes, the two systems function similarly; in modes where the systems do not function similarly, the different functions are noted.

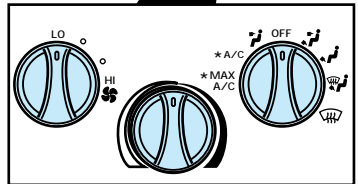
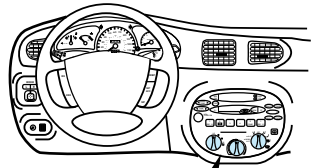

* If equipped with air conditioning

Controls and features

Vents

The airflow from the vents may be adjusted by moving the horizontal lever or by moving the vent up and down according to your airflow preference.

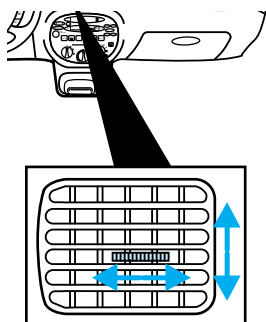

Operating the climate control

Turn the fan speed dial to the desired speed.

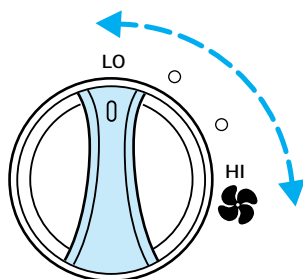

Turn the temperature dial to the desired mix of warm and cool air (left for cooler and right for warmer).

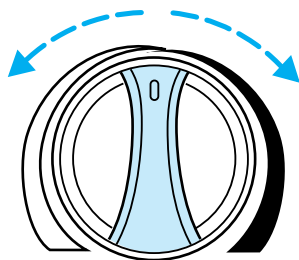

Controls and features

Turn the air distribution dial to the desired airflow position. For vehicles with manual heating systems, the modes can only be used for heating or ventilating (except OFF).

To prevent humidity buildup inside of the vehicle, always drive with the climate control system turned on.

Do not put objects under the front seats that interfere with the flow of air to the back seat area.

* If equipped with air conditioning

Using the MAX A/C mode

- MAX A/C mode (if equipped) can be used for air conditioning or heating. This mode is noisier but more economical than A/C; it will only function if the air temperature outside the vehicle is about 10°C (50°F) or higher.

Select MAX A/C and turn the temperature dial to the left for recirculated, cooled airflow through these vents:

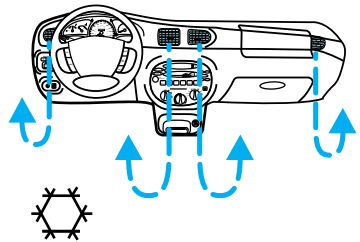
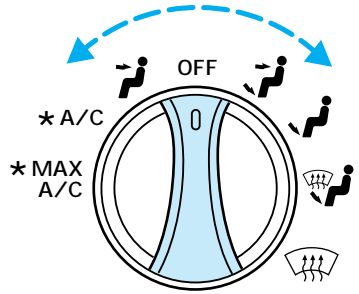

Using the A/C mode

- A/C mode (if equipped) can be used for heating, ventilating, or air conditioning; the air

Controls and features

conditioning can only function if the air temperature outside the vehicle is about 10°C (50°F) or higher. Select A/C and turn the temperature dial to the left for recirculated, cooled airflow through these vents:

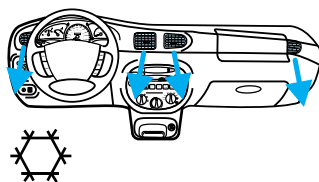

Using the panel mode

- This brings in outside air and can be used for heating and ventilating. Select  for airflow through these vents:

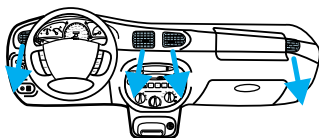

Using the floor mode

In the OFF mode, outside air is shut out and the fan will not operate.

Using the panel/floor mode

Manual heating system

- This mode brings in outside air and can be used for heating and ventilating.

Manual heating and air conditioning system

- This mode brings in outside air and can be used for heating, ventilating, or air conditioning; the air conditioning can only

Controls and features

function if the air temperature outside the vehicle is about 10°C (50°F) or higher. Select this mode for airflow through these vents:

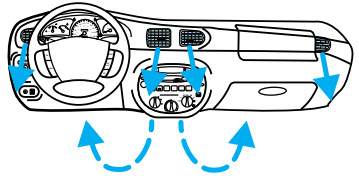

Using the floor mode

In this mode, with the temperature control knob between full cool and full hot ranges, slightly warmer air will be directed toward your feet and cooler air toward your chest. In the full cool or full hot ranges, the airflow toward both feet and chest will be the same temperature.

- This allows for maximum heating, but can also be used for ventilating. Select  for airflow through the rear seat floor ducts and these vents:

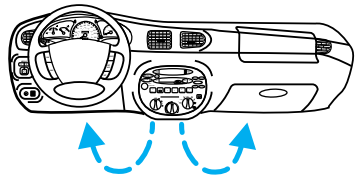

Using the defrost/floor mode

Manual heating system

- This brings in outside air and can be used for heating or ventilating.

Controls and features

Manual heating and air conditioning system

- This brings in outside air and can be used for heating, ventilating, or air conditioning in order to dehumidify the windshield; the air conditioning can only function if the air temperature outside the vehicle is about 10°C (50°F) or higher. Select  for airflow through these vents:

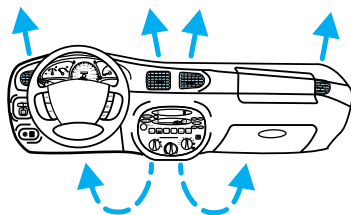

Using the defrost mode

Manual heating system

- This brings in outside air and can be used for heating and ventilating and will clear ice or fog from the windshield and front side windows.

Manual heating and air conditioning system

- This brings in outside air and can be used for heating, ventilating, or air conditioning in order to dehumidify the windshield; the air conditioning can only function if the air temperature outside the vehicle is about 10°C (50°F) or higher.

Controls and features

Select  for airflow through these vents:

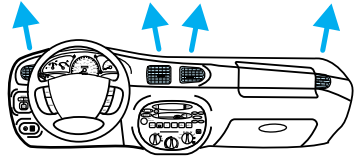

Special features

For slightly warm airflow toward your feet and slightly cool airflow toward your chest at the same time:

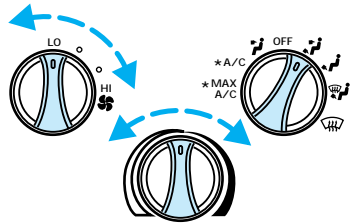

* If equipped with air conditioning
For about the same temperature
airflow toward your chest and feet:

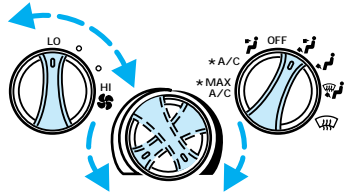

* If equipped with air conditioning

For better airflow

Remove snow, ice, and leaves from
the intake vents for the best
airflow:

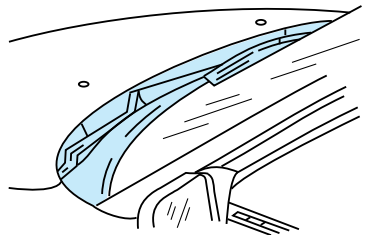

Controls and features

REAR WINDOW DEFROSTER (IF EQUIPPED)

Press the defroster switch to clear the rear window of thin ice and fog:

The ignition must be in the ON position to operate the rear window defroster.

The defroster turns off automatically after fifteen minutes. To manually turn off the defroster before fifteen minutes have passed, push the switch again.

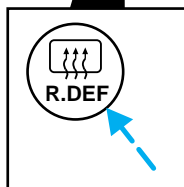
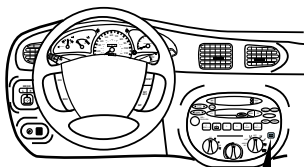

Controls and features

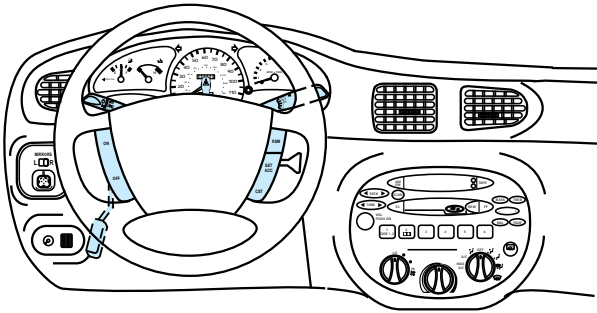

Ignition

LOCK locks the steering wheel and allows the key to be removed from the ignition. (Push the key in while turning to LOCK on vehicles with manual transaxles.) LOCK also locks automatic transaxle gearshifts.

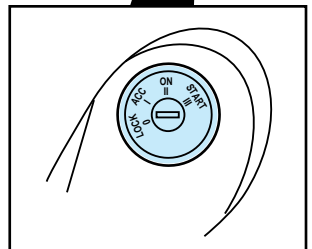
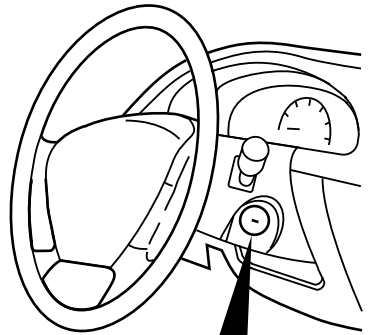

Controls and features

ACC allows operation of some accessories without starting the engine.



ON allows testing of the vehicle's warning lights.

START cranks the engine. The key returns to the ON position after it is released.

For more information on the vehicle ignition and starting the vehicle, refer to *Preparing to start the vehicle* in the *Starting* chapter.

Headlamp switch

Rotate the headlamp switch to the desired position.

-  Headlamps on
-  Parking lamps, side marker lamps, instrument panel lamps, license lamps, and tail lamps on
- OFF Lamps off

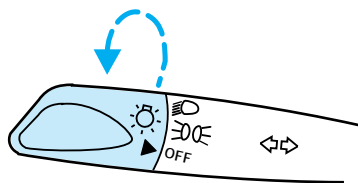

Daytime running light (DRL) system (if equipped)

The DRL system turns on the high beam headlamps, with a reduced light output, when:

- the vehicle is running
- the vehicle has a fully released parking brake
- the headlamp system is in the OFF position

Controls and features

 The daytime running light (DRL) system will not illuminate the tail lamps and parking lamps. Turn on your headlamps at dusk. Failure to do so may result in a collision.

High beams and flash-to-pass

Push for high beam headlamp operation.

Pull and release quickly for “flash-to-pass” operation.

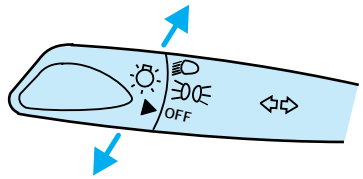

Foglamps (if equipped)

Rotate the switch to turn the foglamps on and off.

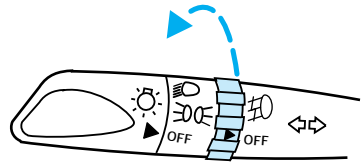

Speed control (if equipped)

Maintain vehicle speed at least 50 km/h (30 mph) to operate the speed control system.

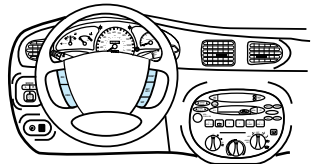

Controls and features

Press the ON portion of the ON / OFF button to turn on.

Press the OFF portion of the ON / OFF button to turn off.

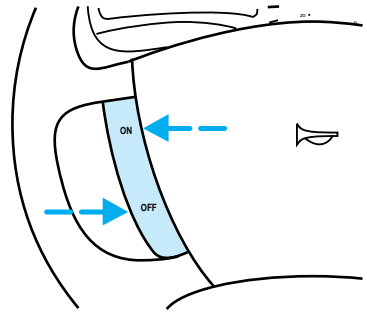

Press the RSM button to resume a set speed.

Hold the SET ACC portion of the SET ACC / CST button to set the desired speed. Hold SET ACC to increase speed; tap to increase speed in 1.6 km/h (1 mph) increments.

Hold the CST portion of the SET ACC / CST button to decrease speed; tap to decrease speed; tap to decrease speed in 1.6 km/h (1 mph) increments.

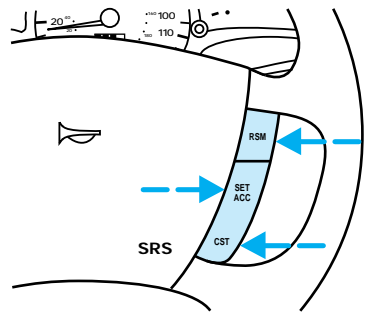

Speed control can be canceled by pressing the brake pedal or clutch pedal (if equipped).

Do not shift into N (automatic transaxle) or neutral (manual transaxle) with the speed control on.

Use only Federal Communications Commission (FCC) or Canadian Radio and Telecommunications Commission (CRTC) approved radio transmitting equipment in your vehicle to prevent speed control malfunctions.

Controls and features

Tilt steering (if equipped)

Pull the lever down to adjust the steering column angle.

Push the lever back up to lock the steering wheel in position.



Never adjust the steering wheel when the vehicle is moving. You could lose control of the vehicle and injure someone.

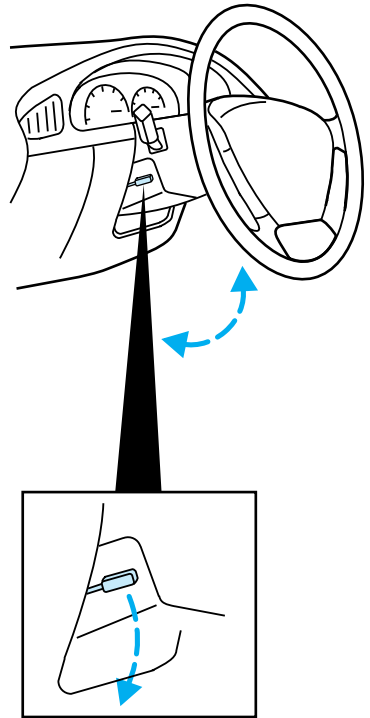

Hazard flasher switch

For information on the hazard flasher switch, refer to the *Roadside emergencies* chapter.

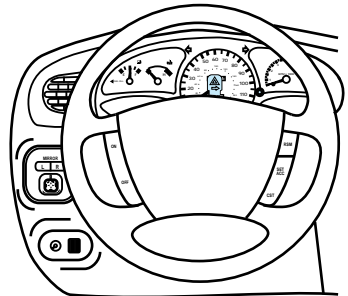

Controls and features

Windshield wipers and washer

Wipers

Rotate the windshield wiper switch to the desired interval position.

Push up and release to wipe the windshield only once. Pull down to select the wipers on continuously.

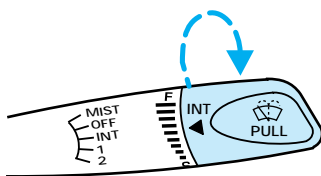

Washer

Pull toward you for windshield washer fluid operation.

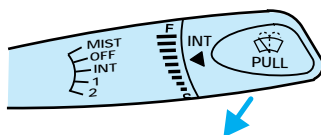

Rear window wipers and washer (if equipped)

Wipers

For rear operation, rotate the rear window wiper and washer switch to the desired position. Select:

ON Rear wiper on

OFF Rear wiper and washer off

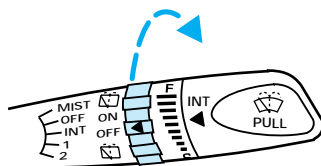

Washer

For rear window washer fluid operation, pull toward you. Select:

Top  Rear washer on

Bottom  Brief rear wiper and washer operation (for quick cleaning).

Controls and features

OVERHEAD CONTROLS

Overhead Lamps

Move the overhead lamp switch to the desired position:

OFF Overhead lamp off

DOOR Overhead lamp illuminates when a door is opened

ON Overhead lamp on

Map lamps (if equipped)

Press to turn the map lamps on and off.

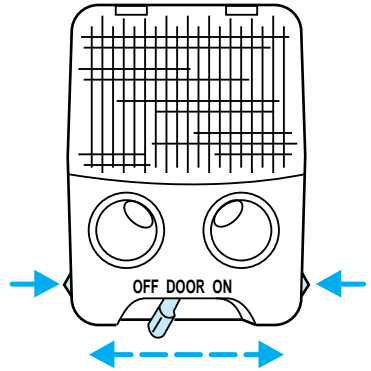

DOOR MOUNTED CONTROLS

Power door locks (if equipped)

Push to lock or unlock the doors.

L All doors locked

U All doors unlocked

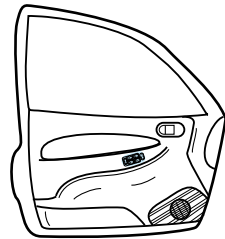

Controls and features

- Driver side

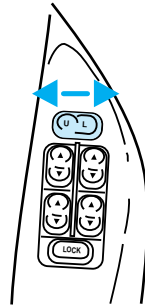

- Front passenger side

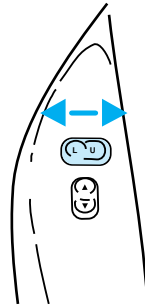

Childproof locks

The rear doors can be set to prevent children from opening the doors from the inside. To set the rear childproof locks:

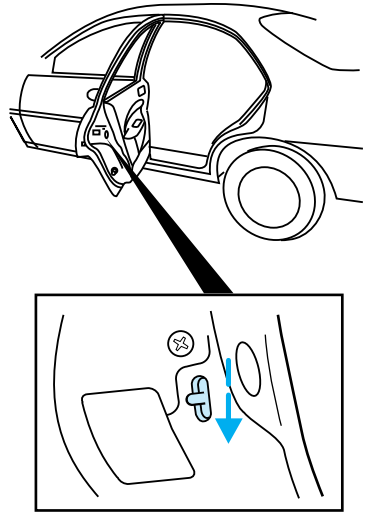

The childproof lock must be set separately for each door. Setting the lock on one door will not set the lock for both rear doors.

To return the rear doors to normal operation, return the lever to the raised position.

Illuminated entry (if equipped)

For more information on the illuminated entry system, refer to *Illuminated entry* under *Remote entry system* in this chapter.

Controls and features

Power windows (if equipped)

Driver side controls

Press the appropriate window switch to operate the power windows.

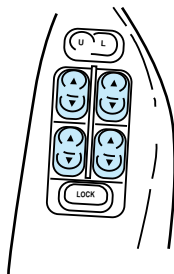

- Driver window



- Front passenger window



- Left rear passenger window



Controls and features

- Right rear passenger window



To prevent passengers from operating the power windows, press the lock button.

Press again to unlock and allow the passengers to operate the power windows.

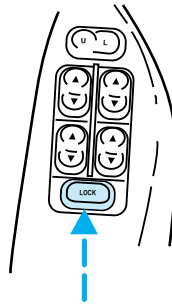

One-touch down feature

To open the driver side window completely, press and release the lower portion of the driver side window switch.

To stop the window while it is in motion, press the switch again.

Passenger controls

Press the window switch to operate the power window at each door position.

Controls and features

- Front passenger side

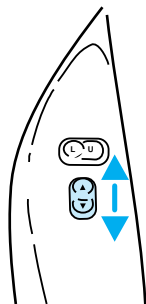

- Rear passengers

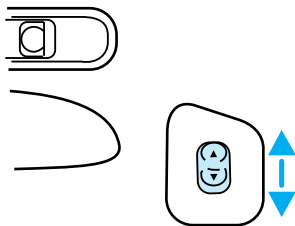

CONSOLE CONTROLS

Gearshift

For information about the gearshift on vehicles with automatic or manual transaxles, refer to the *Transaxles* section of the *Driving* chapter.

Controls and features

- Automatic

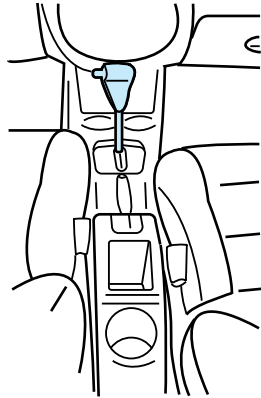

- Manual

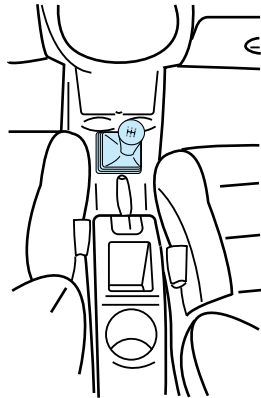

Controls and features

Parking brake

For information on the parking brake, refer to *Preparing to start the vehicle* in the *Driving* chapter.

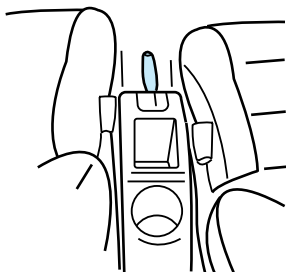

FLOOR CONTROLS

Floor mat hook (if equipped)

Fasten the floor mat to the floor to prevent the mat from shifting.

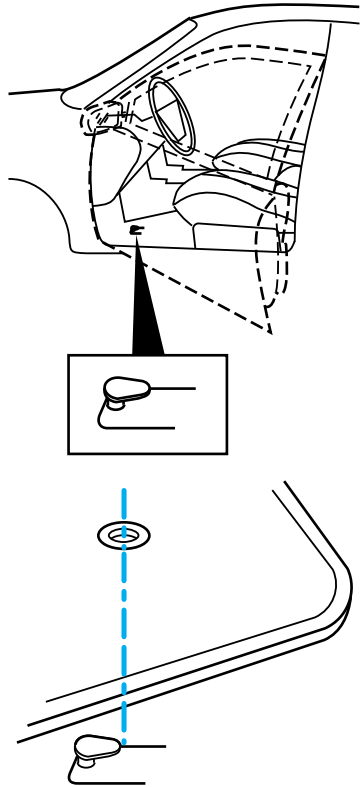

Controls and features

TRUNK/LIFTGATE CONTROLS

Compact disc changer (if equipped)

For information on compact disc changer, refer to the *Audio Guide*.

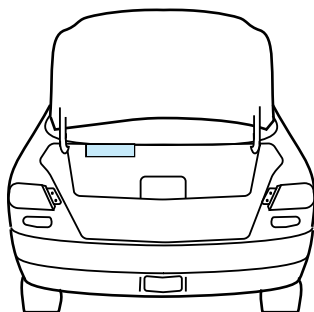

Wagon liftgate lamp

Press the switch to turn the liftgate lamp on or off.

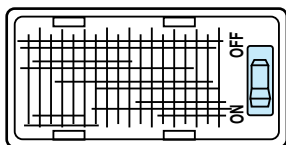

Controls and features

Wagon sliding shade

Pull the shade to cover the cargo area.

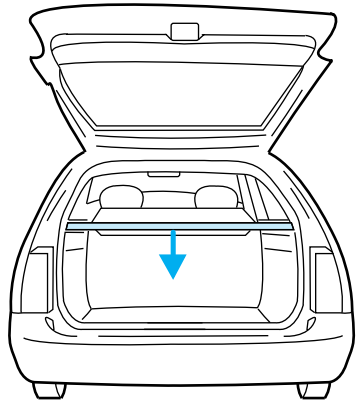

Hook the shade into the notches in the rear trim panels.

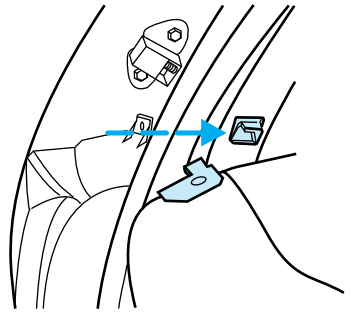

Rewinding the sliding shade

If the shade is damaged or loses its spring tension from excessive use, manual rewind of the shade may be necessary. The following procedure is a two-person operation:

Controls and features

1. Remove the shade from the mounting brackets by detaching the safety clip and pressure fit plastic knobs from either side of the shade. Extend the shade fully with the smooth grain facing you.
2. Wrap the vinyl around the tube twice by twisting the tube away from you. Tuck the edges of the vinyl inside the end cap with each wrap.
3. Fold the vinyl toward the center, making sure the edges clear the end cap slots. Use tape or a rubber band to hold the vinyl on the left side of the tube.
4. Push in the right end cap (marked R) about 6 mm (1/4 inch) to disengage the clutch and hold in while turning the tube toward you fourteen times.
5. Let go of the right end cap and unfold the vinyl. Place the vinyl into the end cap slots.
6. Place the shade back in the vehicle.

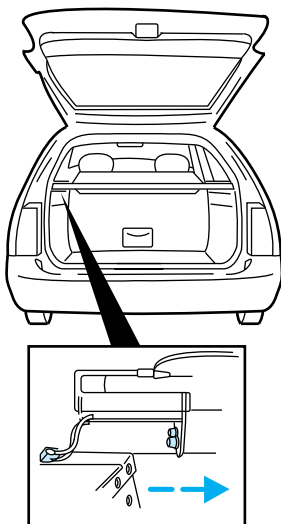

To avoid possible injury during a sudden stop or collision, the cover should be attached to the brackets when not in use.

Fuel pump shut-off switch

The fuel pump shut-off switch stops the fuel pump when the vehicle has been involved in a collision or substantial jolt. If the vehicle does not start, it is possible that the fuel pump shut-off switch needs to be reset.



If you see or smell fuel, do not reset the switch or try to start your vehicle. Have all the passengers get out of the vehicle and call the local fire department or a towing service.

The fuel pump shut-off switch is located in the rear passenger side of your vehicle. With the sedan model, a label marks its location.

Press the button on the switch to reset the fuel pump:

- Sedan

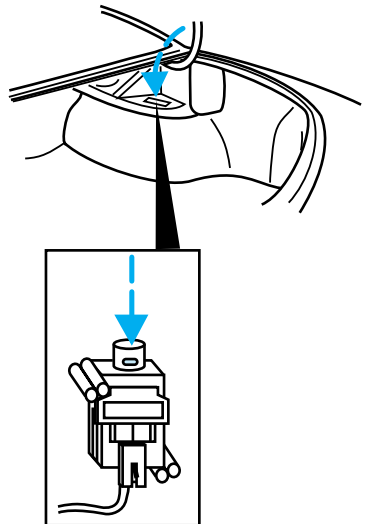

Controls and features

- Wagon

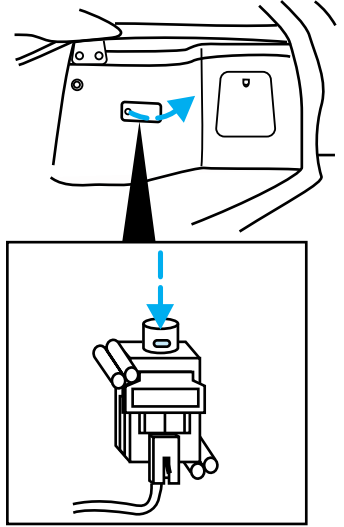

REMOTE ENTRY AND ANTI-THEFT SYSTEM

- Sedan

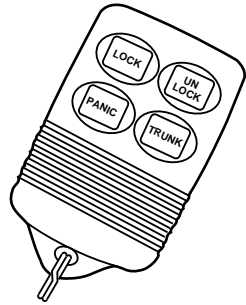

- Wagon

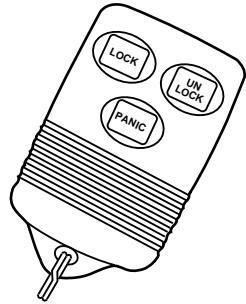

Remote entry system (if equipped)

The remote entry system is available as a driver-door only or as an all-door system. The remote entry features only operate with the ignition in the OFF position.

When the ignition is in ON or ACC, the system is disarmed. If the vehicle is left running and locked, the system will not allow reentry using the remote entry transmitter.

The operating range of the remote entry system may be affected by weather conditions (such as very

Controls and features

cold temperatures) or structures around the vehicle (buildings, other vehicles, radio and TV towers, etc.). Typical operating range will allow you to be up to 10 meters (33 ft) away from your vehicle.

Unlocking the doors and wagon liftgate

Driver-door only system

- Press once to unlock the driver side door.
- Press again within five seconds to unlock the wagon liftgate (if equipped)
- Sedan

- Wagon

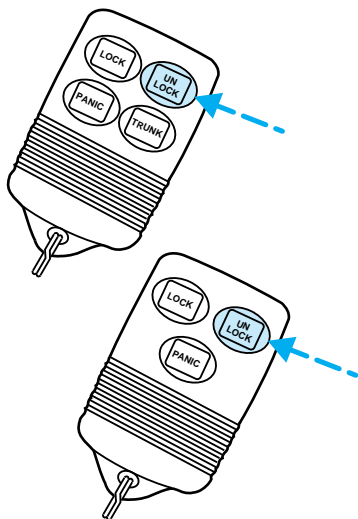

All-door system

- Press once to unlock the driver side door.

Controls and features

- Press again within five seconds to unlock passenger doors and wagon liftgate (if equipped).

Opening the trunk (if equipped)

Press once to open the trunk.

- Sedan

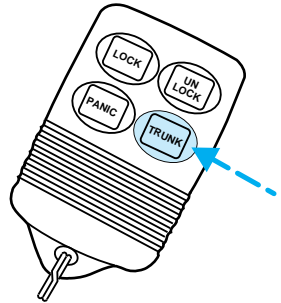

Locking the doors

Driver-door only system

- Press once to lock only the driver's door.
- Press again within five seconds to verify system has attempted to lock the door (horn will sound once and parking lamps will flash).

The remote opens and locks the driver's door only, it will not activate the other three doors.

A bright yellow key fob and "DRIVER'S DOOR ONLY" label are provided with your remote entry system. They provide an additional reminder that the remote entry system locks and unlocks only the driver's door.

If the other doors are unlocked, they will remain unlocked even after the system has locked the

Controls and features

driver's door. The other doors must be locked manually.

- Sedan

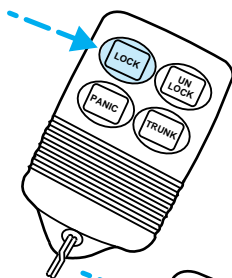

- Wagon

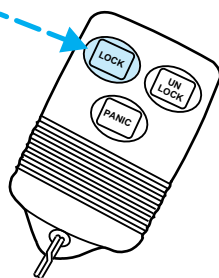

All-door system

- Press once to lock all doors.
- Press again within five seconds to verify doors are locked (horn will sound once and parking lamps will flash).

If a door is ajar, the horn will sound twice when the LOCK button is pressed a second time with the all-door system.

Controls and features

Sounding a panic alarm

Press once to sound an alarm (with either the driver-door only or all-door system).

- Sedan

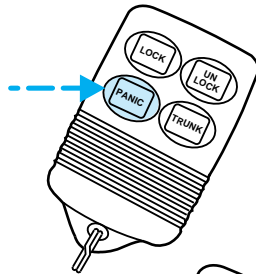

- Wagon

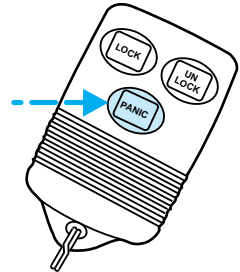

The parking lamps flash, the horn sounds, and the illuminated entry system turns on.

Press a second time to turn off the alarm.

Illuminated entry

Interior lamps illuminate when the UNLOCK button is pressed on the remote entry transmitter (if equipped). The illuminated entry function illuminates the interior overhead lamp for approximately 20 seconds, until the key is inserted into the ignition and turned to ON, or until the LOCK button is pressed on the remote entry transmitter. The interior overhead lamp must be set to the DOOR position in order for the

Controls and features

illuminated entry system to activate.

Anti-theft system (if equipped)

The anti-theft system protects against unauthorized entry into an armed and locked vehicle. When an unauthorized entry occurs, the system activates and:

- flashes the parking lamps and anti-theft indicator light
- sounds the horn

The horn and parking lamps shut off after approximately three minutes. The lights and horn will remain off unless another unauthorized entry is attempted.

Arming the system

The anti-theft system can be armed when:

- the ignition is in the LOCK position and the key is removed
- the panic alarm is off
- all doors are closed

Controls and features

Press once to arm the anti-theft system.

The THEFT light in the instrument cluster illuminates until the arming procedure is complete. After the arming procedure is complete, the THEFT light flashes.

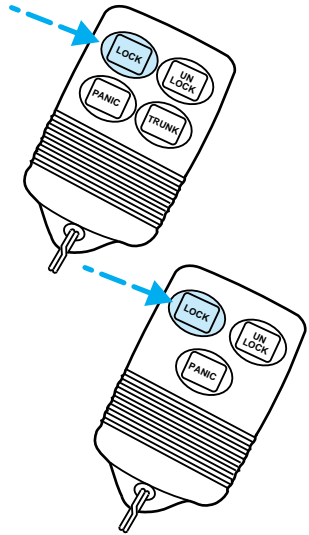

Disarming an untriggered system

Press once to disarm the untriggered anti-theft system.

If the driver armed the system but did not exit the vehicle, the system can also be disarmed by inserting the key and turning the ignition to ON.

The system will not disarm by using the key in any door/trunk lock cylinder.

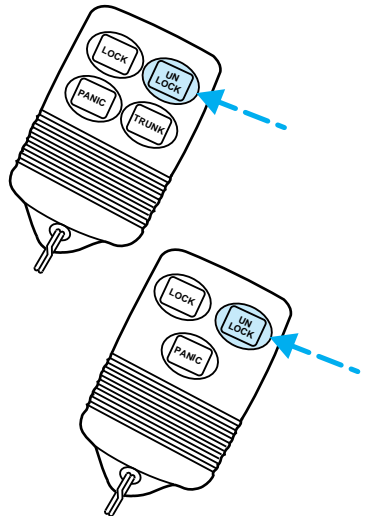

Controls and features

Disarming a triggered system

Press either the UNLOCK or PANIC button to disarm a triggered anti-theft system.

A triggered system can also be disarmed by inserting the key and turning the ignition to ON.

This device complies with Part 15 of the FCC rules. Operation is subject to the two following conditions: (1) this device may not cause harmful interference, and (2) this device must accept any interference received, including interference that may cause undesired operation.

Replacement batteries for the remote entry and/or anti-theft system transmitters can be purchased at pharmacies, watch stores, or at authorized dealers.

If a transmitter is lost, a new one may be programmed by your dealer. Take any remaining transmitters with you to the dealer so they may be reprogrammed.

The system will work with up to four transmitters. Your vehicle comes equipped with two transmitters; additional transmitters can be ordered from your dealer. It will be necessary to have all of the transmitters programmed to the remote entry system by the dealer at the same time.

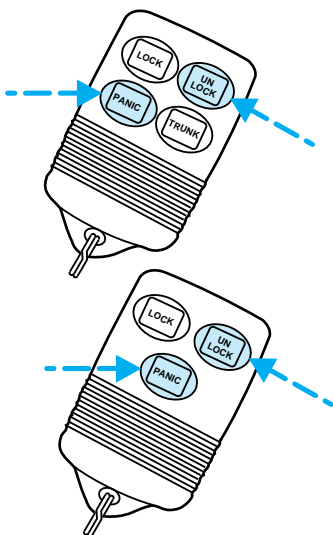

Seating and safety restraints

FRONT SEATS

Lift handle to slide the seat forward or backward



Lift to adjust the seatback

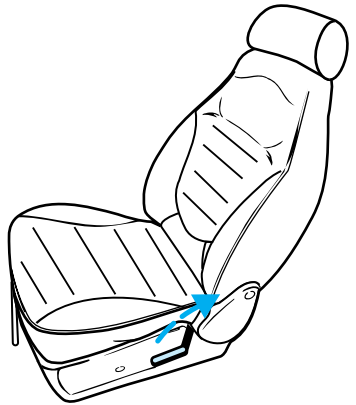

Seating and safety restraints

Head restraints

Push the release button to lower the head restraint

To raise the head restraint, pull without pushing the release button.

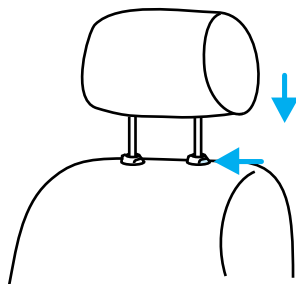

REAR SEATS

Stow the built-in child seat (if equipped) in order to fold the rear seatback down. Refer to *Built-in child seat* in this chapter for more information.

Push the seatback back to a raised position and latch for normal seating.

The full rear seat bench is shown. The split-folding rear seat (if equipped) operates in a similar manner.

Press to unlock the seatback:

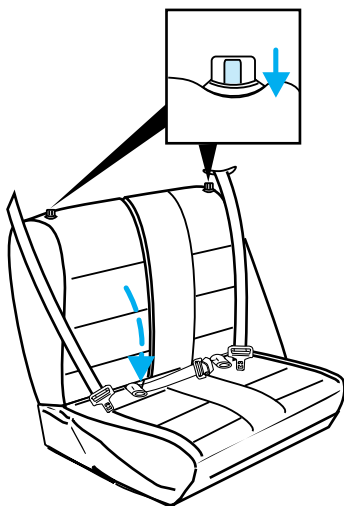

Seating and safety restraints

SAFETY RESTRAINTS PRECAUTIONS

The use of safety belts helps to restrain you and your passengers in case of a collision. In most states and in Canada, the law requires the use of safety belts.



To reduce the risk of serious injury in a collision, always drive and ride with your seatback upright and the lap belt snug and low across the hips.



Safety belts must be worn by all vehicle occupants to be properly restrained and help reduce the risk of injury in a collision.



To prevent the risk of injury make sure children sit where they can be properly restrained.



It is extremely dangerous to ride in a cargo area, inside or outside of a vehicle. In a collision, people riding in these areas are more likely to be seriously injured or killed.



Do not allow people to ride in any area of your vehicle that is not equipped with seats and safety belts.

Seating and safety restraints



Be sure everyone in your vehicle is in a seat and using a safety belt properly.

USING THE SAFETY RESTRAINTS PROPERLY

Combination lap and shoulder belts

Insert the tongue into the slot to fasten.

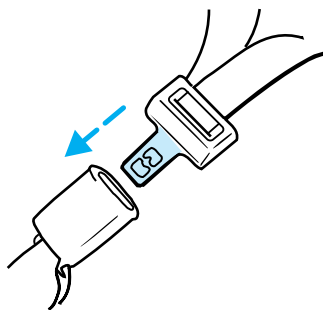

Push the red release button and remove the tongue from the slot to unfasten.

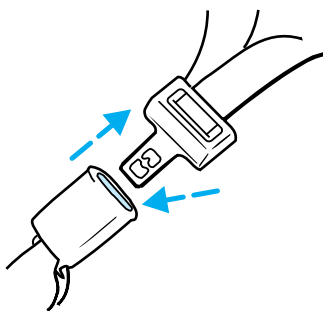

The lap belts should fit snugly and as low as possible around the hips, not around the waist.

The outboard safety restraints in the vehicle are combination lap and shoulder safety belts. The front and rear seat passenger outboard safety belts have the two types of locking modes.

Seating and safety restraints

Vehicle sensitive (emergency) locking mode

The vehicle sensitive mode is the normal retractor mode, which locks the belts in response to vehicle movement. For example, if the driver brakes suddenly or turns a corner sharply, the combination safety belts will lock to restrain forward movement of the driver and passengers.

The retractor can be made to lock by pulling sharply on the belt.



Automatic locking mode

In this mode, the occupant is locked in a certain position by the shoulder belt and the belt does not adjust tightness during vehicle movement.

The automatic locking mode is not available on the driver safety belt.

When to use the automatic locking mode

- When a tight lap and shoulder belt fit is desired.
- **Any time** a child safety seat is installed in the vehicle. For more information on the proper use of a child safety seat, refer to *Children and infant or child safety seats* later in this chapter.

Seating and safety restraints

Using the automatic locking mode

The automatic locking mode must be used when installing an aftermarket child safety seat in any outboard passenger seat.

1. Buckle the combination lap and shoulder belt.

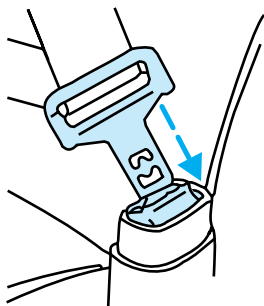

2. Grasp the shoulder belt portion and pull downward until the entire belt is extracted.

3. Allow the belt to retract. As the belt retracts, you will hear a clicking sound. This indicates that the safety belt is now in the automatic locking mode.

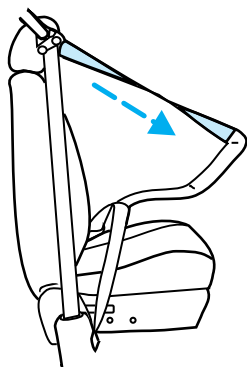

Canceling the automatic locking mode

Disconnect the combination lap and shoulder belt and allow it to completely retract. This will cancel the automatic locking mode and activate the vehicle sensitive (emergency locking) mode.

Seating and safety restraints

Front seat safety belt height adjustment

Adjust the height of the shoulder belt so the belt rests across the middle of your shoulder.

- To lower the height of the shoulder belt:

Push the button down.

Slide down.

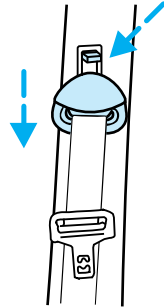

- To raise the height of the shoulder belt:

Slide up.

Pull down on the height adjustment assembly to make sure it is locked in place.

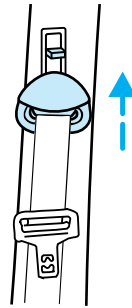

Lap belt

A lap belt is located in the center of the rear seat.

Adjusting the lap belt

Because the lap belt does not have a retractor to automatically adjust itself during vehicle movement, the lap belt should be adjusted before use.

- To shorten the belt:

Seating and safety restraints

Buckle the belt. Pull the loose end of the belt until snug.

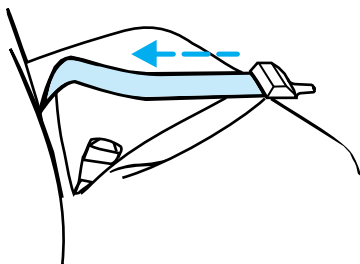

- To lengthen the belt:

Tip and pull the tongue.

The lap belt must fit snugly and as low as possible around the hips. Do not wear the lap belt around your waist.

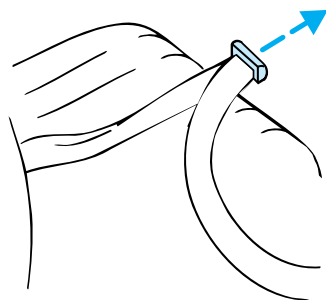

Safety belt maintenance

Check the safety belt systems periodically for damage and to ensure that they work properly.

Seating and safety restraints

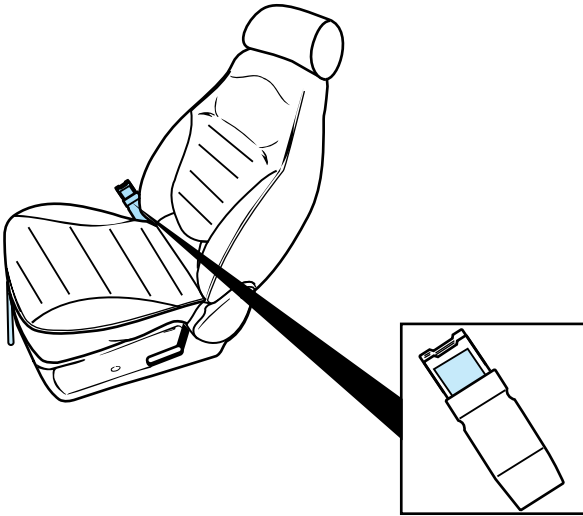

The short plastic boot on the front safety belt at the passenger inboard buckle location covers an energy absorbing sew pattern on the safety belt. In the event of a collision, the sew pattern may release, and the orange portion of the warning label may become visible. If this occurs, the safety belt and buckle must be replaced.



Failure to follow these instructions will affect the performance of the safety belts and increase the risk of personal injury.

Seating and safety restraints

SAFETY BELT INDICATOR LIGHT AND WARNING CHIME

 illuminates in the instrument cluster and a chime sounds to remind the occupants to fasten their safety belts.

Conditions of operation

| If . . . | Then . . . |
|--|--|
| The driver's safety belt is not buckled before the ignition key is turned to ON... | The safety belt indicator illuminates for one to two minutes and the warning chime sounds for 4-8 seconds. |
| The driver's side safety belt is buckled while the indicator light is illuminated and the warning chime is sounding... | The safety belt indicator light and the warning chime turn off. |
| The driver's safety belt is buckled before the ignition key is turned to ON... | The safety belt indicator light and warning chime remain off. |

AIR BAG PRECAUTIONS

Your vehicle is equipped with an air bag supplemental restraint system (SRS) designed to work with the safety belts to help protect you and your right front seat passenger in the event of a collision.



All occupants of the vehicle, including the driver, should always wear their safety belts, even when an air bag SRS is provided.

Seating and safety restraints

 Do not place objects or mount equipment on or near the air bag cover on the steering wheel or in front seat areas that may come into contact with a deploying air bag. Failure to follow this instruction may increase the risk of personal injury in the event of a collision.

 Do not attempt to service, repair, or modify the air bag SRS or its fuses. See your Ford or Lincoln-Mercury dealer.

AIR BAG SYSTEM DESCRIPTION

The air bags and their corresponding warning and information labels are found in the following locations:

The air bag system activates in collisions more severe than hitting a parked vehicle (of similar size and weight) head-on at approximately 20 km/h (13 mph). This activation speed may vary if your vehicle is involved in a collision with something that will move or deform and according to the angle of impact. The air bag is not designed to inflate in rollovers, side impacts, or rear impacts.

Air bags and air bag equipped vehicles should be disposed of only by qualified service personnel using Ford approved procedures.

The system consists of two parts:

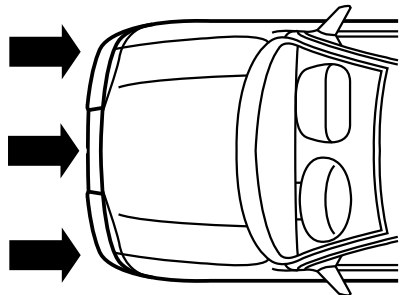
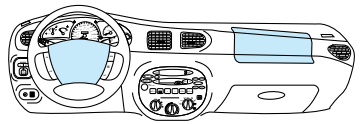

Seating and safety restraints

- The driver air bag in the middle of the steering wheel and the passenger air bag above the glove compartment.
- The electrical system, made up of impact sensors, a diagnostic module, and a backup power supply.

The air bags inflate within a fraction of a second after air bag sensors detect a severe frontal collision. Gas generators within the air bags fill the air bags with a non-toxic, non-flammable gas. After the vehicle occupants have impacted the air bags, the gas empties through holes in the air bags and the air bags deflate. You may notice smoke and smell the escaping gas after the air bags deflate. This is normal.

You and your passenger **must** wear your safety belts in order for the air bag system to operate effectively.

AIR BAG WARNING LIGHT AND WARNING CHIME

When you turn the ignition key to the ON position, the air bag system performs a self-check of the:

- air bag sensors
- air bag module
- air bag inflators
- available battery power
- air bag warning light

Following a successful system self-check, the  warning light



Seating and safety restraints

in the instrument cluster illuminates for approximately six seconds to indicate that the system is functional.

If you hear a group of five beeps, or if the  warning light does not illuminate, stays lit, or flashes, the air bag system requires immediate service. Have the vehicle serviced by your dealer.

CHILD RESTRAINT PRECAUTIONS

You are required by law to use safety restraints for children in the United States and Canada. If small children ride in your vehicle (generally children who are four years of age or younger and who weigh 18 kg [40 lb] or less), you must put them in safety seats made specially for children. Check your local and state laws for specific requirements regarding the safety of your children.



Never let a passenger hold a child on his or her lap while the vehicle is moving. The passenger cannot protect the child from injury in a collision.

Always follow the instructions and warnings that come with any infant or child restraint you might use.

If possible, place children in the rear seat of your vehicle. Accident statistics suggest that children are safer when properly restrained in rear seating positions than when

Seating and safety restraints

they are restrained in front seating positions.



Rear-facing infant seats should never be placed in the front seat.

CHILDREN AND SAFETY BELTS

Children who are too large for child safety seats (as specified by the manufacturer of your child safety seat) should always wear safety belts.

Follow all the important safety restraint and air bag precautions that apply to adult passengers in your vehicle.

If the shoulder belt portion of a combination lap and shoulder belt can be positioned so it does not cross or rest in front of the child's face or neck, the child should wear the lap and shoulder belt. Moving the child closer to the center of the vehicle may help to provide a good shoulder belt fit.

To improve the fit of lap and shoulder belts on children who have outgrown child safety seats, Ford recommends use of a belt-positioning booster seat that is labelled as conforming to all Federal motor vehicle safety standards. Belt-positioning booster seats raise the child and provide a shorter, firmer seating cushion that encourages safer seating posture and better fit of lap and shoulder belts on the child. A

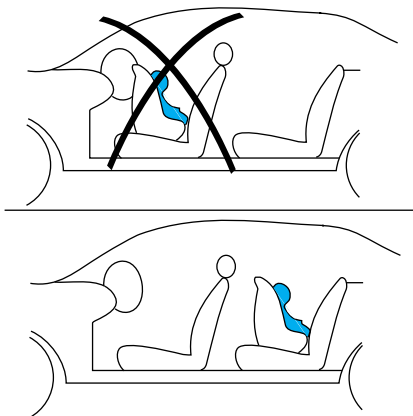

Seating and safety restraints

belt-positioning booster should be used if the shoulder belt rests in front of the child's face or neck, or if the lap belt does not fit snugly on both thighs, or if the thighs are too short to let the child sit all the way back on the seat cushion when the lower legs hang over the edge of the seat cushion. You may wish to discuss the specific needs of your child with your pediatrician.

CHILDREN AND INFANT OR CHILD SAFETY SEATS



Carefully follow all of the manufacturer's instructions included with the safety seat you put in your vehicle. If you do not install and use the safety seat properly, the child may be injured in a sudden stop or collision.

When installing a child safety seat:

- use the correct safety belt buckle for that seating position.
- make sure the tongue is securely fastened in the buckle.
- keep the buckle release button pointing up and away from the safety seat, with the tongue between the child seat and the release button, to prevent accidental unbuckling.
- place seatbacks in the upright position.

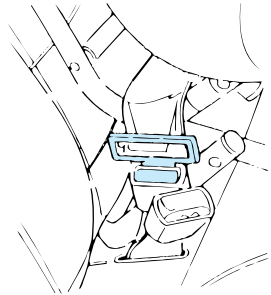

Seating and safety restraints

- put the safety belt in the automatic locking mode. Refer to *Using the automatic locking mode* in this chapter.

Installing child safety seats in combination lap and shoulder belt seating positions

1. Position the child safety seat in a seat with a combination lap and shoulder belt.

If you choose to install a child safety seat in the front passenger seat, move the seat as far back as possible.



2. Pull down on the shoulder belt and then grasp the shoulder belt and lap belt together.

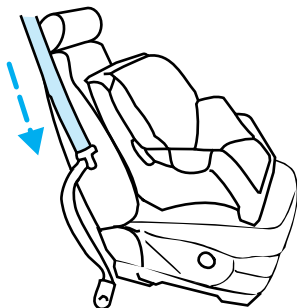

Seating and safety restraints

3. While holding the shoulder and lap belt portions together, route the tongue through the child seat according to the child seat manufacturer's instructions. Be sure the belt webbing is not twisted.

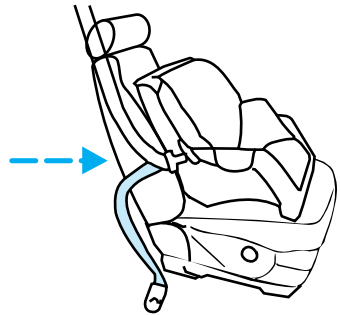

4. Insert the belt tongue into the proper buckle until you hear and feel the latch engage. Make sure the tongue is latched securely by pulling on it.

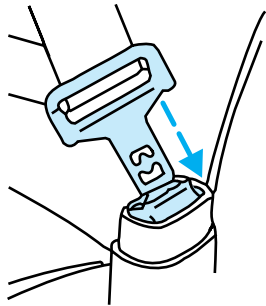

5. To put the retractor in the automatic locking mode, grasp the shoulder portion of the belt and pull downward until all of the belt is extracted.

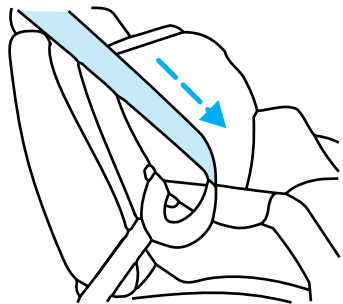

6. Allow the belt to retract. The belt will click as it retracts to indicate it is in the automatic locking mode.

Seating and safety restraints

7. Pull the lap belt portion across the child seat toward the buckle and pull up on the shoulder belt while pushing down on the child seat to tighten the belt as much as possible.

8. Allow the safety belt to retract to remove any slack in the belt.

9. Before placing the child in the seat, forcibly tilt the seat from side to side and forward and back to make sure the seat is securely held in place.

10. Try to pull the belt out of the retractor to make sure the retractor is in the automatic locking mode (you should not be able to pull more belt out). If the retractor is not locked, unbuckle the belt and repeat steps two through nine.

- Check to make sure the child seat is properly secured before each use.

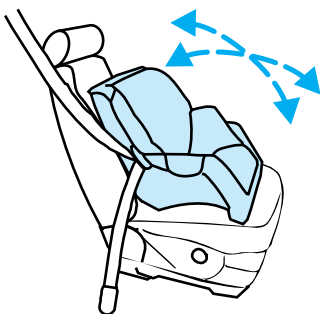
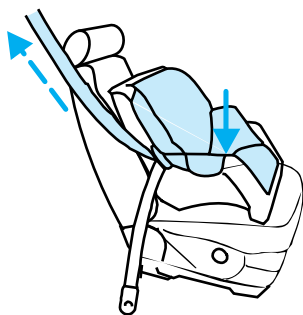

Installing child safety seats in the rear center seating position

1. Tip the tongue and pull to lengthen the lap belt.

2. Place the child safety seat in the center seating position.

3. Route the lap belt through the child safety seat according to the child seat manufacturer's instructions.

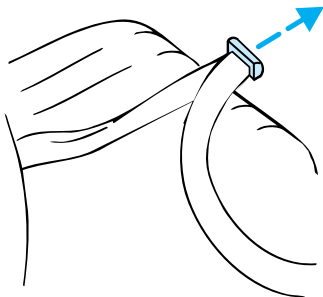

Seating and safety restraints

4. Insert the tongue into the proper buckle.
5. Push down on the child safety seat while pulling on the loose part of the lap belt webbing to tighten the belt.
6. Before placing the child in the child safety seat, forcibly tilt the seat from side to side and forward and back to make sure the seat is securely held in place. If the child seat moves excessively, repeat steps five and six or properly install the child seat in a different seating position.

Using a tether strap

Contact the manufacturer of your safety seat for information about ordering a tether strap if one is not provided with the seat. The tether anchor hardware kit is part number 613D20.

Your vehicle has tether anchor attachment locations on the rear package tray behind the back seat (sedan) or along the rear edge of the roof (wagon). Carefully follow the instructions provided with the kit.

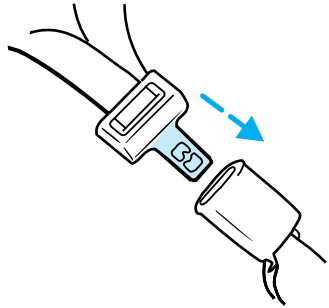

Seating and safety restraints

Tether anchor hardware (Canadian vehicles only)

All vehicles built for sale in Canada include a tether anchor hardware kit for use with Canadian child safety seats. Attachment holes (at each rear seating position) have been provided in your vehicle to attach the anchor hardware, if required. Additional kits can be obtained at no charge from any Ford or Lincoln-Mercury dealer.

Tether anchor hardware (US vehicles only)

Vehicles built for sale in the US do not include a tether anchor hardware kit for use with child safety seats. However, attachment holes (at each rear seating position) have been provided in your vehicle to attach the anchor hardware, if required. Kits can be obtained at no charge from any Ford or Lincoln-Mercury dealer.



Only use the tether attachment hole locations shown. The tether anchor may not perform properly if the wrong mounting location is used.

Ford recommends using child safety seats with a top tether strap designed to secure an aftermarket child safety seat in the front or rear seating position. Follow the child safety seat manufacturer's instructions for installing a child safety seat with a tether strap.

Seating and safety restraints

Ford recommends you attach tethered safety seats in a rear seating position with the tether strap attached to the tether anchoring bracket as shown in the instructions provided with the tether anchor kit.

If a tethered seat must be installed in the front passenger seat:

1. Install the child safety seat in the front passenger seat. For instructions on how to install the seat, refer to *Installing child safety seats in combination lap and shoulder belt seating positions* in this chapter.
2. Hook the tether strap clip to the tongue of the rear center lap belt and ensure that the belt is pulled tight.

To install a child safety seat using a tether strap in the back seat:

1. Install the child safety seat in the rear right, left or center seat position. For instructions on how to install the seat, refer to *Installing child safety seats in lap belt seating positions* in this chapter.

- Sedan

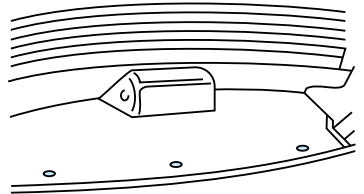
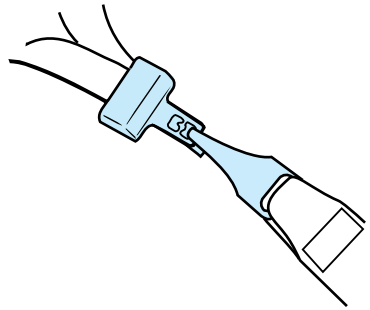

Seating and safety restraints

- Wagon
2. Refer to the instructions provided with the tether anchor kit.
 3. Refer to the instructions provided with your child safety seat to securely attach the child safety seat by tether to the tether strap anchor location.



Failure to follow these precautions could increase the risk and / or severity of injury in a collision.

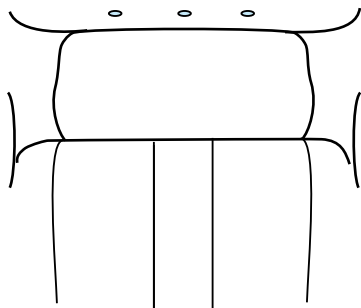

BUILT-IN CHILD SEAT (IF EQUIPPED)

The rear seat may include a built-in child seat. This child seat conforms to all federal and Canadian motor vehicle safety standards.

Read the labels located on the child seat cushion and the shoulder belt for information on the built-in child seat.

Use the built-in child seat **only** under the following conditions:

| | | |
|-----------------------|---------------------|---|
| At least one year old | 10-27 kg (22-60 lb) | Shoulders must be below the shoulder harness slots on the built-in child seat |
|-----------------------|---------------------|---|

Children not meeting these requirements should be secured in an approved aftermarket child seat. Refer to *Children and infant or child safety seats* in this chapter.

Seating and safety restraints

Regularly inspect the lap and shoulder belt system of your child seat. If there is any damage to the system or if it is not functioning properly, see your dealer.

Placing your child in the built-in child seat



Failure to follow all of the instructions on the use of this child restraint system can result in your child striking the vehicle's interior during a sudden stop or crash.



Never use the built-in child seat as a booster cushion with the adult safety belts. A child using the adult belts could slide forward and out from under the safety belts.



The rear seatback must be fully locked before operating the child restraint system.

Seating and safety restraints

Ensure that the latch release buttons are in the full up (locked) position.

When the latch release buttons are in full up (locked) position and the built-in child seat is open, the rear seatback cannot be unlocked or folded down.

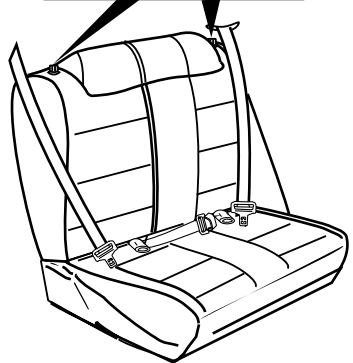
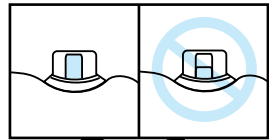

1. Pull down the top portion of the child seat.



Seating and safety restraints

2. Release the cushion retention clip.

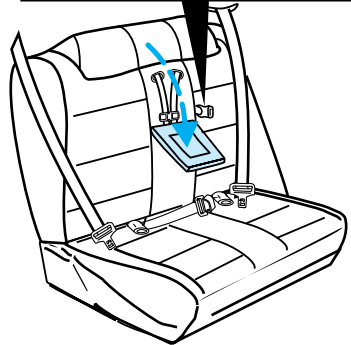
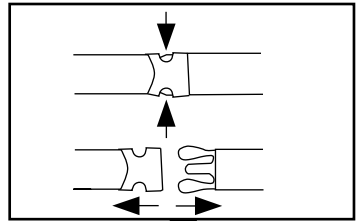

3. Lower the child seat cushion.
If the child seat cannot be opened,
return it to the dealer for repair.

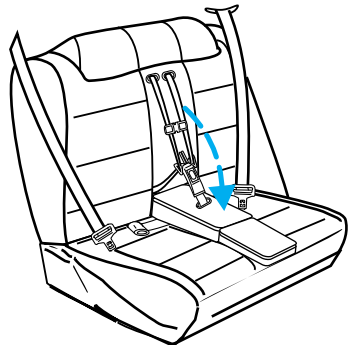

Seating and safety restraints

4. Fold the end portion of the child seat under the child seat cushion.

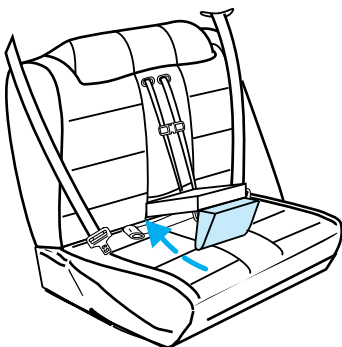

5. Disconnect the chest clip, if connected. Squeeze together the release tabs on the top and bottom of the chest clip.

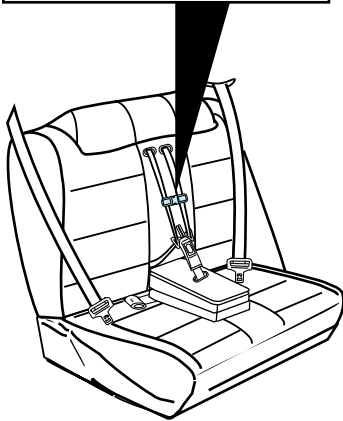
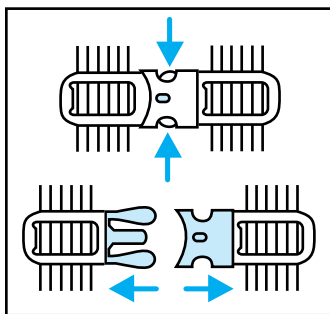

Seating and safety restraints

6. Place the child in the seat and position the shoulder belts.

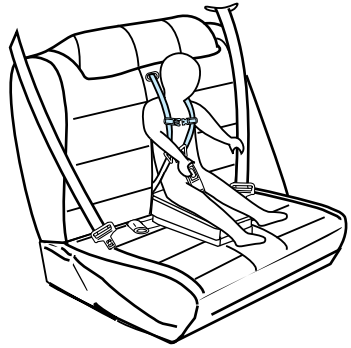

7. Insert the left safety belt tongue into the left side of the buckle. Repeat for the right side. Verify that the indicator window on each tongue is green to ensure proper safety belt connections.

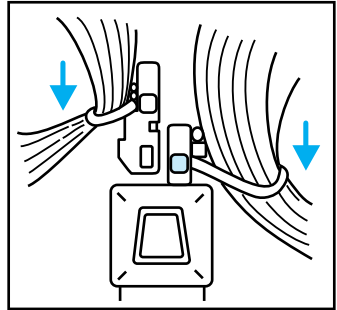

Seating and safety restraints

 If both tongues do not latch in the buckle, do not use the child seat. See your dealer for repairs.

8. Fasten the left and right chest clip halves together to hold the shoulder belts in place comfortably on the child's shoulders. Verify that the indicator window on the chest clip is green to ensure a proper chest clip connection.

- When either of the tongues or the chest clip is unbuckled, the red color appears in the window.
- The chest clip is designed to pull apart easily in the event of collision. The clip helps keep the belts on the shoulders of a squirming or sleeping child.

9. Pull on the safety belt tongues to ensure they are both securely latched. If they are not latched, repeat steps seven and eight.

If necessary, the shoulder belts can be put in the automatic lock mode to limit the child's movement in the child seat. The mode may be used if the child is sleeping or attempting to get out of the child seat.

If not placed in an automatic locking mode, the child seat shoulder belts are in the vehicle sensitive (emergency locking) mode which locks the shoulder belt in the event of a crash, hard braking, or hard cornering.

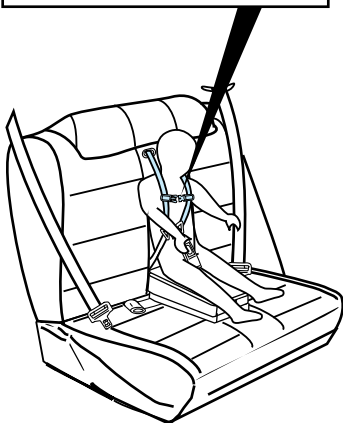
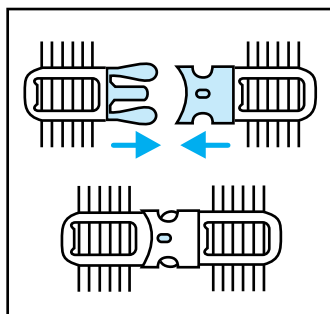

Seating and safety restraints

Activating the automatic locking mode on the built-in child seat

1. Fully pull out both shoulder belts.
2. Allow the belts to tighten snugly against the child's shoulders.

Canceling the automatic locking mode on the built-in child seat

1. Disconnect the chest clip. Press the buckle release button and remove both safety belt tongues from the buckle.
2. Slide both shoulder belts from the child's shoulders and arm and allow them to retract fully.



Seating and safety restraints

Removing your child from the built-in child seat

1. Disconnect the chest clip by squeezing the release tabs together and pulling the two sides apart.

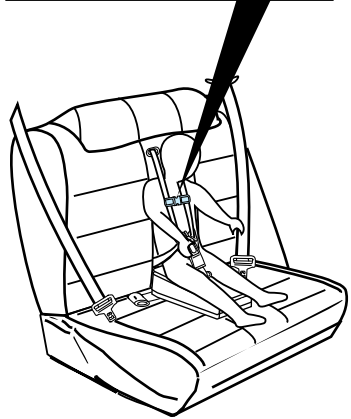
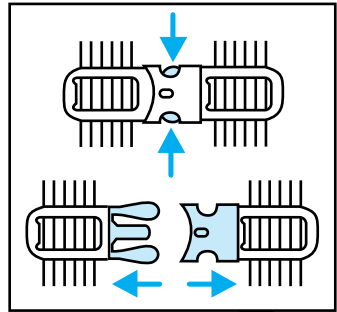

Seating and safety restraints

2. Press the release button on the buckle.
3. Slide the shoulder belts off the child's shoulders and remove the child.
4. Return the child seat cushion to the stowed (upright) position.
5. Ensure the shoulder belts are in the center of the built-in child seatback and connect the cushion retention clip.
6. Fold the child seat into the seatback and tuck the top of the child seat under the rear seat flap.
7. Press firmly on the center of the built-in child seat to ensure it is stowed properly.

When not in use, the built-in child seat can be stowed so that the rear center seat position may be used or the rear seatback can be folded down.

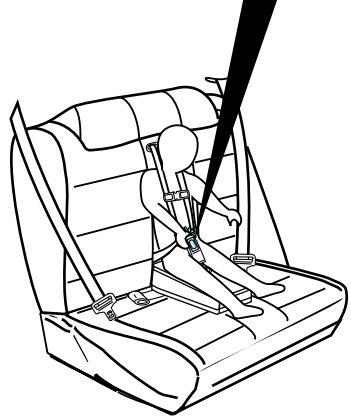
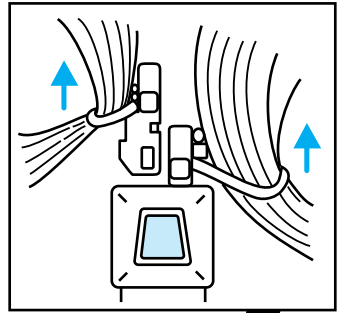

Seating and safety restraints

Inspecting the built-in child seat after a collision



All built-in child restraints, including seats, buckles, retractors, seat latches, interlocks, and attaching hardware should be inspected by a qualified Dealer technician after any collision. If the child seat was in use during a collision, Ford recommends replacing it. However, if the collision was minor and a qualified technician finds that the child restraints do not show damage and continue to operate properly, they do not need to be replaced. Built-in child seats not in use during a collision should also be inspected and replaced if either damage or improper operation is noted.

For information on cleaning your built-in child seat, refer to *Cleaning the built-in child seat* in the *Maintenance and care* section.

A computer system controls the engine's idle revolutions per minute (RPM). When the engine starts, the idle RPM runs higher than when the engine is warm. If the engine idle speed does not slow down automatically, have the vehicle checked. Do not allow the vehicle to idle for more than ten minutes.



Extended idling at high engine speeds can produce very high temperatures in the engine and exhaust system, creating the risk of fire or other damage.



Do not park, idle, or drive your vehicle in dry grass or other dry ground cover. The emission system heats up the engine compartment and exhaust system, which can start a fire.



Do not start your vehicle in a closed garage or other enclosed area. Never sit in a stopped vehicle for more than a short period of time with the engine running. Exhaust fumes are toxic. For more information and instructions, refer to *Guarding against exhaust fumes* in this chapter.

Starting

PREPARING TO START THE VEHICLE

Engine starting is controlled by the spark ignition system. This system meets all Canadian

Interference-Causing Equipment standard requirements regulating the impulse electrical field strength of radio noise.

Before starting the vehicle:

1. Make sure all vehicle occupants have buckled their safety belts. For more information on safety belts and their proper usage, refer to the *Seating and safety restraints* chapter.
2. Make sure the headlamps and vehicle accessories are off.

If starting a vehicle with an automatic transaxle:

- Make sure the parking brake is set.

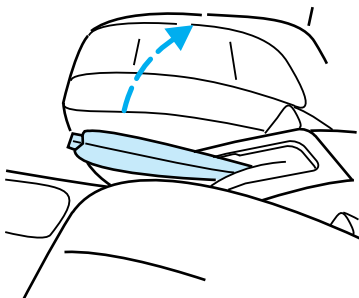
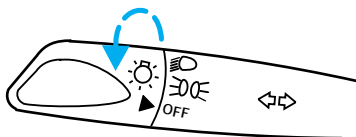

If starting a vehicle with an automatic transaxle:

- make sure that the gearshift is in P.

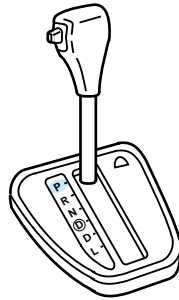

If starting a vehicle with a manual transaxle:

- push the clutch pedal to the floor.

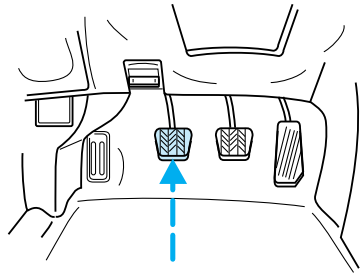

- place the gearshift in the neutral position.

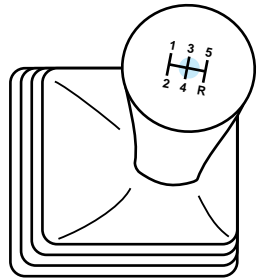

Starting

4. Turn the key to the ON position (without turning the key to START). Make sure the following lights illuminate briefly. If a light fails to illuminate, have the vehicle serviced.

If the driver's safety belt is fastened, the  light does not illuminate.

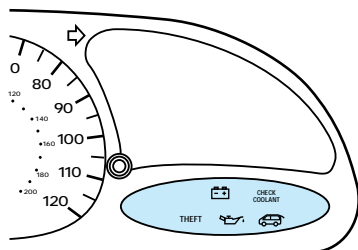
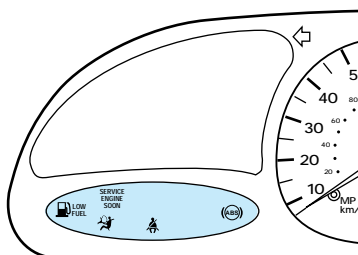
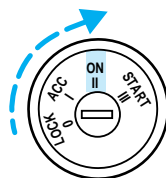

STARTING THE VEHICLE

After completing the steps under *Preparing to start the vehicle*:

1. Turn the key to START and release. **Do not** press the accelerator.

- The key will return to the ON position.

2. After idling for a few seconds, apply the brake and release the parking brake.

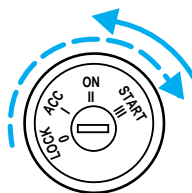

Special conditions when starting

Starting a cold engine

At temperatures -12°C (10°F) and below, do not hold the key in the START position longer than 15 seconds. If the engine does not start on the first attempt:

1. Turn the ignition key to LOCK and wait approximately ten seconds.
2. Try starting the engine again.

At temperatures above -12°C (10°F), do not hold the key in the START position longer than five seconds. If the engine does not start on the first attempt:

1. Turn the ignition key to LOCK and wait approximately five seconds.
2. Try starting the engine again.

Starting a warm engine

Do not hold the key in the START position longer than five seconds. If the engine does not start on the first attempt:

1. Turn the ignition key to LOCK and wait a few seconds until the starter stops.
2. Try starting the engine again.

Starting the engine after two failed attempts

If the engine does not start after two attempts:

1. Turn the key to LOCK and wait about two minutes.

Starting

2. Press the accelerator all the way to the floor and hold.
3. Turn the key to START. Release it once the engine starts.
4. Release the accelerator gradually as the engine speeds up.

If the engine still does not start, refer to *Fuel pump shut-off switch* in the *Roadside emergencies* chapter.

Using the engine block heater (if equipped)

Engine block heaters are strongly recommended if you live in a region where temperatures consistently reach -29°C (-20°F) or below during the winter months. An engine block heater warms the engine coolant, which improves starting, warms up the engine faster, and allows the heater-defrost system to respond quickly.

If your vehicle is equipped with an engine block heater, use it whenever the temperature is -23°C (-10°F) or below.

To turn the heater on, plug it into a grounded 110-volt outlet. It is recommended that you use a 110-volt circuit that is protected by a Ground Fault Circuit Interrupter.

For best results, plug the heater in at least three hours before you start your vehicle. Using the heater for longer than three hours will not damage the engine, so you can

plug it in at night to start the vehicle the next morning.



Do not use your heater with ungrounded electrical systems or two-pronged (cheater) adapters. You can be injured by an electrical shock if you use an ungrounded connection.

GUARDING AGAINST EXHAUST FUMES

Carbon monoxide, although colorless and odorless, is present in exhaust fumes. Take precautions to avoid its dangerous effects.



If you smell exhaust fumes inside your vehicle, have your dealer inspect your vehicle immediately. Do not drive if you smell exhaust fumes.

Have the exhaust and body ventilation systems checked whenever:

- the vehicle is raised for service
- the sound of the exhaust system changes
- the vehicle has been damaged in a collision

Improve vehicle ventilation by keeping all air inlet vents clear of snow, leaves, and other debris.

Starting

If the engine is idling while the vehicle is stopped in an open area for long periods of time, open the windows at least 2.5 cm (1 in). Adjust the heating or air conditioning (if equipped) to bring in fresh air.

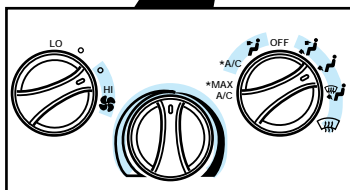
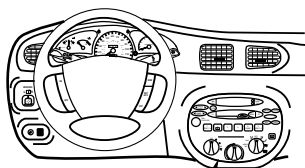

*If equipped with air conditioning

BRAKES

Power-assisted brakes

Apply the brake pedal gradually to avoid locking up the wheels. The brakes will adjust automatically as the brake pads or linings wear down.

Utilize these strategies for maximum braking performance:

- If driving down a long or steep hill, shift to a lower gear and do not apply the brakes continuously. Continuously applying the brakes on a hill could overheat them and make them less effective.
- Occasional brake squeal during light to moderate stops is normal. Significantly increased squeal is an indicator that brake service is needed.
- Apply the brakes gently several times after driving through standing water or washing your vehicle to dry them.

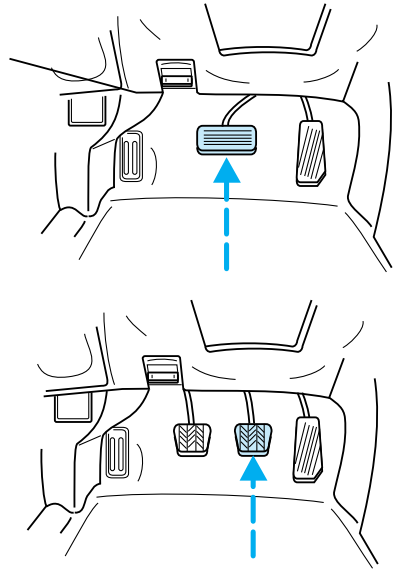

Anti-lock brake system (ABS)

Apply ABS brakes steadily. **Do not** pump the brakes in a panic stop. The brake system will prevent wheel lockup by automatically releasing and reapplying the brakes.

Even with ABS, the brakes could lock up on roads with alternating slippery and dry patches or with loose surfaces such as snow or gravel. Be careful when braking.

Driving

The ABS brake system conducts a self-test each time the vehicle is driven. A mechanical noise may be heard while the system conducts its self-test.

ABS warning light

The  light in the instrument cluster illuminates and remains illuminated if an ABS fault is detected. Have your vehicle serviced by a qualified service technician as soon as possible.

Normal braking operation is still effective unless the  light is also illuminated.

Parking brake

The parking brake should be used whenever the vehicle is parked.

To set the parking brake:

The parking brake is not designed to stop a moving vehicle. However, if the normal brakes fail, the parking brake can be set to stop the vehicle. The vehicle's stopping distance will increase greatly and vehicle steering response will be limited.

When the ignition is turned to ON, the  light in the instrument cluster illuminates and remains illuminated until the parking brake is released.

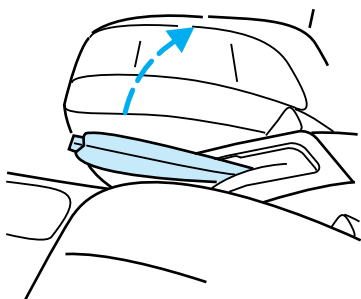



If the parking brake is fully released but the warning light remains on, have the brakes checked immediately. They may not be working properly.



Always set the parking brake fully and make sure that the gearshift is securely latched in P (automatic transaxle) or first gear (manual transaxle).

To release the parking brake:

- While pressing the release button, pull the handle upward to release the brake.
- Push handle downward to the off position.

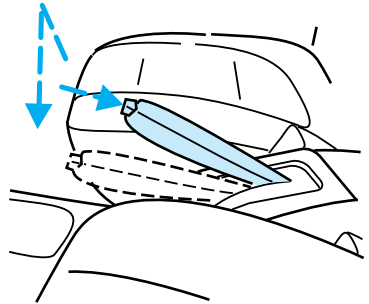

Driving

TRANSAXLES

Automatic

The normal driving position for the automatic transaxle is the **D** position.

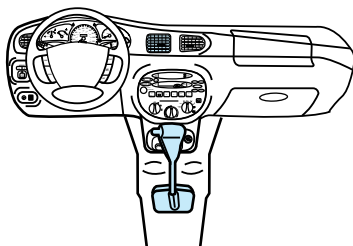

To move the automatic transaxle gearshift:

P — Park

R — Reverse

N — Neutral

D — Overdrive: the normal driving position for best fuel economy

D — Drive: more engine braking than **D**

L — Low: more engine braking than D at speeds up to 60 km/h (38 mph)

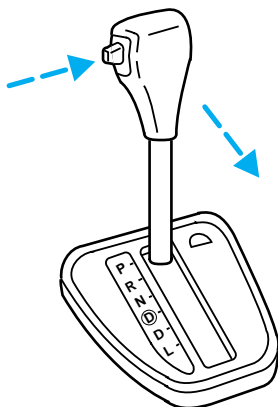
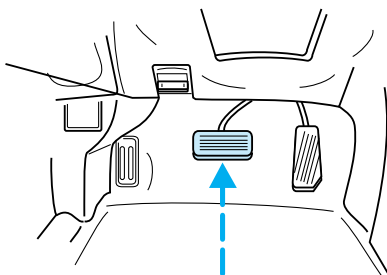



Hold the brake the pedal down while you move the gearshift lever from position to position. If you do not hold the brake pedal down, your vehicle may move unexpectedly and cause injury.

Moving a locked gearshift

Automatic transaxle vehicles are equipped with a shift-lock safety feature that prevents the gearshift from being moved out of P without the brake pedal depressed.

If you cannot move the gearshift out of P with the brake pedal depressed:

1. Continue depressing the brake pedal, and remove the shift-lock override cap with a 2.5 cm (1 inch) or longer screwdriver.
2. Insert the screwdriver into the shift-lock override opening and push down.

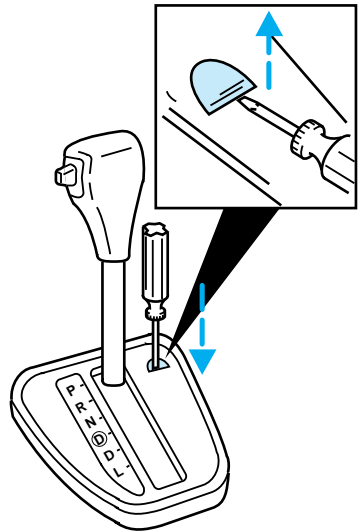

Driving

3. Push and hold the thumb button.
4. Move the gearshift.

If it is necessary to use the above procedure to move the gearshift, it is possible that a fuse has blown and the vehicle's brakelamps may not be operating properly. For more information on fuses and fuse replacement, refer to *Fuses and relays* in the *Roadside emergencies* chapter.

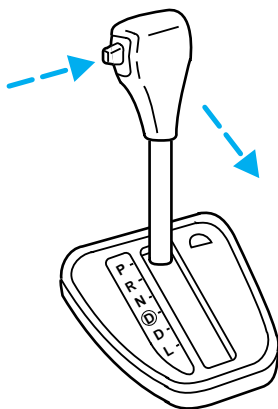

Do not drive your vehicle until you verify that the brakelamps are working.

If an automatic transaxle vehicle gets stuck in mud or snow it may be rocked out of the spot. To rock the vehicle out, shift between forward and reverse gears in a steady rhythm. Press lightly on the accelerator in each gear. Do not rock the vehicle for more than a few minutes; this could damage the vehicle.



Do not spin the wheels at over 55 km/h (35 mph). The tires may fail and injure a passenger or bystander.

Manual

To move the manual transaxle gearshift:

- Depress the brake pedal and then the clutch.
- Move the gearshift to the selected gear.

Always come to a complete stop before shifting into R. Shift through the neutral position (in the center) before moving the gearshift into R. If R is not engaged, move the gearshift lever back to the neutral position, release the clutch, and try again.

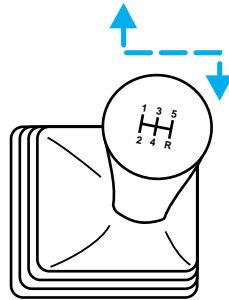
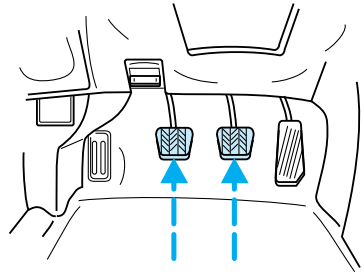
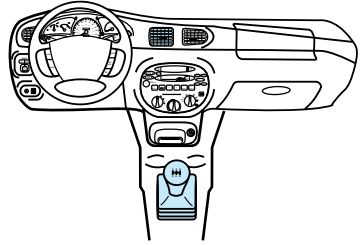

Driving

Upshifting

For normal acceleration:

| Upshift from... | At the following speed: |
|------------------------|--------------------------------|
| 1 to 2 | 22 km/h (14 mph) |
| 2 to 3 | 40 km/h (25 mph) |
| 3 to 4 | 58 km/h (36 mph) |
| 4 to 5 | 72 km/h (45 mph) |

For cruising:

| Upshift from... | At the following speed: |
|------------------------|--------------------------------|
| 1 to 2 | 18 km/h (11 mph) |
| 2 to 3 | 35 km/h (22 mph) |
| 3 to 4 | 51 km/h (32 mph) |
| 4 to 5 | 66 km/h (41 mph) |

Upshift light (if equipped)

The  light in the instrument cluster illuminates to indicate when to shift for the best fuel economy. The vehicle will not be harmed if the transaxle is not shifted when the light illuminates, but the vehicle will use more fuel.

The  light can be ignored when you are:

- downshifting
- driving on steep hills
- using the engine to brake the vehicle
- seeking more power for a difficult acceleration

To maximize gearshift performance:

- Do not drive with your foot resting on the clutch pedal and do not use the clutch pedal to hold the vehicle at a standstill. These actions will reduce clutch life.
- Downshift on steep hills to reduce the vehicle's chances of stalling and to prevent unnecessary brake wear.

LOADING YOUR VEHICLE

Before loading a vehicle, familiarize yourself with these terms:

- **Base curb weight** — weight of the vehicle including any standard equipment, fluids, lubricants, etc. It does not include passengers or aftermarket equipment.
- **Payload** — combined maximum allowable weight of cargo, passengers and optional equipment.
- **GVW (Gross vehicle weight)** — base curb weight plus the payload weight (including passengers, cargo and optional equipment). Remember, the GVW is not a limit or a specification.
- **GVWR (Gross vehicle weight rating)** — maximum total weight of the base vehicle, passengers, optional equipment, and cargo. The GVWR is specific to each vehicle and is listed on the Safety Compliance Certification Label on the driver's door pillar.

Driving

- **GAWR (Gross axle weight rating)** — carrying capacity for each axle system (front and rear). This amount is specific to each vehicle and is listed on the Safety Compliance Certification Label on the driver's door pillar.

Payload = Gross vehicle weight rating - Base curb weight

To obtain correct weights, try taking your vehicle to a shipping company or an inspection station for trucks.

Do not use replacement tires with lower weight capacities than the originals because they may lower the vehicle's GVWR and GAWR limitations. (Replacement tires with a higher weight limit than the originals do not increase the GVWR and GAWR limitations.)



If the GVWR or the GAWR specified on the Safety Compliance Certification Label is exceeded, your vehicle may be damaged or you may lose control and cause injury.

Trailer towing

Your vehicle is capable of towing a trailer up to 454 kg (1000 lb) gross trailer weight with a maximum tongue load of 45 kg (100 lb). The trailer should have 18.6 m² (20 ft²) or less frontal area.

Do not exceed the maximum loads stated on the Safety Compliance Certification Label. For load

specification terms found on the label, refer to *Loading your vehicle* in this chapter. Remember to figure in the tongue load of your loaded trailer when figuring the total weight.



Towing trailers beyond the maximum recommended gross trailer weight exceeds the limits of the vehicle and could result in engine damage, transaxle/axle damage, structural damage, loss of control, and personal injury.

Preparing to tow

Use the proper equipment for towing a trailer and make sure it is properly attached to your vehicle. See your dealer or a reliable trailer dealer if you require assistance.

Auxiliary coolers are recommended for the power steering system and automatic transaxle system (if equipped) if you are planning on:

- traveling farther than 80 km (50 miles).
- towing in hilly terrain.
- towing frequently.

Using a hitch

Do not use hitches that clamp onto the vehicle bumper. Use a load carrying hitch.

Distribute the load so that only 10 to 15% of the total weight of the trailer is on the tongue. Tie down the load so that it does not shift

Driving

and change the weight on the hitch.

Using trailer brakes

Use electric brakes or manual, automatic, or surge-type hydraulic brakes that meet federal and local regulations. Install and adjust the brakes according to the manufacturer's instructions.



Do not connect a trailer's hydraulic brake system directly to your vehicle's brake system. Your vehicle may not have enough braking power and your chances of having a collision greatly increase.

Using safety chains

Always connect the trailer's safety chains to the vehicle. To connect the chains, cross the chains under the trailer tongue and attach to the vehicle frame or hook retainers (not the bumper). Make sure there is enough slack to allow the vehicle to turn corners.

Using trailer lamps

See your local trailer dealer or rental agency for the proper instructions and equipment for hooking up trailer lamps.

Do not hook the trailer lights directly into the vehicle's lighting system wiring. If the trailer lamps are not installed properly, the warning lights in the instrument cluster may not work properly.

Driving while towing a trailer

Do not drive faster than 88 km/h (55 mph) while towing a 454 kg (1000 lb) trailer. Do not drive faster than 72 km/h (45 mph) with any weight trailer while towing in hilly country or on hot days.

Speed control (if equipped) may not work properly while towing on very long, steep grades.

If driving with an automatic transaxle:

- use D or L rather than  while towing up or down steep hills.
- anticipate stops and brake gradually.

If driving with a manual transaxle:

- select a gear that avoids jerking or excessive engine speed.
- avoid driving excessively in first or second gear. In first or second gear the trailer may be too big or too heavily loaded for the vehicle drivetrain.
- shift to a lower gear while towing up or down steep hills.
- anticipate stops and brake gradually.

Servicing while towing

If you tow a trailer for long distances, your vehicle requires more frequent service than a vehicle not used for towing. Refer to the *Service Guide* for more information.

Driving

Towing behind a recreational vehicle (RV)

Do not tow your vehicle behind another vehicle, such as an RV, unless front wheel dollies are used.

Luggage rack (if equipped)

Load luggage as far back as it will safely go on the rack without causing the vehicle to exceed the gross vehicle weight rating (GVWR) or gross axle weight rating (GAWR).

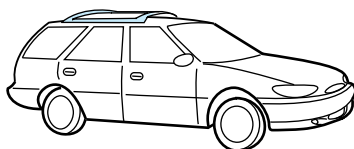

FUEL CONSUMPTION

Fuel economy can be improved by avoiding:

- lack of regular, scheduled maintenance
- excessive speed
- rapid acceleration
- driving with the brake pedal depressed
- sudden stops
- extended engine idling
- use of speed control in hilly terrain
- extended use of the air conditioner, defroster, rear window defroster and other accessories
- underinflated tires
- heavy loads
- aftermarket add-ons such as bike, ski or luggage racks, bug deflectors, etc.

Roadside emergencies

USING THE HAZARD SWITCH

Use the hazard flashers to warn traffic of vehicle problems:

- Slide the hazard switch to the right to activate the hazard flashers.
- Slide the hazard switch to the left to deactivate the continuously blinking flashers.

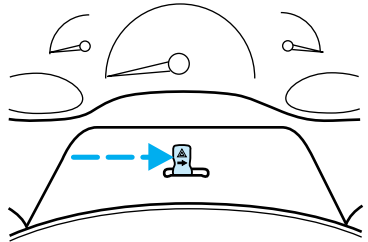

RESETTING THE FUEL PUMP SHUT-OFF SWITCH

The fuel pump shut-off switch stops the fuel pump when the vehicle has been involved in a collision or major jolt. If the vehicle does not start, it is possible that the fuel pump shut-off switch needs to be reset.



If you see or smell fuel, do not reset the switch or try to start your vehicle. Have all passengers get out of the vehicle and call the local fire department or a towing service.

To reset the fuel pump, press the button on the switch. The switch is located immediately below the hole in the trunk side trim.

Roadside emergencies

- Sedan

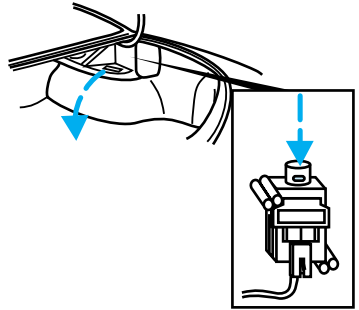

- Wagon

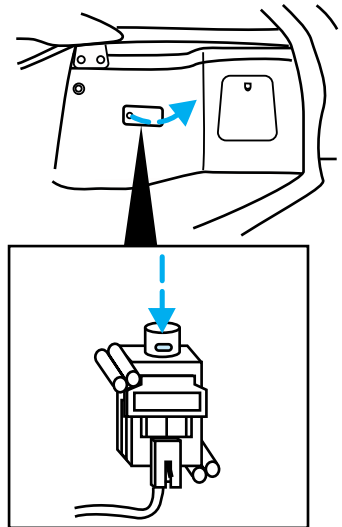

Roadside emergencies

FUSES AND RELAYS

If electrical components in the vehicle are not working, a fuse may have blown. Blown fuses are identified by a broken wire. Check the appropriate fuses before replacing any electrical components.

Use the fuse puller tool provided on the passenger compartment fuse panel cover to replace fuses.

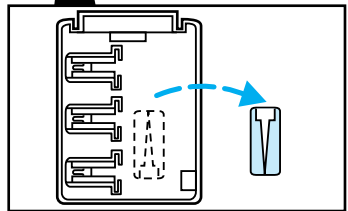
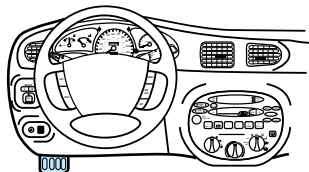
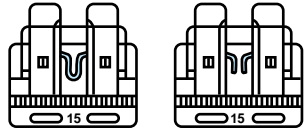

Always replace a fuse with one that has the specified amperage rating. Using a fuse with a higher amperage rating can cause severe wire damage and could start a fire.

Roadside emergencies

Even after a fuse is replaced, it will continue to blow if the cause of the overload is not identified and corrected. If a fuse continues to blow, have the vehicle's electrical system checked.

The (POWER WIND) 30A on the instrument panel fuse panel cover represents a circuit breaker that controls the vehicle's power windows. The circuit breaker is located just above the fuse panel cover. To reset a circuit breaker, press the reset button.

The (HEATER) 30A circuit breaker controls the vehicle's heater. The circuit breaker is located just above and to the left of the instrument panel fuse panel. To reset a circuit breaker, press the reset button.

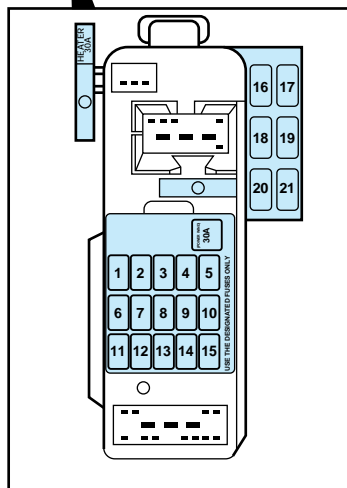
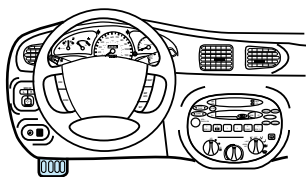

Roadside emergencies

| Fuse rating | Color |
|--------------------|--------------|
| 10 amp | Red |
| 15 amp | Blue |
| 20 amp | Yellow |
| 30 amp | Light Green |
| 30 amp fuse link | Pink |
| 40 amp | Green |
| 60 amp fuse link | Yellow |
| 80 amp fuse link | Black |
| 100 amp fuse link | Blue |

Instrument panel fuse panel

| Number | Fuse amperage rating | Circuits protected |
|----------------------|-----------------------------|--|
| 1 Stop | 15 amp | Brakelamps, shift lock |
| 2 Tail | 15 amp | Instrument cluster illumination, license plate lamp, parking lamps, side marker lamps, tail lamps, (radio, climate control illumination) |
| 3 Sun roof | — | Not used |
| 4 ASC | 10 amp | Speed control |
| 5 — | — | Not used |
| 6 (Door lock) | 30 amp | Power door locks |
| 7 Horn | 15 amp | Horn |
| 8 (Air Conditioning) | 15 amp | A/C, clutch |

Roadside emergencies

| Number | Fuse amperage rating | Circuits protected |
|-----------------|-----------------------------|---|
| 9 Meter | 10 amp | Backup lamps, shift lock, gauges, speed control, turn signals, key-in-ignition reminder chime |
| 10 Wiper | 20 amp | Windshield wipers and washer |
| 11 (Rear wiper) | 10 amp | Rear wiper and washer |
| 12 Hazard | 15 amp | Hazard flashers, turn signals |
| 13 Room | 10 amp | Clock, interior lamp, luggage compartment lamp, safety belt warning chime, radio power |
| 14 Engine | 15 amp | Engine control system |
| 15 Mirrors | 5 amp | Power mirrors |
| 16 — | — | Not used |
| 17 — | — | Not used |
| 18 (Fog) | 10 amp | Daytime running lamps / fog lamps |
| 19 — | — | Not used |
| 20 Cigar | 20 amp | Cigar lighter |
| 21 (Radio) | 15 amp | Radio (Premium sound) |

Roadside emergencies

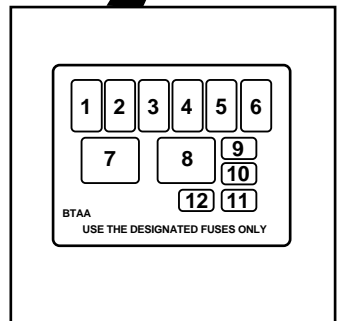
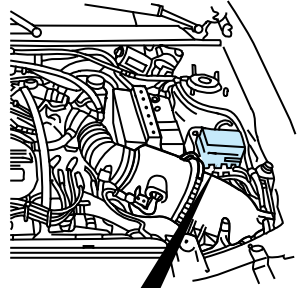

Engine compartment fuse panel

| Number | Fuse amperage rating | Circuits protected |
|------------------|----------------------|---------------------------------|
| 1 Fuel injection | 30 amp | Fuel injection system, air bags |
| 2 Defog. | 30 amp | Rear window defroster |
| 3 Main | 100 amp | Overall circuit protection |

Roadside emergencies

| Number | Fuse amperage rating | Circuits protected |
|---------------|----------------------|--|
| 4 BTN | 40 amp | Passenger compartment fuses 1, 2, 6, 12, 13, 7 |
| 5 (ABS) | 60 amp | Anti-lock brake system (ABS) |
| 6 Cooling fan | 40 amp | Cooling fan |
| 7 Head | — | Head lamp relay |
| 8 Not used | — | — |
| 9 OBD II | 10 amp | On-board diagnostics |
| 10 Fuel pump | 20 amp | Fuel pump |
| 11 Head RH | 20 amp | Passenger side headlamps |
| 12 Head LH | 20 amp | Driver side headlamps |

CHANGING THE TIRES

Temporary spare tire information

The temporary spare tire for your vehicle is labeled as such. It is smaller than a regular tire and is designed for emergency use only.



If you use the temporary spare tire continuously or do not follow these precautions, the tire could fail, causing you to lose control of the vehicle, possibly injuring yourself or others.

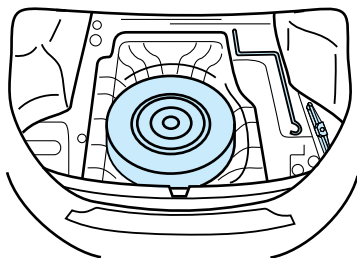

When driving with the temporary spare tire, **do not**:

Roadside emergencies

- exceed 80 km/h (50 mph) under any circumstances
- load the vehicle beyond the maximum vehicle load rating listed on the Safety Compliance Certification Label
- use tire chains
- drive through an automatic car wash (because of the vehicle's reduced ground clearance)
- try to repair the temporary spare tire or remove it from its wheel
- use the wheel for any other type of vehicle

Tire changing procedure

1. Park on a level surface.
2. Activate the hazard flashers.
3. Set the parking brake.
4. Place the gearshift in P (automatic transaxle) or R (manual transaxle).
 - Automatic

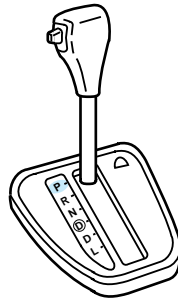
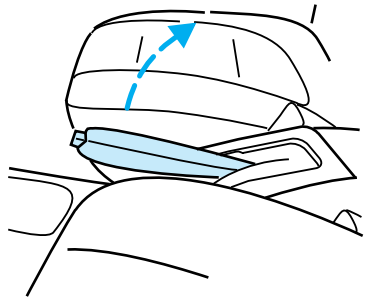

Roadside emergencies

- Manual

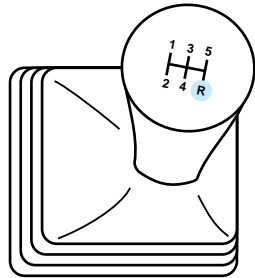

5. Block the diagonally opposite wheel.

- Remove the lug wrench first. Use the lug wrench to remove the hold-down bolts on the spare tire and jack.

Roadside emergencies

6. Remove the jack, jack handle and spare tire from the vehicle's rear cargo area.

- Locate the wheel cover hold-down lug nut.
- Completely remove this lug nut.

Use the lug wrench provided with the jack to loosen the retention bolts on the spare tire.

- Do not attempt to remove the wheel cover until lug nuts are removed.

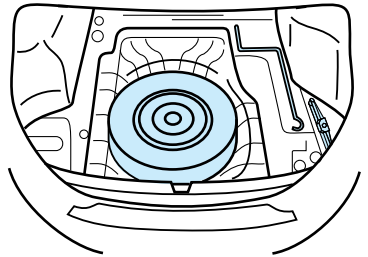
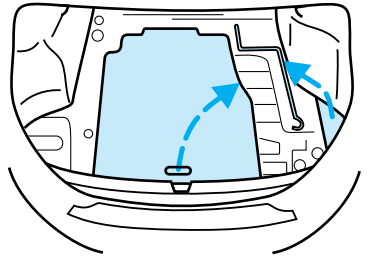
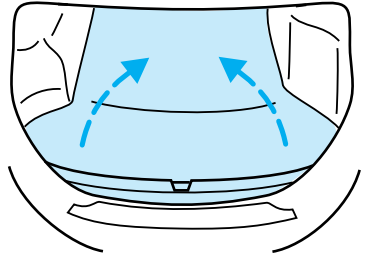

Roadside emergencies

7. Loosen the remaining wheel lug nuts with the lug wrench about one half turn counterclockwise.

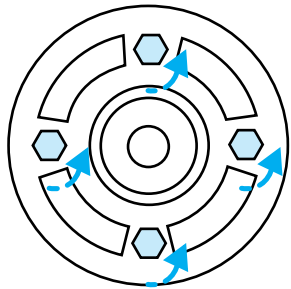

8. Position the jack at the jack notch closest to the wheel.

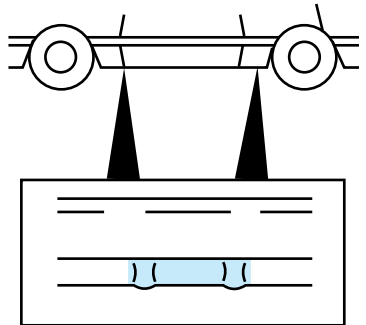

9. Insert the jack handle and raise the vehicle until the tire just clears the ground.

10. Remove the wheel lug nuts and flat tire, and install the spare with the "temporary use" label facing outward.

11. Install the same metric wheel lug nuts as removed and tighten until snug.

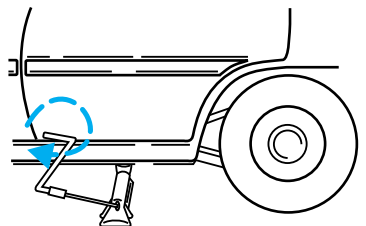

Roadside emergencies



Installation of an English thread nut on a metric stud (or vice-versa) will not properly secure the wheel to the hub. Damaged studs may result in wheel separation and possible injury.

12. Lower the vehicle and tighten the wheel lug nuts in the pattern shown.

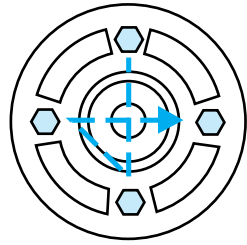

13. Unblock the wheels and put the tire, jack, jack handle, and lug wrench away.

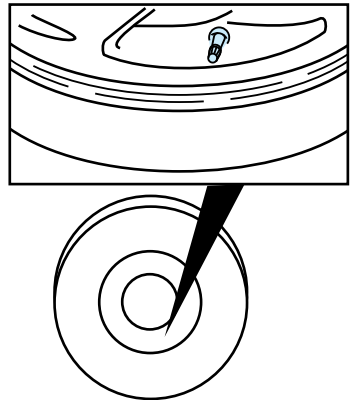

Roadside emergencies

JUMP-STARTING A DISABLED VEHICLE



The gases around the battery can explode if exposed to flames, sparks, or lit smoking materials. An explosion could result in injury or vehicle damage.



To protect yourself when charging a battery, always shield your face and eyes. Make sure that you can breathe fresh air.



Batteries contain sulfuric acid which burns skin, eyes, and clothing.

If the battery acid touches someone's skin, eyes, or clothing, immediately flush the area with water for at least fifteen minutes. If someone swallows acid, have him or her drink lots of milk or water first, then Milk of Magnesia, a beaten egg, or vegetable oil. Consult a physician immediately.



To avoid damage or injury, follow these directions in the order they are given. If in doubt, call for road service.

Before jump-starting a vehicle:

- make sure the booster battery vehicle has a 12-volt starting

Roadside emergencies

system; a 24-volt power supply will cause vehicle damage

- park the vehicles close to each other, but do not allow the two vehicles to touch.
- check to make sure neither battery is disconnected
- remove any excessive corrosion from the battery terminals
- turn on the heater fan in each vehicle to prevent damage from voltage surges

To jump start the vehicle:

1. Connect the jumper cables in numerical order.

- ① Disabled battery positive terminal
- ② Booster battery positive terminal
- ③ Booster battery negative terminal
- ④ Disabled vehicle engine

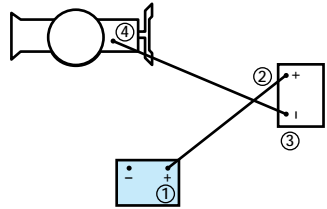

Do not connect the end of the second cable to the negative (-) terminal of the battery to be jumped. A spark may cause an explosion of the gases that surround the battery.

2. Start the engine in the vehicle with the booster battery.
3. Wait a few minutes and start the engine in the vehicle with the disabled battery.

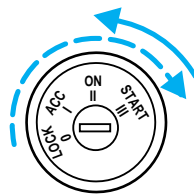

Roadside emergencies

4. Disconnect the jumper cables in numerical order:

- ① Engine
- ② Booster battery negative terminal
- ③ Booster battery positive terminal
- ④ Previously disabled battery positive terminal

Let the vehicle idle for a few minutes to allow the engine to relearn the proper idle conditions. Avoid using unnecessary electrical accessories for a short while to let the battery recharge. A battery charger may be necessary to fully recharge the battery.

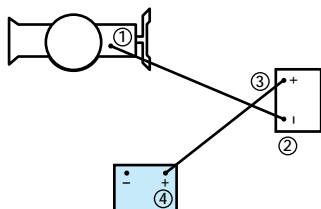

Roadside emergencies

WRECKER TOWING

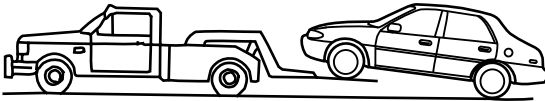
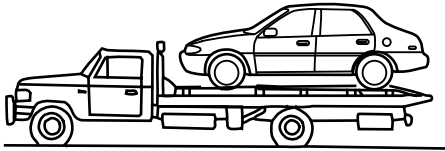
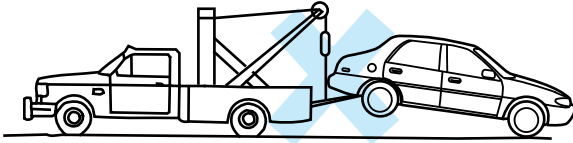

If towing is necessary, it is recommended that your vehicle be towed with wheel lift or flatbed equipment. Do not tow with slingbelt equipment. Ford Motor Company has not developed or approved a T-hook or slingbelt towing procedure.

Maintenance and care

SERVICE RECOMMENDATIONS

Whenever possible, Ford has designed parts that do not require servicing. However when servicing is required, Ford's goal is to make servicing your vehicle as easy as possible. To help you:

- We highlight do-it-yourself items in the engine compartment for easy location.
- Often, parts (such as the headlamp bulbs) may be replaced without tools.
- We provide you with a *Service Guide* that makes tracking routine service of your vehicle easy.

If your vehicle requires professional servicing, your dealership can provide the necessary parts and service. Check the *Warranty Information Guide* to find out what parts and services are covered. Use only recommended fuels, lubricants, fluids, and service parts conforming to Ford specifications. Motorcraft parts are designed and built to provide the best performance in your vehicle.

Precautions for servicing your vehicle

Be particularly careful when inspecting or servicing your vehicle. Here are some general precautions for your safety:

Maintenance and care

- Never get under a vehicle that is supported only by a jack. If you must work under a vehicle, use safety stands.
- Keep all lit cigarettes and other smoking materials away from the battery and all fuel-related parts.

Working with the engine off

1. Set the parking brake and make sure that the gearshift is securely latched in P (automatic transaxle), or first gear (manual transaxle).
2. Turn the engine off and remove the key from the ignition.

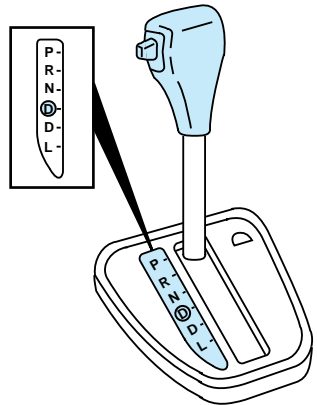
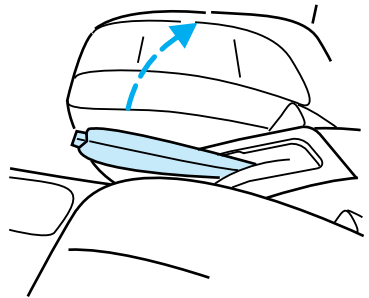

Maintenance and care

3. Block the wheels to prevent the vehicle from moving unexpectedly.

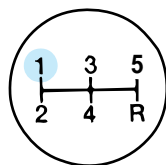
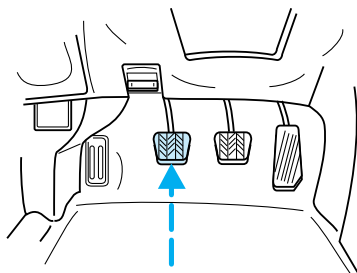

Maintenance and care

Working with the engine on

1. Set the parking brake and make sure that the gearshift is securely latched in P (automatic transaxle), or N (manual transaxle).
2. Do not work on a vehicle in an enclosed space with the engine running.

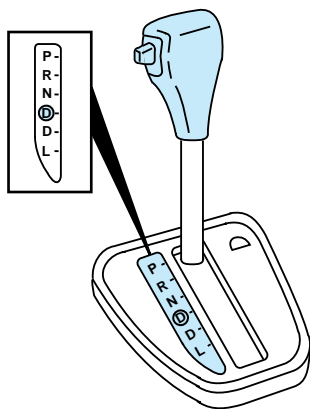
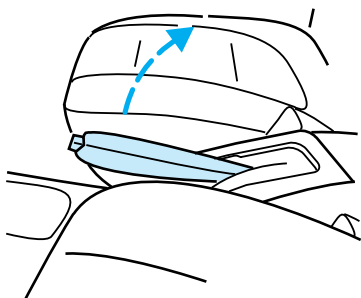

Maintenance and care

3. Block the wheels to prevent the vehicle from moving unexpectedly.
4. If work must be done with the engine running, avoid wearing loose clothing or jewelry that could get caught in moving parts. Take appropriate precautions with long hair.

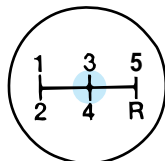
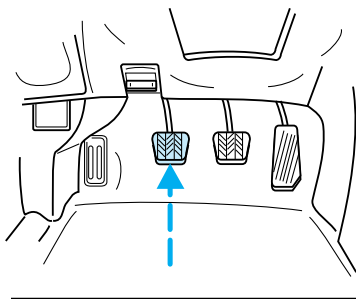

Opening the hood

1. Inside the vehicle, pull the hood release handle located under the bottom left corner of the instrument panel.
 2. Outside the vehicle, release the auxiliary latch located under the center of the hood.
 3. Lift the hood and secure it in the open position with the prop rod.
 4. To close the hood, remove the prop rod and shut so that the auxiliary latch is closed.
- After closing the hood, try to lift it to be sure that it is closed securely.

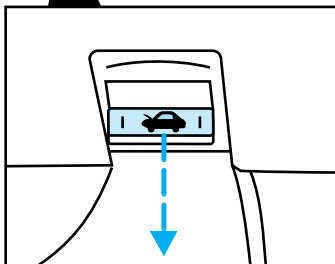
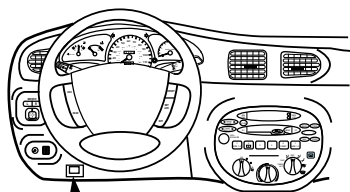

IDENTIFYING COMPONENTS IN THE ENGINE COMPARTMENT

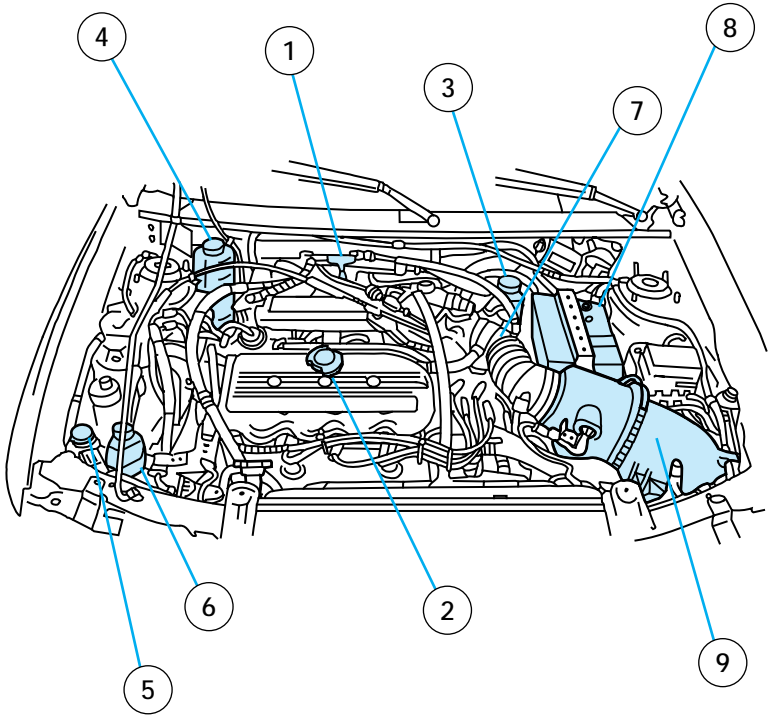

1. Engine oil dipstick
2. Engine oil filler cap
3. Brake fluid reservoir
4. Windshield washer fluid
5. Coolant reservoir
6. Steering fluid reservoir
7. Automatic transmission dipstick
8. Battery
9. Air filter assembly

Maintenance and care

CHECKING AND ADDING ENGINE OIL

Use SAE 5W-30 motor oil CERTIFIED FOR GASOLINE ENGINES by the American Petroleum Institute. Look for the certification — Ford specification WSS-M2C153-F.

Additional engine oil additives, oil treatments, or engine treatments are never needed and could, under certain conditions, lead to engine damage which is not covered by your Warranty.



Changing the engine oil and oil filter

Change the engine oil and oil filter per the following, whichever occurs first.

5,000 MILES (8,000 KM) OR 6 MONTHS
NORMAL SCHEDULE

3,000 MILES (5,000 KM) OR 3 MONTHS
SEVERE DUTY SCHEDULE

EXTENSIVE IDLING
TRAILER TOWING
DRIVING IN SEVERE DUST
POLICE, TAXI, OR DELIVERY

Oil change intervals

Refer to the *Service Guide* booklet for additional information.

Checking the engine oil

Check the engine oil every time you fuel your vehicle.

Maintenance and care

To check the engine oil, follow these steps:

1. Once the engine is warm, turn the engine off. Make sure the vehicle is parked on level ground.

2. Automatic transaxle:

- Engage the parking brake.
- Place the gearshift in P.

Manual transaxle:

- Engage the parking brake.
- Depress the clutch and place the gearshift in first gear.

3. Open the hood. If you need assistance, refer to *Opening the Hood* in this chapter. Protect yourself from engine heat.

4. Remove the engine oil dipstick and wipe it clean. Insert the dipstick fully, then remove it again. The oil level should be in the range shown on the dipstick.

5. Carefully pull the dipstick out again. If the oil level is below the ADD arrow, add engine oil as necessary. If the engine oil is beyond the FULL arrow, engine damage or high oil consumption may occur and some oil must be removed from the engine.

6. Put the dipstick back and ensure that it is properly seated.

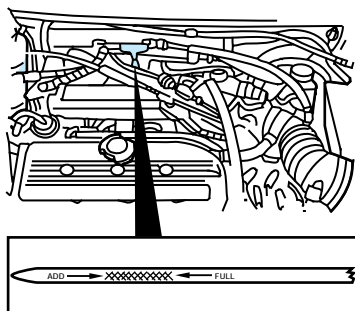

Maintenance and care

Adding engine oil

1. Check the engine oil. For instructions, refer to *Checking the engine oil* in this chapter.

2. If the fluid level is not within the normal range, add engine oil by removing the engine oil filler cap and pouring in oil.

3. Confirm that the oil level is full, but be careful not to overfill the engine.

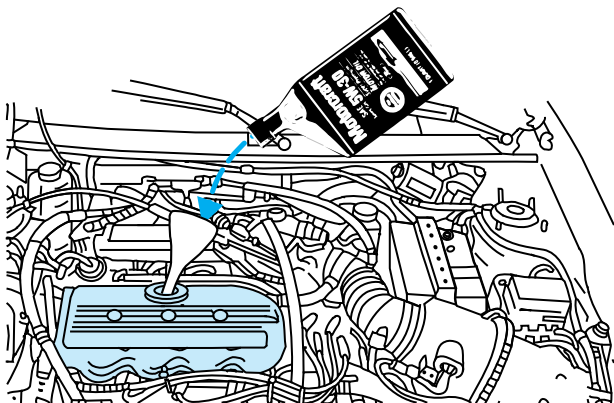

Continuous contact with USED motor oil has caused cancer in laboratory rats.

CHECKING AND ADDING BRAKE FLUID

Brake fluid should be checked and refilled as needed at least once a year:

- Clean the reservoir cap before removal to prevent dirt or water from entering the reservoir.
- Visually inspect the fluid level.
- If necessary, add brake fluid until the level reaches MAX.
- Use only a DOT 3 brake fluid certified to meet Ford specifications. Refer to *Lubricant specifications* in the *Capacities and specifications* chapter.

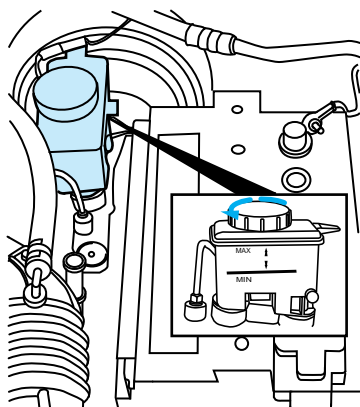

Brake fluid is toxic.



If you use brake fluid that is not DOT 3, you will cause permanent damage.



Do not let the reservoir in the master cylinder run dry. This may cause the brakes to fail.

Maintenance and care

CHECKING AND ADDING MANUAL TRANSAXLE CLUTCH FLUID

The brake fluid reservoir and clutch master cylinder are part of the same unit; both are refillable through the brake fluid reservoir with brake fluid. During normal operation, the fluid level in the brake fluid reservoir will rise slowly. For more information on brake fluid maintenance, refer to *Checking and adding brake fluid* in this chapter.

CHECKING AND ADDING WASHER FLUID

What you should know about washer fluid

In freezing weather (temperatures below 0°C [32°F]), washer fluid containing a small amount of antifreeze is used. State or local regulations on volatile organic compounds may restrict the use of methanol, a common type of antifreeze. Use a non-methanol antifreeze in freezing weather only if the fluid does not damage the paint finish, wiper blades, or washer system.



Washer fluid contains methanol and is poisonous. Follow all instructions on the bottle of washer fluid.

Maintenance and care

Washer fluid for the windshield reservoir

The vehicle's windshield washer fluid reservoir is located on the passenger side of the engine compartment. If washer fluid needs to be added to the reservoir:

- Lift the windshield reservoir cover.
- Add enough washer fluid to fill the reservoir.

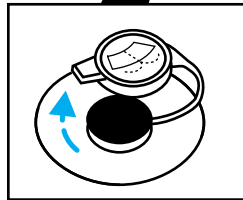
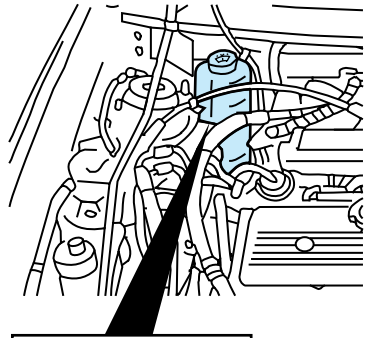

Washer fluid for the liftgate (if equipped)

The wagon's rear reservoir is located on the passenger side of the storage compartment. Remove the access cover to locate the washer reservoir cap. The reservoir must be filled slowly to allow trapped air to escape.

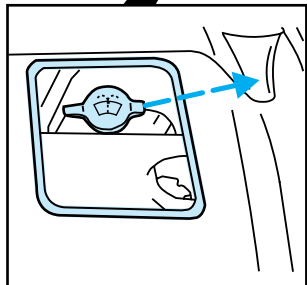
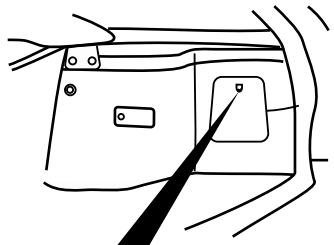

Maintenance and care

ADDING ENGINE COOLANT



Be careful not to add engine coolant to the windshield washer fluid reservoir. If sprayed on the windshield, engine coolant could make it difficult to see through the windshield.

When the engine is cool, add a 50/50 mixture of engine coolant and water to the engine coolant recovery reservoir — **DO NOT ADD DIRECTLY TO THE RADIATOR.** Add straight water only in an emergency, but you should replace it with a 50/50 mixture of coolant and distilled water as soon as possible.

Check the coolant level in the coolant recovery reservoir the next few times you drive the vehicle. If necessary, add enough of a 50/50 mixture of coolant and water to bring the liquid level to the fill line on the reservoir.



Never remove the coolant recovery cap while the engine is running or hot.

If you must remove the coolant recovery cap, follow these steps to avoid personal injury caused by escaping steam or engine coolant:

1. Before you remove the cap, turn the engine off and let it cool.

2. When the engine is cool, wrap a thick cloth around the cap and turn it slowly, counterclockwise to the first stop.
3. Step back while the pressure releases.
4. When you are sure that all the pressure has been released, use the cloth to press the cap down, turn it counterclockwise, and remove it.

Use Ford Premium Engine Coolant E2FZ-19549-AA (in Canada, Motorcraft CXC-8-B) or an equivalent premium engine coolant that meets Ford Specification ESE-M97B44-A. Ford Premium Engine Coolant is an optimized formula that will protect all metals and rubber elastomers used in Ford cooling systems for 4 years or 50,000 miles (80,000 km).

Do not use alcohol or methanol antifreeze or any engine coolants mixed with alcohol or methanol antifreeze. Do not use supplemental coolant additives in your vehicle. These additives may harm your engine cooling system. *The use of an improper coolant may void the warranty of your vehicle's engine cooling system.*

Recycled Engine Coolant

Ford Motor Company recommends that Ford and Lincoln-Mercury dealers use recycled engine coolant produced by Ford-approved processes. Not all coolant recycling processes

Maintenance and care

produce coolant which meets Ford specification ESE-M97B44-A, and use of such coolant may harm engine and cooling system components.

Always dispose of used automotive fluids in a responsible manner. Follow your community's regulations and standards for recycling and disposing of automotive fluids.

Coolant Refill Capacity

To find out how much fluid your vehicle's cooling system can hold, see *Refill capacities for fluids* in the Index.

Have your dealer check the engine cooling system for leaks if you have to add more than a quart (liter) of engine coolant per month.

Severe Winter Climate

If you drive in extremely cold climates (less than -34°F [-36°C]), it may be necessary to increase the coolant concentration above 50%. Refer to the chart on the coolant container to ensure the coolant concentration in your vehicle is such that the coolant will not freeze at the temperature level in which you drive during winter months. Never increase the engine coolant concentration above 60%. Leave a 50/50 mixture of engine coolant and water in your vehicle year-round in non-extreme climates.

CHECKING AND ADDING POWER STEERING FLUID

Check the power steering fluid at least twice a year by completing the following steps:

1. Start the engine.
2. When the engine coolant temperature gauge reaches the normal zone, turn off the engine.
3. Visually inspect the fluid level in the power steering reservoir.
4. If necessary, add power steering fluid until the fluid level reaches MAX. Do not overfill the power steering reservoir.

- As a maintenance precaution, visually inspect the lines and hoses of the power steering system for leaks and damage.
- If new fluid is frequently required, consult a qualified service technician.

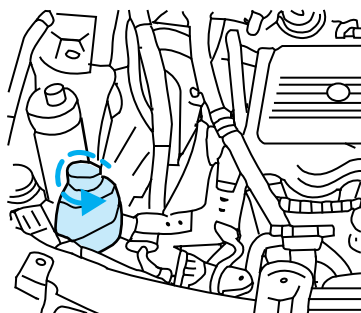
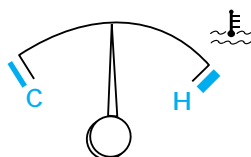
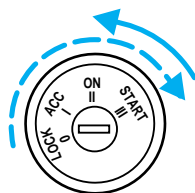

CHECKING AND ADDING TRANSAXLE FLUID

Checking and adding automatic transaxle fluid

Check the automatic transaxle fluid according to the owner maintenance checks in the *Service Guide*.

Maintenance and care

It is best to check the transaxle fluid level at the normal operating temperature, after approximately 35 km (20 miles) of driving. If the transaxle fluid level must be checked under different circumstances, make sure the outside temperature is above 10 °C (50 °F) to obtain an accurate fluid level check.

Checking the automatic transaxle fluid

1. Park the vehicle on a level surface.
2. With the vehicle running and the brake pedal depressed, move the gearshift through each of the gear ranges, allowing each gear to engage.

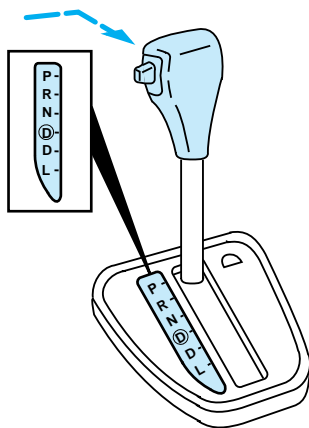
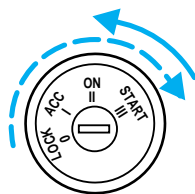

3. Move the gearshift to P.

Maintenance and care

- 4 Set the parking brake.
5. Remove the dipstick and wipe it with a clean, dry rag.
6. Install the dipstick.
7. Remove the dipstick and inspect the fluid level.



Your vehicle should not be driven if the fluid level is below the bottom hole in the dipstick and outside temperatures are above 10 °C (50 °F).

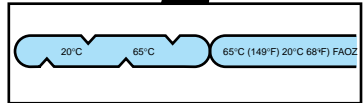
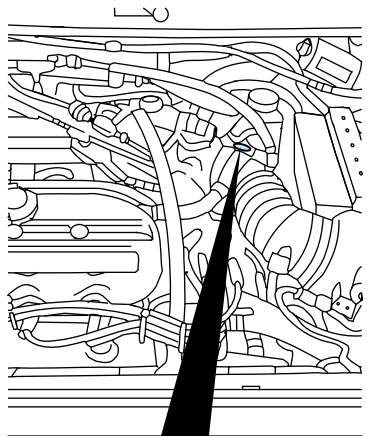
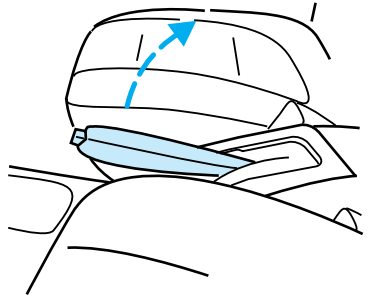

When adding automatic transaxle fluid:

- Ensure that the correct type is added. For automatic transaxle fluid specifications, refer to *Capacities and specifications* in this chapter.

Maintenance and care

- Add the fluid in 250 ml (½ pint) increments through the filler tube. Do not overfill the automatic transaxle fluid reservoir. If this occurs, the excess fluid should be removed by a qualified technician.



Always dispose of used automotive fluids in a responsible manner. Follow your community's standards for disposing of these types of fluids. Call your local recycling center to find out more about recycling automotive fluids.

Checking and adding manual transaxle fluid

For information on checking and adding manual transaxle fluid, refer to *Checking and adding clutch fluid* in this section.

WHAT YOU SHOULD KNOW ABOUT YOUR BATTERY

If the original equipment maintenance-free battery needs replacing, it may be replaced with a low-maintenance battery. For information on appropriate replacement batteries, refer to *Motorcraft part numbers* in the *Capacities and specifications* chapter.

Maintenance and care

 Batteries normally produce explosive gases that can cause personal injury. Do not allow flames, sparks, or lit smoking materials to come near the battery. When charging or working near a battery, always cover your face, protect your eyes, and provide ventilation.

 Batteries contain sulfuric acid that can burn skin, eyes, and clothing.

 Applying too much pressure on the ends when lifting a battery could cause acid to spill. Lift the battery with a carrier or with your hands on opposite corners.

Servicing your battery

The low-maintenance battery has removable vent caps for checking the electrolyte level and adding water. Check the electrolyte level every 24 months or 40, 000 km (24, 000 miles) in average temperatures below 32 °C (90 °F). Keep the electrolyte level in each cell up to the level indicator. Do not overfill.

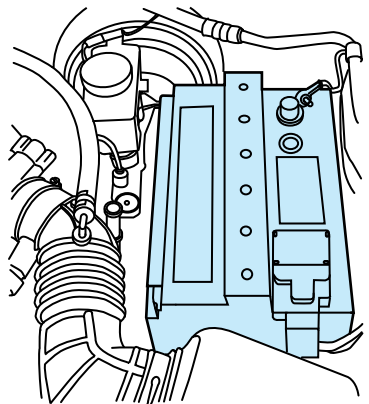

Maintenance and care

If the electrolyte level becomes low, refill the battery with distilled water. If necessary, distilled water may be substituted with tap water that is not hard and does not have a high mineral or alkali content. If the battery needs water quite often, have the charging system checked for a possible malfunction.

Your vehicle is equipped with a battery saver control feature designed to prevent your battery from accidental wear down due to doors left ajar. For information on the system and how it works, see *Interior overhead lamp* in this chapter.

Because your vehicle's engine is electronically controlled, some control conditions are maintained by power from the battery. When the battery is disconnected or a new battery is installed, the computer must "relearn" its idle conditions before your vehicle will drive properly. To begin this process:

1. Put the gearshift in P (automatic transaxle) or N (manual transaxle).
 2. Turn off all accessories and start the vehicle.
 3. Let the engine idle for at least one minute.
 4. The relearning process will automatically complete as you drive the vehicle.
- If you do not allow the engine to relearn its idle, the idle quality

Maintenance and care

of your vehicle may be adversely affected until the idle is eventually relearned.

- If the battery has been disconnected or a new battery has been installed, the clock and preset radio stations must be reset once the battery is reconnected.
- Always dispose of used automotive batteries in a responsible manner. Follow your community's standards for disposal. Call your local recycling center to find out more about recycling automotive batteries.

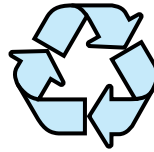

CHECKING AND CHANGING YOUR AIR FILTER

If the vehicle is operated in very dusty or sandy areas, replace the filter more often than the recommended intervals.



Do not drive without an air filter; this could result in excessive engine wear.

Maintenance and care

Changing your air filter

1. Unlock the clamp that holds the engine air cleaner assembly in place by releasing the clamp locking clip on the front portion of the assembly.

- The clamp will spring open and remain attached to the left side of the assembly.

2. Swing the left side of the assembly open.

3. Remove the air filter element from the open end of the engine air cleaner assembly and replace it with a new element.

- When replacing the element, be sure to align the nubs on both the air cleaner element and the open end of the air cleaner assembly. If these nubs are not aligned, the new element will not fit properly within the assembly and the assembly may malfunction.

4. Swing the left side of the assembly closed and secure the locking clamp.

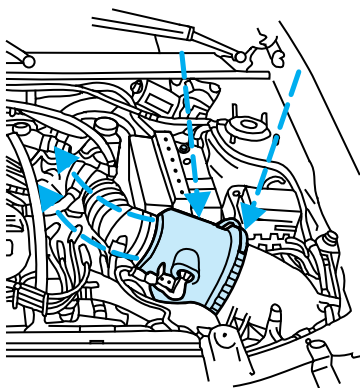

CHECKING AND CHANGING YOUR WIPER BLADES

Check the windshield wiper blades at least twice a year; also check them whenever the wipers seem less effective than usual.

Substances such as tree sap and some hot wax treatments used by commercial car washes can reduce the effectiveness of wiper blades.

To make reaching the wiper blades easy, simply turn the ignition to the ON position and turn the wipers on. Wait for them to reach a vertical position and turn the ignition to LOCK. Do not move the wipers manually across the windshield, this may cause damage to the wipers.

Inspect the wiper arm pivots on a regular basis to ensure that the wiper arms move freely. Lubricate the pivot points as necessary.

Replacing wiper blades

If the wiper blades do not work properly after cleaning, replacement of the blade assembly or the blade element may be necessary.

There are three different lengths of wiper blades on your vehicle. The driver side wiper blade is 51 cm (20 in) long, and the passenger side wiper blade is 44.5 cm (17.5 in) long, and the rear window wiper is 35 cm (13.75 in) long. Ensure that you install the correct length wiper blade in the correct location.

To replace the wiper blades:

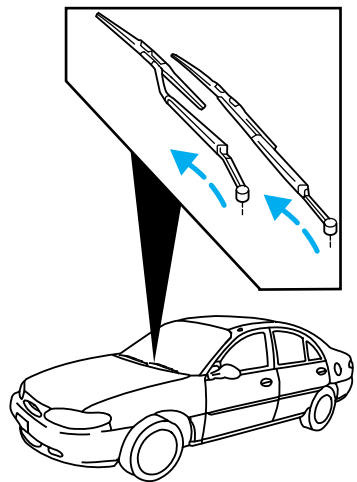

Maintenance and care

1. Pull the wiper arm away from the windshield and lock into the service position.
2. Turn the blade at an angle from the wiper arm. Push the lock pin with a screwdriver to release the blade and pull the wiper blade down toward the windshield to remove it from the arm.
3. Attach the new wiper to the wiper arm and press it into place until a click is heard.

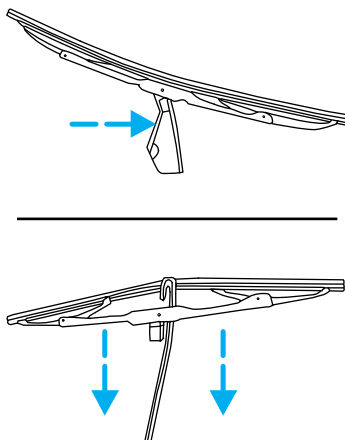

WHAT YOU SHOULD KNOW ABOUT TIRE GRADES

The U.S. Department of Transportation (DOT) requires Ford to give its customers the following tire information:

Treadwear

The treadwear grade is a comparative rating based on the wear rate of the tire when tested under controlled conditions on a specified government test course. For example, a tire graded 150 would wear $1\frac{1}{2}$ times as well on the government course as a tire graded 100. The relative performance of tires depends upon the actual conditions of their use, however, and may depart significantly from the norm due to variations in driving habits, service practices, and differences in road characteristics and climate.

Traction A B C

The traction grades, from highest to lowest, are A, B, and C; they represent the tire's ability to stop on wet pavement as measured under controlled conditions on specified government test surfaces of asphalt and concrete. A tire marked C may have poor traction performance.



The traction grade assigned to this tire is based on braking (straightahead) traction tests and does not include cornering (turning) traction.

Temperature A B C

The temperature grades are A (the highest), B, and C; they represent the tire's resistance to the generation of heat and its ability to dissipate heat when tested under controlled conditions on a specified indoor laboratory test wheel. Sustained high temperature can cause the material of the tire to degenerate and reduce tire life. Excessive temperature can lead to sudden tire failure. The grade C corresponds to a level of performance which all passenger car tires must meet under the Federal Motor Vehicle Safety Standard No. 109. Grades A and B represent higher levels of performance on the laboratory test wheel than the minimum required by law.

Maintenance and care

 The temperature grade for this tire is established for a tire that is properly inflated and not overloaded. Excessive speed, underinflation, or excessive loading, either separately or in combination, can cause heat build up and possible tire failure.

SERVICING YOUR TIRES

Checking the tire pressure

Check the tire pressure periodically and inflate tires as necessary. To check the tire pressure, insert the tire pressure gauge into the valve stem.

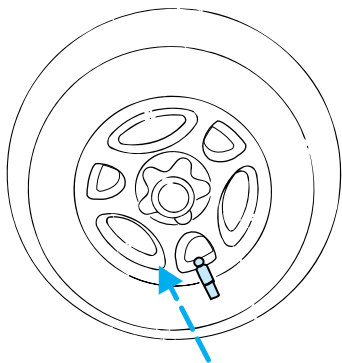

The cold pressure amount is listed on the Safety Compliance Certification Label located on the passenger's door inside latch pillar.

 Improperly inflated tires can affect vehicle handling and can fail suddenly, possibly resulting in loss of vehicle control.

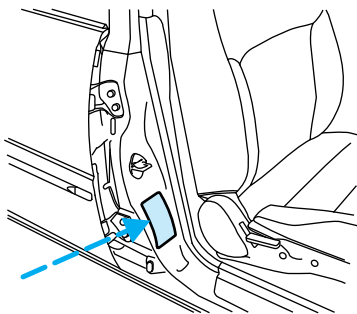

Rotating your tires

Rotate your tires at regular intervals to ensure even wear. These intervals are listed in the *Service Guide*.

- Four-tire rotation

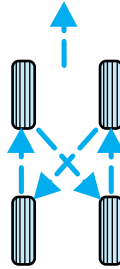

- Five-tire rotation

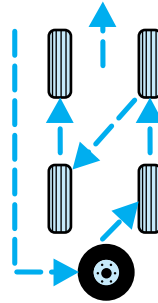

Replacing the tires

Replace the tires when the wear band is visible through the tire treads.

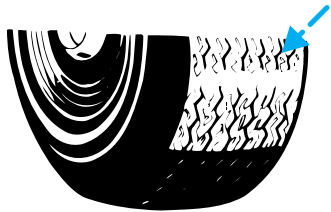

When replacing full size; tires, never mix radial bias belted or bias-type tires. Use only the tire sizes that are listed on the tire pressure decal.

Maintenance and care

 Make sure all replacement tires are of the same type, load-carrying capacity, and tread design (e.g. "All Terrain"), as originally offered by Ford.

 Failure to follow these precautions may adversely affect the handling of the vehicle and make it easier to lose control and roll over.

IDENTIFYING TIRE TYPES

Your vehicle requires the use of the following tire types: wagon and sedan 18565R14 tires and T115/70D14 mini-spares. When purchasing replacement tires for your vehicle, consult your Ford or Lincoln-Mercury dealer or qualified service technician to assure that correct tire types are used.

USING SNOW TIRES AND CHAINS

 Snow tires must be the same size and grade as the tires currently on your vehicle.

The tires on your vehicle have all weather treads to provide traction in rain and snow. However, in some climates using snow tires and chains may be necessary. Follow these guidelines when using snow tires and chains:

- Use only SAE Class "S" chains.

Maintenance and care

- Install chains securely, verifying that the chains do not touch any wiring, brake lines, or fuel lines.
- Install tire chains on front tires only.
- Drive cautiously. If you hear the chains rub or bang against your vehicle, stop and retighten the chains. If this does not work, remove the chains to prevent damage to your vehicle.
- When possible, avoid overloading your vehicle.
- Remove the tire chains when they are no longer needed. Do not use tire chains on dry roads.
- The suspension insulation and bumpers will help prevent vehicle damage. Do not remove these components from your vehicle when using snow tires and chains.

WHAT YOU SHOULD KNOW ABOUT AUTOMOTIVE FUEL



Automotive fuels can cause serious injury or death if misused or mishandled.

Observe the following guidelines when handling automotive fuel:

- Extinguish all smoking material and any open flames before fueling your vehicle.
- Automotive fuels can be harmful or fatal if swallowed. If fuel is swallowed, call a physician immediately, even if no

Maintenance and care

symptoms are apparent. The toxic effects of fuels may not be evident for many hours.

- Fuels can also be harmful if absorbed through the skin. If fuel is splashed on the skin, promptly remove contaminated clothing and wash skin thoroughly with soap and water.
- If fuel is splashed in the eyes, remove contact lenses, flush eyes with water for fifteen minutes, and seek immediate medical attention.
- Be particularly careful if you are taking Antabuse or other forms of disulfiram for the treatment of alcoholism. Breathing gasoline vapors or skin contact with fuel could cause an adverse reaction. Consult a physician immediately.

If you replace your fuel cap with an aftermarket fuel filter cap, the customer warranty may be void if any damage to the fuel tank and/or fuel system occurs.



Do not overfill the fuel tank. The pressure in an overfilled tank may cause leakage and lead to fuel spray and fire.



If you do not use a proper fuel cap, the pressure in the fuel tank can damage the fuel system or cause it to work improperly in a collision.



If the fuel cap is venting vapor or you hear a hissing sound, wait until it stops before completely removing the cap.

CHOOSING THE RIGHT FUEL

Use only UNLEADED FUEL. The use of leaded fuel is prohibited by law and could damage your vehicle. The damage may not be covered by your warranty.

Your vehicle was not designed to use fuel containing manganese-based additives such as MMT. Additionally, vehicles certified to California emission standards (indicated on the underhood Vehicle Emissions Control Information label) are designed to operate on California reformulated gasolines. If California reformulated gasoline is not available when you refuel, your vehicle can be operated on non-California fuels. However, even though your engine will perform adequately on other gasolines, the performance of the emission control devices and systems may be adversely affected. Repair of damage caused by using a fuel that your vehicle was not designed for may not be covered by your warranty.

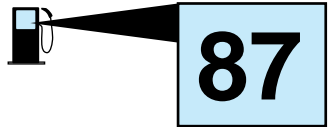

Maintenance and care

Octane Recommendation

Your vehicle is designed to use regular gasoline with an (R+M)/2 octane rating of 87. We do not recommend gasolines labeled as “regular” in high altitude areas that are sold with octane ratings of 86 or even less.

Do not be concerned if your vehicle sometimes knocks lightly. However, if it knocks heavily under most driving conditions on the recommended octane fuel, see your dealer or a qualified service technician to prevent any engine damage.

Fuel Quality

If you are experiencing starting, rough idle or hesitation problems, try a different brand of fuel. If the condition persists, see your dealer or a qualified service technician.

The American Automobile Manufacturers Association (AAMA) issued a gasoline specification to provide information on high quality fuels that optimize the performance of your vehicle. We recommend the use of gasolines that meet the AAMA specification if they are available.

It should not be necessary to add any aftermarket products to your fuel tank if you continue to use a high-quality fuel.

Cleaner Air

Ford approves the use of gasolines to improve air quality, including reformulated gasolines, that contain oxygenates such as a

maximum of 10% ethanol or 15% MTBE. There should be no more than 5% methanol with cosolvents and additives to protect the fuel system.

WHAT YOU SHOULD KNOW ABOUT THE EMISSION CONTROL SYSTEM



For more information on your vehicle's emission control system, see the Vehicle Emission Control Information Decal located on the inside left side of the engine compartment.

The catalytic converter enables the vehicle's emission control system to operate properly.

Follow these guidelines to ensure proper emission system operation:

- Use only unleaded fuel.
- Avoid running out of fuel.
- Do not turn off the ignition while your vehicle is in motion.
- Have maintenance performed according to the intervals in the *Service Guide*.

If you notice one or more of the following, the emission system may not be working properly; have the vehicle serviced as soon as possible:

- fluid leaks
-  ,  ,  , lights illuminate in the instrument cluster and remain lit
- strange odors

Maintenance and care

- engine runs more than five seconds after shut off or engine misfires, surges, stalls, or backfires
- loss of oil pressure

Important emission control information

By law, anyone who manufactures, repairs, services, sells, leases, or trades vehicles, or who supervises a fleet of vehicles is not permitted to intentionally remove an emission control device or prevent it from working. Do not make any unauthorized changes to the vehicle or engine. Changes that cause more unburned fuel to reach the exhaust system can increase the temperature of the engine or exhaust system.

When your vehicle is serviced, never use a metal exhaust collector. The use of a metal collector may melt or deform plastic parts.



Do not park, idle, or drive your vehicle in dry grass or other dry ground cover. The emission system heats up the engine compartment and exhaust system, which can start a fire.

Preparing your vehicle for inspection / maintenance (I/M) testing

In some localities it may become a legal requirement to pass an I/M test of the on-board diagnostic

(OBD) II system. If the vehicle's powertrain system or battery has just been serviced, the OBD II system is reset to a not ready for I/M testing condition. To ready the OBD II system for I/M testing, the law specifies that a minimum of 30 minutes of city and highway driving is necessary as described below:

- At least twenty minutes driving in stop-and-go, city-type traffic with at least four idle periods.
- At least ten minutes of driving on an expressway or highway.

Before completing the above driving modes, the engine must be warmed up and at operating temperature. Once started, the vehicle must not be turned off during these modes.

Maintenance and care

EXTERIOR LAMPS

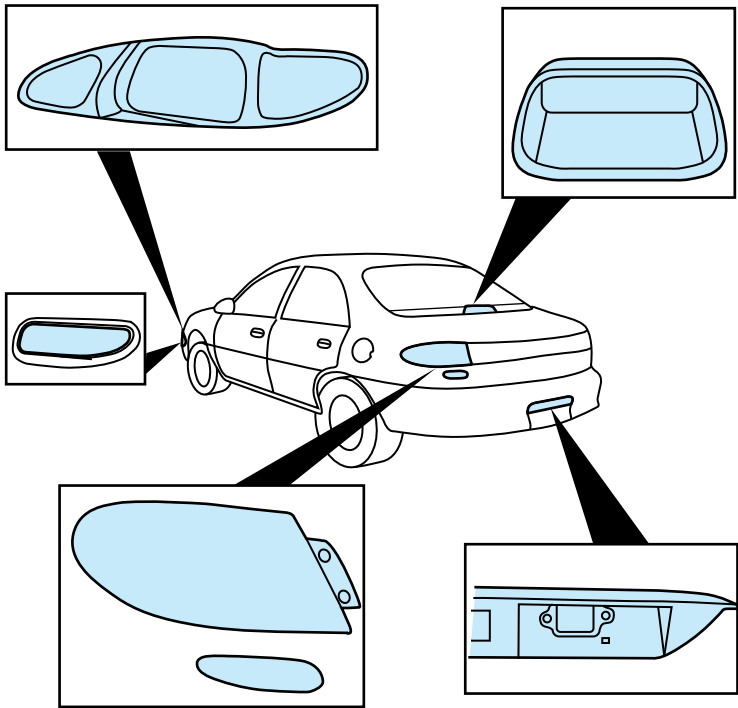

REPLACING THE EXTERIOR BULBS

Check the operation of the following lamps frequently:

- headlamps
- foglamps (if equipped)
- high-mount brakelamp
- license plate lamp
- tail lamps/backup lamps
- interior overhead lamp

- hazard flasher

The overview of your vehicle's exterior lamps shows the tail lamp/backup lamp assembly for the sedan model only. The lamp assembly for the wagon is similar, although the bulb replacement process differs. For more information, see *Tail lamps/Backup lamps* in this section. In addition, the headlamp assembly includes the headlamp and the turn signal/parking lamp assemblies

Do not remove lamp bulbs unless they may be replaced immediately with new ones. If a bulb is removed for an extended period of time, contaminants may enter the lamp housings and affect performance.



Handle a halogen bulb carefully and keep out of children's reach. Grasp the bulb only by its plastic base and do not touch the glass; the oil from your hand could cause the bulb to break the next time that the headlamps are operated.

Maintenance and care

Headlamps

To change the headlamp bulbs:

1. Be sure that the headlamp knob is in the OFF position.

2. Open the hood and find the headlamp socket.

3. Remove the protective dust shield housing by turning the shield counterclockwise.

4. Remove the bulb retaining ring by rotating it counterclockwise (when viewed from the rear).

5. Disconnect the electrical connector and remove the bulb by pulling it straight out.

6. Replace the bulb by pushing a new one straight in with the bulb's plastic base facing upward. You may need to turn the bulb slightly to align the grooves in the plastic base with the tabs in the bulb socket.

7. Slip the bulb retaining ring over the plastic base and lock the ring by rotating it clockwise until it snaps.

8. Reconnect electrical connector.

9. Replace the housing protective dust shield and lock the shield by rotating clockwise until it locks into position.

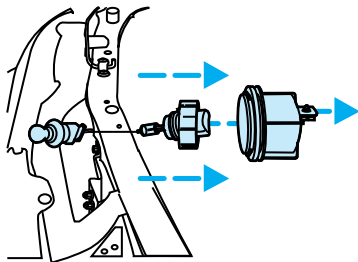
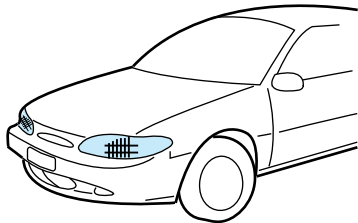

Maintenance and care

Foglamps (if equipped)

To change the foglamp bulbs:

1. Disconnect the electrical connector from the back of the foglamp assembly.
2. Twist, then pull the bulb from the foglamp assembly and twist in a replacement bulb.
3. Connect the electrical connector to the back of the foglamp assembly.

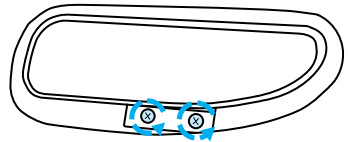
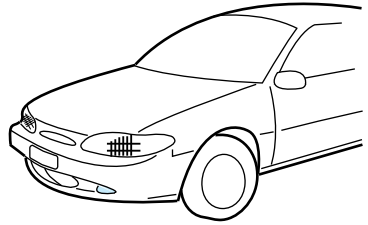

Maintenance and care

High-mount brakelamp (sedan)

The high-mount brakelamp is located on the rear of your vehicle.

The brakelamp will be mounted with two fastener clips and an assembly cover on the package tray.

1. Remove the push pins and cover from the package tray.
2. Detach the socket from the housing and remove the bulb.
3. Replace the bulb and ease the socket back into the housing.
4. Replace the housing cover and secure with the push pins.

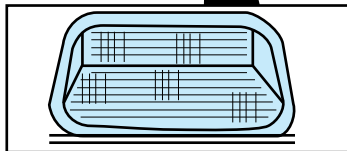
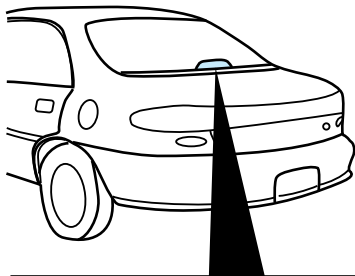

Liftgate lamp (wagon)

The wagon liftgate lamp is located on the rear of the vehicle. Follow these steps to replace the liftgate lamp bulb:

1. Open the liftgate.

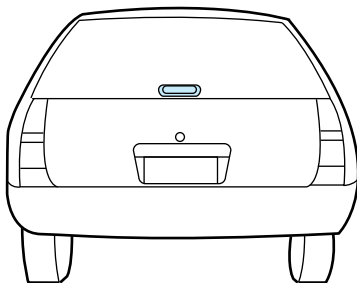

Maintenance and care

2. To remove the liftgate lamp bulb assembly cover mounted on the liftgate's interior rear window:

- press in the inner portion of the two mounting screws on either side of the cover
- pull out the outer portion of the mounting screws

3. Detach the socket from the housing and remove the bulb.

4. Replace the bulb and ease the socket back into the housing.

5. Replace the bulb assembly cover and secure the mounting screws.

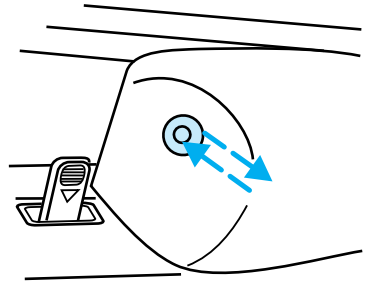

License plate lamps

To change the license plate lamp bulbs:

1. Carefully remove screws and pull the license plate lamp assembly from the rear bumper.
2. Carefully pull the lamp lens from the assembly.
3. Remove the bulb to be replaced and install a new bulb.
4. Replace the lamp lens, the assembly, and the screws.

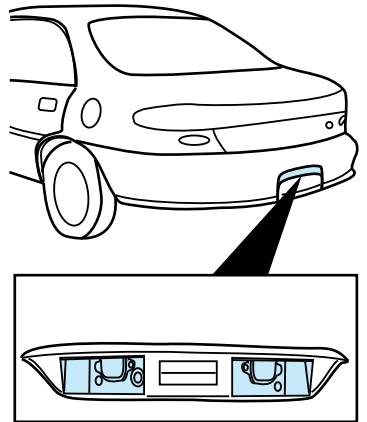

Maintenance and care

- Sedan

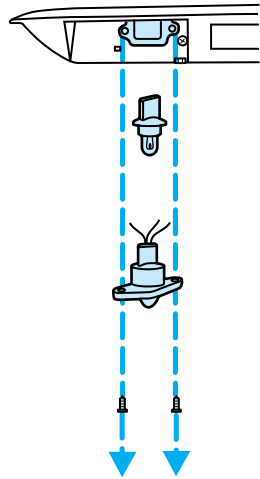

- Wagon

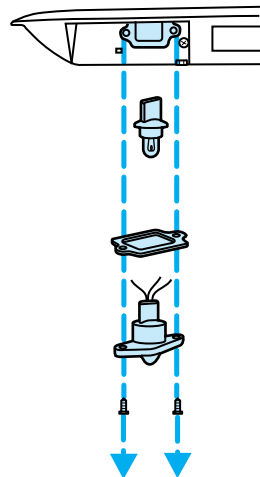

Tail lamps / Backup lamps (sedan)

The tail lamp assemblies and the backup bulb assemblies are located in the same portion of the vehicle rear, one just below the other. Follow the same steps to replace either bulb.

1. Open the trunk lid to expose the tail lamp assembly. Remove the two screws from the front of the lamp.
2. The tail lamp has hidden fasteners which can be disengaged by hitting the lamp, with your hand, toward the side of the vehicle.
3. Remove the socket that contains the burned out bulb by rotating it counterclockwise, then pulling it out of the lamp assembly.
4. Pull the burned out bulb from the socket and replace it with a new bulb.

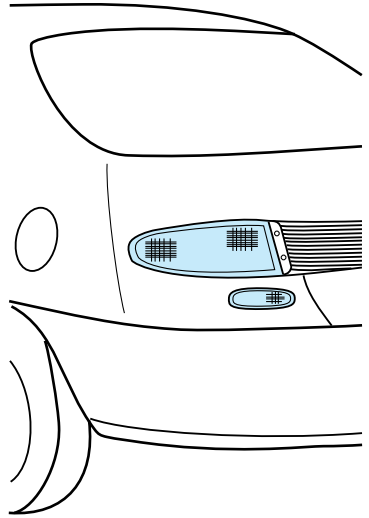

Maintenance and care

5. Push the socket into the lamp, then secure it by rotating it clockwise.

6. Position the tail lamp on the vehicle and gently hit the lens to engage the clips. Replace the screws.

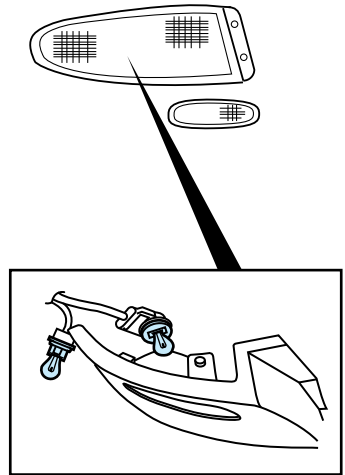

Tail lamps/Backup lamps (wagon)

To replace the tail lamp bulbs:

1. Open the liftgate to expose the tail lamp assembly. Remove the lens screws and pull the lens aside.

2. Remove the socket that contains the burned out bulb by rotating it counterclockwise, then pulling it out of the lamp assembly.

3. Pull the burned out bulb from the socket and secure a new bulb.

4. Push the socket into the lamp, then secure it by rotating clockwise.

5. Position the lamp on the vehicle and replace the screws.

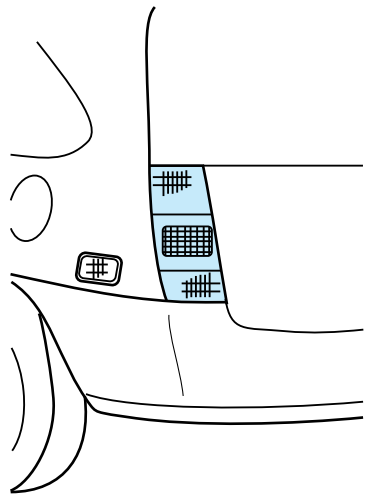

Maintenance and care

The side marker lamp assemblies are accessible through the interior of the vehicle. The right assembly (when facing the front of the vehicle) is behind the same interior panel as the liftgate washer fluid; the left assembly is located behind a similar-looking interior panel directly opposite the right panel. Both access panels are directly below the rear side windows.

To replace the backup lamp bulbs:

1. Open the liftgate and lean inside the vehicle. Access the backup bulb assemblies by carefully pulling open the interior panel.

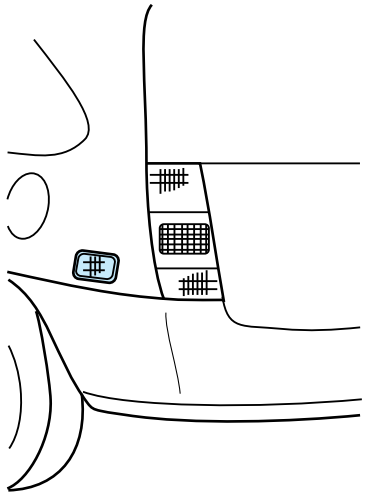
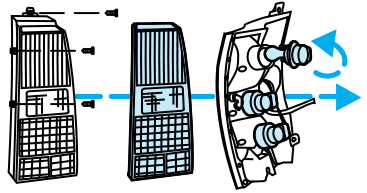

Maintenance and care

2. Remove the bulb assembly from the interior recess.
3. Twist the bulb counterclockwise to remove it and secure a new bulb.
4. Replace the bulb assembly in the interior recess and replace the access panel.

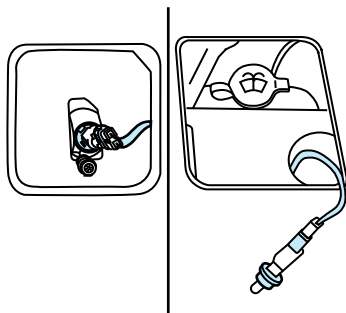

Interior overhead lamp

The interior overhead lamp is located on the center of the ceiling of the vehicle. To replace the bulbs:

1. Remove the lamp lens by applying pressure to both tabs at the top of the lamp assembly and pulling the lens down and off.
2. Pull the bulb to remove it and secure a new bulb.
3. Replace the lamp lens by applying pressure to both sides of the lamp lens and popping the lens up and on to the lamp assembly.

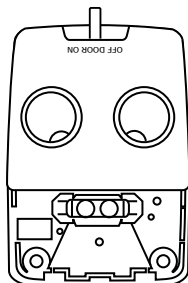
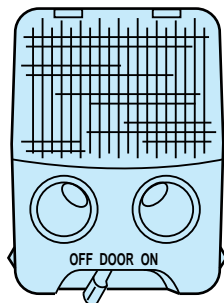

The interior overhead lamp is equipped with a battery saver control system designed to prevent excessive wear on the battery. When a door is not closed properly, the battery saver control system timer is activated. The timer will give you between eight and ten minutes to close the door before it automatically turns off the interior overhead lamp. If the door is left open, closed, and then left open again, the timer will automatically reset.

The battery saver control system is not activated when the headlamps are left on. A warning chime will sound when the engine is turned off to draw your attention to headlamps left on.

Map lamp

The map lamps are located in the rear portion of the interior overhead lamp assembly. Replacement of the two bulbs requires removal of the bulb assembly cover and the use of several different tools. See a qualified service technician or your dealer for replacement of the map lamp bulbs.

Hazard flasher

For more information on the hazard flasher and hazard switch, refer to *Using the hazard switch* in the *Roadside emergencies* chapter. For bulb replacement, see your dealer or a qualified service technician.

Maintenance and care

BULB SPECIFICATIONS

| Function | Number of bulbs | Trade number |
|--|------------------------|---------------------|
| Exterior illumination | | |
| Front park/turn lamps | 2 | 3457 |
| Foglamps (if equipped) | 2 | 881 |
| Headlamps — aero high and low beam | 2 | 9007 |
| Rear license plate lamp | 2 | 168 |
| High-mount brakelamp | 1 | 921 |
| Notchback — Backup lamp | 2 | 3156 |
| Notchback — Brakelamp | 2 | 3157 |
| Notchback — Rear/turn/side marker | 2 | 3157 |
| Liftgate wagon rear side marker lamp | 2 (1 each side) | 168 |
| Interior illumination | | |
| Cargo lamp liftgate (wagon) | 1 | 12V/5W |
| Interior overhead lamp | 2 | 12V/10W |
| Luggage compartment lamp (if equipped) | 1 | 5W |
| PRNDL illumination | 1 | 197 |
| Heater control nomenclature | 1 | 14V/3.0 |
| High beam indicator | 1 | W |
| Instrument panel gauge (cluster) | 4 | 194 |
| Sport cluster w/ tachometer | 2 | 194 |
| Turn signal indicator | 1 | 194 |
| Upshift indicator (if equipped) | (1 each) | 194 |
| Warning lights — all | | 194 |

Maintenance and care

| Function | Number of bulbs | Trade number |
|----------------|-----------------|---|
| Anti-theft LED | 1 LED | See your dealer to order replacement assembly, service part #F57Z13B765-A |

Aiming the headlamps

Your vehicle is equipped with a variable headlamp aiming device (VHAD) on each headlamp reflector extension and headlamp housing. Each headlamp may be properly aimed in the horizontal direction and the vertical direction by performing the following steps. The horizontal aim must be adjusted first. This procedure requires the use of a 4 mm box wrench or open end wrench.

Position the vehicle on a surface that is level in the front-to-rear direction.

If the vehicle cannot be placed on a true level surface, the headlamps still can be adjusted using the VHAD if the slope of the surface is accurately known and does not differ by more than 30.5 mm (1.2 in) from true level.

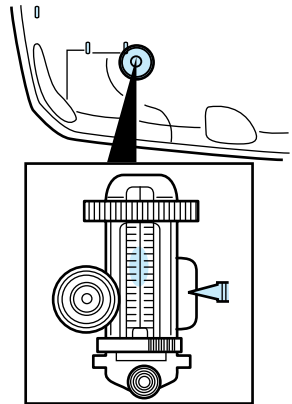

Maintenance and care

Adjusting the horizontal aim

1. With the hood open, locate the horizontal indicator and adjusting screw.
2. Use a 4 mm wrench to turn the horizontal adjusting screw until the reference mark on the reflector extension aligns with the “O” reference mark on the horizontal indicator when viewed directly from above.
3. When the horizontal aim has been adjusted, close the headlamp access panel.

Adjusting the vertical aim

1. Do not adjust the vertical aim until after adjusting the horizontal aim.
2. With the hood open, locate the bubble level vertical aim indicator. It is visible when viewed from above the rear of the headlamp.
3. With the vehicle on a level surface, use a 4 mm wrench to turn the vertical aim adjustment screw (outboard screw) located on the back of the lamp assembly clockwise or counterclockwise until the bubble in the spirit level is centered when viewed from directly above the bubble.
4. Close the hood.

If the vehicle is on a downward or upward slope of not more than 1.2° , the VHAD's bubble level can be used to correct for the effects of the surface slope, provided that the slope is accurately known.

Maintenance and care

Each graduation of the bubble level represents 0.19° of downward or upward slope. To correct for the effects of surface slope, turn the vertical aim adjustment screw until the bubble is centered at a position corresponding to the slope of the surface.

CLEANING AND CARING FOR YOUR VEHICLE

Contact your dealer for more information on recommended cleaners and their availability in your area.

Washing your vehicle

Wash your vehicle regularly with cold or lukewarm water. Never use strong detergents or soap. If your vehicle is particularly dirty, use a quality car shampoo. Always use a clean sponge and plenty of water for best results. We recommend that you have the underbody of your vehicle washed at the end of the winter to remove deposits left by snow, salt, and water.

Wax the body paintwork of your vehicle several times a year. This will help to retain the glossy paintwork finish and water droplets will run off more easily.

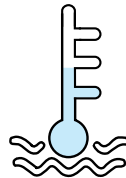

Remove any after dealer accessories, such as antennae, before entering a commercial car wash.

Maintenance and care

After washing your vehicle, apply the brakes several times to dry them.

Repairing paint chips

Minor scratches or paint damage from road chippings may be camouflaged with Ford exterior lacquer touch-up paint, AL81-XXXX-B or ALBZ-19500-XXXXA. XXXX indicates the code, meeting Ford specification ESR-M2P100-C. Follow the application instructions on the product. Be sure to remove aggressive particles such as bird droppings, tree resins, insect remains, tar spots, and road salt, that may damage your paint.

Cleaning the wheels

Wash the wheels with the same detergent used to clean the body of your vehicle. Do not use acid based wool cleaners, steel wool, fuel, or strong detergents. Never use abrasives that will damage the finish of special wheel surfaces. Use a tar and road oil remover to remove grease and tar.

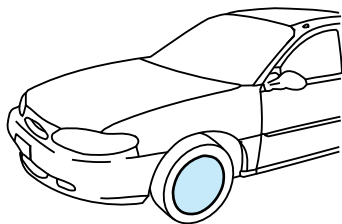

Cleaning plastic parts

Some of the vehicle's trim parts are plastic. Clean with a tar and road oil remover if necessary. Use a vinyl cleaner for routine cleaning. Do not clean plastic parts with thinners, solvents, or petroleum based cleaners.

Cleaning the instrument panel

Any cleaner or polish that increases the gloss of the upper portion of the instrument panel should be avoided. The dull finish in this area is to help protect the driver from windshield reflection.

Cleaning the exterior lamps

Do not use dry paper towels, chemical solvents, or abrasive cleaners to clean the lamps; these products may cause scratches or crack the lamps.

Cleaning the engine

A clean engine is more efficient than a dirty one because a buildup of grease and dirt acts as an insulator and keeps the engine warmer than normal. Follow these guidelines to clean your engine:

- Take care when using a power washer to clean the engine. The high pressure fluid could penetrate sealed parts and cause damage.
- In order to avoid cracking the engine block or fuel injection pump, do not spray these components with cold water.
- The alternator and air intake must be covered to prevent water damage when cleaning the engine.
- Never wash or rinse the engine while it is running; water in a running engine may cause internal damage.

Maintenance and care

Cleaning the wiper blades

If the blades do not wipe properly, clean both the windshield and the wiper blades using undiluted windshield washer solution or a mild detergent. Rinse thoroughly with clean water. Do not use fuel, kerosene, paint thinner, or other solvents to clean the wiper blades; these fluids will damage the blades.

Cleaning the built-in child seat

Clean the built in child seat with mild soap and water. Do not use household cleaning products because they may weaken the safety belt webbing or damage the vinyl parts of the seat.

The child seat liner is removable and may be machine washed and air dried.

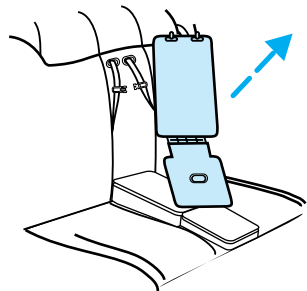

Cleaning and maintaining the safety belts

Clean the safety belts with a mild soap solution recommended for cleaning upholstery or carpets. Do not bleach or dye the belts; this may weaken the belt webbing.

Check the safety belt system periodically to ensure there are no nicks, wear, or cuts. If the vehicle has been involved in an accident, have all the safety belts and child seat anchoring brackets (if equipped) examined by a qualified technician.

Capacities and specifications

MOTORCRAFT PART NUMBERS

| Component | Ford part number — 2.0 liter SPI engine |
|-------------|---|
| Air filter | F7CX-9601-AA |
| Battery | BX-58C |
| Fuel filter | FG-862 |
| Oil filter | FL400-A |
| PCV valve | EV-229 |
| Spark plug* | AGSF-34-E |

* Refer to the Vehicle Emission Control Information (VECI) decal, located on the underside of the hood, for gap specifications.

REFILL CAPACITIES

Your vehicle's fuel capacity

The fuel capacity for your vehicle is 48.0 L (12.7 gallons).

- To avoid overspill from the filler neck, stop fueling at the second automatic shut off.
- For more information on fueling your vehicle, refer to *Choosing the right fuel* in the *Maintenance and care* chapter.

Capacities and specifications

| Capacities — liters (quarts) | 2.0 liter SPI engine |
|--|----------------------------------|
| Engine Oil — including filter / excluding filter | 3.8 L (4.0 qt) / 3.3 L (3.5 qt) |
| Manual transaxle | 3.35 L (3.55 qt) |
| Automatic transaxle — full torque converter / empty torque converter | 3.9 L (4.1 qt) / 6.3 L (6.7 qt) |
| Radiator filler cap | 110 kPa (16 psi) |
| Engine coolant <ul style="list-style-type: none"> ● automatic transaxle ● manual transaxle | 6.0 L (6.3 qt) 5.0 L (5.3 qt) |

LUBRICANT SPECIFICATIONS

| Item | Ford part name | Ford part number | Ford specification |
|--------------------------|---|--------------------------------|----------------------------|
| Brake master cylinder | Ford High Performance DOT 3 Motor Vehicle Brake Fluid | C6AZ-19542-AB | ESA-M6C25-A, DOT 3 |
| Constant velocity joints | CV Joint Grease — High Temperature | E43Z-19590-A | ESP-MIC207-A |
| Door weatherstrips | Silicone Lubricant (tube) (aerosol) | COAZ-19553-AA D7AZ-19553-AA | ESR-M13P4-A ESR-M13P4-A |
| Engine coolant | Ford Premium Cooling System Fluid | E2FZ-19549-AA, -B | ESE-M97B44-A |

Capacities and specifications

| Item | Ford part name | Ford part number | Ford specification |
|---|--|--------------------------------------|-----------------------------------|
| Engine oil | Motorcraft 5W-30 Super Premium Motor Oil | XO-5W-30 | WSS-M2C153-F |
| Hinges and latches | Ford Multi-Purpose Grease Spray (Aerosol) | F5AZ-19G209-AA | ESR-M1C159-A and ESB-M1C93A |
| Lock cylinders | Penetrating Lubricant | E8AZ-19A501-B | N/A |
| Power steering pump | Premium Power Steering Fluid | E6AZ-19582-AA | ESW-M2C33-F |
| Automatic and manual transaxle | Motorcraft MERCON® Multi-Purpose (ATF) Transmission Fluid | XT-2-BDX, -QDX | MERCON |
| Wheel bearings, rear | Motorcraft Premium Long-Life Grease | XG-1-C, -K | ESA-M1C75-B |
| Windshield washer fluid reservoir | Ultra-Clear Windshield Washer Concentrate | C9AZ-19550-AC or C9AZ-19550-BC | ESR-M17P5-A |

Capacities and specifications

ENGINE DATA

| | | |
|-------------------------------------|--|---------------------|
| Engine | 2.0 liter; 121 CID; 4 cylinder (in-line); compression ratio 9.2:1; single overhead cam; split port induction (SPI) | |
| Horsepower | 110 at 5,000 rpm | |
| Torque | 169 Nm (125 lb ft at 3,750 rpm) | |
| Required fuel grade | 87 (R+M)/2 | |
| Firing order / Injection timing | 1-3-4-2 | |
| Spark plug gap | 1.3 to 1.4 mm / 0.052 to 0.056 | |
| Ignition system | DIS | |
| Valve clearances cold inlet exhaust | 0: Maintenance free | 0: Maintenance free |

VEHICLE DIMENSIONS

| Dimensions — cm (inches) | Sedan | Wagon |
|--|---|---|
| ① Overall length | 443.25 cm (174.5 in) | 439.1 cm (172.9 in) |
| ② Overall width (excluding exterior mirrors) | 168.00 cm (66.2 in) | 170 cm (67 in) |
| ③ Maximum height | 135.00 cm (53.2 in) | 136.9 cm (53.9 in) |
| ④ Wheelbase | 250.00 cm (98.4 in) | 250 cm (98.4 in) |
| ⑤ Track Front Rear | 143.5 cm (56.5 in), 143.5 cm (56.5 in) | 143.5 cm (56.5 in), 143.5 cm (56.5 in) |

Capacities and specifications

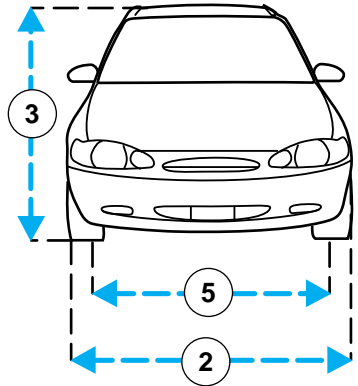
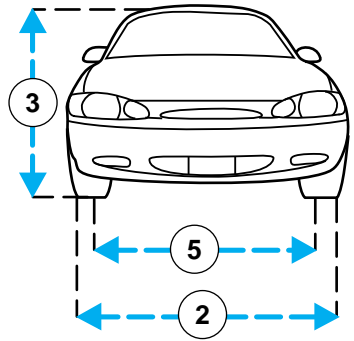

Capacities and specifications

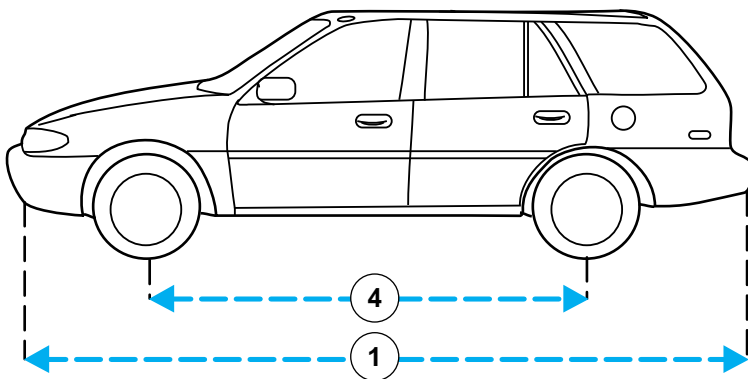
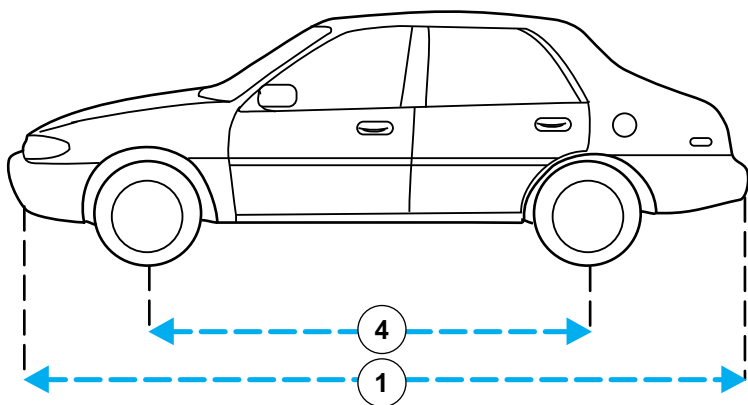

Capacities and specifications

IDENTIFYING YOUR VEHICLE

Vehicle identification plate

The vehicle identification plate is located on the front panel of the engine compartment. This plate bears technical information on your vehicle and identifies various components.

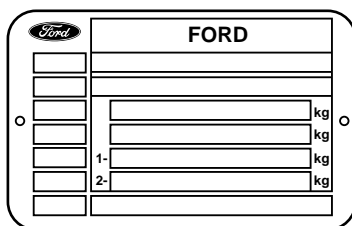

Vehicle identification number

The vehicle identification number (VIN) is attached to a metal tag and is located in the following areas of your vehicle for maximum theft protection:

- left and right front fenders
- hood
- left and right front doors
- front and rear bumper
- left and right rear quarter panels
- decklid
- liftgate
- engine compartment
- transaxle

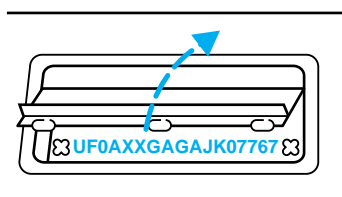

Engine number

The engine number is stamped on the engine block.

Reporting safety defects

If you believe that your vehicle has a defect which could cause a crash or could cause injury or death, you should immediately inform the National Highway Traffic Safety Administration (NHTSA) in addition to notifying Ford Motor Company.

If NHTSA receives similar complaints, it may open an investigation and if it finds that a safety defect existing in a group of vehicles, it may order a recall and remedy campaign. However, NHTSA cannot become involved in individual problems between you, your dealer, or Ford Motor Company.

To contact NHTSA, you may either call the Auto Safety Hotline toll-free at 1-800-424-9393 (202-366-0123 in the Washington D.C. area) or write to:

NHTSA
U.S. Department of Transportation
400 Seventh Street
Washington D. C. 20590

You can also obtain other information motor vehicle safety from the hotline.

- Aiming headlamps173
- Air bag supplemental restraint system62
 - description62,63
 - disposal63
 - driver air bag64
 - indicator light7,64
 - operation63
 - tone generator64
 - wearing safety belts64
- Air cleaner filter145
 - replacing146
- Air conditioning
 - manual heating and air conditioning system19
- Anti-lock brake system (ABS) ...93
 - noise93
 - see also Brake93
 - warning light94
- Anti-theft system45
 - arming the system50
 - description50
 - disarming a triggered system ..52
 - disarming an untriggered system51
 - warning light9
- Automatic transaxle96
 - driving with96
 - fluid, adding141
 - fluid, checking140
- Battery142
 - servicing143
- Brakes93
 - anti-lock93
 - anti-lock brake system (ABS) warning light9
 - fluid, checking and adding133
 - power braking93
- Break-in period2
- Bulbs, replacing160
 - halogen161
 - headlamps162
 - high-mount brakelamp164
 - rear lamps164,165,167,168
 - specifications172
- Cargo area shade41
- Changing a tire114
- Charging system warning light9
- Child safety seats
 - and air bags185
- Childproof locks33
- Cleaning your vehicle175
 - built-in child seat178
 - engine compartment177
 - exterior177
 - instrument panel177
 - plastic parts176
 - safety belts178
 - washing175
 - waxing175
 - wheels176
 - wiper blades178
- Climate control system17
 - air conditioning19
 - air distribution dial19
 - temperature dial18
- Clutch
 - fluid134
- Controls15,31,36,39,40
 - steering column25
- Daytime running light system ...26
- Defects, reporting186
- Disabled vehicle (see Towing) 123
- Driving under special conditions
 - towing a trailer105
- Emergencies, roadside107
- Emission control system ...157,158
- Engine129,182
 - check engine warning light7
 - Engine block heater91
 - Engine coolant
 - checking and adding136
 - low coolant warning light10

Index

- Engine oil130
 - check oil warning light9
 - checking and adding130
- Exhaust fumes91
- Fan18
- Flashing the lights27
- Floor mats39
- Foglamps27,163
- Fuel
 - capacity179
 - improving fuel economy106
 - low fuel warning light7
 - safety information relating to automotive fuels153
- Fuel pump shut-off switch ..43,107
 - starting after a collision43
- Fuse panels
 - engine compartment113
 - instrument panel111
- Fuses109
 - charts111,113
 - checking and replacing109
 - circuit breakers110
- Gauges, Electronic12
- Gauges, Mechanical12
 - engine coolant temperature gauge13
 - fuel gauge13
 - odometer14
 - speedometer13
 - trip odometer14
- Gearshift36,97
- GVWR (Gross Vehicle Weight Rating)101
 - definition101
- Hazard flashers29,107
- Head restraints54
- Headlamps
 - daytime running lights26
 - replacing bulbs162
 - turning on and off26
- High beams
 - indicator light9
 - operation27
- High-mount brakelamp
 - replacing the bulb164
- Hood128
 - prop rod128
 - release lever128
 - working under the hood124
- Idle
 - relearning144
- Ignition
 - positions of the ignition25
- Inspection/maintenance (I/M) testing158
- Instrument cluster
 - sport6,7
 - standard6
- Instrument panel15
 - lighting up panel and interior 6,15
 - location of components4,5
- Interval wipers30
- Jump-starting your vehicle120
 - attaching cables121
 - disconnecting cables122
- Lamps160
 - bulb replacement specifications chart172
 - daytime running light system ..26
 - dome lamps170
 - fog lamps27,163
 - headlamps26,162
 - high beams27
 - high-mount brakelamp164
 - illuminated entry system33
 - interior lamps31,170
 - map lamps31,171
 - replacing bulbs160
 - tail lamps167,168
- License plate lamps165
- Liftgate40,164
 - warning light10

| | |
|-------------------------------------|---------|
| Lights, warning and indicator | 6 |
| air bag | 7,64 |
| anti-lock brakes (ABS) | 9 |
| anti-theft | 9 |
| brake | 8 |
| charging system | 9 |
| checkcoolant | 10 |
| high beam | 9 |
| liftgate ajar | 10 |
| low fuel | 7 |
| oil pressure | 9 |
| safety belt | 8 |
| service engine soon | 7 |
| turn signal indicator | 9 |
| upshift indicator | 8 |
| Load limits | 101 |
| GVWR | 101 |
| trailer towing | 102 |
| Lubricant specifications | 180 |
| Luggage rack | 106 |
| Manual transaxle | 99 |
| driving | 99 |
| fluid, checking and adding | 134 |
| shifting gears | 100 |
| Mirrors | |
| side view mirrors (power) | 16 |
| Motorcraft parts | 179 |
| National Highway Traffic | |
| Safety Administration | 186 |
| Parking brake | 94 |
| automatic release | 38 |
| operation | 94 |
| warning light | 8 |
| Parts (see Motorcraft Parts) .. | 179 |
| Power door locks | 31 |
| Power features | |
| door locks | 31 |
| windows | 34 |
| Power steering | |
| fluid, checking and adding | 139 |
| Rear window | |
| defroster | 24 |
| washer | 30 |
| wiper | 30 |
| Refill capacities for fluids | 179 |
| Relays | 109 |
| Remote control | 45 |
| Remote entry system | 45 |
| illuminated entry | 49 |
| locking/unlocking doors | 46,47 |
| opening the trunk | 47 |
| panic alarm | 49 |
| Repairing paint chips | 176 |
| Reporting safety defects | 186 |
| Restraints, safety (see Safety | |
| restraints) | 55 |
| head | 54 |
| infant | 67 |
| Roadside emergencies | 107 |
| Safety chains, when towing a | |
| trailer | 104 |
| Safety defects, reporting | 186 |
| Safety restraints | 55 |
| adjusting the safety belts | 59 |
| automatic locking mode | |
| (retractor) | 57 |
| for children | 65 |
| lap and shoulder belts | 56,59 |
| maintenance | 60 |
| proper use | 55,56 |
| vehicle sensitive locking | |
| mode | 57 |
| warning light and chime .. | 8,10,62 |
| Safety seats for children | 67 |
| automatic locking mode | |
| (retractor) | 81 |
| built-in child seat | 74 |
| in front seat | 68 |
| in rear seat | 70 |
| tether anchorage hardware | 71 |
| Seats | 53 |
| adjusting the seat, manual | 53 |
| child safety seats | 67 |
| folding rear seats | 54 |

Index

- head restraints54
- split-folding rear seat54
- Servicing your vehicle
 - precautions when servicing ...124
 - servicing when you tow105
- Special driving conditions89
- Specification chart, lubricants180
- Speed control27
- Starting your vehicle88
 - preparing to start your vehicle86
 - starting a cold engine89
 - starting a warm engine89
- Steering wheel
 - tilting29
- Tail lamps
 - bulb replacement167,168
- Tilt steering wheel29
- Tire types152
- Tires148
 - changing114
 - checking the pressure150
 - replacing151
 - rotating151
 - snow tires and chains152
 - tire grades148
 - treadwear148
- Trailer towing102
 - safety chains104
 - tips105
 - trailer brakes104
 - trailer lamps104
- Transaxle96
 - fluid, checking and adding (automatic)139
- Turn signal
 - indicator lights9
- Upshift indicator light8,100
- Upshift speeds100
- Vehicle dimensions182
- Vehicle headlamp aiming device (VHAD)173
- Vehicle Identification Number (VIN)185
- Ventilating your vehicle (see Climate control)18,19,23
- Warning chimes10
 - headlamps on11
 - key in ignition11
 - safety belt10
- Washer fluid134
 - reservoir135
 - windshield30
- Windows
 - one-touch down35
 - power windows, operating34
- Windshield
 - washing30
- Windshield washer fluid and wipers
 - checking and adding fluid134
 - checking and replacing wiper blades146
 - liftgate reservoir135
 - operation30
- Wrecker towing123

Filling station information

| | |
|----------------------|--|
| Fuel | UNLEADED FUEL ONLY — Octane 87 |
| Fuel tank capacity | 48.0 L (12.7 gallons) |
| Engine oil | Use only engine oil displaying the American Petroleum Institute Certification Mark. SAE-5W30 is preferred. |
| Tire size & pressure | Refer to Tire Pressure Decal on passenger's door pillar. |
| Hood release | Pull handle under the left side of the instrument panel. |