

Table of Contents

Introduction	4
Instrument Cluster	12
Warning lights and chimes	12
Gauges	19
Entertainment Systems	23
AM/FM stereo	23
AM/FM stereo with CD	25
AM/FM stereo with in-dash six CD	32
Auxiliary input jack	40
Satellite radio information	44
Navigation system	47
Family entertainment system	48
Climate Controls	76
Heater only	76
Manual heating and air conditioning	77
Dual automatic temperature control	80
Lights	85
Headlamps	85
Turn signal control	90
Bulb replacement	91
Driver Controls	98
Windshield wiper/washer control	98
Steering wheel adjustment	99
Power windows	102
Mirrors	103
Speed control	109
Upfitter controls	114
Moon roof	115
Message center	120
Tailgate	140

Table of Contents

Locks and Security	146
Keys	146
Locks	146
Anti-theft system	159
Seating and Safety Restraints	162
Seating	162
Safety restraints	170
Airbags	184
Child restraints	192
Tires, Wheels and Loading	204
Tire information	206
Tire inflation	209
Tire Pressure Monitoring System (TPMS)	224
Vehicle loading	236
Trailer towing	242
Trailer brake controller-integrated	246
Recreational towing	253
Driving	255
Starting	255
Brakes	260
Traction Control™	262
Transmission operation	265
Snowplowing	291
Roadside Emergencies	294
Getting roadside assistance	294
Hazard flasher switch	296
Fuel pump shut-off switch	296
Fuses and relays	297
Changing tires	307
Lug nut torque	321
Jump starting	322
Wrecker towing	327

Table of Contents

Customer Assistance	329
Reporting safety defects (U.S. only)	335
Reporting safety defects (Canada only)	336
Cleaning	337
Maintenance and Specifications	346
Hood	347
Engine compartment	348
Engine oil	351
Battery	354
Engine coolant	356
Fuel information	362
Air filter(s)	380
Part numbers	382
Maintenance product specifications and capacities	383
Accessories	390
Index	392

All rights reserved. Reproduction by any means, electronic or mechanical including photocopying, recording or by any information storage and retrieval system or translation in whole or part is not permitted without written authorization from Ford Motor Company. Ford may change the contents without notice and without incurring obligation.

Copyright © 2007 Ford Motor Company

Introduction

CALIFORNIA Proposition 65 Warning



WARNING: Engine exhaust, some of its constituents, and certain vehicle components contain or emit chemicals known to the State of California to cause cancer and birth defects or other reproductive harm. In addition, certain fluids contained in vehicles and certain products of component wear contain or emit chemicals known to the State of California to cause cancer and birth defects or other reproductive harm.

PERCHLORATE MATERIAL

Certain components of this vehicle such as airbag modules, seat belt pretensioners, and button cell batteries may contain Perchlorate Material – Special handling may apply for service or vehicle end of life disposal. See www.dtsc.ca.gov/hazardouswaste/perchlorate.

CONGRATULATIONS

Congratulations on acquiring your new Ford. Please take the time to get well acquainted with your vehicle by reading this handbook. The more you know and understand about your vehicle, the greater the safety and pleasure you will derive from driving it.

For more information on Ford Motor Company and its products visit the following website:

- In the United States: www.ford.com
- In Canada: www.ford.ca
- In Australia: www.ford.com.au
- In Mexico: www.ford.com.mx

Additional owner information is given in separate publications.

This *Owner's Guide* describes every option and model variant available and therefore some of the items covered may not apply to your particular vehicle. Furthermore, due to printing cycles it may describe options before they are generally available.

Remember to pass on this *Owner's Guide* when reselling the vehicle. It is an integral part of the vehicle.



Fuel pump shut-off switch: In the event of an accident the safety switch will automatically cut off the fuel supply to the engine. The switch can also be activated through sudden vibration (e.g. collision when parking). To reset the switch, refer to the *Fuel pump shut-off switch* in the *Roadside Emergencies* chapter.

Introduction

SAFETY AND ENVIRONMENT PROTECTION

Warning symbols in this guide

How can you reduce the risk of personal injury to yourself or others? In this guide, answers to such questions are contained in comments highlighted by the warning triangle symbol. These comments should be read and observed.

Warning symbols on your vehicle

When you see this symbol, it is imperative that you consult the relevant section of this guide before touching or attempting adjustment of any kind.



Protecting the environment

We must all play our part in protecting the environment. Correct vehicle usage and the authorized disposal of waste, cleaning and lubrication materials are significant steps towards this aim. Information in this respect is highlighted in this guide with the tree symbol.



BREAKING-IN YOUR VEHICLE

During the first 1,000 miles (1,600 km) of driving, maintain speeds below 70 mph (113 km/h) and vary speeds frequently. This is recommended to give the moving parts a chance to break-in.

Do not tow a trailer or use your vehicle to snowplow until it has been driven at least 500 miles (800 km). Refer to *Trailer towing* in the *Tires, Wheels and Loading* chapter for more information on towing a trailer and *Snowplowing* in the *Driving* chapter.

Do not add friction modifier compounds or special break-in oils during the first few thousand miles (kilometers) of operation, since these additives may prevent piston ring seating. See *Engine oil* in the *Maintenance and Specifications* chapter for more information on oil usage.

Introduction

SPECIAL NOTICES

New Vehicle Limited Warranty

For a detailed description of what is covered and what is not covered by your vehicle's New Vehicle Limited Warranty, refer to the *Warranty Guide* that is provided to you along with your *Owner's Guide*.

Service Data Recording

Service data recorders in your vehicle are capable of collecting and storing diagnostic information about your vehicle. This potentially includes information about the performance or status of various systems and modules in the vehicle, such as engine, throttle, steering or brake systems. In order to properly diagnose and service your vehicle, Ford Motor Company, Ford of Canada, Ford Motor Company, S.A. de C.V. and service and repair facilities may access vehicle diagnostic information through a direct connection to your vehicle when diagnosing or servicing your vehicle.

Event Data Recording

Other modules in your vehicle — event data recorders — are capable of collecting and storing data during a crash or near crash event. The recorded information may assist in the investigation of such an event. The modules may record information about both the vehicle and the occupants, potentially including information such as:

- how various systems in your vehicle were operating;
- whether or not the driver and passenger seatbelts were buckled;
- how far (if at all) the driver was depressing the accelerator and/or the brake pedal;
- how fast the vehicle was traveling; and
- where the driver was positioning the steering wheel.

To access this information, special equipment must be directly connected to the recording modules. Ford Motor Company, Ford of Canada and Ford Motor Company, S.A. de C.V. do not access event data recorder information without obtaining consent, unless pursuant to court order or where required by law enforcement, other government authorities or other third parties acting with lawful authority. Other parties may seek to access the information independently of Ford Motor Company, Ford of Canada and Ford Motor Company, S.A. de C.V.

Introduction

Vehicle Modification Data Recording

Some aftermarket products may cause severe engine and/or transmission damage; refer to the *What is not covered* section in *The new vehicle limited warranty for your vehicle* chapter of your vehicle's *Warranty Guide* for more information. Some vehicles are equipped with Powertrain Control Systems that can detect and store information about vehicle modifications that increase horsepower and torque output; this information cannot be erased and will stay in the system's memory even if the modification is removed. When a dealer or repair facility works on your vehicle, it may be necessary for them to access the information in the Powertrain Control System. This information will likely identify if any unauthorized modifications have been made to the system and may be used to determine if repairs will be covered by warranty.

Special instructions

For your added safety, your vehicle is fitted with sophisticated electronic controls.



Please read the section *Airbag Supplemental Restraint System (SRS)* in the *Seating and Safety Restraints* chapter. Failure to follow the specific warnings and instructions could result in personal injury.



Front seat mounted rear-facing child or infant seats should **NEVER** be placed in front of an active passenger airbag.

Cell phone use

The use of Mobile Communications Equipment has become increasingly important in the conduct of business and personal affairs. However, drivers must not compromise their own or others' safety when using such equipment. Mobile Communications can enhance personal safety and security when appropriately used, particularly in emergency situations. Safety must be paramount when using mobile communications equipment to avoid negating these benefits.

Mobile Communication Equipment includes, but is not limited to cellular phones, pagers, portable email devices, in-vehicle communications systems, telematics devices and portable two-way radios.

Introduction



Driving while distracted can result in loss of vehicle control, accident and injury. Ford strongly recommends that drivers use extreme caution when using any device that may take their focus off the road. The driver's primary responsibility is the safe operation of their vehicle. Only use cell phones and other devices not essential to the driving task when it is safe to do so.

Notice to owners of diesel-powered vehicles

Read the *6.0 and 6.4 Liter Power Stroke Direct Injection Turbo Diesel Owner's Guide Supplement* for information regarding correct operation and maintenance of your Diesel-powered light truck.

Notice to owners of pickup trucks and utility type vehicles



Utility vehicles have a significantly higher rollover rate than other types of vehicles.

Before you drive your vehicle, please read this *Owner's Guide* carefully. Your vehicle is not a passenger car. As with other vehicles of this type, failure to operate this vehicle correctly may result in loss of vehicle control, vehicle rollover, personal injury or death.

Be sure to read *Driving off-road with truck and utility vehicles* in the *Driving* chapter.

Using your vehicle with a snowplow

For more information and guidelines for using your vehicle with a snowplow, refer to *Snowplowing* in the *Driving* chapter.

Using your vehicle as an ambulance

If your light truck is equipped with the Ford Ambulance Preparation Package, it may be utilized as an ambulance. Ford urges ambulance manufacturers to follow the recommendations of the *Ford Incomplete Vehicle Manual*, *Ford Truck Body Builder's Layout Book* and the *Qualified Vehicle Modifiers (QVM) Guidelines* as well as pertinent supplements. For additional information, please contact the Truck Body Builders Advisory Service at 1-877-840-4338.

Introduction

Use of your Ford light truck as an ambulance, without the Ford Ambulance Preparation Package voids the Ford New Vehicle Limited Warranty and may void the Emissions Warranties. In addition, ambulance usage without the preparation package could cause high underbody temperatures.

If your vehicle is equipped with the Ford Ambulance Preparation Package, it will be indicated on the Safety Compliance Certification Label. The label is located on the driver's side door pillar or on the rear edge of the driver's door. You can determine whether the ambulance manufacturer followed Ford's recommendations by directly contacting that manufacturer. Ford Ambulance Preparation Package is only available on certain 6.4L Diesel engine equipped vehicles.

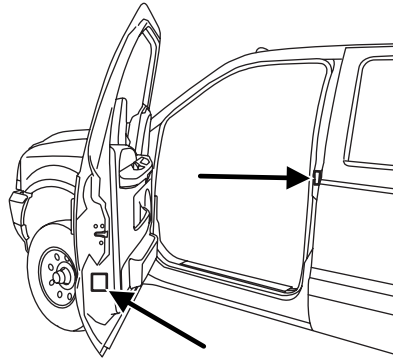

Using your vehicle as a stationary power source (PTO)

Refer to the *Driving* chapter for more information and guidelines for operating a vehicle equipped with an aftermarket power take-off system.



















Export unique (non-United States/Canada) vehicle specific information

For your particular global region, your vehicle may be equipped with features and options that are different from the ones that are described in this *Owner's Guide*. A market unique supplement may be supplied that complements this book. By referring to the market unique supplement, if provided, you can properly identify those features, recommendations and specifications that are unique to your vehicle. This *Owner's Guide* is written primarily for the U.S. and Canadian Markets. Features or equipment listed as standard may be different on units built for Export. **Refer to this Owner's Guide for all other required information and warnings.**

Introduction











These are some of the symbols you may see on your vehicle.

Vehicle Symbol Glossary

Safety Alert		See Owner's Guide	
Fasten Safety Belt		Airbag - Front	
Airbag - Side		Child Seat Lower Anchor	
Child Seat Tether Anchor		Brake System	
Anti-Lock Brake System		Parking Brake System	
Brake Fluid - Non-Petroleum Based		Parking Aid System	
Stability Control System		Speed Control	
Master Lighting Switch		Hazard Warning Flasher	
Fog Lamps-Front		Fuse Compartment	
Fuel Pump Reset		Windshield Wash/Wipe	
Windshield Defrost/Demist		Rear Window Defrost/Demist	

Introduction

Vehicle Symbol Glossary

Power Windows Front/Rear		Power Window Lockout	
Child Safety Door Lock/Unlock		Interior Luggage Compartment Release	
Panic Alarm		Engine Oil	
Engine Coolant		Engine Coolant Temperature	
Do Not Open When Hot		Battery	
Avoid Smoking, Flames, or Sparks		Battery Acid	
Explosive Gas		Fan Warning	
Power Steering Fluid		Maintain Correct Fluid Level	
Service Engine Soon		Engine Air Filter	
Passenger Compartment Air Filter		Jack	
Check Fuel Cap		Low Tire Pressure Warning	

Instrument Cluster

WARNING LIGHTS AND CHIMES

Vehicles equipped with a manual transmission

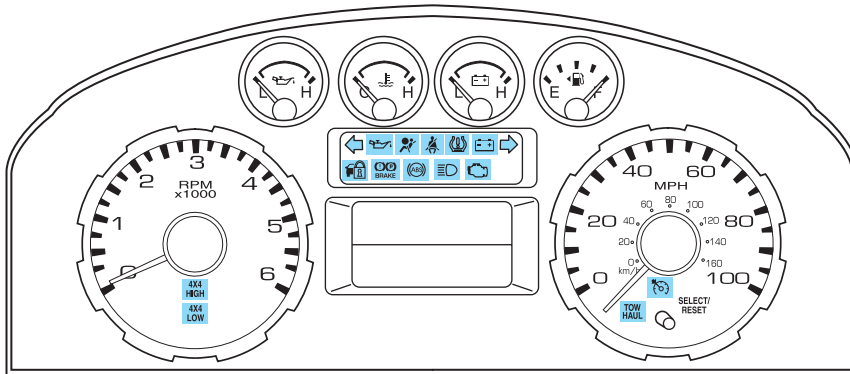

Vehicles equipped with an automatic transmission

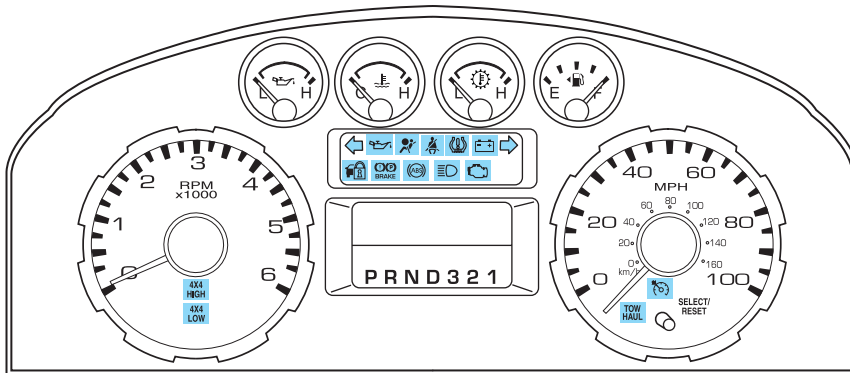

Instrument Cluster

Harley-Davidson vehicles

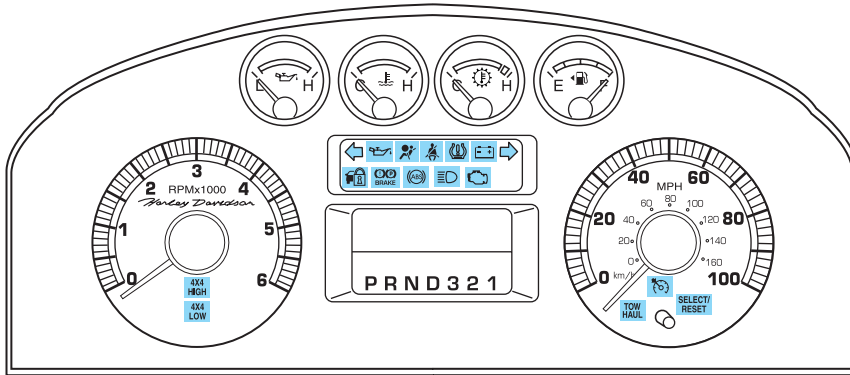

Warning lights and gauges can alert you to a vehicle condition that may become serious enough to cause expensive repairs. A warning light may illuminate when a problem exists with one of your vehicle's functions. Many lights will illuminate when you start your vehicle to make sure the bulbs work. If any light remains on after starting the vehicle, refer to the respective system warning light description for additional information.

Note: Some Warning Lights are reconfigurable telltale (RTT) indicator lights and will illuminate in the Message Center Display and function the same as the warning light.

Service engine soon: The *Service engine soon* indicator light illuminates when the ignition is first turned to the RUN position to check



the bulb. Solid illumination after the engine is started indicates the On Board Diagnostics System (OBD-II) has detected a malfunction. Refer to *On board diagnostics (OBD-II)* in the *Maintenance and Specifications* chapter. If the light is blinking, engine misfire is occurring which could damage your catalytic converter. Drive in a moderate fashion (avoid heavy acceleration and deceleration) and have your vehicle serviced immediately.

Instrument Cluster



Under engine misfire conditions, excessive exhaust temperatures could damage the catalytic converter, the fuel system, interior floor coverings or other vehicle components, possibly causing a fire.

Brake system warning light: To confirm the brake system warning light is functional, it will momentarily illuminate when the ignition is turned to the RUN

position when the engine is not running, or in a position between RUN and START, or by applying the parking brake when the ignition is turned to the RUN position. If the brake system warning light does not illuminate at this time, seek service immediately from your authorized dealer. Illumination after releasing the parking brake indicates low brake fluid level and the brake system should be inspected immediately by your servicing authorized dealer.



Driving a vehicle with the brake system warning light on is dangerous. A significant decrease in braking performance may occur. It will take you longer to stop the vehicle. Have the vehicle checked by your authorized dealer immediately. Driving extended distances with the parking brake engaged can cause brake failure and the risk of personal injury.

Anti-lock brake system: If the ABS light stays illuminated or continues to flash, a malfunction has been detected, have the system serviced immediately by your authorized dealer. Normal braking is still functional unless the brake warning light also is illuminated.



Airbag readiness: If this light fails to illuminate when ignition is turned to RUN, continues to flash or remains on, have the system serviced immediately by your authorized dealer. A chime will also sound when a malfunction in the supplemental restraint system has been detected.



Instrument Cluster

Safety belt: Reminds you to fasten your safety belt. A Belt-Minder® chime will also sound to remind you to fasten your safety belt. Refer to the *Seating and Safety Restraints* chapter to activate/deactivate the Belt-Minder® chime feature.



Engine oil pressure: Illuminates when the oil pressure falls below the normal range. Refer to *Engine oil* in the *Maintenance and Specifications* chapter.



Low tire pressure warning (if equipped): Illuminates when your tire pressure is low. If the light remains on at start up or while driving, the tire pressure should be checked. Refer to *Inflating Your Tires* in the *Tires, Wheels and Loading* chapter. When the ignition is first turned to ON, the light will illuminate for 3 seconds to ensure the bulb is working. If the light does not turn on, have the system inspected by your authorized dealer. For more information on this system, refer to *Understanding Your Tire Pressure Monitoring System (TPMS)* in the *Tires, Wheels and Loading* chapter.

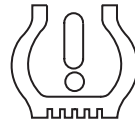

Charging system: Illuminates when the battery is not charging properly.



Powertrain malfunction/Reduced power/Electronic throttle control (RTT):

Displays when the engine has defaulted to a “limp-home” operation or when a transmission problem has been detected and shifting may be restricted. If the light remains on, have the system serviced immediately by your authorized dealer.



Traction Control™ (RTT)

(if equipped): Displays when the Traction Control™ system is active.

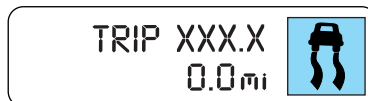

Instrument Cluster

If the light remains on, have the system serviced immediately by your authorized dealer. Refer to *Traction Control™* in the *Driving* chapter for more information.

Check fuel cap (RTT): Displays when the fuel cap may not be properly installed. Continued driving with this light on may cause the Service engine soon warning light to come on. Refer to *Fuel filler cap* in the *Maintenance and Specifications* chapter.

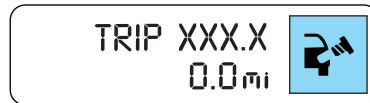

Engine coolant temperature (RTT): Displays when the engine coolant temperature is high. Stop the vehicle as soon as safely possible, switch off the engine and let it cool. Refer to *Engine coolant* in the *Maintenance and Specifications* chapter.

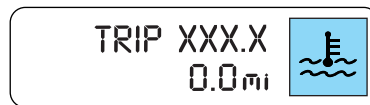

Never remove the coolant reservoir cap while the engine is running or hot.

Low fuel (RTT): Displays when the fuel level in the fuel tank is at or near empty (refer to *Fuel gauge* in this chapter).

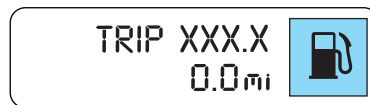

Door ajar (RTT): Displays when the ignition is in the RUN position and any door is open.

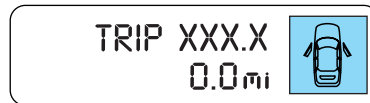

Transmission Tow/Haul Feature (automatic transmission)

(if equipped): The Tow Haul light remains illuminated as long as the Tow/Haul feature is activated. Refer to the *Driving* chapter for transmission function and operation. If the light remains illuminated and will not cancel using the Tow/Haul switch located on the end of the gear shift lever, have the system serviced immediately or damage to the transmission could occur.

TOW
HAUL

Instrument Cluster

Four wheel drive low (if equipped): Illuminates when four-wheel drive low is engaged.

4x4
LOW

Four wheel drive high (if equipped): Illuminates when four-wheel drive high is engaged.

4x4
HIGH

Anti-theft: Flashes when the SecuriLock™ Passive Anti-Theft System has been activated.



Speed control (if equipped): Illuminates when the speed control is activated. Turns off when the speed control system is deactivated.



Turn signal: Illuminates when the left or right turn signal or the hazard lights are turned on. If the indicators stay on or flash faster, check for a burned out bulb.



High beams: Illuminates when the high beam headlamps are turned on.



If your vehicle is equipped with a diesel engine, it has some unique warning lights; refer to *Instrument Cluster* in your *6.0 and 6.4 Liter Power Stroke Direct Injection Turbo Diesel Owner's Guide Supplement* for detailed information on their function.

Diesel warning lights:

- Glow plug pre-heat
- Water in fuel

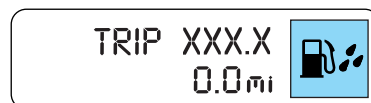

Instrument Cluster

- Low oil pressure

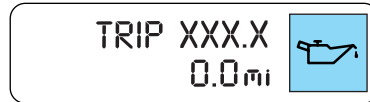

Key-in-ignition warning chime: Sounds when the key is left in the ignition in the OFF, LOCK or ACCESSORY position and the driver's door is opened.

Headlamps on warning chime: Sounds when the headlamps or parking lamps are on, the ignition is off (the key is not in the ignition) and the driver's door is opened.

Parking brake on warning chime: Sounds when the parking brake is set, the engine is running and the vehicle is driven more than 3 mph (5 km). If the warning remains on after the parking brake is off, contact your authorized dealer as soon as possible.

Turn signal chime: Sounds when the turn signal lever has been activated to signal a turn and not turned off after the vehicle is driven more than 2 miles (3.2 km).

Message center activation chime: Sounds when some warning messages appears in the message center display for the first time.

Overspeed chime (if equipped): Sounds when the vehicle speed reaches 75 mph (120 km/h) or higher.

Airbag secondary warning chime: Sounds to inform the driver, in the event that the airbag readiness warning lamp is inoperable, that there is a fault in the supplemental restraint system

Instrument Cluster

GAUGES

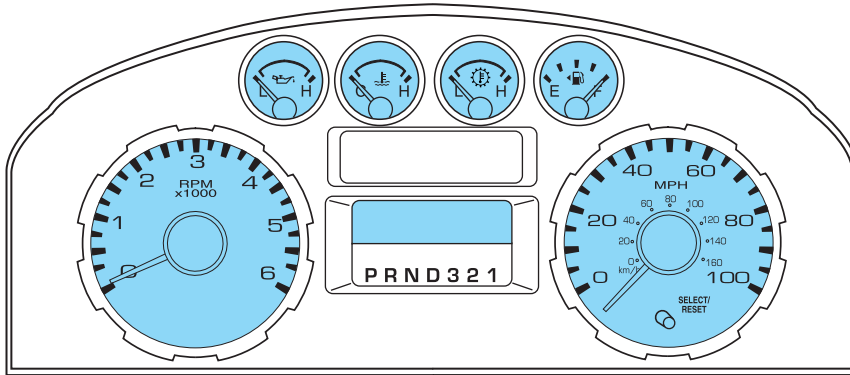

Speedometer: Indicates the current vehicle speed.

Standard instrument cluster

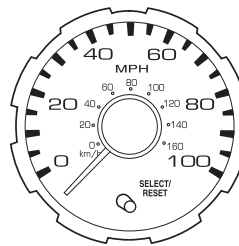

Harley-Davidson instrument cluster

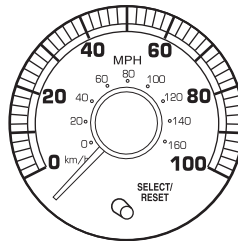

Instrument Cluster

Engine coolant temperature

gauge: Indicates engine coolant temperature. At normal operating temperature, the needle will be in the normal range (between “H” and “C”). **If it enters the red section, the engine is overheating. Stop the vehicle as soon as safely possible, switch off the engine and let the engine cool.**

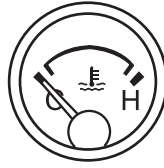

Never remove the coolant reservoir cap while the engine is running or hot.

Odometer: Registers the total miles (kilometers) of the vehicle. Refer to *Standard message center* or *Optional message center* in the *Driver Controls* chapter on how to switch the display from Metric to English.

0.0 mi

Trip odometer: Registers the miles (kilometers) of individual journeys.

TRIP XXX.X
0.0 mi

If equipped with a one button message center (Select/Reset),

press and release the SELECT/RESET button on the cluster to toggle between odometer and trip odometer display. To reset, press and hold for less than 2 seconds.

If equipped with a three button message center, press and release the message center INFO button until TRIP A or TRIP B appears in the display. Press the RESET button to reset.

Tachometer: Indicates the engine speed in revolutions per minute. Driving with your tachometer pointer continuously at the top of the scale may damage the engine.

Instrument Cluster

Standard instrument cluster

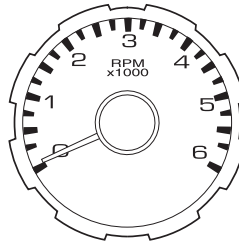

Harley-Davidson instrument cluster

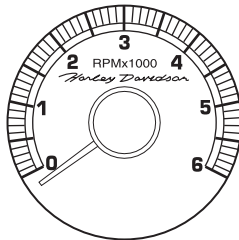

Engine oil pressure gauge:

Indicates engine oil pressure. The needle should stay in the normal operating range (between “L” and “H”). If the needle falls below the normal range, stop the vehicle, turn off the engine and check the engine oil level. Add oil if needed. If the oil level is correct, have your vehicle checked at your authorized dealer.



Fuel gauge: Indicates approximately how much fuel is left in the fuel tank (when the ignition is in the RUN position). The fuel gauge may vary slightly when the vehicle is in motion or on a grade. The FUEL icon and arrow indicates which side of the vehicle the fuel filler door is located.



Refer to *Filling the tank* in the *Maintenance and Specifications* chapter for more information.

Instrument Cluster

Battery voltage gauge (manual transmission only): Indicates the battery voltage when the ignition is in the RUN position. If the pointer moves and stays outside the normal operating range, have the vehicle's electrical system checked as soon as possible.

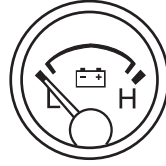

Transmission fluid temperature gauge (automatic transmission only): If the gauge is in the:

Normal area (normal) - the transmission fluid is within the normal operating temperature (between "H" and "C").

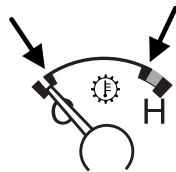

Yellow area (warning) — the transmission fluid is higher than normal operating temperature. This can be caused by special operation conditions (i.e. snowplowing, towing or off road use). Refer to *Special Operating Conditions* in the *scheduled maintenance information* for instructions. Operating the transmission for extended periods of time with the gauge in the yellow area may cause internal transmission damage.

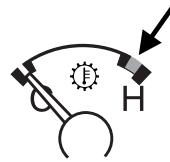

Altering the severity of the driving conditions is recommended to lower the transmission temperature into the normal range.

Red area (over temperature) — the transmission fluid is overheating. Stop the vehicle to allow the temperature to return to normal range.

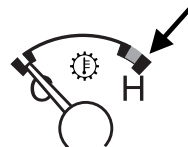



If the gauge is operating in the Yellow or Red area, stop the vehicle and verify the airflow is not restricted such as snow or debris blocking airflow through the grill. If the gauge continues to show high temperatures, see your authorized dealer.

Entertainment Systems

AUDIO SYSTEMS

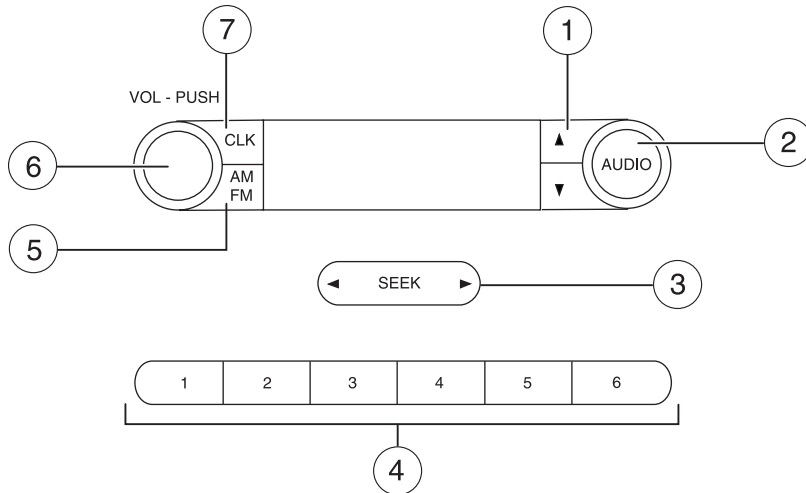
AM/FM stereo system (if equipped)



 Driving while distracted can result in loss of vehicle control, accident and injury. Ford strongly recommends that drivers use extreme caution when using any device that may take their focus off the road. The driver's primary responsibility is the safe operation of their vehicle. Only use cell phones and other devices not essential to the driving task when it is safe to do so.

The AM/FM stereo system does not contain rear speakers; only front driver side and passenger side speakers.

Accessory delay: Your vehicle is equipped with accessory delay. With this feature, the window switches and radio may be used for up to ten minutes after the ignition is turned off or until either front door is opened.

1. **▲ / ▼ (Tuner):** Press to manually go up or down the radio frequency. Press and hold for a fast advance through radio frequencies. Also use in AUDIO mode to gain access to various settings.



Entertainment Systems

2. **AUDIO:** Press AUDIO repeatedly to gain access to the following settings:



TREB (Treble): Press AUDIO to reach the treble setting.

Use ▲ / ▼ / ◀ SEEK ▶ .

BASS (Bass): Press AUDIO to reach the bass setting. Use ▲ / ▼ / ◀ SEEK ▶ .

BAL (Balance): Press AUDIO to reach the balance setting.

Use ▲ / ▼ / ◀ SEEK ▶ to adjust between the left and right speakers.

Setting the clock: Press and hold CLK until the hours start to flash, then use ▲ / ▼ / ◀ SEEK ▶ to adjust. To adjust minutes, press CLK again to make the minutes start to flash and use ▲ / ▼ / ◀ SEEK ▶ to adjust. Press CLK again to exit the clock setting mode.

3. **SEEK:** Press ◀ SEEK ▶ to access the previous/next strong station.



4. **Memory presets:** To set a station: Select frequency band AM/FM1/FM2; tune to a station, press and hold a preset button until sound returns. You may store up to six stations in each frequency band for a total of 18.



5. **AM/FM:** Press AM/FM to select AM/FM1/FM2 frequency band.



6. **ON/OFF/Volume:** Press VOL - PUSH to turn ON/OFF. Turn VOL - PUSH to increase/decrease volume.

VOL - PUSH



7. **CLK (Clock):** Press CLK to toggle between the clock and radio frequency.



Entertainment Systems

AM/FM stereo single CD/satellite compatible sound system (if equipped)

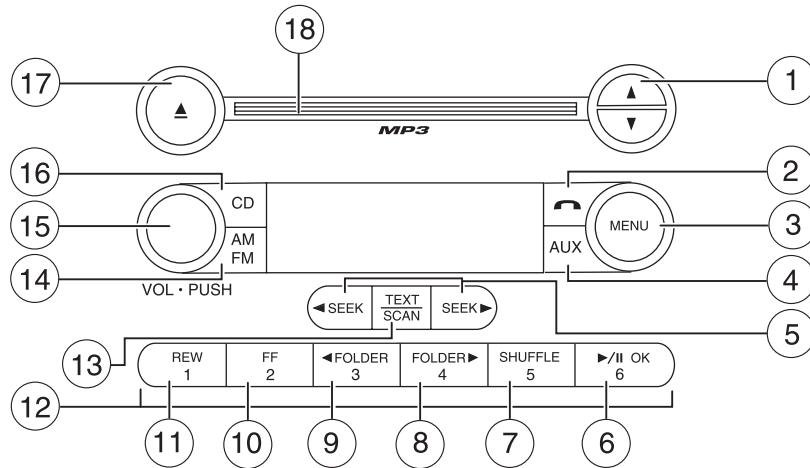

! Driving while distracted can result in loss of vehicle control, accident and injury. Ford strongly recommends that drivers use extreme caution when using any device that may take their focus off the road. The driver's primary responsibility is the safe operation of their vehicle. Only use cell phones and other devices not essential to the driving task when it is safe to do so.

Accessory delay: Your vehicle is equipped with accessory delay which allows you to operate the window switches and the audio for up to ten minutes after the ignition has been turned off or until either front door is opened.

1. ▲ / ▼ : Press ▲ / ▼ to manually go up or down the radio frequency. Press and hold for a fast advance through radio frequencies.



In satellite radio mode (if equipped), press ▲ / ▼ to tune to the next/previous channel.

Satellite radio is available only with a valid SIRIUS radio subscription. Check with your authorized dealer for availability.





Entertainment Systems







2. **☎ (Phone):** Pressing  **(Phone)** results in “NO PHONE” message shown in display.



3. **MENU:** Press MENU repeatedly to access to the following settings:







Setting the clock: Press MENU until SET HOUR or SET MINUTES is displayed. Use  /  /  SEEK, SEEK  to adjust the hours/minutes.

CATEGORY (satellite radio, if equipped - early availability): Press MENU until the currently active category appears in the display (CATEGORY MODE). In CATEGORY MODE, press  /  to scroll through the list of available SIRIUS channel Categories (Pop, Rock, News, etc.) Press  SEEK, SEEK  or SCAN to select the category. After a category is selected, press SEEK to search for that specific category of channels only (i.e. ROCK). To select a different category, press MENU until the category appears in the display. Press  /  to select a different category. You may also select CATEGORY ALL to seek all available SIRIUS categories and channels.

Satellite radio is available only with a valid SIRIUS radio subscription. Check with your authorized dealer for availability.

Note: If your vehicle is equipped with Satellite Radio, you will either have the CATEGORY option above or the CATEOGRY option within the SATELLITE RADIO MENU below.

SATELLITE RADIO MENU (if equipped - late availability): Press MENU when satellite radio mode is active to access. Press OK to enter into the satellite radio menu. Press  /  to cycle through the following options:

- **CATEGORY:** Press OK to enter category mode. Press  /  to scroll through the list of available SIRIUS channel Categories (Pop, Rock, News, etc.) Press OK when the desired category appears in the display. After a category is selected, press SEEK to search for that specific category of channels only (i.e. ROCK). You may also select CATEGORY ALL to seek all available SIRIUS categories and channels. Press OK to close and return to the main menu.

Entertainment Systems

- **SAVE SONG:** Press OK to save the currently playing song title in the system's memory. (If you try to save something other than a song, CANT SAVE will appear in the display.) When the chosen song is playing on any satellite radio channel, the system will alert you with an audible prompt. Press OK while SONG ALERT is in the display and the system will take you to the channel playing the desired song. You can save up to 20 song titles. If you attempt to save a song when the system is full, the display will read REPLACE SONG? Press OK to access the saved songs and press ▲ / ▼ to cycle through the saved songs. When the song appears in the display that you would like to replace, press OK. SONG REPLACED will appear in the display.
- **DELETE SONG:** Press OK to delete a song title from the system's memory. Press ▲ / ▼ to cycle through the saved songs. When the song title appears in the display that you would like to delete, press OK. The song will appear in the display for confirmation. Press OK again and the display will read SONG DELETED. If you do not want to delete the currently listed song, press ▲ / ▼ to select either RETURN or CANCEL.
Note: If there are no songs presently saved, the display will read NO SONGS.
- **DELETE ALL SONGS:** Press OK to delete all songs from the system's memory. The display will read ARE YOU SURE ? Press OK to confirm deletion of all saved songs and the display will read ALL DELETED.
Note: If there are no songs presently saved, the display will read NO SONGS.
- **ENABLE ALERTS / DISABLE ALERTS:** Press OK to enable/disable the satellite alert status which alerts you when your selected songs are playing on a satellite radio channel. (The system default is disabled.) SONG ALERTS ENABLED/DISABLED will appear in the display. The menu listing will display the opposite state. For example, if you have chosen to enable the song alerts, the menu listing will read DISABLE as the alerts are currently on, so your other option is to turn them off.

Satellite radio is available only with a valid SIRIUS radio subscription. Check with your authorized dealer for availability.

Entertainment Systems

AUTOSET: Press MENU until the display reads AUTOSET. Autoset allows you to set the strongest local radio stations without losing your original manually set preset stations for AM/FM1/FM2. Use ▲ / ▼ / ◀ SEEK, SEEK ▶ to turn on/off.

When the six strongest stations are filled, the station stored in preset 1 will begin playing. If there are less than six strong stations, the system will store the last one in the remaining presets.

BASS: Press MENU to reach the bass setting. Use ▲ / ▼ / ◀ SEEK, SEEK ▶ to adjust.

TREB (Treble): Press MENU to reach the treble setting. Use ▲ / ▼ / ◀ SEEK, SEEK ▶ to adjust.

BAL (Balance): Press MENU to reach the balance setting. Use ▲ / ▼ / ◀ SEEK, SEEK ▶ to adjust the audio between the left (L) and right (R) speakers.

FADE: Press MENU to reach the fade setting. Use ▲ / ▼ / ◀ SEEK, SEEK ▶ to adjust the audio between the back (B) and front (F) speakers.

SPEEDVOL (Speed sensitive volume, if equipped): Press MENU to reach the SPEEDVOL setting. Radio volume automatically gets louder with increasing vehicle speed to compensate for road and wind noise. Use ▲ / ▼ / ◀ SEEK, SEEK ▶ to adjust.

The default setting is *off*; increasing your vehicle speed will not change the volume level.

Adjust 1–7: Increasing this setting from 1 (lowest setting) to 7 (highest setting) allows the radio volume to automatically change slightly with vehicle speed to compensate for road and wind noise.

Recommended level is 1–3; SPEED OFF turns the feature off and level 7 is the maximum setting.

Track/Folder mode: Available only on MP3 discs in CD mode. In Track mode, pressing ◀ SEEK, SEEK ▶ will scroll through all tracks on the disc

In Folder mode, pressing ◀ SEEK, SEEK ▶ will scroll only through tracks within the selected folder.

Press ◀ FOLDER, FOLDER ▶ to access the previous/next folder (if available).

Entertainment Systems

COMPRESS (Compression): Available only in CD/MP3 mode. Press MENU until COMPRESS ON/OFF appears in the display.

Use ▲ / ▼ / ◀ SEEK, SEEK ▶ to toggle ON/OFF. When COMPRESS is ON, the system will bring the soft and loud CD passages together for a more consistent listening level.

4. **AUX:** Press repeatedly to cycle through FES/DVD (if equipped), LINE IN (auxiliary audio mode, if equipped) and SAT1, SAT2 and SAT3 modes (satellite radio, if equipped).



For location and further information on auxiliary audio mode, refer to *Auxiliary input jack* later in this chapter.

Satellite radio is available only with a valid SIRIUS radio subscription. Check with your authorized dealer for availability.

5. **SEEK: In radio mode,**

press ◀ / ▶ to access the previous/next strong station.



In CD/MP3 mode, press ◀ / ▶ to access the previous/next CD/MP3 track.

In satellite radio mode (if equipped), press ◀ SEEK, SEEK ▶ to seek to the previous/next channel. If a specific category is selected, (Jazz, Rock, News, etc.), press ◀ SEEK, SEEK ▶ to seek to the previous/next channel in the selected category. Press and hold ◀ SEEK, SEEK ▶ to fast seek through the previous /next channels.

In TEXT MODE, press ◀ SEEK, SEEK ▶ to view the previous/additional display text.

In CATEGORY MODE, press ◀ SEEK, SEEK ▶ to select a category.

Satellite radio is available only with a valid SIRIUS radio subscription. Check with your authorized dealer for availability.

6. **▶ / || OK (Play/Pause):** This

control is operational in CD/MP3 mode. When a CD/MP3 is playing, press to pause or play the current CD/MP3. The CD/MP3 status will display in the radio display.



OK: Use in various menu selections.



If your vehicle is equipped with a Family Entertainment System (FES) please refer to the *DVD supplement* for further information.

Entertainment Systems



7. **SHUFFLE:** In CD/MP3 mode, press SHUFFLE to engage shuffle mode. SHUFFLE ON will appear in the display. If you wish to engage shuffle mode right away, press SEEK to begin random play. Otherwise, random play will begin when the current track is finished playing. CD SHUF will appear in the display. To disengage, press SHUFFLE again. SHUFFLE OFF will appear in the display.



Note: In CD/MP3 mode, press SHUFFLE to play the tracks in random order. In MP3 folder mode, the system will randomly play all tracks within the current folder.

8. **FOLDER** : In folder mode, press FOLDER  to access next folder on MP3 discs, if available.



9.  **FOLDER:** In folder mode, press  FOLDER to access the previous folder on MP3 discs, if available.



10. **FF (Fast forward):** Press FF to manually advance in a CD/MP3 track.



11. **REW (Rewind):** Press REW to manually reverse in a CD/MP3 track.



12. **Memory presets:** To set a station: Select frequency band AM/FM1/FM2; tune to a station, press and hold a preset control until sound returns. You may store up to six stations in each frequency band for a total of 18.



In satellite radio mode (if equipped), there are 18 available presets, six each for SAT1, SAT2 and SAT3. To save satellite channels in your memory presets, tune to the desired channel then press and hold a preset control until sound returns.

Satellite radio is available only with a valid SIRIUS radio subscription. Check with your authorized dealer for availability.

13. **TEXT/SCAN: In radio and CD/MP3 mode,** press and hold for a brief sampling of radio stations or CD tracks. Press again to stop.



In CD/MP3 mode, press and release to display track title, artist name, and disc title.

Entertainment Systems

In satellite radio mode (if equipped), press and release to enter TEXT MODE and display the current song title. While in TEXT MODE, press again to scroll through the current song title, artist, channel category and the SIRIUS long channel name.

In TEXT MODE sometimes the display requires additional text to be displayed. When the “>” indicator is active, press SEEK ► to view the additional display text. When the “<” indicator is active, press ◀ SEEK to view the previous display text.

In satellite radio mode (if equipped), press and hold to hear a brief sampling of the next channels. Press again to stop. In CATEGORY MODE, press SCAN to hear a brief sampling of the channels in the selected category. Press again to stop.

Satellite radio is available only with a valid SIRIUS radio subscription. Check with your authorized dealer for availability.

14. **AM/FM:** Press AM/FM to select AM/FM1/FM2 frequency band.



15. **ON/OFF/Volume:** Press VOL-PUSH to turn ON/OFF. Turn VOL-PUSH to increase/decrease volume.



VOL - PUSH

Note:If the volume is set above a certain level and the ignition is turned off, the volume will come back on at a “nominal” listening level when the ignition switch is turned back on.

16. **CD:** Press to enter CD/MP3 mode. If a CD/MP3 is already loaded into the system, CD/MP3 play will begin where it ended last.



17. **▲ (CD eject):** Press to eject a CD.





18. **CD slot:** Insert a CD label side up in the CD slot.

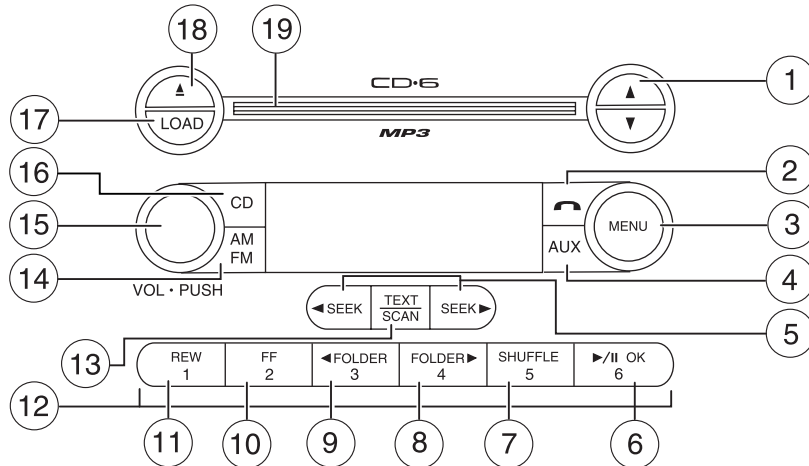

Entertainment Systems

Premium/Audiophile in-dash six CD/MP3/satellite compatible sound system (if equipped)



 Driving while distracted can result in loss of vehicle control, accident and injury. Ford strongly recommends that drivers use extreme caution when using any device that may take their focus off the road. The drivers primary responsibility is the safe operation of their vehicle. Only use cell phones and other devices not essential to the driving task when it is safe to do so.

Accessory delay: Your vehicle is equipped with accessory delay which allows you to operate the window switches and audio for up to ten minutes after the ignition has turned off or until either front door has opened.

1. ▲ / ▼ (Tune/Disc selector):

In radio mode, press to manually go up (▲) or down (▼) the radio frequency. Press and hold for a fast advance through radio frequencies.

In menu mode, use to select various settings.

In CD/MP3 mode, press to select the desired disc.



Entertainment Systems

Satellite radio is available only with a valid SIRIUS radio subscription. Check with your authorized dealer for availability.

2. **☎ (Phone):** Pressing **☎ (Phone)** results in “NO PHONE” message shown in display.



3. **MENU:** Press repeatedly to access to the following settings:



Setting the clock: Press until SELECT HOUR or SELECT MINS is displayed. Press **▲ / ▼ / ◀ SEEK ▶** to adjust the hours/minutes.

CATEGORY (satellite radio if equipped - early availability): Press MENU until the currently active category appears in the display (CATEGORY MODE). In CATEGORY MODE, press **▲ / ▼** to scroll through the list of available Sirius channel Categories (Pop, Rock, News, etc.) Press **◀ SEEK ▶** or SCAN to select the category. After a category is selected, press SEEK to search for that specific category of channels only (i.e. ROCK). To select a different category, press MENU until the category appears in the display. Press **▲ / ▼** to select a different category. You may also select CATEGORY ALL to seek all available Sirius categories and channels.

Satellite radio is available only with a valid SIRIUS radio subscription. Check with your authorized dealer for availability.

Note: If your vehicle is equipped with Satellite Radio, you will either have the CATEGORY option above or the CATEOGRY option within the SATELLITE RADIO MENU below.

SATELLITE RADIO MENU (if equipped - late availability): Press MENU when satellite radio mode is active to access. Press OK to enter into the satellite radio menu. Press **▲ / ▼** to cycle through the following options:

- **CATEGORY:** Press OK to enter category mode. Press **▲ / ▼** to scroll through the list of available SIRIUS channel Categories (Pop, Rock, News, etc.) Press OK when the desired category appears in the display. After a category is selected, press SEEK to search for that specific category of channels only (i.e. ROCK). You may also select CATEGORY ALL to seek all available SIRIUS categories and channels. Press OK to close and return to the main menu.

Entertainment Systems

- **SAVE SONG:** Press OK to save the currently playing song title in the system's memory. (If you try to save something other than a song, CANT SAVE will appear in the display.) When the chosen song is playing on any satellite radio channel, the system will alert you with an audible prompt. Press OK while SONG ALERT is in the display and the system will take you to the channel playing the desired song. You can save up to 20 song titles. If you attempt to save a song when the system is full, the display will read REPLACE SONG? Press OK to access the saved songs and press ▲ / ▼ to cycle through the saved songs. When the song appears in the display that you would like to replace, press OK. SONG REPLACED will appear in the display.
- **DELETE SONG:** Press OK to delete a song from the system's memory. Press ▲ / ▼ to cycle through the saved songs. When the song appears in the display that you would like to delete, press OK. The song will appear in the display for confirmation. Press OK again and the display will read SONG DELETED. If you do not want to delete the currently listed song, press ▲ / ▼ to select either RETURN or CANCEL.
Note: If there are no songs presently saved, the display will read NO SONGS.
- **DELETE ALL SONGS:** Press OK to delete all songs from the system's memory. The display will read ARE YOU SURE ? Press OK to confirm deletion of all saved songs and the display will read ALL DELETED.
Note: If there are no songs presently saved, the display will read NO SONGS.
- **ENABLE ALERTS / DISABLE ALERTS:** Press OK to enable/disable the satellite alert status which alerts you when your selected songs are playing on a satellite radio channel. (The system default is disabled.) SONG ALERTS ENABLED/DISABLED will appear in the display. The menu listing will display the opposite state. For example, if you have chosen to enable the song alerts, the menu listing will read DISABLE as the alerts are currently on, so your other option is to turn them off.

Satellite radio is available only with a valid SIRIUS radio subscription. Check with your authorized dealer for availability.

AUTOSET: Press MENU until the display reads AUTOSET. Autoset allows you to set the strongest local radio stations without losing your original manually set preset stations for AM/FM1/FM2. Use ▲ / ▼ / ◀ SEEK, SEEK ▶ to turn on/off.

Entertainment Systems

When the six strongest stations are filled, the station stored in preset 1 will begin playing. If there are less than six strong stations, the system will store the last one in the remaining presets.

RBDS: Available only in FM mode. This feature allows you to search RBDS-equipped stations for a certain category of music format: CLASSIC, COUNTRY, INFORM, JAZZ/RB, ROCK, etc.

To activate, press MENU repeatedly until RBDS (ON/OFF) appears in the display. Use ▲ / ▼ / ◀ SEEK ▶ to toggle RBDS ON/OFF. When RBDS is OFF, you will not be able to search for RBDS equipped stations or view the station name or type.

To search for specific RBDS music categories: When the desired category appears in the display, press ▲ / ▼ to find the desired type, then press and release ◀ SEEK, SEEK ▶ or press and hold SCAN to begin the search.

To view the station name or type: When the desired category appears in the display, press TEXT/SCAN to toggle between displaying the station type (COUNTRY, ROCK, etc.) or the station name (WYCD, WXYZ, etc.).

BASS: Press MENU to reach the bass setting. Use ▲ / ▼ / ◀ SEEK, SEEK ▶ to adjust.

TREB (Treble): Press MENU to reach the treble setting. Use ▲ / ▼ / ◀ SEEK, SEEK ▶ to adjust.

BAL (Balance): Press MENU to reach the balance setting. Use ▲ / ▼ / ◀ SEEK, SEEK ▶ to adjust the audio between the left (L) and right (R) speakers.

FADE: Press MENU to reach the fade setting. Use ▲ / ▼ / ◀ SEEK, SEEK ▶ to adjust the audio between the back (B) and front (F) speakers.

ALL SEATS (Occupancy mode) (Available on Audiophile radios only): Press MENU repeatedly to access. Press ▲ / ▼ / ◀ SEEK ▶ to optimize sound for ALL SEATS, DRIVERS SEAT or REAR SEATS.

SPEEDVOL (Speed sensitive volume, if equipped): Press MENU to reach the SPEEDVOL setting. Radio volume automatically gets louder with increasing vehicle speed to compensate for road and wind noise. Use ▲ / ▼ / ◀ SEEK, SEEK ▶ to adjust.

Entertainment Systems

The default setting is *off*; increasing your vehicle speed will not change the volume level.

Adjust 1–7: Increasing this setting from 1 (lowest setting) to 7 (highest setting) allows the radio volume to automatically change slightly with vehicle speed to compensate for road and wind noise.

Recommended level is 1–3; SPEED OFF turns the feature off and level 7 is the maximum setting.

Track/Folder Mode: Available only on MP3 discs in CD mode. In Track Mode, pressing ◀ SEEK ▶ will scroll through all tracks on the disc.

In Folder mode, pressing ◀ SEEK ▶ will scroll only through tracks within the selected folder.

Press ◀ FOLDER, FOLDER ▶ to access the previous/next folder (if available).

COMPRESS (Compression): Available only in CD/MP3 mode. Press MENU until COMPRESS ON/OFF appears in the display.

Use ▲ / ▼ / ◀ SEEK, SEEK ▶ to toggle ON/OFF. When COMPRESS is ON, the system will bring soft and loud CD passages together for a more consistent listening level.

4. **AUX:** Press repeatedly to cycle through FES/DVD (if equipped), LINE IN (Auxiliary audio mode, if equipped), SAT1, SAT2 and SAT3 modes (Satellite Radio if equipped). For location and further information on the auxiliary audio mode, refer to *Auxiliary input jack* later in this chapter.

Satellite radio is available only with a valid SIRIUS radio subscription. Check with your authorized dealer for availability.

5. **SEEK: In radio mode,** press ◀ / ▶ to access the previous/next strong station.

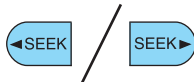

In CD/MP3 mode, press ◀ / ▶ to access the previous/next CD track.

In satellite radio mode (if equipped), press ◀ SEEK, SEEK ▶ to seek to the previous/next channel. If a specific category is selected, (Jazz, Rock, News, etc.), press ◀ SEEK, SEEK ▶ to seek to the previous/next channel in the selected category. Press and hold ◀ SEEK, SEEK ▶ to fast seek through the previous /next channels.

Entertainment Systems

In **TEXT MODE**, press ◀ SEEK, SEEK ▶ to view the previous/additional display text.

In **CATEGORY MODE**, press ◀ SEEK, SEEK ▶ to select a category.

Satellite radio is available only with a valid SIRIUS radio subscription. Check with your authorized dealer for availability.

6. ▶ / || **OK (Play/Pause)**: This control is operational in CD/MP3 mode. When a CD/MP3 is playing, press to pause or play the current CD. The CD status will display in the radio display.



OK: Use in various menu selections.

If your vehicle is equipped with a Family Entertainment System (FES) please refer to the *DVD supplement* for further information.

7. **SHUFFLE**: In CD/MP3 mode, press SHUFFLE to engage shuffle mode. SHUFFLE ON will appear in the display. If you wish to engage shuffle mode right away, press SEEK to begin random play. Otherwise, random play will begin when the current track is finished playing. CD SHUF will appear in the display. To disengage, press SHUFFLE again. SHUFFLE OFF will appear in the display.



Note: In track mode, all tracks on the *current* disc will shuffle in random order. In MP3 folder mode, the system will randomly play all tracks within the current folder.

8. **FOLDER ▶**: In folder mode, press FOLDER ▶ to access next folder on MP3 discs, if available.



9. ◀ **FOLDER**: In folder mode, press ◀ FOLDER to access the previous folder on MP3 discs, if folders are available.



10. **FF (Fast forward)**: Press FF to manually advance in a CD/MP3 track.



Entertainment Systems

11. **REW (Rewind):** Press REW to manually reverse in a CD/MP3 track.



12. **Memory presets:** To set a station: Select frequency band AM/FM1/FM2; tune to a station, press and hold a preset control until sound returns. You may store up to six stations in each frequency band for a total of 18.



In satellite radio mode (if equipped), there are 18 available presets, six each for SAT1, SAT2 and SAT3. To save satellite channels in your memory presets, tune to the desired channel then press and hold a preset control until sound returns.

Satellite radio is available only with a valid SIRIUS radio subscription. Check with your authorized dealer for availability.

13. **TEXT/SCAN: In radio and CD/MP3 mode,** press and hold for 2 seconds to activate mode to hear a brief sampling of radio stations or CD tracks. Press again to stop.



In CD/MP3 mode, press and release to display track title, artist name, and disc title and file name (if available).

In satellite radio mode (if equipped), press and release to enter TEXT MODE and display the current song title. While in TEXT MODE, press again to scroll through the current song title, artist, channel category and the SIRIUS long channel name.

In TEXT MODE, sometimes the display requires additional text to be displayed. When the ">" indicator is active, press SEEK ► to view the additional display text. When the ">" indicator is active, press ◀ SEEK to view the previous display text.

In satellite radio mode (if equipped), press and hold to hear a brief sampling of the next channels. Press again to stop.

In CATEGORY MODE, press SCAN to hear a brief sampling of channels in the selected category. Press again to stop. *Satellite radio is available only with a valid SIRIUS subscription. Check with your authorized dealer for availability.*

14. **AM/FM:** Press to select AM/FM1/FM2 frequency band.



Entertainment Systems

15. **ON/OFF/Volume:** Press to turn ON/OFF. Turn to increase/decrease volume.



VOL - PUSH

Note: If the volume is set above a certain level and the ignition is turned off, the volume will come back on at a “nominal” listening level when the ignition switch is turned back on.

16. **CD:** Press to enter CD/MP3 mode. If a CD/MP3 is already loaded into the system, CD/MP3 play will begin where it ended last.



17. **LOAD:** To load a disc into the system, press LOAD. Select a slot number using memory presets 1–6. When the display reads LOAD CD#, load the desired disc, label side up.



If you do not choose a slot within 5 seconds, the system will choose for you. Once loaded, the first track will begin to play.

To auto load up to 6 discs, press and hold LOAD until the display reads AUTOLOAD#. Load the desired disc, label side up. The system will prompt you to load discs for the remaining available slots. Insert the discs, one at a time, label side up, when prompted. Once loaded, the disc in the last slot loaded will begin to play.

Note: An MP3 disc with folders will show F001 (folder #) T001 (track #) in the display. An MP3 disc without folders will show T001 (track#) in the display. Refer to *MP3 folder structure* later in this chapter for further information.

18. **▲ (CD eject):** To eject a disc from the system, press ▲. Select the correct slot number using memory presets 1–6. When ready, the system will eject the disc and the display will read REMOVE CD. If the disc is not removed in 15 seconds, the system will reload the disc.



To auto eject up to 6 CDs, press and hold ▲ until the system begins ejecting the current disc. Remove the current disc and the next disc will be ejected. If the current disc is not removed, the system will reload the disc.

Entertainment Systems

19. **CD slot:** Insert a CD/MP3 label side up.



Auxiliary input jack (if equipped)

Your vehicle may be equipped with an Auxiliary Input Jack (AIJ). The Auxiliary Input Jack, located on the instrument panel below the power point, provides a way to connect your portable music player to the in-vehicle audio system. This allows the audio from a portable music player to be played through the vehicle speakers with high fidelity.

To achieve optimal performance, please observe the following instructions when attaching your portable music device to the audio system.

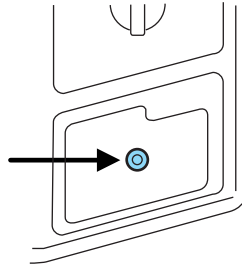

Required equipment:

1. Any portable music player designed to be used with headphones
2. An audio extension cable with stereo male 1/8 in. (3.5 mm) connectors at each end

To play your portable music player using the auxiliary input jack:

1. Begin with the vehicle parked and the radio turned off.
2. Ensure that the battery in your portable music player is new or fully charged and that the device is turned off.
3. Attach one end of the audio extension cable to the headphone output of your player and the other end of the audio extension cable to the AIJ in your vehicle.
4. Turn the radio on, using either a tuned FM station or a CD loaded into the system. Adjust the volume to a comfortable listening level.
5. Turn the portable music player on and adjust the volume to 1/2 the volume.
6. Press AUX on the vehicle radio repeatedly until LINE IN appears in the display.

You should hear audio from your portable music player although it may be low.

7. Adjust the sound on your portable music player until it reaches the level of the FM station or CD by switching back and forth between the AUX and FM or CD controls.

Entertainment Systems

Troubleshooting:

1. Do not connect the audio input jack to a line level output. Line level outputs are intended for connection to a home stereo and are not compatible with the AIJ. The AIJ will only work correctly with devices that have a headphone output with a volume control.
2. Do not set the portable music player's volume level higher than is necessary to match the volume of the CD or FM radio in your audio system as this will cause distortion and will reduce sound quality. Many portable music players have different output levels, so not all players should be set at the same levels. Some players will sound best at full volume and others will need to be set at a lower volume.
3. If the music sounds distorted at lower listening levels, turn the portable music player volume down. If the problems persist, replace or recharge the batteries in the portable music player.
4. The portable music player must be controlled in the same manner when it is used with headphones as the AIJ does not provide control (play, pause, etc.) over the attached portable music player.
5. For safety reasons, connecting or adjusting the settings on your portable music player should not be attempted while the vehicle is moving. Also, the portable music player should be stored in a secure location, such as the center console or the glove box, when the vehicle is in motion. The audio extension cable must be long enough to allow the portable music player to be safely stored while the vehicle is in motion.

GENERAL AUDIO INFORMATION

Radio frequencies

AM and FM frequencies are established by the Federal Communications Commission (FCC) and the Canadian Radio and Telecommunications Commission (CRTC). Those frequencies are:

AM - 530, 540–1700, 1710 kHz

FM- 87.7, 87.9–107.7, 107.9 MHz

Radio reception factors

There are three factors that can affect radio reception:

- Distance/strength: The further you travel from an FM station, the weaker the signal and the weaker the reception.
- Terrain: Hills, mountains, tall buildings, power lines, electric fences, traffic lights and thunderstorms can interfere with your reception.
- Station overload: When you pass a broadcast tower, a stronger signal may overtake a weaker one and play while the weak station frequency is displayed.

Entertainment Systems

CD/CD player care

Do:

- Handle discs by their edges only. Never touch the playing surface.
- Inspect discs before playing. Clean only with an approved CD cleaner and wipe from the center out.
- Wipe discs from the center out.

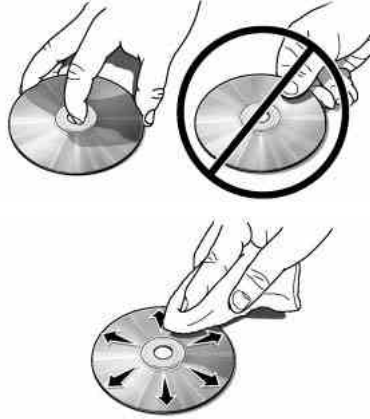

Don't:

- Expose discs to direct sunlight or heat sources for extended periods of time.
- Insert more than one disc into each slot of the CD changer magazine.
- Clean using a circular motion.

CD units are designed to only play commercially manufactured, round (4.75 in / 12 cm) audio compact discs. Due to technical incompatibility, certain homemade compact discs may not function correctly when used in Ford CD players.

Do not use any irregular shaped CDs or discs with a scratch protection film attached.

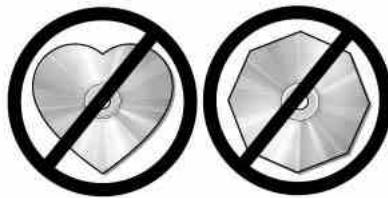

Entertainment Systems

CDs with homemade paper (adhesive) labels should not be inserted into the CD player as the label may peel and cause the CD to become jammed. It is recommended that homemade CDs be identified with permanent felt tip marker rather than adhesive labels. Ballpoint pens may damage CDs. Please contact your authorized dealer for further information.



Audio system warranty and service

Refer to the *Warranty Guide* for audio system warranty information. If service is necessary, see your authorized dealer.

MP3 track and folder structure

Your MP3 system recognizes MP3 individual tracks and folder structure as follows:

- There are two different modes for MP3 disc playback: MP3 track mode (system default) and MP3 folder mode. For more information on track and folder mode, refer to *Sample MP3 structure* in the following section.
- MP3 track mode ignores any folder structure on the MP3 disc. The player numbers each MP3 track on the disc (noted by the .mp3 file extension) from T001 to a maximum of T255.

Note: The maximum number of playable MP3 files may be less depending on the structure of the CD and the exact model of the radio present.

- MP3 folder mode represents a folder structure consisting of one level of folders. The CD player numbers all MP3 tracks on the disc (noted by the .mp3 file extension) and all folders containing MP3 files, from F001 (folder) T001 (track) to F253 T255.
- Creating discs with only one level of folders will help with navigation through the disc files.

Entertainment Systems

Sample MP3 structure

If you are burning your own MP3 discs, it is important to understand how the system will read the structures you create. While various files may be present, (files with extensions other than mp3), only files with the .mp3 extension will be played. This enables you to use the same MP3 disc for a variety of tasks on your work computer, home computer and your in vehicle system.

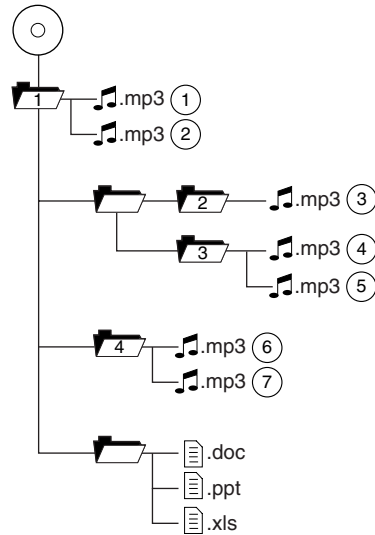

In track mode, the system will display and play the structure as if it were only one level deep (all .mp3 files will be played, regardless of being in a specific folder). In folder mode, the system will only play the .mp3 files in the current folder.

Satellite radio information (if equipped)

Satellite radio channels: SIRIUS broadcasts a variety of music, news, sports, weather, traffic and entertainment satellite radio channels. For more information and a complete list of SIRIUS satellite radio channels, visit www.sirius.com in the United States, www.sirius-canada.ca in Canada, or call SIRIUS at 1-888-539-7474.

Satellite radio reception factors: To receive the satellite signal, your vehicle has been equipped with a satellite radio antenna located on the roof of your vehicle. The vehicle roof provides the best location for an unobstructed, open view of the sky, a requirement of a satellite radio system. Like AM/FM, there are several factors that can affect satellite radio reception performance:

- **Antenna obstructions:** For optimal reception performance, keep the antenna clear of snow and ice build-up and keep luggage and other material as far away from the antenna as possible.

Entertainment Systems

- Terrain: Hills, mountains, tall buildings, bridges, tunnels, freeway overpasses, parking garages, dense tree foliage and thunderstorms can interfere with your reception.
- Station overload: When you pass a ground based broadcast repeating tower, a stronger signal may overtake a weaker one and result in an audio mute.

Unlike AM/FM audible static, you will hear an audio mute when there is a satellite radio signal interference. Your radio display may display NO SIGNAL to indicate the interference.

SIRIUS satellite radio service: SIRIUS Satellite Radio is a subscription based satellite radio service that broadcasts music, sports, news and entertainment programming. A service fee is required in order to receive SIRIUS service. Vehicles that are equipped with a factory installed SIRIUS Satellite Radio system include:

- Hardware and limited subscription term, which begins on the date of sale or lease of the vehicle.
- Online media player providing access to all 65 SIRIUS music channels over the internet (U.S. customers only).

For information on extended subscription terms, contact SIRIUS at 1-888-539-7474.

Note: SIRIUS reserves the unrestricted right to change, rearrange, add or delete programming including canceling, moving or adding particular channels, and its prices, at any time, with or without notice to you. Ford Motor Company shall not be responsible for any such programming changes.

Satellite Radio Electronic Serial Number (ESN): This 12-digit Satellite Serial Number is needed to activate, modify or track your satellite radio account. You will need this number when communicating with SIRIUS. While in Satellite Radio mode, you can view this number on the radio display by pressing AUX and Preset 1 control simultaneously.

Entertainment Systems

Radio Display	Condition	Action Required
ACQUIRING	Radio requires more than two seconds to produce audio for the selected channel.	No action required. This message should disappear shortly.
SAT FAULT	Internal module or system failure present.	If this message does not clear within a short period of time, or with an ignition key cycle, your receiver may have a fault. See your authorized dealer for service.
INVALID CHNL	Channel no longer available.	This previously available channel is no longer available. Tune to another channel. If the channel was one of your presets, you may choose another channel for that preset button.
UNSUBSCRIBED	Subscription not available for this channel.	Contact SIRIUS at 1-888-539-7474 to subscribe to the channel or tune to another channel.
NO TEXT	Artist information not available.	Artist information not available at this time on this channel. The system is working properly.

Entertainment Systems

Radio Display	Condition	Action Required
NO TEXT	Song title information not available.	Song title information not available at this time on this channel. The system is working properly.
NO TEXT	Category information not available.	Category information not available at this time on this channel. The system is working properly.
NO SIGNAL	Loss of signal from the SIRIUS satellite or SIRIUS tower to the vehicle antenna.	You are in a location that is blocking the SIRIUS signal (i.e., tunnel, under an overpass, dense foliage, etc). The system is working properly. When you move into an open area, the signal should return.
UPDATING	Update of channel programming in progress.	No action required. The process may take up to three minutes.
CALL SIRIUS 1-888-539-7474	Satellite service has been deactivated by SIRIUS Satellite Radio.	Call SIRIUS at 1-888-539-7474 to re-activate or resolve subscription issues.

NAVIGATION SYSTEM (IF EQUIPPED)

Your vehicle may be equipped with a Navigation System. Refer to the *Navigation supplement* for further information.

Entertainment Systems

FAMILY ENTERTAINMENT DVD SYSTEM (IF EQUIPPED)



Driving while distracted can result in loss of vehicle control, accident and injury. Ford strongly recommends that drivers use extreme caution when using any device that may take their focus off the road. The driver's primary responsibility is the safe operation of their vehicle. Only use cell phones and other devices not essential to the driving task when it is safe to do so.

Your vehicle may be equipped with a Family Entertainment System (FES) which allows you to listen to audio CDs, MP3 discs, watch DVDs and to plug in and play a variety of standard video game systems. The DVD player is capable of playing standard DVDs, CDs, MP3s and is compatible with CD-R/W, CD-R and certain CD-ROM media.

Please review this material to become familiar with the FES features and controls as well as the very important safety information.

Quick start

Your Family Entertainment System includes a DVD system, two sets of wireless infrared (IR) headphones and a wireless infrared (IR) remote control.

To play a DVD in the DVD system:

The DVD system can play DVD-Video, DVD-R, DVD-R/W discs as well as audio CDs and video CDs. To ensure proper disc operation, check the disc for finger prints, scratches and cleanliness. Clean with a soft cloth, wiping from center to edge.

1. Ensure that the vehicle ignition is in the RUN or ACCESSORY position.
2. Insert a DVD into the system, label-side up to turn on the system. It will load automatically.
3. Press the power button on the DVD player, then press Play ► to begin to play the disc.



If a DVD is already loaded into the system, press PLAY on the DVD player.

Note: If sound can be heard, but no video is present, press VIDEO to select the video source (DVD or aux-inputs).

Entertainment Systems

Press VIDEO to change the source displayed on the screen. Press repeatedly to cycle through: DVD-DISC, DVD-AUX, NON-DVD, OFF.



Press the power button to turn the system off. The indicator light will turn off indicating the system is off.



Note: The audio from the DVD system will play over all vehicle speakers and can be adjusted by the radio volume control.

To play a CD in the DVD system:

The DVD system can play audio CDs, CD-R and CD-R/W, CD-ROM and video CDs. To ensure proper disc operation, check the disc for finger prints and scratches. Clean the disc with a soft cloth, wiping from the center to the edge.

1. Ensure that the vehicle ignition is in the RUN or ACCESSORY position.

2. Insert a CD into the system, label-side up to turn on the DVD system. It will load and automatically begin to play. If there is already a CD in the system, press PLAY on the DVD player.

3. The disc will begin to play and the 'CD Audio Disc' screen will display. From this screen, you can also select from COMPRESSION, SHUFFLE and SCAN features.



To play an MP3 disc in the DVD system:

1. Ensure that the vehicle ignition is in the RUN or ACCESSORY position.

Entertainment Systems

2. Insert an MP3 disc into the system, label-side up to turn on the DVD system. It will load and automatically begin to play. If there is already a disc in the system, press PLAY on the DVD player.

3. The disc will begin to play and the 'MP3 Audio Disc' screen will display and allow you to access the COMPRESSION, SHUFFLE, SCAN and FOLDER MODE features.



To play an auxiliary source through the DVD system

The DVD system can be used to connect and play auxiliary electronic devices such as game systems, personal camcorders, video cassette recorders, etc.

1. Ensure that the vehicle ignition is in the RUN or ACCESSORY position.

2. Press the power button to turn the DVD system on. The indicator light next to the power button will illuminate.



3. Connect an auxiliary audio/video source by connecting RCA cords (not included) to the RCA jacks on the left hand side of the system.

- Yellow (1) — video input
- White (2) — left channel audio input
- Red (3) — right channel audio input

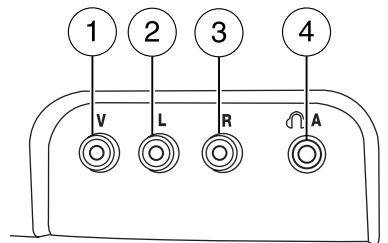

4. Press MEDIA on the DVD system to change the media source to AUX.

5. Press VIDEO on the DVD system to change the video source to DVD-AUX. If your source is properly plugged in, it will appear on the LCD (Liquid Crystal Display) screen. If your auxiliary source does not have a video signal, or if the DVD system does not detect a video signal

Entertainment Systems

from the auxiliary source, the screen will remain black. If the video source is set to DVD-AUX, the display will automatically turn on if a video signal is detected.

To listen to audio over the headphones (Dual play mode):

1. You may listen to channels A and B over wired or wireless headphones. Refer to *Using the infrared wireless headphones* and *Using wired headphones* for further information.

- Black (4) — wired headphone output (wired headphones not included)

2. Press the headphone/speaker button on the DVD player or press the 2 and 4 memory presets on the audio system at the same time.



A green light will illuminate next to either the A or B Headphone Control Button to indicate which channel is active (able to be controlled).

3. Press MEDIA to change the audio source of the active channel (A or B). The audio source will be shown on the display. You may change the active channel by pressing the A or B headphone control button.

Note: Channel A can access any possible media source (AM, FM1, FM2, SAT (if equipped), CD, DVD, AUX). Channel B can only access DVD and AUX sources.

Note: Refer to *Single play/Dual play* for more information.



Using the infrared (IR) wireless headphones:

1. Press the power control on the earpiece to turn the headphones ON.
2. Select Channel A or B for each set of wireless headphones by using the A/B control on the ear piece.
3. Adjust the headphone volume using the rotary dial on the earpiece.

Using wired headphones (not included):



Do not leave children unattended in the vehicle and do not let children operate the system while unsupervised. If wired headphones or auxiliary systems are used, children may become entangled in the cords and seriously injure themselves.

1. Connect the wired headphones in to the headphone jacks on either side of the DVD system. Each side is labeled  A or  B. Headphones plugged into jack A will listen to Channel A and headphones plugged into jack B will listen to Channel B.

Entertainment Systems

2. Adjust the volume levels using the volume controls on the DVD system.



To adjust display brightness:

To decrease/increase the brightness level on the display screen, press the brightness control on the DVD system. A display will appear at the bottom of the screen indicating the brightness level. The brightness display will only appear when the menu is not displayed.

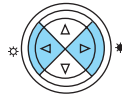

DVD player controls

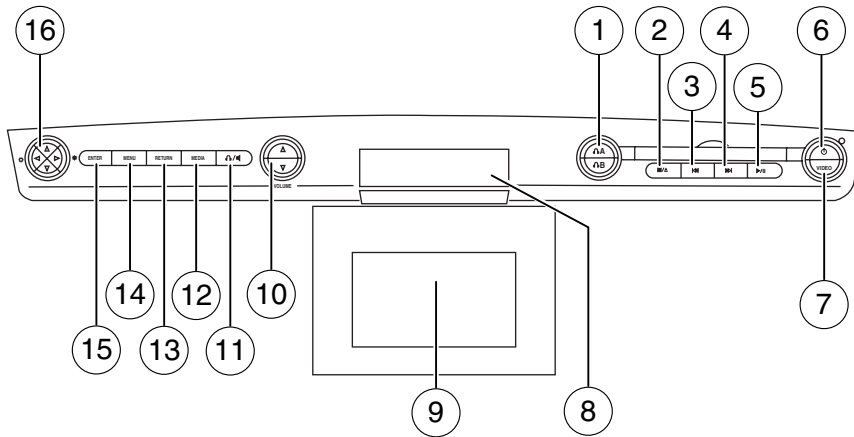

1. Headphone control A/B: Press to select either the A or B headphone source. Then press MEDIA to select the desired playing media for that headset. When a headphone channel has been selected (A or B), selections will affect the source on that channel only.



Entertainment Systems

Note: Headphone A can access any possible media (AM, FM1, FM2, SAT (if equipped), CD, DVD, DVD-AUX). Headphone B can only access DVD and DVD-AUX.

For further information, refer to *Single play/Dual play* later in this section.

2. **■ / ▲ (Stop/Eject):** Press once to stop and press a second time to eject a disc from the DVD system.



3. **◀◀ (Reverse):** Press and release for the previous chapter or track. Press and hold to reverse search a DVD, Video CD, or FES CD in DVD/CD mode.



4. **▶▶ (Fast forward):** Press and release for the next chapter or track. Press and hold to forward search a DVD, Video CD, or FES CD in DVD/CD mode.



5. **▶ / || (Play/Pause):** Press (Play) to select DVD mode (and to turn the DVD system on if it is off). If a disc is present, it will resume or begin to play. Press (Pause) while playing a disc to pause a DVD or CD.



6. **On/Off:** Press to turn the DVD system On/Off.



7. **VIDEO:** Press repeatedly to cycle through the following video state options which will be indicated on the bottom right hand corner of the display: DVD DISC, DVD-AUX, NON-DVD and Off (no indicator). If you select the DVD-AUX video source, the display will turn off if there is no video signal detected. When a video signal is detected on the auxiliary video input, and the display is in the DVD-AUX video mode, the display will automatically turn on.



8. **Infrared (IR) Receiver & Transmitter:** System sensor which reads the signals from the remote control and sends audio signals to the infrared (IR) wireless headphones.

Entertainment Systems

9. **LCD screen:** The eight inch diagonal screen rotates down to view and up into housing to store when not in use. Ensure that the screen is latched into the housing when being stored.

10. **Volume:** When in Single Play, press to increase (▲) or decrease (▼) the volume over all speakers. When in Dual Play, press to increase (▲) or decrease (▼) the volume



for the wired headphones. (Wireless headphone volume is controlled with the rotary dial on the right ear piece.)

11.  (Headphones/Speakers): Press once for Dual Play (Headphone mode- the rear speakers are muted) and press again for Single Play (same media playing through all speakers). You can also press the 2 and 4 memory preset buttons on the audio system at the same time to perform the same function. For further interaction information, refer to *Single Play/Dual play* under *Operation* later in this section.

12. **MEDIA:** Press repeatedly to select from the various possible playing media sources (AM, FM1, FM2, SAT (if equipped), CD, DVD, DVD-AUX). The media will show in the status display on the top of the screen when in Dual Play mode. When in Single Play mode, the media source will be displayed on the radio.



Note: Channel A can access any possible media source (AM, FM1, FM2, SAT (if equipped), CD, DVD, DVD-AUX). Channel B can only access DVD and DVD-AUX sources.

13. **RETURN:** Press to return to the playing media or to resume playback.



14. **MENU:** When playing a DVD, press MENU once to enter the DVD disc menu (if available) and press twice to enter the system set-up menu. From the set-up menu, you may select from Angle, Aspect Ratio, Language, Subtitles, Disc resume, Compression, Restore Defaults and Back. For more detailed information, refer to *Menu mode*.



Entertainment Systems

15. **ENTER:** Press to select/confirm the current selection.



16. **Cursor /Brightness controls:**

Use the cursor controls to make various selections when in any menu. When not in a menu, and in DVD mode, press ◀/▶ to adjust the brightness. A display bar will appear at the bottom of the screen indicating the brightness levels.

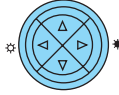

Remote control

Unless otherwise stated, all operations can be carried out with the remote control. Always point the remote control directly at the player. Ensure that there are no obstructions between the remote and player.

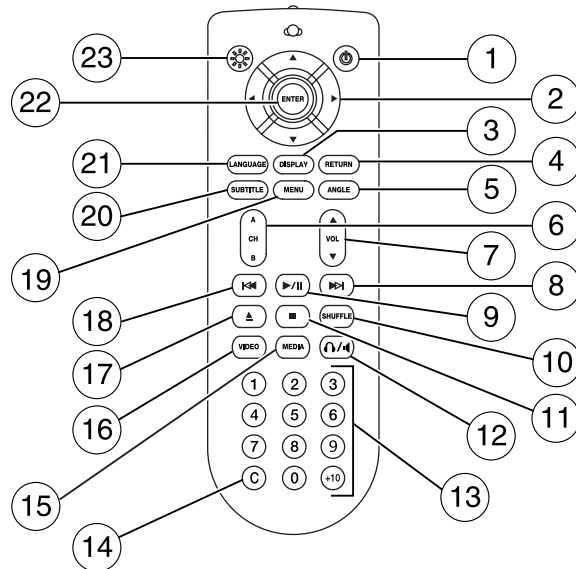

1. **Power control:** Press to turn the FES (Family Entertainment System) ON/OFF.
2. **Cursor controls:** Use in various active menus to advance the cursor up/down/left/right. When not in a Menu, the left and right cursor controls decrease and increase the display brightness.

Entertainment Systems

3. **DISPLAY:** Press to access the on-screen display of the FES functions and adjustments.
4. **RETURN:** Press to return to the previous menu screen.
5. **ANGLE** (DVD dependent): Press to select the angle to view the scene.
6. **Channel A/B:** Press to select either A or B headphones and then use the MEDIA control to select the desired playing media for the headphones.
7. **VOL (Volume):** When in Single Play, press to increase (▲) or decrease (▼) the volume over all speakers. When in Dual Play, press to increase (▲) or decrease (▼) the volume for the wired headphones. (Wireless headphone volume is controlled with the rotary dial on the right ear piece.)
8. **Fast Forward/Next:** In DVD mode, press and hold for a quick advance within the DVD. Press and release to advance to the next chapter. In CD/MP3 mode, press to access the next track.
9. **Play/Pause:** Press to play or pause a DVD.
10. **SHUFFLE:** Press to play all tracks on the current CD/MP3 disc in random order.
11. **STOP:** Press to stop the current DVD or CD/MP3.
12.  **Speaker/Headphone** (Single/Dual Play): Press to toggle between Single Play (same media playing through all speakers) and Dual Play (headphone mode — the rear speakers are muted). You can also press the 2 and 4 memory presets on the audio system at the same time to perform the same function.
13. **Numeric Keypad:** Use the numeric controls to enter in a specific CD/MP3 track or DVD chapter to be played.
14. **C (Cancel):** Press to cancel/clear the numeric input (i.e. chapter number).
15. **MEDIA:** Press to cycle through the possible media sources: AM, FM1, FM2, SAT (if equipped), CD, DVD, LINE IN (if equipped), DVD-AUX.
Channel B can only access DVD and AUX sources.
16. **VIDEO:** Press to cycle through video states: DVD-DISC, DVD-AUX, NON-DVD, Off.
17. **EJECT:** Press to eject a disc from the FES.

Entertainment Systems

18. **Fast reverse/Previous:** When a DVD is playing, press and hold for a quick reverse within the DVD. Press and release for the previous chapter. Press PLAY to resume normal playback speed and volume. In CD/MP3 mode, press to access the previous track.

19. **MENU:** Press to access the DVD disc menu for selections. Press MENU again when in the DVD disc menu to access the system set-up menu.

20. **SUBTITLE** (DVD dependent): Press to turn the subtitle feature ON or OFF.

21. **LANGUAGE** (DVD dependent): Press to select the desired language.

22. **ENTER:** Press to select the highlighted menu option.

23. **ILLUMINATION:** Press to illuminate the remote control and backlight all of the buttons.

Battery replacement

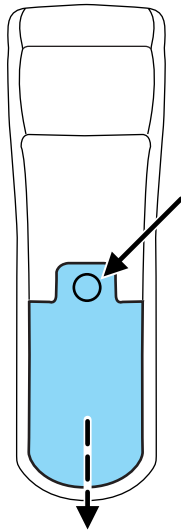

Batteries are supplied with the remote control unit. Since all batteries have a limited shelf life, replace them when the unit fails to control the DVD player.

Entertainment Systems

Remove the screw and unlatch the battery cover to access the batteries. The remote control unit uses two AAA batteries which are supplied with the unit.

Headphones

Wireless headphones

 The driver should never use the headphones while driving the vehicle. Using headphones may prevent the driver from hearing audible warnings such as horns or emergency sirens, which could result in a crash causing serious injury. Give your full attention to driving and to the road.

Your FES system is equipped with two sets of battery powered, infrared wireless headphones. Two AAA batteries are needed to operate the headphones. (Batteries are included.)

Additional infrared wireless headphones may be purchased for use with the system. Also, wired headphones may be purchased and plugged in where indicated on the left and right hand sides of the system. Refer to *Wired Headphones* following.



Entertainment Systems

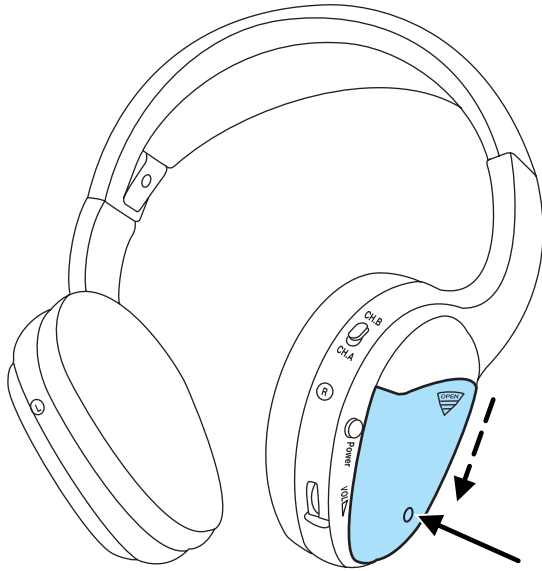

To install the batteries, remove the screw at the bottom of the cover. Then, lightly press down on top and slide the cover off.

When replacing the batteries, use two new batteries (alkaline recommended) and install them with the correct orientation as indicated in the battery housing.

Entertainment Systems



To operate the headphones:

- Press POWER on the ear piece to turn on the headphones. A red indicator light will illuminate indicating the headphones are ON. Press POWER again to turn the headphones off.
- Adjust the headphones to comfortably fit your head using the headband adjustment.
- Select the desired audio source (Channel A or B) for each set of wireless headphones by using the A/B selection switch on the ear piece.
- Adjust the volume control to the desired listening level.

Ensure that the headphones are turned off when not in use. After approximately one minute of not being in use (no infrared signal is received), the wireless headphones will automatically turn off. They will also turn off after two hours of continuous use as a power save feature. If this happens, simply turn the headphones on again and continue use.

Entertainment Systems

Wired headphones





Do not leave children unattended in the vehicle and do not let children operate the system while unsupervised. If wired headphones or auxiliary systems are used, children may become entangled in the cords and seriously injure themselves.



The driver should never use the headphones while driving the vehicle. Using headphones may prevent the driver from hearing audible warnings such as horns or emergency sirens, which could result in a crash causing serious injury. Give your full attention to driving and to the road.

You may purchase wired headphones for your FES (Family Entertainment System). Plug them into the 3.5 mm headphone jack(s) located on the left and right sides of the system. (Channel A is located on the left side and Channel B is located on the right side.) These headphones will be active when in Dual Play mode.

To listen to the audio on wired headphones (not included), connect the wired headphones into the headphone jacks on the sides of the DVD system. The wired headphone jack for Channel A is located on the left side of the FES and is labeled  A. Headphones plugged into this headphone jack will hear audio from the audio source selected to be the Channel A source. The wired headphone jack for Channel B is located on the right side of the FES and is labeled  B. Headphones plugged into this headphone jack will hear audio from the audio source selected to be the Channel B source.

Adjust the headphone volume using the volume control on the DVD system.



Operation

Single play/Dual play

Your DVD and audio system work together with the infrared headphones and wired headphones (not included) to allow the rear seat passengers to listen to the radio (and other media sources) over the headphones. This enables the front and rear seat passengers to listen to a variety of sources a variety of ways.



Entertainment Systems

Single Play: Single play consists of all occupants in the vehicle listening to the same playing media over the front and rear speakers. When the DVD system is on, and the same source is playing through the front and rear speakers, SINGLE PLAY will appear in the front radio display.

Dual Play: Dual play is when the rear seat passengers choose to listen to a different playing media than the front seat passengers. With the DVD and Rear Seat Controls turned ON, the rear seat passengers may choose to listen to the radio, CD, MP3, DVD, or DVD-AUX media sources over headphones while the front speakers play the chosen selection for the front audio system, they may listen to another over the headphones. DUAL PLAY will appear in the radio display.

When both the front seat passengers and the rear seat passengers listen to the same audio source, SHARED MODE will appear on the radio.

Note: If the front seat passengers are listening to the radio, the rear seat passengers can also listen to the radio; however, they will be limited to listening to the same radio channel.

Press  /  on the DVD player to listen to audio over the headphones.



The headphone control will now be active and a green light next to the A or B headphone control buttons will illuminate. The system can output two different audio sources over the headphones. These are called Channel A and Channel B. Both Channel A and Channel B can be listened to on the wired headphones (not included) or on the infrared (IR) wireless headphones.

Press the Headphone Control button A to change the audio source for Channel A.



Press MEDIA to change the audio source for Channel A. This information will display on the DVD system screen.



Press the Headphone Control button B to change the audio source for Channel B.



Press MEDIA to change the audio source for Channel B. This information will display on the DVD system screen. Channel B can listen to either the DVD media or the DVD system auxiliary inputs (DVD-AUX).

Entertainment Systems

Operation with an aftermarket audio system (Headphone only mode)

When the Family Entertainment System (FES) detects that the original radio supplied by Ford Motor Company has been removed from the vehicle, the Family Entertainment System will work in a state referred to as “Headphone Only Mode”.

While operating in Headphone Only Mode, the system will have limited functionality.

- The system will only output audio to the headphones. It will not be capable of providing audio to the speakers.
- The available sources in FES Headphone Only Mode are DVD-DISC and DVD-AUX, regardless of headphone channel (A or B).
- When a disc is inserted into the FES while in Headphone Only Mode, both headphone channels (A&B) will be connected to FES-DISC.

Menu mode

Press MENU once on the DVD system to access the DVD disc menu if available.

Press MENU twice to access the DVD set-up menu and the following features:

1. ZOOM
2. ANGLE
3. ASPECT RATIO
4. LANGUAGE
5. SUB TITLES



Angle mode

Select ANGLE to select various angles of view for the DVD.



Entertainment Systems

This is disc dependent — some DVD discs may have more viewing angles to select from. Once you have made your selection, press ENTER to confirm. The system default is Angle 1.



Aspect ratio

Select ASPECT RATIO to select the viewing size and shape of the video displayed on the LCD screen. This is disc dependent.



You can select from: WIDE, LETTER BOX or PAN SCAN. Once you have made your selection, press ENTER to confirm. The LCD screen display will immediately change to your selection after the system resumes playback of the DVD. The system default is WIDE (16:9).

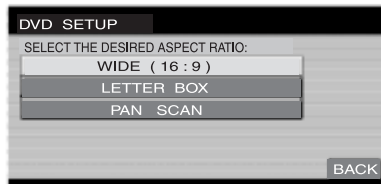

Language

Select LANGUAGE to select the language you would like to use for audio output (English, Spanish, French). This is disc dependent.



Entertainment Systems

Once you have made your selection, press ENTER to confirm. The system default is English.



Subtitles

Select SUBTITLES to turn the subtitle option on or off. The system default is OFF.



Once you have made your selection, press ENTER to confirm. This is disc dependent.

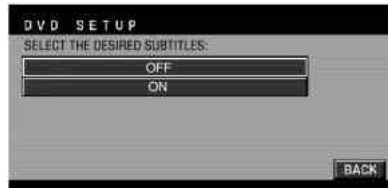

Audio CDs

To play audio CDs on your DVD system:

1. Ensure that the vehicle ignition is in the RUN or ACCESSORY position.
2. Ensure that the DVD system is ON.
3. Insert an audio CD into the DVD system, label side up.

4. The track and elapsed time will appear in the status bar. Use the DVD cursor controls on the bezel to highlight which track you would like to play. You can also use the cursor controls to highlight

COMPRESSION, SHUFFLE or

SCAN. Once you have highlighted the desired track or function, press ENTER on the DVD bezel to confirm your selection.



Entertainment Systems

COMP (Compression): Compression brings soft and loud CD passages together for a more consistent listening level when in CD mode. Press to turn the feature on/off.

SHUFFLE: Press to hear all tracks on the current CD in random order. Press again to stop.

SCAN: Press for a brief sampling of all tracks on the current CD. Press again to stop.

Playing MP3 discs

To play an MP3 disc on your DVD system:

1. Ensure that the vehicle ignition is in the RUN or ACCESSORY position.
2. Ensure that the DVD system is on.
3. Insert the MP3 disc into the DVD system, label side up.

4. The folder, track and elapsed time will appear in the status bar. The screen will list the Artist, Title, Album and File Name.



COMP (Compression):

Compression brings soft and loud CD/MP3 passages together for a more consistent listening level when in CD mode. Press to turn the feature on/off.

SHUFFLE: Press to hear all tracks on the current MP3 folder in random order. Press again to stop.

SCAN: Press for a brief sampling of all tracks on the current MP3 folder. Press again to stop.

FOLDER LIST: Press access folder mode and to go to the previous/next folder in the MP3 disc.

MP3 disc quality factors

Several factors can effect disc playback quality:

- Disc capacity — Each disc contains about 650 MB of storage capacity. We do not recommend using high capacity discs containing 700MB of storage.
- Disc type — Some CD-RW discs may operate inconsistently and may cause an error message to appear. We recommend burning MP3 files onto CD-R discs.
- Disc finalization — The disc may be left open for the purpose of adding sessions to it at a later time, but be sure to close each session or the disc will not play.

Entertainment Systems

- Bit rate — The player supports bit rates from 32–320 kbps, as well as variable bit rate MP3 files, but lower bit rates will have a noticeable effect on sound quality and are recommended only for speech or low fidelity music material. We recommend that you encode MP3 files using a high quality encoder.
- PC configuration — Encoding MP3 files requires intensive use of your computer's resources. Follow the PC configuration recommendations of the encoder software vendor. We recommend that you avoid running other software applications on your PC during MP3 encoding to avoid undesirable noise and distortion.

CD, MP3 and CD player care

- Handle discs by their edges only. Never touch the playing surface.
- Do not expose discs to direct sunlight or heat sources for extended periods of time.
- Do not insert more than one disc into the slot of the CD player (if equipped).
- Always store discs out of direct sunlight. Excessive heat may damage or warp discs.
- Use care when handling and playing CD-R and CD-RW discs, which are more susceptible to damage from heat, light and stress than are regular CDs.
- Always insert and remove a disc by holding the disc flat, with the playing surface facing down, in order to prevent damage to the disc or the player.
- Never insert any object other than a compact disc (CD) or digital versatile disc (DVD) into the player, as doing so may damage the player and may cause injury to you.
- Do not disassemble the player. The laser used in disc playback is extremely harmful to the eyes.

The FES DVD system is designed to play commercially pressed 12 cm (4.75 in) audio compact discs and digital versatile discs (DVD) only. Due to technical incompatibility, certain recordable and re-recordable compact discs may not function correctly when used in Ford CD and DVD players. Irregular shaped CDs or DVDs, CDs or DVDs with a scratch protection film attached, and CDs with homemade paper (adhesive) labels should not be inserted into the FES DVD system. The label may peel and cause the CD or DVD to become jammed. It is recommended that homemade

Entertainment Systems

CDs or DVDs be identified with permanent felt tip marker rather than adhesive labels. Ball point pens may damage CDs or DVDs. Please contact your authorized dealer for further information.

Playing a DVD

1. Ensure that the vehicle ignition is in the RUN or ACCESSORY position.
2. Ensure that the navigation system is on.
3. Insert a DVD label-side up into the system.
4. Use the DVD bezel controls to:

Press to play or pause a DVD.



Press to stop or eject a DVD.



Press and release to go to the previous chapter. Press and hold for a fast reverse search.



Press and release to go to the next chapter. Press and hold for a fast forward search.



Press when not in menu mode to adjust brightness, or when in menu mode to navigate through the menu selections.



Press to adjust volume levels.



Slow play

1. With a DVD playing, press pause.



2. Press and hold the reverse or advance button to enter into slow play mode. Once in slow play mode, press and release the reverse or advance button repeatedly to cycle through 1/4 and 1/2. These will display on the status bar on top of the screen as the screens cycle through at this rate.



Entertainment Systems

Frame by frame

1. With a DVD playing, press pause.



2. Press the right cursor button. The DVD will advance one frame. Each press of the right cursor button will advance the DVD video by one frame.

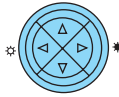

Headphone/auxiliary jacks

There are wired headphones (not included) and auxiliary jacks on the left and right side of your DVD system. They can be used to plug in wired headphones or to connect and play auxiliary electronic devices such as game systems, personal camcorders, video cassette recorders, etc.

On the left side of the system is the Headphone A input jack. This headphone will listen to the media selected on the Channel A source. When you need to make any adjustments to the media, volume, etc, ensure that the Channel A source is highlighted.

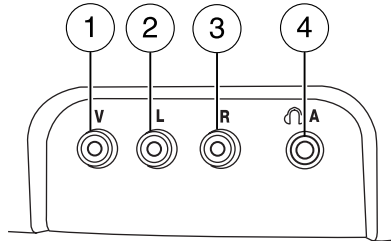

Also located here are the various auxiliary jacks which can be used to plug in a VCR, camcorder, video games, etc. The specific jacks are as follows:

1. Yellow: video input
2. White: left channel audio input
3. Red: right channel audio input
4. Black: wired headphone jack (not included)

The B headphone jack (5) is located on the right side of the DVD system. Plug in wired headphones (not included) here.

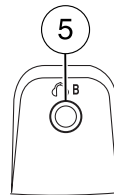

Note: The B headphones can only access DVD and AUX modes. They cannot access radio sources.

Entertainment Systems

Audio displays

Your DVD system interacts closely with the front audio system. Status messages will appear in the radio display showing the DVD status. Some possible radio display messages:

- SINGLE PLAY or DUAL PLAY
- DVD LOAD
- DVD MENU
- DVD STOP

Audio interaction

You can then also use the front audio controls to advance, reverse, play and pause a DVD. While a DVD is playing you may use the following controls on the front radio:

- **SEEK:** Press to advance to the previous (◀) or next (▶) DVD chapters.
- ▶ || : Press to play a DVD or to pause the DVD.

When the radio displays “DVD MENU”, press PLAY on the radio (memory preset #6), to play the disc.

Parental control for the DVD system

Your Family Entertainment System (FES) allows you to have control over the rear seat controls in a few different ways. The DVD system is automatically activated when the vehicle ignition is ON, which allows the rear seat passengers to use the DVD system.

There are three levels of control of the FES buttons. The states are FULL (enabled), LOCAL or



LOCKED (disabled). To change the level of control, press the memory preset controls 3 and 5 simultaneously on the front audio controls. The control level will cycle each time the buttons are pressed simultaneously. The three states are described as:

FULL (enabled): The FES has control over the primary (speaker) and secondary (headphone) audio sources.

LOCAL: The FES has control over the secondary source (headphones) only. The radio will ignore button presses that affect the primary (speaker) audio source.

LOCKED (disabled): The FES buttons are locked and all FES button presses are ignored by the radio and the FES except for load and eject.

Entertainment Systems

When the DVD system is ON, you can then press the memory preset controls 2 and 4 simultaneously to toggle between Single Play and Dual Play. In Single Play mode, all speakers listen to the same media. In Dual Play mode, rear seat passengers can use the infrared wireless, or wired (not included) headphones to listen to a different playing media than the front seat passengers.



General information

Note: DVDs are formatted by regions. US and Canada systems can only play region 1 DVDs and Mexico systems can only play region 4 DVDs. Systems sold in vehicles targeted for other parts of the world would have different regions. If a playback problem is encountered, please ensure that you are using a disc designed for your vehicle. The region coding can be found stamped on the disc or on the box, and can say 'region-1' or 'region 4', etc. They may also be marked by a numerical symbol.

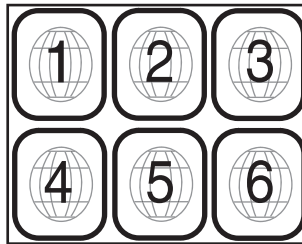

Macrovision: This product incorporates copyright protection technology that is protected by method claims of certain U.S. patents and other intellectual property rights owned by Macrovision Corporation and other rights owners. Use of this copyright protection technology must be authorized by Macrovision Corporation, and is intended for home and other limited viewing uses only unless otherwise authorized by Macrovision Corporation. Reverse engineering or disassembly is prohibited.

MP3: Supply of this product only conveys a license for private, non-commercial use and does not convey a license nor imply any right to use this product in any commercial (i.e. revenue generating) real time broadcasting (terrestrial, satellite, cable and /or any other media) broadcasting/streaming via internet, intranets and/or other networks or in other electronic content distribution systems, such as pay-audio or audio-on-demand applications. An independent license for such use is required. For details, please visit [http:// www.mp3licensing.com](http://www.mp3licensing.com).

Entertainment Systems

Safety information

 Driving while distracted can result in loss of vehicle control, accident and injury. Ford strongly recommends that drivers use extreme caution when using any device that may take their focus off the road. The driver's primary responsibility is the safe operation of their vehicle. Only use cell phones and other devices not essential to the driving task when it is safe to do so.

Read all of the safety and operating instructions before operating the system and retain for future reference.

Do not attempt to service, repair or modify the Family Entertainment System (FES). See your dealer.

Do not insert foreign objects into the DVD compartment.

 Do not leave children unattended in the vehicle and do not let children operate the system while unsupervised. If wired headphones or auxiliary systems are used, children may become entangled in the cords and seriously injure themselves.

 The front glass on the liquid crystal display (LCD) flip-down screen may break when hit with a hard surface. If the glass breaks, do not touch the liquid crystalline material. In case of contact with skin, wash immediately with soap and water.

 The driver should not attempt to operate any function of the DVD system while the vehicle is in motion. Give full attention to driving and to the road. Pull off the road in a safe place before inserting or extracting DVDs from the system. A remote control is included in the system to allow the rear seat occupants to operate the FES functions without distracting the driver.

Do not expose the liquid crystal display (LCD) flip-down screen to direct sunlight or intensive ultraviolet rays for extensive periods of time. Ultraviolet rays deteriorate the liquid crystal.

Be sure to review User Manuals for video games and video game equipment when used as auxiliary inputs for your Family Entertainment System (FES).

Entertainment Systems

Do not operate video games or video equipment if the power cords and/or cables are broken, split or damaged. Carefully place cords and/or cables where they will not be stepped on or interfere with the operation of seats and/or compartments.

Disconnect video games and video equipment power cords and/or cables when not in use.

Avoid touching auxiliary input jacks with your fingers. Do not blow on them or allow them to get wet or dirty.

Do not clean any part of the DVD player with benzene, paint thinner or any other solvent.

Federal Communication Commission (FCC) Compliance

Changes or modifications not approved by Ford Lincoln-Mercury could void user's authority to operate the equipment. This equipment has been tested and found to comply with the limits for a Class B digital device, pursuant to Part 15 of the FCC Rules. These limits are designed to provide reasonable protection against harmful interference in a residential installation. This equipment generates, uses and can radiate radio frequency energy and, if not installed and used in accordance with the instructions, may cause harmful interference and radio communications.

However, there is no guarantee that interference will not occur in a particular installation. If this equipment does cause harmful interference to radio or television reception, which can be determined by turning the equipment off and on, the user is encouraged to consult the dealer or an experienced radio/TV technician for help.

Care and service of the DVD player

Environmental extremes

DVD players which are subjected to harsh environmental conditions may be damaged or perform at less than maximum capability. To avoid these outcomes, whenever possible avoid exposing your DVD player to:

- extremely hot or cold temperatures.
- direct sunlight.
- high humidity.
- a dusty environment.
- locations where strong magnetic fields are generated.

Entertainment Systems

Temperature extremes

When the vehicle is parked under direct sunlight or in an extremely cold place for a long period of time, wait until the cabin temperature of the vehicle is at normal temperature before operating the system.

Humidity and moisture condensation

Moisture in the air will condense in the DVD player under extremely humid conditions or when moving from a cold place to a warm one. Moisture condensation may cause damage to the DVD and/or player. If moisture condensation occurs, do not insert a CD or DVD into the player. If one is already in the player, remove it. Turn the DVD player ON to dry the moisture before inserting a DVD. This could take an hour or more.

Foreign substances

Exercise care to prevent dirt and foreign objects from entering the DVD player compartment. Be especially careful not to spill liquids of any kind onto the media controls or into the system. If liquid is accidentally spilled onto the system, immediately turn the system OFF and consult a qualified service technician.

Cleaning the liquid crystal display (LCD) flip-down screen

Clean the display screen by applying a small amount of water or any ammonia-based household glass cleaner directly to a soft cloth. Rub the screen gently until the dust, dirt or fingerprints are removed. Do not spray the screen directly with water or glass cleaning solvents. Overspray from these fluids could drip down into the internal electronics of the screen and cause damage. Do not apply excessive pressure while cleaning the screen.

Cleaning DVD and CD discs

Inspect all discs for contamination before playing. If necessary, clean discs only with an approved DVD and CD cleaner and wipe from the center out to the edge. Do not use circular motion.

Compatibility with aftermarket audio systems (headphone only mode)

When the Family Entertainment System (FES) detects that the original radio supplied by Ford Motor Company has been removed from the vehicle, the FES will work in a state referred to as "Headphone Only Mode." This mode allows the FES to operate as a standalone system, without interface to the radio.

Entertainment Systems

While operating in Headphone Only Mode, the system will have limited functionality.

- The system will only output audio to the headphones. It will not be capable of providing audio to the speakers.
- The available sources in FES Headphone Only Mode are DVD-DISC and DVD-AUX, regardless of headphone channel (A or B).
- When a disc is inserted into the FES while in Headphone Only Mode, both headphone channels (A and B) will be connected to FES-DISC.

Climate Controls

HEATER ONLY SYSTEM (IF EQUIPPED)

1. **Fan speed adjustment:** Controls the volume of air circulated in the vehicle.

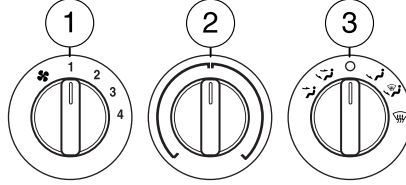

2. **Temperature selection:**

Controls the temperature of the airflow in the vehicle.

3. **Air flow selections:** Controls the direction of the airflow in the vehicle. See the following for a brief description on each control:

 : Distributes outside air through the instrument panel vents.

 : Distributes outside air through the instrument panel vents and the floor vents.

O (OFF): Outside air is shut out and the fan will not operate.

 : Distributes outside air through the floor vents.

 : Distributes outside air through the windshield defroster vents, floor vents and demister vents.

 : Distributes outside air through the windshield defroster vents and demister vents. Can be used to clear windshield of fog and thin ice.

Operating tips

- To reduce fog build up on the windshield during humid weather, place the air flow selector in the  position.
- To reduce humidity build up inside the vehicle during cold or warm weather, do not drive with the air flow selector in the O (OFF) position.
- Do not put objects under the front seats that will interfere with the air flow to the rear seats.
- Remove any snow, ice or leaves from the air intake area at the base of the windshield.

To aid in side window defogging/demisting in cold weather:

1. Select .
2. Modulate the temperature control to maintain comfort.
3. Set the fan speed to the highest setting.
4. Direct the outer instrument panel vents toward the side windows.

Climate Controls

To increase airflow to the outer instrument panel vents, close the vents located in the middle of the instrument panel.



Do not place objects on top of the instrument panel as these objects may become projectiles in a collision or sudden stop.

MANUAL HEATING AND AIR CONDITIONING SYSTEMS (IF EQUIPPED)

- Manual heating and air conditioning system

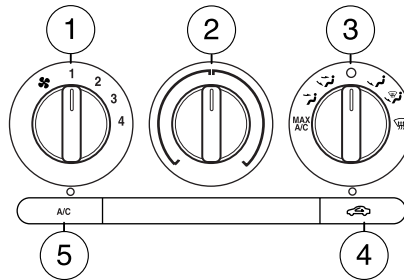

- Manual heating and air conditioning system with heated mirrors

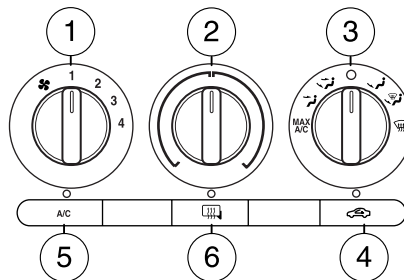

- Manual heating and air conditioning system with heated mirrors and heated seats

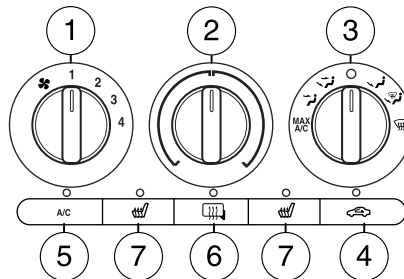

Climate Controls

1. **Fan speed adjustment:** Controls the volume of air circulated in the vehicle.

2. **Temperature selection:** Controls the temperature of the airflow in the vehicle.

3. **Air flow selections:** Controls the direction of the airflow in the vehicle. See the following for a brief description on each control.

MAX A/C: Distributes recirculated air through the instrument panel vents only to cool the vehicle. This re-cooling of the interior air is more economical and efficient. Recirculated air may also help reduce undesirable odors from entering the vehicle.

 : Distributes air through the instrument panel vents.

 : Distributes air through the instrument panel vents and the floor vents.



O (OFF): Outside air is shut out and the fan will not operate.

 : Distributes air through the floor vents.

 : Distributes air through the windshield defroster vents and floor vents.

 : Distributes outside air through the windshield defroster vents. Can be used to clear ice or fog from the windshield.

4.  **Recirculated air:** Press to activate/deactivate air recirculation in cabin. Recirculated air may reduce the amount of time to cool down the interior of the vehicle and may also help reduce undesired odors from reaching the interior of the vehicle. Recirculation engages automatically with selection of MAX A/C or can be engaged manually in any other airflow selection except defrost. Recirculation may turn off automatically in all airflow selections except MAX A/C.

5. **A/C:** Press to activate/deactivate air conditioning. Use with recirculated air to improve cooling performance and efficiency. Engages automatically in MAX A/C,  and .

6.  **(Heated mirrors):** Press to turn the heated mirrors on and off. The heated mirrors turn off automatically after 10 minutes.

7.  **(Heated seats):** Press to turn the heated seats on and off. The heated seats turn off when the ignition is turned off.

Climate Controls

Operating tips

- To reduce fog build up on the windshield during humid weather, place the air flow selector in the  position.
- To reduce humidity build up inside the vehicle, do not drive with the air flow selector in the O (OFF) position.
- Do not put objects under the front seats that will interfere with the airflow to the rear seats.
- Remove any snow, ice or leaves from the air intake area at the base of the windshield.
- To improve the A/C cool down, drive with the windows slightly open for 2–3 minutes after start up or until the vehicle has been “aired out.”

For maximum cooling performance in MAX A/C mode:

1. Move the temperature control to the coolest setting.
2. Set the fan to the highest speed initially, then adjust in order to maintain comfort.

To aid in side window defogging and demisting in cold weather:

1. Select .
2. Select A/C.
3. Set the temperature control to maintain comfort.
4. Set the fan speed to highest setting.
5. Direct the outer instrument panel vents towards the side windows.



Do not place objects on top of the instrument panel as these objects may become projectiles in a collision or sudden stop.

Climate Controls

DUAL AUTOMATIC TEMPERATURE CONTROL (DATC) SYSTEMS (IF EQUIPPED)

- DATC

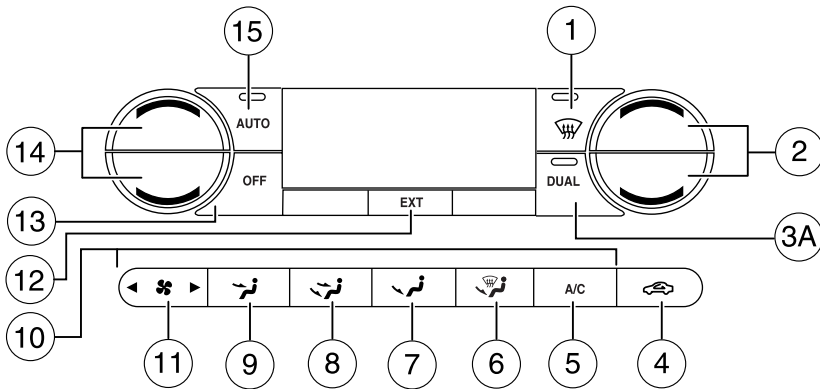

- DATC with heated mirrors

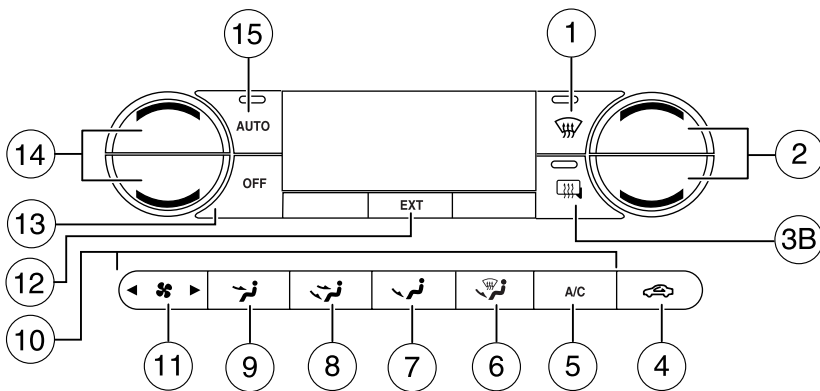



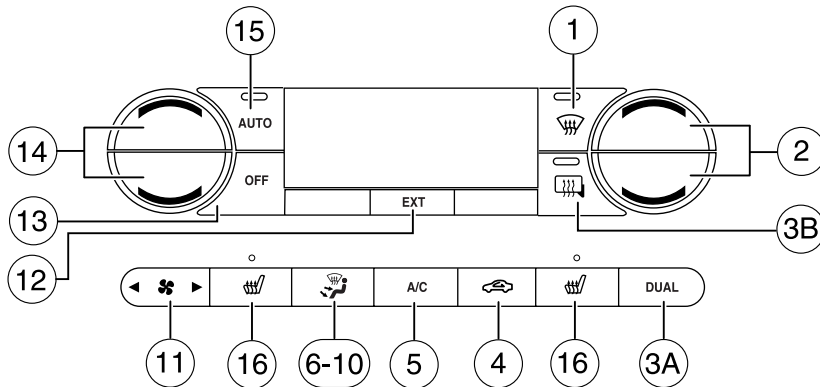

Climate Controls

- DATC with heated seats and heated mirrors



Temperature conversion: To switch between Fahrenheit and Celsius, refer to *Units (English/Metric)* under either *Standard Message Center* or *Optional Message Center* in the *Driver Controls* chapter

In order to achieve maximum cooling performance, press , A/C, , and set the temperature to 60°F (16°C) and the highest blower setting.











1.  **Defrost:** Distributes outside air through the windshield defroster and demister vents. Can be used to clear thin ice or fog from the windshield. To exit  select another mode.

2. **Passenger temperature control:** Press to increase/decrease the passenger side temperature in the vehicle cabin.

3A. **Dual:** (Single/dual electric temperature control): Allows the driver to have full control of the cabin temperature settings (single zone) or allows the passenger to have control of their individual temperature settings (dual zone control). Press to turn on dual zone mode, press again to return to single zone.



3B.  **Heated mirrors:** Press to defrost the outside rear view mirrors. The heated mirrors will turn off after 10 minutes or can be turned off by pressing the button again. Refer to *Power mirrors* in the *Driver Controls* chapter for more information.

Climate Controls

4.  **Recirculation control:** Press to activate/deactivate air recirculation in cabin. Recirculated air may reduce the amount of time to cool down the interior of the vehicle and may also help reduce undesired odors from reaching the interior of the vehicle. Recirculation can be engaged manually in any other airflow selection except  (defrost). Recirculation may turn off automatically in all airflow selections except MAX A/C.
5. **A/C control:** Press to activate/deactivate air conditioning. Use with recirculated air to improve cooling performance and efficiency. Engages automatically in AUTO,  (defrost) and  (floor/defrost).
6. **Manual override controls:** Press this control to manually select where you want the airflow directed. To return to full automatic control, press AUTO.
7.  : Distributes air through the windshield defroster vents and floor vents.
8.  : Distributes air through the floor vents.
9.  : Distributes air through the instrument panel vents and the floor vents.
10.  : Distributes air through the instrument panel vents.
11.  **Fan speed control:** Press to manually increase or decrease the fan speed. To return to automatic fan operation, press AUTO.
12. **EXT:** Press to display outside temperature. Press again to display cabin temperature settings.
13. **OFF:** Outside air is shut out and the fan will not operate.
14. **Driver temperature control:** Press to increase/decrease the driver side temperature in the vehicle cabin.
15. **AUTO:** To engage automatic temperature control, press AUTO and select the desired temperature using the temperature control. The system will automatically determine fan speed, airflow location, A/C on or off, and outside or recirculated air, to heat or cool the vehicle to reach the desired temperature.
16.  **Heated seat controls:** Press to turn the heated seats on and off. The heated seats turn off when the ignition is turned off.

Climate Controls

Operating tips



- To reduce fog build up on the windshield during humid weather, place the air flow selector in the  position.
- To reduce humidity build up inside the vehicle, do not drive with the system OFF, or with recirculated air  engaged and A/C off.
- Do not put objects under the front seats that will interfere with the airflow to the back seats.
- Remove any snow, ice or leaves from the air intake area at the base of the windshield.
- To improve the A/C cool down, drive with the windows slightly open for 2-3 minutes after start up or until the vehicle has been “aired out”.

For maximum cooling performance (MAX A/C):

Automatic operation:

1. Press AUTO for full automatic operation.
2. Do not override A/C or  (recirculated air).
3. Set the temperature to 60°F (16°C).

Override operation:

1. Select air distribution.
2. Select A/C and  (recirculated air). Use  (recirculated air) with A/C to provide colder airflow.
3. Set the temperature to 60°F (16°C).
4. Set highest fan speed initially, then adjust to maintain comfort.

In (panel) or (panel/floor) modes:

1. Move temperature control to full cold.
2. Select A/C and  (recirculated air). Use recirculated air with A/C to provide colder airflow.
3. Set highest fan speed initially, then adjust to maintain comfort.

Climate Controls

To aid in side window defogging/demisting in cold weather:

1. Select .
2. Select A/C.
3. Adjust the temperature control to maintain comfort.
4. Set the fan speed to the highest setting.
5. Direct the outer instrument panel vents towards the side windows.

To increase airflow to the outer instrument panel vents, close the vents located in the middle of the instrument panel.



Do not place objects on top of the instrument panel as these objects may become projectiles in a collision or sudden stop.

Lights

HEADLAMP CONTROL

- Turns the lamps off.
- P⊖ Turns on the parking lamps, instrument panel lamps, license plate lamps and tail lamps.
- ☰☽ Turns the headlamps on.

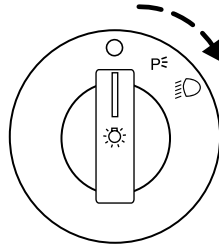

Autolamp control (if equipped)

The autolamp system provides light sensitive automatic on-off control of the exterior lights normally controlled by the headlamp control.

The autolamp system also keeps the lights on for approximately 20 seconds or on vehicles equipped with a message center, you can select a delay from 0–180 seconds, after the ignition switch is turned to OFF.

- To turn autolamps on, rotate the control counterclockwise.
- To turn autolamps off, rotate the control clockwise to ○ (OFF).

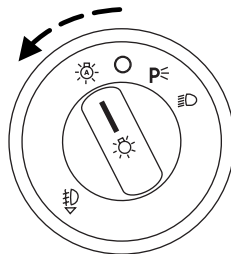

Foglamp control (if equipped)

The headlamp control also operates the foglamps. The foglamps can be turned on when the headlamp control is in the P⊖, ☰☽ or ☰☽ positions and the high beams are not turned on.

Pull headlamp control towards you to turn foglamps on. The foglamp indicator light (☰☽) will illuminate.

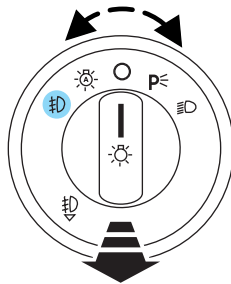

Lights

Daytime running lamps (DRL) (if equipped)

Turns the headlamps on with a reduced output.

To activate:

- the ignition must be in the on position,
- the headlamp control is in the  (OFF) or parking lamp position and
- the parking brake must be disengaged.



Always remember to turn on your headlamps at dusk or during inclement weather. The Daytime Running Lamp (DRL) system does not activate the tail lamps and generally may not provide adequate lighting during these conditions. Failure to activate your headlamps under these conditions may result in a collision.

High beams

Push the lever toward the instrument panel to activate. Pull the lever towards you to deactivate.

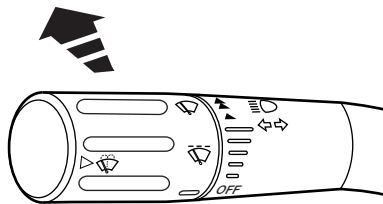

Flash-to-pass

Pull toward you slightly to activate and release to deactivate.

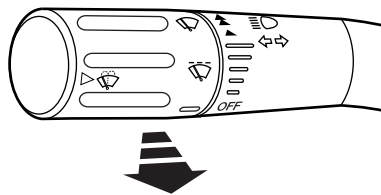

PANEL DIMMER CONTROL

Use to adjust the brightness of the instrument panel and all applicable illuminated switches in the vehicle during headlamp and parklamp operation.

Move the control to the full upright position, past detent, to turn on the interior lamps.

Note: If the battery is disconnected, discharged, or a new battery is installed, the dimmer switch requires re-calibration. Rotate the dimmer switch from the full dim position to the full Dome/ON position to reset. This will ensure that your displays are visible under all lighting conditions

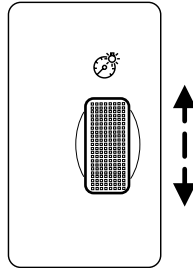

AIMING THE HEADLAMPS

Your vehicle may be equipped with a sealed beam or aerodynamic headlamp system. Sealed beam headlamps may be aimed in the vertical (up/down) and the horizontal (left/right) directions using the procedures following. The aerodynamic headlamps can only be aimed in the vertical direction (up/down) using the following procedures. The headlamps on your vehicle are properly aimed at the assembly plant and should not normally need adjusting.

Vertical and horizontal aim adjustment (sealed beam headlamps)

The headlamps on your vehicle are intended to be aimed using mechanical aimers. If mechanical aimers are used and the cross-car sight line is in any way blocked, set the legs of the universal adaptor all to the same setting, such that the cross-car sight line is no longer blocked, per the instructions for the brand of mechanical aimer used. You can also aim the headlamps visually using the procedure below.

Lights

To adjust the headlamps:

1. Park your vehicle on a level surface about 25 feet (7.6 meters) away from a vertical plain surface (3). Check your headlamp alignment at night or in a dark area so that you can see the headlamp beam pattern.

- (1) 8 feet (2.4 meters)
- (2) Center height of lamp to ground
- (3) 25 feet (7.6 meters)
- (4) Horizontal reference line
- (5) Center of headlamps
- (6) Center line of the vehicle

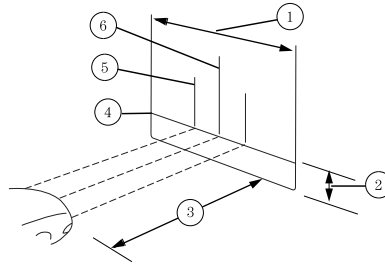

2. The center of the headlamp is marked either on the lens (a circle or cross marker) or on the bulb shield, internal to the lamp (mark or feature). Measure the height from the center of your headlamp to the ground (2) and mark an 8 foot (2.4 meter) long horizontal line on the wall or screen (1) at this height (masking tape works well).

3. Turn on the low beam headlamps and open the hood.

4. Locate the high intensity area of the beam pattern and place the top edge of the intensity zone even with the horizontal reference line (4). If the top edge of the high intensity area is not even with the horizontal line, follow the next step to adjust it.

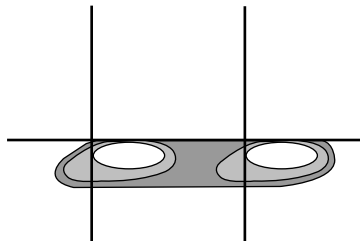

Lights

5. Locate the vertical adjuster (2) for each headlamp. Adjust the aim by turning the adjuster control either clockwise (to adjust up) or counterclockwise (to adjust down).

6. In addition to the horizontal line marked in step 2, a pair of vertical lines (5) must be marked at the center line of the headlamps on the wall or screen.

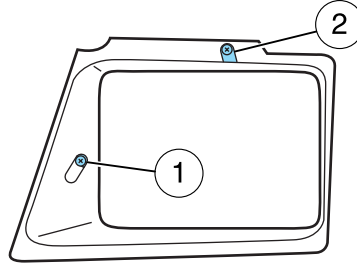

7. On the wall or screen, locate the high intensity area of the beam pattern. The left edge of the high intensity area should be even with the vertical line corresponding to the headlamp under adjustment. If the left edge of the high intensity area is not even with the vertical line, follow the next step to adjust it.

8. Locate the horizontal adjuster (1) for each headlamp. Turn it clockwise or counterclockwise, to place the left edge of the high intensity area even with the vertical line corresponding to the headlamp under adjustment.

Vertical aim adjustment (aerodynamic headlamps)

The headlamps on your vehicle can only be vertically adjusted. Your vehicle does not require horizontal aim adjustments.

To adjust the headlamps:

1. Park the vehicle directly in front of a wall or screen on a level surface, approximately 25 feet (7.6 meters) away.

- (1) 8 feet (2.4 meters)
- (2) Center height of lamp to ground
- (3) 25 feet (7.6 meters)

Lights

- (4) Horizontal reference line

2. Measure the height from the center of your headlamp (indicated by a 3.0 mm circle on the lens) to the ground and mark an 8 foot (2.4 meter) horizontal reference line on the vertical wall or screen at this height (a piece of masking tape works well).

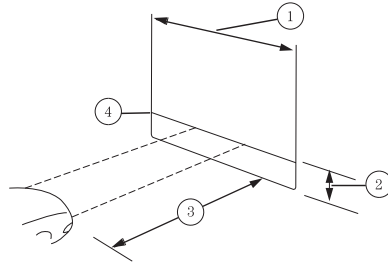

3. Turn on the low beam headlamps to illuminate the wall or screen and open the hood. Cover one of the headlamps so no light from that lamp hits the wall.

4. On the wall or screen you will observe a light pattern with a distinct horizontal edge towards the right. If this edge is not at the horizontal reference line, the beam will need to be adjusted so the edge is at the same height as the horizontal reference line.

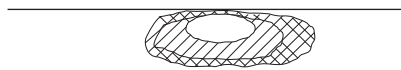

5. Locate the vertical adjuster on each headlamp, then use a E5 Torx socket to turn the adjuster either counterclockwise (to adjust down) or clockwise (to adjust up) aligning the upper edge of the light pattern up to the horizontal line.

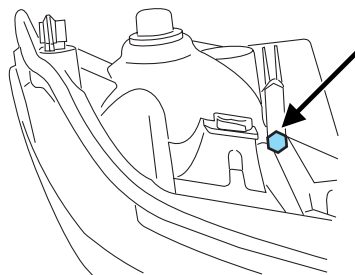

6. Repeat Steps 3–5 for the other headlamp.

7. Close the hood and turn off the lamps.

TURN SIGNAL CONTROL

- Push down to activate the left turn signal.
- Push up to activate the right turn signal.

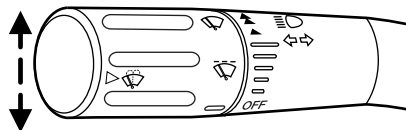

Lights

MAP LAMPS (IF EQUIPPED)

The dome lamp turns on when:

- any door is opened,
- the instrument panel dimmer switch is rotated up until the courtesy lamps come on, and
- any of the remote entry controls are pressed and the ignition is OFF.

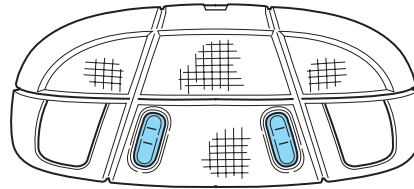

BULBS

Headlamp condensation

The headlamps are vented to equalize pressure. When moist air enters the headlamp(s) through the vents, there is a possibility that condensation can occur. This condensation is normal and will clear within 45 minutes of headlamp operation.

Using the right bulbs

Check the operation of all the bulbs frequently.

Replacing exterior bulbs

Check the operation of all the bulbs frequently.

Function	Number of bulbs	Trade number
Headlamps (aerodynamic)	2	H13/9008
Headlamps (sealed beam)	2	H6054
Park lamp with aerodynamic headlamp	2	3157A or 3157AK
Park lamp with sealed beam headlamp	2	4157K/3157
Sidemarker	2	194
Tail/stop/turn/sidemarker (Pick-up only)	2	4157K or 3157
Tail/stop/turn/sidemarker (Chassis cabs only; if equipped)	2	3157
Back-up (Pick-ups only)	2	3156 or 3156K
Back-up (Chassis cabs only)	2	3157
High-mount stoplamp	1	922

Lights

Function	Number of bulbs	Trade number
Foglamp	2	9145
License plate lamp	2	194
Cargo lamp	2	906
Mirror turn signal	2	2825
Mirror clearance lamp	2	2825
Front clearance lamps (2) and Front identification lamps (3)	5	194
Rear fender clearance*	4	W5W
Interior visor lamp (if equipped)	4	194
Rear identification	3	194
All replacement bulbs are clear in color except where noted.		
To replace all instrument panel lights - see your authorized dealer		
* Dual rear wheels, or if equipped.		

Replacing headlamp bulbs (aerodynamic)

1. Make sure that the headlamp control is in the off position and open the hood.
2. Remove the four bolts from the top, side and bottom front of the headlamp assembly.
3. Pull the assembly straight out disengaging two snap clips to fender.
4. Disconnect the electrical connector by squeezing the release tab and pushing the connector forward and then pulling it rearward.

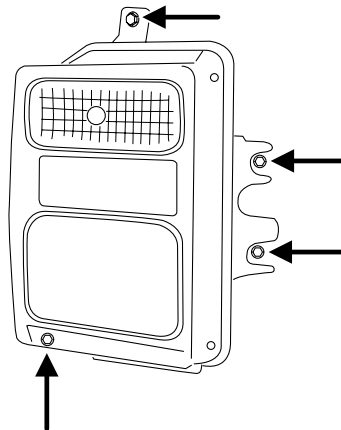

Lights

5. Remove the bulb assembly by turning it counterclockwise and pulling it straight out.

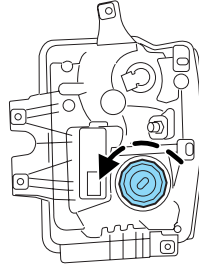

Handle a halogen headlamp bulb carefully and keep out of children's reach. Grasp the bulb only by its plastic base and do not touch the glass. The oil from your hand could cause the bulb to break the next time the headlamps are operated.

Install the new bulb(s) in reverse order.

Replacing park/turn and sidemarker lamp bulbs (aerodynamic)

1. Make sure that the headlamp control is in the off position and open the hood.
2. Remove the four bolts from the top, side and bottom front of the headlamp assembly.
3. Pull the assembly straight out.

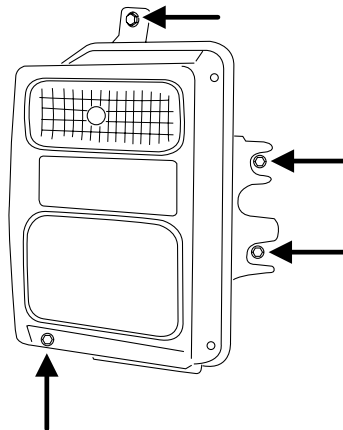

Lights

4. Remove the bulb assembly, (1) sidemarker or (2) park/turn by turning it counterclockwise and pulling it straight out.
5. Pull the old bulb out from the socket.

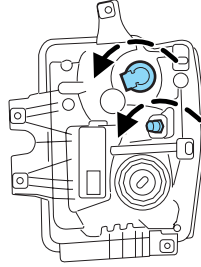

Install the new bulb(s) in reverse order.

Replacing headlamp bulbs (sealed beam)

1. Make sure that the headlamp control is in the off position and open the hood.
2. Remove the three screws and one bolt from the top and bottom of the park lamp/bezel assembly.
3. Remove the four screws and the headlamp retaining ring from headlamp.
4. Disconnect the electrical connector from the headlamp.

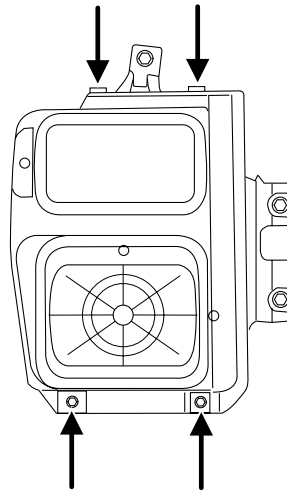

Install the new bulb(s) in reverse order.

Replacing park/turn/sidemarker bulbs (sealed beam)

1. Make sure that the headlamp control is in the off position and open the hood.

Lights

2. Remove the three screws and one bolt from the top and bottom of the park lamp/bezel assembly.
3. Pull the assembly straight out disengaging snap clip.

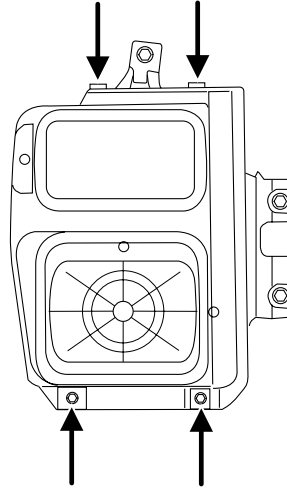

4. Remove the bulb assembly, sidemarker or park/turn by turning it counterclockwise. (Top view of assembly shown.)
5. Pull the old bulb out from the socket.

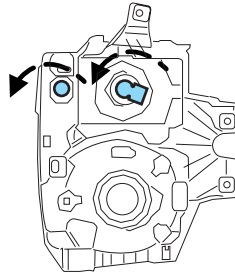

Install the new bulb(s) in reverse order.

Replacing brake/tail/turn/back-up lamp bulbs - Pick-ups only

1. Make sure the headlamp switch is in the off position and then open the tailgate to expose the lamp assemblies.
2. Remove the two bolts from the tail lamp assembly and carefully pull the lamp assembly from the tailgate pillar by releasing the two retaining tabs.

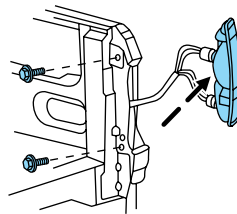

Lights

3. Rotate the bulb socket counterclockwise and remove from lamp assembly.

4. Pull the bulb straight out of the socket.

Install the new bulb(s) in reverse order.

Replacing brake/tail/turn/back-up lamp bulbs - Chassis cabs only; if equipped

1. Make sure the headlamp switch is in the off position.

2. Remove the four screws and the lamp lens from lamp assembly.

3. Carefully pull the bulb straight out of the socket and push in the new bulb.

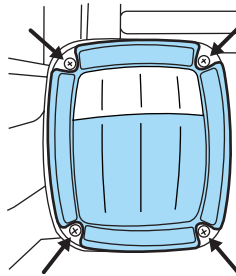

Replacing cargo lamp and high-mount brakelamp bulbs

1. Make sure the headlamp switch is in the off position.

2. Remove the two screws and lamp assembly from vehicle as wiring permits.

3. Remove the bulb socket by rotating counterclockwise.

4. Pull the bulb straight out of the socket.

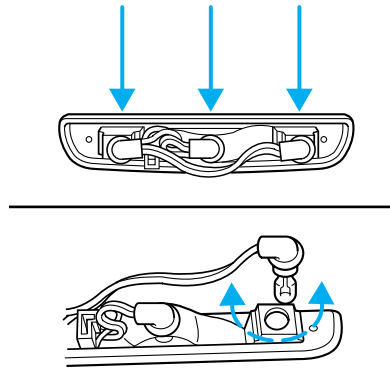

Lights

Front clearance and identification lamp bulbs

1. Make sure the headlamp switch is in the off position.
2. Remove the screw and lens from the lamp assembly.
3. Pull the bulb straight out of the socket.

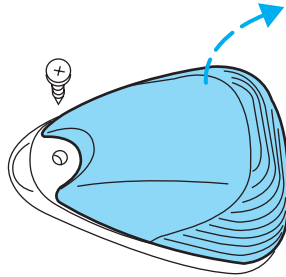

Install the bulb(s) in reverse order.

Replacing foglamp bulbs (if equipped)

1. Make sure the headlamp switch is in the OFF position.
2. Remove the bulb socket from the foglamp by turning counterclockwise.
3. Disconnect the electrical connector from the foglamp bulb.

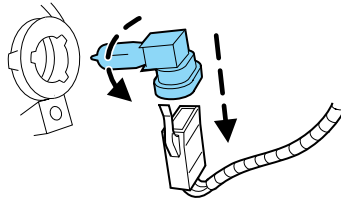

Install the new bulb(s) in reverse order.

Replacing license plate lamp bulbs

The license plate bulbs are located behind the rear bumper. To change the license plate lamp bulbs:

1. Reach behind the rear bumper to locate the bulb.
2. Twist the bulb socket counterclockwise and carefully pull to remove it from the lamp assembly.
3. Pull out the old bulb from the socket and push in the new bulb.
4. Install the bulb socket in lamp assembly by turning it clockwise.

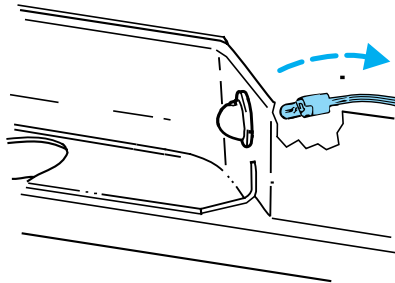

Driver Controls

MULTI-FUNCTION LEVER

Windshield wiper: Rotate the end of the control away from you to increase the speed of the wipers; rotate towards you to decrease the speed of the wipers.

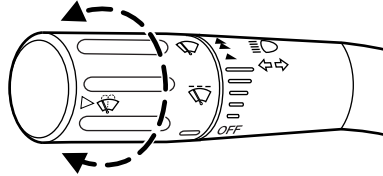

Windshield washer: Push the end of the stalk:

- briefly: causes a single swipe of the wipers without washer fluid.
- a quick push and hold: the wipers will swipe three times with washer fluid.
- a long push and hold: the wipers and washer fluid will be activated for up to ten seconds.

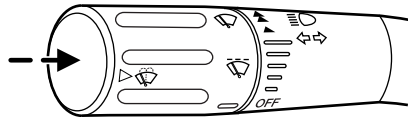

Note: Do not operate the washer when the washer reservoir is empty. This may cause the washer pump to overheat. Check the washer fluid level frequently. Do not operate the wipers when the windshield is dry. This may scratch the glass, damage the wiper blades and cause the wiper motor to burn out. Before operating the wiper on a dry windshield, always use the windshield washer. In freezing weather, be sure the wiper blades are not frozen to the windshield before operating the wipers.

Driver Controls

TILT STEERING WHEEL (IF EQUIPPED)

1. Pull and hold the steering wheel release control toward you.
2. Move the steering up or down until you find the desired location.
3. Release the steering wheel release control. This will lock the steering wheel in position.

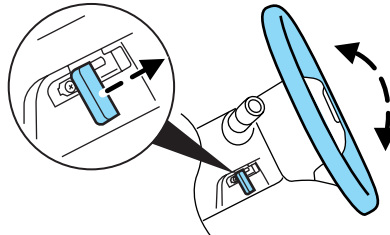

Never adjust the steering column when the vehicle is moving.

TRANSMISSION CONTROL

Tow/Haul feature (5-speed automatic transmission) (if equipped)

To activate, press the transmission control switch (TCS) located on the gearshift. The TOW/HAUL indicator light will illuminate in the instrument cluster. The transmission will operate in all gears. Press the transmission control switch again to deactivate Tow/Haul mode. When you shut off and re-start your vehicle, the transmission will automatically return to normal mode with Tow/Haul feature deactivated. For more information, refer to the *Driving* chapter.

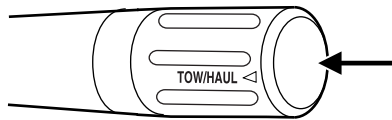

Do not use the Tow/Haul feature when driving in icy or slippery conditions as the increased engine braking can cause the rear wheels to slide and the vehicle to swing around with the possible loss of vehicle control.

Driver Controls

ILLUMINATED VISOR MIRROR (IF EQUIPPED)

Lift the mirror cover to turn on the visor mirror lamp.

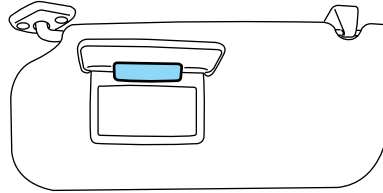

OVERHEAD CONSOLE (IF EQUIPPED)

The appearance of your vehicle's overhead console will vary according to your option package. If your vehicle is equipped with a moon roof, refer to *One-touch moonroof* later in this chapter for information on its operation.

Storage compartment (if equipped)

Press the release on the door to open the storage compartment.

The storage compartment may be used to secure sunglasses or a similar object and the front tab can be used for holding tickets, paper, envelopes, etc. The front bin may be used to store small objects.

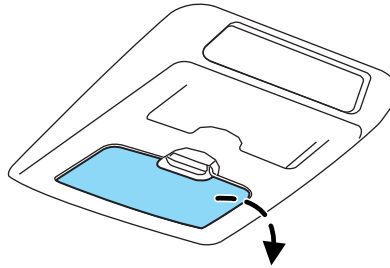

AUXILIARY POWER POINT (12VDC)

Power outlets are designed for accessory plugs only. Do not insert any other object in the power outlet for this will damage the outlet and blow the fuse. Do not hang any type of accessory or accessory bracket from the plug. Improper use of the power outlet can cause damage not covered by your warranty.

Driver Controls

The auxiliary power point is located on the instrument panel.

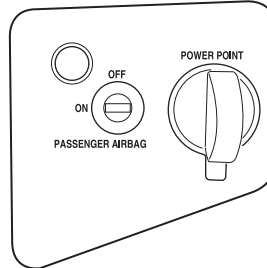

On SuperCab and Crew Cab models, another power point is located on the rear of the center console (if equipped).

Do not use the power point for operating the cigarette lighter element (if equipped).

To prevent the fuse from being blown, do not use the power point(s) over the vehicle capacity of 12 VDC/180W.

To prevent the battery from being discharged, do not use the power point longer than necessary when the engine is not running.

Always keep the power point caps closed when not being used.

Cigar lighter (if equipped)

Do not plug optional electrical accessories into the cigarette lighter socket.

Do not hold the lighter in with your hand while it is heating, this will damage the lighter element and socket. The lighter will be released from its heating position when it is ready to be used.

Note: If the power point or cigar lighter socket is not working, a fuse may have blown. Refer to the *Fuses and relays* in the *Roadside Emergencies* chapter information on checking and replacing fuses.

Improper use of the lighter can cause damage not covered by your warranty.

Driver Controls

POWER WINDOWS



Do not leave children unattended in the vehicle and do not let children play with the power windows. They may seriously injure themselves.



When closing the power windows, you should verify they are free of obstructions and ensure that children and/or pets are not in the proximity of the window openings.

Press and pull the window switches to open and close windows.

- Push down (to the first detent) and hold the switch to open.
- Pull up (to the first detent) and hold the switch to close.

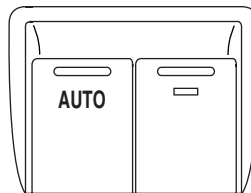

Rear Window Buffeting: When one or both of the rear windows are open, the vehicle may demonstrate a wind throb or buffeting noise; this noise can be alleviated by:

- Lowering a front window approximately two to three inches or
- Opening a 3rd Row Power Quarter Glass, for vehicles equipped with this option

One touch down

Allows the driver's window to open fully without holding the control down. Push the switch completely down to the second detent and release quickly. The window will open fully. Momentarily press the switch to any position to stop the window operation.

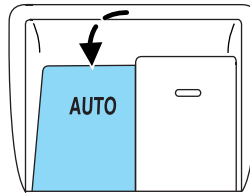

Power rear slider window (if equipped)



Do not leave children unattended in the vehicle and do not let children play with the power windows. They may seriously injure themselves.

Driver Controls

 When closing the power windows, you should verify they are free of obstructions and ensure that children and/or pets are not in the proximity of the window openings.

If your vehicle is equipped with a power rear slide window, the switch is located on the instrument panel behind the right-hand side of the steering wheel.

- Press the right side of the control to open the window.
- Pull the right side of the control to close the window.

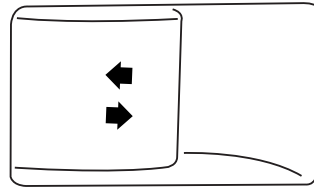

REAR WINDOW

Window lock (if equipped)

The window lock feature allows only the driver to operate the power windows.

To lock out all the window controls except for the driver's, press the right side of the control. Press the left side to restore the window controls.

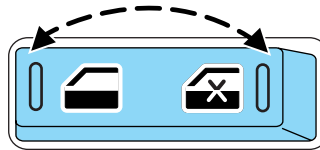

Accessory delay (if equipped)

With accessory delay, the window switches may be used for up to ten minutes after the ignition switch is turned to the OFF position or until any front door is opened.

INTERIOR MIRRORS

The interior rear view mirror has two pivot points on the support arm which lets you adjust the mirror UP or DOWN and from SIDE to SIDE.

Do not adjust the mirror while the vehicle is in motion.

Driver Controls

Automatic dimming inside rear view mirror (if equipped)

Your vehicle may be equipped with an inside rear view mirror which has an auto-dimming function. The electronic day/night mirror will change from the normal (high reflective) state to the non-glare (darkened) state when bright lights (glare) reach the mirror. When the mirror detects bright light from behind the vehicle, it will automatically adjust (darken) to minimize glare.

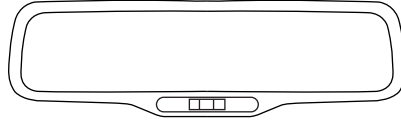

The mirror will automatically return to the normal state whenever the vehicle is placed in R (Reverse) (when the mirror is on) to ensure a bright clear view when backing up.

Do not block the sensors on the front and back of the inside rear view mirror since this may impair proper mirror performance.

Do not clean the housing or glass of any mirror with harsh abrasives, fuel or other petroleum-based cleaning products.

Note: If equipped with a Reverse Camera System (RCS), a video image will display in the mirror when the vehicle is put in (R) Reverse. Refer to *Reverse Camera System (RCS)* in the *Driving* chapter.

POWER SIDE VIEW MIRRORS (IF EQUIPPED)

To adjust your mirrors:

1. Rotate the control clockwise to adjust the right mirror and rotate the control counterclockwise to adjust the left mirror.
2. Move the control in the direction you wish to tilt the mirror.
3. Return to the center position to lock mirrors in place.



The spotter mirror below the main glass (if equipped) must be adjusted manually.

Driver Controls

Heated outside mirrors (if equipped)

The main mirror glass is heated to remove ice, mist and fog. To activate the heated mirrors, press the heated mirror control () located on the climate control panel. The heated mirrors will operate for 10 minutes, then automatically shut off (or shut off when the engine is turned off). In cases of extreme ice and cold, the heater control may need pressing again after 10 minutes in order to fully clear the glass. The spotter mirror below the main glass is not heated.

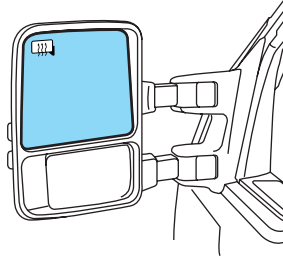

Do not remove ice from the mirrors with a scraper or attempt to re-adjust the mirror glass if it is frozen in place. These actions could cause damage to the glass and mirrors.

Fold-away mirrors

Fold the side mirrors in carefully before driving through a narrow space, like an automatic car wash.

Powerfold mirrors

If equipped with powerfold mirrors, you can fold the side mirrors simultaneously using the power mirror switch.

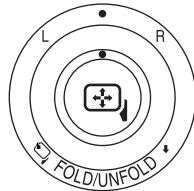

To operate the powerfold mirrors:

1. Rotate the switch to the center/neutral position.
2. Momentarily pull the switch rearward to auto fold in.
3. Momentarily pull the switch rearward again to fold back to design position.

Note: When powerfolding the mirrors, it is normal to hear the sound of the motors.

Driver Controls

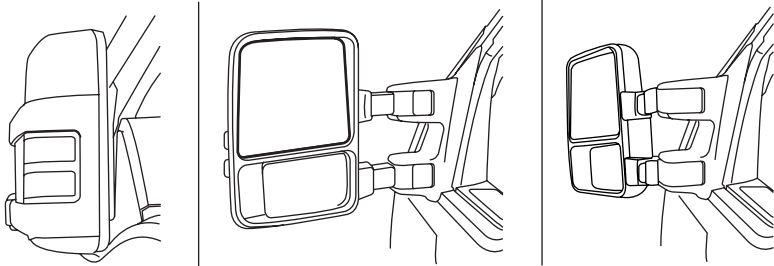

Powerfold mirror positions, from left to right: Position 1, Position 2, Position 3

The powerfold mirrors may be folded forward/rearward manually to any of the three positions shown and electrically to positions 1 and 2 only. If a mirror is folded manually forward to position 3, you must manually fold it back to position 1 or 2 in order for the powerfold function to continue functioning.

Note: Ten or more switch activations within one minute, or repeated fold/unfolding of the mirrors while holding the switch rearward during the full travel may cause the system to disable the fold/unfold function to protect the motors from overheating. Should this occur, wait approximately 3½ minutes for the system to reset and function to return to normal.

Note: The powerfold mirrors are designed to operate while the vehicle is stationary or traveling at moderate speeds. If you attempt to powerfold the mirrors at high speeds, they may not fully fold forward/rearward - slow down and powerfold or manually fold the mirrors in order to complete the fold operation.

If the powerfold mirrors feel loose or fold very easily, it is possible that the powerfold mechanism is out of sync. The powerfold mechanism gets out of sync when a mirror is manually folded partially in toward the door, then electrically powerfolded.

Note: The mirrors will **not** be out of sync if the mirrors are manually folded all the way in or out and then powerfolded.

In order to re-sync the mirrors, manually fold the mirrors toward the door until a click is heard. Then press the powerfold switch to electrically fold the mirrors in then out.

Driver Controls

Note: If the power fold/telescope mirror glass appears loose or vibrates when driving, it is possible that the mirrors have been manually folded or telescoped. To minimize the vibration, ensure that the mirrors are electronically folded and telescoped in/out with the switches on the door trim panel.

Telescoping mirrors (if equipped)

The telescoping feature allows the mirror to extend approximately 2.75 inches (70 mm). This feature is especially useful to the driver when towing a trailer. Mirrors can be manually pulled out or pushed in to the desired telescopic position.

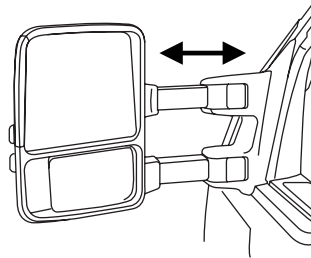

If equipped with power telescoping mirrors, you can simultaneously position both mirrors using the power telescope switch found on the door trim panel.

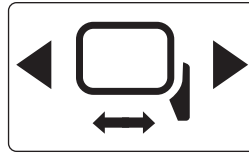

- To telescope the mirrors outboard, press and hold the left side of the power telescope switch until the mirrors reach their desired position. When the end of travel is reached, it is normal to hear the power telescoping motors running as long as you continue to hold the switch.
- To telescope the mirrors inboard, press and hold the right side of the power telescope switch until the mirrors reach their desired position.

Memory mirrors (if equipped)

This system allows automatic positioning of the outside rearview mirrors. For more information on this feature, refer to *Memory seats/power mirrors/adjustable pedals* in the *Seating and Safety Restraints* chapter.

Driver Controls

Mirror mounted side turn signal indicator (if equipped)

When the vehicle turn signals are activated, the outer portion of the mirror housing will blink amber.

The turn signal feature can be seen by other drivers who may approach from the rear of the vehicle.

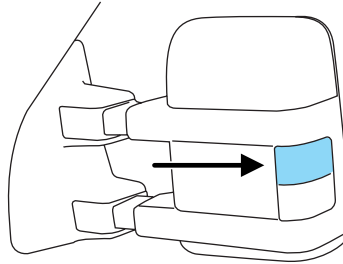

Clearance lamps (if equipped)

Illuminates when the headlamps or parking lamps are switched on.

This provides additional visibility of your vehicle to other drivers on the road.

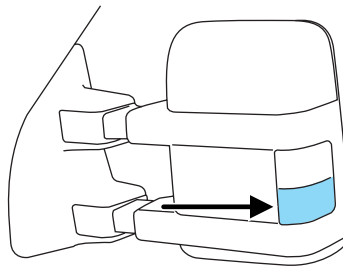

POWER ADJUSTABLE FOOT PEDALS (IF EQUIPPED)

The accelerator and brake pedal should only be adjusted when the vehicle is stopped and the gearshift lever is in the P (Park) position.

Press and hold the rocker control to adjust accelerator and brake pedal toward you or away from you.

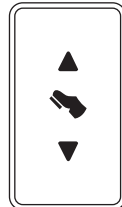

The adjustment allows for approximately 2.75 inches (70 mm) of maximum travel.

Driver Controls



Never adjust the accelerator and brake pedal with feet on the pedals while the vehicle is moving.

The accelerator and brake pedal positions are saved when doing a memory set function and can be recalled along with the vehicle personality features when a memory position is selected through the remote entry transmitter, keyless entry keypad or memory switch on the driver's door (if equipped with memory feature). Refer to *Memory seats/power mirrors/adjustable pedals* in the *Seating and Safety Restraints* chapter.

SPEED CONTROL (IF EQUIPPED)

With speed control set, you can maintain a set speed without keeping your foot on the accelerator pedal.



Do not use the speed control in heavy traffic or on roads that are winding, slippery or unpaved.

Setting speed control

The controls for using your speed control are located on the steering wheel for your convenience.

1. Press the ON control and release it.
2. Accelerate to the desired speed.
3. Press the SET + control and release it.
4. Take your foot off the accelerator pedal.
5. The indicator light () on the instrument cluster will turn on.

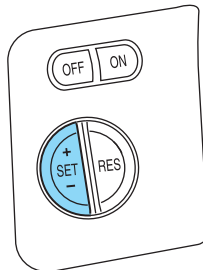
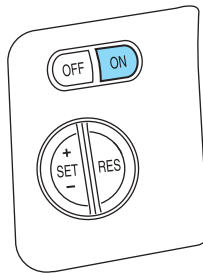

Driver Controls

Note:

- Vehicle speed may vary momentarily when driving up and down a steep hill.
- If the vehicle speed increases above the set speed on a downhill, you may want to apply the brakes to reduce the speed.
- If the vehicle speed decreases more than 10 mph (16 km/h) below your set speed on an uphill, your speed control will disengage.

Resuming a set speed

Press the RES (resume) control and release it. This will automatically return the vehicle to the previously set speed.

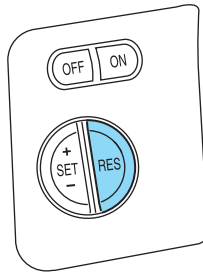

Increasing speed while using speed control

There are two ways to set a higher speed:

- Press and hold the SET + control until you get to the desired speed, then release the control. You can also use the SET + control to operate the Tap-Up function. Press and release this control to increase the vehicle set speed in small amounts by 1 mph (1.6 km/h).
- Use the accelerator pedal to get to the desired speed. When the vehicle reaches that speed press and release the SET + control.

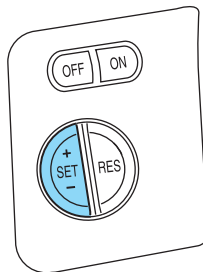

Driver Controls

Reducing speed while using speed control

There are two ways to reduce a set speed:

- Press and hold the SET - control until you get to the desired speed, then release the control. You can also use the SET - control to operate the Tap-Down function. Press and release this control to decrease the vehicle set speed in small amounts by 1 mph (1.6 km/h).
- Depress the brake pedal until the desired vehicle speed is reached, press the SET + control.

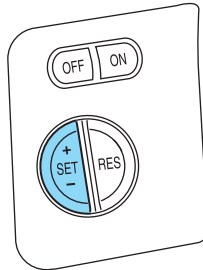

Turning off speed control

There are two ways to turn off the speed control:

- Depress the brake pedal. This will not erase your vehicle's previously set speed.
- Press the speed control OFF control.

Note: When you turn off the speed control or the ignition, your speed control set speed memory is erased.

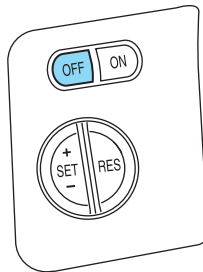

Driver Controls

STEERING WHEEL CONTROLS (IF EQUIPPED)

These controls allow you to operate some radio and climate control features.



Driving while distracted can result in loss of vehicle control, accident and injury. Ford strongly recommends that drivers use extreme caution when using any device that may take their focus off the road. The driver's primary responsibility is the safe operation of their vehicle. Only use cell phones and other devices not essential to the driving task when it is safe to do so.

Audio control features

Press MEDIA to select:

- AM, FM1, FM2
- CD (if equipped)
- DVD (if equipped)
- SAT1, SAT2 or SAT3 (Satellite Radio mode, if equipped).

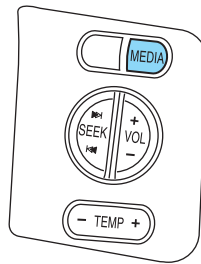

In AM, FM1, or FM2 mode:

- Press **SEEK** to select preset stations within the selected radio band or press and hold to select the next/previous radio frequency.

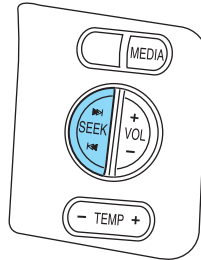

In Satellite radio mode (if equipped):

- Press **SEEK** to advance through preset channels or subscribed channels.

In CD mode:

- Press **SEEK** to select the next selection on the CD or press and hold to forward or reverse the CD.

Driver Controls

In any mode:

- Press VOL + or - to adjust volume.

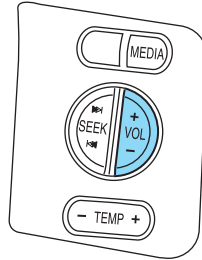

Climate control features (if equipped)

Press TEMP + or - to adjust temperature.

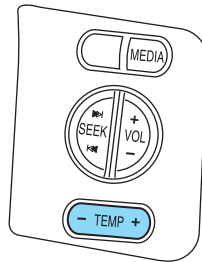

Press FAN + or - to adjust fan speed.

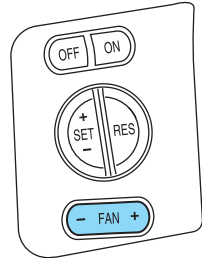

Driver Controls

UPFITTER CONTROLS (IF EQUIPPED)

Your vehicle may be equipped with the Upfitter option package which will provide four switches, mounted in the center of the instrument panel, labeled AUX 1, AUX 2, AUX 3 and AUX 4. These switches will only operate while the ignition is in the 3 (ON) position, whether the engine

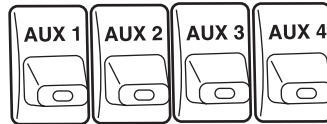

is running or not. It is, however, recommended that the engine remain running to maintain battery charge when using the Upfitter switches for extended duration or higher current draws. (This is even more important for vehicles with diesel engines since the glow plugs are also draining battery power when the ignition key is in the 3 [ON] position.)

When switched on by the operator they provide 10 amps, 15 amps or 30 amps of electrical battery power for a variety of personal or commercial uses.

If your vehicle is equipped with this option, there will also be a relay box located on the driver side end of the instrument panel. See your authorized dealer for service.

The relays are coded as shown in the accompanying illustration.

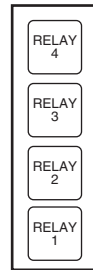

Driver Controls

There will also be one power lead for each switch found as a blunt-cut and sealed wire located below the instrument panel and to the left of the steering column.

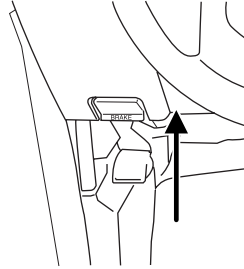

They are coded as follows:

Switch	Circuit number	Wire color	Fuse
AUX 1	CAC05	Yellow	30A
AUX 2	CAC06	Green with Brown Trace	30A
AUX 3	CAC07	Violet with Green Trace	10A
AUX 4	CAC08	Brown	15A

More detailed information about the Upfitter switches can be found in the *Upfitter Switches* bulletin found at www.fleet.ford.com/truckbbas/non-html/Q117.pdf.

ONE-TOUCH MOON ROOF (IF EQUIPPED)

The moon roof control is located on the overhead console.

Note: The moon roof will open to the “**comfort**” position first before opening all the way. The “comfort” position helps to alleviate rumbling wind noise which may happen in the vehicle with the roof fully opened.

To open the moon roof: The moon roof is equipped with a one-touch open feature. Press and release the AUTO control. The moon roof will open to the “comfort” position. Press and release the control again to fully open. To stop the one-touch open feature press either the AUTO or ▼ control again.

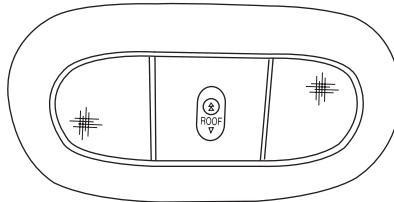

Driver Controls

To close the moon roof: Press and hold the ▼ control until the glass panel stops at the “comfort” position. Press and hold the control again until the glass stops moving (the moon roof does not go to the comfort position). When fully closed, the rear portion of the glass panel will appear higher than the front portion.

To vent the moon roof: Press and hold the ▼ control. **The moon roof must be in the closed position in order to move it into the vent position.** To close, press and hold the AUTO control until the glass panel stops moving.

The moon roof has a built-in sliding shade that can be manually opened or closed when the glass panel is shut. To close the shade, pull it toward the front of the vehicle.



Do not let children play with the moon roof or leave children unattended in the vehicle. They may seriously hurt themselves.



When closing the moon roof, you should verify that it is free of obstructions and ensure that children and/or pets are not in the proximity of the moon roof opening.

HOMELINK® WIRELESS CONTROL SYSTEM (IF EQUIPPED)

The HomeLink® Wireless Control System, located on the driver's visor, provides a convenient way to replace up to three hand-held transmitters with a single built-in device. This feature will learn the radio frequency codes of most transmitters to operate garage doors, entry gate operators, security systems, entry door locks, and home or office lighting.

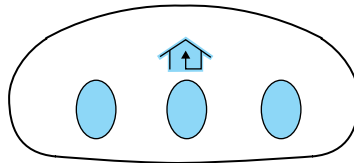

When programming your HomeLink® Wireless Control System to a garage door or gate, be sure that people and objects are out of the way to prevent potential injury or damage.

Do not use the HomeLink® Wireless Control System with any garage door opener that lacks safety stop and reverse features as required by U.S. federal safety standards (this includes any garage door opener

Driver Controls

model manufactured before April 1, 1982). A garage door which cannot detect an object, signaling the door to stop and reverse, does not meet current U.S. federal safety standards. For more information, contact HomeLink® at: **www.homelink.com** or **1-800-355-3515**.

Retain the original transmitter for use in other vehicles as well as for future programming procedures (i.e. new HomeLink® equipped vehicle purchase). It is also suggested that upon the sale of the vehicle, the programmed HomeLink® buttons be erased for security purposes, refer to *Programming* in this section.

Programming

Do not program HomeLink® with the vehicle parked in the garage.

Note: Your vehicle may require the ignition switch to be turned to the ACC position for programming and/or operation of the HomeLink®. It is also recommended that a new battery be placed in the hand-held transmitter of the device being programmed to HomeLink® for quicker training and accurate transmission of the radio-frequency signal.

1. Position the end of your hand-held transmitter 1-3 inches (2-8 cm) away from the HomeLink® button you wish to program (located on your visor) while keeping the indicator light in view.

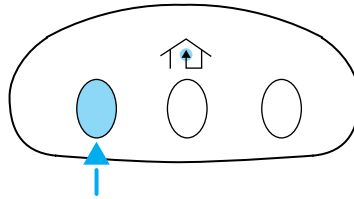

2. Simultaneously press and hold both the chosen HomeLink® and hand-held transmitter buttons until the HomeLink® indicator light changes from a slow to a rapidly blinking light. Now you may release both the HomeLink® and hand-held transmitter buttons.

Note: Some entry gates and garage door openers may require you to replace Step 2 with procedures noted in the *Gate Operator and Canadian Programming* in this section for Canadian residents.

3. Firmly **press, hold for five seconds and release** the programmed HomeLink® button up to two separate times to activate the door. If the door does not activate, press and hold the just-trained HomeLink® button and observe the indicator light.

- If the indicator light **stays on constantly, programming is complete** and your device should activate when the HomeLink® button is pressed and released.
- If the indicator light blinks **rapidly for two seconds and then turns to a constant light continue with “Programming” Steps 4 through**

Driver Controls

6 to complete programming of a rolling code equipped device (most commonly a garage door opener).

4. At the garage door opener receiver (motor-head unit) in the garage, locate the “learn” or “smart” button (usually near where the hanging antenna wire is attached to the unit).

5. Firmly press and release the “learn” or “smart” button. (The name and color of the button may vary by manufacturer.)

Note: There are 30 seconds in which to initiate Step 6.

6. Return to the vehicle and firmly **press, hold for two seconds and release** the programmed HomeLink® button. Repeat the **press/hold/release** sequence again and, depending on the brand of the garage door opener (or other rolling code equipped device), repeat this sequence a third time to complete the programming.

HomeLink® should now activate your rolling code equipped device. To program additional HomeLink® buttons begin with Step 1 in this section. For questions or comments, please contact HomeLink® at www.homelink.com or 1-800-355-3515.

Gate Operator & Canadian Programming

During programming, your hand-held transmitter may automatically stop transmitting — not allowing enough time for HomeLink® to accept the signal from the hand-held transmitter.

After completing Step 1 outlined in the *Programming* section, replace Step 2 with the following:

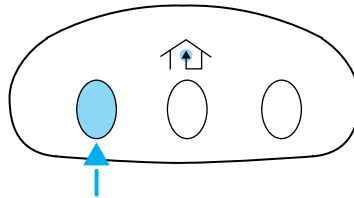

Note: If programming a garage door opener or gate operator, it is advised to unplug the device during the “cycling” process to prevent overheating.

- Continue to press and hold the HomeLink® button (note Step 2 in the *Programming* section) while you press and release — **every two seconds** (“cycle”) your hand-held transmitter until the frequency signal has been accepted by the HomeLink®. The indicator light will flash slowly and then rapidly after HomeLink® accepts the radio frequency signal.
- Proceed with Step 3 in the *Programming* section.

Driver Controls

Operating the HomeLink® Wireless Control System

To operate, simply press and release the appropriate HomeLink® button. Activation will now occur for the trained product (garage door, gate operator, security system, entry door lock, or home or office lighting etc.). For convenience, the hand-held transmitter of the device may also be used at any time. In the event that there are still programming difficulties, contact HomeLink® at www.homelink.com or **1-800-355-3515**.

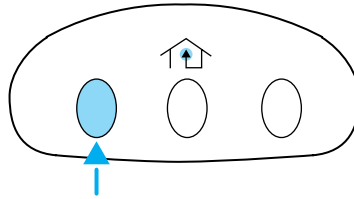

Erasing HomeLink® buttons

To erase the three programmed buttons (individual buttons cannot be erased):

- Press and hold the two outer HomeLink® buttons until the indicator light begins to flash-after 20 seconds. Release both buttons. Do not hold for longer than 30 seconds.

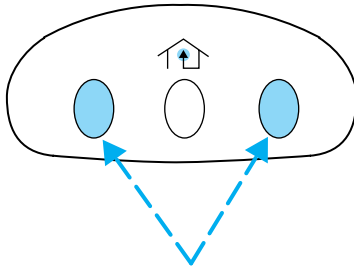

HomeLink® is now in the train (or learning) mode and can be programmed at any time beginning with Step 1 in the *Programming* section.

Reprogramming a single HomeLink® button

To program a device to HomeLink® using a HomeLink® button previously trained, follow these steps:

1. Press and hold the desired HomeLink® button. **Do NOT** release the button.
2. The indicator light will begin to flash after 20 seconds. Without releasing the HomeLink® button, follow Step 1 in the *Programming* section.

For questions or comments, contact HomeLink® at www.homelink.com or **1-800-355-3515**.

Driver Controls

CENTER CONSOLE (IF EQUIPPED)

Your vehicle may be equipped with a variety of console features. These include:

- Utility compartment with cassette/CD holder
- Coin holder
- Pen holder
- Writing surface
- A power point inside and on the rear
- Laptop storage
- Hanging file folder supports
- Rear cupholders (Crew Cab only)

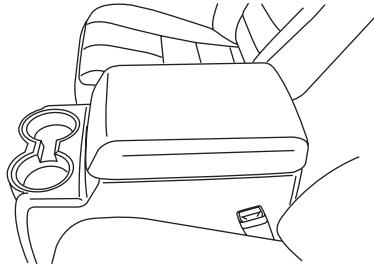

Use only soft cups in the cupholder. Hard objects can injure you in a collision.

STANDARD MESSAGE CENTER (IF EQUIPPED)

With the ignition in the RUN position, the message center, located on your instrument cluster, displays text messages that alert you to possible problems or malfunctions in your vehicle's operating systems. All warning messages will also provide an indicator chime.

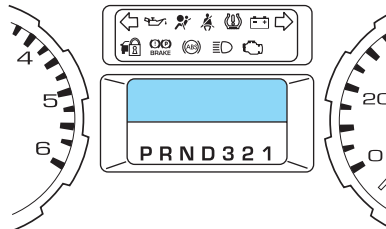

For improved message center readability, if your vehicle is equipped with Autolamp control, the message center brightness cannot be adjusted when parking lamps or headlamps are on in bright daytime ambient conditions, refer to *Autolamp control* in the *Lights* chapter. In lower ambient light conditions, the message center brightness can be adjusted using the panel dimmer control when parking lamps or headlamps are on, refer to *Panel dimmer control* in the *Lights* chapter.

Driver Controls

Selectable features

Press and release the SELECT/RESET control switch, located in the speedometer, to scroll and reset the following functions. Select or reset the function by holding the SELECT/RESET button for more than 2 seconds.

Info menu

This menu displays the following control displays:

- Trip Odometer (Trip A and Trip B)
- Distance to Empty
- Average Fuel Economy
- Setup Menu
- System check
- Blank (Odometer and compass, if equipped, off)

Odometer/Trip odometer

Refer to *Gauges* in the *Instrument Cluster* chapter.

Distance to empty (DTE)

Selecting this function from the INFO MENU estimates approximately how far you can drive with the fuel remaining in your tank under normal driving conditions.

Remember to turn the ignition off when refueling to allow this feature to correctly detect the added fuel.

The DTE function will display LOW FUEL LEVEL and sound a chime for one second when you have approximately 50 miles (80 km) to empty. If you RESET this warning message, this display and chime will return within 10 minutes.

DTE is calculated using a running average fuel economy, which is based on your recent driving history of 500 miles (800 km). This value is not the same as the average fuel economy display. The running average fuel economy is reinitialized to a factory default value if the battery is disconnected.



XXX MILES TO E
0.0mi

Driver Controls

Average fuel economy (AFE)

Select this function to display your average fuel economy in miles/gallon or liters/km.

XX.X MPG
0.0mi

If you calculate your average fuel economy by dividing miles traveled by gallons of fuel used (liters of fuel used by 100 kilometers traveled), your figure may be different than displayed for the following reasons:

- Your vehicle was not perfectly level during fill-up
 - Differences in the automatic shut-off points on the fuel pumps at service stations
 - Variations in top-off procedure from one fill-up to another
 - Rounding of the displayed values to the nearest 0.1 gallon (liter)
1. Drive the vehicle at least 5 miles (8 km) with the speed control system engaged to display a stabilized average.
 2. Record the highway fuel economy for future reference.

It is important to press the SELECT/RESET control switch (press and hold for 2 seconds in order to reset the function) after setting the speed control to get accurate highway fuel economy readings.

Setup menu

Press and hold the SELECT/RESET control switch to get into the SETUP MENU sequence from the INFO MENU for the following displays:

HOLD RESET FOR
SETUP MENU

- Units (English/Metric)
- Language
- Reset to English (if in another language) (see Note below)

Note: When returning to the SETUP menu and a non-English language has been selected, HOLD RESET FOR ENGLISH will be displayed to change back to English. Press and hold the SELECT/RESET control to change back to English.

HOLD RESET FOR
ENGLISH

Driver Controls

Units (English/Metric)

1. Select this function from the SETUP MENU for the current units to be displayed.

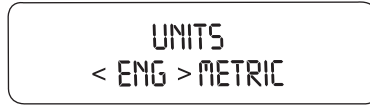

2. Press and hold the SELECT/RESET control switch to change from English to Metric.

3. Press the SELECT/RESET control switch for the next SETUP MENU item or wait for more than 4 seconds to return to the INFO MENU.

Language

Note: When entering the SETUP MENU and a non-English language has been selected, "PRESS RESET FOR ENGLISH" will be displayed to change back to English.

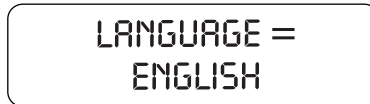

1. Select this function from the SETUP MENU for the current language to be displayed.

2. Press and hold the SELECT/RESET control to select a new language. Selectable languages are English, Spanish and French

3. Press the SELECT/RESET control switch for the next SETUP MENU item or wait for more than 4 seconds to return to the INFO MENU.

System check

Press and hold the SELECT/RESET control switch to select SYSTEM CHECK when HOLD RESET FOR SYSTEM CHECK is displayed in the message center. Selecting this function from the INFO MENU causes the message center to cycle through each of the systems being monitored. For each of the monitored systems, the message center will indicate either an OK message or a warning message for two seconds. Pressing the SELECT/RESET control switch cycles the message center through each of the systems being monitored.

The sequence of the system check report and how it appears in the message center is as follows:

1. ENGINE HOURS
2. CHARGING SYSTEM
3. AIR FILTER (Diesel engine only)
4. DOOR AJAR

Driver Controls

5. BRAKE SYSTEM
6. FUEL LEVEL
7. TRAILER DISCONNECTED (if equipped)

System warnings

System warnings alert you to possible problems or malfunctions in your vehicle's operating systems.

In the event of a multiple warning situation, the message center will cycle the display to show all warnings by displaying each one for 4 seconds.

The message center will display the last selected feature if there are no more warning messages. This allows you to use the full functionality of the message center after you acknowledge the warning by pressing the SELECT/RESET control and clearing the warning message.

Warning messages that have been reset are divided into two categories:

- They will reappear on the display ten minutes from the reset.
- They will not reappear until an ignition OFF-RUN cycle has been completed.

This acts as a reminder that these warning conditions still exist within the vehicle.

Warning display	Status
Park brake engaged	Warning returns after 10 minutes if condition still exists.
Check brake system	
Driver door ajar	Warning returns after the ignition key is turned from OFF to RUN.
Passenger door ajar	
Rear left door ajar	
Rear right door ajar	
Low fuel level	
Trailer fault (if equipped)	
TBC fault (if equipped)	
Trailer disconnected (if equipped)	
Low brake fluid level	

Driver Controls

Warning display	Status
Low tire pressure (if equipped)	Warning can be cleared by pressing the RESET button. Warning can reappear if the condition is still present. Warning will reappear on the next ignition key-cycle if the condition still exists.
Tire Monitor Fault (if equipped)	
Tire Sensor Fault (if equipped)	
Check air filter (diesel engine only)	
Drain water separator (diesel engine only)	
Stop safely now (diesel engine only)	
Engine warming please wait xx(diesel engine only)	
OK to drive (diesel engine only)	
Engine turns off in xx (diesel engine only)	
Engine turned off (diesel engine only)	
Drive to clean exhaust system (diesel engine only)	
Cleaning exhaust filter (diesel engine only)	
Exhaust filter drive complete (diesel engine only)	
Oil change required/Engine oil change soon (diesel engine only)	
Oil life ok (diesel engine only)	

PARK BRAKE ENGAGED Displayed when the parking brake is applied (or not fully released).

Driver Controls

CHECK BRAKE SYSTEM Displayed when a fault has been detected by the ABS module.

DRIVER DOOR AJAR Displayed when the driver's door is not completely closed.

PASSENGER DOOR AJAR Displayed when the passenger's door is not completely closed.

REAR LEFT DOOR AJAR Displayed when the rear left door is not completely closed.

REAR RIGHT DOOR AJAR Displayed when the rear right door is not completely closed.

LOW FUEL LEVEL Displayed as an early reminder of a low fuel condition.

TRAILER FAULT (if equipped): Displayed if there is a short circuit on the electric brake output wire or the trailer brakes are drawing too much current. Refer to *Integrated trailer brake controller* in the *Tires, Wheels and Loading* chapter for more information.

TBC FAULT (if equipped): Displayed in response to faults sensed by the trailer brake controller (TBC). In the event this message is seen, please take your vehicle to an authorized dealer for diagnosis and repair. Refer to *Integrated trailer brake controller* in the *Tires, Wheels and Loading* chapter for more information.

TRAILER DISCONNECTED (if equipped): Displayed when a trailer connection becomes disconnected, either intentionally or unintentionally, and has been sensed during a given ignition cycle. Refer to *Integrated trailer brake controller* in the *Tires, Wheels and Loading* chapter for more information.

LOW BRAKE FLUID LEVEL Indicates the brake fluid level is low and the brake system should be inspected immediately. Refer to *Brake fluid* in the *Maintenance and Specifications* chapter.

LOW TIRE PRESSURE (if equipped): Displayed when one or more tires on your vehicle have low tire pressure. Refer to *Inflating Your Tires* in the *Tires, Wheels and Loading* chapter.

TIRE PRESSURE MONITOR FAULT (if equipped): Displayed when the Tire Pressure Monitoring System is malfunctioning. If the warning stays on or continues to come on, have the system inspected by your authorized dealer.

Driver Controls

TIRE PRESSURE SENSOR FAULT (if equipped): Displayed when a tire pressure sensor is malfunctioning, or your spare tire is in use. For more information on how the system operates under these conditions, refer to *Understanding Your Tire Pressure Monitoring System (TPMS)* in the *Tires, Wheels and Loading* chapter. If the warning stays on or continues to come on, have the system inspected by your authorized dealer.

CHECK AIR FILTER (Diesel engine only): Refer to *Instrument Cluster* in your *6.0 and 6.4 Liter Power Stroke Direct Injection Turbo Diesel Owner's Guide Supplement*.

DRAIN WATER SEPARATOR (Diesel engine only) Displayed when the water separator has reached a predetermined capacity and needs to be drained. Refer to your *6.0 and 6.4 Liter Power Stroke Direct Injection Turbo Diesel Owner's Guide Supplement* for more information.

STOP SAFELY NOW (Diesel engine only) Displayed when the vehicle exhaust system temperature exceeds intended operating range. If this warning occurs, the engine power is reduced and the engine will shutdown when the vehicle speed is below 3 mph (5 km/h). **Stop the vehicle as soon as safely possible** and contact your authorized dealer. Depending on the severity of the over-temperature condition, the vehicle may or may not restart after cycling the ignition off. If the vehicle restarts, there may be limited power, or there could be full function. If the exhaust over-temperature condition reoccurs the message center will display, STOP SAFELY NOW, the chime will sound, the engine power will be reduced again and shut down below 3 mph (5km/h).

ENGINE TURNS OFF IN XX (Diesel engine only). Displayed when the vehicle is in the final 30 seconds of a countdown to where the engine will intentionally be turned off by the PCM. The diesel engine shutdown is a (Regulatory) requirement which may be required of a particular diesel vehicle for sale in States requiring this feature.

ENGINE TURNED OFF (Diesel engine only). Displayed after the 30 second countdown.

ENGINE WARMING PLEASE WAIT XX (Diesel engine only). Displayed in extremely cold weather; typically around -15°F (-26°C). The accelerator pedal will not respond to pressing; this is done so the engine oil can be properly circulated to avoid engine damage from lack of lubrication. A timer will begin a countdown from 30 seconds, then OK TO DRIVE will display once the counter has reached 0 (zero) and the accelerator pedal will respond to pressing.

Driver Controls

OK TO DRIVE (Diesel engine only). Displayed when the time counter has reached 0 (zero) and the engine is sufficiently warm enough to drive in extremely cold weather (refer to the ENGINE WARMING description mentioned previously).

DRIVE TO CLEAN EXHAUST SYSTEM (Diesel engine only). Displayed when the engine control module detects the Diesel particulate filter (DPF) is full of particulates and that the vehicle is not being operated in a manner to allow automatic cleaning. The vehicle operator has to drive the vehicle above 30 mph (48 km/h) for at least 20 minutes to clean the DPF. This will continue to be displayed until an adequate drive cycle is completed. This message is NORMAL.

CLEANING EXHAUST FILTER (Diesel engine only). Displays briefly when the vehicle has entered the cleaning mode normally; or, displays continuously when cleaning the filter after a DRIVE TO CLEAN EXHAUST SYSTEM message was previously displayed. This message is NORMAL.

EXHAUST FILTER DRIVE COMPLETE (Diesel engine only). Displayed when the vehicle has completed the adequate drive cycle to clean the DPF. This message is NORMAL.

OIL CHANGE REQUIRED/ENGINE OIL CHANGE SOON (Diesel engine only). Displayed when the engine oil life remaining is 5 percent or less. When oil life left is between 5% and 0%, the ENGINE OIL CHANGE SOON message will be displayed. When oil life left reaches 0%, the OIL CHANGE REQUIRED message will be displayed. Refer to *6.0 and 6.4 Liter Power Stroke Direct Injection Turbo Diesel Owner's Guide Supplement*.

OIL LIFE OK (Diesel engine only). Displayed after you have changed the oil.

Driver Controls

OPTIONAL MESSAGE CENTER (IF EQUIPPED)

With the ignition in the RUN position, the message center, located on your instrument cluster, displays important vehicle information **through a constant monitor of vehicle systems**. You may select display features on the message center for a display of status. The system will also notify you of potential vehicle problems with a display of system warnings followed by an indicator chime.

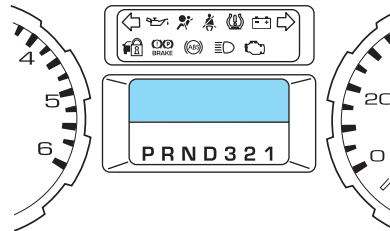

For improved message center readability, if your vehicle is equipped with Autolamp control, the message center brightness cannot be adjusted when parking lamps or headlamps are on in bright daytime ambient conditions, refer to *Autolamp control* in the *Lights* chapter. In lower ambient light conditions, the message center brightness can be adjusted using the panel dimmer control when parking lamps or headlamps are on, refer to *Panel dimmer control* in the *Lights* chapter.

Selectable features

Reset

Press this control to select and reset functions shown in the INFO menu and SETUP menu.

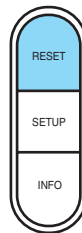

Driver Controls

Info menu

This control displays the following control displays:

- Trip Odometer A or B
- Distance to Empty
- Average Fuel Economy
- Drive Time (Elapsed Travel Timer)
- Blank (Odometer and compass, if equipped, off)

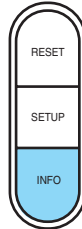

Odometer/Trip odometer

Refer to *Gauges* in the *Instrument Cluster* chapter.

Distance to empty (DTE)

Selecting this function from the INFO menu estimates approximately how far you can drive with the fuel remaining in your tank under normal driving conditions.

Remember to turn the ignition off when refueling to allow this feature to correctly detect the added fuel.

The DTE function will display LOW FUEL LEVEL and sound a tone for one second when you have approximately 50 miles (80 km) to empty. If you RESET this warning message, this display and tone will return within 10 minutes.

DTE is calculated using a running average fuel economy, which is based on your recent driving history of 500 miles (800 km). This value is not the same as the average fuel economy display. The running average fuel economy is reinitialized to a factory default value if the battery is disconnected.

Average fuel economy (AFE)

Select this function from the INFO menu to display your average fuel economy in miles/gallon or liters/100 km.

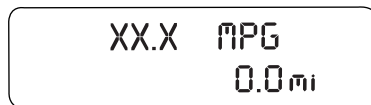

Driver Controls

If you calculate your average fuel economy by dividing miles traveled since last fill-up by gallons of fuel used (multiply liters used by 100, then divide by kilometers traveled), your figure may be different than displayed for the following reasons:

- Your vehicle was not perfectly level during fill-up
- Differences in the automatic shut-off points on the fuel pumps at service stations
- Variations in top-off procedure from one fill-up to another
- Rounding of the displayed values to the nearest 0.1 gallon (liter)

1. Drive the vehicle at least 5 miles (8 km) with the speed control system engaged to display a stabilized average.

2. Record the highway fuel economy for future reference.

It is important to press the RESET control after setting the speed control to get accurate highway fuel economy readings.

Drive timer (Elapsed travel timer)

Select this function from the INFO menu to display a timer.

To operate the Trip Elapsed Drive Time perform the following:

1. Press and release RESET in order to start the timer.
2. Press and release RESET to pause the timer.
3. Press and hold RESET for 2 seconds in order to reset the timer.

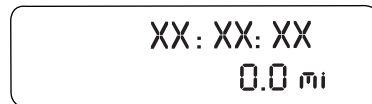

Setup menu

Press this control for the following displays:

- System Check
- Units (English/Metric)
- Autolamp Timer Presets (if equipped)
- Autolock On/Off (if equipped)
- Compass calibration
- Language

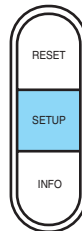

Driver Controls

- Reset to English (if in another language) (see Note below)

Note: When returning to the SETUP menu and a non-English language has been selected, HOLD RESET FOR ENGLISH will be displayed to change back to English. Press and hold the RESET control to change back to English.

HOLD RESET FOR
ENGLISH

System check

Selecting this function from the SETUP menu causes the message center to cycle through each of the systems being monitored. For each of the monitored systems, the message center will indicate either an OK message or a warning message for three seconds.

PRESS RESET
FOR SYS CHECK

Pressing the RESET control cycles the message center through each of the systems being monitored.

The sequence of the system check report and how it appears in the message center is as follows:

1. ENGINE HOURS
2. CHARGING SYSTEM
3. AIR FILTER (Diesel engine only)
4. DOOR AJAR
5. BRAKE SYSTEM
6. FUEL LEVEL

Units (English/Metric)

1. Select this function from the SETUP menu for the current units to be displayed.
2. Press the RESET control to change from English to Metric.

UNITS
< ENG > METRIC

Driver Controls

Autolamp timer presets

This feature keeps your headlights on for up to three minutes after the ignition is switched off.

1. To disable/enable the autolamp delay feature, select this function from the SETUP control for the current display mode.



A rectangular display box with rounded corners. The text inside is arranged in two lines: 'AUTOLAMP DELAY' on the top line and '<0> 10 20' on the bottom line. The text is in a simple, sans-serif font.

2. Press the RESET control to select the new Autolamp delay values of 0, 10, 20, 30, 60, 90, 120 or 180 seconds.

Autolocks

This feature automatically locks all vehicle doors when the vehicle is shifted into any gear, putting the vehicle in motion.

1. To disable/enable the autolock feature, select this function from the SETUP control for the current display mode.



A rectangular display box with rounded corners. The text inside is arranged in two lines: 'AUTO LOCKS' on the top line and '<ON>OFF' on the bottom line. The text is in a simple, sans-serif font.

2. Press the RESET control to turn the autolocks ON or OFF.

Compass display (if equipped)

The compass heading is displayed as one of N, NE, E, SE, S, SW, W and NW in the message center display.

The compass reading may be affected when you drive near large buildings, bridges, power lines and powerful broadcast antenna. Magnetic or metallic objects placed in, on or near the vehicle may also affect compass accuracy.

Usually, when something affects the compass readings, the compass will correct itself after a few days of operating your vehicle in normal conditions. If the compass still appears to be inaccurate, a manual calibration may be necessary. Refer to *Compass zone/calibration adjustment*.

Most geographic areas (zones) have a magnetic north compass point that varies slightly from the northerly direction on maps. This variation is four degrees between adjacent zones and will become noticeable as the vehicle crosses multiple zones. A correct zone setting will eliminate this error. Refer to *Compass zone/calibration adjustment*.

Driver Controls

Compass zone/calibration adjustment

1. Determine your magnetic zone by referring to the zone map.
2. Turn ignition to the RUN position.
3. Start the engine.

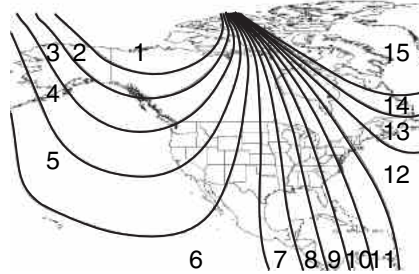

4. From the SETUP menu, press and release the RESET control until the message center display changes to show the current zone setting (XX).

ZONE <XX>
RESET = CHANGE

5. Press and release the RESET control repeatedly until the correct zone setting for your geographic location is displayed on the message center. The range of zone values are from 1 to 15 and “wraps” back to 1.
6. To exit the zone setting mode, and to “lock in” your change:
 - press and release the SETUP control or,
 - press INFO control to exit or,
 - wait 4 seconds and the zone will be “locked in”.

Perform compass calibration in an open area free from steel structures and high voltage lines. For optimum calibration, turn off all electrical accessories (heater/air conditioning, wipers, etc.) and make sure all vehicle doors are shut.

7. Press the RESET control to start the compass calibration function.

RESET FOR
CALIBRATION

8. Slowly drive the vehicle in a circle (less than 3 mph [5 km/h]) until the CIRCLE SLOWLY TO CALIBRATE display changes to CALIBRATION COMPLETED. It will take up to five circles to complete calibration.

CIRCLE SLOWLY
TO CALIBRATE

Driver Controls

9. The compass is now calibrated.

Note: If the RESET control is pressed or 3 minutes has expired, the display will go back to the INFO menu and will show CAL instead of the compass heading until the compass is calibrated.



CALIBRATION
COMPLETED

Language

1. Select this function from the SETUP menu for the current language to be displayed.



LANGUAGE =
ENGLISH

2. Waiting 4 seconds or pressing the RESET control cycles the message center through each of the language choices.

Selectable languages are English, Spanish, or French.

3. Press and hold the RESET control for 2 seconds to set the language choice.

4. Press the SETUP control to exit.

System warnings

System warnings alert you to possible problems or malfunctions in your vehicle's operating systems.

In the event of a multiple warning situation, the message center will cycle the display to show all warnings by displaying each one for 4 seconds.

The message center will display the last selected feature if there are no more warning messages. This allows you to use the full functionality of the message center after you acknowledge the warning by pressing the RESET control and clearing the warning message.

Warning messages that have been reset are divided into two categories:

- They will reappear on the display ten minutes from the reset.
- They will not reappear until an ignition OFF-RUN cycle has been completed.

Driver Controls

This acts as a reminder that these warning conditions still exist within the vehicle.

Warning display	Status
Park brake engaged	Warning returns after 10 minutes if condition still exists.
Check brake system	
Driver door ajar	Warning returns after the ignition key is turned from OFF to RUN.
Passenger door ajar	
Rear left door ajar	
Rear right door ajar	
Low fuel level	
Trailer fault (if equipped)	
TBC fault (if equipped)	
Trailer disconnected (if equipped)	
Low brake fluid level	
Low tire pressure (if equipped)	
Tire Monitor Fault (if equipped)	
Tire Sensor Fault (if equipped)	

Driver Controls

Warning display	Status
Check air filter (diesel engine only)	
Drain water separator (diesel engine only)	
Stop safely now (diesel engine only)	
Engine warming please wait xx(diesel engine only)	
OK to drive (diesel engine only)	
Engine turns off in xx (diesel engine only)	
Engine turned off (diesel engine only)	
Drive to clean exhaust system (diesel engine only)	
Cleaning exhaust filter (diesel engine only)	
Exhaust filter drive complete (diesel engine only)	
Oil change required/Engine oil change soon (diesel engine only)	
Oil life ok (diesel engine only)	

PARK BRAKE ENGAGED. Displayed when the parking brake is applied (or not fully released).

CHECK BRAKE SYSTEM. Displayed when a fault has been detected by the ABS module.

DRIVER DOOR AJAR. Displayed when the driver's door is not completely closed.

PASSENGER DOOR AJAR. Displayed when the passenger's door is not completely closed.

Driver Controls

REAR LEFT DOOR AJAR. Displayed when the rear left door is not completely closed.

REAR RIGHT DOOR AJAR. Displayed when the rear right door is not completely closed.

LOW FUEL LEVEL. Displayed as an early reminder of a low fuel condition.

TRAILER FAULT (if equipped). Displayed if there is a short circuit on the electric brake output wire or the trailer brakes are drawing too much current. Refer to *Integrated trailer brake controller* in the *Tires, Wheels and Loading* chapter for more information.

TBC FAULT (if equipped). Displayed in response to faults sensed by the trailer brake controller (TBC). In the event this message is seen, please take your vehicle to an authorized dealer for diagnosis and repair. Refer to *Integrated trailer brake controller* in the *Tires, Wheels and Loading* chapter for more information.

TRAILER DISCONNECTED (if equipped). Displayed when a trailer connection becomes disconnected, either intentionally or unintentionally, and has been sensed during a given ignition cycle. Refer to *Integrated trailer brake controller* in the *Tires, Wheels and Loading* chapter for more information.

LOW BRAKE FLUID LEVEL. Indicates the brake fluid level is low and the brake system should be inspected immediately. Refer to *Brake fluid* in the *Maintenance and Specifications* chapter.

LOW TIRE PRESSURE (if equipped). Displayed when one or more tires on your vehicle have low tire pressure. Refer to *Inflating Your Tires* in the *Tires, Wheels and Loading* chapter.

TIRE PRESSURE MONITOR FAULT (if equipped). Displayed when the Tire Pressure Monitoring System is malfunctioning. If the warning stays on or continues to come on, have the system inspected by your authorized dealer.

TIRE PRESSURE SENSOR FAULT (if equipped). Displayed when a tire pressure sensor is malfunctioning, or your spare tire is in use. For more information on how the system operates under these conditions, refer to *Understanding Your Tire Pressure Monitoring System (TPMS)* in the *Tires, Wheels and Loading* chapter. If the warning stays on or continues to come on, have the system inspected by your authorized dealer.

CHECK AIR FILTER (Diesel engine only). Refer to *Instrument Cluster* in your *6.0 and 6.4 Liter Power Stroke Direct Injection Turbo Diesel Owner's Guide Supplement*.

Driver Controls

DRAIN WATER SEPARATOR (Diesel engine only). Displayed when the water separator has reached a predetermined capacity and needs to be drained. Refer to your *6.0 and 6.4 Liter Power Stroke Direct Injection Turbo Diesel Owner's Guide Supplement* for more information.

STOP SAFELY NOW (Diesel engine only). Displayed when the vehicle exhaust system temperature exceeds intended operating range. If this warning occurs, the engine power is reduced and the engine will shutdown when the vehicle speed is below 3 mph (5 km/h). **Stop the vehicle as soon as safely possible** and contact your authorized dealer. Depending on the severity of the over-temperature condition, the vehicle may or may not restart after cycling the ignition off. If the vehicle restarts, there may be limited power, or there could be full function. If the exhaust over-temperature condition reoccurs the message center will display, STOP SAFELY NOW, the chime will sound, the engine power will be reduced again and shut down below 3 mph (5km/h).

ENGINE TURNS OFF IN XX (Diesel engine only). Displayed when the vehicle is in the final 30 seconds of a countdown to where the engine will intentionally be turned off by the PCM. The diesel engine shutdown is a (Regulatory) requirement which may be required of a particular diesel vehicle for sale in States requiring this feature.

ENGINE TURNED OFF (Diesel engine only). Displayed after the 30 second countdown.

ENGINE WARMING PLEASE WAIT XX (Diesel engine only). Displayed in extremely cold weather; typically around -15°F (-26°C). The accelerator pedal will not respond to pressing; this is done so the engine oil can be properly circulated to avoid engine damage from lack of lubrication. A timer will begin a countdown from 30 seconds, then OK TO DRIVE will display once the counter has reached 0 (zero) and the accelerator pedal will respond to pressing.

OK TO DRIVE (Diesel engine only). Displayed when the time counter has reached 0 (zero) and the engine is sufficiently warm enough to drive in extremely cold weather (refer to the ENGINE WARMING description mentioned previously).

DRIVE TO CLEAN EXHAUST SYSTEM (Diesel engine only). Displayed when the engine control module detects the Diesel particulate filter (DPF) is full of particulates and that the vehicle is not being operated in a manner to allow automatic cleaning. The vehicle operator has to drive the vehicle above 30 mph (48 km/h) for at least 20 minutes to clean the DPF. This will continue to be displayed until an adequate drive cycle is completed. This message is NORMAL.

Driver Controls

CLEANING EXHAUST FILTER (Diesel engine only). Displays briefly when the vehicle has entered the cleaning mode normally; or, displays continuously when cleaning the filter after a DRIVE TO CLEAN EXHAUST SYSTEM message was previously displayed. This message is NORMAL.

EXHAUST FILTER DRIVE COMPLETE (Diesel engine only). Displayed when the vehicle has completed the adequate drive cycle to clean the DPF. This message is NORMAL.

OIL CHANGE REQUIRED/ENGINE OIL CHANGE SOON (Diesel engine only). Displayed when the engine oil life remaining is 5 percent or less. When oil life left is between 5% and 0%, the ENGINE OIL CHANGE SOON message will be displayed. When oil life left reaches 0%, the OIL CHANGE REQUIRED message will be displayed. Refer to *6.0 and 6.4 Liter Power Stroke Direct Injection Turbo Diesel Owner's Guide Supplement*.

OIL LIFE OK (Diesel engine only). Displayed after you have changed the oil.

TAILGATE LOCK (IF EQUIPPED)

Your vehicle may be equipped with a tailgate lock designed to help prevent theft of the tailgate.

- Insert ignition key and turn to the right to engage lock.
- Turn ignition key to the left to unlock.

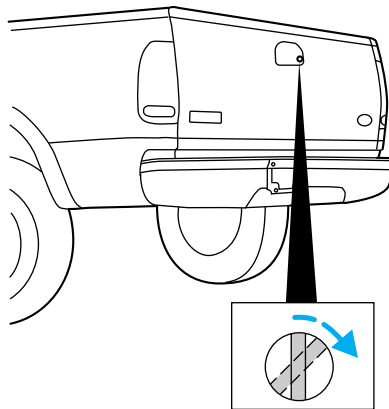

Tailgate removal

Your tailgate is removable to allow more room for loading.

Note: If equipped with a Reverse Camera System (RCS), do steps 1 through 3 before removing the tailgate.

Driver Controls

1. Before removal of the tailgate, locate and disconnect the electrical connector under the pick-up box on the right-hand side of the vehicle near the spare tire.
2. Install the protective cap (tethered to the wiring harness under the vehicle) on the RCS connector.
3. Carefully bring the wiring harness up between the pick-up box and the bumper. Secure the tailgate harness onto the pick-up box.
4. Lower the tailgate.
5. Use a screwdriver to pry the spring clip (on each connector) past the head of the support screw. Disconnect cable.
6. Disconnect the other cable.
7. Lift tailgate to a 45° angle.
8. Lift right side off of its hinge.
9. Lift tailgate back up to within 10° of its closed position while keeping the right-hand side of the tailgate close to the box.
10. Pull left-hand hinge straight to the right to disengage the left-hand tailgate hinge socket from the left-hand box pivot post.
11. Lift left side off of its hinge.



To install, follow the removal procedures in reverse order.

Tailgate step (if equipped)

Your vehicle may be equipped with a feature that allows easier entry into the truck bed. To open the tailgate step:

1. Flip down the tailgate.
2. Pull the yellow latch lever to the Unlock position (🔓) to release the grab handle from its stowed position and raise the handle upright until you feel it latch and see the latch lever in the Lock position (🔒). The yellow lever only needs to be used when releasing the grab handle.

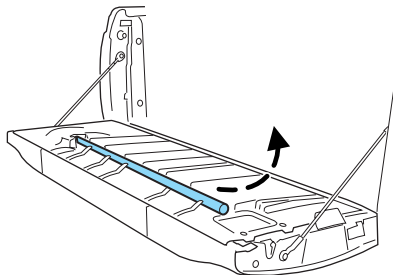

Driver Controls

3. Rotate the center molding to unlatch the tailgate.
4. Flip open the panel to widen the step.

Note: To reduce risk of falling:

- Operate step only when the vehicle is on level surface.
- Operate step only in areas with sufficient lighting
- Always open flip panel to widen step.
- Always use grab handle when stepping up and down.
- Step not intended for bare-footed use.
- Keep step clean from contamination before use (e.g. snow, mud)
- Keep the step load (you + load) below 350 lb. (159 kg).
- Never drive with step deployed.

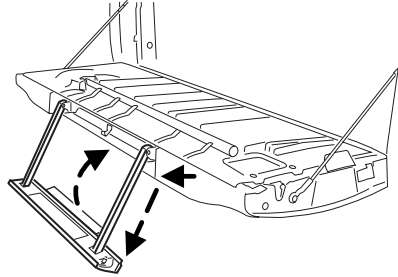

To close the tailgate step:

1. Close the step panel, then lift and fully close the tailgate step into the tailgate.
2. Slide the latch at the bottom of the handle, then lower the handle.

Note:

- Fully close and latch the tailgate step before moving the vehicle.
- Never drive with the step or grab handle deployed.
- Replace slip resistance tape (serviceable item) if worn out.
- Replace handle molding (serviceable item) if damaged.
- Do not tow with grab handle or step frame.

Bed extender (if equipped)

Your vehicle may be equipped with a cargo management feature in the truck bed.

Note: This feature is not intended for off-road usage.

Driver Controls

To open the bed extender into Tailgate Mode:

1. Pull the locking pin toward the center of the vehicle.

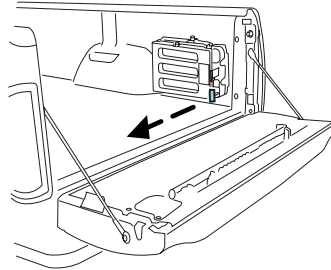

2. Rotate the storage hinge rearward to unlatch the panels.

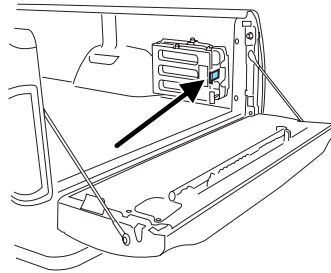

3. Rotate the panels toward the tailgate.

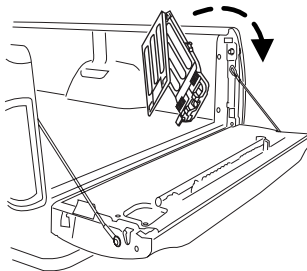

Repeat Steps 1–3 for the other side of the bed extender.

Driver Controls

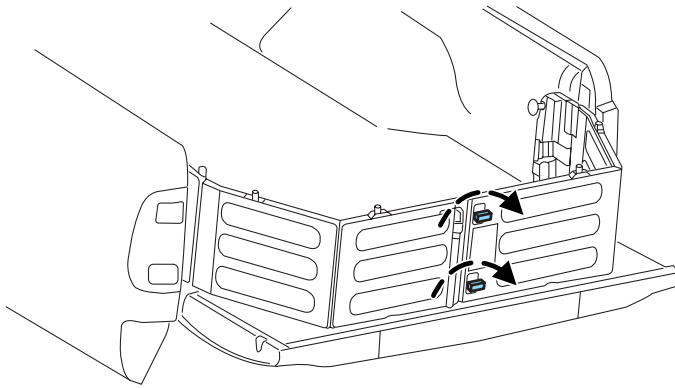

4. Connect the two panels, then rotate both knobs a quarter-turn clockwise to secure the panels.
5. Ensure the latch rod is inserted into the tailgate hole and the locking pins on both sides are engaged into their holes in the pick-up box.
6. Reverse steps for storage of the bed extender.

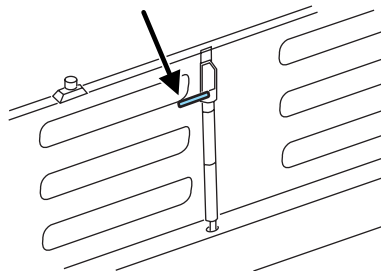

Note: When the vehicle is in motion, ensure the locking pins and knobs are fully engaged.

Note: Ensure all cargo is secured.

Note: When the vehicle is in motion, the tailgate load must not exceed 150 lbs. (68 kg).

Driver Controls

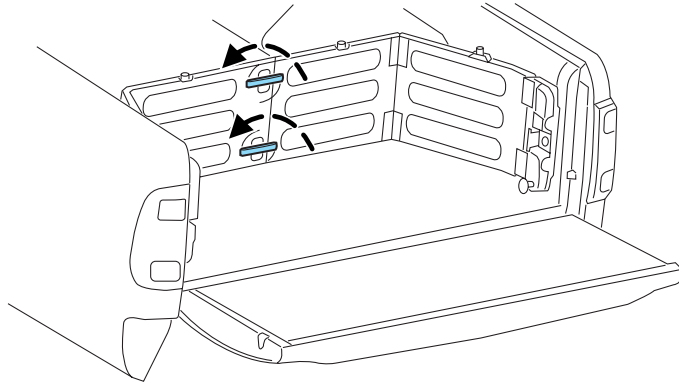

To open the bed extender into Grocery Mode, follow Steps 1–5 by rotating the panels away from the tailgate.

Locks and Security

KEYS

The key operates all locks on your vehicle. You should always carry a second key with you in a safe place in case you require it in an emergency.

If your vehicle is equipped with the SecuriLock™ Passive Anti-theft system, your keys are coded to your vehicle; using a non-coded key will not permit your vehicle to start. If you lose your dealer supplied keys, replacement keys are available through your authorized dealer.

POWER DOOR LOCKS (IF EQUIPPED)

Press control to unlock all doors.

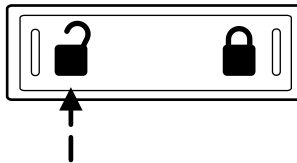

Press control to lock all doors.

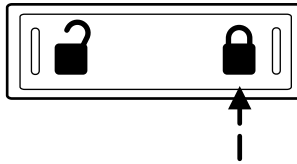

Smart locks (if equipped)

This feature helps prevent you from locking yourself out of the vehicle if your key is still in the ignition.

When you open the driver's door and you lock the vehicle with the power door lock control, all the doors will lock, then the driver's door will automatically unlock reminding you that your key is still in the ignition.

The vehicle can still be locked, with the key in the ignition, using the manual lock button on the door, locking the driver's door with a key, by simultaneously pressing button 7 • 8 and the 9 • 0 controls on the keyless entry keypad (if equipped), or using the lock button on the remote entry transmitter (if equipped).

Locks and Security

Autolock feature (if equipped)

The autolock feature will lock all the doors when:

- all the doors are closed,
- the ignition is in the 3 (ON) position,
- you shift into any gear putting the vehicle in motion, and
- the vehicle attains a speed greater than 12 mph (20 km/h) for greater than 2 seconds.

The autolock feature repeats when:

- any door is opened then closed while the ignition is in the 3 (ON) position and the vehicle speed is 9 mph (15 km/h) or lower, and
- the vehicle then attains a speed greater than 12 mph (20 km/h) for greater than 2 seconds.

Deactivating/activating autolock feature

There are four methods to enable/disable this feature:

- Through your authorized dealer,
- by using a power door unlock/lock procedure,
- using a keypad procedure (if equipped), or
- or by using the instrument cluster message center (if equipped). Refer to *Optional message center* in the *Driver controls* chapter.

Note: The autolock feature can be activated/deactivated independently of the autounlock feature.

Power door lock switch autolock enable/disable procedure

Before starting, ensure the ignition is in the 1 (OFF/LOCK) position and all vehicle doors are closed. You must complete Steps 1–5 within 30 seconds or the procedure will have to be repeated. If the procedure needs to be repeated, wait a minimum of 30 seconds before beginning again.

1. Place the key in the ignition and turn the ignition to the 3 (ON) position.
2. Press the power door unlock control on the door panel three times.
3. Turn the ignition from the 3 (ON) position to the 1 (OFF/LOCK) position.

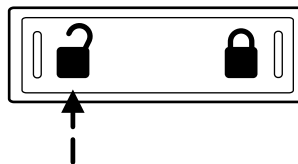

Locks and Security

4. Press the power door unlock control on the door panel three times.
5. Turn the ignition back to the 3 (ON) position. The horn will chirp one time to confirm programming mode has been entered and is active.
6. To enable/disable the autolock feature, press the unlock control, then press the lock control. The horn will chirp once if autolock was deactivated or twice (one short and one long chirp) if autolock was activated.
7. Turn the ignition to the 1 (OFF/LOCK) position. The horn will chirp once to confirm the procedure is complete.

Keyless entry key pad autolock enable/disable procedure

1. Turn the ignition to the 1 (OFF/LOCK) position.
2. Close all the doors.
3. Enter factory-set 5-digit entry code.
4. Press and hold the 3 • 4. While holding the 3 • 4 press the 7 • 8.
5. Release the 7 • 8.
6. Release the 3 • 4.



The user should receive a **horn chirp** to indicate the system has been disabled or a chirp followed by a honk to indicate the system has been enabled.

Autounlock feature (if equipped)

The autounlock feature will unlock all the doors when:

- the ignition is in the 3 (ON) position, all the doors are closed, and the vehicle has been in motion at a speed greater than 12 mph (20 km/h);
- the vehicle has then come to a stop and the ignition is turned to the 1 (OFF/LOCK) or 2 (ACC) position; and
- the driver door is opened within 10 minutes of the ignition being transitioned to the 1 (OFF/LOCK) or 2 (ACC) position.

Note: The doors will not autounlock if the vehicle has been electronically locked before the driver door is opened.

Locks and Security

Deactivating/activating autounlock feature

There are three methods to enable/disable this feature:

- Through your authorized dealer,
- by using a power door unlock/lock sequence,
- using a keypad procedure (if equipped)

Note: The autounlock feature can be activated/deactivated independently of the autolock feature.

Power door lock switch autounlock enable/disable procedure

Before starting, ensure the ignition is in the 1 (OFF/LOCK) position and all vehicle doors are closed. You must complete Steps 1–5 within 30 seconds or the procedure will have to be repeated. If the procedure needs to be repeated, wait a minimum of 30 seconds before beginning again.

1. Place the key in the ignition and turn the ignition to the 3 (ON) position.
2. Press the power door unlock control on the door panel three times.
3. Turn the ignition from the 3 (ON) position to the 1 (OFF/LOCK) position.
4. Press the power door unlock control on the door panel three times.
5. Turn the ignition back to the 3 (ON) position. The horn will chirp one time to confirm programming mode has been entered and is active.
6. To enable/disable the autounlock feature, press the lock control, then press the unlock control. The horn will chirp once if autounlock was deactivated or twice (one short and one long chirp) if autounlock was activated.
7. Turn the ignition to the 1 (OFF/LOCK) position. The horn will chirp once to confirm the procedure is complete.

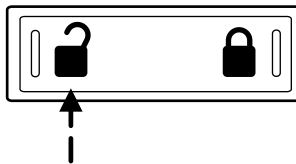

Locks and Security

Keyless entry key pad autounlock enable/disable procedure

1. Turn the ignition to the 1 (OFF/LOCK) position.
2. Close all the doors.
3. Enter factory-set 5-digit entry code.
4. Press and hold the 3 • 4. While holding the 3 • 4, press and release the 7 • 8. While still holding the 3 • 4, press and release the 7 • 8 a second time.
5. Release the 3 • 4.

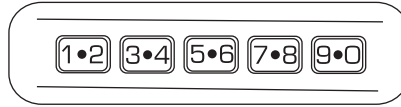

The user should receive a **horn chirp** to indicate the system has been disabled or a chirp followed by a honk to indicate the system has been enabled.

CHILDPROOF DOOR LOCKS (IF EQUIPPED)

- When these locks are set, the rear doors cannot be opened from the inside.
- The rear doors can be opened from the outside when the doors are unlocked.

The childproof locks are located on rear edge of each rear door and must be set separately for each door. Setting the lock for one door will not automatically set the lock for both doors.

- Move lock control up to engage the childproof lock.
- Move lock control down to disengage the childproof lock.

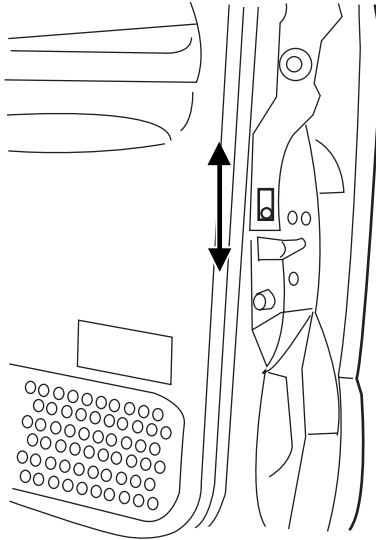

Locks and Security

REMOTE ENTRY SYSTEM (IF EQUIPPED)

This device complies with part 15 of the FCC rules and with RS-210 of Industry Canada. Operation is subject to the following two conditions: (1) This device may not cause harmful interference, and (2) This device must accept any interference received, including interference that may cause undesired operation.

Changes or modifications not expressly approved by the party responsible for compliance could void the user's authority to operate the equipment.

The typical operating range for your remote entry transmitter is approximately 33 feet (10 meters). A decrease in operating range could be caused by:

- weather conditions,
- nearby radio towers,
- structures around the vehicle, or
- other vehicles parked next to your vehicle.

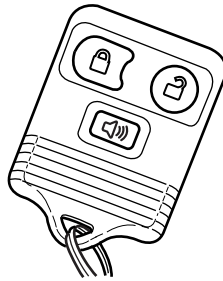

Your vehicle is equipped with a remote entry system which allows you to:

- unlock the vehicle doors without a key.
- lock all the vehicle doors without a key.
- activate the personal alarm.



If there are problems with the remote entry system, make sure to take **ALL remote entry transmitters** with you to the authorized dealer in order to aid in troubleshooting the problem.

Two step door unlocking

1. Press  and release to unlock the driver's door. **Note:** The interior lamps will illuminate (refer to the *Illuminated entry* feature later in this section) if the control on the overhead lamp is **not** set to the **off** position.
2. Press  and release again within three seconds to unlock the passenger doors.



The battery saver feature will turn off the interior lamps 10 minutes after the ignition is turned to the 1 (OFF/LOCK) position.

Locks and Security



One step door unlocking

If the one step door unlocking feature is activated, press  and release once to unlock all of the doors. **Note:** The interior lamps will illuminate (refer to the *Illuminated entry* feature later in this section) if the control on the overhead lamp is **not** set to the **off** position.

Switching from two step to one step door unlocking

Your vehicle comes with two step unlocking enabled. Unlocking can be switched between two step and one step door unlocking by pressing and holding both the  and  buttons simultaneously on the remote entry transmitter for approximately 4 seconds. The hazard lamps will flash twice to indicate that the vehicle has switched to one step unlocking. Repeat the procedure to switch back to two-step unlocking.

Locking the doors

1. Press  and release to lock all the doors. The parking lamps will flash if all the doors are closed and locked.
2. Press  and release again within three seconds to confirm that all the doors are closed and locked. **Note:** The doors will lock again, the horn will chirp once, and the parking lamps will flash once more.

If any of the doors are not properly closed the horn will make two quick chirps and the parklamps will not flash.

Car finder

Press  twice within 3 seconds. the horn will chirp and the turn lamps will flash. It is recommended that this method be used to locate your vehicle, rather than using the panic alarm.

Sounding a panic alarm

Press  to activate the alarm. Press again or turn the ignition to 3 (ON) to deactivate.

Note: The panic alarm will only operate when the ignition is in the 1 (OFF/LOCK) position.

Memory seats/adjustable pedals/mirrors (if equipped)

The remote entry system can also control the memory seat/adjustable pedals/mirrors.

Press  to automatically move the seat, adjustable pedals and mirrors to the desired memory position (the seat position corresponds to the transmitter being used).

Locks and Security

Activating the memory seat feature

To activate this feature:

1. Position the seat, adjustable pedals and mirrors to the position desired.
2. Press the SET control on the driver's door panel.
3. Within five seconds, press one control on the remote transmitter and then press the 1 or 2 control on the lower-center portion of the instrument panel which you would like to associate with the seat and Driver 1 or Driver 2 positions.
4. Repeat this procedure for another remote transmitter if desired.

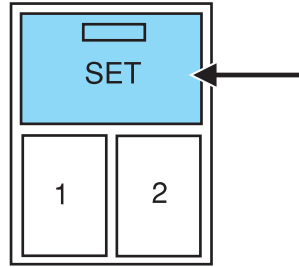

Deactivating the memory seat feature

To deactivate this feature:

1. Press the SET control on the driver's door panel.
2. Within five seconds, press any control on the remote transmitter which you would like to deactivate and then press the SET control on the lower-center portion of the instrument panel.
3. Repeat this procedure for another remote transmitter if desired.

Replacing the battery

The remote entry transmitter uses one coin type three-volt lithium battery CR2032 or equivalent.

To replace the battery:

1. Twist a thin coin between the two halves of the remote entry transmitter near the key ring. DO NOT TAKE THE RUBBER COVER AND CIRCUIT BOARD OFF THE FRONT HOUSING OF THE REMOTE ENTRY TRANSMITTER.

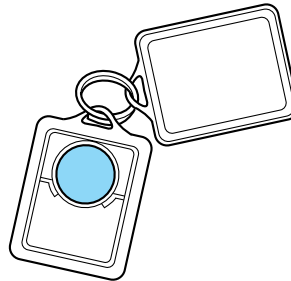

Locks and Security

2. Do not wipe off any grease on the battery terminals on the back surface of the circuit board.

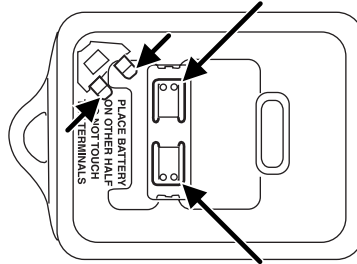

3. Remove the old battery. **Note:** Please refer to local regulations when disposing of transmitter batteries.

4. Insert the new battery. Refer to the diagram inside the remote entry transmitter for the correct orientation of the battery. Press the battery down to ensure that the battery is fully seated in the battery housing cavity.

5. Snap the two halves back together.

Note: Replacement of the battery will **not** cause the remote transmitter to become deprogrammed from your vehicle. The remote transmitter should operate normally after battery replacement.

Replacing lost remote entry transmitters

If you would like to have your remote entry transmitter reprogrammed because you lost one, or would like to buy additional remote entry transmitters, you can either reprogram them yourself, or take **all remote entry transmitters** to your authorized dealer for reprogramming.

Note: If your vehicle is equipped with the memory seats/power mirrors/adjustable pedals feature, you can associate a remote entry transmitter to each memory position using this procedure. The first transmitter that is programmed will recall Driver 1 settings, and the second transmitter that is programmed will recall Driver 2 settings.

How to program your remote entry transmitters

You must have **all remote keyless entry keypads and remote entry transmitters** (maximum of four) available before beginning this procedure. **Note:** Do not press the brake pedal anytime during this sequencing, as doing so will invalidate the procedure.

Locks and Security

To reprogram the remote entry transmitters:

1. Ensure the vehicle is electronically unlocked.
2. Put the key in the ignition.
3. Cycle eight times rapidly (within 10 seconds) between the 1 (OFF/LOCK) position and 3 (ON).

Note: The eighth turn must end in the 3 (ON) position. The doors will lock, then unlock, to confirm that the programming mode has been activated.

4. Within 20 seconds press any button on the remote entry transmitter.

Note: If more than 20 seconds have passed you will need to start the procedure over again. The doors will lock, then unlock, to confirm that this remote entry transmitter has been programmed.

5. Repeat Step 4 to program each additional remote entry transmitter.

6. Turn the ignition to the 1 (OFF/LOCK) position after you have finished programming all of the remote entry transmitters. **Note:** After 20 seconds, you will automatically exit the programming mode. The doors will lock, then unlock, to confirm that the programming mode has been exited.

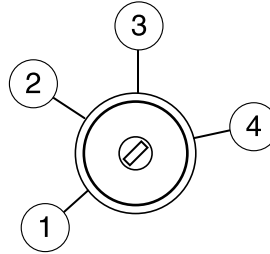

Perimeter lamps illuminated entry

With the Remote Keyless Entry system, the following items will illuminate when the  control on the transmitter is pressed:

- Headlamps
- Parklamps
- Tail lamps

The lamps will automatically turn off:

- if the ignition switch is turned to the 3 (ON) position, or
- the Remote Keyless Entry Transmitter lock control is pressed, or
- the vehicle is locked using the keyless entry keypad (if equipped), or
- after 25 seconds of illumination.

Note: On some vehicles, the perimeter lamps illuminated entry feature will not activate in daylight conditions.

Locks and Security

Deactivating/activating perimeter lamps illuminated entry

You may enable/disable this feature by having your vehicle serviced by your authorized dealer.

You may also perform the following power door lock sequence to enable/disable the perimeter lamps feature. **Note:** Before starting, ensure the ignition is in the 1 (OFF/LOCK) position and all vehicle doors are closed.

You must complete Steps 1–5 within 30 seconds or the procedure will have to be repeated. If the procedure needs to be repeated, wait a minimum of 30 seconds before beginning again.

1. Place the key in the ignition and turn the ignition to the 3 (ON) position.
2. Press the power door unlock control on the door panel three times.
3. Turn the ignition from the 3 (ON) position to the 1 (OFF/LOCK) position.
4. Press the power door unlock control on the door panel three times.
5. Turn the ignition back to the 3 (ON) position. The horn will chirp one time to confirm programming mode has been entered and is active.
6. Press the power door unlock control twice within 5 seconds. **Note:** The horn will chirp once to indicate the perimeter lighting feature has been deactivated. The horn will chirp once and honk once (one short and one long) to indicate the perimeter lighting feature has been activated.
7. Turn the ignition to the 1 (OFF/LOCK) position to exit the procedure. **Note:** The horn will chirp once to confirm the procedure is complete.

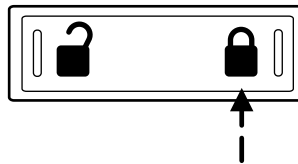

Illuminated entry

The interior lamps illuminate when the remote entry system is used to unlock the door(s).

The illuminated entry system will turn off the interior lights if:

- the ignition switch is turned to the 3 (ON) position, or
- the remote transmitter lock control is pressed, or

Locks and Security

- the 7 • 8 and the 9 • 0 controls on the keyless entry keypad are pressed, or
- after 25 seconds of illumination.

The dome lamp control (if equipped) must **not** be set to the off position for the illuminated entry system to operate.

The inside lights will not turn off if:

- they have been turned on with the dimmer control, or
- any door is open.

The battery saver will shut off the interior lamps 30 minutes after the ignition has been turned to the 1 (OFF/LOCK) position, 10 minutes after if the dome lamp is off, and 30 minutes after if the dome lamp switch is left on.

KEYLESS ENTRY SYSTEM (IF EQUIPPED)

You can use the keyless entry keypad to lock or unlock the doors without using a key.



The keypad can be operated with the factory set 5-digit entry code; this code is located on the owner's wallet card in the glove box, is marked on the computer module, and is available from your authorized dealer. You can also create your own 5-digit personal entry code.

When pressing the controls on the keypad, press the middle of the controls to ensure a good activation.

Programming a personal entry code and keypad association to memory seats, mirrors and pedals

To create your own personal entry code:

1. Enter the factory set code.
2. Within five seconds press the 1 • 2 on the keypad.
3. Enter your personal 5-digit code. Each number must be entered within five seconds of each other.
4. To associate the entry code with a memory setting, enter a sixth digit to indicate which driver should be set in a memory recalled by the personal entry code:
 - Pressing 1 • 2 recalls Driver 1 settings.
 - Pressing 3 • 4 recalls Driver 2 settings.

Locks and Security

- Pressing other keypad buttons or not pressing a keypad button as a sixth digit does not set a driver and will not recall a memory setting.
Note: The factory-set code cannot be associated with a memory setting.

5. The doors will again lock then unlock to confirm that your personal keycode has been programmed to the module.

Tips:

- Do not set a code that uses five of the same number.
- Do not use five numbers in sequential order.
- The factory set code will work even if you have set your own personal code.

Erasing personal code

1. Enter the factory set 5–digit code.
2. Within five seconds, press the 1 • 2 on the keypad and release.
3. Press and hold the 1 • 2 for two seconds. This must be done within five seconds of completing Step 2.

Your personal code is now erased and only the factory set 5–digit code will work.

Anti-scan feature

If an incorrect code has been entered 7 times (35 consecutive button presses), the keypad will go into an anti-scan mode. This mode disables the keypad for one minute and the keypad lamp will flash during this time.

The anti-scan feature will turn off after:

- one minute of keypad inactivity.
- pressing the  control on the remote entry transmitter.
- the ignition is turned to the 3 (ON) position.

Unlocking and locking the doors using keyless entry

To unlock the driver's door, enter the factory set 5-digit code or your personal code. Each number must be pressed within five seconds of each other. The interior lamps will illuminate after entering a valid keypad entry code.

To unlock all doors, press the 3 • 4 control within five seconds.

To lock all doors, press the 7 • 8 and the 9 • 0 at the same time. You **do not** need to enter the keypad code first. **Note:** The interior lamps will turn off.

Locks and Security

SECURILOCK™ PASSIVE ANTI-THEFT SYSTEM (IF EQUIPPED)

SecuriLock™ passive anti-theft system is an engine immobilization system. This system is designed to help prevent the engine from being started unless a **coded key programmed to your vehicle** is used. The use of the wrong type of coded key may lead to a “no-start” condition.

Your vehicle comes with two coded keys; additional coded keys may be purchased from your authorized dealer. The authorized dealer can program your spare keys to your vehicle or you can program the keys yourself. Refer to *Programming spare keys* for instructions on how to program the coded key.

Note: The SecuriLock™ passive anti-theft system is not compatible with non-Ford aftermarket remote start systems. Use of these systems may result in vehicle starting problems and a loss of security protection.

Note: Large metallic objects, electronic devices that are used to purchase gasoline or similar items, or a second coded key on the same key chain may cause vehicle starting issues. You need to prevent these objects from touching the coded key while starting the engine. These objects will not cause damage to the coded key, but may cause a momentary issue if they are too close to the key when starting the engine. If a problem occurs, turn the ignition off, remove all objects on the key chain away from the coded key and restart the engine.

Anti-theft indicator

The anti-theft indicator is located in the instrument cluster.

Vehicles equipped with the SecuriLock™ Passive Anti-theft system behave as follows:

- When the ignition is in the 1 (OFF/LOCK) position, the indicator will flash once every 2 seconds for a total of 10 seconds to indicate the SecuriLock™ system is functioning as a theft deterrent.
- When the ignition is in the 3 (ON) position, the indicator will glow for 3 seconds to indicate a programmed key has been validated and the SecuriLock™ Passive Anti-theft system has enabled the engine.

Vehicles without the SecuriLock™ Passive Anti-theft system behave as follows:

- When the ignition is in the 1 (OFF/LOCK) position, the indicator will not flash.
- When the ignition is in the 3 (ON) position, the indicator will glow for 3 seconds to indicate the engine is enabled.

Locks and Security

Automatic arming

The vehicle is armed immediately after switching the ignition to the 1 (OFF/LOCK) position.

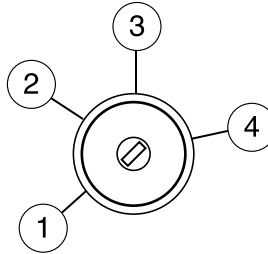

Automatic disarming

Switching the ignition to the 3 (ON) position with a **coded key** disarms the vehicle.

Replacement keys

If your keys are lost or stolen and you don't have an extra coded key, you will need to have your vehicle towed to an authorized dealer. The key codes need to be erased from your vehicle and new coded keys will need to be programmed.

Replacing coded keys can be very costly. Store an extra programmed key away from the vehicle in a safe place to help prevent any inconveniences. Please visit an authorized dealer to purchase additional spare or replacement keys.

Programming spare keys

A maximum of eight keys can be coded to your vehicle. Only SecuriLock™ keys can be used. To program a **coded key** yourself, you will need two previously programmed **coded keys** (keys that already operate your vehicle's engine) and the new unprogrammed key(s) readily accessible for timely implementation of each step in the procedure.

If two previously programmed coded keys are not available, you must bring your vehicle to your authorized dealer to have the spare coded key(s) programmed.

Please read and understand the entire procedure before you begin.

Locks and Security

1. Insert the first previously programmed **coded key** into the ignition and turn the ignition from the 1 (OFF/LOCK) position to the 3 (ON) position (maintain ignition in the 3 (ON) position for at least one second, but no more than ten seconds).

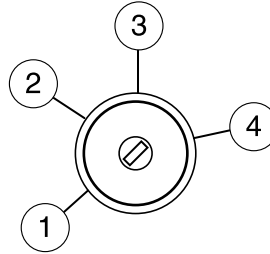

2. Turn ignition from the 3 (ON) position back to the 1 (OFF/LOCK) position in order to remove the first **coded key** from the ignition.

3. Within ten seconds of removing the first **coded key**, insert the second previously programmed **coded key** into the ignition and turn the ignition from the 1 (OFF/LOCK) position to the 3 (ON) position (maintain ignition in the 3 (ON) position for at least one second but no more than ten seconds).

4. Turn the ignition from the 3 (ON) position back to the 1 (OFF/LOCK) position in order to remove the second **coded key** from the ignition.

5. Within 10 seconds of removing the second **coded key**, insert the new unprogrammed key (new key/valet key) into the ignition and turn the ignition from the 1 (OFF/LOCK) position to the 3 (ON) position (maintain ignition in the 3 (ON) position for at least one second, but no more than ten seconds). This step will program your new key to a coded key.

6. To program additional new unprogrammed key(s), repeat Steps 1 through 5.

If successful, the new coded key(s) will start the vehicle's engine and the theft indicator will illuminate for three seconds and then go out.

If not successful, the new coded key(s) will not start the vehicle's engine and the theft indicator will flash on and off and you may repeat Steps 1 through 5. If failure repeats, bring your vehicle to your authorized dealer to have the new spare key(s) programmed.

Seating and Safety Restraints

SEATING

Notes:



Reclining the seatback can cause an occupant to slide under the seat's safety belt, resulting in severe personal injuries in the event of a collision.



Do not pile cargo higher than the seatbacks to reduce the risk of injury in a collision or sudden stop.

Adjustable head restraints (if equipped)

The purpose of these head restraints is to help limit head motion in the event of a rear collision. To properly adjust your head restraints, lift the head restraint so that it is located directly behind your head or as close to that position as possible.

The head restraints can be moved up and down. Lift the head restraint so that it is located directly or as close as possible behind your head.

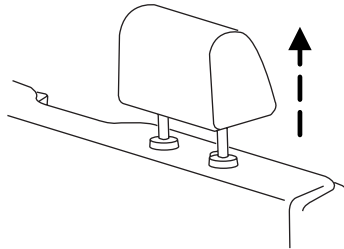

Push control to lower head restraint.

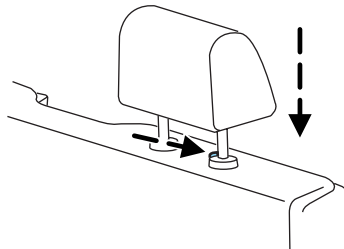

Seating and Safety Restraints

 To minimize the risk of neck injury in the event of a crash, the driver and passenger occupants should not sit in and/or operate the vehicle, until the head restraint is placed in its proper position. The driver should never adjust the head restraint while the vehicle is in motion.

Full bench seat (if equipped)

- Lift the release bar to move the seat forward or backward. Ensure that the seat is related into place.
- Pull up on the lever located at the bottom of the seatback to quickly fold the seatback forward.
- Pull up on the lever located at the side of the seat cushion to recline the seatback and to return the seat to the upright position.

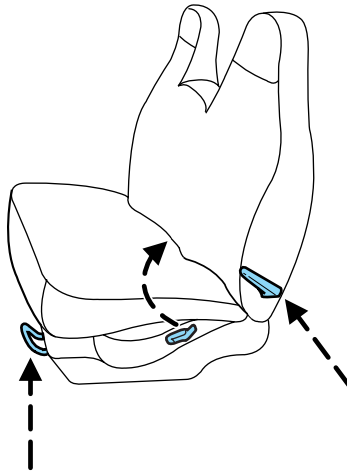

Seating and Safety Restraints

40/20/40 split bench seat (if equipped)

- Lift the track release bar to move the seat forward or backward. Ensure the seat is reattached into place.
- Pull the handle on the side of the seat up to recline the seat.
- Push down the lever located at the bottom of the seatback to quickly fold the seatback forward.

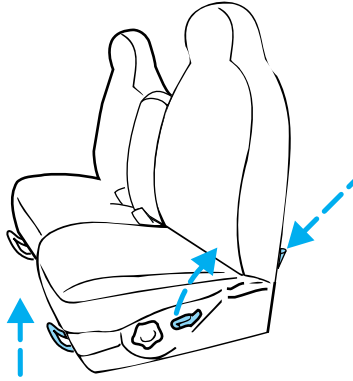

40/20/40 front seat armrest and console (if equipped)

To release the armrest, pull forward on the strap and pull the armrest down.

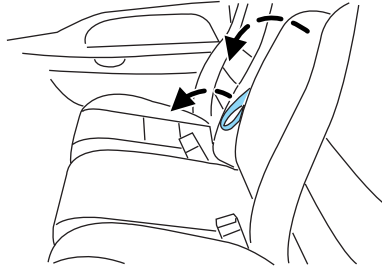

To gain access to the storage compartment in your armrest, lift the latch to open the lid. The lid cannot be opened in the upright position.

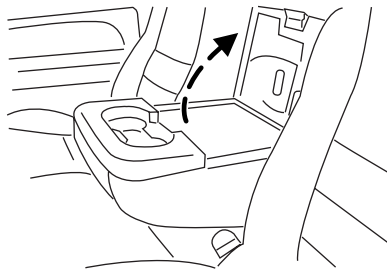

Seating and Safety Restraints

Lift up armrest to return it to a center seatback.

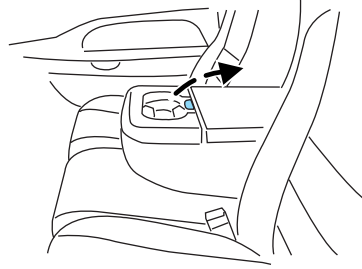

Captain's chair (if equipped)

- Lift the bar to move the seat forward or rearward. Make sure that the seat is related into place.
- To recline the seatback, pull the release lever handle located on the side of the seat up.
- Push down the lever (if equipped) located at the bottom of the seatback to quickly fold the seatback forward.

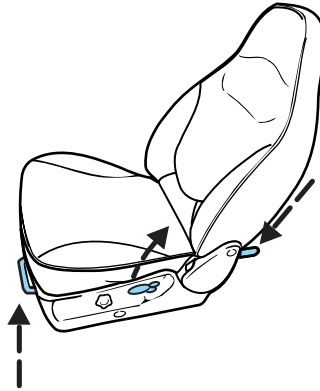

Adjusting the front power seat (if equipped)



Never adjust the driver's seat or seatback when the vehicle is moving.



Do not pile cargo higher than the seatbacks to avoid injuring people in a collision or sudden stop.



Always drive and ride with your seatback upright and the lap belt snug and low across the hips.

Seating and Safety Restraints



Reclining the seatback can cause an occupant to slide under the seat's safety belt, resulting in severe personal injuries in the event of a collision.

The control is located on the outboard side of the seat cushion.

Press front to raise or lower the front portion of the seat cushion.

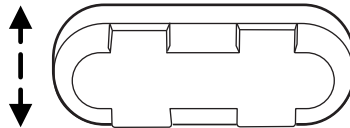

Press rear to raise or lower the rear portion of the seat cushion.

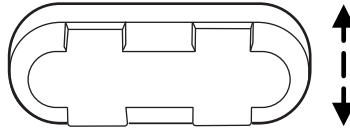

Press the control to move the seat forward, backward, up or down.

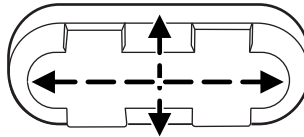

Seating and Safety Restraints

Using the manual lumbar support

The lumbar support control is located on the outboard side of the seat.

Turn the lumbar support clockwise for more support.

Turn the lumbar support counterclockwise for less support.

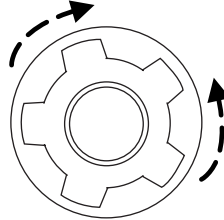

Heated seats (if equipped)

The heated seat control is located on the climate control panel.



Persons who are unable to feel pain to the skin because of advanced age, chronic illness, diabetes, spinal cord injury, medication, alcohol use, exhaustion, or other physical conditions, must exercise care when using the seat heater. The seat heater may cause burns even at low temperatures, especially if used for long periods of time. Do not place anything on the seat that insulates against heat, such as a blanket or cushion, because this may cause the seat heater to overheat. Do not puncture the seat with pins, needles, or other pointed objects because this may damage the heating element which may cause the seat heater to overheat. An overheated seat may cause serious personal injury.

Note: Do not do the following:

- Place heavy objects on the seat.
- Operate the seat heater if water or any other liquid is spilled on the seat. Allow the seat to dry thoroughly.

To operate the heated seats, do the following (engine must be running):

Push  to activate; push  again to deactivate.

The indicator light on the control will illuminate when activated.

Seating and Safety Restraints

Memory seats/power mirrors/adjustable pedals (if equipped)

This system allows automatic positioning of the driver seat, power mirrors, and adjustable pedals to two programmable positions.

The memory seat control is located on the driver door.

- To program position 1, move the driver seat, mirrors and pedals (if equipped) to the desired position using the associated controls. Press the SET control. The SET control indicator light will briefly illuminate. While the light is illuminated, press control 1.
- To program position 2, repeat the previous procedure using control 2.

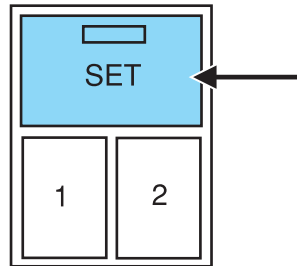

A position can be recalled:

- in any gearshift position if the ignition is **not** in the RUN position.
- only in P (Park) or N (Neutral) if the ignition is in the RUN position.

A memory seat position may be programmed at any time.

The memory positions are also recalled when you press your remote entry transmitter UNLOCK control (if the transmitter is programmed to a memory position) or, when you enter a valid personal entry code that is programmed to a memory position.

To program the memory feature to a remote entry transmitter and for more information on how to use the keypad, refer to *Remote entry system* in the *Locks and Security* chapter.

REAR FOLDING SEAT SYSTEM WITH LOAD FLOOR (IF EQUIPPED)

The rear seatback has a split 60/40 seat. Each seat cushion can be flipped up into the seatback position.

Note: The Crew Cab rear 60/40 split bench seatback is **not** intended to support a cargo load in the forward-folded position.

Seating and Safety Restraints

To fold the seatback down, pull down the latch lever located on the bottom seat back to fold the seat back forward.

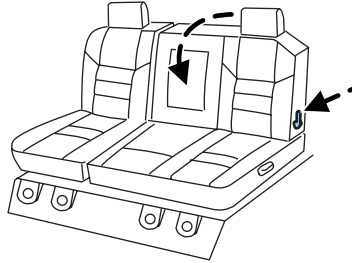

To flip the seat cushion up, pull up on the lever located on the side of the seat cushion to rotate the cushion up until it locks into a vertical storage position, gaining access to the grocery hook located on the underside of the driver-side seat cushion. The maximum load is 25 lb. (11 kg).

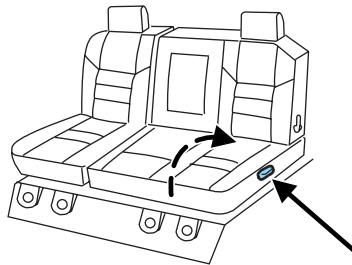

Returning the seat to seating position

- Pull lever on the side of the seat to release seat cushion from storage position.
- Push seat cushion down until it locks into horizontal position.



Before returning the seatback to its original position, make sure that cargo or any objects are not trapped underneath the seatback. After returning the seatback to its original position, pull on the seatback to ensure that it has fully latched. An unlatched seat may become dangerous in the event of a sudden stop or collision.

Seating and Safety Restraints

To gain access to the cupholders and tray, pull down on the armrest.

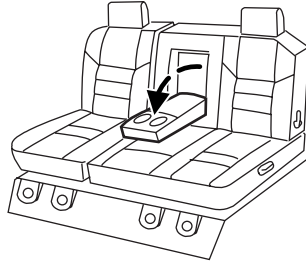

To gain access to the 60/40 load floor, store the cushion in the upright locked position. Pull up on the straps located at the sides of the load floor, and rotate forward until resting on the carpet.

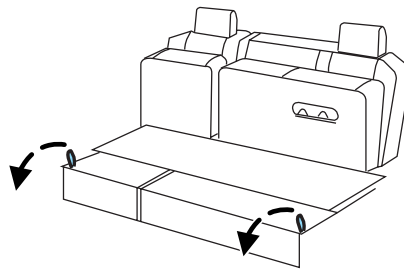

SAFETY RESTRAINTS

Safety restraints precautions



Always drive and ride with your seatback upright and the lap belt snug and low across the hips.



To reduce the risk of injury, make sure children sit in the back seat where they can be properly restrained.



Never let a passenger hold a child on his or her lap while the vehicle is moving. The passenger cannot protect the child from injury in a collision.



All occupants of the vehicle, including the driver, should always properly wear their safety belts, even when an air bag supplemental restraint system (SRS) is provided.

Seating and Safety Restraints



It is extremely dangerous to ride in a cargo area, inside or outside of a vehicle. In a collision, people riding in these areas are more likely to be seriously injured or killed. Do not allow people to ride in any area of your vehicle that is not equipped with seats and safety belts. Be sure everyone in your vehicle is in a seat and using a safety belt properly.



In a rollover crash, an unbelted person is significantly more likely to die than a person wearing a seat belt.



Each seating position in your vehicle has a specific safety belt assembly which is made up of one buckle and one tongue that are designed to be used as a pair. 1) Use the shoulder belt on the outside shoulder only. Never wear the shoulder belt under the arm. 2) Never swing the safety belt around your neck over the inside shoulder. 3) Never use a single belt for more than one person.



Always transport children 12 years old and under in the back seat and always properly use appropriate child restraints.



Safety belts and seats can become hot in a vehicle that has been closed up in sunny weather; they could burn a small child. Check seat covers and buckles before you place a child anywhere near them.



Front and rear seat occupants, including pregnant women, should wear safety belts for optimum protection in an accident.

Seating and Safety Restraints

Combination lap and shoulder belts

1. Insert the belt tongue into the proper buckle (the buckle closest to the direction the tongue is coming from) until you hear a snap and feel it latch. Make sure the tongue is securely fastened in the buckle.

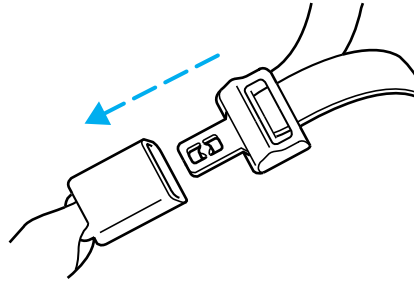

2. To unfasten, push the release button and remove the tongue from the buckle.

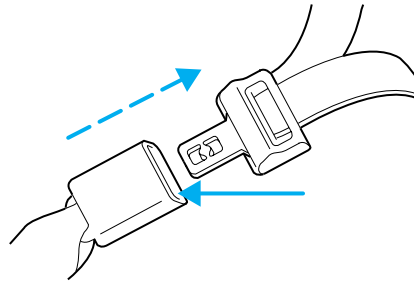

Vehicle sensitive mode

Combination lap and shoulder belts in normal retractor mode allow free shoulder belt length adjustment to your movements and locking in response to vehicle movement. For example, if the driver brakes suddenly or turns a corner sharply, or the vehicle receives an impact of approximately 5 mph (8 km/h) or more, the combination safety belts will lock to help reduce forward movement of the driver and passengers.

Belt sensitive mode

Combination lap and shoulder belts can also be made to lock manually by quickly pulling on the shoulder belt.

Automatic locking mode

When to use the automatic locking mode

In this mode, the shoulder belt is automatically pre-locked. The belt will still retract to remove any slack in the shoulder belt. The automatic locking mode is not available on the driver safety belt.

Seating and Safety Restraints

This mode should be used **any time** a child safety seat is installed except a booster in a front or rear outboard passenger seating position (if equipped). Children 12 years old and under should be properly restrained in the rear seat whenever possible. Refer to *Safety restraints for children* or *Safety seats for children* later in this chapter.

How to use the automatic locking mode

- Buckle the combination lap and shoulder belt.

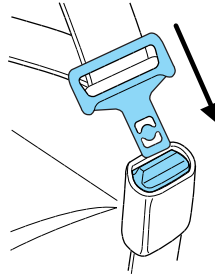

- Grasp the shoulder portion and pull downward until the entire belt is pulled out.



- Allow the belt to retract. As the belt retracts, you will hear a clicking sound. This indicates the safety belt is now in the automatic locking mode.

How to disengage the automatic locking mode

Disconnect the combination lap/shoulder belt and allow it to retract completely to disengage the automatic locking mode and activate the vehicle sensitive (emergency) locking mode.



After any vehicle collision, the front passenger and rear outboard seat belt systems must be checked by your authorized dealer to verify that the “automatic locking retractor” feature for child seats is still functioning properly. In addition, all seat belts should be checked for proper function.

Seating and Safety Restraints



BELT AND RETRACTOR ASSEMBLY MUST BE REPLACED if the seat belt assembly “automatic locking retractor” feature or any other seat belt function is not operating properly when checked according to the procedures in the *Workshop Manual*. Failure to replace the belt and retractor assembly could increase the risk of injury in collisions.

Energy management feature

- This vehicle has a seat belt system with an energy management feature at the front outboard seating positions to help further reduce the risk of injury in the event of a head-on collision.
- The front outboard seat belt systems have a retractor assembly that is designed to pay out webbing in a controlled manner. This feature is designed to help reduce the belt force acting on the occupant’s chest.

Safety belt pretensioner

Your vehicle is equipped with safety belt retractor pretensioners at the driver and front outboard passenger seating positions.

The driver and front outboard passenger safety belt pretensioners are designed to activate only during certain frontal or near-frontal collisions with sufficient longitudinal deceleration. A safety belt pretensioner is a device which tightens the webbing of the lap and shoulder belts during some collisions in such a way that they fit more snugly against the body.

The driver and front outboard passenger safety belt system (including retractors, buckles and height adjusters) must be replaced if the vehicle is involved in a collision that results in the activation of the safety belt pretensioners. Refer to the *Safety belt maintenance* section in this chapter.



Failure to replace the safety belt assembly under the above conditions could result in severe personal injuries in the event of a collision.

Front safety belt height adjustment

The front outboard seating positions are equipped with safety belt height adjusters.

Adjust the height of the shoulder belt so the belt rests across the middle of your shoulder.

Seating and Safety Restraints

 Position the safety belt height adjusters so that the belt rests across the middle of your shoulder. Failure to adjust the safety belt properly could reduce the effectiveness of the seat belt and increase the risk of injury in a collision.

To adjust the shoulder belt height, push the button and slide the height adjuster up or down. Release the button and pull down on the height adjuster to make sure it is locked in place.

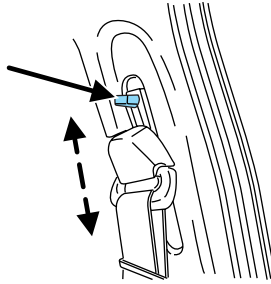

Center lap and shoulder belt (Regular Cab center seating position/SuperCab and Crew Cab rear center seating positions)

 Always use both the lap and shoulder safety belt in the Regular Cab center seating position or in the Super Cab/Crew Cab rear center seating positions.

Regular Cabs with a center 20% seat or Crew Cabs with a rear 60/40 split bench

If you carry large cargo behind the seat or items that might damage or soil the belt, detach the belt from the seat:

1. Release the mini-buckle by inserting a key or safety belt tongue into the slot.

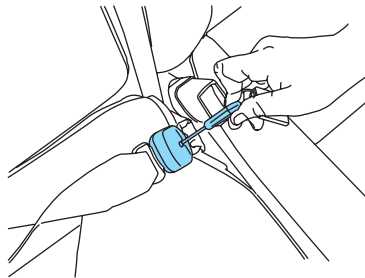

Seating and Safety Restraints

2. Insert the belt into the clip on the back panel. Protect the stowed belt if you carry cargo this may damage or soil the belt.

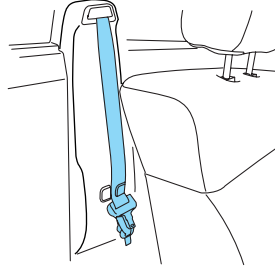

If the belt has been disconnected to carry large objects behind the seat, reconnect it as follows:

1. Remove the belt from the stowage clip on the back panel.

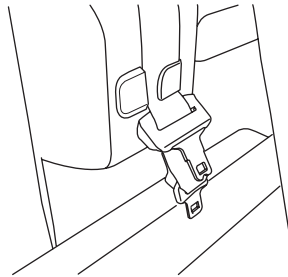

2. Buckle the small tongue on the end of the belt into the mini-buckle on the driver's side. The belt is now ready for use. This mini-buckle should stay buckled at all times unless cargo-carrying makes it necessary to detach the belt.

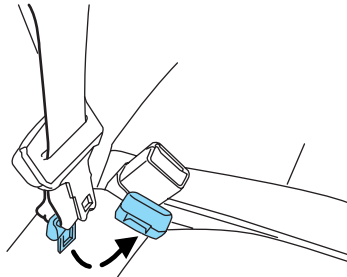

Safety belt with cinch tongue (Regular Cab center seating positions and SuperCab/Crew Cab rear center seating positions)

The cinch tongue will slide up and down the belt webbing when the belt is stowed or while putting safety belts on. When the lap/shoulder safety belt is buckled, the cinch tongue will allow the lap portion to be shortened, but pinches the webbing to keep the lap portion from getting

Seating and Safety Restraints

longer. The cinch tongue is designed to slip during a crash, so always wear the shoulder belt properly and don't allow any slack in either the lap or shoulder portions.

Before you can reach and latch a combination lap and shoulder belt having a cinch tongue into the buckle, you may have to lengthen the lap belt portion of it.

1. To lengthen the lap belt, pull some webbing out of the shoulder belt retractor.
2. While holding the webbing below the tongue, grasp the tip (metal portion) of the tongue so that it is parallel to the webbing and slide the tongue upward.

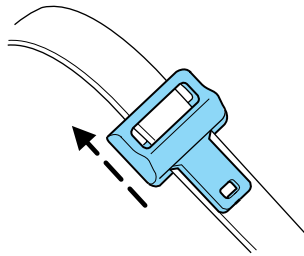

3. Provide enough lap belt length so that the tongue can reach the buckle.

How to fasten the cinch tongue (Regular Cab center seating positions and SuperCab/Crew Cab rear center seating positions)

1. Pull the combination lap and shoulder belt from the retractor so that the shoulder belt portion of the safety belt crosses your shoulder and chest.
2. Be sure the belt is not twisted. If the belt is twisted, remove the twist.
3. Insert the belt tongue into the proper buckle for your seating position until you hear a snap and feel it latch.
4. Make sure the tongue is securely fastened to the buckle by pulling on the tongue.



The lap belt should fit snugly and as low as possible around the hips, not across the waist.

While you are fastened in the safety belt, the combination lap/shoulder belt with a cinch tongue adjusts to your movement. However, if you brake hard, turn hard, or if your vehicle receives an impact of 5 mph (8 km/h) or more, the safety belt will become locked and help reduce your forward movement.

Seating and Safety Restraints

Lap belts

Adjusting the lap belt



The lap belt should fit snugly and as low as possible around the hips, not across the waist.

- **1st row center seating position on SuperCab and Crew Cab**

The lap belt does not adjust automatically.

Insert the tongue into the correct buckle (the buckle closest to the direction the tongue is coming from). To lengthen the belt, turn the tongue at a right angle to the belt and pull across your lap until it reaches the buckle. To tighten the belt, pull the loose end of the belt through the tongue until it fits snugly across the hips.

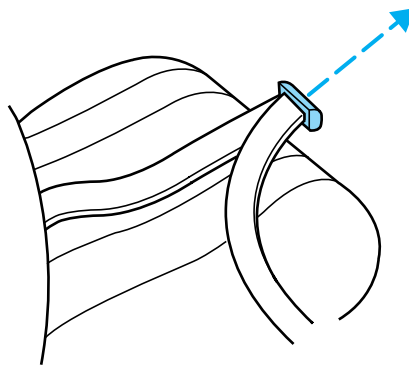

Shorten and fasten the belt when not in use.

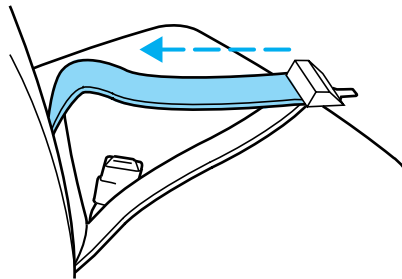

Safety belt warning light and indicator chime

The safety belt warning light illuminates in the instrument cluster and a chime sounds to remind the occupants to fasten their safety belts.

Seating and Safety Restraints

Conditions of operation

If...	Then...
The driver's safety belt is not buckled before the ignition switch is turned to the ON position...	The safety belt warning light illuminates 1-2 minutes and the warning chime sounds 4-8 seconds.
The driver's safety belt is buckled while the indicator light is illuminated and the warning chime is sounding...	The safety belt warning light and warning chime turn off.
The driver's safety belt is buckled before the ignition switch is turned to the ON position...	The safety belt warning light and indicator chime remain off.

Belt-Minder®

The Belt-Minder® feature is a supplemental warning to the safety belt warning function. This feature provides additional reminders to the driver that the driver's safety belt is unbuckled by intermittently sounding a chime and illuminating the safety belt warning lamp in the instrument cluster.

If...	Then...
The driver's safety belt is not buckled before the vehicle has reached at least 3 mph (5 km/h) and 1-2 minutes have elapsed since the ignition switch has been turned to ON...	The Belt-Minder® feature is activated - the safety belt warning light illuminates and the warning chime sounds for 6 seconds every 30 seconds, repeating for approximately 5 minutes or until safety belt is buckled.
The driver's safety belt is buckled while the safety belt indicator light is illuminated and the safety belt warning chime is sounding...	The Belt-Minder® feature will not activate.
The driver's safety belt is buckled before the ignition switch is turned to the ON position...	The Belt-Minder® feature will not activate.

Seating and Safety Restraints

The following are reasons most often given for not wearing safety belts
(All statistics based on U.S. data):

Reasons given...	Consider...
"Crashes are rare events"	36700 crashes occur every day. The more we drive, the more we are exposed to "rare" events, even for good drivers. <i>1 in 4 of us will be seriously injured in a crash during our lifetime.</i>
"I'm not going far"	3 of 4 fatal crashes occur within 25 miles (40 km) of home.
"Belts are uncomfortable"	We design our safety belts to enhance comfort. If you are uncomfortable - try different positions for the safety belt upper anchorage and seatback which should be as upright as possible; this can improve comfort.
"I was in a hurry"	Prime time for an accident. Belt-Minder® reminds us to take a few seconds to buckle up.
"Safety belts don't work"	Safety belts , when used properly, reduce risk of death to front seat occupants by 45% in cars , and by 60% in light trucks .
"Traffic is light"	Nearly 1 of 2 deaths occur in single-vehicle crashes , many when no other vehicles are around.
"Belts wrinkle my clothes"	Possibly, but a serious crash can do much more than wrinkle your clothes, particularly if you are unbelted.
"The people I'm with don't wear belts"	Set the example, teen deaths occur 4 times more often in vehicles with TWO or MORE people. Children and younger brothers/sisters imitate behavior they see.

Seating and Safety Restraints

Reasons given...	Consider...
"I have an airbag"	Airbags offer greater protection when used with safety belts. Frontal airbags are not designed to inflate in rear and side crashes or rollovers.
"I'd rather be thrown clear"	Not a good idea. People who are ejected are 40 times more likely to DIE . Safety belts help prevent ejection, WE CAN'T "PICK OUR CRASH".



Do not sit on top of a buckled safety belt or insert a latchplate into the buckle to avoid the Belt-Minder® chime. To do so may adversely affect the performance of the vehicle's air bag system

One-time disable

Any time the safety belt is buckled and then unbuckled during an ignition ON cycle, the Belt-Minder® will be disabled for that ignition cycle only.

Deactivating/activating the Belt-Minder® feature (Driver only)

Read Steps 1 - 5 thoroughly before proceeding with the deactivation/activation programming procedure.

The Belt-Minder® feature can be deactivated/activated by performing the following procedure:

Before following the procedure, make sure that the following conditions are met:

- the parking brake is set
- the gearshift is in P (Park) (automatic transmission) or the neutral position (manual transmission)
- the ignition switch is in the OFF position
- all vehicle doors are closed
- the driver's safety belt is unbuckled
- the parklamps/headlamps are in the OFF position (If the vehicle is equipped with Autolamps, this will not affect the procedure)

Seating and Safety Restraints



While the design allows you to deactivate your Belt-Minder®, this system is designed to improve your chances of being safely belted and surviving an accident. We recommend you leave the Belt-Minder® system activated for yourself and others who may use the vehicle. To reduce the risk of injury, do not deactivate/activate the Belt-Minder® feature while driving the vehicle.

Belt-Minder® activation and deactivation procedure

1. Turn the ignition switch to the RUN (or ON) position. (DO NOT START THE ENGINE)
2. Wait until the safety belt warning light turns off. (Approximately 1 minute)
 - Step 3 must be completed within 60 seconds after the safety belt warning light turns off.
3. At a moderate speed, buckle then unbuckle the safety belt 9 times, ending with the safety belt in the unbuckled state.
 - After Step 3 is complete, the safety belt warning light will be turned on for 3 seconds.
 - If Step 4 does not occur within 10 seconds at the end of Step 3, Belt-Minder® will automatically exit programming mode without changing its enable status.
4. Within 7 seconds of the light turning on, at a moderate speed, buckle then unbuckle the safety belt.
 - This will disable the Belt-Minder® feature if it is currently enabled. As confirmation, the safety belt warning light will flash 4 times per second for 3 seconds.
 - This will enable the Belt-Minder® feature if it is currently disabled. As confirmation, the safety belt warning light will flash 4 times per second for 3 seconds, followed by 3 seconds with the light off, then followed by the safety belt warning light flashing 4 times per second for 3 seconds again.
5. After receiving confirmation, the deactivation/activation procedure is complete.

Seating and Safety Restraints

Safety belt extension assembly

If the safety belt is too short when fully extended, there is a 8 inch (20 cm) safety belt extension assembly that can be added (part number 611C22). This assembly can be obtained from your authorized dealer.

Use only extensions manufactured by the same supplier as the safety belt. Manufacturer identification is located at the end of the webbing on the label. Also, use the safety belt extension only if the safety belt is too short for you when fully extended.



Do not use extensions to change the fit of the shoulder belt across the torso.

Safety belt maintenance

Inspect the safety belt systems periodically to make sure they work properly and are not damaged. Inspect the safety belts to make sure there are no nicks, tears or cuts. Replace if necessary. All safety belt assemblies, including retractors, buckles, front seat belt buckle assemblies, buckle support assemblies (slide bar-if equipped), shoulder belt height adjusters (if equipped), shoulder belt guide on seatback (if equipped), child safety seat LATCH and tether anchors, and attaching hardware, should be inspected after a collision. Ford Motor Company recommends that all safety belt assemblies in use in vehicles involved in a collision be replaced. However, if the collision was minor and your authorized dealer finds that the belts do not show damage and continue to operate properly, they do not need to be replaced. Safety belt assemblies not in use during a collision should also be inspected and replaced if either damage or improper operation is noted.



Failure to inspect and if necessary replace the safety belt assembly under the above conditions could result in severe personal injuries in the event of a collision.

For proper care of soiled safety belts, refer to *Interior* in the *Cleaning* chapter.

Seating and Safety Restraints

AIRBAG SUPPLEMENTAL RESTRAINT SYSTEM (SRS)

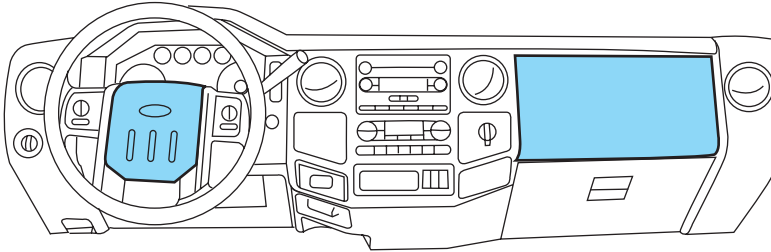

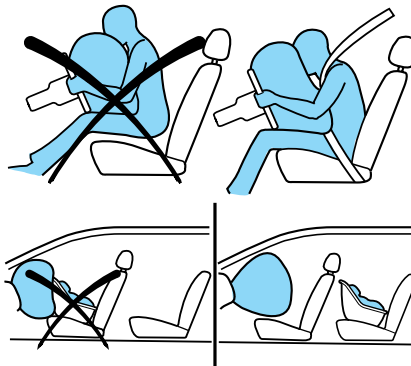

Important SRS precautions

The SRS is designed to work with the safety belt to help protect the driver and right front passenger from certain upper body injuries. Airbags DO NOT inflate slowly; there is a risk of injury from a deploying airbag.



 All occupants of the vehicle, including the driver, should always properly wear their safety belts, even when an air bag supplemental restraint system (SRS) is provided.

 Always transport children 12 years old and under in the back seat and always properly use appropriate child restraints.

 The National Highway Traffic Safety Administration (NHTSA) recommends a minimum distance of at least 10 inches (25 cm) between an occupant's chest and the driver airbag module.

Seating and Safety Restraints



Never place your arm over the air bag module as a deploying air bag can result in serious arm fractures or other injuries.

To properly position yourself away from the airbag:

- Move your seat to the rear as far as you can while still reaching the pedals comfortably.
- Recline the seat slightly one or two degrees from the upright position.



Do not put anything on or over the air bag module. Placing objects on or over the air bag inflation area may cause those objects to be propelled by the air bag into your face and torso causing serious injury.



Do not attempt to service, repair, or modify the airbag supplemental restraint systems or its fuses. See your authorized dealer.



The front passenger air bag is not designed to offer protection to an occupant in the center front seating position.



Modifying or adding equipment to the front end of the vehicle (including frame, bumper, front end body structure and tow hooks) may affect the performance of the airbag system, increasing the risk of injury. Do not modify the front end of the vehicle.



Additional equipment such as snowplow equipment may effect the performance of the airbag sensors increasing the risk of injury. Please refer to the *Ford Truck Body Builders Layout Book* for instructions about the appropriate installation of additional equipment.

Children and airbags

For additional important safety information, read all information on safety restraints in this guide.

Children must always be properly restrained. Failure to follow these instructions may increase the risk of injury in a collision.

Seating and Safety Restraints

 An infant in a rear-facing seat faces a high risk of serious or fatal injuries from a deploying passenger airbag. Rear facing infant seats should NEVER be placed in the front seats, unless the passenger airbag is turned off. See *Passenger airbag ON/OFF switch*.

How does the airbag supplemental restraint system work?

The airbag SRS is designed to activate when the vehicle sustains sufficient longitudinal deceleration. The fact that the airbags did not inflate in a collision does not mean that something is wrong with the system. Rather, it means the forces were not of the type sufficient to cause activation. Airbags are designed to inflate in frontal and near-frontal collisions, not rollover, side-impact, or rear-impacts.

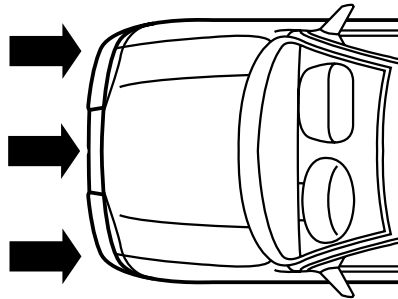

The airbags inflate and deflate rapidly upon activation. After airbag deployment, it is normal to notice a smoke-like, powdery residue or smell the burnt propellant. This may consist of cornstarch, talcum powder (to lubricate the bag) or sodium compounds (e.g., baking soda) that result from the combustion process that inflates the airbag. Small amounts of sodium hydroxide may be present which may irritate the skin and eyes, but none of the residue is toxic.



While the system is designed to help reduce serious injuries, it may also cause minor abrasions, swelling or temporary hearing loss. Because airbags must inflate rapidly and with considerable force, there is the risk of death or serious injuries such as fractures, facial and eye injuries or internal injuries, particularly to occupants who are not properly

Seating and Safety Restraints

restrained or are otherwise out of position at the time of airbag deployment. Thus, it is extremely important that occupants be properly restrained as far away from the airbag module as possible while maintaining vehicle control.



Several air bag system components get hot after inflation. Do not touch them after inflation.



If the air bag has deployed, **the air bag will not function again and must be replaced immediately**. If the air bag is not replaced, the unrepaired area will increase the risk of injury in a collision.

The SRS consists of:

- driver and passenger airbag modules (which include the inflators and airbags),
- one or more impact and safing sensors,
- a readiness light and tone
- and the electrical wiring which connects the components.

The diagnostic module monitors its own internal circuits and the supplemental airbag electrical system wiring (including the impact sensors), the system wiring, the airbag system readiness light, the airbag back up power and the airbag ignitors.

Determining if the system is operational

The SRS uses a readiness light in the instrument cluster or a tone to indicate the condition of the system. Refer to *Airbag readiness* section in the *Instrument Cluster* chapter. Routine maintenance of the airbag is not required.

A difficulty with the system is indicated by one or more of the following:

- The readiness light will either flash or stay lit.
- The readiness light will not illuminate immediately after ignition is turned on.
- A series of five beeps will be heard. The tone pattern will repeat periodically until the problem and/or light are repaired.



If any of these things happen, even intermittently, have the SRS serviced at your authorized dealer immediately. Unless serviced, the system may not function properly in the event of a collision.

Seating and Safety Restraints

Disposal of airbags and airbag equipped vehicles

See your local authorized dealer. Airbags MUST BE disposed of by qualified personnel.

Passenger airbag ON/OFF switch (if equipped)

 An airbag ON/OFF switch (if equipped) may be installed in this vehicle. Before driving, *always* look at the face of the switch to be sure the switch is in the proper position in accordance with these instructions and warnings. Failure to put the switch in a proper position can increase the risk of serious injury or death in a collision.

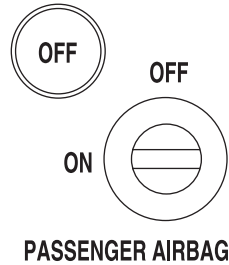

Turning the passenger airbag off

1. Insert the ignition key, turn the switch to OFF position and hold in OFF position while removing the key.
2. When the ignition is turned to the ON position the OFF light illuminates briefly, momentarily shuts off and then turns back on. This indicates that the passenger airbag is deactivated.

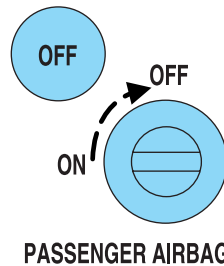

 If the light fails to illuminate when the passenger air bag switch is in the OFF position and the ignition switch is in ON, have the passenger air bag switch serviced at your authorized dealer immediately.

 In order to avoid inadvertent activation of the switch, always remove the ignition key from the passenger air bag ON/OFF switch.

Seating and Safety Restraints

 An infant in a rear-facing seat faces a high risk of serious or fatal injuries from a deploying passenger airbag. Rear facing infant seats should NEVER be placed in the front seats, unless the passenger airbag is turned off.

Turning the passenger airbag back on

The passenger airbag remains OFF until you turn it back ON.

1. Insert the ignition key and turn the switch to ON.
2. The OFF light will briefly illuminate when the ignition is turned to On. This indicates that the passenger airbag is operational.

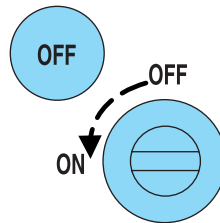

PASSENGER AIRBAG

 If the OFF light is illuminated when the passenger airbag switch is in the ON position and the ignition switch is in ON, have the passenger airbag switch serviced at your authorized dealer immediately.

The passenger side airbag should always be ON (the airbag OFF light should *not* be illuminated) unless the passenger is a person who meets the requirements stated either in Category 1, 2 or 3 of the NHTSA/Transport Canada deactivation criteria which follows.

 The safety belts for the driver and right front passenger seating positions have been specifically designed to function together with the airbags in certain types of crashes. When you turn OFF your airbag, you not only lose the protection of the airbag, you also may reduce the effectiveness of your safety belt system, which was designed to work with the airbag. If you are not a person who meets the requirements stated in the NHTSA/Transport Canada deactivation criteria turning OFF the airbag can increase the risk of serious injury or death in a collision.

Seating and Safety Restraints



If your vehicle has rear seats, always transport children who are 12 and younger in the rear seat. Always use safety belts and child restraints properly. DO NOT place a child in a rear facing infant seat in the front seat unless your vehicle is equipped with an airbag ON/OFF switch and the passenger airbag is turned OFF. This is because the back of the infant seat is too close to the inflating airbag and the risk of a fatal injury to the infant when the airbag inflates is substantial.

The vast majority of drivers and passengers are much safer with an airbag than without. To do their job and reduce the risk of life threatening injuries, airbags must open with great force, and this force can pose a potentially deadly risk in some situations, particularly when a front seat occupant is not properly buckled up. The most effective way to reduce the risk of unnecessary airbag injuries without reducing the overall safety of the vehicle is to make sure all occupants are properly restrained in the vehicle, especially in the front seat. This provides the protection of safety belts and permits the airbags to provide the additional protection they were designed to provide. If you choose to deactivate your airbag, you are losing the very significant risk reducing benefits of the airbag and you are also reducing the effectiveness of the safety belts, because safety belts in modern vehicles are designed to work as a safety system with the airbags.

Read all airbag warning labels in the vehicle as well as the other important airbag instructions and warnings in this Owner's Guide.

NHTSA deactivation criteria (excluding Canada)

1. **Infant.** An infant (less than 1 year old) must ride in the front seat because:
 - the vehicle has no rear seat;
 - the vehicle has a rear seat too small to accommodate a rear-facing infant seat; or
 - the infant has a medical condition which, according to the infant's physician, makes it necessary for the infant to ride in the front so that the driver can constantly monitor the child's condition.
2. **Child age 1 to 12.** A child age 1 to 12 must ride in the front seat because:
 - the vehicle has no rear seat;
 - although children ages 1 to 12 ride in the rear seat(s) whenever possible, children ages 1 to 12 sometimes must ride in the front because no space is available in the rear seat(s) of the vehicle; or

Seating and Safety Restraints

- the child has a medical condition which, according to the child's physician, makes it necessary for the child to ride in the front seat so that the driver can constantly monitor the child's condition.
3. **Medical condition.** A passenger has a medical condition which, according to his or her physician:
- causes the passenger airbag to pose a special risk for the passenger; and
 - makes the potential harm from the passenger airbag in a crash greater than the potential harm from turning OFF the airbag and allowing the passenger, even if belted, to hit the dashboard or windshield in a crash.



This vehicle has special energy management safety belts for the driver and right front passenger. These particular belts are specifically designed to work with airbags to help reduce the risk of injury in a collision. The energy management safety belt is designed to give or release additional belt webbing in some accidents to reduce concentration of force on an occupant's chest and reduce the risk of certain bone fractures and injuries to underlying organs. In a crash, if the airbag is turned OFF, this energy management safety belt might permit the person wearing the belt to move forward enough to incur a serious or fatal injury. The more severe the crash, and the heavier the occupant, the greater the risk is. Be sure the airbag is turned ON for any person who does not qualify under the NHTSA deactivation criteria.

Transport Canada deactivation criteria (Canada Only)

1. **Infant:** An infant (less than 1 year old) must ride in the front seat because:
- my vehicle has no rear seat;
 - the rear seat in my vehicle cannot accommodate a rear-facing infant seat; or
 - the infant has a medical condition which, according to the infant's physician, makes it necessary for the infant to ride in the front seat so that the driver can monitor the infant's condition.
2. **Child age 12 or under:** A child age 12 or under must ride in the front seat because:
- my vehicle has no rear seat;
 - although children age 12 and under ride in the rear seat whenever possible, children age 12 and under have no option but to sometimes ride in the front seat because rear seat space is insufficient; or

Seating and Safety Restraints

- the child has a medical condition that, according to the child's physician, makes it necessary for the child to ride in the front seat so that the driver can monitor the child's condition.
3. **Medical condition:** A passenger has a medical condition that, according to his or her physician:
- poses a special risk for the passenger if the airbag deploys; and
 - makes the potential harm from the passenger airbag deployment greater than the potential harm from turning OFF the airbag and experiencing a crash without the protection offered by the airbag



This vehicle has special energy management safety belts for the driver and right front passenger. These particular belts are specifically designed to work with airbags to help reduce the risk of injury in a collision. The energy management safety belt is designed to give or release additional belt webbing in some accidents to reduce concentration of force on an occupant's chest and reduce the risk of certain bone fractures and injuries to underlying organs. In a crash, if the airbag is turned OFF, this energy management safety belt might permit the person wearing the belt to move forward enough to incur a serious or fatal injury. The more severe the crash, and the heavier the occupant, the greater the risk is. Be sure the airbag is turned ON for any person who does not qualify under the NHTSA deactivation criteria.

SAFETY RESTRAINTS FOR CHILDREN

See the following sections for directions on how to properly use safety restraints for children. Also see *Airbag supplemental restraint system (SRS)* in this chapter for special instructions about using airbags.

Important child restraint precautions

You are required by law to use safety restraints for children in the U.S. and Canada. If small children (generally children who are four years old or younger and who weigh 40 lb. [18 kg] or less) ride in your vehicle, you must put them in safety seats made especially for children. Many states require that children use approved booster seats until they are eight years old. Check your local and state or provincial laws for specific requirements regarding the safety of children in your vehicle. When possible, always place children under age 12 in the rear seat of your vehicle. Accident statistics suggest that children are safer when properly restrained in the rear seating positions than in the front seating position.

Seating and Safety Restraints



Never let a passenger hold a child on his or her lap while the vehicle is moving. The passenger cannot protect the child from injury in a collision.

Always follow the instructions and warnings that come with any infant or child restraint you might use.

Children and safety belts

If the child is the proper size, restrain the child in a safety seat. Children who are too large for child safety seats (as specified by your child safety seat manufacturer) should always wear safety belts.

Follow all the important safety restraint and airbag precautions that apply to adult passengers in your vehicle.

If the shoulder belt portion of a combination lap and shoulder belt can be positioned so it does not cross or rest in front of the child's face or neck, the child should wear the lap and shoulder belt. Moving the child closer to the center of the vehicle may help provide a good shoulder belt fit.



Do not leave children, unreliable adults, or pets unattended in your vehicle.

Child booster seats

Children outgrow a typical convertible or toddler seat when they weigh 40 lb. (18 kg) and are around 4 years of age. Although the lap/shoulder belt will provide some protection, these children are still too small for lap/shoulder belts to fit properly, which could increase the risk of serious injury.

To improve the fit of both the lap and shoulder belt on children who have outgrown child safety seats, Ford Motor Company recommends use of a belt-positioning booster.

Booster seats position a child so that safety belts fit better. They lift the child up so that the lap belt rests low across the hips and the knees bend comfortably. Booster seats also may make the shoulder belt fit better and more comfortably, but make sure that the belt is approximately centered on the shoulder.

Seating and Safety Restraints

When children should use booster seats

Children need to use booster seats from the time they outgrow the toddler seat until they are big enough for the vehicle seat and lap/shoulder belt to fit properly. Generally this is when they weigh about 80 lb. (36 kg) (about 8 to 12 years old).

Booster seats should be used until you can answer YES to ALL of these questions:

- Can the child sit all the way back against the vehicle seat back with knees bent comfortably at the edge of the seat without slouching?

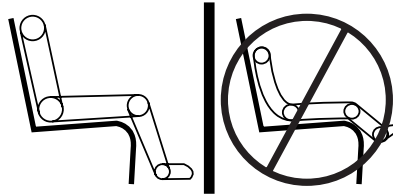

- Does the lap belt rest low across the hips?
- Is the shoulder belt centered on the shoulder and chest?
- Can the child stay seated like this for the whole trip?

Types of booster seats

There are two types of belt-positioning booster seats:

- Those that are backless.

If your backless booster seat has a removable shield, remove the shield and use the lap/shoulder belt. If a seating position has a low seat back and no head restraint, a backless booster seat may place your child's head (top of ear level) above the top of the seat. In this case, move the backless booster to another seating position with a higher seat back and lap/shoulder belts.



Seating and Safety Restraints

- Those with a high back.

If, with a backless booster seat, you cannot find a seating position that adequately supports your child's head, a high back booster seat would be a better choice.



Either type can be used at any seating position equipped with lap/shoulder belts if your child is over 40 lb. (18 kg).

Children and booster seats vary widely in size and shape. Choose a booster that keeps the lap belt low and snug across the hips, never up across the stomach, and lets you adjust the shoulder belt to cross the chest and rest snugly near the center of the shoulder. The drawings below compare the ideal fit (center) to a shoulder belt uncomfortably close to the neck and a shoulder belt that could slip off the shoulder.

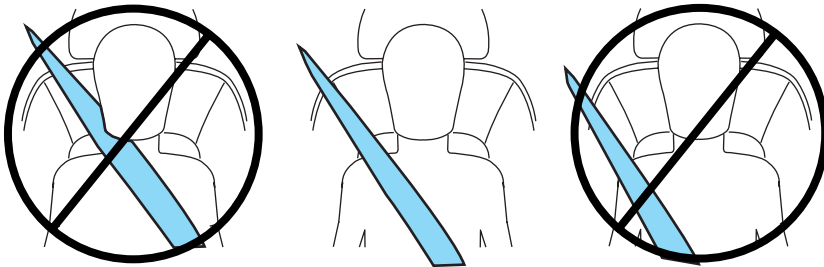

If the booster seat slides on the vehicle seat, placing a rubberized mesh sold as shelf or carpet liner under the booster seat may improve this condition.

The importance of shoulder belts

Using a booster without a shoulder belt increases the risk of a child's head hitting a hard surface in a collision. For this reason, you should never use a booster seat with a lap belt only. It is best to use a booster seat with lap/shoulder belts in the back seat- the safest place for children to ride.



Move a child to a different seating location if the shoulder belt does not stay positioned on the shoulder during use.

Seating and Safety Restraints



Follow all instructions provided by the manufacturer of the booster seat.



Never put the shoulder belt under a child's arm or behind the back because it eliminates the protection for the upper part of the body and may increase the risk of injury or death in a collision.



Never use pillows, books, or towels to boost a child. They can slide around and increase the likelihood of injury or death in a collision.

SAFETY SEATS FOR CHILDREN

Child and infant or child safety seats

Use a safety seat that is recommended for the size and weight of the child. Carefully follow all of the manufacturer's instructions with the safety seat you put in your vehicle. If you do not install and use the safety seat properly, the child may be injured in a sudden stop or collision.

When installing a child safety seat:

- Review and follow the information presented in the *Airbag supplemental restraint system (SRS)* section in this chapter.
- Use the correct safety belt buckle for that seating position (the buckle closest to the direction the tongue is coming from).
- Insert the belt tongue into the proper buckle until you hear a snap and feel it latch. Make sure the tongue is securely fastened in the buckle.
- Keep the buckle release button pointing up and away from the safety seat, with the tongue between the child seat and the release button, to prevent accidental unbuckling.
- Place seat back in upright position.
- Put the safety belt in the automatic locking mode. Refer to *Automatic locking mode* (passenger side front and outboard rear seating positions) (if equipped) section in this chapter.

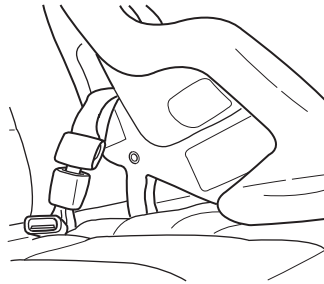

Seating and Safety Restraints

- Top tether anchors can be used for children up to 60 pounds (27 kg) in a child restraint, and to provide upper torso restraint for children up to 80 pounds (36 kg) using an upper torso harness and a belt-positioning booster.

Ford recommends the use of a child safety seat having a top tether strap. Install the child safety seat in a seating position with a tether anchor. For more information on top tether straps and anchors, refer to *Attaching child safety seats with tether straps* in this chapter.



Carefully follow all of the manufacturer's instructions included with the safety seat you put in your vehicle. If you do not install and use the safety seat properly, the child may be injured in a sudden stop or collision.



Rear-facing child seats or infant carriers should never be placed in the front seats, unless the passenger airbag On/Off switch is turned off. See *Passenger airbag ON/OFF switch* in this chapter.

Installing child safety seats with combination lap and shoulder belts

1. Position the child safety seat in a seat with a combination lap and shoulder belt.

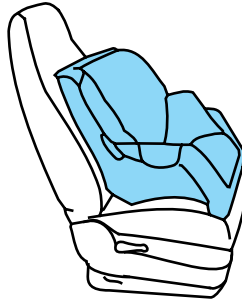

An airbag can kill or injure a child in a child seat. Child seats should NEVER be placed in the front seats, unless the passenger airbag switch is turned off. See *Passenger airbag on/off switch*.



Rear facing child seats should NEVER be placed in the front seats unless the passenger airbag switch is turned off.

Seating and Safety Restraints

2. Pull down on the shoulder belt and then grasp the shoulder belt and lap belt together.

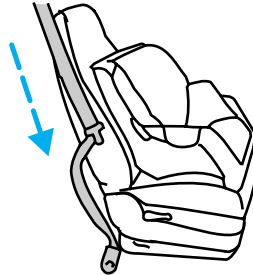

3. While holding the shoulder and lap belt portions together, route the tongue through the child seat according to the child seat manufacturer's instructions. Be sure the belt webbing is not twisted.

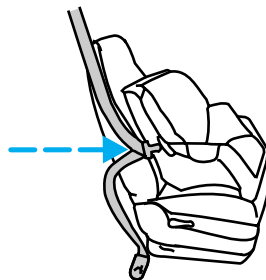

4. Insert the belt tongue into the proper buckle (the buckle closest to the direction the tongue is coming from) for that seating position until you hear and feel the latch engage. Make sure the tongue is latched securely by pulling on it.

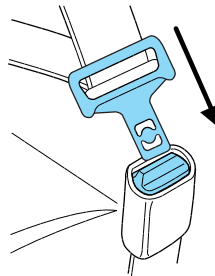

Seating and Safety Restraints

5. To put the retractor in the automatic locking mode, grasp the shoulder portion of the belt and pull downward until all of the belt is extracted and a click is heard.

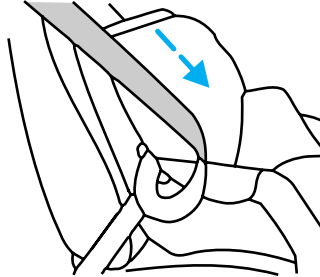

6. Allow the belt to retract. The belt will click as it retracts to indicate it is in the automatic locking mode.

7. Pull the lap belt portion across the child seat toward the buckle and pull up on the shoulder belt while pushing down with knee on the child seat.

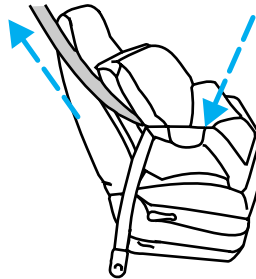

8. Allow the safety belt to retract to remove any slack in the belt.

9. Before placing the child in the seat, forcibly tilt the seat forward and back to make sure the seat is securely held in place. To check this, grab the seat at the belt path and attempt to move it side to side and forward. There should be no more than one inch of movement for proper installation.

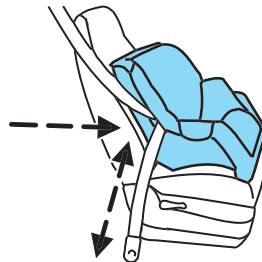

10. Try to pull the belt out of the retractor to make sure the retractor is in the automatic locking mode (you should not be able to pull more belt out). If the retractor is not locked, unbuckle the belt and repeat Steps two through nine.

Check to make sure the child seat is properly secured before each use.

Seating and Safety Restraints

Attaching child safety seats with tether straps

Most new forward-facing child safety seats include a tether strap which goes over the back of the seat and hooks to an anchoring point. Tether straps are available as an accessory for many older safety seats. Contact the manufacturer of your child seat for information about ordering a tether strap.

The passenger seats of your vehicle may be equipped with built-in tether strap anchors located behind the seats as described below.

The tether anchors in your vehicle may be straps on the seatback or an anchor bracket on the rear edge of the seat cushion or an anchor bracket mounted to the body shell on the back panel.

The SuperCab rear seat has three straps behind the top of the seat back that function as both routing loops for the tether straps and anchor loops.

The tether strap anchors in your vehicle are in the following positions (shown from top view):



Attach the tether strap only to the appropriate tether anchor as shown. The tether strap may not work properly if attached somewhere other than the correct tether anchor.

• F-Series Regular Cab

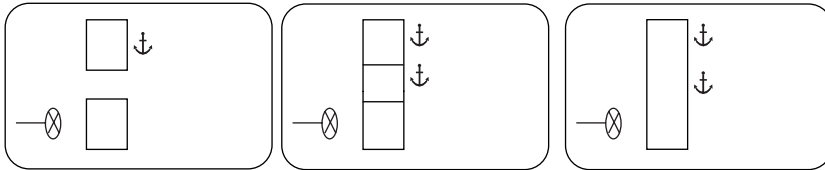

• F-Series SuperCab

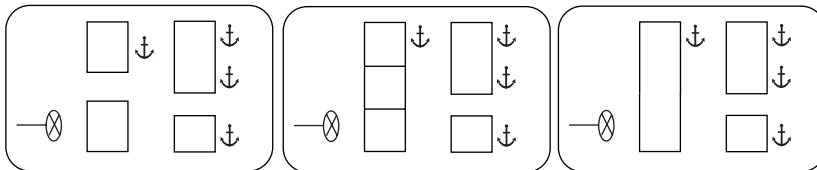

Seating and Safety Restraints

- **F-Series Crew Cab**

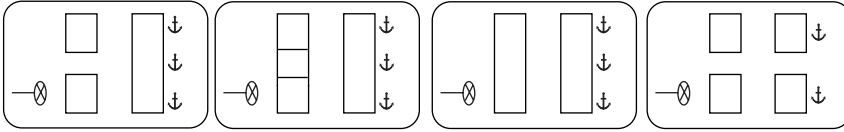

Tether strap attachment

1. Position the child safety seat on the seat cushion.
2. Route the child safety seat tether strap over the back of the seat.
3. Locate the correct anchor for the selected seating position.
4. You may need to pull the seatback forward to access the tether anchors. Make sure the seat is locked in the upright position before installing the child seat. Refer to the *Rear folding seat system with load floor* section in this chapter for information on how to operate the rear seats.
5. Remove tether cover.

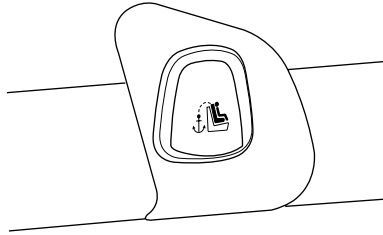

6. Clip the tether strap to the anchor as shown.

- **Front seats (Regular Cab)**

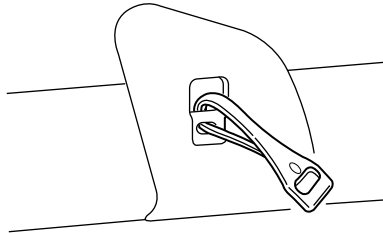

Seating and Safety Restraints

- Front seat (SuperCab)

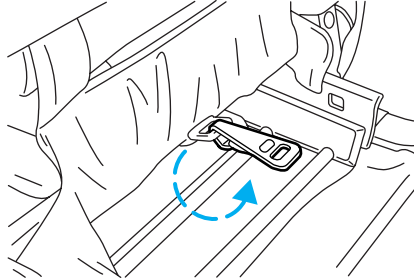

- Rear seats (Crew Cab)

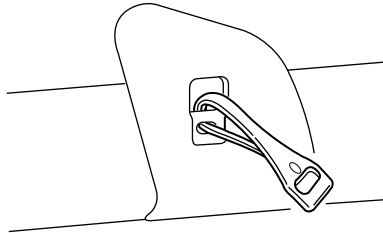

If the tether strap is clipped incorrectly, the child safety seat may not be retained properly in the event of a collision.

7. Refer to the *Installing child safety seats with combination lap and shoulder belts* section of this chapter for further instructions to secure the child safety seat.

8. Tighten the child safety seat tether strap according to the manufacturer's instructions.



If the safety seat is not anchored properly, the risk of a child being injured in a collision greatly increases.

Tether strap attachment (rear SuperCab only)

There are three loops of webbing just above the back of the rear seat (along the bottom edge of the rear window) in the SuperCab. These loops are to be used as both routing loops and anchor loops for up to three child safety seat tether straps.

These straps may be secured below the back of the seat with rubber bands. To access, reach below the back of the seat and pull tether loop out of the rubber band securing it.

Seating and Safety Restraints

Many tether straps cannot be tightened if the tether strap is hooked to the loop directly behind the child seat. To provide a tight tether strap:

1. Route the tether strap through the loop directly behind the child seat.



2. Attach the strap hook onto the loop behind an adjacent seating position.

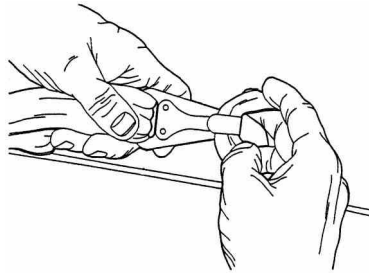

3. Install the child safety seat tightly using the vehicle belts. Follow the instructions in this chapter.

4. Tighten the tether strap according to the child seat manufacturer's instructions.

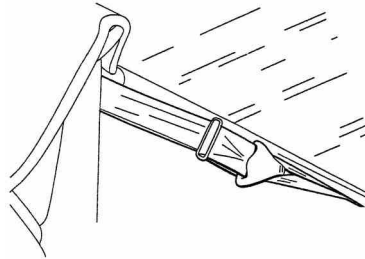

A single loop can be used to route and anchor more than one child seat. For example, the center loop can be used as a routing loop for a child safety seat in the center rear seat and as an anchoring loop for child seats installed in the outboard rear seats.

Tires, Wheels and Loading

NOTICE TO UTILITY VEHICLE AND TRUCK OWNERS

Utility vehicles and trucks handle differently than passenger cars in the various driving conditions that are encountered on streets, highways and off-road. Utility vehicles and trucks are not designed for cornering at speeds as high as passenger cars any more than low-slung sports cars are designed to perform satisfactorily under off-road conditions.

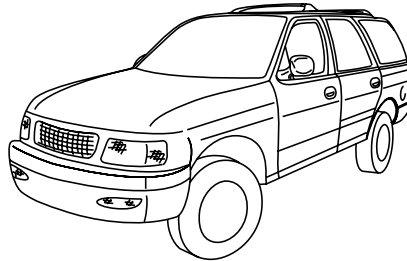

Utility vehicles have a significantly higher rollover rate than other types of vehicles. To reduce the risk of serious injury or death from a rollover or other crash you must:

- Avoid sharp turns and abrupt maneuvers;
- Drive at safe speeds for the conditions;
- Keep tires properly inflated;
- Never overload or improperly load your vehicle; and
- Make sure every passenger is properly restrained.



In a rollover crash, an unbelted person is significantly more likely to die than a person wearing a seat belt. All occupants must wear safety belts and children/infants must use appropriate restraints to minimize the risk of injury or ejection.

Study your *Owner's Guide* and any supplements for specific information about equipment features, instructions for safe driving and additional precautions to reduce the risk of an accident or serious injury.

VEHICLE CHARACTERISTICS

4WD and AWD Systems (if equipped)

A vehicle equipped with AWD or 4WD (when you select the 4WD mode) has the ability to use all four wheels to power itself. This increases traction which may enable you to safely drive over terrain and road conditions that a conventional two-wheel drive vehicle cannot.

204

Tires, Wheels and Loading

Power is supplied to all four wheels through a transfer case or power transfer unit. 4WD vehicles allow you to select different drive modes as necessary. Information on shifting procedures and maintenance can be found in your *Owner's Guide*. You should become thoroughly familiar with this information before you operate your vehicle.

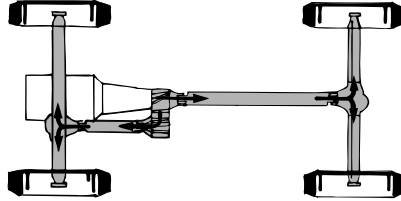

On some 4WD models, the initial shift from two-wheel drive to 4WD while the vehicle is moving can cause a momentary clunk and ratcheting sound. These sounds are normal as the front drivetrain comes up to speed and is not cause for concern.



Do not become overconfident in the ability of 4WD and AWD vehicles. Although a 4WD or AWD vehicle may accelerate better than two-wheel drive vehicle in low traction situations, it won't stop any faster than two-wheel drive vehicles. Always drive at a safe speed.

How your vehicle differs from other vehicles

SUV and trucks can differ from some other vehicles in a few noticeable ways. Your vehicle may be:

- Higher – to allow higher load carrying capacity and to allow it to travel over rough terrain without getting hung up or damaging underbody components.
- Shorter – to give it the capability to approach inclines and drive over the crest of a hill without getting hung up or damaging underbody components. All other things held equal, a shorter wheelbase may make your vehicle quicker to respond to steering inputs than a vehicle with a longer wheelbase.

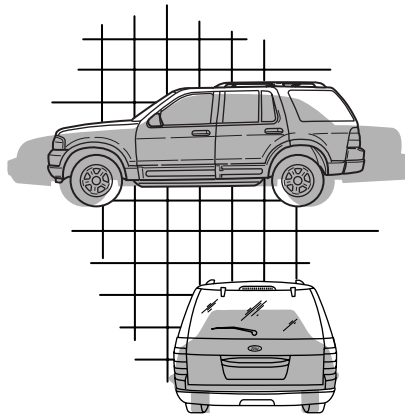

Tires, Wheels and Loading

- Narrower — to provide greater maneuverability in tight spaces, particularly in off-road use.

As a result of the above dimensional differences, SUV's and trucks often will have a higher center of gravity and a greater difference in center of gravity between the loaded and unloaded condition.

These differences that make your vehicle so versatile also make it handle differently than an ordinary passenger car.

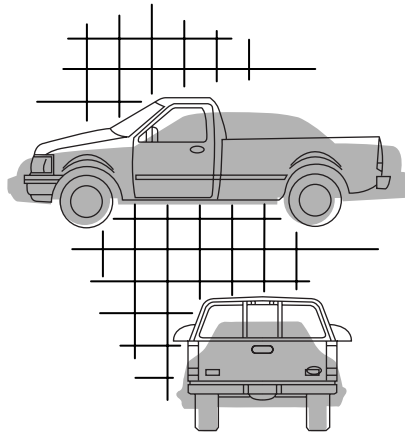

INFORMATION ABOUT UNIFORM TIRE QUALITY GRADING

Tire Quality Grades apply to new pneumatic passenger car tires. The Quality grades can be found where applicable on the tire sidewall between tread shoulder and maximum section width. For example:

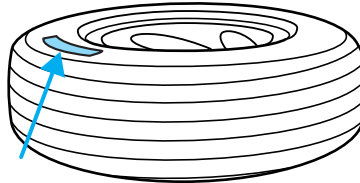

- **Treadwear 200 Traction AA Temperature A**

These Tire Quality Grades are determined by standards that the United States Department of Transportation has set.

Tire Quality Grades apply to new pneumatic passenger car tires. They do not apply to deep tread, winter-type snow tires, space-saver or temporary use spare tires, light truck or "LT" type tires, tires with nominal rim diameters of 10 to 12 inches or limited production tires as defined in Title 49 Code of Federal Regulations Part 575.104(c)(2).

U.S. Department of Transportation-Tire quality grades: The U.S. Department of Transportation requires Ford Motor Company to give you the following information about tire grades exactly as the government has written it.

Tires, Wheels and Loading

Treadwear

The treadwear grade is a comparative rating based on the wear rate of the tire when tested under controlled conditions on a specified government test course. For example, a tire graded 150 would wear one and one-half (1 1/2) times as well on the government course as a tire graded 100. The relative performance of tires depends upon the actual conditions of their use, however, and may depart significantly from the norm due to variations in driving habits, service practices, and differences in road characteristics and climate.

Traction AA A B C

The traction grades, from highest to lowest are AA, A, B, and C. The grades represent the tire's ability to stop on wet pavement as measured under controlled conditions on specified government test surfaces of asphalt and concrete. A tire marked C may have poor traction performance.



The traction grade assigned to this tire is based on straight-ahead braking traction tests, and does not include acceleration, cornering, hydroplaning or peak traction characteristics.

Temperature A B C

The temperature grades are A (the highest), B and C, representing the tire's resistance to the generation of heat and its ability to dissipate heat when tested under controlled conditions on a specified indoor laboratory test wheel. Sustained high temperature can cause the material of the tire to degenerate and reduce tire life, and excessive temperature can lead to sudden tire failure. The grade C corresponds to a level of performance which all passenger car tires must meet under the Federal Motor Vehicle Safety Standard No. 139. Grades B and A represent higher levels of performance on the laboratory test wheel than the minimum required by law.



The temperature grade for this tire is established for a tire that is properly inflated and not overloaded. Excessive speed, underinflation, or excessive loading, either separately or in combination, can cause heat buildup and possible tire failure.

Tires, Wheels and Loading

TIRES

Tires are designed to give many thousands of miles of service, but they must be maintained in order to get the maximum benefit from them.

Glossary of tire terminology

- **Tire Label:** A label showing the OE (Original Equipment) tire sizes, recommended inflation pressure and the maximum weight the vehicle can carry.
- **Tire Identification Number (TIN):** A number on the sidewall of each tire providing information about the tire brand and manufacturing plant, tire size and date of manufacture. Also referred to as DOT code.
- **Inflation pressure:** A measure of the amount of air in a tire.
- **Standard load:** A class of P-metric or Metric tires designed to carry a maximum load at 35 psi [37 psi (2.5 bar) for Metric tires]. Increasing the inflation pressure beyond this pressure will not increase the tire's load carrying capability.
- **Extra load:** A class of P-metric or Metric tires designed to carry a heavier maximum load at 41 psi [43 psi (2.9 bar) for Metric tires]. Increasing the inflation pressure beyond this pressure will not increase the tire's load carrying capability.
- **kPa:** Kilopascal, a metric unit of air pressure.
- **PSI:** Pounds per square inch, a standard unit of air pressure.
- **Cold inflation pressure:** The tire pressure when the vehicle has been stationary and out of direct sunlight for an hour or more and prior to the vehicle being driven for 1 mile (1.6 km).
- **Recommended inflation pressure:** The cold inflation pressure found on the Tire Label or Safety Compliance Certification Label located on the B-Pillar or the edge of the driver's door.
- **B-pillar:** The structural member at the side of the vehicle behind the front door.
- **Bead area of the tire:** Area of the tire next to the rim.
- **Sidewall of the tire:** Area between the bead area and the tread.
- **Tread area of the tire:** Area of the perimeter of the tire that contacts the road when mounted on the vehicle.
- **Rim:** The metal support (wheel) for a tire or a tire and tube assembly upon which the tire beads are seated.

208

Tires, Wheels and Loading

INFLATING YOUR TIRES

Safe operation of your vehicle requires that your tires are properly inflated. Remember that a tire can lose up to half of its air pressure without appearing flat.

Every day before you drive, check your tires. If one looks lower than the others, use a tire gauge to check pressure of all tires and adjust if required.

At least once a month and before long trips, inspect each tire and check the tire pressure with a tire gauge (including spare, if equipped). Inflate all tires to the inflation pressure recommended by Ford Motor Company.

Use a tire gauge to check the tire inflation pressure, including the spare (if equipped), at least monthly and before long trips. You are strongly urged to buy a reliable tire pressure gauge, as automatic service station gauges may be inaccurate. Ford recommends the use of a digital or dial-type tire pressure gauge rather than a stick-type tire pressure gauge.

Use the recommended cold inflation pressure for optimum tire performance and wear. Under-inflation or over-inflation may cause uneven treadwear patterns.



Under-inflation is the most common cause of tire failures and may result in severe tire cracking, tread separation or "blowout", with unexpected loss of vehicle control and increased risk of injury. Under-inflation increases sidewall flexing and rolling resistance, resulting in heat buildup and internal damage to the tire. It also may result in unnecessary tire stress, irregular wear, loss of vehicle control and accidents. A tire can lose up to half of its air pressure and not appear to be flat!

Always inflate your tires to the Ford recommended inflation pressure even if it is less than the maximum inflation pressure information found on the tire. The Ford recommended tire inflation pressure is found on the Safety Compliance Certification Label or Tire Label which is located on the B-Pillar or the edge of the driver's door. Failure to follow the tire pressure recommendations can cause uneven treadwear patterns and adversely affect the way your vehicle handles.

Maximum Permissible Inflation Pressure is the tire manufacturer's maximum permissible pressure and/or the pressure at which the maximum load can be carried by the tire. This pressure is normally higher than the manufacturer's recommended cold inflation pressure which can be found on the Safety Compliance Certification Label or Tire

Tires, Wheels and Loading

Label which is located on the B-Pillar or the edge of the driver's door. The cold inflation pressure should never be set lower than the recommended pressure on the Safety Compliance Certification Label or Tire Label.

When weather temperature changes occur, tire inflation pressures also change. A 10°F (6°C) temperature drop can cause a corresponding drop of 1 psi (7 kPa) in inflation pressure. Check your tire pressures frequently and adjust them to the proper pressure which can be found on the Safety Compliance Certification Label or the Tire Label.

To check the pressure in your tire(s):

1. Make sure the tires are cool, meaning they are not hot from driving even a mile.

If you are checking tire pressure when the tire is hot, (i.e. driven more than 1 mile [1.6 km]), never "bleed" or reduce air pressure. The tires are hot from driving and it is normal for pressures to increase above recommended cold pressures. A hot tire at or below recommended cold inflation pressure could be significantly under-inflated.

Note: If you have to drive a distance to get air for your tire(s), check and record the tire pressure first and add the appropriate air pressure when you get to the pump. It is normal for tires to heat up and the air pressure inside to go up as you drive.

2. Remove the cap from the valve on one tire, then firmly press the tire gauge onto the valve and measure the pressure with the tire gauge.

3. Add enough air to reach the recommended air pressure

Note: If you overfill the tire, release air by pushing on the metal stem in the center of the valve. Then recheck the pressure with your tire gauge.

4. Replace the valve cap.

5. Repeat this procedure for each tire, including the spare.

Note: Some spare tires operate at a higher inflation pressure than the other tires. For T-type/mini-spacer tires (see *Dissimilar Spare Tire/Wheel Information* section for description): Store and maintain at 60 psi (4.15 bar). For dissimilar spare tires and full-size matching spare tires (see the *Dissimilar Spare Tire/Wheel Information* and *Full-size Matching Spare Tire/Wheel Information* sections for descriptions): Store and maintain at the higher of the front and rear inflation pressure as shown on the or Safety Compliance Certification Label or the Tire Label.

6. Visually inspect the tires to make sure there are no nails or other objects embedded that could poke a hole in the tire and cause an air leak.

7. Check the sidewalls to make sure there are no gouges, cuts or bulges.

Tires, Wheels and Loading

Tire inflation information

All tires with Steel Carcass Plies (if equipped):

This type of tire utilizes steel cords in the sidewalls. As such, they cannot be treated like normal light truck tires. Tire service, including adjusting the air pressure, must be performed by personnel trained, supervised and equipped according to Federal Occupational Safety and Health Administration (OSHA) regulations. For example, during any procedure involving tire inflation, the technician or individual must utilize a remote inflation device, and ensure that all persons are clear of the trajectory area.

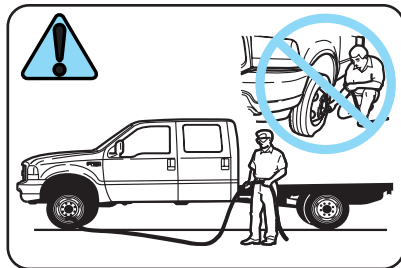

! **WARNING** An inflated tire and rim can be very dangerous if improperly used, serviced or maintained. To avoid serious injury, never attempt to re-inflate a tire which has been run flat or seriously under-inflated without first removing the tire from the wheel assembly for inspection. Do not attempt to add air to tires or replace tires or wheels without first taking precautions to protect persons and property.

Tires, Wheels and Loading

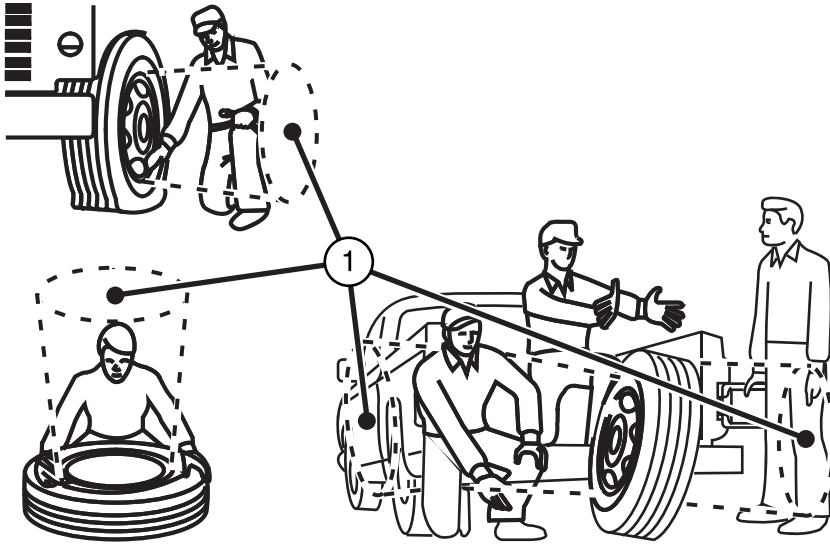

Stay out of the trajectory (1) as indicated in the illustration.

TIRE CARE

Inspecting your tires

Periodically inspect the tire treads for uneven or excessive wear and remove objects such as stones, nails or glass that may be wedged in the tread grooves. Check for holes or cuts that may permit air leakage from the tire and make necessary repairs. Also inspect the tire sidewalls for cracking, cuts, bruises and other signs of damage or excessive wear. If internal damage to the tire is suspected, have the tire demounted and inspected in case it needs to be repaired or replaced. For your safety, tires that are damaged or show signs of excessive wear should not be used because they are more likely to blow out or fail.

Improper or inadequate vehicle maintenance can cause tires to wear abnormally. Inspect all your tires, including the spare, frequently, and replace them if one or more of the following conditions exist:

212

Tires, Wheels and Loading

Tire wear

When the tread is worn down to 1/16th of an inch (2 mm), tires must be replaced to help prevent your vehicle from skidding and hydroplaning. Built-in treadwear indicators, or “wear bars”, which look like narrow strips of smooth rubber across the tread will appear on the tire when the tread is worn down to 1/16th of an inch (2 mm).

When the tire tread wears down to the same height as these “wear bars”, the tire is worn out and must be replaced.

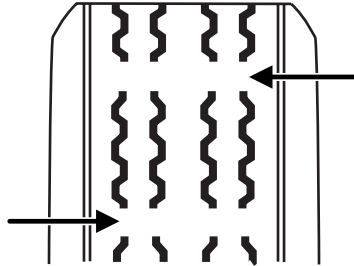

Damage

Periodically inspect the tire treads and sidewalls for damage (such as bulges in the tread or sidewalls, cracks in the tread groove and separation in the tread or sidewall). If damage is observed or suspected have the tire inspected by a tire professional. Tires can be damaged during off-road use, so inspection after off-road use is also recommended.



Age

Tires degrade over time depending on many factors such as weather, storage conditions, and conditions of use (load, speed, inflation pressure, etc.) the tires experience throughout their lives. In general, tires should be replaced after 6 years regardless of tread wear. However, heat caused by hot climates or frequent high loading conditions can accelerate the aging process and may require tires to be replaced more frequently.

You should replace your spare tire when you replace the road tires or after 6 years due to aging even if it has not been used.

Tires, Wheels and Loading

U.S. DOT Tire Identification Number (TIN)

U.S. and Canada Federal regulations require tire manufacturers to place standardized information on the sidewall of all tires. This information identifies and describes the fundamental characteristics of the tire and also provides a U.S. DOT Tire Identification Number for safety standard certification and in case of a recall.

This begins with the letters "DOT" and indicates that the tire meets all federal standards. The next two numbers or letters are the plant code designating where it was manufactured, the next two are the tire size code and the last four numbers represent the week and year the tire was built. For example, the numbers 317 mean the 31st week of 1997. After 2000 the numbers go to four digits. For example, 2501 means the 25th week of 2001. The numbers in between are identification codes used for traceability. This information is used to contact customers if a tire defect requires a recall.

Tire replacement requirements

Your vehicle is equipped with tires designed to provide a safe ride and handling capability.



Only use replacement tires and wheels that are the same size, load index, speed rating and type (such as P-metric versus LT-metric or all-season versus all-terrain) as those originally provided by Ford. The recommended tire and wheel size may be found on either the Safety Compliance Certification Label or the Tire Label which is located on the B-Pillar or edge of the driver's door. If this information is not found on these labels then you should consult your Ford Dealer. Use of any tire or wheel not recommended by Ford can affect the safety and performance of your vehicle, which could result in an increased risk of loss of vehicle control, vehicle rollover, personal injury and death. Additionally the use of non-recommended tires and wheels could cause steering, suspension, axle or transfer case/power transfer unit failure. If you have questions regarding tire replacement, see an authorized dealer.

Tires, Wheels and Loading



When mounting replacement tires and wheels, you should not exceed the maximum pressure indicated on the sidewall of the tire to set the beads without additional precautions listed below. If the beads do not seat at the maximum pressure indicated, re-lubricate and try again.

When inflating the tire for mounting pressures up to 20 psi (138 kPa) greater than the maximum pressure on the tire sidewall, the following precautions must be taken to protect the person mounting the tire:

1. Make sure you have the correct tire and wheel size
2. Lubricate the tire bead and wheel bead area again
3. Stand at a minimum of 12 ft. (3.7 m) away from the tire wheel assembly
4. Use both eye and ear protection

For a mounting pressure more than 20 psi (138 kPa) greater than the maximum pressure, a Ford Dealer or other tire service professional should do the mounting.

Always inflate steel carcass tires with a remote air fill with the person inflating standing at a minimum of 12 ft. (3.7 m) away from the tire wheel assembly.

Important: Remember to replace the wheel valve stems when the road tires are replaced on your vehicle.

It is recommended that the two front tires or two rear tires generally be replaced as a pair.

The tire pressure sensors mounted in the wheels (if equipped) are not designed to be used in aftermarket wheels.

The use of wheels or tires not recommended by Ford Motor Company may affect the operation of your Tire Pressure Monitoring System (if equipped).

If the TPMS indicator is flashing, your TPMS is malfunctioning. Your replacement tire might be incompatible with your TPMS, or some component of the TPMS may be damaged (if equipped).

Safety practices

Driving habits have a great deal to do with your tire mileage and safety.

- Observe posted speed limits
- Avoid fast starts, stops and turns
- Avoid potholes and objects on the road

Tires, Wheels and Loading

- Do not run over curbs or hit the tire against a curb when parking



If your vehicle is stuck in snow, mud, sand, etc., **do not** rapidly spin the tires; spinning the tires can tear the tire and cause an explosion. A tire can explode in as little as three to five seconds.



Never spin the tires in excess of the 35 mph (55 km/h) point indicated on the speedometer.

Highway hazards

No matter how carefully you drive there's always the possibility that you may eventually have a flat tire on the highway. Drive slowly to the closest safe area out of traffic. This may further damage the flat tire, but your safety is more important.

If you feel a sudden vibration or ride disturbance while driving, or you suspect your tire or vehicle has been damaged, immediately reduce your speed. Drive with caution until you can safely pull off the road. Stop and inspect the tires for damage. If a tire is under-inflated or damaged, deflate it, remove wheel and replace it with your spare tire and wheel. If you cannot detect a cause, have the vehicle towed to the nearest repair facility or tire dealer to have the vehicle inspected.

Tire and wheel alignment

A bad jolt from hitting a curb or pothole can cause the front end of your vehicle to become misaligned or cause damage to your tires. If your vehicle seems to pull to one side when you're driving, the wheels may be out of alignment. Have your authorized dealer check the wheel alignment periodically.

Wheel misalignment in the front or the rear can cause uneven and rapid treadwear of your tires and should be corrected by your authorized dealer. Front Wheel Drive (FWD) vehicles and those with an independent rear suspension (if equipped) may require alignment of all four wheels.

The tires should also be balanced periodically. An unbalanced tire and wheel assembly may result in irregular tire wear.

Tires, Wheels and Loading

Tire rotation

Rotating your tires at the recommended interval (as indicated in the *scheduled maintenance information* that comes with your vehicle) will help your tires wear more evenly, providing better tire performance and longer tire life.

- Rear Wheel Drive (RWD) vehicles/Four Wheel Drive (4WD) (front tires at top of diagram)

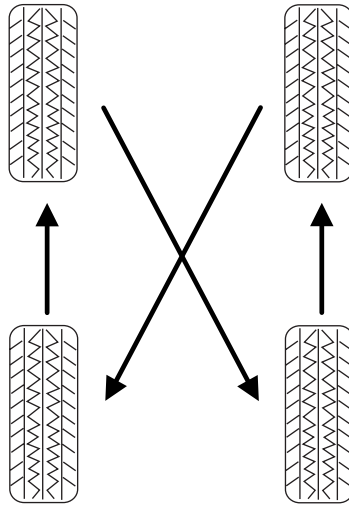

Sometimes irregular tire wear can be corrected by rotating the tires.

Note: If your tires show uneven wear ask your authorized dealer to check for and correct any wheel misalignment, tire imbalance or mechanical problem involved before tire rotation.

Note: Your vehicle may be equipped with a dissimilar spare tire/wheel. A dissimilar spare tire/wheel is defined as a spare tire and/or wheel that is different in brand, size or appearance from the road tires and wheels. If you have a dissimilar spare tire/wheel it is intended for temporary use only and should not be used in a tire rotation.

Note: After having your tires rotated, inflation pressure must be checked and adjusted to the vehicle requirements.

Tires, Wheels and Loading

- Dual Rear Wheel (DRW) – Six tire rotation

If your vehicle is equipped with dual rear wheels it is recommended that the front and rear tires (in pairs) be rotated only side to side. We do not recommend splitting up the dual rear wheels. Rotate them side to side as a set/pair. After tire rotation, inflation pressures must be adjusted for the tires new positions in accordance with vehicle requirements.

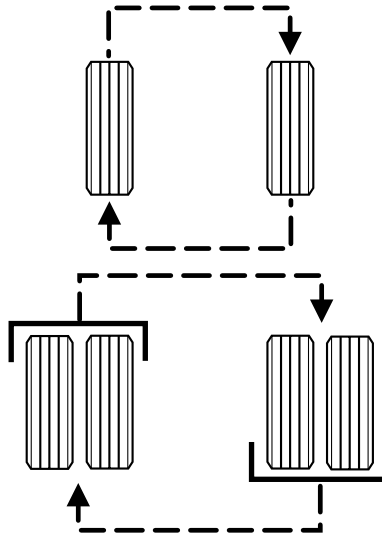

Sometimes irregular tire wear can be corrected by rotating the tires.

Note: If your tires show uneven wear ask your authorized dealer to check for and correct any wheel misalignment, tire imbalance or mechanical problem involved before tire rotation.

Note: Your vehicle may be equipped with a dissimilar spare tire/wheel. A dissimilar spare tire/wheel is defined as a spare tire and/or wheel that is different in brand, size or appearance from the road tires and wheels. If you have a dissimilar spare tire/wheel it is intended for temporary use only and should not be used in a tire rotation.

Note: After having your tires rotated, inflation pressure must be checked and adjusted to the vehicle requirements.



If the tire label shows different tire pressures for the front and rear tires and the vehicle is equipped with TPMS (tire pressure monitoring system), then the settings for the TPMS sensors need to be updated. Always perform the TPMS reset procedure after tire rotation. If the system is not reset, it may not provide a low tire pressure warning when necessary. See the TPMS reset procedure in this chapter.

Tires, Wheels and Loading

INFORMATION CONTAINED ON THE TIRE SIDEWALL

U.S. and Canada Federal regulations require tire manufacturers to place standardized information on the sidewall of all tires. This information identifies and describes the fundamental characteristics of the tire and also provides a U.S. DOT Tire Identification Number for safety standard certification and in case of a recall.

Information on “P” type tires

P215/65R15 95H is an example of a tire size, load index and speed rating. The definitions of these items are listed below. (Note that the tire size, load index and speed rating for your vehicle may be different from this example.)

1. **P:** Indicates a tire, designated by the Tire and Rim Association (T&RA), that may be used for service on cars, SUVs, minivans and light trucks.

Note: If your tire size does not begin with a letter this may mean it is designated by either ETRTO (European Tire and Rim Technical Organization) or JATMA (Japan Tire Manufacturing Association).

2. **215:** Indicates the nominal width of the tire in millimeters from sidewall edge to sidewall edge. In general, the larger the number, the wider the tire.

3. **65:** Indicates the aspect ratio which gives the tire's ratio of height to width.

4. **R:** Indicates a “radial” type tire.

5. **15:** Indicates the wheel or rim diameter in inches. If you change your wheel size, you will have to purchase new tires to match the new wheel diameter.

6. **95:** Indicates the tire's load index. It is an index that relates to how much weight a tire can carry. You may find this information in your *Owner's Guide*. If not, contact a local tire dealer.

Note: You may not find this information on all tires because it is not required by federal law.

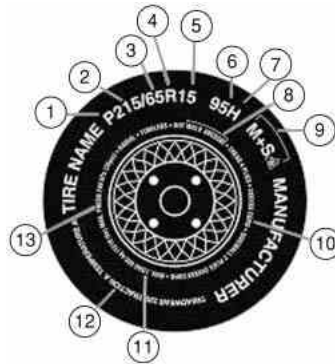

Tires, Wheels and Loading

7. **H:** Indicates the tire's speed rating. The speed rating denotes the speed at which a tire is designed to be driven for extended periods of time under a standard condition of load and inflation pressure. The tires on your vehicle may operate at different conditions for load and inflation pressure. These speed ratings may need to be adjusted for the difference in conditions. The ratings range from 81 mph (130 km/h) to 186 mph (299 km/h). These ratings are listed in the following chart.

Note: You may not find this information on all tires because it is not required by federal law.

Letter rating	Speed rating - mph (km/h)
M	81 mph (130 km/h)
N	87 mph (140 km/h)
Q	99 mph (159 km/h)
R	106 mph (171 km/h)
S	112 mph (180 km/h)
T	118 mph (190 km/h)
U	124 mph (200 km/h)
H	130 mph (210 km/h)
V	149 mph (240 km/h)
W	168 mph (270 km/h)
Y	186 mph (299 km/h)

Note: For tires with a maximum speed capability over 149 mph (240 km/h), tire manufacturers sometimes use the letters ZR. For those with a maximum speed capability over 186 mph (299 km/h), tire manufacturers always use the letters ZR.

8. **U.S. DOT Tire Identification Number (TIN):** This begins with the letters "DOT" and indicates that the tire meets all federal standards. The next two numbers or letters are the plant code designating where it was manufactured, the next two are the tire size code and the last four numbers represent the week and year the tire was built. For example, the numbers 317 mean the 31st week of 1997. After 2000 the numbers go to four digits. For example, 2501 means the 25th week of 2001. The numbers in between are identification codes used for traceability. This information is used to contact customers if a tire defect requires a recall.

9. **M+S or M/S:** Mud and Snow, or

AT: All Terrain, or

AS: All Season.

Tires, Wheels and Loading

10. **Tire Ply Composition and Material Used:** Indicates the number of plies or the number of layers of rubber-coated fabric in the tire tread and sidewall. Tire manufacturers also must indicate the ply materials in the tire and the sidewall, which include steel, nylon, polyester, and others.

11. **Maximum Load:** Indicates the maximum load in kilograms and pounds that can be carried by the tire. Refer to the Tire Label or Safety Compliance Certification Label, which is located on the B-Pillar or the edge of the driver's door, for the correct tire pressure for your vehicle.

12. Treadwear, Traction and Temperature Grades

- **Treadwear:** The treadwear grade is a comparative rating based on the wear rate of the tire when tested under controlled conditions on a specified government test course. For example, a tire graded 150 would wear one and one-half (1½) times as well on the government course as a tire graded 100.
- **Traction:** The traction grades, from highest to lowest are AA, A, B, and C. The grades represent the tire's ability to stop on wet pavement as measured under controlled conditions on specified government test surfaces of asphalt and concrete. A tire marked C may have poor traction performance.
- **Temperature:** The temperature grades are A (the highest), B and C, representing the tire's resistance to the generation of heat and its ability to dissipate heat when tested under controlled conditions on a specified indoor laboratory test wheel.

13. **Maximum Permissible Inflation Pressure:** Indicates the tire manufacturers' maximum permissible pressure and/or the pressure at which the maximum load can be carried by the tire. This pressure is normally higher than the manufacturer's recommended cold inflation pressure which can be found on either the Tire Label or Safety Compliance Certification Label which is located on the B-Pillar or the edge of the driver's door. The cold inflation pressure should never be set lower than the recommended pressure on the vehicle label.

The tire suppliers may have additional markings, notes or warnings such as standard load, radial tubeless, etc.

Tires, Wheels and Loading

Additional information contained on the tire sidewall for “LT” type tires

“LT” type tires have some additional information beyond those of “P” type tires; these differences are described below.

Note: Tire Quality Grades do not apply to this type of tire.

1. **LT:** Indicates a tire, designated by the Tire and Rim Association (T&RA), that is intended for service on light trucks.

2. Load Range/Load Inflation

Limits: Indicates the tire’s load-carrying capabilities and its inflation limits.

3. **Maximum Load Dual lb. (kg) at psi (kPa) cold:** Indicates the maximum load and tire pressure when the tire is used as a dual; defined as four tires on the rear axle (a total of six or more tires on the vehicle).

4. **Maximum Load Single lb. (kg) at psi (kPa) cold:** Indicates the maximum load and tire pressure when the tire is used as a single; defined as two tires (total) on the rear axle.



Tires, Wheels and Loading

Information on “T” type tires

“T” type tires have some additional information beyond those of “P” type tires; these differences are described below:

T145/80D16 is an example of a tire size.

Note: The temporary tire size for your vehicle may be different from this example. Tire Quality Grades do not apply to this type of tire.

1. **T:** Indicates a type of tire, designated by the Tire and Rim Association (T&RA), that is intended for temporary service on cars, SUVs, minivans and light trucks.

2. **145:** Indicates the nominal width of the tire in millimeters from sidewall edge to sidewall edge. In general, the larger the number, the wider the tire.

3. **80:** Indicates the aspect ratio which gives the tire’s ratio of height to width. Numbers of 70 or lower indicate a short sidewall.

4. **D:** Indicates a “diagonal” type tire.

R: Indicates a “radial” type tire.

5. **16:** Indicates the wheel or rim diameter in inches. If you change your wheel size, you will have to purchase new tires to match the new wheel diameter.

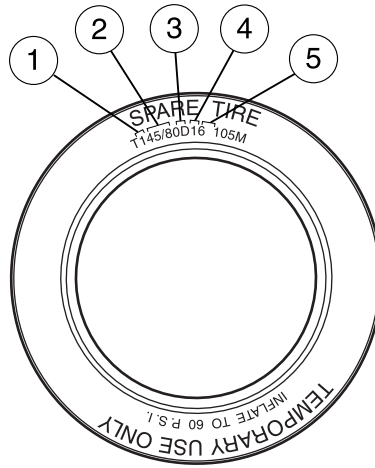

Location of the Tire Label or Safety Compliance Certification Label

You will find a Tire Label or Safety Compliance Certification Label containing tire inflation pressure by tire size and other important information located on the B-Pillar or the edge of the driver’s door. Refer to the payload description and graphic in the *Vehicle loading — with and without a trailer* section.

Tires, Wheels and Loading

TIRE PRESSURE MONITORING SYSTEM (TPMS) (IF EQUIPPED)

Each tire, including the spare (if provided), should be checked monthly when cold and inflated to the inflation pressure recommended by the vehicle manufacturer on the

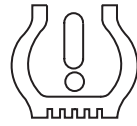

vehicle placard or tire inflation pressure label. (If your vehicle has tires of a different size than the size indicated on the vehicle placard or tire inflation pressure label, you should determine the proper tire inflation pressure for those tires.)

As an added safety feature, your vehicle has been equipped with a tire pressure monitoring system (TPMS) that illuminates a low tire pressure telltale when one or more of your tires is significantly under-inflated. Accordingly, when the low tire pressure telltale illuminates, you should stop and check your tires as soon as possible, and inflate them to the proper pressure. Driving on a significantly under-inflated tire causes the tire to overheat and can lead to tire failure. Under-inflation also reduces fuel efficiency and tire tread life, and may affect the vehicle's handling and stopping ability.

Please note that the TPMS is not a substitute for proper tire maintenance, and it is the driver's responsibility to maintain correct tire pressure, even if under-inflation has not reached the level to trigger illumination of the TPMS low tire pressure telltale.

Your vehicle has also been equipped with a TPMS malfunction indicator to indicate when the system is not operating properly. The TPMS malfunction indicator is combined with the low tire pressure telltale. When the system detects a malfunction, the telltale will flash for approximately one minute and then remain continuously illuminated. This sequence will continue upon subsequent vehicle start-ups as long as the malfunction exists.

When the malfunction indicator is illuminated, the system may not be able to detect or signal low tire pressure as intended. TPMS malfunctions may occur for a variety of reasons, including the installation of replacement or alternate tires or wheels on the vehicle that prevent the TPMS from functioning properly. Always check the TPMS malfunction telltale after replacing one or more tires or wheels on your vehicle to ensure that the replacement or alternate tires and wheels allow the TPMS to continue to function properly.

Tires, Wheels and Loading

The Tire Pressure Monitoring System complies with part 15 of the FCC rules and with RSS-210 of Industry Canada. Operation is subject to the following two conditions: (1) This device may not cause harmful interference, and (2) This device must accept any interference received, including interference that may cause undesired operation.

 The Tire Pressure Monitoring System is NOT a substitute for manually checking tire pressure. The tire pressure should be checked periodically (at least monthly) using a tire gauge, see *Inflating your tires* in this chapter. Failure to properly maintain your tire pressure could increase the risk of tire failure, loss of control, vehicle rollover and personal injury.

Changing tires with TPMS

Each road tire is equipped with a tire pressure sensor fastened to the inside rim of the wheel. The pressure sensor is covered by the tire and is not visible unless the tire is removed. The pressure sensor is located opposite (180 degrees) from the valve stem. Care must be taken when changing the tire to avoid damaging the sensor. It is recommended that you always have your tires serviced by an authorized dealer.

The tire pressure should be checked periodically (at least monthly) using an accurate tire gauge, refer to *Inflating your tires* in this chapter.

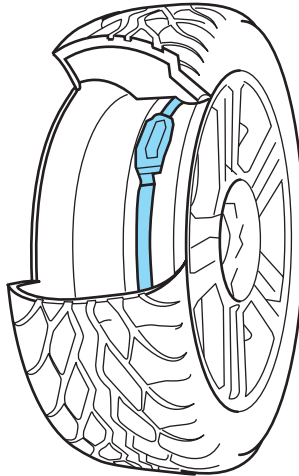

Tires, Wheels and Loading

Understanding your Tire Pressure Monitoring System (TPMS)

The Tire Pressure Monitoring System measures pressure in your four road tires and sends the tire pressure readings to your vehicle. The Low Tire Warning Lamp will turn ON if the tire pressure is significantly low. Once the light is illuminated, your tires are under inflated and need to be inflated to the manufacturer's recommended tire pressure. Even if the light turns ON and a short time later turns OFF, your tire pressure still needs to be checked. Visit www.checkmytires.org for additional information.

When your temporary spare tire is installed

When one of your road tires needs to be replaced with the temporary spare, the TPMS system will continue to identify an issue to remind you that the damaged road wheel/tire needs to be repaired and put back on your vehicle.

To restore the full functionality of the Tire Pressure Monitoring System, have the damaged road wheel/tire repaired and remounted on your vehicle. For additional information, refer to *Changing tires with TPMS* in this section.

Tires, Wheels and Loading

When you believe your system is not operating properly

The main function of the Tire Pressure Monitoring System is to warn you when your tires need air. It can also warn you in the event the system is no longer capable of functioning as intended. Please refer to the following chart for information concerning your Tire Pressure Monitoring System:

Low Tire Pressure Warning Light	Possible cause	Customer Action Required
Solid Warning Light	Tire(s) under-inflated	1. Check your tire pressure to ensure tires are properly inflated; refer to <i>Inflating your tires</i> in this chapter. 2. After inflating your tires to the manufacturer's recommended inflation pressure as shown on the Tire Label (located on the edge of driver's door or the B-Pillar), the vehicle must be driven for at least two minutes over 20 mph (32 km/h) before the light will turn OFF.
	Spare tire in use	Your temporary spare tire is in use. Repair the damaged road wheel/tire and reinstall it on the vehicle to restore system functionality. For a description on how the system functions, refer to <i>When your temporary spare tire is installed</i> in this section.
	TPMS malfunction	If your tires are properly inflated and your spare tire is not in use and the light remains ON, have the system inspected by your authorized dealer.
	Tire rotation without sensor training	On vehicles with different front and rear tire pressures, the TPMS system must be retrained following every tire rotation. Refer to <i>Tire rotation</i> in this chapter.

Tires, Wheels and Loading

Low Tire Pressure Warning Light	Possible cause	Customer Action Required
Flashing Warning Light	Spare tire in use	Your temporary spare tire is in use. Repair the damaged road wheel and re-mount it on the vehicle to restore system functionality. For a description of how the system functions under these conditions, refer to <i>When your temporary spare tire is installed</i> in this section.
	TPMS malfunction	If your tires are properly inflated and your spare tire is not in use and the TPMS warning light still flashes, have the system inspected by your authorized dealer.

When inflating your tires

When putting air into your tires (such as at a gas station or in your garage), the Tire Pressure Monitoring System may not respond immediately to the air added to your tires.

It may take up to two minutes of driving over 20 mph (32 km/h) for the light to turn OFF after you have filled your tires to the recommended inflation pressure.

How temperature affects your tire pressure

The Tire Pressure Monitoring System (TPMS) monitors tire pressure in each pneumatic tire. While driving in a normal manner, a typical passenger tire inflation pressure may increase approximately 2 to 4 psi (14 to 28 kPa) from a cold start situation. If the vehicle is stationary over night with the outside temperature significantly lower than the daytime temperature, the tire pressure may decrease approximately 3 psi (20.7 kPa) for a drop of 30° F (16.6°C) in ambient temperature. This lower pressure value may be detected by the TPMS as being significantly lower than the recommended inflation pressure and activate the TPMS warning for low tire pressure. If the low tire pressure warning light is ON, visually check each tire to verify that no tire is flat. (If one or more tires are flat, repair as necessary.) Check air pressure in the road tires. If any tire is under-inflated, carefully drive the vehicle to the nearest location where air can be added to the tires. Inflate all the tires to the recommended inflation pressure.

228

Tires, Wheels and Loading

TPMS reset procedure (if applicable)

This procedure is only required after tire rotation on vehicles with different front and rear tire pressures.



To determine if your vehicle requires two different pressures - one for the front tires and one for the rear tires - refer to the Safety Compliance Certification Label or Tire Label which is located on the B-Pillar or the edge of the driver's door. See *Vehicle Loading* in this chapter for more information.

Overview

To provide the vehicle's load carrying capability, some trucks require different recommended tire pressures in the front tires as compared to the rear tires. The Tire Pressure Monitoring System (TPMS) equipped on these vehicles is designed to illuminate the Low Tire Pressure Warning indicator at two different pressures; one for the front tires and one for the rear tires. Since tires need to be rotated to provide consistent performance and maximum tire life, the Tire Pressure Monitoring System needs to know when the tires are rotated to determine which set of tires are on the front and which are on the rear. With this information, the system can detect and properly warn of low tire pressures.



Always perform the TPMS reset procedure after tire rotation. If the system is not reset, it may not provide a low tire pressure warning when necessary.

Tires, Wheels and Loading

TPMS reset tool

A special TPMS reset tool has been provided with your vehicle to reset your TPMS after tire rotation. The tool is located with your Owner's Guide materials.

Please take the tool with the provided Velcro® strip on the back and mount it in the bottom right corner of your Owner's Guide case (as shown) for safe keeping.

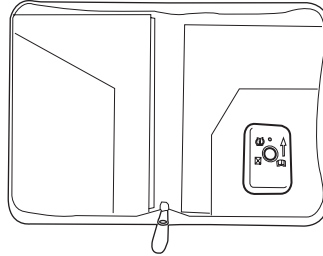

If you find that the reset tool was not provided when delivered, has been lost or no longer functions (the battery is not replaceable), please contact your authorized dealer to obtain a replacement.

To verify that your TPMS reset tool is working, press and release the button on the center of the TPMS tool. The red light should illuminate and remain on for approximately five (5) seconds. If the light does not illuminate, the tool needs to be replaced.

TPMS reset tips

To reduce the chances of interference from another vehicle, TPMS reset should be performed at least three feet (one meter) away from another Ford Motor Company vehicle undergoing the TPMS reset procedure at the same time.

Do not wait more than two (2) minutes between resetting each tire sensor or the system will timeout and the entire procedure will have to be repeated on all four wheels.

A double horn chirp indicates the need to repeat the procedure.

TPMS reset procedure

Note: It is recommended that you read the entire procedure before attempting.

Note: To enter the reset mode, Steps 1–5 **MUST** be completed within 60 seconds.

1. The key must be in the ignition and the ignition turned to OFF/LOCK. Press and release the brake pedal.
2. Cycle the ignition from OFF/LOCK to RUN three (3) times ending in the RUN position. **DO NOT** start the engine.

Tires, Wheels and Loading

3. Press and hold the brake pedal for two (2) seconds, then release.
4. Turn the ignition to OFF/LOCK (**DO NOT** remove the key.)
5. Cycle the ignition from OFF/LOCK to RUN three (3) times ending in RUN. **DO NOT** start the engine.

If reset mode has been entered successfully, the horn will sound once, the TPMS indicator will flash and the message center will display **TRAIN LF TIRE**.

If after repeated attempts to enter reset mode, the horn does not sound, the TPMS indicator does not flash and the message center does not display TRAIN LF TIRE, seek service from your authorized dealer.

TPMS reset sequence

The TPMS system needs to be reset starting with the left front tire in the following clockwise order:

1. Left front tire
2. Right front tire
3. Right rear tire
4. Left rear tire

Tires, Wheels and Loading

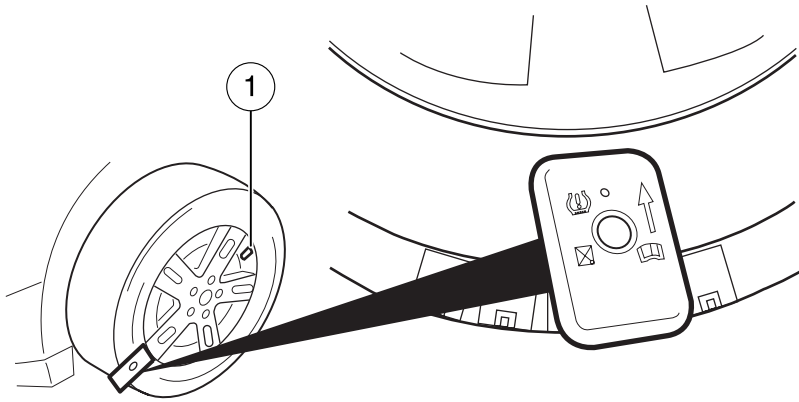

1. **Left front tire:** Place the TPMS reset tool against the left front tire where the tire meets the rim, opposite from the valve stem (1) as shown. This is where the sensor is located inside the rim.

The tool needs to be held against the tire sidewall opposite the valve stem as illustrated with the arrow on the tool pointing towards the rim; do not use the tool with the arrow pointing away from the rim as it may not activate the sensor.

2. Press and release the green button and hold the tool to the tire sidewall until the horn sounds. The red light on the TPMS reset tool will illuminate while the tool is active. The horn will sound once within 10 seconds to indicate the process was successful.

Note: If a double horn chirp is heard, repeat the procedure. If a single horn chirp is not heard, move the vehicle to rotate the wheels at least a $\frac{1}{4}$ -turn and repeat the procedure. If the horn does not sound while attempting to reset any wheel, seek service from your authorized dealer.

3. Perform Steps 1 and 2 on the right front, right rear and finally the left rear tires.

Successful completion of the reset procedure can be verified by turning the ignition to OFF without the horn sounding. If two short beeps are heard, the reset procedure was unsuccessful and must be repeated.

If after repeating the procedure two short beeps are heard when the key is turned to OFF, seek assistance from your authorized dealer.

Tires, Wheels and Loading

Rotation, pressure adjustment and TPMS reset example

The following example describes all the major steps involved in rotating tires on a vehicle with different front and rear tire pressures. It illustrates that the TPMS reset procedure needs to follow tire rotation and pressure adjustment to avoid a possible false low tire warning.

Example:

A particular vehicle has the following recommended tire pressures: 50 psi (345 kPa) front; 80 psi (552 kPa) rear.

Note: For your vehicle's pressure, refer to the Safety Compliance Certification Label located on the B-Pillar or the edge of your vehicle's driver's door.

Before tire rotation

Sensor 1: 50 psi

Sensor 2: 50 psi

Sensor 3: 80 psi

Sensor 4: 80 psi

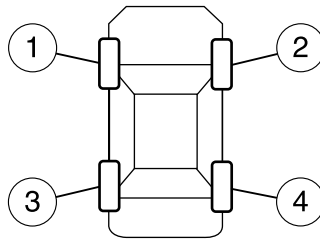

Tire rotation using the recommended sequence (front tires at top of diagram)

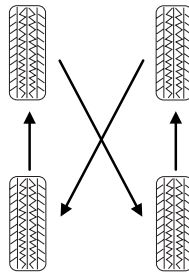

Tires, Wheels and Loading

Sensor position following tire rotation

Sensor 1: 50 psi

Sensor 2: 50 psi

Sensor 3: 80 psi

Sensor 4: 80 psi

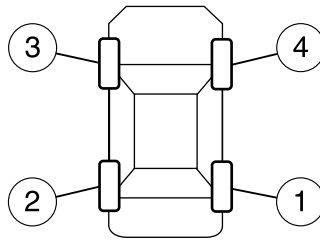

Pressure adjustment without the required TPMS reset procedure

Sensor 1: 80 psi

Sensor 2: 80 psi

Sensor 3: 50 psi

Sensor 4: 50 psi

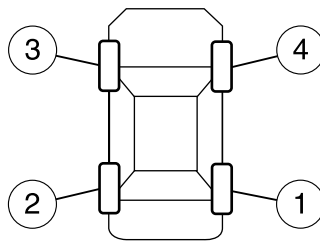

In this situation, the TPMS warning light will come on.

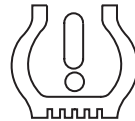

If the TPMS reset procedure is not performed after tire rotation and air pressure adjustment, the TPMS telltale may illuminate for a false low tire pressure condition.

As in this example, the rear tires rotated to the front and properly inflated to 50 psi (345 kPa) for the front axle would falsely illuminate the low tire warning indicator as they are still trained for the rear positions which require 80 psi (552 kPa).

Tires, Wheels and Loading

Rotation, pressure adjustment and successful completion of the TPMS reset procedure

Sensor 1: 80 psi

Sensor 2: 80 psi

Sensor 3: 50 psi

Sensor 4: 50 psi

Tire rotation and air pressure adjustment followed by sensor resetting will ensure the system is properly programmed for vehicles with different front and rear tire pressures and reduce the risk of a false low tire warning.

In this situation, the TPMS warning light will be off.

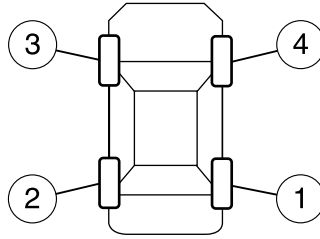

SNOW TIRES AND CHAINS



Snow tires must be the same size and grade as the tires you currently have on your vehicle.

Note: Do not use snow chains on front tires of vehicles with 20" wheels and tires.

The tires on your vehicle have all weather treads to provide traction in rain and snow. However, in some climates, you may need to use snow tires and chains. If you need to use chains, it is recommended that steel wheels (of the same size and specifications) be used, as chains may chip aluminum wheels.

Follow these guidelines when using snow tires and chains:

- Use only SAE Class S chains.
- Install chains securely, verifying that the chains do not touch any wiring, brake lines or fuel lines.
- Drive cautiously. If you hear the chains rub or bang against your vehicle, stop and re-tighten the chains. If this does not work, remove the chains to prevent damage to your vehicle.
- If possible, avoid fully loading your vehicle.
- Remove the tire chains when they are no longer needed. Do not use tire chains on dry roads.
- The suspension insulation and bumpers will help prevent vehicle damage. Do not remove these components from your vehicle when using snow tires and chains.

Tires, Wheels and Loading

VEHICLE LOADING – WITH AND WITHOUT A TRAILER

This section will guide you in the proper loading of your vehicle and/or trailer, to keep your loaded vehicle weight within its design rating capability, with or without a trailer. Properly loading your vehicle will provide maximum return of vehicle design performance. Before loading your vehicle, familiarize yourself with the following terms for determining your vehicle's weight ratings, with or without a trailer, from the vehicle's Tire Label or Safety Compliance Certification Label:

Base Curb Weight – is the weight of the vehicle including a full tank of fuel and all standard equipment. It does not include passengers, cargo, or optional equipment.

Vehicle Curb Weight – is the weight of your new vehicle when you picked it up from your authorized dealer plus any aftermarket equipment.

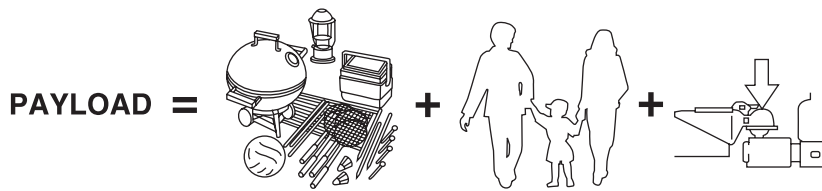

Payload – is the combined weight of cargo and passengers that the vehicle is carrying. The maximum payload for your vehicle can be found on the Tire Label (vehicles exported outside the U.S. and Canada may not have a Tire Label) on the B-Pillar or the edge of the driver's door. Look for **“THE COMBINED WEIGHT OF OCCUPANTS AND CARGO SHOULD NEVER EXCEED XXX kg OR XXX lb.”** for maximum payload. The payload listed on the Tire Label is the maximum payload for the vehicle as built by the assembly plant. If any aftermarket or authorized dealer installed equipment has been installed on the vehicle, the weight of the equipment must be subtracted from the payload listed on the Tire Label in order to determine the new payload.

Tires, Wheels and Loading



The appropriate loading capacity of your vehicle can be limited either by volume capacity (how much space is available) or by payload capacity (how much weight the vehicle should carry). Once you have reached the maximum payload of your vehicle, do not add more cargo, even if there is space available. Overloading or improperly loading your vehicle can contribute to loss of vehicle control and vehicle rollover.

Example only:

TIRE AND LOADING INFORMATION			
SEATING CAPACITY		TOTAL 5	FRONT 2 REAR 3
The combined weight of occupants and cargo should never exceed : XXX kg or XXX lbs.			
TIRE	SIZE	COLD TIRE PRESSURE	SEE OWNERS MANUAL FOR ADDITIONAL INFORMATION
FRONT	LT225/75R 16.5E	200 KPA, 29 PSI	
REAR	LT225/75R 16.5E	200 KPA, 29 PSI	
SPARE	T145/80D16 P225/60R17	420 KPA, 60 PSI 200 KPA, 29 PSI	

TIRE AND LOAD INFORMATION			
SEATING CAPACITY		TOTAL XX	FRONT XX REAR X
NOMBRE DE PLACES		TOTAL XX	AVANT XX ARRIERE X
The combined weight of occupants and cargo should never exceed : XXX kg. La charge du véhicule (occupants et bagages) ne doit jamais dépasser : XXX lbs.			
TIRE PNEUS	SIZE DIMENSIONS	COLD TIRE PRESSURE PRESSION A FROID	SEE OWNERS MANUAL FOR ADDITIONAL INFORMATION
FRONT/ AVANT	LT225/75R 16.5E	200 KPA, 29 PSI	CONSULTER LE GUIDE DU PROPRIETAIRE POUR DE PLUS AMPLES RENSEIGNEMENTS
REAR/ ARRIERE	LT225/75R 16.5E	200 KPA, 29 PSI	
SPARE/ PNEU DE SECOURS	T145/80D16 P225/60R17	420 KPA, 60 PSI 200 KPA, 29 PSI	

Tires, Wheels and Loading

CARGO

=



+

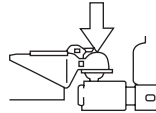

Cargo Weight – includes all weight added to the Base Curb Weight, including cargo and optional equipment. When towing, trailer tongue load or king pin weight is also part of cargo weight.

GAW (Gross Axle Weight) – is the total weight placed on each axle (front and rear) – including vehicle curb weight and all payload.

GAWR (Gross Axle Weight Rating) – is the maximum allowable weight that can be carried by a single axle (front or rear). **These numbers are shown on the Safety Compliance Certification Label located on the B-Pillar or the edge of the driver's door. The total load on each axle must never exceed its GAWR.**



Exceeding the Safety Compliance Certification Label axle weight rating limits could result in substandard vehicle handling or performance, engine, transmission and/or structural damage, serious damage to the vehicle, loss of control and personal injury.

Note: For trailer towing information refer to *Trailer towing* found in this chapter or the *RV and Trailer Towing Guide* provided by your authorized dealer.

Tires, Wheels and Loading

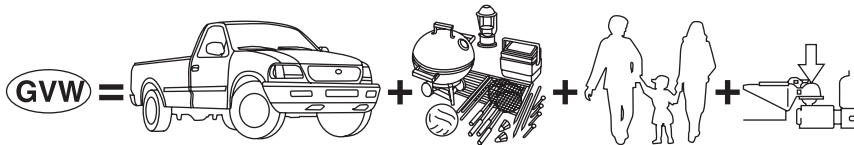

GVW (Gross Vehicle Weight) – is the Vehicle Curb Weight + cargo + passengers.

GVWR (Gross Vehicle Weight Rating) – is the maximum allowable weight of the fully loaded vehicle (including all options, equipment, passengers and cargo).

The GVWR is shown on the Safety Compliance Certification Label located on the B-Pillar or the edge of the driver's door. The GVW must never exceed the GVWR.

Sample Safety Compliance Certification Label
(Refer to actual label on your vehicle)

Front GAWR	GVWR	Rear GAWR
MFD. BY FORD MOTOR CO. IN U.S.A.		
DATE: 06/95	GVWR: 6250 LB/2834 KG	
FRONT GAWR: 3450 LB		REAR GAWR: 3777 LB
1564KG	WITH 1713KG	WITH
P265/75R15SL	TIRES P265/75R15SL	TIRES
15X7.5J	RIMS 15X7.5J	RIMS
AT 30 PSI COLD	AT 30 PSI COLD	
THIS VEHICLE CONFORMS TO ALL APPLICABLE FEDERAL MOTOR VEHICLE SAFETY STANDARDS IN EFFECT ON THE DATE OF MANUFACTURE SHOWN ABOVE.		
XXXXXXXXXXXXXX		F0016
VIN: 1FTEX14H 0 SKB 00000		TC183
TYPE: XXXXXXXXXXXXXXXX		
EXT PNT: XXXXXX XXXXXX		
WD	TYPE-GVW	BODY
155	REM	E
		15B
		TAPE
		SPRINGS
		1M4

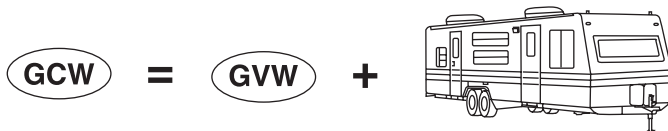

GCW (Gross Combined Weight) – is the weight of the loaded vehicle (GVW) plus the weight of the fully loaded trailer.

GCWR (Gross Combined Weight Rating) – is the maximum allowable weight of the vehicle and the loaded trailer – including all cargo and

Tires, Wheels and Loading

passengers – that the vehicle can handle without risking damage. (Important: The towing vehicles' braking system is rated for operation at GVWR, not at GCWR. Separate functional brakes should be used for safe control of towed vehicles and for trailers where the GCW of the towing vehicle plus the trailer exceed the GVWR of the towing vehicle. **The GCW must never exceed the GCWR.**

Maximum Loaded Trailer Weight – is the highest possible weight of a fully loaded trailer the vehicle can tow. It assumes a vehicle with only mandatory options, no cargo (internal or external), a tongue load of 10–15% (conventional trailer) or king pin weight of 15–25% (fifth wheel trailer), and driver only (150 lb. [68 kg]). **Consult your authorized dealer (or the *RV and Trailer Towing Guide* provided by your authorized dealer) for more detailed information.**

Tongue Load or Fifth Wheel King Pin Weight – refers to the amount of the weight that a trailer pushes down on a trailer hitch.

Examples: For a 5,000 lb. (2,268 kg) conventional trailer, multiply 5,000 by 0.10 and 0.15 to obtain a proper tongue load range of 500 to 750 lb. (227 to 340 kg). For an 11,500 lb. (5,216 kg) fifth wheel trailer, multiply by 0.15 and 0.25 to obtain a proper king pin load range of 1,725 to 2,875 lb. (782 to 1,304 kg)



Do not exceed the GVWR or the GAWR specified on the Safety Compliance Certification Label.



Do not use replacement tires with lower load carrying capacities than the originals because they may lower the vehicle's GVWR and GAWR limitations. Replacement tires with a higher limit than the originals do not increase the GVWR and GAWR limitations.



Exceeding any vehicle weight rating limitation could result in serious damage to the vehicle and/or personal injury.

Steps for determining the correct load limit:

1. Locate the statement “The combined weight of occupants and cargo should never exceed XXX kg or XXX lbs.” on your vehicle's placard.
2. Determine the combined weight of the driver and passengers that will be riding in your vehicle.
3. Subtract the combined weight of the driver and passengers from XXX kg or XXX lbs.

240

Tires, Wheels and Loading

4. The resulting figure equals the available amount of cargo and luggage load capacity. For example, if the “XXX” amount equals 1,400 lbs. and there will be five 150 lb. passengers in your vehicle, the amount of available cargo and luggage load capacity is 650 lbs. ($1,400 - 750$ (5×150) = 650 lb.). In metric units ($635 - 340$ (5×68) = 295 kg.)

5. Determine the combined weight of luggage and cargo being loaded on the vehicle. That weight may not safely exceed the available cargo and luggage load capacity calculated in Step 4.

6. If your vehicle will be towing a trailer, load from your trailer will be transferred to your vehicle. Consult this manual to determine how this reduces the available cargo and luggage load capacity of your vehicle.

The following gives you a few examples on how to calculate the available amount of cargo and luggage load capacity:

- Another example for your vehicle with 1,400 lb. (635 kg) of cargo and luggage capacity. You decide to go golfing. Is there enough load capacity to carry you, 4 of your friends and all the golf bags? You and four friends average 220 lb. (99 kg) each and the golf bags weigh approximately 30 lb. (13.5 kg) each. The calculation would be: $1,400 - (5 \times 220) - (5 \times 30) = 1,400 - 1,100 - 150 = 150$ lb. Yes, you have enough load capacity in your vehicle to transport four friends and your golf bags. In metric units, the calculation would be: $635 \text{ kg} - (5 \times 99 \text{ kg}) - (5 \times 13.5 \text{ kg}) = 635 - 495 - 67.5 = 72.5$ kg.
- A final example for your vehicle with 1,400 lb. (635 kg) of cargo and luggage capacity. You and one of your friends decide to pick up cement from the local home improvement store to finish that patio you have been planning for the past 2 years. Measuring the inside of the vehicle with the rear seat folded down, you have room for 12-100 lb. (45 kg) bags of cement. Do you have enough load capacity to transport the cement to your home? If you and your friend each weigh 220 lb. (99 kg), the calculation would be: $1,400 - (2 \times 220) - (12 \times 100) = 1,400 - 440 - 1,200 = -240$ lb. No, you do not have enough cargo capacity to carry that much weight. In metric units, the calculation would be: $635 \text{ kg} - (2 \times 99 \text{ kg}) - (12 \times 45 \text{ kg}) = 635 - 198 - 540 = -103$ kg. You will need to reduce the load weight by at least 240 lb. (104 kg). If you remove 3-100 lb. (45 kg) cement bags, then the load calculation would be:
 $1,400 - (2 \times 220) - (9 \times 100) = 1,400 - 440 - 900 = 60$ lb. Now you have the load capacity to transport the cement and your friend home. In metric units, the calculation would be: $635 \text{ kg} - (2 \times 99 \text{ kg}) - (9 \times 45 \text{ kg}) = 635 - 198 - 405 = 32$ kg.

Tires, Wheels and Loading

The above calculations also assume that the loads are positioned in your vehicle in a manner that does not overload the Front or the Rear Gross Axle Weight Rating specified for your vehicle on the Tire Label or Safety Compliance Certification Label found on the edge of the driver's door.

Special loading instructions for owners of pickup trucks and utility-type vehicles



For important information regarding safe operation of this type of vehicle, see the *Preparing to drive your vehicle* section in the *Driving* chapter of this owner guide.



Loaded vehicles may handle differently than unloaded vehicles. Extra precautions, such as slower speeds and increased stopping distance, should be taken when driving a heavily loaded vehicle.

Your vehicle can haul more cargo and people than most passenger cars. Depending upon the type and placement of the load, hauling cargo and people may raise the center of gravity of the vehicle.

TRAILER TOWING

Note: The trailer towing charts in this section apply to vehicles equipped with gasoline engines; for vehicles equipped with diesel engines, refer to your *6.0 and 6.4 Liter Power Stroke Direct Injection Turbo Diesel Owner's Guide Supplement*.

Your vehicle may tow a Conventional/Class IV trailer or fifth wheel trailer provided the maximum trailer weight is less than or equal to the maximum trailer weight listed for your engine and rear axle ratio on the following charts.

To calculate your maximum trailer weight:

For pickup trucks: Take curb weight, hitch hardware and the driver's weight, then subtract them from the GCWR listed for your vehicle series, engine, transmission and drive axle ratio (*refer to the chart/table in the following text*). This calculation will give you the maximum trailer weight possible for your vehicle.

For chassis cabs and pickup trucks with aftermarket equipment: Weigh your vehicle at a certified scale and subtract this actual curb weight, hitch hardware, and the driver's weight from the GCWR listed for your vehicle series, engine, transmission and drive axle ratio (*refer to the chart/table in the following text*). This calculation will give you the maximum trailer weight possible for your vehicle.

Tires, Wheels and Loading

The weight of all additional cargo and passengers must be subtracted from the maximum trailer weight calculated above.

Further trailer/hitch restrictions and limitations exist depending on the type of trailer and hitch used. These additional maximum trailer weight and tongue load limitations are listed in the chart/table that follows the listing of GCWRs.

Towing a trailer places an additional load on your vehicle's engine, transmission, axle, brakes, tires and suspension. Inspect these components carefully prior to and after any towing operation. Refer to *Transmission fluid temperature gauge* in the *Instrument Cluster* chapter for the transmission fluid temperature information.

Note: Do not exceed the GCWR listed for your vehicle on the following chart/table, or the GVWR, GAWR or tire ratings specified on the Tire Label or Safety Compliance Certification Label.



Towing trailers beyond the maximum recommended trailer weight which exceeds the limit of the vehicle's GCWR, GVWR, GAWR or tire ratings could result in engine damage, transmission damage, structural damage, loss of vehicle control, vehicle rollover and personal injury.

Maximum GCWR - lb. (kg.)			
Engine	Rear axle ratio	Manual transmission	Automatic transmission
F-250 Pick-up			
5.4L	3.73	15000 (6804)	16000 (7257)
	4.10	17000 (7711)	18000 (8165)
6.8L	4.10	20000 (9072)	21000 (9525)
	4.30	22000 (9979)	22500 (10206)
F-350 Single Rear Wheel (SRW) Pick-up			
5.4L	3.73	15000 (6804)	16000 (7257)
	4.10	17000 (7711)	18000 (8165)
6.8L	4.10	20000 (9072)	21000 (9525)
	4.30	22000 (9979)	23000 (10433)

Tires, Wheels and Loading

Maximum GCWR - lb. (kg.)			
Engine	Rear axle ratio	Manual transmission	Automatic transmission
F-350 Dual Rear Wheel (DRW) Pick-up			
5.4L	4.10	17500 (7938)	18500 (8391)
6.8L	4.10	20500 (9299)	21500 (9752)
	4.30	22500 (10206)	23000 (10433)
F-350 Single Rear Wheel (SRW) Chassis Cab			
5.4L	3.73	15000 (6804)	16000 (7257)
	4.10	17000 (7711)	18000 (8165)
6.8L	4.10	20000 (9072)	21000 (9525)
F-350 Dual Rear Wheel (DRW) Chassis Cab			
5.4L	3.73	15000 (6804)	16500 (7484)
	4.10	17500 (7938)	18500 (8391)
6.8L	4.10	20500 (9299)	21500 (9752)
	4.30	22500 (10206)	23000 (10433)
F-450 Chassis Cab/F-550			
6.8L	4.88/5.38	26000 (11793)	26000 (11793)

Preparing to tow

Use the proper equipment for towing a trailer and make sure it is properly attached to your vehicle. See your authorized dealer or a reliable trailer dealer if you require assistance.

Hitches



ON PICK-UP TRUCKS, the trailer hitch provided on this vehicle enhances collision protection for the fuel system. DO NOT REMOVE!

Do not use hitches that clamp onto the vehicle's bumper or attach to the axle. You must distribute the load in your trailer so that 10%–15% for conventional towing or 15%-25% fifth-wheel towing of the total weight of the trailer is on the tongue.

Tires, Wheels and Loading

Integrated hitch rating

The standard integrated hitch has two ratings depending on mode of operation:

- **Weight carrying** - requires a draw bar and hitch ball. The draw bar supports all the vertical tongue load of the trailer.
- **Weight distributing** - requires an aftermarket weight distributing system which includes draw bar, hitch ball, spring bars and snap-up brackets. The vertical tongue load of the trailer is distributed between the truck and the trailer by this system.

	Hitch Type	Maximum Gross Trailer Weight — lb. (kg)	Maximum Tongue Weight — lb. (kg)
6.8L DRW Pickup 2.5" ID without adapter (requires 2.5" drawbar)	Weight carrying	8000 (3629)	800 (363)
	Weight distributing	15000 (6804)	1500 (680)
6.8L DRW Pickup 2.5" ID with adapter (requires 2" drawbar)	Weight carrying	6000 (2721)	600 (272)
	Weight distributing	12500 (5670)	1250 (567)
All SRW Pickups and 5.4L DRW Pickups 2" receiver	Weight carrying	6000 (2721)	600 (272)
	Weight distributing	12500 (5670)	1250 (567)



Towing trailers beyond the maximum tongue weight exceeds the limit of the towing system and could result in vehicle structural damage, loss of vehicle control and personal injury.

Weight distributing hitch

When hooking up a trailer using a weight distributing hitch, always use the following procedure:

1. Park the unloaded vehicle on a level surface. With the ignition on and all doors closed, allow the vehicle to stand for several minutes so that it can level.
2. Measure the height of a reference point on the front and rear bumpers at the center of the vehicle.

Tires, Wheels and Loading

3. Attach the trailer to the vehicle and adjust the hitch equalizers so that the front bumper height is within $\frac{1}{2}$ " (13 mm) of the reference point. After proper adjustment, the rear bumper should be no higher than in Step 2.

Note: Adjusting a weight distributing hitch so the rear bumper of the vehicle is higher than it was unloaded will defeat the function of the weight distributing hitch and may cause unpredictable handling.

Safety chains

Always connect the trailer's safety chains to the frame or hook retainers of the vehicle hitch. To connect the trailer's safety chains, cross the chains under the trailer tongue and allow slack for turning corners.

If you use a rental trailer, follow the instructions that the rental agency gives to you.

Do not attach safety chains to the bumper.

Trailer brakes

Electric brakes and manual, automatic or surge-type trailer brakes are safe if installed properly and adjusted to the manufacturer's specifications. The trailer brakes must meet local and Federal regulations.



If you own a trailer with a hydraulic brake system, do not connect the trailer's hydraulic brake system directly to your vehicle's brake system. The vehicle's brake system is only designed to carry the appropriate amount of brake fluid for the vehicle alone. Connecting a hydraulic trailer braking system could adversely affect your vehicle's braking performance.

The braking system of the tow vehicle is rated for operation at the GVWR not GCWR.

Integrated trailer brake controller (if equipped)

Your vehicle may be equipped with a fully integrated electronic Trailer Brake Controller (TBC). When used properly, the TBC helps ensure smooth and effective trailer braking by powering the trailer's electric brakes with a proportional output based on the towing vehicle's brake pressure.

246

Tires, Wheels and Loading

 The Ford TBC has only been verified to be compatible with trailers having electric-actuated drum brakes (one to four axles) and not hydraulic surge or electric-over-hydraulic types. It is the responsibility of the customer to ensure that the trailer brakes are adjusted appropriately, functioning normally and all electric connections are properly made.

The TBC user interface consists of the following:

1. **+/- (GAIN adjustment buttons):** Pressing these buttons will adjust the TBC's power output to the trailer brakes (in 0.5 increments). The GAIN setting can be increased to a maximum of 10.0 or decreased to a minimum of 0 (no trailer braking). Pressing and holding a button will raise or lower the setting continuously.

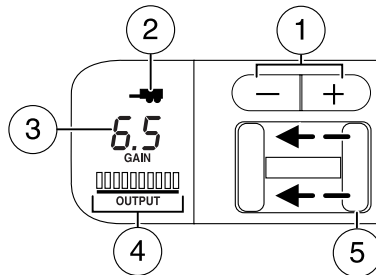

2. **Trailer connection indicator:** This lamp indicates trailer electrical connection status.

- When a successful trailer connection is detected, the indicator will be green.
- If the electrical connection is lost, the indicator will flash red. If the connection is lost while the vehicle is stationary, the indicator will turn off after 30 seconds. If the connection is lost while the vehicle is moving, the indicator will flash until the ignition is turned off, then on again or if there is a reconnection.
- If no electrical connection is detected after the ignition is turned on, pressing a GAIN adjustment button will display the GAIN setting. Sliding the manual control will display the GAIN setting, OUTPUT bar graph and light the trailer indicator red.

3. **GAIN setting display:** Shows the current GAIN setting. This will illuminate when a trailer is connected, flash if the trailer becomes disconnected, or remain off if no trailer is connected.

4. **OUTPUT bar graph:** When the vehicle's brake pedal is pushed, or when the manual control is activated, green bar indicators will illuminate to indicate the amount of power going to the trailer brakes relative to the brake pedal or manual control input.

Tires, Wheels and Loading

5. **Manual control lever:** Slide the control lever to the left to activate power to the trailer's electric brakes independent of the tow vehicle's brakes (see the following *Procedure for adjusting GAIN* section for instructions on proper use of this feature). If the manual control is activated while the brake is also applied, the greater of the two inputs determines the power sent to the trailer brakes.

- **Stop Lamps:** Activating the TBC manual control lever will illuminate both the trailer brake lamps and the tow vehicle brake lamps except the Center High-Mount Stop Lamp (presuming proper trailer electrical connection). Pressing the vehicle brake pedal will also illuminate both trailer and vehicle brake lamps.

GAIN:

The GAIN setting is used to set the TBC for the specific towing condition and should be changed as towing conditions change. Changes to towing conditions include trailer load, vehicle load, road conditions and weather.

The GAIN should be set to provide the maximum trailer braking assistance while ensuring the trailer wheels do not lock when braking. Locked trailer wheels may lead to trailer instability.

Procedure for adjusting GAIN:

Note: This should only be performed in a traffic free environment at speeds of approximately 20–25 mph (30–40 km/h).

1. Make sure the trailer brakes are in good working condition, functioning normally, and properly adjusted. See your trailer dealer if necessary.
2. Hook-up the trailer and make the electrical connections according to the trailer manufacturer's instructions.
3. When a trailer with electric brakes is plugged in, the trailer connection indicator will illuminate green on the TBC and the GAIN setting display will illuminate.
4. Use the GAIN adjustment (+/-) buttons to increase or decrease the GAIN setting to the desired starting point. (A GAIN setting of 6.0 is a good starting point for heavier loads.)
5. In a traffic-free environment, tow the trailer on a dry, level surface at a speed of 20–25 mph (30–40 km/h) and squeeze the manual control lever completely.

Tires, Wheels and Loading

6. If the trailer wheels lock-up (indicated by squealing tires), reduce the GAIN setting; if the trailer wheels turn freely, increase the GAIN setting. Repeat Steps 5 and 6 until the GAIN setting is at a point just below trailer wheel lock-up. If towing a heavier trailer, trailer wheel lockup may not be attainable even with the maximum GAIN setting of 10.

Explanation of instrument cluster messages:

The TBC interacts with the instrument cluster message center. These messages, accompanied by a single chime, will be displayed when the TBC determines a malfunction in the trailer connection, TBC system, or in the trailer. These messages are listed below:

TRAILER DISCONNECTED (if equipped with message center) or CHECK TRAILER (if equipped with mini message center): This message is displayed when a trailer connection was determined and then a disconnection, either intentionally or unintentionally, has been sensed during a given ignition cycle. It is also displayed if a trailer fault occurs causing the trailer to appear disconnected. This message is also displayed during manual activation without a trailer connected.

TBC FAULT: This message is displayed in response to faults sensed by the TBC. In the event this message is seen, please take your vehicle to an authorized dealer for diagnosis and repair. The TBC may still function, but performance may be degraded.

WIRING FAULT ON TRAILER: The TBC is capable of determining certain faults in the vehicle wiring and trailer wiring/brake system. These faults do not mean there is anything wrong with the TBC. This message is displayed when one of the following faults has occurred:

- *Short circuit on the electric brake output wire:* If the TRAILER FAULT message is displayed with no trailer connected, the problem is with the vehicle wiring from the TBC to the 7-pin connector in the bumper. If the message is only displayed with a trailer connected, the problem is related to the trailer wiring; consult your trailer dealer for assistance. This can be a short to ground (i.e., chaffed wire) or a short to voltage (i.e., pulled pin on trailer emergency break-away battery) or trailer brakes drawing too much current.

Note: Your TBC can be diagnosed by your authorized dealer to determine exactly which trailer fault has occurred; however, if the fault is with the trailer this diagnosis is **not** covered under your Ford warranty.

Points to Remember:

- Remember to adjust gain setting before using the TBC for the first time.

Tires, Wheels and Loading

- Readjust GAIN setting on the TBC (according to procedure above) whenever road, weather and trailer or vehicle loading conditions change from those that existed when the gain was initially set.
- The sliding lever on the TBC should be used only for manual activation of trailer brakes to assist with proper adjustment of the GAIN. Misuse, such as application during trailer sway, could cause instability of trailer and/or tow vehicle.
- Avoid towing in adverse weather conditions. The TBC does not provide anti-lock control of the trailer wheels. Trailer wheels can lock-up on slippery surfaces, resulting in reduced stability of trailer and tow vehicle.
- The TBC interacts with the brake system of the vehicle, including ABS, in order to reduce the likelihood of trailer wheel lockup. Therefore, if these systems are not functioning properly the TBC may not function at full performance.
- When the vehicle is turned off, the TBC Output is disabled and the display is shut down. Reactivation of the ignition from 3 (OFF) to 4 (ON) will awaken the TBC module.
- The TBC is only a factory or dealer installed item. Ford is not responsible for warranty or performance of the TBC due to misuse or customer installation.
- **Do not attempt removal of the TBC without consulting the *Workshop Manual*. Damage to the unit may result.**

Trailer lamps

Trailer lamps are required on most towed vehicles. Make sure all running lights, brake lights, turn signals and hazard lights are working. See your authorized dealer or trailer rental agency for proper instructions and equipment for hooking up trailer lamps.

Using a step bumper (if equipped)

The rear bumper is equipped with an integral hitch and only requires a ball with a one inch (2.5 cm) shank diameter. The bumper has a 5,000 lb. (2,270 kg) trailer weight and 500 lb. (227 kg) tongue weight capacity.

If it is necessary to relocate the trailer hitch ball position, a frame-mounted trailer hitch must be installed.

Tires, Wheels and Loading

Driving while you tow

When towing a trailer:

- Do not drive faster than 70 mph (113 km/h) during the first 500 miles (800 km) of trailer towing and don't make full-throttle starts.
- Turn off the speed control. The speed control may shut off automatically when you are towing on long, steep grades.
- Consult your local motor vehicle speed regulations for towing a trailer.
- To eliminate excessive transmission shifting, activate the Tow/Haul feature. This will also assist in transmission cooling. (For additional information, refer to the *Understanding the shift positions of the 5-speed automatic transmission* section in the *Driving* chapter.
- Anticipate stops and brake gradually.
- Do not exceed the GCWR rating or transmission damage may occur.
- Your vehicle may be equipped with a temporary or conventional spare tire. If the spare tire is different in size (diameter and/or width), tread type (All-Season or All-Terrain) or is from a different manufacturer other than the road tires on your vehicle, your spare tire is considered "temporary". Consult information on the spare Tire Label or Safety Compliance Certification Label for limitations when using.

Servicing after towing

If you tow a trailer for long distances, your vehicle will require more frequent service intervals. Refer to your *scheduled maintenance information* for more information.

Trailer towing safety tips

General

- Ensure that the trailer, safety chains and 7-pin electrical connectors are securely fastened.
- Make sure the truck receiver, draw bar, and coupler are properly connected and adjusted.
- Check rear view and side mirrors for proper visibility especially when towing trailer wider than the truck.
- When towing, operate the vehicle at lower speeds than you would when not towing a trailer. The likelihood of trailer sway is greater at higher speeds.

Tires, Wheels and Loading

- If you will be towing a trailer frequently in hot weather, hilly conditions, at GCWR, or any combination of these factors, consider refilling your rear axle with synthetic gear lubricant if not already so equipped. Refer to *Maintenance Product Specifications and Capacities* in the *Maintenance and Specifications* chapter for the proper axle lubricant. Remember that regardless of the rear axle lubricant used, do not tow a trailer for the first 500 miles (800 km) of a new vehicle, and that the first 500 miles of towing be done at no faster than 70 mph (112 km/h) with no full-throttle starts.
- When turning make wide turns to allow trailer tires to properly clear any obstacles.
- Be prepared for trailer sway due to buffeting when larger vehicles pass in either direction.

Loading

- Keep the center-of-gravity low for best handling.
- Trailer loads should be evenly distributed front to back and left to right.
- The load distribution within the trailer should be such that 10%–15% of the trailer weight is on the hitch. (15%–25% for fifth-wheel or gooseneck towing.)
- Never exceed truck, trailer, receiver, ball, tongue, tire or coupler loading recommendations.

Braking

- The trailer brakes must be inspected and serviced at intervals specified by the manufacturer. This includes the shoes, drum and trailer brake magnets.
- Electric brakes also require periodic adjustment to keep the shoes properly spaced. If the brakes get hot when driving or if they will not hold, chances are that they need adjustment.
- Anticipate the need to stop; allow much more distance and time to stop than normal.
- Do not apply the trailer brakes for extended periods of time as they can overheat and lose effectiveness.

Tires, Wheels and Loading

Backing up

- Practice backing up, particularly if you are a novice. Turn the steering wheel to the right to move the trailer's rear end to the right.
- Sharp steering movements may cause the trailer to jackknife or go out of control.

Tires

- All trailer tires should be of the same size, and construction.
- Select tires that meet the trailer loading requirements.
- Always check tow vehicle and trailer tire pressure before towing.

Launching or retrieving a boat

When backing down a ramp during boat launching or retrieval,

- Do not allow the static water level to rise above the bottom edge of the rear bumper.
- Do not allow waves to break higher than 6 inches (15 cm) above the bottom edge of the rear bumper.
- Disconnect the trailer tow electrical connector to prevent blown fuses caused by water entering into your trailer's electrical wiring.

Exceeding these limits may allow water to enter critical vehicle components, adversely affecting driveability, emissions and reliability.

Replace front and rear axle lubricants any time the axles have been submerged in water. Axle lubricant quantities are not to be checked unless a leak is suspected.

RECREATIONAL TOWING

Follow these guidelines if you have a need for recreational (RV) towing. An example of recreational towing would be towing your vehicle behind a motorhome. These guidelines are designed to ensure that your transmission is not damaged.

Tires, Wheels and Loading

Transmission	Drivetrain configuration	Requirements for neutral towing
Manual	4x2	Place transmission into (N) Neutral ¹
Manual	4x4 with manual-shift transfer case	Transmission in (N) Neutral; Transfer case in (N) (Neutral); Hublocks set to FREE ¹
Automatic		
Manual	4x4 with electronic-shift transfer case	Do not tow your vehicle with any wheels on the ground, as vehicle or transmission damage may occur. It is recommended to tow your vehicle with all four (4) wheels off the ground such as when using a car-hauling trailer. Otherwise, no recreational towing is permitted.
Automatic		

¹Always make sure that both hub locks are set to the same position.

In case of a roadside emergency with a disabled vehicle, see *Wrecker Towing* in the *Roadside Emergencies* chapter.

STARTING

Positions of the ignition

1. OFF/LOCK, shuts off the engine and all accessories/locks the steering wheel, gearshift lever and allows key removal.
2. ACC, allows the electrical accessories such as the radio to operate while the engine is not running. This position also unlocks the steering wheel.
3. ON, all electrical circuits operational. Warning lights illuminated. Key position when driving.
4. START, cranks the engine. Release the key as soon as the engine starts.

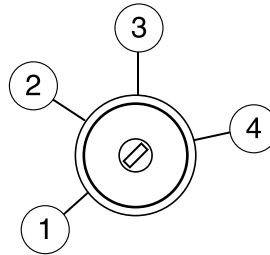

Preparing to start your vehicle

Engine starting is controlled by the powertrain control system. This system meets all Canadian Interference-Causing Equipment standard requirements regulating the impulse electrical field strength of radio noise.

When starting a fuel-injected engine, don't press the accelerator before or during starting. Only use the accelerator when you have difficulty starting the engine. For more information on starting the vehicle, refer to *Starting the engine* in this chapter.



Extended idling at high engine speeds can produce very high temperatures in the engine and exhaust system, creating the risk of fire or other damage.



Do not park, idle, or drive your vehicle in dry grass or other dry ground cover. The emission system heats up the engine compartment and exhaust system, which can start a fire.



Do not start your vehicle in a closed garage or in other enclosed areas. Exhaust fumes can be toxic. Always open the garage door before you start the engine. See *Guarding against exhaust fumes* in this chapter for more instructions.

Driving



If you smell exhaust fumes inside your vehicle, have your dealer inspect your vehicle immediately. Do not drive if you smell exhaust fumes.

Important safety precautions

When the engine starts, the idle RPM runs faster to warm the engine. If the engine idle speed does not slow down automatically, have the vehicle checked. If your vehicle is operated in a heavy snow storm or blowing snow conditions, the engine air induction may become partially clogged with snow and/or ice. If this occurs, the engine may experience a significant reduction in power output. At the earliest opportunity, clear all the snow and/or ice away from the air induction inlet. The following starting instructions are for vehicles equipped with a gasoline engine; if your vehicle is equipped with a Diesel engine, refer to *Starting the engine* in your *6.0 and 6.4 Liter Power Stroke Direct Injection Turbo Diesel Owner's Guide Supplement*.

Before starting the vehicle:

1. Make sure all occupants buckle their safety belts. For more information on safety belts and their proper usage, refer to the *Seating and Safety Restraints* chapter.
2. Make sure the headlamps and electrical accessories are off.

If starting a vehicle with an automatic transmission:

1. Make sure the parking brake is set.

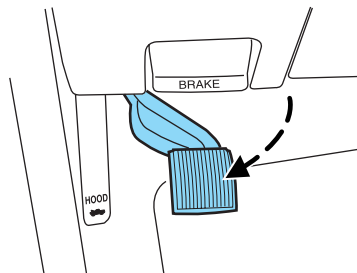

2. Make sure the gearshift is in P (Park).

Driving

If starting a vehicle with a manual transmission:

1. Make sure the parking brake is set.
2. Push the clutch pedal to the floor.

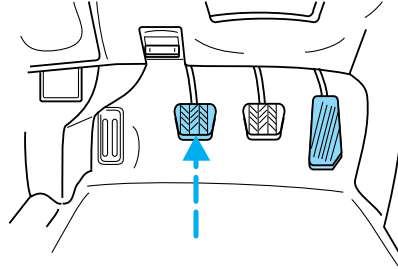

- Turn the key to 3 (ON) without turning the key to 4 (START).

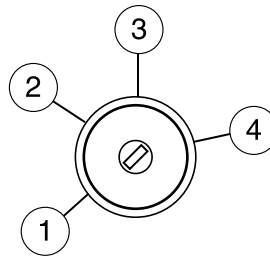

Some warning lights will briefly illuminate. See *Warning lights and chimes* in the *Instrument Cluster* chapter for more information regarding the warning lights.

Starting the engine

1. Turn the key to 3 (ON) without turning the key to 4 (START). If there is difficulty in turning the key, rotate the steering wheel until the key turns freely. This condition may occur when:

- the front wheels are turned
- a front wheel is against the curb

2. Turn the key to 4 (START), then release the key as soon as the engine starts. Excessive cranking could damage the starter.

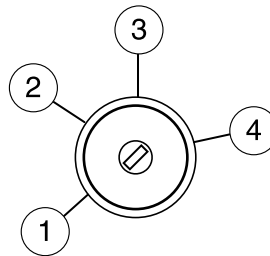

Driving

Note: If the engine does not start on the first try, turn the key to OFF, wait 10 seconds and try again. If the engine still fails to start, press the accelerator to the floor and try again; this will allow the engine to crank with the fuel shut off in case the engine is flooded with fuel.

If your vehicle has an automatic transmission, it will have a computer assisted cranking system. This feature assists in starting the engine. If the ignition key is turned to the 4 (START) position, and then released when the engine begins cranking, the engine may continue cranking for up to 10 seconds or until the vehicle starts

Guarding against exhaust fumes

Carbon monoxide is present in exhaust fumes. Take precautions to avoid its dangerous effects.



If you smell exhaust fumes inside your vehicle, have your dealer inspect your vehicle immediately. Do not drive if you smell exhaust fumes.

Important ventilating information

If the engine is idling while the vehicle is stopped for a long period of time, open the windows at least one inch (2.5 cm) or adjust the heating or air conditioning to bring in fresh air.

ENGINE BLOCK HEATER

An engine block heater warms the engine coolant which aids in starting and allows the heater/defroster system to respond quickly. If your vehicle is equipped with this system, your equipment includes a heater element which is installed in your engine block and a wire harness which allows the user to connect the system to a grounded 120 volt a/c electrical source. The block heater system is most effective when outdoor temperatures reach below 0°F (-18°C).



Failure to follow engine block heater instructions could result in property damage or physical harm.



To reduce the risk of electrical shock, do not use your heater with ungrounded electrical systems or two-pronged (cheater) adapters.

Driving

Prior to using the engine block heater, follow these recommendations for proper and safe operation:

- For your safety, use an outdoor extension cord that is product certified by Underwriter's laboratory (UL) or Canadian Standards Association (CSA). Use only an extension cord that can be used outdoors, in cold temperatures, and is clearly marked "Suitable for Use with Outdoor Appliances." Never use an indoor extension cord outdoors; it could result in an electric shock or fire hazard.
- Use a 16 gauge outdoor extension cord, minimum.
- Use as short an extension cord as possible.
- Do not use multiple extension cords. Instead, use one extension cord which is long enough to reach from the engine block heater cord to the outlet without stretching.
- Make certain that the extension cord is in excellent condition (not patched or spliced). Store your extension cord indoors at temperatures above 32°F (0°C). Outdoor conditions can deteriorate extension cords over a period of time.
- To reduce the risk of electrical shock, do not use your heater with ungrounded electrical systems or two pronged (cheater) adapters. Also ensure that the block heater, especially the cord, is in good condition before use.
- Make sure that when in operation, the extension cord plug /engine block heater cord plug connection is free and clear of water in order to prevent possible shock or fire.
- Be sure that areas where the vehicle is parked are clean and clear of all combustibles such as petroleum products, dust, rags, paper and similar items.
- Be sure that the engine block heater, heater cord and extension cord are solidly connected. A poor connection can cause the cord to become very hot and may result in an electrical shock or fire. Be sure to check for heat anywhere in the electrical hookup once the system has been operating for approximately a half hour.
- Finally, have the engine block heater system checked during your fall tune-up to be sure it's in good working order.

Driving

How to Use the Engine Block Heater

Ensure the receptacle terminals are clean and dry prior to use. To clean them, use a dry cloth.

Depending on the type of factory installed equipment, your engine block heater system may consume anywhere between 400 watts or 1000 watts of energy per hour. Your factory installed block heater system does not have a thermostat; however, maximum temperature is attained after approximately 3 hours of operation. Block heater operation longer than 3 hours will not improve system performance and will unnecessarily use additional electricity.

Make sure system is unplugged and properly stowed before driving the vehicle. While not in use, make sure the protective cover seals the prongs of the engine block heater cord plug.

BRAKES

Occasional brake noise is normal. If a metal-to-metal, continuous grinding or continuous squeal sound is present, the brake linings may be worn-out and should be inspected by your authorized dealer. If the vehicle has continuous vibration or shudder in the steering wheel while braking, the vehicle should be inspected by your authorized dealer.

Refer to *Brake system warning light* in the *Instrument Cluster* chapter for information on the brake system warning light.



Four-wheel anti-lock brake system (ABS)

Your vehicle is equipped with an Anti-lock Braking System (ABS). This system helps you maintain steering control during emergency stops by keeping the brakes from locking. Noise from the ABS pump motor and brake pedal pulsation may be observed during ABS braking and the brake pedal may suddenly travel a little farther as soon as ABS braking is done and normal brake operation resumes. These are normal characteristics of the ABS and should be no reason for concern.

ABS warning lamp

The ABS lamp in the instrument cluster momentarily illuminates when the ignition is turned on. If the light does not illuminate during start up, remains on or flashes, the ABS may be disabled and may need to be serviced.



Even when the ABS is disabled, normal braking is still effective. (If your BRAKE warning lamp illuminates with the parking brake released, have your brake system serviced immediately.)



Using ABS

When hard braking is required, apply continuous force on the brake pedal; do not pump the brake pedal since this will reduce the effectiveness of the ABS and will increase your vehicle's stopping distance. The ABS will be activated immediately, allowing you to retain full steering control during hard braking and on slippery surfaces. However, the ABS does not decrease stopping distance.

Parking brake

To set the parking brake, press the parking brake pedal down until the pedal stops.

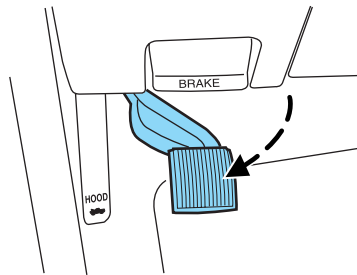

The BRAKE warning lamp in the instrument cluster illuminates and remains illuminated until the parking brake is released.



Driving

Pull the release lever to release the parking brake. To prevent the pedal from releasing too quickly, place your left foot on the parking brake pedal, then pull the release lever, making sure the pedal fully releases. You may want to pull the release lever again to make sure the parking brake is fully released.

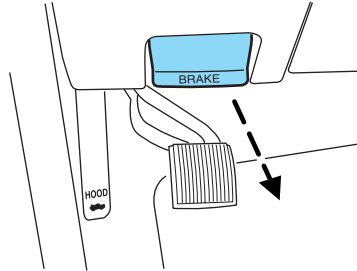

Always set the parking brake fully and make sure that the gearshift is securely latched in P (Park) (automatic transmission) or in 1 (First) (manual transmission).

Note: If your vehicle is equipped with a manual transmission, the engine may be required to run while power accessories operate and the parking brake is set. It is recommended that wheel chocks be used during this operation.

If you're parking your vehicle on a grade or with a trailer, press and hold the brake pedal down, then set the parking brake. There may be a little vehicle movement as the parking brake sets to hold the vehicle's weight. This is normal and should be no reason for concern. If needed, press and hold the service brake pedal down, then try reapplying the parking brake. Chock the wheels if required. If the parking brake cannot hold the weight of the vehicle, the parking brake may need to be serviced or the vehicle may be overloaded.

TRACTION CONTROL™ (IF EQUIPPED)

Your vehicle may be equipped with a Traction Control™ system. This system helps you maintain the stability and steerability of your vehicle, especially on slippery road surfaces such as snow- or ice-covered roads and gravel roads. The system will allow your vehicle to make better use of available traction in these conditions.

During Traction Control™ operation, the traction control light will illuminate and the engine will not “rev-up” when you push further on the accelerator. This is normal system behavior and should be no

reason for concern. Also, if traction control is on when the vehicle is put



Driving

into four-wheel drive mode (if equipped), the traction control system will be automatically disabled. Traction control operation will resume when the vehicle is placed back into two-wheel drive mode.

 Aggressive driving in any road conditions can cause you to lose control of your vehicle increasing the risk of severe personal injury or property damage. The occurrence of a Traction Control™ event is an indication that at least some of the tires have exceeded their ability to grip the road; this may lead to an increased risk of loss of vehicle control, vehicle rollover, personal injury and death. If you experience a severe road event, SLOW DOWN.

The Traction Control™ switch, located on the instrument panel to the left of the climate control system, has an indicator light that illuminates when the system is off. The Traction Control™ system will automatically turn on every time the ignition is turned off and on. The Traction Control™ system should normally be left on.

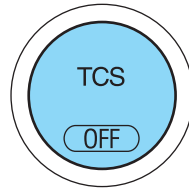

If you should become stuck in snow or ice or on a very slippery road surface, try switching the Traction Control™ system off. This may allow excess wheel spin to “dig” the vehicle out and enable a successful “rocking” maneuver.

If a system fault is detected, the traction control active light will illuminate, the Traction Control™ button will not turn the system on or off and your vehicle should be serviced by an authorized dealer.

STEERING

To help prevent damage to the power steering system:

- Never hold the steering wheel at its furthest turning points (until it stops) for more than three to five seconds when the engine is running.
- Do not operate the vehicle with a low power steering pump fluid level (below the MIN mark on the reservoir).
- Some noise is normal during operation. If excessive, check for low power steering pump fluid level before seeking service by your dealer.
- Heavy or uneven efforts may be caused by low power steering fluid. Check for low power steering pump fluid level before seeking service by your dealer.

Driving

- Do not fill the power steering pump reservoir above the MAX mark on the reservoir, as this may result in leaks from the reservoir.

If the power steering system breaks down (or if the engine is turned off), you can steer the vehicle manually, but it takes more effort.

If the steering wanders or pulls, check for:

- an improperly inflated tire
- uneven tire wear
- loose or worn suspension components
- loose or worn steering components
- improper steering alignment

If any steering components are serviced or replaced, install new fasteners (many are coated with thread adhesive or have prevailing torque features which may not be re-used). Never re-use a bolt or nut. Torque fasteners to specifications in *Workshop Manual*.

A high crown in the road or high crosswinds may also make the steering seem to wander/pull.

TRACTION-LOK AXLE (IF EQUIPPED)

This axle provides added traction on slippery surfaces, particularly when one wheel is on a poor traction surface. Under normal conditions, the Traction-Lok axle functions like a standard rear axle. The axle may exhibit a slight noise or vibration in tight turns with low vehicle speed. This is normal behavior and indicates the axle is working.

PREPARING TO DRIVE YOUR VEHICLE



Utility vehicles have a significantly higher rollover rate than other types of vehicles.



In a rollover crash, an unbelted person is significantly more likely to die than a person wearing a seat belt.

Utility vehicles and trucks have larger tires and increased ground clearance, giving the vehicle a higher center of gravity than a passenger car.

Driving

 Vehicles with a higher center of gravity such as utility vehicles and trucks handle differently than vehicles with a lower center of gravity. Utility vehicles and trucks are **not** designed for cornering at speeds as high as passenger cars any more than low-slung sports cars are designed to perform satisfactorily under off-road conditions. Avoid sharp turns, excessive speed or abrupt maneuvers in these vehicles. Failure to drive cautiously could result in an increased risk of loss of vehicle control, vehicle rollover, personal injury and death.

 Loaded vehicles, with a higher center of gravity, may handle differently than unloaded vehicles. Do not overload your vehicle and use extra precautions, such as driving at slower speeds, avoiding abrupt steering changes and allowing for increased stopping distance, when driving a heavily loaded vehicle. Over loading or loading the vehicle improperly can deteriorate handling capability and contribute to loss of vehicle control and vehicle rollover.

AUTOMATIC TRANSMISSION OPERATION (IF EQUIPPED)

Brake-shift interlock

This vehicle is equipped with a brake-shift interlock feature that prevents the gearshift lever from being moved from P (Park) when the ignition is in the 3 (ON) position and the brake pedal is not depressed.

If you cannot move the gearshift lever out of the P (Park) position with the ignition in the 3 (ON) position and the brake pedal depressed:

1. Apply the parking brake. Turn the ignition key to 1 (OFF/LOCK), then remove the key. Locate the access cover plate for the brake-shift interlock override. It is located on top of the steering column shroud.

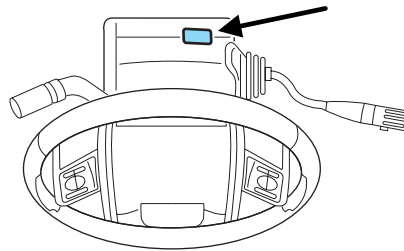

Driving

2. Apply the brake. Use a tool (or a small screwdriver) to pry out the access cover. Insert the tool into the access hole and slide the white override button towards the left. Move the gear shift lever into N (Neutral) while holding the white override disc towards the left.

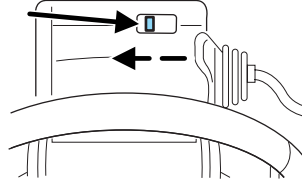



 When the key is in the ignition and in the OFF position, the automatic transmission shift lever can be moved from the P (Park) position without the brake pedal depressed. To avoid unwanted vehicle movement, always set the parking brake.

3. Start the vehicle.

If it is necessary to use the above procedure to move the gearshift lever, it is possible that a fuse has blown or the vehicle's brakelamps are not operating properly. Refer to *Fuses and relays* in the *Roadside Emergencies* chapter.

 Do not drive your vehicle until you verify that the brakelamps are working.

 Always set the parking brake fully and make sure the gearshift is latched in P (Park). Turn the ignition to the LOCK position and remove the key whenever you leave your vehicle.

 If the parking brake is fully released, but the brake warning lamp remains illuminated, the brakes may not be working properly. See your authorized dealer as soon as possible.

Understanding the shift positions of the 5-speed automatic transmission

P R N D 3 2 1

This vehicle is equipped with an adaptive Transmission Shift Strategy. Adaptive Shift Strategy offers the optimal transmission operation and shift quality. When the vehicle's battery has been disconnected for any type of service or repair, the transmission will need to relearn the normal shift strategy parameters, much like having to reset your radio stations when your vehicle battery has been disconnected. The Adaptive Transmission Strategy allows the transmission to relearn these operating parameters. This learning process could take several transmission upshifts and downshifts; during this learning process, slightly firmer shifts may occur. After this learning process, normal shift feel and shift scheduling will resume.

P (Park)

This position locks the transmission and prevents the rear wheels from turning.

To put your vehicle in gear:

- Start the engine
- Depress the brake pedal
- Move the gearshift lever into the desired gear

To put your vehicle in P (Park):

- Come to a complete stop
- Move the gearshift lever and securely latch it in P (Park)



Always set the parking brake fully and make sure the gearshift is latched in P (Park). Turn the ignition to the LOCK position and remove the key whenever you leave your vehicle.

R (Reverse)

With the gearshift lever in R (Reverse), the vehicle will move backward. Always come to a complete stop before shifting into and out of R (Reverse).

Driving

N (Neutral)

With the gearshift lever in N (Neutral), the vehicle can be started and is free to roll. Hold the brake pedal down while in this position.

D (Overdrive) with Tow/Haul OFF

D (Overdrive) with Tow/Haul OFF is the normal driving position for the best fuel economy. The overdrive function allows automatic upshifts and downshifts through gears one through five.

D (Overdrive) with Tow/Haul ON

The Tow/Haul feature improves transmission operation when towing a trailer or a heavy load. All transmission gear ranges are available when using Tow/Haul.

To activate Tow/Haul, press the button on the end of the gearshift lever.

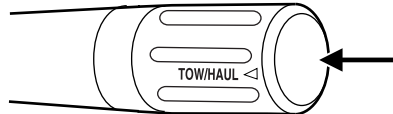

The TOW HAUL indicator light will illuminate in the instrument cluster.

**TOW
HAUL**

Tow/Haul delays upshifts to reduce frequency of transmission shifting. Tow/Haul also provides engine braking in all forward gears when the transmission is in the D (Overdrive) position; this engine braking will slow the vehicle and assist the driver in controlling the vehicle when descending a grade. Depending on driving conditions and load conditions, the transmission may downshift, slow the vehicle and control the vehicle speed when descending a hill, without the accelerator pedal being pressed. The amount of downshift braking provided will vary based upon the amount the brake pedal is depressed.

To deactivate the Tow/Haul feature and return to normal driving mode, press the button on the end of the gearshift lever. The TOW HAUL light will no longer be illuminated.

When you shut-off and restart the engine, the transmission will automatically return to normal D (Overdrive) mode (Tow/Haul OFF).



Do not use the Tow/Haul feature when driving in icy or slippery conditions as the increased engine braking can cause the rear wheels to slide and the vehicle to swing around with the possible loss of vehicle control.

3 (Third)

Transmission starts and operates in third gear only.

Used for improved traction on slippery roads. Selecting 3 (Third) provides engine braking.

2 (Second)

Use 2 (Second) to start-up on slippery roads or to provide additional engine braking on downgrades.

1 (First)

- Provides maximum engine braking.
- Allows upshifts by moving gearshift lever.
- The transmission will not downshift into 1 (First) at high speeds; it will downshift to a lower gear and then shift into 1 (First) when the vehicle reaches slower speeds.

Forced downshifts

- Allowed in D (Overdrive) or D (Drive).
- Depress the accelerator to the floor.
- Allows transmission to select an appropriate gear.

If your vehicle gets stuck in mud or snow

If your vehicle gets stuck in mud or snow, it may be rocked out by shifting between forward and reverse gears, stopping between shifts in a steady pattern. Press lightly on the accelerator in each gear.

Do not rock the vehicle if the engine is not at normal operating temperature or damage to the transmission may occur.

Do not rock the vehicle for more than a minute or damage to the transmission and tires may occur, or the engine may overheat.

MANUAL TRANSMISSION OPERATION (IF EQUIPPED)

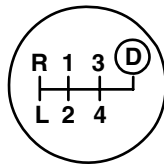

Using the clutch

The manual transmission has a starter interlock that prevents cranking the engine unless the clutch pedal is fully depressed.

Driving

To start the vehicle:

1. Make sure the parking brake is fully set.
2. Press the clutch pedal to the floor, then put the gearshift lever in the neutral position.
3. Start the engine.
4. Press the brake pedal and move the gearshift lever to the desired gear; 1 (First) or R (Reverse).
5. Release the parking brake, then slowly release the clutch pedal while slowly pressing on the accelerator.

During each shift, the clutch pedal must be fully depressed to the floor. Failure to fully depress the clutch pedal to the floor may cause increased shift efforts, prematurely wear transmission components or damage the transmission. Make sure the floor mat is properly positioned so it doesn't interfere with the full extension of the clutch pedal.

Do not drive with your foot resting on the clutch pedal or use the clutch pedal to hold your vehicle at a standstill while waiting on a hill. These actions will reduce the life of the clutch.

Recommended shift speeds

Do not overspeed the engine when going downhill or steep grades. If equipped, use the tachometer and do not allow engine speed to exceed the redline area. Operating the engine beyond the recommended speeds can cause severe engine damage.

Shift according to the following shift speed charts:

Upshifts when accelerating (recommended for best fuel economy)		
6-speed transmission		
Shift from:	Transfer case position ¹ (if equipped)	
	2H or 4H	4L
LO-1	5 mph (8 km/h)	2 mph (3 km/h)
1-2	14 mph (23 km/h)	6 mph (10 km/h)
2-3	22 mph (35 km/h)	9 mph (14 km/h)
3-4	30 mph (48 km/h)	12 mph (19 km/h)
4 - D (Overdrive)	40 mph (64 km/h)	15 mph (24 km/h)

Driving

Maximum downshift speeds ¹		
6-speed transmission		
Shift from:	Transfer case position (if equipped) ²	
	2H or 4H	4L
Ⓓ (Overdrive) - 4	45 mph (72 km/h)	16 mph (26 km/h)
4-3	35 mph (56 km/h)	12 mph (19 km/h)
3-2	20 mph (32 km/h)	8 mph (13 km/h)
2-1	5 mph (8 km/h)	2 mph (3 km/h)
1-LO	Only shift to LO when at a stop.	
¹ Use 2H or 4H for 4WD equipped vehicles.		
² Downshift at lower speeds when driving on slippery surfaces.		

Reverse

1. Make sure that your vehicle is at a complete stop before you shift into R (Reverse). Failure to do so may damage the transmission.
2. Move the gearshift lever into the neutral position and wait at least three seconds before shifting into R (Reverse).
 - The gearshift lever can only be moved into R (Reverse) by moving it from left of 3 (Third) and 4 (Fourth) before shifting into R (Reverse). This is a lockout feature that protects the transmission from accidentally being shifted into R (Reverse) from D (Overdrive).

Parking your vehicle

1. Apply the brake and shift into the neutral position.
2. Fully apply the parking brake, then shift into 1 (First).
3. Turn the ignition off.



Do not park your vehicle in Neutral, it may move unexpectedly and injure someone. Use 1 (First) gear and set the parking brake fully.

Driving

REVERSE SENSING SYSTEM (IF EQUIPPED)

The Reverse Sensing System (RSS) sounds a tone to warn the driver of obstacles near the rear bumper when the R (Reverse) is selected and the vehicle is moving at speeds less than 3 mph (5 km/h). The system is not effective at speeds above 3 mph (5 km/h) and may not detect certain angular or moving objects.



To help avoid personal injury, please read and understand the limitations of the reverse sensing system as contained in this section. Reverse sensing is only an aid for some (generally large and fixed) objects when moving in reverse on a flat surface at “parking speeds”. Inclement weather may also affect the function of the RSS; this may include reduced performance or a false activation.



To help avoid personal injury, always use caution when in reverse and when using the RSS.



This system is not designed to prevent contact with small or moving objects. The system is designed to provide a warning to assist the driver in detecting large stationary objects to avoid damaging the vehicle. The system may not detect smaller objects, particularly those close to the ground.



Certain add-on devices such as large trailer hitches, bike or surfboard racks and any device that may block the normal detection zone of the RSS system may create false beeps.

Driving

The RSS detects obstacles up to 6 feet (2 meters) from the rear bumper with a decreased coverage area at the outer corners of the bumper, (refer to the figures for approximate zone coverage areas). As you move closer to the obstacle, the rate of the tone increases. When the obstacle is less than 10 inches (25.0 cm) away, the tone will sound continuously. If the RSS detects a stationary or receding object further than 10 inches (25.0 cm) from the side of the vehicle, the tone will sound for only three seconds. Once the system detects an object approaching, the tone will sound again.

The RSS may have reduced performance or an increased chance of false detection if the tailgate is not locked and in the upright position. If the tailgate is down, the RSS tone may be heard intermittently or continuously. The tone may also be heard if items in the truck bed protrude rearward outside the bed.

The RSS automatically turns on when the gearshift lever is placed in R (Reverse) and the ignition is on. An RSS control allows the driver to turn the RSS on and off. To turn the RSS off, the ignition must be on, and the gear selector in R (Reverse). An indicator light on the control will illuminate when the system is turned off. If the indicator light illuminates when the RSS is not turned off, it may indicate a failure in the RSS. The RSS will remain off until either the RSS control is pushed again or the ignition switch is recycled.

Keep the RSS sensors (located on the rear bumper/fascia) free from snow, ice and large accumulations of dirt (do not clean the sensors with sharp objects). If the sensors are covered, it will affect the accuracy of the RSS.

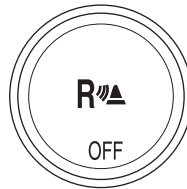
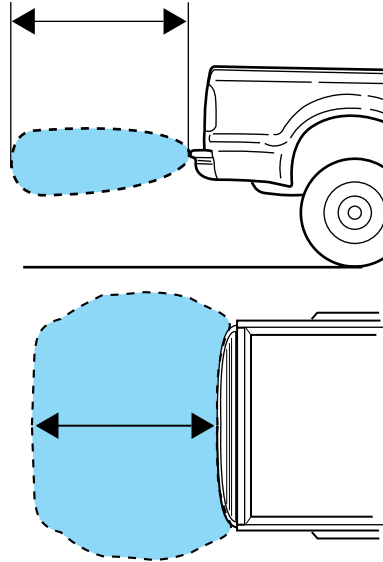

Driving

If your vehicle sustains damage to the rear bumper/fascia, leaving it misaligned or bent, the sensing zone may be altered causing inaccurate measurement of obstacles or false alarms.

REVERSE CAMERA SYSTEM (IF EQUIPPED)

The reverse camera system, located on the tailgate, provides a video image (which appears in the rear view mirror) of the area behind the vehicle. It adds assistance to the driver while reversing or reverse parking the vehicle.

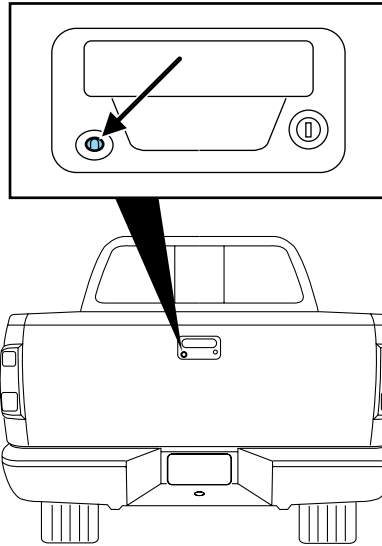

To use the reverse camera system, place the transmission in R (Reverse); an image will display on the left portion of the rear view mirror. The area displayed on the screen may vary according to the vehicle orientation and/or road condition.

- (1) Centerline of vehicle
- (2) Rear bumper
- (3) Red zone
- (4) Yellow zone
- (5) Green zone

Always use caution while backing.

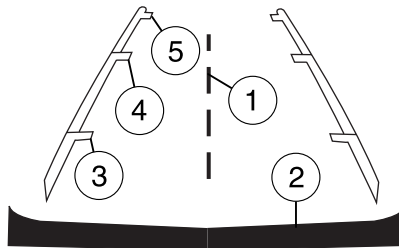

Driving

Objects in the red zone are closest to your vehicle and objects in the green zone are further away. Objects are getting closer to your vehicle as they move from the green zone to the yellow or red zones.

Use the side mirrors and rear view mirror to get better coverage on both sides and rear of the vehicle. When shifting out of reverse and into any other gear, the image will remain on for a few seconds before it shuts off to assist in parking or trailer hookup.

When towing, the reverse camera system will only see what is being towed behind the vehicle; this might not provide adequate coverage as it usually provides in normal operation and some objects might not be seen.

The camera lens for the reverse camera system is located on the tailgate, near the tailgate handle. Keep the lens clean so the video image remains clear and undistorted. Clean the lens with a soft, lint-free cloth and non-abrasive cleaner.

Note: If the reverse camera system image is not clear or seems distorted, it may be covered with water droplets, snow, mud or any other substance. If this occurs, clean the camera lens before using the reverse camera system.



The reverse camera system is a reverse aid supplement device that still requires the driver to use it in conjunction with the rear view mirror and the side mirrors for maximum coverage.



Objects that are close to either corner of the bumper or under the bumper, might not be seen on the screen due to the limited coverage of the reverse camera system.



Backup as slow as possible since higher speeds might limit your reaction time to stop the vehicle.



Do not use the reverse camera system with the tailgate open.

If the back end of the vehicle is hit or damaged, then check with your authorized dealer to have your rear video system checked for proper coverage and operation.

Driving

Nighttime and dark area use

At night time or in dark areas, the reverse camera system relies on the reverse lamp lighting to produce an image. Therefore it is necessary that both reverse lamps are operating in order to get a clear image in the dark. If either of the lamps are not operating, stop using the reverse camera system, at least in the dark, until the lamp(s) are replaced and functioning.

Servicing

- If the vehicle is in R (Reverse) and the screen in the rear view mirror appears blue for three seconds and turns blank afterwards, the camera is not working properly; have the system inspected by your authorized dealer.
- If the image comes on while the vehicle is not in R (Reverse), have the system inspected by your authorized dealer.
- If the vehicle is in R (Reverse) and the screen is blank and no blue screen is observed, the mirror is not working properly; have the system inspected by your authorized dealer.
- If the image is not clear, then check if there is anything covering the lens such as dirt, mud, ice, snow, etc. If the image is still not clear after cleaning, have your system inspected by your authorized dealer.

FOUR-WHEEL DRIVE (4WD) OPERATION (IF EQUIPPED)



For important information regarding safe operation of this type of vehicle, see **Preparing to drive your vehicle** in this chapter.

When four-wheel drive (4WD) is engaged, power is supplied to all four wheels through a transfer case. 4WD can be selected when additional traction is desired.

4WD operation is not recommended on dry pavement. Doing so could result in difficult disengagement of the transfer case, increased tire wear and decreased fuel economy.

Manual Shift On Stop (MSOS) 4x4 system (if equipped)

The 4WD system is engaged or disengaged by rotating the control for both front wheel hub locks from the FREE or LOCK position, then manually engaging or disengaging the transfer case with the floor-mounted shifter. For increased fuel economy in 2WD, rotate both hub locks to the FREE position.

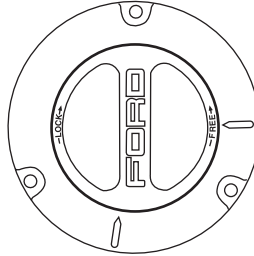

- **For proper operation, make sure that each hub is fully engaged and that both hub locks are set to the same position (both set to LOCK or both set to FREE). To engage LOCK, turn the hub locks completely clockwise; to disengage the hubs (FREE), turn the hub locks completely counterclockwise.**
- Some vehicles may be equipped with wheel ornaments that cover the 4x4 manual hub lock. These ornaments must be removed to access the manual hub locks.

Electronic Shift On the Fly (ESOF) 4x4 system (if equipped)

If equipped with the electronic shift 4WD System, and the instrument panel control is moved to 4X4 LOW while the vehicle is moving above 5 mph (8 km/h), the system will not engage and no damage will occur to the 4WD system. Before 4X4 LOW can be engaged, the vehicle speed must be below 5 mph (8 km/h) with the brake pedal depressed and the transmission in N (Neutral). If your vehicle is equipped with a manual transmission, the clutch pedal also must be depressed. This vehicle is equipped with a non-synchronous low range gearset which will not allow the transfer case to shift into 4X4 LOW if vehicle speed is above 5 mph (8 km/h). It is recommended that a shift to 4X4 LOW is performed while the vehicle is rolling at a speed below 5 mph (8 km/h).

The 4WD system:

- provides 4x4 High engagement and disengagement while the vehicle is moving.
- is operated by a rotary control located on the instrument panel that allows you select 2WD, 4x4 High or 4x4 Low operation.
- uses auto-manual hub locks that can be engaged and disengaged automatically based on the 4x4 mode selected.

Driving

- auto-manual hub locks can be manually overridden by rotating the hub lock control from AUTO to LOCK if desired.
- **automatic operation of the hub locks is recommended**, and will increase fuel economy
- **For proper operation, make sure that each hub is fully engaged and that both hub locks are set to the same position (both set to LOCK or both set to AUTO). To engage LOCK, turn the hub locks completely clockwise; to engage AUTO, turn the hub locks completely counterclockwise.**

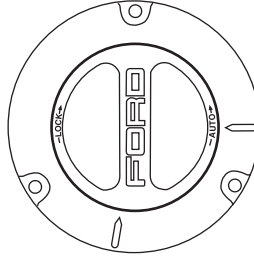

4WD system indicator lights

The 4WD system indicator lights illuminate only under the following conditions. If these lights illuminate when driving in 2WD, contact your authorized dealer as soon as possible.

- **4x4 HIGH** - momentarily illuminates after the engine is started. Illuminates when 4H (4x4 High) or 4L (4x4 Low) is engaged. **4x4 HIGH**
- **4x4 LOW** - momentarily illuminates when the ignition is turned to the ON position. Illuminates when 4L (4x4 Low) is engaged. **4x4 LOW**

Using a Manual Shift On Stop (MSOS) 4x4 system (if equipped)

Note: High shift efforts may be encountered when attempting to shift into and out of 4x4 modes. It is recommended to allow the vehicle to roll at a speed below 5 mph (8 km/h) when shifting.

Note: Some noise may be heard as the 4x4 system shifts or engages. This is normal. In order to reduce engagement noise, it is recommended that all shifts be performed at speeds below 5 mph (8 km/h).

2H (2WD) – For general on-road driving. Sends power to the rear wheels only.

4H (4x4 High) – For winter and off-road conditions. Sends power to front and rear wheels. **This mode is not intended for use on dry pavement.**

N (Neutral) – Only used when towing the vehicle.

4L (4x4 Low) – For low-speed off-road applications that require extra power such as steep grades, deep sand or pulling a boat out of the water. Sends power to front and rear wheels. **This mode is not intended for use on dry pavement.**

Shifting from 2H (2WD) to 4H (4x4 High)

Engage the locking hubs by rotating the hub lock control from FREE to LOCK, then move the transfer case lever from 2H (2WD) to 4H (4x4 High) at a stop or a vehicle speed below 5 mph (8 km/h).

- **For proper operation, make sure that both indicator arrows on the hub are aligned, and that both hubs are set to LOCK.**
- **Do not shift into 4H (4x4 High) with the rear wheels slipping.**

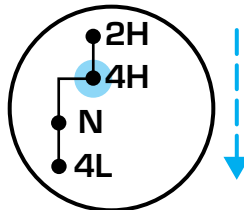
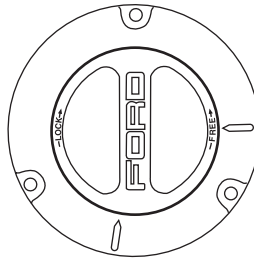

Shifting from 4H (4x4 High) to 2H (2WD)

Move the transfer case lever to 2H (2WD) at a stop or a vehicle speed below 5 mph (8 km/h).

With the vehicle at complete stop, disengage the locking hubs (optional) by rotating the hub lock control from LOCK to FREE.

- **For proper operation, make sure that both indicator arrows on the hub are aligned, and that both hubs are set to FREE**

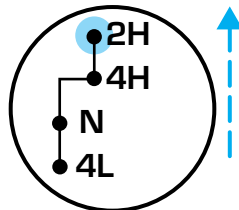

Driving

Shifting from 4H (4x4 High) to 4L (4x4 Low)

1. Bring the vehicle to a stop or a speed below 5 mph (8 km/h).
2. Place the gearshift lever in N (Neutral). If the vehicle is equipped with a manual transmission, also depress the clutch pedal.
3. Move the transfer case shift lever through N (Neutral) directly to 4L (4x4 Low).
4. If the shift lever does not, or only partially moves to the 4L (4x4 Low) position, perform a shift with the transmission in N (Neutral) (or clutch pedal depressed) and the vehicle rolling at a speed below 5 mph (8 km/h). This will ensure the transfer case is fully engaged into 4L (4x4 Low).

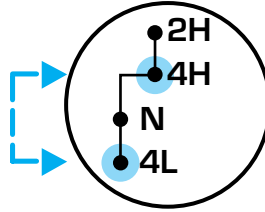

Shifting from 4L (4x4 Low) to 4H (4x4 High) or 2H (2WD)

1. Bring the vehicle to a stop or a speed below 5 mph (8 km/h).
2. Place the gearshift lever in N (Neutral). If the vehicle is equipped with a manual transmission, also depress the clutch pedal.
3. Move the transfer case shift lever through N (Neutral) directly to 4H (4x4 High) or 2H (2WD).
4. If the transfer case **will not** engage into 4H (4x4 High) or 2H (2WD), perform a shift with the transmission in N (Neutral) (or clutch pedal depressed) and the vehicle rolling at a speed below 5 mph (8 km/h).
5. If shifting to 2H (2WD) with the vehicle at a complete stop, disengage the locking hubs (optional) by rotating the hub lock control from LOCK to FREE.

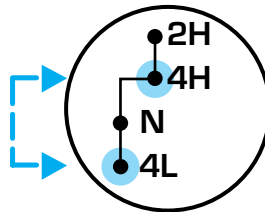

Using the N (Neutral) position

The transfer case neutral position overrides the transmission and puts the vehicle in neutral regardless of transmission gearshift lever position. The vehicle can move forward or backwards.

Driving

This position should only be used when towing the vehicle.

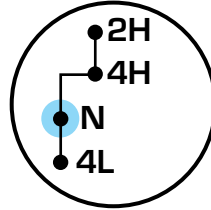

Do not leave the vehicle unattended with the transfer case in the N (Neutral) position. Always set the parking brake fully and turn off the ignition when leaving the vehicle.

Using the Electronic Shift On the Fly (ESOF) 4x4 system (if equipped)

Positions of the electronic shift system

Note: Some noise may be heard as the 4WD system shifts or engages. This is normal.

2WD – For general on-road driving. Sends power to the rear wheels only.

4x4 HIGH – For winter and off-road conditions. Sends power to front and rear wheels. **This mode is not intended for use on dry pavement.**

4x4 LOW – For low-speed off-road applications that require extra power such as steep grades, deep sand or pulling a boat out of the water. Sends power to front and rear wheels. **This mode is not intended for use on dry pavement.**

Shifting from 2WD to 4x4 HIGH

Rotate the 4x4 control to the 4x4 HIGH position at speeds up to 55 mph (88 km/h).

- **The electronic shift 4x4 system is designed to engage 4x4 HIGH when the vehicle is moving. If shifted to 4x4 HIGH while at complete stop, 4x4 may not engage and the 4x4 indicator may not illuminate until the vehicle is allowed to move at a speed above 1 mph (1.6 km/h).**

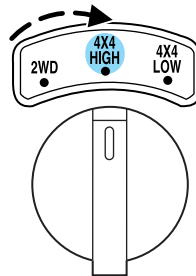

Driving

- **Do not shift into 4x4 HIGH with the rear wheels slipping.**

Shifting from 4x4 HIGH to 2WD

Rotate the 4x4 control to 2WD at any forward speed. Disengagement of the transfer case and front hubs may be delayed due to torque bind which is caused by driving on dry hard surfaces or performing tight turns while using the 4x4 system.

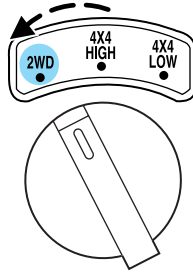

- You **do not** need to operate the vehicle in R (Reverse) to disengage your front hubs, but it will eliminate any torque bind and allow the system to immediately disengage.

Shifting from 4x4 HIGH to 4x4 LOW

1. Bring the vehicle to a complete stop.
2. Place the gearshift in N (Neutral). If the vehicle is equipped with a manual transmission, also depress the clutch pedal.
3. Move the 4x4 control to the 4x4 LOW position.
4. Hold the shift conditions until the 4x4 LOW indicator light illuminates.
5. If the 4x4 LOW indicator light **does not** illuminate within 15 seconds, allow the vehicle to move at a speed below 5 mph (8 km/h), then repeat steps 2 through 5 while the vehicle is rolling before reporting any shift concerns to your authorized dealer.

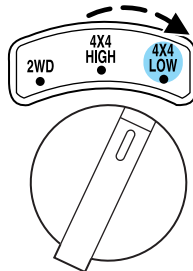

Shifting from 4x4 LOW to 4x4 HIGH or 2WD

1. Bring the vehicle to a complete stop.
2. Place the gearshift in N (Neutral).

3. Move the 4x4 control to the 4x4 HIGH or 2WD position.

4. Hold the shift conditions until the 4x4 LOW indicator light shuts off.

5. If the 4x4 LOW indicator light **does not** shut off within 15 seconds, allow the vehicle to move at a speed below 5 mph (8 km/h), then repeat steps 2 through 5 while the vehicle is rolling before reporting any shift concerns to your authorized dealer.

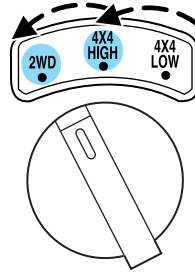

Driving off-road with truck and utility vehicles

4WD vehicles are specially equipped for driving on sand, snow, mud and rough terrain and have operating characteristics that are somewhat different from conventional vehicles, both on and off the road.

Your vehicle may be equipped with a long front air dam that may become damaged (due to reduced ground clearance) when taking your vehicle off-road. This air dam can either be removed or a shorter air dam can be purchased from your authorized dealer. In either case, if the air dam is to be removed (or replaced) before going off-road, refer to the *Workshop Manual* for the procedure or have your authorized dealer perform the work for you.

How your vehicle differs from other vehicles

Truck and utility vehicles can differ from some other vehicles. Your vehicle may be higher to allow it to travel over rough terrain without getting hung up or damaging underbody components.

The differences that make your vehicle so versatile also make it handle differently than an ordinary passenger car.

Maintain steering wheel control at all times, especially in rough terrain. Since sudden changes in terrain can result in abrupt steering wheel motion, make sure you grip the steering wheel from the outside. Do not grip the spokes.

Drive cautiously to avoid vehicle damage from concealed objects such as rocks and stumps.

You should either know the terrain or examine maps of the area before driving. Map out your route before driving in the area. To maintain steering and braking control of your vehicle, you must have all four wheels on the ground and they must be rolling, not sliding or spinning.

Driving

Basic operating principles

- Do not use 4WD on dry, hard surfaced roads. Doing so will produce excessive noise, increase tire wear and may damage drive components. 4WD modes are only intended for consistently slippery or loose surfaces.
- Drive slower in strong crosswinds which can affect the normal steering characteristics of your vehicle.
- Be extremely careful when driving on pavement made slippery by loose sand, water, gravel, snow or ice.

If your vehicle goes off the edge of the pavement

- If your vehicle goes off the edge of the pavement, slow down, but avoid severe brake application, ease the vehicle back onto the pavement only after reducing your speed. Do not turn the steering wheel too sharply while returning to the road surface.
- It may be safer to stay on the apron or shoulder of the road and slow down gradually before returning to the pavement. You may lose control if you do not slow down or if you turn the steering wheel too sharply or abruptly.
- It often may be less risky to strike small objects, such as highway reflectors, with minor damage to your vehicle rather than attempt a sudden return to the pavement which could cause the vehicle to slide sideways out of control or roll over. Remember, your safety and the safety of others should be your primary concern.



Vehicles with a higher center of gravity such as utility and four-wheel drive vehicles handle differently than vehicles with a lower center of gravity. Utility and four-wheel drive vehicles are **not** designed for cornering at speeds as high as passenger cars any more than low-slung sports cars are designed to perform satisfactorily under off-road conditions. Avoid sharp turns, excessive speed and abrupt maneuvers in these vehicles. Failure to drive cautiously could result in an increased risk of loss of vehicle control, vehicle rollover, personal injury and death.

If your vehicle gets stuck

If your vehicle gets stuck in mud or snow it may be rocked out by shifting between forward and reverse gears, stopping between shifts, in a steady pattern. Press lightly on the accelerator in each gear.

Do not rock the vehicle if the engine is not at normal operating temperature or damage to the transmission may occur.

Driving

Do not rock the vehicle for more than a few minutes or damage to the transmission and tires may occur or the engine may overheat.



Do not spin the wheels at over 35 mph (56 km/h). The tires may fail and injure a passenger or bystander.

Refer to *Transmission fluid temperature gauge* in the *Instrument Cluster* chapter for transmission fluid temperature information.

Emergency maneuvers

- In an unavoidable emergency situation where a sudden sharp turn must be made, remember to avoid “over-driving” your vehicle, i.e., turn the steering wheel only as rapidly and as far as required to avoid the emergency. Excessive steering will result in less vehicle control, not more. Additionally, smooth variations of the accelerator and/or brake pedal pressure should be utilized if changes in vehicle speed are called for. Avoid abrupt steering, acceleration or braking which could result in an increased risk of loss of vehicle control, vehicle rollover and/or personal injury. Use all available road surface to return the vehicle to a safe direction of travel.
- In the event of an emergency stop, avoid skidding the tires and do not attempt any sharp steering wheel movements.



Vehicles with a higher center of gravity such as utility and four-wheel drive vehicles handle differently than vehicles with a lower center of gravity. Utility and four-wheel drive vehicles are **not** designed for cornering at speeds as high as passenger cars any more than low-slung sports cars are designed to perform satisfactorily under off-road conditions. Avoid sharp turns, excessive speed and abrupt maneuvers in these vehicles. Failure to drive cautiously could result in an increased risk of loss of vehicle control, vehicle rollover, personal injury and death.

- If the vehicle goes from one type of surface to another (i.e., from concrete to gravel) there will be a change in the way the vehicle responds to a maneuver (steering, acceleration or braking). Again, avoid these abrupt inputs.

Parking

On some 4WD vehicles, when the transfer case is in the N (Neutral) position, the engine and transmission are disconnected from the rest of the driveline. Therefore, the vehicle is free to roll even if the automatic

Driving

transmission is in P (Park) or the manual transmission is in gear. Do not leave the vehicle unattended with the transfer case in the N (Neutral) position. Always set the parking brake fully and turn off the ignition when leaving the vehicle.



Always set the parking brake fully and make sure the gearshift is latched in P (Park). Turn the ignition to the LOCK position and remove the key whenever you leave your vehicle.



If the parking brake is fully released, but the brake warning lamp remains illuminated, the brakes may not be working properly. See your authorized dealer.

4WD Systems

4WD (when you select a 4WD mode), uses all four wheels to power the vehicle. This increases traction, enabling you to drive over terrain and road conditions that a conventional two-wheel drive vehicle cannot.

Power is supplied to all four wheels through a transfer case. On 4WD vehicles, the transfer case allows you to select 4WD when necessary. Information on transfer case operation and shifting procedures can be found in the *Driving* chapter. Information on transfer case maintenance can be found in the *Maintenance and Specifications* chapter. You should become thoroughly familiar with this information before you operate your vehicle.

Normal characteristics

On some 4WD models, the initial shift from two-wheel drive to 4x4 while the vehicle is moving can cause some momentary clunk and ratcheting sounds. This is the front drivetrain coming up to speed and the automatic locking hubs engaging and is not cause for concern.

Sand

When driving over sand, try to keep all four wheels on the most solid area of the trail. Avoid reducing the tire pressures but shift to a lower gear and drive steadily through the terrain. Apply the accelerator slowly and avoid spinning the wheels.

Avoid excessive speed because vehicle momentum can work against you and cause the vehicle to become stuck to the point that assistance may be required from another vehicle. Remember, you may be able to back out the way you came if you proceed with caution.

Driving

Note: If air is released from your tires, the Tire Pressure Monitoring System (TPMS) indicator light may illuminate (if equipped).

Mud and water

If you must drive through high water, drive slowly. Traction or brake capability may be limited.

When driving through water, determine the depth; avoid water higher than the bottom of the hubs (if possible) and proceed slowly. If the ignition system gets wet, the vehicle may stall.



Once through water, always try the brakes. Wet brakes do not stop the vehicle as effectively as dry brakes. Drying can be improved by moving your vehicle slowly while applying light pressure on the brake pedal.

Be cautious of sudden changes in vehicle speed or direction when you are driving in mud. Even 4WD vehicles can lose traction in slick mud. As when you are driving over sand, apply the accelerator slowly and avoid spinning your wheels. If the vehicle does slide, steer in the direction of the slide until you regain control of the vehicle.

If the transmission, transfer case or front axle are submerged in water, their fluids should be checked and changed, if necessary.

Driving through deep water may damage the transmission.

Refer to *Transmission temperature gauge* in the *Instrument Cluster* chapter for transmission fluid temperature information.

If the front or rear axle is submerged in water, the axle lubricant should be replaced.

After driving through mud, clean off residue stuck to rotating driveshafts and tires. Excess mud stuck on tires and rotating driveshafts causes an imbalance that could damage drive components.

“Tread Lightly” is an educational program designed to increase public awareness of land-use regulations and responsibilities in our nation's wilderness areas. Ford Motor

Company joins the U.S. Forest Service and the Bureau of Land Management in encouraging you to help preserve our national forest and other public and private lands by “treading lightly.”



Driving

Driving on hilly or sloping terrain

Although natural obstacles may make it necessary to travel diagonally up or down a hill or steep incline, you should always try to drive straight up or straight down. **Avoid driving crosswise or turning on steep slopes or hills.** A danger lies in losing traction, slipping sideways and possibly rolling over. Whenever driving on a hill, determine beforehand the route you will use. Do not drive over the crest of a hill without seeing what conditions are on the other side. Do not drive in reverse over a hill without the aid of an observer.

When climbing a steep slope or hill, start in a lower gear rather than downshifting to a lower gear from a higher gear once the ascent has started. This reduces strain on the engine and the possibility of stalling.

If you do stall out, do not try to turn around because you might roll over. It is better to back down to a safe location.

Apply just enough power to the wheels to climb the hill. Too much power will cause the tires to slip, spin or lose traction, resulting in loss of vehicle control.

Descend a hill in the same gear you would use to climb up the hill to avoid excessive brake application and brake overheating. Do not descend in neutral; instead, manually shift to a lower gear. Your vehicle has anti-lock brakes, apply the brakes steadily. Do not “pump” the brakes.

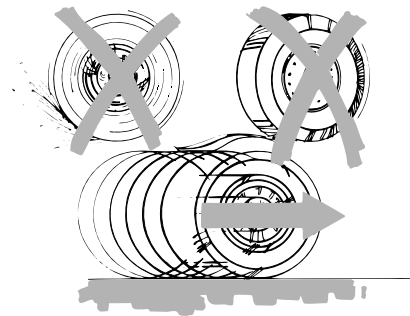
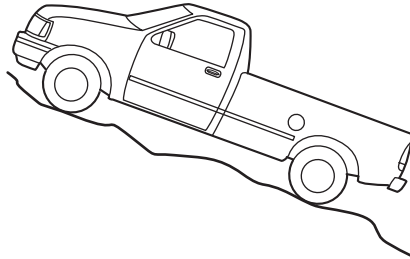

Driving on snow and ice

4WD vehicles have advantages over 2WD vehicles in snow and ice but can skid like any other vehicle.

288

Driving

Should you start to slide while driving on snowy or icy roads, turn the steering wheel in the direction of the slide until you regain control.

Avoid sudden applications of power and quick changes of direction on snow and ice. Apply the accelerator slowly and steadily when starting from a full stop.

Avoid sudden braking as well. Although a 4WD vehicle may accelerate better than a two-wheel drive vehicle in snow and ice, it won't stop any faster, because as in other vehicles, braking occurs at all four wheels. Do not become overconfident as to road conditions.

Make sure you allow sufficient distance between you and other vehicles for stopping. Drive slower than usual and consider using one of the lower gears. In emergency stopping situations, avoid locking of the wheels. Use a "squeeze" technique, push on the brake pedal with a steadily increasing force which allows the wheels to brake yet continue to roll so that you may steer in the direction you want to travel. If you lock the wheels, release the brake pedal and repeat the squeeze technique. If your vehicle is equipped with a Four Wheel Anti-Lock Brake System (ABS), apply the brake steadily. Do not "pump" the brakes. Refer to the *Brakes* section of this chapter for additional information on the operation of the anti-lock brake system.

Never drive with chains on the front tires of 4WD vehicles without also putting them on the rear tires. This could cause the rear to slide and swing around during braking.

Maintenance and Modifications

The suspension and steering systems on your vehicle have been designed and tested to provide predictable performance whether loaded or empty and durable load carrying capability. For this reason, Ford Motor Company strongly recommends that you do not make modifications such as adding or removing parts (such as lift kits or stabilizer bars) or by using replacement parts not equivalent to the original factory equipment.

Any modifications to a vehicle that raise the center of gravity can make it more likely the vehicle will roll over as a result of a loss of control. Ford Motor Company recommends that caution be used with any vehicle equipped with a high load or device (such as ladder racks or pickup box cover).

Failure to maintain your vehicle properly may void the warranty, increase your repair cost, reduce vehicle performance and operational capabilities and adversely affect driver and passenger safety. Frequent inspection of vehicle chassis components is recommended if the vehicle is subjected to heavy off-road usage.

Driving

VEHICLE USED AS A STATIONARY POWER SOURCE

Auxiliary equipment called power take-off, or PTO, is often added to the engine or transmission to operate utility equipment. Examples include a wheel-lift for tow trucks, cranes, tools for construction or tire service, and pumping fluids. PTO applications draw auxiliary horsepower from the powertrain, often while the vehicle is stationary. In this condition, there is limited cooling air flow through the radiator and around the vehicle that normally occurs when a vehicle is moving. The aftermarket PTO system installer, having the most knowledge of the final application, is responsible for determining whether additional chassis heat protection or powertrain cooling is required, and alerting the user to the safe and proper operation.

Ford Super Duty Vehicles are qualified for use as a stationary power source, within limits detailed in the *Ford Truck Body Builders Layout Book*, found at www.fleet.ford.com/truckbbas, and through the Ford Truck Body Builders Advisory Service.

Gas engine vehicles are qualified for up to 10 minutes of continuous operation as a stationary power source, due to the potential for the normal venting of fuel vapors. For stationary PTO operation of extended duration (beyond 10 minutes), diesel engine is recommended. Further consult your aftermarket PTO installer, since the duration of operation limit for the aftermarket PTO may be less than the vehicle is capable of.

DRIVING THROUGH WATER

If driving through deep or standing water is unavoidable, proceed very slowly especially when the depth is not known. Never drive through water that is higher than the bottom of the wheel rims (for cars) or the bottom of the hubs (for trucks).

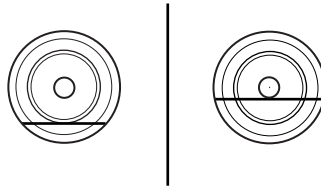

When driving through water, traction or brake capability may be limited. Also, water may enter your engine's air intake and severely damage your engine or your vehicle may stall. **Driving through deep water where the transmission vent tube is submerged may allow water into the transmission and cause internal transmission damage.**

Once through the water, always dry the brakes by moving your vehicle slowly while applying light pressure on the brake pedal.

Wet brakes do not stop the vehicle as quickly as dry brakes.

SNOWPLOWING

Ford recommends that the Super Duty F-Series used for snow removal include a snow plow package option.

Installing the snowplow

Weight limits and guidelines for selecting and installing the snowplow can be found in the *Ford Truck Body Builders Layout Book*, Snowplow section, found at www.fleet.ford.com/truckbbas. A typical installation affects the following:

- Certification to government safety laws such as occupant protection and airbag deployment, braking, and lighting. Look for an “Alterer’s Label” on the vehicle from the snowplow installer certifying that the installation meets all applicable Federal Motor Vehicle Safety Standards (FMVSS).
- The Total Accessory Reserve Capacity (TARC) is shown on the lower right side of the vehicle’s Safety Compliance Certification Label. This applies to Ford-completed vehicles of 10,000 lb. (4,536 kg) GVWR or less. This is the weight of permanently-attached auxiliary equipment, such as snowplow frame-mounting hardware, that can be added to the vehicle and satisfy Ford compliance certification to FMVSS. Exceeding this weight may require the auxiliary equipment installer additional safety certification responsibility. The Front Accessory Reserve Capacity (FARC) is added for customer convenience.
- Rear ballast weight behind the rear axle may be required to prevent exceeding the FGAWR, and provide front-to-rear weight balance for proper braking and steering.
- Front wheel toe may require re-adjustment to prevent premature uneven tire wear. Specifications are found in the Ford *Workshop Manual*.
- Headlight aim may require re-adjustment.
- The tire air pressures recommended for general driving are found on the vehicle’s Safety Certification Label. The maximum cold inflation pressure for the tire and associated load rating is imprinted on the tire sidewall. Tire air pressure may require re-adjustment within these pressure limits to accommodate the additional weight of the snowplow installation.
- Federal and some local regulations require additional exterior lamps for snowplow-equipped vehicles. Consult your authorized dealer for additional information.

Driving

- Snowplowing with vehicles equipped with a diesel engine may result in engine overheating in highway driving with snowplow blade raised unless equipped with the special engine cooling fan clutch that is included with a snow plow package option.

Operating the vehicle with the snowplow attached

Do not use your vehicle for snow removal until it has been driven at least 500 miles (800 km).

The attached snowplow blade restricts airflow to the radiator, and may cause the engine to run at a higher temperature: Attention to engine temperature is especially important when outside temperatures are above freezing. Angle the blade to maximize airflow to the radiator and monitor engine temperature to determine whether a left or right angle provides the best performance.

Follow the severe duty schedule in your *scheduled maintenance information* for engine oil and transmission fluid change intervals.

Snowplowing with your airbag-equipped vehicle

Your vehicle is equipped with a driver and passenger airbag Supplemental Restraint System (SRS) The SRS is designed to activate in certain frontal and offset frontal collisions when the vehicle sustains sufficient longitudinal deceleration.

Careless or high speed driving while plowing snow which results in sufficient vehicle decelerations can deploy the airbag. Such driving also increases the risk of accidents.



All occupants of the vehicle, including the driver, should always properly wear their safety belts, even when an air bag supplemental restraint system (SRS) is provided.

Never remove or defeat the “tripping mechanisms” designed into the snow removal equipment by its manufacturer. Doing so may cause damage to the vehicle and the snow removal equipment as well as possible airbag deployment.



Do not attempt to service, repair, or modify the air bag supplemental restraint system (SRS) or its fuses. See your Ford or Lincoln Mercury dealer.

Driving



Additional equipment such as snowplow equipment may effect the performance of the airbag sensors increasing the risk of injury. Please refer to the *Ford Truck Body Builders Layout Book* for instructions about the appropriate installation of additional equipment.

Transmission operation while plowing

Operate the vehicle with the automatic transmission gearshift lever in the D (Overdrive) position and Tow/Haul off.

- Shift transfer case to 4x4 LOW when plowing in small areas at speeds below 5 mph (8 km/h).
- Shift transfer case to 4x4 HIGH when plowing larger areas or light snow at higher speeds. Do not exceed 15 mph (24 km/h).
- Do not shift the transmission from a forward gear to R (Reverse) until the engine is at idle and the wheels are stopped.
- If the vehicle is stuck, shift the transmission in a steady motion between forward and reverse gears. Do not rock the vehicle for more than a few minutes. The transmission and tires may be damaged or the engine can overheat.

Do not rock the vehicle if the engine is not at normal operating temperature. Do not rock the vehicle for more than a minute. The transmission and tires may be damaged or the engine may overheat.

Refer to *Transmission fluid temperature gauge* in the *Instrument Cluster* chapter for transmission fluid temperature information.



Do not spin the wheels at over 35 mph (56 km/h). The tires may fail and injure a passenger or bystander

Roadside Emergencies

ROADSIDE ASSISTANCE

Getting roadside assistance

To fully assist you should you have a vehicle concern, Ford Motor Company offers a complimentary roadside assistance program. This program is separate from the New Vehicle Limited Warranty. The service is available:

- 24-hours, seven days a week
- for the coverage period listed on the Roadside Assistance Card included in your Owner Guide portfolio.

Roadside assistance will cover:

- a flat tire change with a good spare (except vehicles that have been supplied with a tire inflation kit)
- battery jump start
- lock-out assistance (key replacement cost is the customer's responsibility)
- fuel delivery – Independent Service Contractors, if not prohibited by state, local or municipal law shall deliver up to 2.0 gallons (7.5L) of gasoline or 5 gallons (18.9L) of diesel fuel to a disabled vehicle. Fuel delivery service is limited to two no-charge occurrences within a 12-month period.
- winch out – available within 100 feet (30.5 meters) of a paved or county maintained road, no recoveries.
- towing – Ford/Mercury/Lincoln eligible vehicle towed to an authorized dealer within 35 miles (56.3 km) of the disablement location or to the nearest authorized dealer. If a member requests to be towed to an authorized dealer more than 35 miles (56.3 km) from the disablement location, the member shall be responsible for any mileage costs in excess of 35 miles (56.3 km).

Trailers shall be covered up to \$200 if the disabled eligible vehicle requires service at the nearest authorized dealer. If the trailer is disabled, but the towing vehicle is operational, the trailer does not qualify for any roadside services.

Roadside Emergencies

Canadian customers refer to your Customer Information Guide for information on:

- coverage period
- exact fuel amounts
- towing of your disabled vehicle
- emergency travel expense reimbursement
- travel planning benefits

Using roadside assistance

Complete the roadside assistance identification card and place it in your wallet for quick reference. In the United States, this card is found in the Owner Guide portfolio in the glove compartment. In Canada, the card is found in the *Customer Information Guide* in the glove compartment.

U.S. Ford, Mercury and Lincoln vehicle customers who require Roadside Assistance, call 1-800-241-3673.

Canadian customers who require roadside assistance, call 1-800-665-2006.

If you need to arrange roadside assistance for yourself, Ford Motor Company will reimburse a reasonable amount for towing to the nearest dealership within 35 miles. To obtain reimbursement information, U.S. Ford, Mercury and Lincoln vehicle customers call 1-800-241-3673. Customers will be asked to submit their original receipts.

Canadian customers who need to obtain reimbursement information, call 1-800-665-2006.

Roadside coverage beyond basic warranty

In the United States, you may purchase additional roadside assistance coverage beyond this period through the Ford Auto Club by contacting your authorized dealer or by calling 1-800-FORD-CLUB.

Similarly in Canada, for uninterrupted Roadside Assistance coverage, you may purchase extended coverage prior to your Basic Warranty's Roadside Assistance expiring. For more information and enrollment, contact 1-877-294-2582 or visit our website at www.ford.ca.

Roadside Emergencies

HAZARD FLASHER

The hazard flasher is located on the steering column, just behind the steering wheel. The hazard flashers will operate when the ignition is in any position or if the key is not in the ignition.

Push in the flasher control and all front and rear direction signals will flash. Press the flasher control again to turn them off. Use it when your vehicle is disabled and is creating a safety hazard for other motorists.

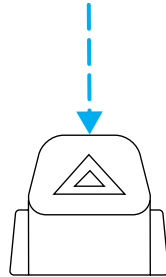

Note: With extended use, the flasher may run down your battery.

FUEL PUMP SHUT-OFF SWITCH

This device stops the electric fuel pump from sending fuel to the engine when your vehicle has had a substantial jolt.

After an accident, if the engine cranks but does not start, this switch may have been activated.

This switch is located on the passenger's side of the instrument panel. Open the front passenger door and remove the small access panel

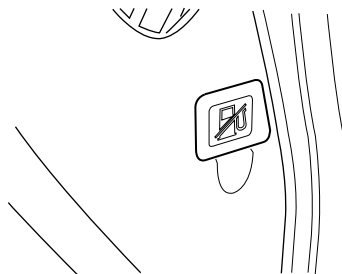

Roadside Emergencies

The switch has a red button on top of it.

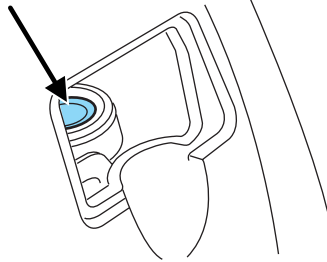

To reset the switch:

1. Turn the ignition off.
2. Check the fuel system for leaks.
3. If no leaks are apparent, reset the switch by pushing in on the reset button.
4. Turn the ignition on.
5. Wait a few seconds and return the key to off.
6. Make another check for leaks.

FUSES AND RELAYS

Fuses

If electrical components in the vehicle are not working, a fuse may have blown. Blown fuses are identified by a broken wire within the fuse. Check the appropriate fuses before replacing any electrical components.

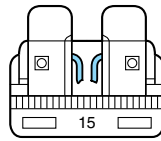

Note: Always replace a fuse with one that has the specified amperage rating. Using a fuse with a higher amperage rating can cause severe wire damage and could start a fire.

Roadside Emergencies

Standard fuse amperage rating and color

Fuse rating	COLOR				
	Mini fuses	Standard fuses	Maxi fuses	Cartridge maxi fuses	Fuse link cartridge
2A	Grey	Grey	—	—	—
3A	Violet	Violet	—	—	—
4A	Pink	Pink	—	—	—
5A	Tan	Tan	—	—	—
7.5A	Brown	Brown	—	—	—
10A	Red	Red	—	—	—
15A	Blue	Blue	—	—	—
20A	Yellow	Yellow	Yellow	Blue	Blue
25A	Natural	Natural	—	—	—
30A	Green	Green	Green	Pink	Pink
40A	—	—	Orange	Green	Green
50A	—	—	Red	Red	Red
60A	—	—	Blue	—	Yellow
70A	—	—	Tan	—	Brown
80A	—	—	Natural	—	Black

Passenger compartment fuse panel

The fuse panel is located in the passenger's footwell. Remove the panel cover to access the fuses.

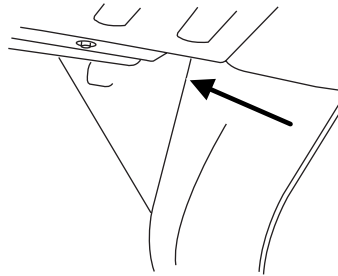

Roadside Emergencies

To remove the fuse panel cover, pull the panel toward you. When the clips of the panel disengage, let the panel fall easily.

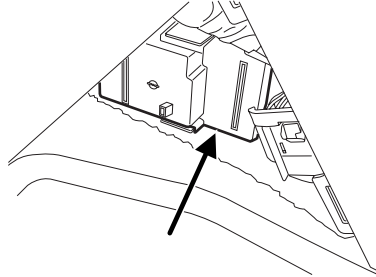

To remove a fuse use the fuse puller tool provided on the fuse panel cover.

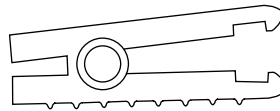

Always disconnect the battery before servicing high current fuses.

Always replace the cover to the passenger compartment fuse panel before reconnecting the battery.

If the battery has been disconnected and reconnected, refer to the *Battery* section of the *Maintenance and Specifications* chapter.

Roadside Emergencies

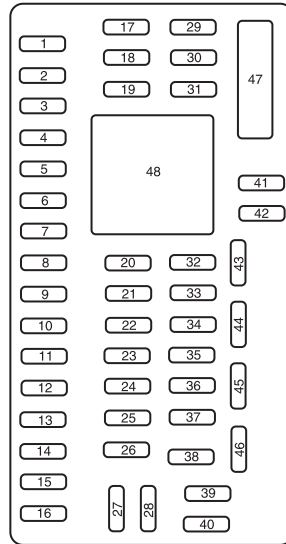

The fuses are coded as follows.

Fuse/Relay Location	Fuse Amp Rating	Passenger Compartment Fuse Panel Description
1	30A	Not used (spare)
2	15A	Not used (spare)
3	15A	Family Entertainment System (FES)
4	30A	Not used (spare)
5	10A	Keypad illumination, Brake-Shift Interlock (BSI), SPBJB
6	20A	Turn signals
7	10A	Left headlamp (Low beam)
8	10A	Right headlamp (Low beam)
9	15A	Interior lighting, Lighted running boards
10	15A	Cargo lamp

Roadside Emergencies

Fuse/Relay Location	Fuse Amp Rating	Passenger Compartment Fuse Panel Description
11	10A	Not used
12	7.5A	Power mirror switch, Driver power seat (Memory)
13	5A	Not used (spare)
14	10A	Upfitter relay #3 feed
15	10A	Climate control head
16	15A	Upfitter Relay #4 Feed
17	20A	All lock motor feeds
18	20A	Heated seat relay feed
19	25A	Not used (spare)
20	15A	Adjustable pedals, Datalink
21	15A	Fog lamp relay feed, Cornering lamps
22	15A	Park lamp relay feed
23	15A	High beam headlight relay feed
24	20A	Horn relay feed
25	10A	Power telescoping mirror switch Demand lamps - underhood and illuminated visor (battery saver)
26	10A	Cluster
27	20A	Ignition switch feed, Passenger compartment fuses 28, 42, 43, 44, and 45, Engine compartment starter relay coil #57 (Diesel engine), Accessory shutoff control module (if equipped) (Diesel engine), Engine compartment starter relay diode (gasoline engines)
28	5A	Radio
29	5A	Not used (spare)
30	5A	Not used (spare)
31	10A	Compass

Roadside Emergencies

Fuse/Relay Location	Fuse Amp Rating	Passenger Compartment Fuse Panel Description
32	10A	Restraints Control Module (RCM), Passenger Airbag Deactivation Indicator
33	10A	Trailer tow brake controller, Trailer tow battery charge relay coil
34	5A	Not used (spare)
35	10A	Reverse Sensing System (RSS), 4x4 module, 4x4 solenoid, Traction control switch, Tow/Haul switch (Diesel engine)
36	5A	Passive Anti-Theft System (PATS) transceiver, Cluster control
37	10A	Dual automatic or Manual climate control, PTC control
38	20A	Subwoofer
39	20A	Radio
40	20A	4x4 module, Satellite radio module
41	15A	Radio, Electrochromatic rear view mirror, Lock switch illumination
42	10A	Heated seat relay coil, Upfitter switch relay coils, Heated mirror relay coil
43	10A	Fuel tank selector switch, 4x4 module
44	10A	Run/Start customer access feed (PTO)
45	5A	Front wiper logic, Blower motor relay coil
46	7.5A	E/C mirror
47	30A Circuit Breaker	Power windows, Moonroof, Power Sliding Backlite
48	Relay	Delayed accessory

Roadside Emergencies

Power distribution box

The power distribution box is located in the engine compartment. The power distribution box contains high-current fuses that protect your vehicle's main electrical systems from overloads.



Always disconnect the battery before servicing high current fuses.



To reduce risk of electrical shock, always replace the cover to the Power Distribution Box before reconnecting the battery or refilling fluid reservoirs.

If the battery has been disconnected and reconnected, refer to the *Battery* section of the *Maintenance and Specifications* chapter.

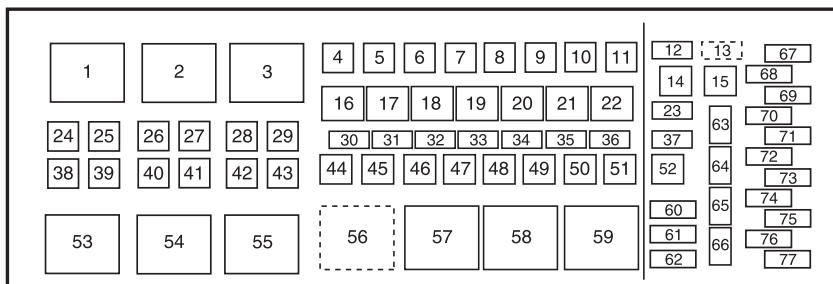

The high-current fuses are coded as follows:

Fuse/Relay Location	Fuse Amp Rating	Power Distribution Box Description
1	Relay	Blower motor/Variable blower control (Dual Zone Climate Control)
2	Relay	Electronic Shift-on-the-Fly (ESOF) Lo-Hi
3	Relay	Heater mirror
4	—	Not used
5	30A*	Trailer Brake Controller (TBC)

Roadside Emergencies

Fuse/Relay Location	Fuse Amp Rating	Power Distribution Box Description
6	40A*	ABS module (Pump)
7	30A*	Upfitter auxiliary switch #1
8	30A*	Upfitter auxiliary switch #2
9	40A*	ABS module (Coil)
10	20A*	Cigar lighter
11	20A*	Instrument panel power point
12	15A**	Brake On/Off (BOO) relay feed
13	5A **	Brake switch, Brake switch relay coil, SJB module, 4x4 module
14	—	Not used
15	—	Not used
16	Relay	A/C clutch
17	Relay	Not used
18	Relay	Fuel Pump Driver Module (FPDM), Fuel injectors (Gasoline engines), Diesel Fuel Control Module (DFCM) (Diesel engine)
19	Relay	Back-up lamps, Reverse Sensing System (RSS), Engine compartment fuse 63
20	Relay	Trailer stop/turn (Left)
21	Relay	Trailer stop/turn (Right)
22	Relay	Stop lamps, Center High-Mounted Stop Lamp (CHMSL), TBC, Customer access
23	15A**	Heater mirror
24	40A*	Blower motor relay
25	—	Not used
26	30A*	ESOF relay lo-hi
27	50A*	Glow Plug Control Module (GPCM) #1 (Diesel engine only)
28	20A*	Heated mirror relay

Roadside Emergencies

Fuse/Relay Location	Fuse Amp Rating	Power Distribution Box Description
29	30A*	Passenger power seat
30	10A**	A/C clutch relay
31	15A**	Power fold mirror relay
32	20A**	Fuel pump relay
33	20A**	Back-up lamp relay
34	25A**	Trailer stop/turn relay
35	5A**	ESOF relay coils
36	10A**	Gasoline engines: Powertrain Control Module (PCM) keep alive power, Canister vent Diesel engine: Engine Control Module (ECM) keep alive power
37	10A**	Transmission Control Module (TCM) (Diesel engine only)
38	—	Not used
39	50A*	ECM power (Diesel engine)
40	30A*	Starter relay
41	20A*	Power point (Center console - Front)
42	30A*	Trailer park lamp relay
43	20A*	Power point (Center console - Rear)
44	30A*	Trailer battery charge relay
45	30A*	Driver power seat or Memory module
46	40A*	Run/Start relay
47	50A*	GPCM #2 (Diesel engine only)
48	30A*	ESOF relay hi-lo
49	30A*	Wiper motor
50	30A*	PCM relay coil, PCM relay (Gasoline engines only)
51	—	Not used
52	—	Not used

Roadside Emergencies

Fuse/Relay Location	Fuse Amp Rating	Power Distribution Box Description
53	Relay	PCM power bus (Fuses 68, 70, 72, 74, 76) (Diesel engine only)
54	Relay	Starter solenoid
55	Relay	Trailer tow park lamps
56	Relay	Trailer tow battery charge
57	Relay	Power Distribution Box (PDB) bus (fuses 67, 69, 71, 73, 75, 77) SJB Run /Start bus (Fuses 29–37, 46)
58	Relay	ESOF hi-lo
59	Relay	PCM power bus (Fuses 68, 70, 72, 74, 76) (Gasoline engines only)
60	Diode	Starter relay (Gasoline engines only)
61	Diode	A/C clutch
62	Diode	Fuel pump
63	15A**	Trailer tow back-up lamps
64	5A**	Mirror marker lamps
65	—	Not used
66	—	Not used
67	—	Not used
68	—	Not used
69	—	Not used
70	10A**	Gasoline engines: A/C clutch relay coil, Refrigerant Containment Switch, Heated PCV Diesel engine: A/C clutch relay coil, Clutch switch, Fuel pump cooler, A/C cycle pressure switch
71	5A**	Fuel pump relay diode, PCM/ECM Run/Start power
72	15A**	Gasoline engines: Ignition coils Diesel engine: Engine TCM

Roadside Emergencies

Fuse/Relay Location	Fuse Amp Rating	Power Distribution Box Description
73	2A**	Reverse Camera System (RCS)
74	20A**	Gasoline engines: VPWR: HEGO, CMS, MAFS, EVMV, CMCV, VCT, IMTV Diesel engine: VPWR: Engine loads
75	5A**	Back-up relay coil power
76	20A**	Gasoline engines: VPWR: PCM Diesel engine: VPWR: ECM
77	10A**	ABS module logic
* Cartridge fuses ** Mini fuses		

CHANGING A FLAT TIRE

If you get a flat tire while driving:

- do not brake heavily.
- gradually decrease the vehicle's speed.
- hold the steering wheel firmly.
- slowly move to a safe place on the side of the road.

Your vehicle may be equipped with a conventional spare tire that is different in one or more of the following: type, brand, size, speed rating and tread design. If this is the case, this dissimilar spare tire is still rated for your vehicle loads (GAWR and GVWR). Temporary spare tires are not equipped with Tire Pressure Monitor System (TPMS) sensors if the system is present.



The use of tire sealant may damage your Tire Pressure Monitoring System (if equipped) and should not be used.



If your vehicle is equipped with a Tire Pressure Monitoring System, refer to *Tire Pressure Monitoring System* in the *Tires, Wheels and Loading* chapter for more information. If the tire pressure monitor sensor becomes damaged, it will no longer function.

Roadside Emergencies

Dissimilar spare tire/wheel information



Failure to follow these guidelines could result in an increased risk of loss of vehicle control, injury or death.

If you have a dissimilar spare tire/wheel, then it is intended for temporary use only. This means that if you need to use it, you should replace it as soon as possible with a road tire/wheel that is the same size and type as the road tires and wheels that were originally provided by Ford. If the dissimilar spare tire or wheel is damaged, it should be replaced rather than repaired.

A dissimilar spare tire/wheel is defined as a spare tire and/or wheel that is different in brand, size or appearance from the road tires and wheels and can be one of three types:

1. **T-type mini-spare:** This spare tire begins with the letter “T” for tire size and may have “Temporary Use Only” molded in the sidewall
2. **Full-size dissimilar spare with label on wheel:** This spare tire has a label on the wheel that states: “THIS TIRE AND WHEEL FOR TEMPORARY USE ONLY”

When driving with one of the dissimilar spare tires listed above, **do not:**

- Exceed 50 mph (80 km/h)
- Load the vehicle beyond maximum vehicle load rating listed on the Safety Compliance Label
- Use snow chains on the end of the vehicle with the dissimilar spare tire
- Use more than one dissimilar spare tire at a time
- Use commercial car washing equipment
- Try to repair the dissimilar spare tire

Use of one of the dissimilar spare tires listed above at any one wheel location can lead to impairment of the following:

- Handling, stability and braking performance
- Comfort and noise
- Ground clearance and parking at curbs
- Winter weather driving capability
- Wet weather driving capability

It is not recommended that the vehicle be operated in 4WD modes with a temporary emergency spare tire. If 4WD operation is necessary, do not operate above speeds of 10 mph (16 km/h) or for distances above 50 miles (80 km).

308

Roadside Emergencies

3. Full-size dissimilar spare without label on wheel

When driving with the full-size dissimilar spare tire/wheel, **do not:**

- Exceed 70 mph (113 km/h)
- Use more than one dissimilar spare tire/wheel at a time
- Use commercial car washing equipment
- Use snow chains on the end of the vehicle with the dissimilar spare tire/wheel

The usage of a full-size dissimilar spare tire/wheel can lead to impairment of the following:

- Handling, stability and braking performance
- Comfort and noise
- Ground clearance and parking at curbs
- Winter weather driving capability
- Wet weather driving capability
- All-Wheel driving capability (if applicable)
- Load leveling adjustment (if applicable)

When driving with the full-size dissimilar spare tire/wheel additional caution should be given to:

- Towing a trailer
- Driving vehicles equipped with a camper body
- Driving vehicles with a load on the cargo rack

Drive cautiously when using a full-size dissimilar spare tire/wheel and seek service as soon as possible.

Spare tire information

Note: If your vehicle is equipped the tire pressure monitoring system (TPMS), the system indicator light will illuminate when the spare is in use. To restore the full functionality of the TPMS system, all road wheels equipped with the tire pressure monitoring sensors must be mounted on the vehicle.

If your vehicle is equipped with TPMS, have a flat tire serviced by an authorized dealer in order to prevent damage to the TPMS sensor; refer to *Tire Pressure Monitoring System (TPMS)* in the *Tires, Wheel and Loading* chapter. Replace the spare tire with the road tire as soon as possible.

T-type/Mini-spare tire information (Harley-Davidson only)

Your vehicle may be equipped with a temporary spare tire. This spare tire is considered “temporary”. Replace the temporary spare with a tire of the same size, speed rating, and load carrying capacity as the other road tires as soon as possible.

Roadside Emergencies

When driving with the temporary spare tire **do not:**

- Exceed 50 mph (80 km/h)
- Load the vehicle beyond maximum vehicle load rating listed on the Safety Compliance Label
- Tow a trailer
- Use snow chains on the end of the vehicle with the temporary spare tire
- Use more than one temporary spare tire at a time

Use of a temporary spare tire at any one wheel location can lead to impairment of the following:

- Handling, stability and braking performance
- Comfort and noise
- Ground clearance and parking at curbs
- Winter weather driving capability
- Wet weather driving capability

Stopping and securing the vehicle



To help prevent the vehicle from moving when you change a tire, be sure the parking brake is set, then block (in both directions) the wheel that is diagonally opposite to the tire being changed.

Refer to the instruction sheet (located in the glove box) for detailed tire change instructions.

Park on a level surface, activate hazard flashers and set the parking brake.

- Automatic transmission: Place gearshift lever in P (Park).
- Manual transmission: Place gearshift lever in R (Reverse).
- Electronic Shift-On-the-Fly (ESOF) 4x4: Place transfer case in 4x4 HIGH or 4x4 LOW before turning off the engine.
- Manual shift transfer case 4x4: Place transfer case in 4H or 4L.

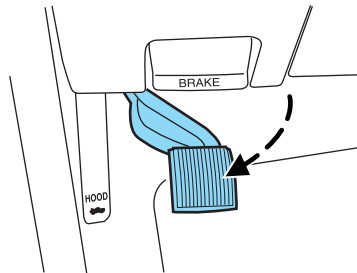

Roadside Emergencies

Location of the spare tire and tools

If your vehicle is equipped with a spare tire, jack and associated tools, refer to the following table for their locations:

Tool	Location
Spare tire (pick-up trucks only)	Under the vehicle, just forward of the rear bumper
Jack	Regular cab and Crew Cab: Fastened to floor pan behind rearmost seat on passenger side SuperCab: Under rear bench seat on passenger side
Jack handle, lug wrench, lug wrench extension (only available on Dual Rear Wheel [DRW] vehicles) and wheel chock (only available on Single Rear Wheel [SRW] vehicles equipped with a diesel engine)	Regular cab: Fastened to floor behind driver seat SuperCab: Fastened to floor under rear seat Crew Cab: Fastened to floor behind rear seat at driver side
Key and spare tire lock	In the glove box
Jack instruction sheet	Under the jack tool kit

Removing the spare tire (with spare tire carrier only)

1. The following tools are required to remove the spare tire:

- one handle extension and two typical extensions. To assemble, align button with hole and slide parts together. To disconnect, depress button and pull apart.
- one wheel nut wrench. Slide over square end of jack handle.

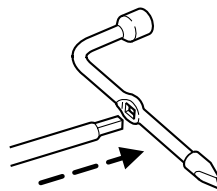
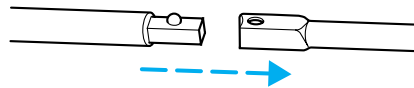

Roadside Emergencies

- **Vehicles equipped with dual rear wheels**, insert the lug wrench extension into the lug wrench to reach the lug nuts.

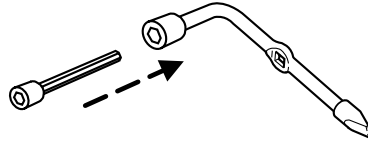

2. Attach the spare tire lock key (A) to the jack handle (B).

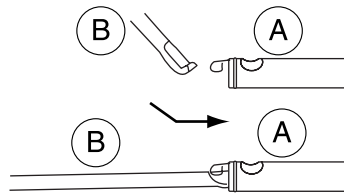

3. Fully insert the jack handle (with one extension) through the bumper hole and into the guide tube. The key and lock will engage with a slight push and counterclockwise turn. Some resistance will be felt when turning the jack handle assembly.

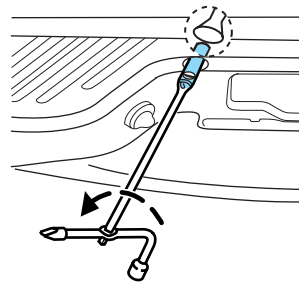

4. Turn the handle counterclockwise and lower the spare tire until you can slide the tire rearward and the cable is slack.

5. Remove the retainer through the center of the wheel.

Tire change procedure

1. Turn engine off and block the wheel that is diagonally opposite of the flat tire using the wheel chock, if equipped. **If the vehicle is a 4x4**, lock the manual hub on the wheel.

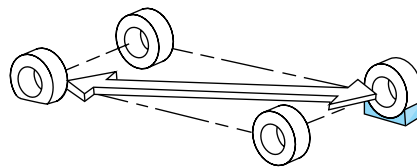



2. Remove the jack, jack handle, lug wrench and spare tire from the stowage locations.
3. Use the tip of the lug wrench to remove any wheel trim.

312

Roadside Emergencies

4. Loosen each wheel lug nut one-half turn counterclockwise but do not remove them until the wheel is raised off the ground.

 When one of the rear wheels is off the ground, the transmission alone will not prevent the vehicle from moving or slipping off the jack, even if the transmission is in P (Park) (automatic transmission) or R (Reverse) (manual transmission). To help prevent the vehicle from moving when you change the tire, be sure that the parking brake is set and the diagonally opposite wheel is blocked.

 If the vehicle slips off the jack, you or someone else could be seriously injured.

The following steps apply to F-250/F-350 Single Rear Wheel (SRW) vehicles only:

5. Insert the hooked end of the jack handle into the jack and use the handle to slide the jack under the vehicle.

6. Position the jack according to the following guides:

- Front (4x2)

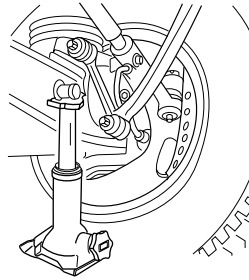
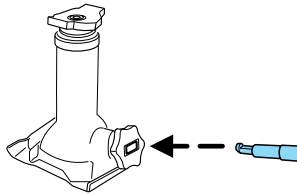

Roadside Emergencies

- Front driver side (4x4)

Note: Make sure the jack fits onto the flat area on the outboard side of the differential.

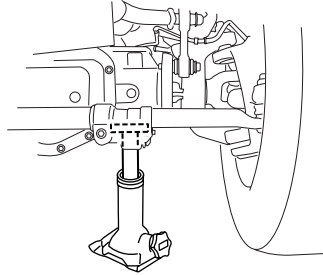

- Front passenger side (4x4)

Note: View shown from the rear of the vehicle to clearly identify the jack point. Place the jack directly under the axle.

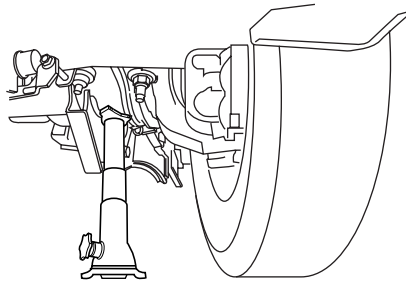

- Rear

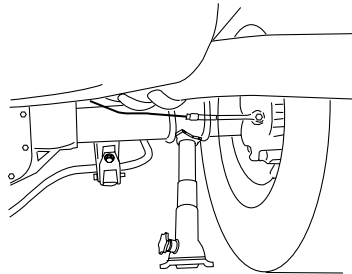

Roadside Emergencies

Never use the front or rear differential as a jacking point.

 To lessen the risk of personal injury, do not put any part of your body under the vehicle while changing a tire. Do not start the engine when your vehicle is on the jack. The jack is only meant for changing the tire.

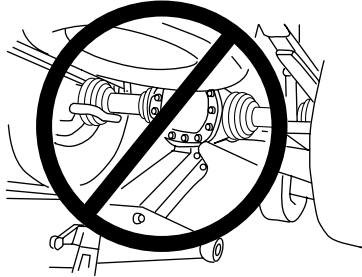

7. Turn the jack handle clockwise until the wheel is completely off the ground and high enough to install the spare tire.

8. Remove the lug nuts with the lug wrench.

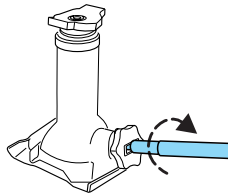

9. Replace the flat tire with the spare tire, making sure the valve stem is facing outward for all front wheels and single rear wheel vehicles. If replacing an inboard rear tire on dual rear wheel vehicles, the valve stem must be facing outward. If replacing the outboard wheel, the valve stem must be facing inward. Reinstall the lug nuts until the wheel is snug against the hub. Do not fully tighten the lug nuts until the wheel has been lowered.

10. Lower the wheel by turning the jack handle counterclockwise.

Go to step 19.

The following steps apply to F-350 Dual Rear Wheel (DRW) and F-450/F-550 vehicles only:

11. Slide the notched end of the jack handle over the release valve and use the handle to slide the jack under the vehicle. Make sure the valve is closed by turning it clockwise.

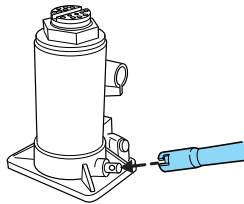

Roadside Emergencies

12. Position the jack according to the following guides:

- Front (4x2): F-350 DRW

Note: Place jack directly under I-beam.

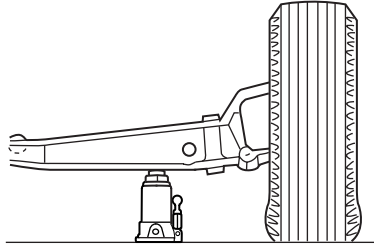

- Front driver side (4x4): F-350 DRW

Note: Make sure the jack fits onto the flat area on the outboard side of the differential housing.

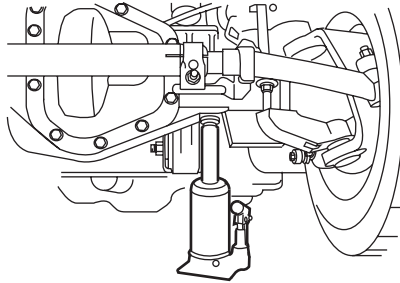

- Front passenger side (4x4): F-350 DRW

Note: View shown from the rear of the vehicle to clearly identify the jack point.

Note: Place the jack directly under axle and inboard of the radius arm so that the jack clears the radius arm.

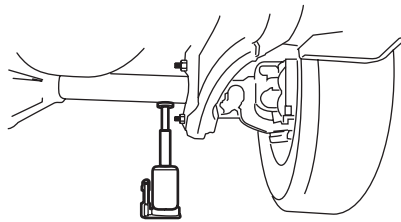

Roadside Emergencies

- Front: F-450/F-550

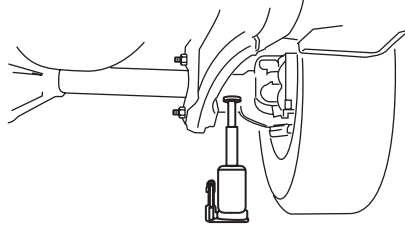

- Rear: F-350 DRW

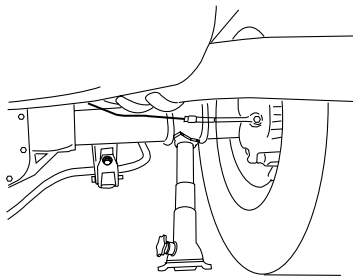

- Rear: F-450/F-550

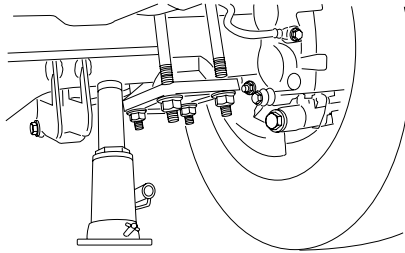

13. Insert the jack handle into the pump linkage.

14. Use an up-and-down motion with the jack handle to raise the wheel completely off the ground.

Hydraulic jacks are equipped with a pressure release valve that prevents lifting loads which exceed the jack's rated capacity.

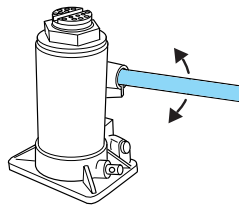

Roadside Emergencies

15. Remove the lug nuts with the lug wrench.
16. Replace the flat tire with the spare tire, making sure the valve stem is facing outward on all front and inboard rear wheels. If replacing the outboard wheel, the valve stem must be facing inward. Reinstall the lug nuts until the wheel is snug against the hub. Do not fully tighten the lug nuts until the wheel has been lowered.
17. Lower the wheel by slowly turning the release valve counterclockwise. Opening the release valve slowly will provide a more controlled rate of descent.

The following steps apply to all vehicles:

18. Remove the jack and fully tighten the lug nuts in the order shown. Refer to *Wheel lug nut torque specifications* later in this chapter for the proper lug nut torque specification.

8-lug nut torque sequence

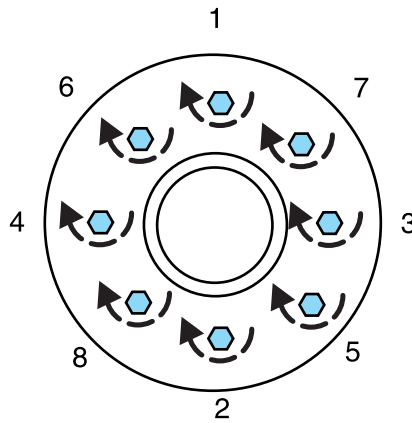

Roadside Emergencies

10-lug nut torque sequence

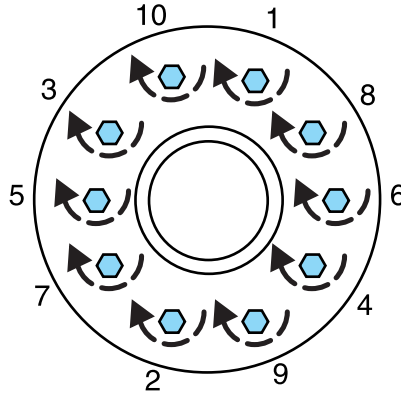

19. Stow the flat tire. Refer to *Stowing the flat/spare tire* if the vehicle is equipped with a spare tire carrier.

Note: Do not stow the Harley-Davidson flat tire and wheel using the spare tire winch mechanism; store the flat in the bed of the truck.

20. Stow the jack, jack handle and lug wrench. Make sure the jack is securely fastened so it does not rattle when driving.

21. Unblock the wheels.

The following step applies to F-250/F-350 Single Rear Wheel (SRW) vehicles only:

22. When installing the wheel center ornaments, ensure that the ornament retention towers on the back side of the ornament are aligned with the studs/lug nuts. The retention towers are designed to be installed over the studs/nuts and retain to the flange on the lug nut.

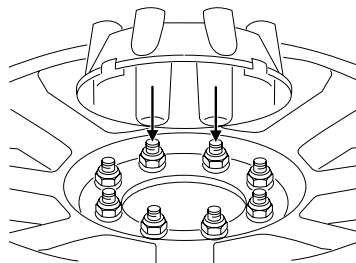

Roadside Emergencies

If the ornament retention towers are aligned between the studs/lug nuts, the ornament is improperly installed. This improper installation may appear and sound correct, but will not keep the ornament on the vehicle. Ornaments improperly installed in this manner will fall off or become loose with minimal force or impact.

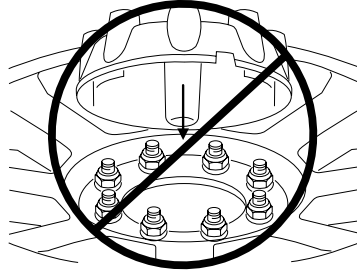

Stowing the flat/spare tire

Note: Failure to follow spare tire stowage instructions may result in failure of cable or loss of spare tire.

1. Lay the tire on the ground with the valve stem facing in the direction specified on the Tire Changing Instructions located in the glove box.
2. Slide the wheel partially under the vehicle and install the retainer through the wheel center. Pull on the cable to align the components at the end of the cable.
3. Turn the jack handle clockwise until the tire is raised to its stowed position underneath the vehicle. The effort to turn the jack handle increases significantly and the spare tire carrier ratchets or slips when the tire is raised to the maximum tightness. Tighten to the best of your ability, to the point where the ratchet/slip occurs, if possible. The spare tire carrier will not allow you to overtighten. If the spare tire carrier ratchets or slips with little effort, take the vehicle to your authorized dealer for assistance at your earliest convenience.
4. Check that the tire lies flat against the frame and is properly tightened. Try to push or pull, then turn the tire to be sure it will not move. Loosen and retighten, if necessary. Failure to properly stow the spare tire may result in failure of the winch cable and loss of the tire.
5. Repeat this tightness check procedure when servicing the spare tire pressure (every six months, per *scheduled maintenance information*), or at any time that the spare tire is disturbed through service of other components.
6. If removed, install the spare tire lock (if equipped) into the bumper drive tube with the spare tire lock key (if equipped) and jack handle.

Roadside Emergencies

WHEEL LUG NUT TORQUE SPECIFICATIONS

On vehicles equipped with single rear wheels, retighten the lug nuts to the specified torque at 500 miles (800 km) after any wheel disturbance (tire rotation, changing a flat tire, wheel removal, etc.).

On vehicles equipped with dual rear wheels, retighten the wheel lug nuts to the specified torque at 100 miles (160 km), and again at 500 miles (800 km) of new vehicle operation and after any wheel disturbance (tire rotation, changing a flat tire, wheel removal, etc.).

Bolt size	Wheel lug nut torque*	
	lb.ft.	N•m
M14 x 1.5	150	200
* Torque specifications are for nut and bolt threads free of dirt and rust. Use only Ford recommended replacement fasteners.		

On all two-piece flat wheel nuts, apply one drop of motor oil between the flat washer and the nut. Do not apply motor oil to the wheel nut threads or the wheel stud threads.

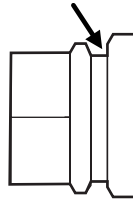

When a wheel is installed, always remove any corrosion, dirt or foreign materials present on the mounting surfaces of the wheel or the surface of the front disc brake hub and rotor that contacts the wheel. Installing wheels without correct metal-to-metal contact at the wheel mounting surfaces can cause the wheel nuts to loosen and the wheel to come off while the vehicle is in motion, resulting in loss of control.

Roadside Emergencies

Inspect the wheel pilot hole prior to installation. If there is visible corrosion in wheel pilot hole, remove loose particles by wiping with clean rag and apply grease. Apply grease only to the wheel pilot hole surface by smearing a “dime” (1 square cm) sized glob of grease around the wheel pilot surface (1) with end of finger. **DO NOT** apply grease to lug nut/stud holes or wheel-to-brake surfaces.

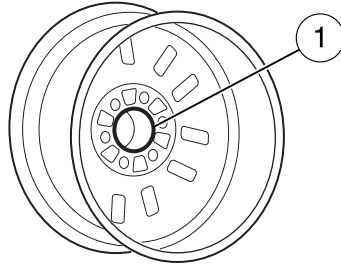

JUMP STARTING YOUR VEHICLE



The gases around the battery can explode if exposed to flames, sparks, or lit cigarettes. An explosion could result in injury or vehicle damage.



Batteries contain sulfuric acid which can burn skin, eyes and clothing, if contacted.

Do not attempt to push-start your automatic transmission vehicle. Automatic transmissions do not have push-start capability. Attempting to push-start a vehicle with an automatic transmission may cause transmission damage.

Preparing your vehicle

When the battery is disconnected or a new battery is installed, the transmission must relearn its shift strategy. As a result, the transmission may have firm and/or soft shifts. This operation is considered normal and will not affect function or durability of the transmission. Over time, the adaptive learning process will fully update transmission operation.

1. **Use only a 12-volt supply to start your vehicle.**
2. Do not disconnect the battery of the disabled vehicle as this could damage the vehicle's electrical system.
3. Park the booster vehicle close to the hood of the disabled vehicle making sure the two vehicles **do not** touch. Set the parking brake on both vehicles and stay clear of the engine cooling fan and other moving parts.

322

Roadside Emergencies

4. Check all battery terminals and remove any excessive corrosion before you attach the battery cables. Ensure that vent caps are tight and level.
5. Turn the heater fan on in both vehicles to protect from any electrical surges. Turn all other accessories off.

Connecting the jumper cables

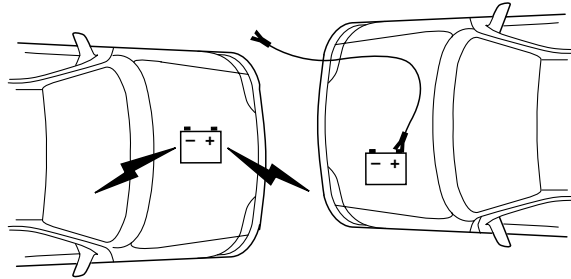

1. Connect the positive (+) jumper cable to the positive (+) terminal of the discharged battery.

Note: In the illustrations, *lightning bolts* are used to designate the assisting (boosting) battery.

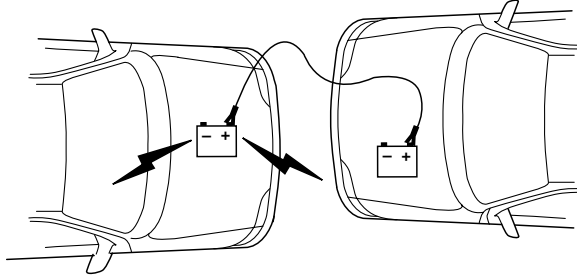

2. Connect the other end of the positive (+) cable to the positive (+) terminal of the assisting battery.

Roadside Emergencies

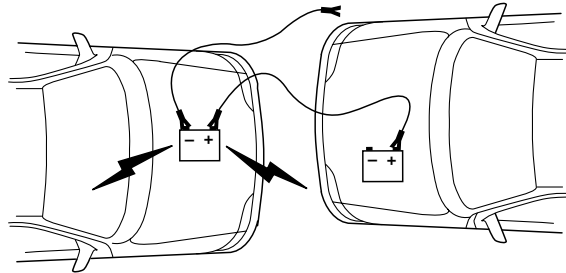

3. Connect the negative (-) cable to the negative (-) terminal of the assisting battery.

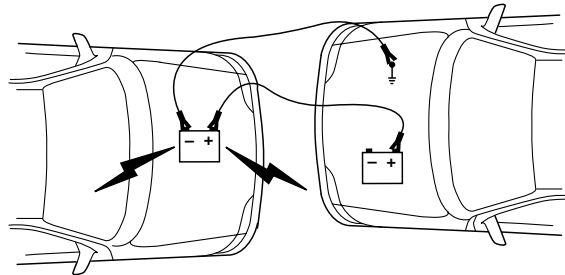

4. Make the final connection of the negative (-) cable to an exposed metal part of the stalled vehicle's engine, away from the battery and the carburetor/fuel injection system. **Do not** use fuel lines, engine rocker covers or the intake manifold as *grounding* points.



Do not connect the end of the second cable to the negative (-) terminal of the battery to be jumped. A spark may cause an explosion of the gases that surround the battery.

5. Ensure that the cables are clear of fan blades, belts, moving parts of both engines, or any fuel delivery system parts.

Roadside Emergencies

Jump starting

1. Start the engine of the booster vehicle and run the engine at moderately increased speed.
2. Start the engine of the disabled vehicle.
3. Once the disabled vehicle has been started, run both engines for an additional three minutes before disconnecting the jumper cables.

Removing the jumper cables

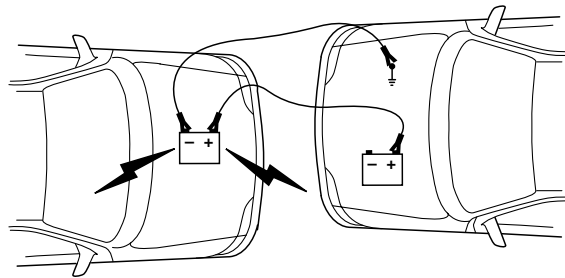

Remove the jumper cables in the reverse order that they were connected.

1. Remove the jumper cable from the *ground* metal surface.

Note: In the illustrations, *lightning bolts* are used to designate the assisting (boosting) battery.

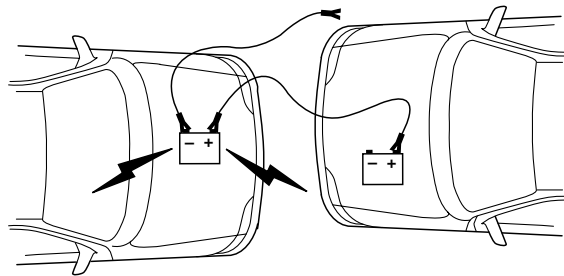

2. Remove the jumper cable on the negative (-) connection of the booster vehicle's battery.

Roadside Emergencies

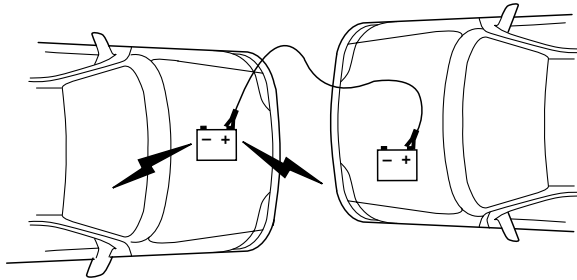

3. Remove the jumper cable from the positive (+) terminal of the booster vehicle's battery.

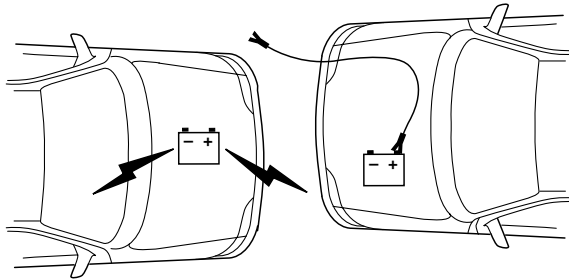

4. Remove the jumper cable from the positive (+) terminal of the disabled vehicle's battery.

After the disabled vehicle has been started and the jumper cables removed, allow it to idle for several minutes so the engine computer can *relearn* its idle conditions.

Roadside Emergencies

WRECKER TOWING

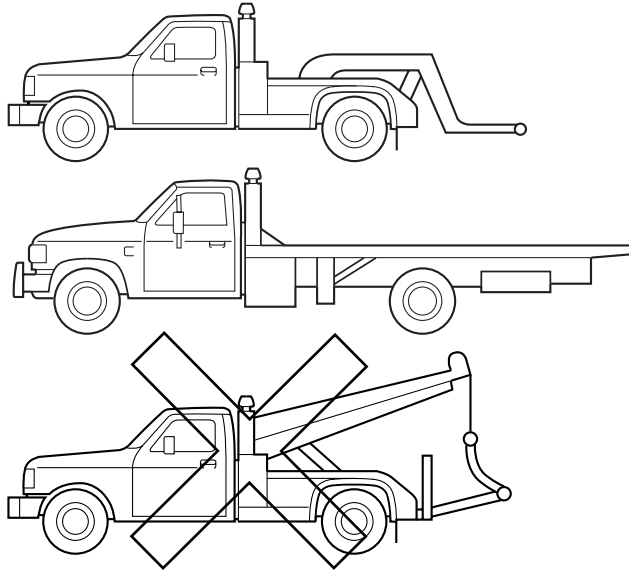

If you need to have your vehicle towed, contact a professional towing service or, if you are a member of a roadside assistance program, your roadside assistance service provider.

Note: It is recommended that the vehicle be towed with a wheel lift or flatbed equipment. Do not tow with a slingbelt. Ford Motor Company has not approved a slingbelt towing procedure. If the vehicle is towed by any other means or incorrectly, vehicle damage may occur.

On 4x2 vehicles, it is acceptable to tow the vehicle with the front wheels on the ground and the rear wheels off the ground using a wheel lift

On 4x4 vehicles, it is recommended that your vehicle be towed using flatbed equipment with all the wheels off the ground. However, a wheel lift may be used to lift the rear of the vehicle so long as, depending on vehicle configurations, the following preparations are met:

- On Electronic Shift-On-the-Fly (ESOF) vehicles, the 4x4 control is turned to the 2WD position prior to towing.
- On manual-shift transfer case vehicles, the front wheel hub locks are in the FREE position prior to towing.

Roadside Emergencies

Note: Towing an ESOF 4x4 vehicle with the front wheels on the ground without disengaging the front hubs may cause damage to the automatic transmission.

Note: Towing a 4x2 or an ESOF 4x4 vehicle with the rear wheels on the ground for more than 50 miles (80 km) and/or in excess of 35 mph (56 km/h) may cause damage to the automatic transmission.

Note: On Dual Rear Wheel (DRW) vehicles, an outer rear wheel must be removed prior to using a wheel lift wrecker.

If the vehicle is towed by other means or incorrectly, vehicle damage may occur.

Ford Motor Company produces a towing manual for all authorized tow truck operators. Have your tow truck operator refer to this manual for proper hook-up and towing procedures for your vehicle.

Emergency Towing

In case of a roadside emergency with a disabled vehicle (without access to wheel dollies, car hauling trailer, or flatbed transport vehicle) your vehicle (regardless of transmission powertrain configuration) can be flat towed (all wheels on the ground) under the following conditions:

- Vehicle is facing forward.
- Place the transmission in N (Neutral).
- Maximum speed is not to exceed 35 mph (56 km/h).
- Maximum distance is 50 miles (80 km).

Customer Assistance

GETTING THE SERVICES YOU NEED

At home

You must take your Ford vehicle to an authorized dealer for warranty repairs. While any authorized dealer handling your vehicle line will provide warranty service, we recommend you return to your selling authorized dealer who wants to ensure your continued satisfaction. Please note that certain warranty repairs require special training and/or equipment, so not all authorized dealers are authorized to perform all warranty repairs. This means that, depending on the warranty repair needed, you may have to take your vehicle to another authorized dealer. A reasonable time must be allowed to perform a repair after taking your vehicle to the authorized dealer. Repairs will be made using Ford or Motorcraft parts, or remanufactured or other parts that are authorized by Ford.

If you have questions or concerns, or are unsatisfied with the service you are receiving, follow these steps:

1. Contact your Sales Representative or Service Advisor at your selling/servicing authorized dealer.
2. If your inquiry or concern remains unresolved, contact the Sales Manager, Service Manager or Customer Relations Manager.
3. If you require assistance or clarification on Ford Motor Company policies or procedures, please contact the Ford Customer Relationship Center at 1-800-392-3673 (FORD).

Away from home

If you own a Ford or Mercury vehicle and are away from home when your vehicle needs service, or if you need more help than the authorized dealer could provide, after following the steps described above, contact the Ford Customer Relationship Center to find an authorized dealer to help you.

In the United States:

Ford Motor Company
Customer Relationship Center
P.O. Box 6248
Dearborn, MI 48121
1-800-392-3673 (FORD)
(TDD for the hearing impaired: 1-800-232-5952)
www.customersaskford.com

Customer Assistance

In Canada:
Customer Relationship Centre
Ford Motor Company of Canada, Limited
P.O. Box 2000
Oakville, Ontario L6J 5E4
1-800-565-3673 (FORD)
www.ford.ca

If you own a Lincoln vehicle and are away from home when your vehicle needs service, or if you need more help than the authorized dealer could provide, after following the steps described above, contact the Ford Customer Relationship Center to find an authorized dealer to help you.

In the United States:
Ford Motor Company
Customer Relationship Center
P.O. Box 6248
Dearborn, MI 48121
1-800-521-4140
(TDD for the hearing impaired: 1-800-232-5952)
www.customersaskford.com

In Canada:
Lincoln Centre
Ford Motor Company of Canada, Limited
P.O. Box 2000
Oakville, Ontario L6J 5E4
1-800-387-9333
www.lincolncanada.com

In order to help you service your Lincoln vehicle, please have the following information available when contacting the Lincoln Centre:

- Your telephone number (home and business)
- The name of the authorized dealer and the city where the authorized dealer is located
- The year and make of your vehicle
- The date of vehicle purchase
- The current odometer reading
- The vehicle identification number (VIN)

Additional Assistance

If you still have a complaint involving a warranty dispute, you may wish to contact the Better Business Bureau (BBB) AUTO LINE program (U.S. only).

330

Customer Assistance

In some states (in the U.S.) you must directly notify Ford in writing before pursuing remedies under your state's warranty laws. Ford is also allowed a final repair attempt in some states.

In the United States, a warranty dispute must be submitted to the BBB AUTO LINE before taking action under the Magnuson-Moss Warranty Act, or to the extent allowed by state law, before pursuing replacement or repurchase remedies provided by certain state laws. This dispute handling procedure is not required prior to enforcing state created rights or other rights which are independent of the Magnuson-Moss Warranty Act or state replacement or repurchase laws.

IN CALIFORNIA (U.S. ONLY)

California Civil Code Section 1793.2(d) requires that, if a manufacturer or its representative is unable to repair a motor vehicle to conform to the vehicle's applicable express warranty after a reasonable number of attempts, the manufacturer shall be required to either replace the vehicle with one substantially identical or repurchase the vehicle and reimburse the buyer in an amount equal to the actual price paid or payable by the consumer (less a reasonable allowance for consumer use). The consumer has the right to choose whether to receive a refund or replacement vehicle.

California Civil Code Section 1793.22(b) presumes that the manufacturer has had a reasonable number of attempts to conform the vehicle to its applicable express warranties if, within the first 18 months of ownership of a new vehicle or the first 18,000 miles (29,000 km), whichever occurs first:

1. Two or more repair attempts are made on the same non-conformity likely to cause death or serious bodily injury OR
2. Four or more repair attempts are made on the same nonconformity (a defect or condition that substantially impairs the use, value or safety of the vehicle) OR
3. The vehicle is out of service for repair of nonconformities for a total of more than 30 calendar days (not necessarily all at one time)

In the case of 1 or 2 above, the consumer must also notify the manufacturer of the need for the repair of the nonconformity at the following address:

Ford Motor Company
16800 Executive Plaza Drive
Mail Drop 3NE-B
Dearborn, MI 48126

Customer Assistance

THE BETTER BUSINESS BUREAU (BBB) AUTO LINE PROGRAM (U.S. ONLY)

Your satisfaction is important to Ford Motor Company and to your dealer. Experience has shown that our customers have been very successful in achieving satisfaction by following the three-step procedure outlined on the front page of the Warranty Guide. However, if your warranty concern has not been resolved using the three-step procedure, you may be eligible to participate in the BBB AUTO LINE program.

The BBB AUTO LINE program consists of two parts – mediation and arbitration. Initially, the BBB will try to resolve your question or concern through mediation. Mediation is a process through which a representative of the BBB will contact the parties and explore options for settlement of your claim. If mediation is not successful, customers with eligible claims may participate in the BBB AUTO LINE arbitration process. An arbitration hearing will be scheduled so that you can present your case in an informal setting before an impartial person. The arbitrator will consider the testimony provided and make a decision after the hearing. You are not bound by the decision but may choose to accept it. If you choose to accept the BBB AUTO LINE decision then Ford must abide by the accepted decision as well. If the arbitrator has decided in your favor and you accept the decision, the BBB AUTO LINE program will contact you to ensure that Ford has complied with the decision in a timely manner. Disputes submitted to the BBB AUTO LINE program are usually decided within forty days after you file your claim with the BBB.

To initiate a claim with the BBB AUTO LINE, you will be asked for your name and address, general information about your new vehicle, information about your warranty concerns and any steps you have already taken to try to resolve them. You will then be mailed a Customer Claim Form that you will need to complete, provide proof of vehicle ownership, sign and return the Customer Claim Form to the BBB. Upon receipt, the BBB will review the claim for eligibility under the Program Summary Guidelines.

You can get more information by calling BBB AUTO LINE at 1-800-955-5100, or writing to:

**BBB AUTO LINE
4200 Wilson Boulevard, Suite 800
Arlington, Virginia 22203-1833**

Note: Ford Motor Company reserves the right to change eligibility limitations, modify procedures, or to discontinue this process at any time without notice and without obligation.

332

Customer Assistance

UTILIZING THE MEDIATION/ARBITRATION PROGRAM (CANADA ONLY)

For vehicles delivered to authorized Canadian dealers. In those cases where you continue to feel that the efforts by Ford of Canada and the authorized dealer to resolve a factory-related vehicle service concern have been unsatisfactory, Ford of Canada participates in an impartial third party mediation/arbitration program administered by the Canadian Motor Vehicle Arbitration Plan (CAMVAP).

The CAMVAP program is a straight-forward and relatively speedy alternative to resolve a disagreement when all other efforts to produce a settlement have failed. This procedure is without cost to you and is designed to eliminate the need for lengthy and expensive legal proceedings.

In the CAMVAP program, impartial third-party arbitrators conduct hearings at mutually convenient times and places in an informal environment. These impartial arbitrators review the positions of the parties, make decisions and, when appropriate, render awards to resolve disputes. CAMVAP decisions are fast, fair, and final as the arbitrator's award is binding both to you and Ford of Canada.

CAMVAP services are available in all territories and provinces. For more information, without charge or obligation, call your CAMVAP Provincial Administrator directly at 1-800-207-0685.

FORD EXTENDED SERVICE PLAN

You can get more protection for your new car or light truck by purchasing Ford Extended Service Plan (Ford ESP) coverage. It provides the following:

- Benefits during the warranty period depending on the plan you purchase (such as: reimbursement for rentals; coverage for certain maintenance and wear items).
- Protection against covered repair costs after your Bumper-to-Bumper Warranty expires.

You may purchase Ford ESP from any participating authorized dealer. There are several plans available in various time, distance and deductible combinations which can be tailored to fit your own driving needs. Ford ESP also offers reimbursement benefits for towing and rental coverage.

When you buy Ford ESP, you receive Peace-of-Mind protection throughout the United States and Canada, provided by a network of more than 4,600 participating authorized dealers.

Customer Assistance

If you did not take advantage of the Ford Extended Service Plan at the time of purchasing your vehicle, you may still be eligible. Since this information is subject to change, please ask your authorized dealer for complete details about Ford Extended Service Plan coverage options, or visit the Ford ESP website at www.ford-esp.com.

GETTING ASSISTANCE OUTSIDE THE U.S. AND CANADA

Before exporting your vehicle to a foreign country, contact the appropriate foreign embassy or consulate. These officials can inform you of local vehicle registration regulations and where to find unleaded fuel.

If you cannot find unleaded fuel or can only get fuel with an anti-knock index lower than is recommended for your vehicle, contact a regional office or owner relations/customer relationship office.

The use of leaded fuel in your vehicle without proper conversion may damage the effectiveness of your emission control system and may cause engine knocking or serious engine damage. Ford Motor Company/Ford of Canada is not responsible for any damage caused by use of improper fuel. Using leaded fuel may also result in difficulty importing your vehicle back into the U.S.

If your vehicle must be serviced while you are traveling or living in Central America, the Caribbean, or the Middle East, contact the nearest authorized dealer. If the authorized dealer cannot help you, write or call:

FORD MOTOR COMPANY
FORD EXPORT OPERATIONS
1555 Fairlane Drive
Fairlane Business Park #3
Allen Park, Michigan 48101
U.S.A.
Telephone: (313) 594-4857
FAX: (313) 390-0804

If you are in another foreign country, contact the nearest authorized dealer. If the authorized dealer employees cannot help you, they can direct you to the nearest Ford affiliate office.

If you buy your vehicle in North America and then relocate outside of the U.S. or Canada, register your vehicle identification number (VIN) and new address with Ford Motor Company Export Operations.

Customers in the U.S. should call 1-800-392-3673.

Customer Assistance

ORDERING ADDITIONAL OWNER'S LITERATURE

To order the publications in this portfolio, contact Helm, Incorporated at:

HELM, INCORPORATED
P.O. Box 07150
Detroit, Michigan 48207

Or call:

For a free publication catalog, order toll free: 1-800-782-4356

Monday-Friday 8:00 a.m. - 6:00 p.m. EST

Helm, Incorporated can also be reached by their website:
www.helminc.com.

(Items in this catalog may be purchased by credit card, check or money order.)

Obtaining a French owner's guide

French Owner's Guides can be obtained from your authorized dealer or by writing to:

Ford Motor Company of Canada, Limited
Service Publications CHQ202
The Canadian Road
P.O. Box 2000
Oakville, ON, Canada
L6J 5E4

REPORTING SAFETY DEFECTS (U.S. ONLY)

If you believe that your vehicle has a defect which could cause a crash or could cause injury or death, you should immediately inform the National Highway Traffic Safety



Administration (NHTSA) in addition to notifying Ford Motor Company.

If NHTSA receives similar complaints, it may open an investigation, and if it finds that a safety defect exists in a group of vehicles, it may order a recall and remedy campaign. However, NHTSA cannot become involved in individual problems between you, your dealer, or Ford Motor Company.

Customer Assistance

To contact NHTSA, you may call the Vehicle Safety Hotline toll-free at 1-888-327-4236 (TTY: 1-800-424-9153); go to <http://www.safercar.gov>; or write to:

Administrator
1200 New Jersey Avenue, Southeast
Washington, D.C. 20590

You can also obtain other information about motor vehicle safety from <http://www.safercar.gov>.

REPORTING SAFETY DEFECTS (CANADA ONLY)

If you believe that your vehicle has a defect which could cause a crash or could cause injury or death, you should immediately inform Transport Canada, using their toll-free number: 1-800-333-0510.

WASHING THE EXTERIOR

Wash your vehicle regularly with cool or lukewarm water and a neutral pH shampoo, such as Motorcraft Detail Wash (ZC-3-A), which is available from your authorized dealer.

- Never use strong household detergents or soap, such as dish washing or laundry liquid. These products can discolor and spot painted surfaces.
- Never wash a vehicle that is “hot to the touch” or during exposure to strong, direct sunlight.
- Always use a clean sponge or car wash mitt with plenty of water for best results.
- Dry the vehicle with a chamois or soft terry cloth towel in order to eliminate water spotting.
- It is especially important to wash the vehicle regularly during the winter months, as dirt and road salt are difficult to remove and cause damage to the vehicle.
- Immediately remove items such as gasoline, diesel fuel, bird droppings and insect deposits because they can cause damage to the vehicle’s paintwork and trim over time.
- Remove any exterior accessories, such as antennas, before entering a car wash.
- **Suntan lotions and insect repellents can damage any painted surface; if these substances come in contact with your vehicle, wash off as soon as possible.**
- **If your vehicle is equipped with running boards, do not use rubber, plastic and vinyl protectant products on the running board surface, as the area may become slippery.**

WAXING

- Wash the vehicle first.
- Do not use waxes that contain abrasives. Use Motorcraft Premium Liquid Wax, ZC-53-A, which is available from your authorized dealer, or an equivalent quality product.
- Do not allow paint sealant to come in contact with any non-body (low-gloss black) colored trim, such as grained door handles, roof racks, bumpers, side moldings, mirror housings or the windshield cowl area. The paint sealant will “gray” or stain the parts over time.

Cleaning

PAINT CHIPS

Your authorized dealer has touch-up paint and sprays to match your vehicle's color. Take your color code (printed on a sticker in the driver's door jamb) to your authorized dealer to ensure you get the correct color.

- Remove particles such as bird droppings, tree sap, insect deposits, tar spots and industrial fallout before repairing paint chips.
- Always read the instructions before using the products.

ALUMINUM WHEELS AND WHEEL COVERS

Aluminum wheels and wheel covers are coated with a clearcoat paint finish. In order to maintain their shine:

- Clean weekly with Motorcraft Wheel and Tire Cleaner (ZC-37-A), which is available from your authorized dealer. Heavy dirt and brake dust accumulation may require agitation with a sponge. Rinse thoroughly with a strong stream of water.
- Never apply any cleaning chemical to hot or warm wheel rims or covers.
- Some automatic car washes may cause damage to the finish on your wheel rims or covers. Chemical-strength cleaners, or cleaning chemicals, in combination with brush agitation to remove brake dust and dirt, could wear away the clearcoat finish over time.
- Do not use hydrofluoric acid-based or high caustic-based wheel cleaners, steel wool, fuels or strong household detergent.
- To remove tar and grease, use Motorcraft Bug and Tar Remover (ZC-42), available from your authorized dealer.

ENGINE

Engines are more efficient when they are clean because grease and dirt buildup keep the engine warmer than normal. When washing:

- Take care when using a power washer to clean the engine. The high-pressure fluid could penetrate the sealed parts and cause damage.
- Do not spray a hot engine with cold water to avoid cracking the engine block or other engine components.
- Spray Motorcraft Engine Shampoo and Degreaser (ZC-20) on all parts that require cleaning and pressure rinse clean.
- Never wash or rinse the engine while it is running; water in the running engine may cause internal damage.
- Cover the highlighted areas to prevent water damage when cleaning the engine.

338

Cleaning

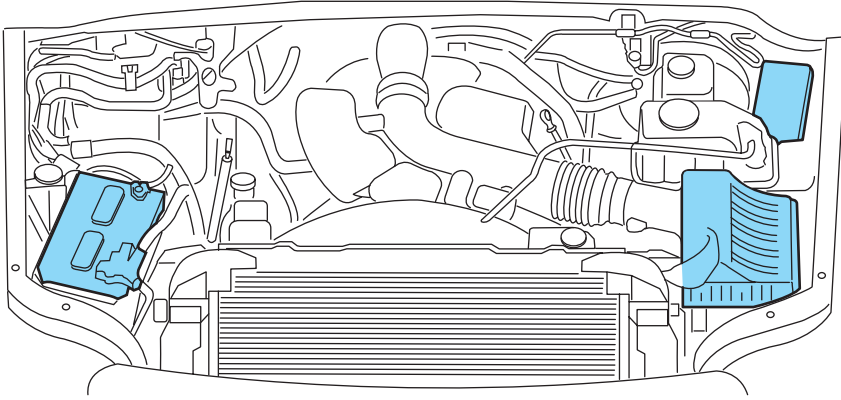

- **5.4L V8 gasoline engine**

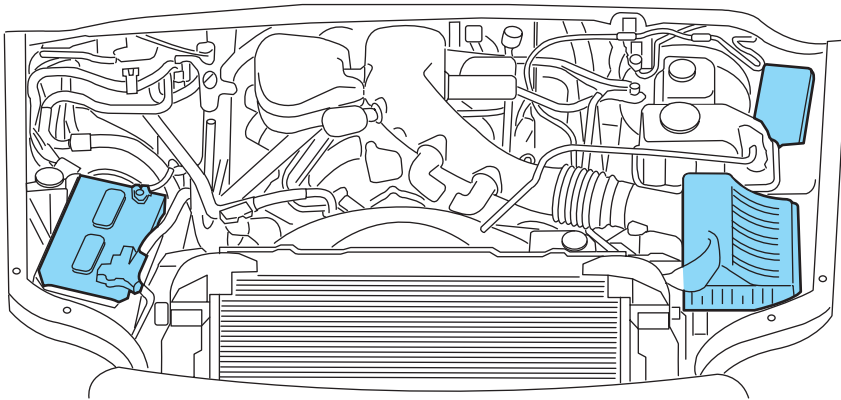

- **6.8L V10 gasoline engine**

Cleaning

PLASTIC (NON-PAINTED) EXTERIOR PARTS

Use only approved products to clean plastic parts. These products are available from your authorized dealer.

- For routine cleaning, use Motorcraft Detail Wash (ZC-3-A).
- If tar or grease spots are present, use Motorcraft Bug and Tar Remover (ZC-42).
- For plastic headlamp lenses, use Motorcraft Ultra Clear Spray Glass Cleaner (ZC-23).

WINDOWS AND WIPER BLADES

The windshield, rear and side windows and the wiper blades should be cleaned regularly. If the wipers do not wipe properly, substances on the vehicle's glass or the wiper blades may be the cause. These may include hot wax treatments used by commercial car washes, water repellent coatings, tree sap, or other organic contamination; these contaminants may cause squeaking or chatter noise from the blades, and streaking and smearing of the windshield. To clean these items, follow these tips:

- The windshield, rear windows and side windows may be cleaned with a non-abrasive cleaner such as Motorcraft Ultra-Clear Spray Glass Cleaner (ZC-23), available from your authorized dealer.
- The wiper blades can be cleaned with isopropyl (rubbing) alcohol or Motorcraft Premium Windshield Washer Concentrate (ZC-32-A), available from your authorized dealer. This washer fluid contains special solution in addition to alcohol which helps to remove the hot wax deposited on the wiper blade and windshield from automated car wash facilities. Be sure to replace wiper blades when they appear worn or do not function properly.
- Do not use abrasives, as they may cause scratches.
- Do not use fuel, kerosene, or paint thinner to clean any parts.

INSTRUMENT PANEL/INTERIOR TRIM AND CLUSTER LENS (EXCEPT HARLEY-DAVIDSON)

Clean the instrument panel, interior trim areas and cluster lens with a clean and damp, white cotton cloth, then with a clean and dry, white cotton cloth; you may also use Motorcraft Dash & Vinyl Cleaner (ZC-38-A) on the instrument panel and interior trim areas.

- Avoid cleaners or polishes that increase the gloss of the upper portion of the instrument panel. The dull finish in this area helps protect the driver from undesirable windshield reflection.

Cleaning

- Be certain to wash or wipe your hands clean if you have been in contact with certain products such as insect repellent and suntan lotion in order to avoid possible damage to the interior painted surfaces.
- Do not use household or glass cleaners as these may damage the finish of the instrument panel, interior trim and cluster lens.



Do not use chemical solvents or strong detergents when cleaning the steering wheel or instrument panel to avoid contamination of the airbag system.

If a staining liquid like coffee/juice has been spilled on the instrument panel or on interior trim surfaces, clean as follows:

1. Wipe up spilled liquid using a clean white cotton cloth.
2. Apply Motorcraft Deluxe Leather and Vinyl Cleaner (ZC-11-A) [In Canada use Motorcraft Multi-Purpose Cleaner (CXC-101)] to the wiped area and spread around evenly.
3. Apply more Motorcraft cleaner to a clean white cotton cloth and press the cloth onto the soiled area—allow this to set at room temperature for 30 minutes.
4. Remove the soaked cloth, and if it is not soiled badly, use this cloth to clean the area by using a rubbing motion for 60 seconds.
5. Following this, wipe area dry with a clean white cotton cloth.

INSTRUMENT PANEL AND CONSOLE (HARLEY-DAVIDSON ONLY)

Your vehicle's instrument panel and console are uniquely painted with both high and low gloss paints that require special care. The high gloss area is similar to that of the vehicle's exterior; the low gloss area is designed to help protect the driver from undesirable windshield reflection.

High gloss paint area

In order to maintain the finish of the instrument panel and console, the high gloss areas should be treated similar to the that of exterior paint or glossy plastic surfaces. When cleaning the high gloss areas:

- **Do not use** paper towels or newspaper.
- **Do not use** silicone or Teflont (PTFE)-based products.

Dust the high gloss areas with a clean, dry cloth, or use Motorcraft Dusting Cloth (ZC-24 or ZC-25) or Motorcraft Dusting Cloth Mitts (ZC-47).

For general cleaning, use mild, soapy water and a soft, damp cloth, then dry with a clean, dry cloth, or use or use Motorcraft Dash & Vinyl Cleaner (ZC-38-A) or Motorcraft Ultra-Clear Spray Glass Cleaner (ZC-23).

Cleaning

For removal of fine scuffs and scratches, use Scotch-Britet Microfiber Cloth or cheese cloth along with Motorcraft Premium Liquid Wax (ZC-53-A), Motorcraft Paint Sealant (ZC-45), or Motorcraft Custom Clear Coat Polish (ZC-8-A). Note: Removal of deep scuffs and scratches should be performed by an authorized dealer or an experienced repair facility.

Low gloss paint area

The low gloss area of the instrument panel's upper dash should be cleaned with mild, soapy water and a soft, damp cloth, or Motorcraft Dash & Vinyl Cleaner (ZC-38-A), then dried with a clean, dry cloth. When cleaning the low gloss areas:

- **Do not use** paper towels or newspaper.
- **Do not use** silicone or Teflon (PTFE)-based products.
- **Do not use** exterior paint waxes or sealants.

Dust the low gloss areas with a clean, dry cloth, or use Motorcraft Dusting Cloth (ZC-24 or ZC-25) or Motorcraft Dusting Cloth Mitts (ZC-47).

INTERIOR

For fabric, carpets, cloth seats and safety belts:

- Remove dust and loose dirt with a vacuum cleaner.
- Remove light stains and soil with Motorcraft Professional Strength Carpet & Upholstery Cleaner (ZC-54).
- If grease or tar is present on the material, spot-clean the area first with Motorcraft Spot and Stain Remover (ZC-14).
- If a ring forms on the fabric after spot cleaning, clean the entire area immediately (but do not oversaturate) or the ring will set.
- Do not use household cleaning products or glass cleaners, which can stain and discolor the fabric and affect the flame retardant abilities of the seat materials.



Do not use cleaning solvents, bleach or dye on the vehicle's seatbelts, as these actions may weaken the belt webbing.

Cleaning

LEATHER SEATS (IF EQUIPPED, EXCEPT FOR THE KING RANCH F-250 AND F-350 CREW CAB)

Your leather seating surfaces have a clear, protective coating over the leather.

For King Ranch F-250 and F-350 Crew Cab leather seats, refer to separate section in this chapter.

- To clean, use a soft cloth with Motorcraft Deluxe Leather and Vinyl Cleaner (ZC-11-A). Dry the area with a soft cloth.
- To help maintain its resiliency and color, use the Motorcraft Deluxe Leather Care Kit (ZC-11-D), available from your authorized dealer.
- Do not use household cleaning products, alcohol solutions, solvents or cleaners intended for rubber, vinyl and plastics, or oil/petroleum-based leather conditioners. These products may cause premature wearing of the clear, protective coating on the seat.

Note: In some instances, color or dye transfer can occur when wet clothing comes in contact with leather upholstery. If this occurs, the leather should be cleaned immediately to avoid permanent staining.

LEATHER SEATS FOR THE KING RANCH F-250 AND F-350 CREW CAB ONLY (IF EQUIPPED)

Your vehicle is equipped with seating covered in premium, top-grain leather which is extremely durable, but still requires special care and maintenance in order to ensure longevity and comfort.

Regular cleaning and conditioning will maintain the appearance of the leather. Failure to care for the leather can result in drying out and fading of the material.

Note: In some instances, color or dye transfer can occur when wet clothing comes in contact with leather upholstery. If this occurs, the leather should be cleaned immediately to avoid permanent staining.

Cleaning

For dirt, use a vacuum cleaner then use a clean, damp cloth or soft brush.

For routine cleaning, wipe the surface with a soft, damp cloth. For more thorough cleaning, wipe the surface with a mild soap. If the leather cannot be completely cleaned using a mild soap and water solution, the leather may be cleaned using a commercially available cleaning product "Tanners Preserve Leather Cleaner" and a 3M "Type T" scrubbing pad.

- Clean spills as quickly as possible.
- Test any cleaner or stain remover on an inconspicuous part of the leather as cleaners may darken the leather. For more specific cleaning information, contact the King Ranch Saddle Shop at 1-800-282-KING (5464).

Cleaning

- Do not spill coffee, ketchup, mustard, orange juice or oil-based products on the leather as they may permanently stain the leather.
- Do not use household cleaning products, alcohol solutions, solvents or cleaners intended for rubber, vinyl or plastics.

Scratches

Natural Markings - Because the leather in the seat comes from genuine steer hides, there will be evidence of naturally occurring markings, such as small scars. These markings give character to the seating covers and should be considered as proof of a genuine leather product.

In order to lessen the appearance of certain scratches and other wear marks, apply conditioner on the affected area following the same instructions as in the *Conditioning* section.

Conditioning

Bottles of King Ranch Leather Conditioner are available at the King Ranch Saddle Shop. Visit the Web site at www.krsaddleshop.com, or telephone (in the United States) 1-800-282-KING (5464). If you are unable to obtain King Ranch Leather Conditioner, use another premium leather conditioner.

- Apply your first conditioning treatment within six months of taking delivery of your vehicle. Condition twice yearly in order to replenish lost oils and revitalize the aroma, suppleness and resilience of the leather.
- Clean the surfaces using the steps outlined in the *Cleaning* section.
- Ensure the leather is dry then apply a nickel-sized amount of conditioner to a clean, dry cloth
- Rub the conditioner into leather until it disappears. Allow the conditioner to dry and repeat the process for the entire interior. If a film appears, wipe off film with a dry, clean cloth.

UNDERBODY

Flush the complete underside of your vehicle frequently. Keep body and door drain holes free from packed dirt.

Note: Use care when using a power washer to clean the driveline, especially the driveshaft and interfacing components. The high-pressure fluid could penetrate the sealed parts and cause damage.

Cleaning

FORD, LINCOLN AND MERCURY CAR CARE PRODUCTS

Your authorized dealer has many quality products available to clean your vehicle and protect its finishes. These quality products have been specifically engineered to fulfill your automotive needs; they are custom designed to complement the style and appearance of your vehicle. Each product is made from high quality materials that meet or exceed rigid specifications. For best results, use the following products or products of equivalent quality:

- Motorcraft Bug and Tar Remover (ZC-42)
- Motorcraft Car Care Kit (ZC-26)
- Motorcraft Car Wash (Canada only) (CXC-21)
- Motorcraft Custom Bright Metal Cleaner (ZC-15)
- Motorcraft Custom Clear Coat Polish (ZC-8-A)
- Motorcraft Custom Vinyl Protectant (ZC-40-A)
- Motorcraft Dash and Vinyl Cleaner (ZC-38-A)
- Motorcraft Deluxe Leather and Vinyl Cleaner (U.S. only) (ZC-11-A)
- Motorcraft Detail Wash (ZC-3-A)
- Motorcraft Dusting Cloth (ZC-24)
- Motorcraft Engine Shampoo and Degreaser (U.S. only) (ZC-20)
- Motorcraft Engine Shampoo (Canada only) (CXC-66-A)
- Motorcraft Multi-Purpose Cleaner (Canada only) (CXC-101)
- Motorcraft Premium Car Wash Concentrate (U.S. only) (ZC-17-B)
- Motorcraft Premium Glass Cleaner (Canada only) (CXC-100)
- Motorcraft Premium Liquid Wax (ZC-53-A)
- Motorcraft Professional Strength Carpet & Upholstery Cleaner (ZC-54)
- Motorcraft Spot and Stain Remover (U.S. only) (ZC-14)
- Motorcraft Tire Clean and Shine (ZC-28)
- Motorcraft Triple Clean (U.S. only) (ZC-13)
- Motorcraft Ultra-Clear Spray Glass Cleaner (ZC-23)
- Motorcraft Vinyl Cleaner (Canada only) (CXC-93)
- Motorcraft Vinyl Conditioner (Canada only) (CXC-94)
- Motorcraft Wash and Wax (Canada only) (CXC-95)
- Motorcraft Wheel and Tire Cleaner (ZC-37-A)

Maintenance and Specifications

SERVICE RECOMMENDATIONS

To help you service your vehicle:

- We highlight do-it-yourself items in the engine compartment for easy location.
- We provide a scheduled maintenance guide which makes tracking routine service easy.

If your vehicle requires professional service, your authorized dealer can provide the necessary parts and service. Check your *Warranty Guide/Owner Information Guide* to find out which parts and services are covered.

Use only recommended fuels, lubricants, fluids and service parts conforming to specifications. Motorcraft parts are designed and built to provide the best performance in your vehicle.

PRECAUTIONS WHEN SERVICING YOUR VEHICLE

- Do not work on a hot engine.
- Make sure that nothing gets caught in moving parts.
- Do not work on a vehicle with the engine running in an enclosed space, unless you are sure you have enough ventilation.
- Keep all open flames and other burning (cigarettes) material away from the battery and all fuel related parts.

Working with the engine off

- Automatic transmission:
 1. Set the parking brake and shift to P (Park).
 2. Turn off the engine and remove the key.
 3. Block the wheels.
- Manual transmission:
 1. Set the parking brake, depress the clutch and place the gearshift in 1 (First).
 2. Turn off the engine and remove the key.
 3. Block the wheels.

Working with the engine on

- Automatic transmission:
 1. Set the parking brake and shift to P (Park).

346

Maintenance and Specifications

2. Block the wheels.

- Manual transmission:

1. Set the parking brake, depress the clutch and place the gearshift in N (Neutral).

2. Block the wheels.

Note: Do not start your engine with the air cleaner removed and do not remove it while the engine is running.

OPENING THE HOOD

1. Inside the vehicle, pull the hood release handle located under the bottom left corner of the instrument panel.

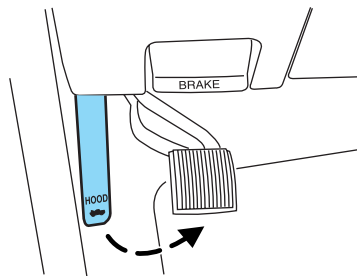

2. Go to the front of the vehicle and release the auxiliary latch located below the passenger side of the grille, next to the headlamp. Slide the handle to release the auxiliary latch.

3. Lift the hood until the lift cylinders hold it open.

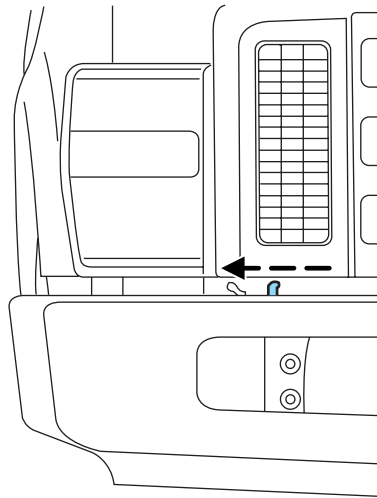

Maintenance and Specifications

IDENTIFYING COMPONENTS IN THE ENGINE COMPARTMENT

Refer to the *6.0 and 6.4 Liter Power Stroke Direct Injection Turbo Diesel Owner's Guide Supplement* for diesel engine component locations.

5.4L V8 gasoline engines

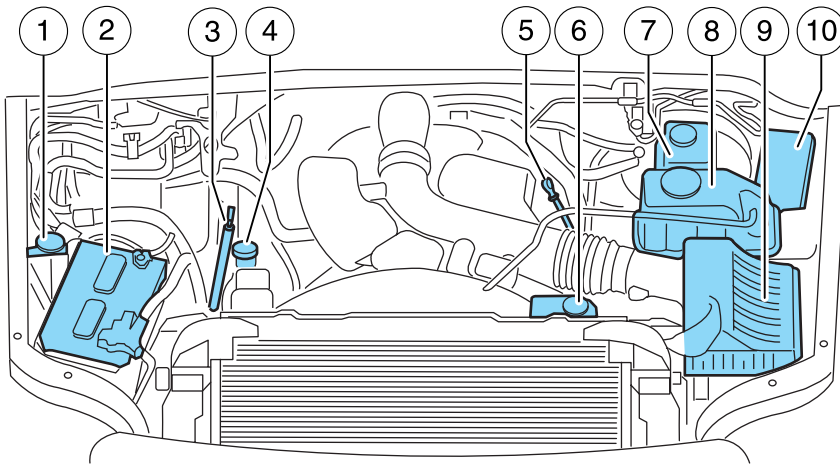

1. Windshield washer fluid reservoir
2. Battery
3. Transmission fluid dipstick (automatic transmission)
4. Engine oil filler cap
5. Engine oil dipstick
6. Power steering fluid reservoir
7. Brake fluid reservoir
8. Engine coolant reservoir
9. Air filter assembly
10. Power distribution box

Maintenance and Specifications

6.8L V10 gasoline engine

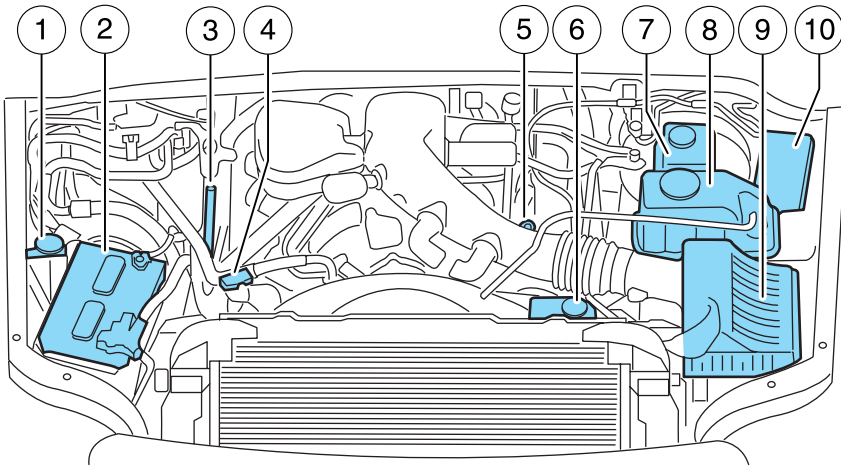

1. Windshield washer fluid reservoir
2. Battery
3. Transmission fluid dipstick (automatic transmission)
4. Engine oil filler cap
5. Engine oil dipstick
6. Power steering fluid reservoir
7. Brake fluid reservoir
8. Engine coolant reservoir
9. Air filter assembly
10. Power distribution box

Maintenance and Specifications

WINDSHIELD WASHER FLUID

Add fluid to fill the reservoir if the level is low. In very cold weather, do not fill the reservoir completely.

Only use a washer fluid that meets Ford specification WSB-M8B16-A2. Do not use any special washer fluid such as windshield water repellent-type fluid or bug wash as this may cause a squeaking/chattering noise, streaking or smearing. Refer to *Maintenance Product Specifications and Capacities* in this chapter.

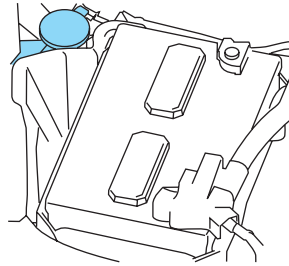

State or local regulations on volatile organic compounds may restrict the use of methanol, a common windshield washer antifreeze additive. Washer fluids containing non-methanol antifreeze agents should be used only if they provide cold weather protection without damaging the vehicle's paint finish, wiper blades or washer system.



If you operate your vehicle in temperatures below 40°F (5°C), use washer fluid with antifreeze protection. Failure to use washer fluid with antifreeze protection in cold weather could result in impaired windshield vision and increase the risk of injury or accident.

Note: Do not put washer fluid in the engine coolant reservoir. Washer fluid placed in the cooling system may harm engine and cooling system components.

CHANGING THE WIPER BLADES

1. Pull the wiper arm away from the vehicle. Turn the blade at an angle from the wiper arm. Push the lock pin manually to release the blade and pull the wiper blade down toward the windshield to remove it from the arm.

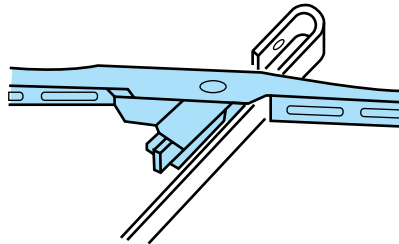

2. Attach the new wiper to the wiper arm and press it into place until a click is heard.

3. Replace wiper blades at least once per year for optimum performance.

350

Maintenance and Specifications

Note: Poor wiper quality can be improved by cleaning the wiper blades and the windshield; refer to *Windows and wiper blades* in the *Cleaning* chapter.

Note: To prolong the life of the wiper blades, it is highly recommended to scrape off the ice on the windshield before turning on the wipers. The layer of ice has many sharp edges and can damage the micro edge of the wiper rubber element.

ENGINE OIL

Checking the engine oil

Refer to the *scheduled maintenance information* for the appropriate intervals for checking the engine oil.

1. Make sure the vehicle is on level ground.
 2. Turn the engine off and wait a few minutes for the oil to drain into the oil pan.
 3. Set the parking brake and ensure the gearshift is securely latched in P (Park) (automatic transmission) or 1 (First) (manual transmission).
 4. Open the hood. Protect yourself from engine heat.
 5. Locate and carefully remove the engine oil dipstick.
- 5.4L/6.8L gasoline engines only; for diesel engine information, refer to the *6.0 and 6.4 Liter Direct Injection Turbo Diesel Owner's Guide Supplement*.

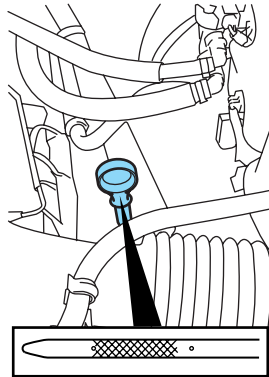

Maintenance and Specifications

- Wipe the dipstick clean. Insert the dipstick fully, then remove it again.
 - If the oil level is **between the MIN and MAX marks**, the oil level is acceptable. **DO NOT ADD OIL.**
 - If the oil level is below the MIN mark, add enough oil to raise the level within the MIN-MAX range.

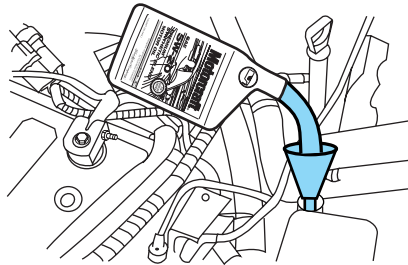

- Oil levels above the MAX mark may cause engine damage. Some oil must be removed from the engine by a service technician.
- Put the dipstick back in and ensure it is fully seated.

Adding engine oil

- Check the engine oil. For instructions, refer to *Checking the engine oil* in this chapter.
- If the engine oil level is not within the normal range, add only certified engine oil of the recommended viscosity. Remove the engine oil filler cap and use a funnel to pour the engine oil into the opening.
- Recheck the engine oil level. Make sure the oil level is not above the MAX mark on the engine oil level dipstick.
- Install the dipstick and ensure it is fully seated.
- Fully install the engine oil filler cap by turning the filler cap clockwise 1/4 of a turn or until the cap is fully seated.

To avoid possible oil loss, DO NOT operate the vehicle with the engine oil dipstick and/or the engine oil filler cap removed.

Maintenance and Specifications

Engine oil and filter recommendations

Look for this certification trademark.

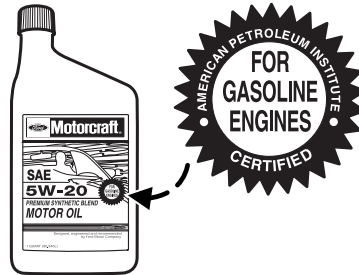

Use SAE 5W-20 engine oil

Only use oils “Certified For Gasoline Engines” by the American Petroleum Institute (API). An oil with this trademark symbol conforms to the current engine and emission system protection standards and fuel economy requirements of the International Lubricant Standardization and Approval Committee (ILSAC), comprised of U.S. and Japanese automobile manufacturers.

To protect your engine’s warranty use Motorcraft SAE 5W-20 or an equivalent SAE 5W-20 oil meeting Ford specification WSS-M2C930-A.

SAE 5W-20 oil provides optimum fuel economy and durability performance meeting all requirements for your vehicle’s engine.

Do not use supplemental engine oil additives, cleaners or other engine treatments. They are unnecessary and could lead to engine damage that is not covered by Ford warranty.

Change your engine oil and filter according to the appropriate schedule listed in the *scheduled maintenance information*.

Ford production and aftermarket (Motorcraft) oil filters are designed for added engine protection and long life. If a replacement oil filter is used that does not meet Ford material and design specifications, start-up engine noises or knock may be experienced.

It is recommended you use the appropriate Motorcraft oil filter or another with equivalent performance for your engine application.

Maintenance and Specifications

BATTERY

Your vehicle is equipped with a Motorcraft maintenance-free battery which normally does not require additional water during its life of service.

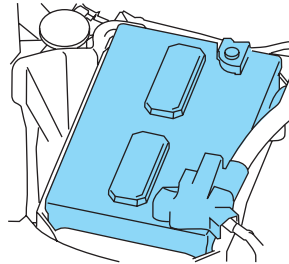

If your battery has a cover/shield, make sure it is reinstalled after the battery has been cleaned or replaced.

For longer, trouble-free operation, keep the top of the battery clean and dry. Also, make certain the battery cables are always tightly fastened to the battery terminals.

If you see any corrosion on the battery or terminals, remove the cables from the terminals and clean with a wire brush. You can neutralize the acid with a solution of baking soda and water.

When the battery is disconnected or a new battery installed, the transmission must learn its adaptive strategy. As a result of this, the transmission may shift firmly. This operation is considered normal and will fully update transmission operation to its optimum shift feel.

Note: Electrical or electronic accessories or components added to the vehicle by the authorized dealer or the owner may adversely affect battery performance and durability.

It is recommended that the negative battery cable terminal be disconnected from the battery if you plan to store your vehicle for an extended period of time. This will minimize the discharge of your battery during storage.



Batteries normally produce explosive gases which can cause personal injury. Therefore, do not allow flames, sparks or lighted substances to come near the battery. When working near the battery, always shield your face and protect your eyes. Always provide proper ventilation.

Maintenance and Specifications

 When lifting a plastic-cased battery, excessive pressure on the end walls could cause acid to flow through the vent caps, resulting in personal injury and/or damage to the vehicle or battery. Lift the battery with a battery carrier or with your hands on opposite corners.

 Keep batteries out of reach of children. Batteries contain sulfuric acid. Avoid contact with skin, eyes or clothing. Shield your eyes when working near the battery to protect against possible splashing of acid solution. In case of acid contact with skin or eyes, flush immediately with water for a minimum of 15 minutes and get prompt medical attention. If acid is swallowed, call a physician immediately.

 Battery posts, terminals and related accessories contain lead and lead compounds. **Wash hands after handling.**

For information on transmission operation after the battery has been disconnected, refer to *Automatic transmission operation* in the *Driving* chapter.

Because your vehicle's engine is also electronically controlled by a computer, some control conditions are maintained by power from the battery. When the battery is disconnected or a new battery is installed, the engine must relearn its idle and fuel trim strategy for optimum driveability and performance. To begin this process:

1. With the vehicle at a complete stop, set the parking brake.
 2. Put the gearshift in P (Park) (automatic transmission) or the neutral position (manual transmission), turn off all accessories and start the engine.
 3. Run the engine until it reaches normal operating temperature.
 4. Allow the engine to idle for at least one minute.
 5. Turn the A/C on and allow the engine to idle for at least one minute.
 6. Drive the vehicle to complete the relearning process.
- The vehicle may need to be driven 10 miles (16 km) or more to relearn the idle and fuel trim strategy.
 - **If you do not allow the engine to relearn its idle trim, the idle quality of your vehicle may be adversely affected until the idle trim is eventually relearned.**

Maintenance and Specifications

If the battery has been disconnected or a new battery has been installed, the clock and the preset radio stations must be reset once the battery is reconnected.

- Always dispose of automotive batteries in a responsible manner. Follow your local authorized standards for disposal. Call your local authorized recycling center to find out more about recycling automotive batteries.

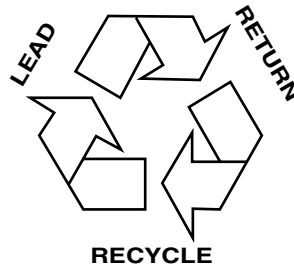

ENGINE COOLANT

Checking engine coolant

The concentration and level of engine coolant should be checked at the mileage (kilometer) intervals listed in the *scheduled maintenance information*. The coolant concentration should be maintained at 50/50 coolant and distilled water, which equates to a freeze point of -34°F (-36°C). Coolant concentration testing is possible with a hydrometer or antifreeze tester (such as the Rotunda Battery and Antifreeze Tester, 014-R1060). The level of coolant should be maintained at the "COLD FILL RANGE" in the coolant reservoir. If the level falls below, add coolant per the instructions in the *Adding engine coolant* section.

Your vehicle was factory-filled with a 50/50 engine coolant and water concentration. If the concentration of coolant falls below 40% or above 60%, the engine parts could become damaged or not work properly. **A 50/50 mixture of coolant and water provides the following:**

- **Freeze protection down to -34°F (-36°C).**
- **Boiling protection up to 265°F (129°C).**
- **Protection against rust and other forms of corrosion.**
- **Enables calibrated gauges to work properly.**

Maintenance and Specifications

When the engine is cold, check the level of the engine coolant in the reservoir.

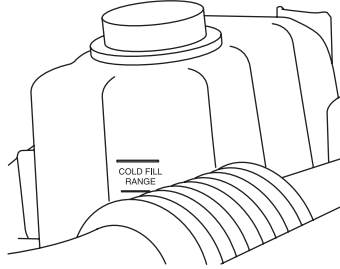

- The engine coolant should be at the “COLD FILL RANGE” in the coolant reservoir.
- Refer to the *scheduled maintenance information* for service interval schedules.
- Be sure to read and understand *Precautions when servicing your vehicle* in this chapter.

If the engine coolant has not been checked at the recommended interval, the engine coolant reservoir may become low or empty. If the reservoir is low or empty, add engine coolant to the reservoir. Refer to *Adding engine coolant* in this chapter.

Note: Automotive fluids are not interchangeable; do not use engine coolant, antifreeze or windshield washer fluid outside of its specified function and vehicle location.

Adding engine coolant

When adding coolant, make sure it is a 50/50 mixture of engine coolant and distilled water. Add the mixture to the coolant reservoir, **when the engine is cool**, until the appropriate fill level is obtained.



Do not add engine coolant when the engine is hot. Steam and scalding liquids released from a hot cooling system can burn you badly. Also, you can be burned if you spill coolant on hot engine parts.



Do not put engine coolant in the windshield washer fluid container. If sprayed on the windshield, engine coolant could make it difficult to see through the windshield.

- **Add Motorcraft Premium Gold Engine Coolant (yellow-colored) meeting Ford Specification WSS-M97B51-A1.**

Maintenance and Specifications

Note: Use of Motorcraft Cooling System Stop Leak Pellets may darken the color of Motorcraft Premium Gold Engine Coolant from yellow to golden tan.

- **Do not add/mix an orange-colored, extended life coolant such as Motorcraft Specialty Orange Engine Coolant meeting Ford specification WSS-M97B44-D, or DEX-COOL® brand with the factory-filled coolant.** Mixing Motorcraft Specialty Orange Engine Coolant or any orange-colored extended life product such as DEX-COOL® brand with your factory filled coolant can result in degraded corrosion protection.
- A large amount of water without engine coolant may be added, in case of emergency, to reach a vehicle service location. In this instance, the cooling system must be drained and refilled with a 50/50 mixture of engine coolant and distilled water as soon as possible. Water alone (without engine coolant) can cause engine damage from corrosion, overheating or freezing.
- **Do not use alcohol, methanol, brine or any engine coolants mixed with alcohol or methanol antifreeze (coolant).** Alcohol and other liquids can cause engine damage from overheating or freezing.
- **Do not add extra inhibitors or additives to the coolant.** These can be harmful and compromise the corrosion protection of the engine coolant.

For vehicles with overflow coolant systems with a non-pressurized cap on the coolant recovery system, add coolant to the coolant recovery reservoir when the engine is cool. Add the proper mixture of coolant and water to the “COLD FILL RANGE” level. For all other vehicles which have a coolant degas system with a pressurized cap, or if it is necessary to remove the coolant pressure relief cap on the radiator of a vehicle with an overflow system, follow these steps to add engine coolant.



To reduce the risk of personal injury, make sure the engine is cool before unscrewing the coolant pressure relief cap. The cooling system is under pressure; steam and hot liquid can come out forcefully when the cap is loosened slightly.

1. Before you begin, turn the engine off and let it cool.
2. When the engine is cool, wrap a thick cloth around the coolant pressure relief cap on the coolant reservoir (a translucent plastic bottle). Slowly turn cap counterclockwise (left) until pressure begins to release.

358

Maintenance and Specifications

3. Step back while the pressure releases.
4. When you are sure that all the pressure has been released, use the cloth to turn it counterclockwise and remove the cap.
5. Fill the coolant reservoir slowly with the proper coolant mixture (see above), to within the “COLD FILL RANGE” on the reservoir.
6. Replace the cap. Turn until tightly installed. (Cap must be tightly installed to prevent coolant loss.)

After any coolant has been added, check the coolant concentration (refer to *Checking engine coolant*). If the concentration is not 50/50 (protection to $-34^{\circ}\text{F}/-36^{\circ}\text{C}$), drain some coolant and adjust the concentration. It may take several drains and additions to obtain a 50/50 coolant concentration.

Whenever coolant has been added, the coolant level in the coolant reservoir should be checked the next few times you drive the vehicle. If necessary, add enough 50/50 concentration of engine coolant and distilled water to bring the liquid level to the proper level.

If you have to add more than 1.0 quart (1.0 liter) of engine coolant per month, have your authorized dealer check the engine cooling system. Your cooling system may have a leak. Operating an engine with a low level of coolant can result in engine overheating and possible engine damage.

Recycled engine coolant

Ford Motor Company does NOT recommend the use of recycled engine coolant in vehicles originally equipped with Motorcraft Premium Gold Engine Coolant since a Ford-approved recycling process is not yet available.



Used engine coolant should be disposed of in an appropriate manner. Follow your community's regulations and standards for recycling and disposing of automotive fluids.

Coolant refill capacity

To find out how much fluid your vehicle's cooling system can hold, refer to *Maintenance Product Specifications and Capacities* in this section.

If your vehicle is equipped with a diesel engine, refer to the *Maintenance Product Specifications and Capacities* section of your *6.0 and 6.4 Liter Power Stroke Direct Injection Turbo Diesel Owner's Guide Supplement*.

Fill your engine coolant reservoir as outlined in *Adding engine coolant* in this section.

Maintenance and Specifications

Severe climates

If you drive in extremely cold climates (less than -34°F [-36°C]):

- **It may be necessary to increase the coolant concentration above 50%.**
- **NEVER increase the coolant concentration above 60%.**
- **Increased engine coolant concentrations above 60% will decrease the overheat protection characteristics of the engine coolant and may cause engine damage.**
- **Refer to the chart on the coolant container to ensure the coolant concentration in your vehicle will provide adequate freeze protection at the temperatures in which you drive in the winter months.**

If you drive in extremely hot climates:

- **It is still necessary to maintain the coolant concentration above 40%.**
- **NEVER decrease the coolant concentration below 40%.**
- **Decreased engine coolant concentrations below 40% will decrease the corrosion protection characteristics of the engine coolant and may cause engine damage.**
- **Decreased engine coolant concentrations below 40% will decrease the freeze protection characteristics of the engine coolant and may cause engine damage.**
- **Refer to the chart on the coolant container to ensure the coolant concentration in your vehicle will provide adequate protection at the temperatures in which you drive.**

Vehicles driven year-round in non-extreme climates should use a 50/50 mixture of engine coolant and distilled water for optimum cooling system and engine protection.

What you should know about fail-safe cooling (if equipped)

If the engine coolant supply is depleted, this feature allows the vehicle to be driven temporarily before incremental component damage is incurred. The “fail-safe” distance depends on ambient temperatures, vehicle load and terrain.

360

Maintenance and Specifications

How fail-safe cooling works

If the engine begins to overheat:

- The engine coolant temperature gauge will move to the red (hot) area.
- The message center will indicate the engine is overheating.
- The  indicator will illuminate.

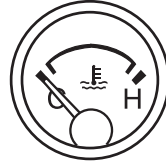

If the engine reaches a preset over-temperature condition, the engine will automatically switch to alternating cylinder operation. Each disabled cylinder acts as an air pump and cools the engine.

When this occurs the vehicle will still operate. However:

- The engine power will be limited.
- The air conditioning system will be disabled.

Continued operation will increase the engine temperature and the engine will completely shut down, causing steering and braking effort to increase.

Once the engine temperature cools, the engine can be re-started. Take your vehicle to a service facility as soon as possible to minimize engine damage.

When fail-safe mode is activated

You have limited engine power when in the fail-safe mode, so drive the vehicle with caution. The vehicle will not be able to maintain high-speed operation and the engine will run rough. Remember that the engine is capable of completely shutting down automatically to prevent engine damage, therefore:

1. Pull off the road as soon as safely possible and turn off the engine.
2. Arrange for the vehicle to be taken to a service facility.
3. If this is not possible, wait a short period for the engine to cool.
4. Check the coolant level and replenish if low.



Never remove the coolant reservoir cap while the engine is running or hot.

Maintenance and Specifications

5. Re-start the engine and take your vehicle to a service facility.

Driving the vehicle without repairing the engine problem increases the chance of engine damage. Take your vehicle to a service facility as soon as possible.

FUEL FILTER

For fuel filter replacement, see your authorized dealer. Refer to the *scheduled maintenance information* for the appropriate intervals for changing the fuel filter.

Replace the fuel filter with an authorized Motorcraft part. The customer warranty may be void for any damage to the fuel system if an authorized Motorcraft fuel filter is not used.

WHAT YOU SHOULD KNOW ABOUT AUTOMOTIVE FUELS

Important safety precautions



Do not overfill the fuel tank. The pressure in an overfilled tank may cause leakage and lead to fuel spray and fire.



The fuel system may be under pressure. If the fuel filler cap is venting vapor or if you hear a hissing sound, wait until it stops before completely removing the fuel filler cap. Otherwise, fuel may spray out and injure you or others.



If you do not use the proper fuel filler cap, excessive pressure or vacuum in the fuel tank may damage the fuel system or cause the fuel cap to disengage in a collision, which may result in possible personal injury.



Automotive fuels can cause serious injury or death if misused or mishandled.



Gasoline may contain benzene, which is a cancer-causing agent.

Maintenance and Specifications

Observe the following guidelines when handling automotive fuel:

- Extinguish all smoking materials and any open flames before refueling your vehicle.
- Always turn off the vehicle before refueling.
- Automotive fuels can be harmful or fatal if swallowed. Fuel such as gasoline is highly toxic and if swallowed can cause death or permanent injury. If fuel is swallowed, call a physician immediately, even if no symptoms are immediately apparent. The toxic effects of fuel may not be visible for hours.
- Avoid inhaling fuel vapors. Inhaling too much fuel vapor of any kind can lead to eye and respiratory tract irritation. In severe cases, excessive or prolonged breathing of fuel vapor can cause serious illness and permanent injury.
- Avoid getting fuel liquid in your eyes. If fuel is splashed in the eyes, remove contact lenses (if worn), flush with water for 15 minutes and seek medical attention. Failure to seek proper medical attention could lead to permanent injury.
- Fuels can also be harmful if absorbed through the skin. If fuel is splashed on the skin and/or clothing, promptly remove contaminated clothing and wash skin thoroughly with soap and water. Repeated or prolonged skin contact with fuel liquid or vapor causes skin irritation.
- Be particularly careful if you are taking “Antabuse” or other forms of disulfiram for the treatment of alcoholism. Breathing gasoline vapors, or skin contact could cause an adverse reaction. In sensitive individuals, serious personal injury or sickness may result. If fuel is splashed on the skin, promptly wash skin thoroughly with soap and water. Consult a physician immediately if you experience an adverse reaction.



 When refueling always shut the engine off and never allow sparks or open flames near the filler neck. Never smoke while refueling. Fuel vapor is extremely hazardous under certain conditions. Care should be taken to avoid inhaling excess fumes.

 The flow of fuel through a fuel pump nozzle can produce static electricity, which can cause a fire if fuel is pumped into an ungrounded fuel container.

Maintenance and Specifications

Use the following guidelines to avoid static build-up when filling an ungrounded fuel container:

- Place approved fuel container on the ground.
- DO NOT fill a fuel container while it is in the vehicle (including the cargo area).
- Keep the fuel pump nozzle in contact with the fuel container while filling.
- DO NOT use a device that would hold the fuel pump handle in the fill position.

Refueling



Fuel vapor burns violently and a fuel fire can cause bad injuries. To help avoid injuries to you and others:

- Read and follow all the instructions on the pump island;
- Turn off your engine when you are refueling;
- Do not smoke if you are near fuel or refueling your vehicle;
- Keep sparks, flames and smoking materials away from fuel;
- Stay outside your vehicle and do not leave the fuel pump unattended when refueling you vehicle — this is against the law in some places;
- Keep children away from the fuel pump; never let children pump fuel.

Fuel filler cap

Your fuel tank filler cap has an indexed design with a 1/4 turn on/off feature.

When fueling your vehicle:

1. Turn the engine off.
2. Carefully turn the filler cap counterclockwise until it stops.
3. Pull to remove the cap from the fuel filler pipe.
4. To install the cap, align the tabs on the cap with the notches on the filler pipe.
5. Turn the filler cap clockwise until it clicks.

If the “Check Fuel Cap” indicator comes on and stays on after you start the engine, the fuel filler cap may not be properly installed. Turn off the engine, remove the fuel filler cap, align the cap properly and reinstall it.

364

Maintenance and Specifications

If you must replace the fuel filler cap, replace it with a fuel filler cap that is designed for your vehicle. The vehicle warranty may be void for any damage to the fuel tank or fuel system if the correct genuine Ford or Motorcraft fuel filler cap is not used.

 The fuel system may be under pressure. If the fuel filler cap is venting vapor or if you hear a hissing sound, wait until it stops before completely removing the fuel filler cap. Otherwise, fuel may spray out and injure you or others.

 If you do not use the proper fuel filler cap, excessive pressure or vacuum in the fuel tank may damage the fuel system or cause the fuel cap to disengage in a collision, which may result in possible personal injury.

FORD RECOMMENDS BP



Choosing the right fuel

Use only UNLEADED fuel or UNLEADED fuel blended with a maximum of 10% ethanol. Your vehicle was not designed to run on E85 fuels that are blended with a maximum of 85% ethanol. The use of leaded fuel is prohibited by law and could damage your vehicle. Do not use fuel containing methanol. It can damage critical fuel system components.

Your vehicle was not designed to use fuel or fuel additives with metallic compounds, including manganese-based additives. Studies indicate that these additives can cause your vehicle's emission control system to deteriorate more rapidly.

Repairs to correct the effects of using a fuel for which your vehicle was not designed may not be covered by your warranty.

Maintenance and Specifications

Octane recommendations

Your vehicle is designed to use “Regular” unleaded gasoline with pump (R+M)/2 octane rating of 87. We do not recommend the use of gasolines labeled as “Regular” that are sold with octane ratings of 86 or lower in high altitude areas.

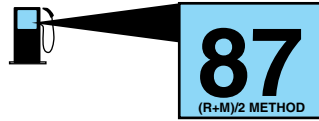

Do not be concerned if your engine sometimes knocks lightly. However, if it knocks heavily under most driving conditions while you are using fuel with the recommended octane rating, see your authorized dealer to prevent any engine damage.

Fuel quality

If you are experiencing starting, rough idle or hesitation driveability problems, try a different brand of unleaded gasoline. “Premium” unleaded gasoline is not recommended for vehicles designed to use “Regular” unleaded gasoline because it may cause these problems to become more pronounced. If the problems persist, see your authorized dealer.

Do not add aftermarket fuel additive products to your fuel tank. It should not be necessary to add any aftermarket products to your fuel tank if you continue to use high quality fuel of the recommended octane rating. These products have not been approved for your engine and could cause damage to the fuel system. Repairs to correct the effects of using an aftermarket product in your fuel may not be covered by your warranty.

Many of the world’s automakers approved the World-wide Fuel Charter that recommends gasoline specifications to provide improved performance and emission control system protection for your vehicle. Gasolines that meet the World-wide Fuel Charter should be used when available. Ask your fuel supplier about gasolines that meet the World-wide Fuel Charter.

Cleaner air

Ford endorses the use of reformulated “cleaner-burning” gasolines to improve air quality, per the fuel recommendations in the *Choosing the right fuel* section.

Running out of fuel

Avoid running out of fuel because this situation may have an adverse affect on powertrain components.

366

Maintenance and Specifications

If you have run out of fuel:

- You may need to cycle the ignition from OFF to ON several times after refueling to allow the fuel system to pump the fuel from the tank to the engine. On restarting, cranking time will take a few seconds longer than normal.
- Normally, adding one gallon of fuel is enough to restart the engine. If the vehicle is out of fuel and on a steep grade, more than one gallon may be required.
- The *Service engine soon* indicator () may come on. For more information on the *Service engine soon* indicator, refer to the *Instrument Cluster* chapter.

ESSENTIALS OF GOOD FUEL ECONOMY

Measuring techniques

Your best source of information about actual fuel economy is you, the driver. You must gather information as accurately and consistently as possible. Fuel expense, frequency of fill-ups or fuel gauge readings are NOT accurate as a measure of fuel economy. We do not recommend taking fuel economy measurements during the first 1,000 miles (1,600 km) of driving (engine break-in period). You will get a more accurate measurement after 2,000 miles-3,000 miles (3,000 km-5,000 km).

Filling the tank

The advertised fuel capacity of the fuel tank on your vehicle is equal to the rated refill capacity of the fuel tank as listed in the *Maintenance Product Specifications and Capacities* section of this chapter.

The advertised capacity is the amount of the indicated capacity and the empty reserve combined. Indicated capacity is the difference in the amount of fuel in a full tank and a tank when the fuel gauge indicates empty. Empty reserve is the small amount of fuel remaining in the fuel tank after the fuel gauge indicates empty.

The amount of usable fuel in the empty reserve varies and should not be relied upon to increase driving range. When refueling your vehicle after the fuel gauge indicates empty, you might not be able to refuel the full amount of the advertised capacity of the fuel tank due to the empty reserve still present in the tank.

For consistent results when filling the fuel tank:

- Turn the engine/ignition off prior to refueling, an error in the reading will result if the engine is left running.

Maintenance and Specifications

- Use the same filling rate setting (low-medium-high) each time the tank is filled.
- Allow no more than 2 automatic click-offs when filling.
- Always use fuel with the recommended octane rating.
- Use a known quality gasoline, preferably a national brand.
- Use the same side of the same pump and have the vehicle facing the same direction each time you fill up.
- Have the vehicle loading and distribution the same every time.

Your results will be most accurate if your filling method is consistent.

Calculating fuel economy

1. Fill the fuel tank completely and record the initial odometer reading (in miles or kilometers).
2. Each time you fill the tank, record the amount of fuel added (in gallons or liters).
3. After at least three to five tank fill-ups, fill the fuel tank and record the current odometer reading.
4. Subtract your initial odometer reading from the current odometer reading.
5. Follow one of the simple calculations in order to determine fuel economy:

Calculation 1: **Divide total miles traveled by total gallons used.**

Calculation 2: **Multiply liters used by 100, then divide by total kilometers traveled.**

Keep a record for at least one month and record the type of driving (city or highway). This will provide an accurate estimate of the vehicle's fuel economy under current driving conditions. Additionally, keeping records during summer and winter will show how temperature impacts fuel economy. In general, lower temperatures give lower fuel economy.

Driving style - good driving and fuel economy habits

Give consideration to the lists that follow and you may be able to change a number of variables and improve your fuel economy.

Habits

- Smooth, moderate operation can yield up to 10% savings in fuel.
- Steady speeds without stopping will usually give the best fuel economy.

Maintenance and Specifications

- Idling for long periods of time (greater than one minute) may waste fuel.
- Anticipate stopping; slowing down may eliminate the need to stop.
- Sudden or hard accelerations may reduce fuel economy.
- Slow down gradually.
- Driving at reasonable speeds (traveling at 55 mph [88 km/h] uses 15% less fuel than traveling at 65 mph [105 km/h]).
- Revving the engine before turning it off may reduce fuel economy.
- Using the air conditioner or defroster may reduce fuel economy.
- You may want to turn off the speed control in hilly terrain if unnecessary shifting between third and fourth gear occurs. Unnecessary shifting of this type could result in reduced fuel economy.
- Warming up a vehicle on cold mornings is not required and may reduce fuel economy.
- Resting your foot on the brake pedal while driving may reduce fuel economy.
- Combine errands and minimize stop-and-go driving.

Maintenance

- Keep tires properly inflated and use only recommended size.
- Operating a vehicle with the wheels out of alignment will reduce fuel economy.
- Use recommended engine oil. Refer to *Maintenance Product Specifications and Capacities* in this chapter.
- Perform all regularly scheduled maintenance items. Follow the recommended maintenance schedule and owner maintenance checks found in your vehicle's *scheduled maintenance information*.

Conditions

- Heavily loading a vehicle or towing a trailer may reduce fuel economy at any speed.
- Carrying unnecessary weight may reduce fuel economy (approximately 1 mpg [0.4 km/L] is lost for every 400 lb [180 kg] of weight carried).
- Adding certain accessories to your vehicle (for example bug deflectors, rollbars/light bars, running boards, ski/luggage racks) may reduce fuel economy.

Maintenance and Specifications

- Using fuel blended with alcohol may lower fuel economy.
- Fuel economy may decrease with lower temperatures during the first 8–10 miles (12–16 km) of driving.
- Driving on flat terrain offers improved fuel economy as compared to driving on hilly terrain.
- Transmissions give their best fuel economy when operated in the top cruise gear and with steady pressure on the gas pedal.
- Four-wheel-drive operation (if equipped) is less fuel efficient than two-wheel-drive operation.
- Close windows for high speed driving.

EPA window sticker

Every new vehicle should have the EPA window sticker. Contact your authorized dealer if the window sticker is not supplied with your vehicle. The EPA window sticker should be your guide for the fuel economy comparisons with other vehicles.

It is important to note the box in the lower left corner of the window sticker. These numbers represent the Range of MPG (L/100 km) expected on the vehicle under optimum conditions. Your fuel economy may vary depending upon the method of operation and conditions.

EMISSION CONTROL SYSTEM

Your vehicle is equipped with various emission control components and a catalytic converter which will enable your vehicle to comply with applicable exhaust emission standards. To make sure that the catalytic converter and other emission control components continue to work properly:

- Use only the specified fuel listed.
- Avoid running out of fuel.
- Do not turn off the ignition while your vehicle is moving, especially at high speeds.
- Have the items listed in your *scheduled maintenance information* performed according to the specified schedule.

The scheduled maintenance items listed in the *scheduled maintenance information* are essential to the life and performance of your vehicle and to its emissions system.

Maintenance and Specifications

If other than Ford, Motorcraft or Ford-authorized parts are used for maintenance replacements or for service of components affecting emission control, such non-Ford parts should be equivalent to genuine Ford Motor Company parts in performance and durability.



Do not park, idle, or drive your vehicle in dry grass or other dry ground cover. The emission system heats up the engine compartment and exhaust system, which can start a fire.

Illumination of the *Service engine soon* light () , charging system warning light or the temperature warning light, fluid leaks, strange odors, smoke or loss of engine power, could indicate that the emission control system is not working properly.





Exhaust leaks may result in entry of harmful and potentially lethal fumes into the passenger compartment.

Do not make any unauthorized changes to your vehicle or engine. By law, vehicle owners and anyone who manufactures, repairs, services, sells, leases, trades vehicles, or supervises a fleet of vehicles are not permitted to intentionally remove an emission control device or prevent it from working. Information about your vehicle's emission system is on the Vehicle Emission Control Information Decal located on or near the engine. This decal also identifies engine displacement.

Please consult your *Warranty Guide* for complete emission warranty information.

On board diagnostics (OBD-II)



Your vehicle is equipped with a computer that monitors the engine's emission control system. This system is commonly known as the On Board Diagnostics System (OBD-II). The OBD-II system protects the environment by ensuring that your vehicle continues to meet government emission standards. The OBD-II system also assists your authorized dealer in properly servicing your vehicle. When the  indicator illuminates, the OBD-II system has detected a malfunction. Temporary malfunctions may cause the  indicator to illuminate. Examples are:

1. The vehicle has run out of fuel - the engine may misfire or run poorly.
2. Poor fuel quality or water in the fuel - the engine may misfire or run poorly.



Maintenance and Specifications

3. The fuel cap may not have been securely tightened. See *Fuel filler cap* in this chapter.
4. Driving through deep water - the electrical system may be wet.

These temporary malfunctions can be corrected by filling the fuel tank with good quality fuel, properly tightening the fuel cap or letting the electrical system dry out. After three driving cycles without these or any other temporary malfunctions present, the  indicator should stay off the next time the engine is started. A driving cycle consists of a cold engine startup followed by mixed city/highway driving. No additional vehicle service is required.

If the  indicator remains on, have your vehicle serviced at the first available opportunity. Although some malfunctions detected by the OBD-II may not have symptoms that are apparent, continued driving with the  indicator on can result in increased emissions, lower fuel economy, reduced engine and transmission smoothness, and lead to more costly repairs.

Readiness for Inspection/Maintenance (I/M) testing

In some localities, it may be a legal requirement to pass an I/M test of the on-board diagnostics system. If the  indicator is on, refer to the description in the Warning lights and chimes section of the Instrument Cluster chapter. Your vehicle may not pass the I/M test with the  indicator on.

If the vehicle's powertrain system or its battery has just been serviced, the on-board diagnostics system is reset to a "not ready for I/M test" condition. To ready the on-board diagnostics system for I/M testing, a minimum of 30 minutes of city and highway driving is necessary as described below:

- First, at least 10 minutes of driving on an expressway or highway.
- Next, at least 20 minutes driving in stop-and-go, city-type traffic with at least four idle periods.

Allow the vehicle to sit for at least eight hours without starting the engine. Then, start the engine and complete the above driving cycle. The engine must warm up to its normal operating temperature. Once started, do not turn off the engine until the above driving cycle is complete.

Maintenance and Specifications

POWER STEERING FLUID

Check the power steering fluid. Refer to the *scheduled maintenance information* for the service interval schedules. If adding fluid is necessary, use only MERCON® ATF.

- Gasoline engine shown; diesel engine similar. Refer to *Identifying components in the engine compartment* in the 6.0 and 6.4 Liter Power Stroke Direct Injection Turbo Diesel Owner Guide Supplement.

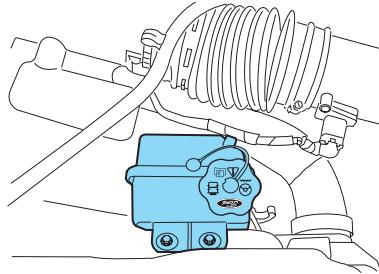

Check the fluid level when it is at ambient temperature, 20°F–80°F (-7°C–25°C):

1. Check the fluid level in the reservoir. It should be between the MIN and MAX range. Do not add fluid if the level is within this range.
2. If the fluid level is low. Add fluid to bring fluid level up to be between the MIN and MAX range.
3. Start the engine.
4. While the engine idles, turn the steering wheel left and right several times.
5. Turn the engine off.
6. Recheck the fluid level in the reservoir. Do not add fluid if the level is between the MIN and MAX range.
7. If the fluid is low, add fluid in small amounts, continuously checking the level until it is between the MIN and MAX range. Be sure to put the cap back on the reservoir.

Maintenance and Specifications

BRAKE FLUID

- Vacuum boost system

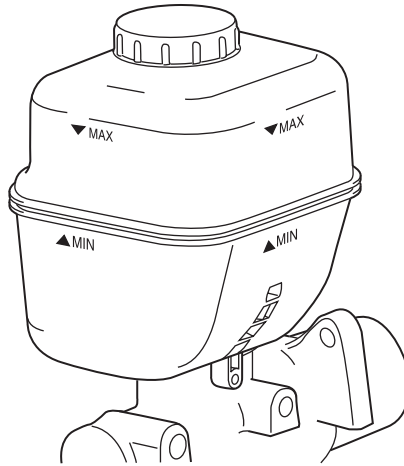

- Hydroboost system

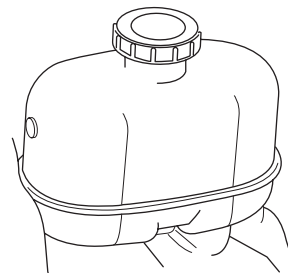

- FEAD-driven vacuum pump/brake booster system

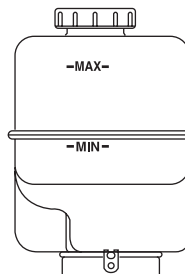

Maintenance and Specifications

The fluid level will drop slowly as the brakes wear, and will rise when the brake components are replaced. Fluid levels between the “MIN” and “MAX” lines are within the normal operating range; there is no need to add fluid. If the fluid levels are outside of the normal operating range the performance of your brake system could be compromised; seek service from your authorized dealer immediately.

CLUTCH FLUID (IF EQUIPPED)

Check the clutch fluid level. Refer to the *scheduled maintenance information* for the service interval schedules.

Use only a DOT 3 brake fluid designed to meet Ford specifications. Refer to *Maintenance product specifications and capacities* in this chapter.



Carefully read cautionary information on product label. For MEDICAL EMERGENCY INFORMATION, contact a physician or Poison Control Center immediately; on Ford-Motorcraft products call: 1-800-959-3673 (FORD). Failure to follow these instructions may result in personal injury.

During normal operation, the fluid level in the clutch reservoir should remain constant or rise slightly. If the fluid level drops, refill the fluid level to the step in the reservoir.

1. Clean the reservoir cap before removal to prevent dirt and water from entering the reservoir.
2. Remove cap and rubber diaphragm from reservoir.
3. Add fluid until the level reaches the step in the reservoir.
4. Reinstall rubber diaphragm and cap onto reservoir.

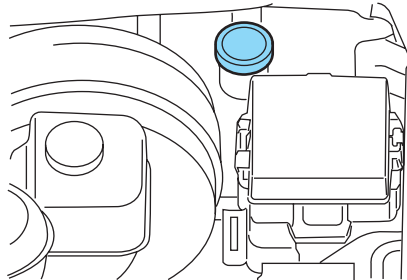

TRANSMISSION FLUID

Checking automatic transmission fluid (if equipped)

Refer to your *scheduled maintenance information* for scheduled intervals for fluid checks and changes. Your transmission does not consume fluid. However, the fluid level should be checked if the transmission is not working properly, i.e., if the transmission slips or shifts slowly or if you notice some sign of fluid leakage.

Maintenance and Specifications

Automatic transmission fluid expands when warmed. To obtain an accurate fluid check, drive the vehicle until it is at normal operating temperature (approximately 20 miles [30 km]). If your vehicle has been operated for an extended period at high speeds, in city traffic during hot weather or pulling a trailer, the vehicle should be turned off for about 30 minutes to allow fluid to cool before checking.

1. Drive the vehicle 20 miles (30 km) or until it reaches normal operating temperature.
2. Park the vehicle on a level surface and engage the parking brake.
3. With the parking brake engaged and your foot on the brake pedal, start the engine and move the gearshift lever through all of the gear ranges. Allow sufficient time for each gear to engage.
4. Latch the gearshift lever in P (Park) and leave the engine running.
5. Remove the dipstick, wiping it clean with a clean, dry lint free rag. If necessary, refer to *Identifying components in the engine compartment* in this chapter for the location of the dipstick.
6. Install the dipstick making sure it is fully seated in the filler tube.
7. Remove the dipstick and inspect the fluid level. The fluid should be in the designated area for normal operating temperature or ambient temperature.

Low fluid level

Do not drive the vehicle if the fluid level is at the bottom of the dipstick and the ambient temperature is above 50°F (10°C).



Correct fluid level

The transmission fluid should be checked at normal operating temperature 150°F-170°F (66°C-77°C) on a level surface. The normal operating temperature can be reached after approximately 20 miles (30 km) of driving.

You can check the fluid without driving if the ambient temperature is above 50°F (10°C). However, if fluid is added at this time, an overfill condition could result when the vehicle reaches normal operating temperature.

Maintenance and Specifications

The transmission fluid should be in this range if at normal operating temperature (150°F-170°F [66°C-77°C]).

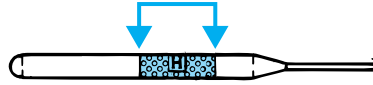

The transmission fluid should be in this range if at ambient temperature (50°F-95°F [10°C-35°C]).



High fluid level

Fluid levels above the safe range may result in transmission failure. An overfill condition of transmission fluid may cause shift and/or engagement concerns and/or possible damage.

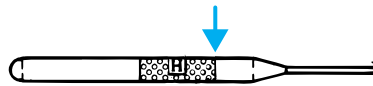

High fluid levels can be caused by an overheating condition.

Adjusting automatic transmission fluid levels

Before adding any fluid, make sure the correct type is used. The type of fluid used is normally indicated on the dipstick handle and also in the *Maintenance Product Specifications and Capacities* section in this chapter.

Use of a non-approved automatic transmission fluid may cause internal transmission component damage.

If necessary, add fluid in 1/2 pint (250 ml) increments through the filler tube until the level is correct.

If an overfill occurs, excess fluid should be removed by a qualified technician.

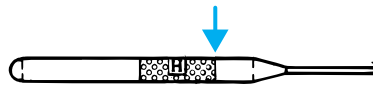

An overfill condition of transmission fluid may cause shift and/or engagement concerns and/or possible damage.

Do not use supplemental transmission fluid additives, treatments or cleaning agents. The use of these materials may affect transmission operation and result in damage to internal transmission components.

Maintenance and Specifications

Checking and adding manual transmission fluid (if equipped)

1. Clean the filler plug.
2. Remove the filler plug and inspect the fluid level.

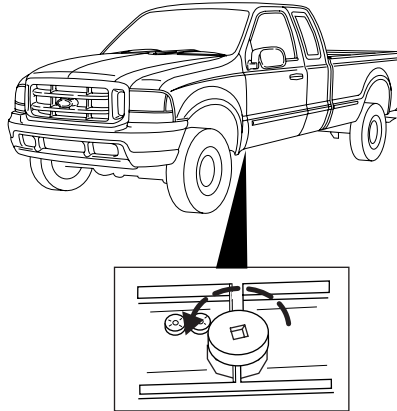

3. Fluid level should be at the bottom of the opening.
4. Add enough fluid through the filler opening so that the fluid level is at the bottom of the opening.
5. Install and tighten the fill plug securely.

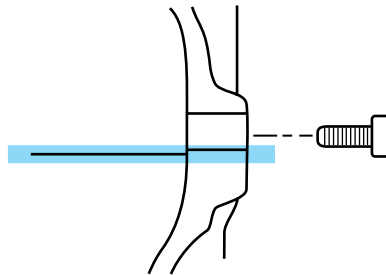

Use only fluid that meets Ford specifications. Refer to *Maintenance Product Specifications and Capacities* in this chapter.

Maintenance and Specifications

TRANSFER CASE FLUID (IF EQUIPPED)

1. Clean the filler plug.
2. Remove the filler plug and inspect the fluid level.

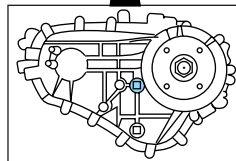
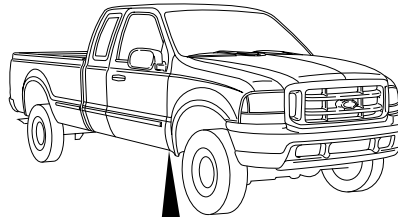

3. Add only enough fluid through the filler opening so that the fluid level is at the bottom of the opening.

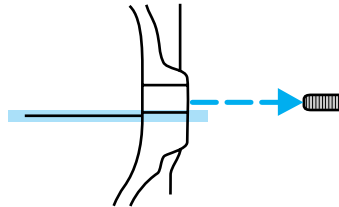

Use only fluid that meets Ford specifications. Refer to *Maintenance Product Specifications and Capacities* in this chapter.

Maintenance and Specifications

DRIVELINE UNIVERSAL JOINT AND SLIP YOKE

If the original universal joints are replaced with universal joints equipped with grease fittings, lubrication will be necessary. Refer to the replacement universal joint manufacturer's recommendation for lubrication type and maintenance intervals.

AIR FILTER MAINTENANCE

Refer to the *scheduled maintenance information* for the appropriate intervals for changing the air filter element.

When changing the air filter element, use only the Motorcraft air filter element listed. Refer to *Motorcraft part numbers* in this chapter.

The following procedure is for vehicles equipped with a gasoline engine. If your vehicle is equipped with a diesel engine, refer to the *6.0 and 6.4 Liter Power Stroke Direct Injection Turbo Diesel Owner's Guide Supplement*.

Note: Do not start your engine with the air cleaner removed and do not remove it while the engine is running.

Changing the air filter element

1. Loosen clamp and disconnect sensor.

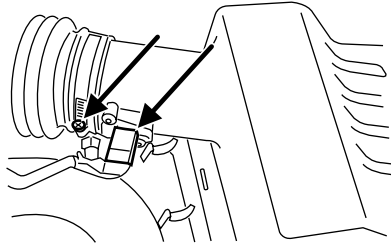

Maintenance and Specifications

2. Release three retainer clamps.

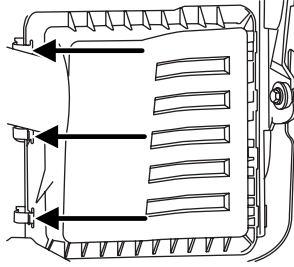

3. Pull air filter cover toward passenger side of vehicle and up to release the tabs. Lift air filter element up and out of housing.

The air filter box needs to be free of any debris before installing a new air filter.

4. Install a new air filter element into the tray assembly.

5. Return air filter cover to original position making sure the four tabs are engaged and secure the three clamps. Tighten clamp on air tube and reconnect sensor.

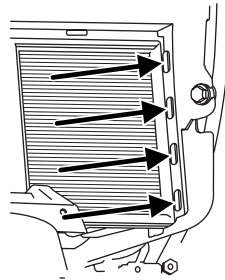

Maintenance and Specifications

MOTORCRAFT PART NUMBERS

Component	5.4L V8/6.8L V10 engines
Air filter element	FA-1883
Fuel filter	FG-1011
Oil filter	FL-820-S
PCV valve	¹
Battery (Standard)	BXT-65-650
Battery (Optional)	BXT-65-750
Spark plugs-platinum	²
Remote Automatic Transmission Filter	^{3, 4}

¹The PCV valve is a critical emission component. It is one of the items listed in the *scheduled maintenance information* and is essential to the life and performance of your vehicle and to its emissions system.

For PCV valve replacement, see your authorized dealer. Refer to the *scheduled maintenance information* for the appropriate intervals for changing the PCV valve.

Replace the PCV valve with one that meets Ford material and design specifications for your vehicle, such as a Motorcraft or equivalent replacement part. The customer warranty may be void for any damage to the emissions system if such a PCV valve is not used.

²For spark plug replacement, see your authorized dealer. Refer to the *scheduled maintenance information* for the appropriate intervals for changing the spark plugs.

Replace the spark plugs with ones that meet Ford material and design specifications for your vehicle, such as Motorcraft or equivalent replacement parts. The customer warranty may be void for any damage to the engine if such spark plugs are not used.

³Also available with 6.4L diesel engine and TorqShift transmission. Part number is FT-176.

⁴Also available with 6.4L diesel engine and TorqShift transmission. Part number is FT-175.

Maintenance and Specifications

MAINTENANCE PRODUCT SPECIFICATIONS AND CAPACITIES

Item	Capacity	Ford part name	Ford part number / Ford specification
Front axle	5.8 pints (2.8L)	Motorcraft SAE 80W-90 Premium Rear Axle Lubricant	XY-80W-90-QL / WSP-M2C197-A
Spindle bearing	—	High Temperature 4X4 Front Axle and Wheel Bearing Grease	E8TZ-19590-A XG-11 (FAD) / ESA-M1C198-A
Rear axle - F-250/350 (10.50 inch axle) ¹	6.9 pints (3.3L)	Motorcraft SAE 75W-140 Synthetic Rear Axle Lubricant	XY-75W140-QL / WSL-M2C192-A
Rear axle - F-350 (DANA M80)	8.5 pints (4.0L)	Motorcraft SAE 75W-90 Synthetic Rear Axle Lubricant	XY-75W90-QLS / WSS-M2C918-A
Rear axle - F-450/550 (Dana S110/S130)	14.0 pints (6.6L)	Motorcraft SAE 75W-140 Synthetic Rear Axle Lubricant	XY-75W140-QL / WSL-M2C192-A
Brake fluid (and clutch fluid, if equipped)	Fill to line or step (for clutch) on reservoir	Motorcraft High Performance DOT 3 Motor Vehicle Brake Fluid	PM-1-C / WSS-M6C62-A
Engine coolant - 5.4L V8 engine with A/C ²	26.4 quarts (25.0L)	Motorcraft Premium Gold Engine Coolant (yellow-colored)	VC-7-B / WSS-M97B51-A1

Maintenance and Specifications

Item	Capacity	Ford part name	Ford part number / Ford specification
Engine coolant - 6.8L V10 engine ²	27.5 quarts (26.0L)	Motorcraft Premium Gold Engine Coolant (yellow-colored)	VC-7-B / WSS-M97B51-A1
Engine and fuel coolant - diesel engine	Refer to the 6.0 and 6.4 Liter Power Stroke Direct Injection Turbo Diesel Owner's Guide Supplement		
Engine oil (includes filter change) - 5.4L V8 and 6.8L V10 gas engines ⁶	7.0 quarts (6.6L)	Motorcraft SAE 5W-20 Premium Synthetic Blend Motor Oil (US) Motorcraft SAE 5W-20 Super Premium Motor Oil (Canada)	XO-5W20-QSP (US) CXO-5W20-LSP12 (Canada) / WSS-M2C930-A and API Certification Mark
Engine oil (includes filter change) - diesel engine ⁶	Refer to the 6.0 and 6.4 Liter Power Stroke Direct Injection Turbo Diesel Owner's Guide Supplement		
Fuel tank - Mid-ship tank (optional on Chassis Cab)	19.0 gallons (71.9L)	—	—
Fuel tank - Short box	30.0 gallons (113.4L)	—	—
Fuel tank - Long box	38.0 gallons (143.9L)	—	—
Fuel tank - Aft axle (Chassis cab only)	40.0 gallons (151.4L)	—	—

Maintenance and Specifications

Item	Capacity	Ford part name	Ford part number / Ford specification
Hinges, latches, striker plates, fuel filler door hinge and seat tracks	—	Multi-Purpose Grease	XG-4 or XL-5 / ESB-M1C93-B
Lock cylinders	—	Motorcraft Penetrating and Lock Lubricant	XL-1 / None
Transmission / parking brake linkages and pivots, brake and clutch pedal shaft (if equipped)	—	Motorcraft Premium Long-Life Grease	XG-1-C or XG-1-K / WSD-M1C27-A
Power steering fluid	Keep fluid level between MIN and MAX on reservoir	MERCON® V Automatic Transmission Fluid	XT-5-QMC / MERCON® V
Transfer case fluid	2.0 quarts (1.9L)	Motorcraft Transfer Case Fluid	XL-12 / —
Manual transmission fluid	5.8 quarts (5.5L) ⁴	Motorcraft Full Synthetic Manual Transmission Fluid	XT-M5-QM / WSS-M2C200-C
Automatic transmission fluid ³	17.5 quarts (16.6L) ⁵ (includes remote filter element change)	Motorcraft MERCON® SP ATF	XT-6-QSP/MERCON® SP

Maintenance and Specifications

Item	Capacity	Ford part name	Ford part number / Ford specification
Windshield washer fluid	3.5 quarts (3.3L)	Motorcraft Premium Windshield Washer Concentrate	ZC-32-A / WSB-M8B16-A2

¹Add 8 oz. (236 ml) of Additive Friction Modifier XL-3 or equivalent meeting Ford Specification EST-M2C118-A for complete refill of limited slip Ford axles. Ford design rear axles contain a synthetic lubricant that does not require changing unless the axle has been submerged in water.

²Add the coolant type originally equipped in your vehicle.

³Ensure the correct automatic transmission fluid is used. Transmission fluid requirements are indicated on the dipstick blade or the dipstick handle. Check the container to verify the fluid being added is of the correct type. Refer to your *scheduled maintenance information* to determine the correct service interval.

Automatic transmissions that require MERCON® SP should only use MERCON® SP fluid. Use of a dual usage fluid in an automatic transmission requiring MERCON® SP may cause transmission damage. Use of any fluid other than the recommended fluid may cause transmission damage.

⁴Service refill capacity is determined by filling the transmission to the bottom of the filler hole with the vehicle on a level surface. The 6-speed manual transmission is equipped with an in-tank cooler. Verify the fluid level after operating vehicle to ensure correct fluid level.

⁵Indicates only approximate dry-fill capacity. Some applications may vary based on cooler size and if equipped with an in-tank cooler. The amount of transmission fluid and fluid level should be set by the indication on the dipstick's normal operating range.

⁶Use of synthetic or synthetic blend motor oil is not mandatory. Engine oil need only meet the requirements of Ford specification WSS-M2C930-A and the API Certification mark.

Maintenance and Specifications

ENGINE DATA

Engine	5.4L V8 engine	6.8L V10 engine
Cubic inches	330	415
Required fuel	87 octane	87 octane
Firing order	1-3-7-2-6-5-4-8	1-6-5-10-2-7-3-8-4-9
Spark plug gap	1.02–1.28mm (0.040–0.050 inch)*	1.02–1.28mm (0.040–0.050 inch)*
Ignition system	Coil on plug	Coil on plug
Compression ratio	9.8:1	9.2:1

*The 5.4L 3V and 6.8L 3V spark plug gap CANNOT be adjusted.

Drivebelt routing

5.4L V8/6.8L V10 engines

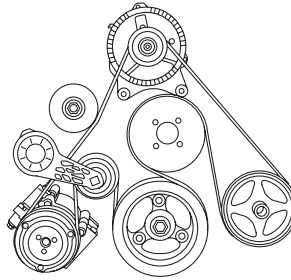

Maintenance and Specifications

IDENTIFYING YOUR VEHICLE

Safety Compliance Certification Label

The National Highway Traffic Safety Administration Regulations require that a Safety Compliance Certification Label be affixed to a vehicle and prescribe where the Safety Compliance Certification Label may be located. The Safety Compliance Certification Label is located on the structure by the trailing edge of the driver's door or the edge of the driver's door.

MFD. BY FORD MOTOR CO. IN U.S.A.	
DATE: XXXXX	GVWR: XXXXX LB/ XXXXX KG
FGAWR: XXXXXXX/XXXXXXXX	RGAWR: XXXXXXX/XXXXXXXX
THIS VEHICLE CONFORMS TO ALL APPLICABLE FEDERAL MOTOR VEHICLE SAFETY STANDARDS IN EFFECT ON THE DATE OF MANUFACTURE SHOWN ABOVE.	
VIN: XXXXXXXXXXXXXXXXX	TYPE: XXXXXXXXXXXXXXXXX
	
MAXIMUM LOAD=OCCUPANTS + LUGGAGE=XXXKG/XXXLB	
OCCUPANTS: X TOTAL X FR X 2ND X RR OCCUPANTS LUGGAGE	
TIRE: XXXX/XXXXX XXX	XX XXXKG/XXXLB
PRESSURE (FR) XXX kPa/ XX PSI COLD	X XXXKG/XXXLB
PRESSURE (RR) XXX kPa/ XX PSI COLD	
TRAILER TOWING - SEE OWNER GUIDE	
EXT PNT: XXXXX XXXXX	RC: XX DSC: XXXX F0000
BAR INT TR TP/PS R	AXLE TR SPR T0000
X XX XXX X	XX X XXXX
UTC VFOHT-15294A10-GA	

Vehicle identification number (VIN)

The vehicle identification number is located on the driver side instrument panel. (Please note that in the graphic XXXX is representative of your vehicle identification number.)

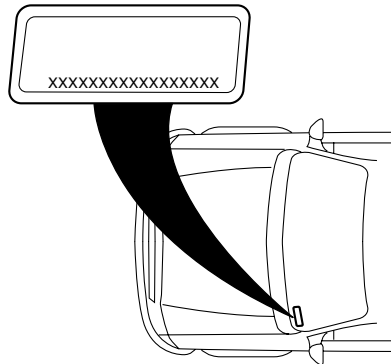

Accessories

GENUINE FORD ACCESSORIES FOR YOUR VEHICLE

A wide selection of Genuine Ford Accessories are available for your vehicle through your local authorized Ford or Ford of Canada authorized dealer. These quality accessories have been specifically engineered to fulfill your automotive needs; they are custom designed to complement the style and aerodynamic appearance of your vehicle. In addition, each accessory is made from high quality materials and meets or exceeds Ford's rigorous engineering and safety specifications. Ford Motor Company will repair or replace any properly authorized dealer-installed Genuine Ford Accessory found to be defective in factory-supplied materials or workmanship during the warranty period, as well as any component damaged by the defective accessory. The accessory will be warranted for whichever provides you the greatest benefit:

- 12 months or 12,000 miles (20,000 km) (whichever occurs first), or
- the remainder of your new vehicle limited warranty.

Contact your authorized dealer for details and a copy of the warranty.

The following is a list of several Genuine Ford Accessories available for your vehicle. Not all accessories are available for all models. For a complete listing of the accessories that are available for your vehicle, please contact your authorized dealer or visit our online store at: www.fordaccessoriesstore.com.

Exterior style

Bug shields

Chrome exhaust tips

Deflectors

Running boards

Splash guards

Step bars

Tonneau covers

Wheels

Interior style

Electrochromatic compass/temperature interior mirrors

Floor mats

Accessories

Lifestyle

Ash cup / smoker's package

Bedliners and bedmats

Cargo organization and management

Towing mirrors

Trailer hitches, wiring harnesses and accessories

Peace of mind

Mobile-Ease™ hands-free communication system

Remote start

Vehicle security systems

Wheel locks

Not all accessories are available for all models.

For maximum vehicle performance, keep the following information in mind when adding accessories or equipment to your vehicle:

- When adding accessories, equipment, passengers and luggage to your vehicle, do not exceed the total weight capacity of the vehicle or of the front or rear axle (GVWR or GAWR as indicated on the Safety Compliance Certification Label). Consult your authorized dealer for specific weight information.
- The Federal Communications Commission (FCC) and Canadian Radio Telecommunications Commission (CRTC) regulate the use of mobile communications systems — such as two-way radios, telephones and theft alarms - that are equipped with radio transmitters. Any such equipment installed in your vehicle should comply with FCC or CRTC regulations and should be installed only by your authorized dealer.
- Mobile communications systems may harm the operation of your vehicle, particularly if they are not properly designed for automotive use.
- To avoid interference with other vehicle functions, such as anti-lock braking systems, amateur radio users who install radios and antennas onto their vehicle should not locate the Amateur Radio Antennas in the area of the driver's side hood.
- Electrical or electronic accessories or components that are added to the vehicle by the authorized dealer or the owner may adversely affect battery performance and durability.

Index

A

- Accessory delay103
- Air cleaner filter380, 382
- Air conditioning80
- Airbag supplemental restraint system184
 - and child safety seats185
 - description184
 - disposal188
 - driver airbag186
 - indicator light187
 - operation186
 - passenger airbag186
 - passenger deactivation switch188
- Ambulance packages8
- Antifreeze
(see Engine coolant)356
- Anti-lock brake system
(see Brakes)260–261
- Anti-theft system159
 - arming the system160
- Audio system
(see Radio)23, 25, 32
- Automatic transmission265
 - driving an automatic overdrive267
 - fluid, adding375
 - fluid, checking375
 - fluid, refill capacities383
- Auxiliary Input Jack40
- Auxiliary power point100
- Axle
 - refill capacities383
 - traction lok264

B

- Battery354

392

- acid, treating emergencies354
- jumping a disabled battery322
- maintenance-free354
- replacement, specifications ...382
- servicing354
- Belt-Minder®179
- Brakes260
 - anti-lock260–261
 - anti-lock brake system (ABS) warning light261
 - fluid, checking and adding ...374
 - fluid, refill capacities383
 - parking261
 - shift interlock265
 - trailer246
- Break-in period5
- Bulbs91

C

- Capacities for refilling fluids383
- Cassette tape player23
- Cell phone use7
- Child safety restraints193
 - child safety belts193
- Child safety seats196
 - attaching with tether straps ..200
 - in front seat197
 - in rear seat197
- Cleaning your vehicle
 - engine compartment338
 - instrument panel340–341
 - interior342
 - plastic parts340
 - safety belts342
 - washing337
 - waxing337
 - wheels338
 - wiper blades340

Index

- Climate control (see Air conditioning or Heating)80
- Clock adjust
6-CD in dash34
AM/FM/CD28
- Clutch
fluid375
operation while driving269
recommended shift speeds270
- Compass, electronic
set zone adjustment134
- Console120
overhead100
- Controls
power seat165
steering column112
- Coolant
checking and adding356
refill capacities359, 383
- Cruise control
(see Speed control)109
- Customer Assistance294
Ford accessories for your
vehicle345
Ford Extended Service
Plan333
Getting assistance outside the
U.S. and Canada334
Getting roadside assistance ...294
Getting the service you
need329
Ordering additional owner's
literature335
Utilizing the
Mediation/Arbitration
Program333
- D**
Daytime running lamps
(see Lamps)86
Dipstick
automatic transmission
fluid375
engine oil351
Driveline universal joint and
slip yoke380
Driving under special
conditions269, 284, 288
sand286
snow and ice288
through water287, 290
DVD system48
- E**
Electronic message
center120, 129
Emergencies, roadside
jump-starting322
Emergency Flashers296
Emission control system370
Engine387
cleaning338
coolant356
diesel8
fail-safe cooling360
idle speed control354
refill capacities383
service points348-349
starting after a collision296
Engine oil351
checking and adding351
dipstick351
filter, specifications353, 382
recommendations353
refill capacities383
Event data recording6
Exhaust fumes258
- F**
Fail safe cooling360

Index

- Family entertainment system48
Fluid capacities383
Foglamps85
Four-Wheel Drive vehicles276
 description281
 driving off road283
 electronic shift277, 281
 indicator light278
 lever operated shift278
 manual locking hubs277
 preparing to drive your
 vehicle264
Fuel362
 calculating fuel
 economy130, 367
 cap364
 capacity383
 choosing the right fuel365
 comparisons with EPA fuel
 economy estimates370
 detergent in fuel366
 filling your vehicle with
 fuel362, 364, 367
 filter, specifications362, 382
 fuel pump shut-off switch296
 improving fuel economy367
 octane rating366, 387
 quality366
 running out of fuel366
 safety information relating to
 automotive fuels362
Fuel pump shut-off switch296
Fuses297–298
- G**
- Gas cap (see Fuel cap)364
Gas mileage
(see Fuel economy)367
Gauges19
- transmission fluid
temperature gauge23
- H**
- Hazard flashers296
Head restraints162
Headlamps85
 aiming87, 89
 autolamp system85
 daytime running lights86
 flash to pass86
 high beam86
 replacing bulbs93–94
 turning on and off85
Heating
 heating and air conditioning
 system76–77, 80
Homelink wireless control
system116
Hood347
- I**
- Ignition255, 387
Infant seats
(see Safety seats)196
Inspection/maintenance (I/M)
testing372
Instrument panel
 cleaning340–341
 cluster12
 lighting up panel and interior .87
- J**
- Jump-starting your vehicle322
- K**
- Keyless entry system157

394

Index

- autolock147
- programming entry code157
- Keys160
- positions of the ignition255
- L**
- Lamps
 - autolamp system85
 - daytime running light86
 - fog lamps85
 - headlamps85
 - headlamps, flash to pass86
 - instrument panel, dimming87
 - interior lamps91
 - replacing bulbs91, 93–97
- Lane change indicator
(see Turn signal)90
- Lights, warning and indicator12
 - anti-lock brakes (ABS)261
- Load limits236
- Loading instructions242
- Locks
 - autolock147
 - childproof150
- Lug nuts321
- Lumbar support, seats167
- M**
- Manual transmission269
 - fluid capacities383
 - reverse271
- Message center120, 129
 - english/metric button132
 - system check button132
 - warning messages124, 135
- Mirrors100, 103
 - fold away105, 107
 - heated105
 - side view mirrors (power)104
 - signal108
- Moon roof115
- Motorcraft parts362, 382
- N**
- Navigation system47
- O**
- Octane rating366
- Oil (see Engine oil)351
- Overdrive99
- P**
- Parking brake261
- Parts (see Motorcraft parts)382
- Pedals (see Power adjustable
foot pedals)108
- Power adjustable foot pedals ...108
- Power distribution box
(see Fuses)303
- Power door locks146
- Power mirrors104
- Power point100
- Power steering263
 - fluid, checking and adding373
 - fluid, refill capacity383
- Power Windows102
- Preparing to drive your
vehicle264
- R**
- Radio23, 25, 32

Index

- Rear seat entertainment system48
- Rear video camera274
- Relays297
- Remote entry system151
 - illuminated entry155–156
 - locking/unlocking doors146, 151–152
- Reverse sensing system272
- Roadside assistance294
- S**
- Safety Belt Maintenance183
- Safety belts (see Safety restraints)170, 172–174, 176
- Safety defects, reporting ..335–336
- Safety restraints170, 172–174, 176
 - Belt-Minder®179
 - extension assembly183
 - for adults172–174, 176
 - for children192–193
 - lap belt178
 - safety belt maintenance183
 - warning light and chime178–179
- Safety seats for children196
- Safety Compliance Certification Label388
- Satellite Radio Information44
- Seat belts (see Safety restraints)170
- Seats162
 - child safety seats196
 - cleaning343
 - heated80
 - memory seat152, 168
- SecuriLock passive anti-theft system159–160
- Servicing your vehicle346
- Setting the clock
 - AM/FM/CD28
 - AM/FM/In-dash 6 CD34
- Snowplowing8, 291–293
- Spark plugs, specifications382, 387
- Special notice9
 - ambulance conversions8
 - diesel-powered vehicles8
 - utility-type vehicles8
- Speed control109
- Starting your vehicle255–257
 - jump starting322
- Steering wheel
 - controls112
 - tilting99
- T**
- Tailgate140
- Tilt steering wheel99
- Tire Pressure Monitoring System (TPMS)
 - Tires, Wheels and Loading ...224
- Tires206–208
 - alignment216
 - care212
 - changing310, 312
 - checking the pressure211
 - inflating209
 - label223
 - replacing214
 - rotating217
 - safety practices215
 - sidewall information219

Index

- snow tires and chains235
- spare tire308–309
- terminology208
- tire grades207
- treadwear207, 213
- Towing242
 - recreational towing253
 - Trailer Brake
 - Controller-Integrated246
 - trailer towing242
 - wrecker327
- Traction control262
- Traction-lok rear axle264
- Trailer Brake
 - Controller-Integrated246
- Transfer case
 - fluid checking379
- Transmission
 - automatic operation99, 265
 - brake-shift interlock (BSI)265
 - fluid, checking and adding
 - (automatic)375
 - (manual)378
 - fluid, refill capacities383
 - manual operation269
- Turn signal90
- U**
 - Upfitter controls114
- V**
 - Vehicle Identification Number (VIN)388
 - Vehicle loading236
 - Ventilating your vehicle258
- W**
 - Warning lights (see Lights)12
 - Washer fluid350
 - Water, Driving through290
 - Windows
 - power102
 - Windshield washer fluid and wipers98
 - checking and adding fluid350
 - replacing wiper blades350
 - Wrecker towing327

