

2012

CHALLENGER

---

OWNER'S MANUAL

SRT8

## **VEHICLES SOLD IN CANADA**

With respect to any Vehicles Sold in Canada, the name Chrysler Group LLC shall be deemed to be deleted and the name Chrysler Canada Inc. used in substitution therefore.

## **DRIVING AND ALCOHOL**

Drunken driving is one of the most frequent causes of accidents.

Your driving ability can be seriously impaired with blood alcohol levels far below the legal minimum. If you are drinking, don't drive. Ride with a designated non-drinking driver, call a cab, a friend, or use public transportation.

### **WARNING!**

Driving after drinking can lead to an accident. Your perceptions are less sharp, your reflexes are slower, and your judgment is impaired when you have been drinking. Never drink and then drive.

This manual illustrates and describes the operation of features and equipment that are either standard or optional on this vehicle. This manual may also include a description of features and equipment that are no longer available or were not ordered on this vehicle. Please disregard any features and equipment described in this manual that are not on this vehicle.

Chrysler Group LLC reserves the right to make changes in design and specifications, and/or make additions to or improvements to its products without imposing any obligation upon itself to install them on products previously manufactured.

Copyright © 2011 Chrysler Group LLC



# TABLE OF CONTENTS

SECTION		PAGE	
1	INTRODUCTION .....	3	1
2	THINGS TO KNOW BEFORE STARTING YOUR VEHICLE .....	9	2
3	UNDERSTANDING THE FEATURES OF YOUR VEHICLE .....	85	3
4	UNDERSTANDING YOUR INSTRUMENT PANEL .....	173	4
5	STARTING AND OPERATING .....	251	5
6	WHAT TO DO IN EMERGENCIES .....	341	6
7	MAINTAINING YOUR VEHICLE .....	363	7
8	MAINTENANCE SCHEDULES .....	417	8
9	IF YOU NEED CONSUMER ASSISTANCE .....	437	9
10	INDEX .....	447	10



# INTRODUCTION

## CONTENTS

---

■ Introduction . . . . .	4	■ Vehicle Identification Number . . . . .	6
■ How To Use This Manual . . . . .	4	■ Vehicle Modifications/Alterations . . . . .	7
■ Warnings And Cautions . . . . .	6		

### INTRODUCTION

Congratulations on selecting your new Chrysler Group LLC vehicle. Be assured that it represents precision workmanship, distinctive styling, and high quality - all essentials that are traditional to our vehicles.

This Owner's Manual has been prepared with the assistance of service and engineering specialists to acquaint you with the operation and maintenance of your vehicle. It is supplemented by Warranty Information, and various customer-oriented documents. Please take the time to read these publications carefully. Following the instructions and recommendations in this manual will help assure safe and enjoyable operation of your vehicle.

**NOTE:** After reviewing the owner information, it should be stored in the vehicle for convenient referencing and remain with the vehicle when sold.

When it comes to service, remember that your authorized dealer knows your vehicle best, has factory-trained technicians and genuine MOPAR® parts, and cares about your satisfaction.





















































































### HOW TO USE THIS MANUAL

Consult the Table of Contents to determine which section contains the information you desire.

Since the specification of your vehicle depends on the items of equipment ordered, certain descriptions and illustrations may differ from your vehicle's equipment.

The detailed index at the back of this Owner's Manual contains a complete listing of all subjects.

Consult the following table for a description of the symbols that may be used on your vehicle or throughout this Owner's Manual:

											
WATER IN FUEL	REAR WINDOW WIPER	WINDSHIELD WIPER INTERMITTENT	EXTERIOR BULB FAILURE	HIGH BEAM	TURN SIGNALS	UPPER AIR OUTLET	HEATED SEAT LOW	DOOR LOCK	ADJUSTABLE PEDALS	ELECTRONIC SPEED CONTROL	ELECTRONIC STABILITY PROGRAM / BRAKE ASSIST SYSTEM
											
FUEL	REAR WINDOW WIPER	WINDSHIELD WASHER	MASTER LIGHTING SWITCH	LOW BEAM	KEY ACTIVATE (POWER OUTLET)	UPPER AND LOWER AIR OUTLET	HEATED SEAT HIGH	WINDOW LIFT	TIRE PRESSURE MONITOR	HILL DESCENT CONTROL	BRAKE SYSTEM WARNING PARKING BRAKE
											
FUEL FILL SIDE	REAR WINDOW WASHER	WINDSHIELD WASHER FLUID LEVEL	DOME LIGHT	FRONT FOG LIGHT	HOOD RELEASE	LOWER AIR OUTLET	RECIRCULATION	CONVERTIBLE 4 WINDOW DOWN	ELECTRONIC STABILITY CONTROL	AWD!	FAILURE OF ANTI-LOCK BRAKING SYSTEM
											
ENGINE OIL	REAR WINDOW DEFROST	WINDSHIELD ELECTRICALLY HEATED	PARK LIGHTS	REAR FOG LAMP	LIFTGATE RELEASE AND LIFTGATE OPEN	DEFROST 1 AND LOWER AIR OUTLET	VENTILATING FAN	WINDOW LOCK	ELECTRONIC THROTTLE CONTROL	4WD!	BRAKE SYSTEM WARNING PARKING BRAKE
											
BATTERY CHARGING	HEATED MIRROR	WINDSHIELD DEFROST	INSTRUMENT PANEL ILLUMINATION	SEAT BELT	SLIDING DOOR	TRUNK / DECK RELEASE	AIR CONDITIONING	CHILD SEAT TETHER ANCHOR	VOICE RECOGNITION BUTTON	WARNING	TOW / HAUL
											
GLOW PLUG	POWER STEERING FLUID	WINDSHIELD WIPER AND WASHER	SIDE AIRBAG	AIRBAG	SLIDING DOOR	EMERGENCY RELEASE HANDLE	LIGHTER	LOWER ANCHOR AND TETHER FOR CHILDREN (LATCH)	DISCONNECT™ BUTTON	HAZARD	4 LOW
											
MALFUNCTION INDICATOR LIGHT	TRANS OIL TEMP	ENGINE COOLANT TEMPERATURE	SRS AIRBAG	PASSENGER AIRBAG OFF	DOOR AJAR	CONVERTIBLE TOP DOWN	CONVERTIBLE TOP UP	HORN	SEE OWNER'S MANUAL ISO	A/C PUSH	ELECTRONIC STABILITY CONTROL OFF

## WARNINGS AND CAUTIONS

This Owner's Manual contains **WARNINGS** against operating procedures that could result in a collision or bodily injury. It also contains **CAUTIONS** against procedures that could result in damage to your vehicle. If you do not read this entire manual, you may miss important information. Observe all Warnings and Cautions.

## VEHICLE IDENTIFICATION NUMBER

The Vehicle Identification Number (VIN) is on the left front corner of the instrument panel and is visible from outside of the vehicle through the windshield. This number also appears on the Automobile Information Disclosure Label affixed to a window on your vehicle, the vehicle registration, and the title.

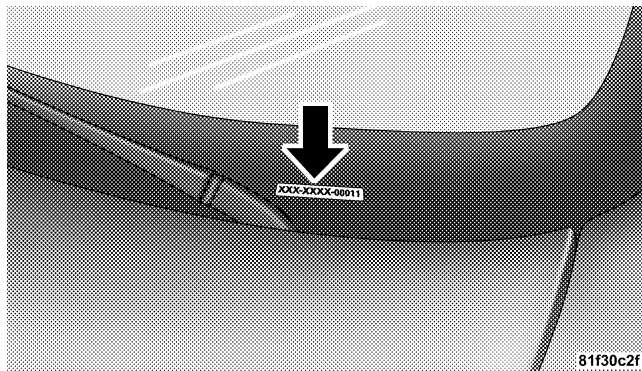

### VIN Location

The vehicle identification number (VIN) is also located on the right front strut tower inside the engine compartment.



## VEHICLE MODIFICATIONS/ALTERATIONS

**WARNING!**

Any modifications or alterations to this vehicle could seriously affect its roadworthiness and safety and may lead to a collision resulting in serious injury or death.

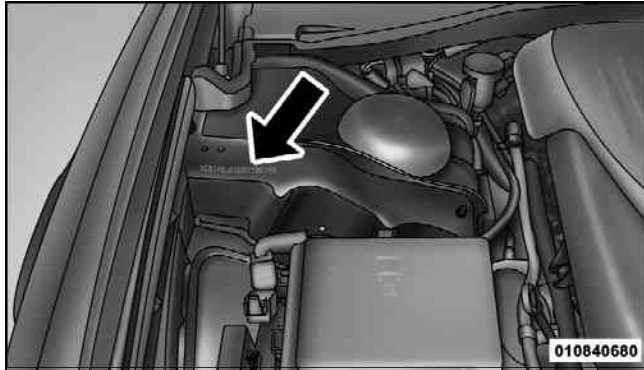

**NOTE:** It is illegal to remove or alter the VIN.



# THINGS TO KNOW BEFORE STARTING YOUR VEHICLE

## CONTENTS

---

■ A Word About Your Keys . . . . .	12	■ Vehicle Security Alarm . . . . .	18
□ Wireless Ignition Node (WIN) . . . . .	12	□ Rearming Of The System . . . . .	19
□ Key Fob . . . . .	13	□ To Arm The System . . . . .	19
□ Removing Key Fob From Ignition . . . . .	14	□ To Disarm The System . . . . .	20
□ Key-In-Ignition Reminder . . . . .	16	■ Illuminated Entry . . . . .	21
■ Sentry Key® . . . . .	16	■ Remote Keyless Entry (RKE) . . . . .	21
□ Replacement Keys . . . . .	17	□ To Unlock The Doors . . . . .	22
□ Customer Key Programming . . . . .	18	□ To Lock The Doors . . . . .	24
□ General Information . . . . .	18	□ To Open The Trunk . . . . .	25

## 10 THINGS TO KNOW BEFORE STARTING YOUR VEHICLE

□ Using The Panic Alarm . . . . .	25	■ Trunk Lock And Release . . . . .	40
□ Programming Additional Transmitters . . . . .	26	■ Trunk Safety Warning . . . . .	41
□ Transmitter Battery Replacement . . . . .	26	□ Trunk Emergency Release . . . . .	42
□ General Information . . . . .	27	■ Occupant Restraints . . . . .	42
■ Remote Starting System — If Equipped . . . . .	27	□ Lap/Shoulder Belts . . . . .	45
□ How To Use Remote Start . . . . .	28	□ Lap/Shoulder Belt Untwisting Procedure . . . . .	51
■ Door Locks . . . . .	31	□ Seat Belts In Passenger Seating Positions . . . . .	51
□ Manual Door Locks . . . . .	31	□ Automatic Locking Retractor Mode (ALR) — If Equipped . . . . .	52
□ Power Door Locks . . . . .	32	□ Energy Management Feature . . . . .	53
■ Keyless Enter-N-Go™ . . . . .	34	□ Seat Belt Pretensioners . . . . .	53
■ Windows . . . . .	38	□ Enhanced Seat Belt Use Reminder System (BeltAlert®) . . . . .	54
□ Power Windows . . . . .	38	□ Seat Belts And Pregnant Women . . . . .	55
□ Wind Buffeting . . . . .	40		

**THINGS TO KNOW BEFORE STARTING YOUR VEHICLE 11**

□ Seat Belt Extender . . . . .	55	■ Safety Tips . . . . .	80
□ Supplemental Restraint System (SRS) — Air Bags . . . . .	56	□ Transporting Passengers . . . . .	80
□ Air Bag Deployment Sensors And Controls . . .	62	□ Exhaust Gas . . . . .	81
□ Event Data Recorder (EDR) . . . . .	69	□ Safety Checks You Should Make Inside The Vehicle . . . . .	82
□ Child Restraints . . . . .	70	□ Periodic Safety Checks You Should Make Outside The Vehicle . . . . .	84
■ Engine Break-In Recommendations . . . . .	79		

## A WORD ABOUT YOUR KEYS

Your vehicle uses a keyless ignition system. This system consists of a Key Fob with Remote Keyless Entry (RKE) transmitter and a Wireless Ignition Node (WIN) with integral ignition switch. You can insert the Key Fob into the ignition switch with either side up.

### *Keyless Enter-N-Go Feature*

This vehicle is equipped with the Keyless Enter-N-Go feature, refer to “Starting Procedures” in “Starting And Operating” for further information.

## Wireless Ignition Node (WIN)

The Wireless Ignition Node (WIN) operates similar to an ignition switch. It has four operating positions, three with detents and one that is spring-loaded. The detent positions are OFF, ACC, and ON/RUN. The START position is a spring-loaded momentary contact position. When released from the START position, the switch automatically returns to the ON/RUN position.

**NOTE:** If your vehicle is equipped with Keyless Enter-N-Go, the Electronic Vehicle Information Center (EVIC) will display the ignition switch position (OFF/ACC/RUN). Refer to “Electronic Vehicle Information Center (EVIC) — If Equipped” in “Understanding Your Instrument Panel” for further information.

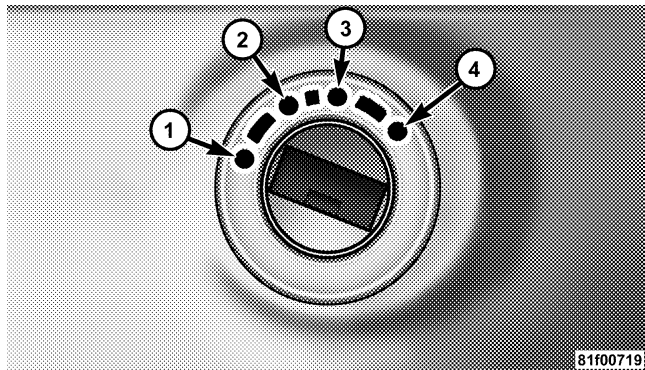

- 1 — OFF
- 2 — ACCESSORY (ACCESSORY)
- 3 — ON/RUN
- 4 — START

## Key Fob

The Key Fob operates the ignition switch. Insert the square end of the key fob into the ignition switch located on the instrument panel and rotate to the desired position. It also contains the Remote Keyless Entry (RKE) transmitter and an emergency key, which stores in the rear of the Key Fob.

The emergency key allows for entry into the vehicle should the battery in the vehicle or the Key Fob go dead. The emergency key is also for locking the glove box. You can keep the emergency key with you when valet parking.

**NOTE:** Entering a vehicle using the emergency key with the theft alarm armed, will result in the alarm sounding. Insert the Key Fob (even if the Key Fob battery is dead) into the ignition switch to disarm theft alarm.

## 14 THINGS TO KNOW BEFORE STARTING YOUR VEHICLE

To remove the emergency key, slide the mechanical latch at the top of the Key Fob sideways with your thumb and then pull the key out with your other hand.

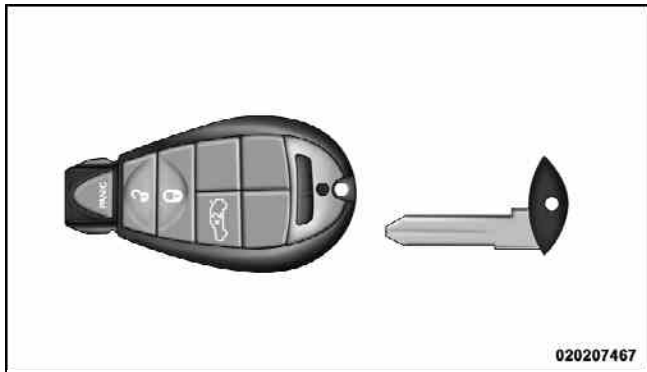

### Emergency Key Removal

**NOTE:** You can insert the double-sided emergency key into the lock cylinders with either side up.

### Removing Key Fob From Ignition

Place the shift lever in PARK. Turn the Key Fob to the OFF position and then remove the Key Fob.

With the Keyless Enter-N-Go system, the EVIC will display the ignition switch position “OFF/ACC/RUN”. Refer to “Electronic Vehicle Information Center (EVIC) — If Equipped” in “Understanding Your Instrument Panel” for further information.

**NOTE:** The power window switches, radio, power sunroof (if equipped), and ignition-powered power outlets will remain active for up to 60 minutes after the ignition switch is turned to the LOCK position. Opening either door will cancel this feature. The time for this feature is programmable. Refer to “Electronic Vehicle Information Center (EVIC)/Personal Settings (Customer-Programmable Features)” in “Understanding Your Instrument Panel” for further information.



**CAUTION!**

- If your vehicle battery becomes low or dead, your Key Fob will become locked in the ignition.
- Do not attempt to remove the Key Fob while in this condition, damage could occur to the Key Fob or ignition module. Only remove the emergency key for locking and unlocking the doors.
- Leave the Key Fob in the ignition and either:
  - Jump Start the vehicle.
  - Charge the battery.

**WARNING!**

- Before exiting a vehicle, always apply the parking brake, shift the transmission into PARK, and remove the key fob from the ignition. When leaving the vehicle, always lock your vehicle.

*(Continued)*

**WARNING! (Continued)**

- Never leave children alone in a vehicle, or with access to an unlocked vehicle.
- Allowing children to be in a vehicle unattended is dangerous for a number of reasons. A child or others could be seriously or fatally injured. Children should be warned not to touch the parking brake, brake pedal or the shift lever.
- Do not leave the key fob in or near the vehicle, and do not leave Keyless Enter-N-Go in the ACC or ON/RUN mode. A child could operate power windows, other controls, or move the vehicle.
- Do not leave children or animals inside parked vehicles in hot weather. Interior heat build-up may cause serious injury or death.

**CAUTION!**

An unlocked car is an invitation to thieves. Always remove the Key Fob from vehicle, cycle the ignition OFF with Keyless Enter-N-Go, and lock all doors when leaving the vehicle unattended.

**Key-In-Ignition Reminder**

Opening the driver's door when the Key Fob is in the ignition and the ignition switch position is OFF or ACC, sounds a signal to remind you to remove the Key Fob.

**NOTE:** The Key-In-Ignition reminder only sounds when the Key Fob is placed in the OFF or ACC ignition position.

If your vehicle is equipped with Keyless Enter-N-Go, opening the driver's door when the vehicle's ignition switch is placed in ACC or ON/RUN (engine stopped)

will cause the reminder chime to sound. Refer to "Starting Procedures" in "Starting And Operating" for further information.

**SENTRY KEY®**

The Sentry Key® Immobilizer System prevents unauthorized vehicle operation by disabling the engine. The system does not need to be armed or activated. Operation is automatic, regardless of whether the vehicle is locked or unlocked.

The system uses a Key Fob with factory-mated Remote Keyless Entry (RKE) transmitter and Wireless Ignition Node (WIN) to prevent unauthorized vehicle operation. Therefore, only Key Fobs that are programmed to the vehicle can be used to start and operate the vehicle. The system will shut the engine off in two seconds if an invalid Key Fob is used to start the engine.

After placing the ignition switch in the ON/RUN position, the Vehicle Security Light will turn on for three

seconds for a bulb check. If the light remains on after the bulb check, it indicates that there is a problem with the electronics. This condition will result in the engine being shut off after two seconds.

If the Vehicle Security Light turns on during normal vehicle operation (vehicle running for longer than 10 seconds), it indicates that there is a fault in the electronics. Should this occur, have the vehicle serviced as soon as possible by an authorized dealer.

### CAUTION!

**The Sentry Key® Immobilizer system is not compatible with some after-market remote starting systems. Use of these systems may result in vehicle starting problems and loss of security protection.**

All of the Key Fobs provided with your new vehicle have been programmed to the vehicle electronics.

## Replacement Keys

**NOTE:** Only Key Fobs that are programmed to the vehicle electronics can be used to start and operate the vehicle. Once a Key Fob is programmed to a vehicle, it cannot be programmed to any other vehicle.

### CAUTION!

- **Always remove the Key Fobs from the vehicle and lock all doors when leaving the vehicle unattended.**
- **For vehicles equipped with Keyless Enter-N-Go, always remember to place the ignition in OFF.**

At the time of purchase, the original owner is provided with a four-digit Personal Identification Number (PIN). Keep the PIN in a secure location. This number is required for authorized dealer replacement of Key Fobs.

Duplication of Key Fobs may be performed at an authorized dealer, this procedure consists of programming a blank Key Fob to the vehicle electronics. A blank Key Fob is one that has never been programmed.

**NOTE:** When having the Sentry Key® Immobilizer System serviced, bring all vehicle Key Fobs with you to the authorized dealer.

### **Customer Key Programming**

Programming Key Fobs or RKE transmitters may be performed at an authorized dealer.

### **General Information**

The Sentry Key® system complies with FCC rules Part 15 and with RSS-210 of Industry Canada. Operation is subject to the following conditions:

- This device may not cause harmful interference.

- This device must accept any interference that may be received, including interference that may cause undesired operation.

### **VEHICLE SECURITY ALARM**

The Vehicle Security Alarm monitors the vehicle doors and trunk for unauthorized entry and the ignition switch for unauthorized operation. While the Vehicle Security Alarm is armed, interior switches for door locks and decklid release are disabled. If something triggers the alarm, the Vehicle Security Alarm will provide the following audible and visible signals: the horn will pulse, the headlights will turn on, park lamps and/or turn signals will flash, and the Vehicle Security Light in the instrument cluster will flash.

## Rearming Of The System

If something triggers the alarm, and no action is taken to disarm it, the Vehicle Security Alarm will turn the horn off after three minutes, turn all of the visual signals off after an additional 15 minutes, and then the Vehicle Security Alarm will rearm itself.

## To Arm The System

Follow these steps to arm the Vehicle Security Alarm:

1. Remove the key from the ignition system (refer to "Starting Procedures" in "Starting And Operating" for further information).
  - For vehicles equipped with Keyless Enter-N-Go, make sure the vehicle ignition system is "OFF".
  - For vehicles not equipped with Keyless Enter-N-Go, make sure the vehicle ignition system is "OFF" and the key is physically removed from the ignition.

2. Perform one of the following methods to lock the vehicle:

- Press LOCK on the interior power door lock switch with the driver and/or passenger door open.
  - Press the LOCK button on the exterior Passive Entry Door Handle with a valid Key Fob available in the same exterior zone (refer to "Keyless Enter-N-Go" in "Things To Know Before Starting Your Vehicle" for further information).
  - Press the LOCK button on the Remote Keyless Entry (RKE) transmitter.
3. If any doors are open, close them.

### To Disarm The System

The Vehicle Security Alarm can be disarmed using any of the following methods:

- Press the UNLOCK button on the Remote Keyless Entry (RKE) transmitter.
- Grasp the Passive Entry Unlock Door Handle (if equipped, refer to "Keyless Enter-N-Go" in "Things To Know Before Starting Your Vehicle" for further information).
- For vehicles equipped with Keyless Enter-N-Go, press the Keyless Enter-N-Go Start/Stop button (requires at least one valid Key Fob in the vehicle).
- For vehicles not equipped with Keyless Enter-N-Go, insert a valid key into the ignition switch and turn the key to the ON position.

**NOTE:** The driver's door key cylinder and the trunk button on the RKE transmitter cannot arm or disarm the Vehicle Security Alarm.

- The Vehicle Security Alarm remains armed during trunk entry. Pressing the trunk button will not disarm the Vehicle Security Alarm. If someone enters the vehicle through the trunk and opens any door the alarm will sound.
- When the Vehicle Security Alarm is armed, the interior power door lock switches will not unlock the doors.
- The Vehicle Security Alarm is designed to protect your vehicle; however, you can create conditions where the system will give you a false alarm. If one of the previously described arming sequences has occurred, the Vehicle Security Alarm will arm regardless of whether you are in the vehicle or not. If you remain in the vehicle and open a door, the alarm will sound. If this occurs, disarm the Vehicle Security Alarm.

- If the Vehicle Security Alarm is armed and the battery becomes disconnected, the Vehicle Security Alarm will remain armed when the battery is reconnected; the exterior lights will flash, the horn will sound. If this occurs, disarm the Vehicle Security Alarm.

### **Tamper Alert**

If something has triggered the Vehicle Security Alarm in your absence, the horn will sound three times and the exterior lights will blink three times when you disarm the Vehicle Security Alarm. Check the vehicle for tampering.

### **ILLUMINATED ENTRY**

The courtesy lights will turn on when you use the Remote Keyless Entry (RKE) transmitter to unlock the doors or open any door.

This feature also turns on the approach lighting in the outside mirrors (if equipped). Refer to “Mirrors” in “Understanding The Features Of Your Vehicle” for further information.

The lights will fade to off after approximately 30 seconds or they will immediately fade to off once the ignition switch is turned to ON/RUN from the OFF position.

### **NOTE:**

- The front courtesy overhead console and door courtesy lights will turn on if the dimmer control is in the “Dome ON” position (extreme top position).
- The Illuminated Entry system will not operate if the dimmer control is in the “Dome defeat” position (extreme bottom position).

### **REMOTE KEYLESS ENTRY (RKE)**

The RKE system allows you to lock or unlock the doors, open the trunk, or activate the Panic Alarm from distances up to approximately 66 ft (20 m) using a hand-held Key Fob with RKE transmitter. The RKE transmitter does not need to be pointed at the vehicle to activate the system.

**NOTE:** Inserting the Key Fob with RKE transmitter into the ignition switch disables the system from responding to any button presses from that RKE transmitter. Driving at speeds 5 mph (8 km/h) and above disables the system from responding to all RKE transmitter buttons for all RKE transmitters.



Key Fob With RKE Transmitter

### To Unlock The Doors

Press and release the UNLOCK button on the RKE transmitter once to unlock the driver's door or twice within five seconds, to unlock both doors. The turn signal lights will flash to acknowledge the unlock signal. The illuminated entry system will also turn on.

If equipped with Keyless Enter-N-Go (Passive Entry), refer to "Keyless Enter-N-Go" under "Things To Know Before Starting Your Vehicle" for further information.

### Remote Key Unlock, Driver Door/All Doors First

This feature lets you program the system to unlock either the driver's door or both doors on the first press of the UNLOCK button on the RKE transmitter. Refer to "Electronic Vehicle Information Center (EVIC)/Personal Settings (Customer-Programmable Features)" in "Understanding Your Instrument Panel" for further information.



- When not using the EVIC, perform the following steps:

1. Press and hold the LOCK button on a programmed RKE transmitter for at least 4 seconds, but no longer than 10 seconds. Then, press and hold the UNLOCK button while still holding the LOCK button.
2. Release both buttons at the same time.
3. Test the feature while outside of the vehicle by pressing the LOCK/UNLOCK buttons on the RKE transmitter with the ignition switch in the OFF position and the Key Fob removed.
4. Repeat these steps if you want to return this feature to its previous setting.

**NOTE:** Pressing the LOCK button on the RKE transmitter while you are inside the vehicle will activate the Security Alarm. Opening a door with the Security Alarm

activated will cause the alarm to sound. Press the UNLOCK button to deactivate the Security Alarm.

### Flash Lights With Remote Key Lock

This feature will cause the turn signal lights to flash when the doors are locked or unlocked with the RKE transmitter. This feature can be turned on or turned off. Refer to “Electronic Vehicle Information Center (EVIC)/Personal Settings (Customer-Programmable Features)” in “Understanding Your Instrument Panel” for further information.

- When not using the EVIC, perform the following steps:
1. Press and hold the UNLOCK button on a programmed RKE transmitter for at least 4 seconds, but no longer than 10 seconds. Then, press and hold the LOCK button while still holding the UNLOCK button.
  2. Release both buttons at the same time.

3. Test the feature while outside of the vehicle by pressing the LOCK/UNLOCK buttons on the RKE transmitter with the ignition switch in the OFF position and the Key Fob removed.

4. Repeat these steps if you want to return this feature to its previous setting.

**NOTE:** Pressing the LOCK button on the RKE transmitter while you are in the vehicle will activate the Security Alarm. Opening a door with the Security Alarm activated will cause the alarm to sound. Press the UNLOCK button to deactivate the Security Alarm.

### **Turn Headlights On With Remote Key Unlock**

This feature activates the headlights for up to 90 seconds when the doors are unlocked with the RKE transmitter. The time for this feature is programmable. Refer to “Electronic Vehicle Information Center (EVIC)/Personal Settings (Customer-Programmable Features)” in “Understanding Your Instrument Panel” for further information.

### **To Lock The Doors**

Press and release the LOCK button on the RKE transmitter to lock both doors. The turn signal lights will flash and the horn will chirp to acknowledge the signal.

If equipped with Keyless Enter-N-Go (Passive Entry), refer to “Keyless Enter-N-Go” under “Things To Know Before Starting Your Vehicle” for further information.

### **Sound Horn With Remote Key Lock**

This feature will cause the horn to chirp when the doors are locked with the RKE transmitter or the Passive Entry feature. This feature can be turned on or turned off. Refer to “Electronic Vehicle Information Center (EVIC)/Personal Settings (Customer-Programmable Features)” in “Understanding Your Instrument Panel” for further information.

- When not using the EVIC, perform the following steps:
  1. Press the LOCK button on a programmed RKE transmitter for at least 4 seconds, but no longer than 10 seconds. Then, press the PANIC button while still holding the LOCK button.
  2. Release both buttons at the same time.
  3. Test the feature while outside of the vehicle by pressing the LOCK button on the RKE transmitter with the ignition switch in the OFF position and the Key Fob removed.
  4. Repeat these steps if you want to return this feature to its previous setting.

**NOTE:** Pressing the LOCK button on the RKE transmitter while you are in the vehicle will activate the Security

Alarm. Opening a door with the Security Alarm activated will cause the alarm to sound. Press the UNLOCK button to deactivate the Security Alarm.

### **To Open The Trunk**

Press the TRUNK button on the RKE transmitter two times within five seconds to open the trunk.

If equipped with Keyless Enter-N-Go (Passive Entry), refer to “Keyless Enter-N-Go” under “Things To Know Before Starting Your Vehicle” for further information.

### **Using The Panic Alarm**

To turn the Panic Alarm feature ON or OFF, press and hold the PANIC button on the RKE transmitter for at least one second and release. When the Panic Alarm is on, the headlights will turn on, the park lights will flash, the horn will pulse on and off, and the interior lights will turn on.

The Panic Alarm will stay on for three minutes unless you turn it off by either pressing the PANIC button a second time or drive the vehicle at a speed of 5 mph (24 km/h) or greater.

### **NOTE:**

- The interior lights will turn off if you turn the ignition switch to the ACC or ON/RUN position while the Panic Alarm is activated. However, the exterior lights and horn will remain on.
- You may need to be less than 35 ft (11 m) from the vehicle when using the RKE transmitter to turn off the Panic Alarm due to the radio frequency noises emitted by the system.

### **Programming Additional Transmitters**

Programming Key Fobs or RKE transmitters may be performed at an authorized dealer.

### **Transmitter Battery Replacement**

The recommended replacement battery is CR2032.

**NOTE:** Perchlorate Material – special handling may apply. See [www.dtsc.ca.gov/hazardouswaste/perchlorate](http://www.dtsc.ca.gov/hazardouswaste/perchlorate)

1. If the RKE transmitter is equipped with a screw, remove the screw. With the RKE transmitter buttons facing down, use a flat blade to pry the two halves of the RKE transmitter apart. Make sure not to damage the elastomer seal during removal.
2. Remove and replace the battery. When replacing the battery, match the + sign on the battery to the + sign on the inside of the battery clip, located on the back cover. Avoid touching the new battery with your fingers. Skin oils may cause battery deterioration. If you touch a battery, clean it with rubbing alcohol.

3. To reassemble the RKE transmitter case, snap the two halves of the case together. Make sure there is an even “gap” between the two halves. If equipped, install and tighten the screw until snug. Test RKE transmitter operation.

### General Information

This device complies with Part 15 of the FCC rules and RSS 210 of Industry Canada. Operation is subject to the following conditions:

- This device may not cause harmful interference.
- This device must accept any interference received, including interference that may cause undesired operation.

**NOTE:** Changes or modifications not expressly approved by the party responsible for compliance could void the user’s authority to operate the equipment.

If your RKE transmitter fails to operate from a normal distance, check for these two conditions:

1. A weak battery in the transmitter. The expected life of the battery is a minimum of three years.
2. Closeness to a radio transmitter such as a radio station tower, airport transmitter, and some mobile or CB radios.

### REMOTE STARTING SYSTEM — IF EQUIPPED

 This system uses the Remote Keyless Entry (RKE) transmitter to start the engine conveniently from outside the vehicle while still maintaining security. The system has a range of approximately 300 ft (91 m).

#### NOTE:

- The vehicle must be equipped with an automatic transmission to be equipped with Remote Start.
- Obstructions between the vehicle and the Key Fob may reduce this range.

## How To Use Remote Start

All of the following conditions must be met before the engine will remote start:

- Shift lever in PARK
- Doors closed
- Hood closed
- Hazard switch off
- Brake switch inactive (brake pedal not pressed)
- Ignition key removed from ignition switch
- Battery at an acceptable charge level, and
- RKE PANIC button not pressed.
- System not disabled from previous remote start event
- Vehicle theft alarm not active
- Ignition in Off position (Keyless Enter-N-Go)

### WARNING!

- Do not start or run an engine in a closed garage or confined area. Exhaust gas contains Carbon Monoxide (CO) which is odorless and colorless. Carbon Monoxide is poisonous and can cause serious injury or death when inhaled.
- Keep Remote Keyless Entry (RKE) transmitters away from children. Operation of the Remote Start System, windows, door locks or other controls could cause serious injury or death.

### To Enter Remote Start Mode



Press and release the REMOTE START button on the RKE transmitter twice within five seconds. The vehicle doors will lock, the parking lights will flash and horn will chirp twice (if

programmed). Then, the engine will start and the vehicle will remain in the Remote Start mode for a 15-minute cycle.

**NOTE:**

- If an engine fault is present the vehicle will start and then shut down 10 seconds later.
- The park lamps will turn on and remain on during Remote Start mode.
- For security, power window and power sunroof operation (if equipped) are disabled when the vehicle is in the Remote Start mode.
- The engine can be started two consecutive times with the RKE transmitter. However, the ignition must be cycled by pushing the START/STOP button twice (or the ignition switch must be cycled to the ON/RUN position) before you can repeat the start sequence for a third cycle.

**To Exit Remote Start Mode Without Driving The Vehicle**

- Press and release the REMOTE START button one time or allow the engine to run for the entire 15-minute cycle.

**NOTE:** To avoid unintentional shut downs, the system will disable the one time press of the REMOTE START button for two seconds after receiving a valid Remote Start request.

**To Exit Remote Start Mode And Drive The Vehicle**

Before the end of 15 minute cycle, press and release the UNLOCK button on the RKE transmitter to unlock the doors and disarm the Vehicle Security Alarm (if equipped). Then, prior to the end of the 15 minute cycle, press and release the START/STOP button. If the START/STOP button is not present, insert the Key Fob into the ignition switch and turn the switch to the ON/RUN position.

**NOTE:**

- For vehicles not equipped with the Keyless Enter-N-Go feature, the ignition switch must be in the ON/RUN position in order to drive the vehicle.
- For vehicles not equipped with the Keyless Enter-N-Go feature, the message “Insert Key/Turn To On” will display in the EVIC until you insert the Key Fob. Once inserted, the message “Turn To On” will display in the EVIC until you turn the Key Fob to ON/RUN.
- For vehicles equipped with the Keyless Enter-N-Go feature, the message “Push Button/Insert Key” will display in the EVIC until you push the START button.

**Cancel Remote Start**

Remote Starting will also cancel if any of the following occur:

- The engine stalls or engine speed exceeds 2500 rpm
- Any engine warning lights come on
- Low Fuel Light turns on
- The hood is opened
- The hazard switch is pressed
- The shift lever is moved out of PARK



## DOOR LOCKS

### Manual Door Locks

To lock each door, push the door lock knob on each door trim panel downward. To unlock each door, pull the door lock knob on each door trim panel upward.

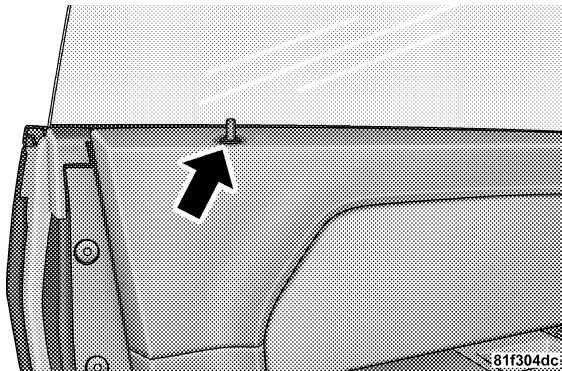

Door Lock Knob

If the door lock knob is down when you shut the door, the door will lock. Therefore, make sure the Key Fob is not inside the vehicle before closing the door.

### WARNING!

- For personal security and safety in the event of an accident, lock the vehicle doors before you drive as well as when you park and leave the vehicle.
- When leaving the vehicle, always remove the Key Fob from the ignition and lock your vehicle. Unsupervised use of vehicle equipment may cause severe personal injuries or death.
- Never leave children alone in a vehicle, or with access to an unlocked vehicle.

*(Continued)*

**WARNING! (Continued)**

- Allowing children to be in a vehicle unattended is dangerous for a number of reasons. A child or others could be seriously or fatally injured. Children should be warned not to touch the parking brake, brake pedal or the shift lever.
- Do not leave the key fob in or near the vehicle, and do not leave a vehicle equipped with Keyless Enter-N-Go in the ACC or ON/RUN mode. A child could operate power windows, other controls, or move the vehicle.

**Power Door Locks**

The power door lock switch is located on each door trim panel. Use this switch to lock or unlock the doors.

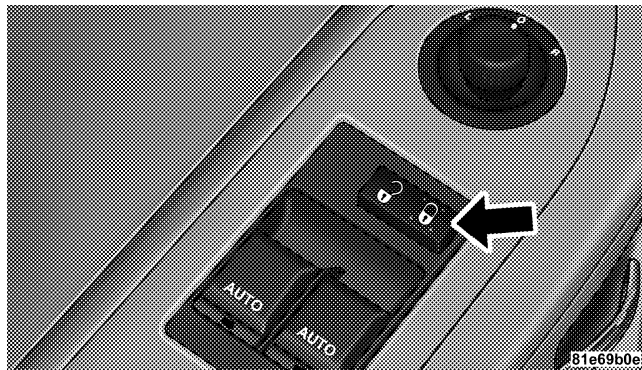

**Power Door Lock Switch**

The doors can also be locked and unlocked with the Keyless Enter-N-Go (Passive Entry) system. For further information, refer to “Keyless Enter-N-Go” in “Things To Know Before Starting Your Vehicle”.

If you press the power door lock switch while the Key Fob is in the ignition, and either door is open, the power locks will not operate. This prevents you from accidentally locking the Key Fob in the vehicle. Removing the Key Fob or closing the door will allow the locks to operate. If a door is open, the Key Fob is in the ignition, and the ignition is in the OFF or ACC position, a chime will sound as a reminder to remove the Key Fob.

#### **Automatic Door Locks — If Equipped**

When enabled, the door locks will lock automatically when the vehicle's speed exceeds 15 mph (24 km/h). The auto door lock feature can be enabled or disabled by your authorized dealer per written request of the customer. Please see your authorized dealer for service.

#### **Automatic Unlock Doors On Exit**

The doors will unlock automatically if:

1. The Automatic Unlock Doors On Exit feature is enabled

2. The transmission was in gear and the vehicle speed returned to 0 mph (0 km/h)
3. The transmission is in NEUTRAL or PARK
4. The driver door is opened
5. The doors were not previously unlocked
6. The vehicle speed is 0 mph (0 km/h)

#### **Automatic Unlock Doors On Exit Programming**

The Automatic Unlock Doors On Exit feature can be enabled or disabled. Refer to "Electronic Vehicle Information Center (EVIC)/Personal Settings (Customer-Programmable Features)" in "Understanding Your Instrument Panel" for further information.

- When not using the EVIC, perform the following steps:
1. Enter the vehicle and close all doors.

## 34 THINGS TO KNOW BEFORE STARTING YOUR VEHICLE

2. Place the Key Fob in the ignition switch.
3. Within 15 seconds, cycle the ignition switch between OFF and ON/RUN and then back to OFF four times ending up in the LOCK position. **However, do not start the engine.**
4. Within 30 seconds, press the power door UNLOCK switch to unlock the doors.
5. A single chime will indicate the completion of the programming.

**NOTE:** If you do not hear the chime, it means that the system did not enter the programming mode and you will need to repeat the procedure.

6. Repeat these steps if you want to return this feature to its previous setting.

**NOTE:** Use the Automatic Unlock Doors On Exit feature in accordance with local laws.

### KEYLESS ENTER-N-GO™

The Passive Entry system is an enhancement to the vehicle's Remote Keyless Entry (RKE) system and a feature of Keyless Enter-N-Go™. This feature allows you to lock and unlock the vehicle's door(s) without having to press the RKE transmitter lock or unlock buttons.

#### NOTE:

- Passive Entry may be programmed ON/OFF; refer to "Electronic Vehicle Information Center (EVIC)/ Personal Settings (Customer-Programmable Features)" in "Understanding Your Instrument Panel" for further information.
- If a Passive Entry door handle has not been used for 72 hours, the Passive Entry feature for the handle may time out. Pulling the deactivated front door handle will reactivate the door handle's Passive Entry feature.

- If wearing gloves on your hands, or if it has been raining on the Passive Entry door handle, the unlock sensitivity can be affected, resulting in a slower response time.
- If you unlock the doors using the Passive Entry door handles, but do NOT pull the handle, the doors will automatically lock after 60 seconds.

***To Unlock From The Driver's Side:***

With a valid Passive Entry RKE transmitter within 5 ft (1.5 m) of the driver's door handle, grab the front driver door handle to unlock the driver's door automatically. The interior door panel lock knob will raise when the door is unlocked.



**Grabbing The Driver's Door Handle**

**NOTE:** If "Unlock All Doors 1st Press" is programmed all doors will unlock when you grab hold of the front driver's door handle. To select between "Unlock Driver Door 1st Press" and "Unlock All Doors 1st Press", refer to "Electronic Vehicle Information Center (EVIC)/Personal Settings (Customer-Programmable Features)" in "Understanding Your Instrument Panel" for further information.

### *To Unlock From The Passenger Side:*

With a valid Passive Entry RKE transmitter within 5 ft (1.5 m) of the passenger door handle, grab the front passenger door handle to unlock both doors automatically. The interior door panel lock knob will raise when the door is unlocked.

**NOTE:** Both doors will unlock when the front passenger door handle is grabbed regardless of the driver's door unlock preference setting ("Unlock Driver Door 1st Press" or "Unlock All Doors 1st Press").

### *Preventing Inadvertent Locking Of Passive Entry RKE Transmitter In Vehicle*

To minimize the possibility of unintentionally locking a Passive Entry RKE transmitter inside your vehicle, the Passive Entry system is equipped with an automatic door unlock feature which will function if there is no Key Fob present in the ignition.

If one of the vehicle doors is open and the door panel switch is used to lock the vehicle, once all open doors have been closed the vehicle checks the inside and outside of the vehicle for any valid Passive Entry RKE transmitters. If one of the vehicle's Passive Entry RKE transmitters is detected inside the vehicle, and no other valid Passive Entry RKE transmitters are detected outside the vehicle, the Passive Entry System automatically unlocks all vehicle doors and chirps the horn three times (on the third attempt ALL doors will lock and the Passive Entry RKE transmitter can be locked in the vehicle).

### *To Enter The Trunk*

With a valid Passive Entry RKE transmitter within 3 ft (1.0 m) of the deck lid, press the button located on the center of the light bar which is located on the deck lid above the license plate.



**Trunk Passive Entry Button**

**NOTE:** If you inadvertently leave your vehicle's Passive Entry RKE transmitter in the trunk and try to close the deck lid, the deck lid will automatically unlatch, unless another one of the vehicle's Passive Entry RKE transmitters is outside the vehicle and within 3 ft (1.0 m) of the deck lid.



**Outside Door Handle Lock Button**

021836568

021836569

**NOTE:**

- After pressing the door handle LOCK button, you must wait two seconds before you can lock or unlock the doors, using either Passive Entry door handle. This is done to allow you to check if the vehicle is locked by pulling the door handle, without the vehicle reacting and unlocking.
- The Passive Entry system will not operate if the RKE transmitter battery is dead.

The vehicle doors can also be locked by using the RKE transmitter lock button or the lock button located on the vehicle's interior door panel.

## WINDOWS

### Power Windows

The window controls on the driver's door control both of the door windows.

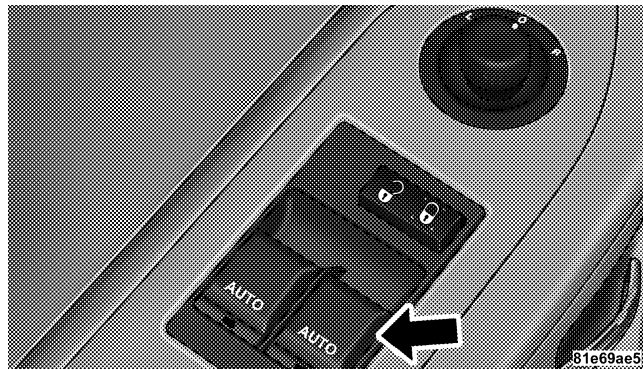

Power Window Switches



There is a single window control on the passenger's door trim panel that operates the window on the passenger's door. The window controls will operate only when the ignition switch is in the ON/RUN or ACC position.

**NOTE:**

- The Key Off Power Delay feature will allow the power windows to operate for up to 60 minutes after the ignition is turned OFF. This feature is cancelled when either front door is opened. The time for this feature is programmable. Refer to "Electronic Vehicle Information Center (EVIC)/Personal Settings (Customer-Programmable Features)" in "Understanding Your Instrument Panel" for further information.
- The door window will lower slightly if it is closed completely when opening the door. The window will return to its fully closed position after closing the door. This action allows the door to open without resistance and prevents window and seal damage.

**WARNING!**

**Never leave children in a vehicle with the key in the ignition switch. Occupants, particularly unattended children, can become entrapped by the windows while operating the power window switches. Such entrapment may result in serious injury or death.**

**AUTO-Down Feature**

The driver's door power window switch and passenger door power window switch have an AUTO-down feature. Press the window switch to the second detent, release, and the window will go down automatically.

To open the window part way, press the window switch to the first detent and release it when you want the window to stop.

To stop the window from going all the way down during the AUTO-down operation, pull up on the switch briefly.

The power window switches will remain active for up to 60 minutes after the ignition switch is turned OFF. Opening either door will cancel this feature. The time for this feature is programmable. Refer to “Electronic Vehicle Information Center (EVIC)/Personal Settings (Customer-Programmable Features)” in “Understanding Your Instrument Panel” for further information.

### Wind Buffeting

Wind buffeting can be described as the perception of pressure on the ears or a helicopter-type sound in the ears. Your vehicle may exhibit wind buffeting with the windows down, or the sunroof (if equipped) in certain open or partially open positions. This is a normal occurrence and can be minimized. If the buffeting occurs with one window open, then open the other window to minimize the buffeting. If the buffeting occurs with the sunroof open, then adjust the sunroof opening to minimize the buffeting.

### TRUNK LOCK AND RELEASE

The trunk lid can be released from inside the vehicle by pressing the Trunk Release button. The button is located on the instrument panel to the left of the steering wheel.

**NOTE:** The transmission must be in PARK before the button will operate. If equipped with a manual transmission, the vehicle speed must be under 5 mph (8 km/h) before the button will operate.

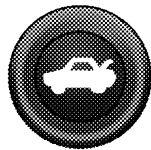

81ac2fd7

**Trunk Release  
Button**

The trunk lid can be released from outside the vehicle by pressing the Trunk Release button on the Remote Keyless Entry (RKE) transmitter twice within five seconds or by using the external release switch located on the underside of the decklid overhang. The release

feature will function only when the vehicle is in the unlock condition.

With the ignition switch in the ON/RUN position, the Trunk Open symbol will display in the instrument cluster indicating that the trunk is open. The odometer display will reappear once the trunk is closed.

With the ignition switch in the OFF position or the key removed from the ignition switch, the Trunk Open symbol will display until the trunk is closed.

Refer to “Keyless Enter-N-Go” in “Things To Know Before Starting Your Vehicle” for more information on trunk operation with the Passive Entry feature.

## TRUNK SAFETY WARNING

### WARNING!

**Do not allow children to have access to the trunk, either by climbing into the trunk from outside, or through the inside of the vehicle. Always close the trunk lid when your vehicle is unattended. Once in the trunk, young children may not be able to escape, even if they entered through the rear seat. If trapped in the trunk, children can die from suffocation or heat stroke.**

### Trunk Emergency Release

As a security measure, a trunk internal emergency release lever is built into the trunk latching mechanism. In the event of an individual being locked inside the trunk, the trunk can be simply opened by pulling on the glow-in-the-dark handle attached to the trunk latching mechanism.

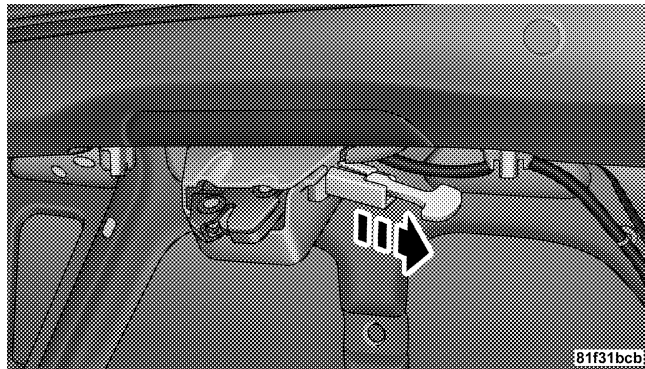

Emergency Release

### OCCUPANT RESTRAINTS

Some of the most important safety features in your vehicle are the restraint systems:

- Three-point lap and shoulder belts for the driver and all passengers
- Advanced Front Air Bags for driver and front passenger
- Supplemental Side Air Bag Inflatable Curtains (SABIC) for the driver and passengers seated next to a window
- Supplemental Seat-Mounted Side Air Bags (SAB) for the driver and front outboard passenger
- An energy-absorbing steering column and steering wheel
- Knee bolsters/blockers for front seat occupants

- Front seat belts incorporate pretensioners that may enhance occupant protection by managing occupant energy during an impact event
- All seat belt systems (except the driver's) include Automatic Locking Retractors (ALRs), which lock the seat belt webbing into position by extending the belt all the way out and then adjusting the belt to the desired length to restrain a child seat or secure a large item in a seat — if equipped

Please pay close attention to the information in this section. It tells you how to use your restraint system properly, to keep you and your passengers as safe as possible.

If you will be carrying children too small for adult-sized seat belts, the seat belts or the Lower Anchors and Tether for CHildren (LATCH) feature also can be used to hold infant and child restraint systems. For more information on LATCH, refer to Lower Anchors and Tether for CHildren (LATCH).

**NOTE:** The Advanced Front Air Bags have a multistage inflator design. This allows the air bag to have different rates of inflation based on several factors, including the severity and type of collision.

Here are some simple steps you can take to minimize the risk of harm from a deploying air bag:

1. **Children 12 years old and under should always ride buckled up in a rear seat.**

### **WARNING!**

**Infants in rear facing child restraints should never ride in the front seat of a vehicle with a passenger Advanced Front Air Bag. An air bag deployment can cause severe injury or death to infants in that position.**

Children that are not big enough to wear the vehicle seat belt properly (see section on Child Restraints) should be

#### 44 THINGS TO KNOW BEFORE STARTING YOUR VEHICLE

secured in the rear seat in child restraints or belt-positioning booster seats. Older children who do not use child restraints or belt-positioning booster seats should ride properly buckled up in the rear seat. Never allow children to slide the shoulder belt behind them or under their arm.

If a child from 1 to 12 years old (not in a rear facing child seat) must ride in the front passenger seat, move the seat as far back as possible and use the proper child restraint. (Refer to "Child Restraints")

You should read the instructions provided with your child restraint to make sure that you are using it properly.

2. All occupants should always wear their lap and shoulder belts properly.

3. The driver and front passenger seats should be moved back as far as practical to allow the Advanced Front Air Bags room to inflate.

4. Do not lean against the door or window. If your vehicle has side air bags, and deployment occurs, the side air bags will inflate forcefully into the space between you and the door.

5. If the air bag system in this vehicle needs to be modified to accommodate a disabled person, contact the Customer Center. Phone numbers are provided under "If You Need Assistance".

#### **WARNING!**

- Relying on the air bags alone could lead to more severe injuries in a collision. The air bags work with your seat belt to restrain you properly. In some collisions, the air bags won't deploy at all. Always wear your seat belts even though you have air bags.

*(Continued)*

**WARNING! (Continued)**

- Being too close to the steering wheel or instrument panel during Advanced Front Air Bag deployment could cause serious injury, including death. Air Bags need room to inflate. Sit back, comfortably extending your arms to reach the steering wheel or instrument panel.
- Supplemental Side Air Bag Inflatable Curtain (SABIC) and Seat-Mounted Side Air Bags (SAB) also need room to inflate. Do not lean against the door or window. Sit upright in the center of the seat.
- In a collision, you and your passengers can suffer much greater injuries if you are not properly buckled up. You can strike the interior of your vehicle or other passengers, or you can be thrown out of the vehicle. Always be sure you and others in your vehicle are buckled up properly.

Buckle up even though you are an excellent driver, even on short trips. Someone on the road may be a poor driver and cause a collision that includes you. This can happen far away from home or on your own street.

Research has shown that seat belts save lives, and they can reduce the seriousness of injuries in a collision. Some of the worst injuries happen when people are thrown from the vehicle. Seat belts reduce the possibility of ejection and the risk of injury caused by striking the inside of the vehicle. Everyone in a motor vehicle should be belted at all times.

**Lap/Shoulder Belts**

All seating positions in your vehicle are equipped with lap/shoulder belts.

The belt webbing retractor is designed to lock during very sudden stops or impacts. This feature allows the shoulder part of the belt to move freely with you under

normal conditions. However, in a collision, the belt will lock and reduce your risk of striking the inside of the vehicle or being thrown out.

**WARNING!**

- It is dangerous to ride in a cargo area, inside or outside of a vehicle. In a collision, people riding in these areas are more likely to be seriously injured or killed.
- Do not allow people to ride in any area of your vehicle that is not equipped with seats and seat belts.
- Be sure everyone in your vehicle is in a seat and using a seat belt properly.

*(Continued)*

**WARNING! (Continued)**

- Wearing a seat belt incorrectly is dangerous. Seat belts are designed to go around the large bones of your body. These are the strongest parts of your body and can take the forces of a collision best.
- Wearing your belt in the wrong place could make your injuries in a collision much worse. You might suffer internal injuries, or you could even slide out of part of the belt. Follow these instructions to wear your seat belt safely and to keep your passengers safe, too.
- Two people should never be belted into a single seat belt. People belted together can crash into one another in a collision, hurting one another badly. Never use a lap/shoulder belt or a lap belt for more than one person, no matter what their size.



## Lap/Shoulder Belt Operating Instructions

1. Enter the vehicle and close the door. Sit back and adjust the front seat.
2. The seat belt latch plate is contacting the seat when the belt is routed through the seat web guide. When the belt is routed outside of the seat web guide, the latch plate will contact the quarter trim panel. Grasp the latch plate and pull out the belt. Slide the latch plate up the webbing as far as necessary to make the belt go around your lap.

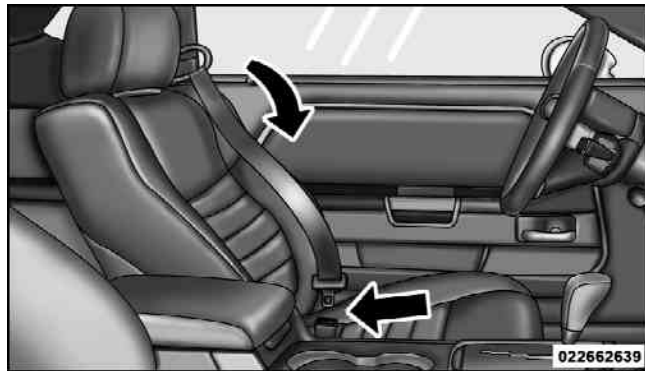

Latch Plate

## 48 THINGS TO KNOW BEFORE STARTING YOUR VEHICLE

3. When the belt is long enough to fit, insert the latch plate into the buckle until you hear a “click.”

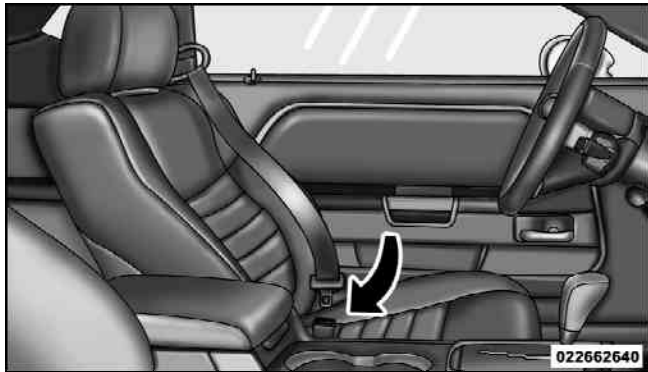

Latch Plate To Buckle

### WARNING!

- A belt that is buckled into the wrong buckle will not protect you properly. The lap portion could ride too high on your body, possibly causing internal injuries. Always buckle your belt into the buckle nearest you.
- A belt that is too loose will not protect you properly. In a sudden stop, you could move too far forward, increasing the possibility of injury. Wear your seat belt snug.

*(Continued)*

**WARNING! (Continued)**

- A belt that is worn under your arm is dangerous. Your body could strike the inside surfaces of the vehicle in a collision, increasing head and neck injury. A belt worn under the arm can cause internal injuries. Ribs are not as strong as shoulder bones. Wear the belt over your shoulder so that your strongest bones will take the force in a collision.
- A shoulder belt placed behind you will not protect you from injury during a collision. You are more likely to hit your head in a collision if you do not wear your shoulder belt. The lap and shoulder belt are meant to be used together.

4. Position the lap belt across your thighs, below your abdomen. To remove slack in the lap belt portion, pull up a bit on the shoulder belt. To loosen the lap belt if it is too tight, tilt the latch plate and pull on the lap belt. A snug belt reduces the risk of sliding under the belt in a collision.

**WARNING!**

- A lap belt worn too high can increase the risk of internal injury in a collision. The belt forces won't be at the strong hip and pelvic bones, but across your abdomen. Always wear the lap belt as low as possible and keep it snug.
- A twisted belt cannot do its job as well. In a collision, it could even cut into you. Be sure the belt is straight. If you cannot straighten a belt in your vehicle, take it to your authorized dealer immediately and have it fixed.

## 50 THINGS TO KNOW BEFORE STARTING YOUR VEHICLE

5. Position the shoulder belt on your chest so that it is comfortable and not resting on your neck. The retractor will withdraw any slack in the belt.

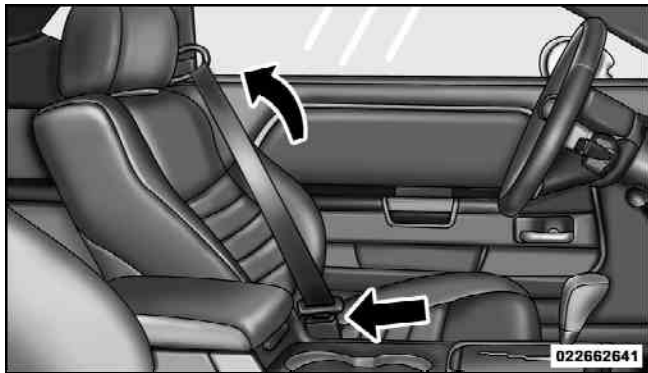

Removing Slack From Belt

6. To release the belt, push the red button on the buckle. The belt will automatically retract to its stowed position. If necessary, slide the latch plate down the webbing to allow the belt to retract fully.

### WARNING!

A frayed or torn belt could rip apart in a collision and leave you with no protection. Inspect the belt system periodically, checking for cuts, frays, or loose parts. Damaged parts must be replaced immediately. Do not disassemble or modify the system. Seat belt assemblies must be replaced after a collision if they have been damaged (bent retractor, torn webbing, etc.).

### Lap/Shoulder Belt Untwisting Procedure

Use the following procedure to untwist a twisted lap/shoulder belt.

1. Position the latch plate as close as possible to the anchor point.
2. At about 6 to 12 in (15 to 30 cm) above the latch plate, grasp and twist the belt webbing 180 degrees to create a fold that begins immediately above the latch plate.
3. Slide the latch plate upward over the folded webbing. The folded webbing must enter the slot at the top of the latch plate.
4. Continue to slide the latch plate up until it clears the folded webbing.

### Seat Belts In Passenger Seating Positions

The seat belts in the passenger seating positions are equipped with Automatic Locking Retractors (ALR) which are used to secure a child restraint system. For

additional information, refer to “Installing Child Restraints Using The Vehicle Seat Belt” under the “Child Restraints” section. The chart below defines the type of feature for each seating position.

	Driver	Center	Passenger
First Row	N/A	N/A	ALR
Second Row	ALR	ALR	ALR
Third Row	N/A	N/A	N/A

- N/A — Not Applicable
- ALR — Automatic Locking Retractor

If the passenger seating position is equipped with an ALR and is being used for normal usage:

Only pull the belt webbing out far enough to comfortably wrap around the occupant’s mid-section so as to not activate the ALR. If the ALR is activated, you will hear a ratcheting sound as the belt retracts. Allow the webbing to retract completely in this case and then carefully pull

out only the amount of webbing necessary to comfortably wrap around the occupant's mid-section. Slide the latch plate into the buckle until you hear a "click."

### **Automatic Locking Retractor Mode (ALR) — If Equipped**

In this mode, the shoulder belt is automatically prelocked. The belt will still retract to remove any slack in the shoulder belt. The Automatic Locking Mode is available on all passenger-seating positions with a combination lap/shoulder belt. Use the Automatic Locking Mode anytime a child safety seat is installed in a seating position that has a belt with this feature. Children 12 years old and under should always be properly restrained in the rear seat.

#### **How To Engage The Automatic Locking Mode**

1. Buckle the combination lap and shoulder belt.
2. Grasp the shoulder portion and pull downward until the entire belt is extracted.

3. Allow the belt to retract. As the belt retracts, you will hear a clicking sound. This indicates the safety belt is now in the Automatic Locking Mode.

#### **How To Disengage The Automatic Locking Mode**

Unbuckle the combination lap/shoulder belt and allow it to retract completely to disengage the Automatic Locking Mode and activate the vehicle sensitive (emergency) locking mode.

#### **WARNING!**

- **The belt and retractor assembly must be replaced if the seat belt assembly Automatic Locking Retractor (ALR) feature or any other seat belt function is not working properly when checked according to the procedures in the Service Manual.**
- **Failure to replace the belt and retractor assembly could increase the risk of injury in collisions.**

## Energy Management Feature

This vehicle has a safety belt system with an Energy Management feature in the front seating positions to help further reduce the risk of injury in the event of a head-on collision. This safety belt system has a retractor assembly that is designed to release webbing in a controlled manner. This feature is designed to help reduce the belt force acting on the occupant's chest.

### WARNING!

- **The belt and retractor assembly must be replaced if the seat belt assembly Automatic Locking Retractor (ALR) feature or any other seat belt function is not working properly when checked according to the procedures in the Service Manual.**
- **Failure to replace the belt and retractor assembly could increase the risk of injury in collisions.**

## Seat Belt Pretensioners

The seat belts for both front seating positions are equipped with pretensioning devices that are designed to remove slack from the seat belt in the event of a collision. These devices may improve the performance of the seat belt by assuring that the belt is tight about the occupant early in a collision. Pretensioners work for all size occupants, including those in child restraints.

**NOTE:** These devices are not a substitute for proper seat belt placement by the occupant. The seat belt still must be worn snugly and positioned properly.

The pretensioners are triggered by the Occupant Restraint Controller (ORC). Like the air bags, the pretensioners are single use items. A deployed pretensioner or a deployed air bag must be replaced immediately.

## Enhanced Seat Belt Use Reminder System (BeltAlert®)

BeltAlert® is a feature intended to remind the driver and front passenger (if equipped with front passenger BeltAlert®) to fasten their seat belts. The feature is active whenever the ignition is on. If the driver or front seat passenger is unbelted, the Seat Belt Reminder Light will turn on and remain on until both front seat belts are fastened.

The BeltAlert® warning sequence begins after the vehicle speed is over 5 mph (8 km/h), by blinking the Seat Belt Reminder Light and sounding an intermittent chime. Once the sequence starts, it will continue for the entire duration or until the respective seatbelts are fastened. After the sequence completes, the Seat Belt Reminder Light remains illuminated until the respective seat belts are fastened. The driver should instruct all other occupants to fasten their seat belts. If a front seat belt is

unbuckled while traveling at speeds greater than 5 mph (8 km/h), BeltAlert® will provide both audio and visual notification.

The front passenger seat BeltAlert® is not active when the front passenger seat is unoccupied. BeltAlert® may be triggered when an animal or heavy object is on the front passenger seat or when the seat is folded flat (if equipped). It is recommended that pets be restrained in the rear seat in pet harnesses or pet carriers that are secured by seat belts, and cargo is properly stowed.

BeltAlert® can be enabled or disabled by your authorized dealer. Chrysler Group LLC does not recommend deactivating BeltAlert®.

**NOTE:** Although BeltAlert® has been deactivated, the Seat Belt Reminder Light will continue to illuminate while the driver's or front passenger (if equipped with BeltAlert®) seat belt remains unfastened.



## Seat Belts And Pregnant Women

We recommend that pregnant women use the seat belts throughout their pregnancy. Keeping the mother safe is the best way to keep the baby safe.

Pregnant women should wear the lap part of the belt across the thighs and as snug across the hips as possible. Keep the belt low so that it does not come across the abdomen. That way the strong bones of the hips will take the force if there is a collision.

## Seat Belt Extender

If a seat belt is too short even when fully extended your authorized dealer can provide you with a seat belt extender. This extender should be used only if the existing belt is not long enough. When it is not required, remove the extender and store it.

### WARNING!

Using a seat belt extender when not needed can increase the risk of injury in a collision. Only use when the seat belt is not long enough when it is worn low and snug and in the recommended seating position. Remove and store the extender when not needed.

**Supplemental Restraint System (SRS) — Air Bags**

This vehicle has Advanced Front Air Bags for both the driver and front passenger as a supplement to the seat belt restraint systems. The driver's Advanced Front Air Bag is mounted in the center of the steering wheel. The passenger's Advanced Front Air Bag is mounted in the instrument panel, above the glove compartment. The words SRS AIRBAG are embossed on the air bag covers.

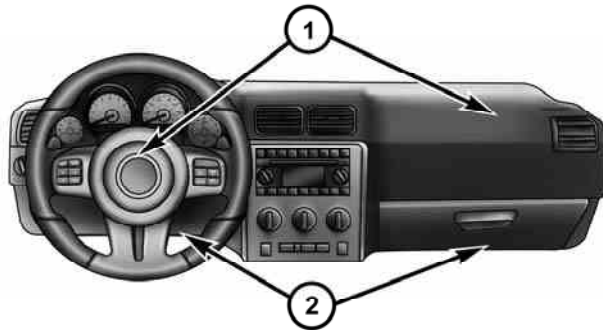

022641325

**Advanced Front Air Bag And Knee Bolster Locations**

- 1 — Driver And Passenger Advanced Front Air Bags
- 2 — Knee Bolster

**NOTE:** The Driver and Front Passenger Advanced Front Air Bags are certified to the new Federal regulations for Advanced Air Bags.

The Advanced Front Air Bags have a multistage inflator design. This allows the air bag to have different rates of inflation based on several factors, including the severity and type of collision.

This vehicle may be equipped with driver and/or front passenger seat track position sensors that may adjust the inflation rate of the Advanced Front Air Bags based upon seat position.

This vehicle may be equipped with a driver and/or front passenger seat belt buckle switch that detects whether the driver or front passenger seat belt is fastened. The seat belt buckle switch may adjust the inflation rate of the Advanced Front Air Bags.

This vehicle is equipped with Supplemental Seat-Mounted Side Air Bags (SAB) to provide enhanced protection for an occupant during a side impact. The Supplemental Seat-Mounted Side Air Bags are located in the outboard side of the front seats.

This vehicle is equipped with Supplemental Side Air Bag Inflatable Curtains (SABIC) to protect the driver, front, and rear passengers sitting next to a window. The SABIC air bags are located above the side windows and their covers are also labeled: SRS AIRBAG.

**NOTE:**

- Air Bag covers may not be obvious in the interior trim, but they will open during air bag deployment.
- After any accident, the vehicle should be taken to an authorized dealer immediately.

**Air Bag System Components**

Your vehicle may be equipped with the following air bag system components:

- Occupant Restraint Controller (ORC)
- Air Bag Warning Light
- Steering Wheel and Column

- Instrument Panel
- Knee Impact Bolster
- Driver Advanced Front Air Bag
- Passenger Advanced Front Air Bag
- Supplemental Seat-Mounted Side Air Bags (SAB)
- Supplemental Side Air Bag Inflatable Curtains (SABIC)
- Front and Side Impact Sensors
- Front Seat Belt Pretensioners, Seat Belt Buckle Switch, and Seat Track Position Sensors

### **Advanced Front Air Bag Features**

The Advanced Front Air Bag system has multistage driver and front passenger air bags. This system provides output appropriate to the severity and type of collision as determined by the Occupant Restraint Controller (ORC), which may receive information from the front impact sensors.

The first stage inflator is triggered immediately during an impact that requires air bag deployment. This low output is used in less severe collisions. A higher energy output is used for more severe collisions.

**WARNING!**

- No objects should be placed over or near the air bag on the instrument panel, because any such objects could cause harm if the vehicle is in a collision severe enough to cause the air bag to inflate.
- Do not put anything on or around the air bag covers or attempt to open them manually. You may damage the air bags and you could be injured because the air bags may no longer be functional. The protective covers for the air bag cushions are designed to open only when the air bags are inflating.
- Do not drill, cut or tamper with the knee bolster in any way.
- Do not mount any accessories to the knee bolster such as alarm lights, stereos, citizen band radios, etc.

**Supplemental Seat-Mounted Side Air Bags (SAB)**

Supplemental Seat-Mounted Side Air Bags (SAB) may provide enhanced protection to help protect an occupant during a side impact. The SAB is marked with an air bag label sewn into the outboard side of the front seats.

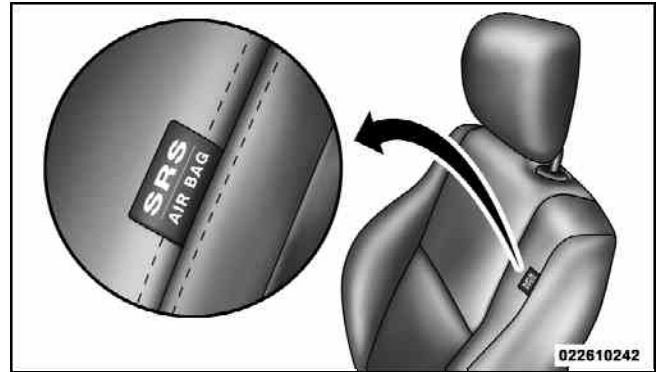
**2**

Supplemental Seat-Mounted Side Air Bag Label

When the air bag deploys, it opens the seam between the front and side of the seat's trim cover. Each air bag deploys independently; a left side impact deploys the left air bag only and a right-side impact deploys the right air bag only.

### **Supplemental Side Air Bag Inflatable Curtain (SABIC)**

SABIC air bags may offer side-impact protection to front and rear seat outboard occupants in addition to that provided by the body structure. Each air bag features inflated chambers placed adjacent to the head of each outboard occupant that reduce the potential for side-impact head injuries. The SABIC deploy downward, covering both windows on the impact side.

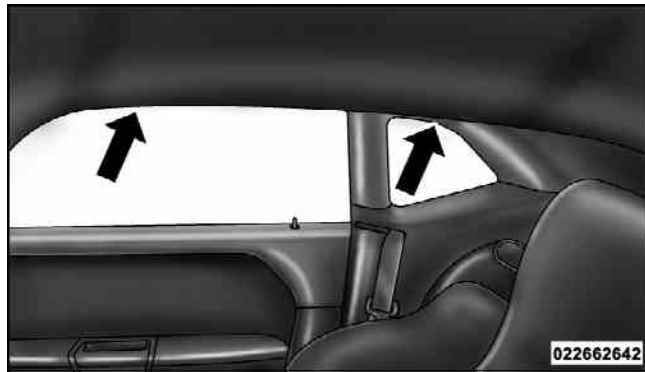

### **Supplemental Side Air Bag Inflatable Curtains (SABIC)**

**NOTE:**

- Air Bag covers may not be obvious in the interior trim, but they will open during air bag deployment.
- Being too close to the SAB and SABIC air bags during deployment could cause you to be severely injured or killed.

The system includes side impact sensors that are calibrated to deploy the side air bags during impacts that require air bag occupant protection.

### **WARNING!**

- If your vehicle is equipped with left and right Supplemental Side Air Bag Inflatable Curtain (SABIC), do not stack luggage or other cargo up high enough to block the location of the SABIC. The area where the SABIC is located should remain free from any obstructions.
- Do not use accessory seat covers or place objects between you and the side air bags; the performance could be adversely affected and/or objects could be pushed into you, causing serious injury.

*(Continued)*

### **WARNING! (Continued)**

- If your vehicle is equipped with SABIC air bags, do not have any accessory items installed which will alter the roof, including adding a sunroof to your vehicle. Do not add roof racks that require permanent attachments (bolts or screws) for installation on the vehicle roof. Do not drill into the roof of the vehicle for any reason.

### **Knee Impact Bolsters**

The Knee Impact Bolsters help protect the knees of the driver and the front passenger, and position front occupants for the best interaction with the Advanced Front Air Bags.

Along with seat belts and pretensioners, Advanced Front Air Bags work with the knee bolsters to provide improved protection for the driver and front passenger. Side air bags also work with seat belts to improve occupant protection.

### **Air Bag Deployment Sensors And Controls**

#### **Occupant Restraint Controller (ORC)**

The **ORC** is part of a Federally regulated safety system required for this vehicle.

The ORC determines if deployment of the front and/or side air bags in a frontal or side collision is required. Based on the impact sensor's signals, a central electronic ORC deploys the Advanced Front Air Bags, SABIC air bags, SAB air bags, and front seat belt pretensioners, as required, depending on several factors, including the severity and type of impact.

Advanced Front Air Bags are designed to provide additional protection by supplementing the seat belts in certain frontal collisions depending on several factors, including the severity and type of collision. Advanced Front Air Bags are not expected to reduce the risk of injury in rear, side, or rollover collisions.

The Advanced Front Air Bags will not deploy in all frontal collisions, including some that may produce substantial vehicle damage — for example, some pole collisions, truck underrides, and angle offset collisions. On the other hand, depending on the type and location of impact, Advanced Front Air Bags may deploy in crashes with little vehicle front-end damage but that produce a severe initial deceleration.

The side air bags will not deploy in all side collisions. Side air bag deployment will depend on the severity and type of collision.



Because air bag sensors measure vehicle deceleration over time, vehicle speed and damage by themselves are not good indicators of whether or not an air bag should have deployed.

Seat belts are necessary for your protection in all collisions, and also are needed to help keep you in position, away from an inflating air bag.

The ORC monitors the readiness of the electronic parts of the air bag system whenever the ignition switch is in the START or ON/RUN position. If the key is in the OFF position, in the ACC position, or not in the ignition, the air bag system is not on and the air bags will not inflate.

The ORC contains a backup power supply system that may deploy the air bags even if the battery loses power or it becomes disconnected prior to deployment.



Also, the ORC turns on the Air Bag Warning Light in the instrument panel for approximately four to eight seconds for a self-check when the ignition is first turned on. After the self-check, the Air Bag Warning Light will turn off. If the ORC detects a malfunction in any part of the system, it turns on the Air Bag Warning Light, either momentarily or continuously. A single chime will sound if the light comes on again after initial startup.

It also includes diagnostics that will illuminate the instrument cluster Air Bag Warning Light if a malfunction is noted that could affect the air bag system. The diagnostics also record the nature of the malfunction.

**WARNING!**

**Ignoring the Air Bag Warning Light in your instrument panel could mean you won't have the air bags to protect you in a collision. If the light does not come on as a bulb check when the ignition is first turned on, stays on after you start the vehicle, or if it comes on as you drive, have an authorized dealer service the air bag system immediately.**

**Driver And Passenger Advanced Front Air Bag Inflator Units**

The Driver and Passenger Advanced Front Air Bag Inflator Units are located in the center of the steering wheel and on the right side of the instrument panel. When the ORC detects a collision requiring the Advanced Front Air Bags, it signals the inflator units. A large quantity of non-toxic gas is generated to inflate the Advanced Front Air Bags. Different air bag inflation rates

are possible, based on the collision type and severity. The steering wheel hub trim cover and the upper right side of the instrument panel separate and fold out of the way as the air bags inflate to their full size. The air bags fully inflate in about 50 to 70 milliseconds. This is about half of the time it takes to blink your eyes. The air bags then quickly deflate while helping to restrain the driver and front passenger.

The Advanced Front Air Bag gas is vented through the vent holes in the sides of the air bag. In this way, the air bags do not interfere with your control of the vehicle.

**Supplemental Seat-Mounted Side Air Bag (SAB) Inflator Units**

The Supplemental Seat-Mounted Side Air Bags are designed to activate only in certain side collisions.

The ORC determines if a side collision requires the side air bags to inflate, based on several factors, including the severity and type of collision.

Based on several factors, including the severity and type of collision, the side air bag inflator on the crash side of the vehicle may be triggered, releasing a quantity of non-toxic gas. The inflating SAB exits through the seat seam into the space between the occupant and the door. The SAB fully inflates in about 10 milliseconds. The side air bag moves at a very high speed and with such a high force that it could injure you if you are not seated properly, or if items are positioned in the area where the side air bag inflates. This especially applies to children.

### **Supplemental Side Air Bag Inflatable Curtain (SABIC) Inflator Units**

During collisions where the impact is confined to a particular area of the side of the vehicle, the ORC may deploy the SABIC air bags, depending on several factors, including the severity and type of collision. In these events, the ORC will deploy the SABIC only on the impact side of the vehicle.

A quantity of non-toxic gas is generated to inflate the side curtain air bag. The inflating side curtain air bag pushes the outside edge of the headliner out of the way and covers the window. The air bag inflates in about 30 milliseconds (about one-quarter of the time that it takes to blink your eyes) with enough force to injure you if you are not belted and seated properly, or if items are positioned in the area where the side curtain air bag inflates. This especially applies to children. The side curtain air bag is only about 3-1/2 in (9 cm) thick when it is inflated.

Because air bag sensors estimate deceleration over time, vehicle speed and damage are not good indicators of whether or not an air bag should have deployed.

### **Front And Side Impact Sensors**

In front and side impacts, impact sensors can aid the ORC in determining appropriate response to impact events.

### Enhanced Accident Response System

In the event of an impact causing air bag deployment, if the communication network remains intact, and the power remains intact, depending on the nature of the event the ORC will determine whether to have the Enhanced Accident Response System perform the following functions:

- Cut off fuel to the engine.
- Flash hazard lights as long as the battery has power or until the ignition key is turned off.
- Turn on the interior lights, which remain on as long as the battery has power or until the ignition key is removed.
- Unlock the doors automatically.

In order to reset the Enhanced Accident Response System functions after an event, the ignition switch must be changed from IGN ON to IGN OFF.

### If A Deployment Occurs

The Advanced Front Air Bags are designed to deflate immediately after deployment.

**NOTE:** Front and/or side air bags will not deploy in all collisions. This does not mean something is wrong with the air bag system.

If you do have a collision which deploys the air bags, any or all of the following may occur:

- The nylon air bag material may sometimes cause abrasions and/or skin reddening to the driver and front passenger as the air bags deploy and unfold. The abrasions are similar to friction rope burns or those you might get sliding along a carpet or gymnasium floor. They are not caused by contact with chemicals. They are not permanent and normally heal quickly. However, if you haven't healed significantly within a few days, or if you have any blistering, see your doctor immediately.

- As the air bags deflate, you may see some smoke-like particles. The particles are a normal by-product of the process that generates the non-toxic gas used for air bag inflation. These airborne particles may irritate the skin, eyes, nose, or throat. If you have skin or eye irritation, rinse the area with cool water. For nose or throat irritation, move to fresh air. If the irritation continues, see your doctor. If these particles settle on your clothing, follow the garment manufacturer's instructions for cleaning.

Do not drive your vehicle after the air bags have deployed. If you are involved in another collision, the air bags will not be in place to protect you.

**WARNING!**

**Deployed air bags and seat belt pretensioners cannot protect you in another collision. Have the air bags, seat belt pretensioners, and the front seat belt retractor assemblies replaced by an authorized dealer immediately. Also, have the Occupant Restraint Controller (ORC) system serviced as well.**

## Maintaining Your Air Bag System

**WARNING!**

- Modifications to any part of the air bag system could cause it to fail when you need it. You could be injured if the air bag system is not there to protect you. Do not modify the components or wiring, including adding any kind of badges or stickers to the steering wheel hub trim cover or the upper right side of the instrument panel. Do not modify the front bumper, vehicle body structure, or add aftermarket side steps or running boards.
- It is dangerous to try to repair any part of the air bag system yourself. Be sure to tell anyone who works on your vehicle that it has an air bag system.

*(Continued)*

**WARNING! (Continued)**

- Do not attempt to modify any part of your air bag system. The air bag may inflate accidentally or may not function properly if modifications are made. Take your vehicle to an authorized dealer for any air bag system service. If your seat including your trim cover and cushion needs to be serviced in any way (including removal or loosening/tightening of seat attachment bolts), take the vehicle to your authorized dealer. Only manufacturer approved seat accessories may be used. If it is necessary to modify the air bag system for persons with disabilities, contact your authorized dealer.

## Air Bag Warning Light



You will want to have the air bags ready to inflate for your protection in a collision. The Air Bag Warning Light monitors the internal circuits and interconnecting wiring associated with air bag system electrical components. While the air bag system is designed to be maintenance free, if any of the following occurs, have an authorized dealer service the air bag system immediately.

- The Air Bag Warning Light does not come on during the four to eight seconds when the ignition switch is first turned to the ON/RUN position.
- The Air Bag Warning Light remains on after the four to eight-second interval.
- The Air Bag Warning Light comes on intermittently or remains on while driving.

**NOTE:** If the speedometer, tachometer, or any engine related gauges are not working, the Occupant Restraint Controller (ORC) may also be disabled. The air bags may not be ready to inflate for your protection. Promptly check the fuse block for blown fuses. Refer to the label located on the inside of the fuse block cover for the proper air bag fuses. See your authorized dealer if the fuse is good.

## Event Data Recorder (EDR)

This vehicle is equipped with an event data recorder (EDR). The main purpose of an EDR is to record, in certain crash or near crash-like situations, such as an air bag deployment or hitting a road obstacle, data that will assist in understanding how a vehicle's systems performed. The EDR is designed to record data related to vehicle dynamics and safety systems for a short period of time, typically 30 seconds or less. The EDR in this vehicle is designed to record such data as:

- How various systems in your vehicle were operating;

## 70 THINGS TO KNOW BEFORE STARTING YOUR VEHICLE

- Whether or not the driver and passenger safety belts were buckled/fastened;
- How far (if at all) the driver was depressing the accelerator and/or brake pedal; and,
- How fast the vehicle was traveling.

These data can help provide a better understanding of the circumstances in which crashes and injuries occur.

**NOTE:** EDR data are recorded by your vehicle only if a non-trivial crash situation occurs; no data are recorded by the EDR under normal driving conditions and no personal data (e.g., name, gender, age, and crash location) are recorded. However, other parties, such as law enforcement, could combine the EDR data with the type of personally identifying data routinely acquired during a crash investigation.

To read data recorded by an EDR, special equipment is required, and access to the vehicle or the EDR is needed. In addition to the vehicle manufacturer, other parties, such as law enforcement, that have the special equipment, can read the information if they have access to the vehicle or the EDR.

### **Child Restraints**

Everyone in your vehicle needs to be buckled up all the time, including babies and children. Every state in the United States and all Canadian provinces require that small children ride in proper restraint systems. This is the law, and you can be prosecuted for ignoring it.

Children 12 years or younger should ride properly buckled up in a rear seat, if available. According to crash statistics, children are safer when properly restrained in the rear seats rather than in the front.



**WARNING!**

**In a collision, an unrestrained child, even a tiny baby, can become a projectile inside the vehicle. The force required to hold even an infant on your lap could become so great that you could not hold the child, no matter how strong you are. The child and others could be badly injured. Any child riding in your vehicle should be in a proper restraint for the child's size.**

There are different sizes and types of restraints for children from newborn size to the child almost large enough for an adult safety belt. Always check the child seat Owner's Manual to ensure you have the correct seat for your child. Use the restraint that is correct for your child.

**Infants And Child Restraints**

Safety experts recommend that children ride rearward-facing in the vehicle until they are two years old or until they reach either the height or weight limit of their rear facing child safety seat. Two types of child restraints can be used rearward-facing: infant carriers and convertible child seats.

The infant carrier is only used rearward-facing in the vehicle. It is recommended for children from birth until they reach the weight or height limit of the infant carrier. Convertible child seats can be used either rearward-facing or forward-facing in the vehicle. Convertible child seats often have a higher weight limit in the rearward-facing direction than infant carriers do, so they can be used rearward-facing by children who have outgrown their infant carrier but are still less than at least two years old. Children should remain rearward-facing until they reach the highest weight or height allowed by their convertible child seat. Both types of child restraints are

held in the vehicle by the lap/shoulder belt or the LATCH child restraint anchor system. Refer to “Lower Anchors and Tether for CHildren (LATCH)”.

### **WARNING!**

**Rearward-facing child seats must never be used in the front seat of a vehicle with the front passenger air bag. An air bag deployment could cause severe injury or death to infants in this position.**

### **Older Children And Child Restraints**

Children who are two years old or who have outgrown their rear-facing convertible child seat can ride forward-facing in the vehicle. Forward-facing child seats and convertible child seats used in the forward-facing direction are for children who are over two years old or who have outgrown the rear-facing weight or height limit of their rear-facing convertible child seat. Children should remain in a forward-facing child seat with a harness for

as long as possible, up to the highest weight or height allowed by the child seat. These child seats are also held in the vehicle by the lap/shoulder belt or the LATCH child restraint anchorage system. Refer to “Lower Anchors and Tether for CHildren (LATCH)”.

All children whose weight or height is above the forward-facing limit for the child seat should use a belt-positioning booster seat until the vehicle’s seat belts fit properly. If the child cannot sit with knees bent over the vehicle’s seat cushion while the child’s back is against the seatback, they should use a belt-positioning booster seat. The child and belt-positioning booster seat are held in the vehicle by the lap/shoulder belt.

### **Children Too Large For Booster Seats**

Children who are large enough to wear the shoulder belt comfortably and whose legs are long enough to bend over the front of the seat when their back is against the seatback should use the lap/shoulder belt in a rear seat.

- Make sure that the child is upright in the seat.
- The lap portion should be low on the hips and as snug as possible.
- Check belt fit periodically. A child's squirming or slouching can move the belt out of position.
- If the shoulder belt contacts the face or neck, move the child closer to the center of the vehicle. Never allow a child to put the shoulder belt under an arm or behind their back.

**NOTE:** For additional information, refer to [www.seatcheck.org](http://www.seatcheck.org) or call 1-866-SEATCHECK. Canadian residents should refer to Transport Canada's website for additional information: <http://www.tc.gc.ca/roadsafety/safedrivers/childsafety/index.htm>

### WARNING!

- Improper installation can lead to failure of an infant or child restraint. It could come loose in a collision. The child could be badly injured or killed. Follow the manufacturer's directions exactly when installing an infant or child restraint.
- A rearward-facing child restraint should only be used in a rear seat. A rearward-facing child restraint in the front seat may be struck by a deploying passenger air bag, which may cause severe or fatal injury to the infant.

Here are some tips on getting the most out of your child restraint:

- Before buying any restraint system, make sure that it has a label certifying that it meets all applicable Safety Standards. Chrysler Group LLC also recommends that

you make sure that you can install the child restraint in the vehicle where you will use it before you buy it.

- The restraint must be appropriate for your child's weight and height. Check the label on the restraint for weight and height limits.
- Carefully follow the instructions that come with the restraint. If you install the restraint improperly, it may not work when you need it.
- Buckle the child into the seat according to the child restraint manufacturer's directions.

### **WARNING!**

**When your child restraint is not in use, secure it in the vehicle with the seat belt or remove it from the vehicle. Do not leave it loose in the vehicle. In a sudden stop or accident, it could strike the occupants or seatbacks and cause serious personal injury.**

### **Lower Anchors and Tether for Children (LATCH)**

Your vehicle's rear seat is equipped with the child restraint anchorage system called LATCH. The LATCH system provides for the installation of the child restraint without using the vehicle's seat belts, instead securing the child restraint using lower anchorages and upper tether straps from the child restraint to the vehicle structure.

LATCH-compatible child restraint systems are now available. However, because the lower anchorages are to be introduced over a period of years, child restraint systems having attachments for those anchorages will continue to have features for installation using the vehicle's seat belts. Child restraints having tether straps and hooks for connection to the top tether anchorages have been available for some time. For some older child restraints, many child restraint manufacturers offer add-on tether strap

kits or retrofit kits. You are urged to take advantage of all the available attachments provided with your child restraint in any vehicle.

All three rear-seating positions have lower anchorages that are capable of accommodating LATCH-compatible child seats. You should never install LATCH-compatible child seats so that two seats share a common lower anchorage. If installing child seats in adjacent rear-seating positions, or if your child restraints are not LATCH-compatible, install the restraints using the vehicle's seat belts.

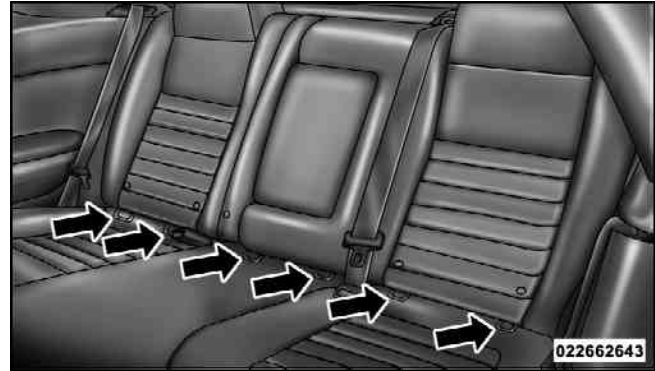

### LATCH Anchorages

#### Installing The LATCH-Compatible Child Restraint System

We urge you to follow the manufacturer's directions carefully when installing your child restraint. Not all child restraint systems will be installed as described here.

Again, carefully follow the installation instructions that are provided with the child restraint system.



The rear seat lower anchorages are round bars located at the rear of the seat cushion where it meets the seatback and are just visible when you lean into the rear seat to install the child restraint. You will easily feel them if you run your finger along the intersection of the seatback and seat cushion surfaces.



In addition, there are tether strap anchorages behind each rear seating position located in the panel between the rear seatback and the rear window. These tether strap anchorages are under a plastic cover with this symbol on it.

Many, but not all, restraint systems will be equipped with separate straps on each side, with each having a hook or connector for attachment to the lower anchorage and a

means of adjusting the tension in the strap. Forward-facing toddler restraints and some rear-facing infant restraints will also be equipped with a tether strap, a hook for attachment to the tether strap anchorage and a means of adjusting the tension of the strap.

You will first loosen the child seat adjusters on the lower straps and on the tether strap so that you can more easily attach the hooks or connectors to the vehicle anchorages. Next, attach the lower hooks or connectors over the top of the seatcover material. Then, rotate the tether anchorage cover directly behind the seat where you are placing the child restraint and attach the tether strap to the anchorage, being careful to route the tether strap to provide the most direct path between the anchor and the child restraint. Finally, tighten all three straps as you push the child restraint rearward and downward into the seat, removing slack in the straps according to the child restraint manufacturer's instructions.

**NOTE:**

- Ensure that the tether strap does not slip into the opening between the seatbacks as you remove slack in the strap.
- When using the LATCH attaching system to install a child restraint, please ensure that all seat belts not being used for occupant restraints are stowed and out of reach of children. It is recommended that before installing the child restraint, buckle the seat belt so the seat belt is tucked behind the child restraint and out of reach. If the buckled seat belt interferes with the child restraint installation, instead of tucking the seat belt behind the child restraint, route the seat belt through the child restraint belt path and then buckle it. This should stow the seat belt out of the reach of an inquisitive child. Remind all children in the vehicle that the seat belts are not toys and should not be played with, and never leave your child unattended in the vehicle.

**WARNING!**

**Improper installation of a child restraint to the LATCH anchorages can lead to failure of an infant or child restraint. The child could be badly injured or killed. Follow the manufacturer's directions exactly when installing an infant or child restraint.**

**2****Installing Child Restraints Using The Vehicle Seat Belt**

The seat belts in the passenger seating positions are equipped with either an Automatic Locking Retractor (ALR) or a cinching latch plate or both. Both types of seat belts are designed to keep the lap portion of the seat belt tight around the child restraint so that it is not necessary to use a locking clip. The ALR will make a ratcheting noise if you extract the entire belt from the retractor and then allow the belt to retract into the retractor. For additional information on ALR, refer to "Automatic Locking Mode".

	Driver	Center	Passenger
	CRS Lock	CRS Lock	CRS Lock
First Row	N/A	N/A	ALR
Second Row	ALR	ALR	ALR

- N/A — Not Applicable
- ALR — Automatic Locking Retractor

To install a child restraint, first, pull enough of the seat belt webbing from the retractor to route it through the belt path of the child restraint and slide the latch plate into the buckle. Next, extract all the seat belt webbing out of the retractor and then allow the belt to retract into the retractor. Finally, pull on any excess webbing to tighten the lap portion around the child restraint. Any seat belt system will loosen with time, so check the belt occasionally, and pull it tight if necessary.

To attach a child restraint tether strap:

1. Rotate the cover over the anchor directly behind the seat where you are placing the child restraint.

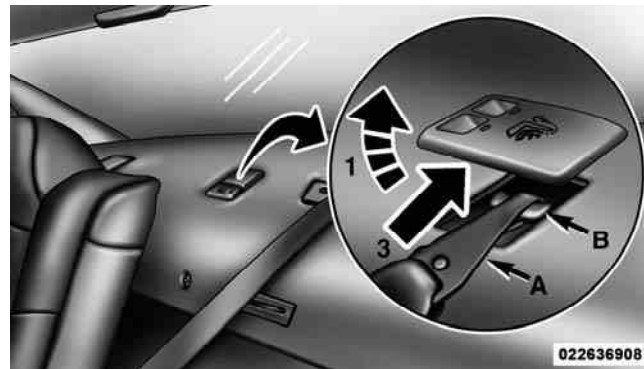

### Tether Strap Mounting

- |                     |                       |
|---------------------|-----------------------|
| 1 — Cover           | A — Tether Strap Hook |
| 3 — Attaching Strap | B — Tether Anchor     |



2. Route the tether strap to provide the most direct path for the strap between the anchor and the child seat.
3. Attach the tether strap hook (A) of the child restraint to the anchor (B) and remove slack in the tether strap according to the child restraint manufacturer's instructions.

**NOTE:** Ensure that the tether strap does not slip into the opening between the seatbacks as you remove slack in the strap.

### **WARNING!**

**An incorrectly anchored tether strap could lead to increased head motion and possible injury to the child. Use only the anchor positions directly behind the child seat to secure a child restraint top tether strap.**

### **Transporting Pets**

Air Bags deploying in the front seat could harm your pet. An unrestrained pet will be thrown about and possibly injured, or injure a passenger during panic braking or in a collision.

Pets should be restrained in the rear seat in pet harnesses or pet carriers that are secured by seat belts.

### **ENGINE BREAK-IN RECOMMENDATIONS**

A long break-in period is not required for the drivetrain (engine, transmission, clutch, and rear axle) in your new vehicle.

Drive moderately during the first 500 miles (800 km). After the initial 60 miles (100 km), speeds up to 50 or 55 mph (80 or 90 km/h) are desirable.

While cruising, brief full-throttle acceleration within the limits of local traffic laws contributes to a good break-in. However, wide-open throttle acceleration in low gear can be detrimental and should be avoided.

The engine oil, transmission fluid, and axle lubricant installed at the factory is high-quality and energy-conserving. Oil, fluid, and lubricant changes should be consistent with anticipated climate and conditions under which vehicle operations will occur. For the recommended viscosity and quality grades, refer to “Maintenance Procedures” in “Maintaining Your Vehicle”.

**CAUTION!**

**Never use Non-Detergent Oil or Straight Mineral Oil in the engine or damage may result.**

**NOTE:** A new engine may consume some oil during its first few thousand miles (kilometers) of operation. This

should be considered a normal part of the break-in and not interpreted as an indication of difficulty.

**SAFETY TIPS****Transporting Passengers**

**NEVER TRANSPORT PASSENGERS IN THE CARGO AREA.**

**WARNING!**

- **Do not leave children or animals inside parked vehicles in hot weather. Interior heat build-up may cause serious injury or death.**
- **It is extremely dangerous to ride in a cargo area, inside or outside of a vehicle. In a collision, people riding in these areas are more likely to be seriously injured or killed.**

*(Continued)*

**WARNING! (Continued)**

- Do not allow people to ride in any area of your vehicle that is not equipped with seats and seat belts.
- Be sure everyone in your vehicle is in a seat and using a seat belt properly.

**Exhaust Gas****WARNING!**

Exhaust gases can injure or kill. They contain carbon monoxide (CO), which is colorless and odorless. Breathing it can make you unconscious and can eventually poison you. To avoid breathing (CO), follow these safety tips:

*(Continued)*

**WARNING! (Continued)**

- Do not run the engine in a closed garage or in confined areas any longer than needed to move your vehicle in or out of the area.
- If you are required to drive with the trunk/liftgate open, make sure that all windows are closed and the climate control BLOWER switch is set at high speed. DO NOT use the recirculation mode.
- If it is necessary to sit in a parked vehicle with the engine running, adjust your heating or cooling controls to force outside air into the vehicle. Set the blower at high speed.

The best protection against carbon monoxide entry into the vehicle body is a properly maintained engine exhaust system.

Whenever a change is noticed in the sound of the exhaust system, when exhaust fumes can be detected inside the vehicle, or when the underside or rear of the vehicle is damaged, have a competent mechanic inspect the complete exhaust system and adjacent body areas for broken, damaged, deteriorated, or mispositioned parts. Open seams or loose connections could permit exhaust fumes to seep into the passenger compartment. In addition, inspect the exhaust system each time the vehicle is raised for lubrication or oil change. Replace as required.

## **Safety Checks You Should Make Inside The Vehicle**

### **Seat Belts**

Inspect the belt system periodically, checking for cuts, frays, and loose parts. Damaged parts must be replaced immediately. Do not disassemble or modify the system.

Front seat belt assemblies must be replaced after a collision. Rear seat belt assemblies must be replaced after a collision if they have been damaged (i.e., bent retractor, torn webbing, etc.). If there is any question regarding belt or retractor condition, replace the belt.

### **Air Bag Warning Light**

The light should come on and remain on for four to eight seconds as a bulb check when the ignition switch is first turned ON. If the light is not lit during starting, see your authorized dealer. If the light stays on, flickers, or comes on while driving, have the system checked by an authorized dealer.

### **Defroster**

Check operation by selecting the defrost mode and place the blower control on high speed. You should be able to feel the air directed against the windshield. See your authorized dealer for service if your defroster is inoperable.

### Floor Mat Safety Information

Always use floor mats designed to fit the footwell of your vehicle. Use only floor mats that leave the pedal area unobstructed and that are firmly secured so that they cannot slip out of position and interfere with the pedals or impair safe operation of your vehicle in other ways.

#### **WARNING!**

Pedals that cannot move freely can cause loss of vehicle control and increase the risk of serious personal injury.

- Always make sure that floor mats are properly attached to the floor mat fasteners.

*(Continued)*

#### **WARNING! (Continued)**

- Never place or install floor mats or other floor coverings in the vehicle that cannot be properly secured to prevent them from moving and interfering with the pedals or the ability to control the vehicle.
- Never put floor mats or other floor coverings on top of already installed floor mats. Additional floor mats and other coverings will reduce the size of the pedal area and interfere with the pedals.
- Check mounting of mats on a regular basis. Always properly reinstall and secure floor mats that have been removed for cleaning.

*(Continued)*

**WARNING! (Continued)**

- Always make sure that objects cannot fall into the driver footwell while the vehicle is moving. Objects can become trapped under the brake pedal and accelerator pedal causing a loss of vehicle control.
- If required, mounting posts must be properly installed, if not equipped from the factory. Failure to properly follow floor mat installation or mounting can cause interference with the brake pedal and accelerator pedal operation causing loss of control of the vehicle.

**Periodic Safety Checks You Should Make Outside The Vehicle****Tires**

Examine tires for excessive tread wear and uneven wear patterns. Check for stones, nails, glass, or other objects lodged in the tread or sidewall. Inspect the tread for cuts

and cracks. Inspect sidewalls for cuts, cracks and bulges. Check the wheel nuts for tightness. Check the tires (including spare) for proper cold inflation pressure.

**Lights**

Have someone observe the operation of exterior lights while you work the controls. Check turn signal and high beam indicator lights on the instrument panel.

**Door Latches**

Check for positive closing, latching, and locking.

**Fluid Leaks**

Check area under vehicle after overnight parking for fuel, engine coolant, oil, or other fluid leaks. Also, if gasoline fumes are detected or if fuel, power steering fluid, or brake fluid leaks are suspected, the cause should be located and corrected immediately.

# UNDERSTANDING THE FEATURES OF YOUR VEHICLE

## CONTENTS

---

■ Mirrors . . . . .	89	■ Uconnect™ Phone — If Equipped . . . . .	93
□ Automatic Dimming Mirror . . . . .	89	□ Operation . . . . .	95
□ Outside Mirrors . . . . .	90	□ Phone Call Features . . . . .	102
□ Outside Mirrors Folding Feature . . . . .	90	□ Uconnect™ Phone Features . . . . .	105
□ Power Mirrors . . . . .	91	□ Advanced Phone Connectivity . . . . .	110
□ Heated Mirrors — If Equipped . . . . .	91	□ Things You Should Know About Your Uconnect™ Phone . . . . .	112
□ Illuminated Vanity Mirrors . . . . .	92	□ General Information . . . . .	123
□ “Slide-On-Rod” And Extender Features Of Sun Visor . . . . .	92		

- Voice Command — If Equipped . . . . . 123
  - Voice Command System Operation . . . . . 123
  - Commands . . . . . 124
  - Voice Training . . . . . 128
- Seats . . . . . 128
  - Power Seats . . . . . 128
  - Heated Seats . . . . . 131
  - Manual Forward Or Rearward Adjustment . . 132
  - Manual Front Seatback Recline . . . . . 133
  - Passenger Seat Easy Entry . . . . . 134
  - Head Restraints . . . . . 134
  - Folding Rear Seat . . . . . 137
- To Open And Close The Hood . . . . . 138
- Lights . . . . . 140
  - Headlights And Parking Lights . . . . . 140
  - Automatic Headlights . . . . . 140
  - Headlights On With Wipers (Available With Automatic Headlights Only) . . . . . 141
  - Headlight Time Delay . . . . . 141
  - Daytime Running Lights — If Equipped . . . . 142
  - Lights-On Reminder . . . . . 142
  - Fog Lights . . . . . 142
  - Multifunction Lever . . . . . 142
  - Turn Signals . . . . . 143
  - Lane Change Assist . . . . . 143
  - High/Low Beam Switch . . . . . 143



<ul style="list-style-type: none"> <li>□ Flash-To-Pass . . . . . 144</li> <li>□ Map/Reading Lights . . . . . 144</li> <li>□ Interior Lights . . . . . 145</li> <li>■ Windshield Wipers And Washers . . . . . 146                     <ul style="list-style-type: none"> <li>□ Intermittent Wiper System . . . . . 146</li> <li>□ Mist Feature . . . . . 147</li> <li>□ Windshield Washers . . . . . 147</li> <li>□ Headlights On With Wipers (Available With Automatic Headlights Only) . . . . . 148</li> </ul> </li> <li>■ Tilt/Telescoping Steering Column . . . . . 148</li> <li>■ Heated Steering Wheel — If Equipped . . . . . 149</li> <li>■ Electronic Speed Control — If Equipped . . . . . 150                     <ul style="list-style-type: none"> <li>□ To Activate . . . . . 151</li> </ul> </li> </ul>	<ul style="list-style-type: none"> <li>□ To Set A Desired Speed . . . . . 151</li> <li>□ To Deactivate . . . . . 151</li> <li>□ To Resume Speed . . . . . 151</li> <li>□ To Vary The Speed Setting . . . . . 152</li> <li>□ To Accelerate For Passing . . . . . 152</li> <li>■ Overhead Console . . . . . 153                     <ul style="list-style-type: none"> <li>□ Courtesy/Reading Lights . . . . . 153</li> <li>□ Sunglasses Storage . . . . . 154</li> </ul> </li> <li>■ Garage Door Opener — If Equipped . . . . . 154                     <ul style="list-style-type: none"> <li>□ Before You Begin Programming HomeLink® . . . . . 155</li> <li>□ Programming A Rolling Code . . . . . 156</li> <li>□ Programming A Non-Rolling Code . . . . . 158</li> </ul> </li> </ul>
--	---

## 88 UNDERSTANDING THE FEATURES OF YOUR VEHICLE

- Canadian/Gate Operator Programming . . . . . 159
- Using HomeLink® . . . . . 160
- Security . . . . . 161
- Troubleshooting Tips . . . . . 161
- General Information . . . . . 162
- Power Sunroof — If Equipped . . . . . 163
  - Opening Sunroof — Express Mode . . . . . 164
  - Opening Sunroof — Manual Mode . . . . . 164
  - Closing Sunroof — Express Mode . . . . . 164
  - Closing Sunroof — Manual Mode . . . . . 164
  - Pinch Protect Feature . . . . . 164
  - Venting Sunroof — Express . . . . . 165
  - Sunshade Operation . . . . . 165
- Wind Buffeting . . . . . 165
- Sunroof Maintenance . . . . . 165
- Ignition Off Operation . . . . . 165
- Electrical Power Outlets . . . . . 165
- Cupholders . . . . . 169
  - Front Cupholders . . . . . 169
  - Rear Cupholders . . . . . 170
- Console Features . . . . . 170
  - Sliding Center Console Armrest . . . . . 170
  - Console Storage . . . . . 171
- Rear Window Features . . . . . 172
  - Rear Window Defroster . . . . . 172

## MIRRORS

### Automatic Dimming Mirror

This mirror automatically adjusts for headlight glare from vehicles behind you. You can turn the feature on or off by pressing the button at the base of the mirror. A light to the left of the button will illuminate to indicate when the dimming feature is activated. The sensor to the right of the button does not illuminate.

**NOTE:** This feature is disabled when the vehicle is moving in reverse.

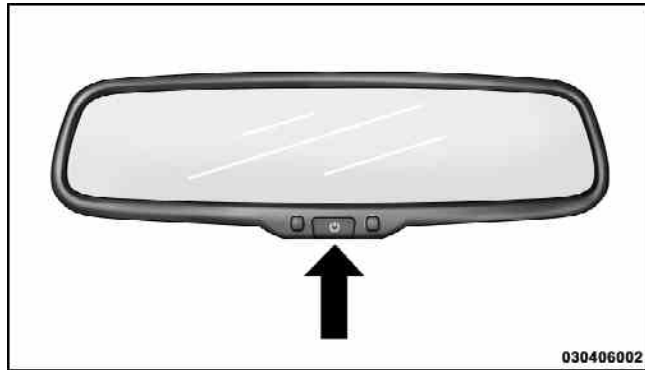

Automatic Dimming Mirror

### CAUTION!

To avoid damage to the mirror during cleaning, never spray any cleaning solution directly onto the mirror. Apply the solution onto a clean cloth and wipe the mirror clean.

## Outside Mirrors

To receive maximum benefit, adjust the outside mirror(s) to center on the adjacent lane of traffic and a slight overlap of the view obtained from the inside mirror.

**NOTE:** The passenger side convex outside mirror will give a much wider view to the rear, and especially of the lane next to your vehicle.

### WARNING!

Vehicles and other objects seen in the passenger side convex mirror will look smaller and farther away than they really are. Relying too much on your passenger side convex mirror could cause you to collide with another vehicle or other object. Use your inside mirror when judging the size or distance of a vehicle seen in the passenger side convex mirror.

## Outside Mirrors Folding Feature

The mirrors are equipped with a rotational hinge. The mirrors have one detent (clockwise) towards the rear of the vehicle and three detent's (counterclockwise) towards the front of the vehicle.

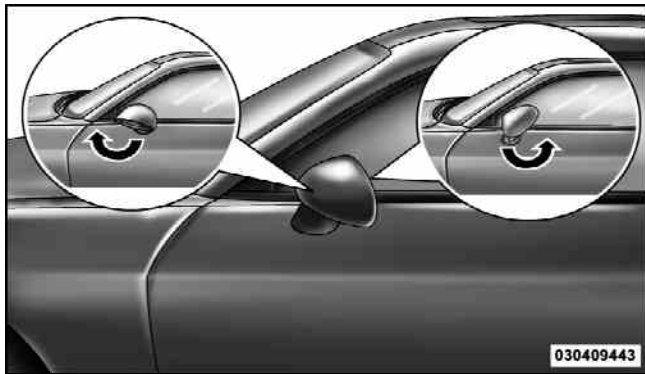

Folding Mirrors

## Power Mirrors

The power mirror switch is located on the driver's door trim panel next to the power door lock switch. A rotary knob selects the left mirror, right mirror or off position.



Power Mirror Control

After selecting a mirror, move the knob in the same direction you want the mirror to move. Use the center off position to guard against accidentally moving a mirror position.

## Heated Mirrors — If Equipped



These mirrors are heated to melt frost or ice. This feature is activated whenever you turn on the rear window defroster. Refer to "Rear Window Features" in "Understanding The Features Of Your Vehicle" for further information.

### Illuminated Vanity Mirrors

An illuminated vanity mirror is located on the sun visor. To use the mirror, rotate the sun visor downward and swing the mirror cover upward. The light turns on automatically. Close the mirror cover to turn off the light.

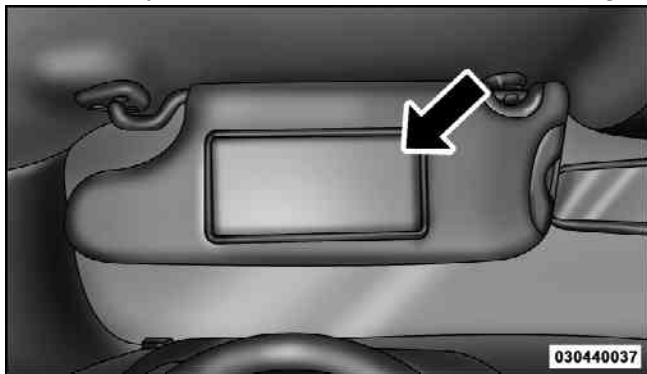

Illuminated Vanity Mirror

### “Slide-On-Rod” And Extender Features Of Sun Visor

To use the “Slide-On-Rod” feature of the sun visor, rotate the sun visor downward and swing the sun visor so it is parallel to the side window, grabbing the sun visor with your left hand pull rearwards until the sun visor is in the desired position. To use the extender feature of the sun visor, grab the extender which is located at the rear of the visor and pull rearward.

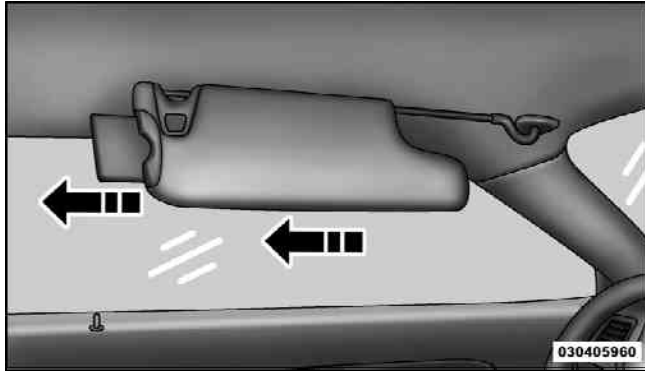

Slide-On-Rod Extender

### Uconnect™ Phone — IF EQUIPPED

Uconnect™ Phone is a voice-activated, hands-free, in-vehicle communications system. Uconnect™ Phone allows you to dial a phone number with your mobile phone using simple voice commands (e.g., “Call” ... “Mike” ... “Work” or “Dial” ... “248-555-1212”). Your

mobile phone’s audio is transmitted through your vehicle’s audio system; the system will automatically mute your radio when using the Uconnect™ Phone.

**NOTE:** The Uconnect™ Phone requires a mobile phone equipped with the Bluetooth® “Hands-Free Profile”, Version 0.96 or higher. See the Uconnect™ website for supported phones.

For Uconnect™ customer support, visit the following websites:

- [www.chrysler.com/uconnect](http://www.chrysler.com/uconnect)
- [www.dodge.com/uconnect](http://www.dodge.com/uconnect)
- [www.jeep.com/uconnect](http://www.jeep.com/uconnect)
- or call 1-877-855-8400

Uconnect™ Phone allows you to transfer calls between the system and your mobile phone as you enter or exit your vehicle and enables you to mute the system's microphone for private conversation.



The Uconnect™ Phone is driven through your Bluetooth® "Hands-Free Profile" mobile phone. Uconnect™ features Bluetooth® technology - the global standard that enables different electronic devices to connect to each other without wires or a docking station, so Uconnect™ Phone works no matter where you stow your mobile phone (be it your purse, pocket, or briefcase), as long as your phone is turned on and has been paired to the vehicle's Uconnect™ Phone. The Uconnect™ Phone allows up to seven mobile phones to be linked to the system. Only one linked (or paired) mobile phone can be used with the system at a time. The system is available in English, Spanish, or French languages.

## WARNING!

**Any voice commanded system should be used only in safe driving conditions following local laws and phone use. All attention should be kept on the roadway ahead. Failure to do so may result in a collision causing serious injury or death.**

### *Uconnect™ Phone Button*



The radio or steering wheel controls (if equipped) will contain the two control buttons (Uconnect™ Phone  button and Voice Command  button) that will enable you to access the system. When you press the button you will hear the word Uconnect™ followed by a BEEP. The beep is your signal to give a command.



### *Voice Command Button*

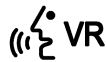

Actual button location may vary with the radio. The individual buttons are described in the “Operation” section.

The Uconnect™ Phone can be used with any Hands-Free Profile certified Bluetooth® mobile phone. See the Uconnect™ website for supported phones. Refer to your mobile service provider or the phone manufacturer for details.

The Uconnect™ Phone is fully integrated with the vehicle’s audio system. The volume of the Uconnect™ Phone can be adjusted either from the radio volume control knob or from the steering wheel radio control (right switch), if so equipped.

The radio display will be used for visual prompts from the Uconnect™ Phone such as “CELL” or caller ID on certain radios.

### **Operation**

Voice commands can be used to operate the Uconnect™ Phone and to navigate through the Uconnect™ Phone menu structure. Voice commands are required after most Uconnect™ Phone prompts. You will be prompted for a specific command and then guided through the available options.

- Prior to giving a voice command, one must wait for the beep, which follows the “Ready” prompt or another prompt.
- For certain operations, compound commands can be used. For example, instead of saying “Setup” and then “Pair a Device”, the following compound command can be said: “Pair a Bluetooth® Device”.
- For each feature explanation in this section, only the compound form of the voice command is given. You can also break the commands into parts and say each part of the command when you are asked for it. For



example, you can use the compound form voice command “Phonebook New Entry”, or you can break the compound form command into two voice commands: “Phonebook” and “New Entry”. Please remember, the Uconnect™ Phone works best when you talk in a normal conversational tone, as if speaking to someone sitting a few feet/meters away from you.

### Voice Command Tree

Refer to “Voice Tree” in this section.

### Help Command

If you need assistance at any prompt, or if you want to know your options at any prompt, say “Help” following the beep. The Uconnect™ Phone will play some of the options at any prompt if you ask for help.

To activate the Uconnect™ Phone, simply press the  button and follow the audible prompts for directions. Uconnect™ Phone sessions begin with a press of the  button on the radio control head.

### Cancel Command

At any prompt, after the beep, you can say “Cancel” and you will be returned to the main menu. However, in a few instances the system will take you back to the previous menu.

### Pair (Link) Uconnect™ Phone To A Mobile Phone

To begin using your Uconnect™ Phone, you must pair your compatible Bluetooth® enabled mobile phone.

To complete the pairing process, you will need to reference your mobile phone Owner’s Manual. The Uconnect™ website may also provide detailed instructions for pairing.

The following are general phone to Uconnect™ Phone pairing instructions:

- Press the  button to begin.
- After the “Ready” prompt and the following beep, say “Device Pairing”.

- When prompted, after the beep, say “Pair a Device” and follow the audible prompts.
- You will be asked to say a four-digit Personal Identification Number (PIN), which you will later need to enter into your mobile phone. You can enter any four-digit PIN. You will not need to remember this PIN after the initial pairing process.
- For identification purposes, you will be prompted to give the Uconnect™ Phone a name for your mobile phone. Each mobile phone that is paired should be given a unique phone name.
- You will then be asked to give your mobile phone a priority level between one and seven, with one being the highest priority. You can pair up to seven mobile phones to your Uconnect™ Phone. However, at any given time, only one mobile phone can be in use, connected to your Uconnect™ System. The priority allows the Uconnect™ Phone to know which mobile

phone to use if multiple mobile phones are in the vehicle at the same time. For example, if priority three and priority five phones are present in the vehicle, the Uconnect™ Phone will use the priority three mobile phone when you make a call. You can select to use a lower priority mobile phone at any time (refer to “Advanced Phone Connectivity” in this section).

### Dial By Saying A Number

- Press the  button to begin.
- After the “Ready” prompt and the following beep, say “Dial”.
- The system will prompt you to say the number you want to call.
- For example, you can say “234-567-8901”.
- The Uconnect™ Phone will confirm the phone number and then dial. The number will appear in the display of certain radios.

### Call By Saying A Name

- Press the  button to begin.
- After the “Ready” prompt and the following beep, say “Call”.
- The system will prompt you to say the name of the person you want to call.
- After the “Ready” prompt and the following beep, say the name of the person you want to call. For example, you can say “John Doe”, where John Doe is a previously stored name entry in the Uconnect™ phonebook or downloaded phonebook. To learn how to store a name in the phonebook, refer to “Add Names to Your Uconnect™ Phonebook”, in the phonebook.
- The Uconnect™ system will confirm the name and then dial the corresponding phone number, which may appear in the display of certain radios.

### Add Names To Your Uconnect™ Phonebook

**NOTE:** Adding names to the Uconnect™ Phonebook is recommended when the vehicle is not in motion.

- Press the  button to begin.
- After the “Ready” prompt and the following beep, say “Phonebook New Entry”.
- When prompted, say the name of the new entry. Use of long names helps the Voice Command and it is recommended. For example, say “Robert Smith” or “Robert” instead of “Bob”.
- When prompted, enter the number designation (e.g., “Home”, “Work”, “Mobile”, or “Other”). This will allow you to store multiple numbers for each phonebook entry, if desired.
- When prompted, recite the phone number for the phonebook entry that you are adding.

After you are finished adding an entry into the phonebook, you will be given the opportunity to add more phone numbers to the current entry or to return to the main menu.

The Uconnect™ Phone will allow you to enter up to 32 names in the phonebook with each name having up to four associated phone numbers and designations. Each language has a separate 32-name phonebook accessible only in that language. In addition, if equipped and supported by your phone, Uconnect™ Phone automatically downloads your mobile phone's phonebook.

### **Phonebook Download – Automatic Phonebook Transfer From Mobile Phone**

If equipped and specifically supported by your phone, Uconnect™ Phone automatically downloads names (text names) and number entries from your mobile phone's phonebook. Specific Bluetooth® Phones with Phone Book Access Profile may support this feature. See Uconnect™ website for supported phones.

- To call a name from the Uconnect™ Phonebook or downloaded Phonebook, follow the procedure in “Call by Saying a Name” section.
- Automatic download and update, if supported, begins as soon as the Bluetooth® wireless phone connection is made to the Uconnect™ Phone, for example, after you start the vehicle.
- A maximum of 1000 entries per phone will be downloaded and updated every time a phone is connected to the Uconnect™ Phone.
- Depending on the maximum number of entries downloaded, there may be a short delay before the latest downloaded names can be used. Until then, if available, the previously downloaded phonebook is available for use.
- Only the phonebook of the currently connected mobile phone is accessible.

- Only the mobile phone's phonebook is downloaded. SIM card phonebook is not part of the Mobile phonebook.
- This downloaded phonebook cannot be edited or deleted on the Uconnect™ Phone. These can only be edited on the mobile phone. The changes are transferred and updated to Uconnect™ Phone on the next phone connection.
- You will then be asked for the name of the phonebook entry that you wish to edit.
- Next, choose the number designation (home, work, mobile, or other) that you wish to edit.
- When prompted, recite the new phone number for the phonebook entry that you are editing.



### **Edit Uconnect™ Phonebook Entries**

#### **NOTE:**

- Editing names in the phonebook is recommended when the vehicle is not in motion.
  - Automatic downloaded phonebook entries cannot be deleted or edited.
  - Press the  button to begin.
  - After the "Ready" prompt and the following beep, say "Phonebook Edit Entry".
- After you are finished editing an entry in the phonebook, you will be given the opportunity to edit another entry in the phonebook, call the number you just edited, or return to the main menu.
- "Phonebook Edit Entry" can be used to add another phone number to a name entry that already exists in the phonebook. For example, the entry John Doe may have a mobile and a home number, but you can add "John Doe's" work number later using the "Phonebook Edit Entry" feature.

## Delete Uconnect™ Phonebook Entry

**NOTE:** Editing phonebook entries is recommended when the vehicle is not in motion.

- Press the  button to begin.
- After the “Ready” prompt and the following beep, say “Phonebook Delete”.
- After you enter the Phonebook Delete menu, you will then be asked for the name of the entry that you wish to delete. You can either say the name of a phonebook entry that you wish to delete or you can say “List Names” to hear a list of the entries in the phonebook from which you choose. To select one of the entries from the list, press the  button while the Uconnect™ Phone is playing the desired entry and say “Delete”.



- After you enter the name, the Uconnect™ Phone will ask you which designation you wish to delete: home, work, mobile, other, or all. Say the designation you wish to delete.
- Note that only the phonebook entry in the current language is deleted.
- Automatic downloaded phonebook entries cannot be deleted or edited.

## Delete/Erase “All” Uconnect™ Phonebook Entries

- Press the  button to begin.
- After the “Ready” prompt and the following beep, say “Phonebook Erase All”.
- The Uconnect™ Phone will ask you to verify that you wish to delete all the entries from the phonebook.
- After confirmation, the phonebook entries will be deleted.

- Note that only the phonebook in the current language is deleted.
- Automatic downloaded phonebook entries cannot be deleted or edited.

### List All Names In The Uconnect™ Phonebook

- Press the  button to begin.
- After the “Ready” prompt and the following beep, say “Phonebook List Names”.
- The Uconnect™ Phone will play the names of all the phonebook entries, including the downloaded phonebook entries, if available.
- To call one of the names in the list, press the  button during the playing of the desired name, and say “Call”.

**NOTE:** The user can also exercise “Edit” or “Delete” operations at this point.

- The Uconnect™ Phone will then prompt you as to the number designation you wish to call.
- The selected number will be dialed.



### Phone Call Features

The following features can be accessed through the Uconnect™ Phone if the feature(s) are available on your mobile service plan. For example, if your mobile service plan provides three-way calling, this feature can be accessed through the Uconnect™ Phone. Check with your mobile service provider for the features that you have.

### Answer Or Reject An Incoming Call — No Call Currently In Progress

When you receive a call on your mobile phone, the Uconnect™ Phone will interrupt the vehicle audio system, if on, and will ask if you would like to answer the



call. Press the  button to accept the call. To reject the call, press and hold the  button until you hear a single beep, indicating that the incoming call was rejected.

### **Answer Or Reject An Incoming Call — Call Currently In Progress**

If a call is currently in progress and you have another incoming call, you will hear the same network tones for call waiting that you normally hear when using your mobile phone. Press the  button to place the current call on hold and answer the incoming call.



**NOTE:** The Uconnect™ Phone compatible phones in the market today do not support rejecting an incoming call when another call is in progress. Therefore, the user can only answer an incoming call or ignore it.

### **Making A Second Call While Current Call Is In Progress**

To make a second call while you are currently on a call, press the  button and say “Dial” or “Call” followed

by the phone number or phonebook entry you wish to call. The first call will be on hold while the second call is in progress. To go back to the first call, refer to “Toggling Between Calls” in this section. To combine two calls, refer to “Conference Call” in this section.

### **Place/Retrieve A Call From Hold**

To put a call on hold, press the  button until you hear a single beep. This indicates that the call is on hold. To bring the call back from hold, press and hold the  button until you hear a single beep.



### **Toggling Between Calls**

If two calls are in progress (one active and one on hold), press the  button until you hear a single beep, indicating that the active and hold status of the two calls have switched. Only one call can be placed on hold at a time.



### Conference Call

When two calls are in progress (one active and one on hold), press and hold the  button until you hear a double beep indicating that the two calls have been joined into one conference call.

### Three-Way Calling

To initiate three-way calling, press the  VR button while a call is in progress, and make a second phone call, as described under “Making a Second Call While Current Call is in Progress”. After the second call has established, press and hold the  button until you hear a double beep, indicating that the two calls have been joined into one conference call.

### Call Termination

To end a call in progress, momentarily press the  button. Only the active call(s) will be terminated and if there is a call on hold, it will become the new active call. If the active call is terminated by the phone far end, a call on hold may not become active automatically. This is cell phone-dependent. To bring the call back from hold, press and hold the  button until you hear a single beep.

### Redial

- Press the  button to begin.
- After the “Ready” prompt and the following beep, say “Redial”.
- The Uconnect™ Phone will call the last number that was dialed from your mobile phone.

**NOTE:** This may not be the last number dialed from the Uconnect™ Phone.

## Call Continuation

Call continuation is the progression of a phone call on the Uconnect™ Phone after the vehicle ignition key has been switched to OFF. Call continuation functionality available on the vehicle can be any one of three types:

- After the ignition key is switched to OFF, a call can continue on the Uconnect™ Phone either until the call ends, or until the vehicle battery condition dictates cessation of the call on the Uconnect™ Phone and transfer of the call to the mobile phone.
- After the ignition key is switched to OFF, a call can continue on the Uconnect™ Phone for a certain duration, after which the call is automatically transferred from the Uconnect™ Phone to the mobile phone.
- An active call is automatically transferred to the mobile phone after the ignition key is switched to OFF.

## Uconnect™ Phone Features

### Language Selection

To change the language that the Uconnect™ Phone is using:

- Press the  button to begin.
- After the “Ready” prompt and the following beep, say the name of the language you wish to switch to English, Espanol, or Francais.
- Continue to follow the system prompts to complete the language selection.

After selecting one of the languages, all prompts and voice commands will be in that language.

**NOTE:** After every Uconnect™ Phone language change operation, only the language-specific 32-name phone-book is usable. The paired phone name is not language-specific and is usable across all languages.

### Emergency Assistance

If you are in an emergency and the mobile phone is reachable:

- Pick up the phone and manually dial the emergency number for your area.

If the phone is not reachable and the Uconnect™ Phone is operational, you may reach the emergency number as follows:

- Press the  button to begin.
- After the “Ready” prompt and the following beep, say “Emergency” and the Uconnect™ Phone will instruct the paired mobile phone to call the emergency number. This feature is supported in the U.S., Canada, and Mexico.

#### NOTE:

- The emergency number dialed is based on the country where the vehicle is purchased (911 for the U.S. and

Canada and 060 for Mexico). The number dialed may not be applicable with the available mobile service and area.

- If supported, this number may be programmable on some systems. To do this, press the  button and say “Setup”, followed by “Emergency”.
- The Uconnect™ Phone does slightly lower your chances of successfully making a phone call as to that for the mobile phone directly.

### WARNING!

**To use your Uconnect™ Phone System in an emergency, your mobile phone must be:**

- **turned on,**
- **paired to the Uconnect™ System,**
- **and have network coverage.**

## Towing Assistance

If you need towing assistance:

- Press the  button to begin.
- After the “Ready” prompt and the following beep, say “Towing Assistance”.

### NOTE:

- The towing assistance number dialed is based on the country where the vehicle is purchased (1-800-528-2069 for the U.S., 1-877-213-4525 for Canada, 55-14-3454 for Mexico City and 1-800-712-3040 for outside Mexico City in Mexico). Please refer to the 24-Hour “Towing Assistance” coverage details on the DVD in the Warranty Information Booklet and the 24-Hour Towing Assistance references.
- If supported, this number may be programmable on some systems. To do this, press the  button and say “Setup”, followed by “Towing Assistance”.

## Paging

To learn how to page, refer to “Working with Automated Systems”. Paging works properly except for pagers of certain companies, which time out a little too soon to work properly with the Uconnect™ Phone.

## Voice Mail Calling

To learn how to access your voice mail, refer to “Working with Automated Systems”.

## Working With Automated Systems

This method is used in instances where one generally has to press numbers on the mobile phone keypad while navigating through an automated telephone system.

You can use your Uconnect™ Phone to access a voice mail system or an automated service, such as a paging service or automated customer service line. Some services require immediate response selection. In some instances, that may be too quick for use of the Uconnect™ Phone.

When calling a number with your Uconnect™ Phone that normally requires you to enter in a touch-tone sequence on your mobile phone keypad, you can press the **VR** button and say the sequence you wish to enter, followed by the word “Send”. For example, if required to enter your PIN followed with a pound, (3 7 4 6 #), you can press the **VR** button and say, “3 7 4 6 # Send”. Saying a number, or sequence of numbers, followed by “Send”, is also to be used for navigating through an automated customer service center menu structure, and to leave a number on a pager.

You can also send stored Uconnect™ phonebook entries as tones for fast and easy access to voice mail and pager entries. To use this feature, dial the number you wish to call and then press the **VR** button and say, “Send.” The system will prompt you to enter the name or number and say the name of the phonebook entry you wish to send.

The Uconnect™ Phone will then send the corresponding phone number associated with the phonebook entry, as tones over the phone.

**NOTE:**

- You may not hear all of the tones due to mobile phone network configurations. This is normal.
- Some paging and voice mail systems have system time out settings that are too short and may not allow the use of this feature.

**Barge In — Overriding Prompts**

The “Voice Command” button can be used when you wish to skip part of a prompt and issue your voice command immediately. For example, if a prompt is asking “Would you like to pair a phone, clear a...,” you could press the **VR** button and say, “Pair a Phone” to select that option without having to listen to the rest of the voice prompt.

### Turning Confirmation Prompts ON/OFF

Turning confirmation prompts off will stop the system from confirming your choices (e.g., the Uconnect™ Phone will not repeat a phone number before you dial it).

- Press the  button to begin.
- After the “Ready” prompt and the following beep, say one of the following:
  - “Setup Confirmation Prompts On”
  - “Setup Confirmation Prompts Off”

### Phone And Network Status Indicators

If available on the radio and/or on a premium display such as the instrument panel cluster, and supported by your mobile phone, the Uconnect™ Phone will provide notification to inform you of your phone and network status when you are attempting to make a phone call using Uconnect™ Phone. The status is given for network signal strength, phone battery strength, etc.

### Dialing Using The Mobile Phone Keypad

You can dial a phone number with your mobile phone keypad and still use the Uconnect™ Phone (while dialing via the mobile phone keypad, the user must exercise caution and take precautionary safety measures). By dialing a number with your paired Bluetooth® mobile phone, the audio will be played through your vehicle’s audio system. The Uconnect™ Phone will work the same as if you dial the number using Voice Command.

**NOTE:** Certain brands of mobile phones do not send the dial ring to the Uconnect™ Phone to play it on the vehicle audio system, so you will not hear it. Under this situation, after successfully dialing a number the user may feel that the call did not go through even though the call is in progress. Once your call is answered, you will hear the audio.

**Mute/Un-Mute (Mute OFF)**

When you mute the Uconnect™ Phone, you will still be able to hear the conversation coming from the other party, but the other party will not be able to hear you. In order to mute the Uconnect™ Phone:

- Press the  VR button.
- Following the beep, say “Mute”.

In order to un-mute the Uconnect™ Phone:

- Press the  VR button.
- Following the beep, say “Mute off”.

**Advanced Phone Connectivity****Transfer Call To And From Mobile Phone**

The Uconnect™ Phone allows ongoing calls to be transferred from your mobile phone to the Uconnect™ Phone without terminating the call. To transfer an ongoing call

from your Uconnect™ Phone paired mobile phone to the Uconnect™ Phone or vice versa, press the  VR button and say “Transfer Call”.

**Connect Or Disconnect Link Between The Uconnect™ Phone And Mobile Phone**

Your mobile phone can be paired with many different electronic devices, but can only be actively “connected” with one electronic device at a time.

If you would like to connect or disconnect the Bluetooth® connection between your mobile phone and the Uconnect™ Phone System, follow the instructions described in your mobile phone User’s Manual.

**List Paired Mobile Phone Names**



- Press the  button to begin.
- After the “Ready” prompt and the following beep, say “Setup Phone Pairing”.



- When prompted, say “List Phones”.
- The Uconnect™ Phone will play the phone names of all paired mobile phones in order from the highest to the lowest priority. To “Select” or “Delete” a paired phone being announced, press the  button and say “Select” or “Delete”. Also, see the next two sections for an alternate way to “Select” or “Delete” a paired phone.



### Select Another Mobile Phone

This feature allows you to select and start using another phone paired with the Uconnect™ Phone.

- Press the  button to begin.
- After the “Ready” prompt and the following beep, say “Setup Select Phone” and follow the prompts.
- You can also press the  button at any time while the list is being played, and then choose the phone that you wish to select.

- The selected phone will be used for the next phone call. If the selected phone is not available, the Uconnect™ Phone will return to using the highest priority phone present in or near (approximately within 30 ft (9 m)) the vehicle.

### Delete Uconnect™ Phone Paired Mobile Phones

- Press the  button to begin.
- After the “Ready” prompt and the following beep, say “Setup Phone Pairing”.
- At the next prompt, say “Delete” and follow the prompts.
- You can also press the  button at any time while the list is being played, and then choose the phone you wish to delete.

## Things You Should Know About Your Uconnect™ Phone



### Uconnect™ Phone Tutorial

To hear a brief tutorial of the system features, press the  button and say “Uconnect™ Tutorial.”

### Voice Training

For users experiencing difficulty with the system recognizing their voice commands or numbers, the Uconnect™ Phone Voice Training feature may be used. To enter this training mode, follow one of the two following procedures:

From outside the Uconnect™ Phone mode (e.g., from radio mode):

- Press and hold the  button for five seconds until the session begins, or,
- Press the  button and say the “Voice Training, System Training, or Start Voice Training” command.

You can either press the Uconnect™ Phone button to restore the factory setting or repeat the words and phrases when prompted by the Uconnect™ Phone. For best results, the Voice Training session should be completed when the vehicle is parked with the engine running, all windows closed, and the blower fan switched off.

This procedure may be repeated with a new user. The system will adapt to the last trained voice only.

### Reset

- press the  button.
- After the “Ready” prompt, and the following beep, say “Setup”, then “Reset”.

This will delete all phone pairing, phone book entries, and other settings in all language modes. The System will prompt you before resetting to factory settings.

## Voice Command

- For best performance, adjust the rearview mirror to provide at least  $\frac{1}{2}$  in (1 cm) gap between the overhead console (if equipped) and the mirror.
- Always wait for the beep before speaking.
- Speak normally, without pausing, just as you would speak to a person sitting a few feet/meters away from you.
- Make sure that no one other than you is speaking during a Voice Command period.
- Performance is maximized under:
  - low-to-medium blower setting,
  - low-to-medium vehicle speed,
  - low road noise,
  - smooth road surface,
- fully closed windows,
- dry weather condition.
- Even though the system is designed for users speaking in North American English, French, and Spanish accents, the system may not always work for some.
- When navigating through an automated system such as voice mail, or when sending a page, at the end of speaking the digit string, make sure to say "Send".
- Storing names in the phonebook when the vehicle is not in motion is recommended.
- It is not recommended to store similar sounding names in the Uconnect™ Phonebook.
- Phonebook (Downloaded and Uconnect™ Phone Local) name recognition rate is optimized when the entries are not similar.

- Numbers must be spoken in single digits. “800” must be spoken “eight-zero-zero” not “eight hundred”.
- You can say “O” (letter “O”) for “0” (zero).
- Even though international dialing for most number combinations is supported, some shortcut dialing number combinations may not be supported.
- In a convertible vehicle, system performance may be compromised with the convertible top down.

### **Far End Audio Performance**

- Audio quality is maximized under:
  - low-to-medium blower setting,
  - low-to-medium vehicle speed,
  - low road noise,
  - smooth road surface,

- fully closed windows,
- dry weather conditions, and
- operation from the driver’s seat.
- Performance, such as audio clarity, echo, and loudness to a large degree rely on the phone and network, and not the Uconnect™ Phone.
- Echo at the phone far end can sometimes be reduced by lowering the in-vehicle audio volume.
- In a convertible vehicle, system performance may be compromised with the convertible top down.

### **Recent Calls**

If your phone supports “Automatic Phonebook Download”, Uconnect™ Phone can list your Outgoing, Incoming and Missed Calls.

## SMS

Uconnect™ Phone can read or send new messages on your phone.

### *Read Messages:*

If you receive a new text message while your phone is connected to Uconnect™ Phone, an announcement will be made to notify you that you have a new text message.

If you wish to hear the new message:

- Press the  button.
- After the “Ready” prompt and the following beep, say “SMS Read” or “Read Messages.”
- Uconnect™ Phone will play the new text message for you.

After reading a message, you can “Reply” or “Forward” the message using Uconnect™ Phone.

### *Send Messages:*

You can send messages using Uconnect™ Phone. To send a new message:

- Press the  button.
- After the “Ready” prompt and the following beep, say “SMS Send” or “Send Message.”
- You can either say the message you wish to send or say “List Messages.” There are 20 preset messages.

To send a message, press the  button while the system is listing the message and say “Send.”

Uconnect™ Phone will prompt you to say the name or number of the person you wish to send the message to.

List of Preset Messages:

1. Yes
2. No
3. Where are you?
4. I need more direction.
5. L O L
6. Why
7. I love you
8. Call me
9. Call me later
10. Thanks
11. See You in 15 minutes
12. I am on my way
13. I'll be late
14. Are you there yet?
15. Where are we meeting?
16. Can this wait?
17. Bye for now
18. When can we meet
19. Send number to call
20. Start without me

### *Turn SMS Incoming Announcement ON/OFF*

Turning the SMS Incoming Announcement OFF will stop the system from announcing the new incoming messages.

- Press the  button.
- After the “Ready” prompt and the following beep, say “Setup, SMS Incoming Message Announcement,” you will then be given a choice to change it.

### **Bluetooth® Communication Link**

Mobile phones have been found to lose connection to the Uconnect™ Phone. When this happens, the connection can generally be reestablished by switching the phone off/on. Your mobile phone is recommended to remain in Bluetooth® ON mode.

### **Power-Up**

After switching the ignition key from OFF to either the ON or ACC position, or after a language change, you must wait at least fifteen seconds prior to using the system.

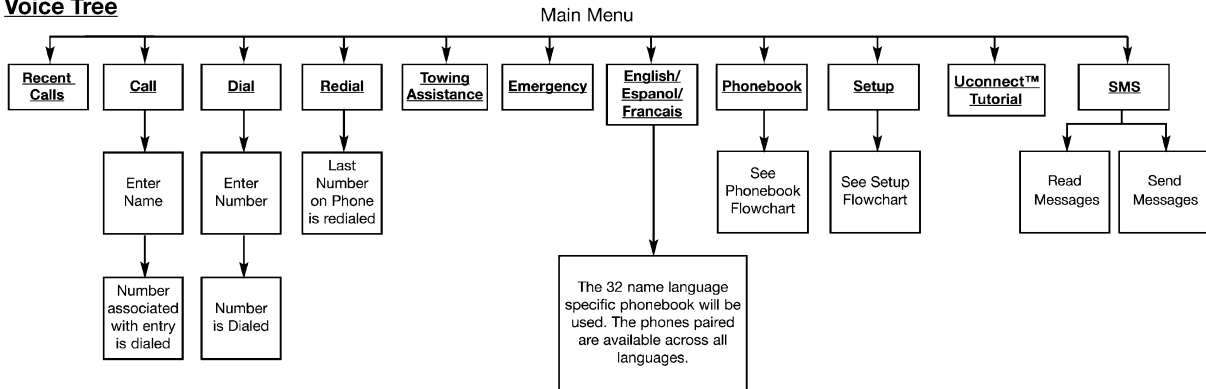
**Voice Tree**

**Note:** Available Voice commands are shown in bold face and are underlined.



**Voice Tree – Phonebook**

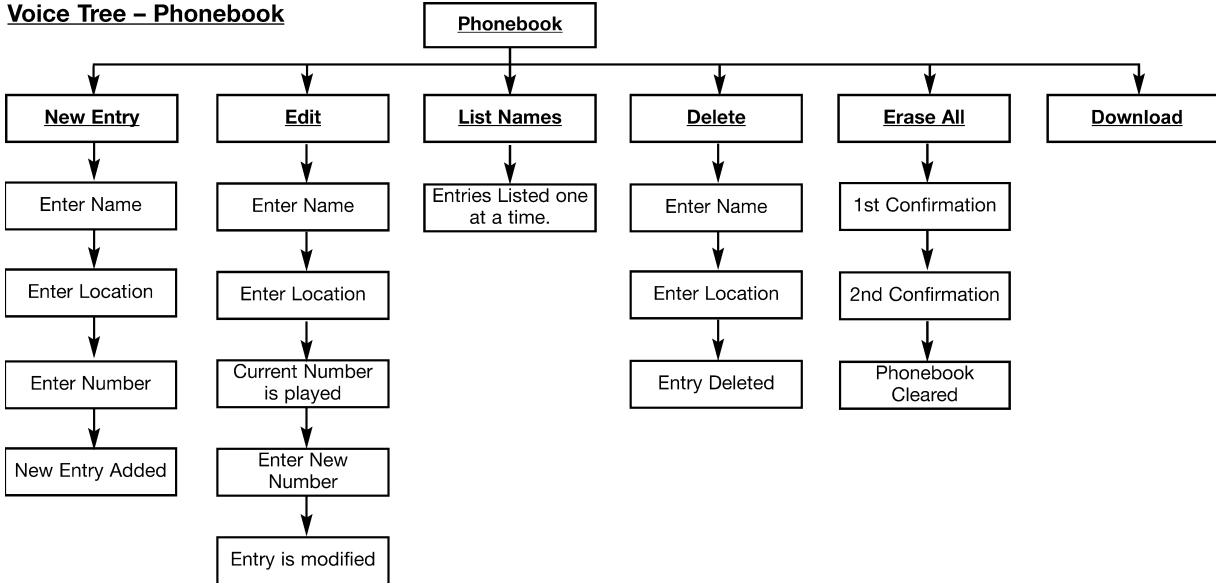

**Note:** Available Voice commands are shown in bold face and are underlined.

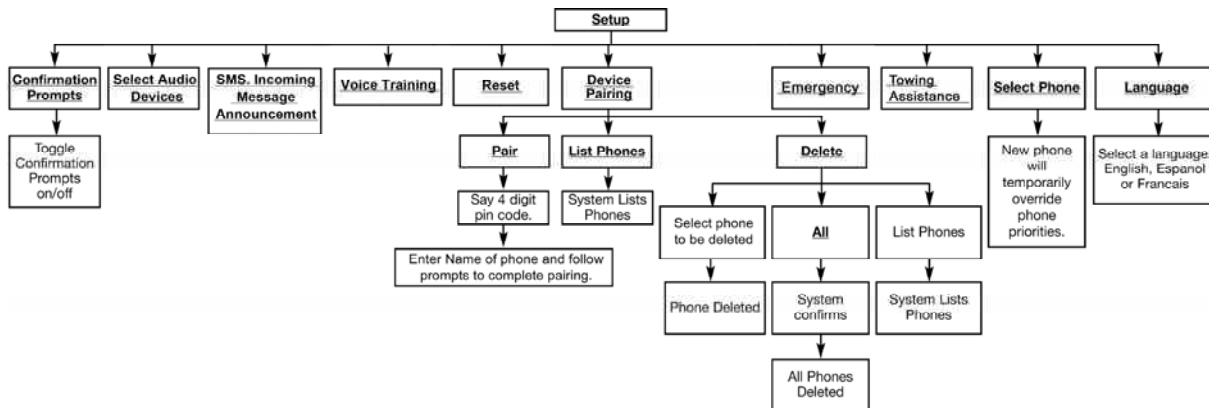
Voice Tree – Setup

Note: Available Voice commands are shown in bold face and are underlined. 030605540

Voice Commands	
Primary	Alternate(s)
zero	
one	
two	
three	
four	
five	
six	
seven	
eight	
nine	
star (*)	
plus (+)	
pound (#)	
add location	
all	

Voice Commands	
Primary	Alternate(s)
call	
cancel	
confirmation prompts	
continue	
delete	
dial	
download	
edit	
emergency	
English	
erase all	
Espanol	
Francais	
help	
home	

Voice Commands	
Primary	Alternate(s)
language	
list names	
list phones	
mobile	
mute	
mute off	
new entry	
no	
other	
pair a phone	
phone pairing	pairing
phonebook	phone book
previous	
record again	
redial	

Voice Commands	
Primary	Alternate(s)
return to main menu	return or main menu
select phone	select
send	
set up	phone settings or phone set up
towing assistance	
transfer call	
Uconnect™ Tutorial	
try again	
voice training	
work	
yes	

## General Information

This device complies with Part 15 of the FCC rules and RSS 210 of Industry Canada. Operation is subject to the following conditions:

- Changes or modifications not expressly approved by the party responsible for compliance could void the user's authority to operate the equipment.
- This device may not cause harmful interference.
- This device must accept any interference received, including interference that may cause undesired operation.

## VOICE COMMAND — IF EQUIPPED

### Voice Command System Operation

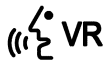

This Voice Command system allows you to control your AM, FM radio, satellite radio, disc player, and a memo recorder.

**NOTE:** Take care to speak into the Voice Interface System as calmly and normally as possible. The ability of the Voice Interface System to recognize user voice commands may be negatively affected by rapid speaking or a raised voice level.

### WARNING!

**Any voice commanded system should be used only in safe driving conditions following local laws. All attention should be kept on the roadway ahead. Failure to do so may result in a collision causing serious injury or death.**

When you press the Voice Command  button, you will hear a beep. The beep is your signal to give a command.

**NOTE:** If you do not say a command within a few seconds, the system will present you with a list of options.

If you ever wish to interrupt the system while it lists options, press the Voice Command  button, listen for the beep, and say your command.

Pressing the Voice Command  button while the system is speaking is known as “barging in.” The system will be interrupted, and after the beep, you can add or change commands. This will become helpful once you start to learn the options.

**NOTE:** At any time, you can say the words “Cancel”, “Help” or “Main Menu”.

These commands are universal and can be used from any menu. All other commands can be used depending upon the active application.

When using this system, you should speak clearly and at a normal speaking volume.

The system will best recognize your speech if the windows are closed, and the heater/air conditioning fan is set to low.

At any point, if the system does not recognize one of your commands, you will be prompted to repeat it.

To hear the first available Menu, press the Voice Command  button and say “Help” or “Main Menu”.

### Commands

The Voice Command system understands two types of commands. Universal commands are available at all times. Local commands are available if the supported radio mode is active.

### Changing the Volume

1. Start a dialogue by pressing the Voice Command  button.
2. Say a command (e.g., “Help”).

3. Use the ON/OFF VOLUME rotary knob to adjust the volume to a comfortable level while the Voice Command system is speaking. Please note the volume setting for Voice Command is different than the audio system.

### Main Menu

Start a dialogue by pressing the Voice Command  button. You may say "Main Menu" to switch to the main menu.

In this mode, you can say the following commands:

- "Radio" (to switch to the radio mode)
- "Disc" (to switch to the disc mode)
- "Memo" (to switch to the memo recorder)
- "Setup" (to switch to system setup)

### Radio AM

To switch to the AM band, say "AM" or "Radio AM". In this mode, you may say the following commands:

- "Frequency #" (to change the frequency)
- "Next Station" (to select the next station)
- "Previous Station" (to select the previous station)
- "Radio Menu" (to switch to the radio menu)
- "Main Menu" (to switch to the main menu)

### Radio FM

To switch to the FM band, say "FM" or "Radio FM". In this mode, you may say the following commands:

- "Frequency #" (to change the frequency)
- "Next Station" (to select the next station)
- "Previous Station" (to select the previous station)

- “Menu Radio” (to switch to the radio menu)
- “Main Menu” (to switch to the main menu)

### Satellite Radio

To switch to satellite radio mode, say “Sat” or “Satellite Radio”. In this mode, you may say the following commands:

- “Channel Number” (to change the channel by its spoken number)
- “Next Channel” (to select the next channel)
- “Previous Channel” (to select the previous channel)
- “List Channel” (to hear a list of available channels)
- “Select Name” (to say the name of a channel)
- “Menu Radio” (to switch to the radio menu)
- “Main Menu” (to switch to the main menu)

### Disc

To switch to the disc mode, say “Disc”. In this mode, you may say the following commands:

- “Track” (#) (to change the track)
- “Next Track” (to play the next track)
- “Previous Track” (to play the previous track)
- “Main Menu” (to switch to the main menu)

### Memo

To switch to the voice recorder mode, say “Memo”. In this mode, you may say the following commands:

- “New Memo” (to record a new memo) — During the recording, you may press the Voice Command  button to stop recording. You proceed by saying one of the following commands:
  - “Save” (to save the memo)



- “Continue” (to continue recording)
- “Delete” (to delete the recording)
- “Play Memos” (to play previously recorded memos)
  - During the playback you may press the Voice Command  button to stop playing memos. You proceed by saying one of the following commands:
    - “Repeat” (to repeat a memo)
    - “Next” (to play the next memo)
    - “Previous” (to play the previous memo)
    - “Delete” (to delete a memo)
- “Delete All” (to delete all memos)

### Setup

To switch to system setup, you may say on of the following:

- “Change to setup”

- “Switch to system setup”
- “Change to setup”
- “Main menu setup” or
- “Switch to setup”

In this mode, you may say the following commands:

- “Language English”
- “Language French”
- “Language Spanish”
- “Tutorial”
- “Voice Training”

**NOTE:** Keep in mind that you have to press the Voice Command  button first and wait for the beep before speaking the “Barge In” commands.

## Voice Training

For users experiencing difficulty with the system recognizing their voice commands or numbers the Uconnect™ Voice “Voice Training” feature may be used.

1. Press the Voice Command  button, say “System Setup” and once you are in that menu then say “Voice Training.” This will train your own voice to the system and will improve recognition.

2. Repeat the words and phrases when prompted by Uconnect™ Voice. For best results, the “Voice Training” session should be completed when the vehicle is parked, engine running, all windows closed, and the blower fan switched off. This procedure may be repeated with a new user. The system will adapt to the last trained voice only.

## SEATS

Seats are a part of the Occupant Restraint System of the vehicle.

### WARNING!

- It is dangerous to ride in a cargo area, inside or outside of a vehicle. In a collision, people riding in these areas are more likely to be seriously injured or killed.
- Do not allow people to ride in any area of your vehicle that is not equipped with seats and seat belts. In a collision, people riding in these areas are more likely to be seriously injured or killed.
- Be sure everyone in your vehicle is in a seat and using a seat belt properly.

## Power Seats

The power seat switches are located on the outboard side of the front seat cushions. The power seat switches are used to control the position of the seat.

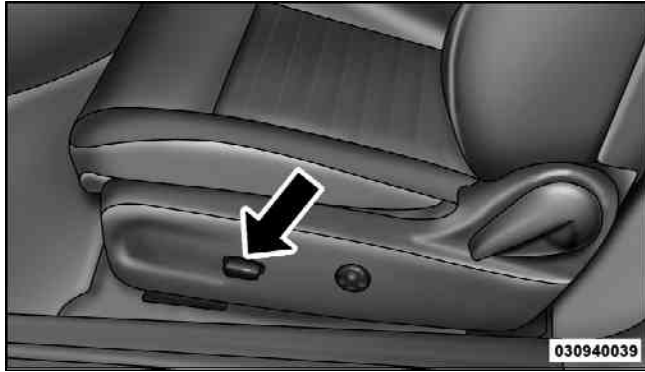

**Power Seat Switch**

### **Adjusting The Seat Forward Or Rearward**

The seat can be adjusted both forward and rearward. Push the seat switch forward or rearward, the seat will move in the direction of the switch. Release the switch when the desired position has been reached.

### **Adjusting The Seat Up Or Down**

The height of the seats can be adjusted up or down. Pull upward or push downward on the seat switch, the seat will move in the direction of the switch. Release the switch when the desired position has been reached.

### **Tilting The Seat Up Or Down**

The angle of the seat cushion can be adjusted in four directions. Pull upward or push downward on the front or rear of the seat switch; the front or rear of the seat cushion will move in the direction of the switch. Release the switch when the desired position has been reached.

### **Power Lumbar — If Equipped**

Vehicles equipped with power driver or passenger seats are also equipped with power lumbar. The power lumbar switch is located on the outboard side of the power seat. Push the switch forward to increase the lumbar support.

## 130 UNDERSTANDING THE FEATURES OF YOUR VEHICLE

Push the switch rearward to decrease the lumbar support. Pushing upward or downward on the switch will raise and lower the position of the support.

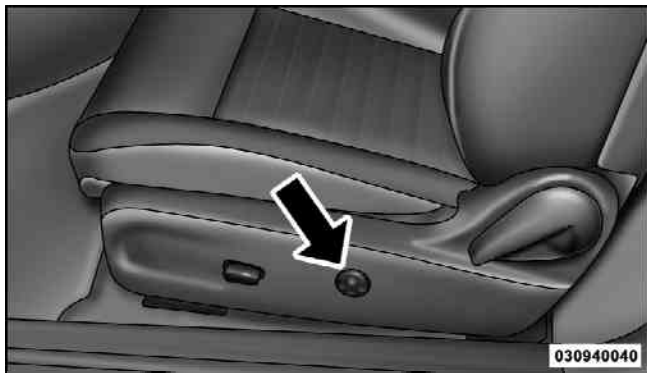

Power Lumbar Switch

### WARNING!

- **Adjusting a seat while driving may be dangerous. Moving a seat while driving could result in loss of control which could cause a collision and serious injury or death.**
- **Seats should be adjusted before fastening the seat belts and while the vehicle is parked. Serious injury or death could result from a poorly adjusted seat belt.**
- **Do not ride with the seatback reclined so that the shoulder belt is no longer resting against your chest. In a collision you could slide under the seat belt, which could result in serious injury or death.**

**CAUTION!**

Do not place any article under a power seat or impede its ability to move as it may cause damage to the seat controls. Seat travel may become limited if movement is stopped by an obstruction in the seat's path.

**Heated Seats**

The front driver and passenger seats may be equipped with heaters in both the seat cushions and seatbacks. The heaters provide the same average heat level for both the cushion and the seatback.

There are two heated seat switches that allow the driver and passenger to operate the seats independently. The controls for each seat are located near the bottom center of the instrument panel.

You can choose from HIGH, LOW or OFF heat settings. Amber indicator lights in each switch indicate the level of heat in use. Two indicator lights will illuminate for HIGH, one for LOW and none for OFF.



Press the switch once to select HIGH-level heating. Press the switch a second time to select LOW-level heating. Press the switch a third time to shut the heating elements OFF.

If HIGH-level heating is selected, the system will automatically switch to the LOW-level after a maximum of 60 minutes of continuous operation. At that time, the number of indicators illuminated changes from two to one, indicating the change. Operation on the LOW-level setting also turns OFF automatically after a maximum of 45 minutes.

**NOTE:** Once a heat setting is selected, heat will be felt within two to five minutes.

**WARNING!**

- Persons who are unable to feel pain to the skin because of advanced age, chronic illness, diabetes, spinal cord injury, medication, alcohol use, exhaustion or other physical condition must exercise care when using the seat heater. It may cause burns even at low temperatures, especially if used for long periods of time.
- Do not place anything on the seat that insulates against heat, such as a blanket or cushion. This may cause the seat heater to overheat. Sitting in a seat that has been overheated could cause serious burns due to the increased surface temperature of the seat.

**Manual Forward Or Rearward Adjustment**

The adjusting bar is at the front of the seat, near the floor. Pull the bar upward to move the seat forward or rearward. Release the bar once the seat is in the position desired. Using body pressure, move forward and rearward on the seat to be sure that the seat adjusters have latched.

**WARNING!**

Adjusting a seat while the vehicle is moving is dangerous. The sudden movement of the seat could cause you to lose control. The seat belt might not be properly adjusted and you could be injured. Adjust the seat only while the vehicle is parked.

### Manual Front Seatback Recline

To adjust the seatback, lift the lever located on the outboard side of the seat, lean back to the desired position and release the lever. To return the seatback, lift the lever, lean forward and release the lever.

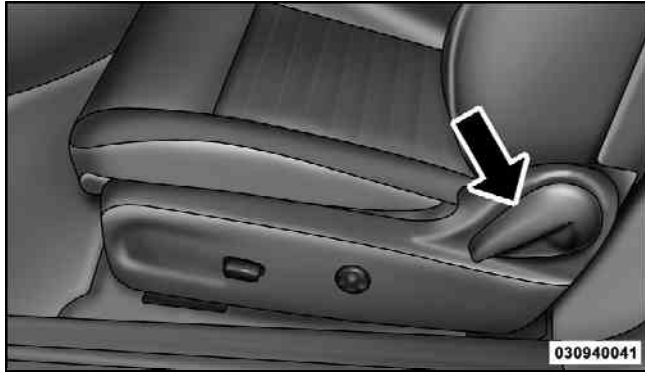

Recline Lever

### WARNING!

**Do not ride with the seatback reclined so that the shoulder belt is no longer resting against your chest. In a collision you could slide under the seat belt, which could result in serious injury or death.**

### Passenger Seat Easy Entry

On the passenger seat, pull forward on the lever located on the side of the seatback in order to dump the seatback and slide the seat forward. You can also temporarily remove the seat belt from the guide loop on the seat and allow the seat belt to retract out of the way. This allows for easier access to the rear seat. To return the seat to a normal seating position, first return the seatback to its original recline location and then slide the entire seat back to the pre-set lock position.

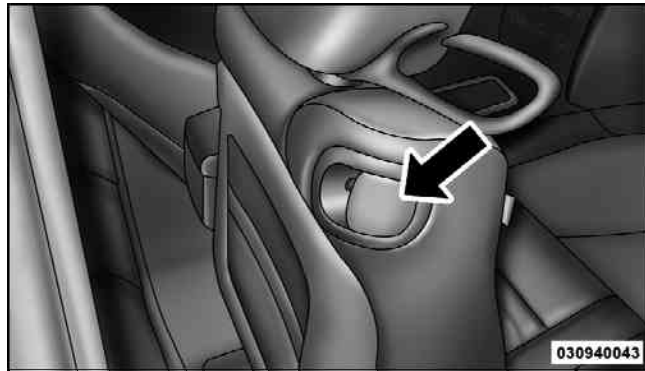

Easy Entry Lever

### Head Restraints

Head restraints are designed to reduce the risk of injury by restricting head movement in the event of a rear impact. Head restraints should be adjusted so that the top of the head restraint is located above the top of your ear.



**WARNING!**

The head restraints for all occupants must be properly adjusted prior to operating the vehicle or occupying a seat. Head restraints should never be adjusted while the vehicle is in motion. Driving a vehicle with the head restraints improperly adjusted or removed could cause serious injury or death in the event of a collision.

**Active Head Restraints — Front Seats**

The front driver and passenger seats are equipped with Active Head Restraints (AHR). In the event of a rear impact the AHRs will automatically extend forward minimizing the gap between the back of the occupants head and the AHR.

The AHRs will automatically return to their normal position following a rear impact. If the AHRs do not return to their normal position see your authorized dealer immediately.

To raise the head restraint, pull upward on the head restraint. To lower the head restraint, press the push button, located at the base of the head restraint, and push downward on the head restraint.

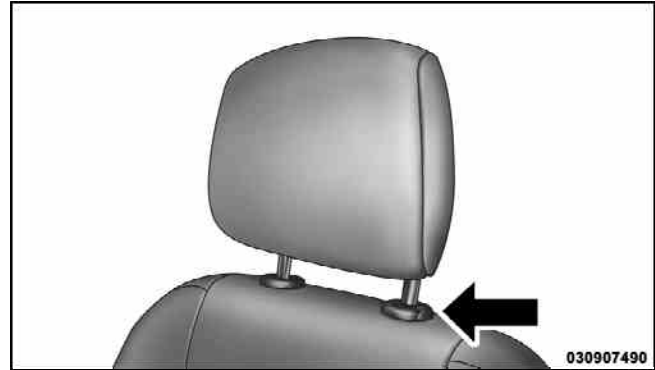

**Push Button**

**NOTE:** The head restraints should only be removed by qualified technicians, for service purposes only. If either of the head restraints require removal, see your authorized dealer.

### WARNING!

Do not place items over the top of the Active Head Restraint, such as coats, seat covers or portable DVD players. These items may interfere with the operation of the Active Head Restraint in the event of a collision and could result in serious injury or death.

### Rear Head Restraints

The center rear head restraint has two positions, up or down. When the seat is being occupied the head restraint should be raised. When there are no occupants in the center seat position the head restraint can be lowered for maximum visibility for the driver.

To raise the head restraint, pull upward on the head restraint. To lower the head restraint, press the push button, located at the base of the head restraint, and push downward on the head restraint.

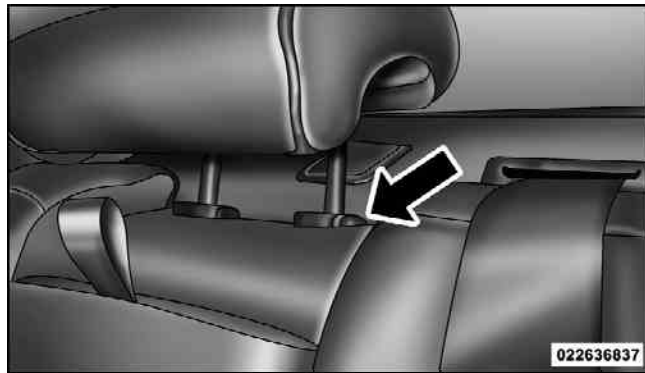

Push Button

**NOTE:** The outboard head restraints are not adjustable. Refer to “Occupant Restraints” in “Things To Know Before Starting Your Vehicle” for tether routing.

## Folding Rear Seat

The rear seatbacks can be folded forward to provide an additional storage area. Pull on the loops located on the upper part of the rear seatback to fold down either or both seatbacks. These loops can be tucked away when not in use.

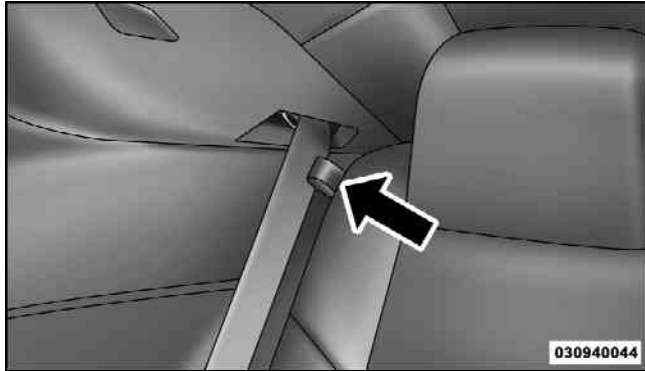

Folding Rear Seat

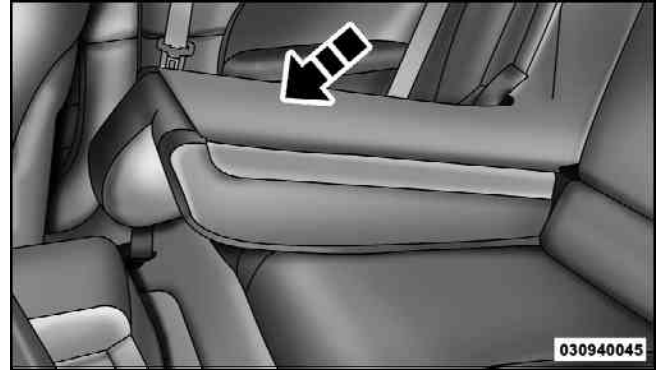

Folded Rear Seat

When the seatback is folded to the upright position, make sure it is latched by strongly pulling on the top of the seatback above the seat strap.

**WARNING!**

- Be certain that the seatback is securely locked into position. If the seatback is not securely locked into position, the seat will not provide the proper stability for child seats and/or passengers. An improperly latched seat could cause serious injury.
- The cargo area in the rear of the vehicle (with the rear seatbacks in the locked-up or folded down position) should not be used as a play area by children when the vehicle is in motion. They could be seriously injured in a collision. Children should be seated and using the proper restraint system.

**TO OPEN AND CLOSE THE HOOD**

Two latches must be released to open the hood.

1. Pull the hood release lever located under the left side of the instrument panel.

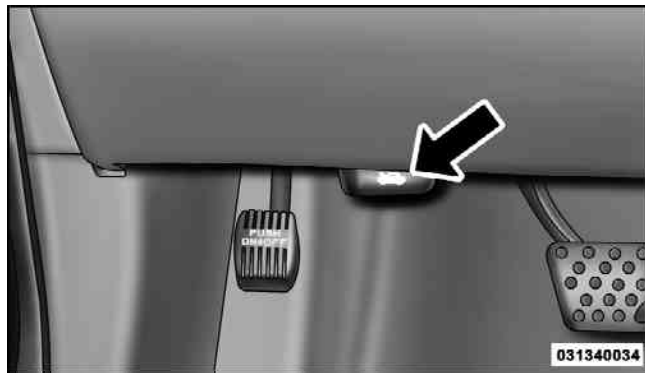

Hood Release Lever

2. Move to the outside of the vehicle and push the safety catch to the left. The safety catch is located under the center front edge of the hood.

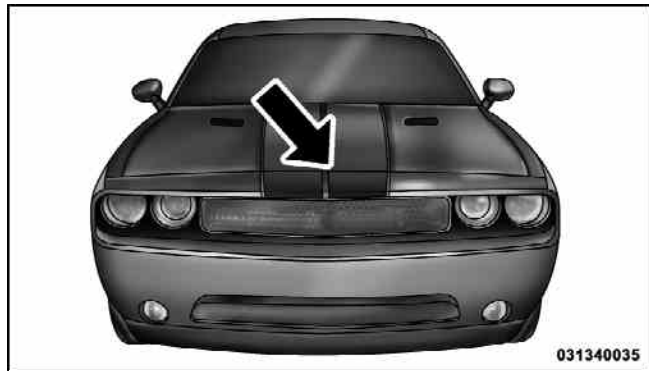

Hood Safety Catch

### CAUTION!

To prevent possible damage, do not slam the hood to close it. Lower the hood until it is open approximately 6 in (15 cm), and then drop it. This should secure both latches. Never drive your vehicle unless the hood is fully closed, with both latches engaged.

### WARNING!

Be sure the hood is fully latched before driving your vehicle. If the hood is not fully latched, it could open when the vehicle is in motion and block your vision. Failure to follow this warning could result in serious injury or death.

## LIGHTS

### Headlights And Parking Lights

The headlight switch is located on the left side of the instrument panel. This switch controls the operation of the headlights, parking lights, instrument panel lights, instrument panel light dimming, interior lights and fog lights.



Headlight Switch

Rotate the headlight switch clockwise to the first detent for parking light and instrument panel light operation. Turn it to the second detent for headlight, parking light and instrument panel light operation.

### Automatic Headlights

This system automatically turns the headlights on or off according to ambient light levels. To turn the system on, rotate the headlight switch counterclockwise to the A (AUTO) position. When the system is on, the headlight time delay feature is also on. This means the headlights will stay on for up to 90 seconds after placing the ignition in the OFF position. To turn the Automatic system off, move the headlight switch out of the AUTO position.

**NOTE:** The engine must be running before the headlights will come on in the automatic mode.

### **Headlights On With Wipers (Available With Automatic Headlights Only)**

When this feature is active, the headlights will turn on approximately 10 seconds after the wipers are turned on if the headlight switch is placed in the AUTO position. In addition, the headlights will turn off when the wipers are turned off if they were turned on by this feature.

The Headlights On with Wipers feature can be enabled or disabled. Refer to “Electronic Vehicle Information Center (EVIC)/Customer-Programmable Features” in “Understanding Your Instrument Panel” for further information.

### **Headlight Time Delay**

This feature provides the safety of headlight illumination for up to 90 seconds when leaving your vehicle in an unlit area.

To activate the delay feature, place the ignition in the OFF position while the headlights are still on. Then, turn off the headlights within 45 seconds. The delay interval begins when the headlight switch is turned off.

If you turn the headlights or parking lights, or place the ignition in the RUN position, the system will cancel the delay.

If you turn the headlights off before the ignition, they will turn off in the normal manner.

**NOTE:** The lights must be turned off within 45 seconds of placing the ignition in the OFF position to activate this feature.

The Headlight delay time is programmable. Refer to “Electronic Vehicle Information Center (EVIC)/Customer-Programmable Features” in “Understanding Your Instrument Panel” for further information.

### Daytime Running Lights — If Equipped

The high beam headlights will come on as Daytime Running Lights whenever the ignition is placed in the RUN position, the headlights are off and the parking brake is released. The headlight switch must be used for normal nighttime driving.

### Lights-On Reminder

If the headlights or parking lights are on after the ignition is placed in the OFF position, a chime will sound to alert the driver when the driver's door is opened.

### Fog Lights

 The front fog light switch is built into the headlight switch. To activate the front fog lights, turn on the parking lights or the low beam headlights and press the headlight switch. To turn off the front fog lights, either press the headlight switch again or turn off the headlight switch.

An indicator light in the instrument cluster illuminates when the fog lights are turned on.

**NOTE:** The fog lights will operate with the low beam headlights or parking lights on. However, selecting the high beam headlights will turn off the fog lights.

### Multifunction Lever

The multifunction lever controls the operation of the turn signals, headlight beam selection, and passing lights. The multifunction lever is located on the left side of the steering column.





031563089

### Multifunction Lever

#### Turn Signals

Move the multifunction lever up or down and the arrows on each side of the instrument cluster flash to show proper operation of the front and rear turn signal lights.

#### NOTE:

- If either light remains on and does not flash, or there is a very fast flash rate, check for a defective outside light bulb. If an indicator fails to light when the lever is moved, it would suggest that the indicator bulb is defective.
- A “Turn Signal On” message will appear in the Electronic Vehicle Information Center (EVIC) and a continuous chime will sound if the vehicle is driven more than 1 mile (1.6 km) with either turn signal on.

#### Lane Change Assist

Tap the lever up or down once, without moving beyond the detent and the turn signal (right or left) will flash three times then automatically turn off.

#### High/Low Beam Switch

Push the multifunction lever away from you to switch the headlights to high beam. Pull the multifunction lever toward you to switch the headlights back to low beam.

### Flash-To-Pass

You can signal another vehicle with your headlights by lightly pulling the multifunction lever toward you. This will turn on the high beam headlights until the lever is released.

**NOTE:** If the multifunction lever is held in the flash-to-pass position for more than 15 seconds, the high beams will shut off.

### Map/Reading Lights

These lights are mounted between the sun visors on the overhead console. Each light is turned on by pressing the lens. Press the lens a second time to turn off the light. These lights also turn on when a door is opened, or when the UNLOCK button on the Remote Keyless Entry (RKE) transmitter is pressed, or when the dimmer control is turned fully upward, past the second detent.



Overhead Console

## Interior Lights

The interior lights come on when a door is opened.

To protect the battery, the interior lights will turn off automatically 10 minutes after the ignition is placed in the OFF position. This will occur if the interior lights were switched on manually or are on because a door is open. This includes the glove box light, but not the trunk light. To restore interior light operation, either place the ignition in the RUN position or cycle the light switch.

## Dimmer Control

The dimmer control is located to the right of the headlight switch. With the parking lights or headlights on, rotating the dimmer control upward will increase the brightness of the instrument panel lights and, if so equipped, the lighting in the door map pockets, door handles and cupholders.

## Dome Light Position

Rotate the dimmer control completely upward to the second detent to turn on the interior lights. The interior lights will remain on when the dimmer control is in this position.

## Interior Light Defeat (OFF)

Rotate the dimmer control to the extreme bottom off position. The interior lights will remain off when the doors are open.

## Parade Mode (Daytime Brightness Feature)

Rotate the dimmer control upward to the first detent. This feature brightens all text displays such as the odometer, Electronic Vehicle Information Center (EVIC), and radio when the parking lights or headlights are on.

## WINDSHIELD WIPERS AND WASHERS



The multifunction lever operates the windshield wipers and washer when the ignition is placed in the ON/RUN or ACC position. The multifunction lever is located on the left side of the steering column.



031563089

Windshield Wiper/Washer Control

Rotate the end of the multifunction lever to the first detent past the intermittent settings for low-speed wiper operation, or to the second detent past the intermittent settings for high-speed wiper operation.

### CAUTION!

Turn the windshield wipers off when driving through an automatic car wash. Damage to the windshield wipers may result if the wiper switch is left in any position other than off.

### Intermittent Wiper System

Use the intermittent wiper when weather conditions make a single wiping cycle with a variable pause between cycles desirable. Rotate the end of the multifunction lever to the first detent position, and then turn the end of the lever to select the desired delay interval. There are four delay settings, which allow you to regulate the wipe interval from a minimum of one cycle every second

to a maximum of approximately 18 seconds between cycles. The delay intervals will double in duration when the vehicle speed is 10 mph (16 km/h) or less.

### **Mist Feature**

Rotate the end of the lever downward to the Mist position to activate a single wipe cycle to clear off road mist or spray from a passing vehicle. The wipers will continue to operate until you release the multifunction lever.

**NOTE:** The mist feature does not activate the washer pump; therefore, no washer fluid will be sprayed on the windshield. The wash function must be used in order to spray the windshield with washer fluid.

### **Windshield Washers**

To use the washer, push the multifunction lever inward (toward the steering column) and hold it for as long as washer spray is desired.

If you activate the washer while the windshield wiper control is in the delay range, the wipers will operate for three wipe cycles after releasing the multifunction lever and then resume the intermittent interval previously selected.

If you activate the washer while the windshield wiper is turned off, the wipers will operate for three wipe cycles and then turn off.

### **WARNING!**

**Sudden loss of visibility through the windshield could lead to a collision. You might not see other vehicles or other obstacles. To avoid sudden icing of the windshield during freezing weather, warm the windshield with the defroster before and during windshield washer use.**

### Headlights On With Wipers (Available With Automatic Headlights Only)

When this feature is active, the headlights will turn on approximately 10 seconds after the wipers are turned on if the headlight switch is placed in the A (AUTO) position. In addition, the headlights will turn off when the wipers are turned off if they were turned on by this feature.

The Headlights On with Wipers feature can be enabled or disabled. Refer to “Electronic Vehicle Information Center (EVIC)/Personal Settings (Customer-Programmable Features)” in “Understanding Your Instrument Panel” for further information.

### TILT/TELESCOPING STEERING COLUMN

This feature allows you to tilt the steering column upward or downward. It also allows you to lengthen or shorten the steering column. The tilt/telescoping control handle is located below the steering wheel at the end of the steering column.

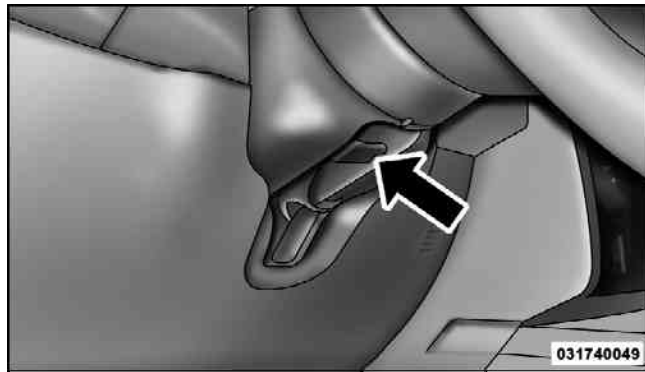

**Tilt Steering Column Lever**

To unlock the steering column, push the lever downward (toward the floor). To tilt the steering column, move the steering wheel upward or downward as desired. To lengthen or shorten the steering column, pull the steering wheel outward or push it inward as desired. To lock the steering column in position, push the lever upward until fully engaged.

**WARNING!**

Do not adjust the steering column while driving. Adjusting the steering column while driving or driving with the steering column unlocked, could cause the driver to lose control of the vehicle. Be sure the steering column is locked before driving your vehicle. Failure to follow this warning may result in serious injury or death.

**HEATED STEERING WHEEL — IF EQUIPPED**

The steering wheel contains a heating element that helps warm your hands in cold weather. The heated steering wheel has only one temperature setting. Once the heated steering wheel has been turned on it will operate for approximately 58 to 70 minutes before automatically shutting off. The heated steering wheel can shut off early or may not turn on when the steering wheel is already warm.

The heated steering wheel switch is located on the switch bank below the climate controls.



031705825

Press the switch to turn on the heated steering wheel. The light on the switch will illuminate to indicate the steering wheel heater is on. Pressing the switch a second time will turn off the heated steering wheel and light indicator.

**NOTE:** The engine must be running for the heated steering wheel to operate.

***Vehicles Equipped With Remote Start***

On models that are equipped with remote start, the heated steering wheel can be programmed to come on during a remote start. Refer to “Remote Starting System — If Equipped” in “Things to Know Before Starting Your Vehicle” for further information.

**WARNING!**

- Persons who are unable to feel pain to the skin because of advanced age, chronic illness, diabetes, spinal cord injury, medication, alcohol use, exhaustion, or other physical conditions must exercise care when using the steering wheel heater. It may cause burns even at low temperatures, especially if used for long periods.
- Do not place anything on the steering wheel that insulates against heat, such as a blanket or steering wheel covers of any type and material.. This may cause the steering wheel heater to overheat.

**ELECTRONIC SPEED CONTROL — IF EQUIPPED**

When engaged, the Electronic Speed Control takes over accelerator operations at speeds greater than 25 mph (40 km/h).

The Electronic Speed Control buttons are located on the right side of the steering wheel.

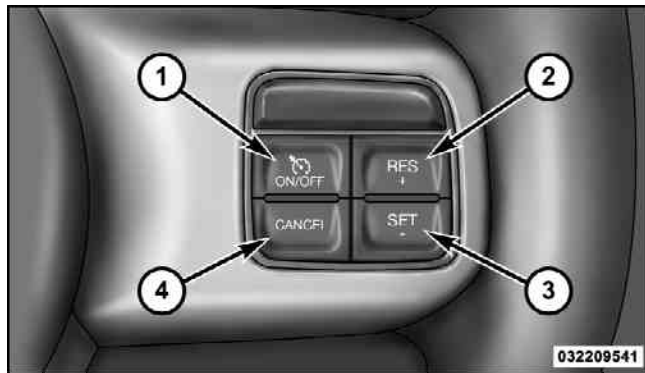

**Electronic Speed Control Buttons**

- |            |           |
|------------|-----------|
| 1 — ON/OFF | 2 — RES + |
| 4 — CANCEL | 3 — SET - |

**NOTE:** In order to ensure proper operation, the Electronic Speed Control System has been designed to shut



down if multiple Speed Control functions are operated at the same time. If this occurs, the Electronic Speed Control System can be reactivated by pushing the Electronic Speed Control ON/OFF button and resetting the desired vehicle set speed.

### **To Activate**

Push the ON/OFF button. The Cruise Indicator Light in the instrument cluster will illuminate. To turn the system off, push the ON/OFF button a second time. The Cruise Indicator Light will turn off. The system should be turned off when not in use.

### **WARNING!**

**Leaving the Electronic Speed Control system on when not in use is dangerous. You could accidentally set the system or cause it to go faster than you want. You could lose control and have an accident. Always leave the system OFF when you are not using it.**

### **To Set A Desired Speed**

Turn the Electronic Speed Control ON. When the vehicle has reached the desired speed, press the SET (-) button and release. Release the accelerator and the vehicle will operate at the selected speed.

**NOTE:** The vehicle should be traveling at a steady speed and on level ground before pressing the SET button.

### **To Deactivate**

A soft tap on the brake pedal, pushing the CANCEL button, or normal brake pressure while slowing the vehicle will deactivate Electronic Speed Control without erasing the set speed memory. Pressing the ON/OFF button or turning the ignition switch OFF erases the set speed memory.

### **To Resume Speed**

To resume a previously set speed, push the RES (+) button and release. Resume can be used at any speed above 20 mph (32 km/h).

### **To Vary The Speed Setting**

When the Electronic Speed Control is set, you can increase speed by pushing the RES (+) button. If the button is continually pressed, the set speed will continue to increase until the button is released, then the new set speed will be established.

Pressing the RES (+) button once will result in a 1 mph (2 km/h) increase in set speed. Each subsequent tap of the button results in an increase of 1 mph (2 km/h).

To decrease speed while the Electronic Speed Control is set, push the SET (-) button. If the button is continually held in the SET (-) position, the set speed will continue to decrease until the button is released. Release the button when the desired speed is reached, and the new set speed will be established.

Pressing the SET (-) button once will result in a 1 mph (2 km/h) decrease in set speed. Each subsequent tap of the button results in a decrease of 1 mph (2 km/h).

### **To Accelerate For Passing**

Press the accelerator as you would normally. When the pedal is released, the vehicle will return to the set speed.

### **Using Electronic Speed Control On Hills**

The transmission may downshift on hills to maintain the vehicle set speed.

**NOTE:** The Electronic Speed Control system maintains speed up and down hills. A slight speed change on moderate hills is normal.

On steep hills, a greater speed loss or gain may occur so it may be preferable to drive without Electronic Speed Control.

**WARNING!**

Electronic Speed Control can be dangerous where the system cannot maintain a constant speed. Your vehicle could go too fast for the conditions, and you could lose control and have an accident. Do not use Electronic Speed Control in heavy traffic or on roads that are winding, icy, snow-covered or slippery.

**OVERHEAD CONSOLE**

The overhead console contains courtesy/reading lights and sunglasses storage. Universal Garage Door Opener (HomeLink®) button and a power sunroof switch may also be included, if equipped.

**Overhead Console****Courtesy/Reading Lights**

At the forward end of the overhead console are two courtesy/reading lights.

Press the lens to turn on the light. Press it a second time to turn off the light.

These lights also turn on when a door is opened, when the UNLOCK button on the Remote Keyless Entry (RKE) transmitter is pressed, or when the dimmer control is turned fully upward, past the second detent.

### **Sunglasses Storage**

At the rear of the console, a compartment is provided for the storage of a pair of sunglasses.

The storage compartment access is a “push/push” design. Push on the raised bar on the compartment door to open. Push on the raised bar to close.

### **GARAGE DOOR OPENER — IF EQUIPPED**

HomeLink® replaces up to three hand-held transmitters that operate devices such as garage door openers, motorized gates, lighting or home security systems. The HomeLink® unit is powered by your vehicle's 12 Volt battery.

The HomeLink® buttons that are located in the overhead console designate the three different HomeLink® channels.

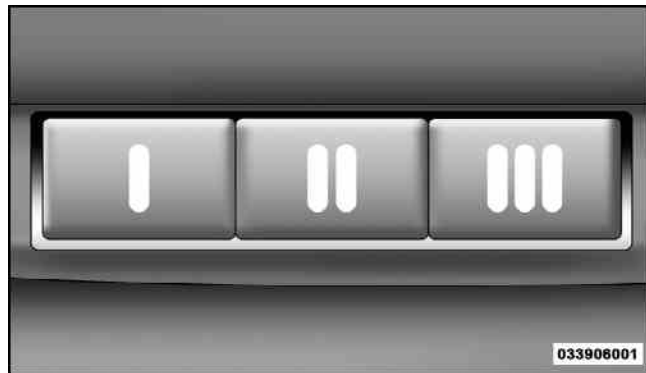

**HomeLink® Buttons**

**NOTE:** HomeLink® is disabled when the Vehicle Security Alarm is active.

**Before You Begin Programming HomeLink®**

Be sure that your vehicle is parked outside of the garage before you begin programming.

For more efficient programming and accurate transmission of the radio-frequency signal it is recommended that a new battery be placed in the hand-held transmitter of the device that is being programmed to the HomeLink® system.

Erase all channels before you begin programming. To erase the channels place the ignition in the ON/RUN position and press and hold the two outside HomeLink®

buttons (I and III) for up 20 seconds. The Electronic Vehicle Information Center (EVIC) will display “CLEARING CHANNELS”. Release the buttons when the EVIC displays “CHANNELS CLEARED”.

**NOTE:**

- Erasing all channels should only be performed when programming HomeLink® for the first time. Do not erase channels when programming additional buttons.
- If you have any problems, or require assistance, please call toll-free 1-800-355-3515 or, on the Internet at [www.HomeLink.com](http://www.HomeLink.com) for information or assistance.

### Programming A Rolling Code

For programming garage door openers that were manufactured after 1995. These garage door openers can be identified by the "LEARN" or "TRAIN" button located where the hanging antenna is attached to the garage door opener. It is NOT the button that is normally used to open and close the door. The name and color of the button may vary by manufacturer.

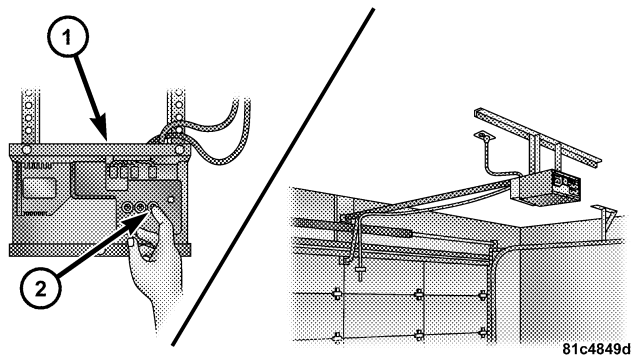

#### Training The Garage Door Opener

- 1 — Door Opener
- 2 — Training Button

1. Turn the ignition switch to the ON/RUN position.
2. Place the hand-held transmitter 1 to 3 inches (3 to 8 cm) away from the HomeLink<sup>®</sup> button you wish to program.

3. Simultaneously press and hold both the Homelink® button you want to program and the hand-held transmitter button.

4. Continue to hold buttons until the EVIC display changes from “CHANNEL # TRAINING” to “CHANNEL # TRAINED”, then release both buttons.

**NOTE:**

- It may take up to 30 seconds or longer in some cases for the channel to train.
- If the EVIC displays “DID NOT TRAIN” repeat from Step 2.

5. At the garage door opener motor (in the garage), locate the “LEARN” or “TRAINING” button. This can usually be found where the hanging antenna wire is attached to the garage door opener/device motor. Firmly press and release the “LEARN” or “TRAINING” button.

On some garage door openers/devices there may be a light that blinks when the garage door opener/device is in the LEARN/TRAIN mode.

**NOTE:** You have 30 seconds in which to initiate the next step after the LEARN button has been pressed.

6. Return to the vehicle and press the programmed HomeLink® button twice (holding the button for two seconds each time). The EVIC will display “CHANNEL # TRANSMIT”. If the garage door opener/device activates, programming is complete.

**NOTE:** If the garage door opener/device does not activate, press the button a third time (for two seconds) to complete the training.

To program the remaining two HomeLink® buttons, repeat each step for each remaining button. DO NOT erase the channels.

### Reprogramming A Single HomeLink® Button

To reprogram a channel that has been previously trained, follow these steps:

1. Turn the ignition switch to the ON/RUN position.
2. Press and hold the desired HomeLink® button until the EVIC displays “CHANNEL # TRAINING” **Do not release the button.**
3. **Without releasing the button** proceed with “Programming A Rolling Code” Step 2 and follow all remaining steps.

### Programming A Non-Rolling Code

For programming Garage Door Openers manufactured before 1995.

1. Turn the ignition switch to the ON/RUN position.
2. Place the hand-held transmitter 1 to 3 inches (3 to 8 cm) away from the HomeLink® button you wish to program.

3. Simultaneously press and hold both the Homelink® button you want to program and the hand-held transmitter button.

4. Continue to hold buttons until the EVIC display changes from “CHANNEL # TRAINING” to “CHANNEL # TRAINED”, then release both buttons.

#### NOTE:

- It may take up to 30 seconds or longer in some cases for the channel to train.
  - If the EVIC displays “DID NOT TRAIN” repeat from Step 2.
5. Press and hold the programmed HomeLink® button. The EVIC will display “CHANNEL # TRANSMIT”. If the garage door opener/device activates, programming is complete.



To program the remaining two HomeLink® buttons, repeat each step for each remaining button. DO NOT erase the channels.

### Reprogramming A Single HomeLink® Button

To reprogram a channel that has been previously trained, follow these steps:

1. Turn the ignition switch to the ON/RUN position.
2. Press and hold the desired HomeLink® button until the EVIC displays “CHANNEL # TRAINING” **Do not release the button.**
3. **Without releasing the button** proceed with “Programming A Non-Rolling Code” Step 2 and follow all remaining steps.

### Canadian/Gate Operator Programming

For programming transmitters in Canada/United States that require the transmitter signals to “time-out” after several seconds of transmission.

Canadian radio frequency laws require transmitter signals to time-out (or quit) after several seconds of transmission – which may not be long enough for HomeLink® to pick up the signal during programming. Similar to this Canadian law, some U.S. gate operators are designed to time-out in the same manner.

It may be helpful to unplug the device during the cycling process to prevent possible overheating of the garage door or gate motor.

1. Turn the ignition switch to the ON/RUN position.
2. Place the hand-held transmitter 1 to 3 inches (3 to 8 cm) away from the HomeLink® button you wish to program.

3. Simultaneously press and hold both the Homelink® button while you press and release (“cycle”), your hand-held transmitter every two seconds.

4. Continue to hold buttons until the EVIC display changes from “CHANNEL # TRAINING” to “CHANNEL # TRAINED”, then release both buttons.

**NOTE:**

- It may take up to 30 seconds or longer in some cases for the channel to train.
- If the EVIC displays “DID NOT TRAIN” repeat from Step 2.

5. Press and hold the programmed HomeLink® button. The EVIC will display “CHANNEL # TRANSMIT”. If the device is plugged in and activates, programming is complete.

If you unplugged the garage door opener/device for programming, plug it back in at this time.

### Reprogramming A Single HomeLink® Button

To reprogram a channel that has been previously trained, follow these steps:

1. Turn the ignition switch to the ON/RUN position.
2. Press and hold the desired HomeLink® button until the EVIC displays “CHANNEL # TRAINING” **Do not release the button.**
3. **Without releasing the button** proceed with “Canadian/Gate Operator Programming” Step 2 and follow all remaining steps.

### Using HomeLink®

To operate, press and release the programmed HomeLink® button. Activation will now occur for the programmed device (i.e., garage door opener, gate operator, security system, entry door lock, home/office lighting, etc.). The hand-held transmitter of the device may also be used at any time.

## Security

It is advised to erase all channels before you sell or turn in your vehicle.

To erase the channels press and hold the two outside HomeLink® buttons (I and III) for up 20 seconds. The Electronic Vehicle Information Center (EVIC) will display “CLEARING CHANNELS”. Release the buttons when the EVIC displays “CHANNELS CLEARED”.

The HomeLink® Universal Transceiver is disabled when the Vehicle Security Alarm is active.

## Troubleshooting Tips

If you are having trouble programming HomeLink®, here are some of the most common solutions:

- Replace the battery in the original hand-held transmitter.
- Press the LEARN button on the Garage Door Opener to complete the training for a Rolling Code.
- Did you unplug the device for programming and remember to plug it back in?

If you have any problems, or require assistance, please call toll-free 1-800-355-3515 or, on the Internet at [www.HomeLink.com](http://www.HomeLink.com) for information or assistance.

**WARNING!**

- Your motorized door or gate will open and close while you are programming the universal transceiver. Do not program the transceiver if people, pets or other objects are in the path of the door or gate. Only use this transceiver with a garage door opener that has a “stop and reverse” feature as required by Federal safety standards. This includes most garage door opener models manufactured after 1982. Do not use a garage door opener without these safety features. Call toll-free 1-800-355-3515 or, on the Internet at [www.HomeLink.com](http://www.HomeLink.com) for safety information or assistance.
- Vehicle exhaust contains carbon monoxide, a dangerous gas. Do not run your vehicle in the garage while programming the transceiver. Exhaust gas can cause serious injury or death.

**General Information**

This device complies with FCC rules Part 15 and Industry Canada RSS-210. Operation is subject to the following two conditions:

1. This device may not cause harmful interference.
2. This device must accept any interference that may be received including interference that may cause undesired operation.

**NOTE:**

- The transmitter has been tested and it complies with FCC and IC rules. Changes or modifications not expressly approved by the party responsible for compliance could void the user's authority to operate the device.
- The term IC before the certification/registration number only signifies that Industry Canada technical specifications were met.

## POWER SUNROOF — IF EQUIPPED

The power sunroof switch is located between the sun visors on the overhead console.

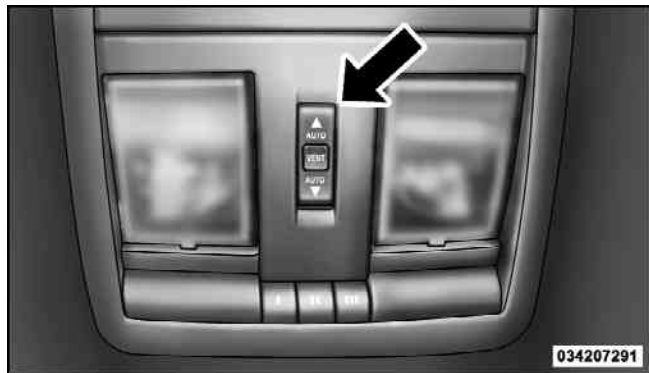

Power Sunroof Switch

### WARNING!

- Never leave children in a vehicle with the key in the ignition switch (or with the ignition in the Accessory or Run position, for vehicles equipped with Keyless Enter-N-Go). Occupants, particularly unattended children, can become entrapped by the power sunroof while operating the power sunroof switch. Such entrapment may result in serious injury or death.
- In a collision, there is a greater risk of being thrown from a vehicle with an open sunroof. You could also be seriously injured or killed. Always fasten your seat belt properly and make sure all passengers are also properly secured.

**WARNING! (Continued)**

- **Do not allow small children to operate the sunroof. Never allow your fingers, other body parts, or any object, to project through the sunroof opening. Injury may result.**

**Opening Sunroof — Express Mode**

Press the switch rearward and release it and the sunroof will open automatically from any position. The sunroof will open fully and stop automatically. This is called “Express Open”. During “Express Open” operation, any movement of the sunroof switch will stop the sunroof.

**Opening Sunroof — Manual Mode**

To open the sunroof, press and hold the switch rearward to full open.

**Closing Sunroof — Express Mode**

Press the switch forward and release it and the sunroof will close automatically from any position. The sunroof

will close fully and stop automatically. This is called “Express Close”. During “Express Close” operation, any movement of the switch will stop the sunroof.

**Closing Sunroof — Manual Mode**

To close the sunroof, press and hold the switch in the forward position.

**Pinch Protect Feature**

This feature will detect an obstruction in the opening of the sunroof during Express Close operation. If an obstruction is detected, the sunroof will automatically retract. Remove the obstruction if this occurs. Next, press the switch forward and release to Express Close.

**NOTE:** If three consecutive sunroof close attempts result in Pinch Protect reversals, the fourth close attempt will be a Manual Close movement with Pinch Protect disabled.

### **Venting Sunroof — Express**

Press and release the “Vent” button, and the sunroof will open to the vent position. This is called “Express Vent”, and will occur regardless of sunroof position. During Express Vent operation, any movement of the switch will stop the sunroof.

### **Sunshade Operation**

The sunshade can be opened manually. However, the sunshade will open automatically as the sunroof opens.

**NOTE:** The sunshade cannot be closed if the sunroof is open.

### **Wind Buffeting**

Wind buffeting can be described as the perception of pressure on the ears or a helicopter-type sound in the ears. Your vehicle may exhibit wind buffeting with the windows down, or the sunroof (if equipped) is in certain open or partially open positions. This is a normal occurrence and can be minimized. If the buffeting occurs with

the rear windows open, open the front and rear windows together to minimize the buffeting. If the buffeting occurs with the sunroof open, adjust the sunroof opening to minimize the buffeting or open any window.

### **Sunroof Maintenance**

Use only a nonabrasive cleaner and a soft cloth to clean the glass panel.

### **Ignition Off Operation**

The power sunroof switches remain active for up to approximately ten minutes after the ignition switch has been turned OFF. Opening either front door will cancel this feature.

### **ELECTRICAL POWER OUTLETS**

There are two 12 Volt (13 Amp) electrical power outlets on this vehicle. Both of the outlets are protected by a fuse.

The front 12 Volt power outlet has power available only when the ignition is placed in the ACC or RUN position.

## 166 UNDERSTANDING THE FEATURES OF YOUR VEHICLE

This power outlet will also operate a conventional cigar lighter unit. If desired, the front power outlet can be converted by your authorized dealer to provide power when the ignition is placed in the OFF position.

**NOTE:** To ensure proper operation a MOPAR® knob and element must be used.

### CAUTION!

- Do not exceed the maximum power of 160 Watts (13 Amps) at 12 Volts. If the 160 Watt (13 Amp) power rating is exceeded the fuse protecting the system will need to be replaced.
- Power outlets are designed for accessory plugs only. Do not insert any other object in the power outlets as this will damage the outlet and blow the fuse. Improper use of the power outlet can cause damage not covered by your New Vehicle Limited Warranty.

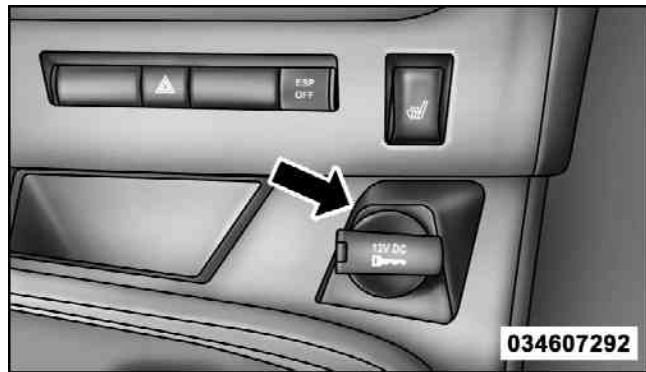

Front Power Outlet

The center console power outlet is powered directly from the battery (power available at all times).



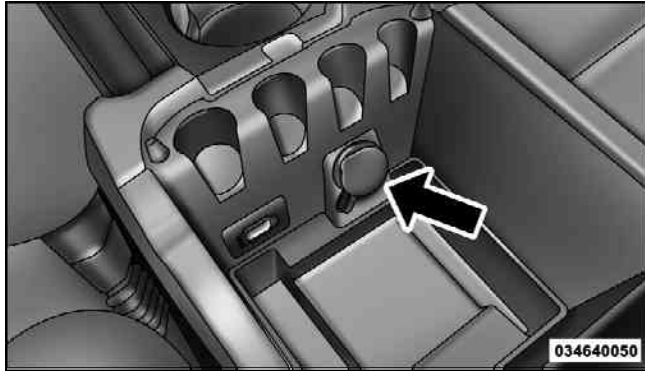

### Center Console Power Outlet

Items plugged into this power outlet may discharge the battery and/or prevent the engine from starting.

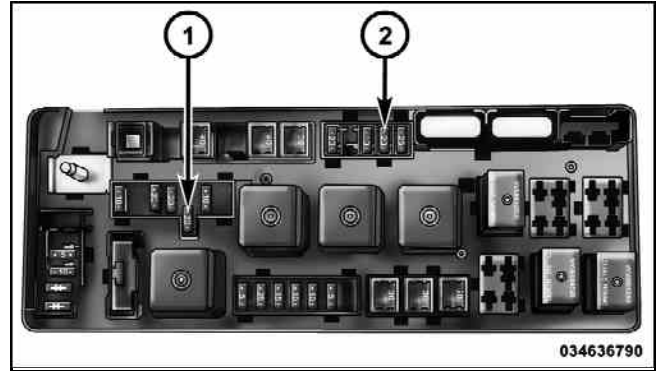

### Power Outlet Fuse Locations

- 1 — #18 Fuse 20 A Yellow Cigar Lighter Instrument Panel
- 2 — #9 Fuse 20 A Yellow Power Outlet Center Console

**WARNING!**

To avoid serious injury or death:

- Only devices designed for use in this type of outlet should be inserted into any 12 Volt outlet.
- Do not touch with wet hands.
- Close the lid when not in use and while driving the vehicle.
- If this outlet is mishandled, it may cause an electric shock and failure.

**CAUTION!**

- Many accessories that can be plugged in draw power from the vehicle's battery even when not in use (i.e., cellular phones, etc.). Eventually, if plugged in long enough, the vehicle's battery will discharge sufficiently to degrade battery life and/or prevent the engine from starting.
- Accessories that draw higher power (i.e., coolers, vacuum cleaners, lights, etc.) will degrade the battery even more quickly. Only use these intermittently and with greater caution.
- After the use of high power draw accessories or long periods of the vehicle not being started (with accessories still plugged in), the vehicle must be driven a sufficient length of time to allow the alternator to recharge the vehicle's battery.

*(Continued)*

**CAUTION! (Continued)**

- Power outlets are designed for accessory plugs only. Do not insert any other object in the power outlet as this will damage the outlet and blow the fuse. Improper use of the power outlet can cause damage not covered by your warranty.

**CUPHOLDERS****Front Cupholders**

The front cupholders are located in the center console.

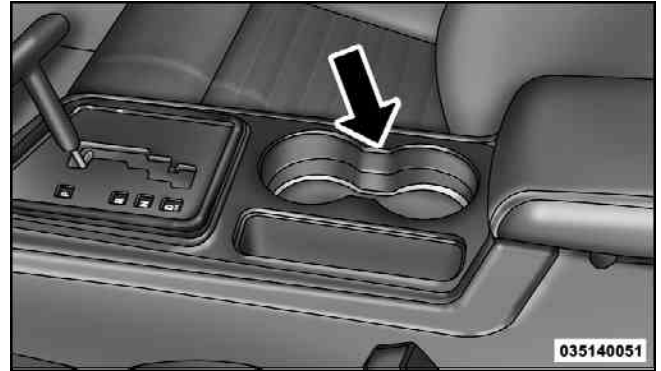

**Front Cupholders**

**Illuminated Front Cupholders — If Equipped**

The front cupholders are illuminated with LEDs. They are turned on with the headlights or parking lights. Refer to “Lights” in “Understanding The Features Of Your Vehicle” for further information.

### Rear Cupholders

The rear seat cupholders are located in the center armrest between the rear seats. The cupholders are positioned forward in the armrest and side-by-side to provide convenient access to beverage cans or bottles while maintaining a resting place for the rear occupant's elbows.

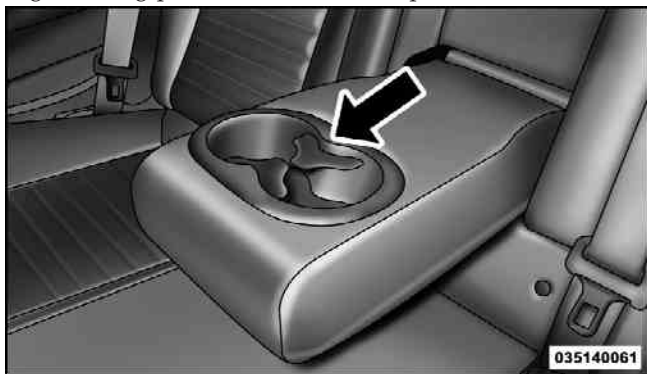

Rear Cupholders

### CONSOLE FEATURES

#### Sliding Center Console Armrest

The center console armrest slides forward with three detents to provide flexibility for comfort, cupholder use and shifting ease.

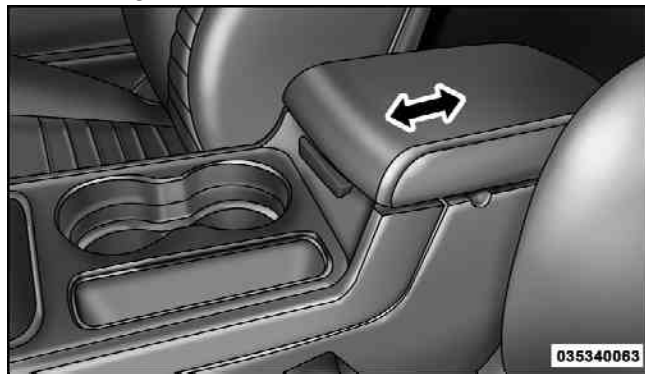

Sliding Console Armrest

### Console Storage

The center console has a storage compartment located underneath the armrest, and also contains a 12 Volt power outlet, a molded-in coin holder (designed to hold various size coins). The center console may also be equipped with a Universal Consumer Interface (UCI). UCI supports Mini, 4G, Photo, Nano, 5G iPod® and iPhone® devices. Refer to “Universal Consumer Interface (UCI) — If Equipped” in “Understanding Your Instrument Panel” for further information.

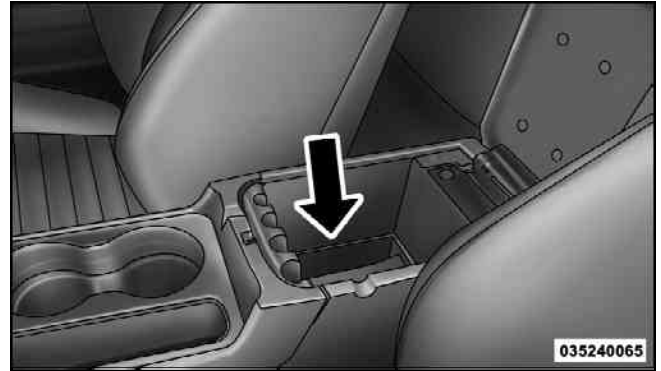

Center Console

**WARNING!**

Do not operate this vehicle with a console compartment lid in the open position. Cellular phones, music players, and other handheld electronic devices should be stowed while driving. Use of these devices while driving can cause an accident due to distraction, resulting in death or injury.

**REAR WINDOW FEATURES****Rear Window Defroster**

The rear window defroster button is located on the climate control (Mode) knob. Press this button to turn on the rear window defroster and the heated outside mirrors (if equipped). An indicator in the button will illuminate when the rear window defroster is on. The rear window defroster automatically turns off after approximately 10 minutes. For an additional five minutes of operation, press the button a second time.

**NOTE:** To prevent excessive battery drain, use the rear window defroster only when the engine is operating.

**CAUTION!**

Failure to follow these cautions can cause damage to the heating elements:

- Use care when washing the inside of the rear window. Do not use abrasive window cleaners on the interior surface of the window. Use a soft cloth and a mild washing solution, wiping parallel to the heating elements. Labels can be peeled off after soaking with warm water.
- Do not use scrapers, sharp instruments, or abrasive window cleaners on the interior surface of the window.
- Keep all objects a safe distance from the window.

# UNDERSTANDING YOUR INSTRUMENT PANEL

## CONTENTS

---

■ Instrument Panel Features . . . . .	176	□ Keyless Enter-N-Go Display — If Equipped . . . . .	198
■ Instrument Cluster . . . . .	177	□ Driver-Selectable Surround Sound (DSS) – If Equipped . . . . .	199
■ Instrument Cluster Descriptions . . . . .	178	□ Compass Display . . . . .	200
■ Electronic Vehicle Information Center (EVIC) . . . . .	188	□ System Warnings (Customer Information Features) . . . . .	202
□ Electronic Vehicle Information Center (EVIC) Displays . . . . .	190	□ Personal Settings (Customer-Programmable Features) . . . . .	202
□ Engine Oil Change Indicator System . . . . .	192		
□ Trip Functions . . . . .	193		
□ Performance Features . . . . .	195		

- Media Center 730N/430/430N (RHR/RER/RBZ/RHB) CD/DVD/HDD/NAV — If Equipped . . . . . 206
  - Operating Instructions (Voice Command System) — If Equipped . . . . . 206
  - Operating Instructions (Uconnect™ Phone) — If Equipped . . . . . 206
- Media Center 130 (Sales Code RES) . . . . . 207
  - Operating Instructions — Radio Mode . . . . . 207
  - Operation Instructions — CD Mode For CD And MP3 Audio Play . . . . . 210
  - Notes On Playing MP3 Files . . . . . 212
  - Operation Instructions - Auxiliary Mode . . . . . 215
- Media Center 130 With Satellite Radio (Sales Code RES+RSC). . . . . 215
  - Operating Instructions — Radio Mode . . . . . 216
  - Operation Instructions — CD Mode For CD And MP3 Audio Play . . . . . 221
  - Notes On Playing MP3 Files . . . . . 223
  - List Button (CD Mode For MP3 Play) . . . . . 226
  - Info Button (CD Mode For MP3 Play) . . . . . 226
  - Uconnect™ Multimedia (Satellite Radio) — If Equipped . . . . . 227
- iPod®/USB/MP3 Control — If Equipped . . . . . 231
  - Connecting The iPod® Or External USB Device . . . . . 232
  - Using This Feature . . . . . 233



<ul style="list-style-type: none"> <li>□ Controlling The iPod® Or External USB Device Using Radio Buttons . . . . . 233</li> <li>□ Play Mode . . . . . 233</li> <li>□ List Or Browse Mode . . . . . 235</li> <li>□ Bluetooth Streaming Audio (BTSA) . . . . . 237</li> <li>■ Harman Kardon® Logic7® High Performance Multichannel Surround Sound System With Driver-Selectable Surround (DSS) — If Equipped . . . . . 238</li> <li>■ Steering Wheel Audio Controls . . . . . 239             <ul style="list-style-type: none"> <li>□ Radio Operation . . . . . 240</li> </ul> </li> </ul>	<ul style="list-style-type: none"> <li>□ CD Player . . . . . 240</li> <li>■ CD/DVD Disc Maintenance . . . . . 241</li> <li>■ Radio Operation And Mobile Phones . . . . . 241</li> <li>■ Climate Controls . . . . . 242             <ul style="list-style-type: none"> <li>□ Automatic Temperature Control (ATC) . . . . . 242</li> <li>□ Automatic Operation . . . . . 242</li> <li>□ Blower Control . . . . . 243</li> <li>□ Manual Operation . . . . . 243</li> <li>□ Operating Tips . . . . . 247</li> </ul> </li> </ul>
--	---

## INSTRUMENT PANEL FEATURES

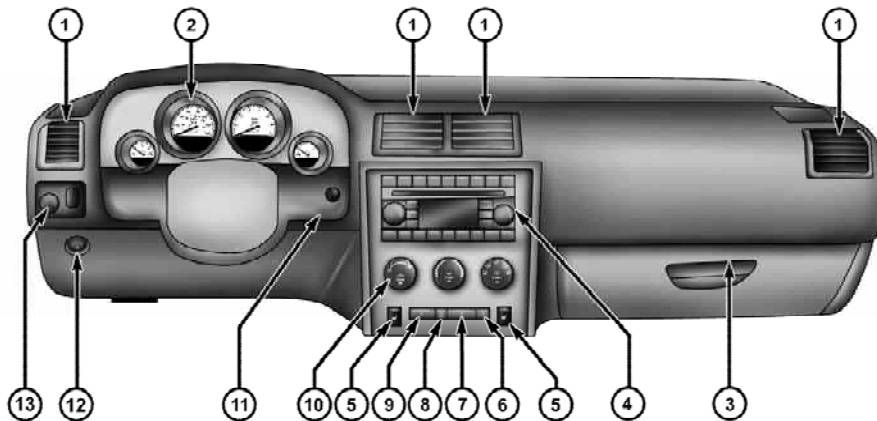

040164072

- 1 — Air Outlets
- 2 — Instrument Cluster
- 3 — Glove Compartment
- 4 — Radio
- 5 — Heated Seat Switch

- 6 — ESC OFF Switch
- 7 — Sport Button
- 8 — Hazard Warning Switch
- 9 — Heated Steering Wheel Switch
- 10 — Climate Control

- 11 — Ignition Switch
- 12 — Trunk Release Button
- 13 — Headlight Switch

## INSTRUMENT CLUSTER

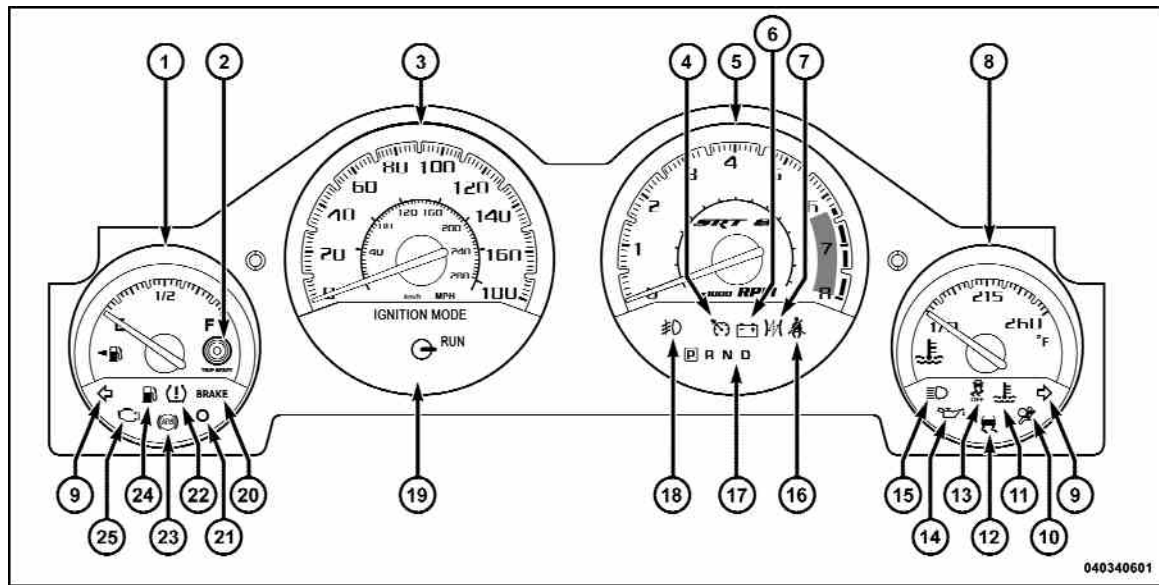

## INSTRUMENT CLUSTER DESCRIPTIONS

### 1. *Fuel Gauge*

The pointer shows the level of fuel in the fuel tank when the ignition switch is in the ON/RUN position.

### 2. *Trip Odometer Button*

Press this button to change the display from odometer to either of two trip odometer settings. The letter "A" or "B" will appear when in the trip odometer mode. Push in and hold the button for two seconds to reset the trip odometer to 0 miles (km). The odometer must be in TRIP mode to reset it.

### 3. *Speedometer*

Indicates vehicle speed.

### 4. *Electronic Speed Control Indicator Light*



This light will turn on when the electronic speed control is on.

### 5. *Tachometer*

The red segments indicate the maximum permissible engine revolutions per minute (RPM x 1000) for each gear range. Ease up on the accelerator before reaching the red area.

### 6. *Charging System Warning Light*



This light shows the status of the electrical charging system. The light should turn on when the ignition switch is first placed in ON/RUN and remain on briefly as a bulb check. If the light stays on or turns on while driving, turn off some of the vehicle's non-essential electrical devices (i.e., radio) or slightly increase engine speed (if at idle). If the light remains on, it means that the charging system is experiencing a problem. See your local authorized dealer to obtain service immediately.

If jump starting is required, refer to "Jump Starting Procedures" in "What To Do In Emergencies".

### 7. *Electronic Throttle Control (ETC) Warning Light*



This light will turn on briefly as a bulb check when the ignition switch is placed in ON/RUN. This light will also turn on while the engine is running if there is a problem with the Electronic Throttle Control (ETC) system.

If the light comes on while the engine is running, safely bring the vehicle to a complete stop as soon as possible, place the shift lever in PARK, and cycle the ignition key. The light should turn off. If the light remains lit with the engine running, your vehicle will usually be drivable. However, see an authorized dealer for service as soon as possible.

If the light is flashing when the engine is running, immediate service is required. In this case, you may experience reduced performance, an elevated/rough idle or engine stall, and your vehicle may require towing.

Also, have the system checked by an authorized dealer if the light does not come on during starting.

### 8. *Temperature Gauge*

The temperature gauge shows engine coolant temperature. Any reading within the normal range indicates that the engine cooling system is operating satisfactorily.

The gauge pointer will likely indicate a higher temperature when driving in hot weather, up mountain grades, or when towing a trailer. It should not be allowed to exceed the upper limits of the normal operating range.

#### **CAUTION!**

**Driving with a hot cooling system could damage your vehicle. If the temperature gauge reads 240°F (116°C) or greater, pull over and stop the vehicle. Idle the vehicle with the air conditioner turned off until the pointer drops back into the normal range 200–230°F (93–110°C). If the pointer remains at 240°F (116°C) or greater and you hear a chime, turn the engine OFF immediately and call for service.**

**WARNING!**

A hot engine cooling system is dangerous. You or others could be badly burned by steam or boiling coolant. You may want to call a service center if your vehicle overheats. If you decide to look under the hood yourself, refer to “Maintaining Your Vehicle” and follow the warnings under the Cooling System Pressure Cap paragraph.

**9. Turn Signal Indicators**

The arrow will flash with the exterior turn signal when the turn signal lever is operated.

**NOTE:**

- A continuous chime will sound if the vehicle is driven more than 1 mile (1.6 km) with either turn signal on.
- Check for an inoperative outside light bulb if either indicator flashes at a rapid rate.

**10. Air Bag Warning Light**

This light will turn on for four to eight seconds as a bulb check when the ignition switch is first turned to the ON/RUN position. If the light is either not on during starting, stays on, or turns on while driving, have the system inspected at an authorized dealer as soon as possible. Refer to “Occupant Restraints” in “Things To Know Before Starting Your Vehicle” for further information.

**11. Engine Temperature Warning Light**

This light will turn on and a single chime will sound to warn of an overheated engine condition. When this light turns on, the engine temperature is critically hot. The vehicle should be turned OFF immediately and serviced as soon as possible.

## 12. *Electronic Stability Control (ESC) Activation/ Malfunction Indicator Light — If Equipped*



The “ESC Activation/Malfunction Indicator Light” in the instrument cluster will come on when the ignition switch is turned to the ON/RUN position. It should go out with the engine running. If the “ESC Activation/Malfunction Indicator Light” comes on continuously with the engine running, a malfunction has been detected in the ESC system. If this light remains on after several ignition cycles, and the vehicle has been driven several miles (kilometers) at speeds greater than 30 mph (48 km/h), see your authorized dealer as soon as possible to have the problem diagnosed and corrected.

### NOTE:

- The “ESC Off Indicator Light” and the “ESC Activation/ Malfunction Indicator Light” come on momentarily each time the ignition switch is turned to ON/RUN.

- Each time the ignition is turned to ON/RUN, the ESC system will be ON, even if it was turned off previously.
- The ESC system will make buzzing or clicking sounds when it is active. This is normal; the sounds will stop when ESC becomes inactive following the maneuver that caused the ESC activation.

## 13. *Electronic Stability Control (ESC) OFF Indicator Light — If Equipped*



This light indicates the Electronic Stability Control (ESC) is off.

## 14. *Oil Pressure Warning Light*



This light indicates low engine oil pressure. The light should turn on momentarily when the engine is started. If the light turns on while driving, stop the vehicle and shut off the engine as soon as possible. A chime will sound for four minutes when this light turns on.

Do not operate the vehicle until the cause is corrected. This light does not indicate how much oil is in the engine. The engine oil level must be checked under the hood.

### 15. High Beam Indicator

 This indicator will turn on when the high beam headlights are on. Push the multifunction lever away from the steering wheel to switch the headlights to high beam.

### 16. Seat Belt Reminder Light

 This light will turn on for four to eight seconds as a bulb check when the ignition switch is first placed in ON/RUN. A chime will sound if the driver's seat belt is unbuckled during the bulb check. The Seat Belt Reminder Light will flash or remain on continuously if the driver's seat belt remains unbuckled after the bulb check or when driving. Refer to "Occupant Restraints" in "Things To Know Before Starting Your Vehicle" for further information.

### 17. Shift Lever Indicator — Automatic Transmission Only

The Shift Lever Indicator is self-contained within the instrument cluster. It displays the gear position of the automatic transmission.

### 18. Front Fog Light Indicator — If Equipped

 This indicator will illuminate when the front fog lights are on.

### 19. Odometer / Electronic Vehicle Information Center (EVIC) Display

The odometer display shows the total distance the vehicle has been driven. The trip odometer shows individual trip mileage. Refer to "Trip Odometer Button" for additional information.

**NOTE:** U.S. Federal regulations require that upon transfer of vehicle ownership, the seller certify to the purchaser the correct mileage that the vehicle has been driven. If your odometer needs to be repaired or serviced,



the repair technician should leave the odometer reading the same as it was before the repair or service. If s/he cannot do so, then the odometer must be set at zero, and a sticker must be placed in the door jamb stating what the mileage was before the repair or service. It is a good idea for you to make a record of the odometer reading before the repair/service, so that you can be sure that it is properly reset, or that the door jamb sticker is accurate if the odometer must be reset at zero.

This display shows the Electronic Vehicle Information Center (EVIC) messages when the appropriate conditions exist. For further information, refer to Electronic Vehicle Information Center (EVIC).

### *Loose Fuel Filler Cap Message*

If the vehicle diagnostic system determines that the fuel filler cap is loose, improperly installed, or damaged, a "Check Gas cap" message will display in the odometer display area. Tighten the fuel filler cap properly and

press the TRIP ODOMETER button to turn off the message. If the problem continues, the message will appear the next time the vehicle is started.

A loose, improperly installed, or damaged fuel filler cap may also turn on the Malfunction Indicator Light (MIL).

### *20. Brake Warning Light*

This light monitors various brake functions, including brake fluid level and parking brake application. If the brake light turns on it may indicate that the parking brake is applied, that the brake fluid level is low, or that there is a problem with the anti-lock brake system reservoir.

If the light remains on when the parking brake has been disengaged, and the fluid level is at the full mark on the master cylinder reservoir, it indicates a possible brake hydraulic system malfunction. In this case, the light will remain on until the condition has been corrected.

The dual brake system provides a reserve braking capacity in the event of a failure to a portion of the hydraulic system. A leak in either half of the dual brake system is indicated by the Brake Warning Light which will turn on when the brake fluid level in the master cylinder has dropped below a specified level.

The light will remain on until the cause is corrected.

**NOTE:** The light may flash momentarily during sharp cornering maneuvers which change fluid level conditions. The vehicle should have service performed, and the brake fluid level checked.

If brake failure is indicated, immediate repair is necessary.

### WARNING!

**Driving a vehicle with the brake light on is dangerous. Part of the brake system may have failed. It will take longer to stop the vehicle. You could have a collision. Have the vehicle checked immediately.**

Vehicles equipped with the Anti-Lock Brake System (ABS), are also equipped with Electronic Brake Force Distribution (EBD). In the event of an EBD failure, the Brake Warning Light will turn on along with the ABS Light. Immediate repair to the ABS system is required.

Operation of the Brake Warning Light can be checked by turning the ignition switch from the OFF position to the ON/RUN position. The light should illuminate for approximately two seconds. The light should then turn off unless the parking brake is applied or a brake fault is detected. If the light does not illuminate, have the light inspected by an authorized dealer.

The light also will turn on when the parking brake is applied with the ignition switch in the ON/RUN position.

**NOTE:** This light shows only that the parking brake is applied. It does not show the degree of brake application.

### 21. *Vehicle Security Light — If Equipped*



This light will flash at a fast rate for approximately 15 seconds, when the vehicle security alarm is arming, and then will flash slowly until the vehicle is disarmed.

### 22. *Tire Pressure Monitoring Telltale Light*



Each tire, including the spare (if provided), should be checked monthly when cold and inflated to the inflation pressure recommended by the vehicle manufacturer on the vehicle placard or tire inflation pressure label. (If your vehicle has tires of a different size than the size indicated on the vehicle placard or tire inflation pressure label, you should determine the proper tire inflation pressure for those tires.)

As an added safety feature, your vehicle has been equipped with a Tire Pressure Monitoring System (TPMS) that illuminates a low tire pressure telltale when one or more of your tires is significantly under-inflated. Accordingly, when the low tire pressure telltale illuminates, you should stop and check your tires as soon as possible, and inflate them to the proper pressure. Driving on a significantly under-inflated tire causes the tire to overheat and can lead to tire failure. Under-inflation also reduces fuel efficiency and tire tread life, and may affect the vehicle's handling and stopping ability.

Please note that the TPMS is not a substitute for proper tire maintenance, and it is the driver's responsibility to maintain correct tire pressure, even if under-inflation has not reached the level to trigger illumination of the TPMS low tire pressure telltale.

Your vehicle has also been equipped with a TPMS malfunction indicator to indicate when the system is not operating properly. The TPMS malfunction indicator is combined with the low tire pressure telltale. When the system detects a malfunction, the telltale will flash for approximately one minute and then remain continuously illuminated. This sequence will continue upon subsequent vehicle start-ups as long as the malfunction exists. When the malfunction indicator is illuminated, the system may not be able to detect or signal low tire pressure as intended. TPMS malfunctions may occur for a variety of reasons, including the installation of replacement or alternate tires or wheels on the vehicle that prevent the TPMS from functioning properly. Always check the TPMS malfunction telltale after replacing one or more tires or wheels on your vehicle, to ensure that the replacement or alternate tires and wheels allow the TPMS to continue to function properly.

### CAUTION!

**The TPMS has been optimized for the original equipment tires and wheels. TPMS pressures and warning have been established for the tire size equipped on your vehicle. Undesirable system operation or sensor damage may result when using replacement equipment that is not of the same size, type, and/or style. Aftermarket wheels can cause sensor damage. Do not use tire sealant from a can or balance beads if your vehicle is equipped with a TPMS, as damage to the sensors may result.**

#### 23. *Anti-Lock Brake (ABS) Light*



This light monitors the Anti-Lock Brake System (ABS). The light will turn on when the ignition switch is placed in the ON/RUN position and may stay on for as long as four seconds.

If the ABS light remains on or turns on while driving, it indicates that the Anti-Lock portion of the brake system is not functioning and that service is required. However, the conventional brake system will continue to operate normally if the BRAKE warning light is not on.

If the ABS light is on, the brake system should be serviced as soon as possible to restore the benefits of Anti-Lock brakes. If the ABS light does not turn on when the ignition switch is placed in the ON/RUN position, have the light inspected by an authorized dealer.

#### 24. *Low Fuel Light*



This light will turn on and a single chime will sound when the fuel level drops to 1/8 tank.

#### 25. *Malfunction Indicator Light (MIL)*



The Malfunction Indicator Light (MIL) is part of an onboard diagnostic system called OBD. The OBD system monitors engine and automatic transmission control systems. The MIL will turn on when

the ignition is in the ON/RUN position before engine start. If the MIL does not come on when turning the key from OFF to ON/RUN, have the condition checked promptly.

Certain conditions, such as a loose or missing gas cap, poor fuel quality, etc., may illuminate the MIL after engine start. The vehicle should be serviced if the MIL stays on through several of your typical driving cycles. In most situations, the vehicle will drive normally and will not require towing.

### CAUTION!

**Prolonged driving with the MIL on could cause damage to the engine control system. It also could affect fuel economy and drivability. If the MIL is flashing, severe catalytic converter damage and power loss will soon occur. Immediate service is required.**

**WARNING!**

A malfunctioning catalytic converter, as referenced above, can reach higher temperatures than in normal operating conditions. This can cause a fire if you drive slowly or park over flammable substances such as dry plants, wood, cardboard, etc. This could result in death or serious injury to the driver, occupants or others.

**ELECTRONIC VEHICLE INFORMATION CENTER (EVIC)**

The Electronic Vehicle Information Center (EVIC) features a driver-interactive display that is located in the instrument cluster.

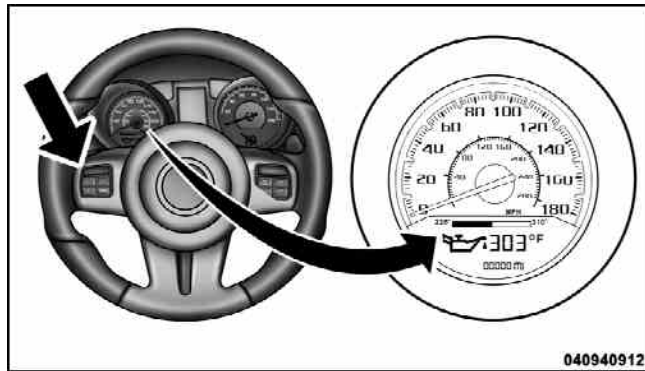
**Electronic Vehicle Information Center**

This system conveniently allows the driver to select a variety of useful information by pressing the switches mounted on the steering wheel. The EVIC consists of the following:

- System Status

- Vehicle Information Warning Message Displays
- Tire Pressure Monitor System
- Personal Settings (Customer-Programmable Features)
- Compass Display
- Outside Temperature Display
- Trip Computer Functions
- Uconnect™ phone Displays (If Equipped)
- Uconnect™ gps Screens (If Equipped)
- Audio Mode Display
- Surround Sound Modes (if equipped with Driver-Selectable Surround [DSS])
- Performance Features

The system allows the driver to select information by pressing the following buttons mounted on the steering wheel:



EVIC Steering Wheel Buttons

**MENU Button**

Press and release the MENU button to access the main menu, or to return to the main menu from the sub-menus.

**UP Button**

Press and release the UP button to scroll upward through the main menus and sub-menus.

**DOWN Button**

Press and release the DOWN button to scroll downward through the main menus and sub-menus.

**SELECT Button**

Press and release the SELECT button for access to main menus, sub-menus or to select a personal setting in the setup menu. Press and hold the SELECT button for two seconds to reset features.

**Electronic Vehicle Information Center (EVIC) Displays**

When the appropriate conditions exist, the EVIC displays the following messages:

- Turn Signal On (with a continuous warning chime if the vehicle is driven more than 1 mile [1.6 km] with either turn signal on)
- Left Front Turn Signal Lamp Out (with a single chime)
- Left Rear Turn Signal Lamp Out (with a single chime)
- Right Front Turn Signal Lamp Out (with a single chime)



- Right Rear Turn Signal Lamp Out (with a single chime)
- Personal Settings Not Available – Vehicle Not in PARK
- Door Ajar
- Door(s) Ajar (with a single chime if vehicle is in motion)
- Trunk Ajar (with a single chime)
- Oil Change Required
- Low Washer Fluid (with a single chime)
- Channel # Transmit
- Channel # Training
- Channel # Trained
- Clearing Channels
- Channels Cleared
- Did Not Train
- Low Tire Pressure (with a single chime)
- Service TPM System (with a single chime)
- ESC Off – Electronic Stability Control is deactivated
- Check Gascap
- Key Fob Battery Low
- Service Keyless System
- Wrong Key
- Damaged Key
- Key not Programmed
- Push Button or Insert Key/Turn To Run (refer to “Remote Starting System” in “Things To Know Before Starting Your Vehicle”)
- 1–4 SKIPSHIFT

- UPSHIFT
- Sport Mode Active
- 0-60 mph (0-100 km/h)
- Braking Distance
- 1/8 Mile
- 1/4 Mile
- Instantaneous G-Force
- Peak G-Force
- Digital Speedometer

## Engine Oil Change Indicator System

### Oil Change Required

Your vehicle is equipped with an engine oil change indicator system. The “Oil Change Required” message

will flash in the EVIC display for approximately 10 seconds after a single chime has sounded, to indicate the next scheduled oil change interval. The engine oil change indicator system is duty cycle based, which means the engine oil change interval may fluctuate, dependent upon your personal driving style.

Unless reset, this message will continue to display each time you turn the ignition switch to the ON/RUN position or cycle the ignition to the ON/RUN position if equipped with Keyless Enter-N-Go. To turn off the message temporarily, press and release the MENU button. To reset the oil change indicator system (after performing the scheduled maintenance) refer to the following procedure.

### *Vehicles Equipped With Keyless Enter-N-Go*

1. Without pressing the brake pedal, cycle the ignition to the ON/RUN position (Do not start the engine.)

2. Fully depress the accelerator pedal, slowly, three times within 10 seconds.
3. Cycle the ignition to the OFF/LOCK position.

#### *Vehicles Not Equipped With Keyless Enter-N-Go*

1. Turn the ignition switch to the ON/RUN position (Do not start the engine.)
2. Fully depress the accelerator pedal, slowly, three times within 10 seconds.
3. Turn the ignition switch to the OFF/LOCK position.

**NOTE:** If the indicator message illuminates when you start the vehicle, the oil change indicator system did not reset. If necessary, repeat this procedure.

#### **Trip Functions**

To access, press and release the MENU button until “Trip Functions” appears in the EVIC, then press and release the SELECT button.

The Trip Functions include the following:

- Average Fuel Economy
- Distance To Empty
- Trip A
- Trip B
- Elapsed Time
- Display Units of Measure in

Press the UP or DOWN button to cycle through the Trip functions, press the SELECT button to select a feature.

The Trip Functions mode displays the following.

#### **Average Fuel Economy**

Shows the average fuel economy since the last reset. When the fuel economy is reset, the display will read “RESET” or show dashes for two seconds. Then, the

history information will be erased, and the averaging will continue from the last fuel average reading before the reset.

### **Distance To Empty (DTE)**

Shows the estimated distance that can be traveled with the fuel remaining in the tank. This estimated distance is determined by a weighted average of the instantaneous and average fuel economy, according to the current fuel tank level. DTE cannot be reset through the SELECT button.

**NOTE:** Significant changes in driving style or vehicle loading will greatly affect the actual drivable distance of the vehicle, regardless of the DTE displayed value.

When the DTE value is less than 30 miles (48 km) estimated driving distance, the DTE display will change to a text display of "LOW FUEL." This display will continue until the vehicle runs out of fuel. Adding a

significant amount of fuel to the vehicle will turn off the "LOW FUEL" text and a new DTE value will display.

### **Trip A**

Shows the total distance traveled for Trip A since the last reset.

### **Trip B**

Shows the total distance traveled for Trip B since the last reset.

### **Elapsed Time**

Shows the total elapsed time of travel since the last reset when the ignition switch is in the ACC position. Elapsed time will increment when the ignition switch is in the ON or START position.

### **Display Units of Measure in**

To make your selection, press and release the SELECT button until "ENGLISH" or "METRIC" appears.

### To Reset The Display

Reset will only occur while a resettable function is being displayed. Press and release the SELECT button once to clear the resettable function being displayed. To reset all resettable functions, press and release the SELECT button a second time within three seconds of resetting the currently-displayed function (>Reset ALL will display during this three-second window).

### Performance Features

#### **WARNING!**

Measurement of vehicle statistics with the Performance Features is intended for off-highway or off-road use only and should not be done on any public roadways. It is recommended that these features be used in a controlled environment and within the limits of the law. The capabilities of the vehicle as measured by the performance pages must never be exploited in a reckless or dangerous manner, which can jeopardize the user's safety or the safety of others. Only a safe, attentive, and skillful driver can prevent accidents.

 This light will illuminate when the sport mode is selected. This mode provides performance based tuning with improved handling through an electronic controlled damping system. This system reduces body roll and pitch in many driving situations including cornering, acceleration and braking. For further information, refer to "Sport Mode" in "Starting And Operating".

The Performance Features include the following:

- 0-60 mph (0-100 km/h)
- Braking Distance
- 1/8 Mile
- 1/4 Mile
- Instantaneous G-Force
- Peak G-Force
- Digital Speedometer

To access, press and release either the UP or DOWN arrow button until "Performance Features" appears in the EVIC, then press and release the SELECT button. Press the UP or DOWN button to cycle through the features. Press the SELECT button to select a feature.

The following describes each feature and its operation:

#### **0-60 mph (0-100 km/h)**

When selected, this screen displays the time it takes for the vehicle to go from 0 to 60 mph (0 to 100 km/h) within 10 seconds.

- The feature will "ready" when the vehicle speed is at 0 mph (0 km/h). The word "READY" will flash when conditions are met for the event to begin.
- Dashes will display if the vehicle fails to reach 60 mph (100 km/h) in less than 10 seconds.
- The time will continue to display until the SELECT button is pressed.

- Pressing the SELECT button will clear the current run time and display the vehicle's best 0-60 mph (0-100 km/h) time.
- To clear the vehicle's best 0-60 mph (0-100 km/h) time, press and hold the SELECT button for five seconds.
- The distance measurement will be aborted if the brake pedal is released before the vehicle comes to a complete stop.
- The distance and speed measurements will continue to display until the SELECT button is pressed.

### Braking Distance

When selected, this screen displays the vehicle's braking distance and the speed at which the brake pedal was depressed.

- This feature will only function when applying the brakes at speeds above 30 mph (48 km/h).
- Engaging the parking brake will disable this feature.
- The word "READY" will flash when conditions are met for the event to begin.
- The distance and speed measurements display while the event is taking place.
- Pressing the SELECT button will clear the current run and prepare the cluster to record a new run.

### 1/8 Mile, 1/4 Mile

When selected, this screen displays the time it takes the vehicle to travel 1/8 mile (1/4 mile) within 30 seconds and the vehicle's speed when it reaches 1/8 mile (1/4 mile).

- The feature will "ready" when the vehicle is at 0 mph (0 km/h). The word "READY" will flash when conditions are met for the event to begin.
- Dashes will display if the vehicle fails to reach 1/8 mile (1/4 mile) in less than 30 seconds.

- The time and speed will continue to display until the SELECT button is pressed.
- Pressing the SELECT button will clear the current run and display the vehicle's best 1/8 mile (1/4 mile) run.
- To clear the vehicle's best 1/8 mile (1/4 mile) run, press and hold the SELECT button for five seconds.

### **Instantaneous G-Force**

When selected, this screen displays the current G-Force (lateral and longitudinal) along with a friction circle that displays the directions of the forces.

### **Peak G-Force**

When selected, this screen displays all four G-Force values (two lateral and two longitudinal).

- When a force greater than zero is measured, the display will update the value as it climbs. As the G-Force falls, the peak forces will continue to display.

- Pressing the SELECT button will clear the peak force values.

### **Digital Speedometer**

When selected, this screen displays vehicle speed and records top speed.

- Press and hold the SELECT button for three seconds to toggle between current speed and top speed.
- To reset top speed, quickly press and release the SELECT button when top speed is displayed.

### **Keyless Enter-N-Go Display — If Equipped**

When the ENGINE START/STOP button is pressed to change ignition switch positions, the Keyless Enter-N-Go icon momentarily appears in the EVIC display showing the new ignition switch position.





### Keyless Enter-N-Go Display

The round symbol in the middle rotates to point at the new ignition switch position. If desired, the ignition switch position graphic can be set to be constantly visible by pressing the EVIC MENU button until the display appears.

041008156

Refer to “Keyless Enter-N-Go” in “Starting And Operating” for more information.

**NOTE:** Under certain conditions, the display may be superseded by another display of higher priority. But when the ignition switch position is changed, the display always re-appears.

### Driver-Selectable Surround Sound (DSS) – If Equipped

Press and release the MENU button until “Surround Sound” displays in the EVIC, then press and release the SELECT button. The EVIC provides information on the current surround mode.

- Stereo
- Surround Sound

While in the Surround Sound menu, press the SELECT button to change surround modes.

## Compass Display



**MENU  
Button**

The compass readings indicate the direction the vehicle is facing. Press and release the MENU button until “Compass” displays in the EVIC, then press and release the SELECT button.

**NOTE:** The system will display the last known outside temperature when starting the vehicle and may need to be driven several minutes before the updated temperature is displayed. Engine temperature can also affect the displayed temperature; therefore, temperature readings are not updated when the vehicle is not moving.

### Automatic Compass Calibration

This compass is self-calibrating, which eliminates the need to set the compass manually. When the vehicle is new, the compass may appear erratic and the EVIC will display “CAL” until the compass is calibrated. You may also calibrate the compass by completing one or more

360 degree turns (in an area free from large metal or metallic objects) until the “CAL” message displayed in the EVIC turns off. The compass will now function normally.

### Manual Compass Calibration

If the compass appears erratic and the “CAL” message does not appear in the EVIC display, you must put the compass into the Calibration Mode manually as follows:

1. Turn the ignition switch ON.
2. Press and release the MENU button until Personal Settings displays in the EVIC.
3. Press the UP or DOWN button until “CALIBRATE COMPASS” displays in the EVIC.
4. Press and release the SELECT button to start the calibration. The message “CAL” will display in the EVIC.

5. Slowly complete one or more 360-degree turns (in an area free from large metal or metallic objects) until the “CAL” message turns off. The compass will now function normally.

### Compass Variance

Compass Variance is the difference between Magnetic North and Geographic North. To compensate for the differences, the variance should be set for the zone where the vehicle is driven, per the zone map. Once properly set, the compass will automatically compensate for the differences and provide the most accurate compass heading.

**NOTE:** Keep magnetic materials away from the top of the instrument panel, such as iPod’s, Mobile Phones, Laptops and Radar Detectors. This is where the compass module is located, and it can cause interference with the compass sensor, and it may give false readings.

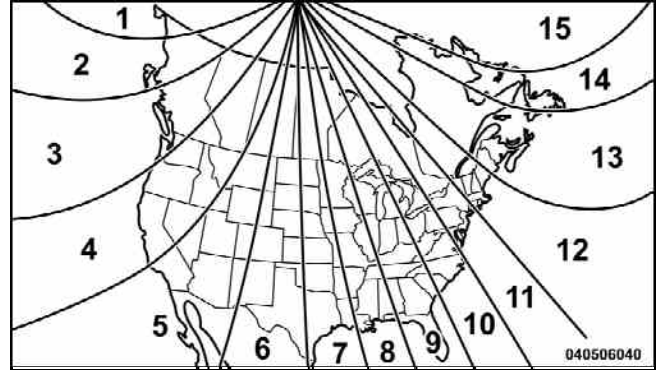

Compass Variance Map

1. Turn the ignition switch ON.
2. Press and release the MENU button until Personal Settings displays in the EVIC.

3. Press the UP or DOWN button until “COMPASS VARIANCE” message and the last variance zone number displays in the EVIC.
4. Press and release the SELECT button until the proper variance zone is selected according to the map.
5. Press and release the MENU button to exit.

### **System Warnings (Customer Information Features)**

Press and release the MENU button until “System Warnings” displays in the EVIC, then press and release the SELECT button. Press the UP or DOWN button to display any one of the following choices.

- *Oil Temperature*

Shows the actual oil temperature.

- *Oil Pressure*

Shows the actual oil pressure.

- *Tire Pressure*

Shows the actual tire pressure for each tire (EXCLUDING THE SPARE TIRE).

### **Personal Settings (Customer-Programmable Features)**

Personal Settings allows the driver to set and recall features when the transmission is in PARK.

Press and release the MENU button until Personal Settings displays in the EVIC, then press the SELECT button.

Use the UP or DOWN button to display one of the following choices.

#### **Language**

When in this display, you may select one of three languages for all display nomenclature, including the trip functions and the Uconnect™ gps (if equipped). Press the SELECT button while in this display to select English, Espanol, or Francais. Then, as you continue, the information will display in the selected language.

**NOTE:** The EVIC will not change the Uconnect™ language selection. Refer to “Uconnect™ phone” in “Understanding The Features Of Your Vehicle” for further information.

### **Unlock Doors Automatically on Exit**

When ON is selected, both doors will unlock when the vehicle is stopped and the transmission is in the PARK or NEUTRAL position and the driver’s door is opened. To make your selection, press and release the SELECT button until “ON” or “OFF” appears.

### **Remote Key Unlock**

When **Driver Door 1st Press** is selected, only the driver’s door will unlock on the first press of the Remote Keyless Entry (RKE) transmitter UNLOCK button. When Driver Door 1st Press is selected, you must press the RKE transmitter UNLOCK button twice to unlock the passenger door. When **All Doors 1st Press** is selected, both of

the doors will unlock on the first press of the RKE transmitter UNLOCK button. To make your selection, press and release the SELECT button until “Driver Door 1st Press” or “All Doors 1st Press” appears.

### **Remote Start Comfort Sys. — If Equipped**

When this feature is selected and the remote start is activated, the heated steering wheel and driver heated seat features will automatically turn on in cold weather. In warm weather, the driver vented seat feature will automatically turn on when the remote start is activated. These features will stay on through the duration of remote start or until the key is turned to RUN. To make your selection, press and release the SELECT button until a check-mark appears next to the feature showing the system has been activated or the check-mark is removed showing the system has been deactivated.

**Sound Horn with Remote Key Lock**

When ON is selected, a short horn sound will occur when the RKE transmitter LOCK button is pressed. This feature may be selected with or without the flash lights on lock/unlock feature. To make your selection, press and release the SELECT button until “ON” or “OFF” appears.

**Flash Lights with Remote Key Lock**

When ON is selected, the front and rear turn signals will flash when the doors are locked or unlocked with the RKE transmitter. This feature may be selected with or without the sound horn on lock feature selected. To make your selection, press and release the SELECT button until “ON” or “OFF” appears.

**Headlamps On with Wipers****(Available with Auto Headlights Only)**

When ON is selected, and the headlight switch is in the AUTO (A) position, the headlights will turn on approximately 10 seconds after the wipers are turned on. The

headlights will also turn off when the wipers are turned off if they were turned on by this feature. To make your selection, press and release the SELECT button until “ON” or “OFF” appears.

**NOTE:** Turning the headlights on during the daytime causes the instrument panel lights to dim. To increase the brightness, refer to “Lights” in “Understanding The Features Of Your Vehicle.”

**Delay Turning Headlights Off**

When this feature is selected, the driver can choose to have the headlights remain on for 0, 30, 60, or 90 seconds when exiting the vehicle. To make your selection, press and release the SELECT button until “0,” “30,” “60,” or “90” appears.

**Hill Start Assist (HSA) — If Equipped**

When on is selected, the HSA system is active. Refer to “Electronic Brake Control System” in “Starting And

Operating” for system function and operating information. To make your selection, press and release the SELECT button until “ON” or “OFF” appears.

### **Turn Headlights On with Remote Key Unlock**

When this feature is selected, the headlights will activate and remain on for up to 90 seconds when the doors are unlocked with the RKE transmitter. To make your selection, press and release the SELECT button until “OFF,” “30 sec.,” “60 sec.,” or “90 sec.” appears.

### **Delay Power Off to Accessories Until Exit**

When this feature is selected, the power window switches, radio, Uconnect™ phone (if equipped), power sunroof (if equipped), and ignition-powered power outlets will remain active for up to 60 minutes after the ignition switch is turned OFF. Opening either front vehicle door will cancel this feature. To make your selection, press and release the SELECT button until “Off,” “45 sec.,” “5 min.,” “10 min.,” “30 min.,” or “60 min.” appears.

### **Turn-by-Turn Navigation — If Equipped**

When ON is selected, the Turn-by-Turn directions will appear in the display as the vehicle approaches a designated turn within a programmed route. To make your selection, press and release the SELECT button until “ON” or “OFF” appears.

### **Keyless Enter-N-Go (Passive Entry)**

This feature allows you to lock and unlock the vehicle’s door(s) without having to press the RKE transmitter lock or unlock buttons. To make your selection, press and release the SELECT button until a check-mark appears next to the feature showing the system has been activated or the check-mark is removed showing the system has been deactivated. Refer to “Keyless Enter-N-Go” in “Things To Know Before Starting Your Vehicle”.

### **Enable/Disable the Rear Park Assist System**

The Rear Park Assist system will scan for objects behind the vehicle when the transmission is in the REVERSE position and the vehicle speed is less than 11 mph (18 km/h). The system can be enabled with Sound Only, Sound and Display, or turned OFF through the EVIC. To make your selection, press and release the SELECT button until a check-mark appears next to the feature showing the system has been activated or the check-mark is removed showing the system has been deactivated. Refer to “Rear Park Assist System” in “Understanding The Features Of Your Vehicle” for system function and operating information.

### **Display Units of Measure In**

The EVIC, odometer, and Uconnect™ gps (if equipped) can be changed between English and Metric units of measure. To make your selection, press and release the SELECT button until “ENGLISH” or “METRIC” appears.

### **MEDIA CENTER 730N/430/430N (RHR/RER/RBZ/RHB) CD/DVD/HDD/NAV — IF EQUIPPED**

**NOTE:** The sales code is located on the lower right side of the unit’s faceplate.

Refer to your Uconnect™ Multimedia RHR, RER, RBZ or RHB user’s manual for detailed operating instructions.

### **Operating Instructions (Voice Command System) — If Equipped**

Refer to “Voice Command” in the Uconnect™ User Manual located on the DVD for further details.

### **Operating Instructions (Uconnect™ Phone) — If Equipped**

Refer to “Uconnect™ Phone” in the Uconnect™ User Manual located on the DVD for further details.



## MEDIA CENTER 130 (SALES CODE RES)

**NOTE:** The radio sales code is located on the lower right side of the radio faceplate.

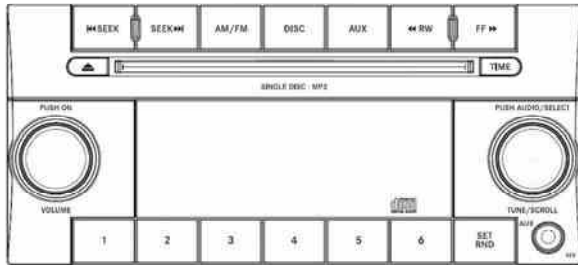

042305232

Media Center 130 (RES)

## Operating Instructions — Radio Mode

**NOTE:** The ignition switch must be in the ON or ACC position to operate the radio.

### Power Switch/Volume Control (Rotary)

Push the ON/VOLUME control knob to turn on the radio. Push the ON/VOLUME control knob a second time to turn off the radio.

### Electronic Volume Control

The electronic volume control turns continuously (360 degrees) in either direction, without stopping. Turning the ON/VOLUME control knob to the right increases the volume, and to the left decreases it.

When the audio system is turned on, the sound will be set at the same volume level as last played.

### **SEEK Buttons**

Press and release the SEEK buttons to search for the next listenable station in AM/FM mode. Press the right switch to seek up and the left switch to seek down. The radio will remain tuned to the new station until you make another selection. Holding either button will bypass stations without stopping, until you release it.

### **TIME Button**

Press the TIME button to alternate display of the time and radio frequency.

### **Clock Setting Procedure**

1. Press and hold the TIME button until the hours blink.
2. Adjust the hours by turning the right side TUNE/SCROLL control knob.
3. After adjusting the hours, press the right side TUNE/SCROLL control knob to set the minutes. The minutes will begin to blink.

4. Adjust the minutes using the right side TUNE/SCROLL control knob. Press the TUNE/SCROLL control knob to save time change.

5. To exit, press any button/knob, or wait five seconds.

### **RW/FF**

Pressing the RW (Rewind) or FF (Fast Forward) buttons causes the tuner to search for the next frequency in the direction of the arrows. This feature operates in either AM or FM frequencies.

### **TUNE Control**

Turn the rotary TUNE/SCROLL control knob clockwise to increase or counterclockwise to decrease the frequency.

### **Setting the Tone, Balance, and Fade**

Push the rotary TUNE/SCROLL control knob and BASS will display. Turn the TUNE/SCROLL control knob to the right or left to increase or decrease the bass tones.

Push the rotary TUNE/SCROLL control knob a second time and MID will display. Turn the TUNE/SCROLL control knob to the right or left to increase or decrease the mid-range tones.

Push the rotary TUNE/SCROLL control knob a third time and TREBLE will display. Turn the TUNE/SCROLL control knob to the right or left to increase or decrease the treble tones.

Push the rotary TUNE/SCROLL control knob a fourth time and BALANCE will display. Turn the TUNE/SCROLL control knob to the right or left to adjust the sound level from the right or left side speakers.

Push the rotary TUNE/SCROLL control knob a fifth time and FADE will display. Turn the TUNE/SCROLL control knob to the left or right to adjust the sound level between the front and rear speakers.

Push the rotary TUNE/SCROLL control knob again to exit setting tone, balance, and fade.

### **AM/FM Button**

Press the buttons to select either AM or FM mode.

### **SET/RND Button — To Set the Pushbutton Memory**

When you are receiving a station that you wish to commit to pushbutton memory, press the SET/RND button. The symbol SET 1 will now show in the display window. Select the button (1 to 6) you wish to lock onto this station and press and release that button. If a button is not selected within five seconds after pressing the SET/RND button, the station will continue to play but will not be stored into pushbutton memory.

You may add a second station to each pushbutton by repeating the above procedure with this exception: Press the SET/RND button twice and SET 2 will show in the display window. Each button can be set for SET 1 and

SET 2 in both AM and FM. This allows a total of 12 AM and 12 FM stations to be stored into pushbutton memory. The stations stored in SET 2 memory can be selected by pressing the pushbutton twice.

Every time a preset button is used, a corresponding button number will display.

### **Buttons 1 - 6**

These buttons tune the radio to the stations that you commit to pushbutton memory (12 AM and 12 FM stations).

### **DISC Button**

Pressing the DISC button will allow you to switch from AM/FM modes to Disc modes.

## **Operation Instructions — CD MODE For CD And MP3 Audio Play**

### **NOTE:**

- The ignition switch must be in the ON or ACC position to operate the radio.
- This radio is capable of playing compact discs (CD), recordable compact discs (CD-R), rewritable compact discs (CD-RW), compact discs with MP3 tracks and multisession compact discs with CD and MP3 tracks.

### **Inserting Compact Disc(s)**

Gently insert one CD into the CD player with the CD label facing up. The CD will automatically be pulled into the CD player and the CD icon will illuminate on the radio display. If a CD does not go into the slot more than 1.0 in (2.5 cm), a disc may already be loaded and must be ejected before a new disc can be loaded.

If you insert a disc with the ignition ON and the radio ON, the unit will switch from radio to CD mode and begin to play when you insert the disc. The display will show the track number, and index time in minutes and seconds. Play will begin at the start of track 1.

### CAUTION!

- This CD player will accept 4-3/4 in (12 cm) discs only. The use of other sized discs may damage the CD player mechanism.
- Do not use adhesive labels. These labels can peel away and jam the player mechanism.
- The RES Media Center is a single CD player. Do not attempt to insert a second CD if one is already loaded.

#### EJECT Button - Ejecting a CD



Press the EJECT button to eject the CD.

If you have ejected a disc and have not removed it within 10 seconds, it will be reloaded. If the CD is not removed, the radio will reinsert the CD but will not play it.

A disc can be ejected with the radio and ignition OFF.

**NOTE:** Ejecting with the ignition OFF is not allowed on convertible or soft-top models (if equipped).

#### SEEK Button

Press the right SEEK button for the next selection on the CD. Press the left SEEK button to return to the beginning of the current selection, or return to the beginning of the previous selection if the CD is within the first second of the current selection. Pressing and holding the SEEK button will allow faster scrolling through the tracks in CD and MP3 modes.

#### TIME Button

Press this button to change the display from a large CD playing time display to a small CD playing time display.

**RW/FF**

Press and hold the FF (Fast Forward) button and the CD player will begin to fast forward until FF is released, or RW or another CD button is pressed. The RW (Reverse) button works in a similar manner.

**AM/FM Button**

Press the button to select either AM or FM mode.

**SET/RND Button (Random Play Button)**

Press this button while the CD is playing to activate Random Play. This feature plays the selections on the compact disc in random order to provide an interesting change of pace.

Press the right SEEK button to move to the next randomly selected track.

Press the RND button a second time to stop Random Play.

**Notes on Playing MP3 Files**

The radio can play MP3 files; however, acceptable MP3 file recording media and formats are limited. When writing MP3 files, pay attention to the following restrictions.

**Supported Media (Disc Types)**

The MP3 file recording media supported by the radio are CDDA, CD-R, CD-RW, MP3, and CDDA+MP3.

**Supported Medium Formats (File Systems)**

The medium formats supported by the radio are ISO 9660 Level 1 and Level 2 and includes the Joliet extension. When reading discs recorded using formats other than ISO 9660 Level 1 and Level 2, the radio may fail to read files properly and may be unable to play the file normally. UDF and Apple HFS formats are not supported.

The radio uses the following limits for file systems:

- Maximum number of folder levels: 8
- Maximum number of files: 255

- Maximum number of folders. (The radio display of file names and folder names is limited. For large numbers of files and/or folders, the radio may be unable to display the file name and folder name, and will assign a number instead. With a maximum number of files, exceeding 20 folders will result in this display. With 200 files, exceeding 50 folders will result in this display.)
- Maximum number of characters in file/folder names:
  - Level 1: 12 (including a separator "." and a three-character extension)
  - Level 2: 31 (including a separator "." and a three-character extension)

Multisession disc formats are supported by the radio. Multisession discs may contain combinations of normal CD audio tracks and computer files (including MP3 files).

Discs created with an option such as "keep disc open after writing" are most likely multisession discs. The use of multisession for CD audio or MP3 playback may result in longer disc loading times.

### Supported MP3 File Formats

The radio will recognize only files with the \*.MP3 extension as MP3 files. Non-MP3 files named with the \*.MP3 extension may cause playback problems. The radio is designed to recognize the file as an invalid MP3 and will not play the file.

When using the MP3 encoder to compress audio data to an MP3 file, the bit rate and sampling frequencies in the following table are supported. In addition, variable bit rates (VBR) are also supported. The majority of MP3 files use a 44.1 kHz sampling rate and a 192, 160, 128, 96 or VBR bit rate.

MPEG Specification	Sampling Frequency (kHz)	Bit Rate (kbps)
MPEG-1 Audio Layer 3	48, 44.1, 32	320, 256, 224, 192, 160, 128, 112, 96, 80, 64, 56, 48, 40, 32
MPEG-2 Audio Layer 3	24, 22.05, 16	160, 128, 144, 112, 96, 80, 64, 56, 48, 40, 32, 24, 16, 8

ID3 Tag information for artist, song title, and album title are supported for version 1 ID3 tags. ID3 version 2 is not supported by the radios.

Playlist files are not supported. MP3 Pro files are not supported.

### Playback of MP3 Files

When a medium containing MP3 data is loaded, the radio checks all files on the medium. If the medium contains a lot of folders or files, the radio will take more time to start playing the MP3 files.

Loading times for playback of MP3 files may be affected by the following:

- Media - CD-RW media may take longer to load than CD-R media
- Medium formats - Multisession discs may take longer to load than non-multisession discs
- Number of files and folders - Loading times will increase with more files and folders

To increase the speed of disc loading, it is recommended to use CD-R media and single-session discs. To create a single-session disc, enable the “Disc at Once” option before writing to the disc.



### Operation Instructions - Auxiliary Mode

The auxiliary (AUX) jack is an audio input jack, which allows the user to plug in a portable device, such as an MP3 player, or cassette player, and utilize the vehicle's audio system to amplify the source and play through the vehicle speakers.

Pressing the DISC/AUX button will change the mode to auxiliary device if the AUX jack is connected.

**NOTE:** The AUX device must be turned on and the device's volume set to proper level. If the AUX audio is not loud enough, turn the device's volume up. If the AUX audio sounds distorted, turn the device's volume down.

### TIME Button (Auxiliary Mode)

Press this button to change the display to time of day. The time of day will display for five seconds (when ignition is OFF).

### MEDIA CENTER 130 WITH SATELLITE RADIO (SALES CODE RES+RSC)

**NOTE:** The radio sales code is located on the lower right side of the radio faceplate.

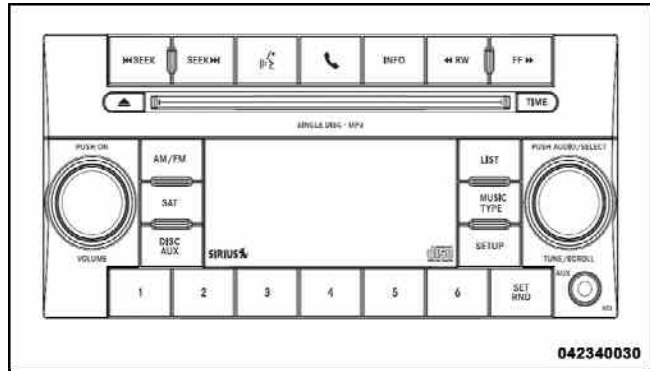

Media Center 130 (RES/RSC)

## Operating Instructions — Radio Mode

**NOTE:** The ignition switch must be in the ON or ACC position to operate the radio.

### Power Switch/Volume Control (Rotary)

Push the ON/VOLUME control knob to turn on the radio. Push the ON/VOLUME control knob a second time to turn off the radio.

### Electronic Volume Control

The electronic volume control turns continuously (360 degrees) in either direction without stopping. Turning the ON/VOLUME control knob to the right increases the volume and to the left decreases it.

When the audio system is turned on, the sound will be set at the same volume level as last played.

### SEEK Buttons

Press and release the SEEK buttons to search for the next listenable station in AM/FM mode. Press the right switch

to seek up and the left switch to seek down. The radio will remain tuned to the new station until you make another selection. Holding either button will bypass stations without stopping until you release it.

### Voice Command System (Radio) — If Equipped

Refer to “Voice Command” in “Understanding The Features Of Your Vehicle”.

### Voice Command Button Uconnect™ Phone — If Equipped

Press this button to operate the Uconnect™ Phone feature (if equipped). Refer to “Uconnect™ Phone” in “Understanding The Features Of Your Vehicle”.

If your vehicle is not equipped with or this feature is not available on your vehicle, a “Not Equipped With Uconnect Phone” message will display on the radio screen.

**Phone Button Uconnect™ Phone — If Equipped**

Press this button to operate the Uconnect™ Phone feature (if equipped). Refer to “Uconnect™ Phone” in “Understanding The Features Of Your Vehicle”.

If your vehicle is not equipped with or this feature is not available on your vehicle, a “Not Equipped With Uconnect Phone” message will display on the radio screen.

**TIME Button**

Press the TIME button to alternate display of the time and radio frequency.

**Clock Setting Procedure**

1. Press and hold the TIME button until the hours blink.
2. Adjust the hours by turning the right side TUNE/SCROLL control knob.

3. After adjusting the hours, press the right side TUNE/SCROLL control knob to set the minutes. The minutes will begin to blink.

4. Adjust the minutes using the right side TUNE/SCROLL control knob. Press the TUNE/SCROLL control knob to save time change.

5. To exit, press any button/knob or wait five seconds.

The clock can also be set by pressing the SETUP button. For vehicles equipped with satellite radio, press the SETUP button, use the TUNE/SCROLL control to select SET CLOCK, and then follow the above procedure, starting at Step 2. For vehicles not equipped with satellite radio, press the SETUP button and then follow the above procedure, starting at Step 2.

**INFO Button**

Press the INFO button for an RDS station (one with call letters displayed). The radio will return a Radio Text message broadcast from an FM station (FM mode only).

**RW/FF**

Pressing the RW (Rewind) or FF (Fast Forward) buttons causes the tuner to search for the next frequency in the direction of the arrows. This feature operates in either AM or FM frequencies.

**TUNE Control**

Turn the rotary TUNE/SCROLL control knob clockwise to increase or counterclockwise to decrease the frequency.

**Setting the Tone, Balance, and Fade**

Push the rotary TUNE/SCROLL control knob and BASS will display. Turn the TUNE/SCROLL control knob to the right or left to increase or decrease the bass tones.

Push the rotary TUNE/SCROLL control knob a second time and MID will display. Turn the TUNE/SCROLL control knob to the right or left to increase or decrease the mid-range tones.

Push the rotary TUNE/SCROLL control knob a third time and TREBLE will display. Turn the TUNE/SCROLL control knob to the right or left to increase or decrease the treble tones.

Push the rotary TUNE/SCROLL control knob a fourth time and BALANCE will display. Turn the TUNE/SCROLL control knob to the right or left to adjust the sound level from the right or left side speakers.

Push the rotary TUNE/SCROLL control knob a fifth time and FADE will display. Turn the TUNE/SCROLL control knob to the left or right to adjust the sound level between the front and rear speakers.

Push the rotary TUNE/SCROLL control knob again to exit setting tone, balance, and fade.

### MUSIC TYPE Button

Pressing this button once will turn on the Music Type mode for five seconds. Pressing the MUSIC TYPE button or turning the TUNE/SCROLL control knob within five seconds will allow the program format type to be selected. Many radio stations do not currently broadcast Music Type information.

Toggle the MUSIC TYPE button to select the following format types:

Program Type	16-Digit Character Display
No program type or undefined	None
Adult Hits	Adlt Hit
Classical	Classicl
Classic Rock	Cls Rock
College	College
Country	Country
Foreign Language	Language

Program Type	16-Digit Character Display
Information	Inform
Jazz	Jazz
News	News
Nostalgia	Nostalgia
Oldies	Oldies
Personality	Persnlty
Public	Public
Rhythm and Blues	R & B
Religious Music	Rel Musc
Religious Talk	Rel Talk
Rock	Rock
Soft	Soft
Soft Rock	Soft Rck
Soft Rhythm and Blues	Soft R&B
Sports	Sports
Talk	Talk

Program Type	16-Digit Character Display
Top 40	Top 40
Weather	Weather

By pressing the SEEK button when the Music Type icon is displayed, the radio will be tuned to the next frequency station with the same selected Music Type name. The Music Type function only operates when in the FM mode.

If a preset button is activated while in the Music Type (Program Type) mode, the Music Type mode will be exited and the radio will tune to the preset station.

### SETUP Button

Pressing the SETUP button allows you to select between the following items:

- **Set Clock** — Pressing the SELECT button will allow you to set the clock. Adjust the hours by turning the TUNE/SCROLL control knob. After adjusting the hours, press the TUNE/SCROLL control knob to set

the minutes. The minutes will begin to blink. Adjust the minutes using the right side TUNE/SCROLL control knob. Press the TUNE/SCROLL control knob to save time change.

### AM/FM Button

Press the button to select either AM or FM mode.

### SET/RND Button — To Set the Pushbutton Memory

When you are receiving a station that you wish to commit to pushbutton memory, press the SET/RND button. The symbol SET 1 will now show in the display window. Select the button (1–6) you wish to lock onto this station and press and release that button. If a button is not selected within five seconds after pressing the SET/RND button, the station will continue to play but will not be stored into pushbutton memory.

You may add a second station to each pushbutton by repeating the above procedure with this exception: Press the SET/RND button twice and SET 2 will show in the display window. Each button can be set for SET 1 and SET 2 in both AM and FM. This allows a total of 12 AM and 12 FM stations to be stored into pushbutton memory. The stations stored in SET 2 memory can be selected by pressing the pushbutton twice.

Every time a preset button is used, a corresponding button number will display.

### **Buttons 1 - 6**

These buttons tune the radio to the stations that you commit to pushbutton memory (12 AM and 12 FM stations).

### **DISC/AUX Button**

Pressing the DISC/AUX button will allow you to switch from AM/FM modes to DISC/AUX mode.

## **Operation Instructions — CD MODE for CD and MP3 Audio Play**

### **NOTE:**

- The ignition switch must be in the ON or ACC position to operate the radio.
- This radio is capable of playing compact discs (CD), recordable compact discs (CD-R), rewritable compact discs (CD-RW), compact discs with MP3 tracks and multisession compact discs with CD and MP3 tracks.

### **Inserting Compact Disc(s)**

Gently insert one CD into the CD player with the CD label facing up. The CD will automatically be pulled into the CD player and the CD icon will illuminate on the radio display. If a CD does not go into the slot more than 1.0 in (2.5 cm), a disc may already be loaded and must be ejected before a new disc can be loaded.

If you insert a disc with the ignition ON and the radio ON, the unit will switch from radio to CD mode and begin to play when you insert the disc. The display will show the track number, and index time in minutes and seconds. Play will begin at the start of track 1.

### CAUTION!

- This CD player will accept 4-3/4 in (12 cm) discs only. The use of other sized discs may damage the CD player mechanism.
- Do not use adhesive labels. These labels can peel away and jam the player mechanism.
- The RES Media Center is a single CD player. Do not attempt to insert a second CD if one is already loaded.

#### EJECT Button - Ejecting a CD



Press the EJECT button to eject the CD.

If you have ejected a disc and have not removed it within 10 seconds, it will be reloaded. If the CD is not removed, the radio will reinsert the CD but will not play it.

A disc can be ejected with the radio and ignition OFF.

**NOTE:** Ejecting with the ignition OFF is not allowed on convertible or soft-top models (if equipped).

#### SEEK Button

Press the right SEEK button for the next selection on the CD. Press the left SEEK button to return to the beginning of the current selection, or return to the beginning of the previous selection if the CD is within the first second of the current selection. Pressing and holding the SEEK button will allow faster scrolling through the tracks in CD and MP3 modes.

#### TIME Button

Press this button to change the display from a large CD playing time display to a small CD playing time display.



**RW/FF**

Press and hold FF (Fast Forward) and the CD player will begin to fast forward until FF is released or RW or another CD button is pressed. The RW (Reverse) button works in a similar manner.

**AM/FM Button**

Press the button to select either AM or FM mode.

**SET/RND Button (Random Play Button)**

Press this button while the CD is playing to activate Random Play. This feature plays the selections on the compact disc in random order to provide an interesting change of pace.

Press the right SEEK button to move to the next randomly selected track.

Press the SET/RND button a second time to stop Random Play.

**Notes On Playing MP3 Files**

The radio can play MP3 files; however, acceptable MP3 file recording media and formats are limited. When writing MP3 files, pay attention to the following restrictions.

**Supported Media (Disc Types)**

The MP3 file recording media supported by the radio are CDDA, CD-R, CD-RW, MP3, and CDDA+MP3.

**Supported Medium Formats (File Systems)**

The medium formats supported by the radio are ISO 9660 Level 1 and Level 2 and includes the Joliet extension. When reading discs recorded using formats other than ISO 9660 Level 1 and Level 2, the radio may fail to read files properly and may be unable to play the file normally. UDF and Apple HFS formats are not supported.

The radio uses the following limits for file systems:

- Maximum number of folder levels: 8
- Maximum number of files: 255

- Maximum number of folders. (The radio display of file names and folder names is limited. For large numbers of files and/or folders, the radio may be unable to display the file name and folder name and will assign a number instead. With a maximum number of files, exceeding 20 folders will result in this display. With 200 files, exceeding 50 folders will result in this display.)
- Maximum number of characters in file/folder names:
  - Level 1: 12 (including a separator "." and a three-character extension)
  - Level 2: 31 (including a separator "." and a three-character extension)

Multisession disc formats are supported by the radio. Multisession discs may contain combinations of normal CD audio tracks and computer files (including MP3 files).

Discs created with an option such as "keep disc open after writing" are most likely multisession discs. The use of multisession for CD audio or MP3 playback may result in longer disc loading times.

### **Supported MP3 File Formats**

The radio will recognize only files with the \*.MP3 extension as MP3 files. Non-MP3 files named with the \*.MP3 extension may cause playback problems. The radio is designed to recognize the file as an invalid MP3 and will not play the file.

When using the MP3 encoder to compress audio data to an MP3 file, the bit rate and sampling frequencies in the following table are supported. In addition, variable bit rates (VBR) are also supported. The majority of MP3 files use a 44.1 kHz sampling rate and a 192, 160, 128, 96 or VBR bit rates.

MPEG Specification	Sampling Frequency (kHz)	Bit Rate (kbps)
MPEG-1 Audio Layer 3	48, 44.1, 32	320, 256, 224, 192, 160, 128, 112, 96, 80, 64, 56, 48, 40, 32
MPEG-2 Audio Layer 3	24, 22.05, 16	160, 128, 144, 112, 96, 80, 64, 56, 48, 40, 32, 24, 16, 8

ID3 Tag information for artist, song title, and album title are supported for version 1 ID3 tags. ID3 version 2 is not supported by the radios.

Playlist files are not supported. MP3 Pro files are not supported.

### Playback of MP3 Files

When a medium containing MP3 data is loaded, the radio checks all files on the medium. If the medium contains a lot of folders or files, the radio will take more time to start playing the MP3 files.

Loading times for playback of MP3 files may be affected by the following:

- Media - CD-RW media may take longer to load than CD-R media
- Medium formats - Multisession discs may take longer to load than non-multisession discs
- Number of files and folders - Loading times will increase with more files and folders

To increase the speed of disc loading, it is recommended to use CD-R media and single-session discs. To create a single-session disc, enable the “Disc at Once” option before writing to the disc.

**LIST Button (CD Mode for MP3 Play)**

Pressing the LIST button will bring up a list of all folders on the disc. Scrolling up or down the list is done by turning the TUNE/SCROLL control knob. Selecting a folder by pressing the TUNE/SCROLL control knob will begin playing the files contained in that folder (or the next folder in sequence if the selection does not contain playable files).

The folder list will time out after five seconds.

**INFO Button (CD Mode for MP3 Play)**

Pressing the INFO button repeatedly will scroll through the following TAG information: Song Title, Artist, File Name, and Folder Name (if available).

Press the INFO button once more to return to "elapsed time" priority mode.

Press and hold the INFO button for three seconds or more and the radio will display song titles for each file.

Press and hold the INFO button again for three seconds to return to "elapsed time" display.

**Operation Instructions - Auxiliary Mode**

The auxiliary (AUX) jack is an audio input jack which allows the user to plug in a portable device such as an MP3 player or cassette player and utilize the vehicle's audio system to amplify the source and play through the vehicle speakers.

Pressing the AUX button will change the mode to auxiliary device if the AUX jack is connected.

**NOTE:** The AUX device must be turned on and the device's volume set to the proper level. If the AUX audio is not loud enough, turn the device's volume up. If the AUX audio sounds distorted, turn the device's volume down.

**TIME Button (Auxiliary Mode)**

Press this button to change the display to time of day. The time of day will display for five seconds (when the ignition is OFF).

**Uconnect™ Multimedia (Satellite Radio) —  
If Equipped**

Satellite radio uses direct satellite-to-receiver broadcasting technology to provide clear digital sound, coast to coast. The subscription service provider is Sirius Satellite Radio. This service offers over 130 channels of music, sports, news, entertainment, and programming for children, directly from its satellites and broadcasting studios.

**NOTE:** Sirius service is not available in Hawaii and has limited coverage in Alaska.

**System Activation**

Sirius Satellite Radio service is pre-activated, and you may begin listening immediately to the one year of audio service that is included with the factory-installed satellite

radio system in your vehicle. Sirius will supply a welcome kit that contains general information, including how to setup your on-line listening account. For further information, call the toll-free number 888-539-7474, or visit the Sirius web site at [www.sirius.com](http://www.sirius.com), or at [www.siriuscanada.ca](http://www.siriuscanada.ca) for Canadian residents.

**Electronic Serial Number/Sirius Identification  
Number (ESN/SID)**

Please have the following information available when calling:

1. The Electronic Serial Number/Sirius Identification Number (ESN/SID).
2. Your Vehicle Identification Number.

To access the ESN/SID, refer to the following steps:

**ESN/SID Access**

With the ignition switch in the ON/RUN or ACC position and the radio on, press the SETUP button and scroll

using the TUNE/SCROLL control knob until Sirius ID is selected. Press the TUNE/SCROLL control knob and the Sirius ID number will display. The Sirius ID number display will time out in two minutes. Press any button on the radio to exit this screen.

### **Selecting Uconnect™ Multimedia (Satellite) Mode**

Press the SAT button until "SAT" appears in the display. A CD may remain in the radio while in the Satellite radio mode.

### **Satellite Antenna**

To ensure optimum reception, do not place items on the roof around the rooftop antenna location. Metal objects placed within the line of sight of the antenna will cause decreased performance. Larger luggage items such as bikes should be placed as far rearward as possible, within the loading design of the rack. Do not place items directly on or above the antenna.

### **Reception Quality**

Satellite reception may be interrupted due to one of the following reasons:

- The vehicle is parked in an underground parking structure or under a physical obstacle.
- Dense tree coverage may interrupt reception in the form of short audio mutes.
- Driving under wide bridges or along tall buildings can cause intermittent reception.
- Placing objects over or too close to the antenna can cause signal blockage.

### **Operating Instructions - Uconnect™ Multimedia (Satellite) Mode**

**NOTE:** The ignition switch must be in the ON/RUN or ACC position to operate the radio.

**SEEK Buttons**

Press and release the SEEK buttons to search for the next channel in Satellite mode. Press the right switch to seek up and the left switch to seek down. The radio will remain tuned to the new channel until you make another selection. Holding either button will bypass channels without stopping until you release it.

**SCAN Button**

Pressing the SCAN button causes the tuner to search for the next channel, pausing for eight seconds before continuing to the next. To stop the search, press the SCAN button a second time.

**INFO Button**

Pressing the INFO button will cycle the display information between Artist, Song Title, and Composer (if available). Also, pressing and holding the INFO button for an additional three seconds will make the radio display the Song Title all of the time (press and hold again to return to normal display).

**RW/FF**

Pressing the RW (Rewind) or FF (Fast Forward) buttons causes the tuner to search for the next channel in the direction of the arrows.

**TUNE Control (Rotary)**

Turn the rotary TUNE/SCROLL control knob clockwise to increase or counterclockwise to decrease the channel.

**MUSIC TYPE Button**

Pressing this button once will turn on the Music Type mode for five seconds. Pressing the MUSIC TYPE button or turning the TUNE/SCROLL control knob within five seconds will allow the program format type to be selected.

Toggle the MUSIC TYPE button again to select the music type.

By pressing the SEEK button when the Music Type function is active, the radio will be tuned to the next channel with the same selected Music Type name.

If a preset button is activated while in the Music Type (Program Type) mode, the Music Type mode will be exited and the radio will tune to the preset channel.

### **SETUP Button**

Pressing the SETUP button allows you to select the following items:

- Display Sirius ID number — Press the AUDIO/SELECT button to display the Sirius ID number. This number is used to activate, deactivate, or change the Sirius subscription.

### **SET Button – To Set the Pushbutton Memory**

When you are receiving a channel that you wish to commit to pushbutton memory, press the SET button. The symbol SET 1 will now show in the display window.

Select the button (1-6) you wish to lock onto this channel and press and release that button. If a button is not selected within five seconds after pressing the SET button, the channel will continue to play but will not be stored into pushbutton memory.

You may add a second channel to each pushbutton by repeating the above procedure with this exception: Press the SET button twice and SET 2 will show in the display window. Each button can be set for SET 1 and SET 2. This allows a total of 12 Satellite channels to be stored into pushbutton memory. The channels stored in SET 2 memory can be selected by pressing the pushbutton twice.

Every time a preset button is used, a corresponding button number will display.

### **Buttons 1 - 6**

These buttons tune the radio to the channels that you commit to pushbutton memory (12 Satellite stations).



## Operating Instructions - Uconnect™ Phone (If Equipped)

Refer to “Uconnect™ Phone” in “Understanding The Features Of Your Vehicle”.

### iPod®/USB/MP3 CONTROL — IF EQUIPPED

**NOTE:** This section is for sales code RES and REQ/REL/RET radios only with Uconnect™. For sales code RBZ/RHB, RHR, RHP, RHW or RB2 touch-screen radio iPod®/USB/MP3 control feature, refer to the separate RBZ/RHB, RHR, RHP, RHW or RB2 User’s Manual. iPod®/USB/MP3 control is available only if equipped as an option with these radios.

This feature allows an iPod® or external USB device to be plugged into the USB port, located in the center console or glove compartment.

iPod® control supports Mini, 4G, Photo, Nano, 5G iPod® and iPhone® devices. Some iPod® software versions may not fully support the iPod® control features. Please visit Apple’s website for software updates.

#### NOTE:

- If the radio has a USB port, refer to the appropriate Uconnect™ Multimedia radio User’s Manual for iPod® or external USB device support capability.
- Connecting an iPod® or consumer electronic audio device to the AUX port located in the radio faceplate, plays media, but does not use the iPod® /MP3 control feature to control the connected device.

### Connecting The iPod® Or External USB Device

Use the connection cable to connect an iPod® or external USB device to the vehicle's USB/AUX connector port which is located in the center console or glove compartment.

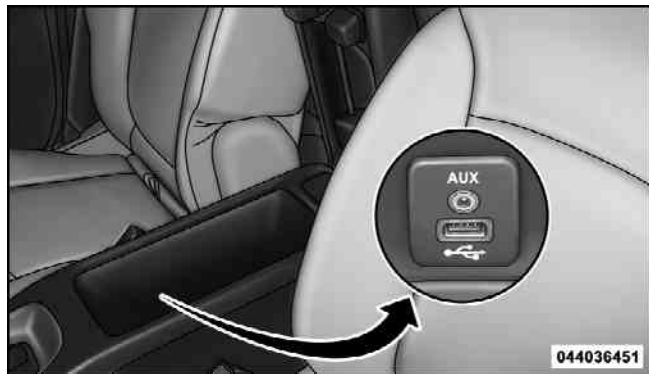

Center Console USB/AUX Connector Port

**NOTE:** The center console will have a position where the iPod® or consumer electronic audio device cable can be routed through without damaging the cable when closing the lid. A factory cut out space for the cable to be routed may be located in the base of the center console on either the front or side. This allows routing of the cable without damaging it while closing the lid. If a cut out is not available in the center console base, route the cable away from the lid latch and in a place that will allow the lid to close without damaging the cable.

Once the audio device is connected and synchronized to the vehicle's iPod®/USB/MP3 control system (iPod® or external USB device may take a few minutes to connect), the audio device starts charging and is ready for use by pressing radio switches, as described below.

**NOTE:** If the audio device battery is completely discharged, it may not communicate with the iPod®/USB/MP3 control system until a minimum charge is attained. Leaving the audio device connected to the iPod®/USB/MP3 control system may charge it to the required level.

### Using This Feature

By using iPod cable or external USB device to connect to USB port:

- The audio device can be played on the vehicle's sound system, providing metadata (artist, track title, album, etc.) information on the radio display.
- The audio device can be controlled using the radio buttons to Play, Browse, and List the iPod® contents.
- The audio device battery charges when plugged into the USB/AUX connector (if supported by the specific audio device)

### Controlling The iPod® Or External USB Device Using Radio Buttons

To get into the iPod®/USB/MP3 control mode and access a connected audio device, either press the "AUX" button on the radio faceplate or press the VR button and say "USB" or "Switch to USB". Once in the iPod®/USB/MP3 control mode, audio tracks (if available from audio device) start playing over the vehicle's audio system.

### Play Mode

When switched to iPod®/USB/MP3 control mode, the iPod® or external USB device automatically starts Play mode. In Play mode, the following buttons on the radio faceplate may be used to control the iPod® or external USB device and display data:

- Use the TUNE control knob to select the next or previous track.

- Turning it clockwise (forward) by one click, while playing a track, skips to the next track or press the VR button and say "Next Track".
- Turning it counterclockwise (backward) by one click, will jump to the previous track in the list or press the VR button and say "Previous Track"
- Jump backward in the current track by pressing and holding the << **RW** button. Holding the << **RW** button long enough will jump to the beginning of the current track.
- Jump forward in the current track by pressing and holding the **FF** >> button.
- A single press backward << **RW** or forward **FF** >> will jump backward or forward respectively, for five seconds.
- Use the << **SEEK** and **SEEK** >> buttons to jump to the previous or next track. Pressing the **SEEK** >> button during play mode will jump to the next track in the list, or press the VR button and say "Next or Previous Track".
- While a track is playing, press the **INFO** button to see the associated metadata (artist, track title, album, etc.) for that track. Pressing the **INFO** button again jumps to the next screen of data for that track. Once all screens have been viewed, the last **INFO** button press will go back to the play mode screen on the radio.
- Pressing the **REPEAT** button will change the audio device mode to repeat the current playing track or press the VR button and say "Repeat ON" or "Repeat Off".
- Press the **SCAN** button to use iPod®/USB/MP3 device scan mode, which will play the first 10 seconds of each track in the current list and then forward to the next song. To stop SCAN mode and start playing the desired track, when it is playing the track, press the

**SCAN** button again. During Scan mode, pressing the << **SEEK** and **SEEK** >> buttons will select the previous and next tracks.

- **RND** button (available on sales code RES radio only): Pressing this button toggles between Shuffle ON and Shuffle OFF modes for the iPod® or external USB device, or press the VR button and say "Shuffle ON" or "Shuffle Off". If the **RND** icon is showing on the radio display, then the shuffle mode is ON.

### List Or Browse Mode

During Play mode, pressing any of the buttons described below, will bring up List mode. List mode enables scrolling through the list of menus and tracks on the audio device.

- **TUNE** control knob: The **TUNE** control knob functions in a similar manner as the scroll wheel on the audio device or external USB device.
- Turning it clockwise (forward) and counterclockwise (backward) scrolls through the lists, displaying the track detail on the radio display. Once the track to be played is highlighted on the radio display, press the **TUNE** control knob to select and start playing the track. Turning the **TUNE** control knob fast will scroll through the list faster. During fast scroll, a slight delay in updating the information on the radio display may be noticeable.
- During all List modes, the iPod® displays all lists in "wrap-around" mode. So if the track is at the bottom of the list, just turn the wheel backward (counterclockwise) to get to the track faster.
- In List mode, the radio **PRESET** buttons are used as shortcuts to the following lists on the iPod® or external USB device.
  - Preset 1 – Playlists

- Preset 2 – Artists
- Preset 3 – Albums
- Preset 4 – Genres
- Preset 5 – Audiobooks
- Preset 6 – Podcasts
- Pressing a PRESET button will display the current list on the top line and the first item in that list on the second line.
- To exit List mode without selecting a track, press the same PRESET button again to go back to Play mode.
- LIST button: The LIST button will display the top level menu of the iPod® or external USB device. Turn the TUNE control knob to list the top-menu item to be selected and press the TUNE control knob. This will display the next sub-menu list item on the audio

device, then follow the same steps to go to the desired track in that list. Not all iPod® or external USB device sub-menu levels are available on this system.

- MUSIC TYPE button: The MUSIC TYPE button is another shortcut button to the genre listing on your audio device.

### CAUTION!

- Leaving the iPod® or external USB device (or any supported device) anywhere in the vehicle in extreme heat or cold can alter the operation or damage the device. Follow the device manufacturer's guidelines.
- Placing items on the iPod® or external USB device, or connections to the iPod® or external USB device in the vehicle, can cause damage to the device and/or to the connectors.

**WARNING!**

Do not plug in or remove the iPod® or external USB device while driving. Failure to follow this warning could result in an accident.

**Bluetooth Streaming Audio (BTSA)**

Music can be streamed from your cellular phone to the Uconnect™ phone system.

**Controlling BTSA Using Radio Buttons**

To get into the BTSA mode, press either “AUX” button on the radio or press the VR button and say “Bluetooth Streaming Audio”.

**Play Mode**

When switched to BTSA mode, some audio devices can start playing music over the vehicle’s audio system, but some devices require the music to be initiated on the device first, then it will get streamed to the Uconnect™

phone system. Seven devices can be paired to the Uconnect™ phone system, but just one can be selected and played.

**Selecting Different Audio Device**

1. Press PHONE button to begin.
2. After the “Ready” prompt and the following beep, say “Setup”, then “Select Audio Devices”.
3. Say the name of the audio device or ask the Uconnect™ phone system to list audio devices.

**Next Track**

Use the SEEK UP button, or press the VR button on the radio and say “Next Track” to jump to the next track music on your cellular phone.

**Previous Track**

Use the SEEK DOWN button, or press the VR button on the radio and say “Previous Track” to jump to the previous track music on your cellular phone.

**Browse**

Browsing is not available on a BTSA device. Only the current song that is playing will display info.

**HARMAN KARDON® Logic7® HIGH PERFORMANCE MULTICHANNEL SURROUND SOUND SYSTEM WITH DRIVER-SELECTABLE SURROUND (DSS) — IF EQUIPPED**

Your vehicle is equipped with a Harman Kardon® audio system with GreenEdge™ technology that offers superior sound quality, higher Sound Pressure Levels (SPL) and reduced energy consumption. The new system utilizes proprietary amplifier and speaker technologies delivering substantial increases in component and system efficiency levels.

The 12 Channel Class D GreenEdge high efficiency amplifier is governed by a high voltage tracking power supply and drives a 7.4-channel playback architecture. The Harman Kardon® audio system offers the ability to choose Logic 7 surround sound for any audio source. The GreenEdge high-efficiency speaker designs ensure the system has higher SPL and a dramatic increase in dynamic sound quality. The speakers are tuned for maximum efficiency and perfectly matched to the amplifier output stage ensuring state of the art multi-seat surround sound processing.

Logic7® multichannel surround-sound technology delivers an immersive, accurate sound-stage to every seating position. This surround effect is available for audio from any source - AM/FM/CD/ Satellite Radio or dashboard AUX input; and is activated through the Electronic



Vehicle Information Center (EVIC). Refer to “Driver-Selectable Surround Sound (DSS)” under “Electronic Vehicle Information Center (EVIC)” in “Understanding Your Instrument Panel”.

Selecting “Surround Sound” through the DSS modes activates the Harman Kardon® Logic7® multichannel surround-sound technology in your vehicle. Some audio will sound better in DSS modes, others in Stereo mode.

When in “Surround Sound” mode, balance is set automatically. Fader control is available in surround mode but should be set to the center position for optimal surround performance.

### STEERING WHEEL AUDIO CONTROLS

The remote sound system controls are located on the rear surface of the steering wheel. Reach behind the wheel to access the switches.



**Remote Sound System Controls  
(Back View Of Steering Wheel)**

The right-hand control is a rocker-type switch with a pushbutton in the center and controls the volume and mode of the sound system. Pressing the top of the rocker switch will increase the volume, and pressing the bottom of the rocker switch will decrease the volume.

Pressing the center button will make the radio switch between the various modes available (AM/FM/SAT/CD/HDD/AUX/VES, etc.).

The left-hand control is a rocker-type switch with a pushbutton in the center. The function of the left-hand control is different depending on which mode you are in.

The following describes the left-hand control operation in each mode.

### **Radio Operation**

Pressing the top of the switch will “Seek” up for the next listenable station and pressing the bottom of the switch will “Seek” down for the next listenable station.

The button located in the center of the left-hand control will tune to the next preset station that you have programmed in the radio preset pushbutton.

### **CD Player**

Pressing the top of the switch once will go to the next track on the CD. Pressing the bottom of the switch once will go to the beginning of the current track, or to the beginning of the previous track if it is within one second after the current track begins to play.

If you press the switch up or down twice, it plays the second track; three times, it will play the third, etc.

The center button on the left side rocker switch has no function for a single-disc CD player. However, when a multiple-disc CD player is equipped on the vehicle, the center button will select the next available CD in the player.

### CD/DVD DISC MAINTENANCE

To keep a CD/DVD in good condition, take the following precautions:

1. Handle the disc by its edge; avoid touching the surface.
2. If the disc is stained, clean the surface with a soft cloth, wiping from center to edge.
3. Do not apply paper or tape to the disc; avoid scratching the disc.
4. Do not use solvents such as benzene, thinner, cleaners, or anti-static sprays.
5. Store the disc in its case after playing.
6. Do not expose the disc to direct sunlight.
7. Do not store the disc where temperatures may become too high.

**NOTE:** If you experience difficulty in playing a particular disc, it may be damaged (i.e., scratched, reflective coating removed, a hair, moisture or dew on the disc) oversized, or have protection encoding. Try a known good disc before considering disc player service.

### RADIO OPERATION AND MOBILE PHONES

Under certain conditions, the mobile phone being on in your vehicle can cause erratic or noisy performance from your radio. This condition may be lessened or eliminated by relocating the mobile phone antenna. This condition is not harmful to the radio. If your radio performance does not satisfactorily “clear” by the repositioning of the antenna, it is recommended that the radio volume be turned down or off during mobile phone operation when not using Uconnect™ (if equipped).

## CLIMATE CONTROLS

### Automatic Temperature Control (ATC)

The Automatic Temperature Control system automatically maintains the climate in the cabin of the vehicle at the comfort levels desired by the driver and passenger.



Automatic Temperature Control

### Automatic Operation

Operation of the system is quite simple.

1. Turn the Mode Control knob (on the right) and the Blower Control knob (on the left) to AUTO.

**NOTE:** The AUTO position performs best for front seat occupants only.



045638695

2. Dial in the temperature you would like the system to maintain by rotating the Temperature Control knob. Once the comfort level is selected, the system will maintain that level automatically using the heating system. Should the desired comfort level require air conditioning, the system will automatically make the adjustment.

You will experience the greatest efficiency by simply allowing the system to function automatically. Selecting the "O" (OFF) position on the blower control stops the system completely and closes the outside air intake.

The recommended setting for maximum comfort for the average person is 72°F (22°C); however, this may vary.

**NOTE:**

- The temperature setting can be adjusted at anytime without affecting automatic operation.
- Pressing the Air Conditioning Control button while in AUTO mode will cause the LED in the control button to flash three times and then turn off. This indicates that the system is in AUTO mode and requesting the air conditioning is not necessary.
- If your air conditioning performance seems lower than expected, check the front of the A/C condenser located in front of the radiator for an accumulation of dirt or insects. Clean with a gentle water spray from behind the radiator and through the condenser. Fabric front fascia protectors may reduce airflow to the condenser, reducing air conditioning performance.

**Blower Control**



045597536

For full automatic operation or for automatic blower operation, turn the knob to the AUTO position. In manual mode there are seven blower speeds that can be individual selected. In off position the blower will shut off.

**Manual Operation**

This system offers a full complement of manual override features, which consist of Blower Preferred Automatic, Mode Preferred Automatic, or Blower and Mode Preferred Automatic. This means the operator can override the blower, the mode, or both. There is a manual blower range for times when the AUTO setting is not desired. The blower can be set to any fixed blower speed by rotating the Blower Control knob (on the left).

**NOTE:** Please read the Automatic Temperature Control Operation Chart that follows for details.

<b>Automatic Temperature Control Operation</b>		<b>The system will...</b>				
<b>Operation</b>	<b>How</b>	<b>Blower Control</b>	<b>Mode Control</b>	<b>Air Temperature Control</b>	<b>Air Recirculation Control</b>	<b>A/C Operation</b>
Full Automatic Operation	Set blower knob to Auto. Set mode knob to Auto. Set temperature knobs for comfort.	Automatic	Automatic	Automatic	Automatic but can be overridden.	Automatic
Blower Preferred Automatic	Set blower knob to any desired airflow level other than Auto. Set mode knob to Auto. Set temperature knobs for comfort.	User selectable to any speed.	Automatic	Automatic	Automatic but can be overridden.	Automatic
Mode Preferred Automatic	Set mode knob to any desired air delivery point other than Auto. Set blower knob to Auto. Set temperature knobs for comfort.	Automatic	User selectable to any air delivery point.	Automatic	User selectable outside or recirculated.	User selectable A/C on or off.
Blower and Mode Preferred Automatic	Set blower knob to any desired airflow level other than Auto. Set mode knob to any desired air delivery point other than Auto. Set temperature knobs for comfort.	User selectable to any speed.	User selectable to any air delivery point.	Automatic	User selectable outside or recirculated.	User selectable A/C on or off.

The operator can override the AUTO mode setting to change airflow distribution by rotating the Mode Control knob (on the right) to one of the following positions.

- *Panel*

 Air is directed through the outlets in the instrument panel. These outlets can be adjusted to direct airflow.

**NOTE:** The center instrument panel outlets can be aimed so that they are directed toward the rear seat passengers for maximum airflow to the rear.

- *Bi-Level*

 Air is directed through the panel and floor outlets.

**NOTE:** For all settings, except full cold or full hot, there is a difference in temperature between the upper and lower outlets. The warmer air flows to the floor outlets. This feature gives improved comfort during sunny but cool conditions.

- *Floor*

 Air is directed through the floor outlets with a small amount flowing through the defrost and side window demist outlets.

- *Mix*

 Air is directed through the floor, defrost, and side window demist outlets. This setting works best in cold or snowy conditions that require extra heat to the windshield. This setting is good for maintaining comfort while reducing moisture on the windshield.

- *Defrost*

 Air is directed through the windshield and side window demist outlets. Use this mode with maximum blower and temperature settings for best windshield and side window defrosting.

- *Air Conditioner Control*



Press this button to turn on the air conditioning during manual operation only. When the air conditioning is turned on, cool dehumidified air will flow through the outlets selected with the Mode control dial. Press this button a second time to turn OFF the air conditioning. An LED in the button illuminates when manual compressor operation is selected.

- *Recirculation Control*



The system will automatically control recirculation. However, pressing the Recirculation Control button will put the system in recirculation mode. This can be used when outside conditions such as smoke, odors, dust, or high humidity are present. Activating recirculation will cause the LED in the control button to illuminate.

**NOTE:**

- When the ignition switch is turned to the LOCK position, the recirculation feature will be cancelled.
- In cold weather, use of the Recirculation mode may lead to excessive window fogging. The Recirculation mode is not allowed in the floor, defrost, or defrost/floor mode in order to improve window clearing. Recirculation will be disabled automatically if these modes are selected.
- Extended use of recirculation may cause the windows to fog. If the interior of the windows begins to fog, press the Recirculation button to return to outside air. Some temp/humidity conditions will cause captured interior air to condense on windows and hamper visibility. For this reason, the system will not allow Recirculation to be selected while in floor, defrost, or defrost/floor mode. Attempting to use the recirculation while in these modes will cause the LED in the control button to blink and then turn off.



- Most of the time, when in Automatic Operation, you can temporarily put the system into Recirculation Mode by pressing the Recirculation button. However, under certain conditions, while in Automatic Mode, the system is blowing air out the defrost vents. When these conditions are present, and the Recirculation button is pressed, the indicator will flash and then turn off. This tells you that you are unable to go into Recirculation Mode at this time. If you would like the system to go into Recirculation Mode, you must first move the Mode knob to Panel, Panel/Floor and then press the Recirculation button. This feature reduces the possibility of window fogging.

### Operating Tips

**NOTE:** Refer to the chart at the end of this section for suggested control settings for various weather conditions.

### Summer Operation

The engine cooling system in air-conditioned vehicles must be protected with a high-quality antifreeze coolant to provide proper corrosion protection and to protect against engine overheating. A solution of 50% ethylene glycol antifreeze coolant and 50% water is recommended. Refer to “Maintenance Procedures” in “Maintaining Your Vehicle” for proper coolant selection.

### Winter Operation

Use of the air Recirculation Mode during winter months is not recommended because it may cause window fogging.

### Vacation Storage

Anytime you store your vehicle, or keep it out of service (i.e., vacation) for two weeks or more, run the air conditioning system at idle for about five minutes in the fresh air and high blower settings. This will ensure adequate system lubrication to minimize the possibility of compressor damage when the system is started again.

### Window Fogging

Interior fogging on the windshield can be quickly removed by turning the mode selector to Defrost. The Defrost/Floor mode can be used to maintain a clear windshield and provide sufficient heating. If side window fogging becomes a problem, increase blower speed. Vehicle windows tend to fog on the inside in mild but rainy or humid weather.

**NOTE:** Recirculate without A/C should not be used for long periods as fogging may occur.

### Side Window Demisters

A side window demister outlet is located at each end of the instrument panel. These non-adjustable outlets direct air toward the side windows when the system is in the FLOOR, MIX, or DEFROST mode. The air is directed at the area of the windows through which you view the outside mirrors.











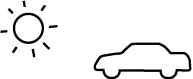









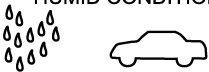

### Outside Air Intake

Make sure the air intake, located directly in front of the windshield, is free of obstructions such as leaves. Leaves collected in the air intake may reduce airflow, and if they enter the plenum, they could plug the water drains. In winter months, make sure the air intake is clear of ice, slush, and snow.

### A/C Air Filter

The A/C Filter prevents most dust and pollen from entering the cabin. The filter acts on air coming from outside the vehicle and recirculated air within the passenger compartment. Refer to "Maintenance Procedures" in "Maintaining Your Vehicle" for A/C Air Filter service information or see your authorized dealer for service. Refer to "Maintenance Schedules" for filter service intervals.

### Control Setting Suggestions for Various Weather Conditions

WEATHER	CONTROL SETTINGS
<p>HOT WEATHER AND VEHICLE INTERIOR IS VERY HOT</p> 	<p>Open the windows, start the vehicle, press the  button to turn recirculate off. Set the Fan control to the high position (full clockwise). Press the A/C button. Set the Mode control at or between  and . Set the temperature control to full cool. After the hot air is pushed from the vehicle press the  button to turn recirculate on and roll up the windows. Once you are comfortable, press the  button to turn recirculate off and adjust the temperature control for comfort.</p>
<p>WARM WEATHER</p> 	<p>Press the  button to turn recirculate off. If it's sunny, set the Mode control at or near  and turn the air conditioning on. If it's cloudy or dark, set the Mode control at or near .</p>
<p>COOL OR COLD HUMID CONDITIONS</p> 	<p>Press the  button to turn recirculate off. If it's sunny, set the Mode control at or between  and  then turn the air conditioning on. If it's cloudy or dark, set the Mode control at or near  and turn the air conditioning on. If the windows begin to fog, set Mode control at or between  and .</p>
<p>COLD DRY CONDITIONS</p> 	<p>Set the Mode control at or near . If it is sunny, you may want more upper air. In this case, set the Mode control at or between  and . In very cold weather, if you need extra heat at the windshield, set the Mode control at or near the .</p>



# STARTING AND OPERATING

## CONTENTS

---

■ Starting Procedures . . . . .	255	■ Engine Block Heater — If Equipped . . . . .	263
□ Manual Transmission – If Equipped . . . . .	255	■ Manual Transmission — If Equipped . . . . .	263
□ Automatic Transmission – If Equipped . . . . .	256	□ Six-Speed Manual Transmission . . . . .	263
□ Keyless Enter-N-Go . . . . .	257	■ Automatic Transmission — If Equipped . . . . .	267
□ Normal Starting . . . . .	258	□ Key Ignition Park Interlock . . . . .	269
□ Extreme Cold Weather (Below $-20^{\circ}\text{F}$ Or $-29^{\circ}\text{C}$ ) . . . . .	261	□ Brake/Transmission Shift Interlock System . . . . .	269
□ If Engine Fails To Start . . . . .	261	□ Five-Speed Automatic Transmission . . . . .	269
□ After Starting . . . . .	263	□ Gear Ranges . . . . .	270

- AutoStick® . . . . . 276
  - Steering Wheel Mounted Paddle Shifters Or Console Mounted Shifter . . . . . 276
- Sport Mode . . . . . 278
- Driving On Slippery Surfaces . . . . . 279
  - Acceleration . . . . . 279
  - Traction . . . . . 280
- Driving Through Water . . . . . 281
  - Flowing/Rising Water . . . . . 281
- Power Steering . . . . . 283
  - Power Steering Fluid Check . . . . . 284
- Parking Brake . . . . . 285
  - Manual Transmission – If Equipped . . . . . 286
  - Automatic Transmission – If Equipped . . . . . 286
- Brake System . . . . . 288
  - Anti-Lock Brake System (ABS) . . . . . 288
- Electronic Brake Control System . . . . . 291
  - Anti-Lock Brake System (ABS) . . . . . 291
  - Traction Control System (TCS) . . . . . 292
  - Brake Assist System (BAS) . . . . . 292
  - Hill Start Assist (HSA) . . . . . 293
  - Electronic Stability Control (ESC) . . . . . 295
    - ESC Activation/Malfunction Indicator Light And ESC Off Indicator Light . . . . . 299
  - Synchronizing ESC . . . . . 300

<ul style="list-style-type: none"> <li>■ Tire Safety Information . . . . . 300                     <ul style="list-style-type: none"> <li>□ Tire Markings . . . . . 300</li> <li>□ Tire Terminology And Definitions . . . . . 305</li> <li>□ Tire Loading And Tire Pressure . . . . . 306</li> </ul> </li> <li>■ Tires — General Information . . . . . 310                     <ul style="list-style-type: none"> <li>□ Tire Pressure . . . . . 310</li> <li>□ Tire Inflation Pressures . . . . . 311</li> <li>□ Radial Ply Tires . . . . . 313</li> <li>□ F1 Three-Season Tires — If Equipped . . . . . 313</li> <li>□ Tire Spinning . . . . . 314</li> <li>□ Tread Wear Indicators . . . . . 314</li> <li>□ Life Of Tire . . . . . 315</li> <li>□ Replacement Tires . . . . . 316</li> </ul> </li> </ul>	<ul style="list-style-type: none"> <li>■ Tire Chains . . . . . 317</li> <li>■ Snow Tires . . . . . 319</li> <li>■ Tire Rotation Recommendations . . . . . 319                     <ul style="list-style-type: none"> <li>□ Tire Rotation – Four Season/Rsa Tires . . . . . 320</li> <li>□ Tire Rotation – F1 Three Season Tires . . . . . 321</li> </ul> </li> <li>■ Tire Pressure Monitor System (TPMS) . . . . . 321                     <ul style="list-style-type: none"> <li>□ Premium System . . . . . 324</li> <li>□ General Information . . . . . 328</li> </ul> </li> <li>■ Fuel Requirements . . . . . 329                     <ul style="list-style-type: none"> <li>□ 6.4L Engine . . . . . 329</li> <li>□ Reformulated Gasoline . . . . . 329</li> <li>□ Gasoline/Oxygenate Blends . . . . . 330</li> <li>□ E-85 Usage In Non-Flex Fuel Vehicles . . . . . 330</li> </ul> </li> </ul>
--	--

## 254 STARTING AND OPERATING

- MMT In Gasoline . . . . . 331
- Materials Added To Fuel . . . . . 331
- Fuel System Cautions . . . . . 332
- Carbon Monoxide Warnings . . . . . 333
- Adding Fuel . . . . . 334
  - Fuel Filler Cap (Gas Cap) . . . . . 334
  - Loose Fuel Filler Cap Message . . . . . 335
- Vehicle Loading . . . . . 335
  - Vehicle Certification Label . . . . . 336
  - Gross Vehicle Weight Rating (GVWR) . . . . . 336
  - Gross Axle Weight Rating (GAWR) . . . . . 336
  - Overloading . . . . . 337
  - Loading . . . . . 337
- Trailer Towing . . . . . 337
- Recreational Towing  
(Behind Motorhome, Etc.) . . . . . 338
  - Automatic Transmission — If Equipped . . . . . 338
  - Manual Transmission — If Equipped . . . . . 339



## STARTING PROCEDURES

Before starting your vehicle, adjust your seat, adjust the inside and outside mirrors, fasten your seat belt, and if present, instruct all other occupants to buckle their seat belts.

### WARNING!

- When leaving the vehicle, always remove the key fob from the ignition and lock your vehicle.
- Never leave children alone in a vehicle, or with access to an unlocked vehicle. Allowing children to be in a vehicle unattended is dangerous for a number of reasons. A child or others could be seriously or fatally injured. Children should be warned not to touch the parking brake, brake pedal or the shift lever.

*(Continued)*

### WARNING! (Continued)

- Do not leave the key fob in or near the vehicle, and do not leave a vehicle equipped with Keyless Enter-N-Go in the ACC or ON/RUN mode. A child could operate power windows, other controls, or move the vehicle.

### Manual Transmission – If Equipped

Apply the parking brake, place the shift lever in NEUTRAL and press the clutch pedal before starting vehicle. This vehicle is equipped with a clutch interlocking ignition system. It will not start unless the clutch pedal is pressed to the floor.

### Normal Starting With Integrated Key – Manual Transmission

Normal starting of either a cold or a warm engine does not require pumping or pressing the accelerator pedal. Press the clutch pedal fully to the floor, and turn the

ignition switch to the START position and release when the engine starts. If the engine fails to start within 15 seconds, turn the ignition switch to the OFF position, wait 10 to 15 seconds, then repeat the “Normal Starting” procedure.

### WARNING!

Do not attempt to push or tow your vehicle to get it started. Unburned fuel could enter the catalytic converter and once the engine has started, ignite and damage the converter and vehicle. If the vehicle has a discharged battery, booster cables may be used to obtain a start from another vehicle. This type of start can be dangerous if done improperly, so follow the procedure carefully. Refer to “Jump Starting” in “What To Do In Emergencies” for further information.

### Automatic Transmission – If Equipped

The shift lever must be in the NEUTRAL or PARK position before you can start the engine. Apply the brakes before shifting into any driving gear.

### CAUTION!

Damage to the transmission may occur if the following precautions are not observed:

- Shift into PARK only after the vehicle has come to a complete stop.
- Shift into or out of REVERSE only after the vehicle has come to a complete stop and the engine is at idle speed.
- Do not shift from REVERSE, PARK, or NEUTRAL into any forward gear when the engine is above idle speed.
- Before shifting into any gear, make sure your foot is firmly on the brake pedal.

## Using Fob With Integrated Key (Tip Start)

**NOTE:** Normal starting of either a cold or a warm engine is obtained without pumping or pressing the accelerator pedal.

**Do not** press the accelerator. Use the Fob with Integrated Key to briefly turn the ignition switch to the START position and release it as soon as the starter engages. The starter motor will continue to run, and it will disengage automatically when the engine is running. If the engine fails to start, the starter will disengage automatically in 10 seconds. If this occurs, turn the ignition switch to the LOCK position, wait 10 to 15 seconds, then repeat the “Normal Starting” procedure.

## Keyless Enter-N-Go

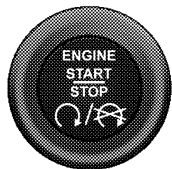

050105203

This feature allows the driver to operate the ignition switch with the push of a button, as long as the ENGINE START/STOP button is installed and the Remote Keyless Entry (RKE) transmitter is in the passenger compartment.

## Installing And Removing The ENGINE START/STOP Button

### *Installing The Button*

1. Remove the key fob from the ignition switch.
2. Insert the ENGINE START/STOP button into the ignition switch with the lettering facing up and readable.
3. Press firmly on the center of the button to secure it into position.

### *Removing The Button*

1. The ENGINE START/STOP button can be removed from the ignition switch for key fob use.
2. Insert the metal part of the emergency key under the chrome bezel at the 6 o'clock position and gently pry the button loose.

**NOTE:** The ENGINE START/STOP button should only be removed or inserted with the ignition in the OFF position.

### **Normal Starting**

#### **Using The ENGINE START/STOP Button – Automatic Transmission Only**

**NOTE:** Normal starting of either a cold or a warm engine is obtained without pumping or pressing the accelerator pedal.

To start the engine, the transmission must be in PARK or NEUTRAL. Press and hold the brake pedal while pressing the ENGINE START/STOP button once. The system takes over and attempts to start the vehicle. If the vehicle fails to start, the starter will disengage automatically after 10 seconds. If you wish to stop the cranking of the engine prior to the engine starting, press the button again.

#### **Using The ENGINE START/STOP Button – Manual Transmission Only**

**NOTE:** Normal starting of either a cold or a warm engine is obtained without pumping or pressing the accelerator pedal.

To start the engine, press and hold the clutch pedal while pressing and holding the ENGINE START/STOP button. Release the button when the engine starts. If the vehicle fails to start within 15 seconds, release the button, wait 10 to 15 seconds, then repeat the “Normal Starting”

procedure. If you wish to stop the cranking of the engine prior to the engine starting, release the button.

### **To Turn Off The Engine Using ENGINE START/STOP Button – Automatic Transmission Only**

1. Place the shift lever in PARK, then press and release the ENGINE START/STOP button.
2. The ignition switch will return to the OFF position.
3. If the shift lever is not in PARK, the ENGINE START/STOP button must be held for two seconds and vehicle speed must be above 5 mph (8 km/h) before the engine will shut off. The ignition switch position will remain in the ACC position until the shift lever is in PARK and the button is pressed twice to the OFF position. If the shift lever is not in PARK and the ENGINE START/STOP button is pressed once, the EVIC (if equipped) will

display a “Vehicle Not In Park” message and the engine will remain running. Never leave a vehicle out of the PARK position, or it could roll.

**NOTE:** If the ignition switch is left in the ACC or RUN (engine not running) position and the transmission is in PARK, the system will automatically time out after 30 minutes of inactivity and the ignition will switch to the OFF position.

### **To Turn Off The Engine Using ENGINE START/STOP Button – Manual Transmission Only**

1. With the vehicle stopped, place the shift lever in NEUTRAL, then press and release the ENGINE START/STOP button.
2. The ignition switch will return to the OFF position.
3. Place the shift lever in first gear or Reverse and then apply the parking brake.

**NOTE:**

- If the ignition switch is left in the ACC position, the system will automatically time out after 30 minutes of inactivity and the ignition will switch to the OFF position.
- If the ignition switch is left in the RUN position, the system will automatically time out after 30 minutes of inactivity if the vehicle speed is 0 mph (0 km/h) and the engine is not running.
- If the vehicle speed is above 5 mph (8 km/h), the ENGINE START/STOP button must be held for two seconds before the engine will shut off. The ignition switch position will remain in the ACC position until the vehicle is stopped and the button is pressed twice to the OFF position.

**Keyless Enter-N-Go Functions – With Driver’s Foot OFF The Brake Pedal/Clutch Pedal (In PARK Or NEUTRAL Position)**

The Keyless Enter-N-Go feature operates similar to an ignition switch. It has four positions, OFF, ACC, RUN and START. To change the ignition switch positions without starting the vehicle and use the accessories follow these steps.

- Starting with the ignition switch in the OFF position:
- Press the ENGINE START/STOP button once to change the ignition switch to the ACC position (EVIC displays “IGNITION MODE ACCESSORY”),
- Press the ENGINE START/STOP button a second time to change the ignition switch to the ON/RUN position (EVIC displays “IGNITION MODE RUN”),
- Press the ENGINE START/STOP button a third time to return the ignition switch to the OFF position (EVIC displays “IGNITION MODE OFF”).

**Extreme Cold Weather (Below  $-20^{\circ}\text{F}$  Or  $-29^{\circ}\text{C}$ )**

To ensure reliable starting at these temperatures, use of an externally powered electric engine block heater (available from your authorized dealer) is recommended.

**If Engine Fails To Start****WARNING!**

- Never pour fuel or other flammable liquids into the throttle body air inlet opening in an attempt to start the vehicle. This could result in a flash fire causing serious personal injury.

*(Continued)*

**WARNING! (Continued)**

- Do not attempt to push or tow your vehicle to get it started. Vehicles equipped with an automatic transmission cannot be started this way. Unburned fuel could enter the catalytic converter and once the engine has started, ignite and damage the converter and vehicle. If the vehicle has a discharged battery, booster cables may be used to obtain a start from a booster battery or the battery in another vehicle. This type of start can be dangerous if done improperly. Refer to "Jump Starting" in "What To Do In Emergencies" for further information.

### **Clearing A Flooded Engine (Using ENGINE START/STOP Button) – Automatic Transmission Only**

If the engine fails to start after you have followed the “Normal Starting” or “Extreme Cold Weather” procedures, it may be flooded. To clear any excess fuel, press and hold the brake pedal, push the accelerator pedal all the way to the floor and hold it, then press and release the ENGINE START/STOP button once. The starter motor will engage automatically, run for 10 seconds, and then disengage. Once this occurs, release the accelerator pedal and the brake pedal, wait 10 to 15 seconds, then repeat the “Normal Starting” procedure.

### **Clearing A Flooded Engine (Using ENGINE START/STOP Button) – Manual Transmission Only**

If the engine fails to start after you have followed the “Normal Starting” or “Extreme Cold Weather” procedures, it may be flooded. To clear any excess fuel, press and hold the clutch pedal, push the accelerator pedal all

the way to the floor and hold it, then press and hold the ENGINE START/STOP button for no more than 15 seconds. Release the accelerator pedal and the clutch pedal, wait 10 to 15 seconds, then repeat the “Normal Starting” procedure.

### **Clearing A Flooded Engine (Using Fob With Integrated Key)**

If the engine fails to start after you have followed the “Normal Starting” or “Extreme Cold Weather” procedures, it may be flooded. To clear any excess fuel, push the accelerator pedal all the way to the floor and hold it. Then, turn the ignition switch to the START position and release it as soon as the starter engages. The starter motor will disengage automatically in 10 seconds. Once this occurs, release the accelerator pedal, turn the ignition switch to the LOCK position, wait 10 to 15 seconds, then repeat the “Normal Starting” procedure.



**CAUTION!**

To prevent damage to the starter, wait 10 to 15 seconds before trying again.

**After Starting**

The idle speed is controlled automatically and it will decrease as the engine warms up.

**ENGINE BLOCK HEATER — IF EQUIPPED**

The engine block heater warms the engine, and permits quicker starts in cold weather. Connect the cord to a standard 110-115 Volt AC electrical outlet with a grounded, three-wire extension cord.

The engine block heater cord is routed under the hood on the driver side of the vehicle. It has a removable cap that is located on the driver side of the Integrated Power Module.

The engine block heater must be plugged in at least one hour to have an adequate warming effect on the engine.

**WARNING!**

Remember to disconnect the engine block heater cord before driving. Damage to the 110-115 Volt electrical cord could cause electrocution.

**MANUAL TRANSMISSION — IF EQUIPPED****Six-Speed Manual Transmission****WARNING!**

You or others could be injured if you leave the vehicle unattended without having the parking brake fully applied. The parking brake should always be applied when the driver is not in the vehicle, especially on an incline.

**CAUTION!**

- Never drive with your foot resting on the clutch pedal, or try to hold the vehicle on a hill with the clutch pedal partially engaged, as this will cause abnormal wear on the clutch. Refer to “Electronic Brake Control System/Hill Start Assist” in “Starting and Operating” for further information.
- Failure to press the clutch pedal fully to the floor may cause increased shift efforts, and may result in damage to the clutch and transmission.
- Do not rest your hand on the shift lever while driving, as this may result in transmission synchronizer damage.
- Do not attempt to shift the transmission if the rear wheels are spinning due to loss of traction. Damage to the transmission may occur.

**NOTE:** During cold weather, you may experience increased effort in shifting until the transmission fluid warms up. This is normal.



Manual Shifter

## Shifting

Fully press the clutch pedal and lift your foot off the accelerator pedal before shifting gears. As you release the clutch pedal, lightly press the accelerator pedal. Damage to the transmission or clutch may occur if you do not fully press the clutch pedal and lift off of the accelerator pedal when shifting.

The six-speed manual transmission has a spring that centers the shift lever near third and fourth gear. This spring helps you know which gear you are in when you are shifting. Be careful when shifting from first to second or downshifting from sixth to fifth.

The spring will try to pull the shift lever toward third and fourth gear. Make sure you move the shift lever into second or fifth gear. If you let the shift lever move in the direction of the pulling, you may end shifting from first to fourth or from sixth to third gear.

## CAUTION!

**Always make sure the vehicle comes to a complete stop before shifting into REVERSE. Failure to do so may result in transmission damage.**

You must always use first gear (or Reverse) when starting from a standing position.

## Recommended Shift Speeds

To utilize your manual transmission efficiently for fuel economy, it should be upshifted as listed in recommended shift speed chart.

MANUAL TRANSMISSION RECOMMENDED SHIFT SPEEDS			
	1-4	4-5	5-6
mph	20	37	48
(km/h)	(32)	(59)	(77)

Earlier upshifts during cruise conditions (relatively steady speeds) may result in increased fuel economy.

Higher upshift speeds may be used to obtain a desired acceleration rate.

**NOTE:**

- Your vehicle is equipped with a transmission reverse inhibitor system. When vehicle speed is greater than 3 mph (5 km/h), the reverse inhibitor activates to help prevent shifts into REVERSE. When at a complete stop, you may notice lighter shift efforts into REVERSE with the ignition switch in the ON position (RUN position for Keyless Enter-N-Go) as compared to the LOCK position (OFF position for Keyless Enter-N-Go). This is normal operation of the transmission reverse inhibitor system.
- Due to the high performance nature of your drivetrain, you may hear your transmission. This can be most noticeable when the vehicle is idling in NEUTRAL with

the clutch engaged (clutch pedal released), but it may also be heard when driving at low engine RPM. Also, this may be more noticeable when the transmission is warm. This is a normal condition and is not an indication of a problem with your clutch or transmission.

**1–4 Skip Shift**

There are times when you must shift the transmission directly from first gear to fourth gear instead of from first gear to second gear. This is to help you get the best possible fuel economy from your vehicle. This occurs when the engine coolant (antifreeze) is higher than 106°F (41°C), vehicle speed is greater than 19 mph (30 km/h) but less than 21 mph (34 km/h), and the transmission is in first gear, and the accelerator is at 1/4 throttle or less. The “1–4 Skip Shift Indicator Message” will be displayed during these times.

When the “1–4 Skip Shift Indicator Message” is displayed, the shift mechanism will only allow shifts from first gear to fourth gear. After you shift the transmission to fourth gear, you can press the clutch in and shift to another forward gear.

### **Downshifting**

To maintain a safe speed and prolong brake life, downshift to maintain a safe speed when descending a steep grade.

#### **WARNING!**

Skipping more than one gear while downshifting, could cause you to lose control of your vehicle. You could have a collision.

#### **CAUTION!**

- If you skip more than one gear while downshifting or downshift at too high an engine speed, you could damage the engine, transmission, or clutch.
- Do not downshift into first gear when the vehicle is moving faster than 15 mph (24 km/h), as you could damage the engine and/or clutch.

### **AUTOMATIC TRANSMISSION — IF EQUIPPED**

#### **CAUTION!**

Damage to the automatic transmission may occur if the following precautions are not observed:

- Shift into PARK only after the vehicle has come to a complete stop.

*(Continued)*

**CAUTION! (Continued)**

- Shift into or out of REVERSE only after the vehicle has come to a complete stop and the engine is at idle speed.
- Do not shift between PARK, REVERSE, NEUTRAL, or DRIVE when the engine is above idle speed.
- Before shifting into any gear, make sure your foot is firmly pressing the brake pedal.

**NOTE:** You must press and hold the brake pedal while shifting out of PARK.

**WARNING!**

- It is dangerous to move the shift lever out of PARK or NEUTRAL if the engine speed is higher than idle speed. If your foot is not firmly pressing on the brake pedal, the vehicle could accelerate quickly forward or in reverse. You could lose control of the vehicle and hit someone or something. Only shift into gear when the engine is idling normally and when your foot is firmly pressing on the brake pedal.

*(Continued)*

**WARNING! (Continued)**

- **Unintended movement of a vehicle could injure those in or near the vehicle. As with all vehicles, you should never exit a vehicle while the engine is running. Before exiting a vehicle, always apply the parking brake, shift the transmission into PARK, and turn the engine OFF. When the ignition is in the OFF position, the shift lever is locked in PARK, securing the vehicle against unwanted movement. Furthermore, you should never leave unattended children inside a vehicle.**

**Key Ignition Park Interlock**

This vehicle is equipped with a Key Ignition Park Interlock which requires the shift lever to be placed in PARK before the engine can be turned off. This helps the driver avoid inadvertently leaving the vehicle without placing

the transmission in PARK. This system also locks the shift lever in PARK whenever the ignition switch is in the OFF position.

**Brake/Transmission Shift Interlock System**

This vehicle is equipped with a Brake Transmission Shift Interlock (BTSI) system that holds the shift lever in the PARK position unless the brakes are applied. To move the shift lever out of the PARK position, the ignition switch must be turned to the ON/RUN position (engine running or not) and the brake pedal must be pressed.

**Five-Speed Automatic Transmission**

The shift lever position display (located in the instrument panel cluster) indicates the transmission gear range. You must press the brake pedal to move the shift lever out of the PARK position (refer to “Brake/Transmission Shift Interlock System” in this section). To drive, move the shift lever from PARK or NEUTRAL to the DRIVE position.

The electronically-controlled transmission provides a precise shift schedule. The transmission electronics are self-calibrating; therefore, the first few shifts on a new vehicle may be somewhat abrupt. This is a normal condition, and precision shifts will develop within a few hundred miles (kilometers).

Shifting from DRIVE to PARK or REVERSE should be done only after the accelerator pedal is released and the vehicle is stopped. Be sure to keep your foot on the brake pedal when moving the shift lever between these gears.

The console mounted shift lever provides PARK, REVERSE, NEUTRAL, DRIVE, and AutoStick® shift positions. Once the shifter is in DRIVE, tapping the shift lever side to side (+/-), or pressing the paddle shifters will place the vehicle in AutoStick®. AutoStick® allows for manual shift control (refer to “AutoStick®” in this section). While in AutoStick® the transmission gear position will be displayed in the EVIC.

### **Gear Ranges**

DO NOT race the engine when shifting from PARK or NEUTRAL into another gear range.

#### **PARK**

This range supplements the parking brake by locking the transmission. The engine can be started in this range. Never attempt to use PARK while the vehicle is in motion. Apply the parking brake when leaving the vehicle in this range.

When parking on a level surface, you may place the shift lever in the PARK position first, and then apply the parking brake.

When parking on a hill, apply the parking brake before placing the shift lever in PARK, otherwise the load on the transmission locking mechanism may make it difficult to move the shift lever out of PARK. As an added precaution, turn the front wheels toward the curb on a downhill grade and away from the curb on an uphill grade.



**WARNING!**

- Never use the PARK position as a substitute for the parking brake. Always apply the parking brake fully when parked to guard against vehicle movement and possible injury or damage.
- Your vehicle could move and injure you and others if it is not completely in PARK. Check by trying to move the shift lever rearward (with the brake pedal released), after you have placed it in PARK. Make sure the transmission is in PARK before leaving the vehicle.

*(Continued)*

**WARNING! (Continued)**

- It is dangerous to move the shift lever out of PARK or NEUTRAL if the engine speed is higher than idle speed. If your foot is not firmly pressing on the brake pedal, the vehicle could accelerate quickly forward or in reverse. You could lose control of the vehicle and hit someone or something. Only shift into gear when the engine is idling normally and when your foot is firmly pressing on the brake pedal.

*(Continued)*

**WARNING! (Continued)**

- Unintended movement of a vehicle could injure those in or near the vehicle. As with all vehicles, you should never exit a vehicle while the engine is running. Before exiting a vehicle, always apply the parking brake, shift the transmission into PARK, and turn the engine off. When the ignition is in the OFF position, the shift lever is locked in the PARK, securing the vehicle against unwanted movement.
- When leaving the vehicle, always remove the key fob from the ignition and lock your vehicle.

*(Continued)*

**WARNING! (Continued)**

- Never leave children alone in a vehicle, or with access to an unlocked vehicle. Allowing children to be in a vehicle unattended is dangerous for a number of reasons. A child or others could be seriously or fatally injured. Children should be warned not to touch the parking brake, brake pedal or the shift lever.
- Do not leave the key fob in or near the vehicle, and do not leave Keyless Enter-N-Go in the ACC or ON/RUN mode. A child could operate power windows, other controls, or move the vehicle.

**CAUTION!**

- Before moving the shift lever out of PARK, you must turn the ignition switch from the LOCK/OFF position to the ON/RUN position, and also press the brake pedal. Otherwise, damage to the shift lever could result.
- DO NOT race the engine when shifting from PARK or NEUTRAL into another gear range, as this can damage the drivetrain.

The following indicators should be used to ensure that you have engaged the shift lever into the PARK position:

- When shifting into PARK, move the shift lever all the way forward and to the left until it stops and is fully seated.
- Look at the shift lever position display and verify that it indicates the PARK position.

- With brake pedal released, verify that the shift lever will not move out of PARK.

**REVERSE**

This range is for moving the vehicle backward. Shift into REVERSE only after the vehicle has come to a complete stop.

**NEUTRAL**

Use this range when the vehicle is standing for prolonged periods with engine running. The engine may be started in this range. Set the parking brake and shift the transmission into PARK if you must leave the vehicle.

**WARNING!**

**Do not coast in NEUTRAL and never turn off the ignition to coast down a hill. These are unsafe practices that limit your response to changing traffic or road conditions. You might lose control of the vehicle and have a collision.**

**CAUTION!**

**Towing the vehicle, coasting, or driving for any other reason with the transmission in NEUTRAL can result in severe transmission damage. Refer to “Recreational Towing” in “Starting And Operating” and “Towing A Disabled Vehicle” in “What To Do In Emergencies” for further information.**

**DRIVE**

This range should be used for most city and highway driving. It provides the smoothest upshifts and downshifts, and the best fuel economy. The transmission automatically upshifts through underdrive first, second, and third gears, direct fourth gear and overdrive fifth gear. The DRIVE position provides optimum driving characteristics under all normal operating conditions.

When frequent transmission shifting occurs (such as when operating the vehicle under heavy loading conditions, in hilly terrain, traveling into strong head winds, or while towing heavy trailers), use the “AutoStick®” mode (refer to “AutoStick®” in this section) to select a lower gear. Under these conditions, using a lower gear will improve performance and extend transmission life by reducing excessive shifting and heat buildup.

**Transmission Limp Home Mode**

Transmission function is monitored electronically for abnormal conditions. If a condition is detected that could result in transmission damage, Transmission Limp Home Mode is activated. In this mode, the transmission remains in the current gear until the vehicle is brought to a stop. After the vehicle has stopped, the transmission will remain in second gear regardless of which forward gear is selected. PARK, REVERSE, and NEUTRAL will continue to operate. The Malfunction Indicator Light (MIL)

may be illuminated. Limp Home Mode allows the vehicle to be driven to an authorized dealer for service without damaging the transmission.

In the event of a momentary problem, the transmission can be reset to regain all forward gears by performing the following steps:

1. Stop the vehicle.
2. Shift the transmission into PARK.
3. Turn the engine OFF.
4. Wait approximately 10 seconds.
5. Restart the engine.
6. Shift into the desired gear range. If the problem is no longer detected, the transmission will return to normal operation.

**NOTE:** Even if the transmission can be reset, we recommend that you visit your authorized dealer at your earliest possible convenience. Your authorized dealer has diagnostic equipment to determine if the problem could recur.

If the transmission cannot be reset, authorized dealer service is required.

### **Overdrive Operation**

The automatic transmission includes an electronically controlled Overdrive (fifth gear). The transmission will automatically shift into the Overdrive gear if the following conditions are present:

- the shift lever is in the DRIVE position,
- vehicle speed is sufficiently high, and
- the driver is not heavily pressing the accelerator

## AUTOSTICK®

### Steering Wheel Mounted Paddle Shifters Or Console Mounted Shifter

AutoStick® is a driver-interactive transmission feature that offers manual gear shifting to provide you with more control of the vehicle. AutoStick® allows you to maximize engine braking, and improve overall vehicle performance.

This system can also provide you with more control during passing, city driving, cold slippery conditions, mountain driving, trailer towing, and many other situations.

#### Operation

When the shift lever is in the DRIVE position, the transmission will operate automatically, shifting between the five available gears. To engage AutoStick®, simply move the shift lever to the right or left (+/-) while in the DRIVE position, or press one of the steering wheel

mounted shift paddles (+/-). When AutoStick® is active, the current transmission gear is displayed in the Electronic Vehicle Information Center (EVIC) portion of the instrument cluster. In AutoStick® mode, the transmission will shift when manually selected by the driver (using the shift lever, or the shift paddles), unless an engine lugging or overspeed condition would result. It will remain in the selected gear until another upshift or downshift is chosen, except as described below.

- The transmission will automatically downshift as the vehicle slows (to prevent engine lugging) and will display the current gear.
- The transmission will automatically downshift to first gear when coming to a stop.
- You can start out in first or second gear. Tapping (+) (at a stop) will allow starting in second gear. Starting out in second gear is helpful in snowy or icy conditions.

- The system will ignore attempts to upshift at too low of a vehicle speed.
- Transmission shifting will be more noticeable when AutoStick® is engaged. To disengage AutoStick® mode, hold the shift lever to the right or press and hold the (+) shift paddle until “D” is once again displayed in the instrument cluster. You can shift in or out of the AutoStick® mode at any time without taking your foot off the accelerator pedal.
- An “UPSHIFT” message will appear in the Electronic Vehicle Information Center (EVIC) portion of the instrument cluster when using AutoStick®, to alert the driver to upshift to the next gear. The “UPSHIFT” message will appear when approaching the maximum engine speed.

**WARNING!**

**Do not downshift for additional engine braking on a slippery surface. The drive wheels could lose their grip and the vehicle could skid, causing a collision or personal injury.**

**Auto**

- If AutoStick® is engaged while in “Auto” mode, the transmission will automatically shift up if maximum engine speed is reached.
- Heavily pressing the accelerator pedal may generate an automatic downshift for improved acceleration.
- This mode should be used for most driving situations.

## Sport

- If AutoStick is engaged while in “Sport” mode, the transmission will remain in the selected gear even when maximum engine speed is reached. Refer to “Sport Mode” in “Starting And Operating” for further information.
- Engine overspeed protection is achieved through fuel cut off at or near redline.
- This mode will provide aggressive shifting and is intended for spirited driving.

## SPORT MODE

This vehicle is equipped with an electronic controlled dampening system. This system reduces body roll and pitch in many driving situations including cornering, acceleration and braking. In addition, the driver has the ability to select a more aggressive shifting pattern. On the center console, there is a “SPORT” button that when

pressed will cycle through three different driving modes. This is the description of each mode of operation:

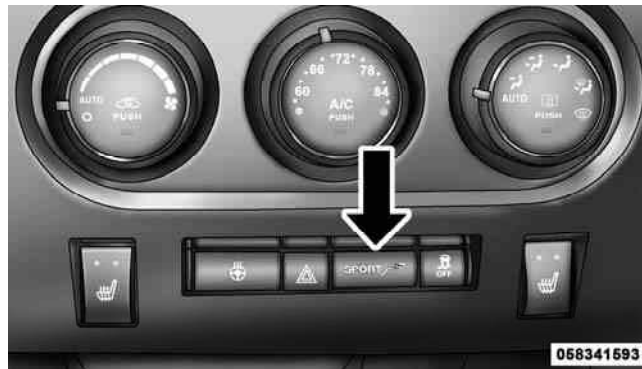

### SPORT Button

- Off – This is the initial position. This mode will give a sporty, but comfortable ride. Within this mode, the suspension will adapt to the vehicle inputs, including



vehicle speed, steering inputs, braking and acceleration. The transmission will be optimized for smooth less, aggressive shifting. The system will return to OFF when the ignition switch is cycled from RUN to OFF to RUN, if this mode is selected.

- Sport Mode – This mode is selected by the first press of the “SPORT” button. A “SPORT” message will display in the instrument cluster. The system will return to SPORT mode when the ignition switch is cycled from RUN to OFF to RUN, if this mode is selected. This mode will set suspension for maximum performance handling and is intended for spirited driving.
- TRACK Mode – This includes SPORT mode and affects automatic transmission shifting in either Auto or Manual mode. Refer to “AutoStick” in “Starting And Operating” for further information. In TRACK mode, the transmission has a sportier, more aggressive shift pattern. In Manual mode, the transmission will

hold gear at redline during manual shifting (console shifter or paddle shifters). A “TRACK” message will display in the instrument cluster. The system will return to SPORT mode when the ignition switch is cycled from RUN to OFF to RUN, if this mode is selected.

**NOTE:** For manual transmission vehicles, the available driving modes are Sport on or Sport Off. Track is not available.

## DRIVING ON SLIPPERY SURFACES

### Acceleration

Rapid acceleration on snow covered, wet, or other slippery surfaces may cause the driving wheels to pull erratically to the right or left. This phenomenon occurs when there is a difference in the surface traction under the rear (driving) wheels.

**WARNING!**

**Rapid acceleration on slippery surfaces is dangerous. Unequal traction can cause sudden pulling of the rear wheels. You could lose control of the vehicle and possibly have a collision. Accelerate slowly and carefully whenever there is likely to be poor traction (ice, snow, wet mud, loose sand, etc.).**

**Traction**

When driving on wet or slushy roads, it is possible for a wedge of water to build up between the tire and road surface. This is known as hydroplaning and may cause partial or complete loss of vehicle control and stopping ability. To reduce this possibility, the following precautions should be observed:

1. Slow down during rainstorms or when the roads are slushy.

2. Slow down if the road has standing water or puddles.
3. Replace tires when tread wear indicators first become visible.
4. Keep tires properly inflated.
5. Maintain sufficient distance between your vehicle and the vehicle in front of you to avoid a collision in a sudden stop.

Your vehicle is equipped with a Limited Slip Differential (LSD) that reduces, but does not eliminate, the amount of wheel slip across a given axle for improved handling.

## DRIVING THROUGH WATER

Driving through water more than a few inches/centimeters deep will require extra caution to ensure safety and prevent damage to your vehicle.

### CAUTION!

- Due to lower ground clearance, driving your vehicle up steep driveways, approach ramps or near parking blocks may cause damage to the front fascia and ground effects.
- Driving through snow more than 4 inches (100 mm) deep may cause damage to the front fascia and ground effects.

## Flowing/Rising Water

### WARNING!

Do not drive on, or cross, a road or a path where water is flowing and/or rising (as in storm run-off). Flowing water can wear away the road or path's surface and cause your vehicle to sink into deeper water. Furthermore, flowing and/or rising water can carry your vehicle away swiftly. Failure to follow this warning may result in injuries that are serious or fatal to you, your passengers, and others around you.

### Shallow Standing Water

Although your vehicle is capable of driving through shallow standing water, consider the following Caution and Warning before doing so.

#### CAUTION!

- Always check the depth of the standing water before driving through it. Never drive through standing water that is deeper than the bottom of the tire rims mounted on the vehicle.
- Determine the condition of the road or the path that is under water, and if there are any obstacles in the way, before driving through the standing water.
- Do not exceed 5 mph (8 km/h) when driving through standing water. This will minimize wave effects.

#### CAUTION!

- Driving through standing water may cause damage to your vehicle's drivetrain components. Always inspect your vehicle's fluids (i.e., engine oil, transmission, axle, etc.) for signs of contamination (i.e., fluid that is milky or foamy in appearance) after driving through standing water. Do not continue to operate the vehicle if any fluid appears contaminated, as this may result in further damage. Such damage is not covered by the New Vehicle Limited Warranty.
- Getting water inside your vehicle's engine can cause it to lock up and stall out, and cause serious internal damage to the engine. Such damage is not covered by the New Vehicle Limited Warranty.

**WARNING!**

- Driving through standing water limits your vehicle's traction capabilities. Do not exceed 5 mph (8 km/h) when driving through standing water.
- Driving through standing water limits your vehicle's braking capabilities, which increases stopping distances. Therefore, after driving through standing water, drive slowly and lightly press on the brake pedal several times to dry the brakes.
- Getting water inside your vehicle's engine can cause it to lock up and stall out, and leave you stranded.
- Failure to follow these warnings may result in injuries that are serious or fatal to you, your passengers, and others around you.

**POWER STEERING**

The standard power steering system will give you good vehicle response and increased ease of maneuverability in tight spaces. The system will provide mechanical steering capability if power assist is lost.

If for some reason the power assist is interrupted, it will still be possible to steer your vehicle. Under these conditions, you will observe a substantial increase in steering effort, especially at very low vehicle speeds and during parking maneuvers.

**NOTE:**

- Increased noise levels at the end of the steering wheel travel are considered normal and do not indicate that there is a problem with the power steering system.
- Upon initial start-up in cold weather, the power steering pump may make noise for a short amount of time. This is due to the cold, thick fluid in the steering system. This noise should be considered normal, and it does not in any way damage the steering system.

**WARNING!**

Continued operation with reduced power steering assist could pose a safety risk to yourself and others. Service should be obtained as soon as possible.

**CAUTION!**

Prolonged operation of the steering system at the end of the steering wheel travel will increase the steering fluid temperature and it should be avoided when possible. Damage to the power steering pump may occur.

**Power Steering Fluid Check**

Checking the power steering fluid level at a defined service interval is not required. The fluid should only be checked if a leak is suspected, abnormal noises are

apparent, and/or the system is not functioning as anticipated. Coordinate inspection efforts through an authorized dealer.

**CAUTION!**

Do not use chemical flushes in your power steering system as the chemicals can damage your power steering components. Such damage is not covered by the New Vehicle Limited Warranty.

**WARNING!**

Fluid level should be checked on a level surface and with the engine off to prevent injury from moving parts and to ensure accurate fluid level reading. Do not overfill. Use only manufacturer's recommended power steering fluid.

If necessary, add fluid to restore to the proper indicated level. With a clean cloth, wipe any spilled fluid from all surfaces. Refer to “Fluids, Lubricants, and Genuine Parts” in “Maintaining Your Vehicle” for further information.

### **PARKING BRAKE**

Before leaving the vehicle, make sure that the parking brake is fully applied and place the shift lever in the PARK or REVERSE (manual transmission only) position.

When the parking brake is applied and the ignition switch is in the ON position (RUN position with Keyless Enter-N-Go), the “Brake Warning Light” in the instrument cluster will illuminate.

### **NOTE:**

- When the parking brake is applied and the transmission is placed in gear, the “Brake Warning Light” will flash. If vehicle speed is detected, a chime will sound to alert the driver. Fully release the parking brake before attempting to move the vehicle.
- This light only shows that the parking brake is applied. It does not show the degree of brake application.

When parking on a hill, it is important to turn the front wheels toward the curb on a downhill grade and away from the curb on an uphill grade. For vehicles equipped with an automatic transmission, apply the parking brake before placing the shift lever in PARK, otherwise the load on the transmission locking mechanism may make it difficult to move the shift lever out of PARK. The parking brake should always be applied whenever the driver is not in the vehicle.

### Manual Transmission – If Equipped

The foot operated parking brake is positioned below the lower left corner of the instrument panel. To release the parking brake, pull the parking brake release handle.

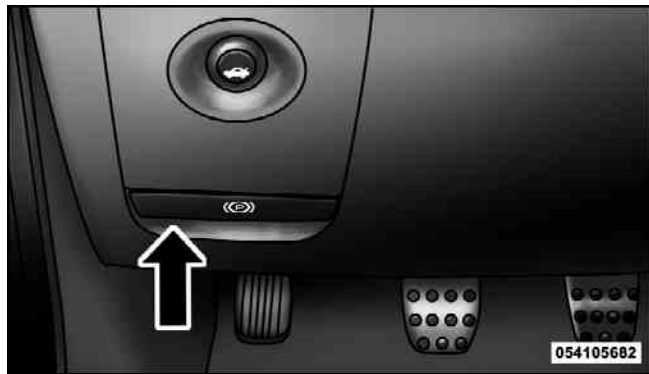

Parking Brake Release

### Automatic Transmission – If Equipped

The foot operated parking brake is located below the lower left corner of the instrument panel. To apply the park brake, firmly push the park brake pedal fully. To release the parking brake, press the park brake pedal a second time and let your foot up as you feel the brake disengage.

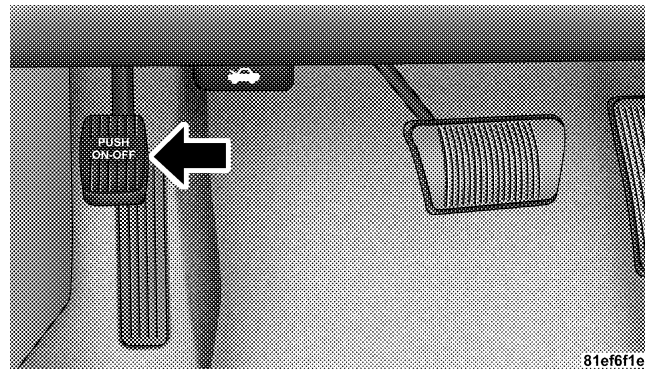

Parking Brake



**WARNING!**

- Never use the PARK position as a substitute for the parking brake. Always apply the parking brake fully when parked to guard against vehicle movement and possible injury or damage.
- When leaving the vehicle, always remove the key fob from the ignition and lock your vehicle.
- Never leave children alone in a vehicle, or with access to an unlocked vehicle. Allowing children to be in a vehicle unattended is dangerous for a number of reasons. A child or others could be seriously or fatally injured. Children should be warned not to touch the parking brake, brake pedal or the shift lever.

*(Continued)*

**WARNING! (Continued)**

- Do not leave the key fob in or near the vehicle, and do not leave a vehicle equipped with Keyless Enter-N-Go in the ACC or ON/RUN mode. A child could operate power windows, other controls, or move the vehicle.
- Be sure the parking brake is fully disengaged before driving; failure to do so can lead to brake failure and a collision.
- Always fully apply the parking brake when leaving your vehicle, or it may roll and cause damage or injury. Also be certain to leave the transmission in PARK. Failure to do so may allow the vehicle to roll and cause damage or injury.

**CAUTION!**

If the “Brake Warning Light” remains on with the parking brake released, a brake system malfunction is indicated. Have the brake system serviced by an authorized dealer immediately.

**BRAKE SYSTEM**

Your vehicle is equipped with dual hydraulic **BRAKE** brake systems. If either of the two hydraulic systems loses normal capability, the remaining system will still function. There will be some loss of overall braking effectiveness. This may be evident by increased pedal travel during application, greater pedal force required to slow or stop, and potential activation of the “Brake Warning Light.”

In the event power assist is lost for any reason (for example, repeated brake applications with the engine

OFF) the brakes will still function. The effort required to brake the vehicle will be much greater than that required with the power system operating.

**Anti-Lock Brake System (ABS)**

The Anti-Lock Brake System (ABS) provides increased vehicle stability and brake performance under most braking conditions. The system automatically “pumps” the brakes during severe braking conditions to prevent wheel lock-up.

The Electronic Brake Force Distribution (EBD) prevents the rear wheels from over-braking and provides greater control of available braking forces applied to the rear axle.

When the vehicle is driven over 7 mph (11 km/h), you may also hear a slight clicking sound as well as some related motor noises. These noises are the system performing its self check cycle to ensure that the ABS system

is working properly. This self check occurs each time the vehicle is started and accelerated past 7 mph (11 km/h).

ABS is activated during braking under certain road or stopping conditions. ABS-inducing conditions can include ice, snow, gravel, bumps, railroad tracks, loose debris, or panic stops.

You also may experience the following when the brake system goes into Anti-Lock:

- The ABS motor running (it may continue to run for a short time after the stop),
- The clicking sound of solenoid valves,
- Brake pedal pulsations, and a slight drop or fall away of the brake pedal at the end of the stop.

These are all normal characteristics of ABS.

### WARNING!

- The Anti-Lock Brake System (ABS) contains sophisticated electronic equipment that may be susceptible to interference caused by improperly installed or high output radio transmitting equipment. This interference can cause possible loss of anti-lock braking capability. Installation of such equipment should be performed by qualified professionals.
- Pumping of the Anti-Lock Brakes will diminish their effectiveness and may lead to a collision. Pumping makes the stopping distance longer. Just press firmly on your brake pedal when you need to slow down or stop.

*(Continued)*

**WARNING! (Continued)**

- The Anti-Lock Brake System (ABS) cannot prevent the natural laws of physics from acting on the vehicle, nor can it increase braking or steering efficiency beyond that afforded by the condition of the vehicle brakes and tires or the traction afforded.
- The Anti-Lock Brake System (ABS) cannot prevent collisions, including those resulting from excessive speed in turns, following another vehicle too closely, or hydroplaning.
- The capabilities of an Anti-Lock Brake System (ABS) equipped vehicle must never be exploited in a reckless or dangerous manner, that could jeopardize the user's safety or the safety of others.

All vehicle wheels and tires must be the same size and type and tires must be properly inflated to produce accurate signals for the computer.

**Anti-Lock Brake Warning Light**

 The "Anti-Lock Brake System (ABS) Warning Light" monitors the anti-lock brake system. The light will come on when the ignition switch is turned to the ON position and may stay on for as long as four seconds.

If the "ABS Warning Light" remains on or comes on while driving, it indicates that the anti-lock portion of the brake system is not functioning and that service is required. However, the conventional brake system will continue to operate normally if the "Brake Warning Light" is not on.

If the "ABS Warning Light" is on, the brake system should be serviced as soon as possible to restore the benefits of anti-lock brakes. If the "ABS Warning Light" does not come on when the ignition switch is turned to the ON position, have the bulb repaired as soon as possible.

If both the “Brake Warning Light” and the “ABS Warning Light” remain on, the ABS and EBD systems are not functioning. Immediate repair to the ABS system is required.

### **ELECTRONIC BRAKE CONTROL SYSTEM**

Your vehicle is equipped with an advanced electronic brake control system commonly referred to as ESC. This system includes the Anti-Lock Brake System (ABS), the Traction Control System (TCS), the Brake Assist System (BAS), and the Electronic Stability Control (ESC). These systems work together to enhance both vehicle stability and control in various driving conditions.

An additional electronic brake control feature called Hill Start Assist (HSA) is standard on manual transmission models.

### **Anti-Lock Brake System (ABS)**

This system aids the driver in maintaining vehicle control under adverse braking conditions by controlling hydraulic brake pressure. This prevents wheel lock-up to help avoid skidding on slippery surfaces during braking. Refer to “Anti-Lock Brake System” in “Starting and Operating” for further information.

#### **WARNING!**

**The ABS cannot prevent the natural laws of physics from acting on the vehicle, nor can it increase the traction afforded by prevailing road conditions. The ABS cannot prevent collisions, including those resulting from excessive speed in turns, driving on very slippery surfaces, or hydroplaning. The capabilities of an ABS-equipped vehicle must never be exploited in a reckless or dangerous manner that could jeopardize the user’s safety or the safety of others.**

### **Traction Control System (TCS)**

This system monitors the amount of wheel spin of each driven wheel. If wheel spin is detected, brake pressure is applied to the slipping wheel(s) and engine power is reduced to provide enhanced acceleration and stability.

A feature of the TCS system functions similar to a limited-slip differential and controls the wheel spin across a driven axle. If one wheel on a driven axle is spinning faster than the other, the system will apply the brake of the spinning wheel. This will allow more engine torque to be applied to the wheel that is not spinning. This feature remains active even if TCS and ESC are in the "Partial Off" or "Full Off" modes. Refer to "Electronic Stability Control (ESC)" in this section for more information.

### **Brake Assist System (BAS)**

This system complements the ABS by optimizing the vehicle braking capability during emergency braking maneuvers. This system detects an emergency braking situation by sensing the rate and amount of brake application and then applies optimum pressure to the brakes. This can help reduce braking distances.

Applying the brakes very quickly results in the best BAS assistance. To receive the benefits of this system, you must apply continuous brake pedal pressure during the stopping sequence. Do not reduce brake pedal pressure unless braking is no longer desired. Once the brake pedal is released, the BAS is deactivated.

**WARNING!**

The BAS cannot prevent the natural laws of physics from acting on the vehicle, nor can it increase the traction afforded by prevailing road conditions. The BAS cannot prevent collisions, including those resulting from excessive speed in turns, driving on very slippery surfaces, or hydroplaning. The capabilities of a BAS-equipped vehicle must never be exploited in a reckless or dangerous manner that could jeopardize the user's safety or the safety of others.

**Hill Start Assist (HSA)**

The HSA system is designed to assist the driver when starting a vehicle from a stop on a hill. HSA will maintain the level of brake pressure the driver applied for a short period of time after the driver takes their foot off of the brake pedal. If the driver does not apply the throttle

during this short period of time, the system will release brake pressure and the vehicle will roll down the hill. The system will release brake pressure in proportion to amount of throttle applied as the vehicle starts to move in the intended direction of travel.

**HSA Activation Criteria**

The following criteria must be met in order for HSA to activate:

- Vehicle must be stopped.
- Vehicle must be on a 7% grade or greater hill.
- Gear selection matches vehicle uphill direction (i.e., vehicle facing uphill is in forward gear; vehicle backing uphill is in REVERSE gear).

**WARNING!**

**There may be situations on minor hills (i.e., less than 8%), with a loaded vehicle, or while pulling a trailer, when the system will not activate and slight rolling may occur. This could cause a collision with another vehicle or object. Always remember the driver is responsible for braking the vehicle.**

**Disabling/Enabling HSA**

If you wish to turn on or off the HSA system, it can be done using the Customer Programmable Features in the Electronic Vehicle Information Center (EVIC). Refer to “Electronic Vehicle Information Center (EVIC)” in “Understanding Your Instrument Panel” for further information.

For vehicles not equipped with the EVIC, perform the following steps:

**NOTE:** You must complete Steps 1 through 8 within 90 seconds.

1. Center the steering wheel (front wheels pointing straight forward).
2. Shift the transmission into NEUTRAL.
3. Apply the parking brake.
4. Start the engine.
5. Release the clutch pedal.
6. Rotate the steering wheel one-half turn to the left.
7. Press the “ESC Off” switch (located in the lower switch bank below the climate controls) four times within 20 seconds. The “ESC Activation/Malfunction Indicator Light” should turn on and turn off two times.



8. Rotate the steering wheel back to center and then an additional half-turn to the right.
9. Turn the ignition switch to the OFF position and then back to the ON position. If the sequence was completed properly, the “ESC Activation/Malfunction Indicator Light” will blink several times to confirm HSA is disabled.
10. Repeat these steps if you want to return this feature to it’s previous setting.

### **Electronic Stability Control (ESC)**

This system enhances directional control and stability of the vehicle under various driving conditions. The ESC corrects for oversteering and understeering the vehicle by applying the brake of the appropriate wheel. Engine power may also be reduced to assist in counteracting the condition of oversteer or understeer and help the vehicle maintain the desired path.

The ESC uses sensors in the vehicle to determine the path that the driver intends to steer the vehicle and compares it to the actual path of the vehicle. When the actual path does not match the intended path, the ESC applies the brake of the appropriate wheel to assist in counteracting the condition of oversteer or understeer.

- Oversteer - when the vehicle is turning more than appropriate for the steering wheel position.
- Understeer - when the vehicle is turning less than

**WARNING!**

The Electronic Stability Control (ESC) cannot prevent the natural laws of physics from acting on the vehicle, nor can it increase the traction afforded by prevailing road conditions. ESC cannot prevent accidents, including those resulting from excessive speed in turns, driving on very slippery surfaces, or hydroplaning. ESC also cannot prevent accidents resulting from loss of vehicle control due to inappropriate driver input for the conditions. Only a safe, attentive, and skillful driver can prevent accidents. The capabilities of an ESC equipped vehicle must never be exploited in a reckless or dangerous manner which could jeopardize the user's safety or the safety of others.

**ESC Operating Modes**

The ESC system has three available operating modes:

***ESC On***

This is the normal operating mode for the ESC. Whenever the vehicle is started, the ESC system will be in this mode. This mode should be used for most driving situations. The ESC should only be turned OFF for specific reasons as noted in the following paragraphs.

***Partial Off***

The "Partial Off" mode is intended for times when a more spirited driving experience is desired. It is also intended for driving in deep snow, sand, or gravel. This mode disables the TCS portion of the ESC and raises the threshold for ESC activation, which allows for more wheel spin than what ESC normally allows.

The “ESC Off” switch is located in the switch bank near the bottom center of the instrument panel. To enter the “Partial Off” mode, momentarily press the “ESC Off” switch and the “ESC Activation/Malfunction Indicator Light” will illuminate. To turn the ESC ON again, momentarily press the “ESC Off” switch and the “ESC Activation/Malfunction Indicator Light” will turn off.

**NOTE:** To improve the vehicle’s traction when driving with snow chains, or when starting off in deep snow, sand, or gravel, it may be desirable to switch to the “Partial Off” mode by momentarily pressing the “ESC Off” switch. Once the situation requiring “Partial Off” mode is overcome, turn the ESC ON again by momentarily pressing the “ESC Off” switch. This may be done while the vehicle is in motion.

## WARNING!

**When in “Partial Off” mode, the TCS portion of ESC, except for the limited wheel slip feature described in the TCS section, has been disabled. All other stability features of ESC function normally. When in “Partial Off” mode, the enhanced vehicle stability offered by the ESC system is reduced.**

### *Full Off*

This mode is intended for off-highway or off-road use only and should not be used on any public roadways. In this mode, all TCS and ESC stability features are turned OFF. To enter the “Full Off” mode, press and hold the “ESC Off” switch for five seconds while the vehicle is stopped with the engine running. After five seconds, a chime will sound, the “ESC Activation/Malfunction Indicator Light” will illuminate, and the “ESC OFF” message will display in the vehicle odometer. Press and

release the TRIP ODOMETER button located on the instrument cluster to clear this message. The "ESC OFF" message may appear in the Electronic Vehicle Information Center (EVIC). Refer to "Electronic Vehicle Information Center (EVIC)" in "Understanding Your Instrument Panel" for further information. To turn ESC ON again, momentarily press the "ESC Off" switch.

**NOTE:** The "ESC OFF" message will display and the audible chime will sound when the shift lever is moved into the PARK position from any position other than PARK and then moved out of the PARK position. This will occur when the message was previously cleared.

### **WARNING!**

In the ESC "Full Off" mode, the engine torque reduction and stability features are cancelled. Therefore, the enhanced vehicle stability offered by ESC is unavailable.

**NOTE:** When the ESC is switched OFF, a feature of the system remains active. This feature controls wheel spin across an axle quite similarly to a limited slip differential. If one wheel on an axle is spinning faster than the other, the system will apply the brake of the spinning wheel and allow more engine torque to be applied to the wheel that is not spinning. To improve the vehicle's traction when driving with tire chains, or when starting off in deep snow, sand, or gravel, it may be desirable to switch to the "Partial Off" mode by momentarily pressing the "ESC Off" switch.

### **WARNING!**

With the ESC switched OFF, the enhanced vehicle stability offered by ESC is unavailable. In an emergency evasive maneuver, the ESC system will not engage to assist in maintaining stability. The "Full Off" ESC mode is intended for off-highway or off-road only.

## ESC Activation/Malfunction Indicator Light and ESC OFF Indicator Light



The “ESC Activation/Malfunction Indicator Light” in the instrument cluster will come on when the ignition switch is turned to the ON position. It should go out with the engine running. If the “ESC Activation/Malfunction Indicator Light” comes on continuously with the engine running, a malfunction has been detected in the ESC system. If this light remains on after several ignition cycles, and the vehicle has been driven several miles (kilometers) at speeds greater than 30 mph (48 km/h), see your authorized dealer as soon as possible to have the problem diagnosed and corrected.

The “ESC Activation/Malfunction Indicator Light” (located in the instrument cluster) starts to flash as soon as the tires lose traction and the ESC system becomes active. The “ESC Activation/Malfunction Indicator Light” also flashes when TCS is active. If the “ESC Activation/

Malfunction Indicator Light” begins to flash during acceleration, ease up on the accelerator and apply as little throttle as possible. Be sure to adapt your speed and driving to the prevailing road conditions.

### NOTE:

- The “ESC Activation/Malfunction Indicator Light” and the “ESC OFF Indicator Light” come on momentarily each time the ignition switch is turned ON.
- Each time the ignition is turned ON, the ESC system will be ON even if it was turned off previously.
- The ESC system will make buzzing or clicking sounds when it is active. This is normal; the sounds will stop when ESC becomes inactive following the maneuver that caused the ESC activation.



The “ESC OFF Indicator Light” indicates the Electronic Stability Control (ESC) is off.

## Synchronizing ESC



If the power supply is interrupted (battery disconnected or discharged), the “ESC Activation/Malfunction Indicator Light” may illuminate with the engine running. If this should occur, turn the steering wheel completely to the left and then to the right. The “ESC Activation/Malfunction Indicator Light” should go out. However, if the light remains on, have the ESC and BAS checked at your authorized dealer as soon as possible.

## TIRE SAFETY INFORMATION

### Tire Markings

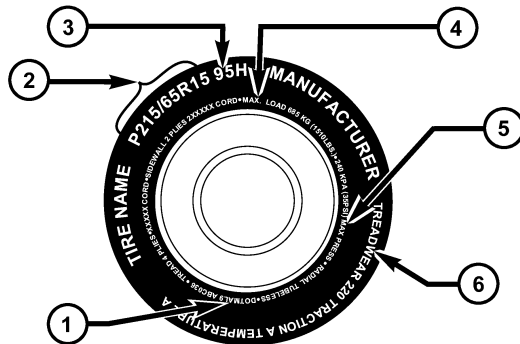

81f05e05

1 — U.S. DOT Safety Standards Code (TIN)  
2 — Size Designation  
3 — Service Description

4 — Maximum Load  
5 — Maximum Pressure  
6 — Treadwear, Traction and Temperature Grades

**NOTE:**

- P (Passenger) - Metric tire sizing is based on U.S. design standards. P-Metric tires have the letter "P" molded into the sidewall preceding the size designation. Example: P215/65R15 95H.
- European-Metric tire sizing is based on European design standards. Tires designed to this standard have the tire size molded into the sidewall beginning with the section width. The letter "P" is absent from this tire size designation. Example: 215/65R15 96H.
- Temporary spare tires are spares designed for temporary emergency use only. Temporary high pressure compact spare tires have the letter "T" or "S" molded into the sidewall preceding the size designation. Example: T145/80D18 103M.

**CAUTION!**

**Do not use two different size tires on the rear wheels, as this can result in rear axle damage.**

## Tire Sizing Chart

TIRE SIZING TERMS	
<b>Size Designation:</b>	
<b>P</b>	Passenger Car tire size based on U.S. design standards
<b>"...blank..."</b>	Passenger Car tire based on European design standards
<b>LT</b>	Light Truck tire based on U.S. design standards
<b>T or S</b>	Temporary compact spare tire
<b>31</b>	Overall diameter in inches (in)
<b>215</b>	Section width in millimeters (mm)
<b>65</b>	Aspect ratio in percent (%) — Ratio of section height to section width of tire
<b>10.5</b>	Section width in inches (in)
<b>R</b>	Construction code — "R" means radial construction — "D" means diagonal or bias construction
<b>15</b>	Rim diameter in inches (in)



## TIRE SIZING TERMS

### Service Description:

**95** = Load Index

— A numerical code associated with the maximum load a tire can carry

**H** = Speed Symbol

— A symbol indicating the range of speeds at which a tire can carry a load corresponding to its load index under certain operating conditions

— The maximum speed corresponding to the speed symbol should only be achieved under specified operating conditions (i.e., tire pressure, vehicle loading, road conditions, and posted speed limits)

### Load Identification:

"...blank..." = Absence of any text on the sidewall of the tire indicates a Standard Load (SL) Tire

**Extra Load (XL)** = Extra load (or reinforced) tire

**Light Load (LL)** = Light load tire

**C, D, E, F, G** = Load range associated with the maximum load a tire can carry at a specified pressure

**Maximum Load** — Maximum load indicates the maximum load this tire is designed to carry

**Maximum Pressure** — Maximum pressure indicates the maximum permissible cold tire inflation pressure for this tire

**Tire Identification Number (TIN)**

The TIN may be found on one or both sides of the tire, however, the date code may only be on one side. Tires with white sidewalls will have the full TIN, including the date code, located on the white sidewall side of the tire.

Look for the TIN on the outboard side of black sidewall tires as mounted on the vehicle. If the TIN is not found on the outboard side, then you will find it on the inboard side of the tire.

<b>TIRE IDENTIFICATION NUMBER</b>	
<b>EXAMPLE: DOT MA L9 ABCD 0301</b>	
<b>DOT</b> = Department of Transportation	
	— This symbol certifies that the tire is in compliance with the U.S. Department of Transportation tire safety standards, and is approved for highway use
<b>MA</b> = Code representing the tire manufacturing location (two digits)	
<b>L9</b> = Code representing the tire size (two digits)	
<b>ABCD</b> = Code used by the tire manufacturer (one to four digits)	
<b>03</b> = Number representing the week in which the tire was manufactured (two digits)	
	—03 means the 3rd week.
<b>01</b> = Number representing the year in which the tire was manufactured (two digits)	
	—01 means the year 2001
	— Prior to July 2000, tire manufacturers were only required to have one number to represent the year in which the tire was manufactured. Example: 031 could represent the 3rd week of 1981 or 1991

## Tire Terminology and Definitions

Term	Definition
<b>B-Pillar</b>	The vehicle B-Pillar is the structural member of the body located behind the front door.
<b>Cold Tire Inflation Pressure</b>	Cold tire inflation pressure is defined as the tire pressure after the vehicle has not been driven for at least 3 hours, or driven less than 1 mile (1.6 km) after sitting for a three hour period. Inflation pressure is measured in units of PSI (pounds per square inch) or kPa (kilopascals).
<b>Maximum Inflation Pressure</b>	The maximum inflation pressure is the maximum permissible cold tire inflation pressure for this tire. The maximum inflation pressure is molded into the sidewall.
<b>Recommended Cold Tire Inflation Pressure</b>	Vehicle manufacturer's recommended cold tire inflation pressure as shown on the tire placard.
<b>Tire Placard</b>	A paper label permanently attached to the vehicle describing the vehicle's loading capacity, the original equipment tire sizes and the recommended cold tire inflation pressures.

## Tire Loading And Tire Pressure

### Tire and Loading Information Placard Location

**NOTE:** The proper cold tire inflation pressure is listed on the driver's side B-Pillar or the rear edge of the driver's side door.

### Tire and Loading Information Placard

**TIRE AND LOADING INFORMATION**

SEATING CAPACITY - TOTAL 5 FRONT 2 REAR 3

THE COMBINED WEIGHT OF OCCUPANTS AND CARGO SHOULD NEVER EXCEED XXX KG OR XXX LBS.

TIRE	FRONT	REAR	SPARE
ORIGINAL TIRE SIZE	P195/70R14	P195/70R14	T125/70D15
COLD TIRE INFLATION PRESSURE	200kPa, 29PSI	200kPa, 29PSI	420kPa, 60PSI

SEE OWNER'S MANUAL FOR ADDITIONAL INFORMATION 4N109268

Callouts: 1 points to SEATING CAPACITY, 2 points to WEIGHT LIMIT, 3 points to ORIGINAL TIRE SIZE, 4 points to COLD TIRE INFLATION PRESSURE.

This placard tells you important information about the:

- 1) number of people that can be carried in the vehicle
- 2) total weight your vehicle can carry
- 3) tire size designed for your vehicle
- 4) cold tire inflation pressures for the front, rear, and spare tires.

### Loading

The vehicle maximum load on the tire must not exceed the load carrying capacity of the tire on your vehicle. You will not exceed the tire's load carrying capacity if you adhere to the loading conditions, tire size, and cold tire inflation pressures specified on the Tire and Loading Information placard and in the "Vehicle Loading" section of this manual.

811b5a9a

Tire and Loading Information Placard

**NOTE:** Under a maximum loaded vehicle condition, gross axle weight ratings (GAWRs) for the front and rear axles must not be exceeded. For further information on GAWRs, vehicle loading, and trailer towing, refer to “Vehicle Loading” in this section.

To determine the maximum loading conditions of your vehicle, locate the statement “The combined weight of occupants and cargo should never exceed XXX kg or XXX lbs.” on the Tire and Loading Information placard. The combined weight of occupants, cargo/luggage and trailer tongue weight (if applicable) should never exceed the weight referenced here.

### *Steps For Determining Correct Load Limit*

1. Locate the statement “The combined weight of occupants and cargo should never exceed XXX kg or XXX lbs” on your vehicle’s placard.

2. Determine the combined weight of the driver and passengers that will be riding in your vehicle.

3. Subtract the combined weight of the driver and passengers from XXX kg or XXX lbs.

4. The resulting figure equals the available amount of cargo and luggage load capacity. For example, if “XXX” amount equals 1,400 lbs (635 kg) and there will be five 150 lb (68 kg) passengers in your vehicle, the amount of available cargo and luggage load capacity is 650 lbs (295 kg) (since  $5 \times 150 = 750$ , and  $1400 - 750 = 650$  lbs [295 kg]).

5. Determine the combined weight of luggage and cargo being loaded on the vehicle. That weight may not safely exceed the available cargo and luggage load capacity calculated in Step 4.

6. If your vehicle will be towing a trailer, load from your trailer will be transferred to your vehicle. Consult this manual to determine how this reduces the available cargo and luggage load capacity of your vehicle.

**NOTE:**

- The following table shows examples on how to calculate total load, cargo/luggage, and towing capacities of your vehicle with varying seating configurations and number and size of occupants. This table is for illustration purposes only and may not be accurate for the seating and load carry capacity of your vehicle.
- For the following example, the combined weight of occupants and cargo should never exceed 865 lbs (392 kg).

Occupants			Combined weight of occupants and cargo from Tire Placard	MINUS	Combined Occupant's weight	=	AVAILABLE Cargo/Luggage and Trailer Tongue Weight
TOTAL	FRONT	REAR					
<u>EXAMPLE 1</u>			↓ 865 lbs	minus	Occupant 1: 200 lbs Occupant 2: 130 lbs Occupant 3: 160 lbs Occupant 4: 100 lbs Occupant 5: 80 lbs TOTAL WEIGHT: 670 lbs	=	↓ 195 lbs
5	2	3					
<u>EXAMPLE 2</u>			↓ 865 lbs	minus	Occupant 1: 210 lbs Occupant 2: 180 lbs Occupant 3: 150 lbs TOTAL WEIGHT: 540 lbs	=	325 lbs
3	2	1					
<u>EXAMPLE 3</u>			↓ 865 lbs	minus	Occupant 1: 200 lbs Occupant 2: 200 lbs TOTAL WEIGHT: 400 lbs	=	465 lbs
2	2	0					

EXAMPLE

**WARNING!**

Overloading of your tires is dangerous. Overloading can cause tire failure, affect vehicle handling, and increase your stopping distance. Use tires of the recommended load capacity for your vehicle. Never overload them.

**TIRES — GENERAL INFORMATION****Tire Pressure**

Proper tire inflation pressure is essential to the safe and satisfactory operation of your vehicle. Three primary areas are affected by improper tire pressure:

**Safety****WARNING!**

- Improperly inflated tires are dangerous and can cause collisions.
- Under-inflation increases tire flexing and can result in over-heating and tire failure.
- Over-inflation reduces a tire's ability to cushion shock. Objects on the road and chuckholes can cause damage that result in tire failure.
- Over-inflated or under-inflated tires can affect vehicle handling and can fail suddenly, resulting in loss of vehicle control.
- Unequal tire pressures can cause steering problems. You could lose control of your vehicle.

*(Continued)*



**WARNING! (Continued)**

- Unequal tire pressures from one side of the vehicle to the other can cause the vehicle to drift to the right or left.
- Always drive with each tire inflated to the recommended cold tire inflation pressure.

**Economy**

Improper inflation pressures can cause uneven wear patterns to develop across the tire tread. These abnormal wear patterns will reduce tread life resulting in a need for earlier tire replacement. Under-inflation also increases tire rolling resistance resulting in higher fuel consumption.

**Ride Comfort and Vehicle Stability**

Proper tire inflation contributes to a comfortable ride. Over-inflation produces a jarring and uncomfortable ride.

**Tire Inflation Pressures**

The proper cold tire inflation pressure is listed on the driver's side "B" Pillar or rear edge of the driver's side door.

Some vehicles may have supplemental tire pressure information for vehicle loads that are less than the maximum loaded vehicle condition. These pressure conditions will be found in the "Supplemental Tire Pressure Information" section of this manual.

The pressure should be checked and adjusted as well as inspected for signs of tire wear or visible damage at least once a month. Use a good quality pocket-type gauge to check tire pressure. Do not make a visual judgement when determining proper inflation. Radial tires may look properly inflated even when they are under-inflated.

**CAUTION!**

**After inspecting or adjusting the tire pressure, always reinstall the valve stem cap. This will prevent moisture and dirt from entering the valve stem, which could damage the valve stem.**

Inflation pressures specified on the placard are always “cold tire inflation pressure.” Cold tire inflation pressure is defined as the tire pressure after the vehicle has not been driven for at least three hours, or driven less than 1 mile (1.6 km) after a three hour period. The cold tire inflation pressure must not exceed the maximum inflation pressure molded into the tire sidewall.

Check tire pressures more often if subject to a wide range of outdoor temperatures, as tire pressures vary with temperature changes.

Tire pressures change by approximately 1 psi (7 kPa) per 12°F (7°C) of air temperature change. Keep this in mind when checking tire pressure inside a garage, especially in the winter.

Example: If garage temperature = 68°F (20°C) and the outside temperature = 32°F (0°C) then the cold tire inflation pressure should be increased by 3 psi (21 kPa), which equals 1 psi (7 kPa) for every 12°F (7°C) for this outside temperature condition.

Tire pressure may increase from 2 to 6 psi (13 to 40 kPa) during operation. DO NOT reduce this normal pressure build up or your tire pressure will be too low.

### Tire Pressures For High Speed Operation

The manufacturer advocates driving at safe speeds within posted speed limits. Where speed limits or conditions are such that the vehicle can be driven at high speeds, maintaining correct tire inflation pressure is very important. Increased tire pressure and reduced vehicle loading may be required for high-speed vehicle operation. Refer to original equipment or an authorized tire dealer for recommended safe operating speeds, loading and cold tire inflation pressures.

#### **WARNING!**

**High speed driving with your vehicle under maximum load is dangerous. The added strain on your tires could cause them to fail. You could have a serious collision. Do not drive a vehicle loaded to the maximum capacity at continuous speeds above 75 mph (120 km/h).**

### Radial Ply Tires

#### **WARNING!**

**Combining radial ply tires with other types of tires on your vehicle will cause your vehicle to handle poorly. The instability could cause a collision. Always use radial ply tires in sets of four. Never combine them with other types of tires.**

Cuts and punctures in radial tires are repairable only in the tread area because of sidewall flexing. Consult your authorized tire dealer for radial tire repairs.

### F1 Three-Season Tires — If Equipped

This vehicle may be equipped with wheel and tires to enhance performance. To continue to provide this performance, extra care should be taken when operating your vehicle.

These low-profile high performance tires are not designed for off-road or winter (snow or cold weather) conditions, and their noise, ride, and wear will be different than non-performance tires.

**WARNING!**

Do not use these tires when temperatures are below 40°F (4°C) or in snow/ice conditions. You could lose control and have an accident resulting in serious injury or death.

**Tire Spinning**

When stuck in mud, sand, snow, or ice conditions, do not spin your vehicle's wheels above 30 mph (48 km/h).

Refer to "Freeing A Stuck Vehicle" in "What To Do In Emergencies" for further information.

**WARNING!**

Fast spinning tires can be dangerous. Forces generated by excessive wheel speeds may cause tire damage or failure. A tire could explode and injure someone. Do not spin your vehicle's wheels faster than 30 mph (48 km/h) for more than 30 seconds continuously when you are stuck, and do not let anyone near a spinning wheel, no matter what the speed.

**Tread Wear Indicators**

Tread wear indicators are in the original equipment tires to help you in determining when your tires should be replaced.

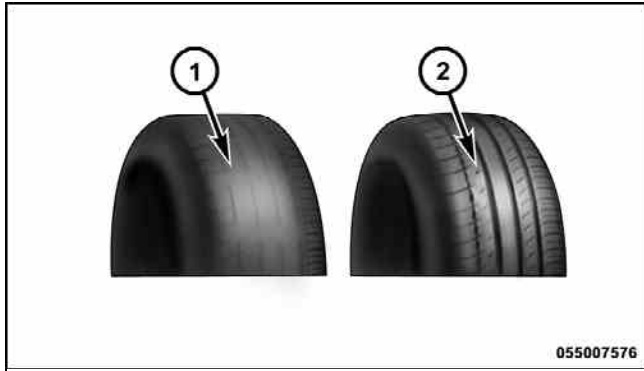

- 1 — Worn Tire  
2 — New Tire

These indicators are molded into the bottom of the tread grooves. They will appear as bands when the tread depth becomes 1/16 in (2 mm). When the tread is worn to the tread wear indicators, the tire should be replaced.

### Life Of Tire

The service life of a tire is dependent upon varying factors including, but not limited to:

- Driving style
- Tire pressure
- Distance driven

### WARNING!

**Tires and the spare tire should be replaced after six years, regardless of the remaining tread. Failure to follow this warning can result in sudden tire failure. You could lose control and have a collision resulting in serious injury or death.**

Keep dismantled tires in a cool, dry place with as little exposure to light as possible. Protect tires from contact with oil, grease, and gasoline.

## Replacement Tires

The tires on your new vehicle provide a balance of many characteristics. They should be inspected regularly for wear and correct cold tire inflation pressure. The manufacturer strongly recommends that you use tires equivalent to the originals in size, quality and performance when replacement is needed. (Refer to the paragraph on "Tread Wear Indicators"). Refer to the "Tire and Loading Information" placard for the size designation of your tire. The Load Index and Speed Symbol for your tire will be found on the original equipment tire sidewall. See the Tire Sizing Chart example found in the Tire Safety Information section of this manual for more information relating to the Load Index and Speed Symbol of a tire.

It is recommended to replace the two front tires or two rear tires as a pair. Replacing just one tire can seriously affect your vehicle's handling. If you ever replace a wheel, make sure that the wheel's specifications match those of the original wheels.

It is recommended you contact your original equipment or an authorized tire dealer with any questions you may have on tire specifications or capability. Failure to use equivalent replacement tires may adversely affect the safety, handling, and ride of your vehicle.

### WARNING!

- **Do not use a tire, wheel size or rating other than that specified for your vehicle. Some combinations of unapproved tires and wheels may change suspension dimensions and performance characteristics, resulting in changes to steering, handling, and braking of your vehicle. This can cause unpredictable handling and stress to steering and suspension components. You could lose control and have a collision resulting in serious injury or death. Use only the tire and wheel sizes with load ratings approved for your vehicle.**

*(Continued)*

**WARNING! (Continued)**

- Never use a tire with a smaller load index or capacity, other than what was originally equipped on your vehicle. Using a tire with a smaller load index could result in tire overloading and failure. You could lose control and have a collision.
- Failure to equip your vehicle with tires having adequate speed capability can result in sudden tire failure and loss of vehicle control.

**CAUTION!**

Replacing original tires with tires of a different size may result in false speedometer and odometer readings.

**TIRE CHAINS**

Use only compact chains or other traction aids that meet SAE type "Class S" specifications. Chains must be the proper size for the vehicle, as recommended by the chain manufacturer. Only install tire chains on 245/45ZR20 size tires.

**NOTE:** Do not use tire chains on a compact spare tire.

**CAUTION!**

To avoid damage to your vehicle or tires, observe the following precautions:

- Because of restricted chain clearance between tires and other suspension components, it is important that only chains in good condition are used. Broken chains can cause serious damage. Stop the vehicle immediately if noise occurs that could indicate chain breakage. Remove the damaged parts of the chain before further use.

*(Continued)*

**CAUTION! (Continued)**

- Install chains on the rear wheels as tightly as possible and then retighten after driving about ½ mile (0.8 km).
- Do not exceed 30 mph (48 km/h).
- Drive cautiously and avoid severe turns and large bumps, especially with a loaded vehicle.
- Use on rear wheels only.
- Do not drive for prolonged period on dry pavement.
- Observe the tire chain manufacturer's instructions on the method of installation, operating speed, and conditions for use. Always use the lower suggested operating speed of the chain manufacturer if different from the speed recommended by the manufacture.

**NOTE:** In order to avoid damage to tires, chains, and your vehicle do not drive for a prolonged period on dry pavement. Observe the tire chain manufacturer's instructions on method of installation, operating speed, and conditions for usage.

Always use the lower suggested operating speed if both the chain manufacturer and vehicle manufacturer suggest a maximum speed. This notice applies to all chain traction devices, including link and cable (radial) chains.



## SNOW TIRES

Some areas of the country require the use of snow tires during the winter. All season tires can be identified by the M+S designation on the tire sidewall.

If you need snow tires, select tires equivalent in size and type to the original equipment tires. Use snow tires only in sets of four; failure to do so may adversely affect the safety and handling of your vehicle.

Snow tires generally have lower speed ratings than what was originally equipped with your vehicle and should not be operated at sustained speeds over 75 mph (120 km/h). For speeds above 75 mph (120 km/h) refer to original equipment or an authorized tire dealer for recommended safe operating speeds, loading and cold tire inflation pressures.

While studded tires improve performance on ice, skid and traction capability on wet or dry surfaces may be poorer than that of non-studded tires. Some states prohibit studded tires; therefore, local laws should be checked before using these tire types.

## TIRE ROTATION RECOMMENDATIONS

The tires on the front and rear of your vehicle operate at different loads and perform different steering, driving, and braking functions. For these reasons, they wear at unequal rates.

These effects can be reduced by timely rotation of tires. The benefits of rotation are especially worthwhile with aggressive tread designs such as those on all season type tires. Rotation will increase tread life, help to maintain mud, snow, and wet traction levels, and contribute to a smooth, quiet ride.

Refer to the “Maintenance Schedule” for the proper maintenance intervals. Remember, more frequent rotation is permissible if desired. Also, correct for anything causing rapid or unusual wear prior to performing the tire rotation.

#### **Tire Rotation – Four Season/RSA Tires**

The suggested rotation method for vehicles equipped with all season tires is the “forward-cross” as shown in the following diagram.

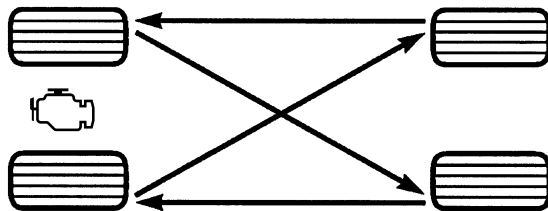

81f0565d

Tire Rotation

### Tire Rotation – F1 Three Season Tires

The suggested rotation method is the “side-to-side” as shown in the following diagram. This method is required due to different size tires on the front and rear of the vehicle.

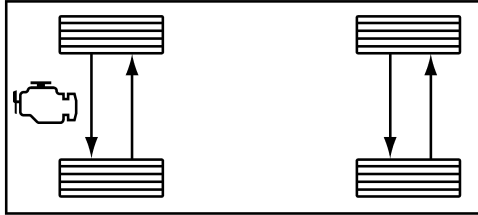

Tire Rotation

81f10b20

### TIRE PRESSURE MONITOR SYSTEM (TPMS)

The Tire Pressure Monitor System (TPMS) will warn the driver of a low tire pressure based on the vehicle recommended cold placard pressure.

The tire pressure will vary with temperature by about 1 psi (6.9 kPa) for every 12°F (6.5°C). This means that when the outside temperature decreases, the tire pressure will decrease. Tire pressure should always be set based on cold inflation tire pressure. This is defined as the tire pressure after the vehicle has not been driven for at least three hours, or driven less than 1 mile (1.6 km) after a three hour period. The cold tire inflation pressure must not exceed the maximum inflation pressure molded into the tire sidewall. Refer to “Tires – General Information” in “Starting and Operating” for information on how to properly inflate the vehicle’s tires. The tire pressure will also increase as the vehicle is driven - this is normal and there should be no adjustment for this increased pressure.

The TPMS will warn the driver of a low tire pressure if the tire pressure falls below the low-pressure warning limit for any reason, including low temperature effects and natural pressure loss through the tire.

The TPMS will continue to warn the driver of low tire pressure as long as the condition exists, and will not turn off until the tire pressure is at or above the recommended cold placard pressure. Once the low tire pressure warning (Tire Pressure Monitoring [TPM] Telltale Light) illuminates, you must increase the tire pressure to the recommended cold placard pressure in order for the "TPM Telltale Light" to turn off. The system will automatically update and the "TPM Telltale Light" will turn off once the system receives the updated tire pressures. The vehicle may need to be driven for up to 20 minutes above 15 mph (24 km/h) in order for the TPMS to receive this information.

For example, your vehicle may have a recommended cold (parked for more than three hours) placard pressure of 30 psi (207 kPa). If the ambient temperature is 68°F (20°C) and the measured tire pressure is 27 psi (186 kPa), a temperature drop to 20°F (-7°C) will decrease the tire pressure to approximately 23 psi (158 kPa). This tire pressure is sufficiently low enough to turn ON the "TPM Telltale Light." Driving the vehicle may cause the tire pressure to rise to approximately 27 psi (186 kPa), but the "TPM Telltale Light" will still be ON. In this situation, the "TPM Telltale Light" will turn OFF only after the tires are inflated to the vehicle's recommended cold placard pressure value.

**CAUTION!**

- The TPMS has been optimized for the original equipment tires and wheels. TPMS pressures and warning have been established for the tire size equipped on your vehicle. Undesirable system operation or sensor damage may result when using replacement equipment that is not of the same size, type, and/or style. Aftermarket wheels can cause sensor damage. Do not use aftermarket tire sealants or balance beads if your vehicle is equipped with a TPMS, as damage to the sensors may result.
- After inspecting or adjusting the tire pressure, always reinstall the valve stem cap. This will prevent moisture and dirt from entering the valve stem, which could damage the TPM sensor.

**NOTE:**

- The TPMS is not intended to replace normal tire care and maintenance or to provide warning of a tire failure or condition.
- The TPMS should not be used as a tire pressure gauge while adjusting your tire pressure.
- Driving on a significantly under-inflated tire causes the tire to overheat and can lead to tire failure. Under-inflation also reduces fuel efficiency and tire tread life, and may affect the vehicle's handling and stopping ability.
- The TPMS is not a substitute for proper tire maintenance, and it is the driver's responsibility to maintain correct tire pressure using an accurate tire pressure gauge, even if under-inflation has not reached the level to trigger illumination of the "TPM Telltale Light."

- Seasonal temperature changes will affect tire pressure, and the TPMS will monitor the actual tire pressure in the tire.

### Premium System

The Tire Pressure Monitor System (TPMS) uses wireless technology with wheel rim mounted electronic sensors to monitor tire pressure levels. Sensors mounted to each wheel as part of the valve stem transmit tire pressure readings to the receiver module.

**NOTE:** It is particularly important for you to check the tire pressure in all of the tires on your vehicle monthly and to maintain the proper pressure.

The TPMS consists of the following components:

- Receiver module,
- Four TPM sensors,
- Various TPMS messages, which display in the Electronic Vehicle Information Center (EVIC), and
- TPM Telltale Light

### Tire Pressure Monitoring Low Pressure Warnings

 The “TPM Telltale Light” will illuminate in the instrument cluster and a chime will sound when tire pressure is low in one or more of the four active road tires. In addition, the EVIC will display a “LOW TIRE” message and a graphic showing the pressure values of each tire with the low tire pressure values flashing.

**EXAMPLE ONLY**

Low Tire PSI

27		30
27		21
2345 mi		

819793fc

Should this occur, you should stop as soon as possible and inflate all of the tires with a low pressure condition (those flashing in the EVIC graphic) to the vehicle's recommended cold placard pressure inflation value. Once the system receives the updated tire pressures, the system will automatically update, the graphic display in the EVIC will stop flashing, and the "TPM Telltale Light" will turn off. The vehicle may need to be driven for up to 20 minutes above 15 mph (24 km/h) in order for the TPMS to receive this information.

### Service TPMS Warning

If a system fault is detected, the “TPM Telltale Light” will flash on and off for 75 seconds and then remain on solid. The system fault will also sound a chime. In addition, the EVIC will display a “SERVICE TPM SYSTEM” message for a minimum of five seconds and then display dashes (- -) in place of the pressure value to indicate which sensor is not being received.

EXAMPLE ONLY

Tire PSI  
30 33  
30 --





If the ignition switch is cycled, this sequence will repeat, providing the system fault still exists. If the system fault no longer exists, the "TPM Telltale Light" will no longer flash, and the "SERVICE TPM SYSTEM" message will no longer display, and a pressure value will display in place of the dashes. A system fault can occur due to any of the following:

1. Signal interference due to electronic devices or driving next to facilities emitting the same radio frequencies as the TPM sensors.
2. Installing aftermarket window tinting that contains materials that may block radio wave signals.
3. Accumulation of snow or ice around the wheels or wheel housings.
4. Using tire chains on the vehicle.
5. Using wheels/tires not equipped with TPM sensors.

The EVIC will also display a "SERVICE TPM SYSTEM" message for a minimum of five seconds when a system fault related to an incorrect sensor location fault is detected. In this case, the "SERVICE TPM SYSTEM" message is then followed with a graphic display with pressure values still shown. This indicates that the pressure values are still being received from the TPM sensors but they may not be located in the correct vehicle position. The system still needs to be serviced as long as the "SERVICE TPM SYSTEM" message is displayed.

#### *Vehicles With Compact Spare*

1. The compact spare tire does not have a TPM sensor. Therefore, the TPMS will not monitor the pressure in the compact spare tire.

2. If you install the compact spare tire in place of a road tire that has a pressure below the low-pressure warning limit, upon the next ignition switch cycle, the “TPM Telltale Light” will remain ON and a chime will sound. In addition, the graphic in the EVIC will still display a flashing pressure value.

3. After driving the vehicle for up to 20 minutes above 15 mph (24 km/h), the “TPM Telltale Light” will flash on and off for 75 seconds and then remain on solid. In addition, the EVIC will display a “SERVICE TPM SYSTEM” message for a minimum of five seconds and then display dashes (- -) in place of the pressure value.

4. For each subsequent ignition switch cycle, a chime will sound, the “TPM Telltale Light” will flash on and off for 75 seconds and then remain on solid, and the EVIC will display a “SERVICE TPM SYSTEM” message for a minimum of five seconds and then display dashes (- -) in place of the pressure value.

5. Once you repair or replace the original road tire and reinstall it on the vehicle in place of the compact spare, the TPMS will update automatically. In addition, the “TPM Telltale Light” will turn OFF and the graphic in the EVIC will display a new pressure value instead of dashes (- -), as long as no tire pressure is below the low-pressure warning limit in any of the four active road tires. The vehicle may need to be driven for up to 20 minutes above 15 mph (24 km/h) in order for the TPMS to receive this information.

### General Information

This device complies with Part 15 of the FCC rules and RSS 210 of Industry Canada. Operation is subject to the following conditions:

- This device may not cause harmful interference.
- This device must accept any interference received, including interference that may cause undesired operation.

The TPM sensors are regulated under one of the following licenses:

United States . . . . . MRXC4W4MA4  
 Canada . . . . . 2546A-C4W4MA4

## FUEL REQUIREMENTS

### 6.4L Engine



The 6.4L engine is designed to meet all emissions regulations and provide excellent fuel economy and performance when using high-quality premium unleaded gasoline with an octane rating of 91 or higher.

Light spark knock at low engine speeds is not harmful to your engine. However, continued heavy spark knock at high speeds can cause damage and immediate service is required. Poor quality gasoline can cause problems such

as hard starting, stalling, and hesitations. If you experience these symptoms, try another brand of gasoline before considering service for the vehicle.

Over 40 auto manufacturers worldwide have issued and endorsed consistent gasoline specifications (the Worldwide Fuel Charter, WWFC) which define fuel properties necessary to deliver enhanced emissions, performance, and durability for your vehicle. The manufacturer recommends the use of gasolines that meet the WWFC specifications if they are available.

### Reformulated Gasoline

Many areas of the country require the use of cleaner burning gasoline referred to as “reformulated gasoline.” Reformulated gasolines contain oxygenates and are specifically blended to reduce vehicle emissions and improve air quality.

The manufacturer supports the use of reformulated gasolines. Properly blended reformulated gasolines will provide excellent performance and durability of engine and fuel system components.

### **Gasoline/Oxygenate Blends**

Some fuel suppliers blend unleaded gasoline with oxygenates such as 10% ethanol, MTBE, and ETBE. Oxygenates are required in some areas of the country during the winter months to reduce carbon monoxide emissions. Fuels blended with these oxygenates may be used in your vehicle.

#### **CAUTION!**

**Do not use gasolines containing Methanol or E-85 Ethanol. Use of these blends may result in starting and driveability problems and may damage critical fuel system components.**

Problems that result from using methanol/gasoline or E-85 ethanol blends are not the responsibility of the manufacturer. While MTBE is an oxygenate made from methanol, it does not have the negative effects of methanol.

### **E-85 Usage In Non-Flex Fuel Vehicles**

Non-FFV vehicles are compatible with gasoline containing 10% ethanol (E10). Gasoline with higher ethanol content may void the vehicle's warranty.

If a Non-FFV vehicle is inadvertently fueled with E-85 fuel, the engine will have some or all of these symptoms:

- operate in a lean mode
- OBD II "Malfunction Indicator Light" on
- poor engine performance
- poor cold start and cold drivability
- increased risk for fuel system component corrosion

To fix a Non-FFV vehicle inadvertently fueled once with E-85 perform the following:

- drain the fuel tank (see your authorized dealer)
- change the engine oil and oil filter
- disconnect and reconnect the battery to reset the engine controller memory

More extensive repairs will be required for prolonged exposure to E-85 fuel.

### **MMT In Gasoline**

MMT is a manganese-containing metallic additive that is blended into some gasoline to increase octane. Gasoline blended with MMT provides no performance advantage beyond gasoline of the same octane number without MMT. Gasoline blended with MMT reduces spark plug life and reduces emissions system performance in some vehicles. The manufacturer recommends that gasoline without MMT be used in your vehicle. The MMT content

of gasoline may not be indicated on the gasoline pump, therefore, you should ask your gasoline retailer whether the gasoline contains MMT. It is even more important to look for gasoline without MMT in Canada, because MMT can be used at levels higher than those allowed in the United States. MMT is prohibited in Federal and California reformulated gasoline.

### **Materials Added to Fuel**

All gasoline sold in the United States is required to contain effective detergent additives. Use of additional detergents or other additives is not needed under normal conditions and they would result in additional cost. Therefore, you should not have to add anything to the fuel.

**Fuel System Cautions****CAUTION!**

Follow these guidelines to maintain your vehicle's performance:

- The use of leaded gas is prohibited by Federal law. Using leaded gasoline can impair engine performance and damage the emissions control system.
- An out-of-tune engine or certain fuel or ignition malfunctions can cause the catalytic converter to overheat. If you notice a pungent burning odor or some light smoke, your engine may be out of tune or malfunctioning and may require immediate service. Contact your authorized dealer for service assistance.

*(Continued)*

**CAUTION! (Continued)**

- The use of fuel additives, which are now being sold as octane enhancers, is not recommended. Most of these products contain high concentrations of methanol. Fuel system damage or vehicle performance problems resulting from the use of such fuels or additives is not the responsibility of the manufacturer.

**NOTE:** Intentional tampering with the emissions control system can result in civil penalties being assessed against you.

## Carbon Monoxide Warnings

### WARNING!

Carbon monoxide (CO) in exhaust gases is deadly. Follow the precautions below to prevent carbon monoxide poisoning:

- Do not inhale exhaust gases. They contain carbon monoxide, a colorless and odorless gas, which can kill. Never run the engine in a closed area, such as a garage, and never sit in a parked vehicle with the engine running for an extended period. If the vehicle is stopped in an open area with the engine running for more than a short period, adjust the ventilation system to force fresh, outside air into the vehicle.

*(Continued)*

### WARNING! (Continued)

- Guard against carbon monoxide with proper maintenance. Have the exhaust system inspected every time the vehicle is raised. Have any abnormal conditions repaired promptly. Until repaired, drive with all side windows fully open.
- Keep the trunk closed when driving your vehicle to prevent carbon monoxide and other poisonous exhaust gases from entering the vehicle.

## ADDING FUEL

### Fuel Filler Cap (Gas Cap)

The gas cap is located behind the fuel filler door on the left side of the vehicle. Use a finger to pull open the door. If the gas cap is lost or damaged, be sure the replacement cap is for use with this vehicle.

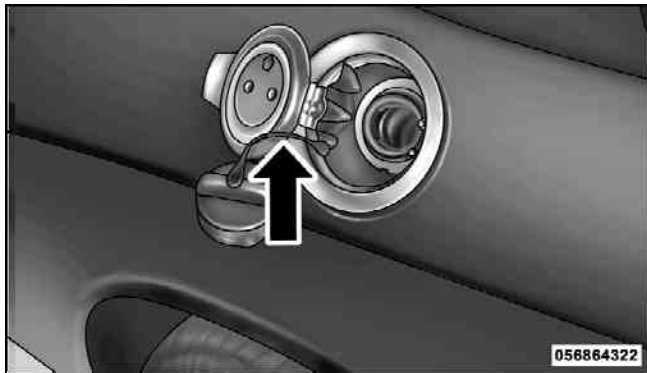

Fuel Fill Cap

**NOTE:** When removing the fuel filler cap, lay the cap tether in the hook, located on the fuel filler door.

### CAUTION!

- Damage to the fuel system or emissions control system could result from using an improper fuel tank filler tube cap (gas cap).
- A poorly fitting gas cap could let impurities into the fuel system.
- A poorly fitting gas cap may cause the “Malfunction Indicator Light (MIL)” to turn on.
- To avoid fuel spillage and overfilling, do not “top off” the fuel tank after filling. When the fuel nozzle “clicks” or shuts off, the fuel tank is full.



**WARNING!**

- Never have any smoking materials lit in or near the vehicle when the gas cap is removed or the tank is being filled.
- Never add fuel to the vehicle when the engine is running.
- A fire may result if gasoline is pumped into a portable container that is inside of a vehicle. You could be burned. Always place gas containers on the ground while filling.

**NOTE:**

- Tighten the gas cap until you hear a “clicking” sound. This is an indication that the gas cap is tightened properly. The MIL in the instrument cluster may turn on if the gas cap is not secured properly. Make sure that the gas cap is tightened each time the vehicle is refueled.

- When the fuel nozzle “clicks” or shuts off, the fuel tank is full.

**Loose Fuel Filler Cap Message**

If the vehicle diagnostic system determines that the fuel filler cap is loose, improperly installed, or damaged, a “Check Gascap” message will display in the Electronic Vehicle Information Center (EVIC). If this occurs, tighten the fuel filler cap properly and press the TRIP ODOMETER button to turn off the message. If the problem continues, the message will appear the next time the vehicle is started.

A loose, improperly installed, or damaged fuel filler cap may also turn on the MIL. Refer to “Onboard Diagnostic System” in “Maintaining Your Vehicle” for further information.

**VEHICLE LOADING**

The load carrying capacity of your vehicle is shown on the “Vehicle Certification Label.” This information should be used for passenger and luggage loading as indicated.

Do not exceed the specified Gross Vehicle Weight Rating (GVWR) or the Gross Axle Weight Rating (GAWR).

### **Vehicle Certification Label**

Your vehicle has a Vehicle Certification Label affixed to the rear of the driver's door.

The label contains the following information:

- Name of manufacturer
- Month and year of manufacture
- Gross Vehicle Weight Rating (GVWR)
- Gross Axle Weight Rating (GAWR) front
- Gross Axle Weight Rating (GAWR) rear
- Vehicle Identification Number (VIN)
- Type of Vehicle
- Month Day and Hour of Manufacture (MDH)

The bar code allows a computer scanner to read the VIN.

### **Gross Vehicle Weight Rating (GVWR)**

The GVWR is the total allowable weight of your vehicle. This includes driver, passengers, and cargo. The total load must be limited so that you do not exceed the GVWR.

### **Gross Axle Weight Rating (GAWR)**

The GAWR is the maximum capacity of the front and rear axles. Distribute the load over the front and rear axles evenly. Make sure that you do not exceed either front or rear GAWR.

#### **WARNING!**

**Because the front wheels steer the vehicle, it is important that you do not exceed the maximum front or rear GAWR. A dangerous driving condition can result if either rating is exceeded. You could lose control of the vehicle and have a collision.**

## Overloading

The load carrying components (axle, springs, tires, wheels, etc.) of your vehicle will provide satisfactory service as long as you do not exceed the GVWR and the front and rear GAWR.

The best way to figure out the total weight of your vehicle is to weigh it when it is fully loaded and ready for operation. Weigh it on a commercial scale to ensure that it is not over the GVWR.

Figure out the weight on the front and rear of the vehicle separately. It is important that you distribute the load evenly over the front and rear axles.

Overloading can cause potential safety hazards and shorten useful service life. Heavier axles or suspension components do not necessarily increase the vehicle's GVWR.

## Loading

To load your vehicle properly, first figure out its empty weight, axle-by-axle and side-by-side. Store heavier items down low and be sure you distribute their weight as evenly as possible. Stow all loose items securely before driving. If weighing the loaded vehicle shows that you have exceeded either GAWR, but the total load is within the specified GVWR, you must redistribute the weight. Improper weight distribution can have an adverse effect on the way your vehicle steers and handles and the way the brakes operate.

**NOTE:** Refer to the "Vehicle Certification Label" affixed to the rear of the driver's door for your vehicle's GVWR and GAWRs.

## TRAILER TOWING

Trailer towing with this vehicle is not recommended.

**RECREATIONAL TOWING (BEHIND MOTORHOME, ETC.)**

Towing Condition	Wheels OFF the Ground	Manual Transmission	Automatic Transmission
Flat Tow	None	<ul style="list-style-type: none"> <li>• Transmission in NEUTRAL</li> <li>• 65 mph (105 km/h) maximum speed</li> </ul>	<b>NOT ALLOWED</b>
Dolly Tow	Front	<b>Not Recommended</b>	<b>NOT ALLOWED</b>
	Rear	<b>Not Recommended</b>	<b>Not Recommended</b>
On Trailer	<b>All</b>	OK	OK

**Automatic Transmission — If Equipped**

Recreational towing (with rear wheels on the ground) is **NOT ALLOWED**. The only acceptable method for towing this vehicle (behind another vehicle) is on a vehicle trailer with all four wheels **OFF** the ground.

Use of a towing dolly (with rear wheels on the ground) is **NOT ALLOWED**, as severe transmission damage will occur. Use of a towing dolly (with front wheels on the ground) is not recommended, as vehicle damage may occur.

**CAUTION!**

**Towing this vehicle in violation of the above requirements can cause severe transmission damage. Damage from improper towing is not covered under the New Vehicle Limited Warranty.**

**Manual Transmission — If Equipped**

Vehicles with a manual transmission may be flat towed (with all four wheels on the ground) under the following conditions:

- The shift lever must be in NEUTRAL.
- The towing speed must not exceed 65 mph (105 km/h).
- There is no limitation on towing distance.

Manual transmission vehicles may also be towed using a vehicle trailer (with all four wheels off the ground).

Use of a towing dolly is not recommended, as vehicle damage may occur.

**CAUTION!**

**Towing this vehicle in violation of the above requirements can cause severe engine or transmission damage. Damage from improper towing is not covered under the New Vehicle Limited Warranty.**



# WHAT TO DO IN EMERGENCIES

## CONTENTS

---

■ Hazard Warning Flashers . . . . .	342	□ Jump-Starting Procedure . . . . .	355
■ If Your Engine Overheats . . . . .	342	■ Freeing A Stuck Vehicle . . . . .	357
■ TIREFIT Kit . . . . .	343	■ Shift Lever Override . . . . .	359
□ TIREFIT Storage . . . . .	344	■ Towing A Disabled Vehicle . . . . .	360
□ TIREFIT Kit Components And Operation . . .	344	□ Automatic Transmission . . . . .	361
□ TIREFIT Usage Precautions . . . . .	346	□ Manual Transmission . . . . .	362
□ Sealing A Tire With TIREFIT . . . . .	348	□ Without The Key Fob . . . . .	362
■ Jump-Starting Procedures . . . . .	353		
□ Preparations For Jump-Start . . . . .	354		

## HAZARD WARNING FLASHERS

The Hazard Warning flasher switch is located in the switch bank near the bottom center of the instrument panel.



Press the switch to turn on the Hazard Warning flasher. When the switch is activated, all directional turn signals will flash on and off to warn oncoming traffic of an emergency. Press the switch a second time to turn off the Hazard Warning flashers.

This is an emergency warning system and it should not be used when the vehicle is in motion. Use it when your vehicle is disabled and it is creating a safety hazard for other motorists.

When you must leave the vehicle to seek assistance, the Hazard Warning flashers will continue to operate even though the ignition is placed in the OFF position.

**NOTE:** With extended use the Hazard Warning flashers may wear down your battery.

## IF YOUR ENGINE OVERHEATS

In any of the following situations, you can reduce the potential for overheating by taking the appropriate action.

- On the highways — slow down.
- In city traffic — while stopped, place the transmission in NEUTRAL, but do not increase engine idle speed.

**NOTE:** There are steps that you can take to slow down an impending overheat condition:

- If your air conditioner (A/C) is on, turn it off. The A/C system adds heat to the engine cooling system and turning the A/C off can help remove this heat.



- You can also turn the temperature control to maximum heat, the mode control to floor and the blower control to high. This allows the heater core to act as a supplement to the radiator and aids in removing heat from the engine cooling system.

### CAUTION!

Driving with a hot cooling system could damage your vehicle. If the temperature gauge reads 240°F (116 °C) or greater pull over and stop the vehicle. Idle the vehicle with the air conditioner turned off until the pointer drops back into the normal range 200–230°F (93–110°C). If the pointer remains at 240°F (116°C) or greater and you hear a chime, turn the engine off immediately and call for service.

### WARNING!

You or others can be badly burned by hot engine coolant (antifreeze) or steam from your radiator. If you see or hear steam coming from under the hood, do not open the hood until the radiator has had time to cool. Never try to open a cooling system pressure cap when the radiator or coolant bottle is hot.

### TIREFIT KIT

Small punctures up to ¼ in (6 mm) in the tire tread can be sealed with TIREFIT. Foreign objects (e.g., screws or nails) should not be removed from the tire. TIREFIT can be used in outside temperatures down to approximately -4°F (-20°C).

This kit will provide a temporary tire seal, allowing you to drive your vehicle up to 100 miles (160 km) with a maximum speed of 55 mph (88 km/h).

## TIREFIT Storage

The TIREFIT kit is located in the trunk.

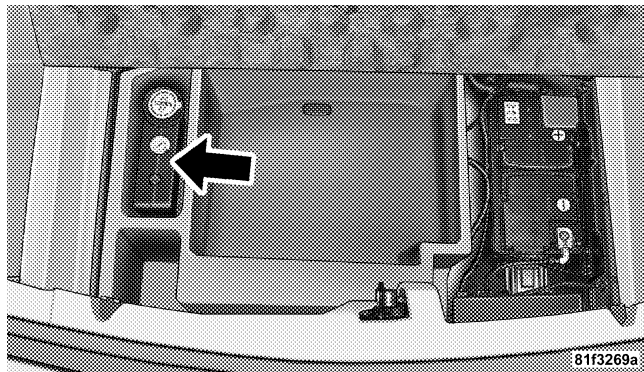

**TIREFIT Location**

## TIREFIT Kit Components And Operation

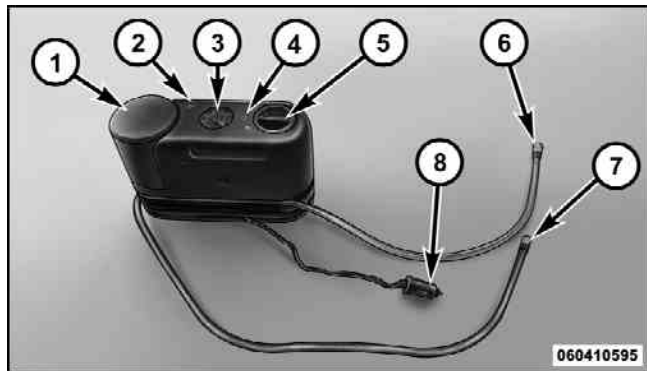

1. Sealant Bottle
2. Deflation Button
3. Pressure Gauge
4. Power Button

5. Mode Select Knob
6. Sealant Hose (Clear)
7. Air Pump Hose (Black)
8. Power Plug

### Using The Mode Select Knob And Hoses

Your TIREFIT kit is equipped with the following symbols to indicate the air or sealant mode.

#### Selecting Air Mode



Turn the Mode Select Knob (5) to this position for air pump operation only. Use the Black Air Pump Hose (7) when selecting this mode.

#### Selecting Sealant Mode



Turn the Mode Select Knob (5) to this position to inject the TIREFIT Sealant and to inflate the tire. Use the Sealant Hose (clear hose) (6) when selecting this mode.

#### Using The Power Button



Push and release the Power Button (4) once to turn On the TIREFIT kit. Push and release the Power Button (4) again to turn Off the TIREFIT kit.

#### Using The Deflation Button



Press the Deflation Button (2) to reduce the air pressure in the tire if it becomes over-inflated.

### TIREFIT Usage Precautions

- Replace the TIREFIT Sealant Bottle (1) and Sealant Hose (6) prior to the expiration date (printed on the bottle label) to assure optimum operation of the system. Refer to “Sealing a Tire with TIREFIT” section (F) “Sealant Bottle and Hose Replacement”.
- The Sealant Bottle (1) and Sealant Hose (6) are a one tire application use. After each use, always replace these components immediately at an authorized dealer.
- When the TIREFIT sealant is in a liquid form, clean water, and a damp cloth will remove the material from the vehicle or tire and wheel components. Once the sealant dries, it can easily be peeled off and properly discarded.
- For optimum performance, make sure the valve stem on the wheel is free of debris before connecting the TIREFIT kit.
- You can use the TIREFIT air pump to inflate bicycle tires. The kit also comes with two needles, located in the Accessory Storage Compartment (on the bottom of the air pump) for inflating sport balls, rafts, or similar inflatable items. However, use only the Air Pump Hose (7) and make sure the Mode Select Knob (5) is in the Air Mode when inflating such items to avoid injecting sealant into them. The TIREFIT Sealant is only intended to seal punctures less than ¼ in (6 mm) diameter in the tread of your vehicle.
- Do not lift or carry the TIREFIT kit by the hoses.

#### **WARNING!**

- **Do not attempt to seal a tire on the side of the vehicle closest to traffic. Pull far enough off the road to avoid the danger of being hit when using the TIREFIT kit.**

*(Continued)*

**WARNING! (Continued)**

- Do not use TIREFIT or drive the vehicle under the following circumstances:
  - If the puncture in the tire tread is approximately 1/4 in. (6 mm) or larger.
  - If the tire has any sidewall damage.
  - If the tire has any damage from driving with extremely low tire pressure.
  - If the tire has any damage from driving on a flat tire.
  - If the wheel has any damage.
  - If you are unsure of the condition of the tire or the wheel.
- Keep TIREFIT away from open flames or heat source.

*(Continued)***WARNING! (Continued)**

- A loose TIREFIT kit thrown forward in a collision or hard stop could endanger the occupants of the vehicle. Always stow the TIREFIT kit in the place provided. Failure to follow these warnings can result in injuries that are serious or fatal to you, your passengers, and others around you.
- Take care not to allow the contents of TIREFIT to come in contact with hair, eyes, or clothing. TIREFIT is harmful if inhaled, swallowed, or absorbed through the skin. It causes skin, eye, and respiratory irritation. Flush immediately with plenty of water if there is any contact with eyes or skin. Change clothing as soon as possible, if there is any contact with clothing.

*(Continued)*

**WARNING! (Continued)**

- **TIREFIT Sealant solution contains latex. In case of an allergic reaction or rash, consult a physician immediately. Keep TIREFIT out of reach of children. If swallowed, rinse mouth immediately with plenty of water and drink plenty of water. Do not induce vomiting! Consult a physician immediately.**

**Sealing A Tire With TIREFIT****(A) Whenever You Stop To Use TIREFIT:**

1. Pull over to a safe location and turn on the vehicle's Hazard Warning flashers.
2. Verify that the valve stem (on the wheel with the deflated tire) is in a position that is near to the ground. This will allow the TIREFIT Hoses (6) and (7) to reach the valve stem and keep the TIREFIT kit flat on the ground.

This will provide the best positioning of the kit when injecting the sealant into the deflated tire and running the air pump. Move the vehicle as necessary to place the valve stem in this position before proceeding.

3. Place the transmission in PARK (auto transmission) or in Gear (manual transmission) and turn Off the ignition.
4. Set the parking brake.

**(B) Setting Up To Use TIREFIT:**

1. Turn the Mode Select Knob (5) to the Sealant Mode position.
2. Uncoil the Sealant Hose (6) and then remove the cap from the fitting at the end of the hose.
3. Place the TIREFIT kit flat on the ground next to the deflated tire.

4. Remove the cap from the valve stem and then screw the fitting at the end of the Sealant Hose (6) onto the valve stem.

5. Uncoil the Power Plug (8) and insert the plug into the vehicle's 12 Volt power outlet.

**NOTE:** Do not remove foreign objects (e.g., screws or nails) from the tire.

### **(C) Injecting TIREFIT Sealant Into The Deflated Tire:**

- Always start the engine before turning ON the TIREFIT kit.

**NOTE:** Manual transmission vehicles must have the parking brake engaged and the shift lever in NEUTRAL.

- After pressing the Power Button (4), the sealant (white fluid) will flow from the Sealant Bottle (1) through the Sealant Hose (6) and into the tire.

**NOTE:** Sealant may leak out through the puncture in the tire.

**If the sealant (white fluid) does not flow** within 0 – 10 seconds through the Sealant Hose (6):

1. Press the Power Button (4) to turn Off the TIREFIT kit. Disconnect the Sealant Hose (6) from the valve stem. Make sure the valve stem is free of debris. Reconnect the Sealant Hose (6) to the valve stem. Check that the Mode Select Knob (5) is in the Sealant Mode position and not Air Mode. Press the Power Button (4) to turn On the TIREFIT kit.

2. Connect the Power Plug (8) to a different 12 Volt power outlet in your vehicle or another vehicle, if available. Make sure the engine is running before turning ON the TIREFIT kit.

3. The Sealant Bottle (1) may be empty due to previous use. Call for assistance.

**NOTE:** If the Mode Select Knob (5) is on Air Mode and the pump is operating, air will dispense from the Air Pump Hose (7) only, not the Sealant Hose (6).

**If the sealant (white fluid) does flow** through the Sealant Hose (6):

1. Continue to operate the pump until sealant is no longer flowing through hose (typically takes 30 - 70 seconds). As the sealant flows through the Sealant Hose (6), the Pressure Gauge (3) can read as high as 70 psi (5 Bar). The Pressure Gauge (3) will decrease quickly from approximately 70 psi (5 Bar) to the actual tire pressure when the Sealant Bottle (1) is empty.

2. The pump will start to inject air into the tire immediately after the Sealant Bottle (1) is empty. Continue to operate the pump and inflate the tire to the pressure indicated on the tire pressure label on the driver-side latch pillar (recommended pressure). Check the tire pressure by looking at the Pressure Gauge (3).

**If the tire does not inflate to at least 26 psi (1.8 Bar) pressure within 15 minutes:**

- The tire is too badly damaged. Do not attempt to drive the vehicle further. Call for assistance.

**NOTE:** If the tire becomes over-inflated, press the Deflation Button to reduce the tire pressure to the recommended inflation pressure before continuing.

**If the tire inflates to the recommended pressure or is at least 26 psi (1.8 Bar) pressure within 15 minutes:**

1. Press the Power Button (4) to turn off the TIREFIT kit.
2. Remove the Speed Limit sticker from the top of the Sealant Bottle (1) and place the sticker on the instrument panel.
3. Immediately disconnect the Sealant Hose (6) from the valve stem, reinstall the cap on the fitting at the end of the hose, and place the TIREFIT kit in the vehicle storage location. Quickly proceed to (D) "Drive Vehicle".



**CAUTION!**

- The metal end fitting from Power Plug (8) may get hot after use, so it should be handled carefully.
- Failure to reinstall the cap on the fitting at the end of the Sealant Hose (6) can result in sealant contacting your skin, clothing, and the vehicle's interior. It can also result in sealant contacting internal TIREFIT kit components which may cause permanent damage to the kit.

**(D) Drive Vehicle:**

Immediately after injecting sealant and inflating the tire, drive the vehicle 5 miles (8 km) or 10 minutes to ensure distribution of the TIREFIT Sealant within the tire. Do not exceed 55 mph (88 km/h).

**WARNING!**

TIREFIT is not a permanent flat tire repair. Have the tire inspected and repaired or replaced after using TIREFIT. Do not exceed 55 mph (88 km/h) until the tire is repaired or replaced. Failure to follow this warning can result in injuries that are serious or fatal to you, your passengers, and others around you.

**(E) After Driving:**

Pull over to a safe location. Refer to “Whenever You Stop to Use TIREFIT” before continuing.

1. Turn the Mode Select Knob (5) to the Air Mode position.
2. Uncoil the power plug and insert the plug into the vehicle's 12 Volt power outlet.

3. Uncoil the Air Pump Hose (7) (black in color) and screw the fitting at the end of hose (7) onto the valve stem.
4. Check the pressure in the tire by reading the Pressure Gauge (3).

**If tire pressure is less than 19 psi (1.3 Bar)**, the tire is too badly damaged. Do not attempt to drive the vehicle further. Call for assistance.

**If the tire pressure is 19 psi (1.3 bar) or higher:**

1. Press the Power Button (4) to turn on TIREFIT and inflate the tire to the pressure indicated on the tire and loading information label on the driver-side door opening.

**NOTE:** If the tire becomes over-inflated, press the Deflation Button to reduce the tire pressure to the recommended inflation pressure before continuing.

2. Disconnect the TIREFIT kit from the valve stem, reinstall the cap on the valve stem and unplug from 12 Volt outlet.

3. Place the TIREFIT kit in its proper storage area in the vehicle.
4. Have the tire inspected and repaired or replaced at the earliest opportunity at an authorized dealer or tire service center.
5. Replace the Sealant Bottle (1) and Sealant Hose (6) assembly at your authorized dealer as soon as possible. Refer to “(F) Sealant Bottle and Hose Replacement.”

**NOTE:** When having the tire serviced, advise the authorized dealer or service center that the tire has been sealed using the TIREFIT service kit.

**(F) Sealant Bottle And Hose Replacement:**

1. Uncoil the Sealant Hose (6) (clear in color).
2. Locate the round Sealant Bottle release button in the recessed area under the sealant bottle.

3. Press the Sealant Bottle release button. The Sealant Bottle (1) will pop up. Remove the bottle and dispose of it accordingly.
4. Clean any remaining sealant from the TIREFIT housing.
5. Position the new Sealant Bottle (1) in the housing so that the Sealant Hose (6) aligns with the hose slot in the front of the housing. Press the bottle into the housing. An audible click will be heard indicating the bottle is locked into place.
6. Verify that the cap is installed on the fitting at the end of the Sealant Hose (6) and return the hose to its storage area (located on the bottom of the air pump).
7. Return the TIREFIT kit to its storage location in the vehicle.

## JUMP-STARTING PROCEDURES

If your vehicle has a discharged battery it can be jump-started using a set of jumper cables and a battery in another vehicle or by using a portable battery booster pack. Jump-starting can be dangerous if done improperly so please follow the procedures in this section carefully.

**NOTE:** When using a portable battery booster pack follow the manufacturer's operating instructions and precautions.

### CAUTION!

**Do not use a portable battery booster pack or any other booster source with a system voltage greater than 12 Volts or damage to the battery, starter motor, alternator or electrical system may occur.**

**WARNING!**

Do not attempt jump-starting if the battery is frozen.  
It could rupture or explode and cause personal injury.

**Preparations For Jump-Start**

The battery is stored under an access cover in the trunk. Remote battery posts are located on the right side of the engine compartment for jump-starting.

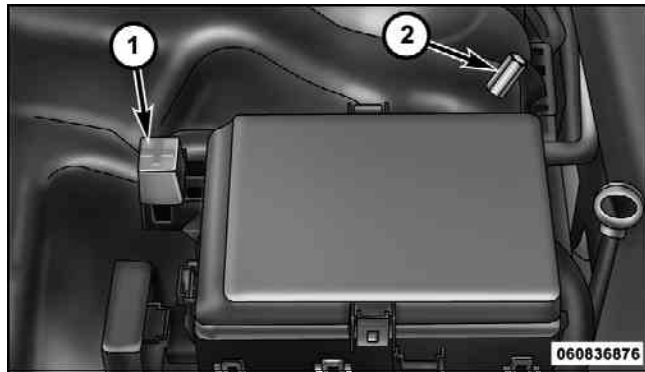

**Remote Battery Posts**

- 1 — Remote Positive (+) Post
- 2 — Remote Negative (-) Post

**WARNING!**

- Take care to avoid the radiator cooling fan whenever the hood is raised. It can start anytime the ignition switch is on. You can be injured by moving fan blades.
- Remove any metal jewelry such as watch bands or bracelets that might make an inadvertent electrical contact. You could be seriously injured.
- Batteries contain sulfuric acid that can burn your skin or eyes and generate hydrogen gas which is flammable and explosive. Keep open flames or sparks away from the battery.

1. Set the parking brake, shift the automatic transmission into PARK and turn the ignition to LOCK.
2. Turn off the heater, radio, and all unnecessary electrical accessories.

3. If using another vehicle to jump-start the battery, park the vehicle within the jumper cables reach, set the parking brake and make sure the ignition is OFF.

**WARNING!**

Do not allow vehicles to touch each other as this could establish a ground connection and personal injury could result.

**Jump-Starting Procedure****WARNING!**

Failure to follow this procedure could result in personal injury or property damage due to battery explosion.

**CAUTION!**

Failure to follow these procedures could result in damage to the charging system of the booster vehicle or the discharged vehicle.

1. Connect the positive (+) end of the jumper cable to the remote positive (+) post of the discharged vehicle.
2. Connect the opposite end of the positive (+) jumper cable to the positive (+) post of the booster battery.
3. Connect the negative end (-) of the jumper cable to the negative (-) post of the booster battery.
4. Connect the opposite end of the negative (-) jumper cable to the remote negative (-) post of the vehicle with the discharged battery.

**WARNING!**

Do not connect the cable to the negative post (-) of the discharged battery. The resulting electrical spark could cause the battery to explode and could result in personal injury.

5. Start the engine in the vehicle that has the booster battery, let the engine idle a few minutes, and then start the engine in the vehicle with the discharged battery.

Once the engine is started, remove the jumper cables in the reverse sequence:

6. Disconnect the negative (-) jumper cable from the remote negative (-) post of the vehicle with the discharged battery.
7. Disconnect the negative end (-) of the jumper cable from the negative (-) post of the booster battery.

8. Disconnect the opposite end of the positive (+) jumper cable from the positive (+) post of the booster battery.
9. Disconnect the positive (+) end of the jumper cable from the remote positive (+) post of the discharged vehicle.

If frequent jump-starting is required to start your vehicle you should have the battery and charging system inspected at your authorized dealer.

### **CAUTION!**

Accessories that can be plugged into the vehicle power outlets draw power from the vehicle's battery, even when not in use (i.e., cellular phones, etc.). Eventually, if plugged in long enough, the vehicle's battery will discharge sufficiently to degrade battery life and/or prevent the engine from starting.

### **FREING A STUCK VEHICLE**

If your vehicle becomes stuck in mud, sand, or snow, it can often be moved by a rocking motion. Turn your steering wheel right and left to clear the area around the front wheels. Then shift back and forth between REVERSE and DRIVE/1st Gear. Using minimal accelerator pedal pressure to maintain the rocking motion, without spinning the wheels, is most effective.

### **CAUTION!**

Racing the engine or spinning the wheels may lead to transmission overheating and failure. Allow the engine to idle with the shift lever in NEUTRAL for at least one minute after every five rocking-motion cycles. This will minimize overheating and reduce the risk of transmission failure during prolonged efforts to free a stuck vehicle.

**NOTE:** Turn off the Electronic Stability Program (ESP) before rocking the vehicle. Refer to “Electronic Stability Program,” or “Traction Control” in “Starting And Operating” for further information.

### CAUTION!

- When “rocking” a stuck vehicle by moving between REVERSE and DRIVE/1st Gear, do not spin the wheels faster than 15 mph (24 km/h), or drivetrain damage may result.
- Revving the engine or spinning the wheels too fast may lead to transmission overheating and failure. It can also damage the tires. Do not spin the wheels above 30 mph (48 km/h) while in gear (no transmission shifting occurring).

### WARNING!

Fast spinning tires can be dangerous. Forces generated by excessive wheel speeds may cause damage, or even failure, of the axle and tires. A tire could explode and injure someone. Do not spin your vehicle’s wheels faster than 30 mph (48 km/h) or for longer than 30 seconds continuously without stopping when you are stuck and do not let anyone near a spinning wheel, no matter what the speed.



## SHIFT LEVER OVERRIDE

If a malfunction occurs and the shift lever cannot be moved out of the PARK position, you can use the following procedure to temporarily move the shift lever:

1. Firmly apply the parking brake.
2. Remove the shift lever override access cover located to the right of the shift lever.
3. Turn the ignition switch to the ON/RUN position (engine Off).
4. Press and maintain firm pressure on the brake pedal.
5. Using a screwdriver or similar tool, press and hold the override tab through the access port on the center console.



Shift Lever Override Access Cover

6. Move the shift lever to the NEUTRAL position.
7. The vehicle may then be started in NEUTRAL.
8. Reinstall the shift lever override access cover.

## TOWING A DISABLED VEHICLE

This section describes procedures for towing a disabled vehicle using a commercial wrecker service.

Towing Condition	Wheels OFF The Ground	AUTOMATIC TRANSMISSION	MANUAL TRANSMISSION
Flat Tow	NONE	If transmission is operable: <ul style="list-style-type: none"> <li>• Transmission in <b>NEUTRAL</b></li> <li>• 30 mph (48 km/h)<b>max</b> speed</li> <li>• 15 miles (24 km) <b>max</b> distance</li> </ul>	If transmission is operable: <ul style="list-style-type: none"> <li>• Transmission in <b>NEUTRAL</b></li> <li>• 65 mph (104 km/h)<b>max</b> speed</li> </ul>
Wheel Lift or Dolly Tow	Front	<b>NOT ALLOWED</b>	NOT RECOMMENDED
	Rear	NOT RECOMMENDED	NOT RECOMMENDED
Flatbed	<b>ALL</b>	<b>BEST METHOD</b>	<b>BEST METHOD</b>

Proper towing or lifting equipment is required to prevent damage to your vehicle. Use only tow bars and other equipment designed for the purpose, following equipment manufacturer's instructions. Use of safety chains is mandatory. Attach a tow bar or other towing device to

main structural members of the vehicle, not to bumpers or associated brackets. State and local laws applying to vehicles under tow must be observed.

If you must use the accessories (wipers, defrosters, etc.) while being towed, the ignition must be in the ON/RUN position, not the ACC position.

If the vehicle's battery is discharged, see "Shift Lever Override" in "What To Do In Emergencies" for instructions on shifting the automatic transmission out of the PARK position for towing.

### CAUTION!

- Do not attempt to use sling type equipment when towing. When securing the vehicle to a flatbed truck, do not attach to front or rear suspension components. Damage to your vehicle may result from improper towing.
- The manufacturer does not recommend that you tow this vehicle on a tow dolly. Vehicle damage may occur.

### Automatic Transmission

The manufacturer recommends towing your vehicle with all four wheels OFF the ground using a flatbed.

If flatbed equipment is not available, and the transmission is operable, the vehicle may be flat towed (with all four wheels on the ground) under the following conditions:

- The shift lever must be in NEUTRAL.
- The towing distance must not exceed 15 miles (24 km).
- The towing speed must not exceed 30 mph (48 km/h).

If the transmission is not operable, or the vehicle must be towed faster than 30 mph (48 km/h) or farther than 15 miles (24 km), then the only acceptable method of towing is with a flatbed truck.

### CAUTION!

Failure to follow these towing methods can cause severe transmission damage. Such damage is not covered by the New Vehicle Limited Warranty.

### Manual Transmission

The manufacturer recommends towing your vehicle with all four wheels OFF the ground using a flatbed.

If flatbed equipment is not available, and the transmission is operable, the vehicle may be flat towed (with all four wheels on the ground) under the following conditions:

- The shift lever must be in NEUTRAL.
- The towing speed must not exceed 65 mph (104 km/h).

There is no limitation on towing distance. If the transmission is not operable, then the only acceptable method of towing is with a flatbed truck.

#### **CAUTION!**

**Failure to follow these towing methods can cause severe transmission damage. Such damage is not covered by the New Vehicle Limited Warranty.**

### Without The Key Fob

Special care must be taken when the vehicle is towed with the ignition in the OFF position. The only approved method of towing without the ignition key is with a flatbed truck. Proper towing equipment is necessary to prevent damage to the vehicle.

#### **CAUTION!**

**Failure to follow these towing methods can cause severe transmission damage. Such damage is not covered by the New Vehicle Limited Warranty.**

# MAINTAINING YOUR VEHICLE

## CONTENTS

---

■ Engine Compartment — 6.4L (392 HEMI) . . . . .	366	□ Engine Oil Filter . . . . .	373
■ Onboard Diagnostic System — OBD II . . . . .	367	□ Engine Air Cleaner Filter . . . . .	373
□ Loose Fuel Filler Cap . . . . .	367	□ Maintenance-Free Battery . . . . .	374
■ Emissions Inspection And Maintenance Programs . . . . .	368	□ Air Conditioner Maintenance . . . . .	376
■ Replacement Parts . . . . .	369	□ A/C Air Filter . . . . .	377
■ Dealer Service . . . . .	370	□ Body Lubrication . . . . .	379
■ Maintenance Procedures . . . . .	370	□ Windshield Wiper Blades . . . . .	379
□ Engine Oil . . . . .	371	□ Adding Washer Fluid . . . . .	380
		□ Exhaust System . . . . .	381

- Cooling System . . . . . 383
- Brake System . . . . . 389
- Clutch Hydraulic System (Manual Transmission) – If Equipped . . . . . 391
- Manual Transmission – If Equipped . . . . . 391
- Automatic Transmission – If Equipped . . . . . 392
- Rear Axle . . . . . 393
- Appearance Care And Protection From Corrosion . . . . . 394
- Fuses . . . . . 399
  - Integrated Power Module . . . . . 399
  - Rear Power Distribution Center . . . . . 402
- Vehicle Storage . . . . . 406
- Replacement Bulbs . . . . . 407
  - Bulb Replacement . . . . . 408
    - Low Beam Headlamp, High Beam Headlamp, Park/Turn Lamp — Models With Halogen Headlamps — If Equipped . . . . . 408
    - Low Beam Headlamp, High Beam Headlamp, And Park/Turn Lamp — Models With High Intensity Discharge (HID) Headlamps — If Equipped . . . . . 408
  - Front/Rear Side Marker Lamp . . . . . 409
  - Tail/Turn And Stop Lamp . . . . . 409
  - Center Tail/Backup Lamp . . . . . 412

□ Center High-Mounted Stop Lamp (CHMSL) . . . . .	412	■ Fluids, Lubricants, And Genuine Parts . . . . .	414
□ License Lamp . . . . .	412	□ Engine . . . . .	414
■ Fluid Capacities . . . . .	413	□ Chassis . . . . .	415

## ENGINE COMPARTMENT — 6.4L (392 HEMI)

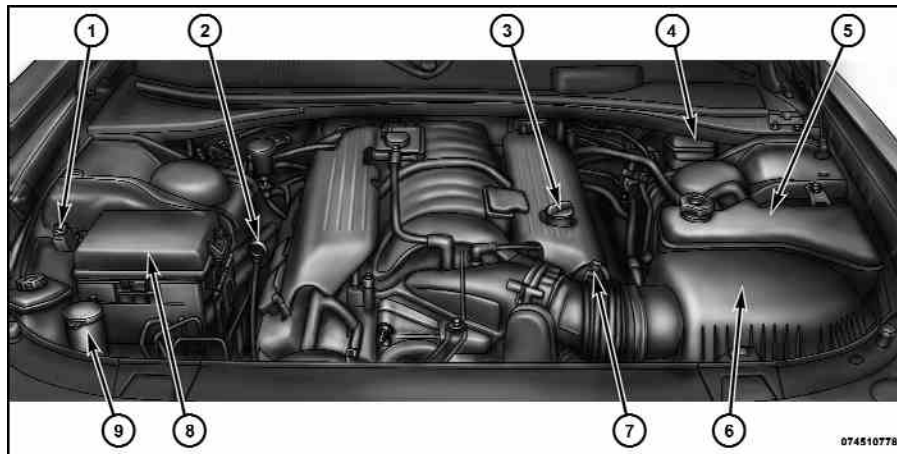

- 1 — Remote Jump Start (Positive Battery Post)
- 2 — Engine Oil Dipstick
- 3 — Engine Oil Fill
- 4 — Brake Fluid Reservoir
- 5 — Engine Coolant Reservoir

- 6 — Air Cleaner Filter
- 7 — Power Steering Fluid Reservoir
- 8 — Integrated Power Module (Fuses)
- 9 — Washer Fluid Reservoir



## ONBOARD DIAGNOSTIC SYSTEM — OBD II

Your vehicle is equipped with a sophisticated onboard diagnostic system called OBD II. This system monitors the performance of the emissions, engine, and automatic transmission control systems. When these systems are operating properly, your vehicle will provide excellent performance and fuel economy, as well as engine emissions well within current government regulations.

If any of these systems require service, the OBD II system will turn on the “Malfunction Indicator Light” (MIL). It will also store diagnostic codes and other information to assist your service technician in making repairs. Although your vehicle will usually be drivable and not need towing, see your authorized dealer for service as soon as possible.

### CAUTION!

- **Prolonged driving with the MIL on could cause further damage to the emission control system. It could also affect fuel economy and drivability. The vehicle must be serviced before any emissions tests can be performed.**
- **If the MIL is flashing while the engine is running, severe catalytic converter damage and power loss will soon occur. Immediate service is required.**

### Loose Fuel Filler Cap

If the vehicle diagnostic system determines that the fuel filler cap is loose, improperly installed, or damaged, a “gASCAP” message will display in the odometer or a “Check Gas cap” message will display in the Electronic Vehicle Information Center (EVIC) (if equipped). If this occurs, tighten the fuel filler cap properly and press the

Trip Odometer button to turn off the message. If the problem continues, the message will appear the next time the vehicle is started.

A loose, improperly installed, or damaged fuel filler cap may also turn on the MIL.

## EMISSIONS INSPECTION AND MAINTENANCE PROGRAMS

In some localities, it may be a legal requirement to pass an inspection of your vehicle's emissions control system. Failure to pass could prevent vehicle registration.



For states that require an Inspection and Maintenance (I/M), this check verifies the "Malfunction Indicator Light (MIL)" is functioning and is not on when the engine is running, and that the OBD II system is ready for testing.

Normally, the OBD II system will be ready. The OBD II system may **not** be ready if your vehicle was recently serviced, recently had a dead battery or a battery replacement. If the OBD II system should be determined not ready for the I/M test, your vehicle may fail the test.

Your vehicle has a simple ignition key-actuated test, which you can use prior to going to the test station. To check if your vehicle's OBD II system is ready, you must do the following:

1. Turn the ignition switch to the ON position, but do not crank or start the engine.
2. If you crank or start the engine, you will have to start this test over.
3. As soon as you turn the ignition switch to the ON position, you will see the MIL symbol come on as part of a normal bulb check.

4. Approximately 15 seconds later, one of two things will happen:

a. The MIL will flash for about 10 seconds and then return to being fully illuminated until you turn OFF the ignition or start the engine. This means that your vehicle's OBD II system is **not ready** and you should **not** proceed to the I/M station.

b. The MIL will not flash at all and will remain fully illuminated until you turn OFF the ignition or start the engine. This means that your vehicle's OBD II system is **ready** and you can proceed to the I/M station.

If your OBD II system is **not ready**, you should see your authorized dealer or repair facility. If your vehicle was recently serviced or had a battery failure or replacement, you may need to do nothing more than drive your vehicle as you normally would in order for your OBD II system to update. A recheck with the above test routine may then indicate that the system is now ready.

Regardless of whether your vehicle's OBD II system is ready or not, if the MIL is illuminated during normal vehicle operation you should have your vehicle serviced before going to the I/M station. The I/M station can fail your vehicle because the MIL is on with the engine running.

### REPLACEMENT PARTS

Use of genuine MOPAR® parts for normal/scheduled maintenance and repairs is highly recommended to ensure the designed performance. Damage or failures caused by the use of non-MOPAR® parts for maintenance and repairs will not be covered by the manufacturer's warranty.

## DEALER SERVICE

Your authorized dealer has the qualified service personnel, special tools, and equipment to perform all service operations in an expert manner. Service Manuals are available which include detailed service information for your vehicle. Refer to these Service Manuals before attempting any procedure yourself.

**NOTE:** Intentional tampering with emissions control systems may void your warranty and could result in civil penalties being assessed against you.

### WARNING!

You can be badly injured working on or around a motor vehicle. Only do service work for which you have the knowledge and the proper equipment. If you have any doubt about your ability to perform a service job, take your vehicle to a competent mechanic.

## MAINTENANCE PROCEDURES

The pages that follow contain the **required** maintenance services determined by the engineers who designed your vehicle.

Besides those maintenance items specified in the fixed maintenance schedule, there are other components which may require servicing or replacement in the future.

### CAUTION!

- Failure to properly maintain your vehicle or perform repairs and service when necessary could result in more costly repairs, damage to other components or negatively impact vehicle performance. Immediately have potential malfunctions examined by an authorized Chrysler Group LLC dealership or qualified repair center.

*(Continued)*

**CAUTION! (Continued)**

- **Your vehicle has been built with improved fluids that protect the performance and durability of your vehicle and also allow extended maintenance intervals. Do not use chemical flushes in these components as the chemicals can damage your engine, transmission, power steering or air conditioning. Such damage is not covered by the New Vehicle Limited Warranty. If a flush is needed because of component malfunction, use only the specified fluid for the flushing procedure.**

**Engine Oil****Checking Oil Level**

To assure proper engine lubrication, the engine oil must be maintained at the correct level. Check the oil level at regular intervals, such as every fuel stop. The best time to

check the engine oil level is about five minutes after a fully warmed engine is shut off or before starting the engine after it has sat overnight.

Checking the oil while the vehicle is on level ground will improve the accuracy of the oil level readings. Maintain the oil level in the “SAFE” range. Adding 1.0 qt (1.0 L) of oil when the reading is at the bottom of the “SAFE” range will result in an oil level at the top of the “SAFE” range on these engines.

**CAUTION!**

**Overfilling or underfilling will cause oil aeration or loss of oil pressure. This could damage your engine.**

**Change Engine Oil**

The oil change indicator system will remind you that it is time to take your vehicle in for scheduled maintenance. Refer to “Maintenance Schedule” for further information.

**NOTE:** Under no circumstances should oil change intervals exceed 6,000 miles (10 000 km) or six months, whichever occurs first.

### Engine Oil Selection

For best performance and maximum protection under all types of operating conditions, the manufacturer only recommends full synthetic engine oils that meet the American Petroleum Institute (API) categories of SM or SM/CF.

The manufacturer recommends the use of a full synthetic SAE 0W-40 engine oil or equivalent.

### **CAUTION!**

**Do not use chemical flushes in your engine oil as the chemicals can damage your engine. Such damage is not covered by the New Vehicle Limited Warranty.**

### Engine Oil Viscosity (SAE Grade)

SAE 0W-40 engine oil is preferred for use in all operating temperatures.

The engine oil filler cap also shows the recommended engine oil viscosity for your engine. For information on engine oil filler cap location, refer to “Engine Compartment” in “Maintaining Your Vehicle” for further information.

### Synthetic Engine Oils

You may use synthetic engine oils provided the recommended oil quality requirements are met, and the recommended maintenance intervals for oil and filter changes are followed.

### Materials Added To Engine Oil

Do not add any supplemental materials, other than leak detection dyes, to the engine oil. Engine oil is an engineered product and its performance may be impaired by supplemental additives.

### Disposing Of Used Engine Oil And Oil Filters

Care should be taken in disposing of used engine oil and oil filters from your vehicle. Used oil and oil filters, indiscriminately discarded, can present a problem to the environment. Contact your authorized dealer, service station, or governmental agency for advice on how and where used oil and oil filters can be safely discarded in your area.

### Engine Oil Filter

The engine oil filter should be replaced with a new filter at every engine oil change.

### Engine Oil Filter Selection

This manufacturer's engines have a full-flow type oil filter. Use a filter of this type for replacement. The quality of replacement filters varies considerably. Only high quality filters should be used to assure most efficient service. MOPAR® engine oil filters are a high quality oil filter and are recommended.

### Engine Air Cleaner Filter

Refer to the "Maintenance Schedule" for the proper maintenance intervals.

#### **WARNING!**

**The air induction system (air cleaner, hoses, etc.) can provide a measure of protection in the case of engine backfire. Do not remove the air induction system (air cleaner, hoses, etc.) unless such removal is necessary for repair or maintenance. Make sure that no one is near the engine compartment before starting the vehicle with the air induction system (air cleaner, hoses, etc.) removed. Failure to do so can result in serious personal injury.**

### Engine Air Cleaner Filter Selection

The quality of replacement engine air cleaner filters varies considerably. Only high quality filters should be used to assure most efficient service. MOPAR® engine air cleaner filters are a high quality filter and are recommended.

### Maintenance-Free Battery

Your vehicle is equipped with a maintenance-free battery. You will never have to add water, nor is periodic maintenance required.

**NOTE:** The battery is stored under an access cover in the trunk. Remote battery terminals are located in the engine compartment for jump-starting. Refer to “Jump-Starting Procedures” in “What To Do In Emergencies” for further information.

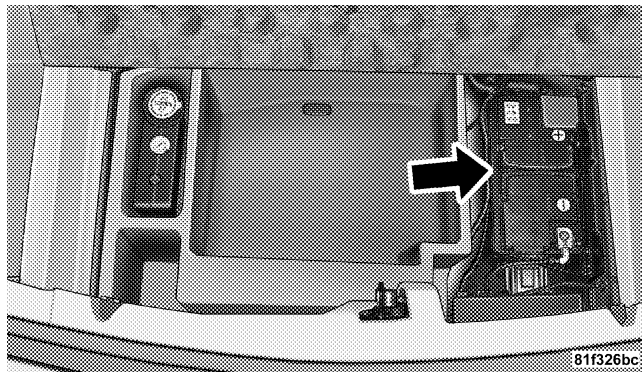

**Battery Location**



**WARNING!**

- Battery fluid is a corrosive acid solution and can burn or even blind you. Do not allow battery fluid to contact your eyes, skin, or clothing. Do not lean over a battery when attaching clamps. If acid splashes in eyes or on skin, flush the area immediately with large amounts of water.
- Battery gas is flammable and explosive. Keep flame or sparks away from the battery. Do not use a booster battery or any other booster source with an output greater than 12 Volts. Do not allow cable clamps to touch each other.
- Battery posts, terminals, and related accessories contain lead and lead compounds. Wash hands after handling.
- The battery in this vehicle has a vent hose that should not be disconnected and should only be replaced with a battery of the same type (vented).

**CAUTION!**

- It is essential when replacing the cables on the battery that the positive cable is attached to the positive post and the negative cable is attached to the negative post. Battery posts are marked positive (+) and negative (-) and are identified on the battery case. Cable clamps should be tight on the terminal posts and free of corrosion.
- If a “fast charger” is used while the battery is in the vehicle, disconnect both vehicle battery cables before connecting the charger to the battery. Do not use a “fast charger” to provide starting voltage.

### **Air Conditioner Maintenance**

For best possible performance, your air conditioner should be checked and serviced by an authorized dealer at the start of each warm season. This service should include cleaning of the condenser fins and a performance test. Drive belt tension should also be checked at this time.

#### **CAUTION!**

Do not use chemical flushes in your air conditioning system as the chemicals can damage your air conditioning components. Such damage is not covered by the New Vehicle Limited Warranty.

#### **WARNING!**

- Use only refrigerants and compressor lubricants approved by the manufacturer for your air conditioning system. Some unapproved refrigerants are flammable and can explode, injuring you. Other unapproved refrigerants or lubricants can cause the system to fail, requiring costly repairs. Refer to Warranty Information Book, located on the DVD, for further warranty information.
- The air conditioning system contains refrigerant under high pressure. To avoid risk of personal injury or damage to the system, adding refrigerant or any repair requiring lines to be disconnected should be done by an experienced technician.

### Refrigerant Recovery And Recycling

R-134a Air Conditioning Refrigerant is a hydrofluorocarbon (HFC) that is endorsed by the Environmental Protection Agency and is an ozone-saving product. However, the manufacturer recommends that air conditioning service be performed by authorized dealers or other service facilities using recovery and recycling equipment.

**NOTE:** Use only manufacturer approved A/C system sealers, stop leak products, seal conditioners, compressor oil, and refrigerants.

### A/C Air Filter

The filter is located in the fresh air inlet under the hood, behind a removable panel in the cowl on the passenger side of the vehicle, next to the windshield wipers. When installing a new filter, ensure its proper orientation.

1. Remove the access door in the cowl screen by pressing the retaining clips.

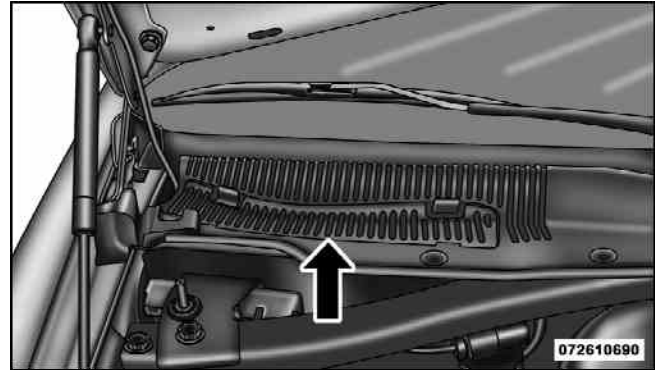

Access Door

2. Unsnap both ends and lift the filter access cover.

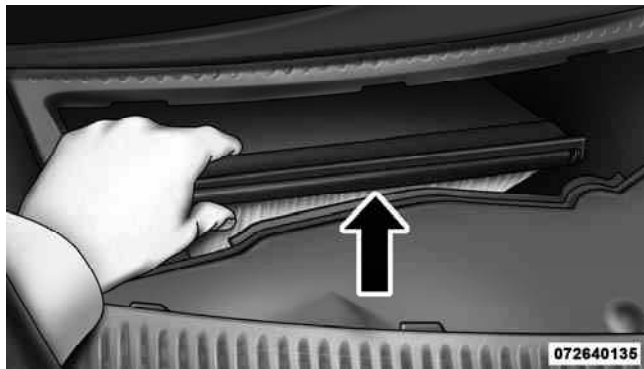

Filter Access Cover

3. Remove the used filter.
4. Install the new filter with arrows pointing in the direction of airflow, which is toward the rear of the vehicle (text and arrows on the filter will indicate this).

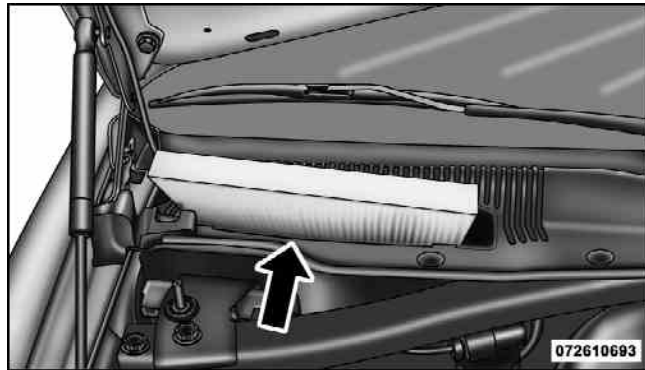

A/C Air Filter

5. Close the filter access cover.
- Refer to the "Maintenance Schedule" for the proper maintenance intervals.

## Body Lubrication

Locks and all body pivot points, including such items as seat tracks, door hinge pivot points and rollers, liftgate, tailgate, sliding doors and hood hinges, should be lubricated periodically with a lithium based grease, such as MOPAR® Spray White Lube or equivalent, to assure quiet, easy operation and to protect against rust and wear. Prior to the application of any lubricant, the parts concerned should be wiped clean to remove dust and grit; after lubricating excess oil and grease should be removed. Particular attention should also be given to hood latching components to ensure proper function. When performing other underhood services, the hood latch, release mechanism and safety catch should be cleaned and lubricated.

The external lock cylinders should be lubricated twice a year, preferably in the Fall and Spring. Apply a small

amount of a high quality lubricant, such as MOPAR® Lock Cylinder Lubricant or equivalent, directly into the lock cylinder.

## Windshield Wiper Blades

Clean the rubber edges of the wiper blades and the windshield periodically with a sponge or soft cloth and a mild nonabrasive cleaner. This will remove accumulations of salt or road film.

Operation of the wipers on dry glass for long periods may cause deterioration of the wiper blades. Always use washer fluid when using the wipers to remove salt or dirt from a dry windshield.

Avoid using the wiper blades to remove frost or ice from the windshield. Keep the blade rubber out of contact with petroleum products such as engine oil, gasoline, etc.

**NOTE:** Life expectancy of wiper blades varies depending on geographical area and frequency of use. Poor performance of blades may be present with chattering, marks, water lines or wet spots. If any of these conditions are present, clean the wiper blades or replace as necessary.

### **Adding Washer Fluid**

The windshield washer fluid reservoir is located in the front of the engine compartment. Be sure to check the fluid level in the reservoir at regular intervals. Fill the reservoir with windshield washer solvent (not radiator antifreeze) and operate the system for a few seconds to flush out the residual water.

When refilling the washer fluid reservoir, apply some washer fluid to a cloth or towel and wipe the wiper blades clean. This will help blade performance.

To prevent freeze-up of your windshield washer system in cold weather, select a solution or mixture that meets or exceeds the temperature range of your climate. This rating information can be found on most washer fluid containers.

The fluid reservoir will hold nearly 1 gal (4 l) of washer fluid when the message “Low Washer Fluid” appears in the Electronic Vehicle Information Center (EVIC).

### **WARNING!**

**Commercially available windshield washer solvents are flammable. They could ignite and burn you. Care must be exercised when filling or working around the washer solution.**

## Exhaust System

The best protection against carbon monoxide entry into the vehicle body is a properly maintained engine exhaust system.

If you notice a change in the sound of the exhaust system; or if the exhaust fumes can be detected inside the vehicle; or when the underside or rear of the vehicle is damaged; have an authorized technician inspect the complete exhaust system and adjacent body areas for broken, damaged, deteriorated, or mispositioned parts. Open seams or loose connections could permit exhaust fumes to seep into the passenger compartment. In addition, inspect the exhaust system each time the vehicle is raised for lubrication or oil change. Replace as required.

### WARNING!

- Exhaust gases can injure or kill. They contain carbon monoxide (CO), which is colorless and odorless. Breathing it can make you unconscious and can eventually poison you. To avoid breathing CO, refer to “Safety Tips/Exhaust Gas” in “Things To Know Before Starting Your Vehicle” for further information.
- A hot exhaust system can start a fire if you park over materials that can burn. Such materials might be grass or leaves coming into contact with your exhaust system. Do not park or operate your vehicle in areas where your exhaust system can contact anything that can burn.

**CAUTION!**

- The catalytic converter requires the use of unleaded fuel only. Leaded gasoline will destroy the effectiveness of the catalyst as an emissions control device and may seriously reduce engine performance and cause serious damage to the engine.
- Damage to the catalytic converter can result if your vehicle is not kept in proper operating condition. In the event of engine malfunction, particularly involving engine misfire or other apparent loss of performance, have your vehicle serviced promptly. Continued operation of your vehicle with a severe malfunction could cause the converter to overheat, resulting in possible damage to the converter and vehicle.

Under normal operating conditions, the catalytic converter will not require maintenance. However, it is important to keep the engine properly tuned to assure proper catalyst operation and prevent possible catalyst damage.

**NOTE:** Intentional tampering with emissions control systems can result in civil penalties being assessed against you.

In unusual situations involving grossly malfunctioning engine operation, a scorching odor may suggest severe and abnormal catalyst overheating. If this occurs, stop the vehicle, turn off the engine and allow it to cool. Service, including a tune-up to manufacturer's specifications, should be obtained immediately.



To minimize the possibility of catalytic converter damage:

- Do not shut off the engine or interrupt the ignition, when the transmission is in gear and the vehicle is in motion.
- Do not try to start the engine by pushing or towing the vehicle.
- Do not idle the engine with any spark plug wires disconnected or removed, such as when diagnostic testing, or for prolonged periods during very rough idle or malfunctioning operating conditions.

## Cooling System

### **WARNING!**

- When working near the radiator cooling fan, disconnect the fan motor lead or turn the ignition switch to the LOCK position (OFF position for Keyless Enter-N-Go). The fan is temperature controlled and can start at any time the ignition switch is in the ON position (RUN position for Keyless Enter-N-Go).
- You or others can be badly burned by hot coolant or steam from your radiator. If you see or hear steam coming from under the hood, do not open the hood until the radiator has had time to cool. Never try to open a cooling system pressure cap when the radiator is hot.

### **Coolant Checks**

Check the engine coolant (antifreeze) protection every 12 months (before the onset of freezing weather, where applicable). If coolant is dirty or rusty in appearance, the system should be drained, flushed, and refilled with fresh coolant. Check the front of the A/C condenser for any accumulation of bugs, leaves, etc. If dirty, clean by gently spraying water from a garden hose vertically down the face of the condenser.

Check the coolant recovery bottle tubing for brittle rubber, cracking, tears, cuts, and tightness of the connection at the bottle and radiator. Inspect the entire system for leaks.

With the engine at normal operating temperature (but not running), check the cooling system pressure cap for proper vacuum sealing by draining a small amount of coolant from the radiator drain cock. If the cap is sealing properly, the engine coolant (antifreeze) will begin to

drain from the coolant recovery bottle. **DO NOT REMOVE THE COOLANT PRESSURE CAP WHEN THE COOLING SYSTEM IS HOT.**

### **Cooling System – Drain, Flush, And Refill**

If the solution is dirty or contains a considerable amount of sediment, clean and flush with a reliable cooling system cleaner. Follow with a thorough rinsing to remove all deposits and chemicals. Properly dispose of the old antifreeze solution.

Refer to the “Maintenance Schedule” for the proper maintenance intervals.

### **Selection Of Coolant**

Use only the manufacturer’s recommended coolant. Refer to “Fluids, Lubricants, and Genuine Parts” in “Maintaining Your Vehicle” for further information.

**CAUTION!**

- **Mixing of coolants other than specified HOAT engine coolants may result in engine damage and may decrease corrosion protection. If a non-HOAT coolant is introduced into the cooling system in an emergency, it should be replaced with the specified coolant as soon as possible.**
- **Do not use plain water alone or alcohol-based engine coolant (antifreeze) products. Do not use additional rust inhibitors or antirust products, as they may not be compatible with the radiator engine coolant and may plug the radiator.**
- **This vehicle has not been designed for use with propylene glycol-based coolants. Use of propylene glycol-based coolants is not recommended.**

**Adding Coolant**

Your vehicle has been built with an improved engine coolant (antifreeze) that allows extended maintenance intervals. This engine coolant (antifreeze) can be used up to five years or 102,000 miles (170 000 km) before replacement. To prevent reducing this extended maintenance period, it is important that you use the same engine coolant (antifreeze) throughout the life of your vehicle.

Please review these recommendations for using Hybrid Organic Additive Technology (HOAT) engine coolant (antifreeze). When adding engine coolant (antifreeze):

- The manufacturer recommends using MOPAR® Antifreeze/Coolant 5 Year/100,000 Mile Formula HOAT (Hybrid Organic Additive Technology) or equivalent.

- Mix a minimum solution of 50% HOAT engine coolant and distilled water. Use higher concentrations (not to exceed 70%) if temperatures below  $-34^{\circ}\text{F}$  ( $-37^{\circ}\text{C}$ ) are anticipated.
- Use only high purity water such as distilled or deionized water when mixing the water/engine coolant (antifreeze) solution. The use of lower quality water will reduce the amount of corrosion protection in the engine cooling system.

Please note that it is the owner's responsibility to maintain the proper level of protection against freezing according to the temperatures occurring in the area where the vehicle is operated.

**NOTE:** Mixing engine coolant (antifreeze) types will decrease the life of the engine coolant (antifreeze) and will require more frequent coolant changes.

### Cooling System Pressure Cap

The cap must be fully tightened to prevent loss of coolant and to ensure that coolant will return to the radiator from the coolant recovery bottle.

The cap should be inspected and cleaned if there is any accumulation of foreign material on the sealing surfaces.

#### **WARNING!**

- **The warning words "DO NOT OPEN HOT" on the cooling system pressure cap are a safety precaution. Never add coolant when the engine is overheated. Do not loosen or remove the cap to cool an overheated engine. Heat causes pressure to build up in the cooling system. To prevent scalding or injury, do not remove the pressure cap while the system is hot or under pressure.**

*(Continued)*

**WARNING! (Continued)**

- **Do not use a pressure cap other than the one specified for your vehicle. Personal injury or engine damage may result.**

**Disposal Of Used Coolant**

Used ethylene glycol-based engine coolant is a regulated substance requiring proper disposal. Check with your local authorities to determine the disposal rules for your community. To prevent ingestion by animals or children, do not store ethylene glycol-based engine coolant in open containers or allow it to remain in puddles on the ground. If ingested by a child or pet, seek emergency assistance immediately. Clean up any ground spills immediately.

**Coolant Level**

The coolant bottle provides a quick visual method for determining that the coolant level is adequate. With the

engine OFF and cold, the level of the coolant in the bottle should be between the ranges indicated on the bottle.

The radiator normally remains completely full, so there is no need to remove the radiator cap unless checking for coolant freeze point or replacing coolant. Advise your service attendant of this. As long as the engine operating temperature is satisfactory, the coolant bottle need only be checked once a month.

When additional coolant is needed to maintain the proper level, it should be added to the coolant bottle. Do not overfill.

**Points To Remember**

**NOTE:** When the vehicle is stopped after a few miles (kilometers) of operation, you may observe vapor coming from the front of the engine compartment. This is normally a result of moisture from rain, snow, or high

humidity accumulating on the radiator and being vaporized when the thermostat opens, allowing hot coolant to enter the radiator.

If an examination of your engine compartment shows no evidence of radiator or hose leaks, the vehicle may be safely driven. The vapor will soon dissipate.

- Do not overfill the coolant recovery bottle.
- Check the coolant freeze point in the radiator and in the coolant recovery bottle. If antifreeze needs to be added, the contents of the coolant recovery bottle must also be protected against freezing.
- If frequent coolant additions are required, or if the level in the coolant recovery bottle does not drop when the engine cools, the cooling system should be pressure tested for leaks.
- Maintain coolant concentration at 50% HOAT engine coolant (minimum) and distilled water for proper corrosion protection of your engine, which contains aluminum components.
- Make sure that the radiator and coolant recovery bottle overflow hoses are not kinked or obstructed.
- Keep the front of the radiator clean. If your vehicle is equipped with air conditioning, keep the front of the condenser clean.
- Do not change the thermostat for Summer or Winter operation. If replacement is ever necessary, install ONLY the correct type thermostat. Other designs may result in unsatisfactory coolant performance, poor gas mileage, and increased emissions.

## Brake System

In order to assure brake system performance, all brake system components should be inspected periodically. Refer to the “Maintenance Schedule” for the proper maintenance intervals.

### WARNING!

**Riding the brakes can lead to brake failure and possibly a collision. Driving with your foot resting or riding on the brake pedal can result in abnormally high brake temperatures, excessive lining wear, and possible brake damage. You would not have your full braking capacity in an emergency.**

## Master Cylinder – Brake Fluid Level Check

Check the fluid level in the master cylinder immediately if the “Brake Warning Light” indicates system failure.

Check the fluid level in the master cylinder when performing underhood services.

Clean the top of the master cylinder area before removing the cap. Add fluid to bring the level up to the “MAX” mark on the side of the master cylinder reservoir.

Overfilling of fluid is not recommended because it may cause leaking in the system.

Add enough fluid to bring the level up to the requirements described on the brake fluid reservoir. With disc brakes, fluid level can be expected to fall as the brake pads wear. However, low fluid level may be caused by a leak and a checkup may be needed.

Use only manufacturer's recommended brake fluid. Refer to "Fluids, Lubricants, and Genuine Parts" in "Maintaining Your Vehicle" for further information.

**WARNING!**

- Use only manufacturer's recommended brake fluid. Refer to "Fluids, Lubricants, and Genuine Parts" in "Maintaining Your Vehicle" for further information. Using the wrong type of brake fluid can severely damage your brake system and/or impair its performance. The proper type of brake fluid for your vehicle is also identified on the original factory installed hydraulic master cylinder reservoir.

*(Continued)*

**WARNING! (Continued)**

- To avoid contamination from foreign matter or moisture, use only new brake fluid or fluid that has been in a tightly closed container. Keep the master cylinder reservoir cap secured at all times. Brake fluid in an open container absorbs moisture from the air resulting in a lower boiling point. This may cause it to boil unexpectedly during hard or prolonged braking, resulting in sudden brake failure. This could result in a collision.
- Overfilling the brake fluid reservoir can result in spilling brake fluid on hot engine parts, causing the brake fluid to catch fire. Brake fluid can also damage painted and vinyl surfaces, care should be taken to avoid its contact with these surfaces.

*(Continued)*



**WARNING! (Continued)**

- Do not allow petroleum based fluid to contaminate the brake fluid. Brake seal components could be damaged, causing partial or complete brake failure. This could result in a collision.

Use only brake fluid that has been in a tightly closed container to avoid contamination from foreign matter or moisture.

**Clutch Hydraulic System (Manual Transmission) – If Equipped**

The clutch hydraulic system is fed by a segregated volume of fluid within the brake system master cylinder reservoir. In the event of leakage or wear, use only the manufacturer's recommended brake fluid. Refer to "Fluids, Lubricants, and Genuine Parts" in "Maintaining Your Vehicle" for further information.

**Manual Transmission – If Equipped****Fluid Level Check**

Check the fluid level by removing the fill plug on the left side of the transmission. The fluid level should be at the bottom of the fill hole. Add fluid, if necessary, to maintain the proper level. Refer to "Fluids, Lubricants, and Genuine Parts" in "Maintaining Your Vehicle" for further information.

**Change Transmission Fluid**

If contaminated with water, change the fluid immediately. See your authorized dealer for service.

Refer to the "Maintenance Schedule" for the proper maintenance intervals.

## Automatic Transmission – If Equipped

### Selection Of Lubricant

It is important that the proper lubricant is used in the transmission to assure optimum transmission performance. Use only manufacturer's recommended transmission fluid. Refer to "Fluids, Lubricants, and Genuine Parts" in "Maintaining Your Vehicle" for further information. It is important that the transmission fluid be maintained at the prescribed level using the recommended fluid. No chemical flushes should be used in any transmission; only the approved lubricant may be used.

### Special Additives

Automatic Transmission Fluid (ATF) is an engineered product and its performance may be impaired by supplemental additives. Therefore, do not add any fluid additives to the transmission. The only exception to this

policy is the use of special dyes to aid in detecting fluid leaks. In addition, avoid using transmission sealers as they may adversely affect seals.

### CAUTION!

**Do not use chemical flushes in your transmission as the chemicals can damage your transmission components. Such damage is not covered by the New Vehicle Limited Warranty.**

### Fluid Level Check

Regular automatic transmission fluid level checks are not required. For this reason, the dipstick is omitted.

If you notice fluid loss or gear shift malfunction, have your authorized dealer check the transmission fluid level.

**CAUTION!**

- Using a transmission fluid other than the manufacturer's recommended fluid may cause deterioration in transmission shift quality and/or torque converter shudder. Using a transmission fluid other than that recommended by the manufacturer will require more frequent fluid and filter changes. Refer to "Fluids, Lubricants, and Genuine Parts" in "Maintaining Your Vehicle" for further information.
- The fluid level is preset at the factory and it does not require adjustment under normal operating conditions. If a transmission fluid leak occurs, visit your authorized dealer immediately. Severe damage to the transmission may occur. Your authorized dealer has the proper tools to adjust the fluid level accurately.

**Fluid And Filter Changes**

Refer to the "Maintenance Schedule" for the proper maintenance intervals.

If the transmission is disassembled for any reason, the fluid and filter should be changed.

**Rear Axle****Fluid Level Check**

Checking the fluid level while the vehicle is on level ground will improve the accuracy of the fluid level reading.

Check the fluid level by removing the fill plug on the axle. The fluid level should be at the bottom of the fill hole. Add fluid, if necessary, to maintain the proper level. Refer to "Fluids, Lubricants, and Genuine Parts" in "Maintaining Your Vehicle" for further information.

### **Change Axle Fluid**

Refer to the “Maintenance Schedule” for the proper maintenance intervals.

### **Appearance Care And Protection From Corrosion**

#### **Protection Of Body And Paint From Corrosion**

Vehicle body care requirements vary according to geographic locations and usage. Chemicals that make roads passable in snow and ice, and chemicals that are sprayed on trees and road surfaces during other seasons, are highly corrosive to the metal in your vehicle. Outside parking, which exposes your vehicle to airborne contaminants, road surfaces on which the vehicle is operated, extreme hot or cold weather and other extreme conditions will have an adverse effect on paint, metal trim, and underbody protection.

The following maintenance recommendations will enable you to obtain maximum benefit from the corrosion resistance built into your vehicle.

### **What Causes Corrosion?**

Corrosion is the result of deterioration or removal of paint and protective coatings from your vehicle.

The most common causes are:

- Road salt, dirt, and moisture accumulation.
- Stone and gravel impact.
- Insects, tree sap, and tar.
- Salt in the air near seacoast localities.
- Atmospheric fallout/industrial pollutants.

### **Washing**

- Wash your vehicle regularly. Always wash your vehicle in the shade using MOPAR® Car Wash or equivalent, or a mild car wash soap, and rinse the panels completely with clear water.

- If insects, tar, or other similar deposits have accumulated on your vehicle, use MOPAR® Super Kleen Bug and Tar Remover or equivalent to remove.
- Use a high quality cleaner wax, such as MOPAR® Cleaner Wax or equivalent to remove road film, stains and to protect your paint finish. Take care never to scratch the paint.
- Avoid using abrasive compounds and power buffing that may diminish the gloss or thin out the paint finish.

### CAUTION!

- **Do not use abrasive or strong cleaning materials such as steel wool or scouring powder that will scratch metal and painted surfaces.**
- **Use of power washers exceeding 1,200 psi (8 274 kPa) can result in damage or removal of paint and decals.**

### Special Care

- If you drive on salted or dusty roads or if you drive near the ocean, hose off the undercarriage at least once a month.
- It is important that the drain holes in the lower edges of the doors, rocker panels, and trunk be kept clear and open.
- If you detect any stone chips or scratches in the paint, touch them up immediately. The cost of such repairs is considered the responsibility of the owner.
- If your vehicle is damaged due to a collision or similar cause that destroys the paint and protective coating, have your vehicle repaired as soon as possible. The cost of such repairs is considered the responsibility of the owner.

- If you carry special cargo such as chemicals, fertilizers, de-icer salt, etc., be sure that such materials are well packaged and sealed.
- If a lot of driving is done on gravel roads, consider mud or stone shields behind each wheel.
- Use MOPAR® Touch Up Paint or equivalent on scratches as soon as possible. Your authorized dealer has touch up paint to match the color of your vehicle.

### Wheel And Wheel Trim Care

- All wheels and wheel trim, especially aluminum and chrome plated wheels, should be cleaned regularly with a mild soap and water to prevent corrosion.
- To remove heavy soil and/or excessive brake dust, use MOPAR® Wheel Cleaner or equivalent or select a non-abrasive, non-acidic cleaner.

### CAUTION!

**Do not use scouring pads, steel wool, a bristle brush, or metal polishes. Do not use oven cleaner. These products may damage the wheel's protective finish. Avoid automatic car washes that use acidic solutions or harsh brushes that may damage the wheel's protective finish. Only MOPAR® Wheel Cleaner or equivalent is recommended.**

### Stain Repel Fabric Cleaning Procedure – If Equipped

Stain Repel seats may be cleaned in the following manner:

- Remove as much of the stain as possible by blotting with a clean, dry towel.
- Blot any remaining stain with a clean, damp towel.

- For tough stains, apply MOPAR® Total Clean or equivalent, or a mild soap solution to a clean, damp cloth and remove the stain. Use a fresh, damp towel to remove soap residue.
- For grease stains, apply MOPAR® Multi-Purpose Cleaner or equivalent to a clean, damp cloth and remove the stain. Use a fresh, damp towel to remove soap residue.
- Do not use any harsh solvents or any other form of protectants on Stain Repel products.

### Interior Care

Use MOPAR® Fabric Cleaner or equivalent to clean fabric upholstery and MOPAR® Carpet Cleaner or equivalent for carpeting.

Interior Trim should be cleaned starting with a damp cloth, or MOPAR® Satin Select or equivalent. Do not use harsh cleaners or Armor All®. Use MOPAR® Total Clean or equivalent to clean vinyl upholstery.

MOPAR® Total Clean or equivalent is specifically recommended for leather upholstery.

Your leather upholstery can be best preserved by regular cleaning with a damp soft cloth. Small particles of dirt can act as an abrasive and damage the leather upholstery and should be removed promptly with a damp cloth. Stubborn soils can be removed easily with a soft cloth and MOPAR® Total Clean or equivalent. Care should be taken to avoid soaking your leather upholstery with any liquid. Please do not use polishes, oils, cleaning fluids, solvents, detergents, or ammonia-based cleaners to clean your leather upholstery. Application of a leather conditioner is not required to maintain the original condition.

### WARNING!

**Do not use volatile solvents for cleaning purposes. Many are potentially flammable, and if used in closed areas they may cause respiratory harm.**

### **Cleaning Headlights**

Your vehicle has plastic headlights that are lighter and less susceptible to stone breakage than glass headlights.

Plastic is not as scratch resistant as glass; and therefore, different lens cleaning procedures must be followed.

To minimize the possibility of scratching the lenses and reducing light output, avoid wiping with a dry cloth. To remove road dirt, wash with a mild soap solution followed by rinsing.

Do not use abrasive cleaning components, solvents, steel wool or other aggressive material to clean the lenses.

### **Glass Surfaces**

All glass surfaces should be cleaned on a regular basis with MOPAR® Glass Cleaner or any commercial household-type glass cleaner. Never use an abrasive type cleaner. Use caution when cleaning the inside rear window equipped with electric defrosters or the right rear

quarter window equipped with the radio antenna. Do not use scrapers or other sharp instruments that may scratch the elements.

When cleaning the rear view mirror, spray cleaner on the towel or rag that you are using. Do not spray cleaner directly on the mirror.

### **Cleaning Plastic Instrument Cluster Lenses**

The lenses in front of the instruments in this vehicle are molded in clear plastic. When cleaning the lenses, care must be taken to avoid scratching the plastic.

1. Clean with a wet soft rag or micro-fiber towel. A mild soap solution may be used, but do not use high alcohol content or abrasive cleaners. If soap is used, wipe clean with a clean damp rag.
2. Dry with a soft cloth.



### Seat Belt Maintenance

Do not bleach, dye, or clean the belts with chemical solvents or abrasive cleaners. This will weaken the fabric. Sun damage can also weaken the fabric.

If the belts need cleaning, use MOPAR® Total Clean or equivalent, a mild soap solution, or lukewarm water. Do not remove the belts from the vehicle to wash them. Dry with a soft cloth.

Replace the belts if they appear frayed or worn or if the buckles do not work properly.

### Cleaning The Center Console Cupholders

Clean with a damp cloth or towel using a mild detergent with the cupholder in the center console.

**NOTE:** The cupholder cannot be removed.

## FUSES

### Integrated Power Module

The Integrated Power Module is located in the engine compartment. This module contains fuses and relays.

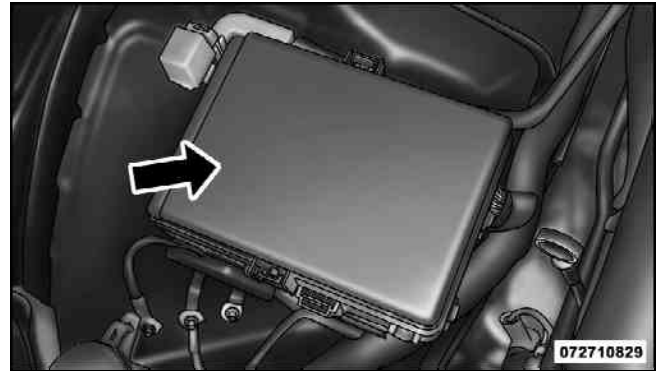

Integrated Power Module

**CAUTION!**

- When installing the integrated power module cover, it is important to ensure the cover is properly positioned and fully latched. Failure to do so may allow water to get into the integrated power module and possibly result in an electrical system failure.
- When replacing a blown fuse, it is important to use only a fuse having the correct amperage rating. The use of a fuse with a rating other than indicated may result in a dangerous electrical system overload. If a properly rated fuse continues to blow, it indicates a problem in the circuit that must be corrected.

Cavity	Cartridge Fuse	Mini-Fuse	Description
1	—	15 Amp Blue	Washer Motor
2	—	25 Amp Natural	Powertrain Control Module (PCM)
3	—	25 Amp Natural	Ignition Run/Start
4	—	25 Amp Natural	EGR Solenoid/ Alternator
5	—	15 Amp Blue	Powertrain Control Module
6	—	25 Amp Natural	Ignition Coils/ Injectors
7	—	25 Amp Natural	Headlamp Washer Relay – If Equipped
8	—	30 Amp Green	Starter

Cavity	Cartridge Fuse	Mini-Fuse	Description
9	—	—	—
10	30 Amp Pink	—	Windshield Wiper
11	30 Amp Pink	—	Anti-Lock Brake System (ABS) Valves
12	40 Amp Green	—	Radiator Fan Lo/High
13	50 Amp Red	—	Anti-Lock Brake System (ABS) Pump Motor
14	—	—	Spare

Cavity	Cartridge Fuse	Mini-Fuse	Description
15	50 Amp Red	—	Radiator Fan Motor
16	—	—	—
17	—	—	—
18	—	—	—
19	—	—	—
20	—	—	—
21	—	—	—
22	—	—	—

### Rear Power Distribution Center

There is also a power distribution center located in the trunk under the spare tire access panel. This center contains fuses and relays.

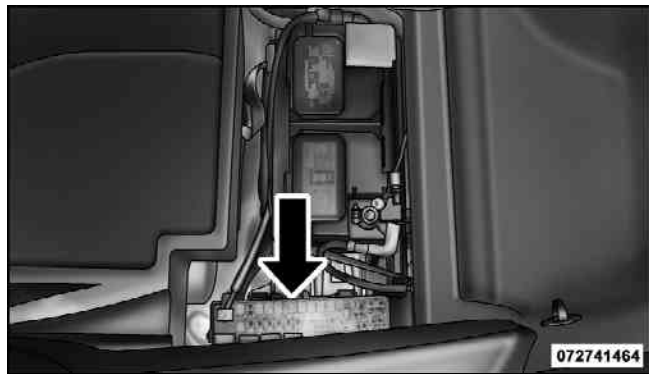

Rear Power Distribution Center

### CAUTION!

- When installing the power distribution center cover, it is important to ensure the cover is properly positioned and fully latched. Failure to do so may allow water to get into the power distribution center and possibly result in an electrical system failure.
- When replacing a blown fuse, it is important to use only a fuse having the correct amperage rating. The use of a fuse with a rating other than indicated may result in a dangerous electrical system overload. If a properly rated fuse continues to blow, it indicates a problem in the circuit that must be corrected.

Cavity	Cartridge Fuse	Mini-Fuse	Description
1	60 Amp Yellow	—	Ignition Off Draw (IOD) <b>Cavity 1 of the Rear Power Distribution Center contains a black IOD fuse needed for vehicle processing during assembly. The service replacement part is a 60 Amp yellow cartridge fuse.</b>
2	40 Amp Green	—	Integrated Power Module (IPM)
3	—	—	—
4	40 Amp Green	—	Integrated Power Module (IPM)

Cavity	Cartridge Fuse	Mini-Fuse	Description
5	30 Amp Pink	—	Heated Seats – If Equipped
6	—	20 Amp Yellow	Fuel Pump
7	—	15 Amp Blue	Audio Amplifier – If Equipped
8	—	15 Amp Blue	Diagnostic Link Connector (DLC)/ Wireless Control Module (WCM)/ Wireless Ignition Node (WIN)
9	—	20 Amp Yellow	Power Outlet
10	—	25 Amp Natural	Vacuum Pump – If Equipped
11 *	—	—	—

Cavity	Cartridge Fuse	Mini-Fuse	Description
12 *	—	—	—
13 *	—	—	—
14	—	10 Amp Red	AC Heater Control/Cluster/Security Module – If Equipped
15	—	20 Amp Yellow	Active Damper – If Equipped
16	—	20 Amp Yellow	Heated Seat Module – If Equipped
17	—	20 Amp Yellow	Instrument Cluster
18	—	20 Amp Yellow	Cigar Lighter (Instrument Panel)
19	—	10 Amp Red	Stop Lights

Cavity	Cartridge Fuse	Mini-Fuse	Description
20	—	—	—
21	—	—	—
22	—	—	—
23	—	—	—
24	—	—	—
25	—	—	—
26	—	—	—
27	—	10 Amp Red	Occupant Restraint Controller (ORC)
28	—	10 Amp Red	Ignition Run, AC Heater Control/ Occupant Restraint Controller (ORC)

Cavity	Cartridge Fuse	Mini-Fuse	Description
29	—	5 Amp Orange	Cluster/Electronic Stability Program (ESP)/Powertrain Control Module (PCM)/STOP LIGHT Switch
30	—	10 Amp Red	Door Modules/Power Mirrors/Steering Control Module (SCM)
31	—	—	—
32	—	—	—
33	—	—	—
34	—	—	—
35	—	5 Amp Orange	Antenna Module – If Equipped/Power Mirrors

Cavity	Cartridge Fuse	Mini-Fuse	Description
36	—	25 Amp Natural	Hands-Free Phone – If Equipped/Radio/Amplifier Feed
37	—	15 Amp Blue	Transmission
38	—	10 Amp Red	Cargo Light/Vehicle Information Module – If Equipped
39	—	10 Amp Red	Heated Mirrors – If Equipped
40	—	5 Amp Orange	Auto Inside Rearview Mirror/Heated Seats – If Equipped/Switch Bank
41	—	—	—
42	30 Amp Pink	—	Front Blower Motor

Cavity	Cartridge Fuse	Mini-Fuse	Description
43	30 Amp Pink	—	Rear Window Defroster
44	20 Amp Blue	—	Amplifier/Sunroof – If Equipped

\* Cavities 11, 12, and 13 contain self-resetting fuses (circuit breakers) that are only serviceable by an authorized dealer. The cluster and the driver seat switch are fused by the 25 Amp circuit breaker in cavity 11. The passenger seat switch is fused by the 25 Amp circuit breaker in cavity 12. The door modules, the driver power window switch, and the passenger power window switch are fused by the 25 Amp circuit breaker in cavity 13. If you experience temporary or permanent loss of these systems, see your authorized dealer for service.

## VEHICLE STORAGE

If you are leaving your vehicle dormant for more than 21 days, you may want to take these steps to protect your battery.

- Disconnect the negative cable from the battery.
- Anytime you store your vehicle, or keep it out of service (i.e., vacation) for two weeks or more, run the air conditioning system at idle for about five minutes in the fresh air and high blower setting. This will ensure adequate system lubrication to minimize the possibility of compressor damage when the system is started again.



**REPLACEMENT BULBS**

<b>LIGHT BULBS – Interior</b>	<b>Bulb Number</b>
Rear Courtesy/Reading Lamps . . . . .	W5W
Rear Compartment (Trunk) Lamp . . . . .	562
Overhead Console Reading Lamps . . . . .	578
Visor Vanity Lamps . . . . .	A6220
Glove Box Lamp – If Equipped. . . . .	194
Door Courtesy . . . . .	562
Shift Indicator Lamp . . . . .	JKLE14140
Optional Door Map Pocket/Cupholder . . . . .	LED (Serviced at Authorized Dealer)

**NOTE:** For lighted switches, see your authorized dealer for replacement instructions.

All of the interior bulbs are glass wedge base or glass cartridge types. Aluminum base bulbs are not approved and should not be used for replacement.

<b>LIGHT BULBS – Exterior</b>	<b>Bulb Number</b>
Headlamp – High Intensity Discharge (HID) . . . . .	D1S (Serviced at Authorized Dealer)
Halogen Headlamp. . . . .	H13
Front Park/Turn Lamp. . . . .	3157A
Front Fog Lamp . . . . .	PSX24W (Serviced at Authorized Dealer)
Front Side Marker . . . . .	168
Tail Lamp . . . . .	3057K
Tail/Stop/Turn Lamp . . . . .	3057K
Rear Side Marker . . . . .	168
Backup Lamp . . . . .	921
Center High-Mount Stop Lamp (CHMSL) . . . . .	LED (Serviced at Authorized Dealer)
License. . . . .	168

## BULB REPLACEMENT

### Low Beam Headlamp, High Beam Headlamp, Park/Turn Lamp — Models With Halogen Headlamps — If Equipped

See your authorized dealer for bulb replacement.

### Low Beam Headlamp, High Beam Headlamp, And Park/Turn Lamp — Models With High Intensity Discharge (HID) Headlamps — If Equipped

#### HID Headlamps

The headlamps are a type of high voltage discharge tube. High voltage can remain in the circuit even with the headlamp switch off and the key removed. **Because of this, you should not attempt to service a headlamp bulb yourself. If a headlamp bulb fails, take your vehicle to an authorized dealer for service.**

#### WARNING!

A transient high voltage occurs at the bulb sockets of HID headlamps when the headlamp switch is turned ON. It may cause serious electrical shock or electrocution if not serviced properly. See your authorized dealer for service.

**NOTE:** On vehicles equipped with HID headlamps, when the headlamps are turned on, there is a blue hue to the lamps. This diminishes and becomes more white after approximately 10 seconds, as the system charges.

## Front/Rear Side Marker Lamp

1. Remove the front/rear side marker. Use a fiber stick or similar tool to gently pry the lamp on the outboard side to disengage the clip.

### NOTE:

- If a screwdriver is used, make sure a soft material is placed between the vehicle body and tool so not to scratch the paint.
2. Rotate the bulb's socket counterclockwise, and remove the bulb and socket assembly from the housing.
  3. Pull the bulb out of the socket and insert the replacement bulb.
  4. Install the bulb and socket assembly into the housing, and rotate the socket clockwise to lock it in place.
  5. Reinstall the front/rear side marker.

## Tail/Turn And Stop Lamp

1. Open the trunk.
2. Using a screwdriver, remove the tail lamp retainer.

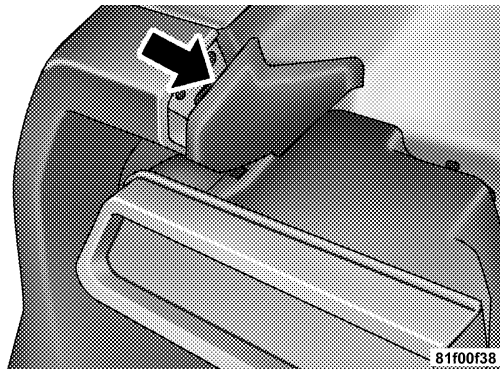

3. Remove the fasteners from the back of the tail lamp assembly.

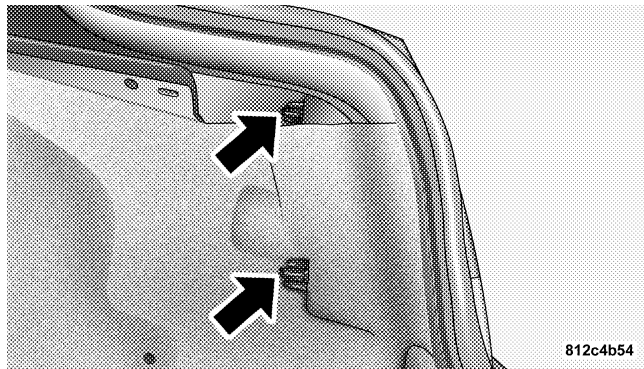

4. Pull back the trunk liner.

5. Remove the remaining fasteners from the back of the tail lamp assembly.

6. Pull the tail lamp assembly clear from the vehicle to access the bulbs.

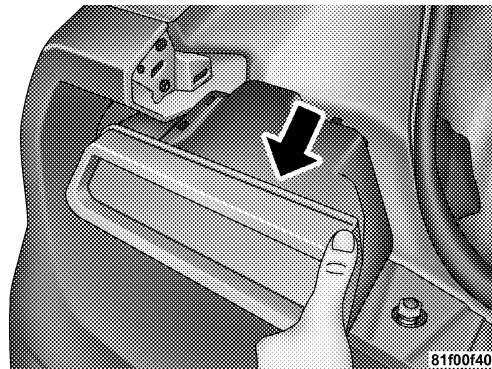

7. Push the electrical connector locking tab to the side.

8. Disconnect the electrical connector.

9. Turn the appropriate bulb and socket assembly counterclockwise to remove it from the tail lamp assembly.

10. Disconnect the bulb from the socket assembly and install the replacement bulb.
11. Reinstall the bulb and socket assembly into the tail lamp assembly, and then turn it clockwise.
12. Reinstall the tail lamp assembly, fasteners, electrical connector, and trunk liner.
13. Reinstall tail lamp retainer.

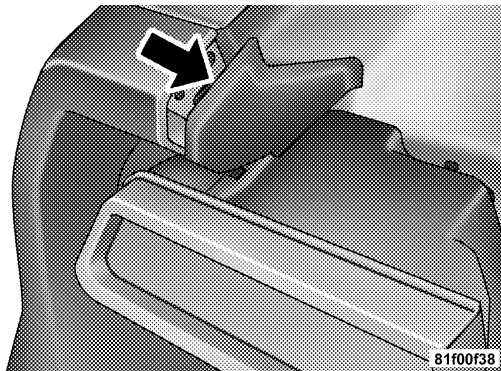

14. Close the trunk.

### Center Tail/Backup Lamp

See your authorized dealer for bulb replacement.

### Center High-Mounted Stop Lamp (CHMSL)

The CHMSL uses LED lamps that are not serviceable separately. The CHMSL must be replaced as an assembly, see your authorized dealer.

### License Lamp

1. Remove the screws securing the lamp to the rear fascia.
2. Remove the bulb and socket assembly.
3. Disconnect the bulb from the socket assembly and install the replacement bulb.

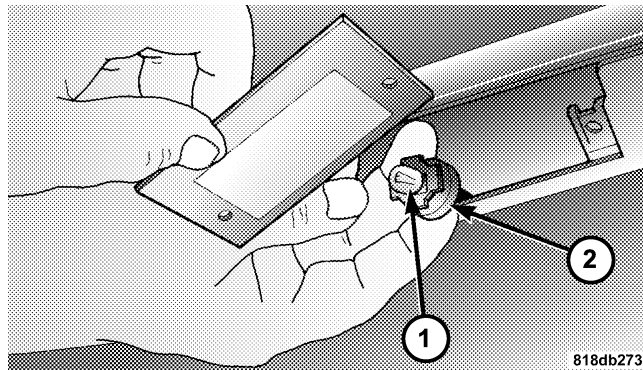

818db273

- 1 — License Lamp Bulb  
2 — Socket

4. Reinstall the bulb and socket assembly.
5. Reattach the lamp to the rear fascia, and then install the screws.

**FLUID CAPACITIES**

	<b>U.S.</b>	<b>Metric</b>
<b>Fuel (Approximate)</b>	19 Gallons	72 Liters
<b>Engine Oil with Filter</b>		
6.4 Liter Engine (SAE 0W-40, Synthetic API Certified)	7 Quarts	6.6 Liters
<b>Cooling System *</b>		
6.4 Liter Engine (MOPAR® Antifreeze/Coolant 5 Year/100,000 Mile Formula or equivalent)	15 Quarts	14.4 Liters
* Includes heater and coolant recovery bottle filled to MAX level.		

**FLUIDS, LUBRICANTS, AND GENUINE PARTS****Engine**

<b>Component</b>	<b>Fluid, Lubricant, or Genuine Part</b>
Engine Coolant	MOPAR® Antifreeze/Coolant 5 Year/100,000 Mile Formula HOAT (Hybrid Organic Additive Technology) or equivalent.
Engine Oil	For best performance and maximum protection under all types of operating conditions, the manufacturer only recommends full synthetic engine oils that meet the American Petroleum Institute (API) categories of SM or SM/CF. The manufacturer recommends the use of a full synthetic SAE 0W-40 engine oil or equivalent.
Engine Oil Filter	MOPAR® Engine Oil Filter or equivalent.
Spark Plugs	LZTR6AP11EG (Gap 0.043 in [1.1 mm])
Fuel Selection	Premium Unleaded 91 Octane Only or higher.



**Chassis**

<b>Component</b>	<b>Fluid, Lubricant, or Genuine Part</b>
Manual Transmission – If Equipped	MOPAR® ATF+4® Automatic Transmission Fluid or equivalent licensed ATF+4® product.
Automatic Transmission – If Equipped	MOPAR® ATF+4® Automatic Transmission Fluid or equivalent licensed ATF+4® product.
Brake Master Cylinder	MOPAR® DOT 3, SAE J1703 should be used. If DOT 3, SAE J1703 brake fluid is not available, then DOT 4 is acceptable. Use only recommended brake fluids.
Power Steering Reservoir	MOPAR® Power Steering Fluid + 4, MOPAR® ATF+4® Automatic Transmission Fluid or equivalent licensed ATF+4® product.
Rear Axle	MOPAR® Synthetic Gear Lubricant SAE 75W90 (API GL-5) or equivalent (with MOPAR® Friction Modifier — Hypoid Gear Additive).



---

# MAINTENANCE SCHEDULES

## CONTENTS

---

■	Maintenance Schedule . . . . .	418
□	Required Maintenance Intervals . . . . .	420

## MAINTENANCE SCHEDULE

The Scheduled Maintenance services listed in this manual must be done at the times or mileages specified to protect your vehicle warranty and ensure the best vehicle performance and reliability. More frequent maintenance may be needed for vehicles in severe operating conditions, such as dusty areas and very short trip driving. Inspection and service should also be done anytime a malfunction is suspected.

The oil change indicator system will remind you that it is time to take your vehicle in for scheduled maintenance.

On Electronic Vehicle Information Center (EVIC) equipped vehicles, "Oil Change Required" will be displayed in the EVIC and a single chime will sound, indicating that an oil change is necessary.

On Non-EVIC equipped vehicles, "Change Oil" will flash in the instrument cluster odometer and a single chime will sound, indicating that an oil change is necessary.

Based on engine operation conditions, the oil change indicator message will illuminate. This means that service is required for your vehicle. Have your vehicle serviced as soon as possible, within the next 500 miles (805 km).

**NOTE:**

- The oil change indicator message will not monitor the time since the last oil change. Change your vehicle's oil if it has been six months since your last oil change, even if the oil change indicator message is NOT illuminated.
- Change your engine oil more often if you drive your vehicle off-road for an extended period of time.
- Under no circumstances should oil change intervals exceed 6,000 miles (10,000 km) or six months, whichever comes first.

Your authorized dealer will reset the oil change indicator message after completing the scheduled oil change. If a scheduled oil change is performed by someone other

than your authorized dealer, the message can be reset by referring to the steps described under "Electronic Vehicle Information Center (EVIC)/Oil Change Required" in "Understanding Your Instrument Panel" or under "Instrument Cluster Description/Odometer/Trip Odometer" in "Understanding Your Instrument Panel" for further information.

*At Each Stop for Fuel*

- Check the engine oil level. Refer to "Maintenance Procedures/Engine Oil" in "Maintaining Your Vehicle" for further information.
- Check the windshield washer solvent and add if required.

*Once a Month*

- Check tire pressure and look for unusual wear or damage.
- Inspect the battery, and clean and tighten the terminals as required.
- Check the fluid levels of the coolant reservoir, brake master cylinder, and power steering, and add as needed.
- Check all lights and other electrical items for correct operation.

*At Each Oil Change*

- Change the engine oil filter.
- Inspect the brake hoses and lines.

**CAUTION!**

**Failure to perform the required maintenance items may result in damage to the vehicle.**

**Required Maintenance Intervals**

Refer to the Maintenance Schedules on the following pages for the required maintenance intervals.

**6,000 Miles (10,000 km) or 6 Months Maintenance Service Schedule**

- Change the engine oil and engine oil filter.
- Rotate tires.

\_\_\_\_\_  
Odometer Reading Date

\_\_\_\_\_  
Repair Order # Dealer Code

\_\_\_\_\_  
Signature, Authorized Service Center

**12,000 Miles (20,000 km) or 12 Months Maintenance Service Schedule**

- Change the engine oil and engine oil filter.
- Rotate tires.
- If you are using your vehicle in dusty or off-road conditions, inspect the engine air cleaner filter, and replace if necessary.
- Replace the air conditioning filter.
- Inspect the brake linings, and replace if necessary.
- Inspect the exhaust system. Perform the first inspection at 12,000 miles (20 000 km) or 12 months.
- Inspect the manual transmission fluid (if equipped), add as necessary.
- Inspect the front suspension, tie rod ends and boot seals for cracks or leaks and all parts for damage, wear, improper looseness or end play; replace if necessary.

\_\_\_\_\_  
Odometer Reading Date

\_\_\_\_\_  
Repair Order # Dealer Code

\_\_\_\_\_  
Signature, Authorized Service Center

**18,000 Miles (30,000 km) or 18 Months Maintenance Service Schedule**

- Change the engine oil and engine oil filter.
- Rotate tires.
- Inspect the rear axle fluid.

\_\_\_\_\_ Date

\_\_\_\_\_ Dealer Code

\_\_\_\_\_  
Signature, Authorized Service Center

**24,000 Miles (40,000 km) or 24 Months Maintenance Service Schedule**

- Change the engine oil and engine oil filter.
- Rotate tires.
- If you are using your vehicle in dusty or off-road conditions, inspect the engine air cleaner filter, and replace if necessary.
- Replace the air conditioning filter.
- Inspect the brake linings, and replace if necessary.
- Inspect the CV joints.
- Inspect the exhaust system.
- Inspect the front suspension, tie rod ends and boot seals for cracks or leaks and all parts for damage, wear, improper looseness or end play; replace if necessary.
- Change the manual transmission fluid (if equipped) if using your vehicle for any of the following: Most of your driving is at sustained high speeds during hot weather, above 90°F (32°C), driving in dusty conditions, or stop and go driving.

\_\_\_\_\_ Date

\_\_\_\_\_ Dealer Code

\_\_\_\_\_  
Signature, Authorized Service Center



**30,000 Miles (50,000 km) or 30 Months Maintenance Service Schedule**

- Change the engine oil and engine oil filter.
- Rotate tires.
- Replace the engine air cleaner filter.
- Adjust parking brake on vehicles equipped with four-wheel disc brakes.

\_\_\_\_\_  
Odometer Reading Date

\_\_\_\_\_  
Repair Order # Dealer Code

\_\_\_\_\_  
Signature, Authorized Service Center

**36,000 Miles (60,000 km) or 36 Months Maintenance Service Schedule**

- Change the engine oil and engine oil filter.
- Rotate tires.
- If you are using your vehicle in dusty or off-road conditions, inspect the engine air cleaner filter, and replace if necessary.
- Replace the air conditioning filter.
- Inspect the brake linings, and replace if necessary.
- Inspect the rear axle fluid.
- Inspect the manual transmission fluid (if equipped), add as necessary.
- Inspect the front suspension, tie rod ends and boot seals for cracks or leaks and all parts for damage, wear, improper looseness or end play; replace if necessary.

\_\_\_\_\_  
Odometer Reading Date

\_\_\_\_\_  
Repair Order # Dealer Code

\_\_\_\_\_  
Signature, Authorized Service Center

**42,000 Miles (70,000 km) or  
42 Months Maintenance  
Service Schedule**

- Change the engine oil and engine oil filter.
- Rotate tires.

---

Odometer Reading Date

---

Repair Order # Dealer Code

---

Signature, Authorized Service Center

**48,000 Miles (80,000 km) or 48 Months Maintenance Service Schedule**

- Change the engine oil and engine oil filter.
- Rotate tires.
- If you are using your vehicle in dusty or off-road conditions, inspect the engine air cleaner filter, and replace if necessary.
- Replace the air conditioning filter.
- Inspect the brake linings, and replace if necessary.
- Inspect the CV joints.
- Inspect the exhaust system.
- Inspect the front suspension, tie rod ends and boot seals for cracks or leaks and all parts for damage, wear, improper looseness or end play; replace if necessary.
- Change the rear axle fluid if using your vehicle for any of the following: police, taxi, fleet, or frequent trailer towing.
- Change the manual transmission fluid (if equipped) if using your vehicle for any of the following: Most of your driving is at sustained high speeds during hot weather, above 90°F (32°C), driving in dusty conditions, or stop and go driving.

---

Odometer Reading Date

---

Repair Order # Dealer Code

---

Signature, Authorized Service Center

**54,000 Miles (90,000 km) or 54 Months Maintenance Service Schedule**

- Change the engine oil and engine oil filter.
- Rotate tires.
- Inspect the rear axle fluid.

\_\_\_\_\_  
 Odometer Reading Date

\_\_\_\_\_  
 Repair Order # Dealer Code

\_\_\_\_\_  
 Signature, Authorized Service Center

**60,000 Miles (100,000 km) or 60 Months Maintenance Service Schedule**

- Change the engine oil and engine oil filter.
- Rotate tires.
- Replace the engine air cleaner filter.
- Replace the air conditioning filter.
- Inspect the brake linings, and replace if necessary.
- Adjust parking brake on vehicles equipped with four-wheel disc brakes.
- Inspect the manual transmission fluid (if equipped), add as necessary.
- Change the automatic transmission fluid and filter if using your vehicle for any of the following: police, taxi, fleet, or frequent trailer towing.
- Flush and replace the engine coolant at 60 months or 102,000 miles (170 000 km) whichever comes first.
- Inspect the front suspension, tie rod ends and boot seals for cracks or leaks and all parts for damage, wear, improper looseness or end play; replace if necessary.

\_\_\_\_\_  
 Odometer Reading Date

\_\_\_\_\_  
 Repair Order # Dealer Code

\_\_\_\_\_  
 Signature, Authorized Service Center

**66,000 Miles (110,000 km) or 66 Months Maintenance Service Schedule**

- Change the engine oil and engine oil filter.
- Rotate tires.

\_\_\_\_\_  
Odometer Reading Date

\_\_\_\_\_  
Repair Order # Dealer Code

\_\_\_\_\_  
Signature, Authorized Service Center

**72,000 Miles (120,000 km) or 72 Months Maintenance Service Schedule**

- Change the engine oil and engine oil filter.
- Rotate tires.
- If you are using your vehicle in dusty or off-road conditions, inspect the engine air cleaner filter, and replace if necessary.
- Replace the air conditioning filter.
- Inspect the brake linings, and replace if necessary.
- Inspect the CV joints.
- Inspect the rear axle fluid.
- Inspect the exhaust system.
- Inspect the front suspension, tie rod ends and boot seals for cracks or leaks and all parts for damage, wear, improper looseness or end play; replace if necessary.
- Change the manual transmission fluid (if equipped) if using your vehicle for any of the following: Most of your driving is at sustained high speeds during hot weather, above 90°F (32°C), driving in dusty conditions, or stop and go driving.

\_\_\_\_\_  
Odometer Reading Date

\_\_\_\_\_  
Repair Order # Dealer Code

\_\_\_\_\_  
Signature, Authorized Service Center

**78,000 Miles (130,000 km) or 78 Months Maintenance Service Schedule**

- Change the engine oil and engine oil filter.
- Rotate tires.

\_\_\_\_\_ Date

\_\_\_\_\_ Dealer Code

\_\_\_\_\_  
Signature, Authorized Service Center

**84,000 Miles (140,000 km) or 84 Months Maintenance Service Schedule**

- Change the engine oil and engine oil filter.
- Rotate tires.
- If you are using your vehicle in dusty or off-road conditions, inspect the engine air cleaner filter, and replace if necessary.
- Replace the air conditioning filter.
- Inspect the brake linings, and replace if necessary.
- Inspect the manual transmission fluid (if equipped), add as necessary.
- Inspect the front suspension, tie rod ends and boot seals for cracks or leaks and all parts for damage, wear, improper looseness or end play; replace if necessary.

\_\_\_\_\_ Date

\_\_\_\_\_ Dealer Code

\_\_\_\_\_  
Signature, Authorized Service Center

**90,000 Miles (150,000 km) or 90 Months Maintenance Service Schedule**

- Change the engine oil and engine oil filter.
- Rotate tires.
- Replace the engine air cleaner filter.
- Inspect and replace the PCV Valve if necessary.\*
- Inspect the rear axle fluid.
- Adjust parking brake on vehicles equipped with four-wheel disc brakes.

\_\_\_\_\_  
Odometer Reading Date

\_\_\_\_\_  
Repair Order # Dealer Code

\_\_\_\_\_  
Signature, Authorized Service Center

**96,000 Miles (160,000 km) or 96 Months Maintenance Service Schedule**

- Change the engine oil and engine oil filter.
- Rotate tires.
- If you are using your vehicle in dusty or off-road conditions, inspect the engine air cleaner filter, and replace if necessary.
- Replace the air conditioning filter.
- Replace the spark plugs.
- Inspect the brake linings, and replace if necessary.
- Inspect the CV joints.
- Inspect the exhaust system.
- Inspect the front suspension, tie rod ends and boot seals for cracks or leaks and all parts for damage, wear, improper looseness or end play; replace if necessary.
- Change the rear axle fluid if using your vehicle for any of the following: police, taxi, fleet, or frequent trailer towing.
- Change the manual transmission fluid (if equipped).

\_\_\_\_\_  
Odometer Reading Date

\_\_\_\_\_  
Repair Order # Dealer Code

\_\_\_\_\_  
Signature, Authorized Service Center

**102,000 Miles (170,000 km) or 102 Months Maintenance Service Schedule**

- Change the engine oil and engine oil filter.
- Rotate tires.
- Flush and replace the engine coolant at 102,000 miles (170 000 km) or 60 months whichever comes first.

\_\_\_\_\_ Date

\_\_\_\_\_ Dealer Code

\_\_\_\_\_  
Signature, Authorized Service Center

**108,000 Miles (180,000 km) or 108 Months Maintenance Service Schedule**

- Change the engine oil and engine oil filter.
- Rotate tires.
- If you are using your vehicle in dusty or off-road conditions, inspect the engine air cleaner filter, and replace if necessary.
- Replace the air conditioning filter.
- Inspect the brake linings, and replace if necessary.
- Inspect the rear axle fluid.
- Inspect the manual transmission fluid (if equipped), add as necessary.
- Inspect the front suspension, tie rod ends and boot seals for cracks or leaks and all parts for damage, wear, improper looseness or end play; replace if necessary.

\_\_\_\_\_ Date

\_\_\_\_\_ Dealer Code

\_\_\_\_\_  
Signature, Authorized Service Center



**114,000 Miles (190,000 km) or 114 Months Maintenance Service Schedule**

- Change the engine oil and engine oil filter.
- Rotate tires.

\_\_\_\_\_  
Odometer Reading Date

\_\_\_\_\_  
Repair Order # Dealer Code

\_\_\_\_\_  
Signature, Authorized Service Center

**120,000 Miles (200,000 km) or 120 Months Maintenance Service Schedule**

- Change the engine oil and engine oil filter.
- Rotate tires.
- Replace the engine air cleaner filter.
- Replace the air conditioning filter.
- Inspect the brake linings, and replace if necessary.
- Adjust parking brake on vehicles equipped with four-wheel disc brakes.
- Inspect the CV joints.
- Inspect the exhaust system.
- Inspect the front suspension, tie rod ends and boot seals for cracks or leaks and all parts for damage, wear, improper looseness or end play; replace if necessary.
- Change the automatic transmission fluid and filter.
- Change the manual transmission fluid (if equipped) if using your vehicle for any of the following: Most of your driving is at sustained high speeds during hot weather, above 90°F (32°C), driving in dusty conditions, or stop and go driving.

\_\_\_\_\_  
Odometer Reading Date

\_\_\_\_\_  
Repair Order # Dealer Code

\_\_\_\_\_  
Signature, Authorized Service Center

**126,000 Miles (210,000 km) or 126 Months Maintenance Service Schedule**

- Change the engine oil and engine oil filter.
- Rotate tires.
- Inspect the rear axle fluid.

\_\_\_\_\_ Date

\_\_\_\_\_ Dealer Code

\_\_\_\_\_  
Signature, Authorized Service Center

**132,000 Miles (220,000 km) or 132 Months Maintenance Service Schedule**

- Change the engine oil and engine oil filter.
- Rotate tires.
- If you are using your vehicle in dusty or off-road conditions, inspect the engine air cleaner filter, and replace if necessary.
- Replace the air conditioning filter.
- Inspect the brake linings, and replace if necessary.
- Inspect the manual transmission fluid (if equipped), add as necessary.
- Inspect the front suspension, tie rod ends and boot seals for cracks or leaks and all parts for damage, wear, improper looseness or end play; replace if necessary.

\_\_\_\_\_ Date

\_\_\_\_\_ Dealer Code

\_\_\_\_\_  
Signature, Authorized Service Center

**138,000 Miles (230,000 km) or  
138 Months Maintenance  
Service Schedule**

- Change the engine oil and engine oil filter.
- Rotate tires.

---

Odometer Reading

Date

---

Repair Order #

Dealer Code

---

Signature, Authorized Service Center

**144,000 Miles (240,000 km) or 144 Months Maintenance Service Schedule**

- Change the engine oil and engine oil filter.
- Rotate tires.
- If you are using your vehicle in dusty or off-road conditions, inspect the engine air cleaner filter, and replace if necessary.
- Replace the air conditioning filter.
- Inspect the brake linings, and replace if necessary.
- Inspect the CV joints.
- Inspect the exhaust system.
- Inspect the front suspension, tie rod ends and boot seals for cracks or leaks and all parts for damage, wear, improper looseness or end play; replace if necessary.
- Change the rear axle fluid if using your vehicle for any of the following: police, taxi, fleet, or frequent trailer towing.
- Change the manual transmission fluid (if equipped) if using your vehicle for any of the following: Most of your driving is at sustained high speeds during hot weather, above 90°F (32°C), driving in dusty conditions, or stop and go driving.

\_\_\_\_\_

Odometer Reading Date

\_\_\_\_\_

Repair Order # Dealer Code

\_\_\_\_\_

Signature, Authorized Service Center

**150,000 Miles (250,000 km) or  
150 Months Maintenance  
Service Schedule**

- Change the engine oil and engine oil filter.
- Rotate tires.
- Replace the engine air cleaner filter.
- Adjust parking brake on vehicles equipped with four-wheel disc brakes.

---

Odometer Reading

Date

---

Repair Order #

Dealer Code

---

Signature, Authorized Service Center

## 436 MAINTENANCE SCHEDULES

\* This maintenance is recommended by the manufacturer to the owner, but is not required to maintain emissions warranty.

**WARNING!**

- You can be badly injured working on or around a motor vehicle. Do only service work for which you have the knowledge and the right equipment. If you have any doubt about your ability to perform a service job, take your vehicle to a competent mechanic.
- Failure to properly inspect and maintain your vehicle could result in a component malfunction and effect vehicle handling and performance. This could cause an accident

# IF YOU NEED CONSUMER ASSISTANCE

## CONTENTS

---

■ Suggestions For Obtaining Service For Your Vehicle. . . . .	439	□ Customer Assistance For The Hearing Or Speech Impaired (TDD/TTY) . . . . .	441
□ Prepare For The Appointment . . . . .	439	□ Service Contract . . . . .	441
□ Prepare A List . . . . .	439	■ Warranty Information . . . . .	442
□ Be Reasonable With Requests . . . . .	439	■ MOPAR® Parts . . . . .	442
■ If You Need Assistance . . . . .	439	■ Reporting Safety Defects . . . . .	442
□ Chrysler Group LLC Customer Center . . . . .	440	□ In The 50 United States And Washington, D.C. . . . .	442
□ Chrysler Canada Inc. Customer Center . . . . .	440	□ In Canada . . . . .	443
□ In Mexico Contact . . . . .	440	■ Publication Order Forms . . . . .	443

■ Department Of Transportation Uniform Tire	
Quality Grades . . . . .	445
□ Treadwear . . . . .	445
□ Traction Grades . . . . .	445
□ Temperature Grades . . . . .	446



## **SUGGESTIONS FOR OBTAINING SERVICE FOR YOUR VEHICLE**

### **Prepare For The Appointment**

If you're having warranty work done, be sure to have the right papers with you. Take your warranty folder. All work to be performed may not be covered by the warranty. Discuss additional charges with the service manager. Keep a maintenance log of your vehicle's service history. This can often provide a clue to the current problem.

### **Prepare A List**

Make a written list of your vehicle's problems or the specific work you want done. If you've had an accident or work done that is not on your maintenance log, let the service advisor know.

### **Be Reasonable With Requests**

If you list a number of items and you must have your vehicle by the end of the day, discuss the situation with

the service advisor and list the items in order of priority. At many authorized dealers, you may obtain a rental vehicle at a minimal daily charge. If you need a rental, it is advisable to make these arrangements when you call for an appointment.

### **IF YOU NEED ASSISTANCE**

The manufacturer and its authorized dealers are vitally interested in your satisfaction. We want you to be happy with our products and services.

Warranty service must be done by an authorized dealer. We strongly recommend that you take the vehicle to an authorized dealer. They know your vehicle the best, and are most concerned that you get prompt and high quality service. The manufacturer's authorized dealers have the facilities, factory-trained technicians, special tools, and the latest information to ensure the vehicle is fixed correctly and in a timely manner.

This is why you should always talk to an authorized dealer's service manager first. Most matters can be resolved with this process.

- If for some reason you are still not satisfied, talk to the general manager or owner of the authorized dealership. They want to know if you need assistance.
- If an authorized dealership is unable to resolve the concern, you may contact the manufacturer's customer center.

Any communication to the manufacturer's customer center should include the following information:

- Owner's name and address
- Owner's telephone number (home and office)
- Authorized dealership name
- Vehicle Identification Number (VIN)
- Vehicle delivery date and mileage

**Chrysler Group LLC Customer Center**

P.O. Box 21-8004

Auburn Hills, MI 48321-8004

Phone: (800) 423-6343

**Chrysler Canada Inc. Customer Center**

P.O. Box 1621

Windsor, Ontario N9A 4H6

Phone: (800) 465-2001 English / (800) 387-9983 French

**In Mexico contact:**

Av. Prolongacion Paseo de la Reforma, 1240

Sante Fe C.P. 05109

Mexico, D. F.

In Mexico City: 5081-7568

Outside Mexico City: 1-800-505-1300

## **Customer Assistance For The Hearing Or Speech Impaired (TDD/TTY)**

To assist customers who have hearing difficulties, the manufacturer has installed special TDD (Telecommunication Devices for the Deaf) equipment at its customer center. Any hearing or speech impaired customer, who has access to a TDD or a conventional teletypewriter (TTY) in the United States, can communicate with the manufacturer by dialing 1-800-380-CHRY.

Canadian residents with hearing difficulties that require assistance can use the special needs relay service offered by Bell Canada. For TTY teletypewriter users, dial 711 and for Voice callers, dial 1 800 855-0511 to connect with a Bell Relay Service operator.

## **Service Contract**

You may have purchased a service contract for a vehicle to help protect you from the high cost of unexpected repairs after the manufacturer's New Vehicle Limited Warranty expires. The manufacturer stands behind only

the manufacturer's service contracts. If you purchased a manufacturer's service contract, you will receive Plan Provisions and an Owner Identification Card in the mail within three weeks of the vehicle delivery date. If you have any questions about the service contract, call the manufacturer's Service Contract National Customer Hotline at 1-800-521-9922 (Canadian residents, call (800) 465-2001 English / (800) 387-9983 French).

The manufacturer will not stand behind any service contract that is not the manufacturer's service contract. It is not responsible for any service contract other than the manufacturer's service contract. If you purchased a service contract that is not a manufacturer's service contract, and you require service after the manufacturer's New Vehicle Limited Warranty expires, please refer to the contract documents, and contact the person listed in those documents.

We appreciate that you have made a major investment when you purchased the vehicle. An authorized dealer has also made a major investment in facilities, tools, and training to assure that you are absolutely delighted with the ownership experience. You'll be pleased with their sincere efforts to resolve any warranty issues or related concerns.

**WARNING!**

Engine exhaust, some of its constituents, and certain vehicle components contain, or emit, chemicals known to the State of California to cause cancer and birth defects, or other reproductive harm. In addition, certain fluids contained in vehicles and certain products of component wear contain, or emit, chemicals known to the State of California to cause cancer and birth defects, or other reproductive harm.

**WARRANTY INFORMATION**

See the Warranty Information Booklet, located on the DVD, for the terms and provisions of Chrysler Group LLC warranties applicable to this vehicle and market.

**MOPAR® PARTS**

MOPAR® fluids, lubricants, parts, and accessories are available from an authorized dealer. They are recommended for your vehicle in order to help keep the vehicle operating at its best.

**REPORTING SAFETY DEFECTS**

**In The 50 United States And Washington, D.C.**

If you believe that your vehicle has a defect that could cause a crash or cause injury or death, you should immediately inform the National Highway Traffic Safety Administration (NHTSA) in addition to notifying the manufacturer.

If NHTSA receives similar complaints, it may open an investigation, and if it finds that a safety defect exists in a group of vehicles, it may order a recall and remedy campaign. However, NHTSA cannot become involved in individual problems between you, your authorized dealer, and the manufacturer.

To contact NHTSA, you may either call the Auto Safety Hotline toll free at 1-888-327-4236 (TTY: 1-800-424-9153), or go to <http://www.safercar.gov>; or write to: Administrator, NHTSA, 1200 New Jersey Avenue, SE., West Building, Washington, D.C. 20590. You can also obtain other information about motor vehicle safety from <http://www.safercar.gov>.

### **In Canada**

If you believe that your vehicle has a safety defect, you should contact the Customer Service Department immediately. Canadian customers who wish to report a safety defect to the Canadian government should contact Transport Canada, Motor Vehicle Defect Investigations and Recalls at 1-800-333-0510 or go to <http://www.tc.gc.ca/roadsafety/>

### **PUBLICATION ORDER FORMS**

To order the following manuals, you may use either the website or the phone numbers listed below. Visa, Mastercard, American Express, and Discover orders are accepted. If you prefer mailing your payment, please call for an order form.

**NOTE:** A street address is required when ordering manuals (no P.O. Boxes).

- *Service Manuals*

These comprehensive Service Manuals provide the information that students and professional technicians need in diagnosing/troubleshooting, problem solving, maintaining, servicing, and repairing Chrysler Group LLC vehicles. A complete working knowledge of the vehicle, system, and/or components is written in straightforward language with illustrations, diagrams, and charts.

- *Diagnostic Procedure Manuals*

Diagnostic Procedure Manuals are filled with diagrams, charts and detailed illustrations. These practical manuals make it easy for students and technicians to find and fix problems on computer-controlled vehicle systems and features. They show exactly how to find and correct problems the first time, using step-by-step troubleshooting and drivability procedures, proven diagnostic tests and a complete list of all tools and equipment.

- *Owner's Manuals*

These Owner's Manuals have been prepared with the assistance of service and engineering specialists to acquaint you with specific Chrysler Group LLC vehicles. Included are starting, operating, emergency and maintenance procedures as well as specifications, capabilities and safety tips.

*Call toll free at:*

- **1-800-890-4038 (U.S.)**
- **1-800-387-1143 (Canada)**

Or

*Visit us on the Worldwide Web at:*

- **[www.techauthority.com](http://www.techauthority.com)**

## DEPARTMENT OF TRANSPORTATION UNIFORM TIRE QUALITY GRADES

The following tire grading categories were established by the National Highway Traffic Safety Administration. The specific grade rating assigned by the tire's manufacturer in each category is shown on the sidewall of the tires on your vehicle.

All passenger car tires must conform to Federal safety requirements in addition to these grades.

### Treadwear

The Treadwear grade is a comparative rating, based on the wear rate of the tire when tested under controlled conditions on a specified government test course. For example, a tire graded 150 would wear one and one-half times as well on the government course as a tire graded 100. The relative performance of tires depends upon the actual conditions of their use, however, and may depart

significantly from the norm due to variations in driving habits, service practices, and differences in road characteristics and climate.

### Traction Grades

The Traction grades, from highest to lowest, are AA, A, B, and C. These grades represent the tire's ability to stop on wet pavement, as measured under controlled conditions on specified government test surfaces of asphalt and concrete. A tire marked C may have poor traction performance.

### WARNING!

**The traction grade assigned to this tire is based on straight-ahead braking traction tests, and does not include acceleration, cornering, hydroplaning, or peak traction characteristics.**

### Temperature Grades

The temperature grades are A (the highest), B, and C, representing the tire's resistance to the generation of heat and its ability to dissipate heat, when tested under controlled conditions on a specified indoor laboratory test wheel. Sustained high temperature can cause the material of the tire to degenerate and reduce tire life, and excessive temperature can lead to sudden tire failure. The grade C corresponds to a level of performance, which all passenger car tires must meet under the Federal Motor Vehicle Safety Standard No. 109. Grades B and A represent higher levels of performance on the laboratory test wheel, than the minimum required by law.

#### **WARNING!**

**The temperature grade for this tire is established for a tire that is properly inflated and not overloaded. Excessive speed, under-inflation, or excessive loading, either separately or in combination, can cause heat buildup and possible tire failure.**



---

# INDEX

- About Your Brakes . . . . . 285,288
- ABS (Anti-Lock Brake System) . . . . . 288,291
- Adding Engine Coolant (Antifreeze) . . . . . 385
- Adding Fuel . . . . . 334
- Adding Washer Fluid . . . . . 380
- Additives, Fuel . . . . . 331
- Air Cleaner, Engine (Engine Air Cleaner Filter) . . . 373
- Air Conditioner Maintenance . . . . . 376
- Air Conditioning . . . . . 242
- Air Conditioning Controls . . . . . 242
- Air Conditioning Filter . . . . . 248,377
- Air Conditioning Refrigerant . . . . . 376,377
- Air Conditioning System . . . . . 242,376
- Air Conditioning, Operating Tips . . . . . 249
- Air Pressure, Tires . . . . . 311
- Airbag . . . . . 56,65
- Airbag Deployment . . . . . 66
- Airbag Light . . . . . 63,64,69,82,180
- Airbag Maintenance . . . . . 68
- Airbag, Side . . . . . 59,62,64,65
- Airbag, Window (Side Curtain) . . . . . 60,62,65
- Alarm (Security Alarm) . . . . . 18
- Alarm Light . . . . . 185
- Alarm System (Security Alarm) . . . . . 18
- Alarm, Panic . . . . . 25
- Alterations/Modifications, Vehicle . . . . . 7
- Antenna, Satellite Radio . . . . . 228
- Anti-Lock Brake System (ABS) . . . . . 288,291
- Anti-Lock Warning Light . . . . . 186,290
- Anti-Theft Security Alarm (Theft Alarm) . . . . . 18
- Antifreeze (Engine Coolant) . . . . . 384,413
- Disposal . . . . . 387
- Appearance Care . . . . . 394
- Arming Theft System (Security Alarm) . . . . . 18
- Assistance Towing . . . . . 107
- Auto Down Power Windows . . . . . 39
- Auto Unlock, Doors . . . . . 33

Automatic Dimming Mirror . . . . .	89	B-Pillar Location . . . . .	306
Automatic Door Locks . . . . .	33	Battery . . . . .	374
Automatic Headlights . . . . .	140	Keyless Transmitter Replacement (RKE) . . . . .	26
Automatic Temperature Control (ATC) . . . . .	242	Location . . . . .	374
Automatic Transaxle		Belts, Seat . . . . .	45,82
Special Additives . . . . .	392	Body Mechanism Lubrication . . . . .	379
Automatic Transmission . . . . .	269,392,393	Brake Assist System . . . . .	292
Adding Fluid . . . . .	393,415	Brake Control System, Electronic . . . . .	291
Autostick . . . . .	276	Brake Fluid . . . . .	415
Fluid and Filter Changes . . . . .	393	Brake System . . . . .	288,389
Fluid Change . . . . .	393	Anti-Lock (ABS) . . . . .	288,291
Fluid Level Check . . . . .	392	Fluid Check . . . . .	389,415
Fluid Type . . . . .	415	Master Cylinder . . . . .	389
Special Additives . . . . .	392	Parking . . . . .	285
Autostick . . . . .	276	Warning Light . . . . .	183,288
Axle Fluid . . . . .	415	Brake, Parking . . . . .	285
Axle Lubrication (Axle Fluid) . . . . .	415	Brake/Transmission Interlock . . . . .	269
		Brakes . . . . .	288,389
		Break-In Recommendations, New Vehicle . . . . .	79

- Brightness, Interior Lights . . . . . 145  
Bulb Replacement . . . . . 407,408  
Bulbs, Light . . . . . 84,407
- Calibration, Compass . . . . . 200  
Capacities, Fluid . . . . . 413  
Caps, Filler  
    Fuel . . . . . 334  
    Oil (Engine) . . . . . 372  
    Power Steering . . . . . 284  
    Radiator (Coolant Pressure) . . . . . 386  
Car Washes . . . . . 394  
Carbon Monoxide Warning . . . . . 81,333  
Cargo (Vehicle Loading) . . . . . 335  
Cellular Phone . . . . . 93,241  
Center High Mounted Stop Light . . . . . 412  
Certification Label . . . . . 336  
Chains, Tire . . . . . 317  
Chart, Tire Sizing . . . . . 302  
Check Engine Light  
(Malfunction Indicator Light) . . . . . 368  
Checking Your Vehicle For Safety . . . . . 80  
Checks, Safety . . . . . 80  
Child Restraint . . . . . 70,72,75,77  
Child Restraint Tether Anchors . . . . . 74,75  
Clean Air Gasoline . . . . . 329  
Cleaning  
    Wheels . . . . . 396  
    Windshield Wiper Blades . . . . . 379  
Clock . . . . . 208,217  
Cold Weather Operation . . . . . 261  
Compact Disc (CD) Maintenance . . . . . 241  
Compass . . . . . 200  
Compass Calibration . . . . . 200  
Compass Variance . . . . . 201  
Computer, Trip/Travel . . . . . 193

Connector		Corrosion Protection	394
UCI	231	Cruise Light	178
Universal Consumer Interface (UCI)	231	Cupholders	169,399
Console	170	Customer Assistance	439
Console, Floor	170	Data Recorder, Event	69
Console, Overhead	153	Daytime Brightness, Interior Lights	145
Contract, Service	441	Daytime Running Lights	142
Coolant Pressure Cap (Radiator Cap)	386	Dealer Service	370
Cooling System	383	Deck Lid, Emergency Release	42
Adding Coolant (Antifreeze)	385	Deck Lid, Power Release	40
Coolant Capacity	413	Defroster, Rear Window	172
Coolant Level	384,387	Defroster, Windshield	82,245
Disposal of Used Coolant	387	Delay (Intermittent) Wipers	146
Drain, Flush, and Refill	384	Diagnostic System, Onboard	367
Inspection	387	Dimmer Switch, Headlight	143
Points to Remember	387	Dipsticks	
Pressure Cap	386	Oil (Engine)	371
Radiator Cap	386	Power Steering	284
Selection of Coolant (Antifreeze)	384,413,414		

- Disabled Vehicle Towing . . . . . 360
- Disposal
- Antifreeze (Engine Coolant) . . . . . 387
  - Engine Oil . . . . . 373
- Door Locks . . . . . 31
- Door Locks, Automatic . . . . . 33
- Door Opener, Garage . . . . . 154
- Driving
- On Slippery Surfaces . . . . . 279
  - Through Flowing, Rising, or Shallow Standing Water . . . . . 281
- Electric Remote Mirrors . . . . . 91
- Electrical Power Outlets . . . . . 165
- Electronic Brake Control System . . . . . 291
- Electronic Power Distribution Center (Fuses) . . . . . 402
- Electronic Speed Control (Cruise Control) . . . . . 150
- Electronic Stability Control (ESC) . . . . . 295
- Electronic Throttle Control Warning Light . . . . . 179
- Electronic Vehicle Information Center (EVIC) . . . . . 188
- Emergency Deck Lid Release . . . . . 42
- Emergency Trunk Release . . . . . 42
- Emergency, In Case of
- Freeing Vehicle When Stuck . . . . . 357
  - Hazard Warning Flasher . . . . . 342
  - Jump Starting . . . . . 353
  - Overheating . . . . . 342
  - Towing . . . . . 360
- Emission Control System Maintenance . . . . . 368
- Engine . . . . . 366
- Air Cleaner . . . . . 373
  - Block Heater . . . . . 263
  - Break-In Recommendations . . . . . 79
  - Checking Oil Level . . . . . 371
  - Compartment . . . . . 366
  - Coolant (Antifreeze) . . . . . 384,414
  - Cooling . . . . . 383
  - Exhaust Gas Caution . . . . . 81,333

Fails to Start . . . . .	261	Exhaust Gas Caution . . . . .	81,333
Flooded, Starting . . . . .	261	Exhaust System . . . . .	81,381
Fuel Requirements . . . . .	329	Exterior Folding Mirrors . . . . .	90
Jump Starting . . . . .	353	Exterior Lighting . . . . .	140
Oil . . . . .	371,413,414	Exterior Lights . . . . .	84
Oil Change Interval . . . . .	371	Filler Location Fuel . . . . .	334
Oil Filler Cap . . . . .	372	Filters	
Oil Filter . . . . .	373	Air Cleaner . . . . .	373
Oil Filter Disposal . . . . .	373	Air Conditioning . . . . .	248,377
Oil Selection . . . . .	372,413	Engine Oil . . . . .	373,414
Oil Synthetic . . . . .	372	Engine Oil Disposal . . . . .	373
Overheating . . . . .	342	Flash-To-Pass . . . . .	144
Starting . . . . .	255	Flashers	
Temperature Gauge . . . . .	179	Hazard Warning . . . . .	342
Engine Oil Viscosity . . . . .	372	Turn Signal . . . . .	84,143,180
Enhanced Accident Response Feature . . . . .	66	Flooded Engine Starting . . . . .	261
Entry System, Illuminated . . . . .	21	Fluid Capacities . . . . .	413
Ethanol . . . . .	330	Fluid Leaks . . . . .	84
Event Data Recorder . . . . .	69		

Fluid Level Checks		Gauge	178
Automatic Transmission	392	Materials Added	331
Brake	389	Methanol	330
Cooling System	384	Octane Rating	329,414
Engine Oil	371	Requirements	329
Power Steering	284	Specifications	414
Fluid, Brake	415	Tank Capacity	413
Fluids	414	Fuel System Caution	334
Fluids, Lubricants and Genuine Parts	414	Fueling	334
Fog Lights	142,182	Fuses	399
Folding Rear Seat	137		
Freeing A Stuck Vehicle	357	Garage Door Opener (HomeLink®)	154
Fuel	329	Gas Cap (Fuel Filler Cap)	334,367
Adding	334	Gasoline (Fuel)	329
Additives	331	Gasoline, Clean Air	329
Clean Air	329	Gasoline, Reformulated	329
Ethanol	330	Gauges	
Filler Cap (Gas Cap)	334	Coolant Temperature	179
Gasoline	329	Fuel	178



Speedometer . . . . .	178	Headlights . . . . .	408
Tachometer . . . . .	178	Automatic . . . . .	140
Gear Ranges . . . . .	270	Bulb Replacement . . . . .	408
Gear Select Lever Override . . . . .	359	Cleaning . . . . .	398
General Information . . . . .	18,27,123,328	Delay . . . . .	141
General Maintenance . . . . .	370	High Beam/Low Beam Select Switch . . . . .	143
Glass Cleaning . . . . .	398	Lights On Reminder . . . . .	142
Gross Axle Weight Rating . . . . .	336	On With Wipers . . . . .	141,148
Gross Vehicle Weight Rating . . . . .	336	Passing . . . . .	144
GVWR . . . . .	336	Switch . . . . .	140
Hands-Free Phone (Uconnect™) . . . . .	93	Time Delay . . . . .	141
Hazard		Washers . . . . .	380
Driving Through Flowing, Rising, or Shallow		Heated Mirrors . . . . .	91
Standing Water . . . . .	281	Heated Seats . . . . .	131
Hazard Warning Flasher . . . . .	342	Heater . . . . .	242
Head Restraints . . . . .	134	Heater, Engine Block . . . . .	263
Headlight Washers . . . . .	380	High Beam/Low Beam Select (Dimmer) Switch . . . . .	143
		Hill Start Assist . . . . .	293
		Holder, Cup . . . . .	169

- HomeLink® (Garage Door Opener) Transmitter . . . 154
- Hood Release . . . . . 138
- Ignition . . . . . 14
- Key . . . . . 12,14
- Ignition Key Removal . . . . . 14
- Illuminated Entry . . . . . 21
- Immobilizer (Sentry Key) . . . . . 16
- Infant Restraint . . . . . 70,71
- Information Center, Vehicle . . . . . 188
- Instrument Cluster . . . . . 177,178
- Instrument Panel and Controls . . . . . 176
- Instrument Panel Lens Cleaning . . . . . 398
- Integrated Power Module (Fuses) . . . . . 399
- Interior Appearance Care . . . . . 397
- Interior Lights . . . . . 145
- Intermittent Wipers (Delay Wipers) . . . . . 146
- Introduction . . . . . 4
- Jump Starting . . . . . 353
- Key-In Reminder . . . . . 16
- Key, Programming . . . . . 18
- Key, Replacement . . . . . 17
- Key, Sentry (Immobilizer) . . . . . 16
- Keyless Enter-N-Go™ . . . . . 34,198,257
- Keyless Entry System . . . . . 21
- Keyless Go . . . . . 12,198
- Keys . . . . . 12
- Kicker Sound System . . . . . 238
- Knee Bolster . . . . . 56
- Lane Change and Turn Signals . . . . . 143
- Lane Change Assist . . . . . 143
- Lap/Shoulder Belts . . . . . 45
- LATCH  
(Lower Anchors and Tether for CHildren) . . . . . 74,75

- Latches . . . . . 84  
     Hood . . . . . 138  
 Lead Free Gasoline . . . . . 329  
 Leaks, Fluid . . . . . 84  
 Life of Tires . . . . . 315  
 Light Bulbs . . . . . 84,407  
 Lights . . . . . 84,140  
     Airbag . . . . . 63,64,69,82,180  
     Alarm . . . . . 185  
     Anti-Lock . . . . . 186,290  
     Automatic Headlights . . . . . 140  
     Brake Assist Warning . . . . . 299  
     Brake Warning . . . . . 183,288  
     Bulb Replacement . . . . . 407,408  
     Center Mounted Stop . . . . . 412  
     Courtesy/Reading . . . . . 144,153  
     Cruise . . . . . 178  
     Daytime Running . . . . . 142  
     Dimmer Switch, Headlight . . . . . 142,143  
     Electronic Stability Program (ESP) Indicator . . . . . 299  
     Electronic Throttle Control Warning . . . . . 179  
     Engine Temperature Warning . . . . . 180  
     Exterior . . . . . 84  
     Fog . . . . . 142,182  
     Hazard Warning Flasher . . . . . 342  
     Headlight Switch . . . . . 140  
     Headlights . . . . . 140,408  
     Headlights On Reminder . . . . . 142  
     Headlights On With Wipers . . . . . 141,148  
     High Beam . . . . . 143,182  
     High Beam Indicator . . . . . 182  
     High Beam/Low Beam Select . . . . . 143  
     Illuminated Entry . . . . . 21  
     Instrument Cluster . . . . . 140,178  
     Intensity Control . . . . . 145  
     Interior . . . . . 145,153  
     License . . . . . 412  
     Lights On Reminder . . . . . 142

- Low Fuel . . . . . 187
- Malfunction Indicator (Check Engine) . . . . . 187
- Map Reading . . . . . 144,153
- Oil Pressure . . . . . 181
- Parade Mode (Daytime Brightness) . . . . . 145
- Passing . . . . . 144
- Reading . . . . . 144,153
- Seat Belt Reminder . . . . . 182
- Security Alarm (Theft Alarm) . . . . . 185
- Service . . . . . 407,408
- Service Engine Soon  
(Malfunction Indicator) . . . . . 187
- Theft Alarm (Security Alarm) . . . . . 185
- Tire Pressure Monitoring (TPMS) . . . . . 185,321
- Traction Control . . . . . 299
- Turn Signal . . . . . 84,142,143,180
- Vanity Mirror . . . . . 92
- Voltage . . . . . 178
- Warning (Instrument Cluster Description) . . . 178
- Loading Vehicle . . . . . 335,337
  - Capacities . . . . . 337
  - Tires . . . . . 306
- Locks . . . . . 31
  - Auto Unlock . . . . . 33
  - Automatic Door . . . . . 33
  - Door . . . . . 31
  - Power Door . . . . . 32
- Low Tire Pressure System . . . . . 321
- Lower Anchors and Tether for  
CHildren (LATCH) . . . . . 74,75
- Lubrication, Body . . . . . 379
- Maintenance Free Battery . . . . . 374
- Maintenance Procedures . . . . . 370
- Maintenance Schedule . . . . . 418
- Maintenance, General . . . . . 370
- Maintenance, Sunroof . . . . . 165
- Malfunction Indicator Light (Check Engine) . . 187,368

Manual Transmission . . . . .	263,391,393	MTBE/ETBE . . . . .	330
Fluid Level Check . . . . .	391,393	Multi-Function Control Lever . . . . .	142
Shift Speeds . . . . .	265	New Vehicle Break-In Period . . . . .	79
Manual, Service . . . . .	443	Occupant Restraints . . . . .	42,62,66
Map/Reading Lights . . . . .	144,153	Occupant Restraints (Sedan) . . . . .	59,60,62,65
Master Cylinder (Brakes) . . . . .	389	Octane Rating, Gasoline (Fuel) . . . . .	329,414
Methanol . . . . .	330	Odometer . . . . .	178
Mini-Trip Computer . . . . .	193	Trip . . . . .	178
Mirrors . . . . .	89	Oil Change Indicator . . . . .	192
Automatic Dimming . . . . .	89	Oil Change Indicator, Reset . . . . .	192
Electric Powered . . . . .	91	Oil Filter, Change . . . . .	373
Electric Remote . . . . .	91	Oil Filter, Selection . . . . .	373
Exterior Folding . . . . .	90	Oil, Engine . . . . .	371,414
Heated . . . . .	91	Capacity . . . . .	413
Outside . . . . .	90	Change Interval . . . . .	371
Vanity . . . . .	92	Checking . . . . .	371
Modifications/Alterations, Vehicle . . . . .	7	Dipstick . . . . .	371
Monitor, Tire Pressure System . . . . .	321		
Mopar Parts . . . . .	369,442		

Disposal	373	Paint Care	394
Filter	373,414	Panic Alarm	25
Filter Disposal	373	Parking Brake	285
Materials Added to	372	Passing Light	144
Recommendation	372,413	Personal Settings	202
Synthetic	372	Pets	79
Viscosity	372,413	Phone, Cellular	93
Onboard Diagnostic System	367,368	Phone, Hands-Free (Uconnect™)	93
Opener, Garage Door (HomeLink®)	154	Placard, Tire and Loading Information	306
Operating Precautions	367	Power	
Operator Manual (Owner's Manual)	4	Brakes	288
Outside Rearview Mirrors	90	Deck Lid Release	40
Overdrive	275	Distribution Center (Fuses)	402
Overdrive OFF Switch	275	Door Locks	32
Overhead Console	153	Mirrors	91
Overheating, Engine	342	Outlet (Auxiliary Electrical Outlet)	165
Owner's Manual (Operator Manual)	4,443	Seats	128
		Steering	283,284

Sunroof . . . . .	163	Reformulated Gasoline . . . . .	329
Windows . . . . .	38	Refrigerant . . . . .	377
Power Steering Fluid . . . . .	415	Release, Hood . . . . .	138
Pregnant Women and Seat Belts . . . . .	55	Reminder, Lights On . . . . .	142
Pretensioners		Reminder, Seat Belt . . . . .	54
Seat Belts . . . . .	53	Remote Control	
Programmable Electronic Features . . . . .	202	Starting System . . . . .	27
Programming Transmitters		Remote Keyless Entry (RKE) . . . . .	21
(Remote Keyless Entry) . . . . .	21	Remote Sound System (Radio) Controls . . . . .	239
Radial Ply Tires . . . . .	313	Remote Starting System . . . . .	27
Radiator Cap (Coolant Pressure Cap) . . . . .	386	Remote Trunk Release . . . . .	40
Radio Operation . . . . .	241	Replacement Bulbs . . . . .	407
Rear Cupholder . . . . .	170	Replacement Keys . . . . .	17
Rear Seat, Folding . . . . .	137	Replacement Parts . . . . .	369
Rear Window Defroster . . . . .	172	Replacement Tires . . . . .	316
Rear Window Features . . . . .	172	Reporting Safety Defects . . . . .	442
Recorder, Event Data . . . . .	69	Restraint, Head . . . . .	134
Recreational Towing . . . . .	338	Restraints, Child . . . . .	70
		Restraints, Occupant . . . . .	42

Rocking Vehicle When Stuck . . . . .	357	Operating Instructions . . . . .	47
Rotation, Tires . . . . .	319	Pretensioners . . . . .	53
Safety Checks Inside Vehicle . . . . .	82	Rear Seat . . . . .	45
Safety Checks Outside Vehicle . . . . .	84	Reminder . . . . .	182
Safety Defects, Reporting . . . . .	442	Untwisting Procedure . . . . .	51
Safety Information, Tire . . . . .	300	Seats . . . . .	128
Safety Tips . . . . .	80	Adjustment . . . . .	128
Safety, Exhaust Gas . . . . .	81	Head Restraints . . . . .	134
Satellite Radio Antenna . . . . .	228	Heated . . . . .	131
Schedule, Maintenance . . . . .	418	Height Adjustment . . . . .	128
Seat Belt Maintenance . . . . .	399	Power . . . . .	128
Seat Belt Reminder . . . . .	54	Rear Folding . . . . .	137
Seat Belts . . . . .	42,45,82	Seatback Release . . . . .	137
And Pregnant Women . . . . .	55	Tilting . . . . .	128
Child Restraint . . . . .	70,71,72,77	Security Alarm (Theft Alarm) . . . . .	18
Extender . . . . .	55	Selection of Coolant (Antifreeze) . . . . .	384,414
Front Seat . . . . .	45,47	Selection of Oil . . . . .	372
Inspection . . . . .	82	Sentry Key (Immobilizer) . . . . .	16
		Sentry Key Programming . . . . .	18



Sentry Key Replacement . . . . .	17	Slippery Surfaces, Driving On . . . . .	279
Service Assistance . . . . .	439	Snow Chains (Tire Chains) . . . . .	317
Service Contract . . . . .	441	Snow Tires . . . . .	319
Service Engine Soon Light (Malfunction Indicator) . . . . .	187	Sound System	
Service Manuals . . . . .	443	Kicker . . . . .	238
Setting the Clock . . . . .	208,217	Spark Plugs . . . . .	414
Settings, Personal . . . . .	202	Specifications	
Shift Indicator Light . . . . .	266	Fuel (Gasoline) . . . . .	414
Shift Lever Override . . . . .	359	Oil . . . . .	414
Shift Speeds . . . . .	265	Speed Control (Cruise Control) . . . . .	150
Shift Speeds, Manual Transmission . . . . .	265	Speedometer . . . . .	178
Shifting . . . . .	267	Sport Mode . . . . .	278
Automatic Transmission . . . . .	267	Starting . . . . .	27,255
Short Message Service (SMS) . . . . .	115	Automatic Transmission . . . . .	256
Shoulder Belts . . . . .	45	Cold Weather . . . . .	261
Side Airbag . . . . .	64	Engine Fails to Start . . . . .	261
Side Window Demisters (Defrosters) . . . . .	248	Remote . . . . .	27
Signals, Turn . . . . .	84,143,180	Starting and Operating . . . . .	255
		Starting Procedures . . . . .	255

Steering		Synthetic Engine Oil . . . . .	372
Column Controls . . . . .	142	System, Remote Starting . . . . .	27
Column Lock . . . . .	148	Tachometer . . . . .	178
Power . . . . .	283,284	Telescoping Steering Column . . . . .	148
Tilt Column . . . . .	148	Temperature Control, Automatic (ATC) . . . . .	242
Wheel, Heated . . . . .	149	Temperature Gauge, Engine Coolant . . . . .	179,343
Wheel, Tilt . . . . .	148	Tether Anchor, Child Restraint . . . . .	74
Steering Wheel Audio Controls . . . . .	239	Text Messaging . . . . .	115
Steering Wheel Mounted Sound		Theft Alarm (Security Alarm) . . . . .	18
System Controls . . . . .	239	Theft System (Security Alarm) . . . . .	18
Storage . . . . .	406	Tilt Steering Column . . . . .	148
Storage, Vehicle . . . . .	247,406	Time Delay, Headlight . . . . .	141
Storing Your Vehicle . . . . .	406	Tire and Loading Information Placard . . . . .	306
Stuck, Freeing . . . . .	357	Tire Identification Number (TIN) . . . . .	304
Sun Roof . . . . .	163	Tire Markings . . . . .	300
Sunglasses Storage . . . . .	154	Tire Safety Information . . . . .	300
Sunroof Maintenance . . . . .	165	TIREFIT . . . . .	343
Supplemental Restraint System - Airbag . . . . .	56		

Tires . . . . .	84,310,445	Spinning . . . . .	314
Aging (Life of Tires) . . . . .	315	Tread Wear Indicators . . . . .	314
Air Pressure . . . . .	310	To Open Hood . . . . .	138
Chains . . . . .	317	Towing . . . . .	337
General Information . . . . .	310	24-Hour Towing Assistance . . . . .	107
High Speed . . . . .	313	Disabled Vehicle . . . . .	360
Inflation Pressures . . . . .	311	Recreational . . . . .	338
Life of Tires . . . . .	315	Towing Assistance . . . . .	107
Load Capacity . . . . .	306	Traction Control . . . . .	292
Pressure Monitor System (TPMS) . . . . .	321	Trailer Towing . . . . .	337
Pressure Warning Light . . . . .	185	Transmission . . . . .	392
Quality Grading . . . . .	445	Automatic . . . . .	267,269,392
Radial . . . . .	313	Fluid . . . . .	415
Replacement . . . . .	316	Manual . . . . .	263
Rotation . . . . .	319	Shifting . . . . .	265,267
Safety . . . . .	300,310	Transmitter Battery Service (Remote Keyless Entry) . . . . .	26
Sizes . . . . .	302	Transmitter Programming (Remote Keyless Entry) . . . . .	21
Snow Tires . . . . .	319		

- Transmitter, Garage Door Opener (HomeLink®) . . . 154  
Transmitter, Remote Keyless Entry (RKE) . . . . . 21  
Transporting Pets . . . . . 79  
Tread Wear Indicators . . . . . 314  
Trip Odometer . . . . . 178  
Trunk Lid (Deck Lid) . . . . . 40,42  
Trunk Release Remote Control . . . . . 40  
Trunk Release, Emergency . . . . . 42  
Turn Signals . . . . . 143,180
- UCI Connector . . . . . 231  
Uconnect™ (Hands-Free Phone) . . . . . 93  
Uniform Tire Quality Grades . . . . . 445  
Universal Consumer Interface (UCI) Connector . . . 231  
Universal Transmitter . . . . . 154  
Unleaded Gasoline . . . . . 329  
Untwisting Procedure, Seat Belt . . . . . 51
- Vanity Mirrors . . . . . 92
- Variance, Compass . . . . . 201  
Vehicle Certification Label . . . . . 336  
Vehicle Identification Number (VIN) . . . . . 6  
Vehicle Loading . . . . . 306,335,337  
Vehicle Modifications/Alterations . . . . . 7  
Vehicle Storage . . . . . 247,406  
Vehicle Theft Alarm (Security Alarm) . . . . . 18  
Viscosity, Engine Oil . . . . . 372  
Voice Recognition System (VR) . . . . . 123
- Warning Flasher, Hazard . . . . . 342  
Warning Lights  
(Instrument Cluster Description) . . . . . 178  
Warnings and Cautions . . . . . 6  
Warranty Information . . . . . 442  
Washer  
    Adding Fluid . . . . . 380  
Washers, Windshield . . . . . 146,147,380  
Washing Vehicle . . . . . 394

Water		
Driving Through	281	
Wheel and Wheel Trim	396	
Wheel and Wheel Trim Care	396	
Wind Buffeting	40,165	
Window Fogging	248	
Windows	38	
Power	38	
Windshield Defroster	82,245	
Windshield Washers	146,147,380	
Fluid	380	
Windshield Wiper Blades	379	
Windshield Wipers	146	
Wiper Blade Replacement	379	
Wiper, Delay	146	
Wipers, Intermittent	146	

## **INSTALLATION OF RADIO TRANSMITTING EQUIPMENT**

Special design considerations are incorporated into this vehicle's electronic system to provide immunity to radio frequency signals. Mobile two-way radios and telephone equipment must be installed properly by trained personnel. The following must be observed during installation.

The positive power connection should be made directly to the battery and fused as close to the battery as possible. The negative power connection should be made to body sheet metal adjacent to the negative battery connection. This connection should not be fused.

Antennas for two-way radios should be mounted on the roof or the rear area of the vehicle. Care should be used in mounting antennas with magnet bases. Magnets may affect the accuracy or operation of the compass on vehicles so equipped.

The antenna cable should be as short as practical and routed away from the vehicle wiring when possible. Use only fully shielded coaxial cable.

Carefully match the antenna and cable to the radio to ensure a low Standing Wave Ratio (SWR).

Mobile radio equipment with output power greater than normal may require special precautions.

All installations should be checked for possible interference between the communications equipment and the vehicle's electronic systems.



STICK WITH THE SPECIALISTS®

Chrysler Group LLC  
12D492-126-AE



5th Edition

Printed in U.S.A.