



2009

OWNER'S MANUAL



DODGE

CALIBER

VEHICLES SOLD IN CANADA

With respect to any Vehicles Sold in Canada, the name Chrysler LLC shall be deemed to be deleted and the name Chrysler Canada Inc. used in substitution therefore.

DRIVING AND ALCOHOL

Drunken driving is one of the most frequent causes of accidents.

Your driving ability can be seriously impaired with blood alcohol levels far below the legal minimum. If you are drinking, don't drive. Ride with a designated non-drinking driver, call a cab, a friend, or use public transportation.

WARNING!

Driving after drinking can lead to an accident. Your perceptions are less sharp, your reflexes are slower, and your judgment is impaired when you have been drinking. Never drink and then drive.

This manual illustrates and describes the operation of features and equipment that are either standard or optional on this vehicle. This manual may also include a description of features and equipment that are no longer available or were not ordered on this vehicle. Please disregard any features and equipment described in this manual that are not on this vehicle.

Chrysler LLC reserves the right to make changes in design and specifications, and/or make additions to or improvements to its products without imposing any obligation upon itself to install them on products previously manufactured.

Copyright © 2008 Chrysler LLC



TABLE OF CONTENTS

SECTION

PAGE

1	INTRODUCTION	3	1
2	THINGS TO KNOW BEFORE STARTING YOUR VEHICLE	9	2
3	UNDERSTANDING THE FEATURES OF YOUR VEHICLE	75	3
4	UNDERSTANDING YOUR INSTRUMENT PANEL	163	4
5	STARTING AND OPERATING	245	5
6	WHAT TO DO IN EMERGENCIES	323	6
7	MAINTAINING YOUR VEHICLE	337	7
8	MAINTENANCE SCHEDULES	381	8
9	IF YOU NEED CONSUMER ASSISTANCE	399	9
10	INDEX	409	10

INTRODUCTION

CONTENTS

■ Introduction	4	■ Vehicle Identification Number	6
■ How To Use This Manual	4	■ Vehicle Modifications/Alterations	7
■ Warnings And Cautions	6		

INTRODUCTION

This Owner's Manual has been prepared with the assistance of service and engineering specialists to acquaint you with the operation and maintenance of your vehicle. It is supplemented by a Warranty Information Booklet and various customer-oriented documents. You are urged to read these publications carefully. Following the instructions and recommendations in this manual will help assure safe and enjoyable operation of your vehicle.

NOTE: After you read the manual, it should be stored in the vehicle for convenient referencing and remain with the vehicle when sold, so that the new owner will be aware of all safety warnings.

When it comes to service, remember that your authorized dealer knows your vehicle best, has the factory-trained technicians and genuine Mopar® parts, and is interested in your satisfaction.

HOW TO USE THIS MANUAL

Consult the Table of Contents to determine which section contains the information you desire.

The detailed index at the back of this Owner's Manual contains a complete listing of all subjects.

Consult the following table for a description of the symbols that may be used on your vehicle or throughout this Owner's Manual:

WARNINGS AND CAUTIONS

This Owner's Manual contains **WARNINGS** against operating procedures that could result in an accident or bodily injury. It also contains **CAUTIONS** against procedures that could result in damage to your vehicle. If you do not read this entire manual, you may miss important information. Observe all Warnings and Cautions.

VEHICLE IDENTIFICATION NUMBER

The Vehicle Identification Number (VIN) is found on the left front corner of the instrument panel, visible through the windshield. This number also appears on the vehicle registration and title.

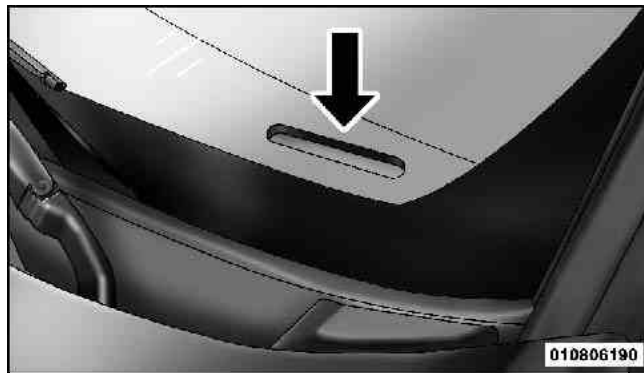

Vehicle Identification Number

VEHICLE MODIFICATIONS/ALTERATIONS**WARNING!**

Any modifications or alterations to this vehicle could seriously affect its roadworthiness and safety and may lead to an accident resulting in serious injury or death.

THINGS TO KNOW BEFORE STARTING YOUR VEHICLE

CONTENTS

■ A Word About Your Keys	12	□ To Set The Security Alarm	19
□ Ignition Key Removal	12	□ To Disarm The System	19
□ Locking Doors With The Key	15	□ Vehicle Security Alarm Manual Override	19
□ Key-In-Ignition Reminder	15	■ Remote Keyless Entry — If Equipped	20
■ Sentry Key®	15	□ To Unlock The Doors And Liftgate	21
□ Replacement Keys	16	□ Remote Key Unlock, Driver Door/All First Press	21
□ Customer Key Programming	17	□ Illuminated Approach — If Equipped	22
□ General Information	18	□ To Lock The Doors And Liftgate	22
■ Vehicle Security Alarm — If Equipped	18		

10 THINGS TO KNOW BEFORE STARTING YOUR VEHICLE

- Sound Horn With Remote Key Lock 22
- Flash Lights With Remote Key Lock/Unlock . . 23
- Using The Panic Alarm 24
- Programming Additional RKE Transmitters . . . 25
- General Information 25
- RKE Transmitter Battery Replacement 25
- Door Locks 26
 - Manual Door Locks 26
 - Power Door Locks 27
 - Child-Protection Door Lock System (Rear Doors) — If Equipped 31
- Power Windows — If Equipped 32
 - Power Window Switches 32
 - Auto Down 33
 - Window Lockout Switch 34
- Liftgate 34
- Occupant Restraints 36
 - Lap/Shoulder Belts 37
 - Adjustable Upper Shoulder Belt Anchorage . . . 42
 - Second Row Center Lap/Shoulder Belt Operating Instructions 43
 - Seat Belt Pretensioners 46
 - Enhanced Seat Belt Use Reminder System (BeltAlert®) 47
 - Seat Belts And Pregnant Women 48
 - Driver And Front Passenger Supplemental Restraint System (SRS) — Airbag 49

THINGS TO KNOW BEFORE STARTING YOUR VEHICLE 11

Child Restraints 62

■ Engine Break-In Recommendations 70

■ Safety Tips 71

Transporting Passengers 71

Exhaust Gas 72

Safety Checks You Should Make Inside The
Vehicle 73

Periodic Safety Checks You Should Make
Outside The Vehicle 73

A WORD ABOUT YOUR KEYS

The authorized dealer that sold you your new vehicle has the key code numbers for your vehicle locks. These numbers can be used to order duplicate keys. Ask your authorized dealer for these numbers and keep them in a safe place.

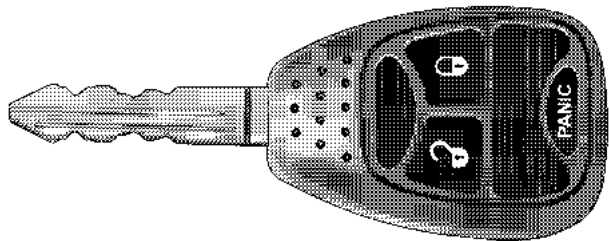

8163e6a8

Vehicle Key

Ignition Key Removal

Automatic Transmission — If Equipped

1. Place the shift lever in PARK.
2. Turn the ignition switch to the ACC (Accessory) position.
3. Push the key and cylinder inward and rotate the key to the LOCK position.
4. Remove the key from the ignition switch lock cylinder.

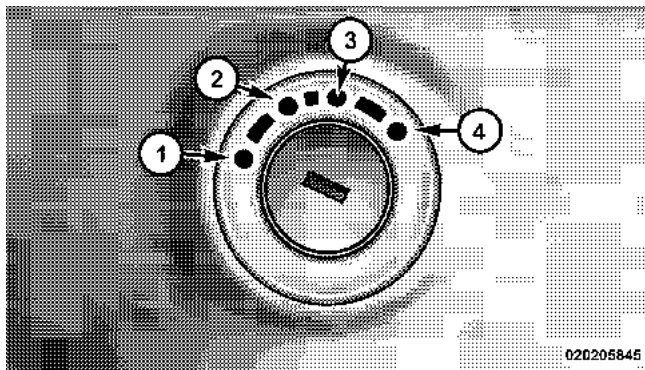

Ignition Switch Positions

1 — LOCK

2 — ACC (ACCESSORY)

3 — ON

4 — START

NOTE: If you try to remove the key before you place the shift lever in PARK, the key may become trapped temporarily in the ignition switch cylinder. If this occurs, rotate the key to the right slightly, then remove the key as

described. If a malfunction occurs, the system will trap the key in the ignition cylinder to warn you that this safety feature is inoperable. The engine can be started and stopped but the key cannot be removed until you obtain service.

2

WARNING!

Never leave children alone in a vehicle. Leaving unattended children in a vehicle is dangerous for a number of reasons. A child or others could be seriously or fatally injured. Do not leave the keys in the ignition. A child could operate power windows, other controls, or move the vehicle.

CAUTION!

An unlocked car is an invitation to thieves. Always remove the key from the ignition and lock all the doors when leaving the vehicle unattended.

Manual Transmission

1. Turn the ignition switch to the ACC (Accessory) position.
2. Push the key and cylinder inward and rotate the key to the LOCK position.
3. Remove the key from the ignition switch lock cylinder.

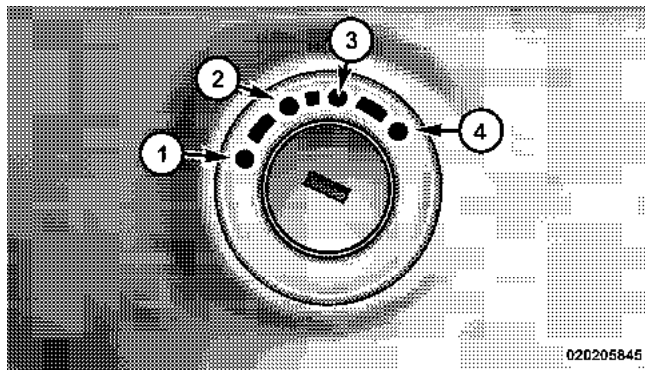
**Ignition Switch Positions**

- | | |
|---------------------|-----------|
| 1 — LOCK | 3 — ON |
| 2 — ACC (ACCESSORY) | 4 — START |

020205845

Locking Doors With The Key

You can insert the key with either side up. To lock the door, turn the key to the right. To unlock the door, turn the key to the left. Refer to “Body Lubrication” under “Maintenance Procedures” in Section 7.

Key-In-Ignition Reminder

Opening the driver’s door when the key is in the ignition and the ignition position is LOCK or ACC, sounds a signal to remind you to remove the key.

NOTE: With the driver’s door open and the key in the ignition, the power door locks will not lock and Remote Keyless Entry (RKE) transmitter will not function.

SENTRY KEY®

The Sentry Key® Immobilizer System prevents unauthorized vehicle operation by disabling the engine. The system does not need to be armed or activated. Operation

is automatic, regardless of whether the vehicle is locked or unlocked.

The system uses ignition keys that have an embedded electronic chip (transponder) to prevent unauthorized vehicle operation. Therefore, only keys that are programmed to the vehicle can be used to start and operate the vehicle. The system will shut the engine off in two seconds if someone uses an invalid key to try to start the engine.

NOTE: A key that has not been programmed is also considered an invalid key, even if it is cut to fit the ignition switch lock cylinder for that vehicle.

During normal operation, after turning on the ignition switch, the Vehicle Security Light will turn on for three seconds for a bulb check. If the light remains on after the bulb check, it indicates that there is a problem with the electronics. In addition, if the Vehicle Security Light begins to flash after the bulb check, it indicates that

someone used an invalid key to try to start the engine. Either of these conditions will result in the engine being shut off after two seconds.

If the Vehicle Security Light turns on during normal vehicle operation (vehicle running for longer than 10 seconds), it indicates that there is a fault in the electronics. Should this occur, have the vehicle serviced as soon as possible.

NOTE:

- The Sentry Key® Immobilizer System is not compatible with some aftermarket remote starting systems. Use of these systems may result in vehicle starting problems and loss of security protection.
- Exxon/Mobil Speedpass™, additional Sentry Keys®, or any other transponder-equipped components on the same key chain will **not** cause a key-related (transponder) fault unless the additional part is **physically held against the ignition key** being used when

starting the vehicle. Cell phones, pagers, or other Radio Frequency (RF) electronics will not cause interference with this system.

All of the keys provided with your new vehicle have been programmed to the vehicle electronics.

Replacement Keys

NOTE: Only keys that are programmed to the vehicle electronics can be used to start and operate the vehicle. Once a Sentry Key® is programmed to a vehicle, it cannot be programmed to any other vehicle.

CAUTION!

Always remove the Sentry Keys® from the vehicle and lock all doors when leaving the vehicle unattended.

At the time of purchase, the original owner is provided with a four-digit Personal Identification Number (PIN). Keep the PIN in a secure location. This number is required for authorized dealer replacement of keys. Duplication of keys may be performed at an authorized dealer or by following the customer key programming procedure. This procedure consists of programming a blank key to the vehicle electronics. A blank key is one that has never been programmed.

NOTE: When having the Sentry Key® Immobilizer System serviced, bring all vehicle keys with you to an authorized dealer.

Customer Key Programming

If you have two valid Sentry Keys®, you can program new Sentry Keys® to the system by performing the following procedure:

1. Cut the additional Sentry Key® Transponder blank(s) to match the ignition switch lock cylinder key code.

2. Insert the first valid key into the ignition switch. Turn the ignition switch to the ON position for at least three seconds, but no longer than 15 seconds. Then, turn the ignition switch to the LOCK position and remove the first key.

3. Insert the second valid key into the ignition switch. Turn the ignition switch to the ON position within 15 seconds. After 10 seconds, a chime will sound. In addition, the Vehicle Security Light will begin to flash. Turn the ignition switch to the LOCK position and remove the second key.

4. Insert a blank Sentry Key® into the ignition switch. Turn the ignition switch to the ON position within 60 seconds. After 10 seconds, a single chime will sound. In addition, the Vehicle Security Light will stop flashing. To indicate that programming is complete, the Vehicle Security Light will turn on again for three seconds and then turn off.

The new Sentry Key® is programmed. **The Remote Keyless Entry (RKE) transmitter will also be programmed during this procedure.**

Repeat this procedure to program up to eight keys. If you do not have a programmed Sentry Key®, contact your authorized dealer for details.

NOTE: If a programmed key is lost, see your authorized dealer to have all remaining keys erased from the system's memory. This will prevent the lost key from starting your vehicle. The remaining keys must then be reprogrammed. All vehicle keys must be taken to an authorized dealer at the time of service to be reprogrammed.

General Information

The Sentry Key® system complies with FCC rules Part 15 and with RSS-210 of Industry Canada. Operation is subject to the following conditions:

- This device may not cause harmful interference.
- This device must accept any interference that may be received, including interference that may cause undesired operation.

VEHICLE SECURITY ALARM — IF EQUIPPED

This Vehicle Security Alarm monitors the doors, hood, liftgate, and ignition switch for unauthorized operation.

If something triggers the Vehicle Security Alarm the horn will sound for 30 seconds and flash the lights for 60 seconds. If the triggering device is not deactivated, the horn will sound again after a five second delay for another 30 seconds. If the trigger remains present, this cycle will repeat for up to five minutes.

To Set The Security Alarm

1. Remove the key from the ignition switch and get out of the vehicle.
2. Lock the door using either the power door LOCK switch or the Remote Keyless Entry (RKE) transmitter and close all doors.
3. The Vehicle Security Light in the instrument cluster will flash rapidly for approximately 16 seconds. This shows that the Vehicle Security Alarm is arming. During this period, if a door is opened, the ignition switch is

turned ON, or the power door locks are unlocked in any manner, the Vehicle Security Alarm will automatically disarm. After approximately 16 seconds, the Vehicle Security Light will flash slowly. This shows that the Vehicle Security Alarm is fully armed.

To Disarm The System

Press UNLOCK on the RKE transmitter.

Vehicle Security Alarm Manual Override

The Vehicle Security Alarm will not arm if you lock the doors using the manual door lock plunger.

REMOTE KEYLESS ENTRY — IF EQUIPPED

This system allows you to lock or unlock the doors and liftgate or activate the Panic Alarm from distances up to approximately 66 ft (20 m) using a handheld Remote Keyless Entry (RKE) transmitter. The RKE transmitter does not need to be pointed at the vehicle to activate the system.

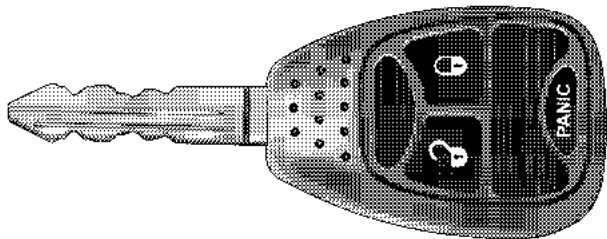

8163e6a8

Three Button RKE Transmitter

NOTE: The line of transmission must not be blocked with metal objects.

To Unlock The Doors And Liftgate

Press and release the UNLOCK button on the RKE transmitter once to unlock the driver's door, or twice within five seconds to unlock all doors and liftgate. The turn signal lights will flash to acknowledge the unlock signal. The illuminated entry system will also turn on.

Remote Key Unlock, Driver Door/All First Press

This feature lets you program the system to unlock either the driver's door or all doors on the first press of the UNLOCK button on the RKE transmitter. To change the current setting, proceed as follows:

- For vehicles equipped with the Electronic Vehicle Information Center (EVIC), refer to “RKE Unlock,” under “Personal Settings (Customer-Programmable Features),” under “Electronic Vehicle Information Center (EVIC)” in Section 4.

- For vehicles not equipped with the EVIC, perform the following steps:

1. Press and hold the LOCK button on a programmed RKE transmitter for at least four seconds, but no longer than 10 seconds. Then, press and hold the UNLOCK button while still holding the LOCK button.
2. Release both buttons at the same time.
3. Test the feature while outside of the vehicle by pressing the LOCK/UNLOCK buttons on the RKE transmitter with the ignition switch in the LOCK position and the key removed.
4. Repeat these steps if you want to return this feature to its previous setting.

NOTE: Pressing the LOCK button on the RKE transmitter while you are inside the vehicle will activate the Vehicle Security Alarm. Opening a door with the Vehicle Security Alarm activated will cause the alarm to sound. Press the UNLOCK button to deactivate the Vehicle Security Alarm.

Illuminated Approach — If Equipped

This feature activates the headlights for up to 90 seconds when the doors are unlocked with the RKE transmitter. The time for this feature is programmable on vehicles equipped with the EVIC. Refer to “Illuminated Approach,” under “Personal Settings (Customer-Programmable Features),” under “Electronic Vehicle Information Center (EVIC)” in Section 4.

To Lock The Doors And Liftgate

Press and release the LOCK button on the RKE transmitter to lock all doors and liftgate. The turn signal lights will flash and the horn will chirp to acknowledge the signal.

Sound Horn With Remote Key Lock

This feature will cause the horn to chirp when the doors are locked with the RKE transmitter. This feature can be turned on or turned off. To change the current setting, proceed as follows:

- For vehicles equipped with the EVIC, refer to “Sound Horn with Lock,” under “Personal Settings (Customer-Programmable Features),” under “Electronic Vehicle Information Center (EVIC)” in Section 4.

- For vehicles not equipped with the EVIC, perform the following steps:
 1. Press the LOCK button on a programmed RKE transmitter for at least 4 seconds, but no longer than 10 seconds. Then, press the PANIC button while still holding the LOCK button.
 2. Release both buttons at the same time.
 3. Test the feature while outside of the vehicle by pressing the LOCK button on the RKE transmitter with the ignition switch in the LOCK position and the key removed.
 4. Repeat these steps if you want to return this feature to its previous setting.

NOTE: Pressing the LOCK button on the RKE transmitter while you are in the vehicle will activate the Vehicle Security Alarm. Opening a door with the Vehicle Security Alarm activated will cause the alarm to sound. Press the UNLOCK button to deactivate the Vehicle Security Alarm.

Flash Lights With Remote Key Lock/Unlock

This feature will cause the turn signal lights to flash when the doors are locked or unlocked with the RKE transmitter. This feature can be turned on or turned off. To change the current setting, proceed as follows:

- For vehicles equipped with the EVIC, refer to “Flash Light With Lock,” under Personal Settings (Customer-Programmable Features),” under “Electronic Vehicle Information Center (EVIC)” in Section 4.

- For vehicles not equipped with the EVIC, perform the following steps:

1. Press and hold the UNLOCK button on a programmed RKE transmitter for at least 4 seconds, but no longer than 10 seconds. Then, press and hold the LOCK button while still holding the UNLOCK button.

2. Release both buttons at the same time.

3. Test the feature while outside of the vehicle by pressing the LOCK/UNLOCK buttons on the RKE transmitter with the ignition switch in the LOCK position and the key removed.

4. Repeat these steps if you want to return this feature to its previous setting.

NOTE: Pressing the LOCK button on the RKE transmitter while you are in the vehicle will activate the Vehicle Security Alarm. Opening a door with the Vehicle Security

Alarm activated will cause the alarm to sound. Press the UNLOCK button to deactivate the Vehicle Security Alarm.

Using The Panic Alarm

To turn the Panic Alarm feature ON or OFF, press and hold the PANIC button on the RKE transmitter for at least one second and release. When the Panic Alarm is on, the headlights and park lights will flash, the horn will pulse on and off and the interior lights will turn on.

The Panic Alarm will stay on for three minutes unless you turn it off by pressing the PANIC button a second time or if the vehicle speed is 5 mph (8 km/h) or greater.

NOTE: When you turn off the Panic Alarm by pressing the PANIC button a second time, you may have to be closer to the vehicle due to the radio frequency noises of the system.

Programming Additional RKE Transmitters

Refer to Sentry Key® “Customer Key Programming.”

If you do not have a programmed RKE transmitter, contact your authorized dealer for details.

General Information

This device complies with Part 15 of FCC rules and with RS-210 of Industry Canada. Operation is subject to the following conditions:

1. This device may not cause harmful interference.
2. This device must accept any interference that may be received including interference that may cause undesired operation.

NOTE: Changes or modifications not expressly approved by the party responsible for compliance could void the user’s authority to operate the equipment.

If your RKE transmitter fails to operate from a normal distance, check for these two conditions:

1. Weak batteries in the RKE transmitter. The expected life of batteries is five years.
2. Closeness to a radio transmitter such as a radio station tower, airport transmitter, military base, and some mobile or CB radios.

RKE Transmitter Battery Replacement

NOTE: Perchlorate Material – special handling may apply. See “www.dtsc.ca.gov/hazardouswaste/perchlorate.”

The recommended replacement battery is CR2032.

1. If the RKE transmitter is equipped with a screw, remove the screw. With the RKE transmitter buttons facing down, use a flat blade to pry the two halves of the RKE transmitter apart. Make sure not to damage the elastomer seal during removal.

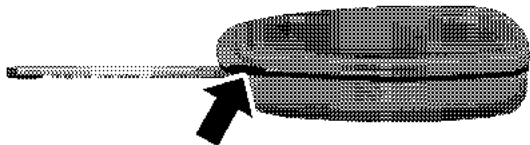

Separating RKE Transmitter Halves

81182c72

2. Remove and replace the batteries. Avoid touching the new batteries with your fingers. Skin oils may cause battery deterioration. If you touch a battery, clean it with rubbing alcohol.

3. To reassemble the RKE transmitter case, snap the two halves together.

NOTE: If the RKE transmitter is equipped with a screw, reinstall and tighten the screw until snug.

DOOR LOCKS

Manual Door Locks

Use the manual door lock plunger to lock the doors from inside the vehicle. If the plunger is down when the door is closed, the door will lock. Make sure the keys are not inside the vehicle before closing the door.

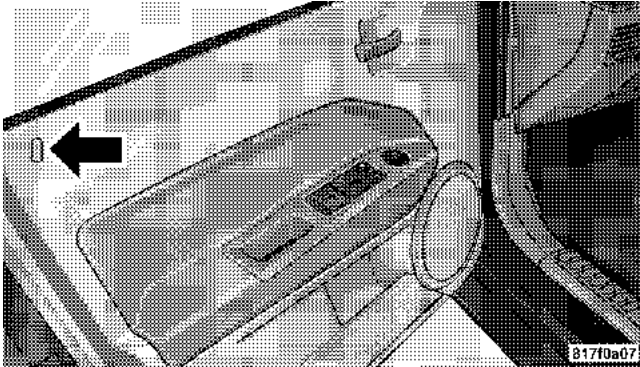

Manual Door Lock Plunger

WARNING!

- For personal security and safety in the event of an accident, lock the vehicle doors as you drive as well as when you park and leave the vehicle.

(Continued)

WARNING! (Continued)

- When leaving the vehicle, always remove the key from the ignition lock and lock your vehicle. Do not leave unattended children in the vehicle or with access to an unlocked vehicle. Unsupervised use of vehicle equipment may cause severe personal injuries and death.

CAUTION!

An unlocked vehicle is an invitation to thieves. Always remove the key from the ignition and lock all of the doors when leaving the vehicle unattended.

Power Door Locks

A power door lock switch is located on the driver's door panel. Press this switch to lock or unlock the doors and liftgate.

NOTE: To prevent from locking the key in the vehicle, the power door lock switch will not operate when the key is in the ignition and either front door is open. A chime will sound as a reminder to remove the key.

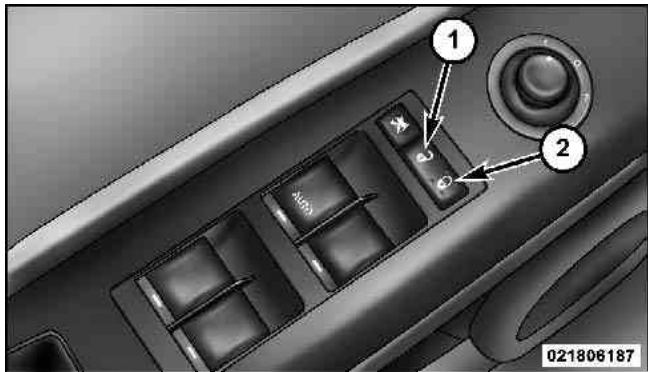

Driver Power Door Lock Switch

1 - Unlock

2 - Lock

Automatic Door Locks — If Equipped

The doors will lock automatically on vehicles with power door locks if all of the following conditions are met:

1. The Auto Lock feature is enabled.
2. The transmission is in gear.
3. All doors are closed.
4. The throttle is pressed.
5. The vehicle speed is above 15 mph (24 km/h), and
6. The doors were not previously locked using the power door lock switch or Remote Keyless Entry (RKE) transmitter.

Automatic Door Locks Programming

The Automatic Door Locks feature can be enabled or disabled as follows:

- For vehicles equipped with the Electronic Vehicle Information Center (EVIC), refer to “Personal Settings (Customer-Programmable Features)” under “Electronic Vehicle Information Center (EVIC) — If Equipped” in Section 4.
- For vehicles not equipped with the EVIC, perform the following procedure:
 1. Close all doors and place the key in the ignition switch.
 2. Within 15 seconds, cycle the ignition switch between LOCK and ON and then back to LOCK four times ending up in the LOCK position (do not start the engine).
 3. Within 30 seconds, depress the power door LOCK switch to lock the doors.

4. A single chime will indicate the completion of the programming.

5. Repeat these steps if you want to return this feature to its previous setting.

NOTE:

- If you do not hear the chime it means that the system did not enter the programming mode and you will need to repeat the procedure.
- Use the Automatic Door Locks feature in accordance with local laws.

Automatic Unlock Doors on Exit

The doors will unlock automatically if:

1. The Automatic Unlock Doors On Exit feature is enabled.
2. The transmission was in gear and the vehicle speed returned to 0 mph (0 km/h).

3. The transmission is in NEUTRAL or PARK.
4. The driver's door is opened.
5. The doors were not previously unlocked.

Automatic Unlock Doors on Exit Programming

The Automatic Unlock Doors On Exit feature can be enabled or disabled as follows:

- For vehicles equipped with the EVIC, refer to “Personal Settings (Customer-Programmable Features)” under “Electronic Vehicle Information Center (EVIC) – If Equipped” in Section 4.
- For vehicles not equipped with the EVIC, perform the following procedure:
 1. Close all doors and place the key in the ignition.
 2. Within 15 seconds, cycle the ignition switch between LOCK and ON and then back to LOCK four times ending up in the LOCK position (do not start the engine).

3. Within 30 seconds, depress the power door UNLOCK switch to unlock the doors.
4. A single chime will indicate the completion of the programming.
5. Repeat these steps if you want to return this feature to its previous setting.

NOTE:

- If you do not hear the chime it means that the system did not enter the programming mode and you will need to repeat the procedure.
- Use the Automatic Unlock Doors On Exit feature in accordance with local laws.

Child-Protection Door Lock System (Rear Doors) — If Equipped

Insert the tip of the ignition key into the lock and rotate to the LOCK or UNLOCK position.

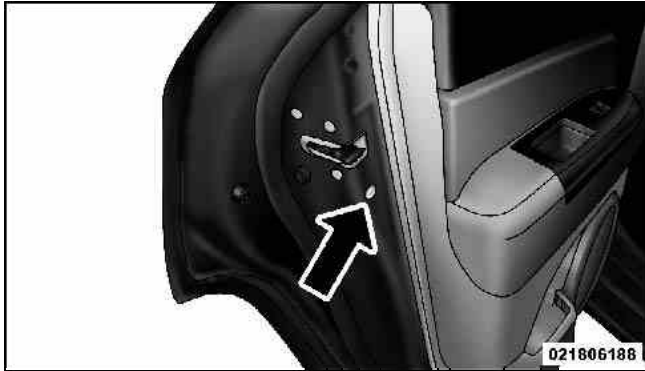

Child-Protection Door Lock Location



Child-Protection Door Lock Function

WARNING!

Avoid trapping anyone in a vehicle in a collision. Remember that the rear doors can only be opened from the outside when the child protection locks are engaged.

NOTE: For emergency exit with the system engaged, move the lock plunger up (unlocked position), roll down the window and open the door with the outside door handle.

POWER WINDOWS — IF EQUIPPED

Power Window Switches

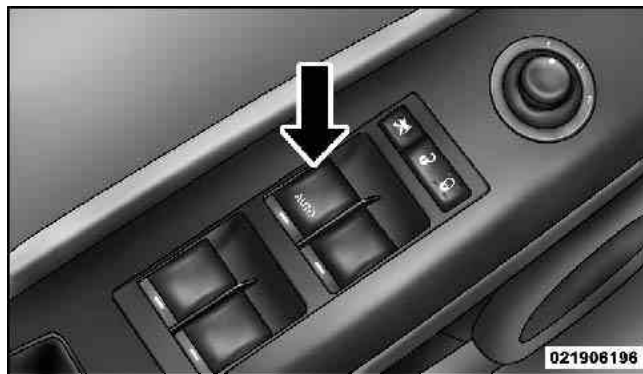

Power Window Switch Location

The window controls on the driver's door trim panel control all the door windows. There are single window

controls on each passenger door trim panel, which operate the passenger door windows. The window controls will operate when the ignition switch is in the ON or ACC position.

NOTE:

- For vehicles not equipped with the Electronic Vehicle Information Center (EVIC), the power window switches will remain active for 45 seconds after the ignition switch is turned to the LOCK position. Opening either front door will cancel this feature.
- For vehicles equipped with the EVIC, the power window switches will remain active for up to 10 minutes after the ignition switch is turned to the LOCK position. Opening either front door will cancel this feature. The time for this feature is programmable. Refer to “Delay Power Off to Accessories Until Exit”

under “Personal Settings (Customer-Programmable Features)” in the “Electronic Vehicle Information Center (EVIC),” in Section 4 of this manual.

WARNING!

Never leave children in a vehicle with the key in the ignition switch. Occupants, particularly unattended children, can become entrapped by the windows while operating the power WINDOW switches. Such entrapment may result in serious injury or death.

Auto Down

The driver's door window switch has an Auto Down feature. Push the window switch past the first detent, release, and the window will go down automatically. To cancel the Auto Down movement, operate the switch in either the up or down direction and release the switch.

Window Lockout Switch

The window lockout switch on the driver's door allows you to disable the window control on the other doors. To disable the window controls on the other doors, press the window LOCKOUT switch. To enable the window controls, press the window LOCKOUT switch a second time.



Window Lockout Switch

LIFTGATE

NOTE: The key that is used to start your vehicle is also used to lock or unlock the doors and open the liftgate.

To unlock the liftgate, insert the key into the lock and turn it to the right (manual lock models only). The liftgate can also be unlocked using the Remote Keyless Entry (RKE) transmitter or by activating the power door lock switches located on the front doors. The central locking/unlocking feature (if equipped) can also be activated from the liftgate key cylinder.

Once unlocked, the liftgate can be opened or closed without using the key. To open the liftgate, squeeze the liftgate release and pull the liftgate open with one fluid motion.

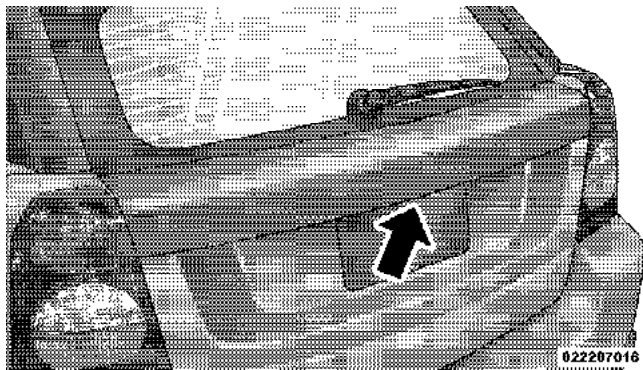

Liftgate Handle

NOTE:

- In the event of a power malfunction, or the RKE transmitter is inoperative, insert the key into the liftgate lock cylinder and turn it to the right (manual lock models only). Using the liftgate handle, pull the liftgate open with one fluid motion.

- Although the liftgate has no inside release mechanism, the liftgate trim panel includes an opening with a snap-in cap that provides access to release the latch in the event of an electrical system malfunction.

2

WARNING!

- Driving with the liftgate open can allow poisonous exhaust gases into your vehicle. You and your passengers could be injured by these fumes. Keep the liftgate closed when you are operating the vehicle.
- If you are required to drive with the liftgate open, make sure that all windows are closed, and the climate control blower switch is set at high speed. **DO NOT** use the recirculation mode.

Gas props support the liftgate in the open position. However, because the gas pressure drops with temperature, it may be necessary to assist the props when opening the liftgate in cold weather.

OCCUPANT RESTRAINTS

Some of the most important safety features in your vehicle are the restraint systems. These include the front and rear seat belts for the driver and all passengers, front airbags for both the driver and front passenger and if equipped, side airbags for both the driver and front passenger. If you will be carrying children too small for adult-size seat belts, your seat belts or the LATCH feature also, can be used to hold infant and child restraint systems.

Please pay close attention to the information in this section. It tells you how to use your restraint system properly to keep you and your passengers as safe as possible.

WARNING!

In a collision, you and your passengers can suffer much greater injuries if you are not properly buckled up. You can strike the interior of your vehicle or other passengers, or you can be thrown out of the vehicle. Always be sure you and others in your vehicle are buckled up properly.

Even though you are an excellent driver, buckle up, even on short trips. Someone on the road may be a poor driver and cause a collision that includes you. This can happen far away from home or on your own street.

Research has shown that seat belts save lives, and they can reduce the seriousness of injuries in a collision. Some of the worst injuries happen when people are thrown

ejection and the risk of injury caused by striking the inside of the vehicle. **Everyone in a motor vehicle should be belted at all times.**

Lap/Shoulder Belts

All the seats in your vehicle are equipped with lap/shoulder belts.

The belt webbing retractor is designed to lock during very sudden stops or collisions. This feature allows the shoulder part of the belt to move freely with you under normal conditions. But in a collision, the belt will lock and reduce the risk of your striking the inside of the vehicle or being thrown out.

WARNING!

- **It is extremely dangerous to ride in a cargo area, inside or outside of a vehicle. In a collision, people riding in these areas are more likely to be seriously injured or killed.**
- **Do not allow people to ride in any area of your vehicle that is not equipped with seats and seat belts.**
- **Be sure everyone in your vehicle is in a seat and using a seat belt properly.**
- **Wearing a seat belt incorrectly is dangerous. Seat belts are designed to go around the large bones of your body. These are the strongest parts of your body and can take the forces of a collision the best.**

(Continued)

WARNING! (Continued)

- Wearing your belt in the wrong place could make your injuries in a collision much worse. You might suffer internal injuries, or you could even slide out of part of the belt. Follow these instructions to wear your seat belt safely and to keep your passengers safe, too.
- Two people should never be belted into a single seat belt. People belted together can crash into one another in an accident, hurting one another badly. Never use a lap/shoulder belt or lap belt for more than one person, no matter what their size.

Lap/Shoulder Belt Operating Instructions

1. Enter the vehicle and close the door. Sit back and adjust the seat.

2. The seat belt latch plate is above the back of the front seat, next to your arm. Grasp the latch plate and pull out the belt. Slide the latch plate up the webbing as far as necessary to allow the belt to go around your lap.

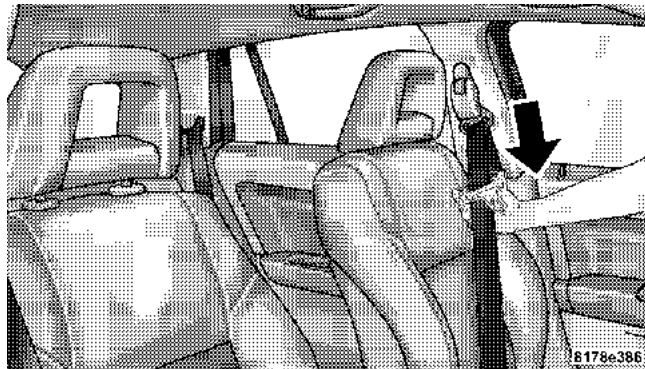

Pulling Out the Latch Plate

3. When the belt is long enough to fit, insert the latch plate into the buckle until you hear a “click.”

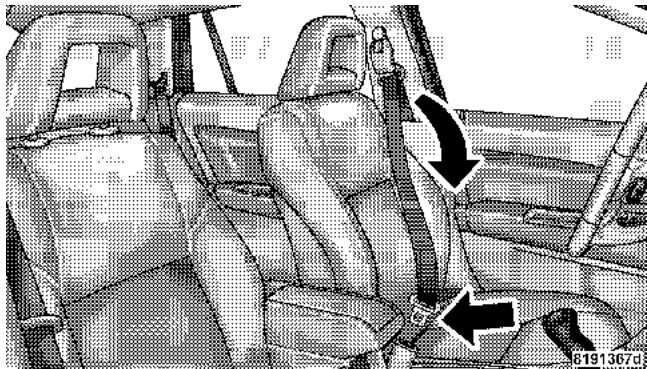

Inserting Latch Plate into Buckle

WARNING!

- A belt that is buckled into the wrong buckle will not protect you properly. The lap portion could ride too high on your body, possibly causing internal injuries. Always buckle your belt into the buckle nearest you.
- A belt that is too loose will not protect you as well. In a sudden stop you could move too far forward, increasing the possibility of injury. Wear your seat belt snugly.

(Continued)

WARNING! (Continued)

- A belt that is worn under your arm is very dangerous. Your body could strike the inside surfaces of the vehicle in a collision, increasing head and neck injury. A belt worn under the arm can cause internal injuries. Ribs aren't as strong as shoulder bones. Wear the belt over your shoulder so that your strongest bones will take the force in a collision.
- A shoulder belt placed behind you will not protect you from injury during a collision. You are more likely to hit your head in a collision if you do not wear your shoulder belt. The lap and shoulder belt are meant to be used together.

4. Position the lap belt across your thighs, below your abdomen. To remove slack in the lap belt portion, pull up on the shoulder belt. To loosen the lap belt if it is too tight, tilt the latch plate and pull on the lap belt. A snug belt reduces the risk of sliding under the belt in a collision.

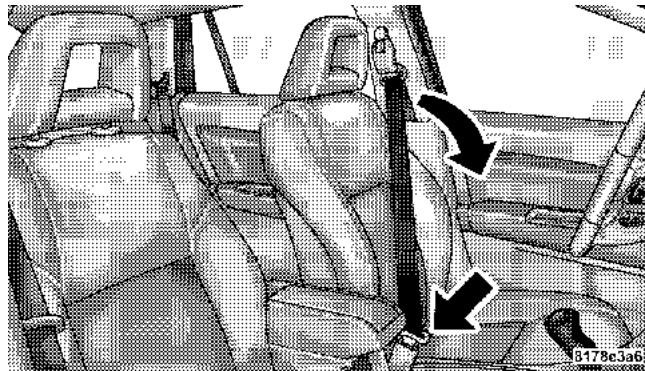

Positioning Lap Belt

WARNING!

- **A lap belt worn too high can increase the risk of internal injury in a collision. The belt forces won't be at the strong hip and pelvic bones, but across your abdomen. Always wear the lap belt as low as possible and keep it snug.**
- **A twisted belt can't do its job as well. In a collision it could even cut into you. Be sure the belt is straight. If you can't straighten a belt in your vehicle, take it to your authorized dealer and have it fixed.**

5. Position the shoulder belt on your chest so that it is comfortable and not resting on your neck. The retractor will withdraw any slack in the belt.

6. To release the belt, push the red button on the buckle. The belt will automatically retract to its stowed position. If necessary, slide the latch plate down the webbing to allow the belt to retract fully.

WARNING!

A frayed or torn belt could rip apart in a collision and leave you with no protection. Inspect the belt system periodically, checking for cuts, frays, or loose parts. Damaged parts must be replaced immediately. Do not disassemble or modify the system. Seat belt assemblies must be replaced after a collision if they have been damaged (bent retractor, torn webbing, etc.).

Adjustable Upper Shoulder Belt Anchorage

In the front seat, the shoulder belt can be adjusted upward or downward to position the belt away from your neck. Push the anchorage button to release the anchorage, and move it up or down to the position that fits you best.

NOTE: The adjustable upper shoulder belt anchorage is equipped with an Easy Up feature. This feature allows the shoulder belt anchorage to be adjusted in the upward position without pressing the release button. To verify the shoulder belt anchorage is latched, pull downward on the shoulder belt anchorage until it is locked into position.

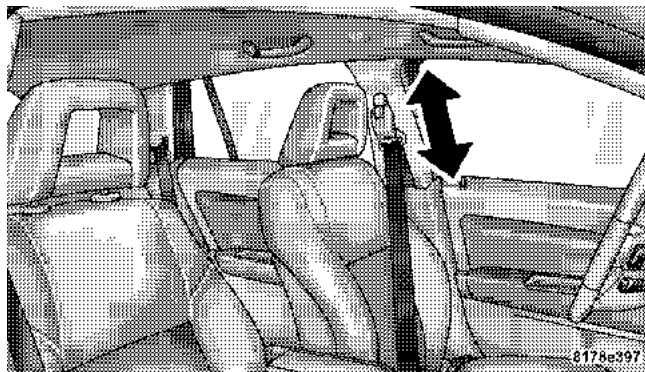

Adjustable Anchorage

As a guide, if you are shorter than average, you will prefer a lower position, and if you are taller than average, you'll prefer a higher position. When you release the anchorage, try to move it down to make sure that it is locked in position.

Second Row Center Lap/Shoulder Belt Operating Instructions

The second row center lap/shoulder belt features a three point seat belt with a mini-latch and buckle, which allows the shoulder belt to detach from the lower anchor when the seat is folded. The mini-buckle and shoulder belt can then be stored out of the way in the right side trim panel for added convenience.

1. Remove the mini-latch and regular latch from its stowed position in the right rear side trim panel.

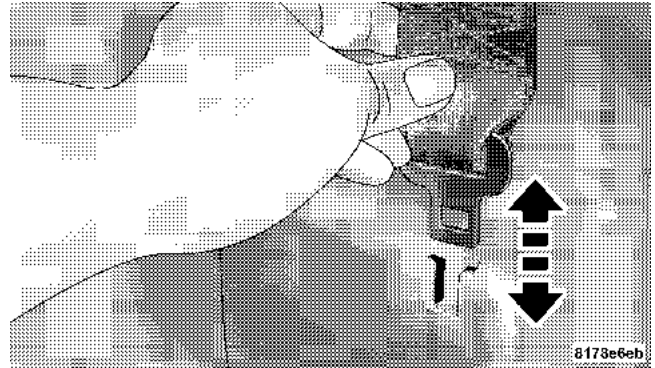

Mini-Latch Stowage

2. Grasp the mini-latch plate and pull the belt over the seat.
3. Route the shoulder belt to the inside of the right head restraint.

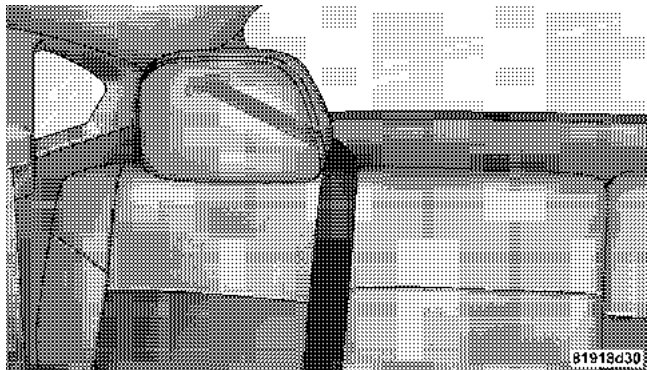

Routing the Rear Center Shoulder Belt

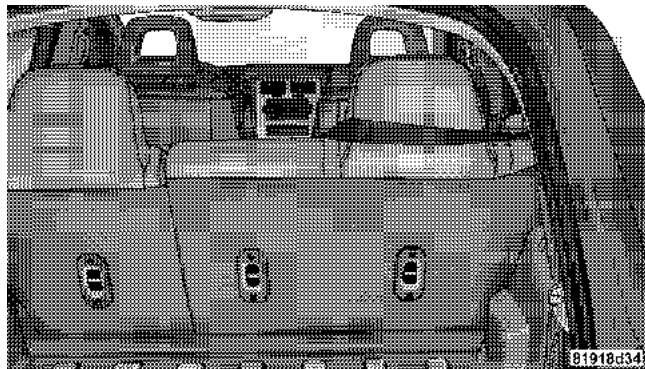

Routing the Rear Center Shoulder Belt

4. When the belt is long enough to fit, insert the mini-latch plate into the mini-buckle until you hear a “click.”
5. Sit back in seat. Slide the regular latch plate up the webbing as far as necessary to allow the belt to go around your lap.

6. When the belt is long enough to fit, insert the latch plate into the buckle until you hear a “click.”

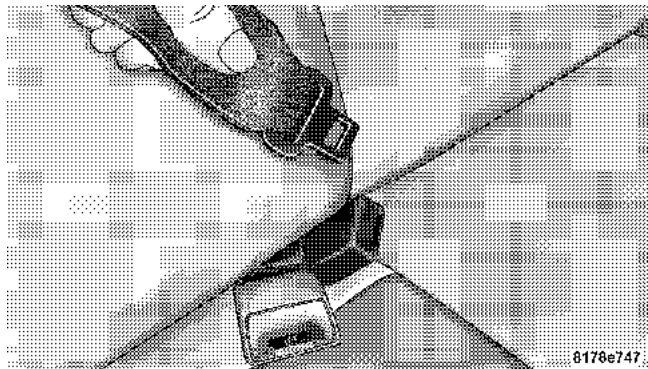

Connecting Mini-Latch to Buckle

7. Position the lap belt across your thighs, below your abdomen. To remove slack in the lap belt portion, pull up

on the shoulder belt. To loosen the lap belt if it is too tight, pull on the lap belt. A snug belt reduces the risk of sliding under the belt in a collision.

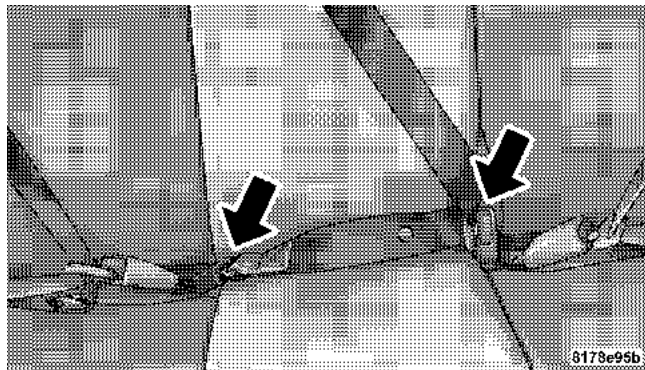

Rear Center Seat Belt Buckled

8. Position the shoulder belt on your chest so that it is comfortable and not resting on your neck. The retractor will withdraw any slack in the belt.

9. To release the belt, push the red button on the buckle.

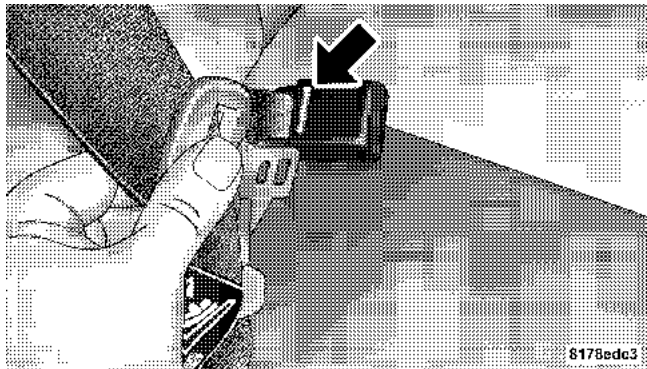

Detaching Mini-Latch And Buckle

10. To disengage the mini-latch from the mini-buckle for storage, insert the regular latch plate into the black button on the top of the mini-buckle. The belt will automatically retract to its stowed position. If necessary,

slide the latch plate down the webbing to allow the belt to retract fully. Insert the mini-latch plate into the slot provided in the trim panel.

Seat Belt Pretensioners

The seat belts for both front seating positions are equipped with pretensioning devices that are designed to remove slack from the seat belt in the event of a collision. These devices improve the performance of the seat belt by assuring that the belt is tight about the occupant early in a collision. Pretensioners work for all size occupants, including those in child restraints.

NOTE: These devices are not a substitute for proper seat belt placement by the occupant. The seat belt still must be worn snugly and positioned properly.

The pretensioners are triggered by the front airbag control module (see Driver and Front Passenger Supplemental Restraint System (SRS) — Airbag Section). Like the

front airbags, the pretensioners are single use items. After a collision that is severe enough to deploy the airbags and pretensioners, both must be replaced.

Enhanced Seat Belt Use Reminder System (BeltAlert®)

If the driver's seat belt has not been buckled within 60 seconds of starting the vehicle and if the vehicle speed is greater than 5 mph (8 km/h), the Enhanced Seat Belt Use Reminder System (BeltAlert®) will alert the driver to buckle their seat belt. The driver should also instruct all other occupants to buckle their seat belts. Once the warning is triggered, BeltAlert® will continue to chime and flash the Seat Belt Reminder Light for 96 seconds or until the driver's seat belt is buckled. BeltAlert® will be reactivated if the driver's seat belt is unbuckled for more than 10 seconds and the vehicle speed is greater than 5 mph (8 km/h).

BeltAlert® Programming

BeltAlert® can be enabled or disabled by your authorized dealer or by performing the following procedure:

NOTE: The following steps must occur within the first 60 seconds of the ignition switch being turned to the ON or START position. Chrysler LLC does not recommend deactivating BeltAlert®.

1. Turn the ignition switch to the LOCK position and buckle the driver's or front passenger's seat belt.
2. Turn the ignition switch to the ON position and wait for the Seat Belt Reminder Light to turn off.
3. Within 60 seconds of turning the ignition switch to the ON position, unbuckle and then re-buckle the driver's or front passenger's seat belt at least three times within 10 seconds, ending with the seat belt buckled.

NOTE: Watch for the Seat Belt Reminder Light to turn on while unbuckling and off while re-buckling the seat belt. It may be necessary to retract the seat belt.

4. Turn the ignition switch to the LOCK position. A single chime will sound to signify that you have successfully completed the programming.

BeltAlert® can be reactivated by repeating this procedure.

NOTE: Although BeltAlert® has been deactivated, the Seat Belt Reminder Light will continue to illuminate while the driver's or front passenger's seat belt remains unbuckled.

Seat Belts And Pregnant Women

We recommend that pregnant women use the seat belts throughout their pregnancy. Keeping the mother safe is the best way to keep the baby safe.

Pregnant women should wear the lap part of the belt across the thighs and as snug across the hips as possible. Keep the belt low so that it does not come across the abdomen. That way the strong bones of the hips will take the force if there is a collision.

Driver And Front Passenger Supplemental Restraint System (SRS) — Airbag

This vehicle has airbags for both the driver and front passenger as a supplement to the seat belt restraint systems. The driver's front airbag is mounted in the center of the steering wheel. The passenger's front airbag is mounted in the instrument panel, above the glove compartment. The words SRS AIRBAG are embossed on the airbag covers.

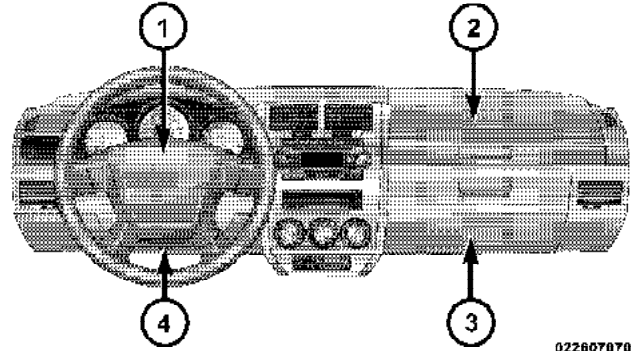

022607070

Airbag and Knee Bolster Location

- | | |
|-------------------|----------------------|
| 1 — Driver Airbag | 2 — Passenger Airbag |
| 3 — Knee Bolster | 4 — Knee Bolster |

NOTE: The front airbags are certified to the Federal regulations that allow less forceful deployment.

The front airbags have a multistage inflator design. This may allow the airbag to have different rates of inflation that are based on collision severity.

This vehicle may also be equipped with side curtain airbags to protect the driver and passengers sitting next to a window. If the vehicle is equipped with side curtain airbags, they are located above the side windows. Their covers are also labeled SRS AIRBAG.

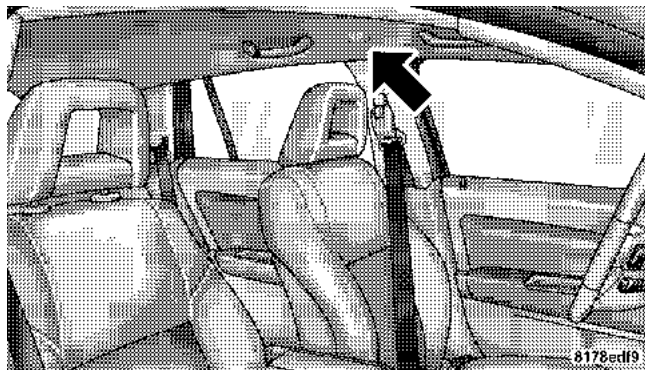

Side Curtain Airbag Location

WARNING!

- Do not put anything on or around the airbag covers or attempt to manually open them. You may damage the airbags and you could be injured because the airbags are not there to protect you. These protective covers for the airbag cushions are designed to open only when the airbags are inflating.
- If your vehicle is equipped with side airbags, do not use accessory seat covers or place objects between you and the side airbags; the performance could be adversely affected and/or objects could be pushed into you, causing serious injury.

(Continued)

WARNING! (Continued)

- If your vehicle is equipped with side airbags, do not attach cup holders or any other objects on or around the door. The inflating side airbag could drive the object into occupants, causing serious injury.

Airbags inflate in moderate to high speed impacts. Along with seat belts and pretensioners, front airbags work with the driver inflatable knee blocker and the integrated passenger knee blocker (non-inflatable) to provide improved protection for the driver and front passenger. Side airbags also work with seat belts to improve occupant protection.

The seat belts are designed to protect you in many types of collisions. The front airbags deploy in moderate to severe frontal collisions. If your vehicle is equipped, the side airbag on the crash side of the vehicle is triggered in

moderate to severe side collisions. In certain types of collisions, both the front and side airbags may be triggered. But even in collisions where the airbags work, you need the seat belts to keep you in the right position for the airbags to protect you properly.

Here are some simple steps you can take to minimize the risk of harm from a deploying airbag:

- 1. Children 12 years old and younger should always ride buckled up in the rear seat.**

WARNING!

Infants in rear-facing child restraints should NEVER ride in the front seat of a vehicle with a passenger front airbag. An airbag deployment can cause severe injury or death to infants in that position.

Children who are not big enough to wear the vehicle seat belt properly (see Section on Child Restraints) should be

secured in the rear seat in child restraints or belt-positioning booster seats. Older children who do not use child restraints or belt-positioning booster seats should ride properly buckled up in the rear seat. Never allow children to slide the shoulder belt behind them or under their arms.

If a child from 1 to 12 years old must ride in the front passenger seat because the vehicle is crowded, move the seat as far back as possible and use the proper child restraint. Refer to the Section on Child Restraints.

You should read the instructions provided with your child restraint to make sure that you are using it properly.

- 2. All occupants should wear their lap and shoulder belts properly.**
- 3. The driver and front passenger seats should be moved back as far as practical to allow the front airbags room to inflate.**

4. If your vehicle has side airbags, do not lean against the door; airbags will inflate forcefully into the space between you and the door.

5. If the airbag system in this vehicle needs to be modified to accommodate a disabled person, contact the Customer Center. Phone numbers are provided under "If You Need Assistance" in Section 9 of this manual.

WARNING!

- Relying on the airbags alone could lead to more severe injuries in a collision. The airbags work with your seat belt to restrain you properly. In some collisions, the airbags won't deploy at all. Always wear your seat belt even though you have airbags.

(Continued)

WARNING! (Continued)

- Being too close to the steering wheel or instrument panel during front airbag deployment could cause serious injury. Airbags need room to inflate. Sit back, comfortably extending your arms to reach the steering wheel or instrument panel.
- If the vehicle has side airbags, they also need room to inflate. Do not lean against the door. Sit upright in the center of the seat.

The front airbag system consists of the following:

- Occupant Restraint Controller (ORC)
- Side Remote Acceleration Sensors (If Equipped)
- Airbag Warning Light
- Driver Airbag
- Front Passenger Airbag

- Supplemental Side Curtain Airbags Above Side Windows (If Equipped)
- Steering Wheel and Column
- Instrument Panel
- Interconnecting Wiring
- Seat Belt Reminder Light
- Knee Impact Bolsters
- Driver Inflatable Knee Blocker
- Front Acceleration Sensors
- Driver and Front Passenger Seat Belt Pretensioners

How The Airbag System Works

- The **Occupant Restraint Controller (ORC)** determines if a frontal collision is severe enough to require the

airbags to inflate. The front airbag inflators are designed to provide different rates of airbag inflation from direction provided by the ORC. This ORC will detect roll over.

The ORC also monitors the readiness of the electronic parts of the system whenever the ignition switch is in the START or ON position. These include all of the items listed above except the knee bolster, the instrument panel, and the steering wheel and column. If the key is in the LOCK position, in the ACC position, or not in the ignition, the airbags are not on and will not inflate.



- The ORC also turns on the Airbag Warning Light in the instrument panel for six to eight seconds as a self-check when the ignition is first turned on. After the self-check, the Airbag Warning Light will turn off. If the ORC detects a malfunction in any part of the system, it turns on the

Airbag Warning Light either momentarily or continuously. A single chime will sound if the light comes on again after initial start up.

WARNING!

Ignoring the AIRBAG Warning Light in your instrument panel could mean you won't have the airbags to protect you in a collision. If the light does not come on, stays on after you start the vehicle, or if it comes on as you drive, have the airbag system checked right away.

may be possible based on collision severity and occupant size. The steering wheel hub trim cover and the upper right side of the instrument panel separate and fold out of the way as the bags inflate to their full size. The bags fully inflate in about 50 - 70 milliseconds. This is about half of the time it takes to blink your eyes. The bags then quickly deflate while helping to restrain the driver and front passenger. The driver's front airbag gas is vented through vent holes in the sides of the airbag. The passenger's front airbag gas is vented through vent holes in the sides of the airbag. In this way, the airbags do not interfere with your control of the vehicle.

- The **Driver and Passenger Airbag/Inflator Units** are located in the center of the steering wheel and the right side of the instrument panel. When the ORC detects a collision requiring the airbags, it signals the inflator units. A large quantity of nontoxic gas is generated to inflate the front airbags. Different airbag inflation rates
- The **Side Impact (SRS) Side Curtain Airbags (If Equipped)** are designed to activate only in certain side collisions.

The ORC module determines if a side collision is severe enough to require the side airbags to inflate. The side airbag control module will not detect roll over, front or rear collisions.

The ORC module monitors the readiness of the electronic parts of the system whenever the ignition switch is in the START or ON position. These include all of the items previously mentioned.

In moderate to severe side collisions, the side airbag inflator on the crash side of the vehicle is triggered, releasing a quantity of nontoxic gas. The side curtain airbag moves at a very high speed and with such a high force, that it could injure you if you are not seated properly, or if items are positioned in the area where the side curtain airbag inflates. This especially applies to children.

NOTE: If your vehicle is equipped with left and right side curtain airbags, do not install a clothing bar

mounted to the coat hooks (or similarly mounted). A clothing bar will impede the proper performance of the bags.

- When the ORC and the impact sensors detect a collision requiring the **Driver Inflatable Knee Blocker**, it signals the inflator unit. A quantity of nontoxic gas is generated to inflate the Driver Inflatable Knee Blocker. The Driver Inflatable Knee Blocker inflates rearward toward the driver's knees to help protect the knees and position the driver for the best interaction with the front airbag. The Driver Inflatable Knee Blocker fully inflates in about 50 milliseconds; this is only about half of the time it takes you to blink your eyes. It then quickly deflates while helping to protect the driver's knees.
- The **Knee Impact Bolsters** help protect the knees and position everyone for the best interaction with the front airbag.

WARNING!

Unapproved modifications or service procedures to the front passenger seat assembly, its related components, or seat cover may inadvertently change the airbag deployment in case of a frontal crash. This could result in death or serious injury to the front seat passenger if the vehicle is involved in an accident. A modified vehicle may not comply with required Federal Motor Vehicle Safety Standards (FMVSS).

If A Deployment Occurs

The airbag systems are designed to deploy when the airbag control modules detect a moderate-to-severe collision. They help restrain the driver and front passenger and then they immediately deflate.

NOTE: A frontal collision that is not severe enough to need airbag protection will not activate the system. This does not mean something is wrong with the airbag system.

If you do have a collision which deploys the airbags, any or all of the following may occur:

- The nylon airbag material may sometimes cause abrasions and/or skin reddening to the driver and front passenger as the airbags deploy and unfold. The abrasions are similar to friction rope burns or those you might get sliding along a carpet or gymnasium floor. They are not caused by contact with chemicals. They are not permanent and normally heal quickly. However, if you haven't healed significantly within a few days, or if you have any blistering, see your doctor immediately.

- As the airbags deflate you may see some smoke-like particles. The particles are a normal by-product of the process that generates the nontoxic gas used for airbag inflation. These airborne particles may irritate the skin, eyes, nose, or throat. If you have skin or eye irritation, rinse the area with cool water. For nose or throat irritation, move to fresh air. If the irritation continues, see your doctor. If these particles settle on your clothing, follow the garment manufacturer's instructions for cleaning.
- It is not advisable to drive your vehicle after the airbags have deployed. If you are involved in another collision, the airbags will not be in place to protect you.

WARNING!

Deployed airbags can't protect you in another collision. Have the airbags replaced by an authorized dealer as soon as possible.

Enhanced Accident Response System

In the event of an impact that causes airbag deployment, with the vehicle stopped, the vehicle communication network intact, and the power intact, the Enhanced Accident Response System performs the following functions:

- Cuts off fuel to the engine.
- Flashes the hazard lights.
- Turns on the interior lights, which remain on as long as the battery has power or until the ignition key is removed.
- Unlocks the doors automatically.

Maintaining Your Airbag System

WARNING!

- **Modifications to any part of the airbag system could cause it to fail when you need it. You could be injured because the airbags are not there to protect you. Do not modify the components or wiring, including adding any kind of badges or stickers to the steering wheel hub trim cover or the upper passenger side of the instrument panel. Do not modify the front bumper, vehicle body structure, or frame.**
- **You need proper knee impact protection in a collision. Do not mount or locate any aftermarket equipment on or behind the knee impact bolster.**
- **It is dangerous to try to repair any part of the airbag system yourself. Be sure to tell anyone who works on your vehicle that it has airbags.**

Airbag Warning Light



You will want to have the airbags ready to inflate for your protection in an impact. While the airbag system is designed to be maintenance free, if any of the following occurs, have an authorized dealer service the system promptly:

- The Airbag Warning Light does not come on or flickers during the six to eight seconds when the ignition switch is first turned on.
- The light remains on or flickers after the six to eight second interval.
- The light flickers or comes on and remains on while driving.

Event Data Recorder (EDR)

In the event of an accident, your vehicle is designed to record up to five seconds of specific vehicle data parameters (see list below) in an event data recorder prior to the

moment of airbag deployment, or near-deployment, and up to a quarter second of high-speed deceleration data during and/or after air bag deployment or near-deployment. EDR data are ONLY recorded if an airbag deploys, or nearly deploys, and are otherwise unavailable.

NOTE:

1. A near-deployment event occurs when the airbag sensor detects severe vehicle deceleration usually indicative of a crash, but not severe enough to warrant airbag deployment.
2. Under certain circumstances, EDR data may not be recorded (e.g., loss of battery power).

In conjunction with other data gathered during a complete accident investigation, the electronic data may be used by Chrysler LLC and others to learn more about the possible causes of crashes and associated injuries in order to assess and improve vehicle performance. In addition

to crash investigations initiated by Chrysler LLC, such investigations may be requested by customers, insurance carriers, government officials, and professional crash researchers, such as those associated with universities, and with hospital and insurance organizations.

In the event that an investigation is undertaken by Chrysler LLC (regardless of initiative), the company or its designated representative will first obtain permission of the appropriate custodial entity for the vehicle (usually the vehicle owner or lessee) before accessing the electronic data stored, unless ordered to download data by a court with legal jurisdiction (i.e., pursuant to a warrant). A copy of the data will be provided to the custodial entity upon request. General data that does not identify particular vehicles or crashes may be released for incorporation in aggregate crash databases, such as those maintained by the U.S. government and various states. Data of a potentially sensitive nature, such as would identify a

particular driver, vehicle, or crash, will be treated confidentially. Confidential data will not be disclosed by Chrysler LLC to any third party except when:

1. Used for research purposes, such as to match data with a particular crash record in an aggregate database, provided confidentiality of personal data is thereafter preserved
2. Used in defense of litigation involving a Chrysler LLC product
3. Requested by police under a legal warrant
4. Otherwise required by law

Data Parameters that May Be Recorded:

- Diagnostic trouble code(s) and warning lamp status for electronically-controlled safety systems, including the airbag system
- Airbag disable lamp status (if equipped)

- "Time" of airbag deployment (in terms of ignition cycles and vehicle mileage)
- Airbag deployment level (if applicable)
- Impact acceleration and angle
- Seat Belt status
- Brake status (service and parking brakes)
- Accelerator status (including vehicle speed)
- Engine control status (including engine speed)
- Transmission gear selection
- Cruise control status
- Traction/stability control status
- Tire pressure monitoring system status

Child Restraints

Everyone in your vehicle needs to be buckled up all the time, including babies and children. Every state in the United States and all Canadian provinces require that small children ride in proper restraint systems. This is the law, and you can be prosecuted for ignoring it.

Children 12 years and younger should ride properly buckled up in a rear seat, if available. According to crash statistics, children are safer when properly restrained in the rear seats rather than in the front.

WARNING!

In a collision, an unrestrained child, even a tiny baby, can become a missile inside the vehicle. The force required to hold even an infant on your lap could become so great that you could not hold the child, no matter how strong you are. The child and others could be badly injured. Any child riding in your vehicle should be in a proper restraint for the child's size.

Infants and Child Restraints

There are different sizes and types of restraints for children from newborn size to the child almost large enough for an adult safety belt. Always check the child seat owner's manual to ensure you have the correct seat for your child. Use the restraint that is correct for your child:

- Safety experts recommend that children ride rearward-facing in the vehicle until they are at least one year old and weigh at least 20 lbs (9 kg). Two types of child restraints can be used rearward-facing: infant carriers and convertible child seats. Both types of child restraints are held in the vehicle by the lap/shoulder belt or the LATCH child restraint anchorage system.
- The infant carrier is only used rearward-facing in the vehicle. It is recommended for children who weigh up to about 20 lbs (9 kg). Convertible child seats can be used either rearward-facing or forward-facing in the

vehicle. Convertible child seats often have a higher weight limit in the rearward-facing direction than infant carriers do, so they can be used rearward-facing by children who weigh more than 20 lbs (9 kg) but are less than one year old.

WARNING!

Rearward-facing child seats must NEVER be used in the front seat of a vehicle with a front passenger airbag. An airbag deployment could cause severe injury or death to infants in this position.

Older Children and Child Restraints

- Children who weigh more than 20 lbs (9 kg) and who are older than one year can ride forward-facing in the vehicle. Forward-facing child seats and convertible child seats used in the forward-facing direction are for children who weigh 20 to 40 lbs. (9 to 18 kg) and who

are older than one year. These child seats are also held in the vehicle by the lap/shoulder belt or the LATCH child restraint anchorage system.

- The belt-positioning booster seat is for children weighing more than 40 lbs (18 kg), but who are still too small to fit the vehicle's seat belts properly. If the child cannot sit with knees bent over the vehicle's cushion while the child's back is against the seatback; they should use a belt positioning booster seat. The child and booster seat are held in the vehicle by the lap/shoulder belt. (Some booster seats are equipped with a front shield and are held in the vehicle by the lap portion).

NOTE: For additional information, refer to www.seatcheck.org or call 1-866-SEATCHECK.

WARNING!

- **Improper installation can lead to failure of an infant or child restraint. It could come loose in a collision. The child could be badly injured or killed. Follow the manufacturer's directions exactly when installing an infant or child restraint.**
- **A rearward-facing child restraint should only be used in a rear seat. A rearward-facing child restraint in the front seat may be struck by a deploying passenger airbag which may cause severe or fatal injury to the infant.**

Here are some tips on getting the most out of your child restraint:

- Before buying any restraint system, make sure that it has a label certifying that it meets all applicable Safety

Standards. We also recommend that you make sure that you can install the child restraint in the vehicle where you will use it before you buy it.

- The restraint must be appropriate for your child's weight and height. Check the label on the restraint for weight and height limits.
- Carefully follow the instructions that come with the restraint. If you install the restraint improperly, it may not work when you need it.

The passenger seat belts are equipped with either cinching latch plates or seat belt retractors that can be switched to an automatic locking mode, which are designed to keep the lap portion tight around the child restraint so that it is not necessary to use a locking clip. If the seat belt has a cinching latch plate, pulling up on the shoulder portion of the lap/shoulder belt will tighten the belt. The cinching latch plate will keep the

belt tight; however, any seat belt system will loosen with time, so check the belt occasionally and pull it tight if necessary.

If the seat belt has a switchable retractor, it will have a distinctive label. To operate the switchable retractor, please refer to Automatic Locking Retractor (ALR) in this section.

- In the rear seat, you may have trouble tightening the lap/shoulder belt on the child restraint because the buckle or latch plate is too close to the belt path opening on the restraint. Disconnect the latch plate from the buckle and twist the short buckle end of the belt several times to shorten it. Insert the latch plate into the buckle with the release button facing out.
- If the belt still can't be tightened, or if by pulling and pushing on the restraint loosens the belt, disconnect the latch plate from the buckle, turn the latch plate

around, and insert the latch plate into the buckle again. If you still can't make the child restraint secure, try a different seating position.

- Buckle the child into the seat according to the child restraint manufacturer's directions.
- When your child restraint is not in use, secure it in the vehicle with the seat belt or remove it from the vehicle. Don't leave it loose in the vehicle. In a sudden stop or collision, it could strike the occupants or seat backs and cause serious personal injury.

Automatic Locking Retractor (ALR)

To operate the switchable retractor, pull the belt from the retractor until there is enough to allow you to pass through the child restraint and slide the latch plate into the buckle. Then pull on the belt until it is completely extended from the retractor. Allow the belt to return into

the retractor, pulling on the excess webbing to tighten the lap portion about the child restraint. Follow the instructions of the child restraint manufacture.

NOTE: To reset this feature, you must let all of the belt webbing return into the retractor. You will not be able to pull out more webbing until all of the webbing has been returned back into the retractor.

LATCH — Child Seat Anchorage System (Lower Anchors and Tether for Children)

WARNING!

Child restraint anchorages are designed to withstand only those loads imposed by correctly fitted child restraints. Under no circumstances are they to be used for adult seat belts, harnesses, or for attaching other items or equipment to the vehicle.

Your vehicle is equipped with the child restraint anchorage system called LATCH. The LATCH system provides for the installation of the child restraint without using the vehicle seat belt. All three rear seating positions have lower anchorages that are capable of accommodating LATCH-compatible child seats having flexible, webbing-mounted lower attachments. Child seats with fixed lower attachments must be installed in the outboard positions only. Regardless of the specific type of lower attachment, **NEVER** install LATCH-compatible child seats such that two seats share a common lower anchorage. If you are installing LATCH-compatible child restraints in adjacent rear seating positions, you can use the LATCH anchors or the vehicle's seat belt for the outboard position, but you must use the vehicle's seat belt at the center position. If your child restraints are not LATCH-compatible, you can only install the child restraints using the vehicle's seat belts. Please refer to "Installing the Child Restraint System" for typical installation instructions.

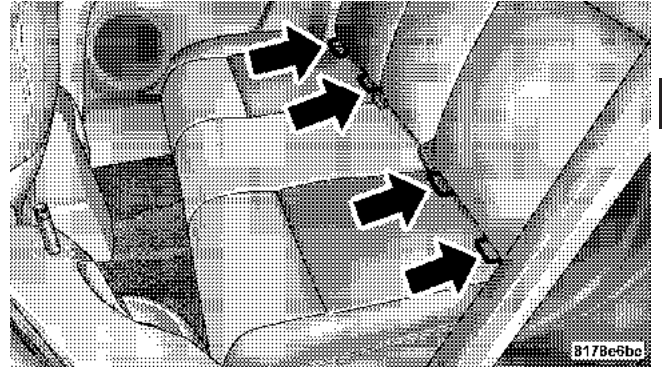

2

Rear Seat LATCH Anchorages

Child restraint systems having attachments designed to connect to the lower anchorages are now available. Child restraints having tether straps and hooks for connection to the top tether anchorage have been available for some time. In fact, many child restraint manufacturers will

provide add-on tether strap kits for some of their older products. Tether anchorage kits are also available for most older vehicles.

Because the lower anchorages are to be introduced to passenger carrying vehicles over a period of years, child restraint systems having attachments for those anchorages will continue to have features for installation in vehicles using the lap or lap/shoulder belt. They will also have tether straps, and you are urged to take advantage of all of the available attachments provided with your child restraint in any vehicle.

NOTE: When using the LATCH attaching system to install a child restraint, please ensure that all seat belts not being used for occupant restraints are stowed and out of reach of children. It is recommended that before installing the child restraint, buckle the seat belt so the seat belt is tucked behind the child restraint and out of reach. If the buckled seat belt interferes with the child

restraint installation, instead of tucking the seat belt behind the child restraint, route the seat belt through the child restraint belt path and then buckle it. This should stow the seat belt out of the reach of an inquisitive child. Remind all children in the vehicle that the seat belts are not toys and should not be played with, and never leave your unattended child in the vehicle.

Installing the Child Restraint System

We urge you to carefully follow the directions of the manufacturer when installing your child restraint. Many, but not all, restraint systems will be equipped with separate straps on each side, with each having a hook or connector and a means for adjusting the tension in the strap. Forward-facing toddler restraints and some rearward-facing infant restraints will also be equipped with a tether strap with a hook and means for adjusting the tension in the strap.

In general, you will first loosen the adjusters on the lower and tether straps so that you can more easily attach the hook or connector to the lower and tether anchorages. The tether strap should be routed under the center of the head restraint and attached to the tether anchor on the rear of the seat back. Then tighten all three straps as you push the child restraint rearward and downward into the seat.

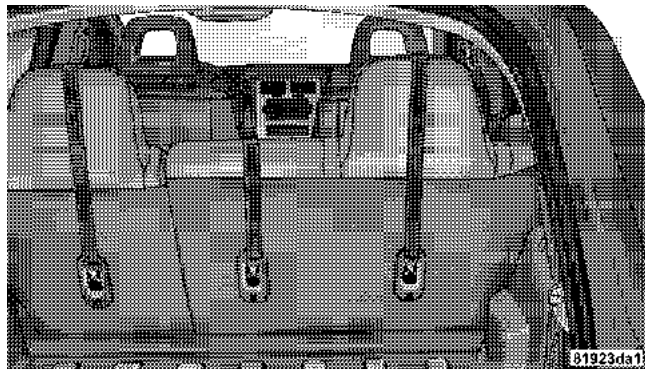

2

Rear Seat Tether Anchors

Not all child restraint systems will be installed as we have described here. Again, carefully follow the instructions that come with the child restraint system.

NOTE: If your child restraint seat is not LATCH-compatible, install the restraint using the vehicle seat belts.

WARNING!

An incorrectly anchored tether strap could lead to increased head motion and possible injury to the child. Use only the anchor position directly behind the child seat to secure a child restraint top tether strap.

Children Too Large For Booster Seats

Children who are large enough to wear the shoulder belt comfortably, and whose legs are long enough to bend over the front of the seat when their back is against the seatback, should use the lap/shoulder belt in a rear seat.

- Make sure that the child is upright in the seat.
- The lap portion should be low on the hips and as snug as possible.
- Check the belt fit periodically. A child's squirming or slouching can move the belt out of position.

- If the shoulder belt contacts the face or neck, move the child closer to the center of the vehicle. Never allow a child to put the shoulder belt under an arm or behind his/her back.

Transporting Pets

Airbags deploying in the front seat could harm your pet. An unrestrained pet will be thrown about and possibly injured, or could injure a passenger during panic braking or in a collision.

Pets should be restrained in the rear seat in pet harnesses or pet carriers that are secured by seat belts.

ENGINE BREAK-IN RECOMMENDATIONS

A long break-in period is not required for the engine in your vehicle.

Drive moderately during the first 300 miles (500 km). After the initial 60 miles (100 km), speeds up to 50 or 55 mph (80 or 90 km/h) are desirable.

While cruising, brief full-throttle acceleration within the limits of local traffic laws, contributes to a good break-in. Wide-open throttle acceleration in low gear can be detrimental and should be avoided.

The engine oil installed in the engine at the factory is a high-quality energy conserving type lubricant. Oil changes should be consistent with anticipated climate conditions under which vehicle operations will occur. The recommended viscosity and quality grades are shown under “Engine Oil”, under “Maintenance Procedures” in section 7 of this manual. **NON-DETERGENT OR STRAIGHT MINERAL OILS MUST NEVER BE USED.**

A new engine may consume some oil during its first few thousand miles (kilometers) of operation. This should be considered as a normal part of the break-in and not interpreted as an indication of difficulty.

SAFETY TIPS

Transporting Passengers

NEVER TRANSPORT PASSENGERS IN THE CARGO AREA.

2

WARNING!

- **It is extremely dangerous to ride in a cargo area, inside or outside of a vehicle. In a collision, people riding in these areas are more likely to be seriously injured or killed.**
- **Do not allow people to ride in any area of your vehicle that is not equipped with seats and seat belts.**
- **Be sure everyone in your vehicle is in a seat and using a seat belt properly.**

Exhaust Gas

WARNING!

Exhaust gases can injure or kill. They contain carbon monoxide (CO), which is colorless and odorless. Breathing it can make you unconscious and can eventually poison you. To avoid breathing (CO) follow these safety tips:

Do not run the engine in a closed garage or in confined areas any longer than needed to move your vehicle in or out of the area.

If it is necessary to sit in a parked vehicle with the engine running, adjust your heating or cooling controls to force outside air into the vehicle. Set the blower at high speed.

If you are required to drive with the trunk/liftgate open, make sure that all windows are closed and the climate control BLOWER switch is set at high speed. DO NOT use the recirculation mode.

The best protection against carbon monoxide entry into the vehicle body is a properly maintained engine exhaust system.

Whenever a change is noticed in the sound of the exhaust system, when exhaust fumes can be detected inside the vehicle, or when the underside or rear of the vehicle is damaged, have a competent mechanic inspect the complete exhaust system and adjacent body areas for broken, damaged, deteriorated, or mispositioned parts. Open seams or loose connections could permit exhaust fumes to seep into the passenger compartment. In addition, inspect the exhaust system each time the vehicle is raised for lubrication or oil change. Replace as required.

Safety Checks You Should Make Inside The Vehicle

Seat Belts

Inspect the belt system periodically, checking for cuts, frays, and loose parts. Damaged parts must be replaced immediately. Do not disassemble or modify the system.

Front seat belt assemblies must be replaced after a collision. Rear seat belt assemblies must be replaced after a collision if they have been damaged (i.e., bent retractor, torn webbing, etc.). If there is any question regarding belt or retractor condition, replace the belt.

Airbag Warning Light

The light should come on and remain on for six to eight seconds as a bulb check when the ignition switch is first turned ON. If the light is not lit during starting, see your authorized dealer. If the light stays on, flickers, or comes on while driving, have the system checked by an authorized dealer.

Defroster

Check operation by selecting the defrost mode and place the blower control on high speed. You should be able to feel the air directed against the windshield. See your authorized dealer for service if your defroster is inoperable.

Periodic Safety Checks You Should Make Outside The Vehicle

Tires

Examine tires for excessive tread wear and uneven wear patterns. Check for stones, nails, glass, or other objects lodged in the tread. Inspect the tread and sidewall for cuts and cracks. Check the wheel nuts for tightness. Check the tires (including spare) for proper pressure.

Lights

Have someone observe the operation of exterior lights while you work the controls. Check turn signal and high beam indicator lights on the instrument panel.

Door Latches

Check for positive closing, latching, and locking.

Fluid Leaks

Check area under vehicle after overnight parking for fuel, engine coolant, oil, or other fluid leaks. Also, if gasoline fumes are detected or if fuel, power steering fluid, or brake fluid leaks are suspected, the cause should be located and corrected immediately.

UNDERSTANDING THE FEATURES OF YOUR VEHICLE

CONTENTS

■ Mirrors	79	■ uconnect® phone — If Equipped	83
□ Inside Day/Night Mirror	79	□ Operation	85
□ Automatic Dimming Inside Mirror — If Equipped	80	□ Phone Call Features	94
□ Outside Mirror — Driver’s Side	80	□ uconnect® phone Features	96
□ Outside Mirror — Passenger’s Side	80	□ Advanced Phone Connectivity	101
□ Power Mirrors — If Equipped	81	□ Things You Should Know About Your uconnect® phone	103
□ Vanity Mirrors — If Equipped	83	□ General Information	112
□ Sun Visor Sliding Feature	83		

- Voice Recognition System (VR) —
 - If Equipped 112
 - Voice Recognition System (VR) Operation . . . 112
 - Commands 114
 - Voice Training 117
- Seats 117
 - Front Seat Adjustment 117
 - Manual Seat Height Adjustment — If Equipped 118
 - Manual Lumbar — If Equipped 119
 - Driver's Seatback Recline 119
 - Adjustable Head Restraints 120
 - Heated Seats — If Equipped 120
 - Fold-Flat Front Passenger Seat 122
 - Folding Rear Seat 123
 - Reclining Rear Seat — If Equipped 124
- To Open And Close The Hood 124
- Lights 126
 - Multifunction Lever 126
 - Headlights, Parking Lights And Instrument Panel Lights 126
 - Lights-On Reminder 127
 - Fog Lights — If Equipped 128
 - Turn Signals 128
 - High Beam/Low Beam Select Switch 129
 - Flash-To-Pass 130
 - Map/Reading Lights 130

- Daytime Running Lights (DRL) — If Equipped 131
- Windshield Wipers And Washers 131
 - Windshield Wiper Operation 131
 - Intermittent Wiper System 132
 - Windshield Washers 132
 - Mist Feature 133
- Tilt Steering Column 134
- Electronic Speed Control — If Equipped 134
 - To Activate 135
 - To Set At A Desired Speed 136
 - To Deactivate 136
 - To Resume Speed 136

- To Vary The Speed Setting 136
- Manual Transaxle 137
- To Accelerate For Passing 137
- Garage Door Opener — If Equipped 138
 - Programming HomeLink® 139
 - Gate Operator/Canadian Programming 142
 - Using HomeLink® 142
 - Reprogramming A Single HomeLink® Button 143
 - Security 143
 - Troubleshooting Tips 143
 - General Information 144
- Power Sunroof — If Equipped 144

<input type="checkbox"/> Opening The Sunroof	145	<input checked="" type="checkbox"/> Cargo Area Features	154
<input type="checkbox"/> Closing The Sunroof	146	<input type="checkbox"/> Cargo Light/Removable Self-Recharging Flashlight — If Equipped	154
<input type="checkbox"/> Pinch Protect Feature	146	<input type="checkbox"/> Cargo Cover — If Equipped	155
<input type="checkbox"/> Pinch Protect Override	146	<input type="checkbox"/> Removable Load Floor	156
<input type="checkbox"/> Venting Sunroof — Express	147	<input type="checkbox"/> Cargo Tie-Down Loops	157
<input type="checkbox"/> Sunshade Operation	147	<input type="checkbox"/> Fold Down Speakers — If Equipped	158
<input type="checkbox"/> Wind Buffeting	147	<input checked="" type="checkbox"/> Rear Window Features	158
<input type="checkbox"/> Sunroof Maintenance	147	<input type="checkbox"/> Rear Window Wiper/Washer	158
<input type="checkbox"/> Ignition Off Operation	147	<input type="checkbox"/> Rear Window Defroster	159
<input checked="" type="checkbox"/> Electrical Power Outlets	148	<input checked="" type="checkbox"/> Cooled Beverage Storage Bin/Glove Compartment — If Equipped	160
<input checked="" type="checkbox"/> Power Inverter — If Equipped	150		
<input checked="" type="checkbox"/> Cupholders	152		
<input checked="" type="checkbox"/> Console Features	152		

MIRRORS

Inside Day/Night Mirror

A two-point pivot system allows for horizontal and vertical mirror adjustment. Adjust the mirror to center on the view through the rear window.

Headlight glare can be reduced by moving the small control under the mirror to the night position (toward the rear of vehicle). The mirror should be adjusted while set in the day position (toward the windshield).

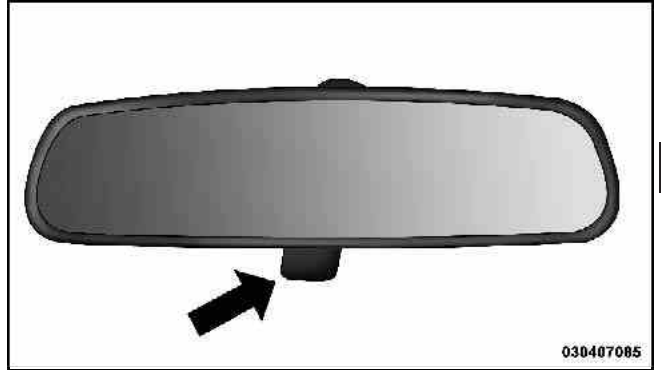

3

Adjusting Rearview Mirror

Automatic Dimming Inside Mirror — If Equipped

This mirror automatically adjusts for headlight glare from vehicles behind you. You can turn the feature on or off by pressing the button at the base of the mirror. A light next to the button will illuminate to indicate when the dimming feature is activated.

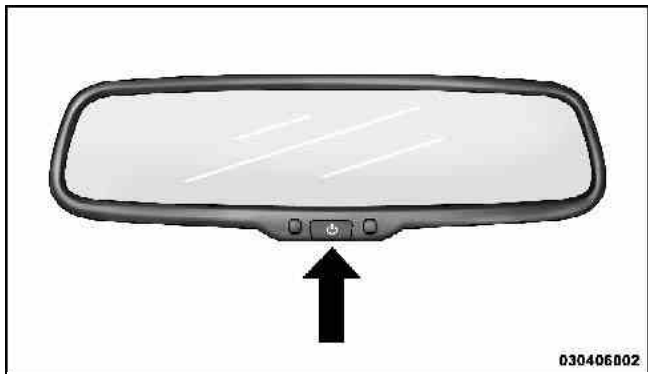

Automatic Dimming Mirror

CAUTION!

To avoid damage to the mirror during cleaning, never spray any cleaning solution directly onto the mirror. Apply the solution onto a clean cloth and wipe the mirror clean.

Outside Mirror — Driver's Side

Adjust the flat (drivers side) outside mirror so you can just see the side of your vehicle in the part of the mirror closest to the vehicle with your head close to the door glass.

Outside Mirror — Passenger's Side

Adjust the convex (passenger side) outside mirror so you can just see the side of your vehicle in the part of the mirror closest to the vehicle with your head close to the center of the vehicle.

WARNING!

Vehicles and other objects seen in the passenger side convex mirror will look smaller and farther away than they really are. Relying too much on your passenger side mirror could cause you to collide with another vehicle or other object. Use your inside mirror when judging the size or distance of a vehicle seen in this convex mirror.

Power Mirrors — If Equipped

The control for the power mirrors is located on the drivers door trim panel.

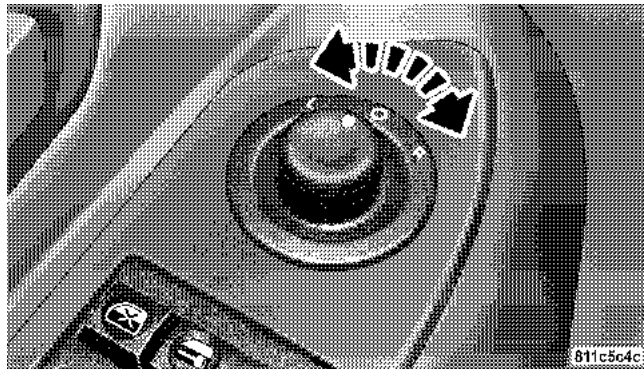

Power Mirror Control

To adjust a mirror, turn the control wand toward the left or right mirror positions indicated. Tilt the control wand in the direction you want the mirror to move. When finished adjusting the mirror, turn the control to the center position to prevent accidentally moving a mirror.

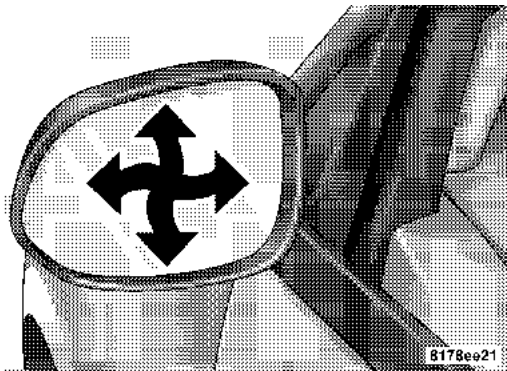

Mirror Directions

WARNING!

Vehicles and other objects seen in the passenger side convex mirror will look smaller and farther away than they really are. Relying too much on your passenger side mirror could cause you to collide with another vehicle or other object. Use your inside mirror when judging the size or distance of a vehicle seen in this convex mirror.

Vanity Mirrors — If Equipped

To use the vanity mirror, rotate the sun visor down and swing the mirror cover upward.

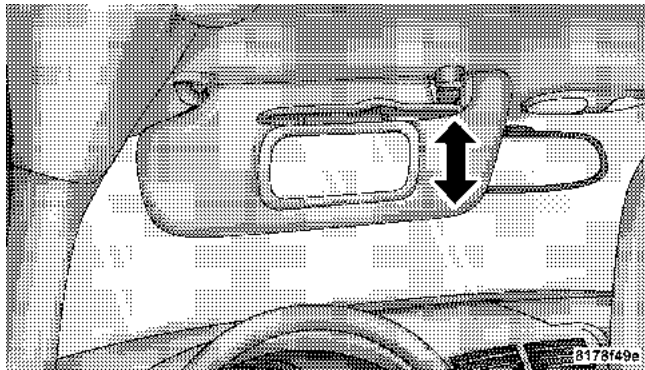

Vanity Mirror

Sun Visor Sliding Feature

The sun visors may be extended out to provide more coverage of the side glass.

uconnect® phone — IF EQUIPPED

NOTE: The sales code RER and REU radios contain an integrated uconnect® phone. Refer to your “Navigation User’s Manual” for uconnect® phone operating instructions for these radios. Radio sales code can be located on the lower right corner of the Radio faceplate.

uconnect® phone is a voice-activated, hands-free, in-vehicle communications system. uconnect® allows you to dial a phone number with your cellular phone using simple voice commands (e.g., “Call” ... “Mike” ... “Work” or “Dial” ... “248-555-1212”). Your cellular phone’s audio is transmitted through your vehicle’s audio system; the system will automatically mute your radio when using the uconnect® phone.

NOTE:

- The uconnect® phone requires a cellular phone equipped with the Bluetooth® "Hands-Free Profile," Version 0.96 or higher. See the uconnect® website for supported phones.

For uconnect® customer support, visit the following websites:

- www.chrysler.com/uconnect
- www.dodge.com/uconnect
- www.jeep.com/uconnect
- or call 1-877-855-8400

uconnect® allows you to transfer calls between the system and your cellular phone as you enter or exit your vehicle and enables you to mute the system's microphone for private conversation.

The uconnect® phone is driven through your Bluetooth® "Hands-Free Profile" cellular phone. uconnect® features Bluetooth® technology - the global standard that enables different electronic devices to connect to each other without wires or a docking station, so uconnect® phone works no matter where you stow your cellular phone (be it your purse, pocket, or briefcase), as long as your phone is turned on and has been paired to the vehicle's uconnect® phone. The uconnect® phone allows up to seven cellular phones to be linked to the system. Only one linked (or paired) cellular phone can be used with the system at a time. The system is available in English, Spanish, or French languages.

Phone Button

The rearview mirror contains the microphone for the system (depending on the type of mirror and radio equipped), and either the radio or the mirror has the two control buttons (PHONE Button and VOICE RECOGNITION button) that will enable you to access the system.

Voice Recognition Button

Actual button location may vary with the radio. The individual buttons are described in the "Operation" section.

The uconnect® phone can be used with any Hands-Free Profile certified Bluetooth® cellular phone. See the uconnect® website for supported phones. If your cellular phone supports a different profile (e.g., Headset Profile) you may not be able to use any uconnect® phone features. Refer to your cellular service provider or the phone manufacturer for details.

The uconnect® phone is fully integrated with the vehicle's audio system. The volume of the uconnect® phone can be adjusted either from the radio volume control knob or from the steering wheel radio control (right switch), if so equipped.

The radio display will be used for visual prompts from the uconnect® phone such as "CELL" or caller ID on certain radios.

Operation

Voice commands can be used to operate the uconnect® phone and to navigate through the uconnect® phone menu structure. Voice commands are required after most uconnect® phone prompts. You will be prompted for a specific command and then guided through the available options.

- Prior to giving a voice command, one must wait for the beep, which follows the "Ready" prompt or another prompt.

- For certain operations, compound commands can be used. For example, instead of saying "Setup" and then "Phone Pairing," the following compound command can be said: "Setup Phone Pairing."
- For each feature explanation in this section, only the combined form of the voice command is given. You can also break the commands into parts and say each part of the command when you are asked for it. For example, you can use the combined form voice command "Phonebook New Entry," or you can break the combined form command into two voice commands: "Phonebook" and "New Entry." Please remember, the uconnect® phone works best when you talk in a normal conversational tone, as if speaking to someone sitting a few feet/meters away from you.

Voice Command Tree

Refer to "Voice Tree" in this section.

Help Command

If you need assistance at any prompt, or if you want to know your options at any prompt, say "Help" following the beep. The uconnect® phone will play all the options at any prompt if you ask for help.

To activate the uconnect® phone from idle, simply press the PHONE button and follow the audible prompts for directions. All uconnect® phone sessions begin with a press of the PHONE button on the radio control head.

Cancel Command

At any prompt, after the beep, you can say "Cancel" and you will be returned to the main menu. However, in a few instances the system will take you back to the previous menu.

Pair (Link) uconnect® phone to a Cellular Phone

To begin using your uconnect® phone, you must pair your compatible Bluetooth® enabled cellular phone.

To complete the pairing process, you will need to reference your cellular phone Owner's Manual. The uconnect® website may also provide detailed instructions for pairing.

The following are general phone to uconnect® phone pairing instructions:

- Press the PHONE button to begin.
- After the "Ready" prompt and the following beep, say "Setup Phone Pairing."
- When prompted, after the beep, say "Pair a Phone" and follow the audible prompts.
- You will be asked to say a four-digit Personal Identification Number (PIN), which you will later need to enter into your cellular phone. You can enter any four-digit PIN. You will not need to remember this PIN after the initial pairing process.

- For identification purposes, you will be prompted to give the uconnect® phone a name for your cellular phone. Each cellular phone that is paired should be given a unique phone name.
- You will then be asked to give your cellular phone a priority level between one and seven, with one being the highest priority. You can pair up to seven cellular phones to your uconnect® phone. However, at any given time, only one cellular phone can be in use, connected to your uconnect® phone. The priority allows the uconnect® phone to know which cellular phone to use if multiple cellular phones are in the vehicle at the same time. For example, if priority three and priority five phones are present in the vehicle, the uconnect® phone will use the priority three cellular phone when you make a call. You can select to use a lower priority cellular phone at any time (refer to "Advanced Phone Connectivity" in this section).

Dial by Saying a Number

- Press the PHONE button to begin.
- After the "Ready" prompt and the following beep, say "Dial."
- The system will prompt you to say the number you want to call.
- For example, you can say "234-567-8901".
- The uconnect® phone will confirm the phone number and then dial. The number will appear in the display of certain radios.

Call by Saying a Name

- Press the PHONE button to begin.
- After the "Ready" prompt and the following beep, say "Call."

- The system will prompt you to say the name of the person you want to call.
- After the "Ready" prompt and the following beep, say the name of the person you want to call. For example, you can say "John Doe," where John Doe is a previously stored name entry in the uconnect® phonebook or downloaded phonebook. To learn how to store a name in the phonebook, refer to "Add Names to Your uconnect® Phonebook," in the phonebook.
- The uconnect® system will confirm the name and then dial the corresponding phone number, which may appear in the display of certain radios.

Add Names to Your uconnect® Phonebook

NOTE: Adding names to the uconnect® phonebook is recommended when the vehicle is not in motion.

- Press the PHONE button to begin.

- After the "Ready" prompt and the following beep, say "Phonebook New Entry."
- When prompted, say the name of the new entry. Use of long names helps the voice recognition and it is recommended. For example, say "Robert Smith" or "Robert" instead of "Bob."
- When prompted, enter the number designation (e.g., "Home," "Work," "Mobile," or "Pager"). This will allow you to store multiple numbers for each phonebook entry, if desired.
- When prompted, recite the phone number for the phonebook entry that you are adding.

After you are finished adding an entry into the phonebook, you will be given the opportunity to add more phone numbers to the current entry or to return to the main menu.

The uconnect® phone will allow you to enter up to 32 names in the phonebook with each name having up to four associated phone numbers and designations. Each language has a separate 32-name phonebook accessible only in that language. In addition, if equipped and supported by your phone, uconnect® phone automatically downloads your cellular phone's phonebook.

Phonebook Download – Automatic Phonebook Transfer From Cellular Phone

If equipped and specifically supported by your phone, uconnect® phone automatically downloads names (text names) and number entries from the cellular phone's phonebook. Specific Bluetooth® Phones with Phone Book Access Profile may support this feature. See uconnect® website for supported phones.

- To call a name from downloaded (or uconnect®) Phonebook, follow the procedure in "Call by Saying a Name" section.

- Automatic download and update, if supported, begins as soon as the Bluetooth® wireless phone connection is made to the uconnect® phone, for example, after you start the vehicle.
- A maximum of 1000 entries per phone will be downloaded and updated every time a phone is connected to the uconnect® phone.
- Depending on the maximum number of entries downloaded, there may be a short delay before the latest downloaded names can be used. Until then, if available, the previous downloaded phonebook is available for use.
- Only the phonebook of the currently connected cellular phone is accessible.
- Only the cellular phone's phonebook is downloaded. SIM card phonebook is not part of the Mobile phonebook.

- This downloaded phonebook cannot be edited or deleted on the uconnect® phone. These can only be edited on the cellular phone. The changes are transferred and updated to uconnect® phone on the next phone connection.

Phonebook Download — Single Entry

If equipped and supported by your phone, uconnect® phone allows the user to download entries from their phone via Bluetooth®. To use this feature, press the PHONE button and say “Phonebook Download.” The system prompts, “Ready to accept “V” card entry via Bluetooth®...” The system is now ready to accept phonebook entries from your phone using the Bluetooth® Object Exchange Profile (OBEX). Please see your phone Owner's Manual for specific instructions on how to send these entries from your phone.

NOTE:

- The phone handset must support Bluetooth® OBEX transfers of phonebook entries to use this feature.
- Some phones cannot send phonebook entries if they are already connected to any system via Bluetooth®, and you may see a message on the phone display that the Bluetooth® link is busy. In this case, the user must first disconnect or drop the Bluetooth® connection to the uconnect® phone, and then send the address book entry via Bluetooth®. Please see your phone Owner's Manual for specific instructions on how to drop the Bluetooth® connection.
- If the phonebook entry is longer than 24 characters, it will only use the first 24 characters.

Edit uconnect® Phonebook Entries**NOTE:**

- Editing names in the phonebook is recommended when the vehicle is not in motion.
- Automatic downloaded phonebook entries cannot be deleted or edited.
- Press the PHONE button to begin.
- After the "Ready" prompt and the following beep, say "Phonebook Edit."
- You will then be asked for the name of the phonebook entry that you wish to edit.
- Next, choose the number designation (home, work, cellular, or pager) that you wish to edit.
- When prompted, recite the new phone number for the phonebook entry that you are editing.

After you are finished editing an entry in the phonebook, you will be given the opportunity to edit another entry in the phonebook, call the number you just edited, or return to the main menu.

"Phonebook Edit" can be used to add another phone number to a name entry that already exists in the phonebook. For example, the entry John Doe may have a cellular and a home number, but you can add "John Doe's" work number later using the "Phonebook Edit" feature.

Delete uconnect® Phonebook Entry

NOTE: Editing phonebook entries is recommended when the vehicle is not in motion.

- Press the PHONE button to begin.
- After the "Ready" prompt and the following beep, say "Phonebook Delete."
- After you enter the Phonebook Delete menu, you will then be asked for the name of the entry that you wish to delete. You can either say the name of a phonebook entry that you wish to delete or you can say "List Names" to hear a list of the entries in the phonebook from which you choose. To select one of the entries from the list, press the VOICE RECOGNITION button while the uconnect® phone is playing the desired entry and say "Delete."
- After you enter the name, the uconnect® phone will ask you which designation you wish to delete: home, work, cellular, pager, or all. Say the designation you wish to delete.
- Note that only the phonebook entry in the current language is deleted.
- Automatic downloaded phonebook entries cannot be deleted or edited.

Delete/Erase “All” uconnect® Phonebook Entries

- Press the PHONE button to begin.
- After the “Ready” prompt and the following beep, say “Phonebook Erase All.”
- The uconnect® phone will ask you to verify that you wish to delete all the entries from the phonebook.
- After confirmation, the phonebook entries will be deleted.
- Note that only the phonebook in the current language is deleted.
- Automatic downloaded phonebook entries cannot be deleted or edited.

List All Names in the uconnect® Phonebook

- Press the PHONE button to begin.

- After the “Ready” prompt and the following beep, say “Phonebook List Names.”
- The uconnect® phone will play the names of all the phonebook entries, including the downloaded phonebook entries, if available.
- To call one of the names in the list, press the VOICE RECOGNITION button during the playing of the desired name, and say “Call.”

NOTE: The user can also exercise “Edit” or “Delete” operations at this point.

- The uconnect® phone will then prompt you as to the number designation you wish to call.
- The selected number will be dialed.

Phone Call Features

The following features can be accessed through the uconnect® phone if the feature(s) are available on your cellular service plan. For example, if your cellular service plan provides three-way calling, this feature can be accessed through the uconnect® phone. Check with your cellular service provider for the features that you have.

Answer or Reject an Incoming Call - No Call Currently in Progress

When you receive a call on your cellular phone, the uconnect® phone will interrupt the vehicle audio system, if on, and will ask if you would like to answer the call. Press the PHONE button to accept the call. To reject the call, press and hold the PHONE button until you hear a single beep, indicating that the incoming call was rejected.

Answer or Reject an Incoming Call - Call Currently in Progress

If a call is currently in progress and you have another incoming call, you will hear the same network tones for call waiting that you normally hear when using your cellular phone. Press the PHONE button to place the current call on hold and answer the incoming call.

NOTE: The uconnect® phone compatible phones in the market today do not support rejecting an incoming call when another call is in progress. Therefore, the user can only answer an incoming call or ignore it.

Making a Second Call While Current Call is in Progress

To make a second call while you are currently on a call, press the VOICE RECOGNITION button and say "Dial" or "Call" followed by the phone number or phonebook entry you wish to call. The first call will be on hold while the second call is in progress. To go back to the first call,

refer to "Toggling Between Calls" in this section. To combine two calls, refer to "Conference Call" in this section.

Place/Retrieve a Call From Hold

To put a call on hold, press the PHONE button until you hear a single beep. This indicates that the call is on hold. To bring the call back from hold, press and hold the PHONE button until you hear a single beep.

Toggling Between Calls

If two calls are in progress (one active and one on hold), press the PHONE button until you hear a single beep, indicating that the active and hold status of the two calls have switched. Only one call can be placed on hold at a time.

Conference Call

When two calls are in progress (one active and one on hold), press and hold the PHONE button until you hear a double beep indicating that the two calls have been joined into one conference call.

Three-Way Calling

To initiate three-way calling, press the VOICE RECOGNITION button while a call is in progress, and make a second phone call, as described under "Making a Second Call While Current Call is in Progress." After the second call has established, press and hold the PHONE button until you hear a double beep, indicating that the two calls have been joined into one conference call.

Call Termination

To end a call in progress, momentarily press the PHONE button. Only the active call(s) will be terminated and if there is a call on hold, it will become the new active call. If the active call is terminated by the far end, a call on

hold may not become active automatically. This is cell phone-dependent. To bring the call back from hold, press and hold the PHONE button until you hear a single beep.

Redial

- Press the PHONE button to begin.
- After the "Ready" prompt and the following beep, say "Redial."
- The uconnect[®] phone will call the last number that was dialed from your cellular phone.

NOTE: This may not be the last number dialed from the uconnect[®] phone.

Call Continuation

Call continuation is the progression of a phone call on the uconnect[®] phone after the vehicle ignition key has been switched to OFF. Call continuation functionality available on the vehicle can be any one of three types:

- After the ignition key is switched to OFF, a call can continue on the uconnect[®] phone either until the call ends, or until the vehicle battery condition dictates cessation of the call on the uconnect[®] phone and transfer of the call to the cellular phone.
- After the ignition key is switched to OFF, a call can continue on the uconnect[®] phone for a certain duration, after which the call is automatically transferred from the uconnect[®] phone to the cellular phone.
- An active call is automatically transferred to the cellular phone after the ignition key is switched to OFF.

uconnect[®] phone Features

Language Selection

To change the language that the uconnect[®] phone is using:

- Press the PHONE button to begin.

- After the "Ready" prompt and the following beep, say the name of the language you wish to switch to English, Espanol, or Francais.
- Continue to follow the system prompts to complete the language selection.

After selecting one of the languages, all prompts and voice commands will be in that language.

NOTE: After every uconnect® phone language change operation, only the language-specific 32-name phone-book is usable. The paired phone name is not language-specific and usable across all languages.

Emergency Assistance

If you are in an emergency and the cellular phone is reachable:

- Pick up the phone and manually dial the emergency number for your area.

If the phone is not reachable and the uconnect® phone is operational, you may reach the emergency number as follows:

- Press the PHONE button to begin.
- After the "Ready" prompt and the following beep, say "Emergency" and the uconnect® phone will instruct the paired cellular phone to call the emergency number. This feature is supported in the U.S., Canada, and Mexico.

NOTE:

- The emergency number dialed is based on the country where the vehicle is purchased (911 for the U.S. and Canada and 060 for Mexico). The number dialed may not be applicable with the available cellular service and area.

- If supported, this number may be programmable on some systems. To do this, press the PHONE button and say 'Setup', followed by 'Emergency'.
- The uconnect® phone does slightly lower your chances of successfully making a phone call as to that for the cell phone directly.

WARNING!

Your phone must be turned on and paired to the uconnect® phone to allow use of this vehicle feature in emergency situations, when the cell phone has network coverage and stays paired to the uconnect® phone.

Towing Assistance

If you need towing assistance:

- Press the PHONE button to begin.

- After the "Ready" prompt and the following beep, say "Towing Assistance."

NOTE:

- The towing assistance number dialed is based on the country where the vehicle is purchased (1-800-528-2069 for the U.S., 1-877-213-4525 for Canada, 55-14-3454 for Mexico City and 1-800-712-3040 for outside Mexico City in Mexico).
- If supported, this number may be programmable on some systems. To do this, press the PHONE button and say "Setup", followed by "Towing Assistance".

Paging

To learn how to page, refer to "Working with Automated Systems." Paging works properly except for pagers of certain companies, which time out a little too soon to work properly with the uconnect® phone.

Voice Mail Calling

To learn how to access your voice mail, refer to "Working with Automated Systems."

Working with Automated Systems

This method is used in instances where one generally has to press numbers on the cellular phone keypad while navigating through an automated telephone system.

You can use your uconnect® phone to access a voice mail system or an automated service, such as a paging service or automated customer service line. Some services require immediate response selection. In some instances, that may be too quick for use of the uconnect® phone.

When calling a number with your uconnect® phone that normally requires you to enter in a touch-tone sequence on your cellular phone keypad, you can press the VOICE RECOGNITION button and say the sequence you wish to enter, followed by the word "Send." For example, if required to enter your PIN followed with a pound, (3 7 4

6 #), you can press the VOICE RECOGNITION button and say, "3 7 4 6 # Send." Saying a number, or sequence of numbers, followed by "Send," is also to be used for navigating through an automated customer service center menu structure, and to leave a number on a pager.

You can also send stored uconnect® phonebook entries as tones for fast and easy access to voice mail and pager entries. To use this feature, dial the number you wish to call and then press the VOICE RECOGNITION button and say, "Send." The system will prompt you to enter the name or number and say the name of the phonebook entry you wish to send. The uconnect® phone will then send the corresponding phone number associated with the phonebook entry, as tones over the phone.

NOTE:

- You may not hear all of the tones due to cellular phone network configurations. This is normal.

- Some paging and voice mail systems have system time out settings that are too short and may not allow the use of this feature.

Barge In - Overriding Prompts

The “Voice Recognition” button can be used when you wish to skip part of a prompt and issue your voice recognition command immediately. For example, if a prompt is asking “Would you like to pair a phone, clear a...,” you could press the VOICE RECOGNITION button and say, “Pair a Phone” to select that option without having to listen to the rest of the voice prompt.

Turning Confirmation Prompts ON/OFF

Turning confirmation prompts off will stop the system from confirming your choices (e.g., the uconnect® phone will not repeat a phone number before you dial it).

- Press the PHONE button to begin.

- After the “Ready” prompt and the following beep, say “Setup Confirmations.” The uconnect® phone will play the current confirmation prompt status and you will be given the choice to change it.

Phone and Network Status Indicators

If available on the radio and/or on a premium display such as the instrument panel cluster, and supported by your cellular phone, the uconnect® phone will provide notification to inform you of your phone and network status when you are attempting to make a phone call using uconnect® phone. The status is given for roaming, network signal strength, phone battery strength, etc.

Dialing Using the Cellular Phone Keypad

You can dial a phone number with your cellular phone keypad and still use the uconnect® phone (while dialing via the cellular phone keypad, the user must exercise caution and take precautionary safety measures). By dialing a number with your paired Bluetooth® cellular

phone, the audio will be played through your vehicle's audio system. The uconnect® phone will work the same as if you dial the number using voice recognition.

NOTE: Certain brands of cellular phones do not send the dial ring to the uconnect® phone to play it on the vehicle audio system, so you will not hear it. Under this situation, after successfully dialing a number the user may feel that the call did not go through even though the call is in progress. Once your call is answered, you will hear the audio.

Mute/Un-Mute (Mute OFF)

When you mute the uconnect® phone, you will still be able to hear the conversation coming from the other party, but the other party will not be able to hear you. In order to mute the uconnect® phone:

- Press the VOICE RECOGNITION button.
- Following the beep, say "Mute."

In order to un-mute the uconnect® phone:

- Press the VOICE RECOGNITION button.
- Following the beep, say "Mute off."

Advanced Phone Connectivity

Transfer Call to and from Cellular Phone

The uconnect® phone allows ongoing calls to be transferred from your cellular phone to the uconnect® phone without terminating the call. To transfer an ongoing call from your uconnect® phone paired cellular phone to the uconnect® phone or vice versa, press the VOICE RECOGNITION button and say "Transfer Call."

Connect or Disconnect Link Between the uconnect® phone and Cellular Phone

Your cellular phone can be paired with many different electronic devices, but can only be actively "connected" with one electronic device at a time.

If you would like to connect or disconnect the Bluetooth® connection between a uconnect® phone paired cellular phone and the uconnect® phone, follow the instructions described in your cellular phone User's Manual.

List Paired Cellular Phone Names

- Press the PHONE button to begin.
- After the "Ready" prompt and the following beep, say "Setup Phone Pairing."
- When prompted, say "List Phones."
- The uconnect® phone will play the phone names of all paired cellular phones in order from the highest to the lowest priority. To "select" or "delete" a paired phone being announced, press the VOICE RECOGNITION button and say "Select" or "Delete." Also, see the next two sections for an alternate way to "select" or "delete" a paired phone.

Select Another Cellular Phone

This feature allows you to select and start using another phone paired with the uconnect® phone.

- Press the PHONE button to begin.
- After the "Ready" prompt and the following beep, say "Setup Select Phone" and follow the prompts.
- You can also press the VOICE RECOGNITION button at any time while the list is being played, and then choose the phone that you wish to select.
- The selected phone will be used for the next phone call. If the selected phone is not available, the uconnect® phone will return to using the highest priority phone present in or near (approximately within 30 ft (9 m)) the vehicle.

Delete uconnect® phone Paired Cellular Phones

- Press the PHONE button to begin.
- After the "Ready" prompt and the following beep, say "Setup Phone Pairing."
- At the next prompt, say "Delete" and follow the prompts.
- You can also press the VOICE RECOGNITION button at any time while the list is being played, and then choose the phone you wish to delete.

Things You Should Know About Your uconnect® phone

uconnect® phone Tutorial

To hear a brief tutorial of the system features, press the PHONE button and say "uconnect® Tutorial."

Voice Training

For users experiencing difficulty with the system recognizing their voice commands or numbers, the uconnect® phone Voice Training feature may be used. To enter this training mode, follow one of the two following procedures:

From outside the uconnect® phone mode (e.g., from radio mode):

- Press and hold the VOICE RECOGNITION button for five seconds until the session begins, or,
- Press the VOICE RECOGNITION button and say the "Setup, Voice Training" command.

Repeat the words and phrases when prompted by the uconnect® phone. For best results, the Voice Training session should be completed when the vehicle is parked with the engine running, all windows closed, and the blower fan switched off.

This procedure may be repeated with a new user. The system will adapt to the last trained voice only.

To restore the Voice Recognition system to factory default settings, enter the Voice Training session via the above procedure and follow the prompts.

Voice Recognition (VR)

- For best performance, adjust the rearview mirror to provide at least 1/2 in (1 cm) gap between the overhead console (if equipped) and the mirror.
- Always wait for the beep before speaking.
- Speak normally, without pausing, just as you would speak to a person sitting a few feet/meters away from you.
- Make sure that no one other than you is speaking during a voice recognition period.
- Performance is maximized under:
 - low-to-medium blower setting,
 - low-to-medium vehicle speed,
 - low road noise,
 - smooth road surface,
 - fully closed windows,
 - dry weather condition.
- Even though the system is designed for users speaking in North American English, French, and Spanish accents, the system may not always work for some.
- When navigating through an automated system such as voice mail, or when sending a page, at the end of speaking the digit string, make sure to say "Send."
- Storing names in the phonebook when the vehicle is not in motion is recommended.

- It is not recommended to store similar sounding names in the uconnect® phonebook.
- Phonebook (Downloaded and uconnect® phone Local) name recognition rate is optimized when the entries are not similar.
- You can say "O" (letter "O") for "0" (zero). "800" must be spoken "eight-zero-zero."
- Even though international dialing for most number combinations is supported, some shortcut dialing number combinations may not be supported.
- In a convertible vehicle, system performance may be compromised with the convertible top down.

Far End Audio Performance

- Audio quality is maximized under:
 - low-to-medium blower setting,

- low-to-medium vehicle speed,
- low road noise,
- smooth road surface,
- fully closed windows,
- dry weather conditions, and
- operation from the driver's seat.
- Performance, such as audio clarity, echo, and loudness to a large degree rely on the phone and network, and not the uconnect® phone.
- Echo at the far end can sometimes be reduced by lowering the in-vehicle audio volume.
- In a convertible vehicle, system performance may be compromised with the convertible top down.

Bluetooth® Communication Link

Cellular phones have been found to lose connection to the uconnect® phone. When this happens, the connection can generally be reestablished by switching the phone off/on. Your cellular phone is recommended to remain in Bluetooth® ON mode.

Power-Up

After switching the ignition key from OFF to either the ON or ACC position, or after a language change, you must wait at least five seconds prior to using the system.

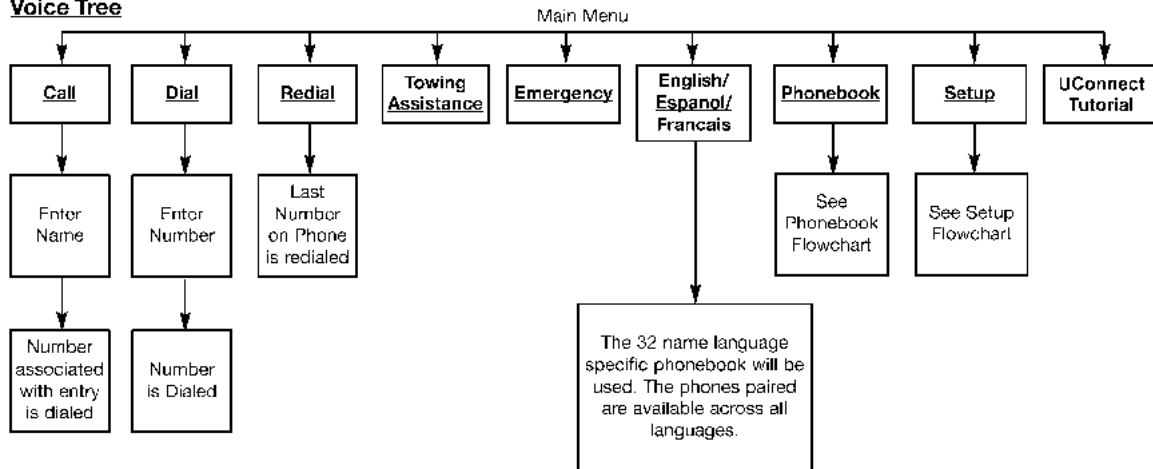
Voice Tree

Note: Available Voice commands are shown in bold face and are underlined.

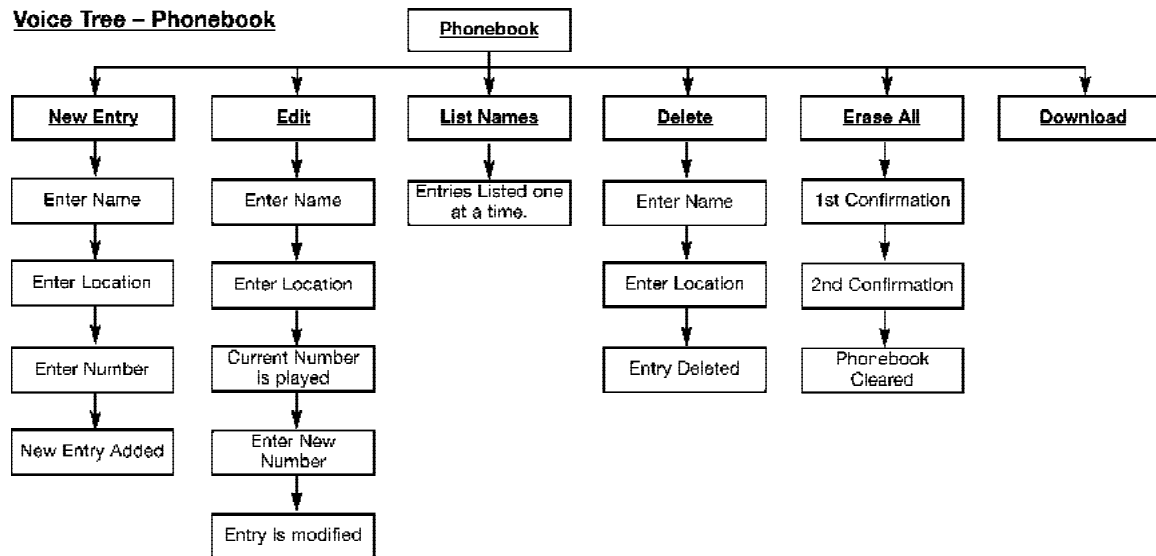
Voice Tree – Phonebook

Note: Available Voice commands are shown in bold face and are underlined.

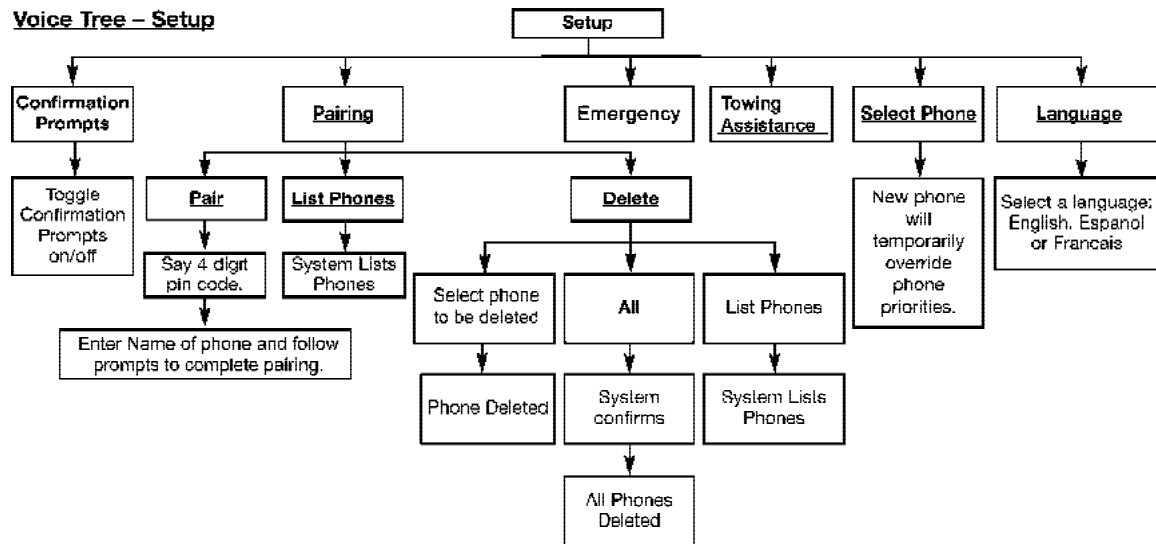
Voice Tree – Setup

Note: Available Voice commands are shown in bold face and are underlined. 030805540

Voice Commands	
Primary	Alternate(s)
zero	
one	
two	
three	
four	
five	
six	
seven	
eight	
nine	
star (*)	
plus (+)	
pound (#)	
add location	
all	

Voice Commands	
Primary	Alternate(s)
call	
cancel	
confirmation prompts	
continue	
delete	
dial	
download	
edit	
emergency	
English	
erase all	
Espanol	
Francais	
help	
home	

Voice Commands	
Primary	Alternate(s)
language	
list names	
list phones	
mobile	
mute	
mute off	
new entry	
no	
pager	
pair a phone	
phone pairing	pairing
phonebook	phone book
previous	
record again	
redial	

Voice Commands	
Primary	Alternate(s)
return to main menu	return or main menu
select phone	select
send	
set up	phone settings or phone set up
towing assistance	
transfer call	
uconnect [®] Tutorial	
try again	
voice training	
work	
yes	

General Information

This device complies with Part 15 of the FCC rules and RSS 210 of Industry Canada. Operation is subject to the following conditions:

- Changes or modifications not expressly approved by the party responsible for compliance could void the user's authority to operate the equipment.
- This device may not cause harmful interference.
- This device must accept any interference received, including interference that may cause undesired operation.

VOICE RECOGNITION SYSTEM (VR) — IF EQUIPPED

Voice Recognition System (VR) Operation



This Voice Recognition system allows you to control your AM, FM radio, satellite radio, disc player, and a memo recorder.

NOTE: Take care to speak into the Voice Interface System as calmly and normally as possible. The ability of the Voice Interface System to recognize user voice commands may be negatively affected by rapid speaking or a raised voice level.

WARNING!

Any voice commanded system should be used only in safe driving conditions and all attention should be kept on the roadway ahead. Failure to do so may result in an accident causing serious injury or death.

When you press the VR button, you will hear a beep. The beep is your signal to give a command.

NOTE: If you do not say a command within a few seconds, the system will present you with a list of options.

If you ever wish to interrupt the system while it lists options, press the VR button, listen for the beep, and say your command.

Pressing the VR button while the system is speaking is known as “barging in.” The system will be interrupted and after the beep you can add or change commands. This will become helpful once you start to learn the options.

NOTE: At any time, you can say the words “Cancel”, “Help”, or “Main Menu”.

These commands are universal and can be used from any menu. All other commands can be used depending upon the active application.

For example, if you are in the disc menu and you are listening to FM radio, you can speak commands from the disc menu or from the FM radio menu.

When using this system, you should speak clearly and at a normal speaking volume.

The system will best recognize your speech if the windows are closed, and the heater/air-conditioning fan is set to low.

At any point, if the system does not recognize one of your commands, you will be prompted to repeat it.

To hear the first available Menu, press the VR button and say “Help” or “Main Menu”.

Commands

The Voice Recognition system understands two types of commands. Universal commands are available at all times. Local commands are available if the supported radio mode is active.

Changing the Volume

1. Start a dialogue by pressing the VR button.
2. Say a command (e.g., “Help”).
3. Use the ON/OFF VOLUME rotary knob to adjust the volume to a comfortable level while the Voice Recognition system is speaking. Please note the volume setting for VR is different than the audio system.

Main Menu

Start a dialogue by pressing the VR button. You may say “Main Menu” to switch to the main menu.

In this mode, you can say the following commands:

- “Radio” (to switch to the radio mode)
- “Disc” (to switch to the disc mode)
- “Memo” (to switch to the memo recorder)
- “System Setup” (to switch to system setup)

Radio AM (or Radio Long Wave or Radio Medium Wave — If Equipped)

To switch to the AM band say “AM” or “Radio AM”. In this mode, you may say the following commands:

- “Frequency” (to change the frequency)
- “Next Station” (to select the next station)
- “Previous Station” (to select the previous station)
- “Radio Menu” (to switch to the radio menu)
- “Main Menu” (to switch to the main menu)

Radio FM

To switch to the FM band say “FM” or “Radio FM”. In this mode, you may say the following commands:

- “Frequency” (to change the frequency)
- “Next Station” (to select the next station)
- “Previous Station” (to select the previous station)
- “Radio Menu” (to switch to the radio menu)
- “Main Menu” (to switch to the main menu)

Satellite Radio

To switch to satellite radio mode say “Sat” or “Satellite Radio”. In this mode, you may say the following commands:

- “Channel Number” (to change the channel by its spoken number)
- “Next Channel” (to select the next channel)

- “Previous Channel” (to select the previous channel)
- “List Channel” (to hear a list of available channels)
- “Select Name” (to say the name of a channel)
- “Radio Menu” (to switch to the radio menu)
- “Main Menu” (to switch to the main menu)

Disc

To switch to the disc mode say “Disc”. In this mode, you may say the following commands:

- “Track” (#) (to change the track)
- “Next Track” (to play the next track)
- “Previous Track” (to play the previous track)
- “Main Menu” (to switch to the main menu)

Memo

To switch to the voice recorder mode say “Memo”. In this mode, you may say the following commands:

- “New Memo” (to record a new memo) — During the recording you may press the VR button to stop recording. You proceed by saying one of the following commands:
 - “Save” (to save the memo)
 - “Continue” (to continue recording)
 - “Delete” (to delete the recording)
- “Play Memos” (to play previously recorded memos) — During the playback you may press the VR button to stop playing memos. You proceed by saying one of the following commands:
 - “Repeat” (to repeat a memo)
 - “Next” (to play the next memo)

- “Previous” (to play the previous memo)
- “Delete” (to delete a memo)
- “Delete All” (to delete all memos)

System Setup

To switch to system setup say “Setup”. In this mode, you may say the following commands:

- “Language German”
- “Language Dutch”
- “Language Italian”
- “Language English”
- “Language French”
- “Language Spanish”
- “Tutorial”
- “Voice Training”

NOTE: Keep in mind that you have to press the VR button first and wait for the beep before speaking the “Barge In” commands.

Voice Training

For users experiencing difficulty with the system recognizing their voice commands or numbers, uconnect® phone Voice Training feature may be used.

1. Press the VR button, say “System Setup” and once you are in that menu then say “Voice Training.” This will train your own voice to the system and will improve recognition.
2. Repeat the words and phrases when prompted by uconnect® phone. For best results, the Voice Training session should be completed when the vehicle is parked, engine running, all windows closed, and the blower fan switched off. This procedure may be repeated with a new user. The system will adapt to the last trained voice only.

SEATS

Front Seat Adjustment

The adjusting bar is at the front of the seats, near the floor. Pull the bar up to move the seat to the desired position.

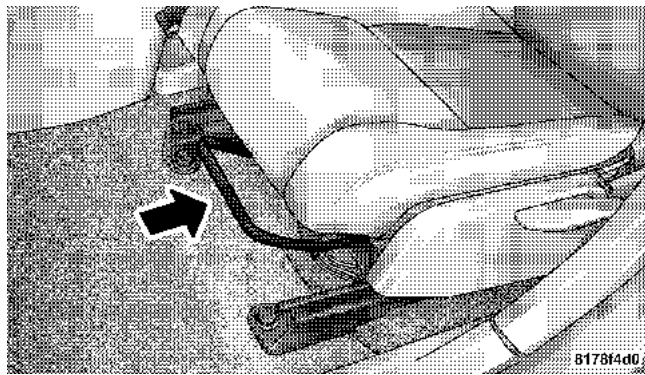

Front Seat Adjustment

Using body pressure, move forward and rearward on the seat to be sure the seat adjusters have latched.

WARNING!

- **Adjusting a seat while the vehicle is moving is dangerous. The sudden movement of the seat could cause you to lose control. The seat belt might not be properly adjusted and you could be injured. Adjust the seat only while the vehicle is parked.**
- **Do not ride with the seatback reclined so that the shoulder belt is no longer resting against your chest. In a collision you could slide under the seat belt and be seriously or even fatally injured. Use the recliner only when the vehicle is parked.**

Manual Seat Height Adjustment — If Equipped

The driver's seat height can be raised or lowered by using the handle on the outboard side of the seat to adjust the driving position.

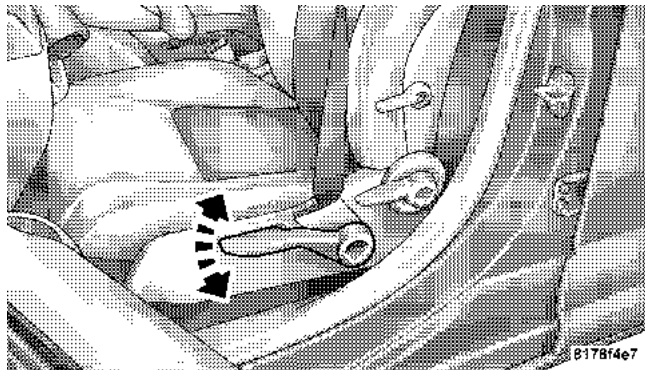

Seat Height Adjustment

Manual Lumbar — If Equipped

The lumbar adjustment handle is located on the outboard side of the driver's seat. To increase or decrease support, rotate the handle up or down.

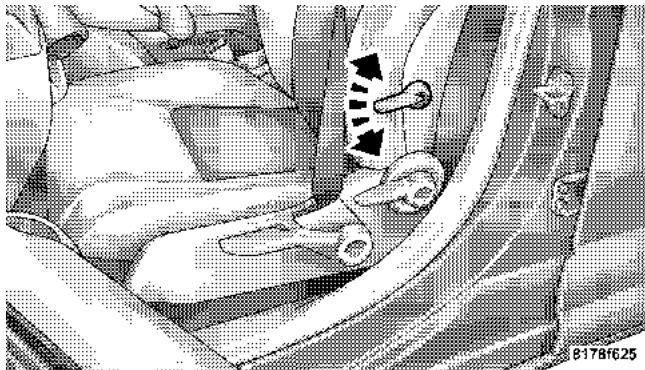

Lumbar Adjustment

Driver's Seatback Recline

To recline:

1. Lean forward before lifting the handle, then lean back to the desired position and release the handle.
2. Lift the handle to return the seatback to an upright position.

3

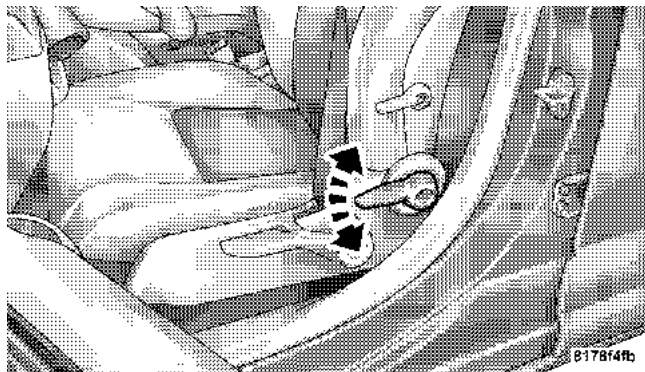

Reclining Seat

Adjustable Head Restraints

Head restraints can reduce the risk of whiplash injury in the event of impact from the rear. Pull up or push down on the head restraints so that the upper edge is as high as practical. To raise the head restraint, pull up on the head restraint. To lower the head restraint, press the button and push down on the head restraint.

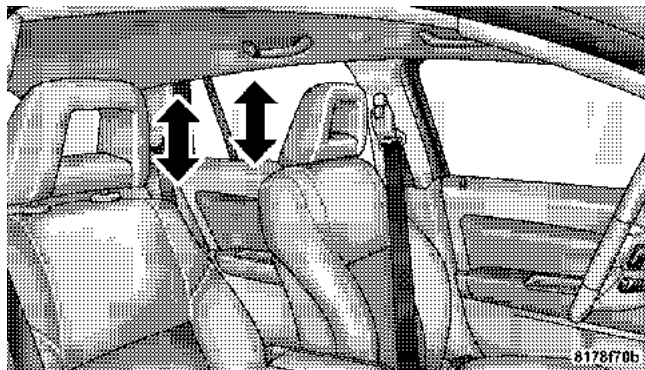

Head Restraint Adjustment

Heated Seats — If Equipped

This feature heats the front driver and passenger seats. The heaters provide the same heat level for both cushion and back. The controls for the front heated seats are located on the center instrument panel area.

After turning the ignition ON, you can choose from High, Low, or Off heat settings. Amber indicator lights in each switch indicate the level of heat in use. Two indicator lights will illuminate for High, one for Low, and none for Off.



Press the switch once to select High-level heating. Press the switch a second time to select Low-level heating. Press the switch a third time to shut the heating elements Off.

If High-level heating is selected, the system automatically switches to Low-level heating and turns one indicator light off after 30 minutes of continuous operation. It will turn the heater and the remaining indicator light off after an additional 30 minutes of continuous operation. If Low-level heating is selected, the system automatically turns the heater and the indicator light off after 30 minutes of continuous operation.

NOTE: Once a heat setting is selected, heat will be felt within two to five minutes.

WARNING!

- **Persons who are unable to feel pain to the skin because of advanced age, chronic illness, diabetes, spinal cord injury, medication, alcohol use, exhaustion or other physical condition must exercise care when using the seat heater. It may cause burns even at low temperatures, especially if used for long periods of time.**
- **Do not place anything on the seat that insulates against heat, such as a blanket or cushion. This may cause the seat heater to overheat.**

Fold-Flat Front Passenger Seat

To fold the front passenger seat, lift the recliner handle to the full upward position and push the seatback forward until it rests on the seat cushion.

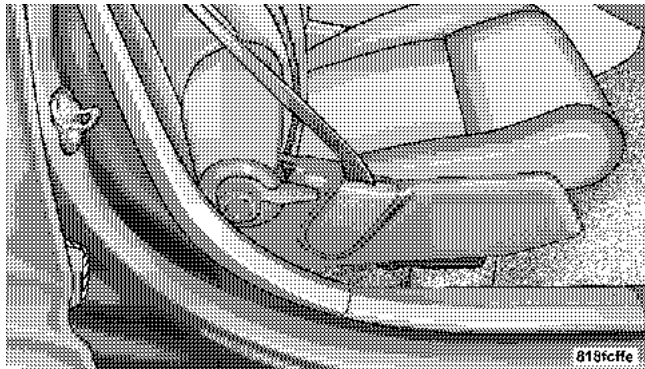

Fold-Flat Front Passenger Seat Handle

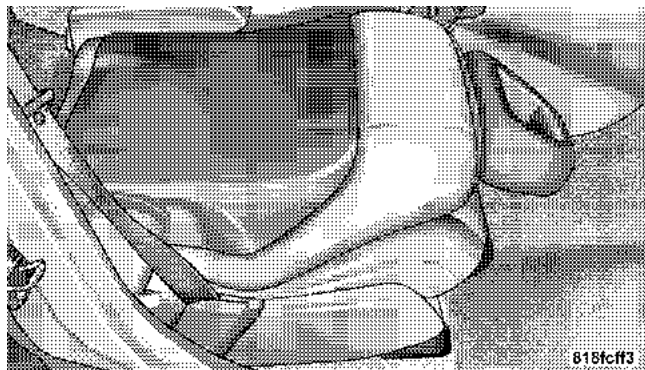

Front Passenger Seat Folded Flat

Folding Rear Seat

To provide additional storage area, each rear seatback can be folded forward. Pull the strap forward to move the seat forward and flat.

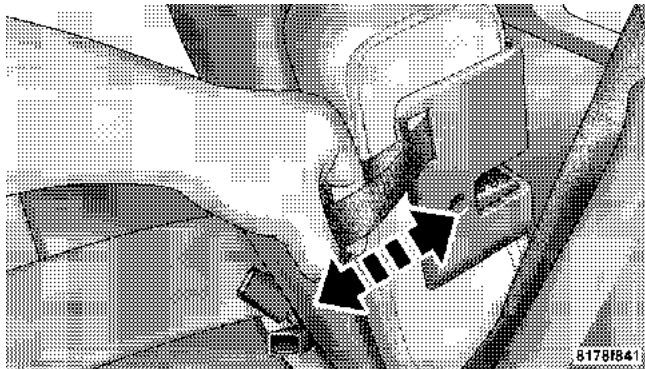

Folding Rear Seat

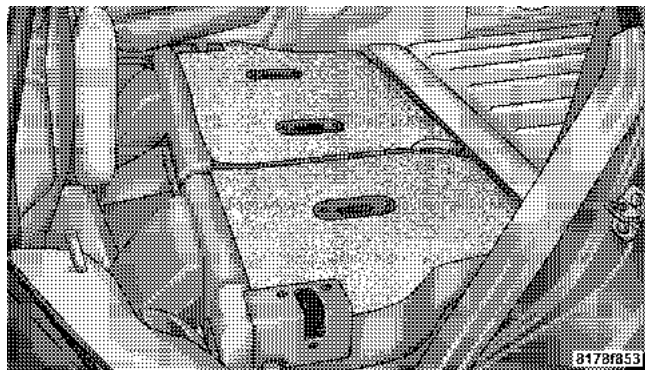

Rear Seat Folded Flat

Reclining Rear Seat — If Equipped

For additional comfort, pull the strap forward just enough to release the seatback latch.

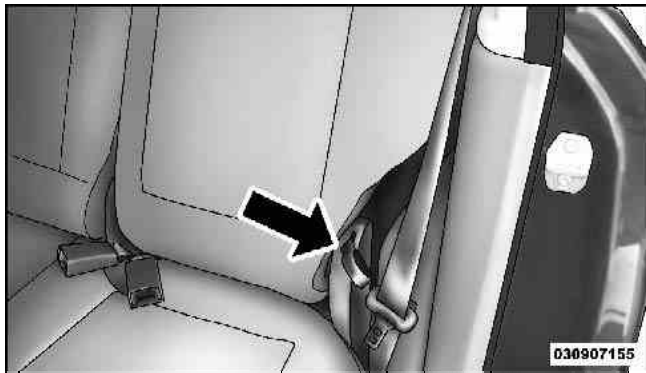

Reclining Rear Seat Strap

Then push the seatback to a reclined position, approximately 35 degrees maximum, and release the strap.

WARNING!

- It is extremely dangerous to ride in a cargo area, inside or outside of a vehicle. In a collision, people riding in these areas are more likely to be seriously injured or killed.
- Do not allow people to ride in any area of your vehicle that is not equipped with seats and seat belts.
- Be sure that everyone in your vehicle is in a seat and using a seat belt properly.

TO OPEN AND CLOSE THE HOOD

To open the hood, two latches must be released.

1. Pull the hood release lever located on the left kick panel.

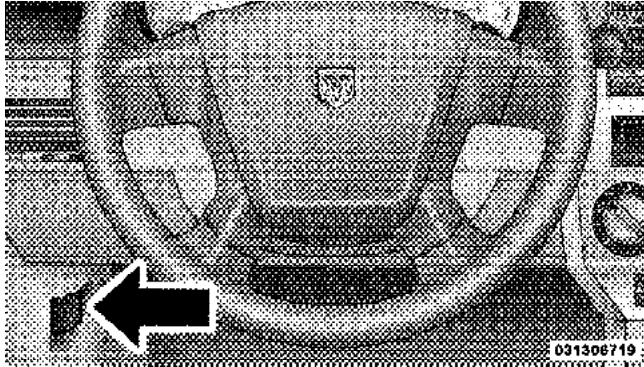

Hood Release Lever

2. Move the safety catch located under the front edge of the hood, near the center and raise the hood.



Safety Catch

Lift the hood prop rod, clipped to the left side (right side facing hood) of the engine compartment, to secure the hood in the open position. Place the hood prop at the location stamped into the inner hood surface.

CAUTION!

To prevent possible damage, do not slam the hood to close it. Lower the hood until it is open approximately 8 in (20 cm) and then drop it. This should secure both latches. Never drive your vehicle unless the hood is fully closed, with both latches engaged.

WARNING!

If the hood is not fully latched it could fly up when the vehicle is moving and block your forward vision. You could have a collision. Be sure all hood latches are fully latched before driving.

LIGHTS**Multifunction Lever**

The multifunction lever controls the operation of the headlights, parking lights, turn signals, headlight beam selection, instrument panel light dimming, interior lights, the passing lights, and fog lights. The multifunction lever is located on the left side of the steering column.

Headlights, Parking Lights and Instrument Panel Lights

Turn the end of the multifunction lever to the first detent for parking light operation. Turn the multifunction lever to the second detent for headlight operation.

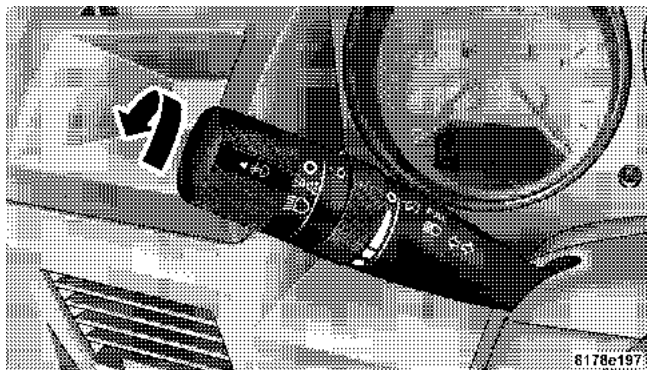

Headlight Control

To change the brightness of the instrument panel lights, rotate the center portion of the multifunction lever up or down.

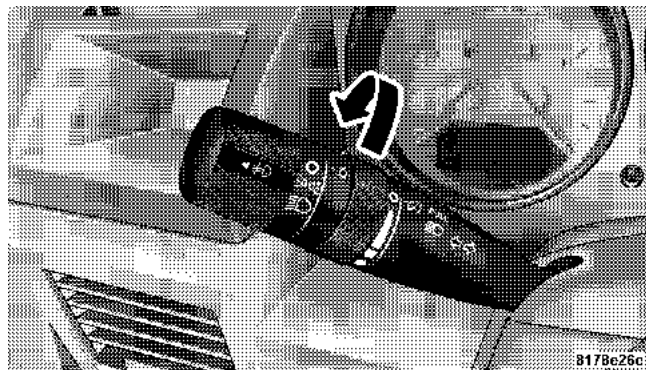

Dimmer Control

Lights-on Reminder

If the headlights or parking lights are on after the ignition is turned OFF, a chime will sound to alert the driver when the driver's door is opened.

Fog Lights — If Equipped

 The front fog light switch is on the multifunction lever. To activate the front fog lights, turn on the parking lights or the low beam headlights and pull out the end of the multifunction lever.

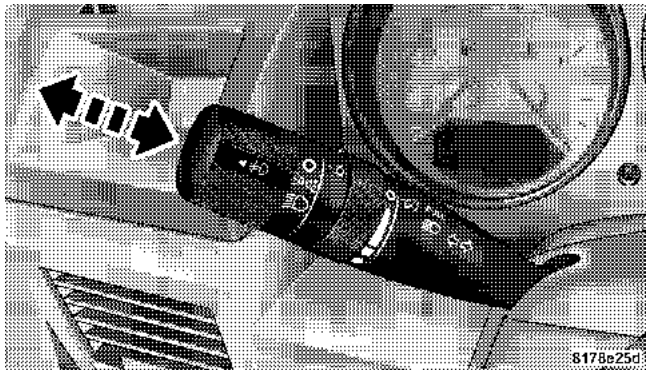

Fog Light Control

NOTE: The fog lights will only operate with the headlights on low beam. Selecting high beam headlights will turn off the fog lights.

Turn Signals

Move the multifunction lever up or down and the arrows on each side of the instrument cluster flash to show proper operation of the front and rear turn signal lights. You can signal a lane change by moving the multifunction lever partially up or down without moving beyond the detent.

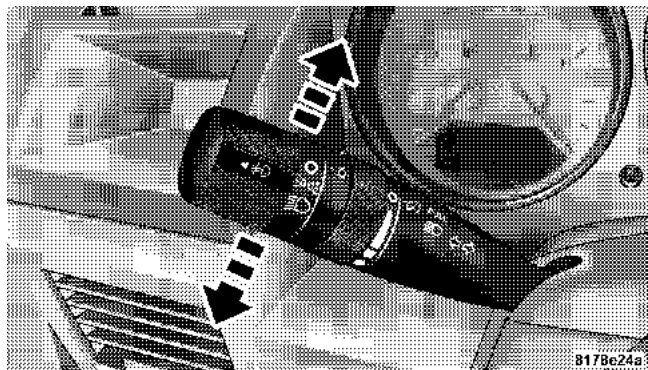

Turn Signal Control

If either light remains on and does not flash, or there is a very fast flash rate, check for a defective outside light bulb. If an indicator fails to light when the multifunction lever is moved, it would suggest that the fuse or indicator bulb is defective.

High Beam/Low Beam Select Switch

Push the multifunction lever away from you to switch the headlights to high beam. Pull the multifunction lever toward you to switch the headlights back to low beam.



High Beam Control

Flash-to-Pass

You can signal another vehicle with your headlights by lightly pulling the multifunction lever toward you. This will cause the headlights to turn on at high beam and remain on until the multifunction lever is released.

NOTE: If the multifunction lever is held in the flash-to-pass position for more than 30 seconds, the high beams will shut off. If this occurs, wait 30 seconds for the next flash-to-pass operation.

Map/Reading Lights

These lights are mounted between the sun visors above the rearview mirror. Each light is turned on by pressing the button. Press the button a second time to turn the light off. The lights also come on when a door is opened or the dimmer control is turned fully upward, past the second detent.

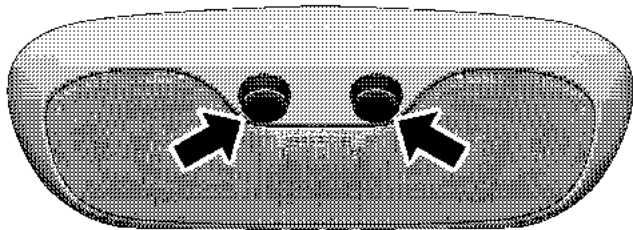

81790d82

Map/Reading Lights

NOTE: The lights will remain on until the switch is pressed a second time, so be sure they have been turned off before leaving the vehicle. The lights will turn off automatically 10 minutes after the ignition is turned OFF if the door is left open or light is switched on.

Daytime Running Lights (DRL) — If Equipped

The high beam headlights will come on as Daytime Running Lights (DRL) at DRL intensity, which is a lower intensity than the normal high beams. The DRL's will come on whenever the ignition is ON, the engine is running, the headlight switch is off, the parking brake is off, the turn signal is off, and the shift lever is in any position except for PARK.

NOTE: The DRLs will automatically turn off when the turn signals or Hazard Warning flashers are in operation and automatically turn back on when the turn signals and Hazard Warning flashers are not operating.

WINDSHIELD WIPERS AND WASHERS



The wipers and washers are operated by a switch on the control lever. The lever is located on the right side of the steering column.

Windshield Wiper Operation

Turn the end of the handle to select the desired wiper speed.

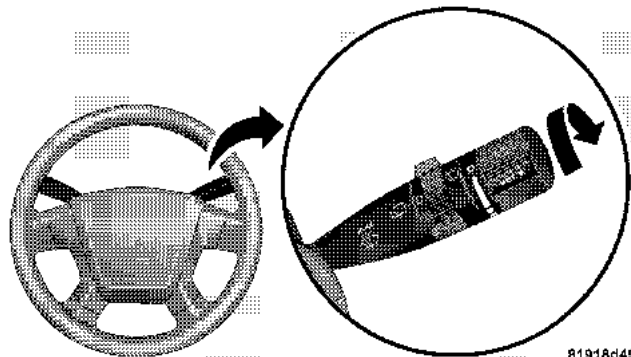

Wiper Control

81918d49

Intermittent Wiper System

Use the intermittent wiper when weather conditions make a single wiping cycle, with a variable pause between cycles, desirable. Select the delay interval by turning the end of the lever. Rotate the knob upward (clockwise) to decrease the delay time and downward (counterclockwise) to increase the delay time. The delay can be regulated from a maximum of approximately 18 seconds between cycles, to a cycle every second.

Windshield Washers

To use the washer, pull the control lever toward you and hold while spray is desired. If the lever is pulled while in the delay range, the wiper will operate in low speed for two wipe cycles after the lever is released, and then resume the intermittent interval previously selected.

If the lever is pulled while in the off position, the wipers will operate for two wipe cycles, then turn off.

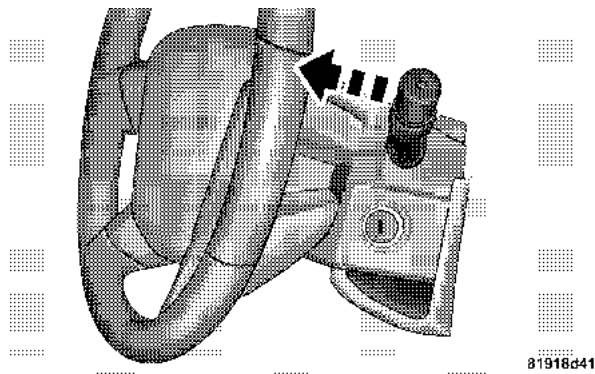

Washer Control

81918d41

Mist Feature

Push down on the wiper control lever to activate a single wipe to clear the windshield of road mist or spray from a passing vehicle. As long as the lever is held down, the wipers will continue to operate.

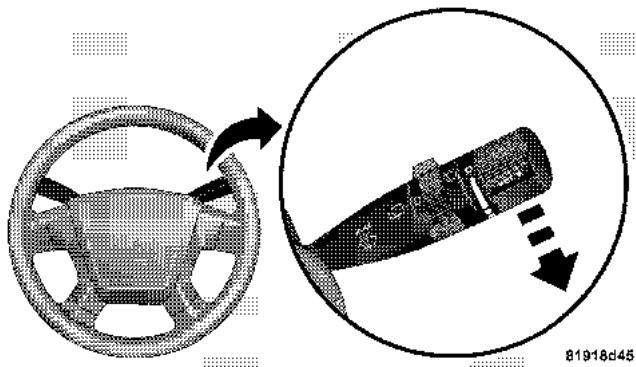

81918d45

Mist Control

CAUTION!

In cold weather, always turn off the wiper switch and allow the wipers to return to the park position before turning off the engine. If the wiper switch is left on and the wipers freeze to the windshield, damage to the wiper motor may occur when the vehicle is restarted.

TILT STEERING COLUMN

To tilt the steering column, push down on the lever below the multifunction lever. With one hand firmly on the wheel, move the steering column up or down as desired. Push the lever back up to lock the column firmly in place.

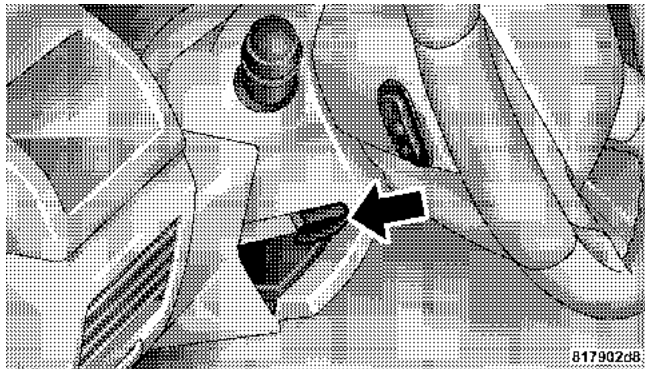

Tilt Steering Control

WARNING!

Tilting the steering column while the vehicle is moving is dangerous. Without a stable steering column, you could lose control of the vehicle and have an accident. Adjust the column only while the vehicle is stopped. Be sure it is locked before driving.

ELECTRONIC SPEED CONTROL — IF EQUIPPED

When engaged, Electronic Speed Control takes over the accelerator operation at speeds greater than 25 mph (40 km/h). The Electronic Speed Control lever is located on the right side of the steering wheel.



81bc4c2c

Electronic Speed Control Lever

NOTE: The Electronic Speed Control system has been designed to shut down if multiple speed control switch functions are operated simultaneously in order to ensure proper operation. If this occurs, the system can be

reactivated by pushing the Electronic Speed Control switch ON/OFF button and resetting the desired vehicle set speed.

To Activate

Push the ON/OFF button. The CRUISE indicator in the instrument cluster will illuminate. To turn the system off, push the ON/OFF button a second time. The CRUISE indicator will turn off. The system should be turned off when not in use.

3

WARNING!

Leaving the Electronic Speed Control system on when not in use is dangerous. You could accidentally set the system or cause it to go faster than you want. You could lose control and have an accident. Always leave the Electronic Speed Control system off when you are not using it.

To Set At A Desired Speed

When the vehicle has reached the desired speed, press down on the Electronic Speed Control lever and release. Release the accelerator and the vehicle will operate at the selected speed.

NOTE: The vehicle should be traveling at a steady speed and on level ground before pressing the SET lever.

To Deactivate

A soft tap on the brake pedal, pulling the Electronic Speed Control lever toward you CANCEL, or normal braking or pressing the clutch pedal while slowing the vehicle will deactivate Electronic Speed Control without erasing the set speed memory. Pressing the ON/OFF button or turning OFF the ignition switch erases the set speed memory.

To Resume Speed

To resume a previously set speed, push the RESUME ACCEL lever up and release. Resume can be used at any speed above 20 mph (32 km/h).

To Vary The Speed Setting

When the Electronic Speed Control is on, speed can be increased by pushing up and holding RESUME ACCEL. Release the Electronic Speed Control lever when the desired speed is reached, and the new speed will be set.

Tapping RESUME ACCEL once will result in a 1 mph (1.6 km/h) speed increase. Each time the Electronic Speed Control lever is tapped, speed increases, so that tapping the Electronic Speed Control lever three times will increase speed by 3 mph (4.8 km/h), etc.

To decrease speed while the Electronic Speed Control is on, push down and hold SET DECEL. Release the Electronic Speed Control lever when the desired speed is reached, and the new speed will be set.

Tapping the SET DECEL button once will result in a 1 mph (1.6 km/h) speed decrease. Each time the button is tapped, speed decreases.

Manual Transaxle

Pressing the clutch pedal will disengage the speed control. A slight increase in engine RPM before the Electronic Speed Control disengages is normal.

Vehicles equipped with manual transaxles may need to be shifted into a lower gear to climb hills without speed loss.

WARNING!

Electronic Speed Control can be dangerous where the system cannot maintain a constant speed. Your vehicle could go too fast for the conditions, and you could lose control. An accident could be the result. Do not use Electronic Speed Control in heavy traffic or on roads that are winding, icy, snow-covered, or slippery.

To Accelerate For Passing

Press the accelerator as you would normally. When the pedal is released, the vehicle will return to the set speed.

Using Electronic Speed Control On Hills

NOTE: The Electronic Speed Control system maintains speed, up and down hills. A slight speed change on moderate hills is normal.

On steep hills, a greater speed loss or gain may occur so it may be preferable to drive without Electronic Speed Control.

GARAGE DOOR OPENER — IF EQUIPPED

HomeLink® replaces up to three remote controls (hand-held transmitters) that operate devices such as garage door openers, motorized gates, lighting, or home security systems. The HomeLink® unit operates off your vehicle's battery.

The HomeLink® buttons that are located in the headliner or sun visor designate the three different HomeLink® channels.

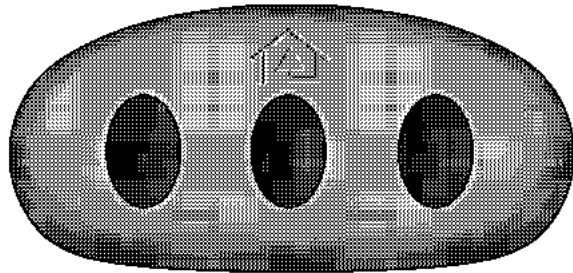

81cb44fe

HomeLink® Buttons

NOTE: HomeLink® is disabled when the Vehicle Security Alarm is active.

WARNING!

- **Your motorized door or gate will open and close while you are training the Universal Transceiver. Do not train the transceiver if people or pets are in the path of the door or gate. Only use this transceiver with a garage door opener that has a “stop and reverse” feature as required by Federal safety standards. This includes most garage door opener models manufactured after 1982. Do not use a garage door opener without these safety features. Call toll-free 1-800-355-3515 or, on the Internet at www.HomeLink.com for safety information or assistance.**
- **Vehicle exhaust contains carbon monoxide, a dangerous gas. Do not run your vehicle in the garage while training the transceiver. Exhaust gas can cause serious injury or death.**

Programming HomeLink®**Before You Begin**

If you have not trained any of the HomeLink® buttons, erase all channels before you begin training.

To do this, press and hold the two outside buttons for 20 seconds until the red indicator flashes.

It is recommended that a new battery be placed in the hand-held transmitter of the device being programmed to HomeLink® for more efficient training and accurate transmission of the radio-frequency signal.

Your vehicle should be parked outside of the garage when programming.

1. Turn the ignition switch to the ON/RUN position.
2. Hold the battery side of the hand-held transmitter away from the HomeLink® button you wish to program.

Place the hand-held transmitter 1–3 in (3–8 cm) away from the HomeLink® button you wish to program while keeping the indicator light in view.

3. Simultaneously press and hold both the chosen HomeLink® button and the hand-held transmitter button until the HomeLink® indicator changes from a slow to a rapidly blinking light, then release both the HomeLink® and hand-held transmitter buttons.

Watch for the HomeLink® indicator to change flash rates. When it changes, it is programmed. It may take up to 30 seconds, or longer in rare cases. The garage door may open and close while you train.

NOTE:

- Some gate operators and garage door openers may require you to replace Step 3 with procedures noted in the “Gate Operator/Canadian Programming” section.

- After training a HomeLink® channel, if the garage door does not operate with HomeLink® and the garage door opener was manufactured after 1995, the garage door opener may have a rolling code. If so, proceed to the heading “Programming A Rolling Code System.”

4. Press and hold the just-trained HomeLink® button and observe the indicator light.

If the indicator light stays on constantly, programming is complete and the garage door (or device) should activate when the HomeLink® button is pressed.

If the indicator light blinks rapidly for two seconds, and then turns to a constant light, continue with programming for a Rolling Code.

5. PROGRAMMING A ROLLING CODE SYSTEM

At the garage door opener motor (in the garage), locate the “Learn” or “Training” button.

This can usually be found where the hanging antenna wire is attached to the garage door opener motor (it is NOT the button normally used to open and close the door).

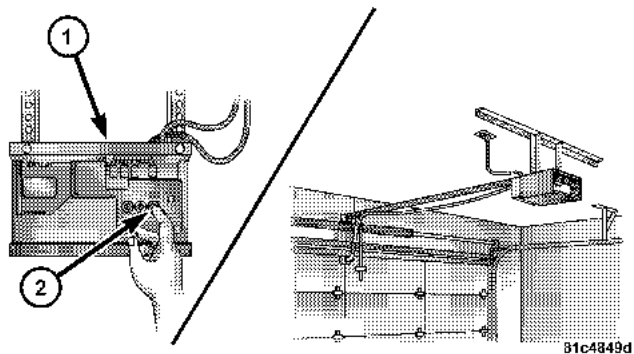

1 — Garage Door Opener
2 — Training Button

6. Firmly press and release the “Learn” or “Training” button. The name and color of the button may vary by manufacturer.

NOTE: There are 30 seconds in which to initiate the next step after the “Learn” button has been pressed.

7. Return to the vehicle and press the programmed HomeLink® button twice (holding the button for two seconds each time). If the device is plugged in and activates, programming is complete.

If the device does not activate, press the button a third time (for two seconds) to complete the training.

If you have any problems, or require assistance, please call toll-free 1-800-355-3515 or, on the Internet at www.HomeLink.com for information or assistance.

To program the remaining two HomeLink® buttons, repeat each step for each remaining button. DO NOT erase the channels.

Gate Operator/Canadian Programming

Canadian radio-frequency laws require transmitter signals to “time-out” (or quit) after several seconds of transmission – which may not be long enough for HomeLink® to pick up the signal during programming. Similar to this Canadian law, some U.S. gate operators are designed to “time-out” in the same manner.

It may be helpful to unplug the device during the cycling process to prevent possible overheating of the garage door or gate motor.

If you are having difficulties programming a garage door opener or a gate operator, replace “Programming HomeLink®” Step 3 with the following:

3. Continue to press and hold the HomeLink® button while you press and release - every two seconds (“cycle”) your hand-held transmitter until HomeLink®

has successfully accepted the frequency signal. The indicator light will flash slowly and then rapidly when fully trained.

If you unplugged the device for training, plug it back in at this time.

Then proceed with Step 4 under “Programming HomeLink®” earlier in this section.

Using HomeLink®

To operate, simply press and release the programmed HomeLink® button. Activation will now occur for the trained device (i.e., garage door opener, gate operator, Security system, entry door lock, home/office lighting, etc. The hand-held transmitter of the device may also be used at any time.

Reprogramming A Single HomeLink® Button

To re-program a channel that has been previously trained, follow these steps:

1. Turn the ignition switch to the ON/RUN position.
2. Press and hold the desired HomeLink® button until the indicator light begins to flash after 20 seconds. **Do not release the button.**
3. **Without releasing the button,** proceed with Programming Homelink® Step 2 and follow all remaining steps.

Security

It is advised to erase all channels before you sell or turn in your vehicle.

To do this, press and hold the two outside buttons for 20 seconds until the red indicator flashes. Note that all channels will be erased. Individual channels cannot be erased.

The HomeLink® Universal Transceiver is disabled when the Vehicle Security Alarm is active.

Troubleshooting Tips

If you are having trouble programming HomeLink®, here are some of the most common solutions:

- Replace the battery in the original transmitter.
- Press the “Learn” button on the Garage Door Opener to complete the training for a Rolling Code.
- Did you unplug the device for training, and remember to plug it back in?

If you have any problems, or require assistance, please call toll-free 1-800-355-3515 or, on the Internet at www.HomeLink.com for information or assistance.

General Information

This device complies with FCC rules Part 15 and Industry Canada RSS-210. Operation is subject to the following two conditions:

1. This device may not cause harmful interference
2. This device must accept any interference that may be received including interference that may cause undesired operation

NOTE: The transmitter has been tested and it complies with FCC and IC rules. Changes or modifications not expressly approved by the party responsible for compliance could void the user's authority to operate the device.

The term IC before the certification/registration number only signifies that Industry Canada technical specifications were met.

POWER SUNROOF — IF EQUIPPED

The power sunroof switch is located in the reading light.

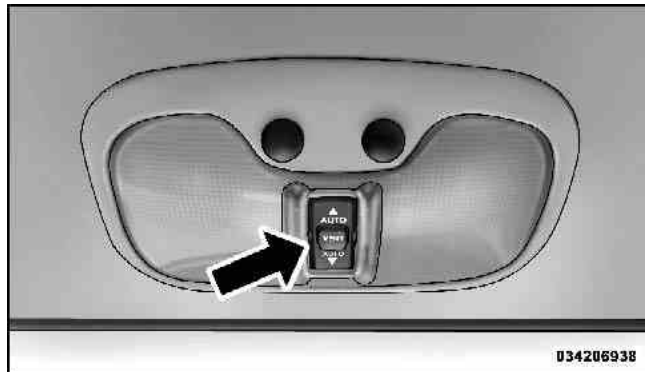

Power Sunroof Switch

WARNING!

- **Never leave children in a vehicle, with the key in the ignition switch. Occupants, particularly unattended children, can become entrapped by the power sunroof while operating the power sunroof switch. Such entrapment may result in serious injury or death.**
- **In an accident, there is a greater risk of being thrown from a vehicle with an open sunroof. You could also be seriously injured or killed. Always fasten your seat belt properly and make sure all passengers are properly secured too.**
- **Do not allow small children to operate the sunroof. Never allow fingers or other body parts, or any object to project through the sunroof opening. Injury may result.**

Opening the Sunroof**Manual Mode**

To open the sunroof, press and hold the switch rearward to full open. Any release of the switch will stop the movement and the sunroof will remain in a partial open condition until the switch is pushed and held rearward again.

Express Mode

Press the switch rearward and release, and the sunroof will open automatically from any position. The sunroof will open fully, and stop automatically, this is called “Express Open”. During Express Open operation any movement of the sunroof switch will stop the sunroof.

Closing the Sunroof

Manual Mode

To close the sunroof, press and hold the switch in the forward position. Again, any release of the switch will stop the movement and the sunroof will remain in a partial close condition until the switch is pushed and held forward again. To ensure sunroof is fully closed, press and hold switch until sunroof has completely stopped moving.

Express Mode

Press the switch forward and release, and the sunroof will close automatically from any position. The sunroof will close fully, and stop automatically, this is called “Express Close”. During Express Close operation, any movement of the switch will stop the sunroof.

Pinch Protect Feature

This feature will detect an obstruction in the opening of the sunroof during Express Close operation. If an obstruction in the path of the sunroof is detected, the sunroof will automatically retract. Remove obstruction and press the switch forward and release to Express Close.

Pinch Protect Override

If a known obstruction (ice, debris, etc.) prevents closing, press the switch forward and hold for two seconds after the reversal occurs. This allows the sunroof to move towards the close position.

NOTE: Pinch protection is disabled while the switch is pressed.

Venting Sunroof — Express

Press and hold the “Vent” button, and the sunroof will open to the vent position. This is called “Express Vent”, and will occur regardless of the sunroof position. During Express Vent operation, any movement of the switch will stop the sunroof.

Sunshade Operation

The sunshade can be opened manually. However, the sunshade will open automatically as the sunroof opens.

NOTE: The sunshade cannot be closed if the sunroof is open.

Wind Buffeting

Wind buffeting can be described as the perception of pressure on the ears or a helicopter-type sound in the ears. Your vehicle may exhibit wind buffeting with the

windows down, or the sunroof (if equipped) in certain open or partially open positions. This is a normal occurrence and can be minimized. If the buffeting occurs with the rear windows open, open the front and rear windows together to minimize the buffeting. If the buffeting occurs with the sunroof open, adjust the sunroof opening to minimize the buffeting or open any window.

Sunroof Maintenance

Use only a nonabrasive cleaner and a soft cloth to clean the glass panel.

Ignition Off Operation

The sunroof will also operate up to 45 seconds after the ignition has been turned OFF. The sunroof operation will be canceled if either of the front doors are opened during the 45 second time period.

ELECTRICAL POWER OUTLETS

There is a standard 12-Volt power outlet located in the instrument panel for added convenience. This outlet can power cell phones, electronics and other low power devices.

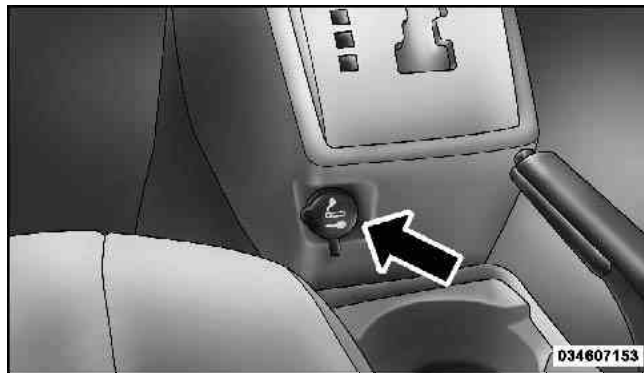

Power Outlet 12-Volts

WARNING!

To avoid serious injury or death:

- Do not use a three-prong adapter.
- Do not insert any objects into the receptacles.
- Do not touch with wet hands.
- Close the lid when not in use and while driving the vehicle.
- If this outlet is mishandled, it may cause an electric shock and failure.

CAUTION!

- Many accessories that can be plugged in draw power from the vehicle's battery, even when not in use (i.e., cellular phones, etc.). Eventually, if plugged in long enough, the vehicle's battery will discharge sufficiently to degrade battery life and/or prevent engine starting.
- Accessories that draw higher power (i.e., coolers, vacuum cleaners, lights, etc.) will degrade the battery even more quickly. Only use these intermittently and with great caution.
- After the use of high power draw accessories, or long periods of the vehicle not being started (with accessories still plugged in), the vehicle must be driven a sufficient length of time to allow the generator to recharge the vehicle's battery.

POWER INVERTER — IF EQUIPPED

A 115-Volt (150-Watt) AC power inverter is located on the rear of the center console for added convenience. This outlet can power cellular phones, electronics and other low power devices requiring power up to 150 Watts. Certain high-end video games, such as Playstation3 and XBox360 will exceed this power limit, as will most power tools. Due to built-in overload protection, the power outlet will shut down if the power rating is exceeded. Each device to be powered should be checked first to make sure it does not exceed the outlet's 150 Watts maximum rating.

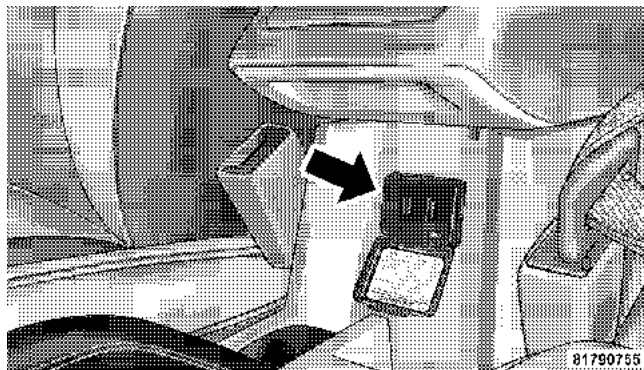
**115-Volt Power Outlet**

WARNING!

To avoid serious injury or death:

- Do not use a three-prong adaptor.
- Do not insert any objects into the receptacles.
- Do not touch with wet hands.
- Close the lid when not in use.
- If this outlet is mishandled, it may cause an electric shock and failure.

CAUTION!

- Many accessories that can be plugged in draw power from the vehicle's battery, even when not in use (i.e., cellular phones, etc.). Eventually, if plugged in long enough, the vehicle's battery will discharge sufficiently to degrade battery life and/or prevent engine starting.

(Continued)

CAUTION! (Continued)

- Accessories that draw higher power (i.e., coolers, vacuum cleaners, lights, etc.) will degrade the battery even more quickly. Only use these intermittently and with great caution.
- After the use of high power draw accessories, or long periods of the vehicle not being started (with accessories still plugged in), the vehicle must be driven a sufficient length of time to allow the generator to recharge the vehicle's battery.

CUPHOLDERS

Your vehicle is equipped with four cupholders. There are two cupholders located in the front.

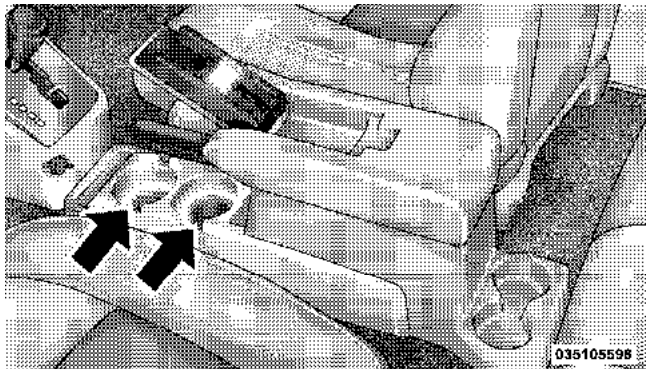

Front Cupholders

There are two cupholders behind the center console for rear passengers.

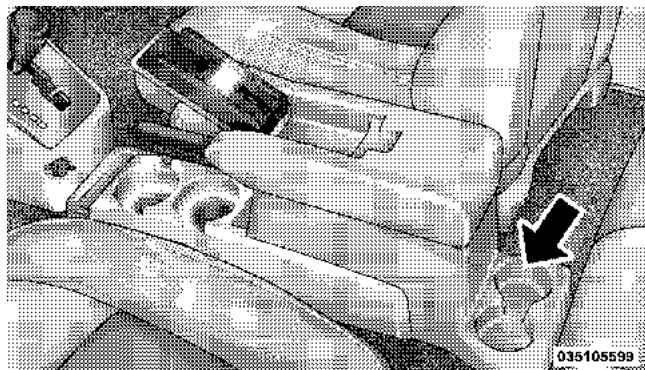

Rear Cupholders

CONSOLE FEATURES

The floor console's sliding armrest moves forward 3 in (76.2 mm) to accommodate shorter drivers. The armrest lid also includes a unique flip pocket for storing a phone or an MP3 player. The bin inside the console can hold up to 10 CD jewel cases or other items securely out of sight.

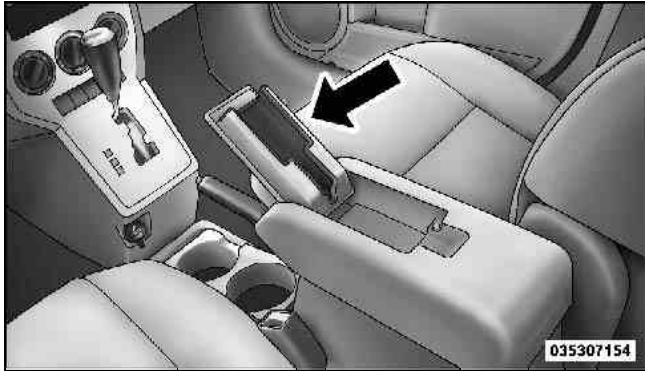

Floor Console Flip Pocket

WARNING!

Do not operate this vehicle with the console compartment lid in the open position. Cell phones, music players, and other handheld electronic devices should be stowed while driving. Use of these devices while driving can cause an accident due to distraction, resulting in death or injury.

NOTE: The flip pocket and console lid features are intended to be used in the upright or open position only while the vehicle is parked. While driving, all handheld devices should be properly stowed, and the flip pocket and the console lid should be closed.

CARGO AREA FEATURES

Cargo Light/Removable Self-Recharging Flashlight — If Equipped

The dual-function light is mounted in the headliner above the cargo area to illuminate the cargo area, and part of it snaps out of the bezel to serve as a flashlight when needed. The flashlight features two bright LED light bulbs and is powered by rechargeable lithium batteries that recharge when snapped back into place for convenience.

Press in on the flashlight to release it.

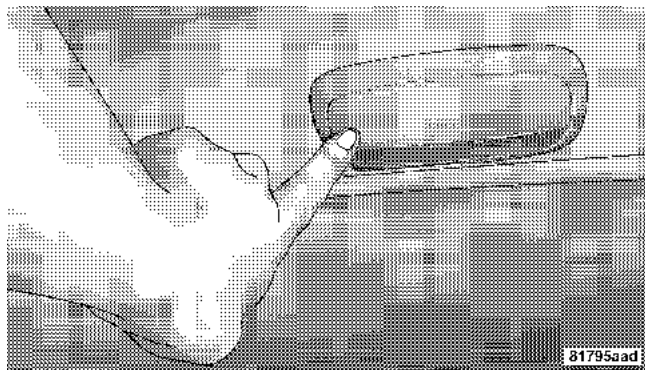

Press And Release

To operate the flashlight, press the switch once for high, twice for low, and a third time to return to off.

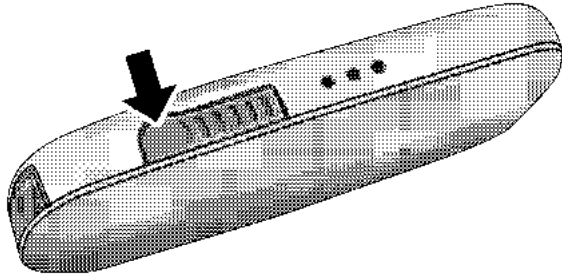

818144f6

Three-Press Switch

Cargo Cover — If Equipped

The cargo area trim panels include two notches for mounting the available tonneau cover that accommodates the reclining rear seat.

To install the Cargo Cover, insert either end of the cover into one of the two notches located in the rear trim panels. With one of the cover ends installed, push inward on the opposite end and install it into the same notch location of the rear trim panel.

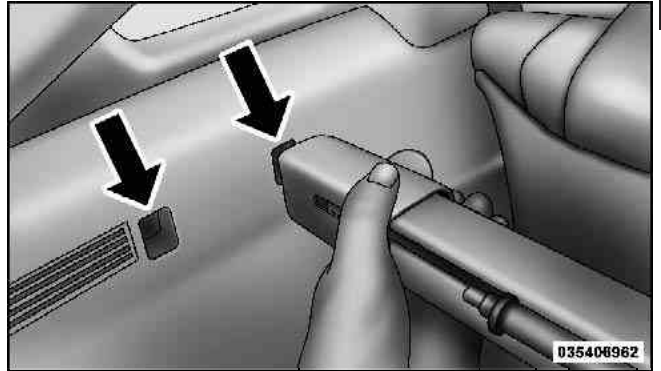

Rear Trim Notches

Using the handle, pull the cover toward you and guide the rear cover posts into the guides located on both sides of the rear trim panel.

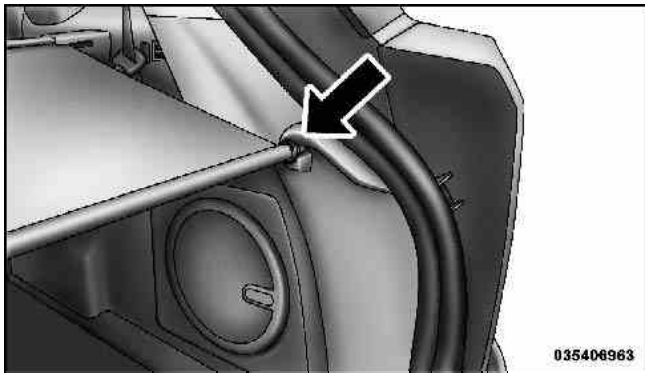

Cargo Cover Guides

WARNING!

In an accident a cargo cover loose in the vehicle could cause injury. It could fly around in a sudden stop and strike someone in the vehicle. Do not store the cargo cover on the cargo floor or in the passenger compartment. Remove the cover from the vehicle when taken from its mounting. Do not store in the vehicle.

Removable Load Floor

The cargo area load floor is removable and can be washed with mild soap and water.

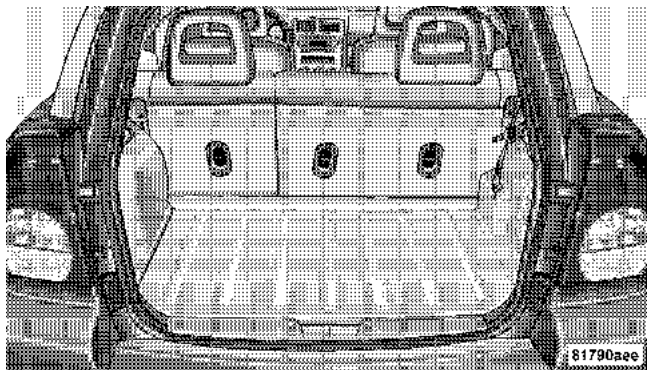

Rear Cargo Area

Cargo Tie-Down Loops

There are two D-rings installed in the cargo area for securing cargo.

WARNING!

- Cargo tie-down loops are not safe anchors for a child seat tether strap. In a sudden stop or collision a loop could pull loose and allow the child seat to come loose. A child could be badly injured. Use only the anchors provided for child seat tethers.
- The weight and position of cargo and passengers can change the vehicle center of gravity and vehicle handling. To avoid loss of control resulting in personal injury, follow these guidelines for loading your vehicle:
- Always place cargo evenly on the cargo floor. Put heavier objects as low and as far forward as possible.

(Continued)

WARNING! (Continued)

- Place as much cargo as possible in front of the rear axle. Too much weight or improperly placed weight over or behind the rear axle can cause the rear of the vehicle to sway.
- Do not pile luggage or cargo higher than the top of the seatback. This could impair visibility or become a dangerous projectile in a sudden stop or collision.
- To help protect against personal injury, passengers should not be seated in the rear cargo area. The rear cargo space is intended for load carrying purposes only, not for passengers, who should sit in seats and use seat belts.

Fold Down Speakers — If Equipped

When the liftgate is open, the speakers can swing down off the trim panel to face rearward, for tailgating and other activities.

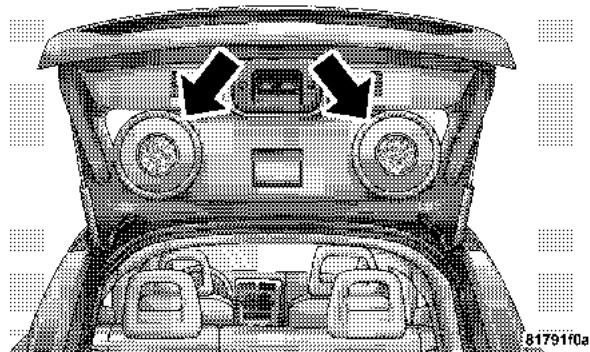

Fold-Down Speakers

REAR WINDOW FEATURES**Rear Window Wiper/Washer**

A switch on the right side of the steering column controls operation of the rear wiper/washer function. Rotating the center of the switch forward to the on position will

activate the wiper. The rear wiper operates in an intermittent mode only. Rotating the center of the switch all the way forward will turn on the wash function. The wash pump will continue to operate as long as the button is pressed. Upon release, the wipers will cycle two times before returning to the set position.

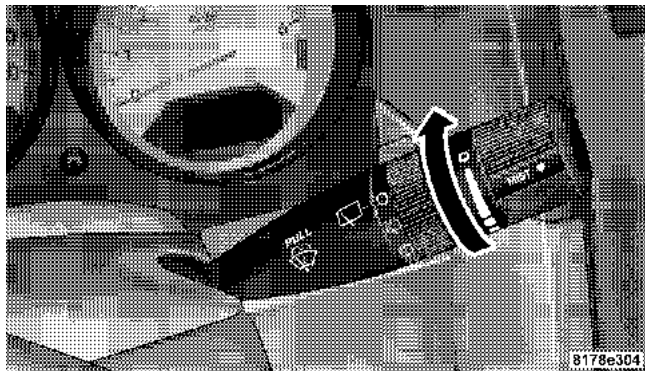

Rear Washer Wiper Control

If the rear wiper is operating when the ignition is turned OFF, the wiper will automatically return to the “Park” position if power accessory delay is active. Power accessory delay can be cancelled by opening the door; if this happens, the rear wiper will stop at its current position and will not go to “Park”.

Rear Window Defroster

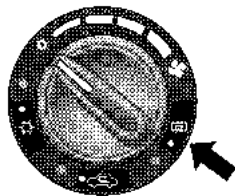

81caad17

The pushbutton is located on the bottom right side of the blower control knob.



Press this button to turn on the rear window defroster. An amber light shows that the defroster is on. The defroster will automatically turn off after

approximately 10 minutes. For an additional five minutes of operation, press the switch a second time. To prevent excessive battery drain, use the defroster only when the engine is operating.

CAUTION!

Use care when washing the inside of the rear window to prevent damage to heating elements. Use a soft cloth and a mild washing solution, wiping parallel to the heating elements. Keep all objects a safe distance from the window to prevent damaging the heating elements.

COOLED BEVERAGE STORAGE BIN/GLOVE COMPARTMENT — IF EQUIPPED

The upper storage bin door swings upward to present the contents of the long shallow bin that can store items out of sight. Beneath this bin is the glove compartment. The

large glove compartment door swings downward and features two levels of storage. The upper bin functions as a Cooled Beverage Storage Bin, for vehicles equipped with air conditioning, for storing up to four 20 oz (1 L) bottles or cans. When desired, cool air enters the compartment to keep the contents cool, depending on ambient temperature and A/C settings.

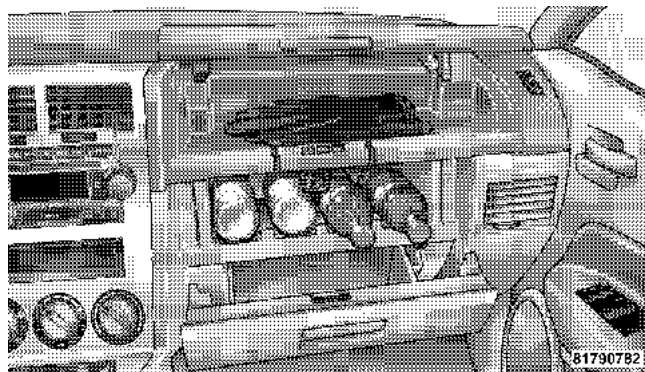

Glove Compartment And Cooled Beverage Storage

NOTE: The use of the Cooled Beverage Storage Bin is for nonperishable beverages only.

To operate the beverage cooler, pull the slide control about 0.5 in (12 mm) toward the passenger compartment. This will allow cool air to enter the beverage cooler. To shut off the beverage cooler when not in use, push the slide control back 0.5 in (12 mm). This will prevent cool air from entering the passenger compartment when in heat mode.

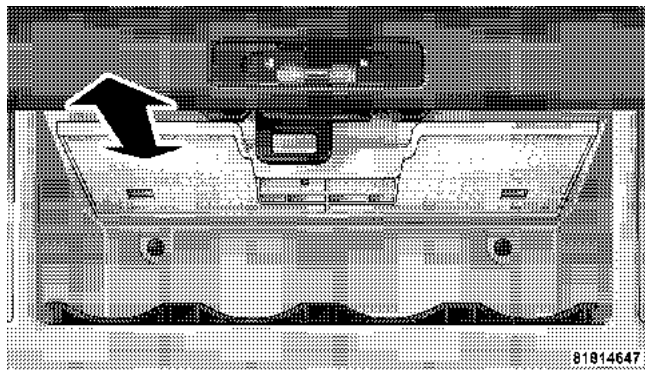

3

Positioning Slide Control

Vehicles without air conditioning can use that space for storage. The lower bin holds the Owner's Manual and other important documents. Another storage bin is located on the outboard side of the steering wheel and can hold small items like parking cards for easy access.

UNDERSTANDING YOUR INSTRUMENT PANEL

CONTENTS

■ Instrument Panel Features	166	□ Average Fuel Economy	184
■ Instrument Cluster – Base	167	□ Distance To Empty (DTE)	184
■ Instrument Cluster – Premium	168	□ Elapsed Time	185
■ Instrument Cluster Descriptions	169	□ Tire Pressure Monitor (TPM)	185
■ Electronic Vehicle Information Center (EVIC) — If Equipped	180	□ Personal Settings (Customer-Programmable Features)	185
□ Oil Change Required	182	■ Sales Code REQ — AM/FM Stereo Radio And 6-Disc CD/DVD Changer (MP3/WMA AUX Jack)	190
□ EVIC Functions	183	□ Operating Instructions - Radio Mode	191
□ Compass/Temperature/Audio	184		

- Operation Instructions - (Disc Mode For CD And MP3/WMA Audio Play, DVD-Video) . . . 198
- Notes On Playing MP3/WMA Files 200
- List Button (Disc Mode For MP3/WMA Play) 203
- Info Button (Disc Mode For MP3/WMA Play) 203
- AM/FM/CD/DVD Radio (RER/REN) – If Equipped 205
 - Operating Instructions — Voice Recognition System (VR) — If Equipped 206
 - Operating Instructions — uconnect® phone — If Equipped 206
 - Clock Setting Procedure 206
- Sales Code RES — AM/FM Stereo Radio With CD Player (MP3 AUX Jack) 208
 - Operating Instructions — Radio Mode 208
 - Operation Instructions — CD Mode For CD And MP3 Audio Play 211
 - Notes On Playing MP3 Files 214
 - Operation Instructions - Auxiliary Mode 217
- Sales Code RES/RSC — AM/FM Stereo Radio With CD Player (MP3 AUX Jack) And Sirius Radio 217
 - Operating Instructions — Radio Mode 218
 - Operation Instructions — CD Mode For CD And MP3 Audio Play 223
 - Notes On Playing MP3 Files 225
 - List Button (CD Mode For MP3 Play) 228

- Info Button (CD Mode For MP3 Play) 228
- uconnect® studios (Satellite Radio) — If Equipped (REN/REQ/RER/RES/REU Radios Only). 229
- System Activation 229
- Electronic Serial Number/Sirius Identification Number (ESN/SID) 230
- Selecting uconnect® studios (Satellite) Mode 230
- Satellite Antenna 231
- Reception Quality 231
- Operating Instructions — uconnect® studios (Satellite) Mode 231
- Operating Instructions — uconnect® phone (If Equipped) 234

- Operating Instructions — Video Entertainment System (VES)™ (If Equipped) 234
- Remote Sound System Controls — If Equipped 234
- Radio Operation 235
- CD Player 235
- CD/DVD Maintenance 235
- Radio Operation And Cellular Phones 236
- Climate Controls 236
- Manual Heating And Air Conditioning System 236
- Air Filtration System – If Equipped 241
- Operating Tips 242

INSTRUMENT PANEL FEATURES

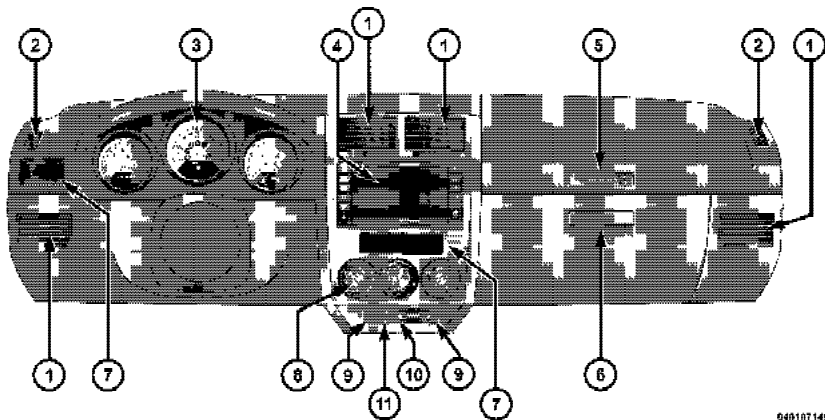

040107145

- 1 - Air Outlet
- 2 - Demisters
- 3 - Instrument Cluster
- 4 - Radio

- 5 - Upper Glove Compartment
- 6 - Lower Glove Compartment/Beverage Cooler - If Equipped
- 7 - Storage Bins
- 8 - Climate Controls

- 9 - Heated Seat Switches - If Equipped
- 10 - Hazard Warning Flasher
- 11 - ESP OFF Switch - If Equipped

INSTRUMENT CLUSTER – BASE

INSTRUMENT CLUSTER – PREMIUM

INSTRUMENT CLUSTER DESCRIPTIONS

1. Fuel Gauge

When the ignition switch is in the ON position, the pointer will show the level of fuel remaining in the fuel tank.

2. Fuel Door Reminder



This indicates that the fuel filler door is located on the left side of the vehicle.

3. Temperature Gauge

The temperature gauge shows engine coolant temperature. Any reading within the normal range indicates that the engine cooling system is operating satisfactorily.

The gauge pointer will likely indicate a higher temperature when driving in hot weather, up mountain grades, or when towing a trailer. It should not be allowed to exceed the upper limits of the normal operating range.

CAUTION!

Driving with a hot engine cooling system could damage your vehicle. If temperature gauge reads “H” pull over and stop the vehicle. Idle the vehicle with the air conditioner turned off until the pointer drops back into the normal range. If the pointer remains on the “H” and you hear continuous chimes, turn the engine off immediately, and call an authorized dealership for service.

WARNING!

A hot engine cooling system is dangerous. You or others could be badly burned by steam or boiling coolant. You may want to call an authorized dealership for service if your vehicle overheats. If you decide to look under the hood yourself, see Section 7 of this manual. Follow the warnings under the Cooling System Pressure Cap paragraph.

4. Speedometer

The Speedometer shows the vehicle speed in miles per hour and/or kilometers per hour (mph/kph).

5. Tachometer

The white area of the scale shows the permissible engine revolutions-per-minute (RPM x 1000) for each gear range. Before reaching the red area, ease up on the accelerator to prevent engine damage.

6. Low Fuel Light

When the fuel level reaches approximately 2.0 gal (7.8 L) this light will turn on, and remain on until fuel is added.

7. Charging System Light

This light shows the status of the electrical charging system. The light should come on when the ignition switch is first turned ON and remain on briefly as a bulb check. If the light stays on or comes on while driving, turn off some of the vehicle's non-essential electrical devices or increase engine speed (if at idle). If the charging system light remains on, it means that the vehicle is experiencing a problem with the charging system. Obtain SERVICE IMMEDIATELY. See an authorized dealer.

8. *Airbag Warning Light*



This light turns on and remains on for seven seconds as a bulb check, when the ignition switch is first turned ON. If the light is not on during starting, stays on, or turns on while driving, have the system inspected by an authorized dealer as soon as possible.

9. *Vehicle Security Light — If Equipped*



This light will flash at a fast rate for approximately 16 seconds, when the vehicle security alarm is arming, and then will flash slowly until the vehicle is disarmed.

10. *Seat Belt Reminder Light*



When the ignition switch is first turned ON, this light will turn on for five to eight seconds as a bulb check. During the bulb check, if the driver's seat

belt is unbuckled, a chime will sound. After the bulb check or when driving, if the driver's seat belt remains unbuckled, the Seat Belt Reminder Light will illuminate and the chime will sound. Refer to "Occupant Restraints" in Section 2 for more information.

11. *Oil Pressure Warning Light*



This light indicates low engine oil pressure. The light should turn on momentarily when the engine is started. If the light turns on while driving, stop the vehicle and shut off the engine as soon as possible. A chime will sound for four minutes when this light turns on.

Do not operate the vehicle until the cause is corrected. This light does not show how much oil is in the engine. The engine oil level must be checked under the hood.

12. Engine Temperature Warning Light



This light warns of an overheated engine condition. As temperatures rise and the gauge approaches **H**, this indicator will illuminate and a single chime will sound after reaching a set threshold. Further overheating will cause the temperature gauge to pass **H**, the indicator will continuously flash and a continuous chime will occur until the engine is allowed to cool.

If the light turns on while driving, safely pull over and stop the vehicle. If the A/C system is on, turn it off. Also, shift the transmission into **NEUTRAL** and idle the vehicle. If the temperature reading does not return to normal, turn the engine off immediately and call for service. Refer to “If Your Engine Overheats” in Section 6 for more information.

13. Shift Lever Indicator

This display indicator shows the automatic transmission shift lever selection.

14. Tire Pressure Monitoring Telltale Light



Each tire, including the spare (if provided), should be checked monthly, when cold and inflated to the inflation pressure recommended by the vehicle manufacturer on the vehicle placard or tire inflation pressure label. (If your vehicle has tires of a different size than the size indicated on the vehicle placard or tire inflation pressure label, you should determine the proper tire inflation pressure for those tires.)

As an added safety feature, your vehicle has been equipped with a Tire Pressure Monitoring System (TPMS) that illuminates a low tire pressure telltale when one or more of your tires is significantly under-inflated.

Accordingly, when the low tire pressure telltale illuminates, you should stop and check your tires as soon as possible, and inflate them to the proper pressure. Driving on a significantly under-inflated tire causes the tire to overheat and can lead to tire failure. Under-inflation also reduces fuel efficiency and tire tread life, and may affect the vehicle's handling and stopping ability.

Please note that the TPMS is not a substitute for proper tire maintenance, and it is the driver's responsibility to maintain correct tire pressure, even if under-inflation has not reached the level to trigger illumination of the TPMS low tire pressure telltale.

Your vehicle has also been equipped with a TPMS malfunction indicator to indicate when the system is not operating properly. The TPMS malfunction indicator is

combined with the low tire pressure telltale. When the system detects a malfunction, the telltale will flash for approximately one minute and then remain continuously illuminated. This sequence will continue upon subsequent vehicle start-ups as long as the malfunction exists. When the malfunction indicator is illuminated, the system may not be able to detect or signal low tire pressure as intended. TPMS malfunctions may occur for a variety of reasons, including the installation of replacement or alternate tires or wheels on the vehicle that prevent the TPMS from functioning properly. Always check the TPMS malfunction telltale after replacing one or more tires or wheels on your vehicle, to ensure that the replacement or alternate tires and wheels allow the TPMS to continue to function properly.

CAUTION!

The TPMS has been optimized for the original equipment tires and wheels. TPMS pressures and warning have been established for the tire size equipped on your vehicle. Undesirable system operation or sensor damage may result when using replacement equipment that is not of the same size, type, and/or style. Aftermarket wheels can cause sensor damage. Do not use tire sealant from a can, or balance beads if your vehicle is equipped with a TPMS, as damage to the sensors may result.

15. Odometer/Trip Odometer

This display indicates the total distance the vehicle has been driven. Also, the cluster will display, replacing the odometer/trip odometer, vehicle warning messages such as: “door/gate ajar”, “gASCAP” (loose gas cap), “LoW TirE” (display toggles between LoW and TirE when tire

pressure is low), and “Change Oil” message. Loose gas cap (gASCAP) will be displayed from the Odometer/Trip Odometer on all models.

NOTE: If the vehicle is equipped with the optional Electronic Vehicle Information Center (EVIC) in the instrument cluster, all warnings including “door” and “gATE” and “Oil Change Required” will only be displayed in the EVIC display. For additional information, refer to “Electronic Vehicle Information Center — If Equipped” in this section.

Change Oil Message

Your vehicle is equipped with an engine oil change indicator system. The “Change Oil” message will flash in the instrument cluster odometer for approximately 12 seconds after a single chime has sounded to indicate the next scheduled oil change interval. The engine oil change indicator system is duty cycle based, which

means the engine oil change interval may fluctuate dependent upon your personal driving style.

Unless reset, this message will continue to display each time you turn the ignition switch to the ON/RUN position. To turn off the message temporarily, press and release the Trip Odometer button on the instrument cluster. To reset the oil change indicator system (after performing the scheduled maintenance), refer to the following procedure:

1. Turn the ignition switch to the ON position. **Do not start the engine.**
2. Fully depress the accelerator pedal slowly three times within 10 seconds.
3. Turn the ignition switch to the OFF/LOCK position.

NOTE: If the indicator message illuminates when you start the vehicle, the oil change indicator system did not reset. If necessary, repeat this procedure.

16. *Malfunction Indicator Light (MIL)*



The Malfunction Indicator Light (MIL) is part of an onboard diagnostic system, called OBD, that monitors engine and automatic transmission control systems. The light will illuminate when the key is in the ON position, before engine start. If the bulb does not come on when turning the key from OFF to ON, have the condition checked promptly.

Certain conditions such as a loose or missing gas cap, poor fuel quality, etc., may illuminate the MIL after engine start. The vehicle should be serviced if the light stays on through several of your typical driving cycles. In most situations the vehicle will drive normally and will not require towing.

If the MIL flashes when the engine is running, serious conditions may exist that could lead to immediate loss of power or severe catalytic converter damage. The vehicle should be serviced as soon as possible if this occurs.

17. *Cruise Indicator — If Equipped*

CRUISE This indicator shows that the Speed Control system is ON.

18. *Trip/Odometer Display Reset Button*

Press this button to change the display from odometer to either of the two trip odometer settings. Trip A or Trip B will appear when in the trip odometer mode. Push in and hold the button for two seconds to reset the trip odometer to 0 miles (0 km). The odometer must be in Trip mode to reset.

19. *Electronic Throttle Control (ETC) Light*

 This light informs you of a problem with the Electronic Throttle Control (ETC) system. If a problem is detected, the light will come on while the engine is running. Cycle the ignition key when the vehicle has completely stopped and the shift lever is placed in the PARK position. The light should turn off. If the light remains lit with the engine

running your vehicle will usually be drivable, however, see an authorized dealer for service as soon as possible. If the light is flashing when the engine is running, immediate service is required and you may experience reduced performance, an elevated/rough idle or engine stall and your vehicle may require towing. The light will come on when the ignition is first turned ON and remain on briefly as a bulb check. If the light does not come on during starting, have the system checked by an authorized dealer.

20. *Electronic Stability Program (ESP) Indicator Light/Traction Control System (TCS) Indicator Light*

 If this indicator light flashes during acceleration, apply as little throttle as possible. While driving, ease up on the accelerator. Adapt your speed and driving to the prevailing road conditions, and do not switch off the Electronic Stability Program (ESP), or Traction Control System (TCS).

21. Turn Signal Indicators

 The arrow will flash with the exterior turn signal when the turn signal lever is operated.

If the vehicle electronics sense that the vehicle has traveled about one mile with the turn signals on, a continuous chime will sound to alert you to turn the signals off. If either indicator flashes at a rapid rate, check for a defective outside light bulb.

22. Front Fog Light Indicator — If Equipped

 This light shows when the front fog lights are ON.

23. Electronic Stability Program (ESP) Indicator Light

 The malfunction lamp for the Electronic Stability Program (ESP) is combined with Brake Assist System (BAS). The yellow “ESP/BAS Warning Lamp” comes on when the ignition switch is turned to the “ON” position. They should go out with the engine running. If the “ESP/BAS Warning

Lamp” comes on continuously with the engine running, a malfunction has been detected in either the ESP or the BAS system. If this light remains on after several ignition cycles, and the vehicle has been driven several miles at speeds greater than 30 mph (48 km/h), see an authorized dealer as soon as possible.

24. Anti-Lock Brake (ABS) Light

 This light monitors the Anti-Lock Brake System (ABS). The light will turn on when the ignition switch is turned to the ON position and may stay on for as long as four seconds.

If the ABS light remains on or turns on while driving, it indicates that the Anti-Lock portion of the brake system is not functioning and that service is required. However, the conventional brake system will continue to operate normally if the BRAKE warning light is not on.

If the ABS light is on, the brake system should be serviced as soon as possible to restore the benefits of Anti-Lock

brakes. If the ABS light does not turn on when the Ignition switch is turned to the ON position, have the light inspected by an authorized dealer.

25. *High Beam Indicator*



This indicator shows that the headlights are on high beam. Push the multifunction lever forward to switch the headlights to high beam, and pull toward yourself (normal position) to return to low beam.

26. *Brake Warning Light*

BRAKE This light monitors various brake functions, including brake fluid level and parking brake application. If the brake light turns on, it may indicate that the parking brake is applied, that the brake fluid level is low, or that there is a problem with the anti-lock brake system reservoir.

If the light remains on when the parking brake has been disengaged, and the fluid level is at the full mark on the master cylinder reservoir, it indicates a possible brake

hydraulic system malfunction or a problem with the Brake Booster has been detected by the Anti-Lock Brake System (ABS) / Electronic Stability Program (ESP) system. In this case, the light will remain on until the condition has been corrected. If the problem is related to the brake booster, the ABS pump will run when applying the brake and a brake pedal pulsation may be felt during each stop.

The dual brake system provides a reserve braking capacity in the event of a failure to a portion of the hydraulic system. A leak in either half of the dual brake system is indicated by the Brake Warning Light, which will turn on when the brake fluid level in the master cylinder has dropped below a specified level.

The light will remain on until the cause is corrected.

NOTE: The light may flash momentarily during sharp cornering maneuvers, which change fluid level conditions. The vehicle should have service performed, and the brake fluid level checked.

If brake failure is indicated, immediate repair is necessary.

WARNING!

Driving a vehicle with the red brake light on is dangerous. Part of the brake system may have failed. It will take longer to stop the vehicle. You could have an accident. Have the vehicle checked immediately.

Vehicles equipped with the Anti-Lock Brake System (ABS), are also equipped with Electronic Brake Force Distribution (EBD). In the event of an EBD failure, the Brake Warning Light will turn on along with the ABS Light. Immediate repair to the ABS system is required.

Operation of the Brake Warning Light can be checked by turning the ignition switch from the OFF position to the ON position. The light should illuminate for approximately two seconds. The light should then turn off unless the parking brake is applied or a brake fault is detected. If the light does not illuminate, have the light inspected by an authorized dealer.

The light also will turn on when the parking brake is applied with the ignition switch in the ON position.

NOTE: This light shows only that the parking brake is applied. It does not show the degree of brake application.

27. Electronic Vehicle Information Center (EVIC)

Button — If Equipped

Pushing this button will switch between the different EVIC functions.

Refer to the Electronic Vehicle Information Center (EVIC) in this section for more information.

28. *Electronic Vehicle Information Center Display — If Equipped*

When the appropriate conditions exist, this display shows the Electronic Vehicle Information Center (EVIC) messages.

Refer to the Electronic Vehicle Information Center (EVIC) in this section for more information.

29. *Transmission Temperature Indicator — If Equipped*

 During sustained high speed driving on hot days, the automatic transmission oil may become too hot. If this happens, the transmission overheat indicator light will come on and the vehicle will slow slightly until the automatic transmission cools down enough to allow a return to the requested speed. If the high speed is maintained, the overheating will reoccur as before in a cyclic fashion.

ELECTRONIC VEHICLE INFORMATION CENTER (EVIC) — If Equipped

The Electronic Vehicle Information Center (EVIC) features a driver-interactive display that is located in the instrument cluster.

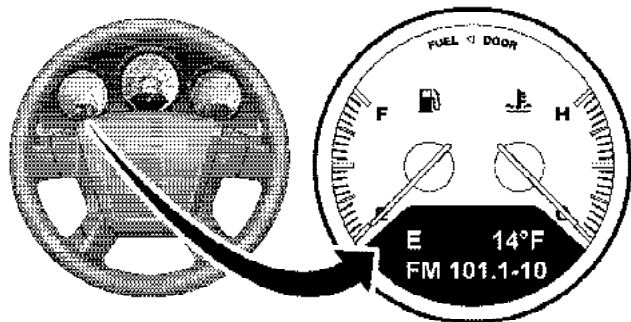

041007204

Electronic Vehicle Information Center (EVIC)

The EVIC consists of the following:

- System Status
- Vehicle information warning message displays
- Personal settings (customer programmable features)
- Compass heading
- Outside temperature display
- Trip computer functions
- uconnect® phone displays — If equipped
- Audio mode display
- Tire Pressure Monitor (TPM)

When the appropriate conditions exist, the EVIC displays the following messages.

- Turn Signal On (with a continuous warning chime after 1 mile (1.6 km) of distance travelled)

- Left Front Turn Signal Light Out (with a single chime)
- Left Rear Turn Signal Light Out (with a single chime)
- Right Front Turn Signal Light Out (with a single chime)
- Right Rear Turn Signal Light Out (with a single chime)
- RKE Battery Low (with a single chime)
- Personal Settings Not Available – Vehicle Not in Park (automatic transmissions) or vehicle is in motion (manual transmissions).
- Left/Right Front Door Ajar (one or more, with a single chime if speed is above 1 mph (1 km/h))
- Left/Right Rear Door Ajar (one or more, with a single chime if speed is above 1 mph (1 km/h))
- Door(s) Ajar (with a single chime if vehicle is in motion)

- Gate Ajar (with a single chime)
- Headlights On
- Key In Ignition
- Check TPM System
- Oil Change Required

Oil Change Required

Your vehicle is equipped with an engine oil change indicator system. The “Change Oil” message will flash in the instrument cluster odometer for approximately 5 seconds after a single chime has sounded to indicate the next scheduled oil change interval. The engine oil change indicator system is duty cycle based, which means the engine oil change interval may fluctuate dependent upon your personal driving style.

Unless reset, this message will continue to display each time you turn the ignition switch to the ON/RUN

position. To turn off the message temporarily, press and release the Trip Odometer button on the instrument cluster. To reset the oil change indicator system (after performing the scheduled maintenance), refer to the following procedure.

1. Turn the ignition switch to the ON position (do not start the engine).
2. Fully depress the accelerator pedal slowly three times within 10 seconds.
3. Turn the ignition switch to the OFF/LOCK position.

NOTE: If the indicator message illuminates when you start the vehicle, the oil change indicator system did not reset. If necessary, repeat this procedure.

EVIC Functions

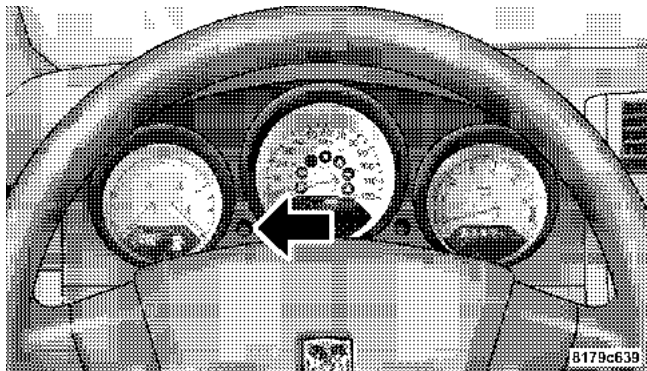

EVIC Button

Press the EVIC button until one of the following functions are displayed on the EVIC:

- Compass/Temperature/Audio
- Average Fuel Economy

- Distance To Empty (DTE)
- Elapsed Time
- Tire Pressure Monitor (TPM)
- Personal Settings

To Reset The Display

Pressing and holding the EVIC button once will clear the function currently being displayed. Reset will only occur if a resettable function is currently being displayed. To reset all resettable functions, press and release the EVIC button a second time within three seconds of resetting the currently displayed function (reset ALL will be displayed during this three second window).

Compass/Temperature/Audio

Press and release the EVIC button to display one of eight compass headings to indicate the direction the vehicle is facing, the outside temperature and the current radio station.

For additional information regarding the compass, refer to “Personal Settings (Customer Programmable Features)” in this section.

Average Fuel Economy

Shows the average fuel economy since the last reset. When the fuel economy is reset, the display will read “RESET” or show dashes for two seconds. Then, the history information will be erased, and the averaging will continue from the last fuel reading before the reset.

Distance To Empty (DTE)

Shows the estimated distance that can be travelled with the fuel remaining in the tank. This estimated distance is determined by a weighted average of the instantaneous and average fuel economy, according to the current fuel tank level. This is not resettable.

NOTE: Significant changes in driving style or vehicle loading will greatly affect the actual drivable distance of the vehicle, regardless of the DTE displayed value.

When the DTE value is less than 30 miles (48 km) estimated driving distance, the DTE display will change to a text display of “LOW FUEL”. This display will continue until the vehicle runs out of fuel. Adding a significant amount of fuel to the vehicle will turn off the “LOW FUEL” text and a new DTE value will be displayed, based on the current values in the DTE calculation and the current fuel tank level.

Elapsed Time

Shows the total elapsed time of travel since the last reset when the ignition switch is in the ACC position. Elapsed time will increment when the ignition switch is in the ON or START position.

Tire Pressure Monitor (TPM)

Refer to “Tire Pressure Monitoring System (TPMS)” under “Starting and Operating” in Section 5.

Personal Settings (Customer-Programmable Features)

This allows the driver to set and recall features when the transmission is in PARK (automatic transmission) or the vehicle is stopped (manual transmissions).

Press and release the EVIC button until “Personal Settings” is displayed in the EVIC.

Use the EVIC button to display one of the following choices:

Language

When in this display you may select different languages for all display nomenclature, including the trip functions. Pressing the EVIC button while in this display selects English, Espanol, or Francais depending on availability. As you continue, the displayed information will be shown in the selected language.

NOTE: uconnect® language will not change using the EVIC. Please refer to “Language Selection” under “uconnect® phone — If Equipped” in Section 3.

Lock Doors Automatically at 15 MPH (24 km/h)

When ON is selected, all doors lock automatically when the speed of the vehicle reaches 15 mph (24 km/h). Press and hold the EVIC button when in this display until “ON” or “OFF” appears to make your selection.

Auto Unlock On Exit

When ON is selected all the vehicle's doors will unlock when the driver's door is opened if the vehicle is stopped (manual transmissions) or the vehicle is stopped and the transmission is in PARK or NEUTRAL position (automatic transmissions). Press and hold the EVIC button when in this display until "ON" or "OFF" appears to make your selection.

Remote Unlock Driver's Door 1st

When **DRIVER'S DOOR 1ST** is selected only the driver's door will unlock on the first press of the Remote Keyless Entry (RKE) transmitter UNLOCK button and require a second press to unlock the remaining locked doors. When **REMOTE UNLOCK ALL DOORS** is selected, all of the doors will unlock at the first press of the RKE transmitter UNLOCK button. Press and hold the EVIC button when in this display until "DRIVER'S DOOR 1ST" or "ALL DOORS" appears to make your selection.

Sound Horn with Remote Key Lock

When ON is selected, a short horn sound will occur when the RKE transmitter LOCK button is pressed. This feature may be selected with or without the flash lights on lock/unlock feature. Press and hold the EVIC button when in this display until "ON" or "OFF" appears to make your selection.

Flash Lights with Remote Key Lock

When ON is selected, the front and rear turn signals will flash when the doors are locked or unlocked using the RKE transmitter. This feature may be selected with or without the sound horn on lock feature selected. Press and hold the EVIC button when in this display until "ON" or "OFF" appears to make your selection.

Delay Turning Headlights Off

When this feature is selected, the driver can choose to have the headlights remain on for 0, 30, 60, or 90 seconds

when exiting the vehicle. Press and hold the EVIC button when in this display until 0, 30, 60, or 90 appears to make your selection.

Delay Power Off to Accessories Until Exit

When this feature is selected, the power window switches, radio, uconnect® phone, power sunroof, and power outlets will remain active for up to 10 minutes after the ignition switch has been turned off. Opening a vehicle door will cancel this feature. Press and hold the EVIC button when in this display until “OFF”, “45 sec.”, “5 min.”, or “10 min.” appears to make your selection.

Turn Headlights on with Remote Key Unlock

When this feature is selected, the headlights will activate and remain on for up to 90 seconds when the doors are unlocked using the RKE transmitter. Press and hold the EVIC button when in this display until “OFF”, “30 sec.”, “60 sec.”, or “90 sec.” appears to make your selection.

Confirmation of Voice Commands — If Equipped

When ON is selected all voice commands from the uconnect® system are confirmed. Press and hold the EVIC button when in this display until “ON” or “OFF” appears to make your selection.

Display English or Metric

The EVIC, odometer, and uconnect® gps system units can be changed between English and Metric.

Press and hold the EVIC button when in this display until “US” or “METRIC” appears to make your selection.

Automatic Compass Calibration

When the vehicle is new, the compass may appear erratic and the EVIC will display “CAL” until the compass is calibrated. You may also calibrate the compass by completing one or more 360 degree turns (in an area free from large metal or metallic objects) until the “CAL” message displayed in the EVIC turns off. The compass will now function normally.

NOTE: A good calibration requires a level surface and an environment free from large metallic objects such as buildings, bridges, underground cables, railroad tracks, etc

Compass Variance

Compass Variance is the difference between Magnetic North and Geographic North. To ensure compass accuracy, the compass variance should be properly set according to the variance map for the zone where the vehicle will be driven. When properly set, the compass will automatically account for this difference.

NOTE: Magnetic and battery powered devices, (such as cell phones, iPod's, radar detectors, PDA's and laptops) should be kept away from the top of the instrument panel. This is where the compass module is located and such devices may interfere and cause false compass readings.

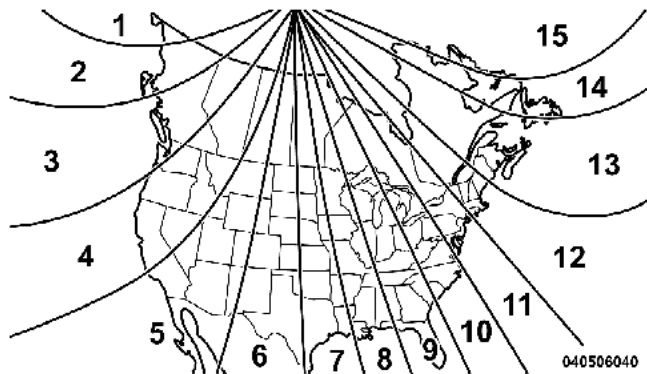

Compass Variance Map

To Set the Variance: with the ignition in the ON position, with a short button press (less than one second) press and release the EVIC button several times until you have displayed the “Personal Settings (Customer-Programmable Features)” menu. Once in the “Personal Settings (Customer-Programmable Features)” menu,

press and release (less than one second) the EVIC button several times until “Compass Variance” is highlighted. The “Compass Variance” message and the current variance zone number will be displayed. To change the zone, press and hold (longer than two seconds) the EVIC button to increment the variance one step. Repeat as necessary, with individual long (for at least one second) EVIC button presses for each increment, until the desired variance is achieved. To exit the Variance Programming, press the EVIC button with a short (less than one second) button press.

NOTE: The factory default Zone is 8. During programming, the Zone value will wrap around from Zone 15 to Zone 1.

Manual Compass Calibration

If the compass appears erratic or inaccurate, and the variance has been properly set, you may wish to manually recalibrate the compass. To manually calibrate the compass:

1. Start the engine and leave the transmission in the PARK position.
2. Using a quick button press (less than one second), press and release the EVIC button several times until the EVIC displays the “Personal Settings (Customer-Programmable Features)” menu.
3. Once in the “Personal Settings (Customer-Programmable Features)” menu, press and release (less than one second) the EVIC button several times until “Calibrate Compass (Yes)” is displayed.
4. Using a long button press (more than one second) press the EVIC button, this will place the Compass in

calibration mode. The CAL indicator will come on continuously in the EVIC display to indicate that the compass is now in the calibration mode, and that the vehicle can now be driven to calibrate.

5. To complete the compass calibration, drive the vehicle in one or more complete 360-degree circle under 5 mph (8 km/h) in an area free from power lines and large metallic objects, until the “CAL” indicator turns off. The compass will now function normally.

NOTE: A short EVIC button press from the “Calibrate Compass (Yes)” screen will exit the EVIC Customer-Programmable Features, and return it to its normal operating mode.

SALES CODE REQ — AM/FM STEREO RADIO AND 6-DISC CD/DVD CHANGER (MP3/WMA AUX JACK)

NOTE: The radio sales code is located on the lower right side of the radio faceplate.

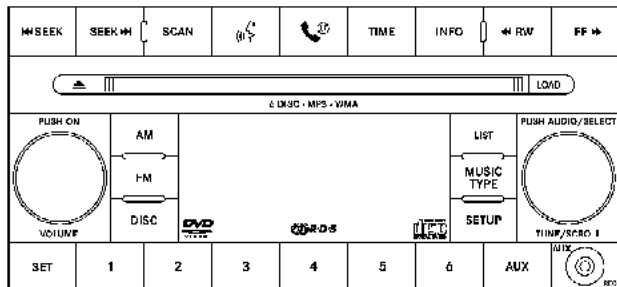

042005200

REQ Radio

Operating Instructions - Radio Mode

NOTE: The ignition switch must be in the ON or ACC position to operate the radio.

Power Switch/Volume Control (Rotary)

Push the ON/VOLUME control knob to turn on the radio. Press the ON/VOLUME control knob a second time to turn off the radio.

Electronic Volume Control

The electronic volume control turns continuously (360 degrees) in either direction without stopping. Turning the ON/VOLUME control knob to the right increases the volume and to the left decreases it.

When the audio system is turned ON, the sound will be set at the same volume level as last played.

SEEK Buttons

Press and release the SEEK buttons to search for the next listenable station in AM/FM mode. Press the right switch

to seek up and the left switch to seek down. The radio will remain tuned to the new station until you make another selection. Holding either button will bypass stations without stopping until you release it.

SCAN Button

Pressing the SCAN button causes the tuner to search for the next listenable station in AM, FM or Satellite (if equipped) frequencies, pausing for five seconds at each listenable station before continuing to the next. To stop the search, press the SCAN button a second time.

Voice Recognition Button uconnect® phone — If Equipped

Press this button to operate the uconnect® phone feature (if equipped). Refer to “uconnect® phone” in Section 3.

If your vehicle is not equipped with or this feature is not available on your vehicle, a “Not Equipped With uconnect” message will display on the radio screen.

Phone Button uconnect® phone — If Equipped

Press this button to operate the uconnect® phone feature (if equipped). Refer to “uconnect® phone” in Section 3.

If your vehicle is not equipped with or this feature is not available on your vehicle, a “Not Equipped With uconnect” message will display on the radio screen.

TIME Button

Press the TIME button to alternate locations of the time and frequency display.

Clock Setting Procedure

1. Press and hold the TIME button until the hours blink.
2. Adjust the hours by turning the right side TUNE/SCROLL control knob.
3. After adjusting the hours, press the right side TUNE/SCROLL control knob to set the minutes. The minutes will begin to blink.

4. Adjust the minutes using the right side TUNE/SCROLL control knob. Press the TUNE/SCROLL control knob to save the time change.

5. To exit, press any button/knob or wait five seconds.

The clock can also be set by pressing the SETUP button and selecting the “SET HOME CLOCK” entry. Once in this display follow the above procedure, starting at step 2.

INFO Button

Press the INFO button for an RDS station (one with call letters displayed). The radio will return a Radio Text message broadcast from an FM station (FM mode only).

RW/FF

Pressing the RW (Rewind) or FF (Fast Forward) buttons causes the tuner to search for the next frequency in the direction of the arrows. This feature operates in AM, FM or Satellite (if equipped) frequencies.

TUNE Control

Turn the rotary TUNE/SCROLL control knob clockwise to increase or counterclockwise to decrease the frequency.

Setting the Tone, Balance, and Fade

Push the rotary TUNE/SCROLL control knob and BASS will display. Turn the TUNE/SCROLL control knob to the right or left to increase or decrease the bass tones.

Push the rotary TUNE/SCROLL control knob a second time and MID will display. Turn the TUNE/SCROLL control knob to the right or left to increase or decrease the mid-range tones.

Push the rotary TUNE/SCROLL control knob a third time and TREBLE will display. Turn the TUNE/SCROLL control knob to the right or left to increase or decrease the treble tones.

Push the rotary TUNE/SCROLL control knob a fourth time and BALANCE will display. Turn the TUNE/

SCROLL control knob to the right or left to adjust the sound level from the right or left side speakers.

Push the rotary TUNE/SCROLL control knob a fifth time and FADE will display. Turn the TUNE/SCROLL control knob to the left or right to adjust the sound level between the front and rear speakers.

Push the rotary TUNE/SCROLL control knob again to exit setting tone, balance, and fade.

MUSIC TYPE Button

Pressing this button once will turn on the Music Type mode for five seconds. Pressing the MUSIC TYPE button or turning the TUNE/SCROLL control knob within five seconds will allow the program format type to be selected. Many radio stations do not currently broadcast Music Type information.

Toggle the MUSIC TYPE button to select the following format types:

Program Type	16-Digit Character Display
No program type or undefined	None
Adult Hits	Adlt Hit
Classical	Classicl
Classic Rock	Cls Rock
College	College
Country	Country
Foreign Language	Language
Information	Inform
Jazz	Jazz
News	News
Nostalgia	Nostalga
Oldies	Oldies

Program Type	16-Digit Character Display
Personality	Persnlty
Public	Public
Rhythm and Blues	R & B
Religious Music	Rel Musc
Religious Talk	Rel Talk
Rock	Rock
Soft	Soft
Soft Rock	Soft Rck
Soft Rhythm and Blues	Soft R & B
Sports	Sports
Talk	Talk
Top 40	Top 40
Weather	Weather

By pressing the SEEK button when the Music Type icon is displayed, the radio will be tuned to the next frequency station with the same selected Music Type name. The Music Type function only operates when in the FM mode.

If a preset button is activated while in the Music Type (Program Type) mode, the Music Type mode will be exited and the radio will tune to the preset station.

SETUP Button

Pressing the SETUP button allows you to select between the following items:

NOTE: Turn the TUNE/SCROLL control knob to scroll through the entries. Push the AUDIO/SELECT button to select an entry and make changes.

- **DVD Enter** - When the disc is in DVD Menu mode, selecting DVD Enter will allow you to play the current highlighted selection. Use the remote control to scroll up and down the menu (if equipped).



- **DISC Play/Pause** - You can toggle between playing the DVD and pausing the DVD by pushing the SELECT button (if equipped).
- **DVD Play Options** - Selecting the DVD Play Options will display the following:
 - Subtitle – Repeatedly pressing SELECT will switch subtitles to different subtitle languages that are available on the disc (if equipped).
 - Audio Stream – Repeatedly pressing SELECT will switch to different audio languages (if supported on the disc) (if equipped).
 - Angle – Repeatedly pressing SELECT will change the viewing angle if supported by the DVD disc (if equipped).

NOTE:

- The available selections for each of the above entries varies depending upon the disc.
- These selections can only be made while playing a DVD.
- **VES™ Power** - Allows you to turn VES™ ON and OFF (if equipped).
- **VES™ Lock** - Locks out rear VES™ remote controls (if equipped).
- **VES™ CH1/CH2** - Allows the user to change the mode of either the IR1 or IR2 wireless headphones by pressing the AUDIO/SELECT button (if equipped).
- **Set Home Clock** - Pressing the SELECT button allows you to set the clock. Turn the TUNE/SCROLL control knob to adjust the hours and then press and turn the

TUNE/SCROLL control knob to adjust the minutes. Press the TUNE/SCROLL control knob again to save changes.

- **Player Defaults** - Selecting this item will allow the user to scroll through the following items and set defaults according to customer preference.

Menu Language — If Equipped

Selecting this item will allow the user to choose the default startup DVD menu language (effective only if language supported by disc). If you want to select a language not listed, then scroll down and select "other." Enter the four-digit country code using the TUNE/SCROLL control knob to scroll up and down to select the number and then push to select.

Audio Language — If Equipped

Selecting this item allows you to choose a default audio language (effective only if the language is supported by the disc). You can select a language not listed by scrolling

down and selecting "other." Enter the country code using the TUNE/SCROLL control knob to scroll up and down to select the number and then push to select.

Subtitle Language — If Equipped

Selecting this item allows you to choose a default subtitle language (effective only if the language is supported by the disc). You can select a language not listed by scrolling down and selecting "other." Enter the country code using the TUNE/SCROLL control knob to scroll up and down to select the number and then push to select.

Subtitles — If Equipped

Selecting this item allows you to choose between subtitle Off or On.

Audio DRC — If Equipped

Selecting this item allows you to limit maximum audio dynamic range. The default is set to "High," and under this setting, dialogues will play at 11 db higher than if the setting is "Normal."

Aspect Ratio — If Equipped

Selecting this item allows you to choose between wide screen, pan scan, and letter box.

AutoPlay — If Equipped

When this is set to On and a DVD video is inserted, it will bypass the DVD menu screen and automatically play the movie. In some rare cases, the DVD player may not auto-play the main title. In such cases, use the MENU button on the remote control to select desired title to play.

NOTE: The user will have to set these defaults before loading a disc. If changes are made to these settings after a disc is loaded, changes will not be effective. Also, the defaults are effective only if the disc supports the customer-preferred settings.

AM and FM Buttons

Press the buttons to select AM or FM mode.

SET Button — To Set the Pushbutton Memory

When you are receiving a station that you wish to commit to pushbutton memory, press the SET button. The symbol SET 1 will now show in the display window. Select the button (1-6) you wish to lock onto this station and press and release that button. If a button is not selected within five seconds after pressing the SET button, the station will continue to play but will not be stored into pushbutton memory.

You may add a second station to each pushbutton by repeating the above procedure with this exception: Press the SET button twice and SET 2 will show in the display window. Each button can be set for SET 1 and SET 2 in both AM and FM. This allows a total of 12 AM, 12 FM, and 12 Satellite (if equipped) stations to be stored into pushbutton memory. The stations stored in SET 2 memory can be selected by pressing the pushbutton twice.

Every time a preset button is used, a corresponding button number will display.

Buttons 1 - 6

These buttons tune the radio to the stations that you commit to pushbutton memory {12 AM, 12 FM, and 12 Satellite (if equipped) stations}.

DISC Button

Pressing the DISC button will allow you to switch from AM/FM modes to Disc modes.

Operation Instructions - (DISC MODE for CD and MP3/WMA Audio Play, DVD-VIDEO)

The radio DVD player and many DVD discs are coded by geographic region. These region codes must match in order for the disc to play. If the region code for the DVD disc does not match the region code for the radio DVD player, it will not play the disc. Customers may take their vehicle to an authorized dealer to change the region code of the player a maximum of five times.

CAUTION!

The radio may shut down during extremely hot conditions. When this occurs, the radio will indicate "Disc Hot" and shut off until a safe temperature is reached. This shutdown is necessary to protect the optics of the DVD player and other radio internal components.

NOTE: The ignition switch must be in the ON or ACC position to operate the radio.

LOAD Button — Loading Compact Disc(s)

Press the LOAD button and the pushbutton with the corresponding number (1-6) where the CD is being loaded. The radio will display PLEASE WAIT and prompt when to INSERT DISC. After the radio displays "INSERT DISC," insert the CD into the player.

Radio display will show "LOADING DISC" when the disc is loading and "READING DISC" when the radio is reading the disc.

CAUTION!

This CD player will accept 4-3/4 in (12 cm) discs only. The use of other sized discs may damage the CD player mechanism.

4

Eject Button — Ejecting Compact Disc(s)

Press the EJECT button and the pushbutton with the corresponding number (1-6) where the CD was loaded and the disc will unload and move to the entrance for easy removal. Radio display will show "EJECTING DISC" when the disc is being ejected and prompt the user to remove the disc.

Press and hold the EJECT button for five seconds and all CDs will be ejected from the radio.

The disc can be ejected with the radio and ignition OFF.

SEEK Button (CD MODE)

Press the right SEEK button for the next selection on the CD. Press the left SEEK button to return to the beginning of the current selection, or return to the beginning of the previous selection if the CD is within the first second of the current selection. Pressing and holding the SEEK button will allow you to scroll through the tracks faster in CD and MP3/WMA modes.

SCAN Button (CD MODE)

Press the SCAN button to scan through each track on the CD currently playing.

TIME Button (CD MODE)

Press this button to change the display from a large CD playing time display to a small CD playing time display.

RW/FF (CD MODE)

Press and hold FF (Fast Forward) and the CD player will begin to fast forward until FF is released, or RW or another CD button is pressed. The RW (Rewind) button works in a similar manner.

AM or FM Button (CD MODE)

Switches the radio into the AM or FM radio mode.

Notes On Playing MP3/WMA Files

The radio can play MP3/WMA files; however, acceptable MP3/WMA file recording media and formats are limited. When writing MP3/WMA files, pay attention to the following restrictions.

Supported Media (Disc Types)

The MP3/WMA file recording media supported by the radio are CDDA, CD-R, CD-RW, MP3, WMA, DVD Video, DVD-R, DVD-RW, DVD+R, DVD+RW, and CDDA+MP3.

Supported Medium Formats (File Systems)

The medium formats supported by the radio are ISO 9660 Level 1 and Level 2 and includes the Joliet extension. When reading discs recorded using formats other than ISO 9660 Level 1 and Level 2, the radio may fail to read files properly and may be unable to play the file normally. UDF and Apple HFS formats are not supported.

The radio uses the following limits for file systems:

- Maximum number of directory levels: 8
- Maximum number of files: 255
- Maximum number of folders: 100
- Maximum number of characters in file/folder names:
 - Level 1: 12 (including a separator "." and a three-character extension)
 - Level 2: 31 (including a separator "." and a three-character extension)

Multisession disc formats are supported by the radio. Multisession discs may contain combinations of normal CD audio tracks and computer files (including MP3/WMA files). Discs created with an option such as "keep disc open after writing" are most likely multisession discs. The use of multisession for CD audio or MP3/WMA playback may result in longer disc loading times.

If a disc contains multi-formats, such as CD audio and MP3/WMA tracks, the radio will only play the MP3/WMA tracks on that disc.

Supported MP3/WMA File Formats

The radio will recognize only files with the *.MP3/WMA extension as MP3/WMA files. Non-MP3/WMA files named with the *.MP3/WMA extension may cause playback problems. The radio is designed to recognize the file as an invalid MP3/WMA and will not play the file.

When using the MP3/WMA encoder to compress audio data to an MP3/WMA file, the bit rate and sampling

frequencies in the following table are supported. In addition, variable bit rates (VBR) are also supported. The majority of MP3/WMA files use a 44.1 kHz sampling rate and a 192, 160, 128, 96 or VBR bit rates.

MPEG Specification	Sampling Frequency (kHz)	Bit Rate (kbps)
MPEG-1 Audio Layer 3	48, 44.1, 32	320, 256, 224, 192, 160, 128, 112, 96, 80, 64, 56, 48
MPEG-2 Audio Layer 3	24, 22.05, 16	160, 128, 144, 112, 96, 80, 64, 56, 48

WMA Specification	Sampling Frequency (kHz)	Bit Rate (kbps)
WMA	44.1 and 48	48, 64, 96, 128, 160, 192 VBR

ID3 Tag information for artist, song title, and album title are supported for ID3 version 1 tags. ID3 version 2 is not supported by the radios.

Playlist files are not supported. MP3 Pro files are not supported.

Playback of MP3/WMA Files

When a medium containing MP3/WMA data is loaded, the radio checks all files on the medium. If the medium contains a lot of folders or files, the radio will take more time to start playing the MP3/WMA files.

Loading times for playback of MP3/WMA files may be affected by the following:

- Media - CD-RW media may take longer to load than CD-R media
- Medium formats - Multisession discs may take longer to load than non-multisession discs

- Number of files and folders - Loading times will increase with more files and folders

To increase the speed of disc loading, it is recommended to use CD-R media and single-session discs. To create a single-session disc, enable the “Disc at Once” option before writing to the disc.

LIST Button (DISC Mode for MP3/WMA Play)

Pressing the LIST button will bring up a list of all folders on the disc. Scrolling up or down the list is done by turning the TUNE/SCROLL control knob. Selecting a folder by pressing the TUNE/SCROLL control knob will begin playing the files contained in that folder (or the next folder in sequence if the selection does not contain playable files).

The folder list will time out after five seconds.

INFO Button (DISC Mode for MP3/WMA Play)

Pressing the INFO button repeatedly will scroll through the following TAG information: Song Title, Artist, File Name, and Folder Name (if available).

Press the INFO button once more to return to “elapsed time” priority mode.

Press and hold the INFO button for three seconds or more and radio will display song titles for each file.

Press and hold the INFO button again for three seconds to return to “elapsed time” display.

Operation Instructions - Auxiliary Mode

The auxiliary (AUX) jack is an audio input jack which allows the user to plug in a portable device such as an MP3/WMA player, cassette player, or microphone and utilize the vehicle’s audio system to amplify the source and play through the vehicle speakers.

Pressing the AUX button will change the mode to auxiliary device if the AUX jack is connected.

NOTE: The AUX device must be turned on and the device's volume set to the proper level. If the AUX audio is not loud enough, turn the device's volume up. If the AUX audio sounds distorted, turn the device's volume down.

SEEK Button (Auxiliary Mode)

No function.

SCAN Button (Auxiliary Mode)

No function.

EJECT Button (Auxiliary Mode)

No function.



TIME Button (Auxiliary Mode)

Press the TIME button to change the display from elapsed playing time to time of day. The time of day will display for five seconds.

RW/FF (Auxiliary Mode)

No function.

SET Button (Auxiliary Mode)

No function.

Operating Instructions — Voice Recognition System (VR) (If Equipped)

For the radio, refer to “Voice Recognition System (VR)” in Section 3.

For uconnect® “Voice Recognition System (VR),” refer to “uconnect® phone” in Section 3.

Operating Instructions - uconnect® phone (If Equipped)

Refer to “uconnect® phone” in Section 3.

**Operating Instructions - uconnect® studios
(Satellite Radio) (If Equipped)**

Refer to “uconnect® studios (Satellite Radio)” in this section.

**Operating Instructions - Video Entertainment
System (VES)™ (If Equipped)**

Refer to separate “Video Entertainment System (VES)™ Guide.”

Dolby®

Manufactured under license from Dolby® Laboratories. “Dolby®” and the double-D symbol are trademarks of Dolby® Laboratories.

Macrovision

This product incorporates copyright protection technology that is protected by U.S. patents and other intellectual property rights. Use of this copyright protection technology must be authorized by Macrovision, and is

intended for home and other limited viewing uses only, unless otherwise authorized by Macrovision. Reverse engineering or disassembly is prohibited.

DTS™

“DTS™” and “DTS™ 2.0” are trademarks of Digital Theater Systems, Inc.

**AM/FM/CD/DVD RADIO (RER/REN) – IF
EQUIPPED**

NOTE: The sales code is located on the lower right side of the unit’s faceplate.

The REN and RER radios contain a CD/DVD player, USB port, and a 30-gigabyte hard drive (HDD). Sirius Satellite Radio is optional. The 6.5 in (16.5 cm) touch screen allows for easy menu selection.

The RER radio also contains a Global Positioning System (GPS)-based Navigation system.

Refer to your uconnect® tunes (REN) or (RER) user's manual for detailed operating instructions.

Operating Instructions — Voice Recognition System (VR) — If Equipped

For the radio, refer to “Voice Recognition System (VR)” in Section 3.

Operating Instructions — uconnect® phone — If Equipped

Refer to “uconnect® phone” in Section 3.

Clock Setting Procedure

uconnect® gps — RER only

The GPS receiver used in this system is synchronized to the time data being transmitted by the GPS satellite. The satellite clock is Greenwich Mean Time (GMT). This is the worldwide standard for time. This makes the system's clock very accurate once the appropriate time zone and daylight savings information is set.

To Manually Set the Clock — RER/REN

1. Turn on the radio.
2. Touch the screen where the time is displayed.
3. Touch the screen where “User Clock” is displayed. The clock setting menu will appear on the screen.
4. To move the hour forward, touch the screen where the word “Hour” with the arrow pointing upward is displayed. To move the hour backward, touch the screen where the word “Hour” with the arrow pointing downward is displayed.
5. To move the minute forward, touch the screen where the word “Min” with the arrow pointing upward is displayed. To move the minute backward, touch the screen where the word “Min” with the arrow pointing downward is displayed.

6. To save the new time setting, touch the screen where the word “Save” is displayed.

Changing Daylight Savings Time

When selected, this feature will display the time of day in daylight savings time. Proceed as follows to change the current setting:

1. Turn on the radio.
2. Touch the screen where the time is displayed. The clock setting menu will appear on the screen.
3. When this feature is on, a check mark will appear in the box next to the words “Daylight Savings.” Touch the screen where the words “Daylight Savings” are displayed to change the current setting.

Show Time if Radio is Off

When selected, this feature will display the time of day on the touch screen when the radio is turned off. Proceed as follows to change the current setting:

1. Turn on the radio.
2. Touch the screen where the time is displayed. The clock setting menu will appear on the screen.
3. When this feature is on, a check mark will appear in the box next to the words “Show Time if Radio is Off.” Touch the screen where the words “Show Time if Radio is Off” are displayed to change the current setting.

Changing the Time Zone

1. Turn on the radio.
2. Touch the screen where the time is displayed. The clock setting menu will appear on the screen.
3. Touch the screen where the words “Set Time Zone” are displayed. The time zone selection menu will appear on the screen.
4. Select a time zone by touching the screen where your selection appears. If you do not see a time zone that you want to select, touch the screen where the word “Page” is displayed to view additional time zones in the menu.
5. Touch the screen where the word “Save” is displayed.

SALES CODE RES — AM/FM STEREO RADIO WITH CD PLAYER (MP3 AUX JACK)

NOTE: The radio sales code is located on the lower right side of the radio faceplate.

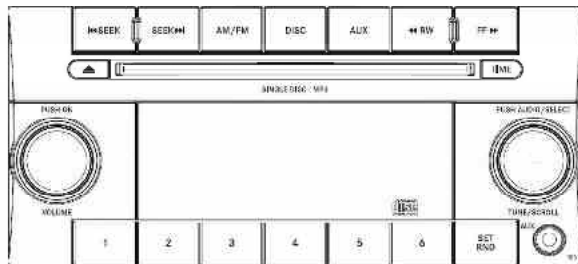

042305232

RES Radio

Operating Instructions — Radio Mode

NOTE: The ignition switch must be in the ON or ACC

Power Switch/Volume Control (Rotary)

Push the ON/VOLUME control knob to turn on the radio. Push the ON/VOLUME control knob a second time to turn off the radio.

Electronic Volume Control

The electronic volume control turns continuously (360 degrees) in either direction, without stopping. Turning the ON/VOLUME control knob to the right increases the volume, and to the left decreases it.

When the audio system is turned on, the sound will be set at the same volume level as last played.

SEEK Buttons

Press and release the SEEK buttons to search for the next listenable station in AM/FM mode. Press the right switch to seek up and the left switch to seek down. The radio will remain tuned to the new station until you make another selection. Holding either button will bypass stations without stopping, until you release it.

TIME Button

Press the TIME button to alternate locations of the time and frequency display.

Clock Setting Procedure

1. Press and hold the TIME button until the hours blink.
2. Adjust the hours by turning the right side TUNE/SCROLL control knob.
3. After adjusting the hours, press the right side TUNE/SCROLL control knob to set the minutes. The minutes will begin to blink.
4. Adjust the minutes using the right side TUNE/SCROLL control knob. Press the TUNE/SCROLL control knob to save time change.
5. To exit, press any button/knob, or wait five seconds.

RW/FF

Pressing the RW (Rewind) or FF (Fast Forward) buttons causes the tuner to search for the next frequency in the direction of the arrows. This feature operates in either AM or FM frequencies.

TUNE Control

Turn the rotary TUNE/SCROLL control knob clockwise to increase or counterclockwise to decrease the frequency.

Setting the Tone, Balance, and Fade

Push the rotary TUNE/SCROLL control knob and BASS will display. Turn the TUNE/SCROLL control knob to the right or left to increase or decrease the bass tones.

Push the rotary TUNE/SCROLL control knob a second time and MID will display. Turn the TUNE/SCROLL control knob to the right or left to increase or decrease the mid-range tones.

Push the rotary TUNE/SCROLL control knob a third time and TREBLE will display. Turn the TUNE/SCROLL control knob to the right or left to increase or decrease the treble tones.

Push the rotary TUNE/SCROLL control knob a fourth time and BALANCE will display. Turn the TUNE/SCROLL control knob to the right or left to adjust the sound level from the right or left side speakers.

Push the rotary TUNE/SCROLL control knob a fifth time and FADE will display. Turn the TUNE/SCROLL control knob to the left or right to adjust the sound level between the front and rear speakers.

Push the rotary TUNE/SCROLL control knob again to exit setting tone, balance, and fade.

AM/FM Button

Press the buttons to select either AM or FM mode.

SET/RND Button — To Set the Pushbutton Memory

When you are receiving a station that you wish to commit to pushbutton memory, press the SET/RND button. The symbol SET 1 will now show in the display window. Select the button (1 to 6) you wish to lock onto this station and press and release that button. If a button is not selected within five seconds after pressing the SET/RND button, the station will continue to play but will not be stored into pushbutton memory.

You may add a second station to each pushbutton by repeating the above procedure with this exception: Press the SET/RND button twice and SET 2 will show in the display window. Each button can be set for SET 1 and SET 2 in both AM and FM. This allows a total of 12 AM and 12 FM stations to be stored into pushbutton memory. The stations stored in SET 2 memory can be selected by pressing the pushbutton twice.

Every time a preset button is used, a corresponding button number will display.

Buttons 1 - 6

These buttons tune the radio to the stations that you commit to pushbutton memory (12 AM and 12 FM stations).

DISC Button

Pressing the DISC button will allow you to switch from AM/FM modes to Disc modes.

Operation Instructions — CD MODE For CD And MP3 Audio Play

NOTE:

- The ignition switch must be in the ON or ACC position to operate the radio.

- This radio is capable of playing compact discs (CD), recordable compact discs (CD-R), rewritable compact discs (CD-RW), compact discs with MP3 tracks and multisession compact discs with CD and MP3 tracks.

Inserting Compact Disc(s)

Gently insert one CD into the CD player with the CD label facing up. The CD will automatically be pulled into the CD player and the CD icon will illuminate on the radio display. If a CD does not go into the slot more than 1.0 in (2.5 cm), a disc may already be loaded and must be ejected before a new disc can be loaded.

If you insert a disc with the ignition ON and the radio ON, the unit will switch from radio to CD mode and begin to play when you insert the disc. The display will show the track number, and index time in minutes and seconds. Play will begin at the start of track 1.

CAUTION!

- **This CD player will accept 4-3/4 in (12 cm) discs only. The use of other sized discs may damage the CD player mechanism.**
- **Do not use adhesive labels. These labels can peel away and jam the player mechanism.**
- **RES is a single CD player. Do not attempt to insert a second CD if one is already loaded.**
- **Dual-media disc types (one side is a DVD, the other side is a CD) should not be used, and they can cause damage to the player.**

EJECT Button - Ejecting a CD

Press the EJECT button to eject the CD.



If you have ejected a disc and have not removed it within 10 seconds, it will be reloaded. If the CD is not removed, the radio will reinsert the CD but will not play it.

A disc can be ejected with the radio and ignition OFF.

NOTE: Ejecting with the ignition OFF is not allowed on convertible or soft-top models (if equipped).

SEEK Button

Press the right SEEK button for the next selection on the CD. Press the left SEEK button to return to the beginning of the current selection, or return to the beginning of the previous selection if the CD is within the first second of

the current selection. Pressing and holding the SEEK button will allow faster scrolling through the tracks in CD and MP3 modes.

TIME Button

Press this button to change the display from a large CD playing time display to a small CD playing time display.

RW/FF

Press and hold the FF (Fast Forward) button and the CD player will begin to fast forward until FF is released, or RW or another CD button is pressed. The RW (Reverse) button works in a similar manner.

AM/FM Button

Press the button to select either AM or FM mode.

SET/RND Button (Random Play Button)

Press this button while the CD is playing to activate Random Play. This feature plays the selections on the compact disc in random order to provide an interesting change of pace.

Press the right SEEK button to move to the next randomly selected track.

Press the RND button a second time to stop Random Play.

Notes on Playing MP3 Files

The radio can play MP3 files; however, acceptable MP3 file recording media and formats are limited. When writing MP3 files, pay attention to the following restrictions.

Supported Media (Disc Types)

The MP3 file recording media supported by the radio are CDDA, CD-R, CD-RW, MP3, and CDDA+MP3.

Supported Medium Formats (File Systems)

The medium formats supported by the radio are ISO 9660 Level 1 and Level 2 and includes the Joliet extension. When reading discs recorded using formats other than ISO 9660 Level 1 and Level 2, the radio may fail to read files properly and may be unable to play the file normally. UDF and Apple HFS formats are not supported.

The radio uses the following limits for file systems:

- Maximum number of folder levels: 8
- Maximum number of files: 255
- Maximum number of folders. (The radio display of file names and folder names is limited. For large numbers of files and/or folders, the radio may be unable to display the file name and folder name, and will assign a number instead. With a maximum number of files,

exceeding 20 folders will result in this display. With 200 files, exceeding 50 folders will result in this display.)

- Maximum number of characters in file/folder names:
 - Level 1: 12 (including a separator "." and a three-character extension)
 - Level 2: 31 (including a separator "." and a three-character extension)

Multisession disc formats are supported by the radio. Multisession discs may contain combinations of normal CD audio tracks and computer files (including MP3 files). Discs created with an option such as "keep disc open after writing" are most likely multisession discs. The use of multisession for CD audio or MP3 playback may result in longer disc loading times.

Supported MP3 File Formats

The radio will recognize only files with the *.MP3 extension as MP3 files. Non-MP3 files named with the *.MP3 extension may cause playback problems. The radio is designed to recognize the file as an invalid MP3 and will not play the file.

When using the MP3 encoder to compress audio data to an MP3 file, the bit rate and sampling frequencies in the following table are supported. In addition, variable bit rates (VBR) are also supported. The majority of MP3 files use a 44.1 kHz sampling rate and a 192, 160, 128, 96 or VBR bit rate.

MPEG Specification	Sampling Frequency (kHz)	Bit Rate (kbps)
MPEG-1 Audio Layer 3	48, 44.1, 32	320, 256, 224, 192, 160, 128, 112, 96, 80, 64, 56, 48, 40, 32
MPEG-2 Audio Layer 3	24, 22.05, 16	160, 128, 144, 112, 96, 80, 64, 56, 48, 40, 32, 24, 16, 8

ID3 Tag information for artist, song title, and album title are supported for version 1 ID3 tags. ID3 version 2 is not supported by the radios.

Playlist files are not supported. MP3 Pro files are not supported.

Playback of MP3 Files

When a medium containing MP3 data is loaded, the radio checks all files on the medium. If the medium contains a lot of folders or files, the radio will take more time to start playing the MP3 files.

Loading times for playback of MP3 files may be affected by the following:

- Media - CD-RW media may take longer to load than CD-R media
- Medium formats - Multisession discs may take longer to load than non-multisession discs
- Number of files and folders - Loading times will increase with more files and folders

To increase the speed of disc loading, it is recommended to use CD-R media and single-session discs. To create a single-session disc, enable the “Disc at Once” option before writing to the disc.

Operation Instructions - Auxiliary Mode

The auxiliary (AUX) jack is an audio input jack, which allows the user to plug in a portable device, such as an MP3 player, or cassette player, and utilize the vehicle's audio system to amplify the source and play through the vehicle speakers.

Pressing the DISC/AUX button will change the mode to auxiliary device if the AUX jack is connected.

NOTE: The AUX device must be turned on and the device's volume set to proper level. If the AUX audio is not loud enough, turn the device's volume up. If the AUX audio sounds distorted, turn the device's volume down.

TIME Button (Auxiliary Mode)

Press this button to change the display to time of day. The time of day will display for five seconds (when ignition is OFF).

SALES CODE RES/RSC — AM/FM STEREO RADIO WITH CD PLAYER (MP3 AUX JACK) AND SIRIUS RADIO

NOTE: The radio sales code is located on the lower right side of the radio faceplate.

Operating Instructions — Radio Mode

NOTE: The ignition switch must be in the ON or ACC position to operate the radio.

Power Switch/Volume Control (Rotary)

Push the ON/VOLUME control knob to turn on the radio. Push the ON/VOLUME control knob a second time to turn off the radio.

Electronic Volume Control

The electronic volume control turns continuously (360 degrees) in either direction without stopping. Turning the ON/VOLUME control knob to the right increases the volume and to the left decreases it.

When the audio system is turned on, the sound will be set at the same volume level as last played.

SEEK Buttons

Press and release the SEEK buttons to search for the next listenable station in AM/FM mode. Press the right switch

to seek up and the left switch to seek down. The radio will remain tuned to the new station until you make another selection. Holding either button will bypass stations without stopping until you release it.

Voice Recognition System (Radio) — If Equipped
Refer to “Voice Recognition System (VR)” in Section 3.

Voice Recognition Button uconnect® phone — If Equipped

Press this button to operate the uconnect® phone feature (if equipped). Refer to “uconnect® phone” in Section 3.

If your vehicle is not equipped with or this feature is not available on your vehicle, a “Not Equipped With uconnect” message will display on the radio screen.

Phone Button uconnect® phone — If Equipped

Press this button to operate the uconnect® phone feature (if equipped). Refer to “uconnect® phone” in Section 3.

If your vehicle is not equipped with or this feature is not available on your vehicle, a “Not Equipped With uconnect” message will display on the radio screen.

TIME Button

Press the TIME button to alternate locations of the time and frequency display.

Clock Setting Procedure

1. Press and hold the TIME button until the hours blink.
2. Adjust the hours by turning the right side TUNE/SCROLL control knob.
3. After adjusting the hours, press the right side TUNE/SCROLL control knob to set the minutes. The minutes will begin to blink.
4. Adjust the minutes using the right side TUNE/SCROLL control knob. Press the TUNE/SCROLL control knob to save time change.

5. To exit, press any button/knob or wait five seconds.

The clock can also be set by pressing the SETUP button. For vehicles equipped with satellite radio, press the SETUP button, use the TUNE/SCROLL control to select SET CLOCK, and then follow the above procedure, starting at Step 2. For vehicles not equipped with satellite radio, press the SETUP button and then follow the above procedure, starting at Step 2.

INFO Button

Press the INFO button for an RDS station (one with call letters displayed). The radio will return a Radio Text message broadcast from an FM station (FM mode only).

RW/FF

Pressing the RW (Rewind) or FF (Fast Forward) buttons causes the tuner to search for the next frequency in the direction of the arrows. This feature operates in either AM or FM frequencies.

TUNE Control

Turn the rotary TUNE/SCROLL control knob clockwise to increase or counterclockwise to decrease the frequency.

Setting the Tone, Balance, and Fade

Push the rotary TUNE/SCROLL control knob and BASS will display. Turn the TUNE/SCROLL control knob to the right or left to increase or decrease the bass tones.

Push the rotary TUNE/SCROLL control knob a second time and MID will display. Turn the TUNE/SCROLL control knob to the right or left to increase or decrease the mid-range tones.

Push the rotary TUNE/SCROLL control knob a third time and TREBLE will display. Turn the TUNE/SCROLL control knob to the right or left to increase or decrease the treble tones.

Push the rotary TUNE/SCROLL control knob a fourth time and BALANCE will display. Turn the TUNE/

SCROLL control knob to the right or left to adjust the sound level from the right or left side speakers.

Push the rotary TUNE/SCROLL control knob a fifth time and FADE will display. Turn the TUNE/SCROLL control knob to the left or right to adjust the sound level between the front and rear speakers.

Push the rotary TUNE/SCROLL control knob again to exit setting tone, balance, and fade.

MUSIC TYPE Button

Pressing this button once will turn on the Music Type mode for five seconds. Pressing the MUSIC TYPE button or turning the TUNE/SCROLL control knob within five seconds will allow the program format type to be selected. Many radio stations do not currently broadcast Music Type information.

Toggle the MUSIC TYPE button to select the following format types:

Program Type	16-Digit Character Display
No program type or undefined	None
Adult Hits	Adlt Hit
Classical	Classicl
Classic Rock	Cls Rock
College	College
Country	Country
Foreign Language	Language
Information	Inform
Jazz	Jazz
News	News
Nostalgia	Nostalga
Oldies	Oldies

Program Type	16-Digit Character Display
Personality	Persnlty
Public	Public
Rhythm and Blues	R & B
Religious Music	Rel Musc
Religious Talk	Rel Talk
Rock	Rock
Soft	Soft
Soft Rock	Soft Rck
Soft Rhythm and Blues	Soft R&B
Sports	Sports
Talk	Talk
Top 40	Top 40
Weather	Weather

By pressing the SEEK button when the Music Type icon is displayed, the radio will be tuned to the next frequency station with the same selected Music Type name. The Music Type function only operates when in the FM mode.

If a preset button is activated while in the Music Type (Program Type) mode, the Music Type mode will be exited and the radio will tune to the preset station.

SETUP Button

Pressing the SETUP button allows you to select between the following items:

- **Set Clock** — Pressing the SELECT button will allow you to set the clock. Turn the TUNE/SCROLL control knob to adjust the hours and then press and turn the TUNE/SCROLL control knob to adjust the minutes. Press the TUNE/SCROLL control knob again to save changes.

AM/FM Button

Press the button to select either AM or FM mode.

SET/RND Button — To Set the Pushbutton Memory

When you are receiving a station that you wish to commit to pushbutton memory, press the SET/RND button. The symbol SET 1 will now show in the display window. Select the button (1 to 6) you wish to lock onto this station and press and release that button. If a button is not selected within five seconds after pressing the SET/RND button, the station will continue to play but will not be stored into pushbutton memory.

You may add a second station to each pushbutton by repeating the above procedure with this exception: Press the SET/RND button twice and SET 2 will show in the display window. Each button can be set for SET 1 and SET 2 in both AM and FM. This allows a total of 12 AM

and 12 FM stations to be stored into pushbutton memory. The stations stored in SET 2 memory can be selected by pressing the pushbutton twice.

Every time a preset button is used, a corresponding button number will display.

Buttons 1 - 6

These buttons tune the radio to the stations that you commit to pushbutton memory (12 AM and 12 FM stations).

DISC/AUX Button

Pressing the DISC/AUX button will allow you to switch from AM/FM modes to DISC/AUX mode.

Operation Instructions — CD MODE for CD and MP3 Audio Play

NOTE:

- The ignition switch must be in the ON or ACC position to operate the radio.

- This radio is capable of playing compact discs (CD), recordable compact discs (CD-R), rewritable compact discs (CD-RW), compact discs with MP3 tracks and multisession compact discs with CD and MP3 tracks.

Inserting Compact Disc(s)

Gently insert one CD into the CD player with the CD label facing up. The CD will automatically be pulled into the CD player and the CD icon will illuminate on the radio display. If a CD does not go into the slot more than 1.0 in (2.5 cm), a disc may already be loaded and must be ejected before a new disc can be loaded.

If you insert a disc with the ignition ON and the radio ON, the unit will switch from radio to CD mode and begin to play when you insert the disc. The display will show the track number, and index time in minutes and seconds. Play will begin at the start of track 1.

CAUTION!

- **This CD player will accept 4-3/4 in (12 cm) discs only. The use of other sized discs may damage the CD player mechanism.**
- **Do not use adhesive labels. These labels can peel away and jam the player mechanism.**
- **RES is a single CD player. Do not attempt to insert a second CD if one is already loaded.**
- **Dual-media disc types (one side is a DVD, the other side is a CD) should not be used, and they can cause damage to the player.**

EJECT Button - Ejecting a CD

Press the EJECT button to eject the CD.



If you have ejected a disc and have not removed it within 10 seconds, it will be reloaded. If the CD is not removed, the radio will reinsert the CD but will not play it.

A disc can be ejected with the radio and ignition OFF.

NOTE: Ejecting with the ignition OFF is not allowed on convertible or soft-top models (if equipped).

SEEK Button

Press the right SEEK button for the next selection on the CD. Press the left SEEK button to return to the beginning of the current selection, or return to the beginning of the previous selection if the CD is within the first second of the current selection. Pressing and holding the SEEK button will allow faster scrolling through the tracks in CD and MP3 modes.

TIME Button

Press this button to change the display from a large CD playing time display to a small CD playing time display.

RW/FF

Press and hold FF (Fast Forward) and the CD player will begin to fast forward until FF is released or RW or another CD button is pressed. The RW (Reverse) button works in a similar manner.

AM/FM Button

Press the button to select either AM or FM mode.

SET/RND Button (Random Play Button)

Press this button while the CD is playing to activate Random Play. This feature plays the selections on the compact disc in random order to provide an interesting change of pace.

Press the right SEEK button to move to the next randomly selected track.

Press the SET/RND button a second time to stop Random Play.

Notes On Playing MP3 Files

The radio can play MP3 files; however, acceptable MP3 file recording media and formats are limited. When writing MP3 files, pay attention to the following restrictions.

Supported Media (Disc Types)

The MP3 file recording media supported by the radio are CDDA, CD-R, CD-RW, MP3, and CDDA+MP3.

Supported Medium Formats (File Systems)

The medium formats supported by the radio are ISO 9660 Level 1 and Level 2 and includes the Joliet extension. When reading discs recorded using formats other than ISO 9660 Level 1 and Level 2, the radio may fail to read files properly and may be unable to play the file normally. UDF and Apple HFS formats are not supported.

The radio uses the following limits for file systems:

- Maximum number of folder levels: 8

- Maximum number of files: 255
- Maximum number of folders. (The radio display of file names and folder names is limited. For large numbers of files and/or folders, the radio may be unable to display the file name and folder name and will assign a number instead. With a maximum number of files, exceeding 20 folders will result in this display. With 200 files, exceeding 50 folders will result in this display.)
- Maximum number of characters in file/folder names:
 - Level 1: 12 (including a separator "." and a three-character extension)
 - Level 2: 31 (including a separator "." and a three-character extension)

Multisession disc formats are supported by the radio. Multisession discs may contain combinations of normal CD audio tracks and computer files (including MP3 files).

Discs created with an option such as "keep disc open after writing" are most likely multisession discs. The use of multisession for CD audio or MP3 playback may result in longer disc loading times.

Supported MP3 File Formats

The radio will recognize only files with the *.MP3 extension as MP3 files. Non-MP3 files named with the *.MP3 extension may cause playback problems. The radio is designed to recognize the file as an invalid MP3 and will not play the file.

When using the MP3 encoder to compress audio data to an MP3 file, the bit rate and sampling frequencies in the following table are supported. In addition, variable bit rates (VBR) are also supported. The majority of MP3 files use a 44.1 kHz sampling rate and a 192, 160, 128, 96 or VBR bit rates.

MPEG Specification	Sampling Frequency (kHz)	Bit Rate (kbps)
MPEG-1 Audio Layer 3	48, 44.1, 32	320, 256, 224, 192, 160, 128, 112, 96, 80, 64, 56, 48, 40, 32
MPEG-2 Audio Layer 3	24, 22.05, 16	160, 128, 144, 112, 96, 80, 64, 56, 48, 40, 32, 24, 16, 8

ID3 Tag information for artist, song title, and album title are supported for version 1 ID3 tags. ID3 version 2 is not supported by the radios.

Playlist files are not supported. MP3 Pro files are not supported.

Playback of MP3 Files

When a medium containing MP3 data is loaded, the radio checks all files on the medium. If the medium contains a lot of folders or files, the radio will take more time to start playing the MP3 files.

Loading times for playback of MP3 files may be affected by the following:

- Media - CD-RW media may take longer to load than CD-R media
- Medium formats - Multisession discs may take longer to load than non-multisession discs
- Number of files and folders - Loading times will increase with more files and folders

To increase the speed of disc loading, it is recommended to use CD-R media and single-session discs. To create a single-session disc, enable the “Disc at Once” option before writing to the disc.

LIST Button (CD Mode for MP3 Play)

Pressing the LIST button will bring up a list of all folders on the disc. Scrolling up or down the list is done by turning the TUNE/SCROLL control knob. Selecting a folder by pressing the TUNE/SCROLL control knob will begin playing the files contained in that folder (or the next folder in sequence if the selection does not contain playable files).

The folder list will time out after five seconds.

INFO Button (CD Mode for MP3 Play)

Pressing the INFO button repeatedly will scroll through the following TAG information: Song Title, Artist, File Name, and Folder Name (if available).

Press the INFO button once more to return to "elapsed time" priority mode.

Press and hold the INFO button for three seconds or more and the radio will display song titles for each file.

Press and hold the INFO button again for three seconds to return to "elapsed time" display.

Operation Instructions - Auxiliary Mode

The auxiliary (AUX) jack is an audio input jack which allows the user to plug in a portable device such as an MP3 player or cassette player and utilize the vehicle's audio system to amplify the source and play through the vehicle speakers.

Pressing the AUX button will change the mode to auxiliary device if the AUX jack is connected.

NOTE: The AUX device must be turned on and the device's volume set to the proper level. If the AUX audio is not loud enough, turn the device's volume up. If the AUX audio sounds distorted, turn the device's volume down.

TIME Button (Auxiliary Mode)

Press this button to change the display to time of day. The time of day will display for five seconds (when the ignition is OFF).

Operating Instructions - uconnect® phone (If Equipped)

Refer to “uconnect® phone” in Section 3.

Operating Instructions - uconnect® studios (Satellite Radio) (If Equipped)

Refer to “uconnect® studios (Satellite Radio)” in this section.

uconnect® studios (SATELLITE RADIO) — IF EQUIPPED (REN/REQ/RER/RES/REU RADIOS ONLY)

Satellite radio uses direct satellite-to-receiver broadcasting technology to provide clear digital sound, coast to coast. The subscription service provider is Sirius Satellite

Radio. This service offers over 130 channels of music, sports, news, entertainment, and programming for children, directly from its satellites and broadcasting studios.

NOTE: Sirius service is not available in Hawaii and has limited coverage in Alaska.

System Activation

Sirius Satellite Radio service is pre-activated and you may begin listening immediately to the one year of audio service that is included with the factory-installed satellite radio system in your vehicle. Sirius will supply a welcome kit that contains general information, including how to setup your on-line listening account at no additional charge. For further information, call the toll-free number 888-539-7474, or visit the Sirius web site at www.sirius.com, or at www.siriuscanada.ca for Canadian residents.

Electronic Serial Number/Sirius Identification Number (ESN/SID)

Please have the following information available when calling:

1. The Electronic Serial Number/Sirius Identification Number (ESN/SID).
2. Your Vehicle Identification Number.

To access the ESN/SID, refer to the following steps:

ESN/SID Access With REQ/RES Radios

With the ignition switch in the ON/RUN or ACC position and the radio on, press the SETUP button and scroll using the TUNE/SCROLL control knob until Sirius ID is selected. Press the TUNE/SCROLL control knob and the Sirius ID number will display. The Sirius ID number display will time out in two minutes. Press any button on the radio to exit this screen.

ESN/SID Access With REN/RER Radios

While in SAT mode, press the MENU button on the radio faceplate.

Next, touch the SUBSCRIPTION tab on the touch screen. All the ESNs that apply to your vehicle will display.

ESN/SID Access With REU Radio

While in SAT mode, press the MENU button on the radio faceplate.

Next, turn the knob surrounding the joystick in the center of the radio to scroll to Subscription, and then press and release the joystick. All of the ESNs that apply to your vehicle will display.

Selecting uconnect® studios (Satellite) Mode

Press the SAT button until "SAT" appears in the display. A CD may remain in the radio while in the Satellite radio mode.

Satellite Antenna

To ensure optimum reception, do not place items on the roof around the rooftop antenna location or strap items to the trunk lid around the trunk lid antenna (if equipped). Metal objects placed within the line of sight of the antenna will cause decreased performance. Larger luggage items such as bikes should be placed as far rearward as possible, within the loading design of the rack. Do not place items directly on or above the antenna.

Reception Quality

Satellite reception may be interrupted due to one of the following reasons:

- The vehicle is parked in an underground parking structure or under a physical obstacle.
- Dense tree coverage may interrupt reception in the form of short audio mutes.
- Driving under wide bridges or along tall buildings can cause intermittent reception.

- Placing objects over or too close to the antenna can cause signal blockage.

Operating Instructions — uconnect® studios (Satellite) Mode

NOTE: The ignition switch must be in the ON or ACC position to operate the radio.

SEEK Buttons

Press and release the SEEK buttons to search for the next channel in Satellite mode. Press the right switch to seek up and the left switch to seek down. The radio will remain tuned to the new channel until you make another selection. Holding either button will bypass channels without stopping until you release it.

SCAN Button (When Equipped)

Pressing the SCAN button causes the tuner to search for the next channel, pausing for eight seconds before continuing to the next. To stop the search, press the SCAN button a second time.

INFO Button — Except REU Radio

Pressing the INFO button will cycle the display information between Artist, Song Title, and Composer (if available). Also, pressing and holding the INFO button for an additional three seconds will make the radio display the song title all of the time (press and hold again to return to normal display).

INFO Button — REU Radio

Pressing the INFO button will display information about Artist, Song Title, and Composer (if available). Pressing the INFO button again will close the INFO screen.

RW/FF

Pressing the RW (Rewind) or FF (Fast Forward) buttons causes the tuner to search for the next channel in the direction of the arrows.

TUNE Control (Rotary)

Turn the rotary TUNE/SCROLL control knob clockwise to increase or counterclockwise to decrease the channel.

MUSIC TYPE Button — Except REU Radio

Pressing this button once will turn on the Music Type mode for five seconds. Pressing the MUSIC TYPE button or turning the TUNE/SCROLL control knob within five seconds will allow the program format type to be selected.

Toggle the MUSIC TYPE button again to select the music type.

By pressing the SEEK button when the Music Type function is active, the radio will be tuned to the next channel with the same selected Music Type name.

If a preset button is activated while in the Music Type (Program Type) mode, the Music Type mode will be exited and the radio will tune to the preset channel.

MUSIC TYPE Button — REU Radio

Pressing this button provides a Music Type list from which you can make a selection. Once a selection is

made, you can seek up or down or scan the channels and the radio will tune to the next station matching the selected format. There is no time-out for this screen. Pressing the MUSIC TYPE button again will close the Music Type screen. Once closed, seek up, seek down, and scan will no longer be based on your selection.

SETUP Button

Pressing the SETUP button allows you to select the following items:

- Display Sirius ID number — Press the AUDIO/SELECT button to display the Sirius ID number. This number is used to activate, deactivate, or change the Sirius subscription.

SET Button – To Set the Pushbutton Memory

When you are receiving a channel that you wish to commit to pushbutton memory, press the SET button. The symbol SET 1 will now show in the display window. Select the button (1-6) you wish to lock onto this channel

and press and release that button. If a button is not selected within five seconds after pressing the SET button, the channel will continue to play but will not be stored into pushbutton memory.

You may add a second channel to each pushbutton by repeating the above procedure with this exception: Press the SET button twice and SET 2 will show in the display window. Each button can be set for SET 1 and SET 2. This allows a total of 12 Satellite channels to be stored into pushbutton memory. The channels stored in SET 2 memory can be selected by pressing the pushbutton twice.

Every time a preset button is used, a corresponding button number will display.

Buttons 1 - 6

These buttons tune the radio to the channels that you commit to pushbutton memory (12 Satellite stations).

Operating Instructions — uconnect® phone (If Equipped)

Refer to “uconnect® phone” in Section 3.

Operating Instructions — Video Entertainment System (VES)™ (If Equipped)

Refer to separate “Video Entertainment System (VES)™ Guide.”

REMOTE SOUND SYSTEM CONTROLS — IF EQUIPPED

The remote sound system controls are located on the rear surface of the steering wheel. Reach behind the wheel to access the switches.

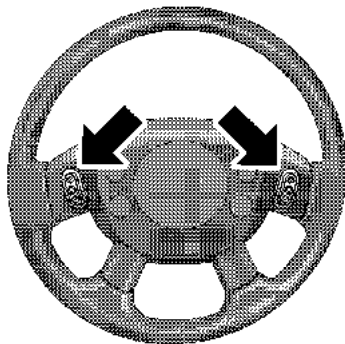

045003761

Remote Sound System Controls (Back View of Steering Wheel)

The right-hand control is a rocker type switch with a pushbutton in the center. Pressing the top of the switch will increase the volume and pressing the bottom of the switch will decrease the volume.

The button located in the center of the right-hand control will switch modes to Radio or CD.

The left-hand control is a rocker type switch with a pushbutton in the center. The function of the left-hand control is different depending on which mode you are in.

The following describes the left-hand control operation in each mode.

Radio Operation

Press the top of the switch to SEEK up for the next listenable station. Press the bottom of the switch to SEEK down for the next listenable station.

The button located in the center of the left-hand control will tune to the next preset station that you have programmed in the radio preset pushbuttons.

CD Player

Press the top of the switch once to go to the next track on the CD. Press the bottom of the switch once to go to the

beginning of the current track or to the beginning of the previous track, if it is within one second after the current track begins to play.

If you press the switch up or down twice it plays the second track, three times, it will play the third, etc.

The button in the center of the left-hand switch changes CD's on the 6-Disc in-dash CD changer radio. This button does not function for all other radios.

CD/DVD MAINTENANCE

To keep a CD/DVD in good condition, take the following precautions:

1. Handle the disc by its edge; avoid touching the surface.
2. If the disc is stained, clean the surface with a soft cloth, wiping from center to edge.

3. Do not apply paper or tape to the disc; avoid scratching the disc.
4. Do not use solvents such as benzene, thinner, cleaners, or antistatic sprays.
5. Store the disc in its case after playing.
6. Do not expose the disc to direct sunlight.
7. Do not store the disc where temperatures may become too high.

NOTE: If you experience difficulty in playing a particular disc, it may be damaged (i.e. scratched, reflective coating removed, a hair, moisture or dew on the disc) oversized, or have protection encoding. Try a known good disc before considering disc player service.

RADIO OPERATION AND CELLULAR PHONES

Under certain conditions, the cellular phone being on in your vehicle can cause erratic or noisy performance from your radio. This condition may be lessened or eliminated by relocating the cellular phone antenna. This condition is not harmful to the radio. If your radio performance does not satisfactorily “clear” by the repositioning of the antenna, it is recommended that the radio volume be turned down or off during cellular phone operation.

CLIMATE CONTROLS

Manual Heating and Air Conditioning System

The Manual Heating and Air Conditioning system allows you to balance the temperature, amount, and direction of air circulating throughout the vehicle. The controls are located on the instrument panel, below the radio.

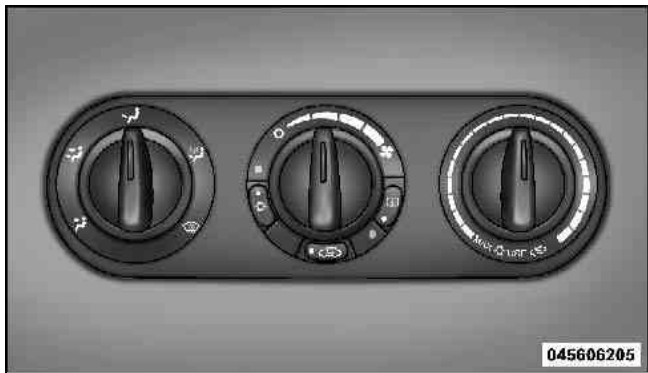

Climate Control

The air conditioning system of your vehicle contains R-134a, a refrigerant that does not deplete the ozone layer in the upper atmosphere.

The controls are as follows:

Mode Control (Air Direction)

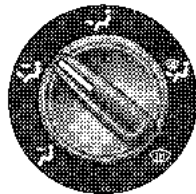

81caad23

The mode control allows you to choose from several patterns of air distribution as identified by the symbols.

4

Panel

 Air is directed through the outlets in the instrument panel. These outlets can be adjusted to direct air flow.

Bi-Level

 Air is directed through the panel and floor outlets.

NOTE: There is a difference in temperature between the upper and lower outlets for added comfort. The warmer air goes to the floor outlets. This feature gives improved comfort during sunny but cool conditions.

Floor

 Air is directed through the floor outlets and side window demister outlets with a small amount through the defrost outlet.

Mix

 Air is directed through the floor, defrost and side window demister outlets. This setting works best in cold or snowy conditions that require extra heat at the windshield. This setting is good for maintaining comfort while reducing moisture on the windshield.

Defrost



Air is directed through the windshield and side window demister outlets. Use this mode with maximum fan and temperature settings for best windshield and side window defrosting.

NOTE: The air conditioning compressor operates in both Mix and Defrost modes even if the Air Conditioning Snowflake button is not pressed. This dehumidifies the air to help dry the windshield. To improve fuel economy, use these modes only when necessary.

Air Outlets

The airflow from each of the instrument panel outlets can be adjusted for direction and turned ON or OFF to control air flow.

NOTE: For maximum airflow to the rear seat passengers, the center instrument panel outlets can be aimed, so that the left center outlet is directed toward the right rear passenger and the right center outlet is directed toward the left rear passenger.

Fan Control

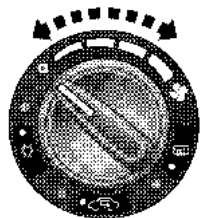

81cab396

Use this control to regulate the amount of air forced through the system in any mode you select. The fan speed increases as you move the control from the left (OFF) to the right position.

NOTE: For vehicles equipped with Remote Start, the climate controls will not function during Remote Start operation if the fan control is left in the “O” (Off) position.

Temperature Control

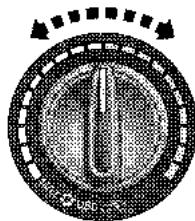

81caad41

Use this control to regulate the temperature of the air inside the passenger compartment. The blue area of the scale indicates cooler temperatures while the red area indicates warmer temperatures.

NOTE: If your air conditioning performance seems lower than expected, check the front of the A/C condenser, located in front of the radiator, for an accumulation of dirt or insects. Clean with a gentle water spray from behind the radiator and through the condenser. Fabric front fascia protectors may reduce air flow to the condenser, reducing air conditioning performance.

Circulation Control

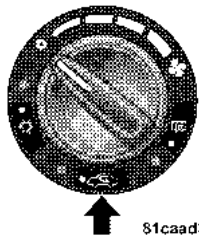

81caad32

Use this button to choose between outside air intake or recirculation of the air inside the vehicle. A light will illuminate when you are in recirculate mode. Only use the recirculate mode to temporarily block out any outside odors, smoke, or dust and to cool the interior rapidly upon initial start

up in very hot or humid weather.

NOTE: Continuous use of the recirculate mode may make the inside air stuffy and window fogging may occur. Extended use of this mode is not recommended.

In cold or damp weather, the use of the Recirculate position will cause windows to fog on the inside because of moisture build up inside the vehicle. For maximum defogging, select the Outside Air position.

NOTE: Recirculation Mode will not operate in floor, mix or defrost modes.

Air Conditioning (Normal)

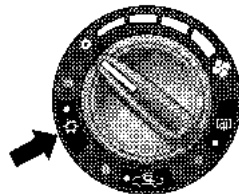

81caad38

Use this button to engage the Air Conditioning. A light will illuminate when the Air Conditioning System is engaged.

NOTE: The air conditioning compressor will not engage until the engine has been running for about 10 seconds.

Air Conditioning (MAX A/C)

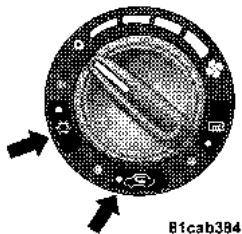

For maximum cooling select the air direction to either the Panel or Bi-Level position using the mode control. Press the A/C button and the recirculation button so that both lights are illuminated and set the temperature control to its coolest setting.

NOTE:

- Recirculation Mode will not operate in Floor, Mix or Defrost modes.
- See “Circulation Control” in this section, for proper or extended use of this position.

Air Filtration System – If Equipped

An air filter is included in the optional Security Group. The filter media includes a particle filtration layer. The filter will reduce, but not eliminate, diesel and agricultural smells. The filter acts only on air coming from outside the vehicle; it does not filter air inside the passenger compartment. The air filter change interval coincides with engine oil and filter change intervals. As with oil changes, the interval is shorter for heavy duty service or dusty conditions. Refer to “Maintenance Schedule” in Section 7. See your authorized dealer for service.

Operating Tips

Window Fogging

Vehicle side windows tend to fog on the inside in mild rainy or humid weather. To clear the windows, set mode to the mix or defrost position. Direct the panel outlets toward the side windows. Do not use recirculate without A/C for long periods as fogging may occur.

Interior fogging on the windshield can be quickly removed by using the defrost position.

If the fogging problem persists, clean the inside window surfaces. The cause of undue fogging may be dirt collecting on the inside surface of the glass



NOTE: In cold weather, the use of the recirculate position will cause windows to fog on the inside because of moisture build up inside the vehicle. Moisture and ice can also accumulate on the inside of the sheet metal and may result in

headliner and/or electronic component damage. For maximum defogging, press the recirculation button until recirculate is off.

Summer Operation

Air conditioned vehicles must be protected with a high-quality antifreeze coolant to provide proper corrosion protection and to raise the boiling point of the coolant for protection against overheating. A 50% concentration is recommended.

Outside Air Intake

When operating the system during the winter months, make sure the air intake, directly in front of the windshield, is free of ice, slush, snow or other obstructions such as leaves. Leaves collected in the air-intake plenum may reduce air flow and plug the plenum water drains.

The blower air will heat faster in cold weather if you use only a low blower speed for the first few minutes of vehicle operation.

Side Window Demisters

A side window demister outlet is at each end of the instrument panel. These nonadjustable outlets direct air toward the side windows when the system is in either the FLOOR, MIX, or DEFROST mode. The air is directed at the area of the windows through which you view the outside mirrors.

STARTING AND OPERATING

CONTENTS

■ Starting Procedures	249	■ Manual Transaxle — If Equipped	251
□ Manual Transmission — If Equipped	249	□ 5-Speed Manual Transaxle	251
□ Automatic Transmission — If Equipped	249	□ Recommended Shift Speeds	253
□ Normal Starting	249	□ Downshifting	253
□ Extremely Cold Weather (Below -20°F Or -29°C)	250	■ Automatic Transaxle — If Equipped	253
□ If Engine Fails To Start	250	□ Brake/Transmission Interlock System	254
□ After Starting	251	□ Automatic Transaxle Ignition Interlock System	255
		□ Gear Ranges	255

■ AutoStick® — If Equipped	257	□ Anti-Lock Brake System (ABS) — If Equipped	266
□ Operation	258	■ Electronic Brake Control System	268
□ General Information	258	□ Anti-Lock Brake System (ABS)	269
■ Driving On Slippery Surfaces	259	□ Brake Assist System (BAS)	269
□ Acceleration	259	□ Traction Control System (TCS)	270
□ Traction	259	□ Electronic Stability Program (ESP)	270
■ Driving Through Water	260	■ Tire Safety Information	274
□ Flowing/Rising Water	260	□ Tire Markings	274
□ Shallow Standing Water	260	□ Tire Identification Number (TIN)	278
■ Power Steering	262	□ Tire Loading And Tire Pressure	279
□ Power Steering Fluid Check	263	■ Tires — General Information	283
■ Parking Brake	264	□ Tire Pressure	283
■ Brake System	265		

□ Tire Inflation Pressures	284	□ Base System	295
□ Tire Pressures For High Speed Operation . . .	285	□ Premium System — If Equipped	297
□ Radial Ply Tires	286	□ General Information	301
□ Compact Spare Tire — If Equipped	286	■ Fuel Requirements	301
□ Limited-Use Spare — If Equipped	287	□ Reformulated Gasoline	302
□ Tire Spinning	288	□ Gasoline/Oxygenate Blends	302
□ Tread Wear Indicators	288	□ E-85 Usage In Non-Flex Fuel Vehicles	302
□ Life Of Tire	289	□ MMT In Gasoline	303
□ Replacement Tires	290	□ Materials Added To Fuel	304
■ Tire Chains	291	□ Fuel System Cautions	304
■ Snow Tires	291	□ Carbon Monoxide Warnings	305
■ Tire Rotation Recommendations	292	■ Adding Fuel	305
■ Tire Pressure Monitoring System (TPMS)	293	□ Fuel Filler Cap (Gas Cap)	305

- Loose Fuel Filler Cap Message 307
- Vehicle Loading 307
 - Vehicle Certification Label 308
- Trailer Towing 310
 - Common Towing Definitions 310
 - Installing A Trailer Hitch 312
 - Trailer Hitch Classification 312
 - Trailer Towing Weights (Maximum Trailer Weight Ratings) 313
 - Trailer And Tongue Weight 314
- Towing Requirements 315
- Towing Tips 320
- Recreational Towing (Behind Motorhome, Etc.) 321
 - Towing This Vehicle Behind Another Vehicle (Flat Towing With All Four Wheels On The Ground) 321

STARTING PROCEDURES

Before starting your vehicle, adjust your seat, adjust both inside and outside mirrors, and fasten your seat belts.

WARNING!

Never leave children alone in a vehicle. Leaving unattended children in a vehicle is dangerous for a number of reasons. A child or others could be seriously or fatally injured. Do not leave the key in the ignition. A child could operate power windows, other controls, or move the vehicle.

Manual Transmission — If Equipped

Before starting the engine fully apply the parking brake, press the clutch pedal to the floor, and place the shift lever in NEUTRAL.

NOTE:

- The engine will not start unless the clutch pedal is pressed to the floor.
- If the key will not turn and the steering wheel is locked, rotate the wheel in either direction to relieve pressure on the locking mechanism and then turn the key.

Automatic Transmission — If Equipped

The shift lever must be in the PARK or NEUTRAL position before you can start the engine. Apply the brakes before shifting to any driving gear.

NOTE: You must press the brake pedal before shifting out of PARK.

Normal Starting

Normal starting of either a cold or a warm engine does not require pumping or depressing the accelerator pedal. Simply turn the ignition switch to the START position

and release when the engine starts. If the engine fails to start within 15 seconds, turn the ignition switch to the OFF position, wait 10 to 15 seconds, then repeat the normal starting procedure.

WARNING!

Do not attempt to push or tow your vehicle to get it started. Vehicles equipped with an automatic trans-axle cannot be started this way. Unburned fuel could enter the catalytic converter and once the engine has started, ignite and damage the converter and vehicle. If the vehicle has a discharged battery, booster cables may be used to obtain a start from another vehicle. This type of start can be dangerous if done improperly, so follow the procedure carefully. See Section 6 of this manual for jump-starting instructions.

Extremely Cold Weather (Below –20°F Or –29°C)

To ensure reliable starting at these temperatures, use of an externally powered electric engine block heater (available from your authorized dealer) is recommended.

If Engine Fails to Start

If the engine fails to start after you have followed the “Normal Starting” procedure, it may be flooded. Push the accelerator pedal all the way to the floor and hold it there. Crank the engine for no more than 15 seconds. This should clear any excess fuel in case the engine is flooded. Leave the ignition key in the ON position, release the accelerator pedal and repeat the “Normal Starting” procedure.

WARNING!

Never pour fuel or other flammable liquid into the throttle body air inlet opening in an attempt to start the vehicle. This could result in flash fire causing serious personal injury.

CAUTION!

To prevent damage to the starter, do not crank the engine for more than 15 seconds at a time. Wait 10 to 15 seconds before trying again.

After Starting

The idle speed will automatically decrease as the engine warms up.

MANUAL TRANSAXLE — IF EQUIPPED**5-Speed Manual Transaxle****WARNING!**

You or others could be injured if you leave the vehicle unattended without having the parking brake fully applied. The parking brake should always be applied when the driver is not in the vehicle, especially on an incline.

Fully depress the clutch pedal before you shift gears. As you release the clutch pedal, lightly depress the accelerator pedal.

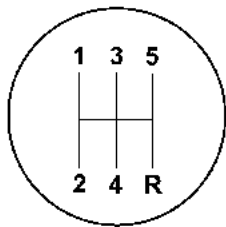

Shift Pattern

80f7bc4b

Use each gear in numerical order, do not skip a gear. Be sure the transaxle is in 1st gear, (not 3rd), when starting from a standing position. Damage to the clutch can result from starting in 3rd gear.

For most city driving, you will find it easier to use only the lower gears. For steady highway driving with light accelerations, 5th gear is recommended.

Never drive with your foot resting on the clutch pedal, and never try to hold the vehicle on a hill with the clutch pedal partially engaged. This will cause abnormal wear on the clutch.

Never shift into REVERSE until the vehicle has come to a complete stop.

NOTE: During cold weather, until the transaxle lubricant is warm, you may experience slightly higher shift efforts. This is normal and not harmful to the transaxle.

Recommended Shift Speeds

To use your manual transaxle for optimal fuel economy, it should be upshifted as listed in the following table.

Manual Transaxle Recommended Shift Speeds					
Units in mph (km/h)					
Engine Size	Acceleration Rate	1 to 2	2 to 3	3 to 4	4 to 5
All Engines	Accel	14 (23)	23 (37)	29 (47)	45 (72)
	Cruise	12 (19)	18 (29)	25 (40)	32 (52)

Downshifting

Proper downshifting will improve fuel economy and prolong engine life.

CAUTION!

If you skip more than one gear while downshifting or downshift at too high a vehicle speed, you could damage the engine, transmission, or clutch.

To maintain a safe speed and prolong brake life, shift down to 2nd or 1st gear when descending a steep grade.

When turning a corner or driving up a steep grade, downshift early so that the engine will not be overburdened.

5

AUTOMATIC TRANSAXLE — IF EQUIPPED

NOTE: The Continuously Variable Automatic Transaxle (CVT) changes ratios in a continuous manner. This may sometimes "feel" as if it is slipping, but this is normal and does not harm anything.

CAUTION!

Damage to the transaxle may occur if the following precautions are not observed:

- Shift into PARK only after the vehicle has come to a complete stop.
- Shift into or out of REVERSE only after the vehicle has come to a complete stop and the engine is at idle speed.
- Do not shift from REVERSE, PARK, or NEUTRAL into any forward gear when the engine is above idle speed.
- Before shifting into any gear, make sure your foot is firmly on the brake pedal.

NOTE: You MUST press and hold the brake pedal down while shifting out of PARK.

WARNING!

It is dangerous to move the shift lever out of PARK or NEUTRAL if the engine speed is higher than idle speed. If your foot is not firmly on the brake pedal, the vehicle could accelerate quickly forward or in reverse. You could lose control of the vehicle and hit someone or something. Only shift into gear when the engine is idling normally and when your right foot is firmly on the brake pedal.

Brake/Transmission Interlock System

This system prevents you from moving the shift lever out of PARK and into any gear unless the brake pedal is pressed. This system is active only while the ignition switch is in the ON or ACC position. Always depress the **brake pedal first**, before moving the shift lever out of PARK.

NOTE: If a malfunction occurs, the transaxle will not shift out of PARK. Battery power is required to release the brake/transmission interlock system. There is a removable plug in the right side of the shifter housing that allows you to insert your finger to override the system. If this occurs, obtain service as soon as possible.

Automatic Transaxle Ignition Interlock System

This system prevents the key from being removed unless the shift lever is in PARK. It also prevents shifting out of PARK unless the key is in the ACC or ON position, and the brake pedal is depressed.

NOTE: If a malfunction occurs, the system will trap the key in the ignition cylinder to warn you that this safety feature is inoperable. The engine can be started and stopped, but the key cannot be removed until you obtain service.

Gear Ranges

DO NOT race the engine when shifting from PARK or NEUTRAL position into another gear range.



Shift Lever

PARK

This supplements the parking brake by locking the transmission. The engine can be started in this range.

Never use PARK while the vehicle is in motion. Apply the parking brake when leaving the vehicle in this range. Always apply the parking brake first, and then place the shift lever into the PARK position.

WARNING!

Unintended movement of a vehicle could injure those in and near the vehicle. As with all vehicles, you should never exit a vehicle while the engine is running. Before exiting a vehicle, you should always shift the vehicle into PARK, remove the key from the ignition, and apply the parking brake. Once the key is removed from the ignition, the shift lever is locked in the PARK position, securing the vehicle against unwanted movement. Furthermore, you should never leave unattended children inside a vehicle.

The following indicators should be used to ensure that you have engaged the shift lever into the PARK position:

- When shifting into PARK firmly move the shift lever all the way forward until it stops.
- Look at the shift indicator window on the shifter bezel to ensure it is in the PARK position.
- You must depress the brake pedal to move the shift lever out of the PARK position.

CAUTION!

Before moving the shift lever out of PARK, you must turn the ignition from LOCK to ON so the steering wheel and shift lever are released. Otherwise, damage to the steering column or shift lever could result. You must also depress the brake pedal.

REVERSE

Shift into this range only after the vehicle has come to a complete stop.

NEUTRAL

The engine may be started in this range.

DRIVE

This should be used for most driving and provides the best ratio for optimum drivability, fuel economy, and performance.

AUTOSTICK® — IF EQUIPPED

Autostick® is a driver-interactive transmission that offers six manual ratio changes to provide you with more control. Autostick® allows you to maximize engine braking, eliminate undesirable upshifts and downshifts, and improve overall vehicle performance. This system can also provide you with more control during passing, city driving, cold slippery conditions, mountain driving,

trailer towing, and many other situations. Automatic ratio changes upward will only occur to protect the Continuously Variable Automatic Transaxle (CVT) and/or the engine from overspeed. Changes down will only happen at minimum engine speed to prevent stalling.



Operation

NOTE: Autostick® is not functional until the CVT warms up in cold weather.

Autostick® operation is activated in the DRIVE position by moving the shift lever side-to-side. Moving the shift lever to the (+) side will activate Autostick® and shift up to the next higher manual ratio, unless you are already operating in or near Overdrive, in which case 6th ratio will be selected. In like manner, moving the shift lever to (-) will activate Autostick® and shift to the next lower manual ratio. After Autostick® is activated, the manual ratio selected is displayed in the transmission ratio display and tipping the shift lever to the (+) or (-) direction will cause an upshift or downshift by one ratio.

Autostick® is deactivated:

- By holding the shift lever to (+) momentarily
- When the shift lever is shifted out of DRIVE

- When in 6th position, touching the shift lever to the right
- When heavy Anti-Lock Brake System (ABS) application is detected

General Information

- If a ratio other than 1st is selected and the vehicle is brought to a stop, the transaxle control logic will automatically select the 1st gear ratio.
- If a low range is selected and the engine accelerates to the rev limit, the transaxle will automatically select the next higher ratio.
- If a downshift would cause the engine to overspeed, that shift will not occur until it is safe for the engine. However, the CVT will stay in the manually selected ratio.

- If the system detects powertrain overheating, the transmission will revert to the automatic shift mode and remain in that mode until the powertrain cools off.
- If the system detects a problem, it will disable the Autostick® mode and the transmission will return to the automatic mode until the problem is corrected.

DRIVING ON SLIPPERY SURFACES

Acceleration

Rapid acceleration on snow covered, wet, or other slippery surfaces may cause the front wheels to pull erratically to the right or left. This phenomenon occurs when there is a difference in the surface traction under the front (driving) wheels.

WARNING!

Rapid acceleration on slippery surfaces is dangerous. Unequal traction can cause sudden pulling of the front wheels. You could lose control of the vehicle and possibly have an accident. Accelerate slowly and carefully whenever there is likely to be poor traction (ice, snow, wet, mud, loose sand, etc.).

Traction

When driving on wet or slushy roads, it is possible for a wedge of water to build up between the tire and road surface. This is hydroplaning and may cause partial or complete loss of vehicle control and stopping ability. To reduce this possibility, the following precautions should be observed:

1. Slow down during rainstorms or when roads are slushy.

2. Slow down if the road has standing water or puddles.
3. Replace the tires when tread wear indicators first become visible.
4. Keep the tires properly inflated.
5. Maintain enough distance between your vehicle and the vehicle in front of you to avoid a collision in a sudden stop.

DRIVING THROUGH WATER

Driving through water more than a few inches/centimeters deep will require extra caution to ensure safety and prevent damage to your vehicle.

Flowing/Rising Water

WARNING!

Do not drive on or cross a road or a path where water is flowing and/or rising (as in storm run-off). Flowing water can wear away the road or path's surface and cause your vehicle to sink into deeper water. Furthermore, flowing and/or rising water can carry your vehicle away swiftly. Failure to follow this warning may result in injuries that are serious or fatal to you, your passengers, and others around you.

Shallow Standing Water

Although your vehicle is capable of driving through shallow standing water, consider the following Caution and Warning before doing so.

CAUTION!

- Always check the depth of the standing water before driving through it. Never drive through standing water that is deeper than the bottom of the tire rims mounted on the vehicle.
- Determine the condition of the road or the path that is under water and if there are any obstacles in the way before driving through the standing water.
- Do not exceed 5 mph (8 km/h) when driving through standing water. This will minimize wave effects.

(Continued)

CAUTION! (Continued)

- Driving through standing water may cause damage to your vehicle's drivetrain components. Always inspect your vehicle's fluids (i.e., engine oil, transmission/transaxle, axle, etc.) for signs of contamination (i.e., fluid that is milky or foamy in appearance) after driving through standing water. Do not continue to operate the vehicle if any fluid appears contaminated, as this may result in further damage. Such damage is not covered by the New Vehicle Limited Warranty.
- Getting water inside your vehicle's engine can cause it to lock up and stall out, and cause serious internal damage to the engine. Such damage is not covered by the New Vehicle Limited Warranty.

WARNING!

- **Driving through standing water limits your vehicle's traction capabilities. Do not exceed 5 mph (8 km/h) when driving through standing water.**
- **Driving through standing water limits your vehicle's braking capabilities, which increases stopping distances. Therefore, after driving through standing water, drive slowly and lightly press on the brake pedal several times to dry the brakes.**
- **Getting water inside your vehicle's engine can cause it to lock up and stall out, and leave you stranded.**
- **Failure to follow these warnings may result in injuries that are serious or fatal to you, your passengers, and others around you.**

POWER STEERING

The standard power steering system will give you good vehicle response and increased ease of maneuverability in tight spaces. The system will provide mechanical steering capability if power assist is lost.

If for some reason the power assist is interrupted, it will still be possible to steer your vehicle. Under these conditions, you will observe a substantial increase in steering effort, especially at very low vehicle speeds and during parking maneuvers.

NOTE: Increased noise levels at the end of the steering wheel travel are considered normal and do not indicate that there is a problem with the power steering system.

Upon initial start-up in cold weather, the power steering pump may make noise for a short amount of time. This is due to the cold, thick fluid in the steering system. This noise should be considered normal, and it does not in any way damage the steering system.

WARNING!

Continued operation with reduced power steering assist could pose a safety risk to yourself and others. Service should be obtained as soon as possible.

CAUTION!

Prolonged operation of the steering system at the end of the steering wheel travel will increase the steering fluid temperature and it should be avoided when possible. Damage to the power steering pump may occur.

Power Steering Fluid Check

Checking the power steering fluid level at a defined service interval is not required. The fluid should only be checked if a leak is suspected, abnormal noises are

apparent, and/or the system is not functioning as anticipated. Coordinate inspection efforts through an authorized dealer.

No chemical flushes should be used in any power steering system; only the approved lubricant may be used.

WARNING!

Fluid level should be checked on a level surface and with the engine off to prevent injury from moving parts and to ensure accurate fluid level reading. Do not overfill. Use only manufacturer's recommended power steering fluid.

If necessary, add fluid to restore to the proper indicated level. With a clean cloth, wipe any spilled fluid from all surfaces. Refer to "Fluids, Lubricants, and Genuine Parts" in Section 7 for the correct fluid type.

PARKING BRAKE

When the parking brake is applied with the ignition ON, the Brake Light in the instrument cluster will come on.

NOTE: This light only shows that the parking brake is on. It does not show the degree of brake application.

If the parking brake is applied while the vehicle is moving, a chime will sound to alert the driver. The chime will sound up to 10 times or until the vehicle has returned to a stop.

Before leaving the vehicle, make sure that the parking brake is set. To set the parking brake, pull up firmly on the lever. Also, place the shift lever in the PARK position (automatic transaxle) or REVERSE position (manual transaxle). To release the parking brake, apply the brake pedal, pull up slightly on the lever, then depress the button on the end of the lever and push the lever fully down toward the floor.

NOTE: The parking brake lever will not release unless the lever is pulled up slightly past its applied position.

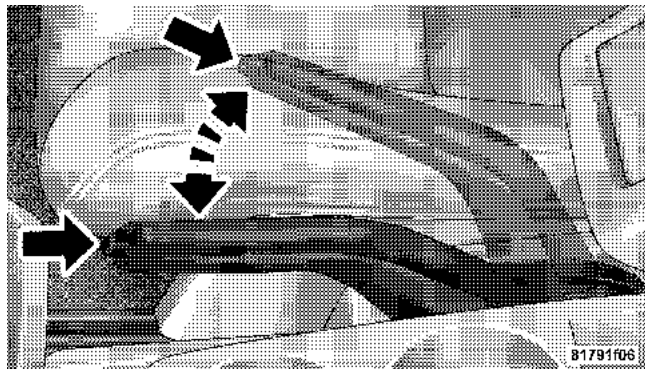

Parking Brake

When parking on a hill, it is important to set the parking brake before placing the shift lever in PARK, otherwise, the load on the automatic transaxle locking mechanism may make it difficult to move the shift lever out of PARK.

As an added precaution, turn the front wheels toward the curb on a downhill grade and away from the curb on a uphill grade.

You should always apply the parking brake before leaving the vehicle.

WARNING!

- **Never leave children alone in a vehicle. Leaving unattended children in a vehicle is dangerous for a number of reasons. A child or others could be seriously or fatally injured. Do not leave the key in the ignition. A child could operate power windows, other controls, or move the vehicle.**
- **Be sure the parking brake is fully disengaged before driving; failure to do so can lead to brake failure and an accident.**

BRAKE SYSTEM

Your vehicle is equipped with power assisted brakes as standard equipment. In the event power assist is lost for any reason (for example, repeated brake applications with the engine off), the brakes will still function. However, the effort required to brake the vehicle will be much greater than that required with the power system operating.

WARNING!

Riding the brakes can lead to brake failure and possibly an accident. Driving with your foot resting or riding on the brake pedal can result in abnormally high brake temperatures, excessive lining wear, and possible brake damage. You would not have your full braking capacity in an emergency.

If either of the two hydraulic systems lose normal capability, the remaining system will still function with some loss of overall braking effectiveness. This will be evident by increased pedal travel during application and greater pedal force required to slow or stop. In addition, if the malfunction is caused by an internal leak, as the brake fluid in the master cylinder drops, the brake warning indicator will light.

WARNING!

Driving a vehicle with the brake light on is dangerous. A significant decrease in braking performance or vehicle stability during braking may occur. It will take you longer to stop the vehicle or will make your vehicle harder to control. You could have an accident. Have the vehicle checked immediately.

Anti-Lock Brake System (ABS) — If Equipped

The ABS provides increased vehicle stability and brake performance under most braking conditions. The system automatically “pumps” the brakes during severe braking conditions to prevent wheel lock-up.

WARNING!

- Pumping of the Anti-Lock Brakes will diminish their effectiveness and may lead to an accident. Pumping makes the stopping distance longer. Just press firmly on your brake pedal when you need to slow down or stop.
- The ABS cannot prevent the natural laws of physics from acting on the vehicle, nor can it increase braking or steering efficiency beyond that afforded by the condition of the vehicle brakes and tires or the traction afforded.

(Continued)

WARNING! (Continued)

- **The ABS cannot prevent accidents, including those resulting from excessive speed in turns, following another vehicle too closely, or hydroplaning. Only a safe, attentive, and skillful driver can prevent accidents.**
- **The capabilities of an ABS-equipped vehicle must never be exploited in a reckless or dangerous manner which could jeopardize the user's safety or the safety of others.**



The ABS light monitors the ABS System. The light will come on when the ignition switch is turned to the ON position and may stay on for as long as four seconds.

If the ABS light remains on or comes on while driving, it indicates that the Anti-Lock portion of the brake system is not functioning and that service is required. However,

the conventional brake system will continue to operate normally if the BRAKE warning light is not on.

If the ABS light is on, the brake system should be serviced as soon as possible to restore the benefits of Anti-Lock brakes. If the ABS light does not come on when the ignition switch is turned to the ON position, have the bulb repaired as soon as possible.

If both the Brake Warning light and the ABS light remain on, the ABS and Electronic Brake Force Distribution (EBD) systems are not functioning. Immediate repair to the ABS is required.

When the vehicle is driven over 7 mph (11 km/h), you may also hear a slight clicking sound as well as some related motor noises. These noises are the system performing its self-check cycle to ensure that the ABS working properly. This self-check occurs each time the vehicle is started and accelerated past 7 mph (11 km/h).

ABS is activated during braking under certain road or stopping conditions. ABS-inducing conditions can include ice, snow, gravel, bumps, railroad tracks, loose debris, or panic stops.

You may also experience the following when the brake system goes into Anti-Lock mode:

- the ABS motor running (it may continue to run for a short time after the stop)
- the clicking sound of solenoid valves
- brake pedal pulsations
- a slight drop or fall away of the brake pedal at the end of the stop

These are all normal characteristics of ABS.

WARNING!

The Anti-Lock Brake System (ABS) contains sophisticated electronic equipment that may be susceptible to interference caused by improperly installed or high output radio transmitting equipment. This interference can cause possible loss of Anti-Lock braking capability. Installation of such equipment should be performed by qualified professionals.

All vehicle wheels and tires must be the same size and type and tires must be properly inflated to produce accurate signals for the computer.

ELECTRONIC BRAKE CONTROL SYSTEM

Your vehicle may be equipped with an optional advanced electronic brake control system that includes Anti-Lock Brake System (ABS), Brake Assist System (BAS), Traction Control System (TCS), and Electronic Stability Program (ESP). All systems work together to

enhance vehicle stability and control in various driving conditions and are commonly referred to as ESP.

Anti-Lock Brake System (ABS)

This system aids the driver in maintaining vehicle control under adverse braking conditions. The system controls hydraulic brake pressure to prevent wheel lockup and help avoid skidding on slippery surfaces during braking. Refer to “Anti-Lock Brake System” in this section of the manual for more information about ABS.

Brake Assist System (BAS)

The BAS is designed to optimize the vehicle’s braking capability during emergency braking maneuvers. The system detects an emergency braking situation by sensing the rate and amount of brake application and then applies optimum pressure to the brakes. This can help reduce braking distances. The BAS complements the Anti-Lock Brake System (ABS). Applying the brakes very quickly results in the best BAS assistance. To receive the

benefit of the system, you must apply **continuous** braking pressure during the stopping sequence (do not “pump” the brakes). Do not reduce brake pedal pressure unless braking is no longer desired. Once the brake pedal is released, the BAS is deactivated.

WARNING!

- **The Brake Assist System (BAS) cannot prevent the natural laws of physics from acting on the vehicle, nor can it increase the traction afforded by prevailing road conditions.**
- **The BAS cannot prevent accidents, including those resulting from excessive speed in turns, driving on very slippery surfaces, or hydroplaning. Only a safe, attentive, and skillful driver can prevent accidents.**

(Continued)

WARNING! (Continued)

- **The capabilities of a BAS-equipped vehicle must never be exploited in a reckless or dangerous manner which could jeopardize the user's safety or the safety of others.**

Traction Control System (TCS)

This system monitors the amount of wheel spin of each of the driven wheels. If wheel spin is detected, brake pressure is applied to the slipping wheel(s) and engine power is reduced to provide enhanced acceleration and stability. A feature of the TCS system functions similar to a limited slip differential and controls the wheel spin across a driven axle. If one wheel on a driven axle is spinning faster than the other, the system will apply the brake of the spinning wheel. This will allow more engine torque to be applied to the wheel that is not spinning. This feature remains active even if TCS and ESP are in the

“Partial Off” mode. Refer to “Electronic Stability Program (ESP)” in this Section of this manual.

Electronic Stability Program (ESP)

This system enhances directional control and stability of the vehicle under various driving conditions. ESP corrects for over-steering or under-steering of the vehicle by applying the brake of the appropriate wheel to assist in counteracting the over-steering or under-steering condition. Engine power may also be reduced to help the vehicle maintain the desired path. ESP uses sensors in the vehicle to determine the vehicle path intended by the driver and compares it to the actual path of the vehicle. When the actual path does not match the intended path, ESP applies the brake of the appropriate wheel to assist in counteracting the over-steer or under-steer condition.

- **Oversteer** - when the vehicle is turning more than appropriate for the steering wheel position.

- Understeer - when the vehicle is turning less than appropriate for the steering wheel position.

ESP Indicator Light

The “ESP Indicator Light” located in the instrument cluster, starts to flash as soon as the tires lose traction and the ESP system becomes active. If the “ESP Indicator Light” begins to flash during acceleration, ease up on the accelerator and apply as little throttle as possible. Be sure to adapt your speed and driving to the prevailing road conditions.

WARNING!

- **Electronic Stability Program (ESP) cannot prevent the natural laws of physics from acting on the vehicle, nor can it increase the traction afforded by prevailing road conditions.**

(Continued)

WARNING! (Continued)

- **ESP cannot prevent accidents, including those resulting from excessive speed in turns, driving on very slippery surfaces, or hydroplaning. Only a safe, attentive, and skillful driver can prevent accidents.**
- **The capabilities of an ESP-equipped vehicle must never be exploited in a reckless or dangerous manner which could jeopardize the user’s safety or the safety of others.**

ESP Operating Modes

The ESP system has two available operating modes.

Full On

This is the normal operating mode for ESP. Whenever the vehicle is started the ESP system will be in this “On” mode. This mode should be used for most driving situations. ESP should only be turned to “Partial Off” for specific reasons as noted below.

Partial Off

This mode is entered by momentarily depressing the ESP OFF switch. This mode is intended to be used if the vehicle is in deep snow, sand or gravel conditions and more wheel spin than ESP would normally allow is required to gain traction.

To turn ESP on again, momentarily depress the ESP OFF switch. This will restore the normal “ESP On” mode of operation.

NOTE: To improve the vehicle’s traction when driving with snow chains, or starting off in deep snow, sand or gravel, it may be desirable to switch to the “Partial Off” mode by pressing the ESP OFF switch. Once the situation requiring ESP to be switched to the “Partial Off” mode is overcome, turn ESP back on by momentarily depressing the ESP OFF switch. This may be done while the vehicle is in motion.

ESP/BAS Warning Light and ESP Indicator Light

The malfunction indicator for the ESP is combined with the BAS indicator. The yellow “ESP/BAS Warning Lamp” and the yellow “ESP Indicator Light” in the instrument cluster both come on when the ignition switch is turned to the ON position. They should both go out with the engine running. If the “ESP/BAS Warning Lamp” comes on continuously with the engine running, a malfunction has been detected in either the ESP or BAS system, or both. If this light remains on after several ignition cycles, and the vehicle has been driven several miles/kilometers at speeds greater than 30 mph (48 km/h), see your authorized dealer as soon as possible to have the problem diagnosed and corrected.

NOTE:

- The “ESP Indicator Light” and the “ESP/BAS Warning Light” come on **momentarily** each time the ignition switch is turned ON.
- Each time the ignition is turned ON, the ESP System will be ON even if it was turned off previously.
- The ESP Control System will make buzzing or clicking sounds when it is active. This is normal; the sounds will stop when ESP becomes inactive following the maneuver that caused the ESP activation.

TIRE SAFETY INFORMATION

Tire Markings

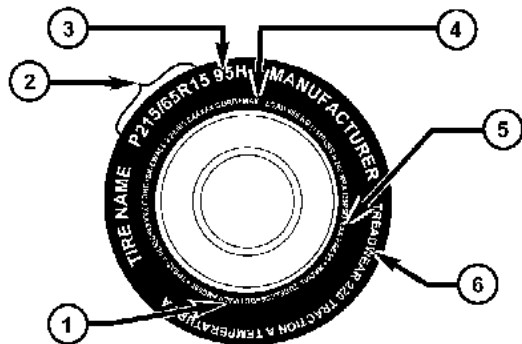

054903773

1 — U.S. DOT Safety Standards Code (TIN)

2 — Size Designation

3 — Service Description

4 — Maximum Load

5 — Maximum Pressure

6 — Treadwear, Traction and Temperature Grades

NOTE:

- P (Passenger) - Metric tire sizing is based on U.S. design standards. P-Metric tires have the letter "P" molded into the sidewall preceding the size designation. Example: P215/65R15 95H.
- European-Metric tire sizing is based on European design standards. Tires designed to this standard have the tire size molded into the sidewall beginning with the section width. The letter "P" is absent from this tire size designation. Example: 215/65R15 96H.

- LT (Light Truck) - Metric tire sizing is based on U.S. design standards. The size designation for LT-Metric tires is the same as for P-Metric tires except for the letters “LT” that are molded into the sidewall preceding the size designation. Example: LT235/85R16.
- Temporary spare tires are high-pressure compact spares designed for temporary emergency use only.

Tires designed to this standard have the letter “T” molded into the sidewall preceding the size designation. Example: T145/80D18 103M.

- High flotation tire sizing is based on U.S. design standards and it begins with the tire diameter molded into the sidewall. Example: 31x10.5 R15 LT.

Tire Sizing Chart

EXAMPLE:

Size Designation:

P = Passenger car tire size based on U.S. design standards

"....blank...." = Passenger car tire based on European design standards

LT = Light truck tire based on U.S. design standards

T = Temporary spare tire

31 = Overall diameter in inches (in)

215 = Section width in millimeters (mm)

65 = Aspect ratio in percent (%)

— Ratio of section height to section width of tire

10.5 = Section width in inches (in)

R = Construction code

— "R" means radial construction

— "D" means diagonal or bias construction

15 = Rim diameter in inches (in)

EXAMPLE:**Service Description:****95** = Load Index

— A numerical code associated with the maximum load a tire can carry

H = Speed Symbol

— A symbol indicating the range of speeds at which a tire can carry a load corresponding to its load index under certain operating conditions

— The maximum speed corresponding to the speed symbol should only be achieved under specified operating conditions (i.e., tire pressure, vehicle loading, road conditions, and posted speed limits)

Load Identification:**"...blank..."** = Absence of any text on the sidewall of the tire indicates a Standard Load (SL) tire**Extra Load (XL)** = Extra load (or reinforced) tire**Light Load** = Light load tire**C, D, E** = Load range associated with the maximum load a tire can carry at a specified pressure**Maximum Load** — Maximum load indicates the maximum load this tire is designed to carry**Maximum Pressure** — Maximum pressure indicates the maximum permissible cold tire inflation pressure for this tire

Tire Identification Number (TIN)

The TIN may be found on one or both sides of the tire, however, the date code may only be on one side. Tires with white sidewalls will have the full TIN, including the date code, located on the white sidewall side of the tire.

Look for the TIN on the outboard side of black sidewall tires as mounted on the vehicle. If the TIN is not found on the outboard side, then you will find it on the inboard side of the tire.

EXAMPLE:**DOT MA L9 ABCD 0301****DOT** = Department of Transportation

— This symbol certifies that the tire is in compliance with the U.S. Department of Transportation tire safety standards and is approved for highway use

MA = Code representing the tire manufacturing location (two digits)**L9** = Code representing the tire size (two digits)**ABCD** = Code used by the tire manufacturer (one to four digits)**03** = Number representing the week in which the tire was manufactured (two digits)

—03 means the 3rd week.

01 = Number representing the year in which the tire was manufactured (two digits)

—01 means the year 2001

— Prior to July 2000, tire manufacturers were only required to have one number to represent the year in which the tire was manufactured. Example: 031 could represent the 3rd week of 1981 or 1991

Tire Loading and Tire Pressure

Tire Placard Location

NOTE: The proper cold tire inflation pressure is listed on the driver's side B-Pillar.

Tire and Loading Information Placard

TIRE AND LOADING INFORMATION			
SEATING CAPACITY - TOTAL 5 FRONT 2 REAR 3			
THE COMBINED WEIGHT OF OCCUPANTS AND CARGO SHOULD NEVER EXCEED XXX KG OR XXX LBS.			
TIRE	FRONT	REAR	SPARE
ORIGINAL TIRE SIZE	P195/70R14	P195/70R14	T125/70D15
COLD TIRE INFLATION PRESSURE	200kPa, 29PSI	200kPa, 29PSI	420kPa, 60PSI
SEE OWNER'S MANUAL FOR ADDITIONAL INFORMATION			4N10926B

811b5a9a

Tire and Loading Information Placard

This placard tells you important information about the:

- 1) number of people that can be carried in the vehicle
- 2) total weight your vehicle can carry
- 3) tire size designed for your vehicle
- 4) cold tire inflation pressures for the front, rear, and spare tires.

Loading

The vehicle maximum load on the tire must not exceed the load carrying capacity of the tire on your vehicle. You will not exceed the tire's load carrying capacity if you adhere to the loading conditions, tire size, and cold tire inflation pressures specified on the Tire and Loading Information placard and in the "Vehicle Loading" section of this manual.

NOTE: Under a maximum loaded vehicle condition, gross axle weight ratings (GAWRs) for the front and rear

axles must not be exceeded. For further information on GAWRs, vehicle loading, and trailer towing, refer to “Vehicle Loading” in this section.

To determine the maximum loading conditions of your vehicle, locate the statement “The combined weight of occupants and cargo should never exceed XXX lbs or XXX kg” on the Tire and Loading Information placard. The combined weight of occupants, cargo/luggage and trailer tongue weight (if applicable) should never exceed the weight referenced here.

Steps for Determining Correct Load Limit

1. Locate the statement “The combined weight of occupants and cargo should never exceed XXX lbs or XXX kg” on your vehicle’s placard.
2. Determine the combined weight of the driver and passengers that will be riding in your vehicle.

3. Subtract the combined weight of the driver and passengers from XXX lbs or XXX kg.

4. The resulting figure equals the available amount of cargo and luggage load capacity. For example, if “XXX” amount equals 1,400 lbs (635 kg) and there will be five 150 lb (68 kg) passengers in your vehicle, the amount of available cargo and luggage load capacity is 650 lbs (295 kg) (since $5 \times 150 = 750$, and $1400 - 750 = 650$ lbs [295 kg]).

5. Determine the combined weight of luggage and cargo being loaded on the vehicle. That weight may not safely exceed the available cargo and luggage load capacity calculated in step 4.

6. If your vehicle will be towing a trailer, load from your trailer will be transferred to your vehicle. Consult this manual to determine how this reduces the available cargo and luggage load capacity of your vehicle.

NOTE:

- The following table shows examples on how to calculate total load, cargo/luggage, and towing capacities of your vehicle with varying seating configurations and number and size of occupants. This table is for illustration purposes only and may not be accurate for the seating and load carry capacity of your vehicle.
- For the following example, the combined weight of occupants and cargo should never exceed 865 lbs (392 kg).

Occupants			Combined weight of occupants and cargo from Tire Placard	MINUS	Combined Occupant's weight	=	AVAILABLE Cargo/Luggage and Trailer Tongue Weight
TOTAL	FRONT	REAR					
<u>EXAMPLE 1</u>			865 lbs	minus	670 lbs	=	195 lbs
5	2	3					
<u>EXAMPLE 2</u>			865 lbs	minus	540 lbs	=	325 lbs
3	2	1					
<u>EXAMPLE 3</u>			865 lbs	minus	400 lbs	=	465 lbs
2	2	0					

Occupant 1: 200 lbs
Occupant 2: 130 lbs
Occupant 3: 160 lbs
Occupant 4: 100 lbs
Occupant 5: 80 lbs
TOTAL WEIGHT: 670 lbs

Occupant 1: 210 lbs
Occupant 2: 180 lbs
Occupant 3: 150 lbs
TOTAL WEIGHT: 540 lbs

Occupant 1: 200 lbs
Occupant 2: 200 lbs
TOTAL WEIGHT: 400 lbs

WARNING!

Overloading of your tires is dangerous. Overloading can cause tire failure, affect vehicle handling, and increase your stopping distance. Use tires of the recommended load capacity for your vehicle. Never overload them.

TIRES — GENERAL INFORMATION**Tire Pressure**

Proper tire inflation pressure is essential to the safe and satisfactory operation of your vehicle. Three primary areas are affected by improper tire pressure:

Safety**WARNING!**

- Improperly inflated tires are dangerous and can cause accidents.
- Underinflation increases tire flexing and can result in tire failure.
- Overinflation reduces a tire's ability to cushion shock. Objects on the road and chuckholes can cause damage that result in tire failure.
- Unequal tire pressures can cause steering problems. You could lose control of your vehicle.
- Overinflated or underinflated tires can affect vehicle handling and can fail suddenly, resulting in loss of vehicle control.

(Continued)

WARNING! (Continued)

- Unequal tire pressures from one side of the vehicle to the other can cause the vehicle to drift to the right or left.
- Always drive with each tire inflated to the recommended cold tire inflation pressure.

Economy

Improper inflation pressures can cause uneven wear patterns to develop across the tire tread. These abnormal wear patterns will reduce tread life resulting in a need for earlier tire replacement. Underinflation also increases tire rolling resistance and results in higher fuel consumption.

Ride Comfort and Vehicle Stability

Proper tire inflation contributes to a comfortable ride. Overinflation produces a jarring and uncomfortable ride.

Tire Inflation Pressures

The proper cold tire inflation pressure is listed on the driver's side "B" Pillar.

Some vehicles may have Supplemental Tire Pressure Information for vehicle loads that are less than the maximum loaded vehicle condition. These pressure conditions will be found in the "Supplemental Tire Pressure Information" section of this manual.

The pressure should be checked and adjusted as well as inspecting for signs of tire wear or visible damage at least once a month. Use a good quality pocket-type gauge to check tire pressure. Do not make a visual judgement when determining proper inflation. Radial tires may look properly inflated even when they are underinflated.

CAUTION!

After inspecting or adjusting the tire pressure, always reinstall the valve stem cap (if equipped). This will prevent moisture and dirt from entering the valve stem, which could damage the valve stem.

Inflation pressures specified on the placard are always “cold tire inflation pressure.” Cold tire inflation pressure is defined as the tire pressure after the vehicle has not been driven for at least three hours or driven less than 1 mile (1.6 km) after a three hour period. The cold tire inflation pressure must not exceed the maximum inflation pressure molded into the tire sidewall.

Check tire pressures more often if subject to a wide range of outdoor temperatures as tire pressures vary with temperature changes.

Tire pressures change by approximately 1 psi (7 kPa) per 12°F (7°C) of air temperature change. Keep this in mind when checking tire pressure inside a garage, especially in the Winter.

Example: If garage temperature = 68°F (20°C) and the outside temperature = 32°F (0°C) then the cold tire inflation pressure should be increased by 3 psi (21 kPa), which equals 1 psi (7 kPa) for every 12°F (7°C) for this outside temperature condition.

Tire pressure may increase from 2 to 6 psi (13 to 40 kPa) during operation. Do not reduce this normal pressure build up or your tire pressure will be too low.

Tire Pressures for High Speed Operation

The manufacturer advocates driving at safe speeds within posted speed limits. Where speed limits or conditions are such that the vehicle can be driven at high speeds, maintaining correct tire inflation pressure is very important. Increased tire pressure and reduced vehicle

loading may be required for high-speed vehicle operation. Refer to original equipment or an authorized tire dealer for recommended safe operating speeds, loading and cold tire inflation pressures.

WARNING!

High speed driving with your vehicle under maximum load is dangerous. The added strain on your tires could cause them to fail. You could have a serious accident. Do not drive a vehicle loaded to the maximum capacity at continuous speeds above 75 mph (120 km/h).

Radial Ply Tires**WARNING!**

Combining radial ply tires with other types of tires on your vehicle will cause your vehicle to handle poorly. The instability could cause an accident. Always use radial ply tires in sets of four (or six, in the case of trucks with dual rear wheels). Never combine them with other types of tires.

Cuts and punctures in radial tires are repairable only in the tread area because of sidewall flexing. Consult your authorized tire dealer for radial tire repairs.

Compact Spare Tire — If Equipped

The compact spare is for temporary emergency use with radial tires. It is engineered to be used on your style

vehicle only. Since this tire has limited tread life, the original tire should be repaired (or replaced) and reinstalled at the first opportunity.

WARNING!

- Temporary use spare tires are for emergency use only. With these tires, do not drive more than 50 mph (80 km/h).
- Temporary-use spare tires have limited tread life. When the tread is worn to the tread wear indicators, the temporary use spare tire needs to be replaced.
- Be sure to follow the warnings which apply to your spare. Failure to do so could result in spare tire failure and loss of vehicle control.

Do not install a wheel cover or attempt to mount a conventional tire on the compact spare wheel, since the wheel is designed specifically for the compact spare.

Do not install more than one compact spare tire/wheel on the vehicle at any given time.

CAUTION!

Because of the reduced ground clearance, do not take your vehicle through an automatic car wash with the compact spare installed. Damage to the vehicle may result.

Limited-Use Spare — If Equipped

The limited-use spare tire is for temporary emergency use on your vehicle. This tire is identified by a limited-use spare tire warning label located on the limited-use spare tire and wheel assembly. This tire may look like the original equipped tire on the front or rear axle of your vehicle, but it is not. Installation of this limited-use spare tire affects vehicle handling. Since it is not the same tire, replace (or repair) the original tire and reinstall on the vehicle at the first opportunity.

WARNING!

The limited-use spare tires are for emergency use only. Installation of this limited-use spare tire affects vehicle handling. With this tire, do not drive more than 50 mph (80 km/h). Keep it inflated to the cold tire inflation pressure listed on either your tire placard or limited-use spare tire and wheel assembly. Replace (or repair) the original tire at the first opportunity and reinstall it on your vehicle. Failure to do so could result in loss of vehicle control.

Tire Spinning

When stuck in mud, sand, snow, or ice conditions, do not spin your vehicle's wheels faster than 30 mph (48 km/h) or for longer than 30 seconds continuously without stopping when you are stuck.

For additional information, refer to "Freeing A Stuck Vehicle" in Section 6.

WARNING!

Fast spinning tires can be dangerous. Forces generated by excessive wheel speeds may cause tire damage or failure. A tire could explode and injure someone. Do not spin your vehicle's wheels faster than 30 mph (48 km/h) or for more than 30 seconds continuously when you are stuck, and do not let anyone near a spinning wheel, no matter what the speed.

Tread Wear Indicators

Tread wear indicators are in the original equipment tires to help you in determining when your tires should be replaced.

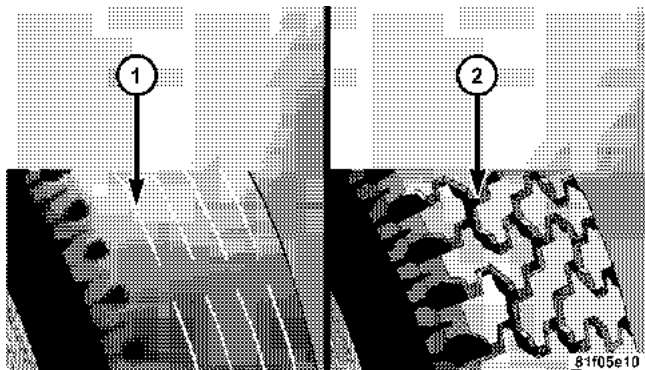

1 — Worn Tire
2 — New Tire

These indicators are molded into the bottom of the tread grooves. They will appear as bands when the tread depth becomes 1/16 in (2 mm). When the tread is worn to the tread wear indicators, the tire should be replaced.

Many states have laws requiring tire replacement at this point.

Life of Tire

The service life of a tire is dependent upon varying factors including, but not limited to:

- Driving style
- Tire pressure
- Distance driven

WARNING!

Tires and the spare tire should be replaced after six years, regardless of the remaining tread. Failure to follow this warning can result in sudden tire failure. You could lose control and have an accident resulting in serious injury or death.

Keep dismantled tires in a cool, dry place with as little exposure to light as possible. Protect tires from contact with oil, grease, and gasoline.

Replacement Tires

The tires on your new vehicle provide a balance of many characteristics. They should be inspected regularly for wear and correct cold tire inflation pressure. The manufacturer strongly recommends that you use tires equivalent to the originals in size, quality and performance when replacement is needed. (Refer to the paragraph on “Tread Wear Indicators”). Refer to the “Tire and Loading Information” placard for the size designation of your tire. The service description and load identification will be found on the original equipment tire. Failure to use equivalent replacement tires may adversely affect the safety, handling, and ride of your vehicle. We recommend that you contact your original equipment or an authorized tire dealer with any questions you may have on tire specifications or capability.

WARNING!

- **Do not use a tire, wheel size or rating other than that specified for your vehicle. Some combinations of unapproved tires and wheels may change suspension dimensions and performance characteristics, resulting in changes to steering, handling, and braking of your vehicle. This can cause unpredictable handling and stress to steering and suspension components. You could lose control and have an accident resulting in serious injury or death. Use only the tire and wheel sizes with load ratings approved for your vehicle.**
- **Never use a tire with a smaller load index or capacity other than what was originally equipped on your vehicle. Using a tire with a smaller load index could result in tire overloading and failure. You could lose control and have an accident.**

(Continued)

WARNING! (Continued)

- Failure to equip your vehicle with tires having adequate speed capability can result in sudden tire failure and loss of vehicle control.

CAUTION!

Replacing original tires with tires of a different size may result in false speedometer and odometer readings.

TIRE CHAINS

Due to limited clearance, tire chains are not recommended.

CAUTION!

Damage to the vehicle may result if tire chains are used.

SNOW TIRES

Some areas of the country require the use of snow tires during Winter. Standard tires are of the all-season type and satisfy this requirement as indicated by the M+S designation on the tire sidewall.

If you need snow tires, select tires equivalent in size and type to the original equipment tires. Use snow tires only in sets of four; failure to do so may adversely affect the safety and handling of your vehicle.

Snow tires generally have lower speed ratings than what was originally equipped with your vehicle and should not be operated at sustained speeds over 75 mph (120 km/h).

TIRE ROTATION RECOMMENDATIONS

Tires on the front and rear axles of vehicles operate at different loads and perform different steering, driving, and braking functions. For these reasons, they wear at unequal rates and tend to develop irregular wear patterns.

These effects can be reduced by timely rotation of tires. The benefits of rotation are especially worthwhile with aggressive tread designs such as those on all season type tires. Rotation will increase tread life, help to maintain mud, snow and wet traction levels, and contribute to a smooth, quiet ride.

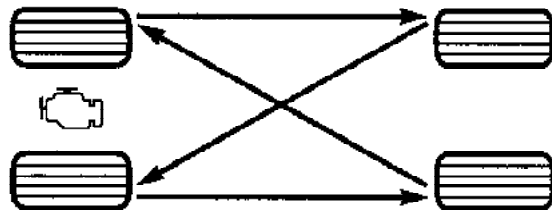

055707139

Tire Rotation

Refer to the “Maintenance Schedule” in Section 8 for the proper maintenance intervals. More frequent rotation is permissible if desired. The reasons for any rapid or unusual wear should be corrected prior to rotation being performed.

TIRE PRESSURE MONITORING SYSTEM (TPMS)

The Tire Pressure Monitor System (TPMS) will warn the driver of a low tire pressure based on the vehicle recommended cold placard pressure.

The tire pressure will vary with temperature by about 1 psi (6.9 kPa) for every 12°F (6.5°C). This means that when the outside temperature decreases, the tire pressure will decrease. Tire pressure should always be set based on “cold inflation tire pressure”. This is defined as the tire pressure after the vehicle has not been driven for at least three hours, or driven less than 1 mile (1 km) after a three hour period. The cold tire inflation pressure must not exceed the maximum inflation pressure molded into the tire sidewall. Refer to “Tires – General Information” in this section for information on how to properly inflate the vehicle’s tires. The tire pressure will also increase as the vehicle is driven - this is normal and there should be no adjustment for this increased pressure.

The TPMS will warn the driver of a low tire pressure if the tire pressure falls below the low-pressure warning limit for any reason, including low temperature effects, or natural pressure loss through the tire.

The TPMS will continue to warn the driver of low tire pressure as long as the condition exists, and will not turn off until the tire pressure is at or above the recommended cold placard pressure. Once the low tire pressure warning (Tire Pressure Monitoring Telltale Light) illuminates, you must increase the tire pressure to the recommended cold placard pressure in order for the Tire Pressure Monitoring Telltale Light to turn off. The system will automatically update and the Tire Pressure Monitoring Telltale Light will turn off once the system receives the updated tire pressures. The vehicle may need to be driven for up to 20 minutes above 15 mph (25 km/h) in order for the TPMS to receive this information.

For example, your vehicle may have a recommended cold (parked for more than three hours) placard pressure of 30 psi (207 kPa). If the ambient temperature is 68°F (20°C) and the measured tire pressure is 27 psi (186 kPa), a temperature drop to 20°F (-7°C) will decrease the tire pressure to approximately 26 psi (179 kPa). This tire pressure is sufficiently low enough to turn ON the Tire Pressure Monitoring Telltale Light. Driving the vehicle may cause the tire pressure to rise to approximately 27 psi (186 kPa), but the Tire Pressure Monitoring Telltale Light will still be ON. In this situation, the Tire Pressure Monitoring Telltale Light will turn OFF only after the tires are inflated to the vehicle's recommended cold placard pressure value.

CAUTION!

- **The TPMS has been optimized for the original equipment tires and wheels. TPMS pressures and warnings have been established for the tire size equipped on your vehicle. Undesirable system operation or sensor damage may result when using replacement equipment that is not of the same size, type, and/or style. Aftermarket wheels can cause sensor damage. Do not use aftermarket tire sealants or balance beads if your vehicle is equipped with a TPMS, as damage to the sensors may result.**
- **After inspecting or adjusting the tire pressure, always reinstall the valve stem cap. This will prevent moisture and dirt from entering the valve stem, which could damage the Tire Pressure Monitoring Sensor.**

NOTE:

- The TPMS is not intended to replace normal tire care and maintenance or to provide warning of a tire failure or condition.
- The TPMS should not be used as a tire pressure gauge while adjusting your tire pressure.
- Driving on a significantly under-inflated tire causes the tire to overheat and can lead to tire failure. Under-inflation also reduces fuel efficiency and tire tread life, and may affect the vehicle's handling and stopping ability.
- The TPMS is not a substitute for proper tire maintenance, and it is the driver's responsibility to maintain correct tire pressure using an accurate tire gauge, even if under-inflation has not reached the level to trigger illumination of the Tire Pressure Monitoring Telltale light.

- Seasonal temperature changes will affect tire pressure, and the TPMS will monitor the actual tire pressure in the tire.

Base System

This is the TPMS warning indicator located in the instrument cluster.

The TPMS uses wireless technology with wheel rim mounted electronic sensors to monitor tire pressure levels. Sensors, mounted to each wheel as part of the valve stem, transmit tire pressure readings to the Receiver Module.

NOTE: It is particularly important for you to check the tire pressure in all of the tires on your vehicle regularly and to maintain the proper pressure.

The TPMS consists of the following components:

- Receiver Module

- Four Tire Pressure Monitoring Sensors
- Tire Pressure Monitoring Telltale Light

Tire Pressure Monitoring Low Pressure Warnings

The Tire Pressure Monitoring Telltale Light will illuminate in the instrument cluster, and an audible chime will be activated when one or more of the four active road tire pressures are low. Should this occur, you should stop as soon as possible, check the inflation pressure of each tire on your vehicle, and inflate each tire to the vehicle's recommended cold placard pressure value. The system will automatically update and the Tire Pressure Monitoring Light will extinguish once the updated tire pressures have been received. The vehicle may need to be driven for up to 20 minutes above 15 mph (25 km/h) to receive this information.

Check TPMS Warnings

The Tire Pressure Monitoring Telltale Light will flash on and off for 75 seconds and remain on solid when a system

fault is detected. The system fault will also sound a chime. If the ignition key is cycled, this sequence will repeat providing the system fault still exists. The Tire Pressure Monitoring Telltale Light will turn off when the fault condition no longer exists. A system fault can occur with any of the following scenarios:

1. Jamming due to electronic devices or driving next to facilities emitting the same radio frequencies as the TPM sensors.
2. Installing some form of aftermarket window tinting that affects radio wave signals.
3. Snow or ice around the wheels or wheel housings.
4. Using tire chains on the vehicle.
5. Using wheels/tires not equipped with TPM sensors.

NOTE: Your vehicle is equipped with a compact spare wheel and tire assembly.

1. The compact spare tire does not have a tire pressure monitoring sensor. Therefore, the TPMS will not monitor the tire pressure in the compact spare tire.
2. If you install the compact spare tire in place of a road tire that has a pressure below the low-pressure warning limit, upon the next ignition key cycle, a chime will sound and the Tire Pressure Monitoring Telltale Light will still turn ON due to the low tire.
3. However, after driving the vehicle for up to 20 minutes above 15 mph (25 km/h), the Tire Pressure Monitoring Telltale Light will flash on and off for 75 seconds and then remain on solid.
4. For each subsequent ignition key cycle, a chime will sound and the Tire Pressure Monitoring Telltale Light will flash on and off for 75 seconds and then remain on solid.

5. Once you repair or replace the original road tire and reinstall it on the vehicle in place of the compact spare tire, the TPMS will update automatically and the Tire Pressure Monitoring Telltale Light will turn OFF, as long as no tire pressure is below the low-pressure warning limit in any of the four active road tires. The vehicle may need to be driven for up to 20 minutes above 15 mph (25 km/h) in order for the TPMS to receive this information.

Premium System — If Equipped

The TPMS uses wireless technology with wheel rim mounted electronic sensors to monitor tire pressure levels. Sensors, mounted to each wheel as part of the valve stem, transmit tire pressure readings to the receiver module.

NOTE: It is particularly important for you to check the tire pressure in all of your tires regularly and to maintain the proper pressure.

The TPMS consists of the following components:

- Receiver Module
- Four Tire Pressure Monitoring Sensors
- Three Trigger Modules (mounted in three of the four wheel wells)
- Various Tire Pressure Monitoring System Messages, which display in the Electronic Vehicle Information Center (EVIC)
- Yellow Tire Pressure Monitoring Telltale Light

Tire Pressure Monitoring Low Pressure Warnings

The Tire Pressure Monitoring Telltale Light will illuminate in the instrument cluster and an audible chime will be activated when one or more of the four active road tire pressures are low. The audible chime will sound once

every ignition cycle for each condition that it detects. In addition, the EVIC will display a graphic of the pressure value(s) with the low tire(s) flashing.

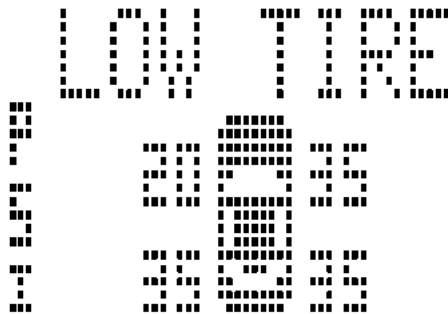

81826bed

Low Tire Pressure Display

Should a low tire condition occur on any of the four active road tire(s), you should stop as soon as possible and inflate all tires that are flashing on the graphic

display to the vehicle's recommended cold placard pressure value. The system will automatically update, the graphic display of the pressure value(s) will stop flashing, and the Tire Pressure Monitoring Light will extinguish once the updated tire pressure(s) have been received. The vehicle may need to be driven for up to 20 minutes above 15 mph (25 km/h) to receive this information.

Check TPMS Message

The Tire Pressure Monitoring Telltale Light will flash on and off for 75 seconds, and remain on solid when a system fault is detected. The system fault will also sound a chime. The EVIC will display a "CHECK TPM SYSTEM" message for three seconds. This text message is then followed by a graphic display, with "-" in place of the pressure value(s) indicating which Tire Pressure Monitoring Sensor(s) is not being received.

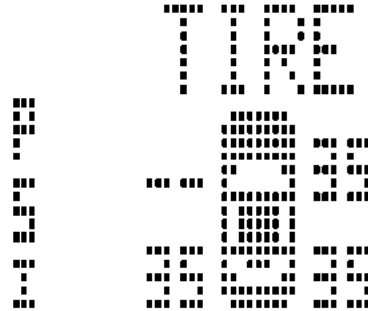

81826bd7

Check TPM System Display

If the ignition key is cycled, this sequence will repeat, providing the system fault still exists. If the system fault no longer exists, the Tire Pressure Monitoring Telltale Light will no longer flash, the "CHECK TPM SYSTEM" text message will not be present, and a pressure value

will be displayed instead of dashes. A system fault can occur with any of the following scenarios:

1. Jamming due to electronic devices or driving next to facilities emitting the same radio frequencies as the TPM sensors.
2. Installing some form of aftermarket window tinting that affects radio wave signals.
3. Snow or ice around the wheels or wheel housings.
4. Using tire chains on the vehicle.
5. Using wheels/tires not equipped with TPM sensors.

NOTE: Your vehicle is equipped with a compact spare wheel and tire assembly.

1. The compact spare tire does not have a tire pressure monitoring sensor. Therefore, the TPMS will not monitor the tire pressure in the compact spare tire.

2. If you install the compact spare tire in place of a road tire that has a pressure below the low-pressure warning limit, upon the next ignition key cycle, a chime will sound and the Tire Pressure Monitoring Telltale Light will still turn ON due to the low tire.

3. However, after driving the vehicle for up to 20 minutes above 15 mph (25 km/h), the Tire Pressure Monitoring Telltale Light will flash on and off for 75 seconds and then remain on solid.

4. For each subsequent ignition key cycle, a chime will sound and the Tire Pressure Monitoring Telltale Light will flash on and off for 75 seconds and then remain on solid.

5. Once you repair or replace the original road tire and reinstall it on the vehicle in place of the compact spare tire, the TPMS will update automatically and the Tire Pressure Monitoring Telltale Light will turn OFF, as long as no tire pressure is below the low-pressure warning

limit in any of the four active road tires. The vehicle may need to be driven for up to 20 minutes above 15 mph (25 km/h) in order for the TPMS to receive this information.

General Information

This device complies with Part 15 of the FCC rules and RSS 210 of Industry Canada. Operation is subject to the following conditions:

- This device may not cause harmful interference.
- This device must accept any interference received, including interference that may cause undesired operation.

The tire pressure sensors are covered under one of the following licenses:

United States	KR5S120123
Canada	2671-S120123

FUEL REQUIREMENTS



Your vehicle is designed to meet all emission regulations and provide excellent fuel economy when using high-quality regular unleaded gasoline with an octane rating of 87. The use of premium gasoline is not recommended, as it will not provide any benefit over regular gasoline in these engines.

Light spark knock at low engine speeds is not harmful to your engine. However, continued heavy spark knock at high speeds can cause damage and immediate service is required.

Poor quality gasoline can cause problems such as hard starting, stalling and hesitations. If you experience these symptoms, try another brand of gasoline (with the appropriate octane rating for your engine) before considering service for the vehicle.

Reformulated Gasoline

Many areas of the country require the use of cleaner burning gasoline referred to as “reformulated gasoline”.

“Reformulated gasolines” contain oxygenates and are specifically blended to reduce vehicle emissions and improve air quality.

The manufacturer supports the use of “reformulated gasolines”. Properly blended “reformulated gasolines” will provide excellent performance and durability of engine and fuel system components.

Gasoline/Oxygenate Blends

Some fuel suppliers blend unleaded gasoline with oxygenates such as 10% ethanol, MTBE, and ETBE. Oxygenates are required in some areas of the country during the winter months to reduce carbon monoxide emissions. Fuels blended with these oxygenates may be used in your vehicle.

CAUTION!

DO NOT use gasolines containing Methanol or E85 Ethanol. Use of these blends may result in starting and drivability problems and may damage critical fuel system components.

Problems that result from using methanol/gasoline blends are not the responsibility of the manufacturer. While MTBE is an oxygenate made from Methanol, it does not have the negative effects of Methanol.

E-85 Usage In Non-Flex Fuel Vehicles

Non-FFV vehicles are compatible with gasoline containing 10% ethanol (E10). Gasoline with higher ethanol content may void the vehicle’s warranty.

If a Non-FFV vehicle is inadvertently fueled with E-85 fuel, the engine will have some or all of these symptoms:

- operate in a lean mode
- OBD II “Malfunction Indicator Light” on
- poor engine performance
- poor cold start and cold drivability
- increased risk for fuel system component corrosion

To fix a Non-FFV vehicle inadvertently fueled once with E-85 perform the following:

- drain the fuel tank (see your authorized dealer)
- change the engine oil and oil filter
- disconnect and reconnect the battery to reset the engine controller memory

More extensive repairs will be required for prolonged exposure to E-85 fuel.

MMT In Gasoline

MMT is a manganese containing metallic additive that is blended into some gasoline to increase the octane number. Gasolines blended with MMT offer no performance advantage beyond gasolines of the same octane number without MMT. Gasolines blended with MMT have been shown to reduce spark plug life and reduce emission system performance in some vehicles. The manufacturer recommends using gasolines without MMT. Since the MMT content of gasoline may not be indicated on the pump, you should ask your gasoline retailer whether or not their gasoline contains MMT.

It is even more important to look for gasolines without MMT in Canada, because MMT can be used at levels higher than those allowed in the United States.

MMT is prohibited in Federal and California reformulated gasolines.

Materials Added To Fuel

All gasoline sold in the United States is required to contain effective detergent additives. Use of additional detergents or other additives is not needed under normal conditions and would result in additional cost. Therefore you should not have to add anything to the fuel.

Fuel System Cautions

CAUTION!

Follow these guidelines to maintain your vehicle's performance:
--

- The use of leaded gas is prohibited by Federal law. Using leaded gasoline can impair engine performance and damage the emission control system.

- An out-of-tune engine, or certain fuel or ignition malfunctions, can cause the catalytic converter to overheat. If you notice a pungent burning odor or some light smoke, your engine may be out of tune or malfunctioning and may require immediate service. Contact your authorized dealer for service assistance.
- The use of fuel additives, which are now being sold as octane enhancers, is not recommended. Most of these products contain high concentrations of Methanol. Fuel system damage or vehicle performance problems resulting from the use of such fuels or additives is not the responsibility of the manufacturer.

NOTE: Intentional tampering with emissions control systems can result in civil penalties being assessed against you.

Carbon Monoxide Warnings

WARNING!

Carbon monoxide (CO) in exhaust gases is deadly. Follow the precautions below to prevent carbon monoxide poisoning:

- Do not inhale exhaust gases. They contain carbon monoxide, a colorless and odorless gas which can kill. Never run the engine in a closed area, such as a garage, and never sit in a parked vehicle with the engine running for an extended period of time. If the vehicle is stopped in an open area with the engine running for more than a short period, adjust the ventilation system to force fresh, outside air into the vehicle.

- Guard against carbon monoxide with proper maintenance. Have the exhaust system inspected every time the vehicle is raised. Have any abnormal conditions repaired promptly. Until repaired, drive with all side windows fully open.
- Keep the liftgate closed when driving your vehicle to prevent carbon monoxide and other poisonous exhaust gases from entering the vehicle.

ADDING FUEL

Fuel Filler Cap (Gas Cap)

The gas cap is behind the fuel filler door, on the left side of the vehicle. If the gas cap is lost or damaged, be sure the replacement cap is for use with this vehicle.

After removing the gas cap, place the gas cap tether cable over a hook on the inside of the fuel door. This keeps the gas cap suspended away from and protects the vehicle's surface.

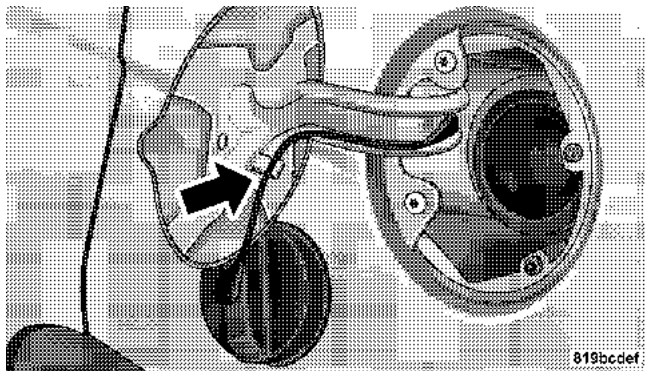

Fuel Filler Door

CAUTION!

- A poorly fitting gas cap may cause the Malfunction Indicator Light (MIL) to turn on.
- To avoid fuel spillage and overfilling, do not “top off” the fuel tank after filling.

NOTE: When the fuel nozzle “clicks” or shuts off, the fuel tank is full.

WARNING!

- Never have any smoking materials lit in or near the vehicle when the gas cap is removed or the tank filled.
- Never add fuel when the engine is running. This is in violation of most state and Federal fire regulations and will cause the Malfunction Indicator Light (MIL) to turn on.

NOTE: Tighten the gas cap about 1/4 turn until you hear one click. This is an indication that cap is properly tightened.

If the gas cap is not tighten properly, the MIL will come on. Be sure the gas cap is tightened every time the vehicle is refueled.

WARNING!

A fire may result if gasoline is pumped into a portable container that is inside of a vehicle. You could be burned. Always place gas containers on the ground while filling.

Loose Fuel Filler Cap Message

If the vehicle diagnostic system determines that the fuel filler cap is loose or improperly installed, a “gASCAP” message will be displayed in the Odometer/Trip Odometer in the instrument cluster. Refer to “Instrument

Cluster Description” in Section 4 of this manual. Tighten the fuel filler cap properly and press the odometer/trip odometer RESET button to turn the message off. If the problem continues, the message will appear the next time the vehicle is started. Refer to “Onboard Diagnostic System — OBD II” in Section 7 of this manual for more information.

CAUTION!

Damage to the fuel system or emission control system could result from using an improper fuel tank filler cap (gas cap). A poorly fitting cap could let impurities into the fuel system.

VEHICLE LOADING

As required by National Highway Traffic Safety Administration regulations, your vehicle has a certification label affixed to the driver’s side door or B-Pillar.

Vehicle Certification Label

Your vehicle has a Vehicle Certification Label attached to the driver's door B-Pillar.

The label contains the following information:

- Name of manufacturer
- Month and year of manufacture
- Gross Vehicle Weight Rating (GVWR)
- Vehicle Identification Number (VIN)
- Type of Vehicle
- Month, Day and Hour of Manufacture (MDH)

The bar code allows a computer scanner to read the Vehicle Identification Number (VIN).

Gross Vehicle Weight Rating (GVWR)

The GVWR is the total allowable weight of your vehicle. This includes driver, passengers, and cargo. The total load must be limited so that you do not exceed the GVWR.

Tire Size

The tire size on the Vehicle Certification Label represents the actual tire size on your vehicle. Replacement tires must be equal to the load capacity of this tire size.

Rim Size

This is the rim size that is appropriate for the tire size listed.

Inflation Pressure

This is the cold tire inflation pressure for your vehicle, for all loading conditions.

Curb Weight

The curb weight of a vehicle is defined as the total weight of the vehicle with all fluids, including vehicle fuel, at full capacity conditions, and with no occupants or cargo loaded into the vehicle. The front and rear curb weight values are determined by weighing your vehicle on a commercial scale before any occupants or cargo are added.

Overloading

The load carrying components (springs, tires, wheels, etc.) of your vehicle will provide satisfactory service as long as you do not exceed the GVWR.

The best way to figure out the total weight of your vehicle is to weigh it when it is fully loaded and ready for operation. Weigh it on a commercial scale to ensure that it is not over the GVWR.

Overloading can cause potential safety hazards and shorten useful service life. Heavier suspension components do not necessarily increase the vehicle's GVWR.

Loading

To load your vehicle properly, first figure out its empty weight. Store heavier items down low and be sure you distribute their weight as evenly as possible. Stow all loose items securely before driving. Improper weight distribution can have an adverse effect on the way your vehicle steers and handles, and the way the brakes operate.

CAUTION!

Do not load your vehicle any heavier than the GVWR. If you do, parts on your vehicle can break, or it can change the way your vehicle handles. This could cause you to lose control. Also, overloading can shorten the life of your vehicle.

TRAILER TOWING

In this section, you will find safety tips and information on limits to the type of towing you can reasonably do with your vehicle. Before towing a trailer carefully review this information to tow your load as efficiently and safely as possible.

To maintain warranty coverage, follow the requirements and recommendations in this manual concerning vehicles used for trailer towing.

Common Towing Definitions

The following trailer towing related definitions will assist you in understanding the following information:

Gross Vehicle Weight Rating (GVWR)

The GVWR is the total allowable weight of your vehicle. This includes driver, passengers, cargo and tongue weight. The total load must be limited so that you do not exceed the GVWR.

Gross Trailer Weight (GTW)

The GTW is the weight of the trailer plus the weight of all cargo, consumables and equipment (permanent or temporary) loaded in or on the trailer in its "loaded and ready for operation" condition. The recommended way to measure GTW is to put your fully loaded trailer on a vehicle scale. The entire weight of the trailer must be supported by the scale.

Gross Combination Weight Rating (GCWR)

The GCWR is the total permissible weight of your vehicle and trailer when weighed in combination.

NOTE: GCWR ratings include a 150 lbs (68 kg) allowance for the presence of a driver.

Gross Axle Weight Rating (GAWR)

The GAWR is the maximum capacity of the front and rear axles. Distribute the load over the front and rear axles evenly. Make sure that you do not exceed either the front or rear GAWR.

WARNING!

It is important that you do not exceed the maximum front or rear GAWR. A dangerous driving condition can result if either rating is exceeded. You could lose control of the vehicle and have an accident.

Tongue Weight (TW)

The tongue weight is the downward force exerted on the hitch ball by the trailer. In most cases it should not be less than 10% or more than 15% of the trailer load. You must consider this as part of the load on your vehicle.

Frontal Area

The frontal area is the maximum height and maximum width of the front of a trailer.

Trailer Sway Control

The trailer sway control is a telescoping link that can be installed between the hitch receiver and the trailer tongue

that typically provides adjustable friction associated with the telescoping motion to dampen any unwanted trailer swaying motions while traveling.

Weight-Carrying Hitch

A weight-carrying hitch supports the trailer tongue weight, just as if it were luggage located at a hitch ball or some other connecting point of the truck. These kind of hitches are the most popular on the market today and they're commonly used to tow small- and medium-sized trailers.

Weight-Distributing Hitch

A weight-distributing hitch system works by applying leverage through spring (load) bars. They are typically used for heavier loads, to distribute trailer tongue weight to the tow vehicle's front axle and the trailer axle(s). When used in accordance with the manufacturer's directions, it provides for a more level ride, offering more

consistent steering and brake control and thereby enhancing towing safety. The addition of a friction/hydraulic sway control also dampens sway caused by traffic and crosswinds, contributing positively to tow vehicle and trailer stability. Trailer sway control and a weight distributing (load equalizing) hitch are recommended for heavier Tongue Weights (TW) and may be required depending on Vehicle and Trailer configuration/loading to comply with GAWR requirements.

Installing A Trailer Hitch

NOTE: If you install a trailer hitch after you purchase the vehicle, you must install a MOPAR® spare tire hold down kit. The kit will allow you to properly secure the spare tire and jack assembly.

WARNING!

Do not operate the vehicle without a properly secured tire and jack assembly. Any loose items may be thrown forward in a collision or hard stop and strike occupants, causing serious or fatal injury.

Trailer Hitch Classification

The following chart provides the industry standard for the maximum trailer weight a given trailer hitch class can tow and should be used to assist you in selecting the correct trailer hitch for your intended towing condition. Refer to the Trailer Towing Weights (Maximum Trailer Weight Ratings) chart for the Maximum GTW towable for your given drivetrain.

Trailer Hitch Classification Definitions	
Class	Max. Trailer Hitch Industry Standards
Class I - Light Duty	2,000 lbs (907 kg)
Refer to the “Trailer Towing Weights (Maximum Trailer Weight Ratings)” chart for the Maximum Gross Trailer Weight (GTW) towable for your given drivetrain.	

All trailer hitches should be professionally installed on your vehicle.

Trailer Towing Weights (Maximum Trailer Weight Ratings)

The following chart provides the maximum trailer weight ratings towable for your given drivetrain.

Engine/Transmission	Frontal Area	Max. GTW (Gross Trailer Wt.)	Max. Tongue Wt. (See Note 1)
2.0L Auto/Man	22 sq ft (2.04 sq m)	1,000 lbs (450 kg)	150 lbs (50 kg)
2.4L Auto/Man	22 sq ft (2.04 sq m)	1,000 lbs (450 kg)	150 lbs (50 kg)
2.4L Auto/Man with Trailer Tow Prep Package (AHC)	32 sq ft (3.0 sq m)	2,000 lbs (907 kg)	300 lbs (136 kg)

Refer to local laws for maximum trailer towing speeds.

Note 1 – The trailer tongue weight must be considered as part of the combined weight of occupants and cargo and should never exceed the weight referenced on the Tire and Loading Information placard. Refer to “Tire–Safety Information” under “Starting and Operating” in Section 5.

Trailer And Tongue Weight

Always load a trailer with 60% to 65% of the weight in the front of the trailer. This places 10% to 15% of the GTW on the tow hitch of your vehicle. Loads balanced over the wheels or heavier in the rear can cause the trailer to sway **severely** from side-to-side which will cause loss of control of vehicle and trailer. Failure to load trailers heavier in front is the cause of many trailer accidents.

Never exceed the maximum tongue weight stamped on your bumper or trailer hitch.

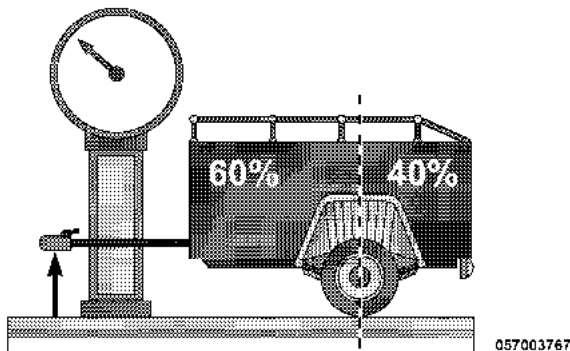

Consider the following items when computing the weight on the rear axle of the vehicle:

- The tongue weight of the trailer.
- The weight of any other type of cargo or equipment put in or on your vehicle.
- The weight of the driver and all passengers.

NOTE: Remember that everything put into or on the trailer adds to the load on your vehicle. Also, additional factory-installed options, or dealer-installed options, must be considered as part of the total load on your vehicle. Refer to the “Tire and Loading Information placard” under “Tire Safety Information” in Section 5 of this manual for the maximum combined weight of occupants and cargo for your vehicle.

Towing Requirements

To promote proper break-in of your new vehicle drive-train components, the following guidelines are recommended:

CAUTION!

- **Avoid towing a trailer for the first 500 miles (805 km) of vehicle operation. Doing so may damage your vehicle.**

(Continued)

CAUTION! (Continued)

- **During the first 500 miles (805 km) of trailer towing, limit your speed to 50 mph (80 km/h).**

Perform the maintenance listed in Section 8 of this manual. When towing a trailer, never exceed the GAWR or GCWR ratings.

WARNING!

Improper towing can lead to an injury accident. Follow these guidelines to make your trailer towing as safe as possible:

(Continued)

WARNING! (Continued)

Make certain that the load is secured in the trailer and will not shift during travel. When trailering cargo that is not fully secured, dynamic load shifts can occur that may be difficult for the driver to control. You could lose control of your vehicle and have an accident.

- When hauling cargo or towing a trailer, do not overload your vehicle or trailer. Overloading can cause a loss of control, poor performance or damage to the brakes, axle, engine, transmission, steering, suspension, chassis structure or tires.
- Safety chains must always be used between your vehicle and trailer. Always connect the chains to the frame or hook retainers of the vehicle hitch. Cross the chains under the trailer tongue and allow enough slack for turning corners.
- Vehicles with trailers should not be parked on a grade. When parking, apply the parking brake on the tow vehicle. Put the tow vehicle automatic transmission in PARK. With a manual transmission, shift the transmission into REVERSE. Always block or "chock" the trailer wheels.
- GCWR must not be exceeded.
- **Total weight must be distributed between the tow vehicle and the trailer such that the following four ratings are not exceeded:**
 1. GVWR
 2. GTW
 3. GAWR

4. Tongue weight rating for the trailer hitch utilized (this requirement may limit the ability to always achieve the 10% to 15% range of tongue weight as a percentage of total trailer weight).

Towing Requirements — Tires

- Do not attempt to tow a trailer while using a compact spare tire.
- Proper tire inflation pressures are essential to the safe and satisfactory operation of your vehicle. Refer to “Tires–General Information” for proper tire inflation procedures.
- Check the trailer tires for proper tire inflation pressures before trailer usage.
- Check for signs of tire wear or visible tire damage before towing a trailer. Refer to “Tires–General Information” for the proper inspection procedure.

- When replacing tires, refer to “Tires–General Information” for proper tire replacement procedures. Replacing tires with a higher load carrying capacity will not increase the vehicle’s GVWR and GAWR limits.

Towing Requirements — Trailer Brakes

- Do **not** interconnect the hydraulic brake system or vacuum system of your vehicle with that of the trailer. This could cause inadequate braking and possible personal injury.
- An electronically actuated trailer brake controller is required when towing a trailer with electronically actuated brakes. When towing a trailer equipped with a hydraulic surge actuated brake system, an electronic brake controller is not required.
- Trailer brakes are recommended for trailers over 1,000 lbs (450 kg) and required for trailers in excess of 2,000 lbs (907 kg).

CAUTION!

If the trailer weighs more than 1,000 lbs (450 kg) loaded, it should have its own brakes and they should be of adequate capacity. Failure to do this could lead to accelerated brake lining wear, higher brake pedal effort, and longer stopping distances.

WARNING!

- Do not connect trailer brakes to your vehicle's hydraulic brake lines. It can overload your brake system and cause it to fail. You might not have brakes when you need them and could have an accident.

(Continued)

WARNING! (Continued)

- Towing any trailer will increase your stopping distance. When towing, you should allow for additional space between your vehicle and the vehicle in front of you. Failure to do so could result in an accident.

Towing Requirements — Trailer Lights and Wiring

Whenever you pull a trailer, regardless of the trailer size, stop lights and turn signals on the trailer are required for motoring safety.

The Trailer Tow Package may include a 4-pin and 7-pin wiring harness. Use a factory approved trailer harness and connector.

NOTE: Do not cut or splice wiring into the vehicle's wiring harness.

The electrical connections are all complete to the vehicle, but you must mate the harness to a trailer connector. Refer to the following illustrations.

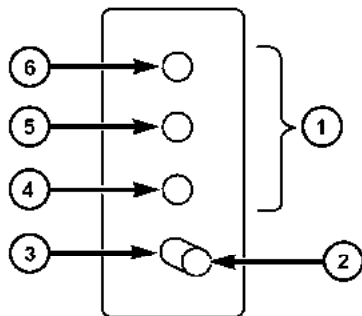

4-Pin Connector

057003766

- 1 — Female Pins
- 2 — Male Pin
- 3 — Ground

- 4 — Park
- 5 — Left Stop/Turn
- 6 — Right Stop/Turn

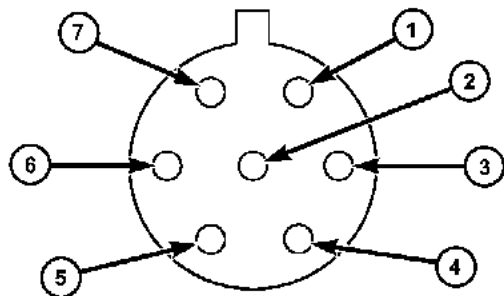

7-Pin Connector

057003765

- 1 — Battery
- 2 — Backup Lamps
- 3 — Right Stop/Turn
- 4 — Electric Brakes

- 5 — Ground
- 6 — Left Stop/Turn
- 7 — Running Lamps

Towing Tips

Before setting out on a trip, practice turning, stopping and backing the trailer in an area away from heavy traffic.

If using a manual transmission vehicle for trailer towing, all starts must be in 1st gear to avoid excessive clutch slippage.

Electronic Speed Control — If Equipped

- Do not use in hilly terrain or with heavy loads.
- When using the speed control, if you experience speed drops greater than 10 mph (16 km/h), disengage it until you can get back to cruising speed.
- Use speed control in flat terrain and with light loads to maximize fuel efficiency.

Cooling System

To reduce potential for engine and transmission overheating, take the following actions:

– *City Driving*

When stopped for short periods of time, put the transmission in NEUTRAL and increase the engine idle speed.

– *Highway Driving*

Reduce speed.

– *Air Conditioning*

Turn off temporarily.

RECREATIONAL TOWING (BEHIND MOTORHOME, ETC.)

Towing This Vehicle Behind Another Vehicle (Flat Towing With All Four Wheels On The Ground)

Recreational Towing Condition	Manual Trans-axle Vehicles	Automatic Transaxle Vehicles
Four Wheel Flat Tow (All Wheels on Ground)	Yes	Never
Two Wheel Dolly Tow (Front or Rear Wheels on Ground)	Never	Never
Flat Bed Tow (All Wheels on Bed of Truck)	Yes	Yes

NOTE: Vehicles equipped with **manual transaxles** may be recreationally towed (flat towed) at any legal highway speed, for any distance, if the **manual transaxle** is in NEUTRAL and the ignition key is in the ACC position.

CAUTION!

- **DO NOT flat tow any vehicle equipped with a automatic transaxle. Damage to the drivetrain will result. If these vehicles require towing, make sure all four wheels are off the ground.**
- **Front or rear wheel lifts should not be used. Internal damage to the transaxle will occur if a front or rear wheel lift is used when recreational towing.**

WHAT TO DO IN EMERGENCIES

CONTENTS

■ Hazard Warning Flasher	324	□ Jacking Instructions	327
■ If Your Engine Overheats	324	■ Jump-Starting Procedures	331
■ Automatic Transaxle Overheating	325	■ Freeing A Stuck Vehicle	333
■ Jacking And Tire Changing	326	■ Towing A Disabled Vehicle	334
□ Jack Location	326	□ With Ignition Key	334
□ Spare Tire Stowage	326	□ Without The Ignition Key	336
□ Preparations For Jacking	327		

HAZARD WARNING FLASHER

The Hazard Warning flasher switch is located on the instrument panel, below the radio.



Press the switch to turn on the Hazard Warning flashers. When the Hazard Warning flasher switch is activated, all directional turn signals will flash on and off to warn oncoming traffic of an emergency. Press the switch a second time to turn off flashers.

Do not use this emergency warning system when the vehicle is in motion. Use it when your vehicle is disabled and is creating a safety hazard for other motorists.

If it is necessary to leave the vehicle to go for service, the Hazard Warning flasher will continue to operate with the ignition key removed and the vehicle locked.

NOTE: With extended use, the Hazard Warning flasher may wear down your battery.

IF YOUR ENGINE OVERHEATS

In any of the following situations, you can reduce the potential for overheating by taking the appropriate action.

- On the highways — Slow down.
- In city traffic — While stopped, put the transmission in NEUTRAL, but do not increase engine idle speed.

If the pointer rises to the **H** (red) mark, the instrument cluster will sound a chime. When safe, pull over and stop the vehicle with the engine at idle. Turn off the air conditioning and wait until the pointer drops back into the normal range. If the pointer remains on the **H** (red) mark for more than a minute, turn the engine off immediately and call for service.

NOTE: There are steps that you can take to slow down an impending overheat condition. If your air conditioner is on, turn it off. The air conditioning system adds heat to

the engine cooling system and turning off the A/C removes this heat. You can also turn the Temperature control to maximum heat, the Mode control to floor, and the fan control to high. This allows the heater core to act as a supplement to the radiator and aids in removing heat from the engine cooling system.

CAUTION!

Driving with a hot cooling system could damage your vehicle. If the temperature gauge reads “H”, pull over when safe and stop the vehicle with the engine at idle. Turn the air conditioner off and wait until the pointer drops back into the normal range. After appropriate action has been taken, if the pointer remains on the “H”, turn the engine OFF immediately and call for service.

WARNING!

A hot engine cooling system is dangerous. You or others could be badly burned by steam or boiling coolant. You may want to call a service center if your vehicle overheats. If you decide to look under the hood yourself, refer to “Maintenance”, Section 7 of this manual. Follow the warnings under the “Cooling System Pressure Cap” paragraph.

AUTOMATIC TRANSAXLE OVERHEATING

During sustained high speed driving or trailer towing up long grades on hot days, the automatic transaxle oil may become too hot.



If this happens, the transmission overheat indicator light will come on, and the vehicle will slow slightly until the automatic transaxle cools down enough to allow a return to the

requested speed. If the high speed is maintained, the overheating will reoccur, as before, in a cyclic fashion.

JACKING AND TIRE CHANGING

WARNING!

- **Being under a jacked-up vehicle is dangerous. The vehicle could slip off the jack and fall on you. You could be crushed. Never put any part of your body under a vehicle that is on a jack. Never start or run the engine while the vehicle is on a jack. If you need to get under a raised vehicle, take it to a service center where it can be raised on a lift.**

(Continued)

WARNING! (Continued)

- **The jack is designed to use as a tool for changing tires only. The jack should not be used to lift the vehicle for service purposes. The vehicle should be jacked on a firm level surface only. Avoid ice or slippery areas.**

Jack Location

The jack and jack-handle are stowed under the load floor in the cargo area.

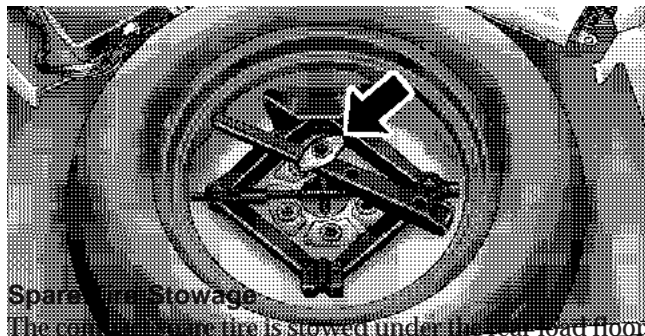

Spare Tire Stowage

The spare tire is stowed under the rear load floor.

Spare Tire Removal

Lift up the load floor cover and remove the hold down.

Preparations For Jacking

1. Park the vehicle on a firm level surface, avoiding ice or slippery areas.

WARNING!

Do not attempt to change a tire on the side of the vehicle close to moving traffic. Pull far enough off the road to avoid the danger of being hit when operating the jack or changing the wheel.

2. Set the parking brake.
3. Place the shift lever in PARK (automatic transaxle) or REVERSE (manual transaxle).
4. Turn OFF the ignition.

5. Turn on the Hazard Warning flasher.

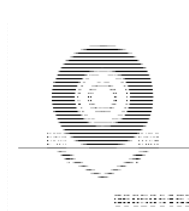

6. Block both the front and rear of the wheel diagonally opposite the jacking position. For example, if changing the right front tire, block the left rear wheel.

NOTE: Passengers should not remain in the vehicle while the vehicle is being jacked.

Jacking Instructions

WARNING!

Carefully follow these tire changing warnings to help prevent personal injury or damage to your vehicle:

(Continued)

WARNING! (Continued)

- Always park on a firm, level surface as far from the edge of the roadway as possible before raising the vehicle.
- Block the wheel diagonally opposite the wheel to be raised.
- Set the parking brake firmly and set an automatic transmission in **PARK**; a manual transmission in **REVERSE**.
- Never start or run the engine with the vehicle on a jack.
- Do not let anyone sit in the vehicle when it is on a jack.
- Do not get under the vehicle when it is on a jack.
- Only use the jack in the positions indicated and for lifting this vehicle during a tire change.

*(Continued)***WARNING! (Continued)**

- If working on or near a roadway, be extremely careful of motor traffic.
- To assure that spare tires, flat or inflated are securely stowed, spares must be stowed with the valve stem facing the ground.
- Turn on the Hazard Warning flasher.

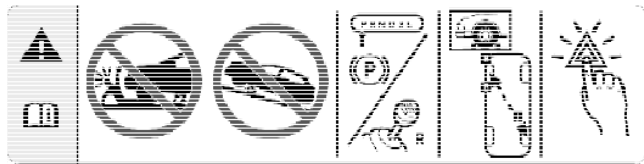
**Jack Warning Label**

1. Remove the scissors jack and lug wrench from the spare wheel as an assembly. Turn the jack screw to the left to loosen the lug wrench and remove the wrench from the jack assembly.

2. Loosen, but do not remove, the wheel nuts by turning them to the left one turn while the wheel is still on the ground.

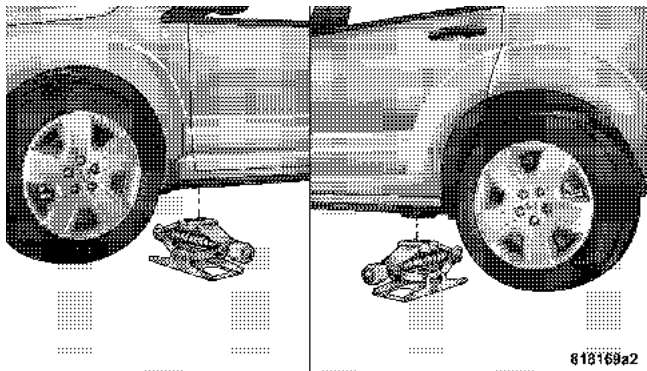

Jacking Locations

CAUTION!

Do not attempt to raise the vehicle by jacking on locations other than those indicated in Step 3.

3. There are two front jacking locations and two rear jacking locations on each side of the body. The front locations are outlined by two triangular cutouts, the rear ones by two rectangular cutouts. For vehicles equipped with plastic trim, the plastic has been cut away to expose the jacking locations in the body.

Do not raise the vehicle until you are sure the jack is securely engaged.

4. Turn the jack screw to the left until the jack can be placed under the jacking location. Once the jack is positioned, turn the jack screw to the right until the jack head is properly engaged with the lift area closest to the wheel to be changed.

WARNING!

Raising the vehicle higher than necessary can make the vehicle less stable. It could slip off the jack and hurt someone near it. Raise the vehicle only enough to remove the tire.

5. Using the swivel wrench raise the vehicle by turning the jack screw to the right. Raise the vehicle only until the tire just clears the surface and enough clearance is obtained to install the spare tire. Minimum tire lift provides maximum stability.

6. Remove the wheel nuts and pull the wheel and wheel covers, where applicable, off the hub. Install the spare wheel and wheel nuts with the cone shaped end of the nuts toward the wheel. Lightly tighten the nuts. To avoid the risk of forcing the vehicle off the jack, do not tighten the nuts fully until the vehicle has been lowered.

WARNING!

To avoid possible personal injury, handle the wheel covers with care to avoid contact with any sharp edges.

NOTE: The wheel cover is held on the wheel by the wheel nuts. When reinstalling the original wheel, properly align the wheel cover to the valve stem, place the wheel cover onto the wheel, then install the wheel nuts.

7. Lower the vehicle by turning the jack screw to the left.

8. Finish tightening the nuts. Push down on the wrench while tightening the wheel nuts. Alternate nuts until each nut has been tightened twice. Correct wheel nut torque is 100 ft lbs (135 N·m). If you doubt that you have tightened the nuts correctly, have them checked with a torque wrench by your authorized dealer or service station.

9. Remove the wheel blocks and lower the jack until it is free. Reassemble the lug wrench to the jack assembly and stow it in the spare tire area. Secure the assembly using the means provided.

WARNING!

A loose tire or jack thrown forward in a collision or hard stop could endanger the occupants of the vehicle. Always stow the jack parts and the spare tire in the places provided.

10. Place the deflated (flat) tire in the cargo area, **have the tire repaired or replaced as soon as possible.**

WARNING!

A loose tire thrown forward in a collision or hard stop could injure the occupants in the vehicle. Have the deflated (flat) tire repaired or replaced immediately.

11. Check the tire pressure as soon as possible. Correct the tire pressure as required.

JUMP-STARTING PROCEDURES

WARNING!

- **Take care to avoid the radiator cooling fan whenever the hood is raised. It can start anytime the ignition switch is on. You can be hurt by the fan.**

(Continued)

WARNING! (Continued)

- **Do not attempt to push or tow your vehicle to get it started. Vehicles equipped with an automatic transaxle cannot be started this way and may be damaged. Unburned fuel could enter the catalytic converter and once the engine has started, ignite and damage the converter and vehicle. If the vehicle has a discharged battery, booster cables may be used to obtain a start from another vehicle. This type of start can be dangerous if done improperly, so follow this procedure carefully.**
- **Wear eye protection and remove any metal jewelry such as watch bands or bracelets that might make an inadvertent electrical contact. You could be seriously injured.**

NOTE: Disconnecting the battery with the ignition in the ON position will cause vehicles with an automatic

transaxle (CVT2) to go into “default mode” and turn on the Malfunction Indicator Light (MIL). See your authorized dealer to correct this condition.

1. When boosting from a battery in another vehicle, park that vehicle within booster cable reach but without letting the vehicles touch. Set the parking brake, place the automatic transmission in PARK (the manual transmission in NEUTRAL) and turn the ignition to OFF for both vehicles.
2. Turn off the heater, radio and all unnecessary electrical loads.
3. Using the two finger screws on the cover, remove the air intake duct covering the battery.
4. Connect one end of a jumper cable to the positive terminal of the booster battery. Connect the other end of the jumper cable to the positive terminal of the discharged battery.

WARNING!

- **Battery fluid is a corrosive acid solution; do not allow battery fluid to contact eyes, skin or clothing. Don't lean over the battery when attaching the clamps or allow the clamps to touch each other. If acid splashes in your eyes or on your skin, flush the contaminated area immediately with large quantities of water.**
- **A battery generates hydrogen gas which is flammable and explosive. Keep flame or spark away from the vent holes. Do not use a booster battery or any other booster source with an output that exceeds 12-Volts.**

5. Connect the other cable, first to the negative terminal of the booster battery and then to the negative terminal of the discharged battery. Make sure you have a good contact.

6. If the vehicle is equipped with a Sentry Key® Immobilizer, turn the ignition switch to the ON position for three seconds before moving the ignition switch to the START position.

7. Start the engine in the vehicle that has the booster battery, let the engine idle a few minutes, then start the engine in the vehicle with the discharged battery.

8. When removing the jumper cables, reverse the sequence exactly. Be careful of the moving belts and fan.

FREEING A STUCK VEHICLE

NOTE: If your vehicle is equipped with Traction Control or ESP, turn the system OFF before attempting to “rock” the vehicle.

If your vehicle becomes stuck in mud, sand or snow, it can often be moved by a rocking motion. Turn your steering wheel right and left to clear the area around the

front wheels. Then shift back and forth between REVERSE and 1st gear. Usually the least accelerator pedal pressure to maintain the rocking motion without spinning the wheels is most effective.

WARNING!

Fast spinning tires can be dangerous. Forces generated by excessive wheel speeds may cause axle, tire damage or failure. A tire could explode and injure someone. Do not spin your vehicle's wheels faster than 30 mph (48 km/h) or for longer than 30 seconds continuously without stopping when you are stuck. And don't let anyone near a spinning wheel, no matter what the speed.

CAUTION!

Racing the engine or spinning the wheels too fast may lead to transaxle overheating and failure. It can also damage the tires. Do not spin the wheels above 30 mph (48 km/h). Do not spin the wheels continuously for more than 30 seconds.

TOWING A DISABLED VEHICLE

With Ignition Key

Automatic Transaxle

- Front Wheel Drive (FWD) vehicles can be towed with the front wheels elevated or on a flatbed truck (all four wheels off the ground).
- All Wheel Drive (AWD) vehicles must be towed on a flatbed truck (all four wheels off the ground).

CAUTION!

DO NOT flat tow any vehicle equipped with an automatic transmission. Damage to the drivetrain will result.

Manual Transaxle

- Front Wheel Drive (FWD) or All Wheel Drive (AWD) vehicles can be flat towed (all four wheels on the ground) with the transmission in NEUTRAL.
- FWD vehicles can be towed with the front wheels elevated.
- FWD or AWD vehicles can be towed on a flatbed truck (all wheels off the ground).

All Transaxles

If it is necessary to use the accessories while being towed (wipers, defrosters, etc.), the key must be in the ON position, not the ACC position. Make certain the transmission remains in NEUTRAL.

CAUTION!

- **If the vehicle being towed requires steering, the ignition switch must be in the ACC position, not in the LOCK position.**
- **Do not attempt to use sling type equipment when towing. When securing the vehicle to a flat bed truck, do not attach to front or rear suspension components. Damage to your vehicle may result from improper towing.**

Without The Ignition Key

Special care must be taken when the vehicle is towed with the ignition in the LOCK position. A dolly should be used under the front wheels if the rear wheels are raised. Proper towing equipment is necessary to prevent damage to the vehicle.

Battery power is required to release the brake/transmission interlock system. There is a removable plug in the right side of the shift lever housing that allows you to insert your finger to override the system. The ignition key must be in the ON position to use the override lever.

MAINTAINING YOUR VEHICLE

CONTENTS

■ Engine Compartment — 2.0L	339	□ Engine Oil	344
■ Engine Compartment — 2.4L	340	□ Engine Oil Filter	347
■ Onboard Diagnostic System — OBD II	341	□ Engine Air Cleaner Filter	347
□ Loose Fuel Filler Cap Message	341	□ Maintenance-Free Battery	348
■ Emissions Inspection And Maintenance Programs	342	□ Air Conditioner Maintenance	349
■ Replacement Parts	343	□ Body Lubrication	350
■ Dealer Service	343	□ Windshield Wiper Blades	350
■ Maintenance Procedures	344	□ Adding Washer Fluid	351
		□ Exhaust System	351

- Cooling System 353
- Brake System 359
- Automatic Transaxle (CVT) — If Equipped . . . 361
- Manual Transaxle — If Equipped 362
- Appearance Care And Protection From Corrosion 362
- Fuses 368
 - Integrated Power Module (IPM) 368
- Vehicle Storage 371
- Replacement Bulbs 371
- Bulb Replacement 372
- Headlights/Front Parking/Front Turn Signal 372
- Fog Lights 372
- Tail Lights, Rear Turn Signals And Backup Lights 373
- License Lights 375
- Center High-Mounted Stoplight 376
- Fluids And Capacities 377
- Fluids, Lubricants, And Genuine Parts 378
 - Engine 378
 - Chassis 379

ENGINE COMPARTMENT — 2.0L

- 1 — Washer Fluid Reservoir
- 2 — Power Steering Fluid Reservoir
- 3 — Engine Oil Fill
- 4 — Air Cleaner Filter
- 5 — Brake Fluid Reservoir

- 6 — Integrated Power Module
 - 7 — Battery (Under Cover)
 - 8 — Coolant Pressure Cap
 - 9 — Engine Oil Dipstick
 - 10 — Engine Coolant Reservoir
-

ENGINE COMPARTMENT — 2.4L

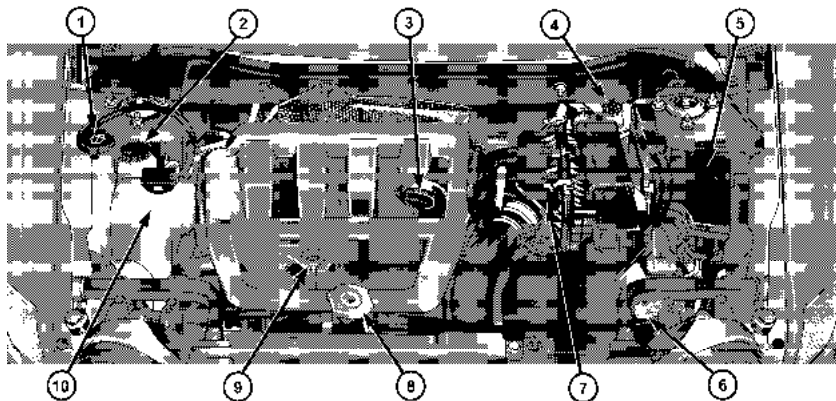

070306628

- 1 — Washer Fluid Reservoir
- 2 — Power Steering Fluid Reservoir
- 3 — Engine Oil Fill
- 4 — Brake Fluid Reservoir
- 5 — Integrated Power Module

- 6 — Battery
- 7 — Air Cleaner Filter
- 8 — Coolant Pressure Cap
- 9 — Engine Oil Dipstick
- 10 — Engine Coolant Reservoir

ONBOARD DIAGNOSTIC SYSTEM — OBD II

Your vehicle is equipped with a sophisticated Onboard Diagnostic system called OBD II. This system monitors the performance of the emissions, engine, and automatic transaxle control systems. When these systems are operating properly, your vehicle will provide excellent performance and fuel economy, as well as engine emissions well within current government regulations.

If any of these systems require service, the OBD II system will turn on the Malfunction Indicator Light (MIL). It will also store diagnostic codes and other information to assist your service technician in making repairs. Although your vehicle will usually be drivable and not need towing, see your authorized dealer for service as soon as possible.

CAUTION!

- **Prolonged driving with the MIL on could cause further damage to the emission control system. It could also affect fuel economy and drivability. The vehicle must be serviced before any emissions tests can be performed.**
- **If the MIL is flashing while the engine is running, severe catalytic converter damage and power loss will soon occur. Immediate service is required.**

Loose Fuel Filler Cap Message

After fuel is added, the vehicle diagnostic system can determine if the fuel filler cap is possibly loose or improperly installed. A “gASCAP” message will be displayed in the instrument cluster. Tighten the gas cap until a “clicking” sound is heard. This is an indication that the gas cap is properly tightened. Press the trip odometer RESET button to turn off the message. If the problem

persists, the message will appear the next time the vehicle is started. This might indicate a damaged cap. If the problem is detected twice in a row, the system will turn on the MIL. Resolving the problem will turn the MIL light off.

EMISSIONS INSPECTION AND MAINTENANCE PROGRAMS

In some localities, it may be a legal requirement to pass an inspection of your vehicle's emissions control system. Failure to pass could prevent vehicle registration.



For states that require an Inspection and Maintenance (I/M), this check verifies the Malfunction Indicator Light (MIL) is functioning and is not on when the engine is running, and that the OBD II system is ready for testing.

Normally, the OBD II system will be ready. The OBD II system may **not** be ready if your vehicle was recently

serviced, recently had a dead battery or a battery replacement. If the OBD II system should be determined not ready for the I/M test, your vehicle may fail the test.

Your vehicle has a simple ignition key-actuated test, which you can use prior to going to the test station. To check if your vehicle's OBD II system is ready, you must do the following:

1. Insert your ignition key into the ignition switch.
2. Turn the ignition to the ON position, but do not crank or start the engine.
3. If you crank or start the engine, you will have to start this test over.
4. As soon as you turn your key to the ON position, you will see the MIL symbol come on as part of a normal bulb check.

5. Approximately 15 seconds later, one of two things will happen:

- a. The MIL will flash for about 10 seconds and then return to being fully illuminated until you turn OFF the ignition or start the engine. This means that your vehicle's OBD II system is **not ready** and you should **not** proceed to the I/M station.
- b. The MIL will not flash at all and will remain fully illuminated until you turn OFF the ignition or start the engine. This means that your vehicle's OBD II system is **ready** and you can proceed to the I/M station.

If your OBD II system is **not ready**, you should see your authorized dealer or repair facility. If your vehicle was recently serviced or had a battery failure or replacement, you may need to do nothing more than drive your vehicle as you normally would in order for your OBD II system to update. A recheck with the above test routine may then indicate that the system is now ready.

Regardless of whether your vehicle's OBD II system is ready or not, if the MIL is illuminated during normal vehicle operation you should have your vehicle serviced before going to the I/M station. The I/M station can fail your vehicle because the MIL is on with the engine running.

REPLACEMENT PARTS

Use of genuine MOPAR® parts for normal/scheduled maintenance and repairs is highly recommended to ensure the designed performance. Damage or failures caused by the use of non-MOPAR® parts for maintenance and repairs will not be covered by the manufacturer's warranty.

DEALER SERVICE

Your authorized dealer has the qualified service personnel, special tools, and equipment to perform all service operations in an expert manner. Service Manuals are available which include detailed service information for

your vehicle. Refer to these manuals before attempting any procedure yourself.

NOTE: Intentional tampering with emissions control systems can result in civil penalties being assessed against you.

WARNING!

You can be badly injured working on or around a motor vehicle. Only do service work for which you have the knowledge and the proper equipment. If you have any doubt about your ability to perform a service job, take your vehicle to a competent mechanic.

MAINTENANCE PROCEDURES

The pages that follow contain the **required** maintenance services determined by the engineers who designed your vehicle.

Besides the maintenance items for which there are fixed maintenance intervals, there are other items that should operate satisfactorily without periodic maintenance. However, if a malfunction of these items does occur, it could adversely affect the engine or vehicle performance. These items should be inspected if a malfunction is observed or suspected.

Engine Oil

Checking Oil Level

To assure proper engine lubrication, the engine oil must be maintained at the correct level. Check the oil level at regular intervals, such as every fuel stop.

The best time to check the engine oil level is about five minutes after a fully warmed engine is shut off. Do not

Checking the oil while the vehicle is on level ground and only when the engine is hot, will improve the accuracy of the oil level readings. Maintain the oil level between the range markings on the dipstick. The range markings will consist of a crosshatch zone that says SAFE or a crosshatch zone that says MIN at the low end of the range and MAX at the high end of the range. Adding 1 qt (1L) of oil when the reading is at the low end of the indicated range will result in the oil level at the full end of the indicator range.

CAUTION!

Do not overfill the engine. Overfilling the engine as indicated by the range markings, as described above, on the engine oil dipstick will cause oil aeration, which can lead to loss of oil pressure and an increase in oil temperature. This could damage your engine.

Change Engine Oil

Refer to the “Maintenance Schedule” in Section 8 for recommended engine oil change intervals.

Engine Oil Selection

For best performance and maximum protection for all engines under all types of operating conditions, the manufacturer recommends engine oils that are API Certified and meet the requirements of Chrysler Material Standard MS-6395.

American Petroleum Institute (API) Engine Oil Identification Symbol



This symbol means that the oil has been certified by the American Petroleum Institute (API). The manufacturer only recommends API Certified engine oils.

Engine Oil Viscosity (SAE Grade)

SAE 5W-20 engine oil is recommended for all operating temperatures. This engine oil improves low temperature starting and vehicle fuel economy. Your engine oil filler cap also states the recommended engine oil viscosity grade for your engine.

Lubricants which do not have both the engine oil certification mark and the correct SAE viscosity grade number should not be used.

Synthetic Engine Oils

You may use synthetic engine oils provided the recommended oil quality requirements are met, and the recommended maintenance intervals for oil and filter changes are followed.

Materials Added To Engine Oils

The manufacturer strongly recommends against the addition of any additives (other than leak detection dyes) to the engine oil. Engine oil is an engineered product and its performance may be impaired by supplemental additives.

Disposing Of Used Engine Oil and Oil Filters

Care should be taken in disposing of used engine oil and oil filters from your vehicle. Used oil and oil filters, indiscriminately discarded, can present a problem to the

environment. Contact your authorized dealer, service station, or governmental agency for advice on how and where used oil and oil filters can be safely discarded in your area.

Engine Oil Filter

The engine oil filter should be replaced at every engine oil change.

Engine Oil Filter Selection

All of this manufacturer's engines have a full-flow type disposable oil filter. Use a filter of this type for replacement. The quality of replacement filters varies considerably. Only high quality filters should be used to assure most efficient service. MOPAR® engine oil filters are high quality oil filters and are recommended.

Engine Air Cleaner Filter

Refer to the "Maintenance Schedule" in Section 8 for the proper maintenance interval.

WARNING!

The air cleaner can provide a measure of protection in the case of engine backfire. Do not remove the air cleaner unless such removal is necessary for repair or maintenance. Make sure that no one is near the engine compartment before starting the vehicle with the air cleaner removed. Failure to do so can result in serious personal injury.

Engine Air Cleaner Filter Selection

The quality of replacement engine air cleaner filters varies considerably. Only high quality filters should be used to assure most efficient service. MOPAR® engine air cleaner filters are a high quality filter and are recommended.

Maintenance-Free Battery

The top of the maintenance-free battery is permanently sealed. You will never have to add water, nor is periodic maintenance required.

WARNING!

- **Battery fluid is a corrosive acid solution and can burn or even blind you. Do not allow battery fluid to contact your eyes, skin, or clothing. Do not lean over a battery when attaching clamps. If acid splashes in eyes or on skin, flush the area immediately with large amounts of water.**
- **Battery gas is flammable and explosive. Keep flame or sparks away from the battery. Do not use a booster battery or any other booster source with an output greater than 12 Volts. Do not allow cable clamps to touch each other.**

(Continued)

WARNING! (Continued)

- **Battery posts, terminals, and related accessories contain lead and lead compounds. Wash hands after handling.**
- **The battery in this vehicle has a vent hose that should not be disconnected and should only be replaced with a battery of the same type (vented).**

CAUTION!

- **It is essential when replacing the cables on the battery that the positive cable is attached to the positive post and the negative cable is attached to the negative post. Battery posts are marked positive (+) and negative (-) and identified on the battery case. Cable clamps should be tight on the terminal posts and free of corrosion.**

(Continued)

CAUTION! (Continued)

- If a “fast charger” is used while the battery is in the vehicle, disconnect both vehicle battery cables before connecting the charger to the battery. Do not use a “fast charger” to provide starting voltage.

Air Conditioner Maintenance

For best possible performance, your air conditioner should be checked and serviced by an authorized dealer at the start of each warm season. This service should include cleaning of the condenser fins and a performance test. Drive belt tension should also be checked at this time.

WARNING!

- Use only refrigerants and compressor lubricants approved by the manufacturer for your air conditioning system. Some unapproved refrigerants are flammable and can explode, injuring you. Other unapproved refrigerants or lubricants can cause the system to fail, requiring costly repairs. Refer to Section 3 of the Warranty Information Book for further warranty information.
- The air conditioning system contains refrigerant under high pressure. To avoid risk of personal injury or damage to the system, adding refrigerant or any repair requiring lines to be disconnected should be done by an experienced repairman.

Refrigerant Recovery And Recycling

R-134a air conditioning refrigerant is a hydrofluorocarbon (HFC) that is endorsed by the Environmental Protection Agency and is an ozone-saving product. However, the manufacturer recommends that air conditioning service be performed by authorized dealers or other service facilities using recovery and recycling equipment.

NOTE: Use only manufacturer approved A/C system sealers, stop leak products, seal conditioners, compressor oil, or refrigerants.

Body Lubrication

Locks and all body pivot points, including such items as seat tracks, door hinge pivot points and rollers, liftgate, tailgate, sliding doors and hood hinges, should be lubricated periodically with a lithium based grease such as MOPAR® Spray White Lube to assure quiet, easy operation and to protect against rust and wear. Prior to the application of any lubricant, the parts concerned should

be wiped clean to remove dust and grit; after lubricating excess oil and grease should be removed. Particular attention should also be given to hood latching components to insure proper function. When performing other underhood services, the hood latch, release mechanism and safety catch should be cleaned and lubricated.

The external lock cylinders should be lubricated twice a year, preferably in the Fall and Spring. Apply a small amount of a high quality lubricant such as MOPAR® Lock Cylinder Lubricant directly into the lock cylinder.

Windshield Wiper Blades

Clean the rubber edges of the wiper blades and the windshield periodically with a sponge or soft cloth and a mild, nonabrasive cleaner or use the washer solvent. This will remove accumulations of salt, waxes or road film and help reduce streaking and smearing.

Operation of the wipers on dry glass for long periods may cause deterioration of the wiper blades. Always use washer fluid when using the wipers to remove salt or dirt from a dry windshield. Avoid using the wiper blades to remove frost or ice from the windshield. Make sure that they are not frozen to the glass before turning them on to avoid damaging the blade. Keep the blade rubber out of contact with petroleum products such as engine oil, gasoline, etc.

Adding Washer Fluid

The windshield washer fluid reservoir is located in the engine compartment (right rear side), and the fluid level should be checked at regular intervals. Fill the reservoir with windshield washer solvent (not engine coolant (antifreeze)).

WARNING!

Commercially available windshield washer solvents are flammable. They could ignite and burn you. Care must be exercised when filling or working around the washer solution.

Exhaust System

The best protection against carbon monoxide entry into the vehicle body is a properly maintained engine exhaust system.

If you notice a change in the sound of the exhaust system, or if exhaust fumes can be detected inside the vehicle or when the underside or rear of the vehicle is damaged, have a competent technician inspect the complete exhaust system and adjacent body areas for broken, damaged, deteriorated, or mispositioned parts. Open seams or loose connections could permit exhaust fumes to seep into the passenger compartment. In addition, inspect the

exhaust system each time the vehicle is raised for an oil change or lubrication. Replace as required.

WARNING!

Exhaust gases can injure or kill. They contain carbon monoxide (CO) which is colorless and odorless. Breathing it can make you unconscious and can eventually poison you. To avoid breathing CO, refer to “Exhaust Gas” in the Safety Tips section of this manual.

The catalytic converter requires the use of unleaded fuel only. Leaded gasoline will destroy the effectiveness of the catalyst as an emission control device.

Under normal operating conditions, the catalytic converter will not require maintenance. However, it is important to keep the engine properly tuned to assure proper catalyst operation and prevent possible catalyst damage.

CAUTION!

Damage to the catalytic converter can result if your vehicle is not kept in proper operating condition. In the event of engine malfunction, particularly involving engine misfire or other apparent loss of performance, have your vehicle serviced promptly. Continued operation of your vehicle with a severe malfunction could cause the converter to overheat, resulting in possible damage to the converter and the vehicle.

WARNING!

A hot exhaust system can start a fire if you park over materials that can burn. Such materials might be grass or leaves coming into contact with your exhaust system. Do not park or operate your vehicle in areas where your exhaust system can contact anything that can burn.

In unusual situations involving grossly malfunctioning engine operation, a scorching odor may suggest severe and abnormal catalyst overheating. If this occurs, stop the vehicle, turn off the engine and allow it to cool. Service, including a tune up to manufacturers specifications, should be obtained immediately.

To minimize the possibility of catalyst damage:

- Do not shut off the engine or interrupt the ignition when the transaxle is in gear and the vehicle is in motion.
- Do not try to start the engine by pushing or towing the vehicle.
- Do not idle the engine with any spark plug wires disconnected for a prolonged period.

Cooling System**WARNING!**

- **When working near the radiator cooling fan, disconnect the fan motor lead or turn the ignition switch to the OFF position. The fan is temperature controlled and can start at any time the ignition switch is in the ON position.**

(Continued)

WARNING! (Continued)

- **You or others can be badly burned by hot coolant or steam from your radiator. If you see or hear steam coming from under the hood, do not open the hood until the radiator has had time to cool. Never try to open a cooling system pressure cap when the radiator is hot.**

Coolant Checks

Check engine coolant (antifreeze) protection every 12 months (before the onset of freezing weather, where applicable). If the engine coolant (antifreeze) is dirty or rusty in appearance, the system should be drained, flushed and refilled with fresh engine coolant (antifreeze). Check the front of the A/C condenser for any accumulation of bugs, leaves, etc. If dirty, clean by gently spraying water from a garden hose vertically down the face of the condenser.

Check the coolant recovery bottle tubing for brittle rubber, cracking, tears, cuts and tightness of the connection at the bottle and radiator. Inspect the entire system for leaks.

Cooling System — Drain, Flush And Refill

Refer to the “Maintenance Schedule” in Section 8 for proper maintenance intervals.

If the engine coolant (antifreeze) is dirty or contains a considerable amount of sediment, clean and flush with a reliable cooling system cleaner. Follow with a thorough rinsing to remove all deposits and chemicals. Properly dispose of old engine coolant (antifreeze).

Selection Of Coolant

Refer to “Fluids, Lubricants, and Genuine Parts” in this section for the correct fluid type.

CAUTION!

- **Mixing of engine coolant (antifreeze) other than specified Hybrid Organic Additive Technology (HOAT) engine coolant (antifreeze), may result in engine damage and may decrease corrosion protection. If a non-HOAT engine coolant (antifreeze) is introduced into the cooling system in an emergency, it should be replaced with the specified engine coolant (antifreeze) as soon as possible.**
- **Do not use water alone or alcohol based engine coolant (antifreeze) products. Do not use additional rust inhibitors or antirust products, as they may not be compatible with the radiator engine coolant and may plug the radiator.**

(Continued)

CAUTION! (Continued)

- **This vehicle has not been designed for use with Propylene Glycol based engine coolant (antifreeze). Use of Propylene Glycol based engine coolant (antifreeze) is not recommended.**

Adding Coolant

Your vehicle has been built with an improved engine coolant (antifreeze) that allows extended maintenance intervals. This engine coolant (antifreeze) can be used up to five years or 102,000 miles (170 000 km) before replacement. To prevent reducing this extended maintenance period, it is important that you use the same engine coolant (antifreeze) throughout the life of your vehicle. Please review these recommendations for using Hybrid Organic Additive Technology (HOAT) engine coolant (antifreeze).

When adding engine coolant (antifreeze), a minimum solution of 50% recommended MOPAR® Antifreeze/Coolant 5 Year/100,000 Mile Formula HOAT (Hybrid Organic Additive Technology), or equivalent, in water should be used. Use higher concentrations (not to exceed 70%) if temperatures below -34°F (-37°C) are anticipated.

Use only high purity water such as distilled or deionized water when mixing the water/engine coolant (antifreeze) solution. The use of lower quality water will reduce the amount of corrosion protection in the engine cooling system.

Please note that it is the owner's responsibility to maintain the proper level of protection against freezing according to the temperatures occurring in the area where the vehicle is operated.

NOTE: Mixing engine coolant (antifreeze) types will decrease the life of the engine coolant (antifreeze) and will require more frequent coolant changes.

Cooling System Pressure Cap

The cap must be fully tightened to prevent loss of engine coolant (antifreeze) and to ensure that engine coolant (antifreeze) will return to the radiator from the coolant recovery bottle.

The cap should be inspected and cleaned if there is any accumulation of foreign material on the sealing surfaces.

WARNING!

- **The warning words “DO NOT OPEN HOT” on the cooling system pressure cap are a safety precaution. Never add engine coolant (antifreeze) when the engine is overheated. Do not loosen or remove the cap to cool an overheated engine. Heat causes pressure to build up in the cooling system. To prevent scalding or injury, do not remove the pressure cap while the system is hot or under pressure.**
- **Do not use a pressure cap other than the one specified for your vehicle. Personal injury or engine damage may result.**

Disposal Of Used Engine Coolant

Used ethylene glycol-based engine coolant (antifreeze) is a regulated substance requiring proper disposal. Check with your local authorities to determine the disposal

rules for your community. To prevent ingestion by animals or children do not store ethylene glycol-based engine coolant (antifreeze) in open containers or allow it to remain in puddles on the ground. If ingested by a child, contact a physician immediately. Clean up any ground spills immediately.

Coolant Level

The coolant bottle provides a quick visual method for determining that the coolant level is adequate. With the engine idling and warm to normal operating temperature, the level of the engine coolant (antifreeze) in the bottle should be between the “ADD” and “FULL” lines shown on the bottle.

The radiator normally remains completely full, so there is no need to remove the radiator cap unless checking for the coolant freeze point or replacing the engine coolant (antifreeze). Advise your service attendant of this. As

long as the engine operating temperature is satisfactory, the coolant bottle need only be checked once a month.

When additional engine coolant (antifreeze) is needed to maintain the proper level, it should be added to the coolant bottle. Do not overfill.

Points to Remember

NOTE: When the vehicle is stopped after a few miles/kilometers of operation, you may observe vapor coming from the front of the engine compartment. This is normally a result of moisture from rain, snow, or high humidity accumulating on the radiator and being vaporized when the thermostat opens, allowing hot engine coolant (antifreeze) to enter the radiator.

If an examination of your engine compartment shows no evidence of radiator or hose leaks, the vehicle may be safely driven. The vapor will soon dissipate.

- Do not overfill the coolant recovery bottle.

- Check the coolant freeze point in the radiator and in the coolant recovery bottle. If engine coolant (antifreeze) needs to be added, the contents of the coolant recovery bottle must also be protected against freezing.
- If frequent engine coolant (antifreeze) additions are required, or if the level in the coolant recovery bottle does not drop when the engine cools, the cooling system should be pressure tested for leaks.
- Maintain engine coolant (antifreeze) concentration at 50% HOAT engine coolant (antifreeze) (minimum) and distilled water for proper corrosion protection of your engine which contains aluminum components.
- Make sure that the radiator and coolant recovery bottle overflow hoses are not kinked or obstructed.

- Keep the front of the radiator clean. If your vehicle is equipped with air conditioning, keep the front of the condenser clean.
- Do not change the thermostat for Summer or Winter operation. If replacement is ever necessary, install ONLY the correct type thermostat. Other designs may result in unsatisfactory engine coolant (antifreeze) performance, poor gas mileage, and increased emissions.

Brake System

In order to assure brake system performance, all brake system components should be inspected periodically. Refer to the “Maintenance Schedule” in Section 8 for proper maintenance intervals.

WARNING!

Riding the brakes can lead to brake failure and possibly an accident. Driving with your foot resting or riding on the brake pedal can result in abnormally high brake temperatures, excessive lining wear, and possible brake damage. You would not have your full braking capacity in an emergency.

Brake Master Cylinder

The fluid level in the master cylinder should be checked when performing under hood services, or immediately if the brake system warning light is on.

Be sure to clean the top of the master cylinder area before removing the cap. If necessary, add fluid to bring the fluid level up to the requirements described on the brake fluid reservoir. Fluid level can be expected to fall as the brake pads wear. The brake fluid level should be checked

when the pads are replaced. However, low fluid level may be caused by a leak and a checkup may be needed.

NOTE: If your vehicle is equipped with a **manual transaxle**, the brake fluid reservoir supplies fluid to both the brake system and the clutch release system. The two systems are separated in the reservoir, and a leak in one system will not affect the other system. The **manual transaxle** clutch release system should not require fluid replacement during the life of the vehicle. If the brake fluid reservoir is low and the brake system does not indicate any leaks or other problems, it may be a result of a leak in the hydraulic clutch release system. See your local authorized dealer for service.

Use only manufacturer's recommended brake fluid. Refer to "Fluids, Lubricants, and Genuine Parts" in this section for the correct fluid type.

WARNING!

- Use of a brake fluid that may have a lower initial boiling point or is unidentified as to specification, may result in sudden brake failure during hard prolonged braking. You could have an accident.
- Overfilling the brake fluid reservoir can result in spilling brake fluid on hot engine parts and the brake fluid catching fire.

CAUTION!

Use of improper brake fluids will affect overall clutch system performance. Improper brake fluids may damage the clutch system resulting in loss of clutch function and the ability to shift the transaxle.

Use only brake fluid that has been in a tightly closed container to avoid contamination from foreign matter.

NOTE: Do not allow petroleum-based fluid to contaminate the brake fluid as seal damage will result!

Automatic Transaxle (CVT) — If Equipped

Selection Of Lubricant

It is important that the proper lubricant is used in the transaxle to assure optimum transaxle performance. Use only the manufacturer's recommended transmission fluid which has been formulated with special metal to metal friction coefficient additives to provide the proper steel belt traction on the drive and driven pulleys. Refer to "Fluids, Lubricants, and Genuine Parts" in this section for the correct fluid type.

CAUTION!

Using a transmission fluid other than the manufacturer's recommended fluid will cause belt slip and result in a complete transmission failure! Refer to "Fluids, Lubricants, and Genuine Parts" in this section for the correct fluid type.

Fluid Level Check

The fluid level in the automatic transaxle should be checked only by a trained technician.

Fluid And Filter Changes

Refer to the "Maintenance Schedule" in Section 8 for the correct maintenance interval.

Special Additives

Do not add any materials (other than leak detection dyes) to Continuously Variable Transaxle (CVT) Fluid

(CVTF+4). CVTF+4 is an engineered product and its performance may be impaired by supplemental additives.

Manual Transaxle — If Equipped

Lubricant Selection

Use only the manufacturers recommended transmission fluid. Refer to “Fluids, Lubricants, and Genuine Parts” in this section for the correct fluid type.

Fluid Level Check

Check the fluid level by removing the fill plug. The fluid level should be between the bottom of the fill hole and a point not more than $3/16$ in (4.7 mm) below the bottom of the hole.

Add fluid, if necessary, to maintain the proper level.

Frequency Of Fluid Change

Under normal operating conditions, the fluid installed at the factory will give satisfactory lubrication for the life of

the vehicle. Fluid changes are not necessary unless lubricant has become contaminated with water.

NOTE: If contaminated with water, the fluid should be changed immediately.

Appearance Care And Protection From Corrosion

Protection Of Body And Paint From Corrosion

Vehicle body care requirements vary according to geographic locations and usage. Chemicals that make roads passable in snow and ice and those that are sprayed on trees and road surfaces during other seasons, are highly corrosive to the metal in your vehicle. Outside parking, which exposes your vehicle to airborne contaminants, road surfaces on which the vehicle is operated, extreme hot or cold weather and other extreme conditions will have an adverse effect on paint, metal trim, and underbody protection.

The following maintenance recommendations will enable you to obtain maximum benefit from the corrosion resistance built into your vehicle.

What Causes Corrosion?

Corrosion is the result of deterioration or removal of paint and protective coatings from your vehicle.

The most common causes of corrosion are:

- Road salt, dirt and moisture accumulation.
- Stone and gravel impact.
- Insects, tree sap and tar.
- Salt in the air near sea coast localities.
- Atmospheric fallout/industrial pollutants.

Washing

- Wash your vehicle regularly. Always wash your vehicle in the shade using MOPAR® Car Wash or a mild car wash soap, and rinse the panels completely with clear water.
- If insects, tar or other similar deposits have accumulated on your vehicle, use MOPAR® Super Kleen Bug and Tar Remover to remove.
- Use MOPAR® Cleaner Wax to remove road film, stains and to protect your paint finish. Take care never to scratch the paint.
- Avoid using abrasive compounds and power buffing that may diminish the gloss or thin out the paint finish.

CAUTION!

Do not use abrasive or strong cleaning materials such as steel wool or scouring powder, which will scratch metal and painted surfaces.

Special Care

- If you drive on salted or dusty roads or if you drive near the ocean, hose off the undercarriage at least once a month.
- It is important that the drain holes in the lower edges of the doors, rocker panels and trunk be kept clear and open.
- If you detect any stone chips or scratches in the paint, touch them up immediately. The cost of such repairs is considered the responsibility of the owner.

- If your vehicle is damaged due to an accident or similar cause which destroys the paint and protective coating, have your vehicle repaired as soon as possible. The cost of such repairs is considered the responsibility of the owner.
- If you carry special cargo such as chemicals, fertilizers, de-icer salt, etc., be sure that such materials are well packaged and sealed.
- If a lot of driving is done on gravel roads, consider mud or stone shields behind each wheel.
- Use MOPAR® Touch Up Paint on scratches as soon as possible. Your authorized dealer has touch up paint to match the color of your vehicle.

Wheel And Wheel Trim Care

All wheels and wheel trim, especially aluminum and chrome plated wheels, should be cleaned regularly with a mild soap and water to prevent corrosion. To remove

heavy soil, use MOPAR® Wheel Cleaner or select a nonabrasive, non-acidic cleaner. Do not use scouring pads, steel wool, a bristle brush or metal polishes. Only MOPAR® cleaners are recommended. Do not use oven cleaner. Avoid automatic car washes that use acidic solutions or harsh brushes that may damage the wheels' protective finish.

Stain Repel Fabric Cleaning Procedure — If Equipped

You can identify if your vehicle has Stain Repel Seat Fabric that makes spills easy to clean, reduces odor from spills and reduces static by the presence of a tag on the side of the seat.

Stain Repel seats may be cleaned in the following manner:

- Remove as much of the stain as possible by blotting with a clean, dry towel.

- Blot any remaining stain with a clean, damp towel.
- For tough stains, apply MOPAR® Total Clean or a mild soap solution to a clean, damp cloth and remove stain. Use a fresh, damp towel to remove soap residue.
- For grease stains, apply MOPAR® Multi-Purpose Cleaner to a clean, damp cloth and remove stain. Use a fresh, damp towel to remove soap residue.
- Do not use any solvents or protectants on Stain Repel products.

Interior Care

Use MOPAR® Total Clean to clean fabric upholstery and carpeting.

Use MOPAR® Total Clean to clean vinyl upholstery.

MOPAR® Total Clean is specifically recommended for leather upholstery.

Your leather upholstery can be best preserved by regular cleaning with a damp, soft cloth. Small particles of dirt can act as an abrasive and damage the leather upholstery and should be removed promptly with a damp cloth. Stubborn soils can be removed easily with a soft cloth and MOPAR® Total Clean. Care should be taken to avoid soaking your leather upholstery with any liquid. Please do not use polishes, oils, cleaning fluids, solvents, detergents, or ammonia based cleaners to clean your leather upholstery. Application of a leather conditioner is not required to maintain the original condition.

WARNING!

Do not use volatile solvents for cleaning purposes. Many are potentially flammable, and if used in closed areas, they may cause respiratory harm.

Cleaning Headlights

Your vehicle has plastic headlights that are lighter and less susceptible to stone breakage than glass headlights.

Plastic is not as scratch resistant as glass and, therefore, different lens cleaning procedures must be followed.

To minimize the possibility of scratching the lenses and reducing light output, avoid wiping with a dry cloth. To remove road dirt, wash with a mild soap solution followed by rinsing.

Do not use abrasive cleaning components, solvents, steel wool or other aggressive material to clean the lenses.

Glass Surfaces

All glass surfaces should be cleaned on a regular basis with MOPAR® Glass Cleaner or any commercial household-type glass cleaner. Never use an abrasive type cleaner. Use caution when cleaning the inside rear window equipped with electric defrosters or the right rear

quarter window equipped with the radio antenna. Do not use scrapers or other sharp instruments which may scratch the elements. When cleaning the rearview mirror, spray cleaner on the towel or rag that you are using. Do not spray cleaner directly on the mirror.

Instrument Panel Cover

The instrument panel cover has a low glare surface which minimizes reflections on the windshield. Do not use protectants or other products which may cause undesirable reflections. Use soap and warm water to restore the low glare surface.

Instrument Panel Bezels

CAUTION!

When installing hanging air fresheners in your vehicle, read the installation instructions carefully. Some air fresheners will damage the finish of painted or decorated parts if allowed to directly contact any surface.

Cleaning Plastic Instrument Cluster Lenses

The lenses in front of the instruments in this vehicle are molded in clear plastic. When cleaning the lenses, care must be taken to avoid scratching the plastic.

1. Clean with a wet, soft rag. A mild soap solution may be used, but do not use high alcohol content or abrasive cleaners. If soap is used, wipe clean with a clean, damp rag.
2. Dry with a soft cloth.

Seat Belt Maintenance

Do not bleach, dye or clean the seat belts with chemical solvents or abrasive cleaners. This will weaken the fabric. Sun damage can also weaken the fabric.

If the seat belts need cleaning, use a mild soap solution or lukewarm water. Do not remove the seat belts from the car to wash them.

Replace the seat belts if they appear frayed or worn or if the buckles do not work properly.

Dry with a soft cloth.

FUSES

Integrated Power Module (IPM)

The Integrated Power Module (IPM) is located in the engine compartment near the air cleaner assembly. This center contains cartridge fuses and mini-fuses. A label that identifies each component may be printed on the

inside of the cover. Refer to “Engine Compartment” in this section of the Owner’s Manual for the underhood location of the IPM.

Cavity	Cartridge Fuse	Mini-Fuse	Description
1	Empty		Empty
2		15 Amp Lt Blue	AWD/4WD ECU Feed
3		10 Amp Red	CHMSL Brake Switch Feed
4		10 Amp Red	Ignition Switch Feed/ OCM
5		20 Amp Yellow	Trailer Tow
6		10 Amp Red	IOD Sw/Pwr Mir/ Steering Cntrl Sdar/ Hands-Free Phone
7		30 Amp Green	IOD Sense1

Cavity	Cartridge Fuse	Mini-Fuse	Description
8		30 Amp Green	IOD Sense2
9	40 Amp Green		Power Seats
10		20 Amp Yellow	CCN Power Locks/ Interior Lighting
11		15 Amp Lt Blue	Power Outlet
12		20 Amp Yellow	Ign Run/Acc Inverter
13		20 Amp Yellow	Pwr Run/Acc Outlet RR/Dome Lamp/ Cigar Lighter
14		10 Amp Red	IOD CCN
15	40 Amp Green		RAD Fan Relay Bat- tery Feed

Cavity	Cartridge Fuse	Mini-Fuse	Description
16		15 Amp Lt Blue	IGN Run/Acc Dome Lamp/Sunroof/Rear Wiper Motor/ACC Inverter
17		10 Amp Red	IOD Feed Mod-Wcm
18	40 Amp Green		ASD Relay Contact PWR Feed
19		20 Amp Yellow	PWR Amp 1 & Amp 2 Feed
20		15 Amp Lt Blue	IOD Feed Radio
21		10 Amp Red	IOD Feed Intrus Mod/Siren (If Equipped)
22		10 Amp Red	IGN RUN Heat/AC/ Compass Sensor

Cavity	Cartridge Fuse	Mini-Fuse	Description
23		15 Amp Lt Blue	ENG ASD Relay Feed 3
24		15 Amp Lt Blue	Power Sunroof Feed
25		10 Amp Red	Heated Mirror (If Equipped)
26		15 Amp Lt Blue	ENG ASD Relay Feed 2
27		10 Amp Red	IGN RUN Only ORC Feed
28		10 Amp Red	IGN RUN ORC/OCM Feed
29			Hot Car (No Fuse Required)
30		20 Amp Yellow	Heated Seat (If Equipped)

Cavity	Cartridge Fuse	Mini-Fuse	Description
31		10 Amp Red	Headlamp Washer Relay Control (If Equipped)
32	30 Amp Pink		ENG ASD Control Feed 1
33		10 Amp Red	ABS MOD/J1962 Conn/PCM
34	30 Amp Pink		ABS Valve Feed
35	40 Amp Green		ABS Pump Feed
36	30 Amp Pink		Headlamp/Washer Control/Smart Glass (If Equipped)
37		25 Amp Natural	Diesel Fuel Heater — If Equipped

CAUTION!

- When installing the IPM cover, it is important to ensure the cover is properly positioned and fully latched. Failure to do so may allow water to get into the IPM, and possibly result in an electrical system failure.
- When replacing a blown fuse, it is important to use only a fuse having the correct amperage rating. The use of a fuse with a rating other than indicated may result in a dangerous electrical system overload. If a properly rated fuse continues to blow, it indicates a problem in the circuit that must be corrected.

VEHICLE STORAGE

If you will not be using your vehicle for more than 21 days, you may want to take steps to preserve your battery.

- Disengage the mini-fuse in the Power Distribution Center labeled IOD (Ignition Off-Draw).
- Disconnect the negative cable from the battery.

REPLACEMENT BULBS

All the inside bulbs are brass or glass wedge base. Aluminum base bulbs are not approved and should not be used for replacement.

LIGHT BULBS — Interior	Bulb Number
Front Header Light	T578
Center Dome Light	T578
Rear Cargo/Flashlight	8-A35LF

LIGHTS BULBS — Exterior	Bulb Number
Low Beam/High Beam Headlight	H13
Front Park/Turn Signal/Side Marker Light	3157AK or 3157A
Front Fog Light	9145
Center High-Mounted Stop Light (CHMSL)	LED Assembly
Rear Turn/Tail/Stop	3157
Backup Light	W16W (921)
License Light	W5W

BULB REPLACEMENT

Headlights/Front Parking/Front Turn Signal

See your authorized dealer for replacement.

Fog Lights

1. Access light through the lower fascia cutout.
2. Rotate bulb and connector 1/4 turn counterclockwise.



3. Pull bulb off connector.

8180f51b

Tail Lights, Rear Turn Signals and Backup Lights

1. Remove the two push-pins from the tail light housing.

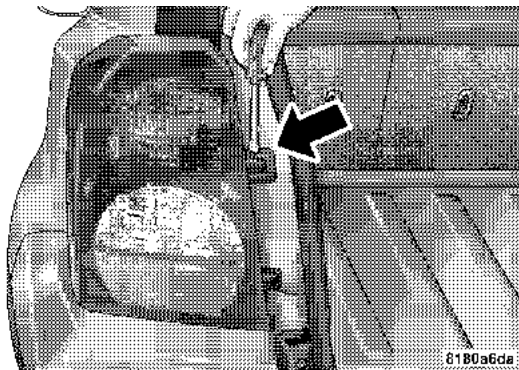

2. Grasp the tail light and pull firmly to disengage the light from the aperture panel.

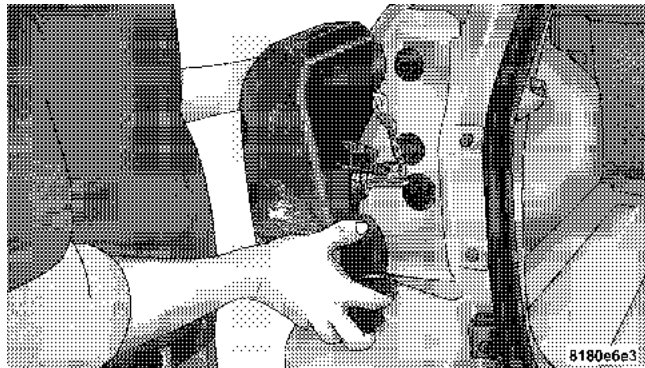

3. Twist and remove socket from light.

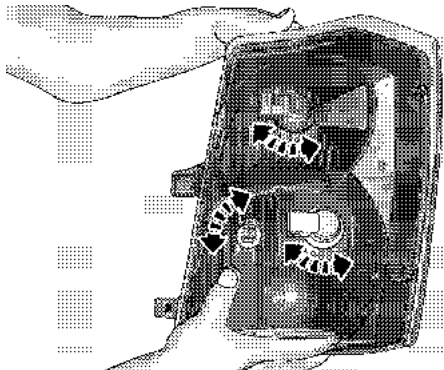

8180e6eb

4. Remove the bulb from the socket and replace.

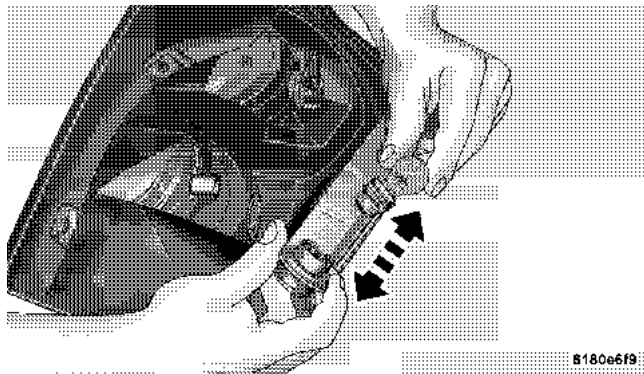

8180e6f9

License Lights

1. Use a screw driver to gently pry against the side of the snap tab to remove the lamp from the liftgate.

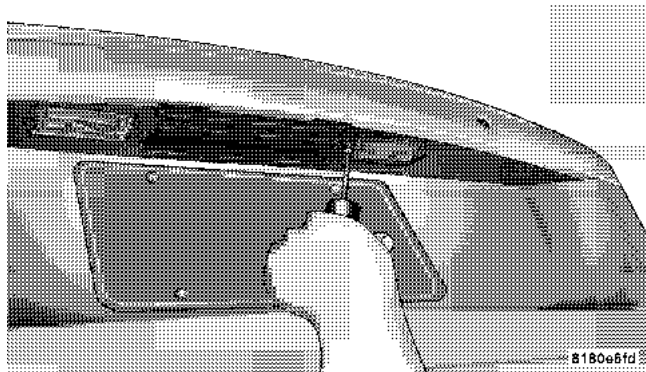

2. Rotate the socket 1/4 turn counterclockwise.

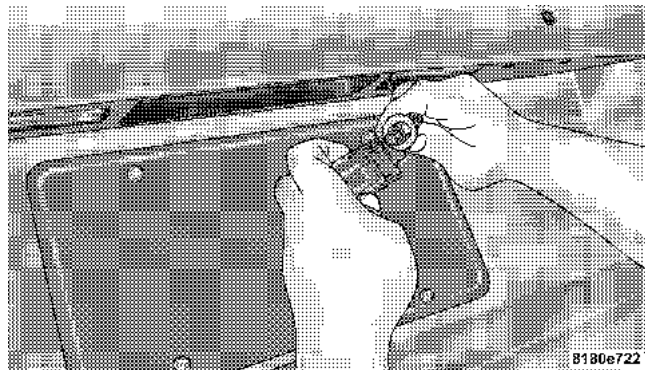

3. Pull the bulb from the socket.

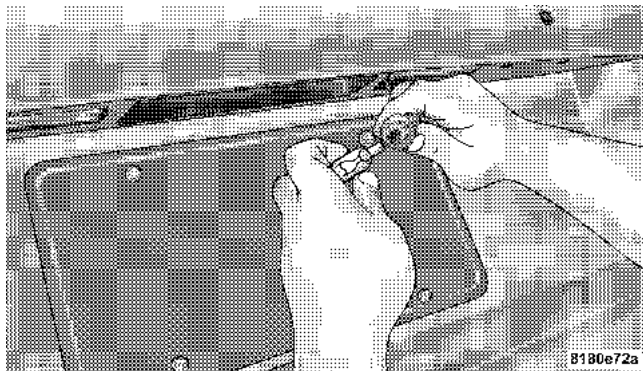

Center High-Mounted Stoplight

The light is an LED assembly. See your authorized dealer for replacement.

FLUIDS AND CAPACITIES

	U.S.	Metric
Fuel (Approximate)	13.6 Gallons	51.5 Liters
Engine Oil with Filter		
2.0L and 2.4L Engine (SAE 5W-20, API Certified)	4.5 Quarts	4.26 Liters
Cooling System *		
2.0L and 2.4L Engine (MOPAR® Engine Coolant/Antifreeze 5 Year/100,000 Mile Formula)	7.2 Quarts	6.8 Liters
* Includes heater and coolant recovery bottle filled to MAX level.		

FLUIDS, LUBRICANTS, AND GENUINE PARTS**Engine**

Component	Fluid, Lubricant, or Genuine Part
Engine Coolant	MOPAR® Antifreeze/Coolant 5 Year/100,000 Mile Formula HOAT (Hybrid Organic Additive Technology)
Engine Oil	Use API Certified SAE 5W-20 Engine Oil, meeting the requirements of Chrysler Material Standard MS-6395. Refer to your engine oil filler cap for correct SAE grade.
Engine Oil Filter	MOPAR® Oil Filter (P/N 04884900AD or equivalent)
Spark Plugs	ZFR5F-11 (Gap 0.043 in [1.1 mm])
Fuel Selection	87 Octane

Chassis

Component	Fluid, Lubricant, or Genuine Part
Automatic Transaxle (CVT)	MOPAR® CVTF + 4 Automatic Transmission Fluid
Manual Transaxle	MOPAR® ATF+4 Automatic Transmission Fluid
Brake Master Cylinder	MOPAR® DOT 3, SAE J1703 should be used. If DOT 3, SAE J1703 brake fluid is not available, then DOT 4 is acceptable. Use only recommended brake fluids or equivalent.
Power Steering Reservoir	MOPAR® Power Steering Fluid +4 or ATF+4 Automatic Transmission Fluid

MAINTENANCE SCHEDULES

CONTENTS

<p>■ Emissions Control System Maintenance 382</p> <p>■ Maintenance Schedule 382</p>	<p>□ Required Maintenance Intervals 384</p>
---	---

EMISSIONS CONTROL SYSTEM MAINTENANCE

The Scheduled Maintenance services listed in **bold type** must be done at the times or mileages specified to ensure the continued proper functioning of the emissions control system. These and all other maintenance services included in this manual, should be done to provide best vehicle performance and reliability. More frequent maintenance may be needed for vehicles in severe operating conditions, such as dusty areas and very short trip driving.

Inspection and service should also be done anytime a malfunction is suspected.

NOTE: Maintenance, replacement or repair of the emissions control devices and systems on your vehicle may be performed by any automotive repair establishment or individual using any automotive part that has been certified pursuant to U.S. EPA or in the State of California, California Air Resources Board regulations.

MAINTENANCE SCHEDULE

The oil change indicator system will remind you that it is time to take your vehicle in for scheduled maintenance.

On Electronic Vehicle Information Center (EVIC) equipped vehicles, “Oil Change Required” will be displayed in the EVIC and a single chime will sound, indicating that an oil change is necessary.

On Non-EVIC equipped vehicles, “Change Oil” will flash in the instrument cluster odometer and a single chime will sound, indicating that an oil change is necessary.

Based on engine operation condition, the oil change indicator message will illuminate; this means that service is required for your vehicle. Have your vehicle serviced as soon as possible, within the next 500 miles (805 km).

NOTE:

- The oil change indicator message will not monitor the time since the last oil change. Change your vehicle’s

oil if it has been six months since your last oil change and even if the oil change indicator message is NOT illuminated.

- Change your engine oil more often if you drive your vehicle off-road for an extended period of time.
- Under no circumstances should oil change intervals exceed 6,000 miles (10 000 km) or six months, whichever comes first.

Your authorized dealer will reset the oil change indicator message after completing the scheduled oil change. If this scheduled oil change is performed by someone other than your authorized dealer, the message can be reset by referring to the steps described under “Oil Change

Required” in “Use Factory Settings” of the EVIC section in this manual or under “Odometer/Trip Odometer” in the Instrument Cluster Descriptions section of this manual.

At Each Stop for Fuel

- Check the engine oil level about five minutes after a fully warmed engine is shut off. Checking the oil level while the vehicle is on level ground will improve the accuracy of the oil level reading. Add oil only when the level is at or below the ADD or MIN mark.
- Check the windshield washer solvent and add if required.

Once a Month

- Check the tire pressure and look for unusual wear or damage.
- Inspect the battery and clean and tighten the terminals as required.
- Check the fluid levels of coolant reservoir, brake master cylinder, power steering and transmission and add as needed.
- Check all lights and other electrical items for correct operation.

At Each Oil Change

- Change the engine oil filter.
- Inspect the brake hoses and lines.
- Check the manual transmission fluid level.

CAUTION!

Failure to perform the required maintenance items may result in damage to the vehicle.

Required Maintenance Intervals

Refer to the Maintenance Schedules on the following pages for the required maintenance intervals.

6,000 Miles (10,000 km) or 6 Months Maintenance Service Schedule

- Change the engine oil and engine oil filter.
- Rotate tires.

Odometer Reading Date

Repair Order # Dealer Code

Signature Authorized Chrysler Dealer

12,000 Miles (20,000 km) or 12 Months Maintenance Service Schedule

- Change the engine oil and engine oil filter.
- Rotate tires.
- If using your vehicle for any of the following: Dusty or off-road conditions. Inspect the engine air cleaner filter; replace if necessary.
- Inspect the brake linings; replace if necessary.
- Replace the air conditioning filter.
- Inspect the CV joints. Perform the first inspection at 12,000 miles (20 000 km) or 12 months.
- Inspect exhaust system. Perform the first inspection at 12,000 miles (20 000 km) or 12 months.

Odometer Reading Date

Repair Order # Dealer Code

Signature Authorized Chrysler Dealer

**18,000 Miles (30,000 km) or
18 Months Maintenance
Service Schedule**

- Change the engine oil and engine oil filter.
- Rotate tires.

Odometer Reading Date

Repair Order # Dealer Code

Signature Authorized Chrysler Dealer

**24,000 Miles (40,000 km) or 24 Months Maintenance Service
Schedule**

- Change the engine oil and engine oil filter.
- Rotate tires.
- If using your vehicle for any of the following: Dusty or off-road conditions. Inspect the engine air cleaner filter; replace if necessary.
- Inspect the brake linings; replace if necessary.
- Replace the air conditioning filter.
- Inspect the CV joints.
- Inspect exhaust system.
- Inspect the front suspension, tie rod ends and boot seals; replace if necessary.

Odometer Reading Date

Repair Order # Dealer Code

Signature Authorized Chrysler Dealer

**30,000 Miles (50,000 km) or
30 Months Maintenance
Service Schedule**

- Change the engine oil and engine oil filter.
- Rotate tires.
- Replace the engine air cleaner filter.
- Replace the spark plugs (except 2.4L PZEV).**
- Adjust the parking brake on vehicles equipped with four-wheel disc brakes.

Odometer Reading Date

Repair Order # Dealer Code

Signature Authorized Chrysler Dealer

**36,000 Miles (60,000 km) or
36 Months Maintenance
Service Schedule**

- Change the engine oil and engine oil filter.
- Rotate tires.
- If using your vehicle for any of the following: Dusty or off-road conditions. Inspect the engine air cleaner filter; replace if necessary.
- Inspect the brake linings; replace if necessary.
- Replace the air conditioning filter.

Odometer Reading Date

Repair Order # Dealer Code

Signature Authorized Chrysler Dealer

**42,000 Miles (70,000 km) or
42 Months Maintenance
Service Schedule**

- Change the engine oil and engine oil filter.
- Rotate tires.

Odometer Reading Date

Repair Order # Dealer Code

Signature Authorized Chrysler Dealer

48,000 Miles (80,000 km) or 48 Months Maintenance Service Schedule

- Change the engine oil and engine oil filter.
- Rotate tires.
- If using your vehicle for any of the following: Dusty or off-road conditions. Inspect the engine air cleaner filter; replace if necessary.
- Inspect the brake linings; replace if necessary.
- Replace the air conditioning filter.
- Inspect the CV joints.
- Inspect exhaust system.
- Inspect the front suspension, tie rod ends and boot seals; replace if necessary.
- Change the manual transmission fluid if using your vehicle for any of the following: trailer towing, snow plowing, heavy loading, taxi, police, delivery service (commercial service), off-road, desert operation or more than 50% of your driving is at sustained speeds during hot weather, above 90°F (32°C).

_____ Date

Odometer Reading

_____ Dealer Code

Repair Order #

Signature Authorized Chrysler Dealer

54,000 Miles (90,000 km) or 54 Months Maintenance Service Schedule

- Change the engine oil and engine oil filter.
- Rotate tires.

_____ Date

Odometer Reading

_____ Dealer Code

Repair Order #

Signature Authorized Chrysler Dealer

60,000 Miles (100,000 km) or 60 Months Maintenance Service Schedule

- Change the engine oil and engine oil filter.
- Rotate tires.
- Replace the engine air cleaner filter.
- Inspect the brake linings; replace if necessary.
- Adjust the parking brake on vehicles equipped with four-wheel disc brakes.
- Replace the air conditioning filter.
- Replace the spark plugs (except 2.4L PZEV).**
- Change the automatic transmission fluid and filter if using your vehicle for any of the following: police, taxi, fleet, or frequent trailer towing.
- Flush and replace the engine coolant at 60 months if not done at 102,000 miles (170 000 km).

_____ Date

Odometer Reading

_____ Dealer Code

Repair Order #

Signature Authorized Chrysler Dealer

66,000 Miles (110,000 km) or 66 Months Maintenance Service Schedule

- Change the engine oil and engine oil filter.
- Rotate tires.

_____ Date

Odometer Reading

_____ Dealer Code

Repair Order #

Signature Authorized Chrysler Dealer

72,000 Miles (120,000 km) or 72 Months Maintenance Service Schedule

- Change the engine oil and engine oil filter.
- Rotate tires.
- If using your vehicle for any of the following: Dusty or off-road conditions. Inspect the engine air cleaner filter; replace if necessary.
- Inspect the brake linings; replace if necessary.
- Replace the air conditioning filter.
- Inspect the CV joints.
- Inspect exhaust system.
- Inspect the front suspension, tie rod ends and boot seals; replace if necessary.

Odometer Reading Date

Repair Order # Dealer Code

Signature Authorized Chrysler Dealer

78,000 Miles (130,000 km) or 78 Months Maintenance Service Schedule

- Change the engine oil and engine oil filter.
- Rotate tires.

Odometer Reading Date

Repair Order # Dealer Code

Signature Authorized Chrysler Dealer

84,000 Miles (140,000 km) or 84 Months Maintenance Service Schedule

- Change the engine oil and engine oil filter.
- Rotate tires.
- If using your vehicle for any of the following: Dusty or off-road conditions. Inspect the engine air cleaner filter; replace if necessary.
- Inspect the brake linings; replace if necessary.
- Replace the air conditioning filter.

Odometer Reading Date

Repair Order # Dealer Code

Signature Authorized Chrysler Dealer

90,000 Miles (150,000 km) or 90 Months Maintenance Service Schedule

- Change the engine oil and engine oil filter.
- Rotate tires.
- Replace the engine air cleaner filter.
- Replace the spark plugs (except 2.4L PZEV).**
- Inspect and replace PCV valve if necessary. †**
- Adjust the parking brake on vehicles equipped with four-wheel disc brakes.

Odometer Reading Date

Repair Order # Dealer Code

Signature Authorized Chrysler Dealer

96,000 Miles (160,000 km) or 96 Months Maintenance Service Schedule

- Change the engine oil and engine oil filter.
- Rotate tires.
- If using your vehicle for any of the following: Dusty or off-road conditions. Inspect the engine air cleaner filter; replace if necessary.
- Inspect the brake linings; replace if necessary.
- Replace the air conditioning filter.
- Inspect the CV joints.
- Inspect exhaust system.
- Inspect the front suspension, tie rod ends and boot seals; replace if necessary.
- Change the manual transmission fluid if using your vehicle for any of the following: trailer towing, snow plowing, heavy loading, taxi, police, delivery service (commercial service), off-road, desert operation or more than 50% of your driving is at sustained speeds during hot weather, above 90°F (32°C).

Odometer Reading Date

Repair Order # Dealer Code

Signature Authorized Chrysler Dealer

102,000 Miles (170,000 km) or 102 Months Maintenance Service Schedule

- Change the engine oil and engine oil filter.
- Rotate tires.
- Flush and replace the engine coolant.
- Replace the spark plugs (2.4L PZEV).**
- Flush and replace the engine coolant if not done at 60 months.

Odometer Reading Date

Repair Order # Dealer Code

Signature Authorized Chrysler Dealer

**108,000 Miles (180,000 km) or
108 Months Maintenance
Service Schedule**

- Change the engine oil and engine oil filter.
- Rotate tires.
- If using your vehicle for any of the following: Dusty or off-road conditions. Inspect the engine air cleaner filter; replace if necessary.
- Inspect the brake linings; replace if necessary.
- Replace the air conditioning filter.

Odometer Reading Date

Repair Order # Dealer Code

Signature Authorized Chrysler Dealer

**114,000 Miles (190,000 km) or
114 Months Maintenance
Service Schedule**

- Change the engine oil and engine oil filter.
- Rotate tires.

Odometer Reading Date

Repair Order # Dealer Code

Signature Authorized Chrysler Dealer

120,000 Miles (200,000 km) or 120 Months Maintenance Service Schedule

- Change the engine oil and engine oil filter.
- Rotate tires.
- Replace the engine air cleaner filter.
- Inspect the brake linings; replace if necessary.
- Adjust the parking brake on vehicles equipped with four-wheel disc brakes.
- Replace the air conditioning filter.
- Inspect the CV joints.
- Inspect exhaust system.
- Inspect the front suspension, tie rod ends and boot seals; replace if necessary.
- Replace the spark plugs (except 2.4L PZEV).**
- Change the automatic transmission fluid and filter.
- Replace the accessory drive belt(s).

Odometer Reading Date

Repair Order # Dealer Code

Signature Authorized Chrysler Dealer

126,000 Miles (210,000 km) or 126 Months Maintenance Service Schedule

- Change the engine oil and engine oil filter.
- Rotate tires.

Odometer Reading Date

Repair Order # Dealer Code

Signature Authorized Chrysler Dealer

**132,000 Miles (220,000 km) or
132 Months Maintenance
Service Schedule**

- Change the engine oil and engine oil filter.
- Rotate tires.
- If using your vehicle for any of the following: Dusty or off-road conditions. Inspect the engine air cleaner filter; replace if necessary.
- Inspect the brake linings; replace if necessary.
- Replace the air conditioning filter.

Odometer Reading Date

Repair Order # Dealer Code

Signature Authorized Chrysler Dealer

**138,000 Miles (230,000 km) or
138 Months Maintenance
Service Schedule**

- Change the engine oil and engine oil filter.
- Rotate tires.

Odometer Reading Date

Repair Order # Dealer Code

Signature Authorized Chrysler Dealer

144,000 Miles (240,000 km) or 144 Months Maintenance Service Schedule

- Change the engine oil and engine oil filter.
- Rotate tires.
- If using your vehicle for any of the following: Dusty or off-road conditions. Inspect the engine air cleaner filter; replace if necessary.
- Inspect the brake linings; replace if necessary.
- Replace the air conditioning filter.
- Inspect the CV joints.
- Inspect exhaust system.
- Inspect the front suspension, tie rod ends and boot seals; replace if necessary.
- Change the manual transmission fluid if using your vehicle for any of the following: trailer towing, snow plowing, heavy loading, taxi, police, delivery service (commercial service), off-road, desert operation or more than 50% of your driving is at sustained speeds during hot weather, above 90°F (32°C).

Odometer Reading Date

Repair Order # Dealer Code

Signature Authorized Chrysler Dealer

150,000 Miles (250,000 km) or 150 Months Maintenance Service Schedule

- Change the engine oil and engine oil filter.
- Rotate tires.
- Replace the engine air cleaner filter.
- Replace the spark plugs (except 2.4L PZEV).**
- Adjust the parking brake on vehicles equipped with four-wheel disc brakes.

Odometer Reading Date

Repair Order # Dealer Code

Signature Authorized Chrysler Dealer

† This maintenance is recommended by the manufacturer to the owner, but is not required to maintain emissions warranty.

WARNING!

You can be badly injured working on or around a motor vehicle. Do only that service work for which you have the knowledge and the right equipment. If you have any doubt about your ability to perform a service job, take your vehicle to a competent mechanic.

IF YOU NEED CONSUMER ASSISTANCE

CONTENTS

■ Suggestions For Obtaining Service For Your Vehicle	401	□ Customer Assistance For The Hearing Or Speech Impaired (TDD/TTY)	403
□ Prepare For The Appointment	401	□ Service Contract	403
□ Prepare A List	401	■ Warranty Information (U.S. Vehicles Only)	404
□ Be Reasonable With Requests	401	■ MOPAR® Parts	404
■ If You Need Assistance	401	■ Reporting Safety Defects	404
□ Chrysler LLC Customer Center	402	□ In The 50 United States And Washington, D.C.	404
□ Chrysler Canada Inc. Customer Center	402	□ In Canada	405
□ In Mexico Contact	402		

■ Publication Order Forms 405

■ Department Of Transportation Uniform Tire
Quality Grades 406

□ Treadwear 407

□ Traction Grades 407

□ Temperature Grades 407

SUGGESTIONS FOR OBTAINING SERVICE FOR YOUR VEHICLE

Prepare For The Appointment

If you're having warranty work done, be sure to have the right papers with you. Take your warranty folder. All work to be performed may not be covered by the warranty. Discuss additional charges with the service manager. Keep a maintenance log of your vehicle's service history. This can often provide a clue to the current problem.

Prepare A List

Make a written list of your vehicle's problems or the specific work you want done. If you've had an accident or work done that is not on your maintenance log, let the service advisor know.

Be Reasonable With Requests

If you list a number of items and you must have your vehicle by the end of the day, discuss the situation with

the service advisor and list the items in order of priority. At many authorized dealers, you may obtain a rental vehicle at a minimal daily charge. If you need a rental, it is advisable to make these arrangements when you call for an appointment.

IF YOU NEED ASSISTANCE

The manufacturer and its authorized dealers are vitally interested in your satisfaction. We want you to be happy with our products and services.

Warranty service must be done by an authorized dealer. We strongly recommend that you take the vehicle to an authorized dealer. They know you and the vehicle best, and are most concerned that you get prompt and high quality service. The manufacturer's authorized dealers have the facilities, factory-trained technicians, special tools, and the latest information to ensure the vehicle is fixed correctly and in a timely manner.

This is why you should always talk to an authorized dealer's service manager first. Most matters can be resolved with this process.

- If for some reason you are still not satisfied, talk to the general manager or owner of the authorized dealership. They want to know if you need assistance.
- If an authorized dealership is unable to resolve the concern, you may contact the manufacturer's customer center.

Any communication to the manufacturer's customer center should include the following information:

- Owner's name and address
- Owner's telephone number (home and office)
- Authorized dealership name
- Vehicle Identification Number (VIN)

- Vehicle delivery date and mileage

Chrysler LLC Customer Center

P.O. Box 21-8004

Auburn Hills, MI 48321-8004

Phone: (800) 992-1997

Chrysler Canada Inc. Customer Center

P.O. Box 1621

Windsor, Ontario N9A 4H6

Phone: (800) 465-2001

In Mexico contact:

Av. Prolongacion Paseo de la Reforma, 1240

Sante Fe C.P. 05109

Mexico, D. F.

In Mexico City: 5081-7568

Outside Mexico City: 1-800-505-1300

Customer Assistance For The Hearing Or Speech Impaired (TDD/TTY)

To assist customers who have hearing difficulties, the manufacturer has installed special TDD (Telecommunication Devices for the Deaf) equipment at its customer center. Any hearing or speech impaired customer, who has access to a TDD or a conventional teletypewriter (TTY) in the United States, can communicate with the manufacturer by dialing 1-800-380-CHRY.

Service Contract

You may have purchased a service contract for a vehicle to help protect you from the high cost of unexpected repairs after the manufacturer's New Vehicle Limited Warranty expires. The manufacturer stands behind only the manufacturer's service contracts. If you purchased a manufacturer's service contract, you will receive Plan Provisions and an Owner Identification Card in the mail within three weeks of the vehicle delivery date. If you

have any questions about the service contract, call the manufacturer's Service Contract National Customer Hotline at 1-800-521-9922.

The manufacturer will not stand behind any service contract that is not the manufacturer's service contract. It is not responsible for any service contract other than the manufacturer's service contract. If you purchased a service contract that is not a manufacturer's service contract, and you require service after the manufacturer's New Vehicle Limited Warranty expires, please refer to the contract documents, and contact the person listed in those documents.

We appreciate that you have made a major investment when you purchased the vehicle. An authorized dealer has also made a major investment in facilities, tools, and training to assure that you are absolutely delighted with

the ownership experience. You'll be pleased with their sincere efforts to resolve any warranty issues or related concerns.

WARNING!

Engine exhaust, some of its constituents, and certain vehicle components contain, or emit, chemicals known to the State of California to cause cancer and birth defects, or other reproductive harm. In addition, certain fluids contained in vehicles and certain products of component wear contain, or emit, chemicals known to the State of California to cause cancer and birth defects, or other reproductive harm.

WARRANTY INFORMATION (U.S. Vehicles Only)

See the Warranty Information Booklet for the terms and provisions of Chrysler Motors LLC warranties applicable to this vehicle.

MOPAR® PARTS

Mopar® fluids, lubricants, parts, and accessories are available from an authorized dealer. They will help keep the vehicle operating at its best.

REPORTING SAFETY DEFECTS

In The 50 United States And Washington, D.C.

If you believe that your vehicle has a defect that could cause a crash or cause injury or death, you should immediately inform the National Highway Traffic Safety Administration (NHTSA) in addition to notifying the manufacturer.

If NHTSA receives similar complaints, it may open an investigation, and if it finds that a safety defect exists in a group of vehicles, it may order a recall and remedy campaign. However, NHTSA cannot become involved in individual problems between you, your authorized dealer, and the manufacturer.

To contact NHTSA, you may either call the Auto Safety Hotline toll free at 1-888-327-4236 (TTY: 1-800-424-9153), or go to <http://www.safercar.gov>; or write to: Administrator, NHTSA, 400 Seventh Street, SW., Washington, D.C. 20590. You can also obtain other information about motor vehicle safety from <http://www.safercar.gov>.

In Canada

If you believe that your vehicle has a safety defect, you should contact the Customer Service Department immediately. Canadian customers who wish to report a safety defect to the Canadian government should write to: Transport Canada, Motor Vehicle Defect Investigations and Recalls, 2780 Sheffield Road, Ottawa, Ontario K1B 3V9.

PUBLICATION ORDER FORMS

To order the following manuals, you may use either the website or the phone numbers listed below. Visa, Mastercard, American Express, and Discover orders are accepted. If you prefer mailing your payment, please call for an order form.

NOTE: A street address is required when ordering manuals (no P.O. Boxes).

- *Service Manuals*

These comprehensive Service Manuals provide the information that students and professional technicians need in diagnosing/troubleshooting, problem solving, maintaining, servicing, and repairing Chrysler LLC vehicles. A complete working knowledge of the vehicle, system, and/or components is written in straightforward language with illustrations, diagrams, and charts.

- *Diagnostic Procedure Manuals*

Diagnostic Procedure Manuals are filled with diagrams, charts and detailed illustrations. These practical manuals make it easy for students and technicians to find and fix problems on computer-controlled vehicle systems and features. They show exactly how to find and correct problems the first time, using step-by-step troubleshooting and drivability procedures, proven diagnostic tests and a complete list of all tools and equipment.

- *Owner's Manuals*

These Owner's Manuals have been prepared with the assistance of service and engineering specialists to acquaint you with specific Chrysler LLC vehicles. Included are starting, operating, emergency and maintenance procedures as well as specifications, capabilities and safety tips.

Call toll free at:

- 1-800-890-4038 (U.S.)
- 1-800-387-1143 (Canada)

Or

Visit us on the Worldwide Web at:

- www.techauthority.com

DEPARTMENT OF TRANSPORTATION UNIFORM TIRE QUALITY GRADES

The following tire grading categories were established by the National Highway Traffic Safety Administration. The specific grade rating assigned by the tire's manufacturer in each category is shown on the sidewall of the tires on your vehicle.

All passenger car tires must conform to Federal safety requirements in addition to these grades.

Treadwear

The Treadwear grade is a comparative rating, based on the wear rate of the tire when tested under controlled conditions on a specified government test course. For example, a tire graded 150 would wear one and one-half times as well on the government course as a tire graded 100. The relative performance of tires depends upon the actual conditions of their use, however, and may depart significantly from the norm due to variations in driving habits, service practices, and differences in road characteristics and climate.

Traction Grades

The Traction grades, from highest to lowest, are AA, A, B, and C. These grades represent the tire's ability to stop on wet pavement, as measured under controlled conditions on specified government test surfaces of asphalt and concrete. A tire marked C may have poor traction performance.

WARNING!

The traction grade assigned to this tire is based on straight-ahead braking traction tests, and does not include acceleration, cornering, hydroplaning, or peak traction characteristics.

Temperature Grades

The temperature grades are A (the highest), B, and C, representing the tire's resistance to the generation of heat and its ability to dissipate heat, when tested under controlled conditions on a specified indoor laboratory test wheel. Sustained high temperature can cause the material of the tire to degenerate and reduce tire life, and excessive temperature can lead to sudden tire failure. The grade C corresponds to a level of performance, which all passenger car tires must meet under the Federal Motor

Vehicle Safety Standard No. 109. Grades B and A represent higher levels of performance on the laboratory test wheel, than the minimum required by law.

WARNING!

The temperature grade for this tire is established for a tire that is properly inflated and not overloaded. Excessive speed, under-inflation, or excessive loading, either separately or in combination, can cause heat buildup and possible tire failure.

INDEX

ABS (Anti-Lock Brake System)	266	Alarm Light	171
Adding Engine Coolant (Antifreeze)	355	Alarm System (Security Alarm)	18
Adding Fuel	305	Alterations/Modifications, Vehicle	7
Adding Washer Fluid	351	Antenna, Satellite Radio	231
Additives, Fuel	304	Antifreeze (Engine Coolant)	354,377,378
Air Cleaner, Engine (Engine Air Cleaner Filter)	347	Capacities	377
Air Conditioner Maintenance	349	Disposal	357
Air Conditioning	236	Anti-Lock Brake System (ABS)	266
Air Conditioning Controls	236	Anti-Lock Warning Light	177
Air Conditioning, Operating Tips	242	Anti-Theft Security Alarm (Theft Alarm)	18
Air Conditioning Refrigerant	349,350	Appearance Care	362
Air Conditioning System	236,349	Assistance Towing	98
Air Pressure, Tires	284	Automatic Dimming Mirror	80
Airbag	49	Automatic Door Locks	28,29
Airbag Deployment	57	Automatic Transaxle	12,249,253,325,361
Airbag Light	59,73,171	Fluid Level Check	361
Airbag Maintenance	59	Interlock System	255
Airbag, Side	55	Overheating	325
Airbag, Window (Side Curtain)	50	Selection Of Lubricant	361

Shifting	255	Brake/Transmission Interlock	254
Special Additives	361	Break-In Recommendations, New Vehicle	70
Autostick	257	Bulb Replacement	371,372
Battery	348	Bulbs, Light	74,371
Keyless Transmitter Replacement (RKE)	25	Capacities, Antifreeze (Engine Coolant)	377
Belts, Seat	73	Capacities, Fluid	377
Beverage Cooler	160	Caps, Filler	
Body Mechanism Lubrication	350	Fuel	305
B-Pillar Location	279	Oil (Engine)	340,346
Brake Assist System	269	Power Steering	263
Brake Fluid	379	Car Washes	363
Brake, Parking	264	Carbon Monoxide Warning	72,305
Brake System	265,359	Cargo Area Cover	155
Anti-Lock (ABS)	266,269	Cargo Area Features	154
Master Cylinder	359	Cargo Compartment	
Parking	264	Light	154
Warning Light	178	Cargo Light	154
Brakes	265,359	Cargo Load Floor	156

- Cargo Tie-Downs 157
- Cellular Phone 83,236
- Center High Mounted Stop Light 376
- Chains, Tire 291
- Changing A Flat Tire 326
- Chart, Tire Sizing 276
- Check Engine Light
(Malfunction Indicator Light) 175,342
- Checking Your Vehicle For Safety 71
- Checks, Safety 71
- Child Restraint 62
- Child Restraint Tether Anchors 66
- Child Restraint with Automatic Belts 65
- Child Safety Locks 31
- Child Seat 68
- Clean Air Gasoline 302
- Cleaning
 Wheels 364
- Climate Control 236
- Clock 192,206,209,219
- Clutch 359
- Clutch Fluid 359
- Coin Holder 152
- Compact Disc (CD) Maintenance 235
- Compact Spare Tire 286
- Console 152
- Contract, Service 403
- Coolant (Antifreeze) 377,378
- Cooler, Beverage 160
- Cooling System 353
 Adding Coolant (Antifreeze) 355
 Coolant Level 354,357
 Disposal of Used Coolant 357
 Drain, Flush, and Refill 354
 Inspection 357
 Points to Remember 356,358
 Pressure Cap 356
 Selection of Coolant (Antifreeze) 354

Corrosion Protection	362	Door Opener, Garage	138
Cruise Light	176	Downshifting	253
Cupholders	152	Driver's Seat Back Tilt	119
Customer Assistance	401	Driving	
		On Slippery Surfaces	259
Data Recorder, Event	59	Through Flowing, Rising, or Shallow	
Dealer Service	343	Standing Water	260
Defroster, Rear Window	159		
Defroster, Windshield	73,238	Electric Remote Mirrors	81
Delay (Intermittent) Wipers	132	Electrical Power Outlets	148
Diagnostic System, Onboard	341	Electronic Brake Control System	268
Dimmer Switch, Headlight	129	Anti-Lock Brake System	269
Dipsticks		Brake Assist System	269
Power Steering	263	Electronic Stability Program	270
Disposal		Traction Control System	270
Antifreeze (Engine Coolant)	357	Electronic Speed Control (Cruise Control)	134
Engine Oil	346	Electronic Stability Program (ESP)	270
Door Locks	26	Electronic Vehicle Information Center (EVIC)	180
Door Locks, Automatic	28		

- Emergency, In Case of
 - Jacking 326
 - Jump Starting 331
 - Towing 334
- Emission Control System Maintenance 342,382
- Engine 340
 - Break-In Recommendations 70
 - Checking Oil Level 344
 - Cooling 353
 - Exhaust Gas Caution 72,305
 - Fuel Requirements 301
 - Jump Starting 331
 - Oil 344,377,378
 - Oil Change Interval 345
 - Oil Filler Cap 340,346
 - Oil Filter 378
 - Oil Selection 345
 - Oil Synthetic 346
 - Overheating 324
 - Temperature Gauge 169
- Enhanced Accident Response Feature 58
- Event Data Recorder 59
- Exhaust Gas Caution 35,72,305,351,352
- Exhaust System 72,351
- Exterior Lights 74
- Filler Location Fuel 169
- Filters
 - Air Cleaner 347
 - Engine Oil 347,378
- Flashers 324
 - Hazard Warning 324
 - Turn Signal 74,177,373
- Flat Tire Stowage 331
- Flooded Engine Starting 250
- Fluid, Brake 379
- Fluid Capacities 377
- Fluid Leaks 74

Fluid Level Checks			
Automatic Transaxle	361		
Power Steering	263		
Fluids	378		
Fluids, Lubricants and Genuine Parts	378		
Fog Lights	128,177,372		
Folding Rear Seat	123		
Folding Rear Seat (Sedan)	123		
Freeing A Stuck Vehicle	333		
Front Position Light	372		
Fuel	301,378		
Adding	305		
Additives	304		
Capacity	377		
Clean Air	302		
Filler Cap (Gas Cap)	169,305		
Filler Door (Gas Cap)	169		
Gasoline	301		
Gauge	169		
Light	170		
Octane Rating	301		
Requirements	301		
Tank Capacity	377		
Fuel System Caution	307		
Fueling	305		
Fuses	368		
Garage Door Opener (HomeLink®)	138		
Gas Cap (Fuel Filler Cap)	305,307,341		
Gasoline, Clean Air	302		
Gasoline (Fuel)	301,377		
Gasoline, Reformulated	302		
Gauges			
Coolant Temperature	169		
Fuel	169		
Odometer	174		
Tachometer	170		
Gearshift	255		

General Information	18,112,301	Switch	126
General Maintenance	344	Heated Seats	120
Glass Cleaning	366	Heater	236
Glove Compartment	160	Hitches	
Gross Axle Weight Rating	310	Trailer Towing	312
Gross Vehicle Weight Rating	308,310	HomeLink® (Garage Door Opener) Transmitter . . .	138
Hands-Free Phone (uconnect®)	83	Hood Release	124
Hazard		Ignition	12
Driving Through Flowing, Rising, or Shallow		Key	12
Standing Water	260	Ignition Key Removal	12
Hazard Warning Flasher	324	Immobilizer (Sentry Key)	15
Head Restraints	120	Infant Restraint	63
Headlights	372	Information Center, Vehicle	180
Cleaning	366	Inside Rearview Mirror	79
High Beam	129	Instrument Cluster	167,169
High Beam/Low Beam Select Switch	129	Instrument Panel and Controls	166
Passing	130	Instrument Panel Cover	367
Replacing	372	Instrument Panel Lens Cleaning	367

Integrated Power Module (Fuses)	368	Latches	74
Interior Appearance Care	365	Hood	124
Intermittent Wipers (Delay Wipers)	132	Lead Free Gasoline	301
Introduction	4	Leaks, Fluid	74
		Life of Tires	289
Jack Location	326	Liftgate (Sedan)	34
Jack Operation	326,327	Liftgate Window Wiper/Washer	158
Jacking Instructions	327	Light Bulbs	74,371
Jump Starting	331	Lights	74,126
		Airbag	59,73,171
Key, Programming	17	Alarm	171
Key, Replacement	16	Anti-Lock	177
Key, Sentry (Immobilizer)	15	Back-Up	373
Key-In Reminder	15	Brake Warning	178
Keyless Entry System (Sedan)	20	Bulb Replacement	372
Keys	12	Cargo	154
		Center Mounted Stop	376
Lane Change and Turn Signals	373	Dimmer Switch, Headlight	126
Lap/Shoulder Belts	37		

Electronic Stability Program (ESP) Indicator	271,273	Tire Pressure Monitoring (TPMS)	172
Engine Temperature Warning	172	Traction Control	271
Exterior	74	Turn Signal	74,126,128,373
Fog	128,177,372	Voltage	170
Headlight Switch	126	Warning (Instrument Cluster Description)	169
Headlights	126	Loading Vehicle	307,309
High Beam Indicator	178	Capacities	309
Instrument Cluster	126	Tires	279
License	375	Locks	
Lights On Reminder	127	Child Protection	31
Low Fuel	170	Door	26
Malfunction Indicator (Check Engine)	175	Power Door	27
Map Reading	130	Lubrication, Body	350
Oil Pressure	171	Lumbar Support	119
Seat Belt Reminder	171	Maintenance Free Battery	348
Security Alarm (Theft Alarm)	19,171	Maintenance, General	344
Service Engine Soon (Malfunction Indicator)	175	Maintenance Procedures	344
Theft Alarm (Security Alarm)	171	Maintenance Schedule	382

- Malfunction Indicator Light (Check Engine) . . . 175,342
- Manual, Service 405
- Manual Transaxle 249,251,362
 - Downshifting 253
 - Fluid Level Check 362
 - Frequency of Fluid Change 362
 - Lubricant Selection 362
- Map/Reading Lights 130
- Master Cylinder (Brakes) 359
- Mirrors 79
 - Automatic Dimming 80
 - Electric Powered 81
 - Outside 80
 - Rearview 79
 - Vanity 83
- Modifications/Alterations, Vehicle 7
- Monitor, Tire Pressure System 293
- Mopar Parts 343,404
- Multi-Function Control Lever 126
- New Vehicle Break-In Period 70
- Occupant Restraints (Sedan) 36
- Octane Rating, Gasoline (Fuel) 301
- Odometer 174
 - Trip 174,176
- Oil Change Indicator 174
- Oil, Engine 344,377
 - Capacity 377
 - Change Interval 345
 - Checking 344
 - Disposal 346
 - Filter 347
 - Identification Logo 346
 - Materials Added to 346
 - Recommendation 345,377
 - Synthetic 346
 - Viscosity 346
- Onboard Diagnostic System 341,342

Opener, Garage Door (HomeLink®)	138	Outlet (Auxiliary Electrical Outlet)	148
Operator Manual (Owner's Manual)	4	Steering	262,263
Outside Air Intake	243	Sunroof	144
Overdrive	257	Windows	32
Overheating, Engine	169,324	Power Steering Fluid	379
Owner's Manual (Operator Manual)	4,405	Pregnant Women and Seat Belts	48
		Preparation for Jacking	327
Paint Care	362	Pretensioners	
Panic Alarm	24	Seat Belts	46
Parking Brake	264	Programmable Electronic Features	185
Passing Light	130		
Personal Settings	185	Radial Ply Tires	286
Pets	70	Radio Operation	236
Phone, Cellular	83	Radio, Satellite (uconnect® studios)	229
Phone, Hands-Free (uconnect®)	83	Rear Fog Lights	373
Placard, Tire and Loading Information	279	Rear Liftgate (Sedan)	34
Power		Rear Seat, Folding	123
Door Locks	27	Rear Window Defroster	159
Mirrors	81	Rear Window Features	158

Rear Wiper/Washer	158	Rotation, Tires	292
Recorder, Event Data	59	Safety Checks Inside Vehicle	73
Recreational Towing	321	Safety Checks Outside Vehicle	73
Refrigerant	350	Safety Defects, Reporting	404
Reminder, Seat Belt	47	Safety, Exhaust Gas	72
Remote Control		Safety Information, Tire	274
Door Locks	20	Safety Tips	71
Security Alarm	18	Satellite Radio Antenna	231
Remote Keyless Entry (Sedan)	20	Satellite Radio (uconnect® studios)	229
Remote Sound System (Radio) Controls	234	Schedule, Maintenance	382
Replacement Bulbs	371	Seat Belt Maintenance	368
Replacement Keys	16	Seat Belt Reminder	47
Replacement Parts	343	Seat Belts	73
Replacement Tires	290	Adjustable Shoulder Belt	42
Reporting Safety Defects	404	Adjustable Upper Shoulder Anchorage	42
Resetting Oil Change Indicator	174	And Pregnant Women	48
Restraints, Child	62,68	Child Restraint	62
Restraints, Infant	63	Front Seat	37
Retractable Cargo Area Cover	155		

Inspection	73	Service Contract	403
Pretensioners	46	Service Engine Soon Light (Malfunction Indicator)	175
Rear Seat	37	Service Manuals	405
Seat Belts (Sedan)	36	Setting the Clock	192,206,209,219
Seats	117	Settings, Personal	185
Adjustment	117	Shift Speeds, Manual Transaxle	253
Head Restraints	120	Shoulder Belts	37
Heated	120	Side Airbag	55
Lumbar Support	119	Side Window Demisters (Defrosters)	244
Rear Folding	123	Signals, Turn	74,177,373
Rear Folding (Sedan)	123	Slippery Surfaces, Driving On	259
Seatback Release	119	Snow Chains (Tire Chains)	291
Tilting	119	Snow Tires	291
Security Alarm (Theft Alarm)	18	Spare Tire	286,287,326
Selection of Oil	345	Specifications	
Sentry Key (Immobilizer)	15	Oil	345
Sentry Key Programming	17	Speed Control (Cruise Control)	134,176
Sentry Key Replacement	16	Speedometer	170
Service Assistance	401		

Speedometer and Odometer	167	Taillights	373
Starting	249	Temperature Gauge, Engine Coolant	169,325
Automatic Transmission	249	Tether Anchor, Child Restraint	66
Engine Fails to Start	250	Theft Alarm (Security Alarm)	18
Manual Transmission	249	Theft System (Security Alarm)	18
Starting Procedures	249	Tie Down Hooks, Cargo	157
Steering		Tilt Steering Column	134
Power	262,263	Tire and Loading Information Placard	279
Tilt Column	134	Tire Identification Number (TIN)	278
Steering Wheel Mounted Sound		Tire Markings	274
System Controls	234	Tire Safety Information	274
Storage	371	Tires	73,283,406
Stuck, Freeing	333	Aging (Life of Tires)	289
Sun Roof	144	Air Pressure	283
Sun Visor Extension	83	Chains	291
Supplemental Restraint System - Airbag	49	Changing	326
Synthetic Engine Oil	346	Compact Spare	286
Tachometer	170	Flat Changing	331
		General Information	283

High Speed	285	24-Hour Towing Assistance	98
Inflation Pressures	284	Disabled Vehicle	334
Jacking	326	Guide	313
Life of Tires	289	Recreational	321
Load Capacity	279	Weight	313
Pressure Monitor System (TPMS)	293	Towing Assistance	98
Pressure Warning Light	172	Traction	259
Quality Grading	406	Trailer Towing	310
Radial	286	Cooling System Tips	320
Replacement	290	Hitches	312
Rotation	292	Minimum Requirements	315
Safety	274,283	Trailer and Tongue Weight	314
Sizes	276	Wiring	318
Snow Tires	291	Trailer Towing Guide	313
Spare Tire	326	Trailer Weight	313
Spinning	288	Transaxle	253
Tread Wear Indicators	288	Automatic	12,249,253,361
Tongue Weight/Trailer Weight	314	Autostick	257
Towing	310	Manual	14,249,251

- Operation 253
- Overdrive 257
- Selection of Lubricant 361
- Transmission
 - Range Indicator 172
- Transmitter Battery Service
(Remote Keyless Entry) 25
- Transmitter, Garage Door Opener (HomeLink®) . . 138
- Transporting Pets 70
- Tread Wear Indicators 288
- Trip Odometer 174
- Trip Odometer Reset Button 176
- Turn Signals 128,177,373

- uconnect® (Hands-Free Phone) 83
- Understanding Your Instrument Panel 166
- Uniform Tire Quality Grades 406
- Universal Transmitter 138
- Unleaded Gasoline 301

- Vanity Mirrors 83
- Vehicle Certification Label 308
- Vehicle Identification Number (VIN) 6
- Vehicle Loading 279,307,309
- Vehicle Modifications/Alterations 7
- Vehicle Storage 371
- Vehicle Theft Alarm (Security Alarm) 18
- Voice Recognition System (VR) 112

- Warning Lights
(Instrument Cluster Description) 169
- Warnings and Cautions 6
- Warranty Information 404
- Washer, Adding Fluid 351
- Washers, Windshield 132
- Washing Vehicle 363
- Water
 - Driving Through 260
- Wheel and Wheel Trim 364

Wheel and Wheel Trim Care	364	Power	32
Wind Buffeting	147	Windshield Defroster	73
Window Airbag (Side Curtain)	50	Windshield Washers	131,132
Window Fogging	243	Windshield Wipers	131,350
Windows	32	Wipers, Intermittent	132

INSTALLATION OF RADIO TRANSMITTING EQUIPMENT

Special design considerations are incorporated into this vehicle's electronic system to provide immunity to radio frequency signals. Mobile two-way radios and telephone equipment must be installed properly by trained personnel. The following must be observed during installation.

The positive power connection should be made directly to the battery and fused as close to the battery as possible. The negative power connection should be made to body sheet metal adjacent to the negative battery connection. This connection should not be fused.

Antennas for two-way radios should be mounted on the roof or the rear area of the vehicle. Care should be used in mounting antennas with magnet bases. Magnets may affect the accuracy or operation of the compass on vehicles so equipped.

The antenna cable should be as short as practical and routed away from the vehicle wiring when possible. Use only fully shielded coaxial cable.

Carefully match the antenna and cable to the radio to ensure a low Standing Wave Ratio (SWR).

Mobile radio equipment with output power greater than normal may require special precautions.

All installations should be checked for possible interference between the communications equipment and the vehicle's electronic systems.



Chrysler LLC
81-226-0939



Second Edition

Printed in U.S.A.