

2008 Caravan



DODGE

2008

Caravan

OWNER'S MANUAL

VEHICLES SOLD IN CANADA

With respect to any Vehicles Sold in Canada, the name Chrysler LLC shall be deemed to be deleted and the name Chrysler Canada Inc. used in substitution therefor.

DRIVING AND ALCOHOL

Drunken driving is one of the most frequent causes of accidents.

Your driving ability can be seriously impaired with blood alcohol levels far below the legal minimum. If you are drinking, don't drive. Ride with a designated non-drinking driver, call a cab, a friend, or use public transportation.

WARNING!

Driving after drinking can lead to an accident. Your perceptions are less sharp, your reflexes are slower, and your judgment is impaired when you have been drinking. Never drink and then drive.

This manual illustrates and describes the operation of features and equipment that are either standard or optional on this vehicle. This manual may also include a description of features and equipment that are no longer available or were not ordered on this vehicle. Please disregard any features and equipment described in this manual that are not on this vehicle.

Chrysler LLC reserves the right to make changes in design and specifications, and/or make additions to or improvements to its products without imposing any obligation upon itself to install them on products previously manufactured.

Copyright © 2007 Chrysler LLC



TABLE OF CONTENTS

SECTION		PAGE	
1	INTRODUCTION	3	1
2	THINGS TO KNOW BEFORE STARTING YOUR VEHICLE	9	2
3	UNDERSTANDING THE FEATURES OF YOUR VEHICLE	97	3
4	UNDERSTANDING YOUR INSTRUMENT PANEL	219	4
5	STARTING AND OPERATING	321	5
6	WHAT TO DO IN EMERGENCIES	409	6
7	MAINTAINING YOUR VEHICLE	431	7
8	MAINTENANCE SCHEDULES	489	8
9	IF YOU NEED CONSUMER ASSISTANCE	497	9
10	INDEX	507	10

INTRODUCTION

CONTENTS

■ Introduction	4	■ Vehicle Identification Number	6
■ How To Use This Manual	4	■ Vehicle Modifications/Alterations	7
■ Warnings And Cautions	6		

INTRODUCTION

This Owner's Manual has been prepared with the assistance of service and engineering specialists to acquaint you with the operation and maintenance of your vehicle. It is supplemented by a Warranty Information Booklet and various customer-oriented documents. You are urged to read these publications carefully. Following the instructions and recommendations in this manual will help assure safe and enjoyable operation of your vehicle.

NOTE: After you read the manual, it should be stored in the vehicle for convenient reference and remain with the vehicle when sold, so that the new owner will be aware of all safety warnings.







































When it comes to service, remember that your authorized dealer knows your vehicle best, has the factory-trained technicians and genuine Mopar® parts, and is interested in your satisfaction.

HOW TO USE THIS MANUAL

Consult the Table of Contents to determine which section contains the information you desire.

The detailed Index at the back of this manual contains a complete listing of all subjects.

Consult the following table for a description of the symbols that may be used on your vehicle or throughout this Owner's Manual.

											ESP BAS ELECTRONIC STABILITY PROGRAM / BRAKE ASSIST SYSTEM
											BRAKE BRAKE SYSTEM WARNING PARKING BRAKE
										AWD!	 FAILURE OF ANTI-LOCK BRAKING SYSTEM
										4WD!	BRAKE BRAKE SYSTEM WARNING PARKING BRAKE
											TOW/HAUL TOW / HAUL
											4 LOW FOUR WHEEL DRIVE LOW
			SRS AIRBAG SUPPLEMENTAL RESTRAINT SYSTEM								

WARNINGS AND CAUTIONS

This manual contains **WARNINGS** against operating procedures that could result in an accident or bodily injury. It also contains **CAUTIONS** against procedures that could result in damage to your vehicle. If you do not read this entire manual you may miss important information. Observe all Warnings and Cautions.

VEHICLE IDENTIFICATION NUMBER

The Vehicle Identification Number (VIN) is found on the left front corner of the instrument panel, visible through the windshield. This number also appears on the Automobile Information Disclosure Label affixed to a window on your vehicle, the vehicle registration and title.

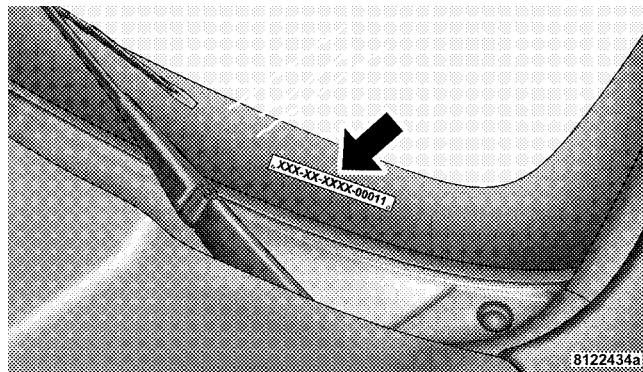

Vehicle Identification Number

NOTE: It is illegal to remove the VIN.

VEHICLE MODIFICATIONS/ALTERATIONS**WARNING!**

Any modifications or alterations to this vehicle could seriously affect its roadworthiness and safety and may lead to an accident resulting in serious injury or death.

THINGS TO KNOW BEFORE STARTING YOUR VEHICLE

CONTENTS

■ A Word About Your Keys	12	■ Remote Starting System — If Equipped	28
□ Wireless Ignition Node (WIN)	12	□ How To Use Remote Start	28
■ Sentry Key® Immobilizer System	15	■ Door Locks	31
□ Replacement Keys	16	□ Manual Door Locks	31
■ Security Alarm System — If Equipped	18	□ Power Door Locks — If Equipped	32
□ Rearming Of The System	18	■ Windows	36
■ Illuminated Entry System — If Equipped	20	□ Power Vent Windows — If Equipped	36
■ Remote Keyless Entry (RKE) — If Equipped	21	□ Power Windows	37
□ Using The RKE Transmitter	21	■ Sliding Side Door	41

10 THINGS TO KNOW BEFORE STARTING YOUR VEHICLE

□ Power Sliding Side Door — If Equipped	42	□ Seat Belt Pretensioners	64
□ Sliding Side Door Child Protection Lock	46	□ Enhanced Seat Belt Use Reminder System (BeltAlert®)	64
■ Liftgate	48	□ Seat Belts And Pregnant Women	65
□ Power Liftgate — If Equipped	49	□ Seat Belt Extender	66
■ Storage Bin Safety Warning	52	□ Supplemental Restraint System (SRS) - Airbag	66
□ Safety Warnings	52	□ Airbag System Components	67
□ Storage Bin Cover Emergency Release Strap — If Equipped	54	□ Front Seat Airbag Features	67
□ Reinstalling Storage Bin Cover Emergency Release Strap	54	□ Airbag Deployment Sensors And Controls	72
■ Occupant Restraints	55	□ Event Data Recorder (EDR)	78
□ Lap/Shoulder Belts	57	□ Integrated Child Seat — If Equipped	80
□ Automatic Locking Retractors (ALR) Mode — If Equipped	63	□ Child Restraints	81
		■ Rear Seat Delete Feature (Commercial Vehicles Only) — If Equipped	89

□ Restraining Infants And Small Children With Seat
Delete Feature (Commercial Vehicles Only)90

■ Engine Break-In Recommendations93

■ Safety Tips93

□ Safety Checks You Should Make Inside The
Vehicle93

□ Periodic Safety Checks You Should Make
Outside The Vehicle94

A WORD ABOUT YOUR KEYS

Your vehicle uses a keyless ignition system. This system consists of a Remote Keyless Entry (RKE) transmitter with integrated ignition Key and a Wireless Ignition Node (WIN) with integral ignition switch. You can insert the double-sided key into the ignition switch with either side up.

Wireless Ignition Node (WIN)

The Wireless Ignition Node (WIN) operates similar to an ignition switch. It has four operating positions, three of which are detented and one spring-loaded. The detented positions are OFF, ACC, and ON. The START position is a spring-loaded momentary contact position. When released from the START position, the switch automatically returns to the detented ON position.

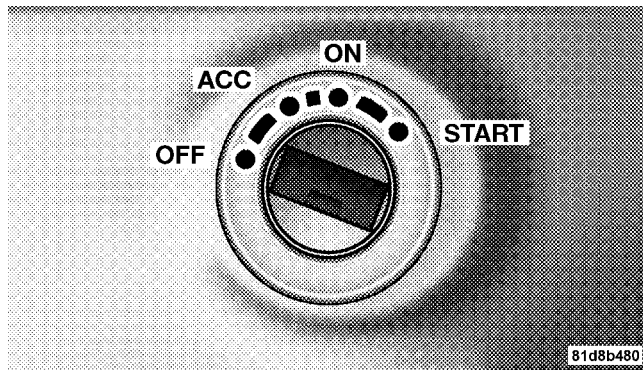

WIN Ignition Positions

Integrated Ignition Key

The integrated ignition key operates the ignition switch. It also contains the Remote Keyless Entry (RKE) transmitter and a valet key, which stores in the rear of the transmitter.

The valet key allows for entry into the vehicle should the battery in the vehicle or the transmitter go dead. The valet key is also for locking the glove box. You can keep the valet key with you when valet parking.

To remove the valet key from the transmitter, slide the mechanical latch at the top of the transmitter sideways with your thumb and then pull the key out with your other hand.

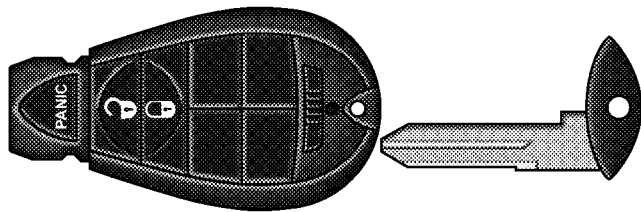

81bb182d

Valet Key Removal

NOTE: You can insert the double-sided valet key into the lock cylinder with either side up.

Tip Start Feature

1. Do not press the accelerator pedal during this process.

14 THINGS TO KNOW BEFORE STARTING YOUR VEHICLE

2. Insert the integrated ignition key into the ignition switch.

3. Turn the ignition switch to the START position and release it as soon as the starter engages.

The starter motor will continue to run and will disengage automatically when the engine begins running.

Ignition Key Removal

Place the gear selector lever in PARK. Turn the ignition key to the OFF position and then remove the key.

NOTE: Power Window switches will also remain active for up to 90 seconds after the ignition switch has been turned OFF, depending upon the accessory delay setting. Opening the front door will cancel this feature.

WARNING!

NEVER leave children alone in a vehicle. Leaving unattended children in a vehicle is dangerous for a number of reasons. A child or others could be seriously or fatally injured. Don't leave the key in the ignition. A child could operate power windows, other controls, or move the vehicle

CAUTION!

An unlocked car is an invitation to thieves. Always remove the key from the ignition and lock all doors when leaving the vehicle unattended.

Key-In-Ignition Reminder

If you open the driver's door with the integrated ignition key in the ignition, a chime will sound to remind you to remove the key.

NOTE: The Key-In-Ignition reminder only sounds when the integrated ignition key is placed in the OFF or ACC position.

SENTRY KEY® IMMOBILIZER SYSTEM

The Sentry Key® Immobilizer system prevents unauthorized vehicle operation by disabling the engine. The system does not need to be armed or activated. Operation is automatic, regardless of whether the vehicle is locked or unlocked.

The system uses the factory-mated Remote Keyless Entry (RKE) transmitter with integrated key and Wireless Ignition Node (WIN) to prevent unauthorized vehicle operation. Therefore, only RKE transmitters that are programmed to the vehicle can be used to start and operate

the vehicle. The system will not allow the engine to crank if an invalid RKE transmitter is used to operate the ignition switch.

After turning the ignition switch to the ON position, the Vehicle Security Alarm Indicator Light located on the instrument cluster will turn on for three seconds for a bulb check. If the light remains on after the bulb check, it indicates that there is a problem with the electronics. In addition, if the light begins to flash after the bulb check, it indicates that someone used an invalid RKE transmitter to start the engine. Either of these conditions will result in the engine being shut off after two seconds.

If the Vehicle Security Alarm Indicator Light, located on the instrument cluster, turns on during normal vehicle operation (vehicle running for longer than 10 seconds), it indicates that there is a fault in the electronics. Should this occur, have the vehicle serviced as soon as possible.

NOTE:

- The Sentry Key® Immobilizer system is not compatible with aftermarket remote starting systems. Use of these systems may result in vehicle starting problems and loss of security protection.
- Exxon/Mobil Speedpass™, additional RKE transmitters, or any other transponder-equipped components on the same key chain **will not** cause a fault unless the additional part is **physically held against the transmitter** being used to start the vehicle. Cell phones, pagers, or other RF electronics will not cause interference with this system.

All of the RKE transmitters provided with your new vehicle have been programmed to the vehicle electronics.

Replacement Keys

NOTE: Only RKE transmitters that are programmed to the vehicle electronics can be used to start and operate the vehicle. Once a transmitter is programmed to a vehicle, it cannot be programmed to any other vehicle.

CAUTION!

Always remove the keys from the vehicle and lock all doors when leaving the vehicle unattended.

At the time of purchase, the original owner is provided with a four-digit Personal Identification Number (PIN). Keep the PIN in a secure location. This number is required for authorized dealer replacement of RKE transmitters. Duplication of RKE transmitters may be performed at an authorized dealer or by using the Customer Key Programming procedure. This procedure consists of

programming a blank transmitter to the vehicle electronics. A blank transmitter is one that has never been programmed.

NOTE: When having the Sentry Key® Immobilizer system serviced, bring all vehicle RKE transmitters with you to the authorized dealer.

Customer Key Programming

If you have two valid RKE transmitters with integrated keys, you can program new transmitters to the system by performing the following steps:

1. Insert the first valid integrated key into the ignition switch and turn the ignition switch to the ON position for at least three seconds, but no longer than 15 seconds. Turn the ignition switch to the OFF position and remove the first key.
2. Insert the second valid integrated key and turn the ignition switch to the ON position within 15 seconds.

After 10 seconds, a chime will sound and the Vehicle Security Alarm Indicator Light will begin to flash. Turn the ignition switch to the OFF position and remove the second key.

3. Insert a blank integrated key into the ignition switch and turn the ignition switch to the ON position within 60 seconds. After 10 seconds, a single chime will sound and the Vehicle Security Alarm Indicator Light will stop flashing, turn the ignition switch on again for three seconds, and then turn it off.

The new integrated key is programmed. **The Remote Keyless Entry (RKE) transmitter will also be programmed during this procedure.**

Repeat this procedure to program up to eight keys. If you do not have a programmed RKE transmitter with integrated key, contact your authorized dealer for details.

NOTE: If a programmed key is lost, see your authorized dealer to have all remaining keys erased from the system's memory. This will prevent the lost key from starting your vehicle. The remaining keys must then be reprogrammed. All vehicle keys must be taken to an authorized dealer at the time of service to be reprogrammed.

General Information

The Sentry Key® system complies with FCC rules Part 15 and with RSS-210 of Industry Canada. Operation is subject to the following conditions:

- This device may not cause harmful interference.
- This device must accept any interference that may be received, including interference that may cause undesired operation.

SECURITY ALARM SYSTEM — IF EQUIPPED

The Vehicle Security Alarm system monitors the vehicle doors for unauthorized entry and the ignition switch for unauthorized operation. When the alarm is activated, the system provides both audible and visual signals. For the first three minutes the horn will sound and the headlights and Vehicle Security Alarm Indicator Light will flash repeatedly. For an additional 15 minutes only the headlights and security telltale will flash. The engine will run only if a valid key is used to start the vehicle.

Rearming Of The System

The Security System will rearm itself after the 15 additional minutes of headlights and Vehicle Security Alarm Indicator Light flashing, if the system has not been disabled. If the condition which initiated the alarm is still present, the system will ignore that condition and monitor the remaining doors and ignition.

Arming The System

Remove the key from the ignition switch and either press a power door lock switch while the driver or passenger door is open or press the LOCK button on the Remote Keyless Entry (RKE) transmitter. After all the doors are locked and closed the Vehicle Security Alarm Indicator Light in the instrument cluster will flash rapidly to signal that the system is arming. The Vehicle Security Alarm Indicator Light in the instrument panel cluster will flash rapidly for about 16 seconds to indicate that the alarm is being set. After the alarm is set, the Vehicle Security Alarm Indicator Light, located in the lower center section of the instrument cluster, will flash at a slower rate to indicate that the system is armed.

NOTE: If the Vehicle Security Alarm Indicator Light stays on continuously during vehicle operation, have the system checked by your authorized dealer.

Disarm The System

Either press the UNLOCK button on the RKE transmitter or insert a valid ignition key into the ignition switch and turn the key to the ON position.

NOTE:

- The driver's door key cylinder and the liftgate button on the RKE transmitter cannot arm or disarm the system.
- The system remains armed during liftgate entry. Pressing the liftgate button will not disarm the system. If someone enters the vehicle through the liftgate and opens any door the alarm will sound.
- When the system is armed, the interior power door lock switches will not unlock the doors.

The Vehicle Security Alarm system is designed to protect your vehicle; however, you can create conditions where the system will give you a false alarm. If one of the

previously described arming sequences has occurred, the system will arm regardless of whether you are in the vehicle or not. If you remain in the vehicle and open a door, the alarm will sound. If this occurs, disarm the system.

If the Security Alarm System is armed and the battery becomes disconnected, the system will remain armed when the battery is reconnected; the exterior lights will flash, the horn will sound, and the ignition will not start the vehicle. If this occurs, disarm the system.

Tamper Alert

If something has triggered the system in your absence, the horn will sound three times when you unlock the doors and the security telltale light will flash for 30 seconds. Check the vehicle for tampering.

Security System Manual Override

The system will not arm if you lock the doors using the manual door lock plunger.

ILLUMINATED ENTRY SYSTEM — IF EQUIPPED

The courtesy lights will turn on when you use the Remote Keyless Entry (RKE) transmitter or open the doors. This feature is only available if you have RKE.

The lights will fade to off after approximately 10 seconds or they will immediately fade to off once the ignition switch is turned ON.

NOTE:

- The front courtesy overhead console, door courtesy and liftgate lights do not turn on if the dimmer control is in the interior lights ON position (extreme top position).
- The Illuminated Entry System will not operate if the dimmer control is in the extreme downward position.

REMOTE KEYLESS ENTRY (RKE) — IF EQUIPPED

This system allows you to lock or unlock the doors and liftgate, and activate the PANIC alarm, optional power liftgate, left power sliding door, and right power sliding door from distances up to about 23 ft (7 m) using a hand-held radio RKE transmitter. The RKE transmitter need not be pointed at the vehicle to activate the system.

NOTE: If the key is in the ignition switch, then all buttons on that RKE transmitter will be disabled. The buttons on the remaining transmitters will work. If the gear selector lever is out of PARK, all the RKE transmitter buttons are disabled for all keys.

Two transmitters may be supplied with the vehicle. Vehicles built without the powered options will be equipped from the factory with three-button transmitters and those built with power options will be equipped with up to seven-buttons on the transmitter.

Using The RKE Transmitter

Three-button transmitters will provide basic UNLOCK, LOCK and PANIC functions.

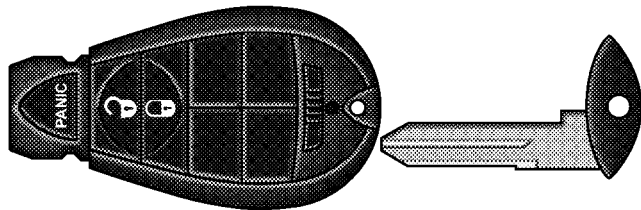

81bb182d

Three-Button RKE transmitter Fob With Integrated Key

Seven-button transmitters will provide functions that allow the same basic operation as the three-button, but may also be used to OPEN/CLOSE the optional power liftgate, left power sliding door, or right power sliding door. Other options of the system allow you to turn ON/OFF the Sound Horn with Remote Lock and Flash Lights with Remote Key LOCK features.

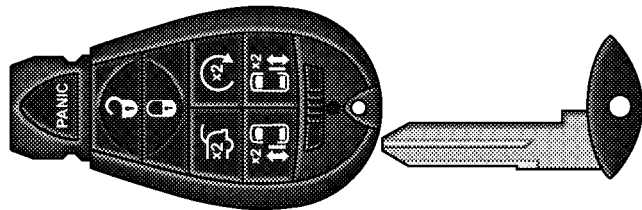

81bb182e

Seven-Button RKE transmitter Fob With Integrated Key

To UNLOCK Doors And Liftgate

Press and release the UNLOCK button on the RKE transmitter once to unlock the driver's door or twice to unlock all doors and liftgate. The illuminated entry system also turns on.

Remote Key Unlock

This feature lets you program the system to unlock either the driver's side door or all doors on the first press of the UNLOCK button on the RKE transmitter.

- For vehicles equipped with the Electronic Vehicle Information Center (EVIC), refer to "Remote Key Unlock," under "Personal Settings (Customer Programmable Features)" under "Electronic Vehicle Information Center (EVIC)" in Section 4 of this manual for details.

- For vehicles not equipped with the EVIC, the Remote UNLOCK feature can be enabled or disabled by performing the following procedure:

1. Perform this operation while standing outside the vehicle.
2. Press the LOCK button for five to ten seconds.
3. While the LOCK button is pressed, (after five seconds) press the UNLOCK button. Release both buttons.

The Remote Key Unlock feature can be reactivated by repeating the above procedure or by performing the procedure in the Electronic Vehicle Information Center (EVIC), Customer Programmable Features section on vehicles so equipped.

To LOCK Doors And Liftgate

Press and release the LOCK button on the RKE transmitter to lock all doors and liftgate. The horn will chirp once to acknowledge the signal.

Sound Horn With Remote Key Lock

This feature will cause the horn to chirp when the doors are locked with the RKE transmitter.

If desired, the Sound Horn with Remote Key Lock feature can be turned on and off by performing the following procedure:

1. Perform this operation while standing outside the vehicle.
2. Press the LOCK button for five to ten seconds.
3. While the LOCK button is pressed (after five seconds), press the PANIC button. Release both buttons.

The Sound Horn with Remote Key Lock feature can be reactivated by repeating this procedure or by performing the procedure in the Electronic Vehicle Information Center (EVIC), Customer Programmable Features section on vehicles so equipped.

Using The PANIC Alarm

To turn the PANIC Alarm feature ON or OFF, press and hold the PANIC button on the RKE transmitter for at least one second and release. When the PANIC Alarm is on, the headlights and park lights will flash, the horn will pulse on and off and the interior lights will turn on.

The PANIC Alarm will stay on for three minutes unless you turn it off by pressing the PANIC button a second time or by turning the ignition switch to the ON position.

NOTE: When you turn off the PANIC Alarm by pressing the PANIC button a second time, you may have to be closer to the vehicle due to the radio frequency noises of the system.

Open/Close Power Liftgate — If Equipped

Press the LIFTGATE button twice on the RKE transmitter within five seconds to Open/Close Power Liftgate. The liftgate will beep for three seconds and then open/close. If the button is pushed while the liftgate is being power closed, the liftgate will reverse to the full open position.

If the liftgate is locked and is not equipped with a powered liftgate, pressing the button twice will result in the liftgate becoming unlocked for 30 seconds allowing you to manually access the liftgate area.

The power liftgate may also be opened and closed by pressing the button located on the overhead console.

If equipped with a rear interior switch on the left rear pillar, pushing once will close the liftgate only. The liftgate cannot be opened from this switch.

Open/Close Power Left Power Sliding Door — If Equipped

Press the Left Power Sliding Door button twice on the RKE transmitter within five seconds to Open/Close Power Left Power Sliding Door. If the button is pushed while the door is being power-closed, the door will reverse to the full open position.

Open/Close Power Right Power Sliding Door — If Equipped

Press the Right Power Sliding Door button twice on the RKE transmitter within five seconds to Open/Close Power Right Power Sliding Door. If the button on the RKE transmitter is pushed while the door is being power closed, the door will reverse to the full open position.

Turn Off Flash Lights With Remote Key Lock — If Equipped

If desired, the Flash Lights With Remote Key Lock feature can be turned on and off by performing the following procedure:

1. Perform this operation while standing outside the vehicle.
2. Press the UNLOCK button on the RKE transmitter for five to ten seconds.
3. While the UNLOCK button on the RKE transmitter is pressed, (after five seconds) press the LOCK button. Release both buttons.

The Flash Lights with Remote Key Lock feature can be reactivated by repeating this procedure or by performing the procedure in Section Four, “Electronic Vehicle Information Center (EVIC), Customer Programmable Features” on vehicles so equipped.

The table below explains the Lamp Flash options.

Function	Which Turn Signal Lamps	Number of Flashes
Lock	All	1
Unlock 1st Press	Left Side	2
Unlock All Doors	All	2
Left Side	Left Side	2
Right Side	Right Side	2
Liftgate	All	2

Programming Additional RKE Transmitters

Refer to Sentry Key® Immobilizer System “Customer Key Programming.”

If you do not have a programmed RKE transmitter, contact your authorized dealer for details.

Replacing the RKE Transmitter Battery

The recommended replacement battery is one CR2032 battery.

NOTE: Perchlorate Material — special handling may apply. See: www.dtsc.ca.gov/hazardouswaste/perchlorate.

NOTE: Do not touch the battery terminals that are on the back housing or the printed circuit board.

1. Battery access is through a door located on the rear of the RKE transmitter. Insert a small, flat bladed screwdriver into the slot and gently pry open the access door.

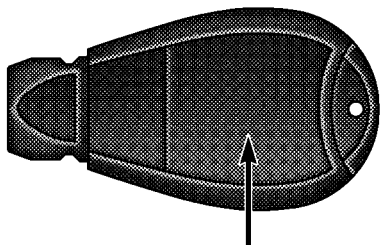
**BATTERY ACCESS DOOR**

81bb1827

Battery Replacement

2. Remove and replace the battery. Avoid touching the new battery with your fingers. Skin oils may cause battery deterioration. If you touch the battery, clean it with rubbing alcohol.
3. Reposition the access door panel over the battery opening and snap into place.

General Information

This device complies with part 15 of the FCC rules and RSS 210 of Industry Canada. Operation is subject to the following conditions:

- This device may not cause harmful interference.
- This device must accept any interference received, including interference that may cause undesired operation.

If your RKE transmitter fails to operate from a normal distance, check for these two conditions.

1. A weak battery in the RKE transmitter. The expected life of the battery is a minimum of three years.
2. Closeness to a radio transmitter such as a radio station tower, airport transmitter, and some mobile or CB radios.

REMOTE STARTING SYSTEM — IF EQUIPPED

Remote Starting conveniently starts the engine from outside the vehicle by using the Remote Keyless Entry (RKE) transmitter while maintaining the Security Alarm System. The Remote Starting System has a targeted range of 328 ft (100 m). In order to Remote Start your vehicle, the hood, liftgate, and all the doors must be closed and the transmission gear selector lever in PARK.

NOTE: Remote Starting requires automatic transaxle-equipped vehicles.

How To Use Remote Start

All of the following conditions must be met before the engine will Remote Start:

- Gear shift lever in PARK
- Doors closed
- Hood closed
- Trunk closed
- HAZARD switch off
- BRAKE switch inactive (brake pedal not pressed)
- Ignition key removed from ignition switch
- Battery at an acceptable charge level, and
- RKE PANIC button not pressed.

To Enter Remote Start Mode

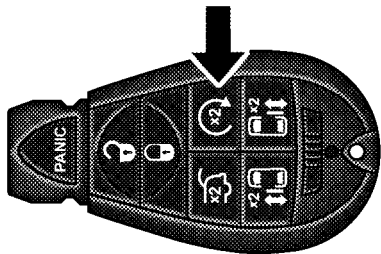

81bbe8f6

Remote Starting Button



Press and release the Remote Start button on the RKE transmitter twice, within five seconds. The parking lights will flash and the horn will

honk twice (if programmed). Then, the engine will start and the vehicle will remain in the Remote Start mode for a 15 minute cycle.

NOTE:

- If your power door locks were unlocked, Remote Start will automatically LOCK the doors.
- The park lights will turn on and remain on during Remote Start mode.
- For security, power window and power sunroof operation (if so equipped) are disabled when the vehicle is in the Remote Start mode.
- The engine can be started two consecutive times (two 15 minute cycles) with the RKE transmitter. However, the ignition switch must be cycled to the ON position before you can repeat the start sequence for a third cycle.

To Enter the Vehicle After Remote Start

To enter the vehicle while the engine is running during a Remote Start, you must first unlock the vehicle using the UNLOCK button on the transmitter. After the vehicle is unlocked, you have 60 seconds to enter the vehicle, insert the key into the ignition switch and move it to the RUN position, otherwise the engine will cancel Remote Starting and automatically turn off.

To Exit Remote Start Mode and Drive the Vehicle

Before the end of the 15 minute cycle, press and release the UNLOCK button on the RKE transmitter to unlock the doors and disarm the Vehicle Security Alarm (if equipped). Then, prior to the end of the 15 minute cycle, insert the key into the ignition switch and turn the switch to the ON position.

NOTE:

- The ignition switch must be in the ON position in order to drive the vehicle.

- For vehicles equipped with the Electronic Vehicle Information Center (EVIC), the message “Insert Key/ Turn To Run” will flash in the EVIC until you insert the key. Once inserted, the message “Turn To Run” will flash in the EVIC until you turn the key to run.

Cancel Remote Start

Remote Starting will also cancel if any of the following occur:

- The engine stalls or RPM exceeds 2500.
- Any engine warning telltale lights come on.
- The hood is opened.
- The Hazard Switch is pressed.
- The transmission gear selector lever is moved out of PARK.
- Pressing the brake pedal.
- Allow the engine to run for the entire 15 minute cycle.

To Turn Off the Engine While in Remote Start Mode

Press and release the Remote Start button one time.

NOTE: To avoid inadvertent shut downs, the system will disable the one time press of the Remote Start button for two seconds after receiving a valid Remote Start request.

When To Reset Remote Start

The vehicle can be started remotely up to a maximum of two times. The vehicle is also allowed a maximum of one failed start, where the Remote Starting sequence was initiated but the engine stopped cranking without starting. After either of these conditions, or if the Security Alarm System is alarming, or if the PANIC button was pressed, the vehicle must be reset by inserting a valid key into the ignition switch, rotating to the RUN position, and then rotating back to the LOCK/OFF position.

DOOR LOCKS

MANUAL DOOR LOCKS

Lock the doors by pushing down on the lock plungers on each door trim panel.

2

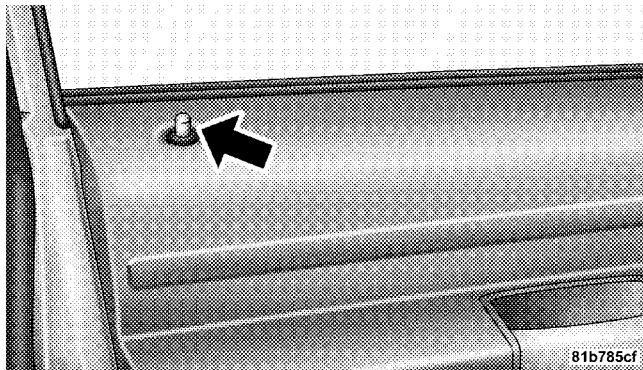

Manual Door Lock Plunger

If the lock plunger is down when you shut the door, the door will lock. Therefore, make sure the keys are not inside the vehicle before closing the door.

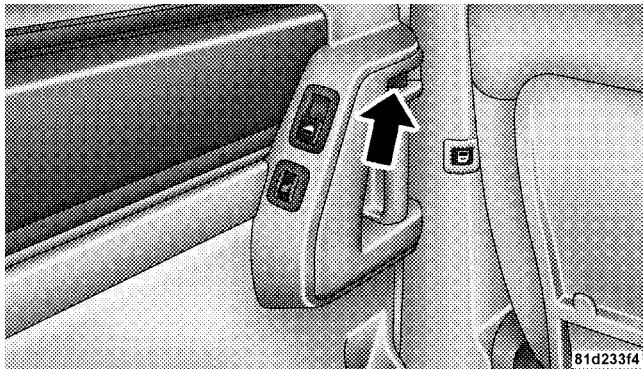

Sliding Door Lock Features

WARNING!

- For personal security and safety in the event of an accident, lock the vehicle doors as you drive as well as when you park and leave the vehicle.
- When leaving the vehicle always remove the key and from the ignition lock, and lock your vehicle. Do not leave unattended children in the vehicle, or with access to an unlocked vehicle. Unsupervised use of vehicle equipment may cause severe personal injuries and death.

Power Door Locks — If Equipped

A power door lock switch is located on each front door trim panel. Use this switch to lock or unlock the doors.

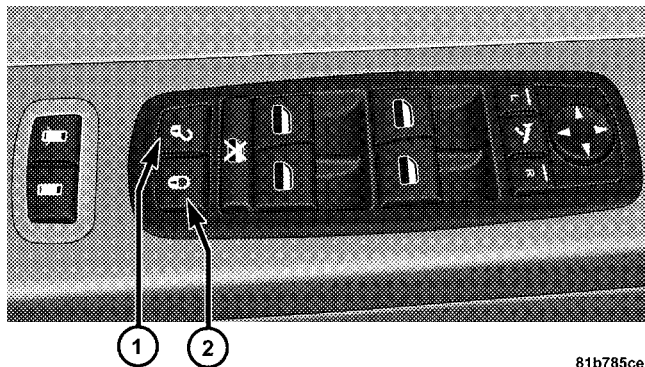

81b785ce

Driver Power Door Locks

1 - Unlock

2 - Lock

If you press the power door lock switch while the key is in the ignition, and any front door is open, the power locks will not operate. This prevents you from accidentally locking your keys in the vehicle. Removing the key or closing the door will allow the locks to operate. A

chime will sound if the key is in the ignition switch and a door is open, as a reminder to remove the key.

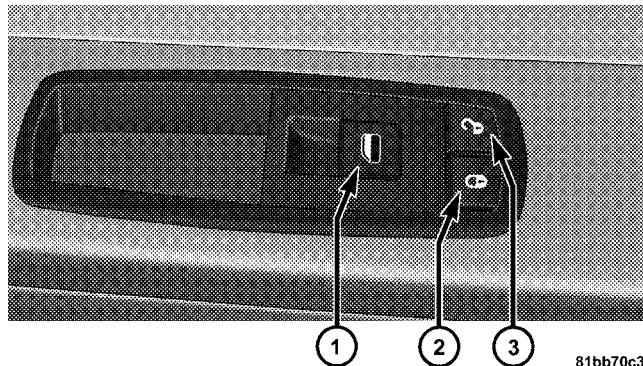

81bb70c3

Front Passenger Power Door Switch Features

1 - Window Open/Close

3 - Doors Unlock

2 - Doors Lock

If you press the power door lock switch while the sliding door is open, the sliding door will lock.

Lock Doors Automatically — If Equipped

If the Lock Doors Automatically feature is enabled, your door locks will lock automatically when the vehicle's speed exceeds 15 mph (24 km/h).

The Lock Doors Automatically feature is enabled when your vehicle is shipped from the assembly plant and can be disabled by using the following procedure:

- On Electronic Vehicle Information Center (EVIC) equipped vehicles, refer to "Personal Settings" in the EVIC section of this manual.
- On non EVIC-equipped vehicles perform the following steps:
 1. Enter your vehicle and close all doors.
 2. Fasten your seat belt. (Fastening the seat belt will cancel any chiming that may confuse you during this programming procedure.)

3. Place the key into the ignition.
4. Within 15 seconds cycle the ignition key from the OFF position to the ON/RUN position a minimum of four times, ending in the OFF position (**do not start the engine**).
5. Within 30 seconds, press the driver's door lock switch in the lock direction.
6. A single chime will be heard to indicate the feature has been disabled.
7. To reactivate this feature, repeat the above steps.
8. If a chime is not heard, the program mode was canceled before the feature could be disabled. If necessary, repeat the above procedure.

The Lock Doors Automatically at 15 mph (24 km/h) feature can be reactivated by repeating the above mentioned procedure or by performing the procedure in the EVIC, Customer Programmable Features section on vehicles so equipped.

Unlock Doors Automatically On Exit — If Equipped

The Unlock Doors Automatically On Exit feature unlocks all of the doors of the vehicle when any door is opened. This will occur only after the gear selector lever has been shifted into the PARK position after the vehicle has been driven (the gear selector lever has been shifted out of PARK and all doors closed).

The Unlock Doors Automatically On Exit feature will not operate if there is any manual operation of the power door locks (lock or unlock).

The Unlock Doors Automatically On Exit feature can be enabled or disabled by performing the following procedure:

1. Enter your vehicle and close all doors.
2. Fasten your seat belt. (Fastening the seat belt will cancel any chimes that may be confusing during this programming procedure.)
3. Insert the key into the ignition switch.
4. Within 15 seconds, cycle the ignition key from the OFF position to the ON/RUN position a minimum of four times ending in the OFF position (**Do not start the engine**).
5. Within 30 seconds, press the driver's door lock switch in the unlock direction.
6. A single chime will sound to indicate the feature has been changed.

- To reactivate this feature, repeat the above steps.
- If a chime is not heard, the program mode was canceled before the feature could be changed. If necessary, repeat the above procedure.

The Unlock Doors Automatically On Exit feature can be reactivated by repeating the above mentioned procedure or by performing the procedure in the EVIC, Customer Programmable Features section on vehicles so equipped.

NOTE: Use the Lock Doors Automatically at 15 mph (24 km/h) and Unlock Doors Automatically On Exit features in accordance with local laws.

WINDOWS

POWER VENT WINDOWS — IF EQUIPPED

Switches on the driver's door trim panel let the driver operate the two vent windows from the driver's seat.

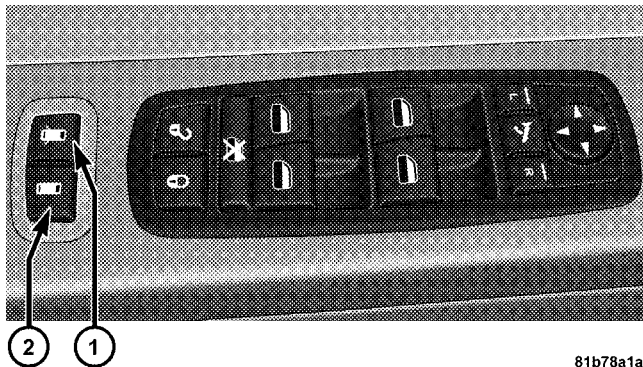

81b78a1a

Power Vent Window Switches

1 — Open

2 — Close

POWER WINDOWS

You can control all windows using switches on the driver's door trim panel. The switches will operate only when the ignition switch is in the ON or ACC position and during power accessory delay.

NOTE: Power Window switches will also remain active for up to 90 seconds after the ignition switch has been turned OFF, depending upon the accessory delay setting. Opening the front door will cancel this feature.

Driver's Master Power Window Switches

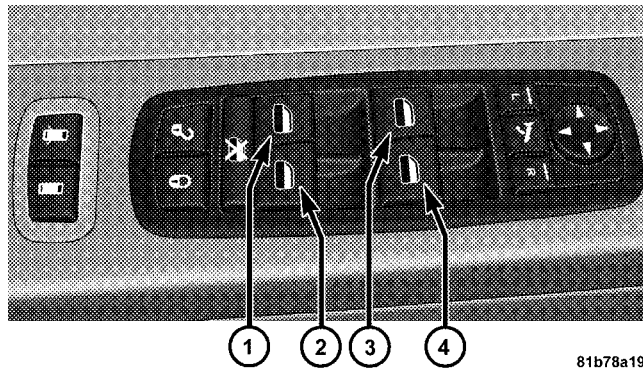

81b78a19

Driver's Power Window Switches

1 - Left Rear
2 - Right Rear

3 - Left Front
4 - Right Front

Power Window Lockout Switch — If Equipped

The driver may lock out all power windows by depressing the bar switch just below the power window switches.

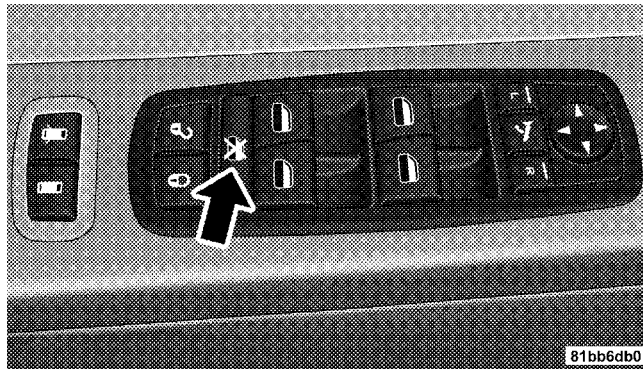

Power Window Lockout Switch

Front Passenger Power Window Switch

There is a single switch on the front passenger's door trim panel which operates the passenger door window

and locks and unlocks all doors. The switch will operate only when the ignition switch is in the ON or ACC position and during power accessory delay.

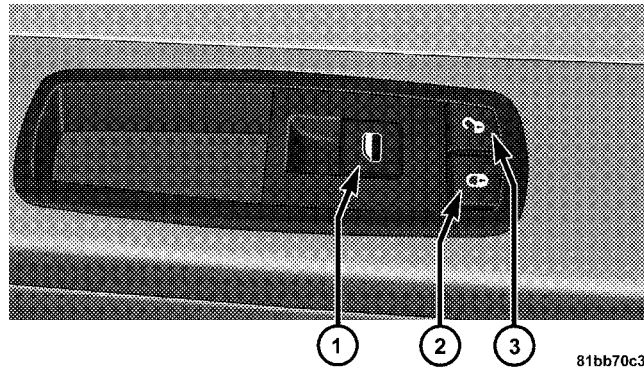

Front Passenger Power Switches

1 - Window Open/Close
2 - Doors Lock

3 - Doors Unlock

Sliding Side Door Power Window Switch

There is a single switch on each sliding side door which operates the sliding side door window.

The switches will operate only when the ignition switch is in the ON or ACC position.

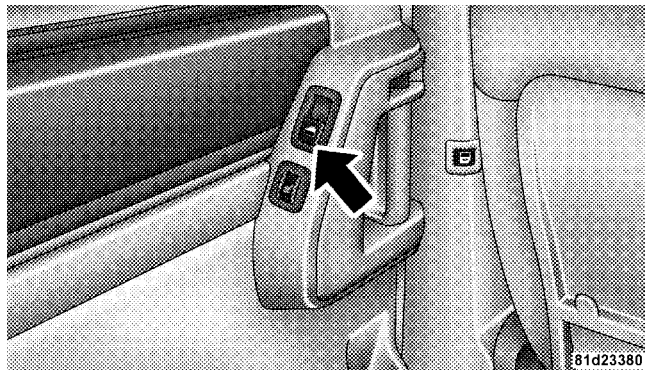

Sliding Door Power Window Switch

NOTE: The sliding door windows do not fully open, stopping several inches above the window sill.

Auto Down Feature — If Equipped

The left and right front window switches may be equipped with an auto down feature. Press the window switch past the detent, release, and the window will go down automatically.

To open the window part way, press the window switch part way and release it when you want the window to stop.

The power window switches remain active for up to 90 seconds (depending on the accessory delay setting) after the ignition switch has been turned off. Opening a vehicle front door will cancel this feature.

Auto Up Feature With Anti-Pinch Protection — If Equipped

The left front window switch may be equipped with an Auto Up feature. Lift the window switch to the second detent, release, and the window will go up automatically.

To stop the window from going all the way up during the Auto Up operation, push down on the switch briefly.

To close the window part way, lift the window switch to the first detent and release when you want the window to stop.

NOTE:

- If the window runs into any obstacle during auto-close, it will reverse direction and then stop. Remove the obstacle and use the window switch again to close the window.

- Any impact due to rough road conditions may trigger the auto reverse function unexpectedly during auto-close. If this happens, pull the switch lightly to the first detent and hold to close window manually.

WARNING!

There is no anti-pinch protection when the window is almost closed. To avoid personal injury be sure to clear your arms, hands, fingers and all objects from the window path before closing.

Auto Up Reset — If Equipped

To reactivate the Auto Up feature, perform the following steps after vehicle power is restored:

1. Pull the window switch up to close the window completely and continue to hold the switch up for an additional two seconds after the window is closed.

2. Push the window switch down firmly to the second detent to open the window completely and continue to hold the switch down for an additional two seconds after the window is fully open.

Wind Buffeting

Wind buffeting can be described as the perception of pressure on the ears or a helicopter-type sound in the ears. Your vehicle may exhibit wind buffeting with the windows down, or the sunroof (if equipped) in certain open or partially open positions. This is a normal occurrence and can be minimized. If the buffeting occurs with the rear windows open, open the front and rear windows together to minimize the buffeting. If the buffeting occurs with the sunroof open, adjust the sunroof opening to minimize the buffeting.

SLIDING SIDE DOOR

The sliding door may be opened from the inside or the outside. Pull outward on exterior handle to open the sliding door. The sliding door inside handle functions by rocking forward and back. Rocking the handle backwards opens the door and rocking forward releases the hold open latch in order to close the door.

To keep your door operating properly, observe the following guidelines:

- Always open the door smoothly.
- Avoid high impacts against the door stop when opening the door. This is very important when your vehicle is parked on an incline as the door will slide faster in the downhill direction.

- There is a hold-open latch that is activated when the sliding door is fully opened. This latch will keep your sliding door open on any incline. To close the sliding door after the hold-open latch is activated, you must rock the inside handle forward or pull outward on the outside handle.

Always make sure that the sliding door is fully latched anytime the vehicle is in motion.

NOTE: The left side sliding door cannot be opened while the fuel door is open. This feature operates only when the sliding door is fully closed prior to opening the fuel door.

POWER SLIDING SIDE DOOR — IF EQUIPPED

The power sliding door may be opened manually or by using the buttons on the Remote Keyless Entry (RKE) transmitter.

Press the button on the transmitter twice within five seconds, to open a power sliding door. When the door is fully open, pressing the button twice within five seconds a second time will close the door.

There are also power sliding side door switches located on the trim panel just in front of the power sliding door for the rear seat passengers. Pressing the switch once will open the power sliding door. When the door is fully open pressing the switch a second time will close the door.

NOTE: The power sliding side door must be unlocked before the power sliding door switches will operate.

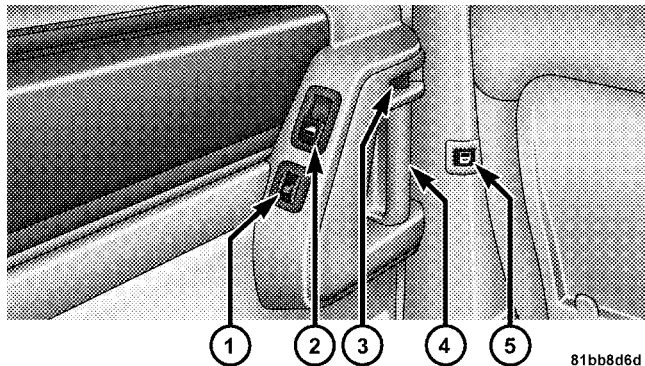

Power Sliding Door Detail

- | | |
|-------------------------|-------------------------------|
| 1 — Heated Seat Switch | 4 — Door Handle |
| 2 — Power Window Switch | 5 — Power Sliding Door Switch |
| 3 — Manual Lock | |

If the inside or outside door handles are used while the power sliding side door is activated, the power sliding door feature will be canceled and the door must be opened or closed manually.

To avoid unintentional operation of the power sliding doors from the rear seats, press the power sliding door master lock button, located in the overhead console, to disable the switches for the rear seat passengers.

NOTE:

- If anything obstructs the power sliding side door while it is closing or opening, the door will automatically reverse to the closed or open position, provided it meets sufficient resistance.
- The left side sliding door cannot be opened while the fuel door is open. This feature operates only when the sliding door is fully closed prior to opening the fuel door.

- If the power sliding side door is not in the full open or close position, it will fully open when a power sliding door switch is pressed. To close the door, wait until it is fully open and then press the switch again.
- The power sliding side door switches will not operate if the transmission gear selector lever is in gear or the vehicle speed is above 0 mph (0 km/h).
- If the power sliding door encounters multiple obstructions within the same cycle, the system will automatically stop and must be opened or closed manually.

WARNING!

You, or others, could be injured if caught in the path of the sliding door. Make sure the door path is clear before closing the door.

Power Sliding Side Door Open Flash

The left and right exterior hazard lights will flash for 12 seconds when either sliding door is opened. This will alert other drivers in the area that passenger(s) could be entering or exiting the vehicle.

The Sliding Side Door Open Flash can be enabled or disabled by performing the following procedure:

1. Place the key in the ignition switch.
2. Cycle the ignition switch ON/OFF four times ending in the OFF position. **(Do not start the engine).**
3. Within 10 seconds of the final cycle, press the hazard switch.
4. A single chime will sound to signify that you have successfully completed the programming.

You can turn the feature back on by repeating the above mentioned procedure.

Power Sliding Side Door Master Lock Switch

The power sliding side doors may also be opened by pressing the switches on the overhead console or the switches located on the trim panel just in front of the sliding door.

To provide a safer environment for small children riding in the rear seats, the second row power sliding door switches may be overridden by pressing the Master Lock Out Switch located in the front overhead console to the ON position.

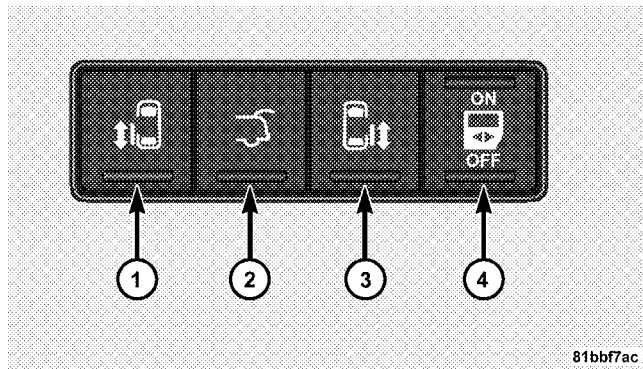

Overhead Console Power Sliding Door Master Switch

1 — Left Door
2 — Liftgate

3 — Right Door
4 — Master Lock

Sliding Side Door Child Protection Lock

To provide a safer environment for small children riding in the rear seats, the sliding doors are equipped with a child protection door lock system.

NOTE: When the child lock system is engaged, the door can be opened only by using the outside door handle even though the inside door lock is in the unlocked position.

To Engage The Child Protection Door Lock

1. Open the sliding side door.

2. Slide the child lock control inward (toward the vehicle) to engage the Child Protection Door Lock.

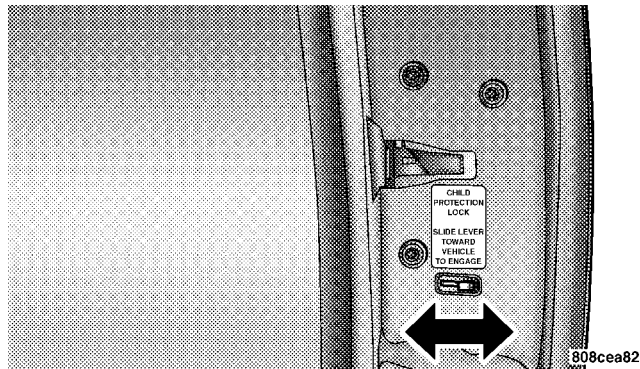

Child Protection Door Lock

3. Repeat Steps 1 and 2 on the opposite sliding door.

NOTE:

- After engaging the Child Protection Door Lock, always test the door from the inside to make certain it is in the desired position.
- When the Child Protection Door Lock system is engaged, (even if the inside door lock is in the unlocked position) the door can be opened only by using the outside door handle, the Remote Keyless Entry (RKE) transmitter, the switches on the overhead console, or the switches located on the trim panel just in front of the power sliding door.
- The power sliding side door will operate from the switches located on the trim panel just in front of the power sliding door, regardless of the Child Protection Door Lock lever position. **To avoid unintentional operation of the power sliding door from the rear seats, press the Master Lock Out Switch located in the front overhead console to the ON position.**

WARNING!

Avoid trapping anyone in the vehicle in a collision. Remember that the sliding doors can only be opened from the outside door handle or the switches located on the trim panel just in front of the power sliding door when the child protection locks are engaged.

2**To Disengage The Child Protection Door Lock**

1. Open the sliding side door.
2. Slide the child lock control outward (away from the vehicle) to disengage the Child Protection Door Lock.
3. Repeat Steps 1 and 2 on the opposite sliding door (if equipped).

LIFTGATE

On vehicles equipped with power locks, the liftgate can be unlocked using the Remote Keyless Entry (RKE) transmitter button, or by activating the power door lock switches located on the front doors.

To open the liftgate, depress the liftgate release handle located on the underside of the license plate bar and pull the liftgate open with one fluid motion.

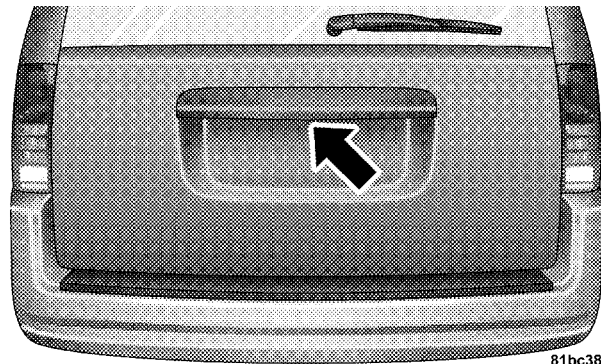

81bc38a8

Liftgate Handle Location

If the liftgate is locked and is not equipped with the power liftgate feature, pressing the button on the RKE transmitter will result in the liftgate becoming unlocked for 30 seconds allowing you to manually access the liftgate area.

POWER LIFTGATE — IF EQUIPPED

The power liftgate may be opened manually or by using the button on the Remote Keyless Entry (RKE) transmitter. Press the button on the transmitter twice within five seconds, to open the power liftgate. When the liftgate is fully open, pressing the button twice within five seconds, a second time, will close the liftgate.

When the RKE transmitter button is pressed and the Flash Lights feature is enabled, the tail lights will flash to signal that the liftgate is opening or closing.

The power liftgate may also be opened and closed by pressing the button located on the front overhead console.

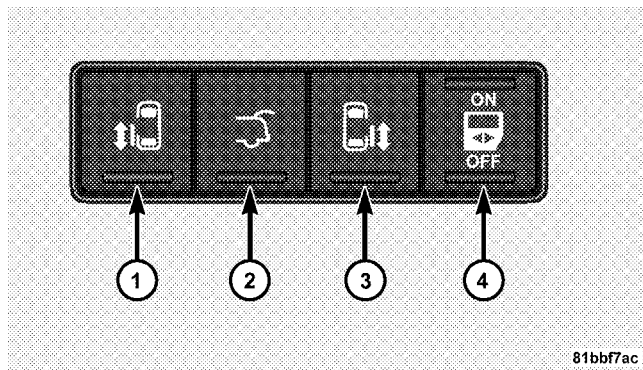

Overhead Console Master Power Switch Detail

1 — Left Door
2 — Liftgate

3 — Right Door
4 — Master Lock

The power liftgate may be closed by pressing the button, located in the upper left trim in the liftgate opening. Pushing once will only close the liftgate. This button cannot be used to open the liftgate.

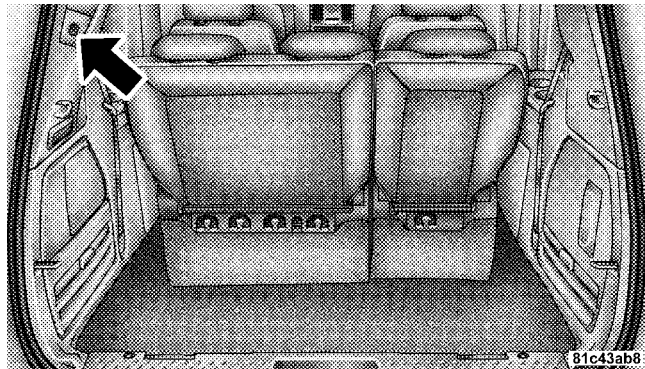

Liftgate Rear Switch

WARNING!

During power operation, personal injury or cargo damage may occur. Ensure the liftgate travel path is clear. Make sure the liftgate is closed and latched before driving away.

NOTE:

- If anything obstructs the power liftgate while it is closing or opening, the liftgate will automatically reverse to the closed or open position, provided it meets sufficient resistance.
- There are also pinch sensors attached to the side of the liftgate opening. Light pressure anywhere along these strips will cause the liftgate to return to the open position.

- The power liftgate must be in the full open or close positions for any of the buttons to operate. If the liftgate is not in the full open or close positions, it must be opened or closed manually.
 - If the liftgate release button is activated while the power liftgate is closing, the liftgate will reverse to the full open position.
 - The power liftgate buttons will not operate if the transmission gear selector lever is in gear or the vehicle speed is above 0 mph (0 km/h).
 - The power liftgate will not operate in temperatures below -12°F (-24°C) or temperatures above 143°F (62°C). Be sure to remove any buildup of snow or ice from the liftgate before pressing any of the power liftgate buttons.
- If the power liftgate encounters multiple obstructions within the same cycle, the system will automatically stop and must be opened or closed manually.

WARNING!

- **Driving with the liftgate open can allow poisonous exhaust gases into your vehicle. You and your passengers could be injured by these fumes. Keep the liftgate closed when you are operating the vehicle.**
- **If you are required to drive with the liftgate open, make sure that all windows are closed, and the climate control blower switch is set at high speed. DO NOT use the recirculation mode.**

Gas props support the liftgate in the open position. However, because the gas pressure drops with temperature, it may be necessary to assist the props when opening the liftgate in cold weather.

STORAGE BIN SAFETY WARNING

Safety Warnings

WARNING!

Always close the storage bin covers when your vehicle is unattended. Do not allow children to have access to the second row seat storage bins. Once in the storage bin, young children may not be able to escape. If trapped in the storage bin, children can die from suffocation or heat stroke.

WARNING!

In an accident, serious injury could result if the seat storage bin covers are not properly latched.

- **DO NOT** drive the vehicle with the storage bin covers open.
- **Keep the storage bin covers closed and latched while the vehicle is in motion.**
- **DO NOT** use a storage bin latch as a tie down.

CAUTION!

The storage bin cover must be flat and locked to avoid damage from contact with the front seat tracks, which have minimal clearance to the cover.

NOTE: Your vehicle may be built with a release strap or release lever attached to the Storage Bin Cover latch mechanism.

Storage Bin Cover Emergency Release Lever — If Equipped

As a security measure, your vehicle may be built with a Storage Bin Cover Emergency Release lever built into the storage bin cover latching mechanism.

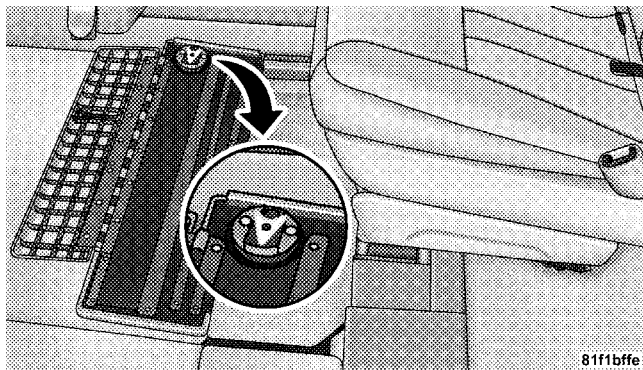

2

Storage Bin Cover Emergency Release Lever

NOTE: In the event of an individual being locked inside the storage bin, the storage bin cover can be opened from inside of the bin by pushing on the glow-in-the-dark lever attached to the storage bin cover latching mechanism.

Storage Bin Cover Emergency Release Strap — If Equipped

As a security measure, your vehicle may be built with a Storage Bin Cover Emergency Release strap built into the storage bin cover latching mechanism.

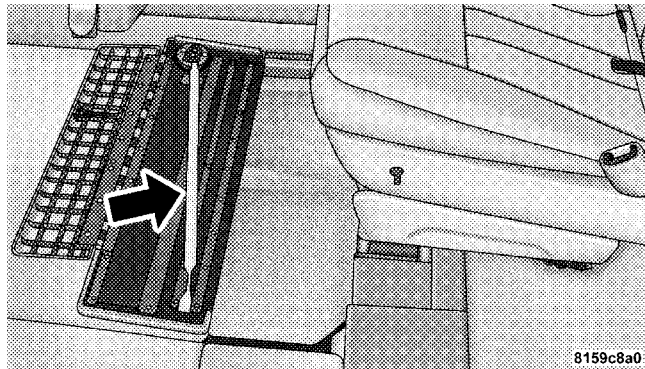

Storage Bin Cover Emergency Release Strap

NOTE: In the event of an individual being locked inside the storage bin, the storage bin cover can be opened from inside of the bin by pulling on the glow-in-the-dark strap attached to the storage bin cover latching mechanism.

Reinstalling Storage Bin Cover Emergency Release Strap

If the storage bin cover strap disengages from the latch, it can be reinstalled by inserting the loose end of the strap into the latch mechanism.

Push the strap into the latch mechanism until it engages around the latch post.

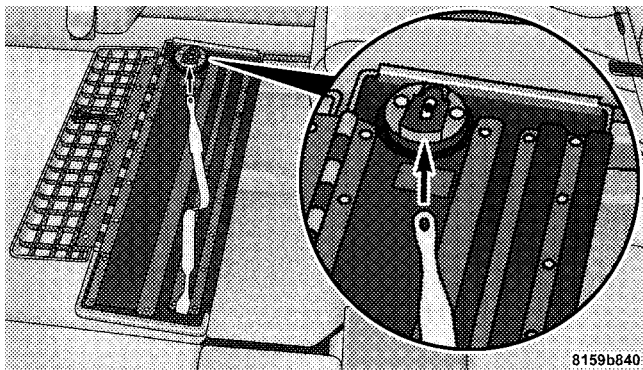

Reinstalling Storage Bin Cover Emergency Release Strap

NOTE: Do not use the storage bin emergency release strap to lift the storage bin cover. The strap is intended for emergency release only.

OCCUPANT RESTRAINTS

Some of the most important safety features in your vehicle are the restraint systems:

- Three-point lap and shoulder belts for all seating positions
- Pretensioning and load-limiting retractors for the front seat belts
- Advanced multistage driver and new active-vent front passenger airbags
- An energy-absorbing steering column and steering wheel
- Knee Bolsters/Blockers for front seat occupants
- Front seat belt retractors incorporate pretensioners to enhance occupant protection by managing occupant energy during an impact event.

- All seat belt systems (except the driver's, Swivel n' Go, and third row center position) include Automatic Locking Retractors (ALRs), which lock the seat belt webbing into position by extending the belt all the way out and then adjusting the belt to the desired length to restrain a child seat or secure a large item in a seat.

If you will be carrying children too small for adult-size seat belts, your seat belts or the Lower Anchors and Tether for CHildren (LATCH) feature also can be used to hold infant and child restraint systems.

NOTE: The front airbags have a multistage inflator design. This allows the airbag to have different rates of inflation that are based on collision severity.

Please pay close attention to the information in this section. It tells you how to use your restraint system properly to keep you and your passengers as safe as possible.

WARNING!

In a collision, you and your passengers can suffer much greater injuries if you are not properly buckled up. You can strike the interior of your vehicle or other passengers, or you can be thrown out of the vehicle. Always be sure you and others in your vehicle are buckled up properly.

Buckle up even though you are an excellent driver, even on short trips. Someone on the road may be a poor driver and cause a collision that includes you. This can happen far away from home or on your own street.

Research has shown that seat belts save lives, and they can reduce the seriousness of injuries in a collision. Some of the worst injuries happen when people are thrown from the vehicle. Seat belts reduce the possibility of ejection and the risk of injury caused by striking the inside of the vehicle. **Everyone in a motor vehicle should be belted at all times.**

Lap/Shoulder Belts

All seats in your vehicle are equipped with Lap/Shoulder Belts.

The belt webbing in the retractor is designed to lock during very sudden stops or collisions. This feature allows the shoulder part of the belt to move freely with you under normal conditions. But in a collision, the belt will lock and reduce the risk of your striking the inside of the vehicle or being thrown out.

WARNING!

It is extremely dangerous to ride in a cargo area, inside or outside of a vehicle. In a collision, people riding in these areas are more likely to be seriously injured or killed.

WARNING!

- **Do not allow people to ride in any area of your vehicle that is not equipped with seats and seat belts.**
- **Be sure everyone in your vehicle is in a seat and using a seat belt properly.**

WARNING!

- **Wearing a seat belt incorrectly is dangerous. Seat belts are designed to go around the large bones of your body. These are the strongest parts of your body and can take the forces of a collision the best.**
- **Wearing your belt in the wrong place could make your injuries in a collision much worse. You might suffer internal injuries, or you could even slide out of part of the belt. Follow these instructions to wear your seat belt safely and to keep your passengers safe, too.**

WARNING!

Two people should never be belted into a single seat belt. People belted together can crash into one another in a collision, hurting one another badly. Never use a lap/shoulder belt or lap belt for more than one person, no matter what their size.

Lap/Shoulder Belt Operating Instructions

1. Enter the vehicle and close the door. Sit back and adjust the seat.

2. The seat belt latch plate is near the seatback of the front seats and next to your arm in the rear seats. Grasp the latch plate and pull out the belt. Slide the latch plate up the webbing as far as necessary to allow the belt to go around your lap.

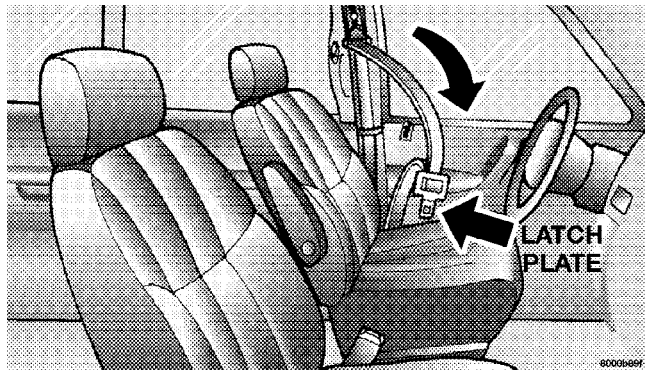

Latch Plate

WARNING!

A belt that is worn under your arm is very dangerous. Your body could strike the inside surfaces of the vehicle in a collision, increasing head and neck injury. A belt worn under the arm can cause internal injuries. Ribs aren't as strong as shoulder bones. Wear the belt over your shoulder so that your strongest bones will take the force in a collision.

WARNING!

A shoulder belt placed behind you will not protect you from injury during a collision. You are more likely to hit your head in a collision if you do not wear your shoulder belt. The lap and shoulder belt are meant to be used together.

3. When the belt is long enough to fit, insert the latch plate into the buckle until you hear a “click”.

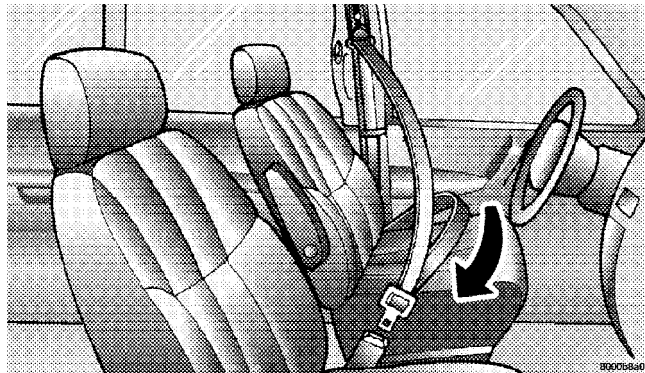

Latch Plate To Buckle

WARNING!

- A belt that is buckled into the wrong buckle will not protect you properly. The lap portion could ride too high on your body, possibly causing internal injuries. Always buckle your belt into the buckle nearest you.
- A belt that is too loose will not protect you as well. In a sudden stop you could move too far forward, increasing the possibility of injury. Wear your seat belt snugly.

4. Position the lap belt across your thighs, below your abdomen. To remove slack in the lap belt portion, pull up on the shoulder belt. To loosen the lap belt if it is too tight, tilt the latch plate and pull on the lap belt. A snug belt reduces the risk of sliding under the belt in a collision.

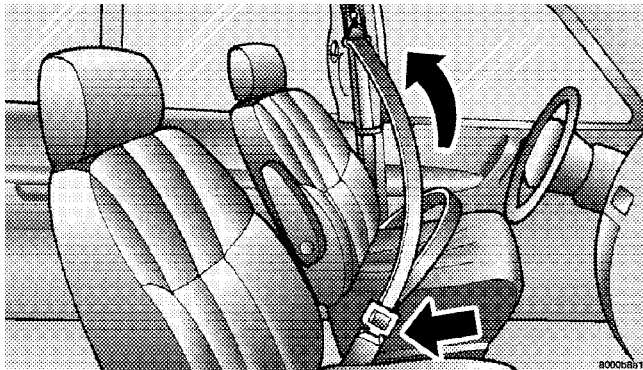

Removing Slack From Belt

WARNING!

- A lap belt worn too high can increase the risk of internal injury in a collision. The belt forces won't be at the strong hip and pelvic bones, but across your abdomen. Always wear the lap belt as low as possible and keep it snug.
- A twisted belt can't do its job as well. In a collision it could even cut into you. Be sure the belt is straight. If you can't straighten a belt in your vehicle, take it to your authorized dealer and have it fixed.

5. Position the shoulder belt on your chest so that it is comfortable and not resting on your neck. The retractor will withdraw any slack in the belt.

6. To release the belt, push the red button on the buckle. The belt will automatically retract to its stowed position. If necessary, slide the latch plate down the webbing to allow the belt to retract fully.

WARNING!

A frayed or torn belt could rip apart in a collision and leave you with no protection. Inspect the belt system periodically, checking for cuts, frays, or loose parts. Damaged parts must be replaced immediately. Do not disassemble or modify the system. Seat belt assemblies must be replaced after a collision if they have been damaged (bent retractor, torn webbing, etc.).

Third Row Center Shoulder Belt Instructions

The shoulder belt for the third row center seat is located in the headliner slightly behind the third row seat.

Pull the strap down and secure the small latch plate of the lap belt into the small buckle until you hear a “click”.

Position the shoulder belt on your chest so that it is comfortable and not resting on your neck. When the belt is long enough to fit, insert the large latch plate into the buckle until you hear a “click”

The retractor will withdraw any slack in the belt.

To release the small latch plate, position the end of the large latch plate against the red button on the small buckle and push upward. Reinstall the latch plates into the headliner.

Adjustable Upper Shoulder Belt Anchorage

In the front seats and the second row outboard seats, the shoulder belt anchorage can be adjusted upward or downward to help position the belt away from your neck. The upper anchorage can be adjusted upward by

pushing anywhere on the anchorage. To move the anchorage downward, squeeze the actuation buttons while simultaneously pushing down on the anchorage assembly.

As a guide, if you are shorter than average you will prefer a lower position, and if you are taller than average you will prefer a higher position. When you release the anchorage, try to move it up or down to make sure that it is locked in position.

Automatic Locking Retractors (ALR) Mode – If Equipped

In this mode, the shoulder belt is automatically pre-locked. The belt will still retract to remove any slack in the shoulder belt. The automatic locking mode is available on all passenger-seating positions with a combination lap/shoulder belt.

When To Use The Automatic Locking Mode

Use The Automatic Locking Mode anytime a child safety seat is installed in a passenger seating position. Children 12 years old and younger should be properly restrained in the rear seat whenever possible.

How To Use The Automatic Locking Mode

1. Buckle the combination lap/shoulder belt.
2. Grasp the shoulder portion and pull downward until the entire belt is extracted.
3. Allow the belt to retract. As the belt retracts, you will hear a clicking sound. This indicates the safety belt is now in the automatic locking mode.

How To Disengage The Automatic Locking Mode

Disconnect the combination lap/shoulder belt and allow it to retract completely to disengage the automatic locking mode and activate the vehicle sensitive (emergency) locking mode.

Seat Belt Pretensioners

The seat belts for both front seating positions are equipped with pretensioning devices that are designed to remove slack from the seat belt in the event of a collision. These devices improve the performance of the seat belt by assuring that the belt is tight about the occupant early in a collision. Pretensioners work for all size occupants, including those in child restraints.

NOTE: These devices are not a substitute for proper seat belt placement by the occupant. The seat belt still must be worn snugly and positioned properly.

The pretensioners are triggered by the Occupant Restraint Controller (ORC). Like the front airbags, the pretensioners are single use items. After a collision that is severe enough to deploy the airbags and pretensioners, both must be replaced.

Enhanced Seat Belt Use Reminder System (BeltAlert®)

If the occupied driver's seat belt has not been buckled within 60 seconds of starting the vehicle and if the vehicle speed is greater than 5 mph (8 km/h), BeltAlert® will alert the driver to buckle the seat belt. The driver should also instruct all other occupants to buckle their seat belts. Once the warning is triggered, BeltAlert® will continue to chime and flash the Seat Belt Warning Light for 96 seconds or until the driver's seat belt is buckled.

BeltAlert® will be reactivated if the driver's seat belt is unbuckled for more than 10 seconds and the vehicle speed is greater than 5 mph (8 km/h).

BeltAlert® Programming

BeltAlert® can be enabled or disabled by your authorized dealer or by following these steps:

NOTE: The following steps must occur within the first 60 seconds of the ignition switch being turned to the ON or START position. DaimlerChrysler does not recommend deactivating BeltAlert®.

1. With all doors closed and the ignition switch in any position except ON or START, buckle the driver's seat belt.
2. Turn the ignition switch to the ON position (engine does not need to be running), and wait for the Seat Belt Warning Light to turn off.
3. Within 60 seconds of turning the ignition switch to the ON/RUN position, unbuckle and then re-buckle the driver's seat belt at least three times within 60 seconds, ending with the seat belt buckled.

NOTE: Watch for the Seat Belt Warning Light to turn on while unbuckling and off while re-buckling the seat belt.

4. Turn the ignition switch to the OFF position. A single chime will sound to signify that you have successfully completed the programming.

BeltAlert® can be reactivated by repeating this procedure.

NOTE: Although BeltAlert® has been deactivated, the Seat Belt Warning Light will continue to illuminate while the driver's seat belt remains unbuckled.

Seat Belts and Pregnant Women

We recommend that pregnant women use the seat belts throughout their pregnancies. Keeping the mother safe is the best way to keep the baby safe.

Pregnant women should wear the lap part of the belt across the thighs and as snug across the hips as possible. Keep the belt low so that it does not come across the abdomen. That way the strong bones of the hips will take the force if there is a collision.

Seat Belt Extender

If a seat belt is too short, even when fully extended and when the adjustable upper shoulder belt anchorage (if equipped) is in its lowest position, your authorized dealer can provide you with a seat belt extender. This extender should be used only if the existing belt is not long enough. When it is not required, remove the extender and stow it.

WARNING!

Using a seat belt extender when not needed can increase the risk of injury in a collision. Only use when the lap belt is not long enough when it is worn low and snug, and in the recommended seating positions. Remove and store the extender when not needed.

Supplemental Restraint System (SRS) - Airbag

This vehicle has airbags for both the driver and front passenger as a supplement to the seat belt restraint systems. The driver's front airbag is mounted in the center of the steering wheel. The passenger's front airbag is mounted in the instrument panel, above the glove compartment. The words SRS AIRBAG are embossed on the airbag covers.

NOTE: The front airbags are certified to the Federal regulations that allow less forceful deployment.

The front airbags have a multistage inflator design. This may allow the airbag to have different rates of inflation that are based on collision severity and occupant size.

This vehicle may also be equipped with Supplemental Seat Side Airbag Inflatable Curtains (SABIC) to protect the driver, front, and rear passengers sitting next to a

window. If the vehicle is equipped with SABIC air bags, they are located above the side windows and their covers are also labeled: SRS AIRBAG.

NOTE: Airbag covers may not be obvious in the interior trim; but they will open to allow airbag deployment.

Airbag System Components

The airbag system consists of the following:

- Occupant Restraint Controller (ORC)
- Airbag Telltale Light
- Driver Airbag
- Front Passenger Airbag
- Front and Side Impact Sensors
- Steering Wheel and Column
- Instrument Panel

- Seat Belt Reminder Light
- Knee Impact Bolster
- Front Seat Belt Retractor Pretensioners
- Front Seat Track Position Sensors
- Supplemental Seat Side Airbag Inflatable Curtains (SABIC) — If Equipped
- Front Seat Side-mounted (Thorax) Airbags — If Equipped

Front Seat Airbag Features

The front airbag system has dual-stage driver and front passenger airbags. This system provides output appropriate to the level of crash severity as determined by the Occupant Restraint Controller (ORC) and the impact sensors at the front of the car.

The first stage inflator is triggered immediately during an impact that requires airbag deployment. The timing of the second stage determines whether the output force is low, medium, or high. If a low output is sufficient to meet the need, the second stage is expended later in the crash event.

Driver Airbag Special Features

Driver airbag deployment and force level is controlled by the driver's seat position as well as impact severity. Use of special inflators result in a very compact driver's side airbag.

In addition to the small size, the inflating gases exit through strategically placed vents, which direct the gas away from the occupant.

Front Passenger Airbag Special Features

A new active venting front passenger airbag is designed to reduce the risk of occupants who may be out of position by the use of active vents positioned on each side of the airbag.

Supplemental Front Seat-Mounted Thorax Side Airbags — If Equipped

Front seat-mounted side (Thorax) airbags provide enhanced protection and work together with supplemental Side Airbag Inflatable Curtains (SABIC) to help protect an occupant during a side impact. The seat-mounted side airbag is marked with an airbag label sewn into the outboard side of the seat.

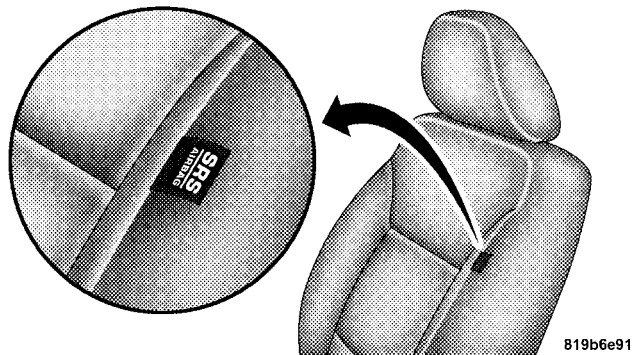

Thorax Airbag Label

When the airbag deploys, it opens the seam between the front and side of the seat's trim cover. Each airbag deploys independently, that is a left side impact deploys the left airbag only and a right-side impact deploys only the right airbag.

WARNING!

- Do not put anything on or around the airbag covers or attempt to open them manually. You may damage the airbags and you could be injured because the airbag inflation capability may be compromised. The protective covers for the airbag cushions are designed to open only when the airbags are inflating.
- Do not use accessory seat covers or place objects between you and the side airbags; the performance could be adversely affected and/or objects could be pushed into you, causing serious injury.

Supplemental Side Airbag Inflatable Curtain (SABIC) — If Equipped

SABIC Airbags offer side-impact and vehicle rollover protection to front and rear seat outboard occupants in addition to that provided by the body structure. Each airbag features inflated chambers placed adjacent to the head of each outboard occupant that reduce the potential for side-impact head injuries. The curtains deploy downward, covering both windows on the impact side.

NOTE: Should a vehicle rollover occur, the SABIC curtains on both sides of the vehicle are deployed.

NOTE: Airbag covers may not be obvious in the interior trim; but they will open to allow airbag deployment.

The system includes sensors adjacent to both front and rear seat occupants that are calibrated to deploy during an impact severe enough to require airbag occupant protection.

WARNING!

If your vehicle is equipped with left and right Side Airbag Inflatable Curtain (SABIC), do not stack luggage or other cargo up high enough to block the location of the SABIC. The area where the side curtain airbag is located should remain free from any obstructions.

Airbags inflate in moderate to high speed impacts. Along with seat belts and pretensioners, front airbags work with the knee bolsters to provide improved protection for the driver and front passenger. Side airbags also work with seat belts to improve occupant protection.

The seat belts are designed to protect you in many types of collisions. The front airbags deploy in moderate to severe frontal collisions. If your vehicle is equipped, the side airbag on the crash side of the vehicle is triggered in

moderate to severe side collisions. In certain types of collisions, both the front and side airbags may be triggered. However, even in collisions where the airbags work, you need the seat belts to keep you in the right position for the airbags to protect you properly.

Here are some simple steps you can take to minimize the risk of harm from a deploying airbag.

1. Children 12 years old and younger should always ride buckled up in a rear seat.

Infants in rear-facing child restraints should **NEVER** ride in the front seat of a vehicle with a passenger front airbag. An airbag deployment can cause severe injury or death to infants in that position.

Children that are not big enough to wear the vehicle seat belt properly (see Section on Child Restraints) should be secured in the rear seat in child restraints or belt-positioning booster seats. Older children who do not use

child restraints or belt-positioning booster seats should ride properly buckled up in the rear seat. Never allow children to slide the shoulder belt behind them or under their arm.

If a child from 1 to 12 years old must ride in the front passenger seat because the vehicle is crowded, move the seat as far back as possible, and use the proper child restraint. Refer to the section on Child Restraints.

You should read the instructions provided with your child restraint to make sure that you are using it properly.

2. All occupants should wear their lap and shoulder belts properly.

3. The driver and front passenger seats should be moved back as far as practical to allow the front airbags room to inflate.

4. If your vehicle has side airbags, do not lean against the door, airbags will inflate forcefully into the space between you and the door.

5. If the airbag system in this vehicle needs to be modified to accommodate a disabled person, contact the Customer Center. Phone numbers are provided under "If You Need Assistance" in Section 9 of this manual.

WARNING!

Relying on the airbags alone could lead to more severe injuries in a collision. The airbags work with your seat belt to restrain you properly. In some collisions, the airbags won't deploy at all. Always wear your seat belts even though you have airbags.

WARNING!

- Being too close to the steering wheel or instrument panel during front airbag deployment could cause serious injury. Airbags need room to inflate. Sit back, comfortably extending your arms to reach the steering wheel or instrument panel.
- Side airbags also need room to inflate. Do not lean against the door. Sit upright in the center of the seat.

Airbag Deployment Sensors and Controls

Occupant Restraint Controller (ORC)

The ORC is part of a Federally regulated safety system required for this vehicle.

The ORC determines if a frontal or side collision is severe enough to require the airbags to inflate. Based on the

impact sensors signals, a central electronic ORC deploys the front airbags, side inflatable airbag curtains, side seat thorax airbags, and front seat belt pretensioners as required for each type of impact.

The ORC monitors the readiness of the electronic parts of the system whenever the ignition switch is in the START or ON position. These include all of the components listed above except the steering wheel and column, instrument panel, and seat belt reminder light. If the key is in the OFF position, in the ACC position, or not in the ignition, the airbags are not on and will not inflate.

The ORC contains a backup power supply system that will deploy the airbags even if the battery loses power or it becomes disconnected prior to deployment.



Also, the ORC turns on the AIRBAG warning light in the instrument panel for approximately four to six seconds for a self-check when the ignition is first turned on. After the self-check,

the AIRBAG warning light will turn off. If the ORC detects a malfunction in any part of the system, it turns on the AIRBAG warning light, either momentarily or continuously. A single chime will sound if the light comes on again after initial start up.

It also includes diagnostics that will illuminate the instrument cluster AIRBAG warning light if a malfunction is noted. The diagnostics also record the nature of the malfunction.

WARNING!

Ignoring the AIRBAG light in your instrument panel could mean you won't have the airbags to protect you in a collision. If the light does not come on, stays on after you start the vehicle, or if it comes on as you drive, have the airbag system checked right away.

Front and Side Impact Sensors

Impact Sensors trigger airbag deployment in front and side impacts, and aid the ORC in determining appropriate response to impact events. Additional sensors in the ORC determine the level of airbag deployment and provide verification.

Acceleration Sensors

Acceleration Sensors trigger airbag deployment based on dramatic acceleration change of the vehicle.

Pressure Sensors

Pressure Sensors trigger airbag deployment based on door cavity pressure changes.

Rollover Sensors

Rollover Sensors trigger airbag deployment in the event of vehicle rollover and aid the ORC in deploying Side Airbag Inflatable Curtains (SABIC) for rollover events.

Supplemental Side Airbag Inflatable Curtain (SABIC) — If Equipped

The ORC deploys the SABIC during collision with other vehicles and during collisions where the impact is confined to a particular area of the vehicle — such as collisions with poles, trees or similar objects.

It will deploy the SABIC only on the impact side of the vehicle.

NOTE: The ORC does detect and protect for rollover when equipped with SABIC airbags.

Enhanced Accident Response System

In the event of an impact causing airbag deployment, and the vehicle communication network intact, and the power intact, the Enhanced Accident Response System performs the following functions:

- Cuts off fuel to the engine.
- Flashes hazard lights.

- Turns on the interior lights, which remain on as long as the battery has power or until the ignition key is removed.
- Unlocks the doors automatically.

If A Deployment Occurs

The airbag systems are designed to deploy when the Occupant Restraint Controller (ORC) detect a moderate-to-severe collision, to help restrain the driver, front passenger and rear passengers, and then immediately deflate.

NOTE: A frontal collision that is not severe enough to need airbag protection will not activate the system. This does not mean something is wrong with the airbag system.

If you do have a collision which deploys the airbags, any or all of the following may occur:

- The nylon airbag material may sometimes cause abrasions and/or skin reddening to the driver and front passenger as the airbags deploy and unfold. The abrasions are similar to friction rope burns or those you might get sliding along a carpet or gymnasium floor. They are not caused by contact with chemicals. They are not permanent and normally heal quickly. However, if you haven't healed significantly within a few days, or if you have any blistering, see your doctor immediately.
- As the airbags deflate, you may see some smoke-like particles. The particles are a normal by-product of the process that generates the nontoxic gas used for airbag inflation. These airborne particles may irritate the skin, eyes, nose, or throat. If you have skin or eye irritation, rinse the area with cool water. For nose or throat

irritation, move to fresh air. If the irritation continues, see your doctor. If these particles settle on your clothing, follow the garment manufacturer's instructions for cleaning.

- It is not advisable to drive your vehicle after the airbags have deployed. If you are involved in another collision, the airbags will not be in place to protect you.

WARNING!

Deployed airbags and seat belt pretensioners cannot protect you in another collision. Have the airbags, seat belt pretensioners, and the front passenger seat belt retractor assembly replaced by an authorized dealer as soon as possible. Also, have the Occupant Restraint Controller System serviced as well.

Maintaining Your Airbag System

WARNING!

- **Modifications to any part of the airbag system could cause it to fail when you need it. You could be injured if the airbag system is not there to protect you. Do not modify the components or wiring, including adding any kind of badges or stickers to the steering wheel hub trim cover or the upper right side of the instrument panel. Do not modify the front bumper, vehicle body structure, or add aftermarket side steps or running boards.**
- **It is dangerous to try to repair any part of the airbag system yourself. Be sure to tell anyone who works on your vehicle that it has an airbag system.**

WARNING!

Do not attempt to modify any part of your advanced airbag system. The airbag may inflate accidentally or may not function properly if modifications are made. Take your vehicle to an authorized dealer for any advanced airbag system service. If your seat, including your trim cover and cushion, needs to be serviced in any way (including removal or loosening/tightening of seat attachment bolts), take the vehicle to your authorized dealer. Only manufacturer approved seat accessories may be used. If it is necessary to modify an advanced airbag system for persons with disabilities, contact your authorized dealer.

NOTE: Perchlorate Material — special handling may apply. See: www.dtsc.ca.gov/hazardouswaste/perchlorate.

Airbag Light

You will want to have the airbags ready to inflate for your protection in a collision. While the airbag system is designed to be maintenance free, if any of the following occurs, have an authorized dealer service the system immediately.

- The AIRBAG light does not come on during the approximately four to six seconds when the ignition switch is first turned ON.
- The light remains on after the approximately four to six-second interval.
- The light comes on and remains on while driving.

NOTE: If the speedometer, tachometer, or any engine related gauges are not working, the Occupant Restraint Controller (ORC) may also be disabled. The airbags may not be ready to inflate for your protection. Promptly check the fuse block for blown fuses. Refer to the label

located on the inside of the fuse block cover for the proper airbag fuses. See your authorized dealer if the fuse is good.

Event Data Recorder (EDR)

In the event of an accident, your vehicle is designed to record up to approximately five seconds of specific vehicle data parameters (see the following list) in an event data recorder prior to the moment of airbag deployment, or near deployment, and up to a quarter-second of high-speed deceleration data during and/or after airbag deployment. EDR data are **ONLY** recorded if an airbag deploys, or nearly deploys, and are otherwise unavailable.

NOTE:

1. A near-deployment event occurs when the airbag sensor detects severe vehicle deceleration usually indicative of a crash, but not severe enough to warrant airbag deployment.

2. Under certain circumstances, EDR data may not be recorded (e.g., loss of battery power).

In conjunction with other data gathered during a complete accident investigation, the electronic data may be used by DaimlerChrysler Corporation and others to learn more about the possible causes of crashes and associated injuries in order to assess and improve vehicle performance. In addition to crash investigations initiated by DaimlerChrysler Corporation, such investigations may be requested by customers, insurance carriers, government officials, and professional crash researchers, such as those associated with universities, and with hospital and insurance organizations.

In the event that an investigation is undertaken by DaimlerChrysler Corporation (regardless of initiative), the company or its designated representative will first obtain permission of the appropriate custodial entity for the vehicle (usually the vehicle owner or lessee) before

accessing the electronic data stored, unless ordered to download data by a court with legal jurisdiction (i.e., pursuant to a warrant). A copy of the data will be provided to the custodial entity upon request. General data that does not identify particular vehicles or crashes may be released for incorporation in aggregate crash databases, such as those maintained by the U.S. government and various states. Data of a potentially sensitive nature, such as would identify a particular driver, vehicle, or crash, will be treated confidentially. Confidential data will not be disclosed by DaimlerChrysler Corporation to any third party except when:

1. Used for research purposes, such as to match data with a particular crash record in an aggregate database, provided confidentiality of personal data is thereafter preserved.
2. Used in defense of litigation involving a DaimlerChrysler Corporation product.

3. Requested by police under a legal warrant.
4. Otherwise required by law.

Data Parameters That May Be Recorded:

- Diagnostic trouble code(s) and warning light status for electronically-controlled safety systems, including the airbag system
- Airbag disable light status (if equipped)
- "Time" of airbag deployment (in terms of ignition cycles and vehicle mileage)
- Airbag deployment level (if applicable)
- Impact acceleration and angle
- Seat belt status
- Brake status (service and parking brakes)
- Accelerator status (including vehicle speed)

- Engine control status (including engine speed)
- Transmission gear selection
- Cruise control status
- Traction/stability control status
- Tire pressure monitoring system status – if equipped

Integrated Child Seat — If Equipped

Operating instructions for the second row bench seat with Integrated Child Seat are included with the seat. If the instructions are not with the seat or in the Owner's Manual Package, replacement instruction can be obtained.

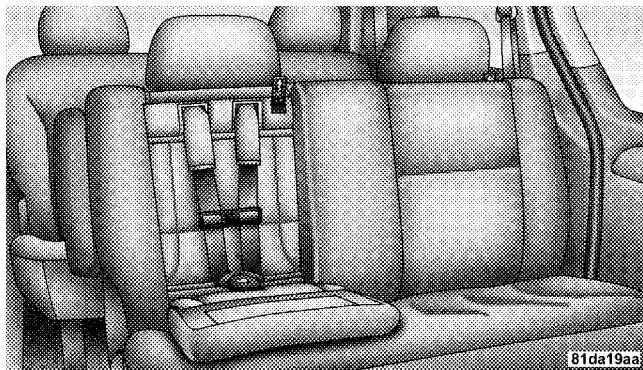

Second Row Bench Seat With Integrated Child Seat
To obtain Integrated Child Seat replacement instructions: Refer to Publication Order Forms at the back of this manual and specify publication number 81-016-8050.

Child Restraints

Everyone in your vehicle needs to be buckled up at all times — babies and children, too. Every state in the United States and all Canadian provinces require that small children ride in proper restraint systems. This is the law, and you can be prosecuted for ignoring it.

Children 12 years and younger should ride properly buckled up in a rear seat. According to crash statistics, children are safer when properly restrained in the rear seats rather than in the front.

WARNING!

In a collision, an unrestrained child, even a tiny baby, can become a missile inside the vehicle. The force required to hold even an infant on your lap could become so great that you could not hold the child, no matter how strong you are. The child and others could be badly injured. Any child riding in your vehicle should be in a proper restraint for the child's size.

2

Infants and Small Children

There are different sizes and types of restraints for children from newborn size to the child almost large enough for an adult safety belt. Always check the child seat owner's manual to ensure you have the right seat for your child. Use the restraint that is correct for your child.

- Safety experts recommend that children ride rearward-facing in the vehicle until they are at least one year old and weigh at least 20 lbs (9 kg). Two types of child restraints can be used rearward-facing: infant carriers and "convertible" child seats. Both types of child restraints are held in the vehicle by the lap/shoulder belt or the LATCH child restraint anchorage system. Refer to "Lower Anchors and Tether for Children (LATCH)" later in this section.
- The infant carrier is only used rearward-facing in the vehicle. It is recommended for children who weigh up to about 20 lbs (9 kg). "Convertible" child seats can be used either rearward-facing or forward-facing in the vehicle. Convertible child seats often have a higher weight limit in the rearward-facing direction than infant carriers do, so they can be used rearward-facing by children who weigh more than 20 lbs (9 kg) but are less than one year old.
- Rearward-facing child seats must **NEVER** be used in the front seat of a vehicle with a front passenger airbag. An airbag deployment could cause severe injury or death to infants in this position.
- Rearward-facing child seats and infant carriers must **NEVER** be used while the second row Swivel 'n Go seats are in the rearward-facing position.

WARNING!

Never place any child seat or infant carrier in the Swivel 'n Go seat while it is in the rearward-facing position. The swivel seat should be locked in the forward position when using any child seat or infant carriers, with the vehicle in motion. Failure to do so could result in serious injury or even death.

Older Children and Child Restraints

Children who weigh more than 20 lbs (9 kg) and who are older than one year can ride forward-facing in the vehicle. Forward-facing child seats and convertible child seats used in the forward-facing direction are for children who weigh 20 to 40 lbs (9 to 18 kg) and who are older than one year. These child seats are also held in the vehicle by the lap/shoulder belt or the LATCH child restraint anchorage system. Refer to “Lower Anchors and Tether for Children (LATCH)” later in this section.

An aftermarket belt-positioning booster seat is for children weighing more than 40 lbs (18 kg), but who are still too small to properly fit the vehicle’s seat belts. If the child can not sit with knees bent over the vehicle’s seat cushion while the child’s back is against the seatback, they should use a belt-positioning booster seat. The child and booster seat are held in the vehicle by the lap/

shoulder belt. (Some booster seats are equipped with a front shield and are held in the vehicle by the lap portion.)

Children Too Large For Booster Seats

Children who are large enough to wear the shoulder belt comfortably, and whose legs are long enough to bend over the front of the seat when their back is against the seatback, should use the lap/shoulder belt in a rear seat.

- Make sure that the child is upright in the seat.
- The lap portion should be low on the hips and as snug as possible.
- Check belt fit periodically. A child’s squirming or slouching can move the belt out of position.

- If the shoulder belt contacts the face or neck, move the child closer to the center of the vehicle. If this doesn't help, move the child to the center rear seating position and use the lap belt. Never allow a child to put the shoulder belt under an arm or behind their back.

NOTE: For additional information, refer to www.seatcheck.org or call 1-866-SEATCHECK.

WARNING!

- **Improper installation can lead to failure of an infant or child restraint. It could come loose in a collision. The child could be badly injured or killed. Follow the manufacturer's directions exactly when installing an infant or child restraint.**
- **A rearward-facing child restraint should only be used in a rear seat. A rearward-facing child restraint in the front seat may be struck by a deploying passenger airbag which may cause severe or fatal injury to the infant.**
- **Occupants riding in Swivel 'n Go seating must be wearing their seat belt and the seat must be locked in either the forward or rearward position. Failure to do so could result in serious injury or even death.**

Here are some tips on getting the most out of your child restraint:

- Before buying any restraint system, make sure that it has a label certifying that it meets all applicable Safety Standards. We also recommend that you make sure that you can install the child restraint in the vehicle where you will use it, before you buy it.
- The restraint must be appropriate for your child's weight and height. Check the label on the restraint for weight and height limits.
- Carefully follow the instructions that come with the restraint. If you install the restraint improperly, it may not work when you need it.
- The passenger seat belts are equipped with cinching latch plates, which are designed to keep the lap portion tight around the child restraint so that it is not necessary to use a locking clip. Pulling up on the shoulder portion of the lap/shoulder belt will tighten the belt. The cinching latch plate will keep the belt tight, however, any seat belt system will loosen with time, so check the belt occasionally and pull it tight if necessary.
- In the rear seat, you may have trouble tightening the lap/shoulder belt on the child restraint because the buckle or latch plate is too close to the belt path opening on the restraint. Disconnect the latch plate from the buckle and twist the short buckle end of the belt several times to shorten it. Insert the latch plate into the buckle with the release button facing out.
- If the belt still can't be tightened, or if pulling and pushing on the restraint loosens the belt, disconnect the latch plate from the buckle, turn the buckle around, and insert the latch plate into the buckle again. If you still can't make the child restraint secure, try a different seating position.

- Buckle the child into the seat according to the child restraint manufacturer's directions.
- When your child restraint is not in use, secure it in the vehicle with the seat belt or remove it from the vehicle. Don't leave it loose in the vehicle. In a sudden stop or collision, it could strike the occupants or seatbacks and cause serious personal injury.

Lower Anchors and Tether for Children (LATCH)

Each vehicle, except commercial cargo vehicles, is equipped with the child restraint anchorage system called LATCH, which stands for Lower Anchors and Tether for Children. Two LATCH child restraint anchorage systems are installed on all second-row seats and in the center position on all 3rd row fold-in-floor seats. Second-row seats also feature tether strap anchorages, located in the rear surface of the seatback. In addition, all third row fold-in-floor seats are equipped with a child restraint tether anchor at the center seating position.

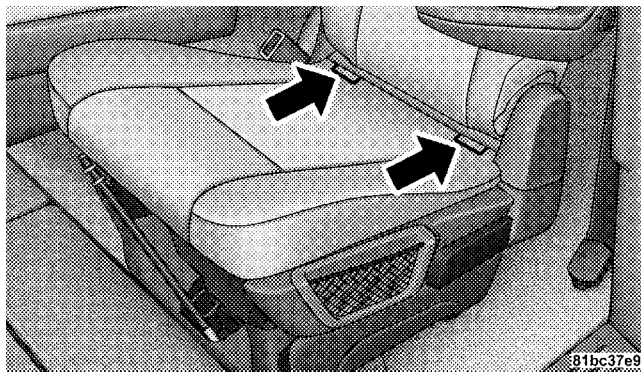

LATCH Anchorages

When using the tether anchorages in the outboard seating positions, ensure that the strap is routed underneath the top of the seatback and the head restraint.

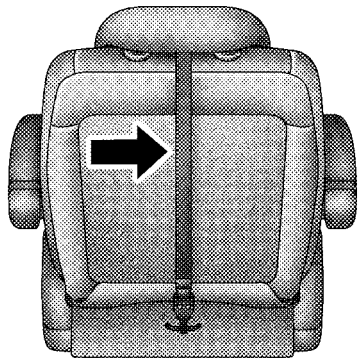

81ce919a

Rear Seat Tether Strap Mounting

When using the tether anchorages in the center position on third row fold-in-floor seating, ensure that the strap is routed underneath the top of the seatback and the head restraint.

WARNING!

An incorrectly anchored tether strap could lead to increased head motion and possible injury to the child. Use only the anchor positions directly behind the child seat to secure a child restraint top tether strap.

2

Child restraint systems having attachments designed to connect to the lower anchorages are now available. Child restraints having tether straps and hooks for connection to the seatback tether anchorage have been available for some time. In fact, many child restraint manufacturers will provide add-on tether strap kits for some of their older products.

NOTE: If your child restraint seat is not LATCH compatible, install the restraint using the vehicle seat belts.

Because the lower anchorages are to be introduced to passenger carrying vehicles over a period of years, child restraint systems having attachments for those anchorages will continue to have features for installation in vehicles using the lap or lap/shoulder belt. They will also have tether straps, and you are urged to take advantage of all of the available attachments provided with your child restraint in any vehicle.

NOTE: When using the LATCH attaching system to install a child restraint, please ensure that all seat belts not being used for occupant restraints are stowed and out of reach of children. It is recommended that before installing the child restraint, buckle the seat belt so the seat belt is tucked behind the child restraint and out of reach. If the buckled seat belt interferes with the child restraint installation, instead of tucking the seat belt behind the child restraint, route the seat belt through the child restraint belt path and then buckle it. This should stow the seat belt out of the reach of an inquisitive child.

Remind all children in the vehicle that the seat belts are not toys and should not be played with, and never leave your child unattended in the vehicle.

Installing the Child Restraint System

We urge that you carefully follow the directions of the manufacturer when installing your child restraint. Many, but not all restraint systems will be equipped with separate straps on each side, with each having a hook or connector and a means for adjusting the tension in the strap. Forward-facing toddler restraints and some rearward-facing infant restraints will also be equipped with a tether strap, a hook and means for adjusting the tension in the strap.

In general, you will first loosen the adjusters on the lower straps and tether straps so that you can more easily attach the hook or connector to the lower anchorages and tether anchorages. Then tighten all three straps as you push the child restraint rearward and downward into the seat.

Not all child restraint systems will be installed as we have described here. Again, carefully follow the instructions that come with the child restraint system.

WARNING!

Improper installation of a child restraint to the LATCH anchorages can lead to failure of an infant or child restraint. The child could be badly injured or killed. Follow the manufacturer's directions exactly when installing an infant or child restraint.

Transporting Pets

Airbags deploying in the front seat could harm your pet. An unrestrained pet could be thrown about and possibly injured, or injure a passenger during panic braking or in a collision.

Pets should be restrained in the rear seat in pet harnesses or pet carriers that are secured by seat belts.

REAR SEAT DELETE FEATURE (COMMERCIAL VEHICLES ONLY) — IF EQUIPPED

Commercial cargo vehicles are not designed for use as a family vehicle and are not intended for carrying children in the front passenger seat. However, if you must carry a child in a vehicle without a rear seat, the passenger seat should be moved to the full rearward position and the child must be in a proper restraint system based on its age, size and weight. NEVER carry a child in a rear facing infant carrier in a vehicle without rear seats. In an accident, serious injury or death may occur from the deploying passenger airbag.

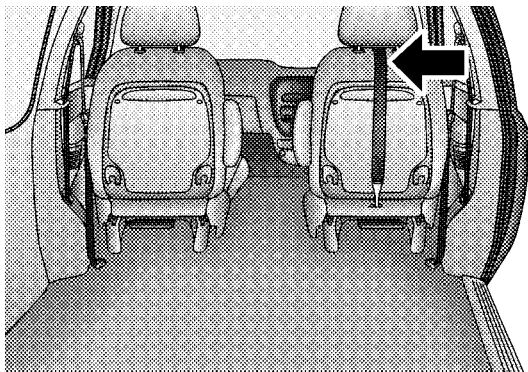

81ce4b6b

Commercial Child Restraint Tether Anchor

This vehicle is equipped with a child restraint tether anchor located on the lower rear of the front passenger seat. **Use this tether anchor to secure only forward facing child restraints equipped with an upper tether strap.**

WARNING!

Rearward-facing infant restraints must never be secured in the passenger seat of a vehicle with a passenger airbag. In an accident a passenger airbag may deploy causing severe injury or death to infants riding in rearward-facing infant restraints.

Restraining Infants and Small Children with Seat Delete Feature (Commercial Vehicles Only)

There are different sizes and types of restraints for children from newborn size to the child almost large enough for an adult safety belt. Use the restraint that is correct for your child:

- The rearward-facing infant carrier is for babies weighing up to about 20 lbs (9 kg), and less than one year old. **THIS TYPE OF SEAT CANNOT BE USED IN A**

VEHICLE EQUIPPED WITH THE REAR SEAT DELETE FEATURE (Commercial Vehicles Only).

- The forward-facing child seat is for children from about 20 to 40 lbs (9 to 18 kg), and more than one year old.
- A “convertible” child seat, one that is designed to be used for children who are too heavy for a rearward-facing infant seat, may be used IN THE FORWARD FACING POSITION ONLY, IT MUST NEVER BE INSTALLED FACING TO THE REAR IN A VEHICLE EQUIPPED WITH THE REAR SEAT DELETE FEATURE (Commercial Vehicles Only). When a convertible seat is properly installed facing forward, the vehicle seat should be adjusted to the **rear most position**.
- Children more than 40 lbs (18 kg) should be secured in the passenger seat in a child restraint or belt-positioning booster seat with the seat adjusted to the

rear most position. Older children who do not use child restraints or belt-positioning booster seats should ride properly buckled in the passenger seat with the seat adjusted to the rear most position. Never allow children to slide the shoulder belt behind them or under their arm.

Tether Installation For Commercial Vehicles With Rear Seat Delete

To secure the child restraint upper tether strap to the vehicle, follow the instructions shown:

1. Locate the child restraint tether anchor on the lower rear of the front passenger seat.
2. Follow the child restraint manufacturer’s directions for proper use of connecting the child restraint to the extended tether strap.
3. Route the tether strap under the head rest.

NOTE: Ensure that the child restraint tether strap is centered between the headrest supports underneath the head rest.

4. Using the hook attached to the child restraint tether strap, attach the child restraint tether strap to the metal anchor on the lower rear of the front passenger seat.
5. Following the child seat manufacturer's instructions, tighten the child restraint tether strap.
6. Inspect the tether anchor strap for nicks, abrasions, discoloration, and loose threads. If these, or any other condition that might effect the performance of the strap is observed, **DO NOT USE**. Contact your authorized DaimlerChrysler dealership for a replacement part.

WARNING!

The vehicle tether anchor is designed to be used with a child restraint only. It should not be used for any other purpose. Before use, inspect the tether anchor strap for nicks, abrasions, discoloration, and loose threads. If these or any other condition that might effect the performance of the strap is observed, DO NOT USE. Personal injury may result. Contact your authorized DaimlerChrysler dealership for a replacement part.

ENGINE BREAK-IN RECOMMENDATIONS

A long break-in period is not required for the engine in your vehicle.

Drive moderately during the first 300 mi (500 km). After the initial 60 mi (100 km), speeds up to 50 or 55 mph (80 or 90 km/h) are desirable.

While cruising, brief full-throttle acceleration, within the limits of local traffic laws, contributes to a good break-in. Wide-open throttle acceleration in low gear can be detrimental and should be avoided.

The engine oil installed in the engine at the factory is a high-quality energy-conserving type lubricant. Oil changes should be consistent with anticipated climate conditions under which vehicle operations will occur. For the recommended viscosity and quality grades, refer to "Maintenance Procedures" in Section 7. **NON-DETERGENT OR STRAIGHT MINERAL OILS MUST NEVER BE USED.**

A new engine may consume some oil during its first few thousand miles (kilometers) of operation. This should be considered as a normal part of the break-in and not interpreted as an indication of difficulty.

SAFETY TIPS

SAFETY CHECKS YOU SHOULD MAKE INSIDE THE VEHICLE

Seat Belts

Inspect the belt system periodically checking for cuts, frays, and loose parts. Damaged parts must be replaced immediately. Do not disassemble or modify the system.

Front seat belt assemblies must be replaced after a collision. Rear seat belt assemblies must be replaced after a collision if they have been damaged (bent retractor, torn webbing, etc.). If there is any question regarding belt or retractor condition, replace the belt.

Airbag Light

The light should come on and remain on for four seconds as a bulb check when the ignition switch is first turned ON. If the LED is not lit during starting and/or the light stays on or comes ON while driving, have the system checked by an authorized dealer.

Defroster

Check operation by selecting the defrost mode and place the blower control on high speed. You should be able to feel the air directed against the windshield.

NOTE: If the defroster is not working or you are unable to feel air against the windshield in defrost mode, please see your authorized dealer service center for repairs.

PERIODIC SAFETY CHECKS YOU SHOULD MAKE OUTSIDE THE VEHICLE**Tires**

Examine tires for excessive tread wear or uneven wear patterns. Check for stones, nails, glass, or other objects lodged in the tread. Inspect tread and sidewall for cuts or cracks. Check wheel nuts for tightness, and tires (including spare) for proper pressure.

Lights

Have someone observe the operation of exterior lights while you work the controls. Check turn signal and high beam indicator lights on the instrument panel.

Fluid Leaks

Check area under vehicle after overnight parking for fuel, engine coolant, oil or other fluid leaks. Also, if gasoline fumes are detected or fuel, power steering fluid, transmission fluid or brake fluid leaks are suspected, the cause should be located and corrected immediately.

Exhaust Gas

WARNING!

Exhaust gases can injure or kill. They contain carbon monoxide (CO) which is colorless and odorless. Breathing it can make you unconscious and can eventually poison you. To avoid breathing (CO) follow the safety tips below.

Do not run the engine in a closed garage or in confined areas any longer than needed to move your vehicle in or out of the area.

If it is necessary to sit in a parked vehicle with the engine running, adjust your heating or cooling controls to force outside air into the vehicle. Set the blower at high speed.

WARNING!

If you are required to drive with the deck lid / liftgate open, make sure that all windows are closed, and the climate control blower switch is set at high speed. DO NOT use the recirculation mode.

UNDERSTANDING THE FEATURES OF YOUR VEHICLE

CONTENTS

■ Mirrors	100	□ Things You Should Know About Your UConnect® System	122
□ Manual Rear View Day/Night Mirror — If Equipped	100	□ General Information	131
□ Exterior Mirrors	102	■ Seats	131
■ Hands-Free Communication (UConnect®) — If Equipped	104	□ Manual Front And Second Row Seat Adjuster	132
□ Operation	106	□ Stow 'n Go Seating — If Equipped	138
□ Phone Call Features	113	□ Swivel 'n Go Premium Seating — If Equipped	148
□ UConnect® System Features	116	■ Driver Memory Seat — If Equipped	155
□ Advanced Phone Connectivity	120		

- Setting Memory Positions And Linking RKE Transmitter To Memory 156
- To Open And Close The Hood 158
 - Hood Safety Switch — If Equipped 159
- Lights 160
 - Interior Lighting 160
 - Exterior Lights 162
- Multifunction Lever 166
 - Turn Signals 166
- Tilt Steering Column — If Equipped 171
- Rear Park Assist System — If Equipped 171
 - Rear Park Assist Sensors 172
- Adjustable Pedals — If Equipped 177
- Electronic Speed Control — If Equipped 179
 - Activating Electronic Speed Control 179
- Overhead Consoles 182
 - Front Overhead Console — If Equipped 182
- Garage Door Opener — If Equipped 185
 - Programming HomeLink® 187
 - Gate Operator/Canadian Programming 190
 - Security 191
 - Troubleshooting Tips 191
 - General Information 191
- Power Sunroof — If Equipped 192
 - Power Sunroof Operation 192
- Electrical Power Outlets — If Equipped 195

- Power Inverter — If Equipped196
- Electrical Outlet Use With Engine Off198
- Sun Screens— If Equipped198
- Cup Holders And Convenience Tray Drawer . . .200
 - Instrument Panel Cup Holders200
 - Interior Bottle Holders201
 - Smokers Package Kit — If Equipped201
- Console Features201
 - Basic Console201
 - Premium Console – If Equipped203
- Storage208
 - Glove Compartments208

- Door Trim Panel Storage209
- Second Row Floor Storage Bins —
If Equipped210
- Removing The Floor Console With Stow 'n Go
Seating — If Equipped211
- Rear Compartment Storage213
- Coat Hooks214
- Cargo Area Storage214
- Roof Luggage Rack — If Equipped215
- Umbrella Holder217
- Load-Leveling System — If Equipped218

MIRRORS

Manual Rear View Day/Night Mirror — If Equipped

Adjust the mirror to center on the view through the rear window. A two point pivot system allows for horizontal and vertical adjustment of the mirror.

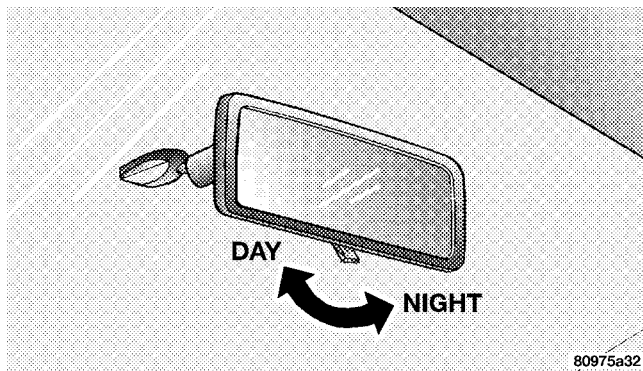

Manual Rearview Mirror

Annoying headlight glare can be reduced by moving the small control under the mirror to the night position (toward rear of vehicle). The mirror should be adjusted while set in the day position (toward windshield).

Automatic Rear View Day/Night Mirror — If Equipped

When using this feature the mirror will automatically adjust for annoying headlight glare from vehicles behind you. You can turn the feature on or off by pressing the button at the base of the mirror. A power indicator light to the side on/off button will indicate when the dimming feature is activated.

CAUTION!

To avoid damage to the mirror during cleaning, never spray any cleaning solution directly onto the mirror. Apply the solution onto a clean cloth and wipe the mirror clean.

3

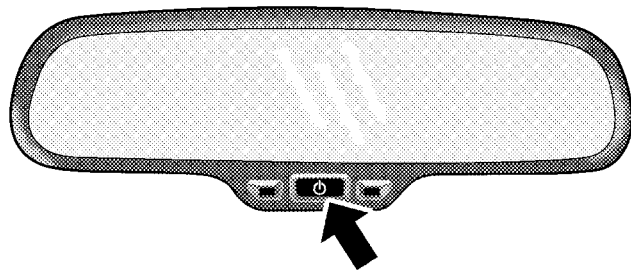

Automatic Dimming Mirror

81f1be98

Illuminated Vanity Mirrors — If Equipped

An illuminated vanity mirror is on the sun visor. To use the mirror, rotate the sun visor down and swing the mirror cover upward. The lights turn on automatically. Closing the mirror cover turns off the lights.

EXTERIOR MIRRORS

Side View Mirrors

To receive maximum benefit, adjust the outside mirror(s) to center on the adjacent lane of traffic with a slight overlap of the view obtained on the inside mirror.

WARNING!

Vehicles and other objects seen in a outside convex mirrors will look smaller and farther away than they really are. Relying too much on side convex mirrors could cause you to collide with another vehicle or other object. Use your inside mirror when judging the size or distance of a vehicle seen in a side convex mirror.

Side View Manual Folding Mirrors

All exterior mirrors are hinged and may be moved either forward or rearward to resist damage. The hinges have three detent positions; full forward, full rearward, and normal.

Driver's Auto-Dimming Side View Mirror — If Equipped

This mirror automatically adjusts for annoying headlight glare from vehicles behind you. You can turn this feature on or off by pressing the button at the base of the Rearview Mirror.

Power Remote Folding Side View Mirrors — If Equipped

Press the power fold button to fold in the mirrors. Press the button again to unfold the mirrors.

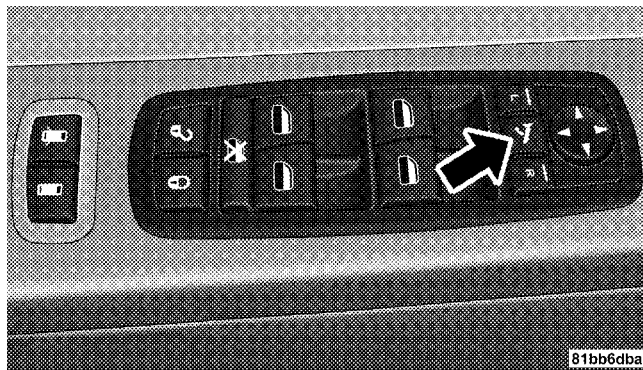

Power Folding Mirror Switch

Both mirrors will always move together and will fold anytime the button is pressed. The ignition switch does not have to be in the ON position.

Power Remote Side View Mirrors — If Equipped

Use the mirror select switch located on the driver's door trim panel, to adjust the view obtained in the outside

mirrors. Press the switch to the **Left** or **Right** for mirror selection. Press the mirror select switch again to guard against accidentally moving a mirror position. The mirror selection will also automatically turn off after 30 seconds.

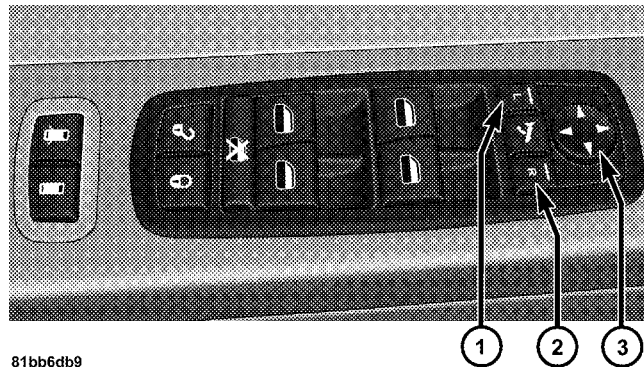

81bb6db9

Power Side Mirror Adjust

- 1 - Left Mirror
- 2 - Right Mirror

- 3 - Adjusting Switch

Select a mirror and press one of the four arrows for the direction you want the mirror to move.

Driver's power mirror preselected positions can be controlled by the optional Driver Memory Seat Feature. Refer to "Driver Memory Seat — If Equipped" in Section 3 of this manual.

HANDS-FREE COMMUNICATION (UConnect®) — IF EQUIPPED

NOTE: The sales code RER, REN and REU radios contain an integrated Hands-Free Communication (UConnect®) system. Refer to your "Navigation User's Manual" for UConnect® system operating instructions for these radios.

UConnect® is a voice-activated, hands-free, in-vehicle communications system. UConnect® allows you to dial a phone number with your cellular phone using simple voice commands (e.g., "Call" ... "Mike" ... "Work" or "Dial"

... "248-555-1212"). Your cellular phone's audio is transmitted through your vehicle's audio system; the system will automatically mute your radio when using the UConnect® system.

NOTE: The UConnect® system requires a cellular phone equipped with the Bluetooth® "Hands-Free Profile," Version 0.96 or higher. See the UConnect® website for supported phones.

NOTE: For UConnect® customer support, visit the following websites:

- www.chrysler.com/uconnect
- www.dodge.com/uconnect
- www.jeep.com/uconnect
- or call 1-877-855-8400

UConnect® allows you to transfer calls between the system and your cellular phone as you enter or exit your vehicle and enables you to mute the system's microphone for private conversation.

The UConnect® phonebook enables you to store up to 32 names, with four numbers per name. Each language has a separate 32-name phonebook accessible only in that language. This system is driven through your Bluetooth® "Hands-Free profile" cellular phone. UConnect® features Bluetooth® technology - the global standard that enables different electronic devices to connect to each other without wires or a docking station, so UConnect® works no matter where you stow your cellular phone (be it your purse, pocket, or briefcase), as long as your phone is turned on and has been paired to the vehicle's UConnect® system. The UConnect® system allows up to seven cellular phones to be linked to the system. Only

one linked (or paired) cellular phone can be used with the system at a time. The system is available in English, Spanish, or French languages.

Phone Button



The rearview mirror contains the microphone for the system (depending on the type of mirror and radio equipped), and either the radio or the mirror has the two control buttons (PHONE Button and VOICE RECOGNITION button) that will enable you to access the system.

Voice Recognition Button



Actual button location may vary with radio. The individual buttons are described in the "Operation" section.

The UConnect® system can be used with any Hands-Free Profile certified Bluetooth® cellular phone. See the UConnect® website for supported phones. If your cellular phone supports a different profile (e.g., Headset Profile) you may not be able to use any UConnect® features. Refer to your cellular service provider or the phone manufacturer for details.

The UConnect® system is fully integrated with the vehicle's audio system. The volume of the UConnect® system can be adjusted either from the radio volume control knob or from the steering wheel radio control (right switch), if so equipped.

The radio display will be used for visual prompts from the UConnect® system such as "CELL" or caller ID on certain radios.

Operation

Voice commands can be used to operate the UConnect® system and to navigate through the UConnect® menu structure. Voice commands are required after most UConnect® system prompts. You will be prompted for a specific command and then guided through the available options.

- Prior to giving a voice command, one must wait for the beep, which follows the "Ready" prompt or another prompt.
- For certain operations, compound commands can be used. For example, instead of saying "Setup" and then "Phone Pairing," the following compound command can be said: "Setup Phone Pairing."
- For each feature explanation in this section, only the combined form of the voice command is given. You can also break the commands into parts and say each part of the command when you are asked for it. For

example, you can use the combined form voice command "Phonebook New Entry," or you can break the combined form command into two voice commands: "Phonebook" and "New Entry." Please remember, the UConnect® system works best when you talk in a normal conversational tone, as if speaking to someone sitting a few feet/meters away from you.

Voice Command Tree

Refer to "Voice Tree" in this section.

Help Command

If you need assistance at any prompt, or if you want to know your options at any prompt, say "Help" following the beep. The UConnect® system will play all the options at any prompt if you ask for help.

To activate the UConnect® system from idle, simply press the PHONE button and follow the audible prompts for directions. All UConnect® system sessions begin with a press of the PHONE button on the radio control head.

Cancel Command

At any prompt, after the beep, you can say "Cancel" and you will be returned to the main menu. However, in a few instances the system will take you back to the previous menu.

Pair (Link) UConnect® System to a Cellular Phone

To begin using your UConnect® system, you must pair your compatible Bluetooth® enabled cellular phone.

To complete the pairing process, you will need to reference your cellular phone Owner's Manual. The UConnect® website may also provide detailed instructions for pairing.

The following are general phone to UConnect® system pairing instructions:

- Press the PHONE button to begin.
- After the "Ready" prompt and the following beep, say "Setup Phone Pairing."

- When prompted, after the beep, say "Pair a Phone" and follow the audible prompts.
- You will be asked to say a four-digit Personal Identification Number (PIN), which you will later need to enter into your cellular phone. You can enter any four-digit PIN. You will not need to remember this PIN after the initial pairing process.
- For identification purposes, you will be prompted to give the UConnect® system a name for your cellular phone. Each cellular phone that is paired should be given a unique phone name.
- You will then be asked to give your cellular phone a priority level between 1 and 7, with 1 being the highest priority. You can pair up to seven cellular phones to your UConnect® system. However, at any given time, only one cellular phone can be in use, connected to your UConnect® system. The priority allows the UConnect® system to know which cellular phone to

use if multiple cellular phones are in the vehicle at the same time. For example, if priority 3 and priority 5 phones are present in the vehicle, the UConnect® system will use the priority 3 cellular phone when you make a call. You can select to use a lower priority cellular phone at any time (refer to "Advanced Phone Connectivity" in this section).

Dial by Saying a Number

- Press the PHONE button to begin.
- After the "Ready" prompt and the following beep, say "Dial."
- The system will prompt you to say the number you want to call.
- For example, you can say "234-567-8901." The phone number that you enter must be of valid length and combination. Based on the country in which the vehicle was purchased, the UConnect® system limits the

user from dialing an invalid combination of numbers. For example, in the U.S., 234-567-890 is nine digits long, which is not a valid U.S. phone number - the closest valid phone number has 10 digits.

- The UConnect® system will confirm the phone number and then dial. The number will appear in the display of certain radios.

Call by Saying a Name

- Press the PHONE button to begin.
- After the "Ready" prompt and the following beep, say "Call."
- The system will prompt you to say the name of the person you want to call.
- After the "Ready" prompt and the following beep, say the name of the person you want to call. For example,

you can say "John Doe," where John Doe is a previously stored name entry in the UConnect® phonebook. To learn how to store a name in the phonebook, refer to "Add Names to Your UConnect® Phonebook," in this section.

- The UConnect® system will confirm the name and then dial the corresponding phone number, which may appear in the display of certain radios.

Add Names to Your UConnect® Phonebook

NOTE: Adding names to the phonebook is recommended when the vehicle is not in motion.

- Press the PHONE button to begin.
- After the "Ready" prompt and the following beep, say "Phonebook New Entry."

- When prompted, say the name of the new entry. Use of long names helps the voice recognition and it is recommended. For example, say "Robert Smith" or "Robert" instead of "Bob."
- When prompted, enter the number designation (e.g., "Home," "Work," "Mobile," or "Pager"). This will allow you to store multiple numbers for each phonebook entry, if desired.
- When prompted, recite the phone number for the phonebook entry that you are adding.

After you are finished adding an entry into the phonebook, you will be given the opportunity to add more phone numbers to the current entry or to return to the main menu.

The UConnect® system will allow you to enter up to 32 names in the phonebook with each name having up to

four associated phone numbers and designations. Each language has a separate 32-name phonebook accessible only in that language.

Phonebook Download

UConnect® allows the user to download entries from their phone via Bluetooth®. To use this feature, press the PHONE button and say "Phonebook Download." The system prompts, "Ready to accept "V" card entry via Bluetooth®..." The system is now ready to accept phonebook entries from your phone using the Bluetooth® Object Exchange Profile (OBEX). Please see your phone Owner's Manual for specific instructions on how to send these entries from your phone.

NOTE:

- The phone handset must support Bluetooth® OBEX transfers of phonebook entries to use this feature.
- Some phones cannot send phonebook entries if they are already connected to any system via Bluetooth®,

and you may see a message on the phone display that the Bluetooth® link is busy. In this case, the user must first disconnect or drop the Bluetooth® connection to the UConnect® system, and then send the address book entry via Bluetooth®. Please see your phone Owner's Manual for specific instructions on how to drop the Bluetooth® connection.

- If the phonebook entry is longer than 24 characters, it will only use the first 24 characters.

Edit Entries in the UConnect® Phonebook

NOTE: Editing names in the phonebook is recommended when the vehicle is not in motion.

- Press the PHONE button to begin.
- After the "Ready" prompt and the following beep, say "Phonebook Edit."

- You will then be asked for the name of the phonebook entry that you wish to edit.
- Next, choose the number designation (home, work, mobile, or pager) that you wish to edit.
- When prompted, recite the new phone number for the phonebook entry that you are editing.

After you are finished editing an entry in the phonebook, you will be given the opportunity to edit another entry in the phonebook, call the number you just edited, or return to the main menu.

"Phonebook Edit" can be used to add another phone number to a name entry that already exists in the phonebook. For example, the entry John Doe may have a mobile and a home number, but you can add "John Doe's" work number later using the "Phonebook Edit" feature.

Delete Entries in the UConnect® Phonebook

NOTE: Editing phonebook entries is recommended when the vehicle is not in motion.

- Press the PHONE button to begin.
- After the "Ready" prompt and the following beep, say "Phonebook Delete."
- After you enter the Phonebook Delete menu, you will then be asked for the name of the entry that you wish to delete. You can either say the name of a phonebook entry that you wish to delete or you can say "List Names" to hear a list of the entries in the phonebook from which you choose. To select one of the entries from the list, press the "Voice Recognition" button while the UConnect® system is playing the desired entry and say "Delete."

- After you enter the name, the UConnect® system will ask you which designation you wish to delete: home, work, mobile, pager, or all. Say the designation you wish to delete.
- Note that only the phonebook entry in the current language is deleted.

Delete All Entries in the UConnect® Phonebook

- Press the PHONE button to begin.
- After the "Ready" prompt and the following beep, say "Phonebook Erase All."
- The UConnect® system will ask you to verify that you wish to delete all the entries from the phonebook.
- After confirmation, the phonebook entries will be deleted.
- Note that only the phonebook in the current language is deleted.

List All Names in the UConnect® Phonebook

- Press the PHONE button to begin.
- After the "Ready" prompt and the following beep, say "Phonebook List Names."
- The UConnect® system will play the names of all the phonebook entries.
- To call one of the names in the list, press the "Voice Recognition" button during the playing of the desired name, and say "Call."

NOTE: The user can also exercise "Edit" or "Delete" operations at this point.

- The UConnect® system will then prompt you as to the number designation you wish to call.
- The selected number will be dialed.

Phone Call Features

The following features can be accessed through the UConnect® system if the feature(s) are available on your cellular service plan. For example, if your cellular service plan provides three-way calling, this feature can be accessed through the UConnect® system. Check with your cellular service provider for the features that you have.

Answer or Reject an Incoming Call - No Call Currently in Progress

When you receive a call on your cellular phone, the UConnect® system will interrupt the vehicle audio system, if on, and will ask if you would like to answer the call. Press the PHONE button to accept the call. To reject the call, press and hold the PHONE button until you hear a single beep, indicating that the incoming call was rejected.

Answer or Reject an Incoming Call - Call Currently in Progress

If a call is currently in progress and you have another incoming call, you will hear the same network tones for call waiting that you normally hear when using your cell phone. Press the PHONE button to place the current call on hold and answer the incoming call.

NOTE: The UConnect® system compatible phones in the market today do not support rejecting an incoming call when another call is in progress. Therefore, the user can only answer an incoming call or ignore it.

Making a Second Call While Current Call in Progress

To make a second call while you are currently on a call, press the “Voice Recognition” button and say “Dial” or “Call” followed by the phone number or phonebook entry you wish to call. The first call will be on hold while the second call is in progress. To go back to the first call, refer

to “Toggling Between Calls” in this section. To combine two calls, refer to “Conference Call” in this section.

Place/Retrieve a Call From Hold

To put a call on hold, press the PHONE button until you hear a single beep. This indicates that the call is on hold. To bring the call back from hold, press and hold the PHONE button until you hear a single beep.

Toggling Between Calls

If two calls are in progress (one active and one on hold), press the PHONE button until you hear a single beep, indicating that the active and hold status of the two calls have switched. Only one call can be placed on hold at one time.

Conference Call

When two calls are in progress (one active and one on hold), press and hold the PHONE button until you hear a double beep indicating that the two calls have been joined into one conference call.

Three-Way Calling

To initiate three-way calling, press the “Voice Recognition” button while a call is in progress, and make a second phone call, as described under “Making a Second Call While Current Call in Progress.” After the second call has established, press and hold the PHONE button until you hear a double beep, indicating that the two calls have been joined into one conference call.

Call Termination

To end a call in progress, momentarily press the PHONE button. Only the active call(s) will be terminated and if there is a call on hold, it will become the new active call. If the active call is terminated by the far end, a call on hold may not become active automatically. This is cell phone-dependent. To bring the call back from hold, press and hold the PHONE button until you hear a single beep.

Redial

- Press the PHONE button to begin.

- After the “Ready” prompt and the following beep, say “Redial.”
- The UConnect® system will call the last number that was dialed from your cellular phone.

NOTE: This may not be the last number dialed from the UConnect® system.

Call Continuation

Call continuation is the progression of a phone call on the UConnect® system after the vehicle ignition key has been switched to OFF. Call continuation functionality available on the vehicle can be any one of three types:

- After the ignition key is switched to OFF, a call can continue on the UConnect® system either until the call ends, or until the vehicle battery condition dictates cessation of the call on the UConnect® system and transfer of the call to the mobile phone.

- After the ignition key is switched to OFF, a call can continue on the UConnect® system for a certain duration, after which the call is automatically transferred from the UConnect® system to the mobile phone.
- An active call is automatically transferred to the mobile phone after the ignition key is switched to OFF.

UConnect® System Features

Language Selection

To change the language that the UConnect® system is using:

- Press the PHONE button to begin.
- After the "Ready" prompt and the following beep, say the name of the language you wish to switch to English, Espanol, or Francais.
- Continue to follow the system prompts to complete language selection.

After selecting one of the languages, all prompts and voice commands will be in that language.

NOTE: After every UConnect® language change operation, only the language-specific 32-name phonebook is usable. The paired phone name is not language-specific and usable across all languages.

Emergency Assistance

If you are in an emergency and the mobile phone is reachable:

- Pick up the phone and manually dial the emergency number for your area.

If the phone is not reachable and the UConnect® system is operational, you may reach the emergency number as follows:

- Press the PHONE button to begin.

- After the "Ready" prompt and the following beep, say "Emergency" and the UConnect® system will instruct the paired cellular phone to call the emergency number. This feature is supported in the U.S., Canada, and Mexico.

NOTE: The emergency number dialed is based on the country where the vehicle is purchased (911 for the U.S. and Canada and 060 for Mexico). The number dialed may not be applicable with the available cellular service and area.

The UConnect® system does slightly lower your chances of successfully making a phone call as to that for the cell phone directly.

Your phone must be turned on and paired to the UConnect® system to allow use of this vehicle feature in emergency situations, when the cell phone has network coverage and stays paired to the UConnect® system.

Towing Assistance

If you need towing assistance:

- Press the PHONE button to begin.
- After the "Ready" prompt and the following beep, say "Towing Assistance."

NOTE: The Towing Assistance number dialed is based on the country where the vehicle is purchased (1-800-528-2069 for the U.S., 1-877-213-4525 for Canada, 55-14-3454 for Mexico City and 1-800-712-3040 for outside Mexico City in Mexico).

Please refer to the 24-Hour "Towing Assistance" coverage details in the Warranty Information Booklet and on the 24-Hour Towing Assistance Card.

Paging

To learn how to page, refer to "Working with Automated Systems." Paging works properly except for pagers of

certain companies, which time out a little too soon to work properly with the UConnect® system.

Voice Mail Calling

To learn how to access your voice mail, refer to "Working with Automated Systems."

Working with Automated Systems

This method is used in instances where one generally has to press numbers on the cellular phone keypad while navigating through an automated telephone system.

You can use your UConnect® system to access a voice mail system or an automated service, such as a paging service or automated customer service line. Some services require immediate response selection. In some instances, that may be too quick for use of the UConnect® system.

When calling a number with your UConnect® system that normally requires you to enter in a touch-tone

sequence on your cellular phone keypad, you can press the "Voice Recognition" button and say the sequence you wish to enter, followed by the word "Send." For example, if required to enter your PIN followed with a pound, (3 7 4 6 #), you can press the "Voice Recognition" button and say, "3 7 4 6 # Send." Saying a number, or sequence of numbers, followed by "Send," is also to be used for navigating through an automated customer service center menu structure, and to leave a number on a pager.

You can also send stored UConnect® phonebook entries as tones for fast and easy access to voice mail and pager entries. To use this feature, dial the number you wish to call and then press the "Voice Recognition" button and say, "Send." The system will prompt you to enter the name or number and say the name of the phonebook entry you wish to send. The UConnect® system will then send the corresponding phone number associated with the phonebook entry, as tones over the phone.

NOTE:

- You may not hear all of the tones due to cellular phone network configurations; this is normal.
- Some paging and voice mail systems have system time out settings that are too short and may not allow the use of this feature.

Barge In - Overriding Prompts

The “Voice Recognition” button can be used when you wish to skip part of a prompt and issue your voice recognition command immediately. For example, if a prompt is asking “Would you like to pair a phone, clear a...,” you could press the “Voice Recognition” button and say, “Pair a Phone” to select that option without having to listen to the rest of the voice prompt.

Turning Confirmation Prompts On/Off

Turning confirmation prompts off will stop the system from confirming your choices (e.g., the UConnect® system will not repeat a phone number before you dial it).

- Press the PHONE button to begin.
- After the “Ready” prompt and the following beep, say “Setup Confirmations.” The UConnect® system will play the current confirmation prompt status and you will be given the choice to change it.

Phone and Network Status Indicators

If available on the radio and/or on a premium display such as the instrument panel cluster, and supported by your cell phone, the UConnect® system will provide notification to inform you of your phone and network status when you are attempting to make a phone call using UConnect®. The status is given for roaming, network signal strength, phone battery strength, etc.

Dialing Using the Cellular Phone Keypad

You can dial a phone number with your cellular phone keypad and still use the UConnect® system (while dialing via the cell phone keypad, the user must exercise caution and take precautionary safety measures). By

dialing a number with your paired Bluetooth® cellular phone, the audio will be played through your vehicle's audio system. The UConnect® system will work the same as if you dial the number using voice recognition.

NOTE: Certain brands of mobile phones do not send the dial ring to the UConnect® system to play it on the vehicle audio system, so you will not hear it. Under this situation, after successfully dialing a number the user may feel that the call did not go through even though the call is in progress. Once your call is answered, you will hear the audio.

Mute/Un-Mute (Mute Off)

When you mute the UConnect® system, you will still be able to hear the conversation coming from the other party, but the other party will not be able to hear you. In order to mute the UConnect® system:

- Press the “Voice Recognition” button.
- Following the beep, say “Mute.”

In order to un-mute the UConnect® system:

- Press the “Voice Recognition” button.
- Following the beep, say “Mute off.”

Advanced Phone Connectivity

Transfer Call to and from Cellular Phone

The UConnect® system allows ongoing calls to be transferred from your cellular phone to the UConnect® system without terminating the call. To transfer an ongoing call from your UConnect® paired cellular phone to the UConnect® system or vice versa, press the “Voice Recognition” button and say “Transfer Call.”

Connect or Disconnect Link Between the UConnect® System and Cellular Phone

Your cellular phone can be paired with many different electronic devices, but can only be actively "connected" with one electronic device at a time.

If you would like to connect or disconnect the Bluetooth® connection between a UConnect® paired cellular phone and the UConnect® system, follow the instructions described in your cellular phone User's Manual.

List Paired Cellular Phone Names

- Press the PHONE button to begin.
- After the "Ready" prompt and the following beep, say "Setup Phone Pairing."
- When prompted, say "List Phones."

- The UConnect® system will play the phone names of all paired cellular phones in order from the highest to the lowest priority. To "select" or "delete" a paired phone being announced, press the "Voice Recognition" button and say "Select" or "Delete." Also, see the next two sections for an alternate way to "select" or "delete" a paired phone.

Select Another Cellular Phone

This feature allows you to select and start using another phone paired with the UConnect® system.

- Press the PHONE button to begin.
- After the "Ready" prompt and the following beep, say "Setup Select Phone" and follow the prompts.
- You can also press the "Voice Recognition" button at any time while the list is being played, and then choose the phone that you wish to select.

- The selected phone will be used for the next phone call. If the selected phone is not available, the UConnect® system will return to using the highest priority phone present in or near (approximately within 30 ft [9 m]) the vehicle.

Delete UConnect® Paired Cellular Phones

- Press the PHONE button to begin.
- After the "Ready" prompt and the following beep, say "Setup Phone Pairing."
- At the next prompt, say "Delete" and follow the prompts.
- You can also press the "Voice Recognition" button at any time while the list is being played, and then choose the phone you wish to delete.

Things You Should Know About Your UConnect® System

UConnect® Tutorial

To hear a brief tutorial of the system features, press the PHONE button and say "UConnect® Tutorial."

Voice Training

For users experiencing difficulty with the system recognizing their voice commands or numbers, the UConnect® system Voice Training feature may be used. To enter this training mode, follow one of the two following procedures:

From outside the UConnect® mode (e.g., from radio mode):

- Press and hold the "Voice Recognition" button for five seconds until the session begins, or,
- Press the "Voice Recognition" button and say the "Setup, Voice Training" command.

Repeat the words and phrases when prompted by the UConnect® system. For best results, the Voice Training session should be completed when the vehicle is parked with the engine running, all windows closed, and the blower fan switched OFF.

This procedure may be repeated with a new user. The system will adapt to the last trained voice only.

To restore the Voice Recognition system to factory default settings, enter the Voice Training session via the above procedure and follow the prompts.

Voice Recognition (VR)

- For best performance, adjust the rearview mirror to provide at least ½ in (1 cm) gap between the overhead console (if equipped) and the mirror.
- Always wait for the beep before speaking.

- Speak normally, without pausing, just as you would speak to a person sitting a few feet/meters away from you.
- Make sure that no one other than you is speaking during a voice recognition period.
- Performance is maximized under:
 - low-to-medium blower setting,
 - low-to-medium vehicle speed,
 - low road noise,
 - smooth road surface,
 - fully closed windows,
 - dry weather condition.
- Even though the system is designed for users speaking in North American English, French, and Spanish accents, the system may not always work for some.

- When navigating through an automated system such as voice mail, or when sending a page, at the end of speaking the digit string, make sure to say "Send."
- Storing names in the phonebook when the vehicle is not in motion is recommended.
- It is not recommended to store similar sounding names in the UConnect® phonebook.
- The UConnect® phonebook nametag recognition rate is optimized for the person who stored the name in the phonebook.
- You can say "O" (letter "O") for "0" (zero). "800" must be spoken "eight-zero-zero."
- Even though international dialing for most number combinations is supported, some shortcut dialing number combinations may not be supported.

- In a convertible vehicle, system performance may be compromised with the convertible top down.

Far End Audio Performance

- Audio quality is maximized under:
 - low-to-medium blower setting,
 - low-to-medium vehicle speed,
 - low road noise,
 - smooth road surface,
 - fully closed windows,
 - dry weather conditions, and
 - operation from the driver's seat.
- Performance, such as audio clarity, echo, and loudness to a large degree rely on the phone and network, and not the UConnect® system.

- Echo at the far end can sometimes be reduced by lowering the in-vehicle audio volume.
- In a convertible vehicle, system performance may be compromised with the convertible top down.

Bluetooth® Communication Link

Cellular phones have been found to lose connection to the UConnect® system. When this happens, the connection can generally be re-established by switching the phone off/on. Your cell phone is recommended to remain in Bluetooth® ON mode.

Power-Up

After switching the ignition key from OFF to either ON or ACC position, or after a language change, you must wait at least five seconds prior to using the system.

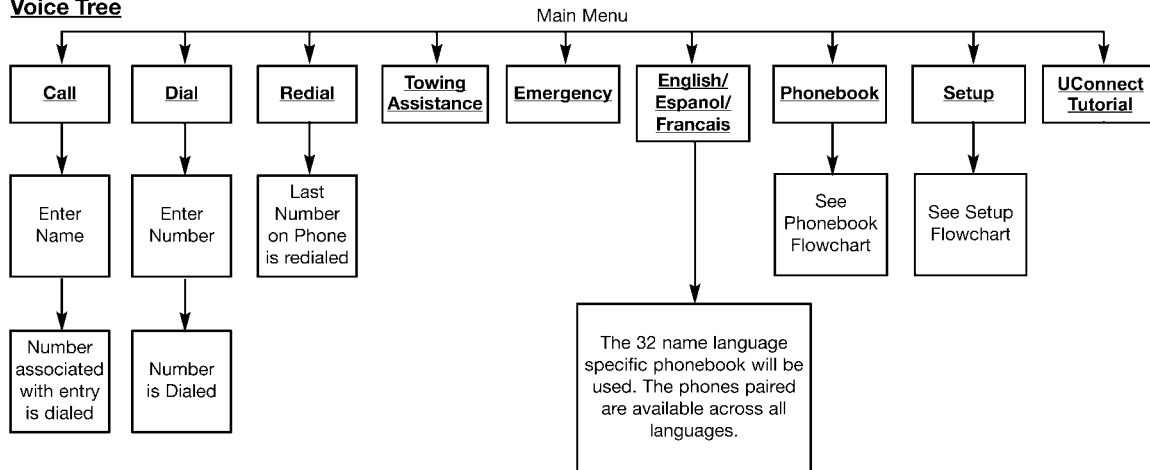
Voice Tree

Note: Available Voice commands are shown in bold face and are underlined.

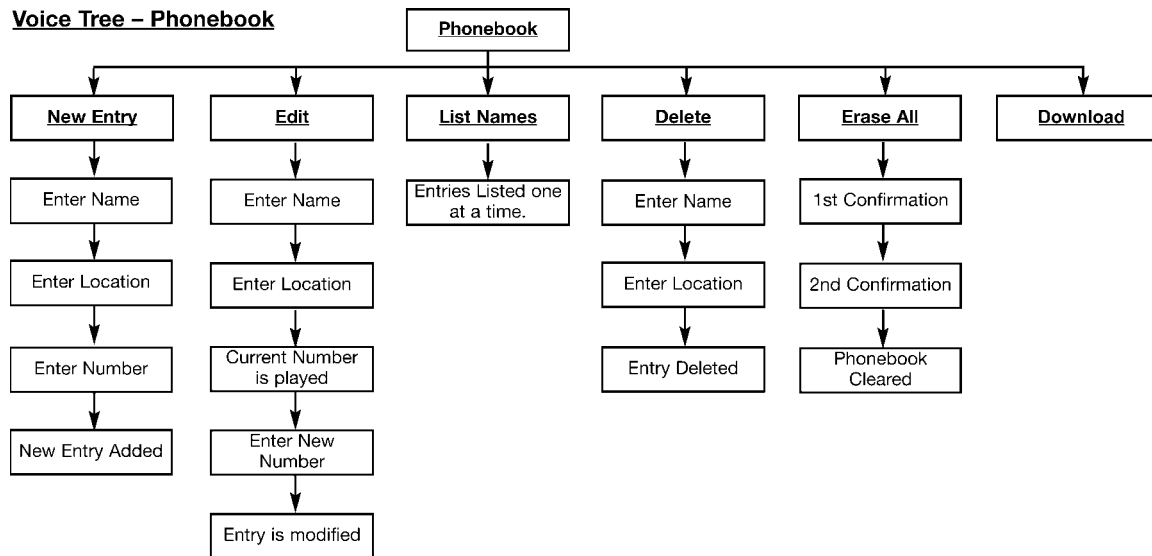
Voice Tree – Phonebook

Note: Available Voice commands are shown in bold face and are underlined.

81c6bf80

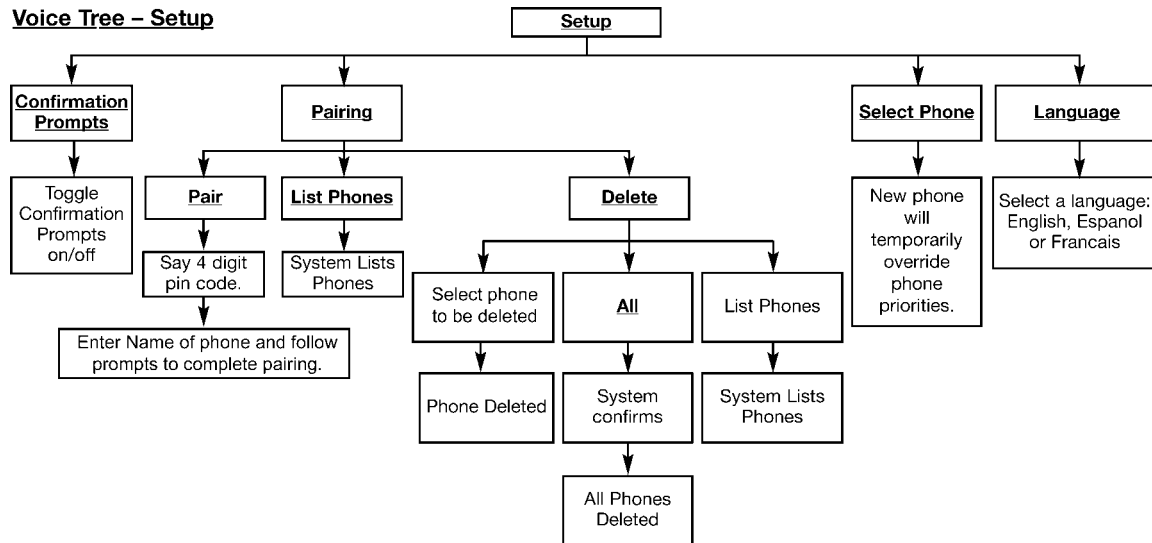
Voice Tree – Setup

Note: Available Voice commands are shown in bold face and are underlined.

Voice Commands	
Primary	Alternate(s)
zero	
one	
two	
three	
four	
five	
six	
seven	
eight	
nine	
star (*)	
plus (+)	
pound (#)	
add location	
all	

Voice Commands	
Primary	Alternate(s)
call	
cancel	
confirmation prompts	
continue	
delete	
dial	
download	
edit	
emergency	
English	
erase all	
Espanol	
Francais	
help	
home	

Voice Commands	
Primary	Alternate(s)
language	
list names	
list phones	
mobile	
mute	
mute off	
new entry	
no	
pager	
pair a phone	
phone pairing	pairing
phonebook	phone book
previous	
record again	
redial	

Voice Commands	
Primary	Alternate(s)
return to main menu	return or main menu
select phone	select
send	
set up	phone settings or phone set up
towing assistance	
transfer call	
UConnect® Tutorial	
try again	
voice training	
work	
yes	

General Information

This device complies with Part 15 of the FCC rules and RSS 210 of Industry Canada. Operation is subject to the following conditions:

- This device may not cause harmful interference.
- This device must accept any interference received, including interference that may cause undesired operation.

SEATS

Seats are a primary part of the Occupant Restraint (protection) System of the vehicle. They need to be used properly for safe operation of the vehicle.

WARNING!

- **DO NOT allow people to ride in any area of your vehicle that is not equipped with seats and seat belts. In a collision, people riding in these areas are more likely to be seriously injured or killed.**
- **Be sure everyone in your vehicle is in a seat and using a seat belt properly.**

Manual Front And Second Row Seat Adjuster

The adjusting bar is located under the front of the seat. Pull the bar up and move the seat to the desired position. Release the bar to lock the seat into position.

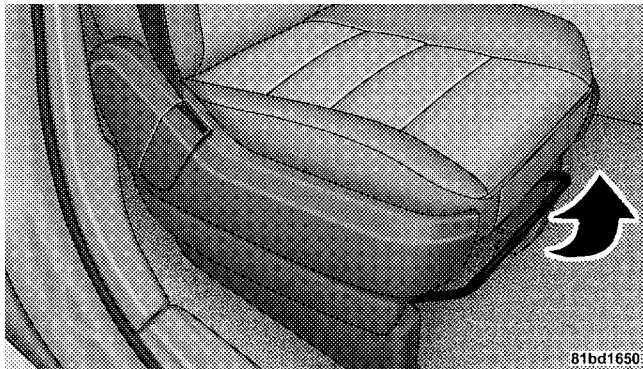

Manual Seat Adjuster

Using body pressure, move forward and rearward on the seat to be sure the seat adjusters have latched.

WARNING!

Adjusting a seat while the vehicle is moving is dangerous. The sudden movement of the seat could cause you to lose control. The seat belt might not be properly adjusted and you could be injured. Adjust any seat only while the vehicle is parked.

8-Way Driver's Power Seat — If Equipped

The driver's power seat switches are located on the outboard side of the seat. The front switch controls up/down, forward/rearward, and tilt adjustment. The rear switch controls the seatback recline adjustment.

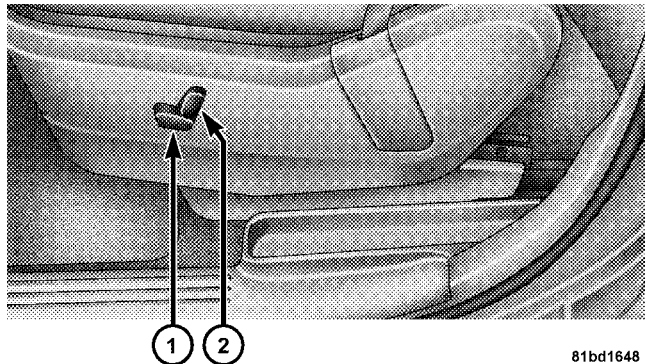

81bd1648

Driver Power Seat Switch

1 - Bottom Control

2 - Seatback Control

CAUTION!

DO NOT place any article under a power seat or impede its ability to move as it may cause damage to the seat controls. Seat travel may become limited if movement is stopped by an obstruction in the seat's path.

Adjustable Head Restraints

Head restraints can reduce the risk of whiplash injury in the event of impact from the rear. Pull up or push down on the head restraint cushion so that the upper edge is as high as practical. To raise the head restraint, pull up on the head restraint. To lower the head restraint, depress the release tab located at the base of the head restraint and push down on the head restraint.

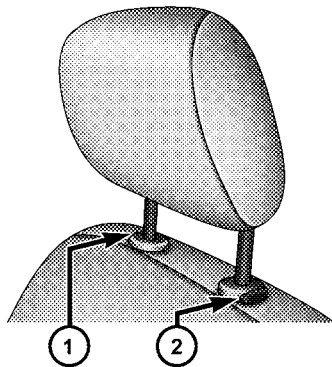

81bd164e

Adjusting The Head Restraint Cushion

1 - Removal Release

2 - Lowering Release

Heated Seats — If Equipped

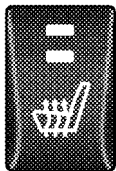

81f1bf07

This feature heats the front driver and passenger seats. The controls for front heated seats are located on the center instrument panel area. The switch indicator lights will show when the HIGH or LOW heat is ON. Press the switch once to choose HIGH (two lights), press it a second time to choose LOW (one light), press it a third time for No Heat (no lights).

Second row heated seat switches are located in the sliding side door handle trim panels and function the same as front switches.

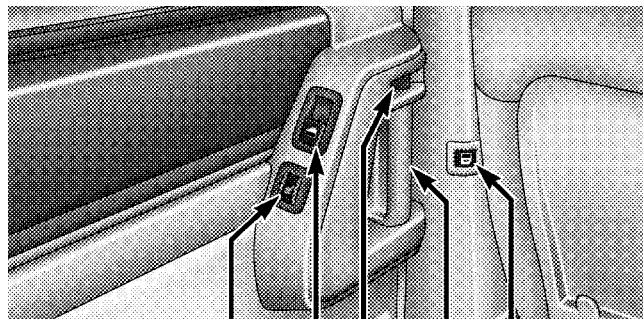

3

81bb8d6d

Sliding Door Controls

- | | |
|-------------------------|-------------------------------|
| 1 - Heated Seat Switch | 4 - Door Handle |
| 2 - Power Window Switch | 5 - Power Sliding Door Switch |
| 3 - Manual Lock | |

WARNING!

Persons who are unable to feel pain to the skin because of advanced age, chronic illness, diabetes, spinal cord injury, medication, alcohol use, exhaustion or other physical condition must exercise care when using the seat heater. It may cause burns even at low temperatures, especially if used for long periods of time. **DO NOT** place anything on the seat that insulates against heat, such as a blanket or cushion. This may cause the seat heater to overheat.

Manual Reclining Seats — If Equipped

The recliner mechanism control is on the outboard side of the seat. To recline, lean forward slightly, lift the lever, then push back to the desired position and release the lever. Lean forward and lift the lever to return the

seatback to its normal position. Using body pressure, lean forward and rearward on the seat to be sure the seatback has latched.

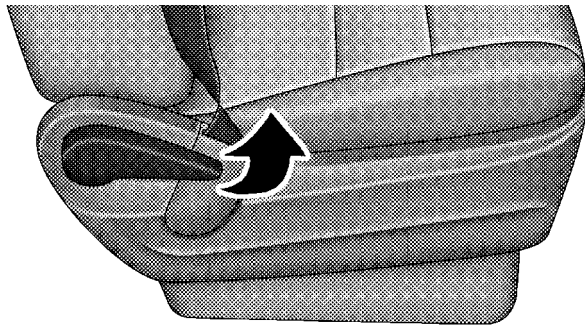

81bd164a

Manual Reclining Seat Control

WARNING!

DO NOT ride with the seatback reclined so that the shoulder belt is no longer resting against your chest. In a collision you could slide under the seat belt and be seriously or fatally injured. Use the recliner only when the vehicle is parked.

Manual Lumbar Adjust Lever — If Equipped

The lumbar adjustment handle is located on the outboard side of the seat. To increase the support, rotate the handle down. To decrease the support, rotate the handle upwards.

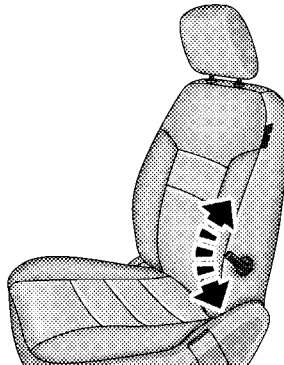
**Manual Lumbar Control**

81bd1649

Stow 'n Go Seating — If Equipped

On vehicles equipped with Stow 'n Go seating, the second and third row seats may be folded into the floor for convenient storage.

To Fold Second Row Seats

1. Move the front seat fully forward.
2. Lower the head restraints and raise the armrests on the second row seat.
3. Slide the storage bin locking mechanism to the "unlocked" position and then pull up on the storage bin latch to open the cover.

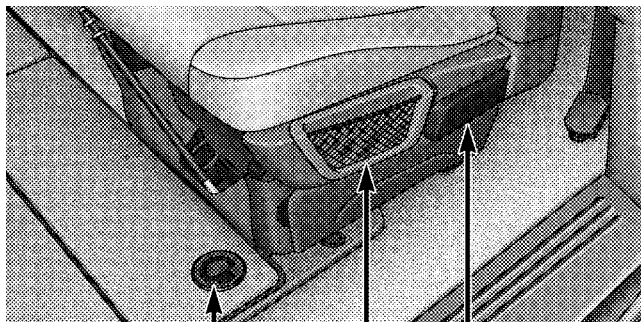

81bd1664

1 - Bin Latch
2 - Storage Pocket

3 - Seatback Release

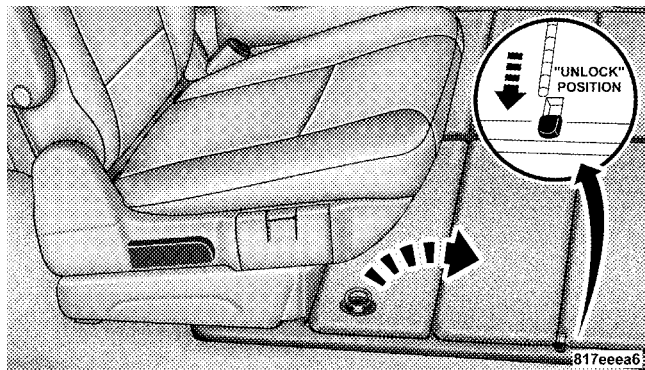

Storage Bin Cover Lock Release

4. Pull up on the seatback recliner lever located on the outboard side of the seat and fold the seatback down. To assure the seatback is latched in the folded position, additional downward pressure on the seatback may be required when folding.

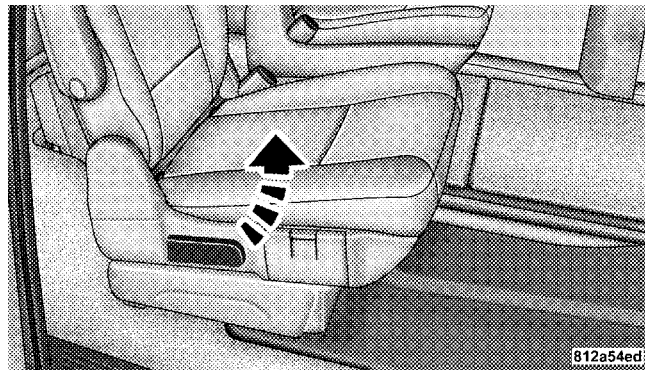

Second Row Seatback Release Lever

5. Pull rearward on the release strap located at the rear of the seat and tumble the seat forward into the storage bin.

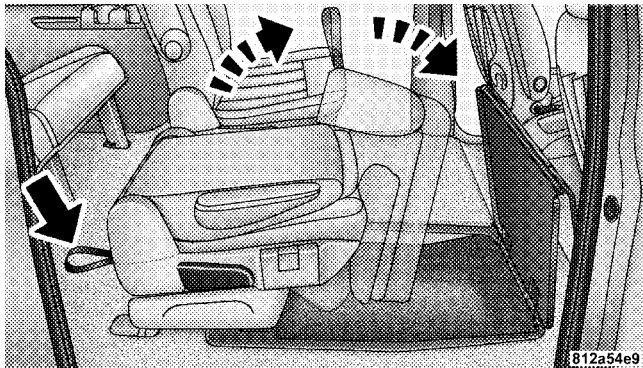

Second Row Seat Release Strap

6. Close the storage bin cover and slide the storage bin locking mechanism to the locked position.

CAUTION!

The storage bin cover must be locked and flat to avoid damage from contact with the front seat tracks, which have minimal clearance to the cover.

WARNING!

In an accident, serious injury could result if the seat storage bin covers are not properly latched.

- **DO NOT** drive the vehicle with the storage bin covers open.
- **Keep** the storage bin covers closed and latched while the vehicle is in motion.
- **DO NOT** use a storage bin latch as a tie down.

To Unfold Second Row Seats

1. Slide the storage bin locking mechanism to the "unlocked" position and then pull up on the storage bin latch to open the cover.
2. Pull up on the handle to lift the seat out of the storage bin and push the seat rearward to latch the seat anchors.

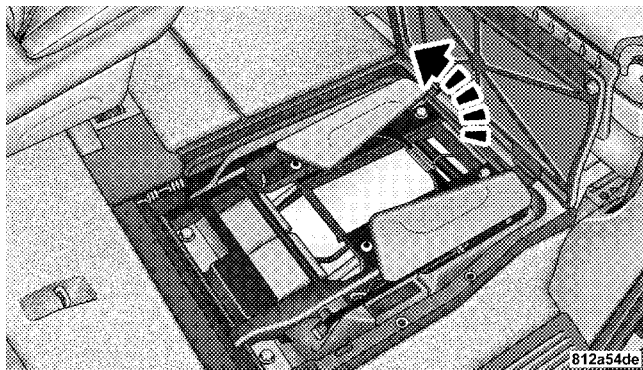

Second Row Seat Release Handle

3. Pull up on the seatback recliner lever located on the outboard side of the seat, to return the seatback to its full upright position.

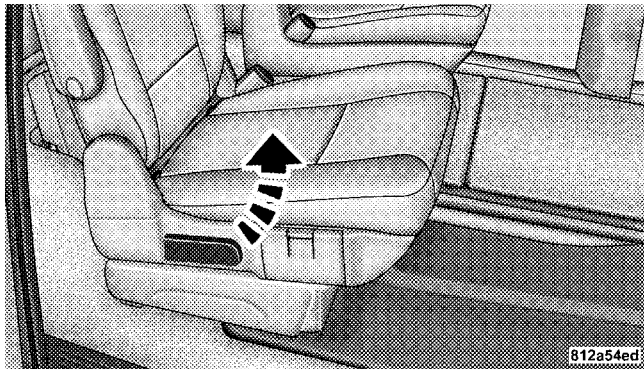

Second Row Seatback Release Lever

4. Close the storage bin cover and adjust the head restraint to the desired position.

Second Row Bench Seat — If Equipped

While the bench seat does not stow in the floor, it is removable for added cargo space. Rollers integrated into the seat frame ease removal through the rear. Floor storage compartments are still available with the bench seat.

Third Row Power Seat — If Equipped

The third row power seat offers the following features:

- The seatbacks can be folded forward for additional cargo space if needed
- Head restraints can be stowed with the seat
- Tailgate mode flips the seat rearward to face out the tailgate.

The power recline feature, located on the side of the seat cushion, adjusts the seatback angle forward/rearward for occupant comfort

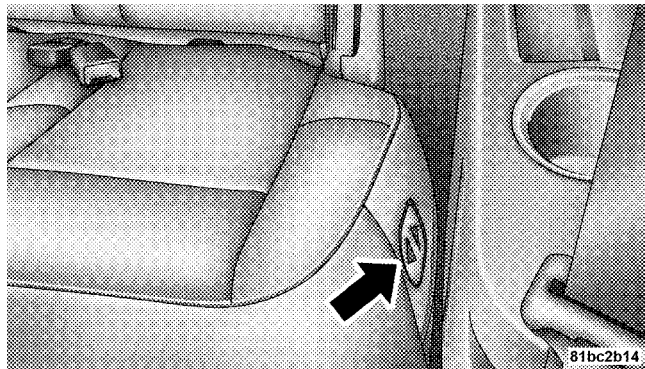

Third Row Power Seat Switch

Remote Third Row Power Seat Switch— If Equipped

A One-Touch Third Row Power Folding Seat switch is located in the left rear trim panel as part of a switch-bank.

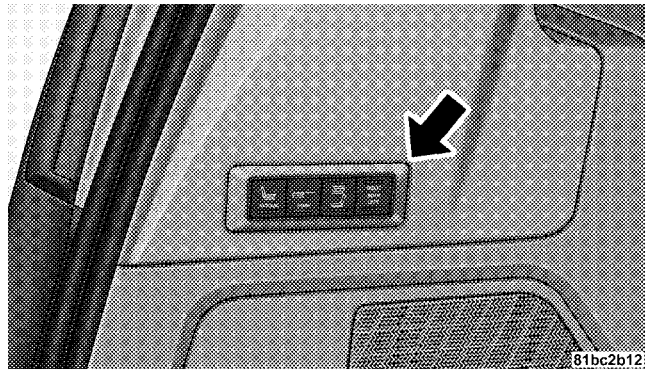

One Touch Folding Seat Third Row

The rear switch bank allows multiple power folding and unfolding positions for the third row seats.

Left and right third row seats can be folded individually or together. The One Touch Third Row Power Folding Seat adjusts to the following positions using the switch bank located on the left rear trim panel:

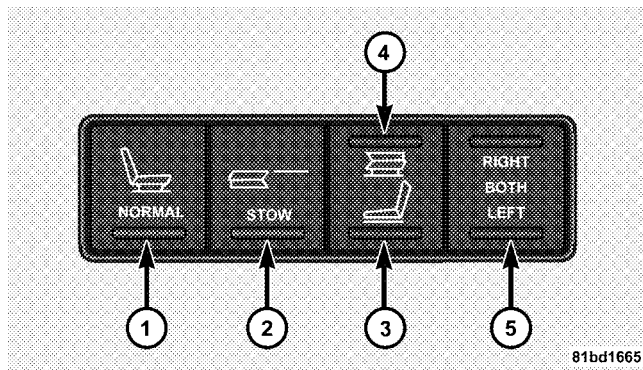

Rear Panel Power Switch Bank

1 — Open to Normal
2 — Stow
3 — Tailgate

4 — Fold Flat
5 — Right/Left or Both Seats

NOTE: The Third Row Power Seat system includes obstacle detection for safe operation. When the system detects an obstacle, the motors will stop and reverse the motion for a brief period. Should this occur, remove the obstacle and repress the button again, for the desired position.

To Fold Third Row Seats Manually — If Equipped

1. Lower the head restraint to its full down position.
2. Pull release strap marked “1” located on the rear of the seat to lower the seatback.
3. Pull release strap marked “2” to release the anchors.

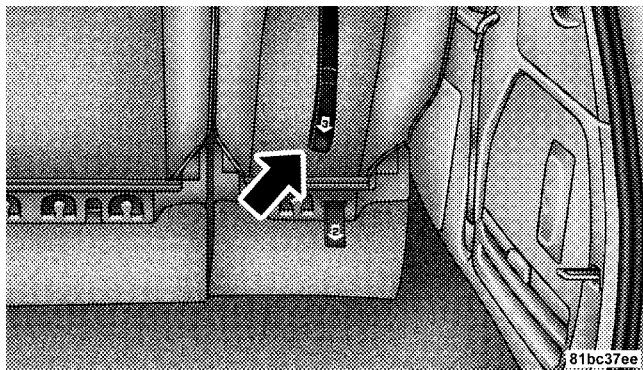

3

Folding Third Row Seat Strap

4. Pull release strap marked “3” and tumble the seat rearward into the storage bin.

To Unfold Third Row Seats

1. Pull up on the assist strap to lift the seat out of the storage bin and push the seat forward until the anchors latch.
2. Pull release strap marked “1” to unlock the recliner.
3. Pulling strap “3” releases the seatback to return to its full upright position.
4. Adjust the head restraint to the desired position.

WARNING!

In a collision, you or others in your vehicle could be injured if seats are not properly latched to their floor attachments. Always be sure the seats are fully latched.

Tailgate Mode

1. Pull release strap “2”, then pull release strap “3” to rotate the entire seat rearward.

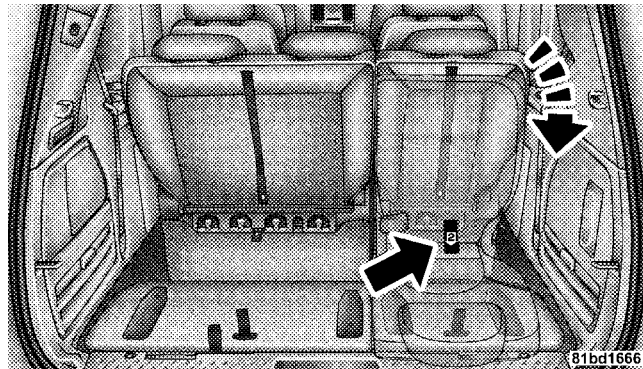

Tailgate Positioning Release Straps 2 and 3

2. To restore the seat to its upright position, lift up on the seatback and push forward until the anchors latch.

WARNING!

To avoid serious injury or death, **NEVER** operate the vehicle with occupants in the third row seat while in the tailgate mode.

Easy Access Seating

The second row Stow 'n Go seats can be tilted forward for easy access to the third row seat or rear cargo area.

To tilt the seat, pull forward on the release strap located on the front of the seat between the seatback and seat cushion and tilt the seat fully forward.

To return the seat to its upright position, push rearward on the seatback until it latches. Always ensure that it is fully latched.

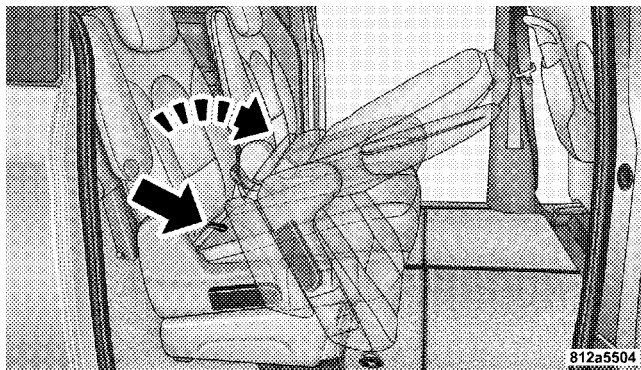

Tilting Second Row Stow 'n Go Seat

WARNING!

In the event of a collision you could be injured if the seat is not fully latched.

Swivel 'n Go Premium Seating — If Equipped

Premium second row Swivel 'n Go Seating features include:

- A table that installs between the second and third row seats. The table disassembles and stows in the hidden second row floor storage bin
- Seats rotate to face forward or rearward
- Seat belts are integrated into the swivel seats
- Dual folding armrests
- A side storage pocket that will accommodate a phone or hand-held game
- Seats are removable

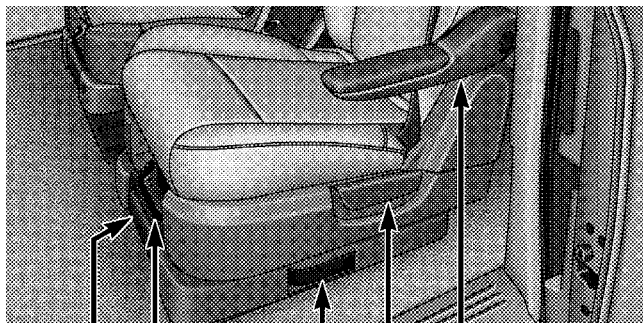

81bd1663

Swivel 'n Go Seating Features

- 1 - Seat Release
- 2 - Fore-Aft Adjustment
- 3 - Swivel Release

- 4 - Seatback Release
- 5 - Moveable Armrest

To swivel the seat: Pull the lower handle on the outboard side of the seat and push the side of the seatback to begin rotation. Once the seat begins to rotate, the handle may be released. The seat locks in position once reaching the forward or rearward positions only.

Seatbacks fold forward on an angle, not flat. This allows the seats to swivel when the seatbacks are folded.

WARNING!

Failure to comply with the following conditions could result in serious injury or even death.

- **NEVER place any child seat or infant carrier in the Swivel 'n Go seat while it is in the rearward facing position.**
- **The swivel seat should be locked in the forward position when using any child seat or infant carriers, with the vehicle in motion.**
- **Occupants riding in Swivel 'n Go seating, must be wearing their seat belt and the seat must be locked in either the forward or rearward position.**
- **Make sure the Swivel 'n Go seat is in a locked position with the handle down. Test the seat after it is locked to see that it doesn't swivel.**

Removing Swivel 'n Go Premium Seating — If Equipped

1. Remove any obstructions from the floor behind the seat, and stow the Third Row Seat.
2. Pull up on the release bar located at the bottom front edge of the swivel seat.
3. From behind the seat, lift up on the rear of the seat cushion while pulling the seat in a rearward direction.
4. Remove the seat from vehicle through the liftgate. Rollers are part of the seat frame and will ease the removal process.
5. Lower the release handle located at the bottom front edge of the seat.

Each seat weighs about 90 lbs. (81 kg).

NOTE: Electrical contacts for the available heated seats automatically disengage or engage as the seat is removed or installed. The contacts slide past each other as the seat is rolled to and from the strikers.

When reinstalling the seat, make certain to lower the release handle to ensure the seat is latched securely.

WARNING!

In a collision, you or others in your vehicle could be injured if seats are not properly latched to their floor attachments. Always be sure the seats are fully latched.

Swivel 'n Go Premium Seating Table — If Equipped

The Swivel 'n Go Seating Table consists of an easily assembled post and top.

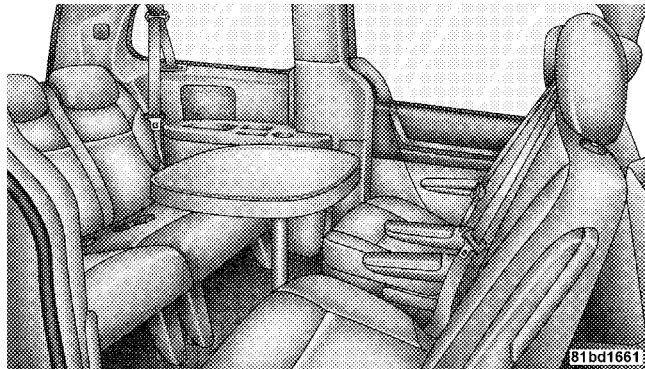

Second Row Seating and Table

The table and leg are stored beneath the floor when not in use. To install the table follow these steps:

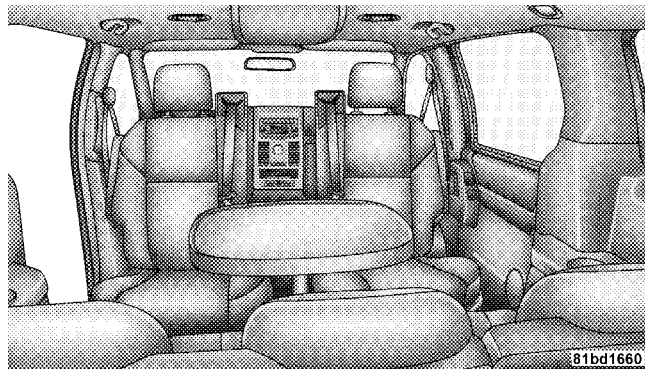

Second Row Seating and Table

1. Swivel the second row seats so they are facing the rear.

2. Open the floor storage cover in front of the second row seats.

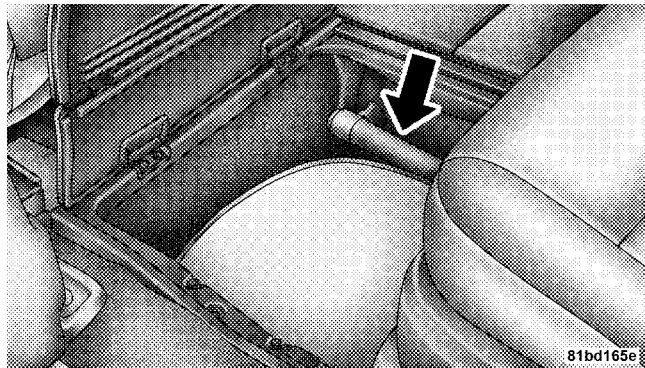
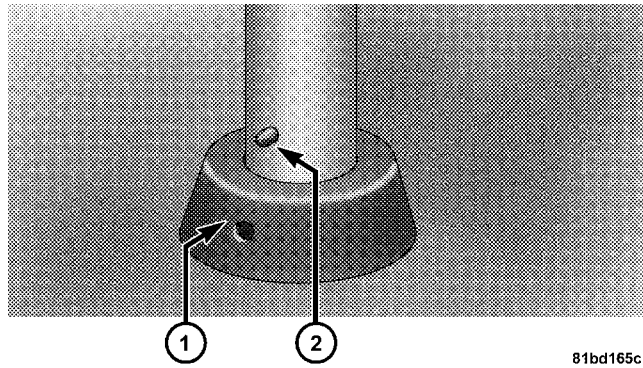

Table and Leg Storage

3. Remove the pole and table top by loosening the hook and loop straps.

4. Insert pole into base by aligning the lock button into notch of the base.



Installing Table Leg Into Base

1 - Table Base

2 - Lock/Release Button

5. Twist the pole in a clockwise rotation until it stops.

Note: You will hear an audible “click” when the lock button engages the base.

6. Place the table top over the installed pole aligning with the mating feature of the underside of the table top. Apply pressure on the table top and press downward.

Note: You will hear an audible “click” when the table latch engages the pole.

WARNING!

Failure to comply with the following conditions could result in serious injury or even death.

- **DO NOT install the table while vehicle is in motion**
- **NEVER drive the vehicle with only the pole installed**
- **DO NOT place heavy or sharp objects on table.**
- **DO NOT place liquid drinks on the table, use available cup holders.**
- **Second Row seats must be locked in the rearward facing position before installing the table.**

To separate the table top from the pole, follow these steps:

1. Locate the release latch on the underside of the table top.

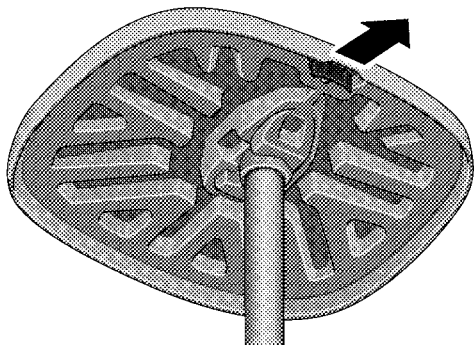

81bd165d

Table Top Release

2. Pull horizontally on the latch to activate the release from the pole.

3. While pulling on the latch, pull upward to remove the table top from the pole.

NOTE: The table top should be removed from the leg prior to removing the leg from its mounting base.

4. Locate the release button on the pole. Press the release button firmly to activate the release from the base.

5. While pressing the release button, twist the pole in a counterclockwise rotation until it stops. Pull upward to remove the pole from the base.

6. Place the pole on the underside of the table top and secure with the hook and loop straps.

7. Once the pole and table top are secured, you may place them in the floor storage bin in front of the second row seats.

NOTE: Always store the table and pole in the floor storage bin when not in use.

Plastic Grocery Bag Retainer Hooks

Retainer hooks which will hold plastic grocery bag handles are built into the seatbacks of all rear seats and some front seats. The floor supports the partial weight of the bagged goods.

DRIVER MEMORY SEAT — IF EQUIPPED

Once programmed, the Memory Buttons 1 and 2 on the driver's door panel can be used to recall the driver's seat, driver's outside mirror, adjustable brake and accelerator pedals, and radio station preset settings. Your Remote Keyless Entry (RKE) transmitters can also be programmed to recall the same positions when the UN-LOCK button is pressed.

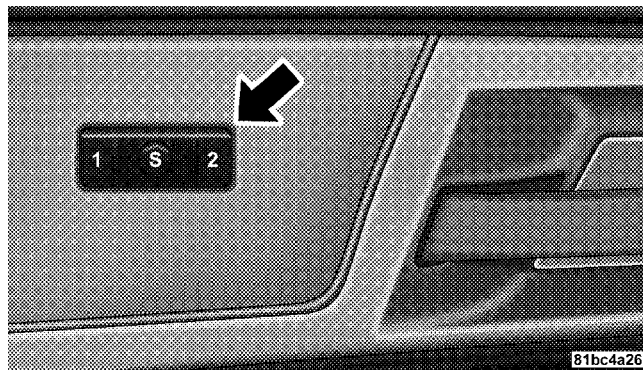

3

Driver Memory Seat Switch

Your vehicle may have been delivered with two Remote Keyless Entry transmitters. One or both transmitters can be linked to either Memory Position. The memory system can accommodate up to four transmitters, each one linked to either of the two memory positions.

Setting Memory Positions And Linking RKE Transmitter To Memory

NOTE: Each time the SET(S) button and a numbered button (1 or 2) are pressed, you erase the memory settings for that button and store a new one.

1. Insert the ignition key and turn the ignition switch to the ON position.
2. Press the driver door Memory Buttons number 1 if you are setting the memory for driver 1, or button number 2 if you are setting the memory for driver 2. The system will recall any stored settings. Wait for the system to complete the memory recall before continuing to step 3.
3. Adjust the driver's seat, recliner, and driver's side-view mirror to the desired positions.
4. Adjust the brake and accelerator pedals to the desired positions.

5. Turn on the radio and set the radio station presets (up to 10 AM and 10 FM stations can be set).
6. Turn the ignition switch to the OFF position and remove the key.
7. Press and release the SET(S) button located on the driver's door. A chime will sound signaling that you are in the memory set mode.
8. Within five seconds, press and release Memory Button 1 or 2 on the driver's door. A chime will sound signaling to you that the driver memory has been set. The next step must be performed within five seconds if you desire to also use a Remote Keyless Entry transmitter to recall memory positions.
9. Press and release the LOCK button on one of the transmitters. A chime will sound signaling to you that the transmitter has been successfully linked to memory.

10. Insert the ignition key and turn the ignition switch to the ON position.

11. Select "Remote Linked to Memory" in the Electronic Vehicle Information Center (EVIC) and enter "Yes" or select "No" from the EVIC and enter "Yes". Refer to the Customer Programmable features in the Electronic Vehicle Information Center (EVIC) section for more information.

12. Repeat the above steps to set the next Memory Position using the other numbered Memory Button or to link another Remote Keyless Entry transmitter to memory.

Memory Position Recall

NOTE: The vehicle must be in PARK to recall memory positions. If a recall is attempted when the vehicle is not in PARK, a message will be displayed in the Electronic Vehicle Information Center (EVIC).

To recall the memory settings for driver one, press Memory Button 1 on the driver's door or the UNLOCK button on the Remote Keyless Entry transmitter linked to Memory Position 1.

To recall the memory setting for driver two, press Memory Button 2 on the driver's door or the UNLOCK button on the Remote Keyless Entry transmitter linked to Memory Position 2.

A recall can be cancelled by pressing any of the memory buttons on the driver's door during a recall (S, 1, or 2). When a recall is cancelled, the driver's seat, driver's mirror, and the pedals stop moving. A delay of one second will occur before another recall can be selected.

To Disable A RKE Transmitter Linked to Memory

1. Turn the ignition switch to the OFF position and remove the key.

2. Press and release Memory Button 1. The system will recall any memory settings stored in position 1. Wait for the system to complete the memory recall before continuing to step 3.
3. Press and release the memory SET(S) button located on the driver's door. A chime will sound signaling that you are in the memory set mode.
4. Within five seconds, press and release Memory Button 1 on the driver's door. A chime will sound signaling to you that the driver memory has been set.
5. Within five seconds, press and release the UNLOCK button on the Remote Keyless Entry transmitter. A chime will sound signaling to you that the transmitter link has been successfully disabled.

To disable another transmitter linked to either Memory Position, repeat steps 1 to 5 for each transmitter.

NOTE: Once programmed, all transmitters linked to memory can be easily enabled or disabled at one time. Refer to the Remote Linked to Memory "Customer Programmable Features" in the Electronic Vehicle Information Center (EVIC) for more information.

TO OPEN AND CLOSE THE HOOD

To open the hood, two latches must be released.

1. Pull the hood release lever located on the instrument panel, below the steering column.
2. Move to the front of the vehicle and look inside the center of the hood opening. Locate, then push the safety catch lever to the right while raising the hood at the same time.

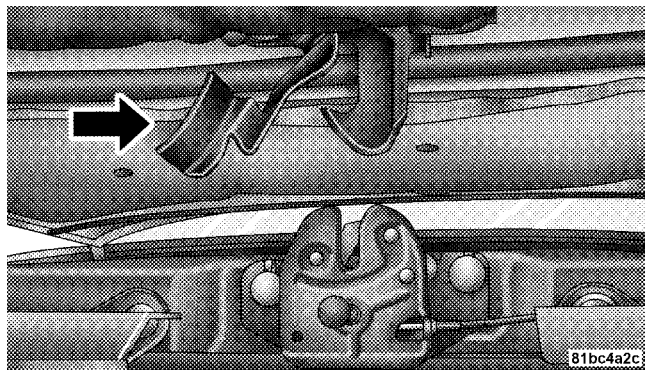

Hood Safety Catch

Use the hood prop rod to secure the hood in the open position.

To prevent possible damage, do not slam the hood to close it. Lower the hood until it is open approximately 12

inches (30 cm) and then drop it. This should secure both latches. Never drive your vehicle unless the hood is fully closed, with both latches engaged.

WARNING!

If the hood is not fully latched, it could fly up when the vehicle is moving and block your forward vision. You could have a collision. Be sure all hood latches are fully latched before driving.

Hood Safety Switch — If Equipped

If the vehicle is equipped with the Electronic Vehicle Information Center (EVIC), and the hood is not latched, the EVIC will display “Hood Ajar” in the instrument cluster EVIC display window.

If the vehicle is equipped with the Compass Mini-Trip Computer (CMTC) and the hood is not latched, a “hood” will be displayed in the PRNDL/Odometer window of the instrument cluster.

LIGHTS

All of the lights, except the hazard warning lights, headlamp high beams and flash to pass, are controlled by switches to the left of the steering column on the instrument panel.

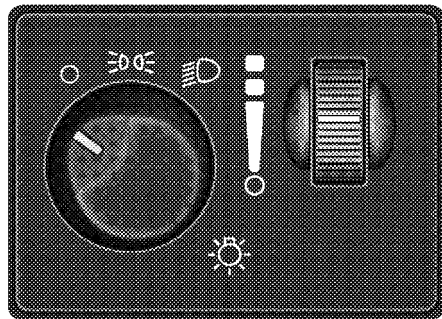

81bc4a9b

Headlight Switch Assembly

Interior Lighting

Interior lights are turned on when a door or liftgate is opened, the keyless entry transmitter is activated, or when the dimmer control is moved to the extreme top.

The interior lights will automatically turn off in about 10 minutes for the first activation and 90 seconds every activation thereafter until the engine is started, if one of the following occur:

- A door, sliding door or the liftgate is left open
- Any overhead reading light is left on
- If the dimmer control is in the extreme top position

NOTE: The key must be out of the ignition switch or the ignition switch must be in the OFF position for this feature to operate.

Dome Light Positions

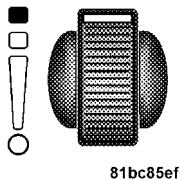

81bc85ef

Rotate the dimmer control completely upward to the second detent (extreme top position) to turn on the interior lights, except the front reading/courtesy lights. The interior lights will remain on when the dimmer control is in this position.

Interior Lighting Defeat (Off)

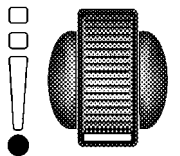

81bc85ec

Rotate the dimmer control to the off position (extreme bottom). The interior lights will remain off when the doors or liftgate are open.

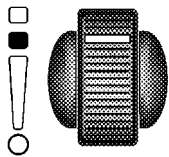
Parade Mode (Daytime Brightness Feature)

81bc85ee

Rotate the dimmer control to the first detent. This feature brightens the odometer, radio and overhead displays when the park lights or headlights are on.

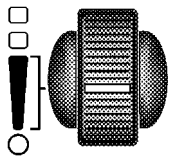
Dimmer Control

81bc85f0

With the park lights or headlights on, rotating the dimmer control for the interior lights on the instrument panel upward will increase the brightness of the instrument panel lights.

HALO Lights — If Equipped

Halo Lights are strategically-placed, soft lighting that helps to illuminate specific areas to aid the occupants in locating specific features while driving at night.



To activate the Halo lights, push in on the Halo switch located below the dimmer control. Pressing the switch in a second time, will turn the Halo lights off.

Exterior Lights**Parking Lights**

 Turn the headlight switch knob to the first detent to turn the park lights on. This also turns on all instrument panel lighting.

Daytime Running Lights (Canada/Fleet Vehicles Only)

The headlights on your vehicle will illuminate when the engine is started and the transmission is in any gear except PARK. This provides a constant lights on condition until the ignition is turned OFF. The lights illuminate at less than 50% of normal intensity. If the parking brake is applied the Daytime Running Lights (DRL) will turn off. Also, if a turn signal is activated, the DRL lamp on the same side of the vehicle will turn off for the duration of the turn signal activation. Once the turn signal is no longer active, the DRL lamp will illuminate.

Headlights



Turn the headlight switch knob to the 2nd detent to turn the headlights and park lights on. This also turns on all instrument panel lighting.

To change the brightness of the instrument panel lights, rotate the dimmer control up or down.

Automatic Headlights — If Equipped

This system automatically turns your headlights on or off based on ambient light levels. To turn the system on, turn the headlight switch to the extreme counterclockwise position aligning the indicator with the “A” on the headlight switch. When the system is on, the Headlight Time Delay feature is also on. This means your headlights will stay on for up to 90 seconds after you turn the ignition switch OFF. To turn the Automatic System off, turn the headlight switch clockwise to the “O” off position.

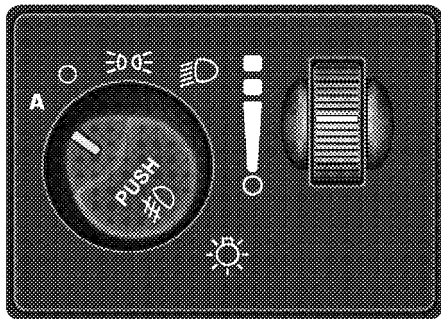

81bc85ed

Automatic Headlights

NOTE: The engine must be running before the headlights will come on in the Automatic mode.

Headlights On with Wipers — If Equipped

If your vehicle is equipped with Automatic Headlights it also has this customer programmable feature. When your

headlights are in the automatic mode, and the engine is running, the headlights will automatically turn on when the wiper system is on.

Headlight Delay — If Equipped

This feature provides the safety of headlight illumination for up to 90 seconds after exiting your vehicle.

To activate the delay feature, turn OFF the ignition switch while the headlights are still on. Then turn off the headlights within 45 seconds. The 90 second delay interval begins when headlight switch is turned off. If the headlights or park lights are turned back on or the ignition switch is turned on, the delay will be cancelled.

The driver can choose, when exiting the vehicle, to have the headlights remain on for 30, 60, or 90 seconds, or not remain on. To change the timer setting see your authorized Dealer.

If the headlights are turned off before the ignition, they will turn off in the normal manner.

NOTE: The headlights must be turned off within 45 seconds of turning the ignition OFF to activate this feature.

Front Fog Lights — If Equipped

Fog Light Symbol To activate the front fog lights, turn on the park lights or the low beam headlights and push in the headlight switch control knob. Pressing the headlight switch control knob in a second time, will turn the front fog lights off.

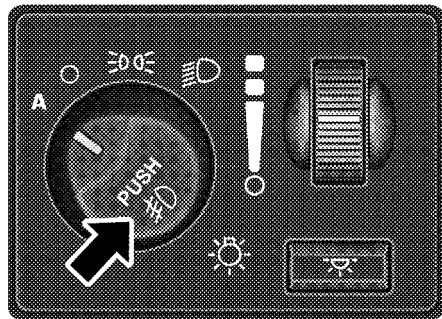

81bca4d8

Fog Light Switch

Lights-On Reminder

If the headlights or the park lights are left on, or if the dimmer control is in the extreme top position after the ignition switch is turned OFF, a chime will sound when the driver's door is opened.

Battery Protection

This feature provides battery protection to avoid wearing down the battery if the headlights, park lights, or front fog lights are left on for extended periods of time when the ignition switch is in the LOCK position. After eight minutes of the ignition switch being in the LOCK position and the headlight switch in any position other than OFF or AUTO, the lights will turn off automatically until the next cycle of the ignition switch or headlight switch.

The battery protection feature will be disabled if the ignition switch is turned to any other position other than LOCK during the three minute delay.

MULTIFUNCTION LEVER

The multifunction control lever is located on the left side of the steering column.

The Multifunction Lever assembly controls:

- Turn Signals
- Headlight Low and High Beams
- Flash-to-Pass (Optical Horn)
- Front and Rear Wiper And Washer Functions

Turn Signals

Move the multifunction lever up or down to signal a right-hand or left-hand turn.

The arrow on either side of the instrument cluster flashes to indicate the direction of the turn, and proper operation of the front and rear turn signal lights.

If either indicator flashes at a rapid rate, check for a defective outside turn signal light bulb. If one of the indicators fails to light when the lever is moved, it would suggest that the indicator light is defective.

You may manually signal a lane change by moving the lever partially up or down.

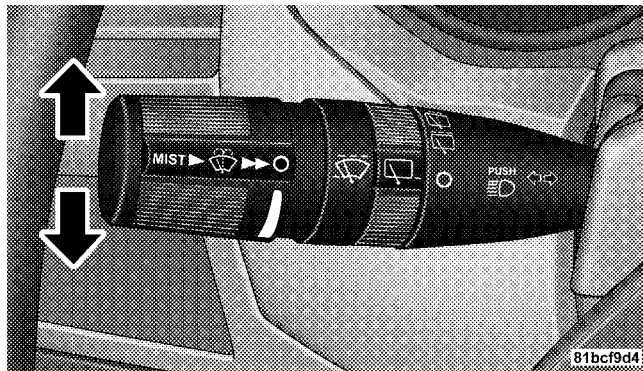

Turn Signal Switch

Turn Signal Auto-Mode

Tap the multifunction control lever once and the turn signal (left or right) will flash three times, and automatically turn off.

Turn Signal Warning

If the vehicle electronics sense that the vehicle has traveled at over 18 mph (29 km/h) for about 1 mi (1.6 km) with the turn signals on, a chime will sound to alert the driver.

Windshield Wiper and Washer Functions

The wipers and washers are operated by a switch within the multifunction lever. Rotate the end of the lever to select the desired wiper speed.

NOTE: Always remove any buildup of snow that prevents the windshield wiper blades from returning to the off position. If the windshield wiper switch is turned off and the blades cannot return to the off position, damage to the wiper motor may occur.

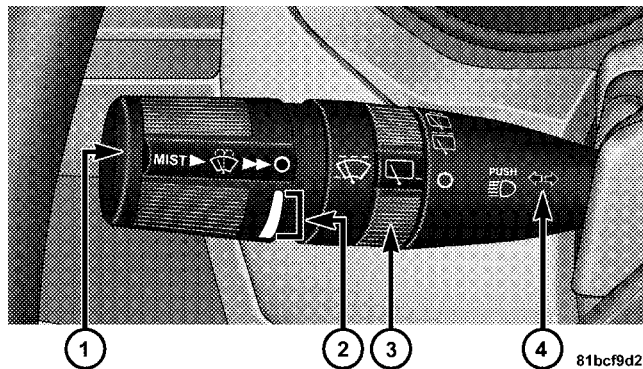

81bcf9d2

Multifunction Lever Features

1 - Front Mist/Washer
2 - Wiper Speeds

3 - Rear Wiper/Washer
4 - Low/High Beam and Flash

1. Multifunction Lever — Mist, Front Wiper and Washer

Press the end of the multifunction lever inward to the first detent and release to clear the windshield. Pressing the multifunction lever inward to the second detent will cause the washers to spray for a maximum of 10 seconds, or until the lever is released, and the wipers will cycle three times.

NOTE: If the multifunction lever is depressed while in the delay range, the wipers will operate for several seconds after the lever is released, and then resume the intermittent interval previously selected.

If the multifunction lever is depressed while in the off position, the wipers will operate for approximately two wipe cycles and automatically turn off.

2. Intermittent, Low and High Speed Wipers

Use the intermittent wipers when weather conditions make a single wiping cycle, with a variable pause between cycles, desirable. Rotate the end of the multifunction lever to the first detent position, then turn the end of the lever to select the desired delay interval. The delay can be regulated from a maximum of about 20 seconds between cycles, to a cycle every 2 seconds. The time delay will be doubled if the vehicle speed is less than 10 mph (16 km/h).

Low Speed is achieved by rotating the multifunction lever past the intermittent settings, to the first detent.

High Speed is achieved by rotating the multifunction lever past the intermittent settings, to the second detent.

3. Rotary Ring — Rear Wiper and Washer

Rotating the rotary ring to the first detent activates the rear intermittent wipers. To activate the washers, rotate

the rotary ring fully forward and the washers will spray until the ring is released, and then resume the intermittent interval.

NOTE: Rear window wipers function in the intermittent wiper speed only.

4. Headlight Low/High Beam Select Switch and Flash-to-Pass

Headlight Low/High Beam Select Switch When the headlights are turned on, pushing the lever assembly toward the instrument panel will switch from low beams to high beams. Pulling back to the neutral position returns to low beam headlights.

Flash-to-Pass (Optical Horn) You can signal another vehicle with your headlights by lightly pulling the multifunction lever toward you. This will cause the headlights to turn on at high beam and remain on until the lever is released.

WARNING!

Sudden loss of visibility through the windshield could lead to an accident. You might not see other vehicles or other obstacles. To avoid sudden icing of the windshield during freezing weather, warm the windshield with defroster before and during windshield washer use.

Headlights On When Wipers Are On — If Equipped

Headlights on when windshield wipers are on may be found on vehicles equipped with automatic headlight system. Refer to the Electronic Vehicle Information Center (EVIC) in Section 4 under “PERSONAL SETTINGS (CUSTOMER PROGRAMMABLE FEATURES)” for more information.

TILT STEERING COLUMN — IF EQUIPPED

To tilt the column, pull the small lever downward (located on the steering column and below the steering wheel) to the open position. You may then position the steering wheel up or down, as desired. Pull the small lever upward to the closed position to lock the steering wheel firmly in place.

WARNING!

Tilting the steering column while the vehicle is moving is dangerous. Without a stable steering column, you could lose control of the vehicle and have an accident. Adjust the column only while the vehicle is stopped. Be sure it is locked before driving.

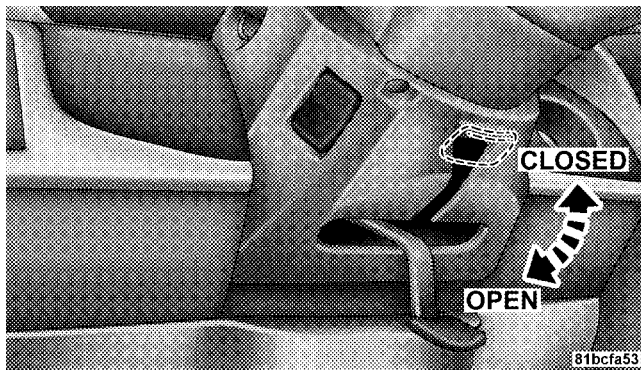

Tilt Steering Column Control

REAR PARK ASSIST SYSTEM — IF EQUIPPED

The Rear Park Assist System provides visual and audible indications of the distance between the rear fascia and the detected obstacle when backing up. When backing up the driver should also use the inside rearview and outside mirrors.

The Rear Park Assist System will remember the last system state (enabled or disabled) from the last ignition cycle when the ignition is changed to the RUN/ON position.

The Rear Park Assist System can be active only when the transaxle gear selector lever is in REVERSE. When in REVERSE, the system scans for objects behind the vehicle using four sensors located in the rear bumper.

NOTE: The system will be active until the vehicle speed is increased to approximately 11 mph (18 km/h) or above. The system will be active again if the vehicle speed is decreased to speeds less than approximately 10 mph (16 km/h).

Rear Park Assist Sensors

The four Rear Park Assist Sensors, located in the rear fascia, monitor the area behind the vehicle that is within the sensors' field of view. The monitored area seems oval in shape. The sensors can detect obstacles from approximately 11.8 in (30 cm) up to 78.7 in (200 cm) from the rear fascia in the horizontal direction, depending on the location and orientation of the obstacle and the type of obstacle.

Rear Park Assist Warning Display

The Rear Park Assist Warning Display, located in the headliner near the liftgate glass, provides both visual and audible warnings to indicate the distance between the rear fascia and the detected obstacle.

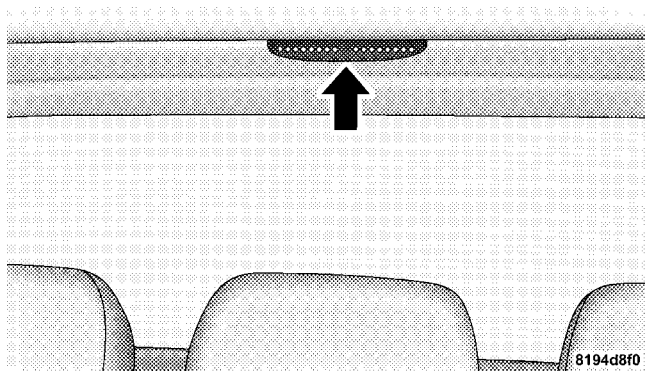

Rear Park Assist LED Lights

When the ignition switch is turned to the RUN/ON position, the warning display will turn on all of its LEDs for about one second. Each side of the warning display has six yellow and two red LED lights, one set to warn of obstacles behind the left rear of the vehicle and the other set to warn of obstacles behind the right rear of the vehicle. The vehicle is close to the obstacle when the red LED is illuminated.

The driver can view the LEDs either through the rear-view mirror or by looking directly at the display above the rear window.

The system dimly illuminates the two outer most yellow LEDs when it is on and detects no obstacles. The following chart shows the warning display operation when the system is detecting an obstacle.

PARK ASSIST WARNING DISPLAY DISTANCES				
DISPLAY LED	OBSTACLE DISTANCE FROM:		REAR CENTER	AUDIBLE SIGNAL
	REAR CORNERS	REAR CENTER		
1st LED		78.7 in (200 cm)	Yellow	Yes, Half Second
2nd LED		51.1 in (130 cm)	Yellow	None
3rd LED		45.2 in (115 cm)	Yellow	None
4th LED	31.5 in (80 cm)	39.3 in (100 cm)	Yellow	None
5th LED	25.5 in (65 cm)	33.5 in (85 cm)	Yellow	None
6th LED	20 in (50 cm)	27.6 in (70 cm)	Yellow	None
7th LED	16 in (40 cm)	19.7 in (50 cm)	Red	at 12 in (30 cm) Intermittent
8th LED	6 in (15 cm)	11.81 in (30 cm)	Red	at 8 in (20 cm) Continuous

NOTE: The Rear Park Assist System will MUTE the radio, if on, when the audible warning is activated.

WARNING!

Drivers must be careful when backing up even when using the Rear Park Assist System. Always check carefully behind your vehicle, and be sure to check for pedestrians, animals, other vehicles, obstructions, or blind spots before backing up. You are responsible for the safety of your surroundings and must continue to pay attention while backing up. Failure to do so can result in serious injury or death.

Before using the Rear Park Assist System, it is strongly recommended that the ball mount and hitch ball assembly be disconnected from the vehicle when the vehicle is not used for towing. Failure to do so can result in injury or damage to vehicles or obstacles because the hitch ball will be much closer to the obstacle than the rear fascia when the warning display turns the red LEDs on. Also, the sensors could detect the ball mount and hitch ball assembly, depending on its size and shape, giving a false indication that an obstacle is behind the vehicle.

CAUTION!

- To avoid vehicle damage the Rear Park Assist System should only be used as a parking aid and is unable to recognize every obstacle, including small objects. Parking curbs might be temporarily detected or not detected at all. Obstacles located above or below the sensors will not be detected when they are in close proximity to the rear of the vehicle.
- To avoid vehicle damage the vehicle must be driven slowly when using the Rear Park Assist System to be able to stop in time when an obstacle is detected. It is recommended that the driver look over his/her shoulder when using the Rear Park Assist System.

NOTE:

- Ensure that the rear bumper is free of dirt and debris to keep the system operating properly.
- Jackhammers, large trucks, and other vibrations could affect the performance of the system.

Enabling and Disassembling The Rear Park Assist System

There are times when you may want to disable the Rear Park Assist System, such as when towing a trailer.

NOTE: The manufacturer suggests disabling the Rear Park Assist System when towing a trailer. Refer to the following procedures.

Vehicles Equipped With the Electronic Vehicle Information Center (EVIC)

You can turn the Rear Park Assist System on or off through the EVIC. For details, refer to “Personal Settings

(Customer Programmable Features)” under “Electronic Vehicle Information Center (EVIC)” in Section 4 of this manual.

Vehicles Equipped With the Compass Mini-Trip Computer (CMTC)

You can turn the Rear Park Assist System ON or OFF through the CMTC by pressing the left reset button in the instrument cluster. Turn the ignition switch to the ON position, then press and hold the rest button for approximately two seconds.

Service The Rear Park Assist System

If the Rear Park Assist System malfunctions, the instrument cluster will actuate a single chime, once per ignition cycle, and it will display the “**SERVICE PARK ASSIST SYSTEM**” message. Refer to “Compass Mini Trip Computer (CMTC) or “Electronic Vehicle Information Center (EVIC)” — as equipped, in Section 4 of this manual.

If **"SERVICE PARK ASSIST SYSTEM"** appears in the Electronic Vehicle Information Center (EVIC), after making sure the rear bumper is clean, please see your authorized dealer.



Should this wrench symbol display with the letter **P** next to it, your Park Sense System needs servicing. Contact your authorized dealer.

Cleaning The Rear Park Assist System

Clean the Rear Park Assist Sensors with water, car wash soap and a soft cloth. Do not use rough or hard cloths. Do not scratch or poke the sensors, otherwise, you could damage the sensors.

ADJUSTABLE PEDALS — IF EQUIPPED

This feature allows both the brake and accelerator pedals to move toward or away from the driver to provide improved position with the steering wheel. The adjustable pedal system is designed to allow a greater range of driver comfort for steering wheel tilt and seat positions. The switch is located on the left side of the steering column.

3

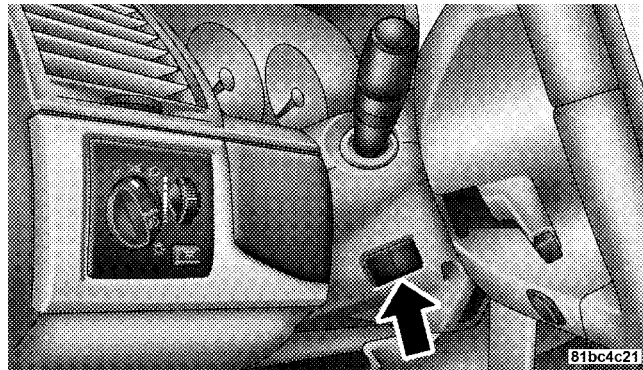

81bc4c21

Adjustable Pedal Switch

Press the button forward to move the pedals forward (toward the front of the vehicle).

Press the button rearward to move the pedals rearward (toward the driver).

- The pedals can be adjusted with the ignition OFF.
- The pedals can be adjusted while driving.
- The pedals **cannot** be adjusted when the vehicle is in REVERSE or when the Electronic Speed Control System is ON. The following messages will be displayed on vehicles equipped with the Electronic Vehicle Information System (EVIC) if the pedals are attempted to be adjusted when the system is locked out (“Adjustable Pedal Disabled — Cruise Control Engaged” or “Adjustable Pedal Disabled — Vehicle In Reverse”).

CAUTION!

Do not place any article under the adjustable pedals or impede its ability to move as it may cause damage to the pedal controls. Pedal travel may become limited if movement is stopped by an obstruction in the adjustable pedal's path.

ELECTRONIC SPEED CONTROL — IF EQUIPPED

When engaged, this device takes over the accelerator operation at speeds greater than 25 mph (40 km/h).



81bc4c2c

Electronic Speed Control Switches

Activating Electronic Speed Control

Push the **ON/OFF** button (located in the end of the lever) once and the **CRUISE** indicator light (located in the message window of the odometer) will illuminate showing the electronic speed control system is on. To turn the system **OFF**, push the **ON/OFF** button again and the system and indicator will turn off.

3

WARNING!

Leaving the Electronic Speed Control system on when not in use is dangerous. You could accidentally **SET** the system or cause it to go faster than you want. You could lose control and have an accident. Always leave the system **OFF** when you aren't using it.

Setting Electronic Speed Control at a Desired Speed

When the vehicle has reached the desired speed, press the **SET** lever downward and then release. Lift your foot off the accelerator and the vehicle will operate at the selected speed.

Deactivating Electronic Speed Control

A soft tap on the brake pedal or pulling the lever **CANCEL** toward you, will deactivate the speed control without erasing the set speed memory. Pushing the **ON/OFF** button to the **OFF** position or turning **OFF** the ignition erases the set speed memory.

Resuming Speed

To resume a previously set speed, raise the lever **RESUME/ACCEL** upwards and release. Resume can be used at any speed above 25 mph (40 km/h).

Varying The Speed Setting

When the speed control is **SET**, speed can be increased by raising and holding the **RESUME/ACCEL** lever upwards. When released, a new set speed will be established.

Raising the lever **RESUME/ACCEL** upwards once will result in a 1 mph (1 km/h) speed increase. Each time the lever is tapped upwards, speed increases so that tapping the lever three times will increase speed by 3 mph (5 km/h), etc.

To decrease speed while speed control is **SET**, press the lever **SET/DECCEL** downward and hold. Release the lever when the desired speed is reached, and the new speed will be **SET**.

Tapping the lever **SET/DECCEL** downward once will result in a 1 mph (1 km/h) speed decrease. Each time the lever is tapped downward, speed decreases.

NOTE: The Electronic Speed Control system has been designed to shut down if multiple speed control switch functions are operated simultaneously in order to ensure proper operation. If this occurs, the system can be reactivated by pushing the speed control switch ON/OFF button and resetting the desired vehicle SET speed.

Accelerating To Pass

Depress the accelerator as you would normally. When the pedal is released, the vehicle will return to the set speed.

NOTE: The speed control system maintains speed up and down hills. A slight speed change on moderate hills is normal.

Your vehicle may experience a downshift (automatic transmissions only) while climbing uphill or descending downhill. This downshift is necessary to maintain vehicle set speed.

On steep hills a greater speed loss or gain may occur so it may be preferable to drive without speed control.

WARNING!

Speed Control can be dangerous where the system can't maintain a constant speed. Your vehicle could go too fast for the conditions, and you could lose control. An accident could be the result. Don't use Speed Control in heavy traffic or on roads that are winding, icy, snow-covered, or slippery.

OVERHEAD CONSOLES

Front Overhead Console — If Equipped

Two versions of the overhead console are available. The base front overhead console models feature fixed incandescent courtesy/reading lights, flip-down sunglass storage and conversation mirror.

Premium front overhead console models feature an LED focused light that illuminates the instrument panel cup holders, Infrared Automatic Temperature Control Sensor (ATC equipped only), two swiveling LED lights, flip-down sunglass storage, conversation mirror, optional power sliding door switches and an optional power liftgate switch.

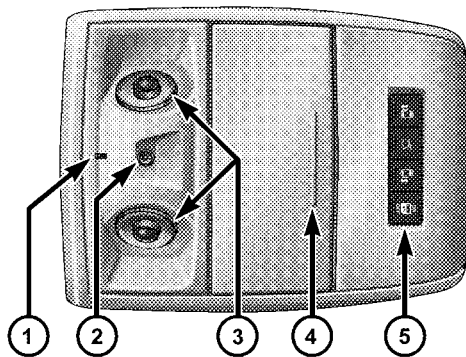

81bf7b28

Front Premium Overhead Console Features

- | | |
|---------------------|--------------------|
| 1 - Cupholder LED | 4 - Storage/Mirror |
| 2 - ATC Sensor | 5 - Switch Bank |
| 3 - Interior Lights | |

Courtesy/Interior Lighting

At the forward end of the console are two courtesy lights (standard dome light has two buttons). The lights turn on when a front door, a sliding door or the liftgate is opened. If your vehicle is equipped with Remote Keyless Entry, the lights will also turn on when the unlock button on the transmitter is pressed.

The courtesy lights also function as reading lights. Press in on each lens to turn these lights on while inside the vehicle. Press a second time to turn the each light off. You may adjust the direction of these lights by pressing the outside ring which is identified with four directional arrows.

The area around the instrument panel cupholders is also illuminated from a light in the overhead console. This light is turned on when the headlight switch is on and will adjust in brightness when the dimmer control is rotated up or down.

Sunglass Storage

At the rear of the front overhead console, a compartment is provided for the storage of two pairs of sunglasses.

Press the door latch to open the compartment. The door will slowly rotate to an open position.

NOTE: The front overhead console used with factory sunroof incorporates a sunroof switch.

Rear Overhead Consoles — If Equipped

The rear overhead storage system is available in two versions: with or without sunroof.

An additional LED at the front of the rear console shines down on the second row footwell area while in courtesy mode, for added convenience.

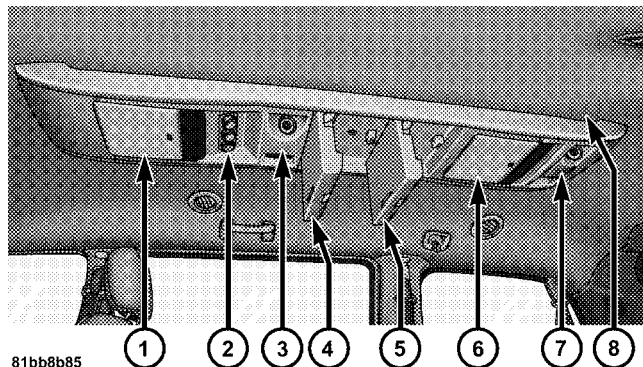

81bb8b85

Overhead Compartment Features

- | | |
|----------------------|----------------------|
| 1 — DVD ¹ | 5 — Storage |
| 2 — Rear HVAC | 6 — DVD ¹ |
| 3 — Interior Lights | 7 — Interior Lights |
| 4 — Storage | 8 — Halo Lighting |

¹ If equipped, otherwise storage.

Rear Courtesy/Reading Lights — If Equipped

The overhead console had two sets of courtesy lights. The lights turn on when a front door, a sliding door or the liftgate is opened. If your vehicle is equipped with Remote Keyless Entry, the lights will also turn on when the unlock button on the transmitter is pressed.

The courtesy lights also function as reading lights. Press in on each lens to turn these lights on while inside the vehicle. Press a second time to turn the each light off. You may adjust the direction of these lights by pressing the outside ring which is identified with four directional arrows.

Rear Console Halo Lighting — If Equipped

The rear overhead console features recessed halo lighting around the perimeter of the console base. This feature provides additional lighting options while traveling and is controlled by the headlight switch. Refer to “Halo Lighting - If Equipped” under “Lighting” in “Understanding The Features Of Your Vehicle” in Section 3.

GARAGE DOOR OPENER — IF EQUIPPED

HomeLink® replaces up to three remote controls (hand-held transmitters) that operate devices such as garage door openers, motorized gates, lighting, or home security systems. The HomeLink® unit operates off your vehicle's battery.

The HomeLink® buttons that are located in the headliner or sun visor designate the three different HomeLink® channels.

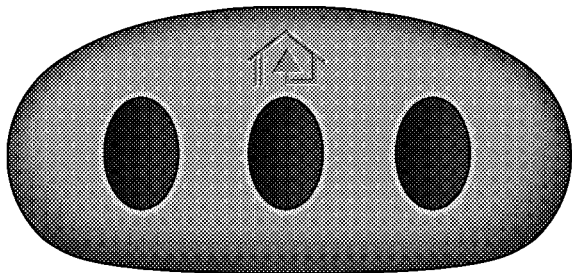

81cb44fe

HomeLink® Buttons

NOTE: HomeLink® is disabled when the Vehicle Security Alarm is active.

WARNING!

Your motorized door or gate will open and close while you are training the Universal Transceiver. Do not train the transceiver if people or pets are in the path of the door or gate. Only use this transceiver with a garage door opener that has a “stop and reverse” feature as required by Federal safety standards. This includes most garage door opener models manufactured after 1982. Do not use a garage door opener without these safety features. Call toll-free 1-800-355-3515 or, on the Internet at www.HomeLink.com for safety information or assistance.

WARNING!

Vehicle exhaust contains carbon monoxide, a dangerous gas. Do not run your vehicle in the garage while training the transceiver. Exhaust gas can cause serious injury or death.

PROGRAMMING HOMELINK®**Before You Begin**

If you have not trained any of the HomeLink® buttons, erase all channels before you begin training.

To do this, press and hold the two outside buttons for 20 seconds until the red indicator flashes.

It is recommended that a new battery be placed in the hand-held transmitter of the device being programmed to HomeLink® for more efficient training and accurate transmission of the radio-frequency signal.

Your vehicle should be parked outside of the garage when programming.

Begin Programming

1. Turn the ignition switch to the ON/RUN position.
2. Hold the battery side of the hand-held transmitter away from the HomeLink® button you wish to program.

Place the hand-held transmitter 1 to 3 in (3 to 8 cm) away from the HomeLink® button you wish to program while keeping the indicator light in view.

3. Simultaneously press and hold both the chosen HomeLink® button and the hand-held transmitter button until the HomeLink® indicator changes from a slow to a rapidly blinking light, then release both the HomeLink® and hand-held transmitter buttons.

Watch for the HomeLink® indicator to change flash rates. When it changes, it is programmed. It may take up to 30 seconds, or longer in rare cases. The garage door may open and close while you train.

NOTE: Some gate operators and garage door openers may require you to replace Step 3 with procedures noted in the “Gate Operator/Canadian Programming” section.

NOTE: After training a HomeLink® channel, if the garage door does not operate with HomeLink® and the garage door opener was manufactured after 1995, the garage door opener may have a rolling code. If so, proceed to Step 5 “Programming A Rolling Code System.”

4. Press and hold the just-trained HomeLink® button and observe the indicator light.

If the indicator light stays on constantly, programming is complete and the garage door (or device) should activate when the HomeLink® button is pressed.

If the indicator light blinks rapidly for two seconds, and then turns to a constant light, proceed to Step 5 “Programming A Rolling Code System.”

5. Programming A Rolling Code System

At the garage door opener motor (in the garage), locate the “Learn” or “Training” button.

This can usually be found where the hanging antenna wire is attached to the garage door opener motor (it is NOT the button normally used to open and close the door).

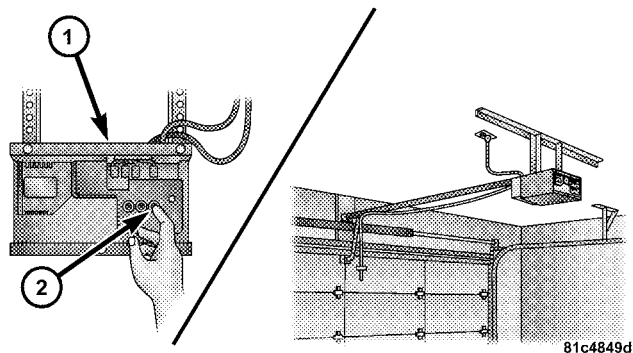

GARAGE DOOR OPENER TRAIN BUTTON

1 — Door Opener

2 — Training Button

6. Firmly press and release the “Learn” or “Training” button. The name and color of the button may vary by manufacturer.

NOTE: There are 30 seconds in which to initiate the next step after the “Learn” button has been pressed.

7. Return to the vehicle and press the programmed HomeLink® button twice (holding the button for two seconds each time). If the device is plugged in and activates, programming is complete.

If the device does not activate, press the button a third time (for two seconds) to complete the training.

If you have any problems, or require assistance, please call toll-free 1-800-355-3515 or, on the Internet at www.HomeLink.com for information or assistance.

To program the remaining two HomeLink® buttons, repeat each step for each remaining button. **DO NOT** erase the channels.

Using HomeLink®

To operate, simply press and release the programmed HomeLink® button. Activation will now occur for the trained device (i.e., garage door opener, gate operator, security system, entry door lock, home/office lighting, etc. The hand-held transmitter of the device may also be used at any time.

Reprogramming a Single Homelink® Button

To reprogram a channel that has been previously trained, follow these steps:

1. Turn the ignition switch to the ON/RUN position.
2. Press and hold the desired HomeLink® button until the indicator light begins to flash after 20 seconds. **Do not release the button.**
3. **Without releasing the button**, proceed with Programming Homelink® Step 2 and follow all remaining steps.

GATE OPERATOR/CANADIAN PROGRAMMING

Canadian radio frequency laws require transmitter signals to time-out (or quit) after several seconds of transmission – which may not be long enough for HomeLink® to pick up the signal during programming. Similar to this Canadian law, some U.S. gate operators are designed to time-out in the same manner.

It may be helpful to unplug the device during the cycling process to prevent possible overheating of the garage door or gate motor.

If you are having difficulties programming a garage door opener or a gate operator, replace “Programming HomeLink®” Step 3, with the following:

3. **Continue to press and hold the HomeLink® button while you press and release - every two seconds (“cycle”) your hand-held transmitter until HomeLink®**

has successfully accepted the frequency signal. The indicator light will flash slowly and then rapidly when fully trained.

If you unplugged the device for training, plug it back in at this time.

Then proceed with Step 4 under “Programming HomeLink®,” earlier in this section.

SECURITY

It is advised to erase all channels before you sell or turn in your vehicle.

To do this, press and hold the two outside buttons for 20 seconds until the red indicator flashes. Note that all channels will be erased. Individual channels cannot be erased.

The HomeLink® Universal Transceiver is disabled when the Vehicle Security Alarm is active.

TROUBLESHOOTING TIPS

If you are having trouble programming HomeLink®, here are some of the most common solutions:

- Replace the battery in the original transmitter.
- Press the “Learn” button on the Garage Door Opener to complete the training for a Rolling Code.
- Did you unplug the device for training, and remember to plug it back in?

If you have any problems, or require assistance, please call toll-free 1-800-355-3515 or, on the Internet at www.HomeLink.com for information or assistance.

GENERAL INFORMATION

This device complies with FCC rules Part 15 and Industry Canada RSS-210. Operation is subject to the following two conditions:

1. This device may not cause harmful interference.

2. This device must accept any interference that may be received including interference that may cause undesired operation.

NOTE: The transmitter has been tested and it complies with FCC and IC rules. Changes or modifications not expressly approved by the party responsible for compliance could void the user's authority to operate the device.

The term IC before the certification/registration number only signifies that Industry Canada technical specifications were met.

POWER SUNROOF — IF EQUIPPED

The power sunroof control switch is located in the front overhead console.

The sunroof panel tilts upward at the rear for ventilation or slides rearward under the roof.

Power Sunroof Operation

Opening the Sunroof Manually

Press the switch rearward and hold, and the sunroof will open automatically from any position. The sunroof will open fully, then stop automatically. During this operation, any release of the sunroof switch will stop the sunroof.

WARNING!

In an accident, there is greater risk of being thrown from a vehicle with an open sunroof. You could also be seriously injured or killed. Always fasten your seat belt properly and make sure all passengers are properly secured too.

Closing the Sunroof Manually

To close the sunroof from an open or vent position, press and hold the switch forward. The sunroof will close fully and stop automatically. Release the switch to stop sunroof travel at any point.

Sunroof Sunshade Operation

The sunroof sunshade can be opened manually. However, the sunshade will open automatically as the sunroof opens.

NOTE: The sunshade cannot be closed if the sunroof is open.

WARNING!

Never leave children in a vehicle, with the keys in the ignition switch. Occupants, particularly unattended children, can become entrapped by the power sunroof while operating the power sunroof switch. Such entrapment may result in serious injury or death.

Express-Open

Press the switch rearward and release, and the sunroof will open automatically from any position. The sunroof will open fully, then stop automatically. This is called Express-Open. During Express-Open operation, any movement of the sunroof switch will stop the sunroof.

Express-Vent

Press and release the "V" button, and the sunroof will automatically open to the vent position. This is called Express-Vent.

Express-Close

Press the switch forward and release, and the sunroof will close automatically from any position. The sunroof will close fully, then stop automatically. This is called Express-Close. During Express-Close operation, any movement of the sunroof switch will stop the sunroof.

WARNING!

Do not allow small children to operate the sunroof. Never allow fingers or other body parts, or any object to project through the sunroof opening. Injury may result.

Ignition OFF Operation

The power sunroof switch will remain active for 10 minutes after the ignition switch is turned OFF. Opening either front door will cancel this feature.

Auto-Express with Anti-Pinch Protection

During express closing, anytime an obstacle that restricts glass movement is detected, the motor will stop and reverse travel to avoid pinching the object.

Auto Express will stop and reverse travel up to three times in succession. After the third time, Auto Express will enter a manual operation mode. This allows the operator to manually control the power switch in order to close or open the sunroof in case of a malfunction.

Wind Buffeting

Wind buffeting can be described as the perception of pressure on the ears or a helicopter type sound in the ears. Your vehicle may exhibit wind buffeting with the windows down, or the sunroof (if equipped) in certain

open or partially open positions. This is a normal occurrence and can be minimized. If the buffeting occurs with the rear windows open, open the front and rear windows together to minimize the buffeting. If the buffeting occurs with the sunroof open, adjust the sunroof opening to minimize the buffeting or open any window.

Sunroof Maintenance

Use only a non-abrasive cleaner and a soft cloth to clean the glass panel.

ELECTRICAL POWER OUTLETS — IF EQUIPPED

Two 12 volt power outlets are located in the center lower instrument panel next to the open storage bin. The upper outlet is controlled by the ignition switch and the lower outlet is connected directly to the battery. The upper outlet will also operate a conventional cigar lighter unit (if equipped with an optional Smoker's Package).

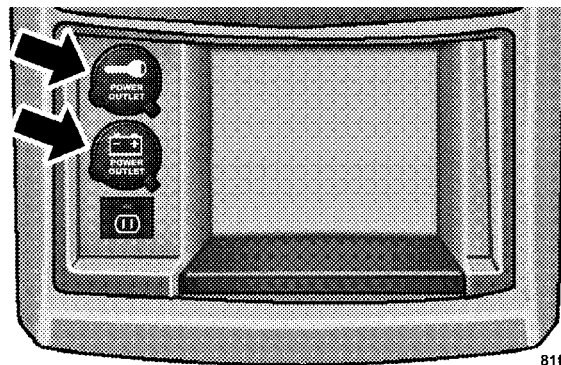

81f21060

The outlets include tethered caps labeled with a key or battery symbol indicating the power source. The lower instrument panel outlet is powered directly from the battery, items plugged into this outlet may discharge the battery and/or prevent engine starting.

The lower outlet is protected by an automatic reset circuit breaker. The automatic circuit breaker restores power

when the overload is removed. The circuit breaker also supplies power to the outlet in the removable floor console, when in the front position. Refer to section 3 “Removable Floor Console” in this manual.

A third outlet is located on the driver’s side, just to the rear of the sliding door and is also controlled by the ignition switch. The lower and rear outlets will not accommodate a conventional cigar lighter unit.

NOTE: If desired, all of the power outlets can be converted by your authorized dealer to provide power with the ignition switch in the OFF position.

POWER INVERTER — IF EQUIPPED

A 110 volt, 150 watt inverter outlet (if equipped) converts DC current to AC current and is located on the left rear trim panel immediately behind the second row left passenger seat. This outlet can be used to power small appliances and electronics.

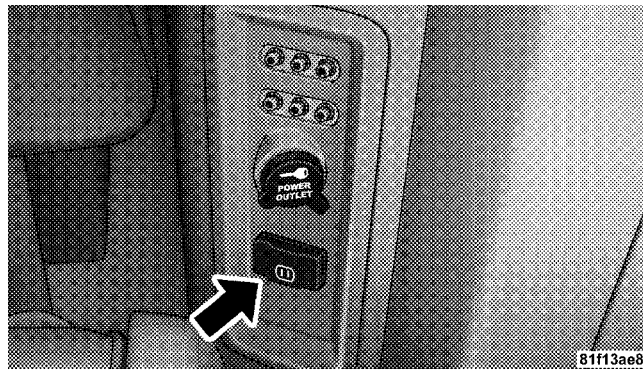

110 Volt Power Inverter

The Power Inverter switch is located near the center of the instrument panel below the two 12 volt power outlets. Press the switch to turn the power on for the outlet, press the switch a second time to turn the power off.

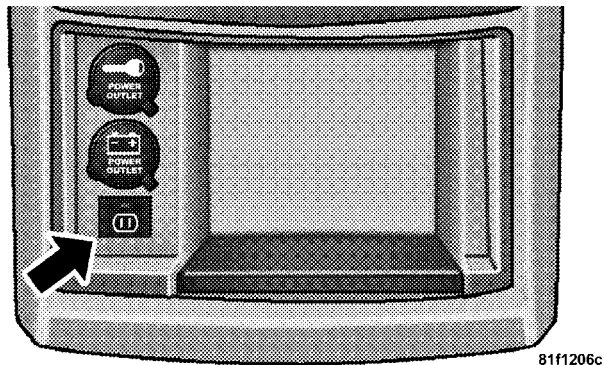

81f1206c

Inverter Outlet Power Switch

NOTE:

- When the Inverter Switch is pressed, there will be a delay of approximately one second before the inverter status indicator turns ON. The status indicator of the AC power inverter indicates whether the inverter is producing AC power.

- Due to built-in overload protection the inverter will shut down if the power rating is exceeded.

WARNING!

To Avoid Serious Injury or Death:

- Do not use a Three-Prong Adaptor.
- Do not insert any objects into the receptacles.
- Do not touch with wet hands.
- Close the lid when not in use.
- If this outlet is mishandled it may cause an electric shock and failure.

ELECTRICAL OUTLET USE WITH ENGINE OFF**CAUTION!**

- Many accessories that can be plugged in draw power from the vehicle's battery, even when not in use (i.e., cellular phones, etc.). Eventually, if plugged in long enough, the vehicle's battery will discharge sufficiently to degrade battery life and/or prevent engine starting.
- Accessories that draw higher power (i.e., coolers, vacuum cleaners, lights, etc.), will degrade the battery even more quickly. Only use these intermittently and with greater caution.
- After the use of high power draw accessories, or long periods of the vehicle not being started (with accessories still plugged in), the vehicle must be driven a sufficient length of time to allow the alternator to recharge the vehicle's battery.
- Power outlets are designed for accessory plugs only. Do not hang any type of accessory or accessory bracket from the plug. Improper use of the power outlet can cause damage.

SUN SCREENS— IF EQUIPPED

Sun Screens are available for second and third row seating windows. The screens store in the sill trim panels and the tops of the windows are equipped with hooks that the Sun Screen attaches to when pulled out.

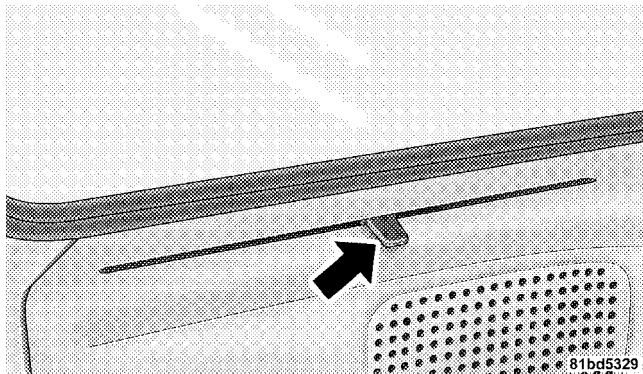
**Sun Screen Retracted**

Gently pull up on the tab to raise the sun screen. Continue pulling the sun screen until the tab is near the top of the window.

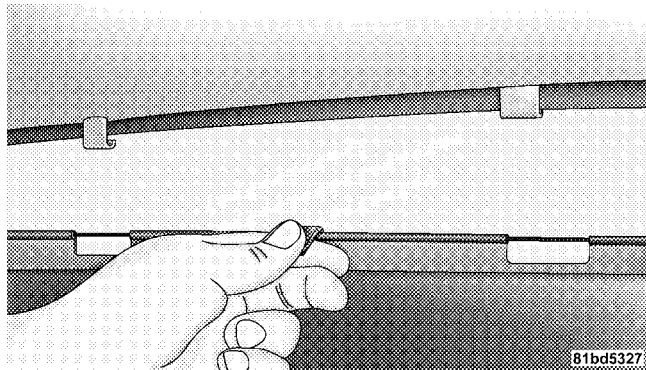

Sun Screen Attaching To Retainer Clips

Once the screen is completely to the top of the window, extend the top bar of the sun screen over the two hooks attached to the top of the window.

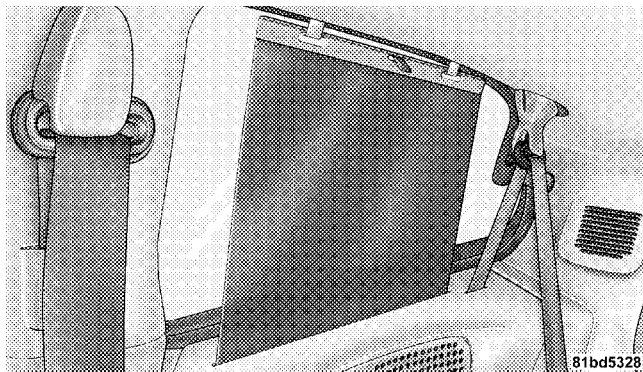

Sun Screen Extended

To lower the sun screen, gently lift the tab upwards to disengage the hooks and feed the screen back into the base sill.

CUP HOLDERS AND CONVENIENCE TRAY DRAWER

There are nine cup holders in the interior. Two cup holders in the center front instrument panel, four in the floor consoles and three more are located in the third row quarter trim panel.

All liners are removable for cleaning. Pull the flexible liner from the cup holder drawer or tray; starting at one edge to ease removal. Refer to “Cleaning The Instrument Panel Cup Holders” in Section 7.

Instrument Panel Cup Holders

The instrument panel cup holders are located in a pull out drawer just above the lower storage bin.

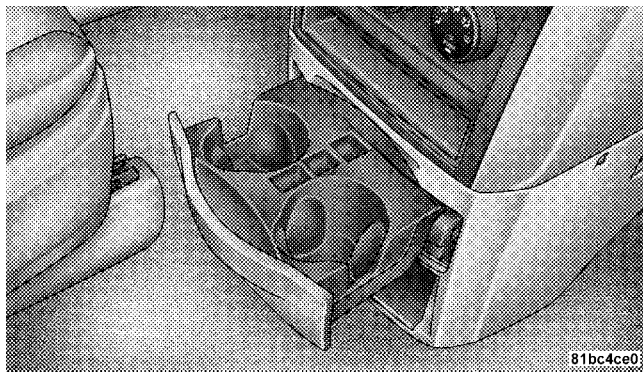

Front Cup Holders

Pull the drawer out firmly until it stops, and place the container to be held in either one of the cup holder wells. The cup holders are designed to accommodate a wide variety of container types and sizes. Press down on the container to engage the cup holder retention fingers.

Interior Bottle Holders

There are four bottle holders located in the interior. One bottle holder is molded into each front interior door trim panels, and one bottle holder is molded into each side sliding interior door trim panel. Each holder accommodates up to 20 oz. (.6 L) size plastic bottles.

Two outboard mesh pockets on intermediate seating. The mesh pockets are flexible enough to hold juice boxes, toys, games or MP3 players, etc.

Smokers Package Kit — If Equipped

With the optional authorized dealer-installed Smokers Package Kit, a removable ash receiver is inserted into one of the two cup holders in the center front instrument panel. To install the ash receiver, align the receiver so the thumb grip on the lid is facing rearward. Press the ash receiver into either of the cup wells to secure. Pull upward on the ash receiver to remove for cleaning and/or storage.

The left rear trim panel cup holder is designed to accommodate a second ash receiver if desired.

CONSOLE FEATURES

There are two consoles available: Basic and Premium.

Basic Console

Basic Console features consist of the following:

- The basic console profile allows vehicle occupants to easily pass through the first row to the second.
- Four cup holders can accept extra large size beverage cups or 20 oz (.6 L) plastic bottles. The cup holders are dishwasher safe for cleaning. To remove, pull the flexible liner from the cup holder drawer or tray; starting at one edge. Refer to “Cleaning The Instrument Panel Cup Holders” in Section 7 for more detailed information.
- A Top Storage Tray.

- The cup holder/tray top is removable to access a large storage bin.
- The Basic Console is removable from the vehicle for additional floor space by removing the cap at the console base.

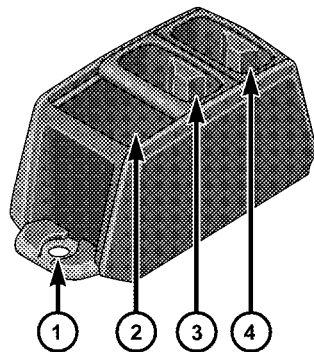

81c27779

Basic Console Features

1 - Console Anchor
2 - Top Tray

3 - Front Cup holders
4 - Rear Cup holders

To Remove The Basic Floor Console

- Remove the front anchor cup plug and clip.

- Slide the console base forward while lifting slightly to clear the rear load floor hook.
- Remove the console.

To Reinstall The Basic Floor Console

- Position the console at a slight angle (front slightly higher than the rear).
- Slide the console rearward into the floor bracket/hook.
- Align the console until the front anchor cup plug hole is centered on the winch hole.
- Reinstall the clip first and then while pushing downward on the console with slight pressure, reinstall the cover plug.
- Pull up on the console to be sure it is firmly latched.

WARNING!

In an accident, serious injury could result if the removable floor console is not properly installed. Always be sure the removable floor console is fully latched.

3

Premium Console – If Equipped

The three-compartment console with sliding storage bin, sliding upper tray with storage and large console storage bin offers multiple configurations.

- Four cup holders can accept large cups or mugs with handles or 20 oz (.6 L) plastic bottles. The cup holders are dishwasher safe for cleaning. To remove, pull the flexible liner from the cup holder drawer or tray; starting at one edge. Refer to “Cleaning The Instrument Panel Cup Holders” in Section 7 for more detailed information.

- Top Tray Storage
- Upper Storage Bin can hold nine regular or 18 thin CD's or other items
- Large Console Center Storage will store headphones for the available rear DVD entertainment system or other items
- 12-Volt DC Power Outlet provides continuous power inside the console for cell phones or other electronics.
- Rear Occupant Accessible
- Multiple Adjustments
- Removable from vehicle for additional floor space.

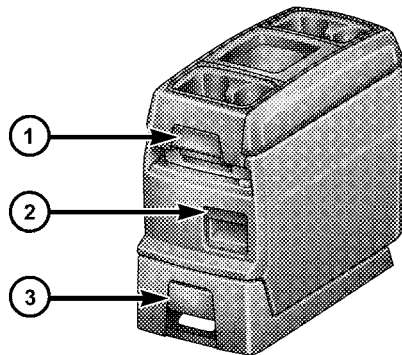

81c27ac2

Premium Console Features

1 - Top Release
2 - Center Release

3 - Console Release

The top and center console sections slide forward and rearward to provide added user comfort. Four cup holders, each of which can accommodate large sized beverage containers. A one-piece cup holder insert for both cavities can easily be removed for cleaning. The cup holders will also accommodate large size cups and 20 oz (.6 L) bottles.

Position 1 shows the console closed with four cup holders and a convenient storage tray.

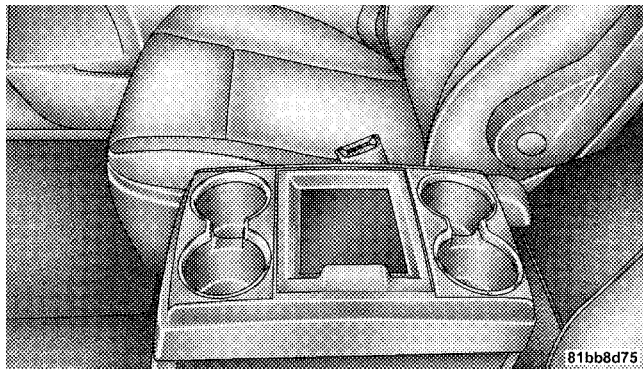

Console Position 1

Position 2 shows the raised storage tray revealing a large storage area below.

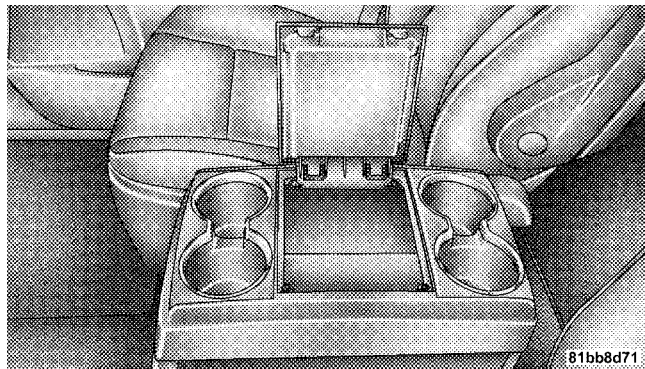

Console Position 2

Dual Storage Bins

Position 3 shows the top portion of the console in a rearward position. This is accomplished by lifting the upper most latch at the front of the console. This provides

easy access to the storage area below and provides two of the four cup holders for the second row passengers.

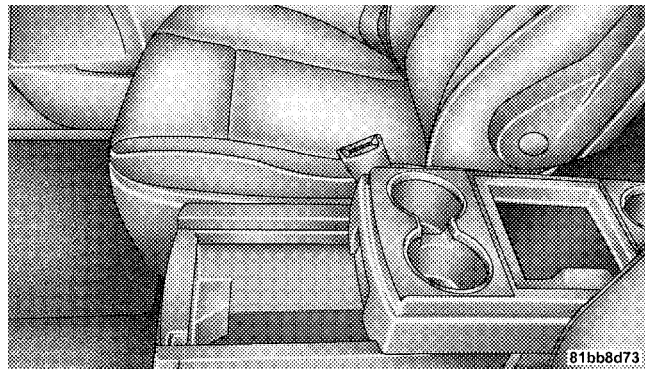

Console Position 3

Position 4 shows the complete console in its rearmost position. Again, lifting second latch handle at the front of the console, allows complete access to a lower storage bin and provides additional cup holders for rear passengers.

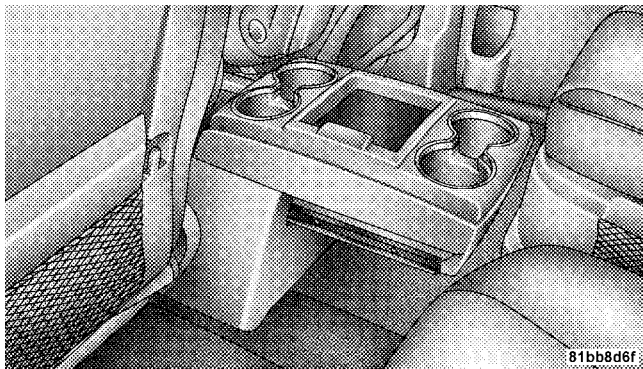

Console Position 4

To Remove The Premium Floor Console

- Pull up on the bottom release handle in the front of the console
- Lift the rear of the console up several inches

- Pull rearward to disengage from floor and remove console

To reinstall the console:

- Position the console at a slight angle (rear slightly higher than the front)
- Slide the console forward into the floor bracket
- Rotate the rear of the console down until it is resting on the floor bracket
- Push down on the rear of the console until it is seated in the rear floor bracket
- Pull up on the console to be sure it is firmly latched

WARNING!

In an accident, serious injury could result if the removable floor console is not properly installed. Always be sure the removable floor console is fully latched.

STORAGE**Glove Compartments**

There are both upper and lower glove compartments.

Upper Glove Compartment

To open the upper compartment (4), press inward on the release button (3). The door will spring open about one in (2.54 cm). Manually lift the front edge of the door upward, until fully opened, and the detent is engaged.

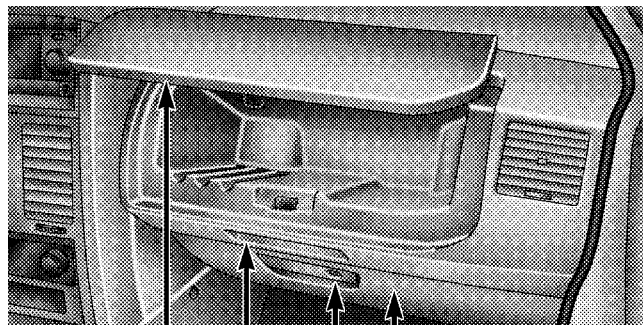

81bb8b87

Glove Compartment Features

- | | |
|-----------------------|-----------------------|
| 1 - Lower Compartment | 3 - Upper Latch |
| 2 - Lower Latch/Lock | 4 - Upper Compartment |

To close the compartment door, push firmly downward on the door's surface to release the detent and latch the door closed.

Lower Glove Compartment

To open the lower compartment (1) pull out on the release handle (2). The lower compartment handle is also equipped with a lock.

Door Trim Panel Storage

Front Door Storage

Both interior front door panels have multiple pockets for storage.

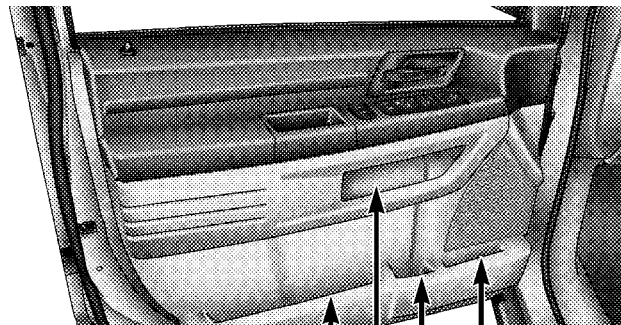

81bd5af1

Front Door Storage

1 - Rear Map Pocket
2 - Storage Pocket

3 - Bottle Holder
4 - Front Map Pocket

Sliding Side Door Bottle Holder

Both sliding doors have a bottle holder molded right into the trim.

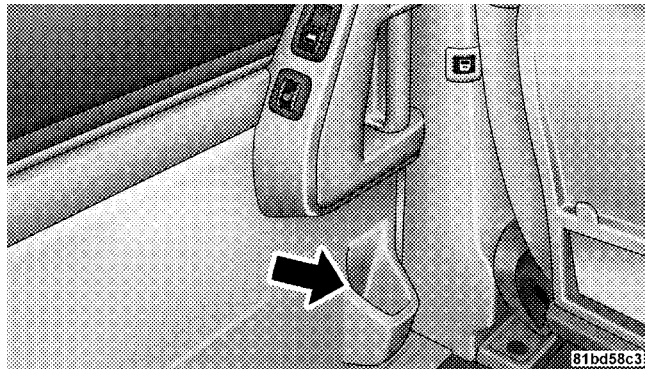

Sliding Door Bottle Holder

Second Row Floor Storage Bins — If Equipped

The Second Row Seat Storage Bins are located on the floor in front of the second row seats. The area below the floor covers can be used for storage when the second row seat is in the upright position.

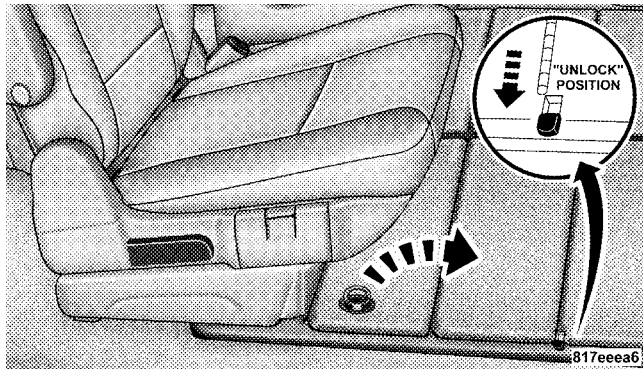

Storage Bin Cover Lock Release

Pull up on the storage bin latch to open the cover. Slide the storage bin locking mechanism to the "unlocked" position to allow greater access to the storage bin.

CAUTION!

The storage bin cover must lay flat and be locked to avoid damage from contact with the front seat tracks, which have minimal clearance to the cover.

WARNING!

In an accident, serious injury could result if the seat storage bin covers are not properly latched.

- DO NOT drive the vehicle with the storage bin covers open.
- Keep the storage bin covers closed and latched while the vehicle is in motion.
- DO NOT use a storage bin latch as a tie down.

Removing The Floor Console With Stow 'n Go Seating — If Equipped

The removable floor console has two power outlets, storage tray, light, removable cell phone holder, tissue holder, pen holder and a map holder. It can be removed from the vehicle by pulling the release handle inside the floor console.

To remove the console use the following procedure:

1. Open the console lid and remove the storage tray.
2. Pull up on the release handle located inside the floor console, and slide the console rearward to disengage from the floor.
3. Remove the floor console.

To reinstall the console use the following procedure:

1. Open the console lid and remove the storage tray.
2. Pull up on the release handle and slide the console forward to engage the front of the console into the floor tray.
3. Pivot the floor console down until it is seated on the floor tray and release the handle.
4. Pull up on the console to be sure it is firmly attached.

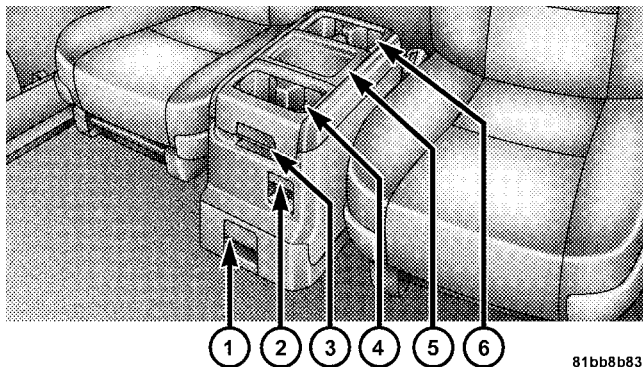

81bb8b83

Removable Floor Console Features

- | | |
|-------------------|----------------------|
| 1 - Removal Latch | 4 - Front Cupholders |
| 2 - Lower Latch | 5 - Top Tray |
| 3 - Upper Latch | 6 - Rear Cupholders |

WARNING!

In an accident, serious injury could result if the removable floor console is not properly installed. Always be sure the removable floor console is fully latched.

Rear Compartment Storage

Your vehicle is equipped with open storage areas located in each rear trim panel.

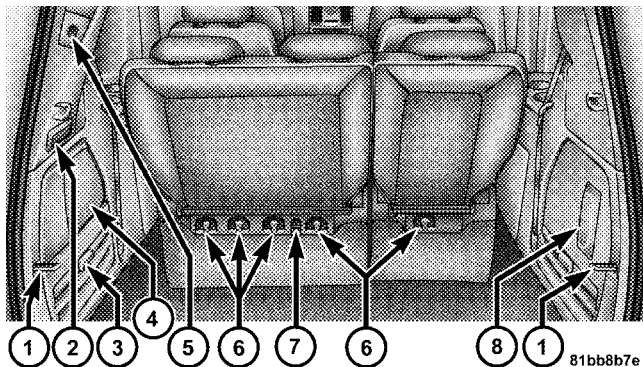
**Third Row Rear Seat and Rear Compartment Features**

- | | |
|----------------------|--------------------|
| 1 — Tie Down | 5 — Liftgate Close |
| 2 — Rear Switches | 6 — Bag Holders |
| 3 — Tire Jack/Handle | 7 — LATCH Anchor |
| 4 — Cubby/Speaker | 8 — Flash Light |

Coat Hooks

Coat hooks are located along the headliner for the second and third row seating positions. The coat hook load limit is 10 lbs (4.5 kg). Exceeding the recommended load limit can cause the coat hooks to break or disengage from the vehicle.

Cargo Area Storage

The seats in your vehicle are in-line which enables you to stow long objects, such as lumber or skis, on the floor without moving the seats.

NOTE: With all rear seat backs folded, a 4 ft x 8 ft (1.2 m x 2.4 m) sheet of building material may be stored on top of the folded seats with the liftgate closed. The front seats must be moved slightly forward of the rearmost position. If the rear seats are removed no front seat adjustment is needed and more than one 4 ft x 8 ft (1.2 m x 2.4 m) sheet of building material may be stored.

The liftgate sill plate has a raised line with the statement “Load To This Line”. This line indicates how far rearward cargo can be placed without interfering with liftgate closing.

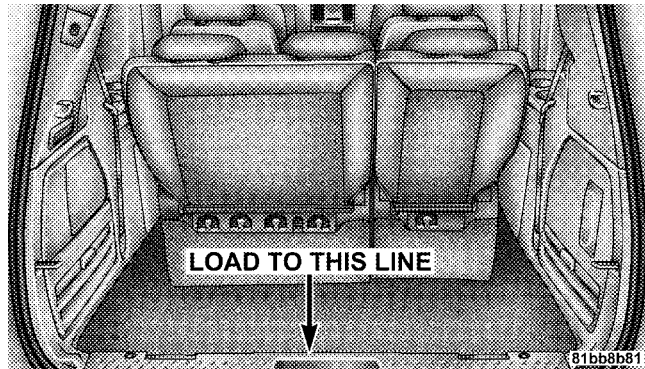

Rear Cargo Area Loading Limit

ROOF LUGGAGE RACK — IF EQUIPPED

The crossbars and siderails are designed to carry the weight on vehicles equipped with a luggage rack. The load must not exceed 150 lbs (68 kg), and should be uniformly distributed over the luggage rack crossbars.

Distribute cargo weight evenly on the roof rack crossbars. The roof rack does not increase the total load carrying capacity of the vehicle. Be sure the total load of cargo inside the vehicle plus that on the external rack does not exceed the maximum vehicle load capacity.

To move the crossbars, loosen the thumb screws located at the upper edge of each crossbar approximately six turns, then move the crossbar to the desired position, keeping the crossbars parallel to the rack frame. Once the crossbar is in place, retighten the thumb screws to lock the crossbar into position.

Attempt to move the crossbar again to ensure that it has properly locked into position.

NOTE: To help control wind noise when installing the crossbars make sure the arrows marked on the underside of the crossbars are facing the front of the vehicle. When the crossbars are not in use, the front crossbar should be fastened just forward of the middle support and the rear crossbar should be fastened at the rearmost position of the side rails. This will help reduce the amount of wind noise when the crossbars are not in use.

The tie down holes on the crossbar ends should always be used to tie down the load. Check the straps frequently to be sure that the load remains securely attached.

CAUTION!

- Crossbars should remain equally spaced or parallel at any luggage rack position for proper function. Noncompliance could result in damage to the luggage rack, cargo and/or vehicle.
- To avoid damage to the roof rack and vehicle, do not exceed the maximum roof rack load capacity of 150 lbs (68 kg). Always distribute heavy loads as evenly as possible and secure the load appropriately.

CAUTION!

- Long loads which extend over the windshield, such as wood panels or surfboards, or loads with large frontal area should be secured to both the front and rear of the vehicle.
- Travel at reduced speeds and turn corners carefully when carrying large or heavy loads on the roof rack. Wind forces, due to natural causes or nearby truck traffic, can add sudden upward lift to a load. This is especially true on large flat loads and may result in damage to the cargo or your vehicle.

WARNING!

Cargo must be securely tied before driving your vehicle. Improperly secured loads can fly off the vehicle, particularly at high speeds, resulting in personal injury or property damage. Follow the Roof Rack Cautions when carrying cargo on your roof rack.

UMBRELLA HOLDER

An umbrella holder has been conveniently molded into the left front door entry scuff molding.

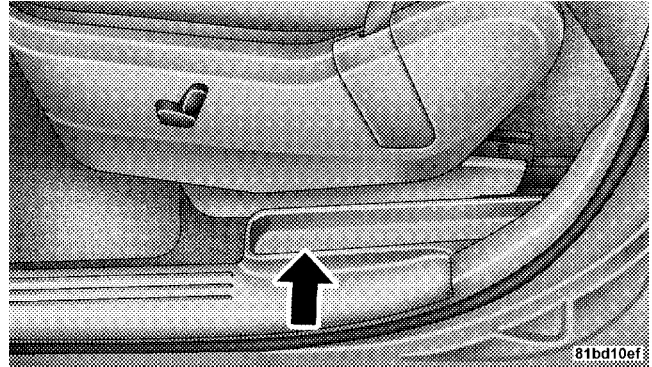
**Umbrella Holder**

LOAD-LEVELING SYSTEM — IF EQUIPPED

The automatic load-leveling system will provide a level riding vehicle under most passenger and cargo loading conditions.

A hydraulic pump contained within the shock absorbers raises the rear of the vehicle to the correct height. It takes approximately 1 mile (1.6 km) of driving for the leveling to complete depending on road surface conditions.

If the leveled vehicle is not moved for approximately 15 hours, the leveling system will bleed itself down. The vehicle must be driven to reset the system.

WARNING!

Do not install the load-leveling system on vehicles that are not equipped with Anti-Lock Brakes. Vehicles without Anti-Lock Brakes (ABS) have a height-sensing proportioning valve. Installing a leveling system will render this system ineffective, inappropriately reducing rear brake pressure, resulting in increased stopping distances. You could have a serious accident.

UNDERSTANDING YOUR INSTRUMENT PANEL

CONTENTS

■ Instrument Panels And Controls	223	□ Compass/Temperature Display	240
■ Base Instrument Cluster	224	■ Electronic Vehicle Information Center (EVIC) — If Equipped	241
■ Premium Instrument Cluster	225	□ EVIC Displays	243
■ Instrument Cluster Descriptions	226	□ Trip Functions	244
■ Compass Mini-Trip Computer (CMTC) — If Equipped	238	□ Compass Display	246
□ Compass Mini-Trip Computer (CMTC) Odometer Displays	238	□ Personal Settings (Customer Programmable Features)	248
□ Compass Mini-Trip Computer (CMTC) Reset Buttons	238	■ Radio General Information	251
		□ Radio Broadcast Signals	251

- Sales Code REQ — AM/FM Stereo Radio And 6-Disc CD/DVD Changer (MP3/WMA AUX Jack)252
 - Operating Instructions - Radio Mode252
 - Operation Instructions - (Disc Mode For CD And MP3/WMA Audio Play, DVD-Video)260
 - Notes On Playing MP3/WMA Files262
 - List Button (Disc Mode For MP3/WMA Play)265
 - Info Button (Disc Mode For MP3/WMA Play)265
- Sales Code RES — AM/FM Stereo Radio With CD Player (MP3 AUX Jack)268
 - Operating Instructions - Radio Mode268
 - Operation Instructions - CD Mode For CD And MP3 Audio Play274
 - Notes On Playing MP3 Files276
 - List Button (CD Mode For MP3 Play)279
 - Info Button (CD Mode For MP3 Play)279
- Sales Code REN — Multimedia System — If Equipped280
 - Operating Instructions — Satellite Radio (If Equipped)281
 - Operating Instructions — Voice Recognition System (VR) (If Equipped)281
 - Operating Instructions — Hands-Free Communication (UConnect®) (If Equipped)281
 - Clock Setting Procedure281

- Sales Code RER — Multimedia System —
If Equipped283
- Operating Instructions — Satellite Radio284
- Operating Instructions — Hands-Free
Communication (UConnect®) (If Equipped) . . .284
- Clock Setting Procedure285
- Satellite Radio — If Equipped
(REN/REQ/RER/RES/REU Radios Only)287
- System Activation287
- Electronic Serial Number/Sirius Identification
Number (ESN/SID)287
- Selecting Satellite Mode288
- Satellite Antenna288
- Reception Quality289

- Operating Instructions - Satellite Mode289
- Operating Instructions - Hands-Free Phone
(If Equipped)292
- Operating Instructions - Video Entertainment
System (VES®) (If Equipped)292
- Universal Consumer Interface (UCI) —
If Equipped292
- Connecting The iPod® Device293
- Controlling The iPod® Using Radio Buttons . . .293
- Play Mode293
- List Or Browse Mode295
- Sirius Backseat TV™ — If Equipped297
- Video Entertainment System (VES®) —
If Equipped297

- Radio Operation And Cellular Phones 299
- Remote Sound System Controls — If Equipped . . 299
 - Radio Operation 299
 - CD Player 300
- CD/DVD Maintenance 300
- Climate Controls 301
 - Manual Heating, Ventilation And Air Conditioning (HVAC) System 301
 - Rear Manual Climate Control Zone — If Equipped 307
 - Automatic Temperature Control (ATC) — If Equipped 309
 - Summer Operation 318
 - Winter Operation 318
 - Vacation/Storage 318
 - Window Fogging 318
 - Outside Air Intake 319
 - Operating Tips 319
 - A/C Air Filter — If Equipped 320
- Electric Rear Window Defroster — If Equipped 320

INSTRUMENT PANELS AND CONTROLS

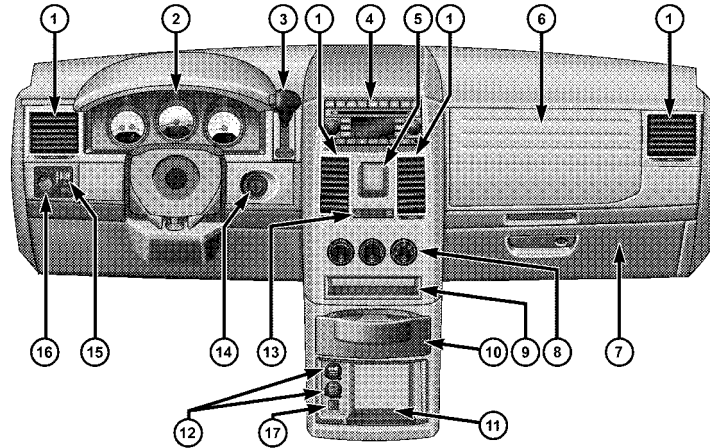

81bb7b60

- 1 - Air Vents
- 2 - Instrument Cluster
- 3 - Gear Selector Lever
- 4 - Radio
- 5 - Storage Bin

- 6 - Upper Glove Compartment
- 7 - Lower Glove Compartment
- 8 - Climate Controls
- 9 - Storage or DVD
- 10 - Cup Holders

- 11 - Storage Bin
- 12 - Power Supply 12V
- 13 - Hazard Switch
- 14 - Ignition Switch
- 15 - Dimmer Switch

- 16 - Head Light Switch
- 17 - Power Inverter Switch

BASE INSTRUMENT CLUSTER

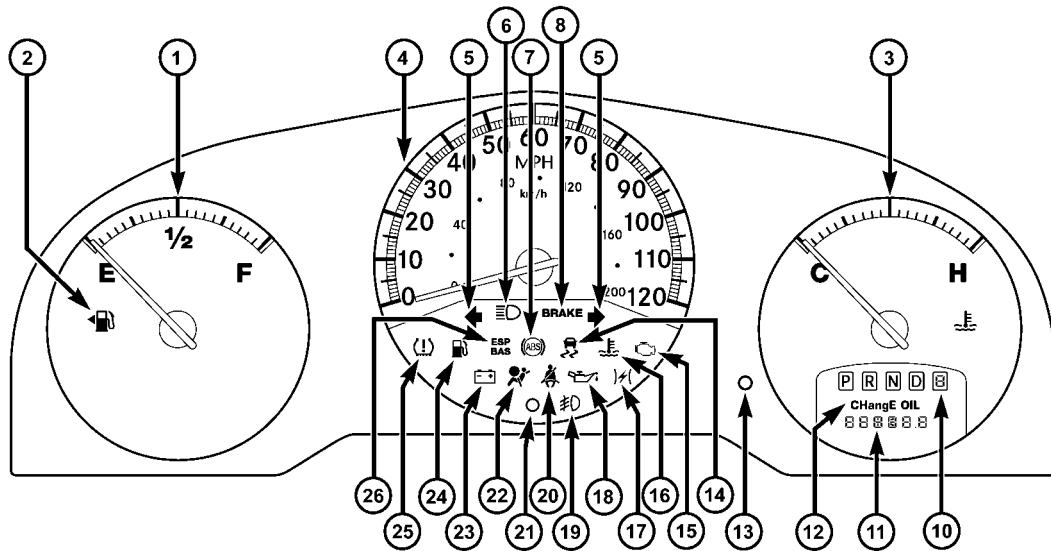

PREMIUM INSTRUMENT CLUSTER

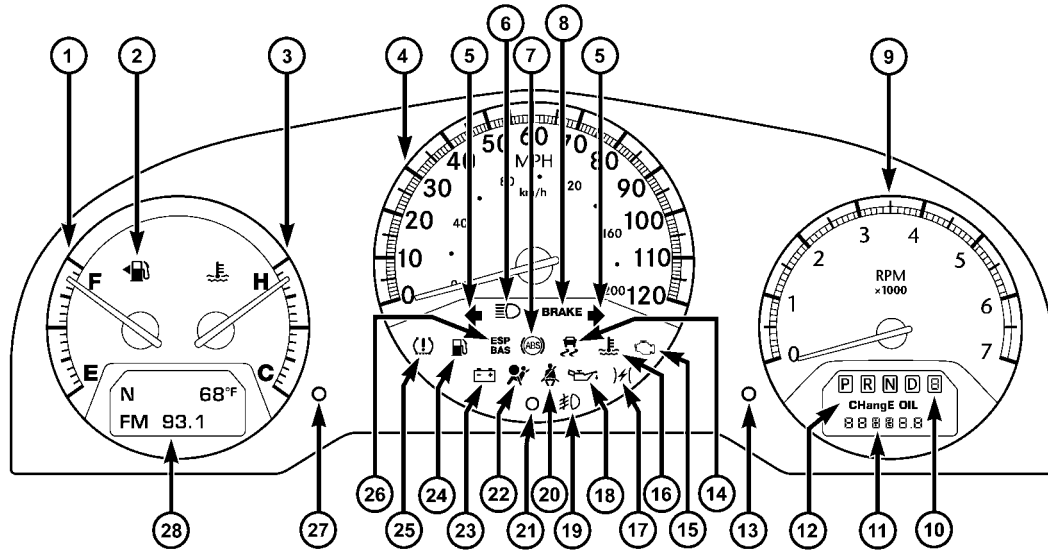

INSTRUMENT CLUSTER DESCRIPTIONS

1. *Fuel Gauge*

The pointer shows the level of fuel in the fuel tank when the ignition switch is in the ON position.

2. *Fuel Door Reminder*



The arrow in this symbol is a reminder that the Fuel Filler Door is located on the left side of the vehicle.

3. *Temperature Gauge*

The temperature gauge shows engine coolant temperature. Any reading within the normal range indicates that the engine cooling system is operating satisfactorily.

The gauge pointer will likely indicate a higher temperature when driving in hot weather, up mountain grades, or when towing a trailer. It should not be allowed to exceed the upper limits of the normal operating range.

CAUTION!

Driving with a hot engine cooling system could damage your vehicle. If temperature gauge reads “H”, pull over and stop the vehicle. Idle the vehicle with the air conditioner turned off until the pointer drops back into the normal range. If the pointer remains on the “H”, and you hear continuous chimes, turn the engine off immediately, and call an authorized dealer for service.

WARNING!

A hot engine cooling system is dangerous. You or others could be badly burned by steam or boiling coolant. You may want to call an authorized dealer if your vehicle overheats. If you decide to look under the hood yourself, see Section 7 of this manual. Follow the warnings under the Cooling System Pressure Cap paragraph.

4. Speedometer

Indicates vehicle speed.

5. Turn Signal Indicators

 The arrow will flash with the exterior turn signal when the turn signal lever is operated.

If the vehicle electronics sense that the vehicle has traveled about one mile with the turn signals on, a

continuous chime will sound to alert you to turn the signals off. If either indicator flashes at a rapid rate, check for a defective outside light bulb.

6. High Beam Light

 This light shows that the headlights are on high beam. Pull the turn signal lever towards the steering wheel to switch the headlights from high or low beam.

7. Anti-Lock Brake System Light

 This light monitors the Anti-Lock Brake System. The light will turn on when the ignition switch is turned to the ON position and may stay on for as long as four seconds.

If the ABS light remains on or turns on while driving, it indicates that the Anti-Lock portion of the brake system is not functioning and that service is required. However, the conventional brake system will continue to operate normally if the BRAKE warning light is not on.

If the ABS light is on, the brake system should be serviced as soon as possible to restore the benefits of Anti-Lock brakes. If the ABS light does not turn on when the Ignition switch is turned to the ON position, have the light inspected by an authorized dealer.

8. Brake System Warning Light

This light monitors various brake functions, including brake fluid level and parking brake application. If the brake light turns on, it may indicate that the parking brake is applied, that the brake fluid level is low, or that there is a problem with the anti-lock brake system (if equipped).

The dual brake system provides a reserve braking capacity in the event of a failure to a portion of the hydraulic system. Failure of either half of the dual brake system is indicated by the Brake Warning Light which will turn on when the brake fluid level in the master cylinder has dropped below a specified level.

The light will remain on until the cause is corrected.

NOTE: The light may flash momentarily during sharp cornering maneuvers which change fluid level conditions. The vehicle should have service performed, and the brake fluid level checked.

If brake failure is indicated, immediate repair is necessary.

WARNING!

Driving a vehicle with the brake light on is dangerous. Part of the brake system may have failed. It will take longer to stop the vehicle. You could have an accident. Have the vehicle checked immediately.

Vehicles equipped with the Anti-Lock Brake System (ABS), are also equipped with Electronic Brake Force Distribution (EBD). In the event of an EBD failure, the

Brake Warning Light will turn on along with the ABS Light. Immediate repair to the ABS system is required.

The operation of the Brake Warning Light can be checked by turning the ignition switch from the OFF position to the ON position. The light should illuminate for approximately two seconds. The light should then turn off unless the parking brake is applied or a brake fault is detected. If the light does not illuminate, have the light inspected by an authorized dealer.

The light also will turn on when the parking brake is applied with the ignition switch in the ON position.

NOTE: This light shows only that the parking brake is applied. It does not show the degree of brake application.

9. Tachometer — Premium Instrument Cluster Only

The white area of the scale shows the permissible engine revolutions-per-minute (RPM x 1000) for each gear range. Before reaching the red area, ease up on the accelerator to prevent engine damage.

10. Transmission Range Indicator

This display indicator shows the automatic transaxle gear selection.

NOTE: You must apply the brakes before shifting from Park.

11. Odometer/Trip Odometer — If Equipped

The odometer shows the total distance the vehicle has been driven.

U.S. federal regulations require that upon transfer of vehicle ownership, the seller certify to the purchaser the correct mileage that the vehicle has been driven. Therefore, if the odometer reading is changed during repair or

replacement, be sure to keep a record of the reading before and after the service so that the correct mileage can be determined.

The trip odometer shows individual trip mileage. To switch from odometer to trip odometer, press the Trip Odometer button.

To reset a trip odometer, display the desired trip odometer to be reset then push and hold the button until the display resets (approximately two seconds).

12. PRNDL/Odometer Display Area

When the appropriate conditions exist, the following odometer messages will display:

CHAngE OIL	Oil Change Required
CRUISE	Cruise Control On
door	Door Ajar
ESPOFF	ESP Off

gATE	Lift Gate Ajar
gASCAP	Fuel Cap Fault
hood*	Hood Ajar
noFUSE	Fuse Fault
LoCOOL	Low Coolant
LoWASH	Low Washer Fluid

NOTE: If your vehicle is equipped with an hood switch, in the case of hood ajar, a warning message will be displayed in either the PRNDL/Odometer display as “hood” or “Hood Ajar” in the EVIC display.

NOTE: Some of the above warnings will be displayed in the Compass Mini-Trip Computer / Electronic Vehicle Information Center Display Area under the Speedometer.

CHAngE OIL

Your vehicle is equipped with an engine oil change indicator system. The “Change Oil” message will flash in the instrument cluster odometer for approximately 12

seconds after a single chime has sounded to indicate the next scheduled oil change interval. The engine oil change indicator system is duty cycle-based, which means the engine oil change interval may fluctuate dependent upon your personal driving style.

Unless reset, this message will continue to display each time you turn the ignition switch to the ON/RUN position. To turn off the message temporarily, press and release the Trip Odometer button on the instrument cluster. To reset the oil change indicator system (after performing the scheduled maintenance) refer to the following procedure.

1. Turn the ignition switch to the ON position (Do not start the engine).
2. Fully depress the accelerator pedal slowly three times within 10 seconds.
3. Turn the ignition switch to the OFF/LOCK position.

NOTE: If the indicator message illuminates when you start the vehicle, the oil change indicator system did not reset. If necessary repeat this procedure.

13. Odometer Display Reset Button

To reset a message display (gATE, gASCAP, noFUSE, CHAngE OIL, LoCOOL, LoWASH), push and hold the button until the display resets (approximately two seconds).

14. Electronic Stability Program (ESP) Indicator Light/Traction Control System (TCS) Indicator Light



If this indicator light flashes during acceleration, apply as little throttle as possible. While driving, ease up on the accelerator. Adapt your speed and driving to the prevailing road conditions, and do not switch off the ESP, or TCS.

15. *Malfunction Indicator Light*



This light is part of an onboard diagnostic system called OBD that monitors engine and automatic transmission control systems. The light will illuminate when the key is in the ON position before engine start. If the bulb does not come on when turning the key from OFF to ON, have the condition checked promptly.

Certain conditions such as a loose or missing gas cap, poor fuel quality, etc. may illuminate the light after engine start. The vehicle should be serviced if the light stays on through several of your typical driving cycles. In most situations the vehicle will drive normally and will not require towing.

The Malfunction Indicator Light flashes to alert to serious conditions that could lead to immediate loss of power or severe catalytic converter damage. The vehicle should be serviced at an authorized dealer as soon as possible if this occurs.

16. *Engine Temperature Warning Light*



This light warns of an overheated engine condition. If the engine is critically hot, a continuous chime will sound for four minutes. After the chime turns off, the engine will still be critically hot until the light turns off.

17. *Electronic Throttle Control (ETC.) Light*



This light informs you of a problem with the Electronic Throttle Control system. If a problem is detected, the light will come on while the engine is running. Cycle the ignition key when the vehicle has completely stopped and the gear selector is placed in the PARK position. The light should turn off. If the light remains lit with the engine running your vehicle will usually be drivable, however, see your dealer for service as soon as possible. If the light is flashing when the engine is running, immediate service is required and you may experience reduced performance, an elevated/rough idle or engine stall and your vehicle may

require towing. The light will come on when the ignition is first turned ON and remain on briefly as a bulb check. If the light does not come on during starting, have the system checked by an authorized dealer.

18. Oil Pressure Warning Light

 This light shows low engine oil pressure. The light should turn on momentarily when the engine is started. If the light turns on while driving, stop the vehicle and shut off the engine as soon as possible. A chime will sound for four minutes when this light turns on.

Do not operate the vehicle until the cause is corrected. This light does not show how much oil is in the engine. The engine oil level must be checked under the hood.

19. Front Fog Light Indicator — If Equipped

 This light shows when the front fog lights are ON.

20. Seat Belt Reminder Light

 When the ignition switch is first turned ON, this light will turn on for five to eight seconds as a bulb check. During the bulb check, if the driver's seat belt is unbuckled, a chime will sound. After the bulb check or when driving, if the driver's seat belt remains unbuckled, the Seat Belt Reminder Light will illuminate and the chime will sound. Refer to the Occupant Restraints section for more information.

21. Vehicle Theft Alarm Light — If Equipped

 This light will flash for approximately 15 seconds when the vehicle theft alarm is arming.

22. Airbag Light

 This light turns on and remains on for four seconds as a bulb check when the ignition switch is first turned ON. If the light is not on

during starting, stays on, or turns on while driving, have the system inspected by an authorized dealer as soon as possible.

23. Voltage Light



This light monitors the electrical system voltage. The light should turn on momentarily as the engine is started. If the light stays on or turns on while driving, it indicates a problem with the charging system. Immediate service should be obtained.

24. Low Fuel Light



When the fuel level reaches approximately 2.0 gallons (7.8 liters) this light will turn on and remain on until fuel is added.

25. Tire Pressure Monitoring Telltale Lamp — If Equipped



Each tire, including the spare (if provided), should be checked monthly when cold and inflated to the inflation pressure recommended by the vehicle manufacturer on the vehicle placard or tire inflation pressure label. (If your vehicle has tires of a different size than the size indicated on the vehicle placard or tire inflation pressure label, you should determine the proper tire inflation pressure for those tires.)

As an added safety feature, your vehicle has been equipped with a Tire Pressure Monitoring System (TPMS) that illuminates a low tire pressure telltale when one or more of your tires is significantly under-inflated. Accordingly, when the low tire pressure telltale illuminates, you should stop and check your tires as soon as possible, and inflate them to the proper pressure. Driving on a significantly under-inflated tire causes the tire to overheat and can lead to tire failure. Underinflation also

reduces fuel efficiency and tire tread life, and may affect the vehicle's handling and stopping ability.

NOTE: Please note that the TPMS is not a substitute for proper tire maintenance, and it is the driver's responsibility to maintain correct tire pressure, even if underinflation has not reached the level to trigger illumination of the TPMS low tire pressure telltale.

Your vehicle has also been equipped with a TPMS malfunction indicator to indicate when the system is not operating properly. The TPMS malfunction indicator is combined with the low tire pressure telltale. When the system detects a malfunction, the telltale will flash for approximately one minute and then remain continuously illuminated. This sequence will continue upon subsequent vehicle start-ups as long as the malfunction exists. When the malfunction indicator is illuminated, the system may not be able to detect or signal low tire pressure as intended. TPMS malfunctions may occur for a variety

of reasons, including the installation of replacement or alternate tires or wheels on the vehicle that prevent the TPMS from functioning properly.

NOTE: Always check the TPMS malfunction telltale after replacing one or more tires or wheels on your vehicle to ensure that the replacement or alternate tires and wheels allow the TPMS to continue to function properly.

CAUTION!

The TPMS has been optimized for the original equipment tires and wheels. TPMS pressures and warning have been established for the tire size equipped on your vehicle. Undesirable system operation or sensor damage may result when using replacement equipment that is not of the same size, type, and/or style. Aftermarket wheels can cause sensor damage. Do not use aftermarket tire sealants or balance beads if your vehicle is equipped with a TPMS, as damage to the sensors may result.

For additional information on TPMS, refer to Section 5 — Starting and Operating, “Tire Pressure Monitoring System” of this manual.

For additional information on Tire Pressures, refer to Section 5 — Starting and Operating, “Tire Inflation Pressures” of this manual.

26. Electronic Stability Program (ESP) Indicator Light

ESP
BAS The malfunction lamp for the ESP is combined with BAS. The yellow “ESP/BAS Warning Lamp” comes on when the ignition switch is turned to the “ON” position. They should go out with the engine running. If the “ESP/BAS Warning Lamp” comes on continuously with the engine running, a malfunction has been detected in either the ESP or the BAS system. If this light remains on after several ignition cycles, and the vehicle has been driven several miles/kilometers at speeds greater than 30 mph (48 km/h), see your authorized dealer as soon as possible.

27. Compass Mini-Trip Computer (CMTC) Reset Button

Press the reset button to scroll through sub menus (i.e., Trip Functions: AVG Fuel Economy, DTE, Elapsed Time, and Units).

NOTE: For more detailed operation, refer to “Compass Mini-Trip Computer” later in this section.

28. Compass Mini-Trip Computer (CMTC) Display / Electronic Vehicle Information Center (EVIC) Display—If Equipped

Compass Mini-Trip Computer (CMTC) — If Equipped
On vehicles equipped with CMTC, the display provides the outside temperature, one of eight compass headings to indicate the direction the vehicle is facing and the current radio station. Refer to “Compass Mini-Trip Computer” later in this section.

Electronic Vehicle Information Center (EVIC) Display ***— If Equipped***

The Electronic Vehicle Information Center (EVIC) features a driver-interactive display that is located in the lower half of the speedometer.

Oil Change Required

Your vehicle is equipped with an engine oil change indicator system. The **Oil Change Required** message will flash in the EVIC display for approximately 10 seconds after a single chime has sounded to indicate the next scheduled oil change interval. The engine oil change indicator system is duty cycle based, which means the engine oil change interval may fluctuate dependent upon your personal driving style.

Unless reset, this message will continue to display each time you turn the ignition switch to the ON/RUN position. To turn off the message temporarily, press and release the Menu button. To reset the oil change indicator system (after performing the scheduled maintenance) refer to the following procedure.

1. Turn the ignition switch to the ON position (Do not start the engine).
2. Fully depress the accelerator pedal slowly three times within 10 seconds.
3. Turn the ignition switch to the OFF/LOCK position.

NOTE: If the indicator message illuminates when you start the vehicle, the oil change indicator system did not reset. If necessary repeat this procedure.

COMPASS MINI-TRIP COMPUTER (CMTC) — IF EQUIPPED

NOTE: The compass on your vehicle is self-calibrating, eliminating the need to manually calibrate the compass.

The Compass Mini-Trip Computer features a driver-interactive display (displays information on outside temperature, compass direction, and trip information). It is located in the instrument cluster, below the Fuel and Temperature gauges.

Compass Mini-Trip Computer (CMTC) Odometer Displays

When the appropriate conditions exist, the following odometer messages will display:

CHAngE OIL	Oil Change Required
CRUISE	Cruise Activated
door	Door Ajar

ESPOFF	ESP Deactivated
gATE	Lift Gate Ajar
gASCAP	Fuel Cap Fault
hood	Hood Ajar
noFUSE	Fuse Fault
LoCOOL	Low Coolant
LoWASH	Low Washer Fluid

These messages can be manually turned off by pressing the right reset button (on the instrument cluster).

Compass Mini-Trip Computer (CMTC) Reset Buttons

CMTC Reset Button

Press the left reset button located on the instrument cluster to scroll through the sub menus (i.e., Trip Functions: AVG Fuel Economy, DTE, Elapsed Time, and Units).

To reset the display shown, turn the ignition switch to the ON position, then press and hold the reset button for approximately two seconds.

When the appropriate conditions exist, the following odometer messages will display:

NE	Eight-point compass headings are displayed (N, S, E, W, NE, NW, SE, SW)
14°F	Temperature (Fahrenheit or Celsius)
AVG	Average Fuel Economy (U.S. or Metric)
DTE	Distance to Empty
ET	Elapsed Time
P	Park Assist On/Off



Should this wrench symbol display with the letter **P** next to it, your Park Assist System needs servicing. Contact your authorized dealer.

NOTE: Temperature and Average Fuel Economy can be changed from U.S. or Metric by pressing and holding the left CMTC Reset Button located on the instrument cluster near the temperature gauge.

Compass Mini-Trip Computer (CMTC) Trip Odometer (ODO)

This display shows the distance traveled since the last reset. Press and release the right button located on the instrument cluster to switch from odometer, to trip A or trip B. Press and hold the right button while the odometer/trip odometer is displayed to reset.

Trip A

Shows the total distance traveled for Trip A since the last reset.

Trip B

Shows the total distance traveled for Trip B since the last reset.

Compass/Temperature Display

Compass Variance

Compass Variance is the difference between magnetic North and Geographic North. In some areas of the country, the difference between magnetic and geographic North is great enough to cause the compass to give false readings. In order to ensure compass accuracy, the compass variance should be properly set according to the compass variance map zone that the vehicle is in.

NOTE: Magnetic materials should be kept away from the top of the instrument panel. This is where the compass sensor is located.

To Set the Variance

NOTE: Refer to the “Compass Variance Map” in the following “Electronic Vehicle Information Center (EVIC)” section for your Zone Value.

Start the engine, and leave the transmission gear selector lever in the PARK position. Press and hold (approximately ten seconds) the CMTC reset button until the current variance zone number is displayed. To change the zone, press and release the CMTC reset button to increment the variance one step. Repeat as necessary, until the desired variance is achieved.

NOTE: The factory default Zone is 8. During programming, the zone value will wrap around from Zone 15 to Zone 1.

Manual Compass Calibration

If the compass appears erratic, inaccurate or abnormal, you may wish to calibrate the compass. Prior to calibrating the compass make sure the proper zone is selected.

1. Start the engine, and leave the transmission in the PARK position.

2. Press and hold (approximately 10 seconds) the CMTC reset button until the current variance zone number is displayed.
3. Release the CMTC reset button, then press and hold again (approximately 10 seconds), until the direction is displayed with the CAL indicator on continuously in the display.
4. To complete the compass calibration, drive the vehicle in one or more complete 360 degree circles under 5 mph (8 km/h) in an area free from power lines, large metallic objects, until the CAL indicator turns off. The compass will now function normally.

ELECTRONIC VEHICLE INFORMATION CENTER (EVIC) — IF EQUIPPED

NOTE: The compass on your vehicle is self-calibrating, eliminating the need to manually calibrate the compass.

The Electronic Vehicle Information Center (EVIC) features a driver-interactive display that is located in the lower half of the speedometer.

This system conveniently allows the driver to select a variety of useful information by pressing the switches mounted on the steering wheel. The EVIC consists of the following:

- System Status display
- Vehicle information warning message displays
- Tire Pressure Monitor System
- Personal Settings (Customer Programmable Features)

- Compass display
- Outside temperature display
- Trip computer functions
- Audio Modes display

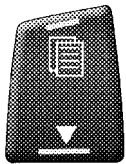

81c27d73

EVIC Menu / Step Control Button as it appears on the left side of the steering column.



Press and release the MENU button and the mode displayed will change between Compass/Temperature, Trip, System Status, and Personal Settings.

Press the STEP button to scroll through sub menus (i.e. Trip Functions, Avg. Fuel Economy, DTE, Elapsed Time, and Units).



81c27d71

Steering Wheel EVIC Compass/Temp Control Button as it appears on the right side of the steering column



Press and release the C/T button to for instant access to the Compass/Temperature Screens.

Press this button to RESET Trip Functions and Change Personal Settings.



EVIC Displays

When the appropriate conditions exist, the EVIC displays the following messages:

- Door(s) Ajar (with a single chime if vehicle is in motion)
- Liftgate Ajar (chime will sound when vehicle starts moving)
- Hood Ajar (If equipped with hood switch)
- Check TPM System. Refer to “Tire Pressure Monitoring System” in Section 5 of this manual.
- Turn Signal On
- RKE Battery Low
- LOW WASHER FLUID
- Oil Change Required
- Left Front Turn Signal Light Out

- Left Rear Turn Signal Light Out
- Right Front Turn Signal Light Out
- Right Rear Turn Signal Light Out
- Park Assist Disabled
- Service Park Assist System
- Personal Settings Not Available – Vehicle Not in Park

Oil Change Required

Your vehicle is equipped with an engine oil change indicator system. The **Oil Change Required** message will flash in the EVIC display for approximately 10 seconds after a single chime has sounded to indicate the next scheduled oil change interval. The engine oil change indicator system is duty cycle based, which means the engine oil change interval may fluctuate dependent upon your personal driving style.

Unless reset, this message will continue to display each time you turn the ignition switch to the ON/RUN position. To turn off the message temporarily, press and release the Menu button. To reset the oil change indicator system (after performing the scheduled maintenance) refer to the following procedure.

1. Turn the ignition switch to the ON position (Do not start the engine).
2. Fully depress the accelerator pedal slowly three times within 10 seconds.
3. Turn the ignition switch to the OFF/LOCK position.

NOTE: If the indicator message illuminates when you start the vehicle, the oil change indicator system did not reset. If necessary repeat this procedure.

TRIP FUNCTIONS

Press and release the MENU button until one of the following Trip Functions displays in the EVIC:

Press the STEP button to scroll through all the Trip Computer functions.

The Trip Functions mode displays the following information:

Average Fuel Economy

Shows the average fuel economy since the last reset. When the fuel economy is reset, the display will read “RESET” or show dashes for two seconds. Then, the history information will be erased, and the averaging will continue from the last fuel average reading before the reset.

Distance To Empty (DTE)

Shows the estimated distance that can be traveled with the fuel remaining in the tank. This estimated distance is determined by a weighted average of the instantaneous and average fuel economy, according to the current fuel tank level.

NOTE: Significant changes in driving style or vehicle loading will greatly affect the actual drivable distance of the vehicle, regardless of the DTE displayed value.

When the DTE value is less than 30 miles (48 km) estimated driving distance, the DTE display will change to a text display of "LOW FUEL." This display will continue until the vehicle runs out of fuel. Adding a significant amount of fuel to the vehicle will turn off the "LOW FUEL" text and a new DTE value will display.

Elapsed Time

Shows the total elapsed time of travel since the last reset when the ignition switch is in the ACC position. Elapsed time will increment when the ignition switch is in the ON or START position.

Display Units of Measure in:

To make your selection, press and release the STEP button until "US" or "METRIC" appears.

To Reset The Display

Reset will only occur while a resettable function is being displayed. Press and release the RESET button once to clear the resettable function being displayed. To reset all resettable functions, press and release the RESET button a second time within three seconds of resetting the currently displayed function (Reset ALL will display during this three-second window).

COMPASS DISPLAY



The compass readings indicate the direction the vehicle is facing. Press and release the compass button to display one of eight compass readings and the outside temperature.

Automatic Compass Calibration

This compass is self-calibrating, which eliminates the need to manually reset the compass. When the vehicle is new, the compass may appear erratic and the EVIC will display CAL until the compass is calibrated. You may also calibrate the compass by completing one or more 360° turns (in an area free from large metal or metallic objects) until the CAL indicator displayed in the EVIC turns off. The compass will now function normally.

Manual Compass Calibration

If the compass appears erratic and the CAL indicator does not appear in the EVIC display, you must put the compass into the Calibration Mode manually as follows:

1. Turn on the ignition switch.
2. Press the MENU button until Personal Settings (Customer Programmable Features) menu is reached.
3. Press the STEP button until “Calibrate Compass” is displayed in the EVIC.
4. Press and release the RESET button to start the calibration. The “CAL” indicator will be displayed in the EVIC.
5. Complete one or more 360° turns (in an area free from large metal or metallic objects) until the CAL indicator turns off. The compass will now function normally.

Compass Variance

Compass Variance is the difference between magnetic North and Geographic North. In some areas of the country, the difference between magnetic and geographic North is great enough to cause the compass to give false readings. For the most accurate compass performance, the compass variance must be set using the following procedure:

NOTE: Magnetic materials should be kept away from the top of the instrument panel. This is where the compass sensor is located.

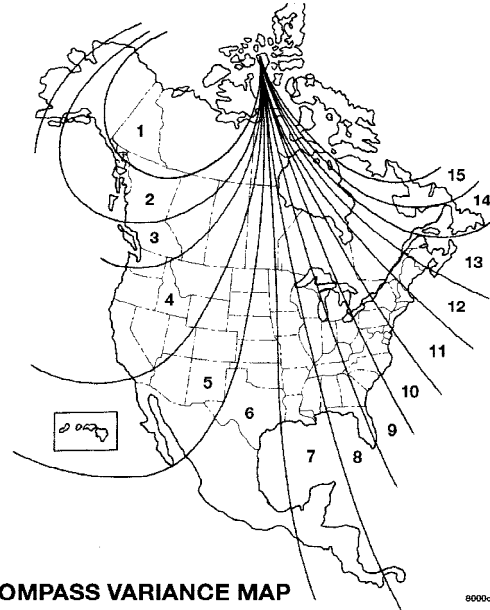

1. Turn the ignition switch ON.
2. Press and hold the compass button for approximately two seconds.
3. Press the STEP button until “Compass Variance” message and the last variance zone number displays in the EVIC.
4. Press and release STEP button until the proper variance zone is selected according to the map.
5. Press and release the compass button to exit.

PERSONAL SETTINGS (CUSTOMER PROGRAMMABLE FEATURES)

Personal Settings allows the driver to set and recall features when the transmission is in PARK. If the transmission is out of PARK or the vehicle begins moving, a warning message **PERSONAL SETTING NOT AVAILABLE** followed in three seconds by **VEHICLE NOT IN PARK**.

Press and release the MENU button until Personal Settings displays in the EVIC.

Use the Step button to display one of the following choices:

Language

When in this display you may select one of five languages for all display nomenclature, including the trip functions and the navigation system (if equipped). Press the reset button while in this display to select English, Spanish (Español), French (Français), Italian (Italiano), German (Deutsch), and Dutch (Nederlands). Then, as you continue, the information will display in the selected language.

Lock Doors Automatically at 15 mph (24 km/h)

When ON is selected, all doors will lock automatically when the vehicle reaches a speed of 15 mph (24 km/h). To make your selection, press and release the RESET button until ON or OFF appears.

Unlock Doors Automatically on Exit

When ON is selected, all doors will unlock when the vehicle is stopped and the transmission is in the PARK or NEUTRAL position and the driver's door is opened. To make your selection, press and release the RESET button until ON or OFF appears.

Remote Key Unlock

When **Driver Door 1st Press** is selected, only the driver's door will unlock on the first press of the remote keyless entry unlock button. When Driver Door 1st Press is selected, you must press of the remote keyless entry unlock button twice to unlock the passenger's doors. When **All Doors 1st Press** is selected, all of the doors will unlock on the first press of the remote keyless entry unlock button. To make your selection, press and release the RESET button until "Driver Door 1st Press" or "All Doors 1st Press" appears.

Sound Horn with Remote Key Lock

When ON is selected, a short horn sound will occur when the remote keyless entry LOCK button is pressed. This feature may be selected with or without the flash lights on lock/unlock feature. To make your selection, press and release the RESET button until ON or OFF appears.

Flash Lights with Remote Key Lock

When ON is selected, the front and rear turn signals will flash when the doors are locked or unlocked with the remote keyless entry transmitter. This feature may be selected with or without the sound horn on lock feature selected. To make your selection, press and release the RESET button until ON or OFF appears.

Automatic High Beams — If Equipped

When this feature is selected, the high beam headlights will deactivate automatically under certain conditions. To make your selection, press and release the FUNCTION

SELECT button until YES (Y) or NO (N) appears. Refer to “Lights/SmartBeams — If Equipped” in Section 3 of this manual for more information.

Headlights On with Wipers (Available with Auto Headlights Only)

When YES (Y) is selected, and the headlight switch is in the AUTO position, the headlights will turn on approximately 10 seconds after the wipers are turned on. The headlights will also turn off when the wipers are turned off if they were turned on by this feature. To make your selection, press and release the FUNCTION SELECT button until YES (Y) or NO (N) appears.

NOTE: Turning the headlights on during the daytime causes the instrument panel lights to dim. To increase the brightness, refer to “Lights” in Section 3 of this manual.

Delay Turning Headlights Off

When this feature is selected, the driver can choose to have the headlights remain on for 0, 30, 60, or 90 seconds

when exiting the vehicle. To make your selection, press and release the RESET button until 0, 30, 60, or 90 appears.

Turn Headlights On with Remote Key Unlock

When this feature is selected, the headlights will activate and remain on for up to 90 seconds when the doors are unlocked with the remote keyless entry transmitter. To make your selection, press and release the RESET button until OFF, 30 sec., 60 sec., or 90 sec. appears.

Delay Power Off to Accessories Until Exit

When this feature is selected, the power window switches, radio, hands-free system (if equipped), DVD video system (if equipped), power sunroof (if equipped), and power outlets will remain active for up to 10 minutes after the ignition switch is turned off. Opening a vehicle door will cancel this feature. To make your selection, press and release the RESET button until Off, 45 sec., 5 min., or 10 min. appears.

Rear Park Assist System — If Equipped

When ENABLE is selected, the Rear Park Assist System is activated. When DISABLE is selected, the System is deactivated and, the instrument cluster will display the "PARK ASSIST DISABLED" message.

Display Units of Measure in

The EVIC, odometer, and navigation system (if equipped) can be changed between English and Metric units of measure. To make your selection, press and release the RESET button until US or METRIC appears.

RADIO GENERAL INFORMATION**RADIO BROADCAST SIGNALS**

Your radio will provide excellent reception under most operating conditions. Like any system, however, car radios have performance limitations, due to mobile operation and natural phenomena, which might lead you to believe your sound system is malfunctioning. To help

you understand and save you concern about these "apparent" malfunctions, you must understand a point or two about the transmission and reception of radio signals.

Two Types of Signals

There are two basic types of radio signals:

1. AM or Amplitude Modulation, in which the transmitted sound causes the amplitude, or height, of the radio waves to vary.
2. FM or Frequency Modulation, in which the frequency of the wave is varied to carry the sound.

AM Reception

AM sound is based on wave amplitude, so AM reception can be disrupted by such things as lightning, power lines and neon signs.

FM Reception

Because FM transmission is based on frequency variations, interference that consists of amplitude variations can be filtered out, leaving the reception relatively clear, which is the major feature of FM radio.

NOTE: The radio, steering wheel radio controls (if equipped), and six-disc CD/DVD changer (if equipped) will remain active for up to 90 seconds after the ignition switch has been turned OFF, depending upon the EVIC, Accessory Delay setting. Opening a vehicle front door will cancel this feature.

Electrical Disturbances

Radio waves may pick up electrical disturbances during transmission. They mainly affect the wave amplitude, and thus remain a part of the AM reception. They interfere very little with the frequency variations that carry the FM signal.

SALES CODE REQ — AM/FM STEREO RADIO AND 6-DISC CD/DVD CHANGER (MP3/WMA AUX JACK)

NOTE: The radio sales code is located on the lower right side of your radio faceplate.

Operating Instructions - Radio Mode

NOTE: The ignition switch must be in the ON or ACC position to operate the radio.

Power Switch/Volume Control (Rotary)

Push the On/Volume control knob to turn on the radio. Press the control knob a second time to turn off the radio.

Electronic Volume Control

The electronic volume control turns continuously (360 degrees) in either direction without stopping. Turning the On/Volume control knob to the right increases the volume and to the left decreases it.

When the audio system is turned on, the sound will be set at the same volume level as last played.

SEEK Buttons

Press and release the SEEK buttons to search for the next listenable station in AM/FM mode. Press the right switch to seek up and the left switch to seek down. The radio will remain tuned to the new station until you make another selection. Holding either button will bypass stations without stopping until you release it.

SCAN Button

Pressing the SCAN button causes the tuner to search for the next listenable station, in AM, FM or Satellite (if equipped) frequencies, pausing for five seconds at each listenable station before continuing to the next. To stop the search, press the SCAN button a second time.

Voice Recognition Button (UConnect® Hands-Free Phone) — If Equipped

Press this button to operate the Hands-Free Phone (UConnect®) feature (if equipped). Refer to “Hands-Free Communication (UConnect®)” in Section 3.

If your vehicle is not equipped with or this feature is not available on your vehicle, a “Not Equipped With UConnect” message will display on the radio screen.

Phone Button (UConnect® Hands-Free Phone) — If Equipped

Press this button to operate the Hands-Free Phone (UConnect®) feature (if equipped). Refer to “Hands-Free Communication (UConnect®)” in Section 3.

If your vehicle is not equipped with or this feature is not available on your vehicle, a “Not Equipped With UConnect” message will display on the radio screen.

TIME Button

Press the TIME button and the time of day will display. In AM or FM mode, pressing the TIME button will switch between the time and frequency displays.

Clock Setting Procedure

1. Press and hold the TIME button until the hours blink.
2. Adjust the hours by turning the right side Tune/Scroll control knob.
3. After adjusting the hours, press the right side Tune/Scroll control knob to set the minutes. The minutes will begin to blink.
4. Adjust the minutes using the right side Tune/Scroll control knob. Press the Tune/Scroll control knob to save the time change.
5. To exit, press any button/knob or wait five seconds.

The clock can also be set by pressing the SETUP button and selecting the “SET HOME CLOCK” entry. Once in this display follow the above procedure, starting at Step 2.

INFO Button

Press the INFO button for an RDS station (one with call letters displayed). The radio will return a Radio Text message broadcast from an FM station (FM mode only).

RW/FF

Pressing the RW (Rewind) or FF (Fast Forward) buttons causes the tuner to search for the next frequency in the direction of the arrows. This feature operates in AM, FM or Satellite (if equipped) frequencies.

TUNE Control

Turn the rotary Tune/Scroll control knob clockwise to increase or counterclockwise to decrease the frequency.

Setting the Tone, Balance, and Fade

Push the rotary Tune/Scroll control knob and BASS will display. Turn the Tune/Scroll control knob to the right or left to increase or decrease the bass tones.

Push the rotary Tune/Scroll control knob a second time and MID will display. Turn the Tune/Scroll control knob to the right or left to increase or decrease the mid-range tones.

Push the rotary Tune/Scroll control knob a third time and TREBLE will display. Turn the Tune/Scroll control knob to the right or left to increase or decrease the treble tones.

Push the rotary Tune/Scroll control knob a fourth time and BALANCE will display. Turn the Tune/Scroll control knob to the right or left to adjust the sound level from the right or left side speakers.

Push the rotary Tune/Scroll control knob a fifth time and FADE will display. Turn the Tune/Scroll control knob to the left or right to adjust the sound level between the front and rear speakers.

Push the rotary Tune/Scroll control knob again to exit setting tone, balance, and fade.

MUSIC TYPE Button

Pressing this button once will turn on the Music Type mode for five seconds. Pressing the MUSIC TYPE button or turning the Tune/Scroll control knob within five seconds will allow the program format type to be selected. Many radio stations do not currently broadcast Music Type information.

Toggle the MUSIC TYPE button to select the following format types:

Program Type	16-Digit Character Display
No program type or undefined	None
Adult Hits	Adlt Hit
Classical	Classicl
Classic Rock	Cls Rock
College	College
Country	Country
Foreign Language	Language
Information	Inform
Jazz	Jazz
News	News
Nostalgia	Nostalgia
Oldies	Oldies
Personality	Persnlty
Public	Public

Program Type	16-Digit Character Display
Rhythm and Blues	R & B
Religious Music	Rel Musc
Religious Talk	Rel Talk
Rock	Rock
Soft	Soft
Soft Rock	Soft Rck
Soft Rhythm and Blues	Soft R&B
Sports	Sports
Talk	Talk
Top 40	Top 40
Weather	Weather

By pressing the SEEK button when the Music Type icon is displayed, the radio will be tuned to the next frequency

station with the same selected Music Type name. The Music Type function only operates when in the FM mode.

If a preset button is activated while in the Music Type (Program Type) mode, the Music Type mode will be exited and the radio will tune to the preset station.

SETUP Button

Pressing the SETUP button allows you to select between the following items:

NOTE: Turn the Tune/Scroll control knob to scroll through the entries. Push the AUDIO/SELECT button to select an entry and make changes.

- **DVD Enter** - When the disc is in DVD Menu mode, selecting DVD Enter will allow you to play the current highlighted selection. Use the remote control to scroll up and down the menu (if equipped).



- **DISC Play/Pause** - You can toggle between playing the DVD and pausing the DVD by pushing the SELECT button (if equipped).
- **DVD Play Options** - Selecting the DVD Play Options will display the following:
 - Subtitle – Repeatedly pressing SELECT will switch subtitles to different subtitle languages that are available on the disc (if equipped).
 - Audio Stream – Repeatedly pressing SELECT will switch to different audio languages (if supported on the disc) (if equipped).
 - Angle – Repeatedly pressing SELECT will change the viewing angle if supported by the DVD disc (if equipped).

NOTE: The available selections for each of the above entries varies depending upon the disc.

NOTE: These selections can only be made while playing a DVD.

- **VES® Power** - Allows you to turn VES® on and off (if equipped).
- **VES® Lock** - Locks out rear VES® remote controls (if equipped).
- **VES® CH1/CH2** - Allows the user to change the mode of either the IR1 or IR2, wireless headphones by pressing the AUDIO/SELECT button (if equipped).
- **Set Home Clock** - Pressing the SELECT button allows you to set the clock. Turn the Tune/Scroll control knob to adjust the hours and then press and turn the Tune/Scroll control knob to adjust the minutes. Press the Tune/Scroll control knob again to save changes.
- **Player Defaults** - Selecting this item will allow the user to scroll through the following items, and set defaults according to customer preference.

Menu Language — If Equipped

Selecting this item will allow the user to choose the default startup DVD menu language (effective only if language supported by disc). If you want to select a language not listed, then scroll down and select "other." Enter the four-digit country code using the Tune/Scroll control knob to scroll up and down to select the number and then push to select.

Audio Language — If Equipped

Selecting this item allows you to choose a default audio language (effective only if the language is supported by the disc). You can select a language not listed by scrolling down and selecting "other." Enter the country code using the Tune/Scroll control knob to scroll up and down to select the number and then push to select.

Subtitle Language — If Equipped

Selecting this item allows you to choose a default subtitle language (effective only if the language is supported by the disc). You can select a language not listed by scrolling down and selecting "other." Enter the country code using the Tune/Scroll control knob to scroll up and down to select the number and then push to select.

Subtitles — If Equipped

Selecting this item allows you to choose between subtitle Off or On.

Audio DRC — If Equipped

Selecting this item allows you to limit maximum audio dynamic range. The default is set to "High," and under this setting, dialogues will play at 11 db higher than if the setting is "Normal."

Aspect Ratio — If Equipped

Selecting this item allows you to choose between wide screen, pan scan, and letter box.

AutoPlay — If Equipped

When this is set to On and a DVD video is inserted, it will bypass the DVD menu screen and automatically play the movie. In some rare cases, the DVD player may not auto-play the main title. In such cases, use the MENU button on the remote control to select desired title to play.

NOTE: The user will have to set these defaults before loading a disc. If changes are made to these settings after a disc is loaded, changes will not be effective. Also, the defaults are effective only if the disc supports the customer-preferred settings.

AM and FM Buttons

Press the buttons to select AM or FM Modes.

SET Button — To Set the Pushbutton Memory

When you are receiving a station that you wish to commit to pushbutton memory, press the SET button. The symbol SET 1 will now show in the display window. Select the button (1-6) you wish to lock onto this station and press and release that button. If a button is not selected within five seconds after pressing the SET button, the station will continue to play but will not be stored into pushbutton memory.

You may add a second station to each pushbutton by repeating the above procedure with this exception: Press the SET button twice and SET 2 will show in the display window. Each button can be set for SET 1 and SET 2 in both AM and FM. This allows a total of 12 AM, 12 FM, and 12 Satellite (if equipped) stations to be stored into pushbutton memory. The stations stored in SET 2 memory can be selected by pressing the pushbutton twice.

Every time a preset button is used, a corresponding button number will display.

Buttons 1 - 6

These buttons tune the radio to the stations that you commit to pushbutton memory {12 AM, 12 FM, and 12 Satellite (if equipped) stations}.

DISC Button

Pressing the DISC button will allow you to switch from AM/FM modes to Disc modes.

Operation Instructions - (DISC MODE for CD and MP3/WMA Audio Play, DVD-VIDEO)

The radio DVD player and many DVD discs are coded by geographic region. These region codes must match in order for the disc to play. If the region code for the DVD disc does not match the region code for the radio DVD player, it will not play the disc. Customers may take their vehicle to an authorized dealer to change the region code of the player a maximum of five times.

CAUTION!

The radio may shut down during extremely hot conditions. When this occurs, the radio will indicate "Disc Hot" and shut off until a safe temperature is reached. This shutdown is necessary to protect the optics of the DVD player and other radio internal components.

NOTE: The ignition switch must be in the ON or ACC position to operate the radio.

LOAD Button — Loading Compact Disc(s)

Press the LOAD button and the pushbutton with the corresponding number (1-6) where the CD is being loaded. The radio will display PLEASE WAIT and prompt when to INSERT DISC. After the radio displays "INSERT DISC," insert the CD into the player.

Radio display will show "LOADING DISC" when the disc is loading and "READING DISC" when the radio is reading the disc.

CAUTION!

This CD player will accept 4-3/4 in (12 cm) discs only. The use of other sized discs may damage the CD player mechanism.

4

Eject Button — Ejecting Compact Disc(s)

Press the EJECT button and the pushbutton with the corresponding number (1-6) where the CD was loaded and the disc will unload and move to the entrance for easy removal. Radio display will show "EJECTING DISC" when the disc is being ejected and prompt the user to remove the disc.

Press and hold the EJECT button for five seconds and all CDs will be ejected from the radio.

The disc can be ejected with the radio and ignition OFF.

SEEK Button (CD MODE)

Press the right SEEK button for the next selection on the CD. Press the left SEEK button to return to the beginning of the current selection, or return to the beginning of the previous selection if the CD is within the first second of the current selection. Pressing and holding the SEEK button will allow you to scroll through the tracks faster in CD, MP3/WMA modes.

SCAN Button (CD MODE)

Press the SCAN button to scan through each track on the CD currently playing.

TIME Button (CD MODE)

Press this button to change the display from a large CD playing time display to a small CD playing time display.

RW/FF (CD MODE)

Press and hold FF (Fast Forward) and the CD player will begin to fast forward until FF is released, or RW or another CD button is pressed. The RW (Rewind) button works in a similar manner.

AM or FM Button (CD MODE)

Switches the radio to the Radio mode.

Notes On Playing MP3/WMA Files

The radio can play MP3/WMA files; however, acceptable MP3/WMA file recording media and formats are limited. When writing MP3/WMA files, pay attention to the following restrictions.

Supported Media (Disc Types)

The MP3/WMA file recording media supported by the radio are CDDA, CD-R, CD-RW, MP3, WMA, DVD Video, DVD-R, DVD-RW, DVD+R, DVD+RW, and CDDA+MP3.

Supported Medium Formats (File Systems)

The medium formats supported by the radio are ISO 9660 Level 1 and Level 2 and includes the Joliet extension. When reading discs recorded using formats other than ISO 9660 Level 1 and Level 2, the radio may fail to read files properly and may be unable to play the file normally. UDF and Apple HFS formats are not supported.

The radio uses the following limits for file systems:

- Maximum number of directory levels: 8
- Maximum number of files: 255
- Maximum number of folders: 100
- Maximum number of characters in file/folder names:
 - Level 1: 12 (including a separator "." and a three-character extension)
 - Level 2: 31 (including a separator "." and a three-character extension)

Multisession disc formats are supported by the radio. Multisession discs may contain combinations of normal CD audio tracks and computer files (including MP3/WMA files). Discs created with an option such as "keep disc open after writing" are most likely multisession discs. The use of multisession for CD audio or MP3/WMA playback may result in longer disc loading times.

If a disc contains multi-formats, such as CD audio and MP3/WMA tracks, the radio will only play the MP3/WMA tracks on that disc.

Supported MP3/WMA File Formats

The radio will recognize only files with the *.MP3/WMA extension as MP3/WMA files. Non-MP3/WMA files named with the *.MP3/WMA extension may cause playback problems. The radio is designed to recognize the file as an invalid MP3/WMA and will not play the file.

When using the MP3/WMA encoder to compress audio data to an MP3/WMA file, the bit rate and sampling frequencies in the following table are supported. In addition, Variable Bit Rates (VBR) are also supported. The majority of MP3/WMA files use a 44.1 kHz sampling rate and a 192, 160, 128, 96 or VBR bit rates.

MP3 File Format

MPEG Specification	Sampling Frequency (kHz)	Bit Rate (kbps)
MPEG-1 Audio Layer 3	48, 44.1, 32	320, 256, 224, 192, 160, 128, 112, 96, 80, 64, 56, 48
MPEG-2 Audio Layer 3	24, 22.05, 16	160, 128, 144, 112, 96, 80, 64, 56, 48

WMA File Format

WMA Specification	Sampling Frequency (kHz)	Bit Rate (kbps)
WMA	44.1 and 48	48, 64, 96, 128, 160, 192 VBR

ID3 Tag information for artist, song title, and album title are supported for ID3 version 1 tags. ID3 version 2 is not supported by the radios.

Playlist files are not supported. MP3 Pro files are not supported.

Playback of MP3/WMA Files

When a medium containing MP3/WMA data is loaded, the radio checks all files on the medium. If the medium contains a lot of folders or files, the radio will take more time to start playing the MP3/WMA files.

Loading times for playback of MP3/WMA files may be affected by the following:

- Media - CD-RW media may take longer to load than CD-R media
- Medium formats - Multisession discs may take longer to load than non-multisession discs
- Number of files and folders - Loading times will increase with more files and folders

To increase the speed of disc loading, it is recommended to use CD-R media and single-session discs. To create a single-session disc, enable the “Disc at Once” option before writing to the disc.

LIST Button (DISC Mode for MP3/WMA Play)

Pressing the LIST button will bring up a list of all folders on the disc. Scrolling up or down the list is done by turning the Tune/Scroll control knob. Selecting a folder by pressing the Tune/Scroll control knob will begin playing the files contained in that folder (or the next folder in sequence if the selection does not contain playable files).

The folder list will time out after five seconds.

INFO Button (DISC Mode for MP3/WMA Play)

Pressing the INFO button repeatedly will scroll through the following TAG information: Song Title, Artist, File Name, and Folder Name (if available).

Press the INFO button once more to return to “elapsed time” priority mode.

Press and hold the INFO button for three seconds or more and radio will display song titles for each file.

Press and hold the INFO button again for three seconds to return to "elapsed time" display.

Operation Instructions - Auxiliary Mode

The auxiliary (AUX) jack is an audio input jack, which allows the user to plug in a portable device such as an MP3/WMA player, cassette player, or microphone and utilize the vehicle's audio system to amplify the source and play through the vehicle speakers.

Pressing the AUX button will change the mode to auxiliary device if the AUX jack is connected.

NOTE: The AUX device must be turned on and the device's volume set to the proper level. If the AUX audio is not loud enough, turn the device's volume up. If the AUX audio sounds distorted, turn the device's volume down.

SEEK Button (Auxiliary Mode)

No function.

SCAN Button (Auxiliary Mode)

No function.

EJECT Button (Auxiliary Mode)

No function.



TIME Button (Auxiliary Mode)

Press the TIME button to change the display from elapsed playing time to time of day. The time of day will display for five seconds.

RW/FF (Auxiliary Mode)

No function.

SET Button (Auxiliary Mode)

No function.

Operating Instructions — Voice Recognition System (VR) (If Equipped)

For the radio, refer to “Voice Recognition System (VR)” in Section 3.

For UConnect® “Voice Recognition System (VR)” refer to “Hands-Free Communication (UConnect®)” in Section 3.

Operating Instructions - Hands-Free Phone (UConnect®) — If Equipped

Refer to “Hands-Free Communication (UConnect®)” in Section 3.

Operating Instructions - Satellite Radio Mode (If Equipped)

Refer to “Satellite Radio” in this section.

Operating Instructions - Video Entertainment System (VES®) (If Equipped)

Refer to separate “Video Entertainment System (VES®) Guide.”

Dolby®

Manufactured under license from Dolby® Laboratories. “Dolby®” and the double-D symbol are trademarks of Dolby® Laboratories.

Macrovision

This product incorporates copyright protection technology that is protected by U.S. patents and other intellectual property rights. Use of this copyright protection technology must be authorized by Macrovision, and is intended for home and other limited viewing uses only, unless otherwise authorized by Macrovision. Reverse engineering or disassembly is prohibited

DTS™

“DTS™” and “DTS™ 2.0” are trademarks of Digital Theater Systems, Inc.

SALES CODE RES — AM/FM STEREO RADIO WITH CD PLAYER (MP3 AUX JACK)

NOTE: The radio sales code is located on the lower right side of your radio faceplate.

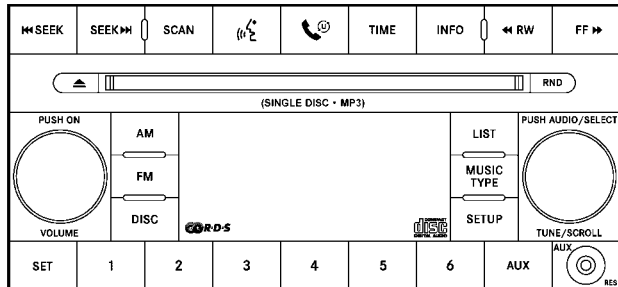

81c7c564

RES Radio

(Non-Satellite Model Shown - With Satellite Similar)

Operating Instructions - Radio Mode

NOTE: The ignition switch must be in the ON or ACC position to operate the radio.

Power Switch/Volume Control (Rotary)

Push the On/Volume control knob to turn on the radio. Push the On/Volume control knob a second time to turn off the radio.

Electronic Volume Control

The electronic volume control turns continuously (360 degrees) in either direction without stopping. Turning the On/Volume control knob to the right increases the volume and to the left decreases it.

When the audio system is turned on, the sound will be set at the same volume level as last played.

SEEK Buttons

Press and release the SEEK buttons to search for the next listenable station in AM/FM mode. Press the right switch

to seek up and the left switch to seek down. The radio will remain tuned to the new station until you make another selection. Holding either button will bypass stations without stopping until you release it.

SCAN Button

Pressing the SCAN button causes the tuner to search for the next listenable station in AM or FM frequencies, pausing for five seconds at each listenable station before continuing to the next. To stop the search, press the SCAN button a second time.

Voice Recognition System (Radio) — If Equipped

Refer to “Voice Recognition System (VR)” in Section 3.

Voice Recognition Button (UConnect® Hands-Free Phone) — If Equipped

Press this button to operate the Hands-Free Phone (UConnect®) feature (if equipped). Refer to “Hands-Free Communication (UConnect®)” in Section 3.

If your vehicle is not equipped with or this feature is not available on your vehicle, a “Not Equipped With UConnect” message will display on the radio screen.

Phone Button (UConnect® Hands-Free Phone) — If Equipped

Press this button to operate the Hands-Free Phone (UConnect®) feature (if equipped). Refer to “Hands-Free Communication (UConnect®)” in Section 3.

If your vehicle is not equipped with or this feature is not available on your vehicle, a “Not Equipped With UConnect” message will display on the radio screen.

TIME Button

Press the TIME button and the time of day will display. In AM or FM mode, pressing the TIME button will switch between the time and frequency displays.

Clock Setting Procedure

1. Press and hold the TIME button, until the hours blink.

2. Adjust the hours by turning the right side Tune/Scroll control knob.
3. After adjusting the hours, press the right side Tune/Scroll control knob to set the minutes. The minutes will begin to blink.
4. Adjust the minutes using the right side Tune/Scroll control knob. Press the Tune/Scroll control knob to save time change.
5. To exit, press any button/knob or wait five seconds.

The clock can also be set by pressing the SETUP button. For vehicles equipped with satellite radio, press the SETUP button, use the Tune/Scroll control to select SET CLOCK, and then follow the above procedure, starting at Step 2. For vehicles not equipped with satellite radio, press the SETUP button and then follow the above procedure, starting at Step 2.

INFO Button

Press the INFO button for an RDS station (one with call letters displayed). The radio will return a Radio Text message broadcast from an FM station (FM mode only).

RW/FF

Pressing the RW (Rewind) or FF (Fast Forward) buttons causes the tuner to search for the next frequency in the direction of the arrows. This feature operates in either AM or FM frequencies.

TUNE Control

Turn the rotary Tune/Scroll control knob clockwise to increase or counterclockwise to decrease the frequency.

Setting the Tone, Balance, and Fade

Push the rotary Tune/Scroll control knob and BASS will display. Turn the Tune/Scroll control knob to the right or left to increase or decrease the bass tones.

Push the rotary Tune/Scroll control knob a second time and MID will display. Turn the Tune/Scroll control knob to the right or left to increase or decrease the mid-range tones.

Push the rotary Tune/Scroll control knob a third time and TREBLE will display. Turn the Tune/Scroll control knob to the right or left to increase or decrease the treble tones.

Push the rotary Tune/Scroll control knob a fourth time and BALANCE will display. Turn the Tune/Scroll control knob to the right or left to adjust the sound level from the right or left side speakers.

Push the rotary Tune/Scroll control knob a fifth time and FADE will display. Turn the Tune/Scroll control knob to the left or right to adjust the sound level between the front and rear speakers.

Push the rotary Tune/Scroll control knob again to exit setting tone, balance, and fade.

MUSIC TYPE Button

Pressing this button once will turn on the Music Type mode for five seconds. Pressing the MUSIC TYPE button or turning the Tune/Scroll control knob within five seconds will allow the program format type to be selected. Many radio stations do not currently broadcast Music Type information.

Toggle the MUSIC TYPE button to select the following format types:

Program Type	16-Digit Character Display
No program type or undefined	None
Adult Hits	Adlt Hit
Classical	Classicl
Classic Rock	Cls Rock
College	College
Country	Country

Program Type	16-Digit Character Display
Foreign Language	Language
Information	Inform
Jazz	Jazz
News	News
Nostalgia	Nostalgia
Oldies	Oldies
Personality	Persnlty
Public	Public
Rhythm and Blues	R & B
Religious Music	Rel Musc
Religious Talk	Rel Talk
Rock	Rock
Soft	Soft
Soft Rock	Soft Rck
Soft Rhythm and Blues	Soft R & B

Program Type	16-Digit Character Display
Sports	Sports
Talk	Talk
Top 40	Top 40
Weather	Weather

By pressing the SEEK button when the Music Type icon is displayed, the radio will be tuned to the next frequency station with the same selected Music Type name. The Music Type function only operates when in the FM mode.

If a preset button is activated while in the Music Type (Program Type) mode, the Music Type mode will be exited and the radio will tune to the preset station.

SETUP Button

Pressing the SETUP button allows you to select between the following items:

- **Set Clock** — Pressing the SELECT button will allow you to set the clock. Turn the Tune/Scroll control knob to adjust the hours and then press and turn the Tune/Scroll control knob to adjust the minutes. Press the Tune/Scroll control knob again to save changes.

AM and FM Buttons

Press the buttons to select AM or FM modes.

SET Button — To Set the Pushbutton Memory

When you are receiving a station that you wish to commit to pushbutton memory, press the SET button. The symbol SET 1 will now show in the display window. Select the button (1 to 6) you wish to lock onto this station and press and release that button. If a button is not

selected within five seconds after pressing the SET button, the station will continue to play but will not be stored into pushbutton memory.

You may add a second station to each pushbutton by repeating the above procedure with this exception: Press the SET button twice and SET 2 will show in the display window. Each button can be set for SET 1 and SET 2 in both AM and FM. This allows a total of 12 AM and 12 FM stations to be stored into pushbutton memory. The stations stored in SET 2 memory can be selected by pressing the pushbutton twice.

Every time a preset button is used, a corresponding button number will display.

Buttons 1 - 6

These buttons tune the radio to the stations that you commit to pushbutton memory (12 AM and 12 FM stations).

DISC Button

Pressing the DISC button will allow you to switch from AM/FM modes to Disc modes.

Operation Instructions - CD MODE for CD and MP3 Audio Play

NOTE: The ignition switch must be in the ON or ACC position to operate the radio.

NOTE: This radio is capable of playing compact discs (CD), recordable compact discs (CD-R), rewritable compact discs (CD-RW), compact discs with MP3 tracks and multisession compact discs with CD and MP3 tracks.

Inserting Compact Disc(s)

Gently insert one CD into the CD player with the CD label facing up. The CD will automatically be pulled into the CD player and the CD icon will illuminate on the radio display. If a CD does not go into the slot more than 1.0 in (2.5 cm), a disc may already be loaded and must be ejected before a new disc can be loaded.

If you insert a disc with the ignition ON and the radio ON, the unit will switch from radio to CD mode and begin to play when you insert the disc. The display will show the disc number, the track number, and index time in minutes and seconds. Play will begin at the start of track 1.

CAUTION!

- **This CD player will accept 4-3/4 in (12 cm) discs only. The use of other sized discs may damage the CD player mechanism.**
- **Do not use adhesive labels. These labels can peel away and jam the player mechanism.**
- **RES is a single CD player. Do not attempt to insert a second CD if one is already loaded.**
- **Dual-media disc types (one side is a DVD, the other side is a CD) should not be used, and they can cause damage to the player.**

EJECT Button - Ejecting a CD

Press the EJECT button to eject the CD.



If you have ejected a disc and have not removed it within 10 seconds, it will be reloaded. If the CD is not removed, the radio will reinsert the CD but will not play it.

A disc can be ejected with the radio and ignition OFF.

NOTE: Ejecting with ignition OFF is not allowed on convertible or soft-top models (if equipped).

SEEK Button

Press the right SEEK button for the next selection on the CD. Press the left SEEK button to return to the beginning of the current selection, or return to the beginning of the previous selection if the CD is within the first second of the current selection. Pressing and holding the SEEK button will allow faster scrolling through the tracks in CD, MP3 modes.

SCAN Button

Press the SCAN button to scan through each track on the CD currently playing.

TIME Button

Press this button to change the display from a large CD playing time display to a small CD playing time display.

RW/FF

Press the RW button to stop the CD at the beginning of the current CD track/title.

Press and hold FF (Fast Forward) and the CD player will begin to fast forward until FF is released or RW or another CD button is pressed. The RW (Reverse) button works in a similar manner.

AM or FM Button

Switches the AM or FM radio to the opposite radio mode.

RND Button (Random Play Button)

Press this button while the CD is playing to activate Random Play. This feature plays the selections on the compact disc in random order to provide an interesting change of pace.

Press the right SEEK button to move to the next randomly selected track.

Press the RND button a second time to stop Random Play.

Notes On Playing MP3 Files

The radio can play MP3 files; however, acceptable MP3 file recording media and formats are limited. When writing MP3 files, pay attention to the following restrictions.

Supported Media (Disc Types)

The MP3 file recording media supported by the radio are CDDA, CD-R, CD-RW, MP3, and CDDA+MP3.

Supported Medium Formats (File Systems)

The medium formats supported by the radio are ISO 9660 Level 1 and Level 2 and includes the Joliet extension. When reading discs recorded using formats other than ISO 9660 Level 1 and Level 2, the radio may fail to read

files properly and may be unable to play the file normally. UDF and Apple HFS formats are not supported.

The radio uses the following limits for file systems:

- Maximum number of folder levels: 8
- Maximum number of files: 255
- Maximum number of folders. (The radio display of file names and folder names is limited. For large numbers of files and/or folders, the radio may be unable to display the file name and folder name and will assign a number instead. With a maximum number of files, exceeding 20 folders will result in this display. With 200 files, exceeding 50 folders will result in this display.)
- Maximum number of characters in file/folder names:
 - Level 1: 12 (including a separator "." and a three-character extension)
 - Level 2: 31 (including a separator "." and a three-character extension)

Multisession disc formats are supported by the radio. Multisession discs may contain combinations of normal CD audio tracks and computer files (including MP3 files). Discs created with an option such as "keep disc open after writing" are most likely multisession discs. The use of multisession for CD audio or MP3 playback may result in longer disc loading times.

Supported MP3 File Formats

The radio will recognize only files with the *.MP3 extension as MP3 files. Non-MP3 files named with the *.MP3 extension may cause playback problems. The radio is designed to recognize the file as an invalid MP3 and will not play the file.

When using the MP3 encoder to compress audio data to an MP3 file, the bit rate and sampling frequencies in the following table are supported. In addition, variable bit

rates (VBR) are also supported. The majority of MP3 files use a 44.1 kHz sampling rate and a 192, 160, 128, 96 or VBR bit rates.

MPEG Specification	Sampling Frequency (kHz)	Bit Rate (kbps)
MPEG-1 Audio Layer 3	48, 44.1, 32	320, 256, 224, 192, 160, 128, 112, 96, 80, 64, 56, 48, 40, 32
MPEG-2 Audio Layer 3	24, 22.05, 16	160, 128, 144, 112, 96, 80, 64, 56, 48, 40, 32, 24, 16, 8

ID3 Tag information for artist, song title, and album title are supported for version 1 ID3 tags. ID3 version 2 is not supported by the radios.

Playlist files are not supported. MP3 Pro files are not supported.

Playback of MP3 Files

When a medium containing MP3 data is loaded, the radio checks all files on the medium. If the medium contains a lot of folders or files, the radio will take more time to start playing the MP3 files.

Loading times for playback of MP3 files may be affected by the following:

- Media - CD-RW media may take longer to load than CD-R media
- Medium formats - Multisession discs may take longer to load than non-multisession discs
- Number of files and folders - Loading times will increase with more files and folders

To increase the speed of disc loading, it is recommended to use CD-R media and single-session discs. To create a single-session disc, enable the “Disc at Once” option before writing to the disc.

LIST Button (CD Mode for MP3 Play)

Pressing the LIST button will bring up a list of all folders on the disc. Scrolling up or down the list is done by turning the Tune/Scroll control knob. Selecting a folder by pressing the Tune/Scroll control knob will begin playing the files contained in that folder (or the next folder in sequence if the selection does not contain playable files).

The folder list will time out after five seconds.

INFO Button (CD Mode for MP3 Play)

Pressing the INFO button repeatedly will scroll through the following TAG information: Song Title, Artist, File Name, and Folder Name (if available).

Press the INFO button once more to return to "elapsed time" priority mode.

Press and hold the INFO button for three seconds or more and the radio will display song titles for each file.

Press and hold the INFO button again for three seconds to return to "elapsed time" display.

Operation Instructions - Auxiliary Mode

The auxiliary (AUX) jack is an audio input jack, which allows the user to plug in a portable device such as an MP3 player, or cassette player, and utilize the vehicle's audio system to amplify the source and play through the vehicle speakers.

Pressing the AUX button will change the mode to auxiliary device if the AUX jack is connected.

NOTE: The AUX device must be turned on and the device's volume set to proper level. If the AUX audio is not loud enough, turn the device's volume up. If the AUX audio sounds distorted, turn the device's volume down.

TIME Button (Auxiliary Mode)

Press this button to change the display to time of day. The time of day will display for five seconds (when ignition is OFF).

Operating Instructions - Hands-Free Phone (UConnect®) (If Equipped)

Refer to “Hands-Free Communication (UConnect®)” in Section 3.

Operating Instructions - Satellite Radio Mode (If Equipped)

Refer to “Satellite Radio” in this section.

Operating Instructions - Video Entertainment System (VES)® (If Equipped)

Refer to separate “Video Entertainment System (VES)® Guide.”

SALES CODE REN — MULTIMEDIA SYSTEM — IF EQUIPPED

NOTE: The sales code is located on the lower right side of the unit’s faceplate.

The REN Multimedia system contains a radio, CD/DVD player, USB port, a 20-gigabyte hard drive (HDD), and a “JukeBox” (virtual CD changer). Sirius Satellite Radio is optional. The 6.5 in (16.5 cm) touch screen allows for easy menu selection.

A 20-gigabyte HDD allows uploads of music and photos from CDs or through the USB port. The Gracenote database finds the artist, track, and title for the music.

An auxiliary input jack permits passengers to listen to a portable MP3 player through the vehicle’s speakers. For vehicles equipped with the Vehicle Entertainment System (VES)®, separate audio outputs allow passengers to listen to the vehicle speakers while different audio tracks play

through the system's wireless headphones. This means rear seat passengers can watch a DVD on the optional rear seat entertainment system, while the driver and front-seat passenger listen to the radio.

Other special features include direct tune, music type selections, easy store presets, backup camera display for vehicles equipped with a backup camera, and on some models, a dual display screen operation. Refer to your radio-specific user's manual for detailed operating instructions.

Operating Instructions — Satellite Radio (If Equipped)

Refer to your Radio-specific user's manual for detailed operating instructions.

Operating Instructions — Voice Recognition System (VR) (If Equipped)

For the radio, refer to “Voice Recognition System (VR)” in Section 3.

For Hands Free Phone Communication (UConnect®) “Voice Recognition System (VR),” refer to “Hands-Free Communication (UConnect®)” in Section 3.

Operating Instructions — Hands-Free Communication (UConnect®) (If Equipped)

Refer to “Hands-Free Communication (UConnect®)” in Section 3.

Clock Setting Procedure

Setting the Clock

1. Turn on the multimedia system.
2. Touch the screen where the time is displayed. The clock setting menu will appear on the screen.

3. To move the hour forward, touch the screen where the word “Hour” with the arrow pointing upward is displayed. To move the hour backward, touch the screen where the word “Hour” with the arrow pointing downward is displayed.

4. To move the minute forward, touch the screen where the word “Min” with the arrow pointing upward is displayed. To move the minute backward, touch the screen where the word “Min” with the arrow pointing downward is displayed.

5. To save the new time setting, touch the screen where the word “Save” is displayed.

Changing Daylight Savings Time

When selected, this feature will display the time of day in daylight savings time. Proceed as follows to change the current setting:

1. Turn on the multimedia system.

2. Touch the screen where the time is displayed. The clock setting menu will appear on the screen.

3. When this feature is on, a check mark will appear in the box next to the words “Daylight Savings.” Touch the screen where the words “Daylight Savings” are displayed to change the current setting.

Show Time if Radio is Off

When selected, this feature will display the time of day on the touch screen when the multimedia system is turned off. Proceed as follows to change the current setting:

1. Turn on the multimedia system.

2. Touch the screen where the time is displayed. The clock setting menu will appear on the screen.

3. When this feature is on, a check mark will appear in the box next to the words “Show Time if Radio is Off.”

Touch the screen where the words “Show Time if Radio is Off” are displayed to change the current setting.

Changing the Time Zone

1. Turn on the multimedia system.
2. Touch the screen where the time is displayed. The clock setting menu will appear on the screen.
3. Touch the screen where the words “Set Time Zone” are displayed. The time zone selection menu will appear on the screen.
4. Select a time zone by touching the screen where your selection appears. If you do not see a time zone that you want to select, touch the screen where the word “Page” is displayed to view additional time zones in the menu.
5. Touch the screen where the word “Save” is displayed.

SALES CODE RER — MULTIMEDIA SYSTEM — IF EQUIPPED

NOTE: The sales code is located on the lower right side of the unit’s faceplate.

The RER Multimedia system contains a radio, Sirius Satellite Radio player, navigation system, CD/DVD player, USB port, 20-gigabyte hard drive (HDD), and the UConnect® Hands-Free Bluetooth® cellular system.

NOTE: If your vehicle is not equipped with UConnect®, the unit will respond with a “Not Equipped With UConnect®” message when selecting controls related to this feature.

A 6.5 in (16.5 cm) touch screen allows easy menu selection, while the Advanced Voice Dialog System recognizes more than 1,000 words for audio, navigation, entertainment, and hands-free mobile phone use.

The satellite navigation capability combines a Global-Positioning System (GPS)-based navigation system with an integrated color screen to provide maps, turn identification, selection menus, and instructions for selecting a variety of destinations and routes.

A shared HDD for the navigation system, the database, and other radio features allows uploads of music and photos from CDs or through the USB port. The Gracenote database finds the artist, track, and title for the music.

An auxiliary input jack permits passengers to listen to a portable MP3 player through the vehicle's speakers. For vehicles equipped with the Vehicle Entertainment System (VES)[®], separate audio outputs allow passengers to listen to the vehicle speakers while different audio tracks play through the system's wireless headphones. This means rear-seat passengers can watch a DVD on the optional rear-seat entertainment system while the driver and front-seat passenger listen to the radio.

Other special features include direct tune, music type selections, traffic messaging (optional), easy store presets, parental lockout for VES[®] (if equipped), backup camera display for vehicles equipped with a backup camera, and on some models, a dual display screen operation. Refer to your "Navigation User's Manual" for detailed operating instructions.

Operating Instructions — Satellite Radio

Refer to your "Navigation User's Manual" for detailed operating instructions.

Operating Instructions — Hands-Free Communication (UConnect[®]) (If Equipped)

Refer to your "Navigation User's Manual" for detailed operating instructions.

Clock Setting Procedure

The GPS receiver in this system is synchronized to the time data being transmitted by the GPS satellites. The satellites' clock is Greenwich Mean Time (GMT). This is the worldwide standard for time. This makes the system's clock very accurate once the appropriate time zone and daylight savings information is set.

Changing the Time Zone

1. Turn on the multimedia system.
2. Touch the screen where the time is displayed. The clock setting menu will appear on the screen. If the words "Time: GPS Time" are displayed at the top of the screen, proceed to Step 4. Otherwise, proceed to Step 3.
3. If the words "Time: User Clock" are displayed at the top of the screen, touch the bottom of the screen where the words "User Clock" are displayed. The GPS time setting menu will appear on the screen.

4. Touch the screen where the words "Set Time Zone" are displayed. The time zone selection menu will appear on the screen.

5. Select a time zone by touching the screen where your selection appears. If you do not see a time zone that you want to select, touch the screen where the word "Page" is displayed to view additional time zones in the menu.

Changing Daylight Savings Time

When selected, this feature will display the time of day in daylight savings time. Proceed as follows to change the current setting:

1. Turn on the multimedia system.
2. Touch the screen where the time is displayed. The clock setting menu will appear on the screen.

3. When this feature is on, a check mark will appear in the box next to the words “Daylight Savings.” Touch the screen where the words “Daylight Savings” are displayed to change the current setting.

Setting the User Clock

If you wish to set the clock to a time different from the system clock, you can manually adjust the time by performing the following:

1. Turn on the multimedia system.
2. Touch the screen where the time is displayed. The clock setting menu will appear on the screen. If the words “Time: User Clock” are displayed at the top of the screen, proceed to Step 4. Otherwise, proceed to Step 3.
3. If the words “Time: GPS Time” are displayed at the top of the screen, touch the bottom of the screen where the words “GPS Time” are displayed. The user clock time setting menu will appear on the screen.

4. To move the hour forward, touch the screen where the word “Hour” with the arrow pointing upward is displayed. To move the hour backward, touch the screen where the word “Hour” with the arrow pointing downward is displayed.

5. To move the minute forward, touch the screen where the word “Min” with the arrow pointing upward is displayed. To move the minute backward, touch the screen where the word “Min” with the arrow pointing downward is displayed.

6. To save the new time setting, touch the screen where the word “Save” is displayed.

Show Time if Radio is Off

When selected, this feature will display the time of day on the touch screen when the system is turned off. Proceed as follows to change the current setting:

1. Turn on the multimedia system.

2. Touch the screen where the time is displayed. The clock setting menu will appear on the screen.
3. When this feature is on, a check mark will appear in the box next to the words “Show Time if Radio is Off.” Touch the screen where the words “Show Time if Radio is Off” are displayed to change the current setting.

SATELLITE RADIO — IF EQUIPPED (REN/REQ/RER/RES/REU RADIOS ONLY)

Satellite radio uses direct satellite-to-receiver broadcasting technology to provide clear digital sound, coast to coast. The subscription service provider is Sirius Satellite Radio. This service offers over 130 channels of music, sports, news, entertainment, and programming for children, directly from its satellites and broadcasting studios.

NOTE: Sirius service is not available in Hawaii and has limited coverage in Alaska.

System Activation

Sirius Satellite Radio service is pre-activated, and you may begin listening immediately to the one year of audio service that is included with the factory-installed satellite radio system in your vehicle. Sirius will supply a welcome kit that contains general information, including how to setup your on-line listening account at no additional charge. For further information, call the toll-free number 888-539-7474, or visit the Sirius web site at www.sirius.com, or at www.siriuscanada.ca for Canadian residents.

Electronic Serial Number/Sirius Identification Number (ESN/SID)

Please have the following information available when calling:

1. The Electronic Serial Number/Sirius Identification Number (ESN/SID).
2. Your Vehicle Identification Number.

To access the ESN/SID, refer to the following steps:

ESN/SID Access With REQ/RES Radios

With the ignition switch in the ON/RUN or ACC position and the radio on, press the SETUP button and scroll using the Tune/Scroll control knob until Sirius ID is selected. Press the Tune/Scroll control knob and the Sirius ID number will display. The Sirius ID number display will time out in two minutes. Press any button on the radio to exit this screen.

ESN/SID Access With REN/RER Radios

While in SAT mode, press the MENU button on the radio faceplate.

Next, touch the SUBSCRIPTION tab on the touch screen. All the ESNs that apply to your vehicle will display.

ESN/SID Access With REU Radio

While in SAT mode, press the MENU button on the radio faceplate.

Next, turn the knob surrounding the joystick in the center of the radio to scroll to Subscription, and then press and release the joystick. All of the ESNs that apply to your vehicle will display.

Selecting Satellite Mode

Press the SAT button until "SAT" appears in the display. A CD may remain in the radio while in the Satellite radio mode.

Satellite Antenna

To ensure optimum reception, do not place items on the roof around the rooftop antenna location or strap items to the trunk lid around the trunk lid antenna (if equipped). Metal objects placed within the line of sight of the antenna will cause decreased performance. Larger luggage items such as bikes should be placed as far rearward as possible, within the loading design of the rack. Do not place items directly on or above the antenna.

Reception Quality

Satellite reception may be interrupted due to one of the following reasons:

- The vehicle is parked in an underground parking structure or under a physical obstacle.
- Dense tree coverage may interrupt reception in the form of short audio mutes.
- Driving under wide bridges or along tall buildings can cause intermittent reception.
- Placing objects over or too close to the antenna can cause signal blockage.

Operating Instructions - Satellite Mode

NOTE: The ignition switch must be in the ON or ACC position to operate the radio.

SEEK Buttons

Press and release the SEEK buttons to search for the next channel in Satellite mode. Press the right switch to seek up and the left switch to seek down. The radio will remain tuned to the new channel until you make another selection. Holding either button will bypass channels without stopping until you release it.

SCAN Button

Pressing the SCAN button causes the tuner to search for the next channel, pausing for eight seconds before continuing to the next. To stop the search, press the SCAN button a second time.

INFO Button — Except REU Radio

Pressing the INFO button will cycle the display information between Artist, Song Title, and Composer (if available). Also, pressing and holding the INFO button for an

additional three seconds will make the radio display the Song Title all of the time (press and hold again to return to normal display).

INFO Button — REU Radio

Pressing the INFO button will display information about Artist, Song Title, and Composer (if available). Pressing the INFO button again will close the INFO screen.

RW/FF

Pressing the RW (Rewind) or FF (Fast Forward) buttons causes the tuner to search for the next channel in the direction of the arrows.

TUNE Control (Rotary)

Turn the rotary Tune/Scroll control knob clockwise to increase or counterclockwise to decrease the channel.

MUSIC TYPE Button — Except REU Radio

Pressing this button once will turn on the Music Type mode for five seconds. Pressing the MUSIC TYPE button

or turning the Tune/Scroll control knob within five seconds will allow the program format type to be selected.

Toggle the MUSIC TYPE button again to select the music type.

By pressing the SEEK button when the Music Type function is active, the radio will be tuned to the next channel with the same selected Music Type name.

If a preset button is activated while in the Music Type (Program Type) mode, the Music Type mode will be exited and the radio will tune to the preset channel.

MUSIC TYPE Button — REU Radio

Pressing this button provides a MUSIC TYPES list from which you can make a selection. Once a selection is made, you can seek up, or down, or scan the channels and the radio will tune to the next station matching the selected format. There is no time-out for this screen.

Pressing the MUSIC TYPE button again will close the MUSIC TYPE screen. Once closed, seek up, seek down, and scan will no longer be based on your selection.

SETUP Button

Pressing the SETUP button allows you to select the following items:

- Display Sirius ID number — Press the AUDIO/SELECT button to display the Sirius ID number. This number is used to activate, deactivate, or change the Sirius subscription.

SET Button – To Set the Pushbutton Memory

When you are receiving a channel that you wish to commit to pushbutton memory, press the SET button. The symbol SET 1 will now show in the display window. Select the button (1-6) you wish to lock onto this channel and press and release that button. If a button is not

selected within five seconds after pressing the SET button, the channel will continue to play but will not be stored into pushbutton memory.

You may add a second channel to each pushbutton by repeating the above procedure with this exception: Press the SET button twice and SET 2 will show in the display window. Each button can be set for SET 1 and SET 2. This allows a total of 12 Satellite channels to be stored into pushbutton memory. The channels stored in SET 2 memory can be selected by pressing the pushbutton twice.

Every time a preset button is used, a corresponding button number will display.

Buttons 1 - 6

These buttons tune the radio to the channels that you commit to pushbutton memory (12 Satellite stations).

Operating Instructions - Hands-Free Phone (If Equipped)

Refer to “Hands-Free Communication (UConnect®)” in Section 3.

Operating Instructions - Video Entertainment System (VES®) (If Equipped)

Refer to separate “Video Entertainment System (VES®) Guide.”

UNIVERSAL CONSUMER INTERFACE (UCI) — IF EQUIPPED

NOTE: This section is for sales code RES/REL and REQ/RET radios only with UConnect®. For sales code REN/REZ touch screen radio and REU/REX/RE1 radio, refer to the separate User’s Manual.

This feature allows you to plug an iPod® mobile digital device into the vehicle’s sound system through a connector (UCI connector) using an optional connection cable (available through MOPAR®). See your authorized dealer for details.

Using this feature,

- the iPod® audio can be played on the vehicle’s sound system, providing metadata (Track Title, Artist, Album, etc.) information display on radio.
- the iPod® can be controlled using the radio buttons to Play, Browse and List the iPod® contents.
- the iPod® battery charges when plugged into the UCI connector.

Connecting The iPod® Device

Use the optional connection cable to connect an iPod® to the vehicle's UCI connector (which is located in the glove box or center console on some vehicles. This location may vary with vehicle). Once the iPod® is connected and synchronized to the vehicle system (this may take a few seconds to connect), the vehicle brand logo appears on the iPod® display, and it starts charging and is ready for use by pressing radio switches as described below.

Controlling The iPod® Using Radio Buttons

To get into the UCI (iPod®) mode and access a connected iPod®, press the AUX button on the radio faceplate. Once in the UCI (iPod®) mode, the iPod® audio track (if available from iPod®) will start playing over the vehicle audio system.

Play Mode

When switched to UCI mode the iPod® will be in Play mode. In Play mode, you may use the following buttons on the radio faceplate to control the iPod® and display data:

Tune/Scroll Knob

Use the Tune/Scroll knob to go to the next or previous track.

The Tune/Scroll knob functions similar to the scroll wheel on the iPod® mobile digital device.

Turning it clockwise (forward) by one click while playing a track skips to the next track.

Turning it counterclockwise (backward) by one click during the first two seconds of the track will jump to the previous track in the list and turning this button at any other time in the track will jump to the beginning of the current track.

RW (Rewind) Button

Press and hold the RW button to move backward in the current track. Holding the RW button long enough will take you back to the beginning of the current track.

Pressing and releasing the RW button will go back five seconds of the current track.

FF (Fast Forward) Button

Press and hold the FF button to move forward in the current track.

Pressing and releasing the FF button will go forward five seconds of the current track.

SEEK Buttons

Use the SEEK buttons to move to the previous or the next track.

If the left (down) button is pressed during the first two seconds of the current track, it will go back to the previous track in the list; if you press this button at any other time in the current track it will go back to the beginning of the track.

If the right (up) button is pressed during Play mode, it will go to the next track in the list.

INFO Button

Press the INFO button while a track is playing to see the information (Track Title, Artist, Album, etc.) for that track. Each press of the INFO button will take you to the next screen of data for that track. Once you have seen all of the screens, the last press of the INFO button will take you back to the Play mode screen on the radio.

REPEAT Button

Press the REPEAT button to repeat the current playing track.

SCAN Button

Pressing the SCAN button will play the first five seconds of each track in the current list and then forward to the next song. To stop the SCAN mode and start playing the desired track, press the SCAN button again.

During the SCAN mode, you can also press the SEEK button to the left or right to go to the previous or next tracks.

RND (Random) Button (RES/REL Radios Only)

Pressing the RND button will switch between the shuffle on and shuffle off modes of the iPod®. If the RND icon is showing on the radio display then the Shuffle mode is on.

List or Browse Mode

During Play mode, pressing any of the following buttons will take you to List mode. List mode enables you to scroll through the list of menus and tracks on the iPod® device.

Tune/Scroll Knob

In the List mode, the Tune/Scroll knob functions in a similar manner as the scroll wheel on the iPod®.

Turning the Tune/Scroll knob clockwise (forward) and counterclockwise (backward) scrolls through lists, displaying the track detail on the radio display. Once you have the track to be played highlighted on the radio display, press the Tune/Scroll knob to select and start playing the track. By turning the Tune/Scroll knob fast, you can jump through the list faster. During fast scroll, you may notice a slight delay in updating the information on the radio display.

During all List modes, the iPod® will display all lists in “wrap-around” mode. So if the track you wish to select is at the bottom of the list, you just turn the Tune/Scroll knob backward (counterclockwise) to get to the track faster.

Radio Preset Buttons

In the List mode, the radio preset buttons are used as shortcuts to the following lists on the iPod® device.

- 1 – Playlists
- 2 – Artists
- 3 – Albums
- 4 – Genres
- 5 – Audiobooks
- 6 – Podcasts

After pressing a preset button, you will see the list you are in on the top line and the first item in that list on the second line.

To exit the List mode without selecting a track, press the same preset button again to go back to Play mode.

LIST Button

Pressing the LIST button will take to the top level menu of the iPod®. This takes you to the same top level menu as on your iPod®. Turn the Tune/Scroll knob to list the top menu item you wish to select and then press the Tune/Scroll knob. This will take you to the next sub menu list item of the iPod® and you can follow the same steps to go to the desired track in that list. Not all iPod® sub menu levels are available on this system.

MUSIC TYPE Button

The MUSIC TYPE button is another shortcut button to the genre listing on your iPod®.

SIRIUS BACKSEAT TV™ — IF EQUIPPED

Satellite video uses direct satellite receiver broadcasting technology to provide streaming video coast to coast. The subscription service provider is SIRIUS Satellite Radio. SIRIUS Backseat TV™ offers three video channels for family entertainment, directly from its satellites and broadcasting studios.

NOTE: SIRIUS service is not available in Hawaii and has limited coverage in Alaska.

Refer to your Video Entertainment System (VES)®, RER Navigation or REN Multimedia User Manuals for detailed operating instructions.

VIDEO ENTERTAINMENT SYSTEM (VES®) — IF EQUIPPED

The optional VES® (Video Entertainment System) is available with:

- One or two video screens
- Additional single-disc DVD player with two—screen system
- Battery-powered two channel remote control
- Two remote headphones
- Integrated remote storage in either screen location
- Three different medias can be played simultaneously (Cabin speakers and Headphone Channels 1 and 2)
- Easy menu driven functions on touch screen radios
- Video and audio input jacks available in rear seating area

- Nine different medias to choose from in each screen (AM, FM, Sirius Radio, DVD1, DVD2, Hard Drive Jukebox, AUX in radio, AUX1, AUX2).

The LCD screen(s) are located in the overhead compartment console.

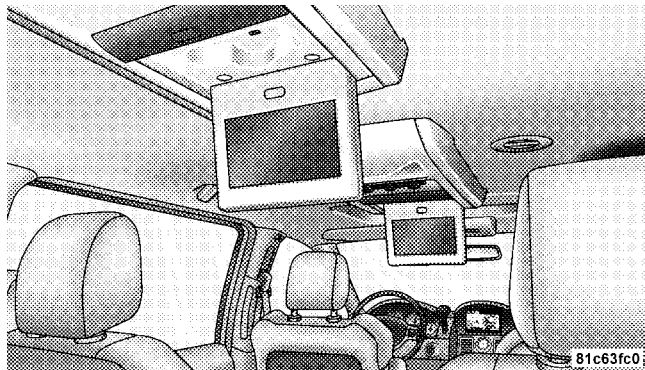

Overhead Video Screens

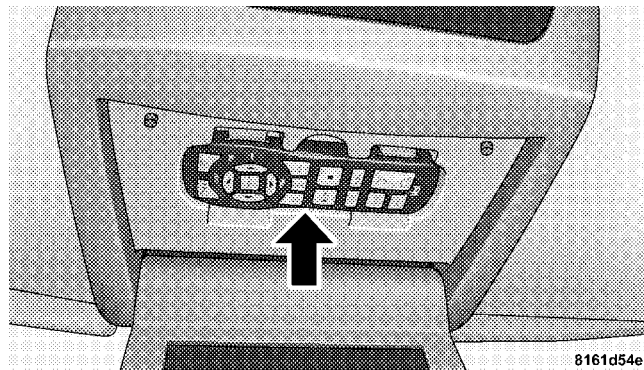

VES® Remote Control Location

NOTE: Refer to your VES® User's Manual for detailed operating instructions.

RADIO OPERATION AND CELLULAR PHONES

Under certain conditions, the cellular phone being ON in your vehicle can cause erratic or noisy performance from your radio. This condition may be lessened or eliminated by relocating the cellular phone antenna. This condition is not harmful to the radio. If your radio performance does not satisfactorily “clear” by the repositioning of the antenna, it is recommended that the radio volume be turned down or off during cellular phone operation.

REMOTE SOUND SYSTEM CONTROLS — IF EQUIPPED

The remote sound system controls are located on the rear surface of the steering wheel at the 3 and 9 O'clock positions.

The right-hand rocker switch has a push button in the center and controls the volume and mode of the sound system. Pressing the top of the rocker switch will increase the volume. Pressing the bottom of the rocker switch will

decrease the volume. Pressing the center button changes the operation of the radio from AM to FM or Tape to CD mode depending on which radio is in the vehicle.

The left-hand rocker switch has a push button in the center. The function of the left-hand switch is different depending on which mode you are in.

The following describes the left hand rocker switch operation in each mode:

Radio Operation

Pressing the top of the switch will SEEK up for the next listenable station and pressing the bottom of the switch will SEEK down for the next listenable station.

The button located in the center of the left hand switch will tune to the next pre-set station that you have programmed in the radio pre-set push-button.

CD Player

Pressing the top of the switch once will go to the next track on the CD. Pressing the bottom of the switch once will go to the beginning of the current track or to the beginning of the previous track if it is within one second after the current track begins to play.

If you press the switch up or down twice it plays the second track, three times, it will play the third, etc.

The button in the center of the left-hand switch has no function in this mode.

CD/DVD MAINTENANCE

To keep the CD/DVD discs in good condition, take the following precautions:

1. Handle the disc by its edge; avoid touching the surface.

2. If a disc is stained, clean the surface with a soft cloth, wiping from center to edge.

3. Do not apply paper, paper CD labels, or tape to the disc; avoid scratching a disc.

4. Do not use solvents such as benzine, thinner, cleaners, or antistatic sprays.

5. Store a disc in its case after playing.

6. Do not expose a disc to direct sunlight.

7. Do not store a disc where temperatures may become too high.

8. Do not play discs that are small in size or have irregular shapes.

CLIMATE CONTROLS

The Climate Control System allows you to regulate the temperature, amount, and direction of air circulating throughout the vehicle. The controls are located on the instrument panel, below the radio.

MANUAL HEATING, VENTILATION AND AIR CONDITIONING (HVAC) SYSTEM

The controls for the manual HVAC system in this vehicle consist of a series of outer rotary dials inner push knobs. These comfort controls can be set to obtain desired interior conditions.

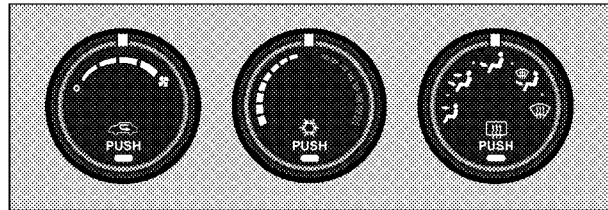

4

81c2cd2b

Manual HVAC Controls

Front Blower Control

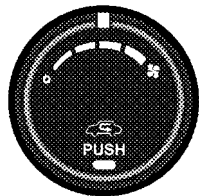

There are four blower speeds. Use this control to regulate the amount of air forced through the system in any mode you select. The blower speed increases as you move the control clockwise from the off position.

Temperature Control

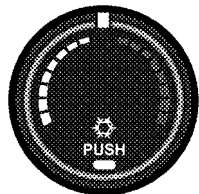

Use this control to regulate the temperature of the air inside the passenger compartment. Rotate the knob counterclockwise from top center into the blue area of the scale indicates cooler temperatures while rotating the knob clockwise into the red area indicates warmer temperatures.

NOTE: If your air conditioning performance seems lower than expected, check the front of the A/C condenser (located in front of the radiator), for an accumulation of dirt or insects. Clean with a gentle water spray from behind the radiator and through the condenser. Fabric front fascia protectors may reduce airflow to the condenser, reducing air conditioning performance.

Mode Control (Air Direction)

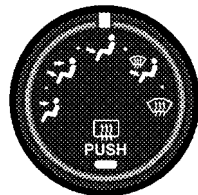

Mode control allows you to choose from several patterns of air distribution. You can select either a primary mode, as identified by the symbols, or a blend of two of these modes. The closer the control is to a particular mode, the more air distribution you receive from that mode.

PANEL Mode

 Air is directed through the outlets in the instrument panel. These outlets can be adjusted to direct airflow.

BI-LEVEL Mode

 Air is directed through the panel and floor outlets.

NOTE: There is a difference in temperature (in any conditions other than full cold or full hot), between the upper and lower outlets for added comfort. The warmer air goes to the floor outlets. This feature gives improved comfort during sunny but cool conditions.

FLOOR Mode

 Air is directed through the floor outlets with a small amount through the defrost and side window demist outlets.

MIX Mode

 Air is directed through the floor, defrost and side window demist outlets. This setting works best in cold or snowy conditions that require extra heat at the windshield. This setting is good for maintaining comfort while reducing moisture on the windshield.

DEFROST Mode

 Air is directed through the windshield and side window demist outlets. Use DEFROST mode with maximum blower and temperature settings for best windshield and side window defrosting.

NOTE: The air conditioning compressor operates in MIX and DEFROST, or a blend of these modes even if the A/C SNOWFLAKE button is not pressed. This dehumidifies the air to help dry the windshield. To improve fuel economy, use these modes only when necessary.

RECIRCULATION Control

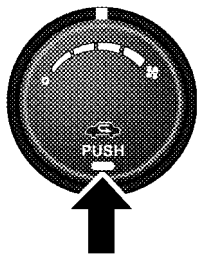

81b9df17

Press this button to choose between outside air intake or recirculation of the air inside the vehicle. A lamp will illuminate when you are in RECIRCULATION mode. Only use the RECIRCULATION mode to temporarily block out any outside odors, smoke, or dust and to cool the interior rapidly upon initial start up in very hot or humid weather.

Press this button to choose between outside air intake or recirculation of the air inside the vehicle. A lamp will illuminate when you are in RECIRCULATION mode. Only use the RECIRCULATION mode to temporarily block out any outside odors, smoke, or dust and to cool the interior rapidly upon initial start up in very hot or humid weather.

NOTE:

- Continuous use of the RECIRCULATION mode may make the inside air stuffy and window fogging may occur. Extended use of this mode is not recommended.

- In cold or damp weather, the use of the RECIRCULATION mode will cause windows to fog on the inside because of moisture build-up inside the vehicle. For maximum defogging, select the Outside Air position.
- In order to prevent fogging, when the recirculation button is pressed and the mode control is set to PANEL the A/C will engage automatically.
- The A/C can be deselected manually without disturbing the mode control selection.

Air Outlets

The airflow from each of the instrument panel outlets can be adjusted for direction and turned on or off to control airflow.

NOTE: For maximum airflow to the rear, the center instrument panel outlets can be directed toward the rear seat passengers.

ECONOMY Mode

If ECONOMY mode is desired, press the A/C button to turn off the indicator light and the A/C compressor. Rotate the temperature control knob to the desired temperature.

Air Conditioning Operation

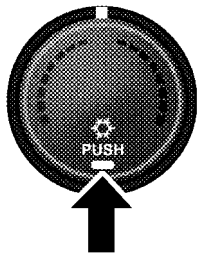

81b9dd53

Push on this button to engage the Air Conditioning. A light will illuminate when the A/C System is engaged

NOTE: The air conditioning compressor will not engage until the engine has been running for about 10 seconds.

MAX A/C

For maximum cooling use the A/C and RECIRCULATION mode buttons at the same time.

Three Zone Basic Temperature Control — If Equipped

With the Three Zone Basic Temperature Control System, each front seat occupant can independently control the Heating, Ventilation, and Air Conditioning (HVAC) operations coming from the outlets on their side of the vehicle.

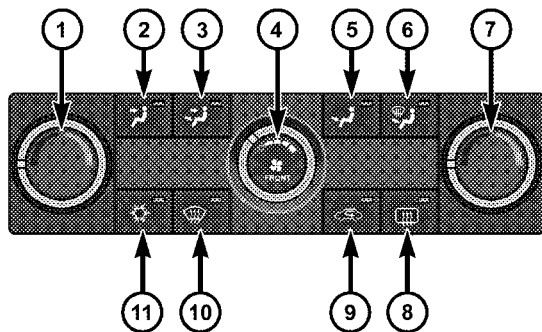

81f1cb6d

Three Zone Temperature Control

- | | |
|---------------|--------------------|
| 1 — Left Temp | 7 — Right Temp |
| 2 — PANEL | 8 — Rear DEFROST |
| 3 — BI-LEVEL | 9 — RECIRCULATE |
| 4 — BLOWER | 10 — Front DEFROST |
| 5 — FLOOR | 11 — A/C |
| 6 — MIX | |

The Three Zone Basic Temperature Control bottom panel controls rear Heating, Ventilation, and Air Conditioning (HVAC) operations.

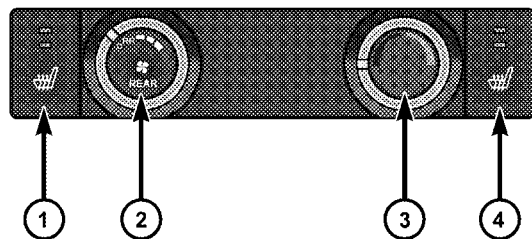

81bc4f90

Front Lower Three Zone Temperature Control Features

- | | |
|----------------------|-----------------------|
| 1 — Left Heated Seat | 3 — Rear Temp |
| 2 — Rear Blower | 4 — Right Heated Seat |

The primary control for the rear blower is on the front climate control unit located on the instrument panel.

The front climate control unit has five positions, off, rear, and a range of blower speeds. Only when the primary control for the rear blower is in the REAR position do the second seat occupants have control of the rear blower speed.

REAR MANUAL CLIMATE CONTROL ZONE — IF EQUIPPED

The Rear Manual Climate Control Zone system has floor air outlets at the rear of the right side sliding door and overhead outlets at each outboard rear seating position. The unit provides warm or cool air through the floor and upper outlets.

The rear blower and temperature controls for the rear seat passengers are located in the headliner near the center of the vehicle.

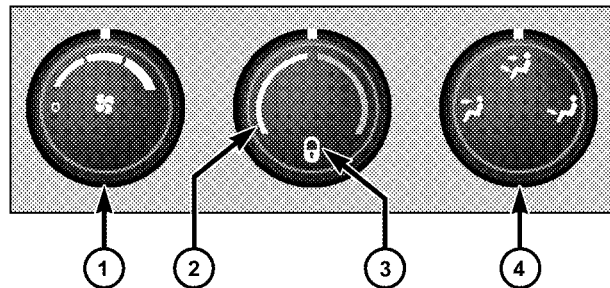

81bc4f92

Rear HVAC Manual Controls

- | | |
|-----------------|--------------------|
| 1 — Blower | 3 — Rear HVAC Lock |
| 2 — Temperature | 4 — MODE Select |

Rear Blower Control

The primary control for the rear blower is on the front climate control unit located on the instrument panel.

Only when the front control for the rear blower is in the **RR** position do the second seat occupants have control of the rear blower speed.

The rear blower control, located in the rear overhead console has an off position and a range of blower speeds. This allows the second seat occupants to control the volume of air circulated in the rear of the vehicle.

CAUTION!

Interior air enters the Manual Rear Zone Climate Control system through an intake grille located in the passenger side trim panel behind the third seat. The heater outlets are located in the passenger side trim panel just behind the sliding door. Do not block or place objects directly in front of the inlet grille or heater outlets. The electrical system could overload causing damage to the blower motor.

Rear Temperature Control

When the blower knob on the front climate control unit is set to any position other than **RR**, the rear temperature selection follows the setting of the rear temperature control knob on the front climate control unit. The rear mode selection follows the setting of the rear mode control knob.

To change the temperature in the rear of the vehicle, rotate the temperature control knob counterclockwise for cold and clockwise for heated air.

When rear controls are locked by the front system, the lock symbol on the temperature knob is illuminated and the rear overhead adjustments are ignored.

The rear airflow modes will mirror the front unit operation. Rear **PANEL** mode is automatically selected when the front control is in the **PANEL** mode. When the front unit is in **BI-LEVEL** mode, airflow will be emitted from both the upper and lower rear outlets. When the front

control is in FLOOR, DEFROST, or MIX modes, airflow will be directed out of the rear floor outlets.

Rear Mode Control

FLOOR Mode



Air comes from the floor outlets.

BI-LEVEL Mode



Air comes from both the headliner outlets and the floor outlets.

NOTE: In many temperature positions, the BI-LEVEL mode is designed to provide cooler air out of the headliner outlets and warmer air from the floor outlets.

HEADLINER Mode



Air comes from the outlets in the headliner. Each of these outlets can be individually adjusted to direct the flow of air. Moving the air vanes of the outlets to one side will shut off the airflow.

AUTOMATIC TEMPERATURE CONTROL (ATC) — IF EQUIPPED

- Front Three Zone ATC allows both the driver and front occupant and rear seat occupants to select individual comfort settings
- Occupants in the vehicle select AUTO mode operation and a comfort temperature setting, using rotary knobs on the control unit.
- The system provides set-and-forget operation for optimum comfort and convenience.
- The system can be controlled manually if desired.
- SYNC feature links the controls for all three zones, allowing one comfort setting for the cabin, if desired.

The Infrared Three-Zone ATC System automatically maintains the interior comfort level desired by the driver and all passengers. This is accomplished by an infrared sensor, located in the forward overhead console. Based on the sensor input, the system automatically adjusts the air temperature, the airflow volume, and amount of outside air recirculation. This maintains a comfortable temperature even under changing conditions.

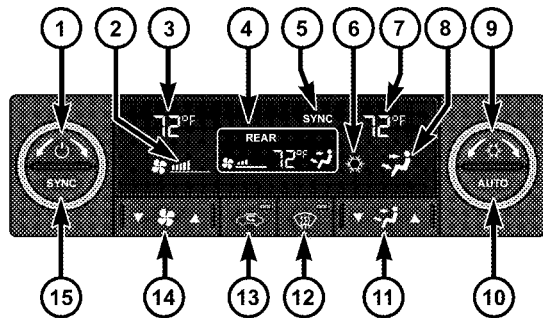

81bc4f86

Front Upper ATC Panel

- | | |
|----------------------|--------------------|
| 1 - Left On/Off | 9 - Right On/Off |
| 2 - Blower | 10 - AUTO Temp |
| 3 - Left Front Temp | 11 - MODE |
| 4 - Rear Blower/Temp | 12 - Front DEFROST |
| 5 - SYNC Indicator | 13 - RECIRCULATE |
| 6 - A/C Indicator | 14 - Blower |
| 7 - Right Front Temp | 15 - SYNC |
| 8 - MODE | |

Below the automatic control, the system selects the appropriate mode (airflow outlets) and fan speed.

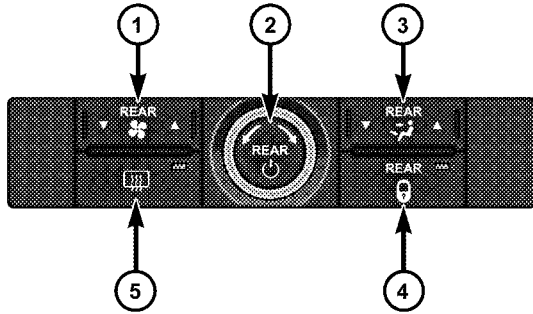

Front Lower ATC Panel

- | | |
|-----------------|--------------------|
| 1 - Blower | 4 - Rear HVAC Lock |
| 2 - Rear On/Off | 5 - Rear DEFROST |
| 3 - Rear Mode | |

81c3adf2

Operation of the system is quite simple.

1. Press the AUTO button and the word AUTO will illuminate in the front ATC display, along with three temperatures for Driver's, Passenger, and Rear seats. The system will then automatically regulate the amount of airflow.

2. Next, adjust the temperature you would like the system to maintain by adjusting the driver's, passenger, and rear seat rotary temperature knobs. Once the desired temperature is displayed, the system will achieve and automatically maintain that comfort level.

3. When the system is set up for your comfort level, it is not necessary to change the settings. You will experience the greatest efficiency by simply allowing the system to function automatically.

NOTE:

- It is not necessary to move the temperature settings for cold or hot vehicles. The system automatically adjusts the temperature, mode and fan speed to provide comfort as quickly as possible.
- The temperature can be displayed in U.S. or Metric by selecting the US/M customer programmable feature. Refer to the “Customer Programmable Features” in Section 3 of this manual.

To provide you with maximum comfort in the automatic mode, during cold start-ups, the blower fan will remain on low and the DELAY symbol will appear in the front ATC display until the engine warms up. The fan will engage immediately if the DEFROST mode is selected or by rotating the blower control to any fixed blower speed.

Manual Operation

This system offers a full complement of manual override features. The AUTO symbol in the front ATC display will be turned off when the system is being used in the manual mode.

NOTE: Each of these features operate independently from each other. If any one feature is controlled manually, the remaining features will continue to operate automatically.

The left blower control knob can be set to any fixed blower speed by pressing the upper front blower rocker button. The fan will now operate at a fixed speed until additional speeds are selected. This allows the front occupants to control the volume of air circulated in the vehicle and cancel the AUTO mode.

The operator can also select the direction of the selecting one of the following positions.

PANEL Mode

 Air comes from the outlets in the instrument panel. Each of these outlets can be individually adjusted to direct the flow of air. Moving the air vanes of the center outlets down, will close off the airflow from the center outlets. The thumbwheel next to the outboard outlets can be rotated to regulate or shut off the airflow from these outlets.

BI-LEVEL Mode

 Air comes from both the instrument panel outlets, floor outlets and defrost. A slight amount of air is also directed through the side window demister outlets.

NOTE: In many temperature positions, the BI-LEVEL mode is designed to provide cooler air out of the panel outlets and warmer air from the floor outlets.

FLOOR Mode

 Air comes from the floor outlets. A slight amount of air is directed through the defrost and side window demister outlets.

MIX Mode

 Air comes from the floor, defrost and side window demister outlets. This mode works best in cold or snowy conditions. It allows you to stay comfortable while keeping the windshield clear.

DEFROST Mode

 Air comes from the windshield and side window demister outlets. Use DEFROST mode with maximum blower and temperature settings for best windshield and side window defrosting.

NOTE: While operating in the other modes, the system will not automatically sense the presence of fog, mist or ice on the windshield. DEFROST mode must be manually selected to clear the windshield and side glass.



The SNOWFLAKE mode or A/C button allows the operator to manually activate or deactivate the air conditioning system. When in SNOWFLAKE mode the ATC display is on, cool, dehumidified air flows through the air outlets. If ECONOMY mode is desired, press the SNOWFLAKE button to turn off the SNOWFLAKE mode in the ATC display and deactivate the A/C system. Note: If fog or mist appears on the windshield or side glass, select DEFROST mode and increase blower speed.

RECIRCULATION Control



When outside air contains smoke, odors, or high humidity, or if rapid cooling is desired, you may wish to recirculate interior air by pressing the RECIRCULATION mode control button. RECIRCULATION mode should only be used temporarily. The recirculation symbol will illuminate in the display when this button is selected. Push the button

a second time to turn off the RECIRCULATION mode LED and allow outside air into the vehicle.

NOTE: In cold weather, use of the RECIRCULATION mode may lead to excessive window fogging. The RECIRCULATION mode is not allowed in the FLOOR, MIX and DEFROST modes to improve window clearing operation. Recirculation will be disabled automatically if these modes are selected. Recirculation will be disabled automatically if these modes are selected.

Rear Automatic Temperature Control (ATC) — If Equipped

The Rear ATC System has floor air outlets at the rear of the right side sliding door and overhead outlets at each outboard rear seating positions. The system provides heated air through the floor outlets or cool, dehumidified air through the headliner outlets.

The REAR SYSTEM control for the Rear ATC System is on the front ATC control unit located on the instrument panel.

Pressing the REAR LOCK button for the Rear ATC System from the front ATC control unit, illuminates a LOCK symbol in the rear display. The rear temperature and air source are controlled from the front ATC control unit.

Rear second row occupants can only adjust the rear ATC control when the REAR LOCK button is turned off.

The Rear ATC System is located in the headliner near the center of the vehicle.

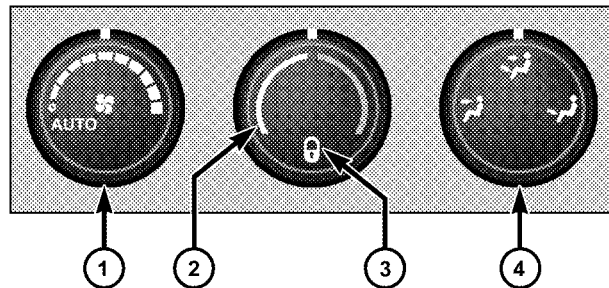

81bc4f84

Rear ATC Control Features

- | | |
|-----------------|---------------|
| 1 - Blower | 3 - Rear Lock |
| 2 - Temperature | 4 - MODE |

Operation of the rear system is quite simple.

1. Press the REAR LOCK button on the front ATC control unit. This turns off the REAR LOCK icon in the rear temperature knob.
2. Rotate the Rear Blower, Rear Temperature and the Rear Mode Control knobs to suit your comfort needs.
3. ATC is selected by adjusting the rear blower knob counterclockwise to AUTO.

Once the desired temperature is displayed, the ATC System will automatically achieve and maintain that comfort level. When the system is set up for your comfort level, it is not necessary to change the settings. You will experience the greatest efficiency by simply allowing the system to function automatically.

NOTE:

- It is not necessary to move the temperature settings for cold or hot vehicles. The system automatically adjusts the temperature, mode and fan speed to provide comfort as quickly as possible.
- The temperature can be displayed in U.S. or Metric by selecting the US/M customer programmable feature. Refer to ELECTRONIC VEHICLE INFORMATION CENTER (EVIC) — IF EQUIPPED, Personal Settings (Customer Programmable Features) in Section 4 of this manual.

Rear Blower Control

The rear blower control knob can be manually set to off or any fixed blower speed by rotating the knob from low to high. This allows the rear seat occupants to control the volume of air circulated in the rear of the vehicle.

CAUTION!

Interior air enters the Rear Automatic Temperature Control System through an intake grille located in the passenger side trim panel behind the third seat. The heater outlets are located in the passenger side trim panel just behind the sliding door. Do not block or place objects directly in front of the inlet grille or heater outlets. The electrical system could overload causing damage to the blower motor.

Rear Temperature Control

To change the temperature in the rear of the vehicle, rotate the temperature knob counterclockwise to lower the temperature and clockwise to increase the temperature. The REAR temperature settings are displayed in the front ATC control.

When rear controls are locked by the front system, the LOCK symbol on the temperature knob is illuminated and any rear overhead adjustments are ignored.

Rear Mode Control**AUTO Mode**

The rear system automatically maintains the correct mode and comfort level desired by the rear seat occupants.

FLOOR Mode

 Air comes from the floor outlets.

BI-LEVEL Mode

 Air comes from both the headliner outlets and the floor outlets.

NOTE: In many temperature positions, the BI-LEVEL mode is designed to provide cooler air out of the headliner outlets and warmer air from the floor outlets.

HEADLINER Mode

 Air comes from the outlets in the headliner. Each of these outlets can be individually adjusted to direct the flow of air. Moving the air vanes of the outlets to one side will shut off the airflow.

SUMMER OPERATION

The engine cooling system in air conditioned vehicles must be protected with a high-quality antifreeze coolant to provide proper corrosion protection and to protect against engine overheating. A 50% solution of ethylene glycol antifreeze coolant in water is recommended. Refer to section 7, “Maintenance Procedures”, of this manual for proper coolant selection.

WINTER OPERATION

To ensure the best possible heater and defroster performance, make sure the engine cooling system is functioning properly and the proper amount, type, and concentration of coolant is used. Refer to section 7,

“Maintenance Procedures”, of this manual for proper coolant selection. Use of the air RECIRCULATION mode during winter months is not recommended because it may cause window fogging.

VACATION/STORAGE

Anytime you store your vehicle, or keep it out of service (i.e., vacation) for two weeks or more, run the air conditioning system at idle for about five minutes in the fresh air and high blower setting. This will ensure adequate system lubrication to minimize the possibility of compressor damage when the system is started again.













WINDOW FOGGING

Vehicle windows tend to fog on the inside in mild rainy or humid weather. To clear the windows, select DEFROST or MIX mode and increase the front blower speed. Do not use the RECIRCULATION mode without A/C for long periods, as fogging may occur.

OUTSIDE AIR INTAKE

Make sure the air intake, located directly in front of the windshield, is free of obstructions such as leaves. Leaves collected in the air intake may reduce airflow and if they enter the plenum they could plug the water drains. In winter months make sure the air intake is clear of ice, slush and snow.

OPERATING TIPS

WEATHER	CONTROL SETTINGS
Hot weather and vehicle interior is very hot 	Set the mode control to  ,  on, and blower on high. Roll down the windows for a minute to flush out the hot air. Once comfort is achieved adjust controls for comfort.
Warm weather 	Turn  on and set the mode control to the  position.
Cool Sunny	Operate in  position.
Cool & Humid conditions 	Set the mode control to  and turn on  to keep windows clear.
Cold Weather	Set the mode control to the  position. If windshield fogging starts to occur, move the control towards the  position.

A/C AIR FILTER — IF EQUIPPED

On vehicles equipped with Automatic Temperature Control (ATC), the climate control system filters out dust and pollen from the air. Refer to Section 7 “Air Conditioning” for filter replacement instructions.

ELECTRIC REAR WINDOW DEFROSTER — IF EQUIPPED

Press this button (located on your front climate control) to turn on the rear window defroster and the optional heated mirrors. A light will show that the defroster is on. The defroster automatically turns off after about ten minutes of operation, as long as the ignition switch is in the ON position.

After the initial time interval has expired, if the rear window defogger switch is pressed to the on position again (during the same ignition cycle), the system will automatically turn off after about five minutes.

NOTE: You may turn off the heated mirror feature at anytime by pressing the rear window defogger switch a second time.

CAUTION!

To avoid damaging the electrical conductors of the rear window defroster, do not use scrapers, sharp instruments, or abrasive window cleaners on the interior surface of the window.

Labels can be peeled off after soaking with warm water.

STARTING AND OPERATING

CONTENTS

■ Starting Procedures	324	■ Brake System	337
□ Automatic Transmission	325	□ Anti-Lock Brake System (ABS)	338
■ Engine Block Heater — If Equipped	327	■ Electronic Brake Control Systems	340
■ Automatic Transmission	328	□ Traction Control System (TCS)	340
□ Brake/Transmission Interlock System	328	■ Power Steering	344
□ Four-Speed Or Six-Speed Automatic Transmission	329	■ Driving On Slippery Surfaces	345
□ Reset Mode - Electronic Transmission	334	□ Acceleration	345
■ Parking Brake	335	□ Traction	346
		■ Driving Through Water	346

- Flowing/Rising Water 346
- Tire Safety Information 348
 - Tire Markings 348
 - Tire Loading And Tire Pressure 353
- Tires — General Information 357
 - Tire Pressure 357
- Tire Chains 367
- Snow Tires 368
- Tire Rotation 368
- Tire Pressure Monitor System (TPMS) 369
 - Basic TPMS Without EVIC — If Equipped 371
 - Premium TPMS With EVIC — If Equipped 373
- Fuel Requirements 377
 - 3.3L & 3.8L Gasoline Engine 377
- Adding Fuel 382
 - Fuel Filler Cap (Gas Cap) 382
 - Loose Fuel Filler Cap Message 384
- Flexible Fuel — 3.3L Engines Only 384
 - E-85 General Information 384
 - Ethanol Fuel (E-85) 385
 - Fuel Requirements 386
 - Selection Of Engine Oil For Flexible Fuel Vehicles (FFV) E-85 And Gasoline Vehicles 387
 - Starting 387
 - Cruising Range 387
 - Replacement Parts 387

□ Maintenance	388	□ Common Towing Definitions	393
■ Vehicle Loading	388	□ Towing Tips	405
□ Vehicle Certification Label	389	■ Recreational Towing (Behind Motorhome, Etc.) . .	407
■ Trailer Towing	393		

STARTING PROCEDURES

Before starting your vehicle, adjust your seat, adjust the inside and outside mirrors, fasten your seat belt, and if present, instruct all other occupants to buckle their seat belts.

WARNING!

NEVER leave unattended children alone in a vehicle. Leaving children in a vehicle is dangerous for a number of reasons. A child or others could be seriously or fatally injured. Don't leave the key in the ignition. A child could operate power windows, other controls, or move the vehicle.

WARNING!

DO NOT leave animals or children inside parked vehicles in hot weather. Interior heat build-up may cause serious injury or death.

WARNING!

Be sure to turn off the engine and remove the key from the ignition switch if you want to rest or sleep in your car. Accidents can be caused by inadvertently moving the gear selection lever. Accidents can also be caused by pressing the accelerator pedal. This may cause excessive heat in the exhaust system, resulting in overheating and vehicle fire, which may cause serious or fatal injuries.

Automatic Transmission

The gear selector lever must be in the NEUTRAL or PARK position before you can start the engine. Depress the brake pedal before shifting into any driving gear.

Normal Starting (Above 32°F/0°C)

1. DO NOT depress the accelerator.
2. Use the Fob with Integrated Key to briefly turn the ignition switch to the START position and release it as soon as the starter engages. The starter motor will continue to run, and it will disengage automatically when the engine is running.
3. If the engine fails to start, the starter will disengage automatically in 10 seconds. If this occurs, turn the ignition switch to the OFF position, wait 10 to 15 seconds, then repeat the normal starting procedure (Steps 1–3 above).

NOTE: This vehicle is equipped with a transmission shift interlocking system. The brake pedal must be depressed to shift out of PARK.

Extremely Cold Weather Starting — Below –20°F (–29°C)

Follow the same instructions in the “Normal Starting” procedure.

To ensure reliable starting at these temperatures, use of an externally powered electric engine block heater (available from your authorized dealer) is recommended.

High Altitude Starting — Above 4,000 ft (1 219 m)

Follow the same instructions in the “Normal Starting” procedure.

To ensure reliable starting at these temperatures, use of an externally powered electric engine block heater (available from your authorized dealer) is recommended.

If The Engine Fails To Start

WARNING!

- **NEVER pour fuel or other flammable liquids into the throttle body air inlet opening in an attempt to start the vehicle. This could result in a flash fire causing serious personal injury.**
- **DO NOT attempt to push or tow your vehicle to get it started. Vehicles equipped with an automatic transmission cannot be started this way. Unburned fuel could enter the catalytic converter and once the engine has started, ignite and damage the converter and vehicle.**
- **If the vehicle has a discharged battery, booster cables may be used to obtain a start from a booster battery or the battery in another vehicle. This type of start can be dangerous if done improperly. Refer to Section 6 of this manual for proper jump-starting procedures and follow them carefully.**

If the engine fails to start after you have followed the “Normal Starting” procedure, it may be flooded. Push the accelerator pedal all the way to the floor and hold it there while cranking the engine. This should clear any excess fuel in case the engine is flooded.

CAUTION!

To prevent damage to the starter, DO NOT crank the engine for more than 15-second intervals at one time. Wait 10 to 15 seconds before trying again.

If the engine has been flooded, it may start to run, but not have enough power to continue running when the key is released. If this occurs, continue cranking with the accelerator pedal pushed all the way to the floor. Release the accelerator pedal and the key once the engine is running smoothly.

If the engine shows no sign of starting after two 15-second intervals of cranking with the accelerator pedal held to the floor, the “Normal Starting” procedure should be repeated.

After Starting

The idle speed will automatically decrease as the engine warms up.

ENGINE BLOCK HEATER — IF EQUIPPED

The engine block heater warms engine coolant and permits quicker starts in cold weather. Connect the electrical cord to a standard 110-115 volt AC electrical outlet with a grounded, three-wire extension cord.

The engine block heater cord is routed under the hood on the driver's side of the vehicle. It has a removable cap that is located on the driver side of the Integrated Power Module.

WARNING!

Remember to disconnect the electrical cord before driving. Damage to the 110-115 volt electrical cord could cause electrocution.

AUTOMATIC TRANSMISSION**CAUTION!**

Damage to the transmission may occur if the following precautions are not observed:

- Shift the gear selector lever into **PARK** only after the vehicle has come to a complete stop.
- Do not shift the gear selector lever from **REVERSE**, **PARK**, or **NEUTRAL** into any forward gear when the engine is above idle speed.
- Before shifting the gear selector lever into any gear, make sure your foot is firmly on the brake pedal.

NOTE: You **MUST** press and hold the brake pedal down while shifting out of **PARK**.

WARNING!

It is dangerous to shift the gear selector lever out of **PARK** or **NEUTRAL** if the engine speed is higher than idle speed. If your foot is not firmly on the brake pedal, the vehicle could accelerate quickly forward or in reverse. You could lose control of the vehicle and hit someone or something. Only shift into gear when the engine is idling normally and when your right foot is firmly on the brake pedal.

Brake/Transmission Interlock System

This system holds the shift lever in the **PARK** position when the ignition switch is in the **LOCK** position. It also prevents you, once the engine is started, from moving the gear selector lever out of **PARK** and into any gear unless the brake pedal is pressed. This system is active only

while the ignition switch is in the ON position. Always press the brake pedal first before moving the gear selector lever out of PARK.

Automatic Transmission Ignition Interlock System

For electrical system malfunctions, there is an override for the interlock system. In order to override this system, remove the cover located to the top right of the gear selector lever in the instrument panel. The override can be activated by pressing the white-colored tab, which can be accessed through the hole in the instrument panel. While the override is pressed, the gear selector lever can be moved out of the PARK position without pressing the brake pedal. After operation, return the cover to its original position.

This system prevents the key from being removed unless the gear selector lever is in PARK. It also prevents shifting the gear selector lever out of PARK unless the key is in the LOCK/OFF or ON positions.

NOTE: If a malfunction occurs, the system will trap the key in the ignition cylinder to warn you that this safety feature is inoperable. The engine can be started and stopped but the key cannot be removed until you obtain service.

Four-Speed or Six-Speed Automatic Transmission

The electronically controlled transmission provides a precise shift schedule. The transmission electronics are self-calibrating; therefore, the first few shifts on a new vehicle may be somewhat abrupt. This is a normal condition, and precision shifts will develop within a few hundred miles (kilometers).

The transmission has only PRND shift positions. Downshifts are carried out by an Electronic Range Select (ERS) by moving the lever — / + while in the DRIVE position,

the instrument cluster will display transmission gear selection as 6, 5, 4, 3, 2, 1 for six-speed and 4, 3, 2, 1 for four-speed transmissions.

Gear Ranges

DO NOT race the engine when shifting the gear selector lever from PARK or NEUTRAL positions into another gear range.

PARK

Shifting the gear selector lever in PARK supplements the parking brake by locking the transmission. The engine can be started in this gear. Never attempt to use PARK while vehicle is in motion. Apply the parking brake when leaving the vehicle in this gear.

When parking on a flat surface, place the shift lever in the PARK position first, and then apply the parking brake.

When parking on a hill, it is important to set the parking brake before placing the shift lever in PARK, otherwise the load on the transmission locking mechanism may make it difficult to move the shift lever out of PARK. As an added precaution, turn the front wheels toward the curb on a downhill grade and away from the curb on an uphill grade.

WARNING!

Never use PARK position on an automatic transmission as a substitute for the parking brake. Always apply parking brake fully when parked to guard against vehicle movement and possible injury or damage.

WARNING!

Unintended movement of a vehicle could injure those in and near the vehicle. As with all vehicles, you should never exit a vehicle while the engine is running. Before exiting a vehicle, you should always shift the gear selector lever into PARK, remove the key from the ignition, and apply the parking brake. Once the key is removed from the ignition, the transmission gear selector lever is locked in the PARK position, securing the vehicle against unwanted movement. Furthermore, you should never leave unattended children or pets inside a vehicle.

The following indicators should be used to ensure that you have engaged the transmission gear selector lever into the PARK position:

- When shifting the gear selector lever into PARK, depress the button on the gear selector lever and firmly move the lever all the way forward until it stops.
- Look at the shift indicator window on the console to ensure gear selector lever is in the PARK position.
- When engaged in PARK, you will not be able to move the gear selector lever rearward without depressing the gear selector lever button.

CAUTION!

Before moving the gear selector lever out of PARK, you must turn the ignition from LOCK/OFF to ON so the steering wheel and gear selector lever are released. Otherwise, damage to the steering column or gear selector lever could result.

REVERSE

Use REVERSE for moving the vehicle rearward. Shift into REVERSE only after the vehicle has come to a complete stop.

NEUTRAL

Shift the gear selector lever into this gear only after the vehicle has come to a complete stop. The engine may be started in this range.

WARNING!

Do not coast in NEUTRAL and never turn off the ignition to coast down a hill. These are unsafe practices that limit your response to changing traffic or road conditions. You might lose control of the vehicle and have an accident.

DRIVE — Six-Speed Transmission

This range should be used for most city and highway driving. It provides the smoothest upshifts, downshifts, and best fuel economy. However, use the Electronic Range Select (ERS) mode by moving the lever — / + and select the “5” range when frequent transmission shifting occurs while using the DRIVE range, such as when operating the vehicle under heavy loading conditions, (i.e., in hilly terrain, traveling into strong head winds or while towing heavy trailers). Under these conditions, using the “5” range will improve performance and extend transmission life by reducing excessive shifting and heat build-up.

DRIVE — Four-Speed Transmission

This range should be used for most city and highway driving. It provides the smoothest upshifts, downshifts, and best fuel economy. However, select the “3” range when frequent transmission shifting occurs while using the DRIVE range, such as when operating the vehicle

under heavy loading conditions, (i.e., in hilly terrain, traveling into strong head winds or while towing heavy trailers). Under these conditions, using the “3” range will improve performance and extend transmission life by reducing excessive shifting and heat build-up.

CAUTION!

If the transmission operating temperature exceeds acceptable limits, the vehicle computer will override DRIVE and select “5” range (on six-speed transmissions) or “3” range (on four-speed transmissions) by changing shift points. This is done to prevent transmission damage due to overheating.

Electronic Range Select (ERS) Operation

The Electronic Range Select (ERS) shift control allows you to move the gear selector lever to the left (-) or right (+) when the gear selector lever is in the D (Drive)

position, this allows the selection of the desired top gear. For example, if the driver shifts the transmission into 3rd gear, the transmission will never shift above 3rd gear, but can shift down to 2nd or 1st gear automatically, when needed.

Switching from ERS to D-Mode (Drive) can be done at any vehicle speed. To shift from “Drive” mode to “ERS” mode, move gear selector lever to the left (-) once. The current gear will be maintained as the top gear. To disable ERS, simply press and hold the gear selector lever to the right (+) until “D” is displayed in the instrument cluster odometer.

5

WARNING!

Do not downshift for additional engine braking on a slippery surface. The drive wheels could lose their grip and the vehicle could skid causing an accident or personal injury.

Odometer Screen Display	1	2	3	4	5	6	D
Actual Gear(s) Allowed —Six-Speed Transmission	1	1-2	1-3	1-4	1-5	1-6	1-6
Actual Gear(s) Allowed —Four-Speed Transmission	1	1-2	1-3	1-4	N/A	N/A	1-4

NOTE: To select the proper gear position for maximum deceleration (engine braking), simply press and hold the gear selector lever to the left (-). The transmission will shift to the range from which the vehicle can best be slowed down.

Reset Mode - Electronic Transmission

The transmission is monitored electronically for abnormal conditions. If a condition is detected that could cause damage, the transmission automatically shifts into 2nd gear (3rd gear for six-speed). The transmission remains in 2nd gear (3rd gear for six-speed) despite the forward gear selected. PARK, REVERSE, and NEUTRAL will continue to operate. This Reset feature allows the vehicle to be driven to an authorized dealer for service without damaging the transmission.

In the event of a momentary problem, the transmission can be reset to regain all forward gears by performing the following steps:

1. Stop the vehicle.
2. Shift into PARK.
3. Turn the ignition switch to the LOCK position.
4. Restart the engine.

5. Shift into the desired gear range and resume driving.

NOTE: Even if the transmission can be reset, it is recommended that you visit an authorized dealer at your earliest possible convenience. Your authorized dealer has diagnostic equipment to determine if the problem could recur.

If the transmission cannot be reset, authorized dealer service is required.

PARKING BRAKE

When the parking brake is applied with the ignition switch ON, the brake light in the instrument cluster will turn on.

NOTE: This light only shows that the parking brake is applied. It does not show the degree of brake application.

Before leaving the vehicle, make sure that the parking brake is fully applied by depressing the pedal located at the bottom left of the instrument panel and place the gear

selector lever in the PARK position. To release the parking brake, depress the emergency break pedal a second time and let your foot up as you feel the brake disengage.

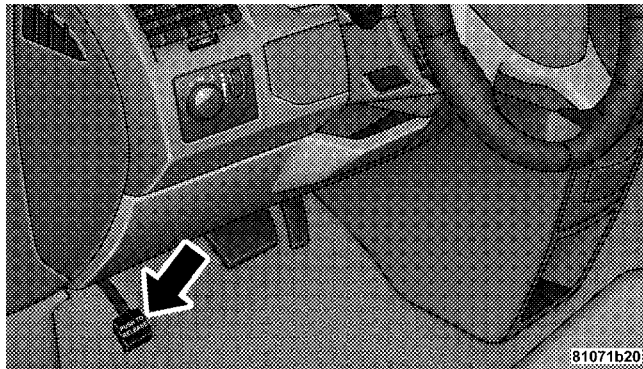

Parking Brake

Be sure the parking brake is firmly set when parked and the gear selector lever is in the PARK position. When parking on a hill you should apply the parking brake

before placing the gear selector lever in PARK, otherwise the load on the transmission locking mechanism may make it difficult to move the gear selector lever out of PARK.

WARNING!

- Always fully apply the parking brake when leaving your vehicle, or it may roll and cause damage or injury. Also be certain to leave an automatic transmission in PARK, a manual transmission in REVERSE or first gear. Failure to do so may allow the vehicle to roll and cause damage or injury.
- Be sure the parking brake is fully disengaged before driving, failure to do so can lead to brake problems due to excessive heating of the rear brakes.

WARNING!

NEVER leave children alone in a vehicle. Leaving unattended children in a vehicle is dangerous for a number of reasons. A child or others could be seriously or fatally injured. Don't leave the key in the ignition. A child could operate power windows, other controls, or move the vehicle

When parking on a hill, turn the front wheels toward the curb on a downhill grade, and away from the curb on an uphill grade.

The parking brake should always be applied whenever the driver is not in the vehicle.

BRAKE SYSTEM

BRAKE



Your vehicle is equipped with dual hydraulic brake systems. If either of the two hydraulic systems loses normal capability, the remaining system will still function. However, there will be some loss of overall braking effectiveness. This will be evident by increased pedal travel during application and greater pedal force required to slow or stop the vehicle. In addition, if the malfunction is caused by a leak in the hydraulic system, the brake warning indicator will turn on as the brake fluid level drops in the master cylinder.

In the event power assist is lost for any reason (for example, repeated brake applications with the engine off), the brakes will still function. The effort required to brake the vehicle will be much greater than that required with the power system operating.

WARNING!

- **Riding the brakes can lead to brake failure and possibly an accident. Driving with your foot resting or riding on the brake pedal can result in abnormally high brake temperatures, excessive lining wear, and possible brake damage. You wouldn't have your full braking capacity in an emergency.**
- **Driving a vehicle with the brake light on is dangerous. A significant decrease in braking performance or vehicle stability during braking may occur. It will take you longer to stop the vehicle or will make your vehicle harder to control. You could have an accident. Have the vehicle checked immediately.**

ANTI-LOCK BRAKE SYSTEM (ABS)

ABS provides increased vehicle stability and brake performance under most braking conditions. The system automatically “pumps” the brakes during severe braking conditions to prevent wheel lock-up.

ABS is activated during braking under certain road or stopping conditions. ABS-inducing conditions can include ice, snow, gravel, bumps, railroad tracks, loose debris, or panic stops.

You may experience the following when the brake system goes into Anti-lock:

- The ABS motor running (it may continue to run for a short time after the stop).
- A clicking sound of solenoid valves.
- Brake pedal pulsations.

- A slight drop or fall away of the brake pedal at the end of the stop.

WARNING!

- **The Anti-Lock Brake System contains sophisticated electronic equipment that may be susceptible to interference caused by improperly installed or high output radio transmitting equipment. This interference can cause possible loss of anti-lock braking capability. Installation of such equipment should be performed by qualified professionals.**
- **Pumping of the Anti-Lock Brakes will diminish their effectiveness and may lead to an accident. Pumping makes the stopping distance longer. Just press firmly on your brake pedal when you need to slow down or stop.**

WARNING!

- **The Anti-Lock Brake System cannot prevent accidents, including those resulting from excessive speed in turns, following another vehicle too closely, or hydroplaning. Only a safe, attentive, and skillful driver can prevent accidents.**
- **The capabilities of an ABS-equipped vehicle must never be exploited in a reckless or dangerous manner which could jeopardize the user's safety or the safety of others.**

All vehicle wheels and tires must be the same size and type, and tires must be properly inflated to produce accurate signals for the computer.

Anti-Lock Brake Light

The ABS light monitors the Anti-Lock System. The light will come on when the ignition switch is turned to the ON position and may stay on for as long as four seconds.

If the ABS light remains on or comes on while driving, it indicates that the Anti-Lock portion of the brake system is not functioning and that service is required. However, the conventional brake system will continue to operate normally if the BRAKE warning light is not on.

If the ABS light is on, the brake system should be serviced as soon as possible to restore the benefits of anti-lock brakes. If the ABS light does not come on when the ignition switch is turned to the ON position, have the bulb repaired as soon as possible.

If both the Brake Warning Light and the ABS Light remain on, the ABS and Electronic Brake Force Distribution (EBD) systems are not functioning. Immediate repair

to the ABS system is required. Consult with your authorized dealer service center as soon as possible.

ELECTRONIC BRAKE CONTROL SYSTEMS

Your vehicle is equipped with an advanced electronic brake control system that includes TCS (Traction Control System), BAS (Brake Assist System) and ESP (Electronic Stability Program). These systems complement the Anti-Lock Brake System (ABS) by optimizing the vehicle braking capability during emergency braking maneuvers.

Traction Control System (TCS)

This system monitors the amount of wheel spin of each of the driven wheels. If wheel spin is detected, brake pressure is applied to the slipping wheel(s) and engine power is reduced to provide enhanced acceleration and stability. A feature of the TCS system functions similar to a limited slip differential and controls the wheel spin across a driven axle. If one wheel on a driven axle is

spinning faster than the other, the system will apply the brake of the spinning wheel. This will allow more engine torque to be applied to the wheel that is not spinning. This feature remains active even if the ESP is in the “Partial Off” mode.



The Traction Control System (TCS) Indicator Light, located in the instrument cluster, starts to flash as soon as the tires lose traction and the wheels begin to spin. This indicates that the TCS is active. If the indicator light flashes during acceleration, ease up on the accelerator and apply as little throttle as possible. Be sure to adapt your speed and driving to the prevailing road conditions, and do not switch off the ESP or TCS.

WARNING!

- **The TCS cannot prevent the natural laws of physics from acting on the vehicle, nor can it increase the traction afforded.**
- **The TCS cannot prevent accidents, including those resulting from excessive speed in turns, or hydroplaning. Only a safe, attentive, and skillful driver can prevent accidents.**
- **The capabilities of a TCS-equipped vehicle must never be exploited in a reckless or dangerous manner, which could jeopardize the user's safety or the safety of others.**

Brake Assist System (BAS)

The BAS is designed to optimize the vehicle's braking capability during emergency braking maneuvers. The system detects an emergency braking situation by sensing the rate and amount of brake application and then applies optimum pressure to the brakes. This can help reduce braking distances. The BAS complements the Anti-Lock Brake System (ABS). Applying the brakes very quickly results in the best BAS assistance. To receive the benefit of the system, you must apply continuous braking pressure during the stopping sequence. Do not reduce brake pedal pressure unless braking is no longer desired. Once the brake pedal is released, the BAS is deactivated.

WARNING!

- **BAS (Brake Assist System) cannot prevent the natural laws of physics from acting on the vehicle, nor can it increase the traction afforded by prevailing road conditions.**
- **BAS cannot prevent accidents, including those resulting from excessive speed in turns, driving on very slippery surfaces, or hydroplaning. Only a safe, attentive, and skillful driver can prevent accidents.**
- **The capabilities of a BAS-equipped vehicle must never be exploited in a reckless or dangerous manner which could jeopardize the user's safety or the safety of others.**

Electronic Stability Program (ESP)

This system enhances directional control and stability of the vehicle under various driving conditions. ESP corrects for over/under steering of the vehicle by applying the brake of the appropriate wheel to assist in counteracting the over/under steer condition. Engine power may also be reduced to help the vehicle maintain the desired path.

ESP uses sensors in the vehicle to determine the vehicle path intended by the driver and compares it to the actual path of the vehicle. When the actual path does not match the intended path, ESP applies the brake of the appropriate wheel to assist in counteracting the oversteer or understeer condition.

- **Oversteer** - when the vehicle is turning more than appropriate for the steering wheel position.
- **Understeer** - when the vehicle is turning less than appropriate for the steering wheel position.

ESP ON

This is the normal operating mode for ESP on 2WD vehicles. Whenever the vehicle is started, the ESP system will be in this mode. This mode should be used for most driving situations. ESP should only be turned off for specific reasons as noted below.

ESP Partial OFF

This mode is entered by momentarily depressing the ESP OFF switch (located in the center switch bank, next to the hazard flasher switch).

ESP OFF When in Partial OFF mode, the TCS portion of ESP, except for the “limited slip” feature described in the TCS section, has been disabled and the ESP/TCS Indicator Light will be illuminated. All other stability features of the ESP function normally. This mode is intended to be used if the vehicle is in deep snow, sand or gravel conditions and more wheel spin than ESP would normally allow is required to

gain traction. To turn ESP on again, momentarily depress the ESP OFF switch. This will restore the normal ESP ON mode of operation.

NOTE: To improve the vehicle’s traction when driving with snow chains, or starting off in deep snow, sand or gravel, it may be desirable to switch to the Partial OFF mode by pressing the ESP OFF switch. Once the situation requiring ESP to be switched to the Partial OFF mode is overcome, turn ESP back on by momentarily depressing the ESP OFF switch. This may be done while the vehicle is in motion.

ESP/BAS Warning Light

ESP BAS The malfunction indicator light for the ESP is combined with BAS. The ESP/BAS Warning light and the ESP/TCS Indicator Light in the instrument cluster both come on when the ignition switch is turned to the ON position. They should go out with the engine running. If the ESP/BAS Warning

Light comes on continuously with the engine running, a malfunction has been detected in either the ESP or the BAS system. If this light remains on after several ignition cycles, and the vehicle has been driven several miles/kilometers at speeds greater than 30 mph (48 km/h), see your authorized dealer as soon as possible to have the problem diagnosed and corrected.

NOTE:

- The ESP/TCS Indicator Light and the ESP/BAS Warning Light come on momentarily each time the ignition switch is turned ON.
- Each time the ignition is turned ON, the ESP System will be ON even if it was turned off previously.
- The ESP Control System will make buzzing or clicking sounds when it is active, this is normal. The sounds will stop when ESP becomes inactive following the maneuver that caused the ESP activation.

POWER STEERING

The standard power steering system will give you good vehicle response and increased ease of maneuverability in tight spaces. The system will provide mechanical steering capability if power assist is lost.

If for some reason the power assist is interrupted, it will still be possible to steer your vehicle. Under these conditions, you will observe a substantial increase in steering effort, especially at very low vehicle speeds and during parking maneuvers.

NOTE: Increased noise levels at the end of the steering wheel travel are considered normal and do not indicate that there is a problem with the power steering system.

Upon initial start-up in cold weather, the power steering pump may make noise for a short amount of time. This is due to the cold, thick fluid in the steering system. This noise should be considered normal, and it does not in any way damage the steering system.

WARNING!

Continued operation with reduced power steering assist could pose a safety risk to yourself and others. Service should be obtained as soon as possible.

CAUTION!

Prolonged operation of the steering system at the end of the steering wheel travel will increase the steering fluid temperature and it should be avoided when possible. Damage to the power steering pump may occur.

DRIVING ON SLIPPERY SURFACES**ACCELERATION**

Rapid acceleration on snow covered, wet, or other slippery surfaces may cause the front wheels to pull erratically to the right or left. This phenomenon occurs when there is a difference in the surface traction under the front (driving) wheels.

WARNING!

Rapid acceleration on slippery surfaces is dangerous. Unequal traction can cause sudden pulling of the front wheels. You could lose control of the vehicle and possibly have an accident. Accelerate slowly and carefully whenever there is likely to be poor traction (ice, snow, wet mud, loose sand, etc.).

TRACTION

When driving on wet or slushy roads, it is possible for a wedge of water to build up between the tire and road surface. This is known as hydroplaning and may cause partial or complete loss of vehicle control and stopping ability. To reduce this possibility, the following precautions should be observed:

1. Slow down during rainstorms or when roads are slushy.
2. Slow down if the road has standing water or puddles.
3. Replace the tires when tread wear indicators first become visible.
4. Keep the tires properly inflated.
5. Maintain sufficient distance between your vehicle and the vehicle in front of you to avoid a collision in a sudden stop.

DRIVING THROUGH WATER

Driving through water more than a few inches/centimeters deep will require extra caution to ensure safety and prevent damage to your vehicle.

Flowing/Rising Water

WARNING!

Do not drive on, or cross, a road or a path where water is flowing and/or rising (as in storm run-off). Flowing water can wear away the road or path's surface and cause your vehicle to sink into deeper water. Furthermore, flowing and/or rising water can carry your vehicle away swiftly. Failure to follow this warning may result in injuries that are serious or fatal to you, your passengers, and others around you.

Shallow Standing Water

Although your vehicle is capable of driving through shallow standing water, consider the following Caution and Warning before doing so.

CAUTION!

- Always check the depth of the standing water before driving through it. Never drive through standing water that is deeper than the bottom of the tire rims mounted on the vehicle.
- Determine the condition of the road or the path that is under water, and if there are any obstacles in the way, before driving through the standing water.
- Do not exceed 5 mph (8 km/h) when driving through standing water. This will minimize wave effects.

CAUTION!

- Driving through standing water may cause damage to your vehicle's drivetrain components. Always inspect your vehicle's fluids (i.e., engine oil, transmission, axle, etc.) for signs of contamination (i.e., fluid that is milky or foamy in appearance) after driving through standing water. Do not continue to operate the vehicle if any fluid appears contaminated, as this may result in further damage. Such damage is not covered by the New Vehicle Limited Warranty.
- Getting water inside your vehicle's engine can cause it to lock up and stall out, and cause serious internal damage to the engine. Such damage is not covered by the New Vehicle Limited Warranty.

WARNING!

- Driving through standing water limits your vehicle's traction capabilities. Do not exceed 5 mph (8 km/h) when driving through standing water.
- Driving through standing water limits your vehicle's braking capabilities, which increases stopping distances. Therefore, after driving through standing water, drive slowly and lightly press on the brake pedal several times to dry the brakes.
- Getting water inside your vehicle's engine can cause it to lock up and stall out, and leave you stranded.
- Failure to follow these warnings may result in injuries that are serious or fatal to you, your passengers, and others around you.

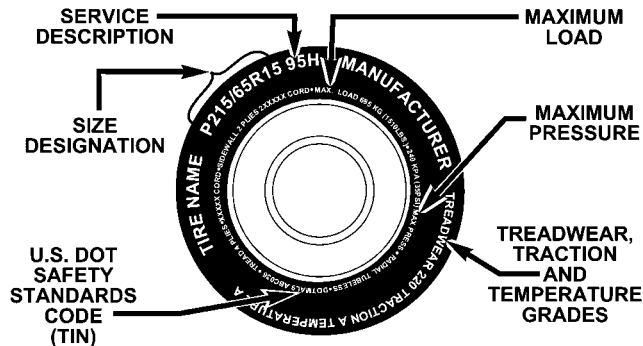
TIRE SAFETY INFORMATION**Tire Markings**

811b44e8

NOTE:

- P (Passenger) - Metric tire sizing is based on U.S. design standards. P-Metric tires have the letter "P" molded into the sidewall preceding the size designation. Example: P215/65R15 95H.
- European-Metric tire sizing is based on European design standards. Tires designed to this standard have the tire size molded into the sidewall beginning with the section width. The letter "P" is absent from this tire size designation. Example: 215/65R15 96H.
- LT (Light Truck) - Metric tire sizing is based on U.S. design standards. The size designation for LT-Metric tires is the same as for P-Metric tires except for the letters "LT" that are molded into the sidewall preceding the size designation. Example: LT235/85R16.
- Temporary spare tires are high-pressure compact spares designed for temporary emergency use only. Tires designed to this standard have the letter "T" molded into the sidewall preceding the size designation. Example: T145/80D18 103M.
- High flotation tire sizing is based on U.S. design standards, and it begins with the tire diameter molded into the sidewall. Example: 31x10.5 R15 LT.

Tire Sizing Chart

Tire Sizing Chart	
P	Passenger Car tire size based on U.S. design standards
"...blank..."	Passenger Car tire based on European design standards
LT	Light Truck tire based on U.S. design standards
T	Temporary spare tire
31	Overall diameter in inches (in)
215	Section width in millimeters (mm)
65	Aspect Ratio of section height to section width of tire, written in percent (%)
10.5	Section width in inches (in)
R	"R" means radial construction
	"D" means diagonal or bias construction
15	Rim diameter in inches (in)
95	Load Index (a numerical code associated with the maximum load a tire can carry)

Tire Sizing Chart	
H	A symbol indicating the range of speeds at which a tire can carry a load corresponding to its load index under certain operating conditions
	The maximum speed corresponding to the speed symbol should only be achieved under specified operating conditions (i.e., tire pressure, vehicle loading, road conditions, and posted speed limits)
"...blank..."	<ul style="list-style-type: none"> • Absence of any text on the sidewall of the tire indicates a Standard Load (SL) Tire • Extra Load (XL) = Extra load (or reinforced) tire • Light Load = Light load tire • C, D, E = Load range associated with the maximum load a tire can carry at a specified pressure
Maximum Load	Maximum load indicates the maximum load this tire is designed to carry
Maximum Pressure	Maximum pressure indicates the maximum permissible cold tire inflation pressure for this tire

Tire Identification Number (TIN)

The TIN may be found on one or both sides of the tire, however, the date code may only be on one side. Tires with white sidewalls will have the full TIN, including the date code, located on the white sidewall side of the tire.

Look for the TIN on the outboard side of black sidewall tires as mounted on the vehicle. If the TIN is not found on the outboard side, then you will find it on the inboard side of the tire.

Tire Identification Number	
EXAMPLE: DOT MA L9 ABCD 0301	
DOT	Department of Transportation — This symbol certifies that the tire is in compliance with the U.S. Department of Transportation tire safety standards, and is approved for highway use
MA	Code representing the tire manufacturing location (two digits)
L	Code representing the tire size (two digits)
ABCD	Code used by the tire manufacturer (one to four digits)
03	Two digit number representing the week in which the tire was manufactured (03 means the 3rd week)
01	Two digit number representing the year in which the tire was manufactured (01 means the year 2001) ¹
¹ Prior to July 2000, tire manufacturers were only required to have one number to represent the year in which the tire was manufactured. Example: 031 could represent the 3rd week of 1981 or 1991	

Tire Loading and Tire Pressure

Tire Placard Location

NOTE: The proper cold tire inflation pressure is listed on either the face of the driver's door or the driver's side B-Pillar.

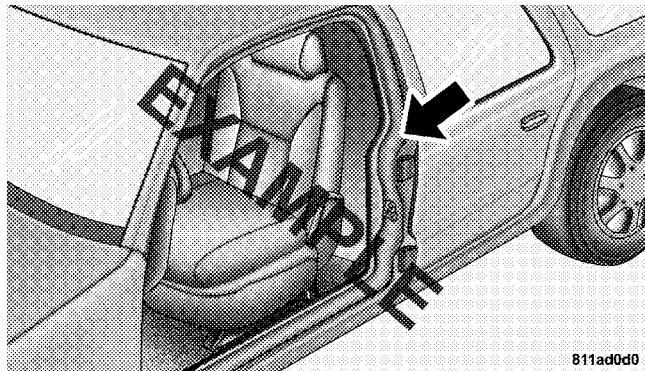

Tire Placard Location

Tire and Loading Information Placard

TIRE AND LOADING INFORMATION			
SEATING CAPACITY - TOTAL 5 FRONT 2 REAR 3			
THE COMBINED WEIGHT OF OCCUPANTS AND CARGO SHOULD NEVER EXCEED XXX KG OR XXX LBS.			
TIRE	FRONT	REAR	SPARE
ORIGINAL TIRE SIZE	P195/70R14	P195/70R14	T125/70D15
COLD TIRE INFLATION PRESSURE	200kPa, 29PSI	200kPa, 29PSI	420kPa, 60PSI
SEE OWNER'S MANUAL FOR ADDITIONAL INFORMATION			4N109268

811b5a9a

Tire and Loading Information Placard

This placard tells you important information about the:

- 1) number of people that can be carried in the vehicle
- 2) total weight your vehicle can carry
- 3) tire size designed for your vehicle
- 4) cold tire inflation pressures for the front, rear, and spare tires.

Loading

The vehicle maximum load on the tire must not exceed the load carrying capacity of the tire on your vehicle. You will not exceed the tire's load carrying capacity if you adhere to the loading conditions, tire size, and cold tire inflation pressures specified on the Tire and Loading Information placard and in the "Vehicle Loading" section of this manual.

NOTE: Under a maximum loaded vehicle condition, gross axle weight ratings (GAWRs) for the front and rear axles must not be exceeded. For further information on GAWRs, vehicle loading, and trailer towing, refer to "Vehicle Loading" in this section.

To determine the maximum loading conditions of your vehicle, locate the statement, "The combined weight of occupants and cargo should never exceed XXX kg or XXX lbs." on the Tire and Loading Information placard. The

combined weight of occupants, cargo/luggage and trailer tongue weight (if applicable) should never exceed the weight referenced here.

Steps for Determining Correct Load Limit

1. Locate the statement, "The combined weight of occupants and cargo should never exceed XXX kg or XXX lbs" on your vehicle's placard.
2. Determine the combined weight of the driver and passengers that will be riding in your vehicle.
3. Subtract the combined weight of the driver and passengers from XXX kg or XXX lbs.
4. The resulting figure equals the available amount of cargo and luggage load capacity. For example, if "XXX" amount equals 1,400 lbs (635 kg) and there will be five each 150 lb (68 kg) passengers in your vehicle, the

amount of available cargo and luggage load capacity is 650 lbs (295 kg) (since $5 \times 150 = 750$, and $1400 - 750 = 650$ lbs [295 kg]).

5. Determine the combined weight of luggage and cargo being loaded on the vehicle. That weight may not safely exceed the available cargo and luggage load capacity calculated in Step 4.

6. If your vehicle will be towing a trailer, load from your trailer will be transferred to your vehicle. Consult this manual to determine how this reduces the available cargo and luggage load capacity of your vehicle.

NOTE: The following table shows examples on how to calculate total load, cargo/luggage, and towing capacities of your vehicle with varying seating configurations and number and size of occupants. This table is for illustration purposes only and may not be accurate for the seating and load carrying capacity of your vehicle.

NOTE: For the following example, the combined weight of occupants and cargo should never exceed 865 lbs (392 kg).

Occupants			Combined weight of occupants and cargo from Tire Placard	MINUS	Combined Occupant's weight	=	AVAILABLE Cargo/Luggage and Trailer Tongue Weight
TOTAL	FRONT	REAR					
<u>EXAMPLE 1</u>			865 lbs	minus	670 lbs	=	195 lbs
5	2	3					
<u>EXAMPLE 2</u>			865 lbs	minus	540 lbs	=	325 lbs
3	2	1					
<u>EXAMPLE 3</u>			865 lbs	minus	400 lbs	=	465 lbs
2	2	0					

Occupant 1: 200 lbs
Occupant 2: 130 lbs
Occupant 3: 160 lbs
Occupant 4: 100 lbs
Occupant 5: 80 lbs
TOTAL WEIGHT: 670 lbs

Occupant 1: 210 lbs
Occupant 2: 180 lbs
Occupant 3: 150 lbs
TOTAL WEIGHT: 540 lbs

Occupant 1: 200 lbs
Occupant 2: 200 lbs
TOTAL WEIGHT: 400 lbs

2WARNING!

Overloading of your tires is dangerous. Overloading can cause tire failure, affect vehicle handling, and increase your stopping distance. Use tires of the recommended load capacity for your vehicle. Never overload them.

TIRES — GENERAL INFORMATION**Tire Pressure**

Proper tire inflation pressure is essential to the safe and satisfactory operation of your vehicle. Three primary areas are affected by improper tire pressure:

1. Safety—**WARNING!**

- Improperly inflated tires are dangerous and can cause accidents.
- Under-inflation increases tire flexing and can result in tire failure.

WARNING!

- Over-inflation reduces a tire's ability to cushion shock. Objects on the road and chuckholes can cause damage that result in tire failure.
- Over-inflated or under-inflated tires can affect vehicle handling and can fail suddenly, resulting in loss of vehicle control.

WARNING!

- **Unequal tire pressures can cause steering problems. You could lose control of your vehicle.**
- **Unequal tire pressures from one side of the vehicle to the other can cause the vehicle to drift to the right or left.**
- **Always drive with each tire inflated to the recommended cold tire inflation pressure.**

2. Economy—

Improper inflation pressures can cause uneven wear patterns to develop across the tire tread. These abnormal wear patterns will reduce tread life resulting in a need for earlier tire replacement. Under-inflation, also increases tire rolling resistance and results in higher fuel consumption.

3. Ride Comfort and Vehicle Stability—

Proper tire inflation contributes to a comfortable ride. Over-inflation produces a jarring and uncomfortable ride.

Tire Inflation Pressures

The proper cold tire inflation pressure is listed either on the face of the driver's door or on the driver's side "B" pillar.

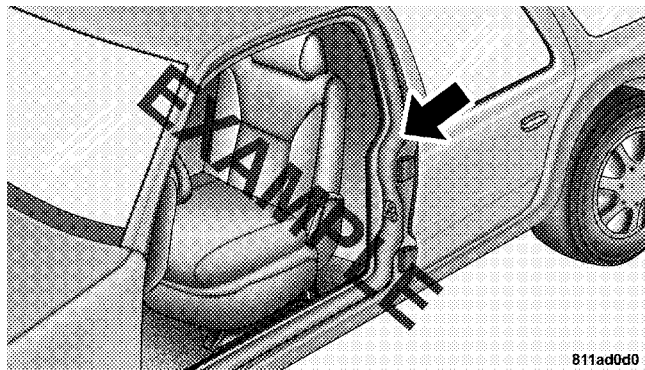

Tire Placard Location

The pressure should be checked and adjusted as well as inspecting for signs of tire wear or visible damage at least once a month. Use a good quality pocket-type gauge to check tire pressure. **DO NOT** make a visual judgement when determining proper inflation. Radial tires may look properly inflated even when they are under inflated.

CAUTION!

After inspecting or adjusting the tire pressure, always reinstall the valve stem cap (if equipped). This will prevent moisture and dirt from entering the valve stem, which could damage the valve stem.

Inflation pressures specified on the placard are always “cold tire inflation pressure.” Cold tire inflation pressure is defined as the tire pressure after the vehicle has not been driven for at least three hours, or driven less than 1 mi (1.6 km) after a three hour period. The cold tire inflation pressure must not exceed the maximum inflation pressure molded into the tire sidewall.

Check tire pressures more often if subject to a wide range of outdoor temperatures, as tire pressures vary with temperature changes.

Tire pressures change by approximately 1 psi (7 kPa) per 12 F (7 C) of air temperature change. Keep this in mind when checking tire pressure inside a garage, especially in the winter.

Example: If garage temperature = 68°F (20°C) and the outside temperature = 32°F (0°C) then the cold tire inflation pressure should be increased by 3 psi (21 kPa), which equals 1 psi (7 kPa) for every 12 F (7 C) for this outside temperature condition.

Tire pressure may increase from 2 to 6 psi (13 to 40 kPa) during operation. DO NOT reduce this normal pressure buildup or your tire pressure will be too low.

Tire Pressures for High-Speed Operation

The manufacturer advocates driving at safe speeds within posted speed limits. Where speed limits or conditions are such that the vehicle can be driven at high speeds, maintaining correct tire inflation pressure is very important. Increased tire pressure and reduced vehicle loading may be required for high-speed vehicle operation. Refer to original equipment information or an authorized tire dealer for recommended safe operating speeds, loading and cold tire inflation pressures.

WARNING!

High-speed driving with your vehicle at or above maximum load is dangerous. The added strain on your tires could cause them to fail. You could have a serious accident. Don't drive a vehicle loaded to the maximum capacity at continuous speeds above 75 mph (120 km/h).

Radial-Ply Tires

WARNING!

Combining radial ply tires with other types of tires on your vehicle will cause your vehicle to handle poorly. The instability could cause an accident. Always use radial ply tires in sets of four (or 6, in case of trucks with dual rear wheels). NEVER combine them with other types of tires.

Cuts and punctures in radial tires are repairable only in the tread area because of sidewall flexing. Consult your authorized tire dealer for radial tire repairs.

Compact Spare Tire — If Equipped

The compact spare is for temporary emergency use with radial tires. It is engineered to be used on your style

vehicle only. Since this tire has limited tread life, the original tire should be repaired (or replaced) and reinstalled at the first opportunity.

WARNING!

- **Temporary use spare tires are for emergency use only. With these tires, DO NOT drive more than 50 mph (80 km/h).**
- **Temporary-use spare tires have limited tread life. When the tread is worn to the tread wear indicators, the temporary use spare tire needs to be replaced.**
- **Be sure to follow the warnings, which apply to your spare. Failure to do so could result in spare tire failure and loss of vehicle control.**

DO NOT install a wheel cover or attempt to mount a conventional tire on the compact spare wheel, since the wheel is designed specifically for the compact spare.

DO NOT install more than one compact spare tire/wheel on the vehicle at any given time.

CAUTION!

Because of the reduced ground clearance, DO NOT take your vehicle through an automatic car wash with the compact spare installed. Damage to the vehicle may result.

Limited-Use Spare Tire — If Equipped

The limited-use spare tire is for temporary emergency use on your vehicle. This tire is identified by a limited-use spare tire warning label located on the limited use spare tire and wheel assembly. This tire may look like the

original equipped tire on the front or rear axle of your vehicle, but it is not. Installation of this limited use spare tire affects vehicle handling. Since it is not the same tire, replace (or repair) the original tire and reinstall on the vehicle at the first opportunity.

WARNING!

- **The limited use spare tire is for emergency use only. Installation of this limited use spare tire affects vehicle handling.**
- **DO NOT drive more than 50 mph (80 km/h) with a limited use spare tire.**

WARNING!

- **Keep the limited use spare tire inflated to the cold tire inflation pressure listed on either your tire placard or limited use spare tire and wheel assembly.**
- **Replace (or repair) the original tire at the first opportunity and reinstall it on your vehicle. Failure to do so could result in loss of vehicle control.**

Tire Spinning

When stuck in mud, sand, snow, or ice conditions, **DO NOT** spin your vehicle's wheels faster than 30 mph (48 km/h) or continuously for longer than 30 seconds without stopping when you are stuck.

Refer to “Freeing A Stuck Vehicle” in Section 6 of this manual for additional information.

WARNING!

- **Fast spinning tires can be dangerous. Forces generated by excessive wheel speeds may cause tire damage or failure. A tire could explode and injure someone.**
- **DO NOT spin your vehicle's wheels faster than 30 mph (48 km/h) or for more than 30 seconds continuously when you are stuck, and don't let anyone near a spinning wheel, no matter what the speed.**

Tread Wear Indicators

Tread wear indicators are in the original equipment tires to help you in determining when your tires should be replaced.

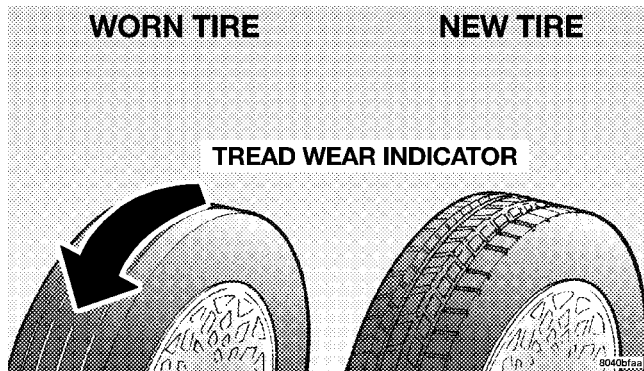

These indicators are molded into the bottom of the tread grooves. They will appear as bands when the tread depth becomes 1/16 in (2 mm). When the tread is worn to the tread wear indicators, the tire should be replaced.

Many states have laws requiring tire replacement at this point.

Tire Life

The service life of a tire is dependent upon varying factors including but not limited to:

- Driving style
- Tire pressure
- Distance driven

WARNING!

Tires and spare tire should be replaced after six years, regardless of the remaining tread. Failure to follow this warning can result in sudden tire failure. You could lose control and have an accident resulting in serious injury or death.

Keep dismantled tires in a cool, dry place with as little exposure to light as possible. Protect tires from contact with oil, grease, and gasoline.

Replacement Tires

The tires on your new vehicle provide a balance of many characteristics. They should be inspected regularly for wear and correct cold tire inflation pressure. The manufacturer strongly recommends that you use tires equivalent to the originals in size, quality and performance when replacement is needed. Please see “Tread Wear Indicators” and “Tire and Loading Information” placard for the size designation of your tire in this section. The service description and load identification will be found on the original equipment tire. Failure to use equivalent replacement tires may adversely affect the safety, handling, and ride of your vehicle. We recommend that you contact your original equipment manufacturer or an authorized tire dealer with any questions you may have on tire specifications or capability.

WARNING!

DO NOT use a tire, wheel size or rating other than that specified for your vehicle. Some combinations of unapproved tires and wheels may change suspension dimensions and performance characteristics, resulting in changes to steering, handling, and braking of your vehicle. This can cause unpredictable handling and stress to steering and suspension components. You could lose control and have an accident resulting in serious injury or death. Use only the tire and wheel sizes with load ratings approved for your vehicle.

WARNING!

- **NEVER** use a tire with a smaller load index or capacity, other than what was originally equipped on your vehicle. Using a tire with a smaller load index could result in tire overloading and failure. You could lose control and have an accident.
- Failure to equip your vehicle with tires having adequate speed capability can result in sudden tire failure and loss of vehicle control.

CAUTION!

Replacing original tires with tires of a different size may result in false speedometer and odometer readings.

Alignment and Tire Balance

Poor suspension alignment may result in:

- Fast tire wear.
- Uneven tire wear, such as feathering and one-sided wear.
- Vehicle pull to right or left.

Tires may also cause the vehicle to pull to the left or right. Alignment will not correct this condition. See your authorized dealer for proper diagnosis.

Improper alignment will not cause vehicle vibration. Vibration may be a result of tire and wheel out-of-balance. Proper balancing will reduce vibration and avoid tire cupping and spotty wear.

TIRE CHAINS

Use only compact chains, or other traction aids that meet SAE type “Class S” specifications. Chains must be the proper size for the vehicle, as recommended by the chain manufacturer.

NOTE: Do not use tire chains on a compact spare tire.

CAUTION!

To avoid damage to your vehicle or tires, observe the following precautions:

- Because of restricted chain clearance between tires and other suspension components, it is important that only chains in good condition are used. Broken chains can cause serious damage. Stop the vehicle immediately if noise occurs that could indicate chain breakage. Remove the damaged parts of the chain before further use.
- Do not exceed 45 mph (70 km/h).
- Drive cautiously and avoid severe turns and large bumps, especially with a loaded vehicle.
- Install chains on the front wheels as tightly as possible and then retighten after driving about one—half mile (0.8 km).
- Do not drive for prolonged period on dry pavement.
- Observe the tire chain manufacturer’s instructions on the method of installation, operating speed, and conditions for use. Always use the lower suggested operating speed of the chain manufacturer if different from the speed recommended by the manufacturer.

Always use the lower suggested operating speed if both the chain manufacturer and vehicle manufacture suggest a maximum speed. This notice applies to all chain traction devices, including link and cable (radial) chains.

SNOW TIRES

Some areas of the country require the use of snow tires during Winter. Standard tires are of the all-season type and satisfy this requirement as indicated by the M+S designation on the tire sidewall.

If you need snow tires, select tires equivalent in size and type to the original equipment tires. Use snow tires only in sets of four; failure to do so may adversely affect the safety and handling of your vehicle.

Snow tires generally have lower speed ratings than what was originally equipped with your vehicle and should not be operated at sustained speeds over 75 mph (120 km/h).

TIRE ROTATION

Tires on the front and rear axles of vehicles operate at different loads and perform different steering, driving, and braking functions. For these reasons, they wear at unequal rates, and tend to develop irregular wear patterns.

These effects can be reduced by timely rotation of tires. The benefits of rotation are especially worthwhile with aggressive tread designs such as those on All-Season type tires. Rotation will increase tread life, help to maintain mud, snow, and wet traction levels, and contribute to a smooth, quiet ride.

Follow the recommended tire rotation frequency for your type of driving found in the “Maintenance Schedules” section of this manual. More frequent rotation is permissible if desired. The reasons for any rapid or unusual wear should be corrected prior to rotation being performed.

The suggested rotation method is the “forward-cross” shown in the following diagram.

TIRE ROTATION PATTERN

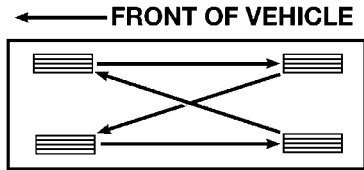

4 TIRE ROTATION

80ba79fe

TIRE PRESSURE MONITOR SYSTEM (TPMS)

The TPMS will warn the driver of a low tire pressure based on the cold inflation tire pressure requirements found on the tire placard located on the driver’s-side B-pillar.

The tire pressure will vary with temperature by about 1 psi (6.9 kPa) for every 12°F (6.5°C). This means that when the outside temperature decreases, the tire pressure will

decrease. Tire pressure should always be set based on cold inflation tire pressure. This is defined as the tire pressure after a vehicle has not been driven for more than three hours - and in outside ambient temperature. **Refer to the “Tires – General Information” in this section for information on how to properly inflate the vehicle’s tires.** The tire pressure will also increase as the vehicle is driven - this is normal and there should be no adjustment for this increased pressure.

The TPMS will warn the driver of a low tire pressure if the tire pressure falls below the low pressure warning threshold for any reason, including low temperature effects, or natural air pressure loss through the tire.

The TPMS will continue to warn the driver of low tire pressure as long as the condition exists, and will not turn off until the tire pressure is at or above recommended cold tire placard pressure. Once the low tire pressure warning has been illuminated, the tire pressure must be

increased to the recommended cold tire placard pressure in order for the TPMS warning lamp to be turned off. The system will automatically update and the TPMS warning lamp will extinguish once the updated tire pressures have been received. The vehicle may need to be driven for up to 10 minutes above 15 mph (25 km/h) to receive this information.

For example, your vehicle may have a recommended cold (parked for more than three hours) tire pressure of 35 psi (241 kPa). If the ambient temperature is 68°F (20°C) and the measured tire pressure is 30 psi (207 kPa), a temperature drop to 20°F (-7°C) will decrease the tire pressure to approximately 26 psi (179 kPa). This tire pressure is sufficiently low enough to turn on the TPMS Warning Light. Driving the vehicle may cause the tire pressure to rise to approximately 30 psi (207 kPa), but the TPMS Warning Light will still be on. In this situation, the

TPMS Warning Light will turn off only after the tires have been inflated to the vehicle's recommended cold tire pressure value.

CAUTION!

The TPMS has been optimized for the original equipment tires and wheels. TPMS pressures have been established for the tire size equipped on your vehicle. Undesirable system operation or sensor damage may result when using replacement equipment that is not of the same size, type, and/or style. Aftermarket wheels can cause sensor damage. Do not use aftermarket sealants or balance beads if your vehicle is equipped with a TPMS, as damage to the sensors may result.

CAUTION!

After inspecting or adjusting the tire pressure always reinstall the valve stem cap. This will prevent moisture and dirt from entering the valve stem, which could damage the TPMS SENSOR.

NOTE:

- The TPMS is not intended to replace normal tire care and maintenance, or to provide warning of a tire failure or condition.
- The TPMS should not be used as a tire pressure gauge while adjusting your tire pressure.
- Driving on a significantly under-inflated tire causes the tire to overheat and can lead to tire failure. Under-inflation also reduces fuel efficiency and tire tread life, and may affect the vehicle's handling and stopping ability.

- The TPMS is not a substitute for proper tire maintenance, and it is the driver's responsibility to maintain correct tire pressure, using an accurate tire pressure gage, even if under-inflation has not reached the level to trigger illumination of the TPMS Warning Lamp.

NOTE: Seasonal temperature changes will affect tire pressure, and the TPMS will monitor the actual tire pressure in the tire.

BASIC TPMS WITHOUT EVIC — IF EQUIPPED

The TPMS uses wireless technology with wheel rim mounted electronic sensors to monitor tire pressure levels. Sensors, mounted to each wheel as part of the valve stem, transmit tire pressure readings to the Receiver Module.

NOTE: It is particularly important, for you to check the tire pressure in all of your tires regularly and to maintain the proper pressure.

The Basic TPMS consists of the following components:

- Receiver Module
- Four Wheel Sensors
- TPMS Telltale Warning Light



The TPMS Telltale Warning Light will illuminate in the instrument cluster, and an audible chime will be activated when one or more of the four active road tire pressures are low.

Should this occur, you should stop as soon as possible, check the inflation pressure of each tire on your vehicle, and inflate each tire to the vehicle's recommended cold tire pressure value (located on the placard on the driver's-side B-Pillar). The system will automatically update and the TPMS Warning Lamp will extinguish once the updated tire pressures have been received.

NOTE: The vehicle may need to be driven for up to 10 minutes above 15 mph (25 km/h) to receive this information.

The TPMS Warning Lamp will flash on and off for 75 seconds, and remain on solid when a system fault is detected. The system fault will also sound a chime. If the ignition key is cycled, this sequence will repeat, providing the system fault still exists. The TPMS Warning Lamp will turn off when the fault condition no longer exists. A system fault can occur with any of the following scenarios:

1. Jamming due to electronic devices or driving next to facilities emitting the same radio frequencies as the TPMS sensors.
2. Installing some form of aftermarket window tinting that affects radio wave signals.
3. Accumulation of excessive snow and/or ice around the wheels or wheel housings.
4. Using tire chains on the vehicle.
5. Using wheels/tires not equipped with TPMS sensors.

NOTE:

1. The compact spare tire (if equipped) does not have a TPMS sensor. Therefore the TPMS will not monitor the pressure in the compact spare tire.
2. If you install the compact spare tire in place of a road tire that has a pressure below the low-pressure warning limit, upon the next ignition key cycle, a chime will sound and the TPMS Telltale Warning Light will turn on.
3. After driving for up to 10 minutes above 15 mph (25 km/h), the TPMS Telltale Warning Light will flash on and off for 75 seconds and then remain on solid.
4. For each subsequent ignition key cycle, a chime will sound and the TPMS Telltale Warning Light will remain on solid.
5. Once you repair or replace the original road tire and reinstall it on the vehicle in place of the compact spare tire, the TPMS will automatically update, and the TPMS

Telltale Warning Light will turn off as long as no tire pressure is below the low-pressure warning limit in any of the four active road tires. The vehicle may need to be driven for up to 10 minutes above 15 mph (25 km/h) for the TPMS to receive this information.

PREMIUM TPMS WITH EVIC — IF EQUIPPED

The TPMS uses wireless technology with wheel rim-mounted electronic sensors to monitor tire pressure levels. Sensors mounted to each wheel as part of the valve stem, transmit tire pressure readings to the Receiver Module.

NOTE: It is particularly important to regularly check and maintain proper tire pressure in all the tires.

The Premium TPMS consists of the following components:

- Receiver Module
- Four TPMS Sensors

- Three Trigger Modules (mounted in three of the four wheel wells)
- Various TPMS Messages, which display in the Electronic Vehicle Information Center (EVIC), and graphics displaying tire pressures
- Yellow TPMS Telltale Warning Light

TPMS Low Pressure Warnings

The TPMS Telltale Warning Light will illuminate in the instrument cluster, and an audible chime will be activated when one or more of the four active road tire pressures are low. In addition, the EVIC will display one or more Low Pressure messages (Left Front, Left Rear, Right Front, Right Rear) for three seconds, and a graphic display of the pressure value(s) with the low tire(s) flashing.

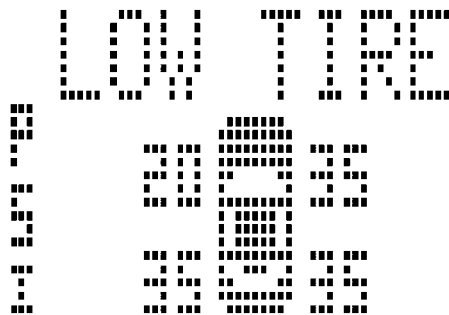

81826bed

Low Tire Pressure Display

Should a low tire condition occur on any of the four active road tire(s), you should stop as soon as possible, and inflate the low tire(s) that is flashing on the graphic display to the vehicle's recommended cold tire pressure value. The system will automatically update, the graphic display of the pressure value(s) will stop flashing, and the TPMS Telltale Warning Light will extinguish once the updated tire pressure(s) have been received. The vehicle may need to be driven for up to 10 minutes above 15 mph (25 km/h) to receive this information.

Check TPMS Message

The TPMS Telltale Warning Light will flash on and off for 75 seconds, and remain on solid when a system fault is detected. The system fault will also sound a chime. The EVIC will display a **CHECK TPM SYSTEM** message for three seconds. This text message is then followed by a graphic display, with - - in place of the pressure value(s) indicating which TPMS Sensor(s) is not being received.

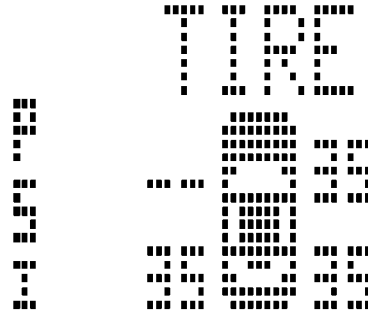

81826bd7

Check TPM System Display

If the ignition key is cycled, this sequence will repeat, providing the system fault still exists. If the system fault no longer exists, the TPMS Telltale Warning Light will no longer flash, the **CHECK TPM SYSTEM** text message

will not be present, and a pressure value will be displayed instead of dashes. A system fault can occur by any of the following scenarios:

1. Jamming due to electronic devices or driving next to facilities emitting the same radio frequencies as the TPMS sensors.
2. Installing some form of aftermarket window tinting that affects radio wave signals.
3. Accumulation of excessive snow and/or ice around the wheels or wheel housings.
4. Using tire chains on the vehicle.
5. Using wheels/tires not equipped with TPMS sensors.

NOTE:

1. The compact spare tire (if equipped) does not have a TPMS. Therefore, the TPMS will not monitor the pressure in the compact spare tire.

2. If you install the compact spare tire in place of a road tire that has a pressure below the low-pressure warning limit, upon the next ignition key cycle, the TPMS Telltale Warning Light will remain on, a chime will sound, and the EVIC will still display a flashing pressure value in the graphic display.

3. After driving the vehicle for up to 10 minutes above 15 mph (25 km/h), the TPMS Telltale Warning Light will flash on and off for 75 seconds and then remain on solid. In addition, the EVIC will display a "CHECK TPM SYSTEM" message for three seconds and then display dashes (- -) in place of the pressure value.

4. For each subsequent ignition key cycle, a chime will sound, the TPMS Telltale Warning Light will flash on and off for 75 seconds and then remain on solid, and the EVIC will display a CHECK TPM SYSTEM message for three seconds and then display dashes (- -) in place of the pressure value.

5. Once you repair or replace the original road tire, and reinstall it on the vehicle in place of the compact spare, the TPMS will update automatically. In addition, the TPMS Telltale Warning Light will turn off and the graphic in the EVIC will display a new pressure value instead of dashes (- -), as long no tire pressure is below the low pressure warning limit in any of the four active road tires.

NOTE: The vehicle may need to be driven for up to 10 minutes above 15 mph (25 km/h) in order for the TPMS to receive this information.

General Information

This device complies with Part 15 of the FCC rules and RSS 210 of Industry Canada. Operation is subject to the following conditions:

- This device may not cause harmful interference.

- This device must accept any interference received, including interference that may cause undesired operation.

The tire pressure sensors are regulated under one of the following licenses:

United States	KR5S120123
Canada	2671-S120123

FUEL REQUIREMENTS

3.3L & 3.8L Gasoline Engine



All engines are designed to meet all emissions regulations and provide excellent fuel economy and performance when using high-quality unleaded “regular” gasoline having an octane rating of 87. The use of premium gasoline is not recommended.

Under normal conditions, the use of premium gasoline will not provide a benefit over high-quality regular

gasolines, and in some circumstances may result in poorer performance.

4.0L Gasoline Engine



The 4.0L engine is designed to meet all emissions regulations and provide satisfactory fuel economy and performance when using high-quality unleaded gasoline having an octane range of 87 to 89. The manufacturer recommends the use of 89 octane for optimum performance. The use of premium gasoline is not recommended. Under normal conditions, the use of premium gasoline will not provide a benefit over high-quality regular and mid-grade gasolines, and in some circumstances may result in poorer performance.

Light spark knock at low engine speeds is not harmful to your engine. However, continued heavy spark knock at high speeds can cause damage and immediate service is required.

Poor quality gasoline can cause problems such as hard starting, stalling and hesitations. If you experience these symptoms, try another brand of “regular” gasoline before considering service for the vehicle.

Over 40 automobile manufacturers around the world have issued and endorsed consistent gasoline specifications (the World Wide Fuel Charter, WWFC) to define fuel properties necessary to deliver enhanced emissions, engine performance, and durability for your vehicle. The manufacturer recommends the use of gasolines that meet the WWFC specifications if they are available.

Reformulated Gasoline

Many areas of the country require the use of cleaner burning gasoline referred to as “Reformulated Gasoline”.

Reformulated gasolines contain oxygenates, and are specifically blended to reduce vehicle emissions and improve air quality.

The manufacturer supports the use of reformulated gasolines. Properly blended reformulated gasolines will provide excellent performance and durability of engine and fuel system components.

Gasoline/Oxygenate Blends

Some fuel suppliers blend unleaded gasoline with oxygenates such as 10% ethanol, MTBE, and ETBE. Oxygenates are required in some areas of the country during the winter months to reduce carbon monoxide emissions. Fuels blended with these oxygenates may be used in your vehicle.

CAUTION!

DO NOT use gasolines containing Methanol or E85 Ethanol. Use of these blends may result in starting and driveability problems and may damage critical fuel system components.

Problems that result from using methanol/gasoline or E85 Ethanol blends are not the responsibility of the manufacturer. While MTBE is an oxygenate made from Methanol, it does not have the negative effects of Methanol.

MMT In Gasoline

MMT is a manganese containing metallic additive that is blended into some gasoline to increase octane. Gasoline blended with MMT provides no performance advantage beyond gasoline of the same octane number without MMT. Gasoline blended with MMT reduces spark plug life and reduces emission system performance in some vehicles. The manufacturer recommends that gasoline without MMT be used in your vehicle. The MMT content of gasoline may not be indicated on the gasoline pump, therefore, you should ask your gasoline retailer whether the gasoline contains MMT.

It is even more important to look for gasolines without MMT in Canada, because MMT can be used at levels higher than those allowed in the United States.

MMT is prohibited in Federal and California reformulated gasolines.

Materials Added to Fuel

All gasoline sold in the United States is required to contain effective detergent additives. Use of additional detergents or other additives are not needed under normal conditions and would result in additional cost. Therefore you should not have to add anything to the fuel.

Fuel System Cautions

CAUTION!

Follow these guidelines to maintain your vehicle's performance:

- The use of leaded gas is prohibited by Federal law. Using leaded gasoline can impair engine performance and damage the emission control system.
- An out-of-tune engine, or certain fuel or ignition malfunctions, can cause the catalytic converter to overheat. If you notice a pungent burning odor or some light smoke, your engine may be out of tune or malfunctioning and may require immediate service. Contact your authorized dealer for service assistance.

- The use of fuel additives which are now being sold as octane enhancers is not recommended. Most of these products contain high concentrations of methanol. Fuel system damage or vehicle performance problems resulting from the use of such fuels or additives is not the responsibility of the manufacturer.

NOTE: Intentional tampering with emissions control systems can result in civil penalties being assessed against you.

Carbon Monoxide Warnings

WARNING!

Carbon monoxide (CO) in exhaust gases is deadly.

- **To prevent carbon monoxide poisoning DO NOT inhale exhaust gases. They contain carbon monoxide, a colorless and odorless gas which can kill.**
- **NEVER run the engine in a closed area, such as a garage, and NEVER sit in a parked vehicle with the engine running for an extended period. If the vehicle is stopped in an open area with the engine running for more than a short period, adjust the ventilation system to force fresh, outside air into the vehicle.**

WARNING!

Carbon monoxide (CO) in exhaust gases is deadly. Follow the precautions below to prevent carbon monoxide poisoning:

- **Guard against carbon monoxide with proper maintenance. Have the exhaust system inspected every time the vehicle is raised. Have any abnormal conditions repaired promptly. Until repaired, drive with all side windows fully open.**
- **Keep the liftgate closed when driving your vehicle to prevent carbon monoxide and other poisonous exhaust gases from entering the vehicle.**

ADDING FUEL**Fuel Filler Cap (Gas Cap)**

As a reminder, a fuel icon with an arrow indicating which side of the vehicle the fuel filler door is located on, is located in the instrument cluster, just below the Fuel Gage.

The gas cap is located behind the fuel filler door on the left side of the vehicle. If the gas cap is lost or damaged, be sure the replacement cap is for use with this vehicle.

NOTE: The driver's side sliding door cannot be opened while the fuel door is open. This feature operates only when the sliding door is fully closed prior to opening the fuel door.

CAUTION!

Damage to the fuel system or emission control system could result from using an improper fuel tank filler tube cap (gas cap). A poorly fitting cap could let impurities into the fuel system and may cause the Malfunction Indicator Light (MIL) to turn on due to fuel vapors escaping from the system.

CAUTION!

To avoid fuel spillage and overfilling, do not “top off” the fuel tank after filling.

NOTE: When the fuel nozzle “clicks” or shuts off, the fuel tank is full.

WARNING!

- Never have any smoking materials lit in or near the vehicle when the gas cap is removed or the tank filled.
- Never add fuel when the engine is running. This is in violation of most state and federal fire regulations and will cause the malfunction indicator light to turn on.

NOTE:

- Tighten the fuel filler cap until you hear a “clicking” sound. This is an indication that the fuel filler cap is properly tightened.
- If the gas cap is not tightened properly, the Malfunction Indicator Light may come on. Be sure the gas cap is tightened every time the vehicle is refueled.

WARNING!

A fire may result if gasoline is pumped into a portable container that is inside of a vehicle. You could be burned. Always place gas containers on the ground while filling.

Loose Fuel Filler Cap Message

- If the **gASCAP** message is displayed in the instrument cluster, this signifies a leak or change in the evaporative system is detected. Sometimes this is the result of a loosely fitting (or possibly damaged) filler cap. Tighten the fuel filler cap properly and press the odometer reset button to turn the **gASCAP** message off.
- Make sure that the fuel filler cap is tightened each time the vehicle is refueled.

- If the problem continues, the message will appear the next time the vehicle is started. See your authorized dealer service center as soon as possible. See Section 7 of this manual for more information.

FLEXIBLE FUEL — 3.3L ENGINES ONLY**E-85 General Information**

The information in this section is for Flexible Fuel Vehicles (FFV) only. These vehicles can be identified by the unique fuel filler door label that states: **Ethanol (E-85) or Unleaded Gasoline Only**. This section only covers those subjects that are unique to these vehicles. Please refer to the other sections of this manual for information on features that are common between Flexible Fuel and gasoline only powered vehicles.

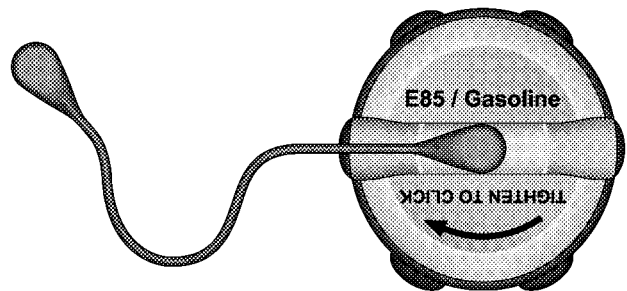

81ae46ab

E-85 Fuel Cap

CAUTION!

Only vehicles with the E-85 Decal and/or fuel filler door label can operate on E-85.



81ae46a9

E-85 Badge

ETHANOL FUEL (E-85)

E-85 is a mixture of approximately 85% fuel ethanol and 15% unleaded gasoline.

WARNING!

Ethanol vapors are extremely flammable and could cause serious personal injury. Never have any smoking materials lit in or near the vehicle when removing the fuel filler tube cap (gas cap) or filling the tank. Do not use E-85 as a cleaning agent and never use it near an open flame.

Fuel Requirements

Your vehicle will operate on both unleaded gasoline with an octane rating of 87, or E-85 fuel, or any mixture of these two.

For best results, a refueling pattern that alternates between E-85 and unleaded gasoline should be avoided. When you do switch fuels, it is recommended that:

- you do not switch when the fuel gauge indicates less than one-quarter full
- you do not add less than 5 gal (19 L) when refueling
- you operate the vehicle immediately after refueling for a period of at least five minutes

Observing these precautions will avoid possible hard starting and/or significant deterioration in driveability during warm up.

NOTE: When the ambient temperature is above 90°F (32°C), you may experience hard starting and rough idle following start-up even if the above recommendations are followed.

Selection Of Engine Oil For Flexible Fuel Vehicles (FFV) E-85 and Gasoline Vehicles

FFV vehicles operated on E85 require specially formulated engine oils. These special requirements are included in Mopar® engine oils, and in equivalent oils meeting DaimlerChrysler Specification MS-6395. The manufacturer only recommends engine oils that are API Certified and meet the requirements of Material Standard MS-6395. MS-6395 contains additional requirements, developed during extensive fleet testing, to provide additional protection to DaimlerChrysler Corporation engines. Use Mopar® or an equivalent oil meeting the specification MS-6395.

Starting

The characteristics of E-85 fuel make it unsuitable for use when ambient temperatures fall below 0°F (-18°C). In the range of 0°F (-18°C) to 32°F (0°C), you may experience an increase in the time it takes for your engine to start, and a deterioration in driveability (sags and/or hesitations) until the engine is fully warmed up.

Cruising Range

Because E-85 fuel contains less energy per gallon than gasoline, you will experience an increase in fuel consumption. You can expect your MPG and your driving range to decrease by about 30% compared to gasoline operation.

Replacement Parts

Many components in your Flexible Fuel Vehicle (FFV) are designed to be compatible with ethanol. Always be sure that your vehicle is serviced with correct ethanol compatible parts.

CAUTION!

Replacing fuel system components with non-ethanol compatible components can damage your vehicle.

Maintenance

If you operate the vehicle using E-85 fuel, follow the maintenance schedule section of this manual.

CAUTION!

Do not use ethanol mixture greater than 85% in your vehicle. It will cause difficulty in cold starting and may affect driveability.

VEHICLE LOADING

As required by National Highway Traffic Safety Administration Regulations, your vehicle has a certification label affixed to the driver's side door or pillar.

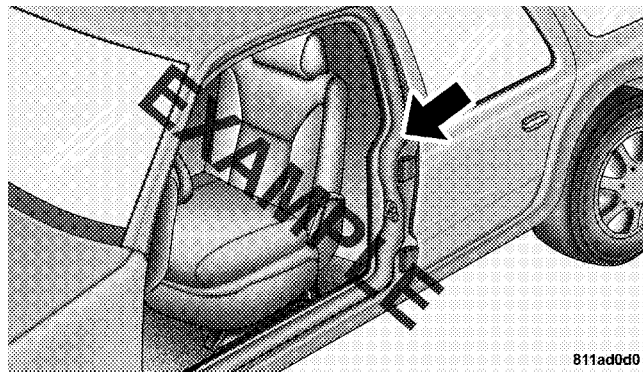

Vehicle Certification Label Location

If seats are removed for carrying cargo, do not exceed the specified GVWR and GAWR.

Vehicle Certification Label

Your vehicle has a Vehicle Certification Label attached to the driver's door pillar.

The label contains the following information:

- Name of manufacturer
- Month and year of manufacture
- Gross Vehicle Weight Rating (GVWR)
- Gross Axle Weight Rating (GAWR) front
- Gross Axle Weight Rating (GAWR) rear
- Vehicle Identification Number (VIN)
- Type of Vehicle
- Month Day and Hour of Manufacture (MDH)

The bar code allows a computer scanner to read the Vehicle Identification Number (VIN).

Gross Vehicle Weight Rating (GVWR)

The GVWR is the total allowable weight of your vehicle. This includes driver, passengers, and cargo. The total load must be limited so that you do not exceed the GVWR.

Gross Axle Weight Rating (GAWR)

The GAWR is the maximum capacity of the front and rear axles. Distribute the load over the front and rear axles evenly. Make sure that you do not exceed either front or rear GAWR.

WARNING!

Because the front wheels drive and steer the vehicle, it is important that you do not exceed the maximum front or rear GAWR. A dangerous driving condition can result if either rating is exceeded. You could lose control of the vehicle and have an accident.

Tire Size

The tire size on the Vehicle Certification Label represents the actual tire size on your vehicle. Replacement tires must be equal to the load capacity of this tire size.

Rim Size

This is the rim size that is appropriate for the tire size listed.

Inflation Pressure

This is the cold tire inflation pressure for your vehicle for all loading conditions up to full GAWR.

Curb Weight

The curb weight of a vehicle is defined as the total weight of the vehicle with all fluids, including vehicle fuel, at full capacity conditions, and with no occupants or cargo loaded into the vehicle. The front and rear curb weight values are determined by weighing your vehicle on a commercial scale before any occupants or cargo are added.

Overloading

The load carrying components (axle, springs, tires, wheels, etc.) of your vehicle will provide satisfactory service as long as you do not exceed the GVWR and front and rear GAWR.

The best way to figure out the total weight of your vehicle is to weigh it when it is fully loaded and ready for operation. Weigh it on a commercial scale to ensure that it is not over the GVWR.

Figure out the weight on the front and rear of the vehicle separately. It is important that you distribute the load evenly over the front and rear axles.

Overloading can cause potential safety hazards and shorten useful service life. Heavier axles or suspension components do not necessarily increase the vehicle's GVWR.

Loading

To load your vehicle properly, first figure out its empty weight, axle by axle and side by side. Store heavier items down low and be sure you distribute their weight as evenly as possible. Stow all loose items securely before driving. If weighing the loaded vehicle shows that you have exceeded either GAWR, but the total load is within the specified GVWR, you must redistribute the weight. Improper weight distribution can have an adverse effect on the way your vehicle steers and handles and the way the brakes operate.

CAUTION!

Do not load your vehicle any heavier than the GVWR or the maximum front and rear GAWR. If you do, parts on your vehicle can break, or it can change the way your vehicle handles. This could cause you to lose control. Also overloading can shorten the life of your vehicle.

A loaded vehicle is shown in the illustration. Note that neither the GVWR or the GAWR capacities have been exceeded.

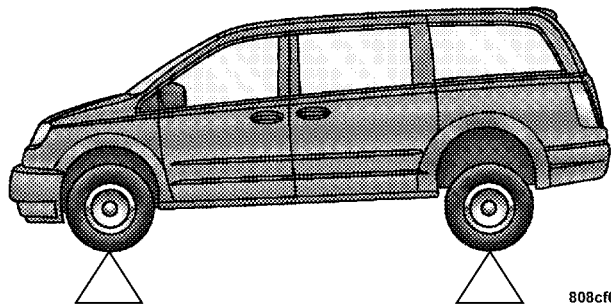

808cf051

LOADING TABLE — EXAMPLE ONLY

	Front Axle	Rear Axle
Empty Weight	2,140 lbs (971 kg)	1,470 lbs (667 kg)
Load (Driver, passengers, and cargo/luggage)	360 lbs (163 kg)	980 lbs (445 kg)
TOTAL	2,500 lbs (1 134 kg)	2,450 lbs (1 111 kg)
GAWR	2,544 lbs (1 154 kg)	2,544 lbs (1 154 kg)

A loaded vehicle is shown in the above table. Note that neither the GVWR nor the GAWR capacities have been exceeded.

NOTE: Refer to the “Vehicle Certification Label” attached to the rear of the driver’s door for your vehicle’s GVWR and GAWR’s. This table is only an example.

TRAILER TOWING

In this section you will find safety tips and information on limits to the type of towing you can reasonably do with your vehicle. Before towing a trailer carefully review this information to tow your load as efficiently and safely as possible.

To maintain warranty coverage, follow the requirements and recommendations in this manual concerning vehicles used for trailer towing.

Common Towing Definitions

The following trailer towing-related definitions will assist you in understanding the following information:

Gross Vehicle Weight Rating (GVWR)

The GVWR is the total allowable weight of your vehicle. This includes driver, passengers, cargo/luggage and trailer tongue weight. The total load must be limited so that you do not exceed the GVWR.

Gross Trailer Weight (GTW)

The gross trailer weight (GTW) is the weight of the trailer plus the weight of all cargo, consumables and equipment (permanent or temporary) loaded in or on the trailer in its "loaded and ready for operation" condition. The recommended way to measure GTW is to put your fully loaded trailer on a vehicle scale. The entire weight of the trailer must be supported by the scale.

Gross Combination Weight Rating (GCWR)

The gross combination weight rating (GCWR) is the total permissible weight of your vehicle and trailer when weighed in combination. (Note that GCWR ratings include a 68 kg (150 lbs) allowance for the presence of a driver).

Gross Axle Weight Rating (GAWR)

The GAWR is the maximum capacity of the front and rear axles. Distribute the load over the front and rear axles evenly. Make sure that you do not exceed either front or rear GAWR.

WARNING!

It is important that you do not exceed the maximum front or rear GAWR. A dangerous driving condition can result if either rating is exceeded. You could lose control of the vehicle and have an accident.

Trailer Tongue Weight (TW)

The downward force exerted on the hitch ball by the trailer. In most cases it should not be less than 10% or more than 15% of the trailer load. You must consider this as part of the load on your vehicle.

Frontal Area

The maximum height and maximum width of the front of a trailer.

Trailer Sway Control

The trailer sway control is a telescoping link that can be installed between the hitch receiver and the trailer tongue that typically provides adjustable friction associated with the telescoping motion to dampen any unwanted trailer swaying motions while traveling.

Weight-Carrying Hitch

A weight-carrying hitch supports the trailer tongue weight, just as if it were luggage located at a hitch ball or some other connecting point of the vehicle. This type of hitch is the most popular on the market today and is commonly used to tow small- and medium-sized trailers.

Weight-Distributing Hitch

A weight-distributing system works by applying leverage through spring (load) bars. They are typically used for heavier loads to distribute trailer tongue weight to the tow vehicle's front axle and the trailer's axle(s). When used in accordance with the manufacturers directions, it provides for a more level ride, offering more consistent steering and brake control thereby enhancing towing safety. The addition of a friction/hydraulic sway control also dampens sway caused by traffic and crosswinds and contributes positively to tow vehicle and trailer stability. Trailer sway control and a weight distributing (load equalizing) hitch are recommended for heavier Tongue Weights (TW), and may be required depending on Vehicle and Trailer configuration/loading to comply with gross axle weight rating (GAWR) requirements.

WARNING!

An improperly adjusted Weight Distributing Hitch system may reduce handling, stability, braking performance, and could result in an accident.

Weight Distributing Systems may not be compatible with Surge Brake Couplers. Consult with an authorized hitch and trailer manufacturer or a reputable authorized Recreational Vehicle dealer for additional information.

EXAMPLE ONLY

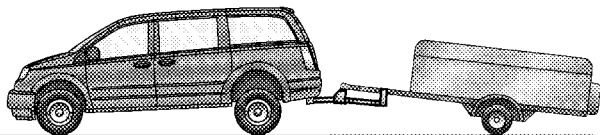

FIG. 3 IMPROPER ADJUSTMENT (INCORRECT)

81bd5242

Weight Distributing Hitch System

EXAMPLE ONLY

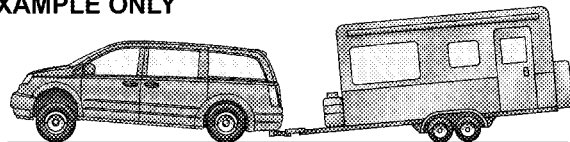

FIG. 1 WITHOUT WEIGHT DISTRIBUTION (INCORRECT)

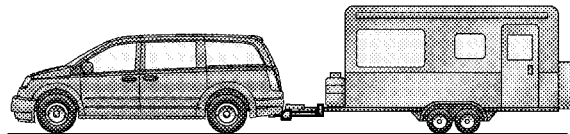

FIG 2. WITH WEIGHT DISTRIBUTION (CORRECT)

81bd5241

Improper Adjustment of Weight Distributing System

Trailer Hitch Classifications

Your vehicle may be factory-equipped for safe towing of trailers weighing over 2,000 lbs (907 kg) with the optional Trailer Tow Prep Package. See an authorized dealer for package content.

The following chart provides the industry standard for the maximum trailer weight a given trailer hitch class can tow and should be used to assist you in selecting the correct trailer hitch for your intended towing condition.

Trailer Hitch Classification Definitions	
Class	Max. Trailer Hitch Industry Standards
Class I - Light Duty	2,000 lbs (907 kg)
Class II - Medium Duty	3,500 lbs (1587 kg)
Class III - Heavy Duty	5,000 lbs (2268 kg)
Class IV - Extra Heavy Duty	10,000 lbs (4540 kg)
Refer to the "Trailer Towing Weights (Maximum Trailer Weight Ratings)" chart for the Maximum Gross Trailer Weight (GTW) towable for your given drivetrain.	

All trailer hitches should be professionally installed on your vehicle.

Trailer Towing Weights (Maximum Trailer Weight Ratings)

The Trailer Towing Weights Chart provides the maximum trailer weight ratings towable for a given drivetrain.

TRAILER TOWING WEIGHTS (MAXIMUM TRAILER WEIGHT RATINGS)				
Engine/ Transaxle	GCWR (Gross Combined Wt. Rating)	Frontal Area	Max. GTW (Gross Trailer Wt.)	Max. Tongue Wt.
3.3L, 3.8L and 4.0L / Auto- matic	7,000 lbs (3 175 kg)	22 sq ft (2.0 sq m)	Up to 2 persons & Luggage 1,800 lbs (816 kg)	180 lbs (82 kg)
	7,000 lbs (3 175 kg)	22 sq ft (2.0 sq m)	3 to 5 persons & Luggage 1,350 lbs (612 kg)	135 lbs (61 kg)
	7,000 lbs (3 175 kg)	22 sq ft (2.0 sq m)	6 to 7 persons & Luggage 1,000 lbs (454 kg)	100 lbs (45 kg)
3.8L and 4.0L /Automatic (with trailer tow package)	9,000 lbs (4 082 kg)	40 sq ft (3.72 sq m)	Up to 2 persons & Luggage 3,800 lbs (1 723 kg) ¹	380 lbs (172 kg)
	9,000 lbs (4 082 kg)	40 sq ft (3.72 sq m)	3 to 5 persons & Luggage 3,350 lbs (1 519 kg) ¹	335 lbs (152 kg)
	9,000 lbs (4 082 kg)	40 sq ft (3.72 sq m)	6 to 7 persons & Luggage 3,000 lbs (1 360 kg) ¹	300 lbs (136 kg)
¹ For vehicles equipped with Fold-in-Floor seating, the Gross Trailer Weight must be reduced by 100 lbs (45 kg). Refer to local laws for maximum trailer towing speeds.				
NOTE: The trailer tongue weight must be considered as part of the combined weight of occupants and cargo, and should never exceed the weight referenced on the Tire and Loading Information placard. Refer to the Tire-Safety Information Section in this manual.				

Trailer and Trailer Tongue Weight

Always load a trailer with 60% to 65% of the weight in the front of the trailer. This places 10% to 15% of the Gross Trailer Weight (GTW) on the tow hitch of your vehicle. Loads balanced over the wheels or heavier in the rear can cause the trailer to severely sway side-to-side, which will cause loss of control of the vehicle and trailer. Failure to load trailers heavier in front is the cause of many trailer accidents.

Never exceed the maximum trailer tongue weight stamped on your bumper or trailer hitch.

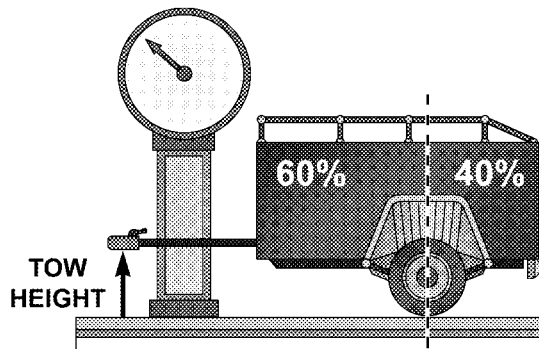

81546c40

5

Consider the following items when computing the weight on the rear axle of the vehicle:

- Trailer tongue weight
- Weight of any other type of cargo/luggage or equipment put in or on your vehicle
- Weight of the driver and all passengers

NOTE: Remember that everything put into or on the trailer adds to the load on your vehicle. Also, additional factory-installed options, or authorized dealer-installed options, must be considered as part of the total load on your vehicle. Refer to the Tire and Loading Information placard in the Tire Safety Information Section of this manual for the maximum combined weight of occupants and cargo for your vehicle.

Towing Requirements

To promote proper break-in of your new vehicle drivetrain components, the following guidelines are recommended:

CAUTION!

- **Avoid towing a trailer for the first 500 mi (805 km) of vehicle operation. Doing so may damage your vehicle.**
- **During the first 500 mi (805 km) of trailer towing, limit your speed to 50 mph (80 km/h).**

Perform the maintenance listed in Section 8 of this manual. When towing a trailer, never exceed the GAWR or GCWR ratings.

WARNING!

Improper towing can lead to an injury accident. Follow these guidelines to make your trailer towing as safe as possible:

Make certain that the load is secured in the trailer and will not shift during travel. When trailering cargo that is not fully secured, dynamic load shifts can occur that may be difficult for the driver to control. You could lose control of your vehicle and have an accident.

- When hauling cargo or towing a trailer, do not overload your vehicle or trailer. Overloading can cause a loss of control, poor performance or damage to brakes, axle, engine, transmission, steering, suspension, chassis structure or tires.

- Safety chains must always be used between your vehicle and trailer. Always connect the chains to the frame or hook retainers of the vehicle hitch. Cross the chains under the trailer tongue and allow enough slack for turning corners.
- Vehicles with trailers should not be parked on a grade. When parking, apply the parking brake on the tow vehicle. Put the tow vehicle automatic transmission in PARK. Always, block or "chock" the trailer wheels.
- GCWR must not be exceeded.
- **Total weight must be distributed between the tow vehicle and the trailer such that the following four ratings are not exceeded:**
 1. GVWR
 2. GTW
 3. GAWR

4. Trailer tongue weight rating for that trailer hitch. (This requirement may limit the ability to always achieve the 10% to 15% range of trailer tongue weight as a percentage of total trailer weight.)

Towing Requirements — Tires

- Do not attempt to tow a trailer while using a compact spare tire.
- Proper tire inflation pressures are essential to the safe and satisfactory operation of your vehicle. Refer to the Tires–General Information section of this manual on Tire Pressures for proper tire inflation procedures.
- Also, check the trailer tires for proper tire inflation pressures before trailer usage.
- Check for signs of tire wear or visible tire damage before towing a trailer. Refer to the Tires–General Information section of this manual on Tread Wear Indicators for the proper inspection procedure.

- When replacing tires refer to the Tires–General Information section of this manual on Replacement Tires for proper tire replacement procedures. Replacing tires with a higher load carrying capacity will not increase the vehicle’s GVWR and GAWR limits.

Towing Requirements — Trailer Brakes

- Do **not** interconnect the hydraulic brake system or vacuum system of your vehicle with that of the trailer. This could cause inadequate braking and possible personal injury.
- An electronically actuated trailer brake controller is required when towing a trailer with electronically actuated brakes. When towing a trailer equipped with a hydraulic surge actuated brake system, an electronic brake controller is not required.

- Trailer brakes are recommended for trailers over 1,000 lbs (454 kg) and required for trailers in excess of 2,000 lbs (907 kg).

CAUTION!

If the trailer weighs more than 1,000 lbs (454 kg) loaded, it should have its own brakes and they should be of adequate capacity. Failure to do this could lead to accelerated brake lining wear, higher brake pedal effort, and longer stopping distances.

WARNING!

Do not connect trailer brakes to your vehicle's hydraulic brake lines. It can overload your brake system and cause it to fail. You might not have brakes when you need them and could have an accident.

Towing any trailer will increase your stopping distance. When towing you should allow for additional space between your vehicle and the vehicle in front of you. Failure to do so could result in an accident.

Towing Requirements — Trailer Lights and Wiring

Whenever you pull a trailer, regardless of the trailer size, stop lights and turn signals on the trailer are required for motoring safety.

The Trailer Tow Package may include a four-pin or a seven-pin wiring harness. Use a factory approved trailer harness and connector.

NOTE: Do not cut or splice wiring into the vehicles wiring harness.

The electrical connections are all complete to the vehicle but you must mate the harness to a trailer connector. Refer to the following four-pin connector and seven-pin connector illustrations.

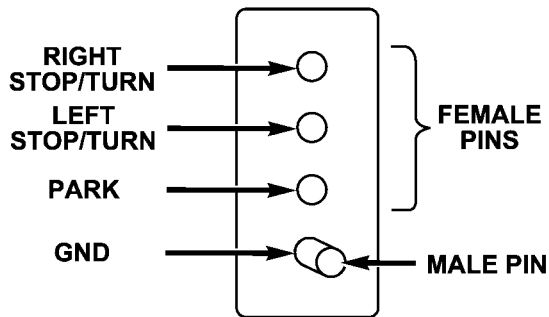

Four-Pin Connector

813262be

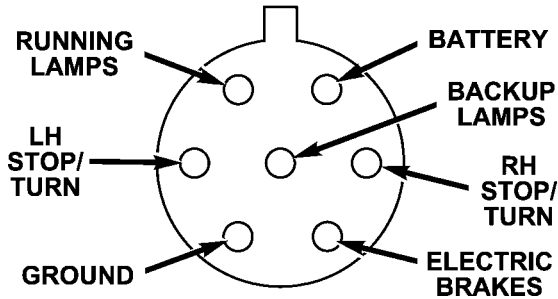

812634c6

Seven-Pin Connector

Towing Tips

Before setting out on a trip, practice turning, stopping and backing the trailer in an area away from heavy traffic.

Towing Tips — Automatic Transmission

The DRIVE gear can be selected when towing. However, if frequent shifting occurs while in DRIVE, move the gear selector lever into third gear (with four-speed transmission) or fifth gear (with six-speed transmission).

NOTE: Moving the gear selector lever into third gear (with four-speed transmission) or fifth gear (with six-speed transmission) while operating the vehicle under heavy operating conditions will improve performance and extend transmission life by reducing excessive shifting and heat build up. This action will also provide better engine braking.

The automatic transmission fluid and filter should be changed if you REGULARLY tow a trailer for more than 45 minutes of continuous operation. Refer to the “Maintenance Schedule” in Section 8 of this manual for transmission fluid change intervals.

NOTE:

- Check the automatic transmission fluid level before towing.
- The six-speed automatic transmission is sealed and requires an authorized dealer service center to check the transmission fluid.

Towing Tips — Electronic Speed Control (If Equipped)

- Don't use in hilly terrain or with heavy loads.
- When using the speed control, if you experience speed drops greater than 10 mph (16 km/h), disengage until you can get back to cruising speed.
- Use speed control in flat terrain and with light loads to maximize fuel efficiency.

Towing Tips — Cooling System

To reduce potential for engine and transmission overheating, take the following actions:

- ***City Driving***

When stopped for short periods of time, put transmission gear selector lever in NEUTRAL but do not increase engine idle speed.

- ***Highway Driving***

Reduce speed.

- ***Air Conditioning***

Turn off temporarily.

- Refer to Cooling System Operating information in the Maintenance section of this manual for more information.

**RECREATIONAL TOWING (BEHIND
MOTORHOME, ETC.)****CAUTION!**

Towing this vehicle behind another vehicle (flat-towing with all four wheels on the ground) IS NOT RECOMMENDED.

NOTE: If the vehicle requires towing make sure all four wheels are off the ground.

WHAT TO DO IN EMERGENCIES

CONTENTS

■ Hazard Warning Flasher	410	■ Jump-Starting Procedure	425
■ If Your Engine Overheats	410	■ Freeing A Stuck Vehicle	427
■ Jacking And Tire Changing	412	■ Towing A Disabled Vehicle	428
□ Jack Location	413	□ Towing With The Ignition Key	428

HAZARD WARNING FLASHER



The hazard flasher switch is located in the center of the instrument panel below the radio.

To engage the Hazard Warning Flashers, depress the switch on the instrument panel. When the Hazard Warning Switch is activated, all directional turn signals will flash on and off to warn oncoming traffic of an emergency. Push the switch a second time to turn off the flashers.

This is an emergency warning system and should not be used when the vehicle is in motion. Use it when your vehicle is disabled and is creating a safety hazard for other motorists.

When you must leave the vehicle to seek assistance, the Hazard Warning Flashers will continue to operate even though the ignition switch is OFF.

NOTE: With extended use, the Hazard Warning Flashers may wear down your battery.

IF YOUR ENGINE OVERHEATS

In any of the following situations, you can reduce the potential for overheating by taking the appropriate action.

- On the highways — Slow down.
- In city traffic — While stopped, shift the transmission gear selector lever into NEUTRAL, but do not increase engine idle speed.

NOTE: There are steps that you can take to slow down an impending overheat condition. If your air conditioner is on, turn it off. The air conditioning system adds heat to the engine cooling system and turning off the A/C removes this heat. You can also turn the Temperature control to maximum heat, the Mode control to floor, and

the fan control to High. This allows the heater core to act as a supplement to the radiator and aids in removing heat from the engine cooling system.

CAUTION!

Driving with a hot cooling system could damage your vehicle. If temperature gauge reads “H”, pull over and stop the vehicle. Idle the vehicle with the air conditioner turned off until the pointer drops back into the normal range. If the pointer remains on the “H”, turn the engine off immediately, and call for service.

WARNING!

A hot engine cooling system is dangerous. You or others could be badly burned by steam or boiling coolant. You may want to call a service center if your vehicle overheats. If you decide to look under the hood yourself, see Section 7, Maintenance, of this manual. Follow the warnings under the Cooling System Pressure Cap paragraph.

JACKING AND TIRE CHANGING**WARNING!**

- **Getting under a jacked-up vehicle is dangerous. The vehicle could slip off the jack and fall on you. You could be crushed. Never get any part of your body under a vehicle that is on a jack. If you need to get under a raised vehicle, take it to a service center where it can be raised on a lift.**
- **The jack is designed to use as a tool for changing tires only. The jack should not be used to lift the vehicle for service purposes. The vehicle should be jacked on a firm level surface only. Avoid ice or slippery areas.**

WARNING!

For vehicles equipped with Stow 'n Go seating, if it is necessary to retrieve the spare tire from under the vehicle on the side of the vehicle close to moving traffic. Pull far enough off the road to avoid the danger of being hit.

Jack Location

The jack, jack handle and winch handle tools are stowed behind the rear left side trim panel in the rear cargo area. Turn the two cover latches to release the cover.

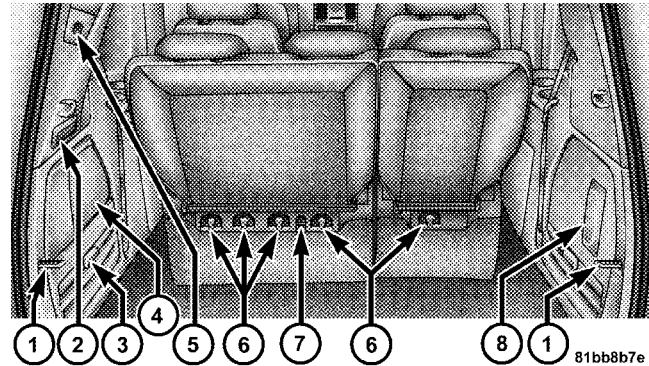

Rear Compartment Features

- | | |
|----------------------|------------------------------|
| 1 - Tie Down | 5 - Liftgate Close Switch |
| 2 - Switch Bank | 6 - Bag Holders |
| 3 - Tire Jack/Handle | 7 - Child Seat LATCH Anchor |
| 4 - Cubby/Speaker | 8 - Rechargeable Flash Light |

Remove the pouch containing the scissors jack, jack handle, and tools.

Spare Tire Removal

For vehicles equipped with Stow 'n Go seating, the spare tire is stowed inside a protective cover located under the center of the vehicle by means of a cable winch mechanism. The “spare tire drive” nut is located on the floor, under a plastic cap at the front of the floor console.

NOTE: The base console, if equipped, must be removed to raise and lower the spare tire. Refer to “Console Features” in Section 3, for the console removal procedure.

The tool pouch contains three pieces and can be assembled into a Spare Tire Hook; to remove the compact spare tire/cover assembly from under the vehicle, or a Winch “T” Handle; to raise/lower the compact spare tire/cover assembly.

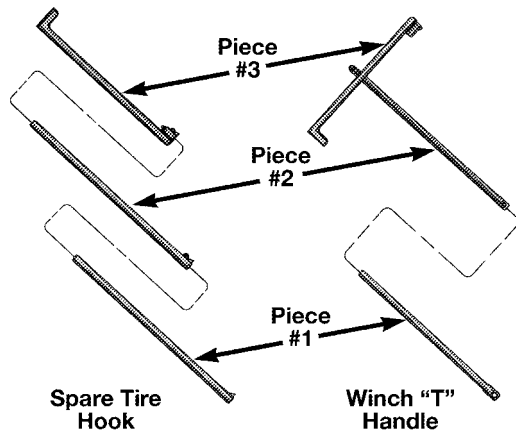

814acba6

Stow 'n Go Tools

Preparations For Jacking

Park the vehicle on a firm level surface, avoid ice or slippery areas, **set the parking brake** and place the gear selector in PARK. Turn OFF the ignition.

- Turn on the Hazard Warning Flasher.

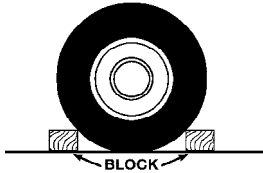

- Block both the front and rear of the wheel diagonally opposite the jacking position. For example, if changing the right front tire, block the left rear wheel.
- Passengers should not remain in the vehicle when the vehicle is being jacked.

Jacking Instructions



Jack Warning Label

WARNING!

Carefully follow these tire changing warnings to help prevent personal injury or damage to your vehicle:

- Always park on a firm, level surface as far from the edge of the roadway as possible before raising the vehicle.
- Block the wheel diagonally opposite the wheel to be raised.
- Set the parking brake firmly and set an automatic transmission in park; a manual transmission in reverse.

WARNING!

Carefully follow these tire changing warnings to help prevent personal injury or damage to your vehicle:

- Never start or run the engine with the vehicle on a jack.
- Do not let anyone sit in the vehicle when it is on a jack.
- Do not get under the vehicle when it is on a jack.
- Only use the jack in the positions indicated and for lifting this vehicle during a tire change.
- If working on or near a roadway, be extremely careful of motor traffic.
- To assure that spare tires, flat or inflated are securely stowed, spares must be stowed with the valve stem facing the ground.
- Turn on the Hazard warning flasher.

1. Loosen (but do not remove) the wheel lug nuts by turning them to the left one turn while the wheel is still on the ground.
2. To remove the compact spare tire/cover assembly, assemble the winch handle extensions to form a “T” and fit the winch “T” handle over the drive nut. Rotate the nut to the left until the winch mechanism stops turning freely. This will allow enough slack in the cable to allow you to pull the spare tire out from under the vehicle.

CAUTION!

The winch mechanism is designed for use with the winch “T” handle only. Use of an air wrench or other power tools is not recommended and can damage the winch.

3. Assemble the winch handle extensions to form the Spare Tire Hook and pull the compact spare tire/cover assembly from under the vehicle.

WARNING!

Getting under a jacked-up vehicle is dangerous. The vehicle could slip off the jack and fall on you. You could be crushed. Never get any part of your body under a vehicle that is on a jack. If you need to get under a raised vehicle, take it to a service center where it can be raised on a lift.

NOTE: If either front tire is flat, it may be necessary to jack up the vehicle to remove the compact spare tire/cover assembly from under the vehicle. Refer to jack engagement locations in the following steps for proper jack placement.

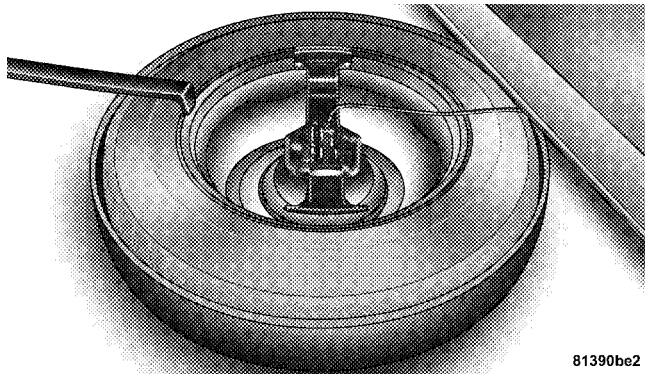

81390be2

Spare Tire Hook & Removal

4. When the compact spare tire/cover assembly is clear of the vehicle, stand the tire/cover assembly upright and remove the wheel spacer by squeezing the two retaining tabs together.

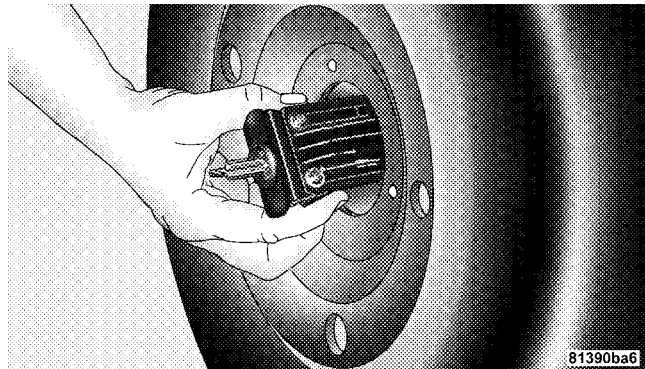

81390ba6

Squeezing Winch Retainer Tabs

5. There are two jack engagement locations on each side of the vehicle body. These locations are on the sill flange of the vehicle body.

NOTE: Rear jack location is between a pair of down-standing tabs on the sill flange of the vehicle body.

Front jack location is on the sill flange of the vehicle body and aligns with the front door edge.

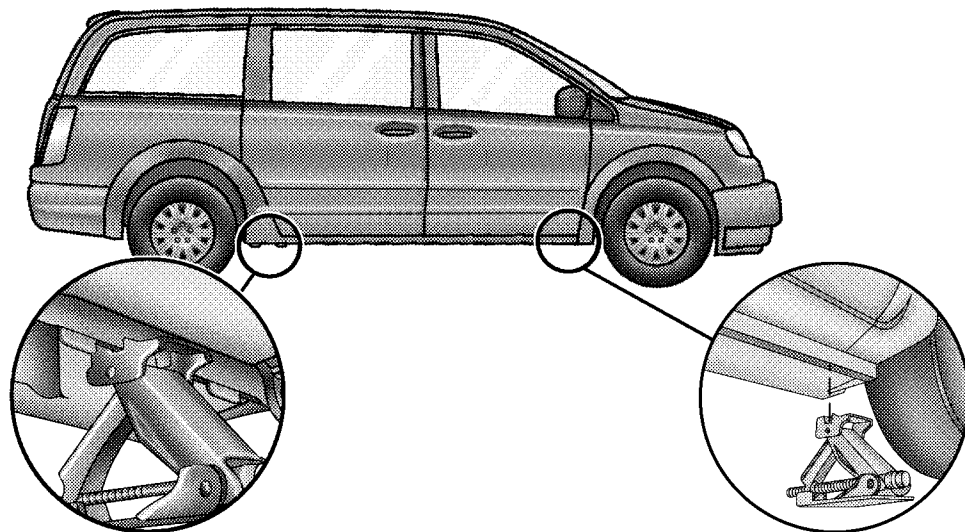

Jack Location

81bc524c

CAUTION!

Do not attempt to raise the vehicle by jacking on locations other than those indicated in Step 5.

6. Place the wrench on the jack screw and turn to the right until the jack head is properly engaged in the described location. **Do not raise the vehicle until you are sure the jack is securely engaged.**

7. Raise the vehicle by turning the jack screw to the right, using the swivel wrench. Raise the vehicle only until the tire just clears the surface and enough clearance is obtained to install the spare tire. Minimum tire lift provides maximum stability.

WARNING!

Raising the vehicle higher than necessary can make the vehicle less stable. It could slip off the jack and hurt someone near it. Raise the vehicle only enough to remove the tire.

8. Remove the wheel lug nuts, for vehicles with wheel covers, remove the cover from the wheel by hand. Do not pry the wheel cover off. Then pull the wheel off the hub.

9. Install the compact spare tire. Lightly tighten the lug nuts. To avoid the risk of forcing the vehicle off the jack, do not tighten the lug nuts fully until the vehicle has been lowered.

NOTE: Do not install the wheel cover on the compact spare.

Do not use a hammer or force to install the wheel covers.

10. Lower the vehicle by turning the jack screw to the left.

11. Finish tightening the lug nuts. Push down on the wrench while tightening for increased leverage. Alternate lug nuts until each nut has been tightened twice. Correct wheel nut tightness is 95 ft lbs (130 N·m). If in doubt about the correct tightness, have them checked with a torque wrench by your authorized dealer or at a service station.

12. Lower the jack to its fully-closed position.

WARNING!

A loose tire or jack thrown forward in a collision or hard stop could endanger the occupants of the vehicle. Always stow the jack parts and the spare tire in the places provided. Have the deflated (flat) tire repaired or replaced immediately.

13. Place the deflated (flat) tire and compact spare tire cover assembly in the rear cargo area. **Do not stow the deflated tire in the spare tire location.** Have the full sized tire repaired or replaced as soon as possible.

14. Stow the cable and wheel spacer before driving the vehicle. Reassemble the winch handle extensions to form a “T” and fit the winch “T” handle over the drive nut. Rotate the nut to the right until the winch mechanism clicks at least three times.

15. Stow the jack, jack handle and winch handle tools.

16. Check the compact spare tire pressure as soon as possible. Correct pressure as required.

Wheel Nuts

All wheel nuts should be tightened occasionally to eliminate the possibility of wheel studs being sheared or the bolt holes in the wheels becoming elongated. This is especially important during the first few hundred miles

of operation, and after each time a tire is changed, to allow the wheel nuts to become properly set. All nuts should first be firmly seated against the wheel. The nuts should then be tightened to recommended torque. Tighten the nuts to final torque in increments. Progress around the bolt circle, tightening the nut opposite to the nut just previously tightened until final torque is achieved. Recommended torque is 95 ft lbs (130 N·m).

Secure The Spare Tire As Follows:

1. To stow the compact spare tire/cover assembly on vehicles equipped with Stow 'n Go seating, assemble the winch handle extensions to form a "T" and fit the winch "T" handle over the drive nut. Rotate the nut to the left until the winch mechanism stops turning freely. This will allow enough slack in the cable to allow you to pull the wheel spacer out from under the vehicle.

WARNING!

A loose compact spare tire/cover assembly, thrown forward in a collision or hard stop could endanger the occupants of the vehicle. Always stow the compact spare tire with the cover assembly in the place provided.

CAUTION!

The winch mechanism is designed for use with the winch "T" handle only. Use of an air wrench or other power tools is not recommended and can damage the winch.

2. Assemble the winch handle extensions to form the Spare Tire Hook and pull the wheel spacer from under the vehicle.
3. Turn the compact spare tire so that the valve stem is down and place the tire into the spare tire cover assembly. Slide the wheel spacer through the center of the wheel and spare tire cover assembly so that the two retainer tabs snap out and engage the spare tire cover on the opposite side.

CAUTION!

The compact spare tire cover assembly must be used when the compact spare tire is stored. Failure to use this cover could drastically reduce the life of the compact spare tire.

WARNING!

Verify that 'both' retainer tabs of the wheel spacer have been properly extended through the center of the wheel and spare tire cover assembly. Failure to properly engage both retainer tabs could result in loss of the spare tire & cover assembly, which will cause vehicle damage and may cause loss of control of the vehicle.

4. Using the winch "T" handle, rotate the drive nut to the right until the compact spare tire/cover assembly is drawn into place against the underside of the vehicle.
5. Continue to rotate the nut to the right until you hear the winch mechanism click three times. It cannot be overtightened. Check under the vehicle to ensure the compact spare tire/cover assembly is positioned correctly against the underside of the vehicle.

CAUTION!

For vehicles equipped with Stow 'n Go seating, the Winch Mechanism is designed specifically to stow a COMPACT Spare Tire ONLY. Do not attempt to use the Winch to stow the Full Size 'Flat' Tire, or any other Full Size Tire. Vehicle damage may result.

JUMP-STARTING PROCEDURE**WARNING!**

- DO NOT attempt to push or tow the vehicle to get it started. Vehicles equipped with an automatic transmission cannot be started this way. Unburned fuel could enter the catalytic converter and once the engine has started, ignite and damage the converter and vehicle.
- If the vehicle has a discharged battery, booster cables may be used to obtain a start from another vehicle. This type of start can be dangerous if done improperly, so follow this procedure carefully.
- Battery fluid is a corrosive acid solution; DO NOT allow battery fluid to contact eyes, skin or clothing. Don't lean over battery when attaching clamps or allow the clamps to touch each other. If acid splashes in the eyes or on the skin, flush the contaminated area immediately with large quantities of water.
- A battery generates hydrogen gas which is flammable and explosive. Keep all flames or sparks away from the vent holes. DO NOT use a booster battery or any other booster source with an output that exceeds 12 volts.
- During cold weather when temperatures are below freezing point, electrolyte in a discharged battery may freeze. DO NOT attempt jump-starting because the battery could rupture or explode. The battery temperature must be brought up above freezing point before attempting jump-start.
- Take special care to avoid the radiator cooling fan whenever the hood is raised. The cooling fan is electrically operated and can start anytime the ignition switch is ON. You can be hurt by the fan.

When jump-starting, proceed as follows:

1. Wear eye protection and remove any metal jewelry such as watch bands or bracelets that might make an inadvertent electrical contact.
2. When a boost is provided by a battery in another vehicle, park that vehicle within booster cable reach and without letting the vehicles touch. Set the parking brake, place the automatic transmission selector lever into PARK and turn the ignition switch to the OFF position for both vehicles.
3. Turn OFF the heater, radio and all unnecessary electrical loads.
4. Connect one end of a jumper cable to the positive terminal of the discharged battery. Connect the other end of the same cable to the positive terminal of the booster battery.

WARNING!

DO NOT permit vehicles to touch each other as this could establish a ground connection and personal injury could result.

5. Connect the other cable, first to the negative terminal of the booster battery, and then to the engine of the vehicle with the discharged battery. Make sure there is a good contact on the engine.

WARNING!

DO NOT connect the cable to the negative post of the discharge battery. The resulting electrical spark could cause the battery to explode.

6. Start the engine in the vehicle which has the booster battery, let the engine idle a few minutes, then start the engine in the vehicle with the discharged battery.
7. When removing the jumper cables, reverse the above sequence exactly. Be careful of the moving belts and fan.

WARNING!

Any procedure other than the jump-starting process listed could result in:

- **Personal injury caused by electrolyte squirting out the battery vent;**
- **Personal injury or property damage due to battery explosion;**
- **Damage to charging system of booster vehicle or of immobilized vehicle.**

FREEING A STUCK VEHICLE

If your vehicle becomes stuck in mud, sand or snow, it can often be moved by a rocking motion. Turn your steering wheel right and left to clear the area around the front wheels. Then shift the gear selector lever back and forth between REVERSE and DRIVE. Usually the least amount of accelerator pedal pressure to maintain the rocking motion without spinning the wheels is most effective.

WARNING!

Fast spinning tires can be dangerous. Forces generated by excessive wheel speeds may cause tire damage or failure. A tire could explode and injure someone. Do not spin your vehicle's wheels faster than 35 mph (55 km/h) when you are stuck. And don't let anyone near a spinning wheel, no matter what the speed.

CAUTION!

Racing the engine or spinning the wheels too fast may lead to transmission overheating and failure. It can also damage the tires. Do not spin the wheels above 35 mph (55 km/h).

TOWING A DISABLED VEHICLE**Towing With The Ignition Key**

Your vehicle may be towed under the following conditions: The gear selector lever must be in NEUTRAL, the distance to be traveled must not exceed 100 mi (160 km), and the towing speed must not exceed 44 mph (72 km/h). Exceeding these towing limits may cause a transmission geartrain failure. If the transmission is not operative, or if the vehicle is to be towed more than 100 mi (160 km), the vehicle must be towed with the front wheels off the ground.

CAUTION!

- Do not attempt to tow this vehicle from the front with sling type towing equipment. Damage to the front fascia will result.
- Always use wheel lift equipment when towing from the front. The only other approved method of towing is with a flat bed truck.
- Do not tow the vehicle from the rear. Damage to the rear sheet metal, liftgate and fascia will occur.

CAUTION!

- **Do not push or tow this vehicle with another vehicle as damage to the bumper fascia and transmission may result.**
- **If the vehicle being towed requires steering, the ignition switch must be in the OFF position, not in the LOCK or ACC positions.**

If it is necessary to use the accessories while being towed (wipers, defrosters, etc.), the key must be in the ON position, not the ACC position. Make certain the transmission remains in NEUTRAL.

Towing Without The Ignition Key

Special care must be taken when the vehicle is towed with the ignition in the LOCK position. The only approved method of towing with out the ignition key is with a flat bed truck. Proper towing equipment is necessary to prevent damage to the vehicle.

Towing This Vehicle Behind Another Vehicle (Flat towing with all four wheels on the ground)

Flat towing of vehicles equipped with an automatic transmission, is only permitted within the limitations described in this section.

Towing This Vehicle Behind Another Vehicle With A Tow Dolly

The manufacturer **does not recommend** that you tow a front wheel drive vehicle on a tow dolly. Vehicle damage may occur.

MAINTAINING YOUR VEHICLE

CONTENTS

■ 3.3L Engine Compartment	434	■ Maintenance Procedures	441
■ 3.8L Engine Compartment	435	□ Engine Oil	441
■ 4.0L Engine Compartment	436	□ Engine Oil Filter	444
■ Onboard Diagnostic System — OBD II	437	□ Drive Belt	445
□ Loose Fuel Filler Cap Message — gASCAP	438	□ Spark Plugs	445
■ Emissions Inspection And Maintenance Programs	438	□ Engine Air Cleaner	445
■ Replacement Parts	440	□ Catalytic Converter	446
■ Authorized Dealer Service	440	□ Maintenance-Free Battery	448
		□ Air Conditioner Maintenance	450

- Power Steering — Fluid Check 452
- Front Suspension — Ball Joints 453
- Steering Shaft Seal 453
- Drive Shaft Universal Joints 454
- Body Lubrication 454
- Windshield Wiper Blades 454
- Cooling System 456
- Hoses And Vacuum/Vapor Harnesses 461
- Fuel System Connections 461
- Brakes 462
- Automatic Transaxle 464
- Front And Rear Wheel Bearings 467
- Appearance Care And Protection From Corrosion 467
- Cleaning The Instrument Panel Cup Holders . . 473
- Fuses/Totally Integrated Power Module (TIPM) 474
- Vehicle Storage 481
- Replacement Light Bulbs 481
- Bulb Replacement 482
 - Headlights 482
 - Front Park/Turn Signal And Side Marker Lights 483
 - Fog Lights 483
 - Rear Tail, Stop, Turn Signal, Side Marker And Backup Lights 484

<input type="checkbox"/> Center High-Mounted Stop Light (CHMSL) . . .	485	<input checked="" type="checkbox"/> Fluids, Lubricants And Genuine Parts	487
<input type="checkbox"/> License Light	485	<input type="checkbox"/> Engine	487
<input checked="" type="checkbox"/> Fluids And Capacities	486	<input type="checkbox"/> Chassis	488

3.3L ENGINE COMPARTMENT

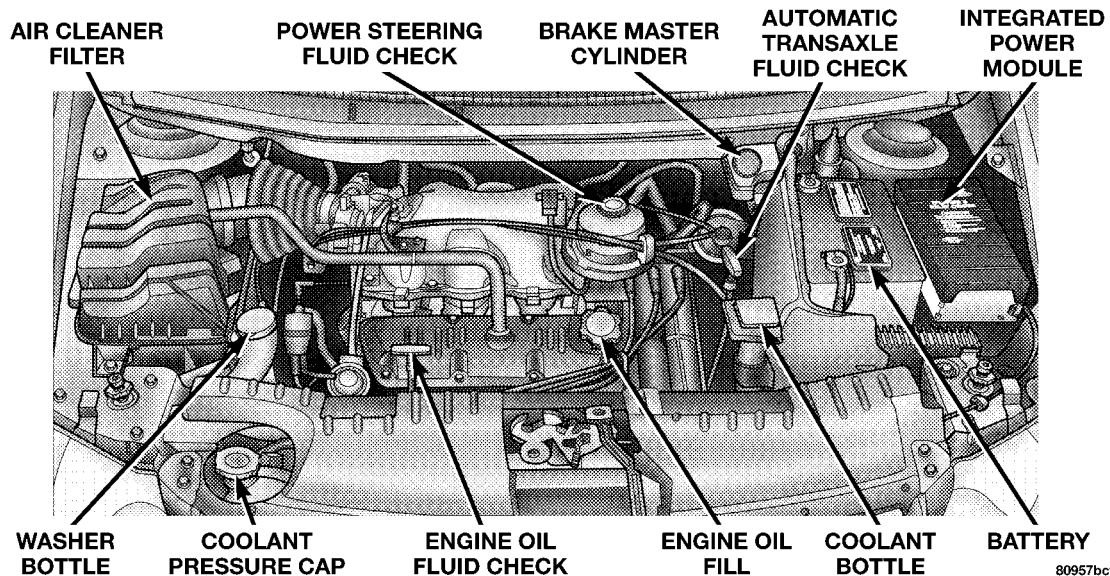

3.8L ENGINE COMPARTMENT

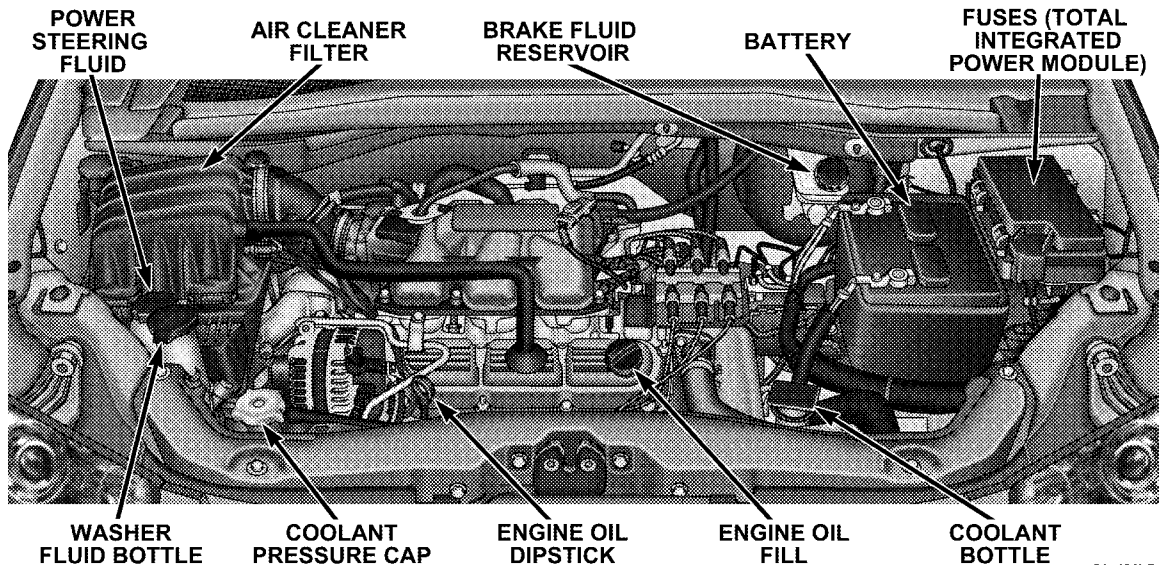

81c421b5

4.0L ENGINE COMPARTMENT

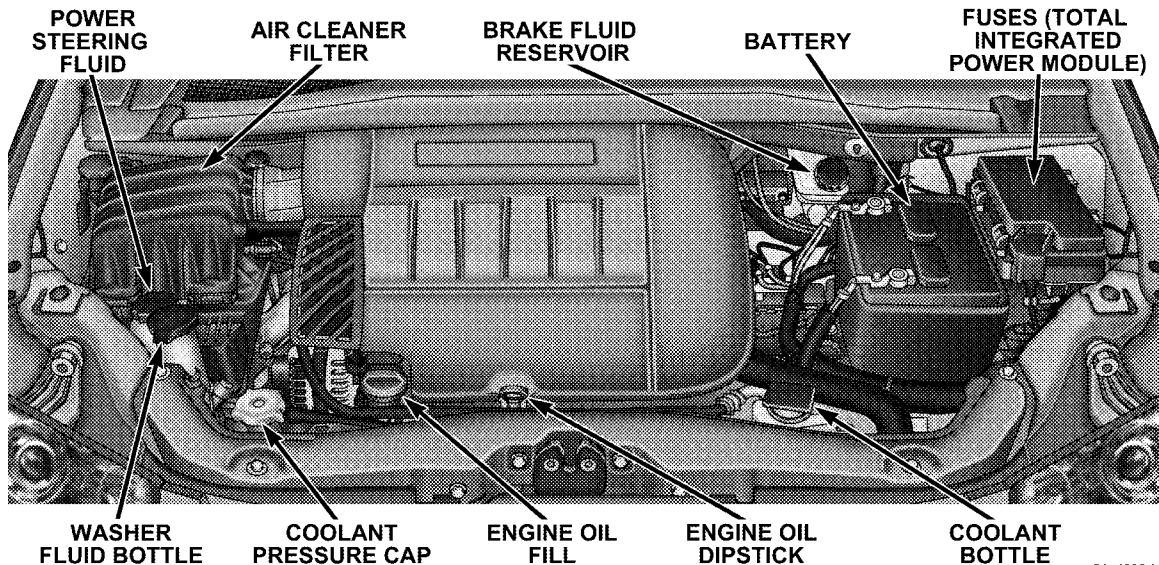

ONBOARD DIAGNOSTIC SYSTEM — OBD II

Your vehicle is equipped with a sophisticated onboard diagnostic system called OBD II. This system monitors the performance of the emissions, engine, and automatic transmission control systems. When these systems are operating properly, your vehicle will provide excellent performance and fuel economy, as well as engine emissions well within current government regulations.

If any of these systems require service, the OBD II system will turn on the “Malfunction Indicator Light.” It will also store diagnostic codes and other information to assist your service technician in making repairs. Although your vehicle will usually be drivable and not need towing, see your authorized dealer for service as soon as possible.

CAUTION!

- **Prolonged driving with the “Malfunction Indicator Light” on could cause further damage to the emission control system. It could also affect fuel economy and driveability. The vehicle must be serviced before any emissions tests can be performed.**
- **If the “Malfunction Indicator Light” is flashing while the engine is running, severe catalytic converter damage and power loss will soon occur. Immediate service is required.**

Loose Fuel Filler Cap Message — gASCAP

Should the “Loose Fuel Filler Cap” or “gASCAP” message appear, there may be a problem in the evaporative system. Before taking the vehicle into an authorized dealer, check first to see if the fuel filler cap is possibly loose, improperly installed, or damaged. A loose fuel filler cap message will be displayed in the instrument cluster. Tighten the gas cap until a “clicking” sound is heard. This is an indication that the gas cap is properly tightened. Press the odometer reset button to turn the message off. If the problem persists, the message will appear the next time the vehicle is started. If the problem is detected twice in a row, the system will turn on the Malfunction Indicator Light (MIL). Resolving the problem will turn the MIL light off. Take your vehicle in to an authorized dealer.

EMISSIONS INSPECTION AND MAINTENANCE PROGRAMS

In some localities, it may be a legal requirement to pass an inspection of this vehicle’s emissions control system. Failure to pass could prevent vehicle registration.



For states that require an Inspection and Maintenance (I/M), this check verifies the Malfunction Indicator Light (MIL) is functioning and is not on when the engine is running, and that the OBD II system is ready for testing.

Normally, the OBD II system will be ready. The OBD II system may **not** be ready if the vehicle was recently serviced, recently had a dead battery, or a battery replacement. If the OBD II system should be determined not ready for the I/M test, the vehicle may fail the test.

This vehicle has a simple ignition key-actuated test, which you can use prior to going to the test station. To check if this vehicle's OBD II system is ready, you must do the following:

1. Insert the ignition key into the ignition switch.
2. Turn the ignition to the ON position, but do not crank or start the engine.
3. If you crank or start the engine, you will have to start this test over.
4. As soon as you turn the ignition key to the ON position, you will see the MIL symbol come on as part of a normal bulb check.
5. Approximately 15 seconds later, one of two things will happen:
 - a. The MIL will flash for about 10 seconds and then return to being fully illuminated until you turn OFF

the ignition key or start the engine. This means that the vehicle's OBD II system is **not ready** and you should **not** proceed to the I/M station.

- b. The MIL will not flash at all and will remain fully illuminated until you turn OFF the ignition key or start the engine. This means that the vehicle's OBD II system is **ready**, and you can proceed to the I/M station.

If the OBD II system is **not ready**, you should see an authorized dealer or repair facility. If this vehicle was recently serviced or had a battery failure or replacement, you may need to do nothing more than drive the vehicle as you normally would in order for the OBD II system to update. A recheck with the above test routine may then indicate that the system is now ready.

Regardless of whether the vehicle's OBD II system is ready or not ready, if the MIL is illuminated during normal vehicle operation, you should have the vehicle

serviced before going to the I/M station. The I/M station can fail the vehicle because the MIL is on with the engine running.

REPLACEMENT PARTS

Use of genuine Mopar® parts for normal/scheduled maintenance and repairs is highly recommended to ensure the designed performance. Damage or failures caused by the use of non-Mopar® parts for maintenance and repairs will not be covered by the manufacturer's warranty.

AUTHORIZED DEALER SERVICE

Your authorized dealer has the qualified service personnel, special tools, and equipment to perform all service operations in an expert manner. Service manuals are available which include detailed service information for your vehicle. Refer to these service manuals before attempting any procedure yourself.

NOTE: Intentional tampering with emissions control systems can result in civil penalties being assessed against you.

WARNING!

You can be badly injured working on or around a motor vehicle. Only do service work for which you have the knowledge and the proper equipment. If you have any doubt about your ability to perform a service job, take your vehicle to a competent mechanic.

MAINTENANCE PROCEDURES

The pages that follow contain the **required** maintenance services determined by the engineers who designed your vehicle.

Besides the maintenance items for which there are fixed maintenance intervals, there are other items that should operate satisfactorily without periodic maintenance. However, if a malfunction of these items does occur, it could adversely affect the engine or vehicle performance. These items should be inspected if a malfunction is observed or suspected.

ENGINE OIL

Checking Oil Level

To assure proper engine lubrication, the engine oil must be maintained at the correct level. Check the oil level at regular intervals, such as every fuel stop.

The best time to check the engine oil level is about five minutes after a fully warmed engine is shut off or before starting the engine after it has sat overnight.

Checking the oil while the vehicle is on level ground will improve the accuracy of the oil level readings. Maintain the oil level between the MIN and MAX markings on the dipstick. Adding one quart of oil when the reading is at the MIN mark will result in a MAX reading on these engines.

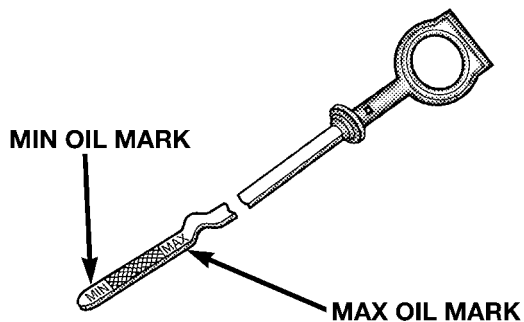

Engine Oil Dipstick

809744ab

CAUTION!

Overfilling or underfilling will cause oil aeration or loss of oil pressure. This could damage your engine.

Change Engine Oil

The oil change indicator system will remind you that it is time to take your vehicle in for scheduled maintenance. Refer to “Maintenance Schedule” in Section 8 of this manual for information on this system.

NOTE: Under no circumstances should oil change intervals exceed 6,000 miles (10 000 km) or six months, whichever occurs first.

Engine Oil Selection

For best performance and maximum protection under all types of operating conditions, the manufacturer only

recommends engine oils that are API certified and meet the requirements of DaimlerChrysler Material Standard MS-6395.

American Petroleum Institute (API) Engine Oil Identification Symbol



This symbol means that the oil has been certified by the American Petroleum Institute (API). The manufacturer only recommends API Certified engine oils.

Engine Oil Viscosity (SAE Grade) — 3.3L & 3.8L Gasoline Engines

SAE 5W-20 engine oil is recommended for all operating temperatures. This engine oil improves low temperature

starting and vehicle fuel economy. Your engine oil filler cap also shows the recommended engine oil viscosity for your vehicle.

For information on engine oil filler cap location, refer to the Engine Compartment illustration in this section.

Lubricants which do not have both, the engine oil certification mark and the correct SAE viscosity grade number should not be used.

Engine Oil Viscosity (SAE Grade) — 4.0 Liter Engines

SAE 10W-30 engine oil is preferred for all operating temperatures. The engine oil filler cap also shows the recommended engine oil viscosity for your vehicle.

Lubricants which DO NOT have both, the engine oil certification mark and the correct SAE viscosity grade number should not be used.

Synthetic Engine Oils

You may use synthetic engine oils provided the recommended oil quality requirements are met, and the recommended maintenance intervals for oil and filter changes are followed.

Materials Added to Engine Oil

The manufacture strongly recommends against the addition of any additives (other than leak detection dyes) to the engine oil. Engine oil is an engineered product and its performance may be impaired by supplemental additives.

Disposing of Used Engine Oil And Oil Filters

Care should be taken in disposing of used engine oil and oil filters from your vehicle. Used oil and oil filters, indiscriminately discarded, can present a problem to the environment. Contact your authorized dealer, service

station, or governmental agency for advice on how and where used oil and oil filters can be safely discarded in your area.

ENGINE OIL FILTER

The engine oil filter should be replaced at every engine oil change.

Engine Oil Filter Selection

The manufacturer's engines have a full-flow type oil filter. Use a filter of this type for replacement. The quality of replacement filters varies considerably. Only high quality filters should be used to assure most efficient service. Mopar® Engine Oil Filters are a high quality oil filter and are recommended.

DRIVE BELT

At the mileage indicated in the maintenance schedule, replace the drive belt with a new drive belt.

NOTE: The drive belt must be routed correctly to ensure proper drive function.

SPARK PLUGS

Spark plugs must fire properly to assure engine performance and emission control. New plugs should be installed at the specified mileage. The entire set should be replaced if there is any malfunction due to a faulty spark plug. Malfunctioning spark plugs can damage the catalytic converter. For proper type of replacement spark plugs, refer to Fluids, Lubricants and Genuine Parts for correct spark plug type.

ENGINE AIR CLEANER

Refer to the “Maintenance Schedule” in Section 8 of this manual for engine air cleaner filter maintenance intervals.

NOTE: Be sure to follow the “dusty or off-road conditions” maintenance interval if applicable.

WARNING!

The air induction system (air cleaner, hoses, etc.) can provide a measure of protection in the case of engine backfire. Do not remove the air induction system (air cleaner, hoses, etc.) unless such removal is necessary for repair or maintenance. Make sure that no one is near the engine compartment before starting the vehicle with the air induction system (air cleaner, hoses, etc.) removed. Failure to do so can result in serious personal injury.

CATALYTIC CONVERTER

The catalytic converter requires the use of unleaded fuel only. Leaded gasoline will destroy the effectiveness of the catalyst as an emission control device.

Under normal operating conditions, the catalytic converter will not require maintenance. However, it is important to keep the engine properly tuned to assure proper catalyst operation and prevent possible catalyst damage.

CAUTION!

Damage to the catalytic converter can result if your vehicle is not kept in proper operating condition. In the event of engine malfunction, particularly involving engine misfire or other apparent loss of performance, have your vehicle serviced promptly. Continued operation of your vehicle with a severe malfunction could cause the converter to overheat, resulting in possible damage to the converter and the vehicle.

NOTE: Intentional tampering with emissions control systems can result in civil penalties being assessed against you.

WARNING!

A hot exhaust system can start a fire if you park over materials that can burn. Such materials might be grass or leaves coming into contact with your exhaust system. Do not park or operate your vehicle in areas where your exhaust system can contact anything that can burn.

In unusual situations involving grossly malfunctioning engine operation, a scorching odor may indicate severe and abnormal catalyst overheating. If this occurs, the vehicle should be stopped, the engine shut off and the vehicle allowed to cool. Thereafter, service, including a tune-up to manufacturer's specifications, should be obtained immediately.

To minimize the possibility of catalyst damage:

- Do not shut off the engine or interrupt the ignition when the transaxle is in gear and the vehicle is in motion.
- Do not try to start engine by pushing or towing the vehicle.
- Do not idle the engine with any spark plug wires disconnected or removed, such as when diagnostic testing, or for prolonged periods during very rough idling or malfunctioning operating conditions.

Exhaust System

The best protection against carbon monoxide entry into the vehicle body is a properly maintained engine exhaust system.

Whenever a change is noticed in the sound of the exhaust system, when exhaust fumes can be detected inside the vehicle, or when the underside or rear of the vehicle is damaged, have a competent mechanic inspect the complete exhaust system and adjacent body areas for broken, damaged, deteriorated, or mispositioned parts. Open seams or loose connections could permit exhaust fumes to seep into the passenger compartment. In addition, inspect the exhaust system each time the vehicle is raised for lubrication or oil change. Replace as required.

WARNING!

Exhaust gases can injure or kill. They contain carbon monoxide (CO) which is colorless and odorless. Breathing it can make you unconscious and can eventually poison you. To avoid breathing CO, refer to “Exhaust Gas” in the Safety Tips section of this manual.

MAINTENANCE-FREE BATTERY

The top of the MAINTENANCE-FREE battery is permanently sealed. You will never have to add water, nor is periodic maintenance required.

WARNING!

- **Battery fluid is a corrosive acid solution and can burn or even blind you. Don't allow battery fluid to contact your eyes, skin or clothing. Don't lean over a battery when attaching clamps. If acid splashes in eyes or on skin, flush the area immediately with large amounts of water.**
- **Battery gas is flammable and explosive. Keep flame or sparks away from the battery. Don't use a booster battery or any other booster source with an output greater than 12 volts. Don't allow cable clamps to touch each other.**
- **Battery posts, terminals and related accessories contain lead and lead compounds. Wash hands after handling.**

CAUTION!

- **It is essential when replacing the cables on the battery that the positive cable is attached to the positive post and the negative cable is attached to the negative post. Battery posts are marked positive (+) and negative (-) and identified on the battery case. Cable clamps should be tight on the terminal posts and free of corrosion.**
- **If a "fast charger" is used while the battery is in the vehicle, disconnect both vehicle battery cables before connecting the charger to battery. Do not use a "fast charger" to provide starting voltage.**

AIR CONDITIONER MAINTENANCE

For best possible performance, your air conditioner should be checked and serviced by an authorized dealer at the start of each warm season. This service should include cleaning of the condenser fins and a system performance check. Drive belt tension should also be checked at this time.

WARNING!

- **Use only refrigerants and compressor lubricants approved by the manufacturer for your air conditioning system. Some unapproved refrigerants are flammable and can explode, injuring you. Other unapproved refrigerants or lubricants can cause the system to fail, requiring costly repairs. Refer to Section 3 of the Warranty Information book for further warranty information.**
- **The air conditioning system contains refrigerant under high pressure. To avoid risk of personal injury or damage to the system, adding refrigerant or any repair requiring lines to be disconnected should be done by an experienced repairman.**

Refrigerant Recovery And Recycling

R-134a Air Conditioning Refrigerant is a hydrofluorocarbon (HFC) that is endorsed by the Environmental Protection Agency and is an ozone-saving product. However, the manufacturer recommends that air conditioning service be performed by an authorized dealer or other an authorized service facility using recovery and recycling equipment.

NOTE: Use only manufacturer approved A/C System Sealers, Stop Leak Products, Seal Conditioners, Compressor Oil, or Refrigerants.

A/C Air Filter — If Equipped

Refer to the “Maintenance Schedule” in Section 8 of this manual for A/C Air Filter service intervals.

WARNING!

Do not remove the A/C Air Filter while the blower is operating or personal injury may result.

The A/C Air Filter is located in the fresh air inlet behind the glove box. Perform the following procedure to replace the filter:

1. Open the glove box and remove all contents.
2. Push in on the sides of the glove box and lower the door.
3. Pivot the glove box downward.

4. Disengage the two retaining tabs that secure the filter cover to the HVAC housing and remove the cover.

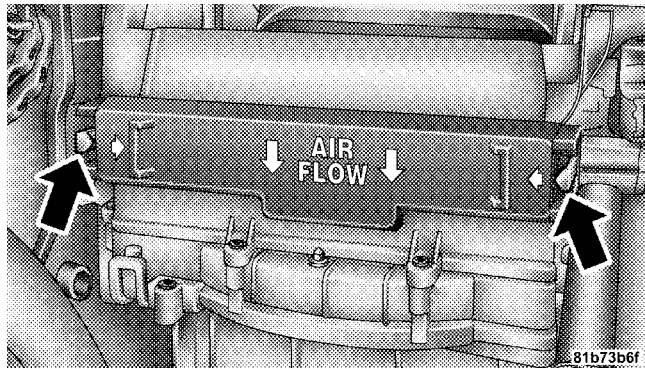

A/C Air Filter Replacement

5. Remove the A/C Air Filter by pulling it straight out of the housing.

6. Install the A/C Air Filter with the arrow on the filter pointing toward the floor. When installing the filter cover, make sure the retaining tabs fully engage the cover.

CAUTION!

The A/C Air Filter is labeled with an arrow to indicate airflow direction through the filter. Failure to properly install the filter will result in the need to replace it more often.

7. Rotate the glove box door back into position.

POWER STEERING — FLUID CHECK

Checking the power steering fluid level at a defined service interval is not required. The fluid should only be checked if a leak is suspected, abnormal noises are

apparent, and/or the system is not functioning as anticipated. Coordinate inspection efforts through an authorized DaimlerChrysler Dealership."

WARNING!

Fluid level should be checked on a level surface and with the engine off to prevent injury from moving parts and to ensure accurate fluid level reading. Do not overfill. Use only manufacturer's recommended power steering fluid.

If necessary, add fluid to restore to the proper indicated level. With a clean cloth, wipe any spilled fluid from all surfaces. Refer to Fluids, Lubricants, and Genuine Parts for correct fluid type.

FRONT SUSPENSION — BALL JOINTS

The front suspension ball joints are permanently sealed. No regular maintenance is required for these components.

STEERING SHAFT SEAL

The steering shaft seal, at the point where the shaft passes through the bulkhead, is lubricated when it is installed. If the seal becomes noisy when the steering shaft is turned, it should be lubricated with a multipurpose grease. Mopar® multipurpose lubricant is recommended.

Steering Linkage

The tie rod end ball joints are permanently lubricated and do not require periodic maintenance.

DRIVE SHAFT UNIVERSAL JOINTS

Your vehicle has constant velocity universal joints. Periodic lubrication of these joints is not required. However, the joint boots should be inspected for external leakage or damage when other maintenance is performed. If leakage or damage is evident, the universal joint boot and grease should be replaced immediately.

Continued operation could result in failure of the universal joint due to water and dirt contamination of the grease. This would require complete replacement of the joint assembly.

BODY LUBRICATION

Locks and all body pivot points, including such items as seat tracks, doors, liftgate, sliding doors and hood hinges, should be lubricated periodically to assure quiet, easy operation and to protect against rust and wear. Prior to the application of any lubricant, the parts concerned should be wiped clean to remove dust and grit; after

lubricating excess oil and grease should be removed. Particular attention should also be given to hood latching components to ensure proper function. When performing other underhood services, the hood latch, release mechanism and safety catch should be cleaned and lubricated.

The external lock cylinders should be lubricated twice a year, preferably in the Fall and Spring. Apply a small amount of a high quality lubricant such as Mopar® Lock Cylinder Lubricant directly into the lock cylinder.

WINDSHIELD WIPER BLADES

The rubber edges of the wiper blades and the windshield should be cleaned periodically with a sponge or soft cloth and a mild nonabrasive cleaner. This will remove accumulations of salt or road film.

Operation of the wipers on dry glass for long periods may cause deterioration of the wiper blades. Always use washer fluid when using the wipers to remove salt or dirt from a dry windshield.

Avoid using the wiper blades to remove frost or ice from the windshield. Keep the blade rubber out of contact with petroleum products such as engine oil, gasoline, etc.

Windshield and Rear Window Washers

The fluid reservoir for the windshield washers and the rear window washer is shared. It is located in the engine compartment and should be checked for fluid level at regular intervals. Fill the reservoir with windshield washer solvent (not radiator antifreeze) and operate the system for a few seconds to flush out the residual water.

The washer fluid reservoir will hold a full gallon of fluid when the Low Washer Fluid Light illuminates.

WARNING!

Commercially available windshield washer solvents are flammable. They could ignite and burn you. Care must be exercised when filling or working around the washer solution.

After the engine has warmed, operate the defroster for a few minutes to reduce the possibility of smearing or freezing the fluid on the cold windshield. Mopar® All Weather Windshield Washer Solution, used with water as directed on the container, aids cleaning action, reduces the freezing point to avoid line clogging, and is not harmful to paint or trim.

COOLING SYSTEM

WARNING!

- **When working near the radiator cooling fan, disconnect the fan motor lead or turn the ignition switch to the OFF position. The fan is temperature controlled and can start at anytime the ignition switch is in the ON position.**
- **You or others can be badly burned by hot coolant or steam from your radiator. If you see or hear steam coming from under the hood, don't open the hood until the radiator has had time to cool. Never try to open a cooling system pressure cap when the radiator is hot.**

Coolant Checks

Check the engine coolant (antifreeze) protection every 12 months (before the onset of freezing weather, where applicable). If coolant is dirty or rusty in appearance, the system should be drained, flushed and refilled with fresh coolant. Check the front of the A/C condenser for any accumulation of bugs, leaves, etc. If dirty, clean by gently spraying water from a garden hose vertically down the face of the condenser.

Check the coolant recovery bottle tubing for brittle rubber, cracking, tears, cuts and tightness of the connection at the bottle and radiator. Inspect the entire system for leaks.

With the engine at normal operating temperature (but not running), check the cooling system pressure cap for proper vacuum sealing by draining a small amount of coolant from the radiator drain cock. If the cap is sealing properly, the engine coolant (antifreeze) will begin to

drain from the coolant recovery bottle. **DO NOT REMOVE THE COOLANT PRESSURE CAP WHEN THE COOLING SYSTEM IS HOT.**

Cooling System — Drain, Flush and Refill

The system should be drained, flushed, and refilled at the intervals shown in the “Maintenance Schedule” in Section 8 of this manual.

If the solution is dirty or contains a considerable amount of sediment, clean and flush with a reliable cooling system cleaner. Follow with a thorough rinsing to remove all deposits and chemicals. Properly dispose of old antifreeze solution.

Selection Of Coolant

Use only the manufacturer’s recommended coolant, refer to Fluids, Lubricants and Genuine Parts for correct coolant type.

CAUTION!

Mixing of coolants other than specified Hybrid Organic Additive Technology (HOAT) engine coolants, may result in engine damage and may decrease corrosion protection. If a non-HOAT coolant is introduced into the cooling system in an emergency, it should be replaced with the specified coolant as soon as possible.

Do not use plain water alone or alcohol base engine coolant (antifreeze) products. Do not use additional rust inhibitors or anti-rust products, as they may not be compatible with the radiator engine coolant and may plug the radiator.

This vehicle has not been designed for use with Propylene Glycol based coolants. Use of Propylene Glycol based coolants is not recommended.

Adding Coolant

Your vehicle has been built with an improved engine coolant that allows extended maintenance intervals. This coolant can be used up to five years or 102,000 mi (170 000 km) before replacement. To prevent reducing this extended maintenance period, it is important that you use the same coolant throughout the life of your vehicle. Please review these recommendations for using Hybrid Organic Additive Technology (HOAT) coolant.

When adding coolant, a minimum solution of 50% recommended Mopar® Antifreeze/ Coolant Five Year/ 100,000 mi (160 934 km) Formula HOAT (Hybrid Organic Additive Technology), or equivalent, in water should be used. Use higher concentrations (not to exceed 70%) if temperatures below -34°F (-37°C) are anticipated.

Use only high purity water such as distilled or deionized water when mixing the water/engine coolant solution.

The use of lower quality water will reduce the amount of corrosion protection in the engine cooling system.

Please note that it is the owner's responsibility to maintain the proper level of protection against freezing according to the temperatures occurring in the area where the vehicle is operated.

NOTE: Mixing coolant types will decrease the life of the engine coolant and will require more frequent coolant changes.

Cooling System Pressure Cap

The cap must be fully tightened to prevent loss of coolant, and to ensure that coolant will return to the radiator from the coolant recovery bottle.

The cap should be inspected and cleaned if there is any accumulation of foreign material on the sealing surfaces.

WARNING!

- **The warning words “DO NOT OPEN HOT” on the cooling system pressure cap are a safety precaution. Never add coolant when the engine is overheated. Do not loosen or remove the cap to cool an overheated engine. Heat causes pressure to build up in the cooling system. To prevent scalding or injury, do not remove the pressure cap while the system is hot or under pressure.**
- **Do not use a pressure cap other than the one specified for your vehicle. Personal injury or engine damage may result.**

Disposal of Used Coolant

Used ethylene glycol-based engine coolant is a regulated substance requiring proper disposal. Check with your local authorities to determine the disposal rules for your

community. To prevent ingestion by animals or children do not store ethylene glycol-based engine coolant in open containers or allow it to remain in puddles on the ground. If ingested by a child, contact a physician immediately. Clean up any ground spills immediately.

Coolant Level

The coolant bottle provides a quick visual method for determining that the coolant level is adequate. With the engine cold, the level of the coolant in the coolant recovery bottle should be between the ranges indicated on the bottle.

The radiator normally remains completely full, so there is no need to remove the radiator cap unless checking for coolant freeze point or replacing coolant. Advise your service attendant of this. As long as the engine operating temperature is satisfactory, the coolant bottle need only be checked once a month.

When additional coolant is needed to maintain the proper level, it should be added to the coolant bottle. Do not overfill.

Points To Remember

NOTE: When the vehicle is stopped after a few miles (a few kilometers) of operation, you may observe vapor coming from the front of the engine compartment. This is normally a result of moisture from rain, snow, or high humidity accumulating on the radiator and being vaporized when the thermostat opens, allowing hot coolant to enter the radiator.

If an examination of your engine compartment shows no evidence of radiator or hose leaks, the vehicle may be safely driven. The vapor will soon dissipate.

- Do not overfill the coolant recovery bottle.

- Check coolant freeze point in the radiator and in the coolant recovery bottle. If antifreeze needs to be added, contents of coolant recovery bottle must also be protected against freezing.
- If frequent coolant additions are required, or if the level in the coolant recovery bottle does not drop when the engine cools, the cooling system should be pressure tested for leaks.
- Maintain coolant concentration at 50% HOAT engine coolant (minimum) and distilled water for proper corrosion protection of your engine which contains aluminum components.
- Make sure that the radiator and coolant recovery bottle overflow hoses are not kinked or obstructed.
- Keep the front of the radiator clean. If your vehicle is equipped with air conditioning, keep the front of the condenser clean, also.

- Do not change the thermostat for summer or winter operation. If replacement is ever necessary, install **ONLY** the correct type thermostat. Other designs may result in unsatisfactory coolant performance, poor gas mileage, and increased emissions.

HOSES AND VACUUM/VAPOR HARNESESSES

Inspect surfaces of hoses and nylon tubing for evidence of heat and mechanical damage. Hard or soft spots, brittle rubber, cracking, tears, cuts, abrasions, and excessive swelling indicate deterioration of the rubber.

Pay particular attention to those hoses nearest to high heat sources such as the exhaust manifold. Inspect hose routing to be sure hoses do not come in contact with any heat source or moving component which may cause heat damage or mechanical wear.

Ensure nylon tubing in these areas has not melted or collapsed.

Inspect all hose connections such as clamps and couplings to make sure they are secure and no leaks are present.

Components should be replaced immediately if there is any evidence of wear or damage that could cause failure.

FUEL SYSTEM CONNECTIONS

The Electronic Fuel Injection high-pressure fuel system's hoses and quick connect fittings have unique material characteristics that provide adequate sealing and resist attack by deteriorated gasoline.

You are urged to use only the manufacture specified hoses with quick connect fittings, or their equivalent in material and specification, in any fuel system servicing. It is mandatory to replace any damaged hoses or quick connect fittings that have been removed during service. Care should be taken in installing quick connect fittings to ensure they are properly installed and fully connected. See your authorized dealer for service.

BRAKES

In order to assure brake system performance, all brake system components should be inspected periodically. Suggested service intervals can be found in the Maintenance Schedules.

WARNING!

Riding the brakes can lead to brake failure and possibly an accident. Driving with your foot resting or riding on the brake pedal can result in abnormally high brake temperatures, excessive lining wear, and possible brake damage. You wouldn't have your full braking capacity in an emergency.

Brake And Power Steering Hoses

When the vehicle is serviced for scheduled maintenance, inspect surface of hoses and nylon tubing for evidence of heat and mechanical damage. Hard and brittle rubber,

cracking, tears, cuts, abrasion, and excessive swelling indicate deterioration of the rubber. Particular attention should be made to examining those hose surfaces nearest to high heat sources, such as the exhaust manifold.

Ensure nylon tubing in these areas has not melted or collapsed.

Inspect all hose connections such as clamps and couplings to make sure they are secure and no leaks are present.

NOTE: Often, fluid such as oil, power steering fluid, and brake fluid are used during assembly plant operations to facilitate the assembly of hoses to couplings. Therefore, oil wetness at the hose-coupling area is not necessarily an indication of leakage. Actual dripping of hot fluid when systems are under pressure (during vehicle operation), should be noted before hose is replaced based on leakage.

NOTE: Inspection of brake hoses should be performed whenever the brake system is serviced and every engine oil change. Inspect hydraulic brake hoses for surface cracking, scuffing, or worn spots. If there is any evidence of cracking, scuffing, or worn spots, the hose should be replaced immediately! Eventual deterioration of the hose can take place resulting in a possibility of a burst failure.

WARNING!

Worn brake hoses can burst and cause brake failure. You could have an accident. If you see any signs of cracking, scuffing, or worn spots, have the brake hoses replaced immediately.

Master Cylinder — Brake Fluid Level Check

The fluid level in the master cylinder should be checked when performing underhood services, or immediately if the brake system warning light indicates system failure.

Clean the top of the master cylinder area before removing the cap. Add fluid to bring the level up to the top of the “FULL” mark on the side of the master cylinder reservoir.

Overfilling of fluid is not recommended because it may cause leaking in the system.

Add enough fluid to bring the level up to the requirements described on the brake fluid reservoir. With disc brakes, fluid level can be expected to fall as the brake pads wear. However, low fluid level may be caused by a leak and a checkup may be needed.

Use only manufacturer’s recommended brake fluid, refer to Fluids, Lubricants and Genuine Parts for correct fluid type.

WARNING!

- **Overfilling the brake fluid reservoir can result in spilling brake fluid on hot engine parts and the brake fluid catching fire.**
- **Use of a brake fluid that has a lower initial boiling point than the recommended MOPAR® DOT 3 product or a brake fluid that is unidentified as to FMVSS specification may result in sudden brake failure during hard prolonged braking. You could have an accident.**

Use only brake fluid that has been in a tightly closed container to avoid contamination from foreign matter or moisture.

CAUTION!

Do not allow petroleum base fluid to contaminate the brake fluid — all brake seal components could be damaged causing partial or complete brake failure.

AUTOMATIC TRANSAXLE

The automatic transaxle and differential assembly are contained within a single housing.

The fluid level in the automatic transaxle should be checked whenever the vehicle is serviced. Operation with an improper fluid level will greatly reduce the life of the transaxle and the fluid.

All Four-Speed automatic transaxles are equipped with a conventional filler tube and dipstick. If fluid is added, it should be added through the filler tube.

All six speed transaxles are equipped with a capped dipstick tube, it is sealed and should not be tampered with. Your authorized dealer has the necessary tools to ensure that the fluid level is set properly.

Selection of Lubricant

It is important that the proper lubricant is used in the transaxle to assure optimum transaxle performance. Use only manufacturer's recommended transaxle fluid; refer to Fluids, Lubricants and Genuine Parts for correct fluid type. It is important that the transaxle fluid be maintained at the prescribed level using the recommended fluid. No chemical flushes should be used in any transaxle; only the approved lubricant may be used.

CAUTION!

Using a transaxle fluid other than the manufacturer's recommended fluid may cause deterioration in transaxle shift quality and/or torque converter shudder. Using a transaxle fluid other than the manufacturer's recommended fluid will result in more frequent fluid and filter changes. Refer to Fluids, Lubricants and Genuine Parts for correct fluid type.

Fluid Level Check — 3.8L and 4.0L Engines with Six-Speed Automatic Transaxle — If Equipped

The Six-Speed automatic transaxle is a sealed unit and has no dipstick. See your authorized dealer to have the transaxle fluid checked or serviced.

Fluid Level Check — 3.3L Engine with Four-Speed Automatic Transaxle — If Equipped

The dipstick is located just behind the radiator, lower right side.

4 SPEED DIPSTICK

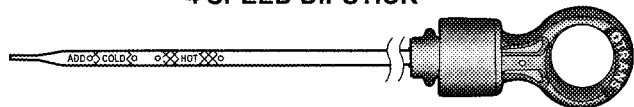

80f34e48

4 Speed ATX Dipstick

To properly check the automatic transaxle fluid level, the following procedure must be used:

1. The vehicle must be on level ground.
2. The engine should be running at curb idle speed for a minimum of 60 seconds.
3. Fully apply parking brake.

4. Place the gear selector lever momentarily in each gear position ending with the lever in PARK. Wipe the area around the dipstick clean to eliminate the possibility of dirt entering the transaxle.

5. Remove the dipstick and determine if the fluid is hot or warm. Hot fluid is approximately 180°F (82°C), which is the normal operating temperature after the vehicle has been driven at least 15 miles (24 km). The fluid cannot be comfortably held between the finger tips. Cold is when the fluid is below 80°F (27°C).

6. Wipe the dipstick clean and reinsert until seated. Remove dipstick and note reading.

- a. If the fluid is hot, the reading should be in the crosshatched area marked "HOT" (between the upper two holes in the dipstick).
- b. If the fluid is cold, the fluid level should be between the lower two holes in the area marked "COLD".

If the fluid level indicates low, add sufficient fluid to bring to the proper level.

CAUTION!

Do not overfill. Dirt and water in the transaxle can cause serious damage. To prevent dirt and water from entering the transaxle after checking or replenishing fluid, make certain that the dipstick cap is reseated properly.

Fluid and Filter Changes

Refer to the “Maintenance Schedule” in Section 8 of this manual for the recommended transaxle fluid and filter change intervals.

If the transaxle is disassembled for any reason, the fluid and filter should be changed.

Special Additives

Automatic Transmission Fluid (ATF) is an engineered product and its performance may be impaired by supplemental additives. Therefore, do not add any fluid additives to the transaxle. The only exception to this policy is the use of special dyes to aid in detecting fluid leaks. In addition, avoid using transaxle sealers as they may adversely affect seals.

FRONT AND REAR WHEEL BEARINGS

Front and rear wheel bearings are permanently sealed. No regular maintenance is required for these components.

APPEARANCE CARE AND PROTECTION FROM CORROSION

Protection of Body and Paint from Corrosion

Vehicle body care requirements vary according to geographic locations and usage. Chemicals that make roads passable in snow and ice, and those that are sprayed on

trees and road surfaces during other seasons, are highly corrosive to the metal in your vehicle. Outside parking, which exposes your vehicle to airborne contaminants, road surfaces on which the vehicle is operated, extreme hot or cold weather and other extreme conditions will have an adverse effect on paint, metal trim, and underbody protection.

The following maintenance recommendations will enable you to obtain maximum benefit from the corrosion resistance built into your vehicle.

What Causes Corrosion?

Corrosion is the result of deterioration or removal of paint and protective coatings from your vehicle.

The most common causes are:

- Road salt, dirt and moisture accumulation
- Stone and gravel impact

- Insects, tree sap and tar
- Salt in the air near seacoast localities
- Atmospheric fallout/industrial pollutants

Washing

- Wash your vehicle regularly. Always wash your vehicle in the shade using Mopar® Car Wash or a mild car wash soap, and rinse the panels completely with clear water.
- If insects, tar or other similar deposits have accumulated on your vehicle, use Mopar® Super Kleen Bug and Tar Remover to remove.
- Use Mopar® Cleaner Wax to remove road film, stains and to protect your paint finish. Take care never to scratch the paint.

- Avoid using abrasive compounds and power buffing that may diminish the gloss or thin out the paint finish.

CAUTION!

Do not use abrasive or strong cleaning materials such as steel wool or scouring powder, which will scratch metal and painted surfaces.

Special Care

- If you drive on salted or dusty roads or if you drive near the ocean, hose off the undercarriage at least once a month.
- It is important that the drain holes in the lower edges of the doors, rocker panels and trunk be kept clear and open.
- If you detect any stone chips or scratches in the paint, touch them up immediately. The cost of such repairs is considered the responsibility of the owner.
- If your vehicle is damaged due to an accident or similar cause which destroys the paint and protective coating, have your vehicle repaired as soon as possible. The cost of such repairs is considered the responsibility of the owner.
- If you carry special cargo such as chemicals, fertilizers, de-icer salt, etc., be sure that such materials are well packaged and sealed.
- If a lot of driving is done on gravel roads, consider mud or stone shields behind each wheel.
- Use Mopar® touch up paint on scratches as soon as possible. Your authorized dealer has touch up paint to match the color of your vehicle.

Wheel and Wheel Trim Care

All wheels and wheel trim, especially aluminum and chrome-plated wheels should be cleaned regularly with a mild soap and water to prevent corrosion. To remove heavy soil and/or excessive brake dust, use Mopar® Wheel Cleaner (05066247AB) or equivalent or select a nonabrasive, non-acidic cleaner. Do not use scouring pads, steel wool, a bristle brush, or metal polishes. Only Mopar® or equivalent is recommended. Do not use oven cleaner. Avoid automatic car washes that use acidic solutions or harsh brushes that may damage the wheels' protective finish.

Interior Care

Instrument Panel Surfaces

The instrument panel cover has a low glare surface, which minimizes reflections in the windshield. Do not

use protectants or other products, which may cause undesirable reflections. Use soap and warm water to restore the low glare surface.

Cleaning Interior Trim

Interior Trim should be cleaned starting with a damp cloth, a damp cloth with Mopar® Total Clean, then Mopar® Spot & Stain Remover if absolutely necessary. Do not use harsh cleaners or Armorall. Use Mopar® Total Clean to clean vinyl upholstery

Cleaning Leather Upholstery

Mopar® Total Clean is specifically recommended for leather upholstery.

Your leather upholstery can be best preserved by regular cleaning with a damp soft cloth. Small particles of dirt can act as an abrasive and damage the leather upholstery and should be removed promptly with a damp cloth. Stubborn soils can be removed easily with a soft cloth and Mopar® Total Clean. Care should be taken to avoid

soaking your leather upholstery with any liquid. Please do not use polishes, oils, cleaning fluids, solvents, detergents, or ammonia-based cleaners to clean your leather upholstery. Application of a leather conditioner is not required to maintain the original condition.

WARNING!

Do not use volatile solvents for cleaning purposes. Many are potentially flammable, and if used in closed areas they may cause respiratory harm.

YES Essentials® Fabric Cleaning Procedure – If Equipped

YES Essentials® seats may be cleaned in the following manner:

- Remove as much of the stain as possible by blotting with a clean, dry towel.

- Blot any remaining stain with a clean, damp towel.
- For tough stains, apply Mopar® Total Clean or a mild soap solution to a clean, damp cloth and remove stain. Use a fresh, damp towel to remove soap residue.
- For grease stains, apply Mopar® Multi-Purpose Cleaner to a clean, damp cloth and remove stain. Use a fresh, damp towel to remove soap residue.
- Do not use any solvents or protectants on Yes Essentials® products.

Cleaning High Gloss Front Door and Pillar Appliques

When cleaning the front door B-pillar appliques, care must be taken to avoid scratching the plastic.

1. Remove all dirt with a wet soft rag. A mild soap solution may be used, do not use high alcohol content or abrasive cleaners. Glass cleaners are not recommended. If soap is used, wipe clean with a clean damp rag.

2. To maintain the high gloss shine, apply a scratch and swirl remover onto a damp cloth and apply to door applique. Rub the applique with a firm pressure then buff lightly with a clean cotton cloth until a high gloss shine is achieved.

Cleaning Headlights

Your vehicle has plastic headlights that are lightweight and less susceptible to stone breakage than glass headlights.

Plastic is not as scratch resistant as glass and therefore different lens cleaning procedures must be followed.

To minimize the possibility of scratching the lenses and reducing light output, avoid wiping with a dry cloth. To remove road dirt, wash with a mild soap solution followed by rinsing.

Do not use abrasive cleaning components, solvents, steel wool or other aggressive material to clean the lenses.

Glass Surfaces

All glass surfaces should be cleaned on a regular basis with Mopar® Glass Cleaner or any commercial household-type glass cleaner. Never use an abrasive type cleaner. Use caution when cleaning the inside rear window equipped with electric defrosters or the right rear quarter window equipped with the radio antenna. Do not use scrapers or other sharp instruments which may scratch the elements.

When cleaning the rearview mirror, spray cleaner on the towel or rag that you are using. Do not spray cleaner directly on the mirror.

Cleaning Plastic Instrument Cluster Lenses

The lenses in front of the instruments in this vehicle are molded in clear plastic. When cleaning the lenses, care must be taken to avoid scratching the plastic.

1. Clean with a wet soft rag. A mild soap solution may be used, but do not use high alcohol content or abrasive cleaners. If soap is used, wipe clean with a clean damp rag.

2. Dry with a soft tissue.

Seat Belt Maintenance

Do not bleach, dye or clean the seatbelts with chemical solvents or abrasive cleaners. This will weaken the fabric. Sun damage can also weaken the fabric.

If the seat belts need cleaning, use a mild soap solution or lukewarm water. Do not remove the belts from the car to wash them.

Replace the seat belts if they appear frayed or worn or if the buckles do not work properly.

Cleaning The Instrument Panel Cup Holders

Removal

Pull the flexible liner from the cup holder drawer; starting at one edge to ease removal.

Cleaning

The liner is top shelf dishwasher safe, or you may follow the cleaning procedure below.

Soak the liner in a mixture of medium hot tap water and one teaspoon of mild liquid dish soap. Let soak for approximately 30 minutes. After 30 minutes pull the liner from the water and dip it back into the water about six times. This will loosen any remaining debris. Rinse the liner thoroughly under warm running water. Shake the excess water from the liner and dry the outer surfaces with a clean soft cloth.

Installation

Place the liner into the cupholder drawer and press the liner into place so that the retention tabs seat into the corresponding openings in the drawer.

FUSES/TOTALLY INTEGRATED POWER MODULE (TIPM)

The Totally Integrated Power Module (TIPM) is located in the engine compartment near the battery. This center contains cartridge fuses and mini fuses. A label that identifies each component may be printed or embossed on the inside of the cover.

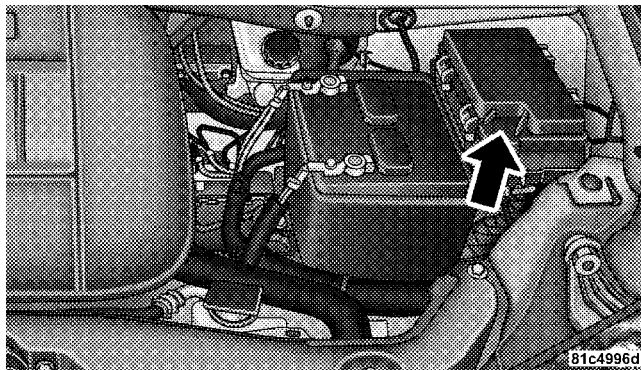
**TIPM Location**

The numbers inside the TIPM cover correspond to the following table.

FUSES/TIPM			
Cavity	Cartridge Fuse	Mini Fuse	Description
J1	40 Amp Green	—	Power Folding Seat
J2	30 Amp Pink	—	Power Liftgate Module
J3	40 Amp Green	—	Rear Door Module (RR Door Node)
J4	25 Amp Natural	—	Driver Door Node
J5	25 Amp Natural	—	Passenger Door Node
J6	40 Amp Green	—	Anti-Lock Brake System (ABS) Pump/ESP
J7	30 Amp Pink	—	Anti-Lock Brake System (ABS) Valve
J8	40 Amp Green	—	Power Memory Seat (If Equipped)
J9	40 Amp Green	—	PZEV Motor/Flex Fuel

FUSES/TIPM			
Cavity	Cartridge Fuse	Mini Fuse	Description
J10	30 Amp Pink	—	Headlamp Wash Relay/Manual Tuning Valve
J11	30 Amp Pink	—	Power Sliding Door Module
J13	60 Amp Yellow	—	Ignition Off Draw (IOD) — Main
J14	40 Amp Green	—	Rear Window Defogger
J15	30 Amp Pink	—	Rear Blower
J17	40 Amp Green	—	Starter Solenoid
J18	20 Amp Yellow	—	Powertrain Control Module (PCM) Trans Range
J19	60 Amp Yellow	—	Radiator Fan
J20	30 Amp Pink	—	Front Wiper LO/HI

FUSES/TIPM			
Cavity	Cartridge Fuse	Mini Fuse	Description
J21	20 Amp Yellow	—	Front/Rear Washer
J22	25 Amp Natural	—	Sunroof Module
M1	—	15 Amp Blue	Center High Mounted Stop Light (CHMSL)/ Brake Switch
M2	—	20 Amp Yellow	Trailer Lighting
M3	—	20 Amp Yellow	—
M4	—	10 Amp Red	Trailer Tow
M5	—	25 Amp Natural	Inverter
M6	—	20 Amp Yellow	—

FUSES/TIPM			
Cavity	Cartridge Fuse	Mini Fuse	Description
M7	—	20 Amp Yellow	Power Outlet #2 (BATT/ ACC SELECT)
M8	—	20 Amp Yellow	Front Heated Seat (If Equipped)
M9	—	20 Amp Yellow	Rear Heated Seat (If Equipped)
M10	—	20 Amp Yellow	Ignition Off Draw — Vehicle Entertainment System (IOD-VES), Satellite Digital Audio Receiver (SDARS), DVD, Hands-Free Module (HFM), Universal Garage Door Opener (UGDO), Vanity Lamp (VANITY LP)
M11	—	10 Amp Red	(Ignition Off Draw) IOD-HVAC/ATC, MW SENSR, Underhood Lamp (UH LMP)

FUSES/TIPM			
Cavity	Cartridge Fuse	Mini Fuse	Description
M12	—	30 Amp Green	Amplifier (AMP)
M13	—	20 Amp Yellow	Ignition Off Draw—Cabin Compartment Node (IOD-CCN), Wireless Control Module (WCM), SIREN, Clock Module (CLK MOD), Multi-Function Control Switch (MULTIFCTN SW)
M14	—	20 Amp Yellow	Trailer Tow (Export Only)

FUSES/TIPM			
Cavity	Cartridge Fuse	Mini Fuse	Description
M15	—	20 Amp Yellow	COL MOD, IR SNS, Heater Ventilation, Air Conditioning/Automatic Temperature Control (HVAC/ATC), Rear View Mirror (RR VW MIR), Cabin Compartment Node (CCN), Transfer Case Switch (T-CASE SW), RUN/ST, Multi-Function Control Switch (MULTIFCTN SW), Tire Pressure Monitor (TPM), Glow Plug Module (GLW PLG MOD) — Export Diesel Only
M16	—	10 Amp Red	Occupant Restraint Controller/Occupant Classification Module (ORC/OCM)

FUSES/TIPM			
Cavity	Cartridge Fuse	Mini Fuse	Description
M17	—	15 Amp Blue	Left Tail/License/Park Lamp (LT-TAIL/LIC/PRK LMP)
M18	—	15 Amp Blue	Right Tail/Park/Run Lamp (RT-TAIL/PRK/RUN LMP)
M19	—	25 Amp Natural	Auto Shut Down (ASD #1 and #2)
M20	—	15 Amp Blue	Cabin Compartment Node Interior Light (CCN INT LIGHT), Switch Bank (SW BANK), Steering Control Module (SCM)
M21	—	20 Amp Yellow	Auto Shut Down (ASD #3)
M22	—	10 Amp Red	Right Horn (RT HORN (HI/LOW)

FUSES/TIPM			
Cavity	Cartridge Fuse	Mini Fuse	Description
M23	—	10 Amp Red	Left Horn (LT HORN (HI/LOW)
M24	—	25 Amp Natural	Rear Wiper (REAR WIPER)
M25	—	20 Amp Yellow	Fuel Pump (FUEL PUMP), Diesel Lift Pump (DSL LIFT PUMP) — Export Only
M26	—	10 Amp Red	Power Mirror Switch (PWR MIRR SW), Driver Window Switch (DRVR WIND SW)
M27	—	10 Amp Red	Ignition Switch (IGN SW), Window Module (WIN MOD)
M28	—	10 Amp Red	Next Generation Controller (NGC), Transmission Feed (TRANS FEED), J1962

FUSES/TIPM			
Cavity	Cartridge Fuse	Mini Fuse	Description
M29	—	10 Amp Red	Occupant Classification Module (OCM)
M30	—	15 Amp Blue	Rear Wiper Module (RR WIPER MOD), Power Folding Mirror (PWR FOLD MIR)
M31	—	20 Amp Yellow	Back-Up Lamps (B/U LAMPS)
M32	—	10 Amp Red	Occupant Restraint Controller (ORC), TT EUROPE
M33	—	10 Amp Red	Next Generation Controller (NGC), Global Powertrain Engine Controller (GPEC)

FUSES/TIPM			
Cavity	Cartridge Fuse	Mini Fuse	Description
M34	—	10 Amp Red	Park Assist (PRK ASST), Heater Ventilation, Air Conditioning Module (HVAC MOD), Headlamp Wash (HDLP WASH), Compass (COMPAS)
M35	—	10 Amp Red	Heated Mirrors
M36	—	20 Amp Yellow	Power Outlet #3 (BATT)
M37	—	10 Amp Red	Anti-Lock Brake System (ABS), Electronic Stability Program (ESP), Stop Lamp Switch (STP LP SW), Fuel Pump Rly Hi Control

FUSES/TIPM			
Cavity	Cartridge Fuse	Mini Fuse	Description
M38	—	25 Amp Natural	Lock/Unlock Motors (LOCK/UNLOCK MTRS)

CAUTION!

- When installing the Integrated Power Module cover, it is important to ensure the cover is properly positioned and fully latched. Failure to do so may allow water to get into the Integrated Power Module, and possibly result in a electrical system failure.
- When replacing a blown fuse, it is important to use only a fuse having the correct amperage rating. The use of a fuse with a rating other than indicated may result in a dangerous electrical system overload. If a properly rated fuse continues to blow, it indicates a problem in the circuit that must be corrected.

The Heated Mirrors, Lower Instrument Panel Power Outlet and Removable Floor Console, when in the front position are fused with self-resetting fuses that are only serviceable by an authorized dealer. The power seats are fused by a 30 Amp circuit breaker located under the driver's seat. The Power Windows are fused by a 25 Amp circuit breaker located under the instrument panel near the steering column. If you experience temporary or permanent loss of these systems, see your authorized dealer for service.

VEHICLE STORAGE

If you are leaving your vehicle dormant for more than 21 days you may want to take steps to protect your battery. You may do the following:

- Remove the 20 Amp mini-fuse in the Integrated Power Module labeled Ignition-Off Draw (IOD).
- Or, disconnect the negative cable from the battery.

- Anytime you store your vehicle, or keep it out of service for two weeks or more, run the air conditioning system at idle for about five minutes in the fresh air and high blower setting. This will ensure adequate system lubrication to minimize the possibility of compressor damage when the system is started again.

REPLACEMENT LIGHT BULBS

LIGHT BULBS — Interior	Bulb Number
Center & Rear Dome Light	578
Center & Rear Reading Lights	578
Front Door Courtesy Light	578
Front Header Reading Lights — If Equipped	578
Instrument Cluster Lights	PC74
Liftgate Light(s).	578
Overhead Console Reading Lights	PC579
Removable Console Light — If Equipped	194
Visor Vanity Lights	6501966

NOTE: For lighted switches, see your dealer for replacement.

All of the interior bulbs are glass wedge base or glass cartridge types. Aluminum base bulbs are not approved and should not be used for replacement.

LIGHT BULBS — Exterior	Bulb Number
Backup, Tail, Stop Light	3157
Center High-Mounted Stop Light . . .	LED (See Note 1)
Fog Light — If Equipped	9145
Front Side Marker, Park/Turn Signal.	P27 / 7W or 3157
Headlight	H13
License.	168

Note 1: The Center High-Mounted Stop Light (CHMSL) uses LED lights that are not serviceable separately. The CHMSL must be replaced as an assembly, see your authorized Dealer.

BULB REPLACEMENT

Headlights

1. Raise the hood to access the rear of the headlight housing.
2. Slide the red lock tab rearward on the connector, then depress the tab and remove the connector from the bulb.
3. Twist the headlight bulb and pull the bulb from headlight housing.
4. Install the new headlight bulb and twist until locked into the headlight housing.

CAUTION!

Do not touch the new bulb with your fingers. Oil contamination will severely shorten bulb life. If the bulb comes in contact with an oily surface, clean the bulb with rubbing alcohol.

5. Connect the wiring connector to bulb and slide red lock tab forward.

Front Park/Turn Signal and Side Marker Lights

1. Raise the hood to access the rear of the headlight housing.

2. Twist the turn signal socket and remove from the headlight housing, then pull the bulb out.

3. Push the new bulb into the socket and reinstall the socket by twisting until locked into the headlight housing.

Fog Lights

NOTE: Access to the fog light bulb is from the rear of the fascia. On the left rear side of the fascia, remove the push pin and lower the hinged access door on the air dam.

1. From behind the bumper fascia, or the access panel on the air dam, twist the bulb counterclockwise, and remove bulb.

CAUTION!

Do not touch the new bulb with your fingers. Oil contamination will severely shorten bulb life. If the bulb comes in contact with an oily surface, clean the bulb with rubbing alcohol.

2. Disconnect wire harness from the bulb.

3. Reconnect the wiring harness to the new bulb and reinstall the bulb by twisting clockwise.

Rear Tail, Stop, Turn Signal, Side Marker and Backup Lights

1. Raise the liftgate.
2. Remove the tail light assembly by removing the two screws from the inboard side. Use a fiber stick or similar tool to gently pry the light on the outboard side to disengage the two ball studs.

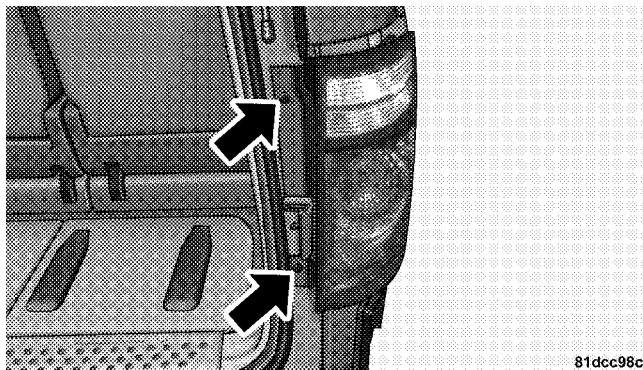

81dcc98c

Removing Tail Light Assembly

NOTE:

- If a screwdriver is used, make sure a soft material is placed between the vehicle body and tool so not to scratch the paint.
- The PRY location is best closest to the studs while dislodging them separately.

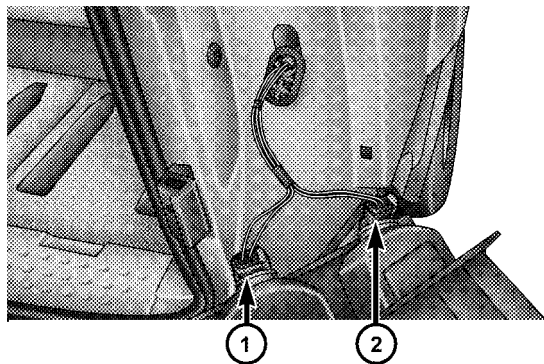

81bc563e

1 — Stop, Tail, Turn Signal
bulb combo

2 — Backup Bulb

3. Twist the socket and remove from the light assembly.
4. Pull the bulb to remove it from the socket.
5. Replace the bulb, reinstall the socket, and reattach the light assembly.

Center High-Mounted Stop Light (CHMSL)

The CHMSL uses LED lights that are not serviceable separately. The CHMSL must be replaced as an assembly, see your authorized Dealer.

License Light

The light for the license plate light is located under the tailgate light bar and above the license plate.

1. Using a small screwdriver, press inward the locking tab on the outboard side of the light assembly and pull down on the light assembly for removal.
2. Twist and remove the socket from the light assembly and pull the bulb out to remove.
3. Push the bulb into the socket, twist the socket into the light assembly and reinstall the light assembly into place ensuring the locking tab is secure.

FLUIDS AND CAPACITIES

FLUIDS AND CAPACITIES	U.S.	Metric
Fuel (approximate)		
All Engines	20 Gals	76 L
Engine Oil with Filter		
3.3L and 3.8L (SAE 5W-20 API Certified)	5.0 Qts	4.7 L
4.0L (SAE 10W-30 API Certified)	5.5 Qts	5.2 L
Cooling System ³		
3.3L, 3.8L and 4.0L (Use Mopar® Antifreeze/Coolant Five Year/ 100,000 Mile Formula or equivalent.)	13.4 Qts	12.6 L
³ Includes heater and coolant recovery bottle filled to MAX level. Add 2.9 Qts (2.8 L) if equipped with a rear heater		

FLUIDS, LUBRICANTS AND GENUINE PARTS

Engine

FLUIDS, LUBRICANTS AND GENUINE PARTS — ENGINE	
Component	Fluids, Lubricants and Genuine Parts
Coolant	Mopar® Antifreeze/Coolant Five Year/100,000 Mile Formula HOAT (Hybrid Organic Additive Technology) or equivalent
Oil – 3.3L, 3.8L	Use API Certified SAE 5W-20 engine oil. Refer to your oil filler cap for correct SAE grade, meeting DaimlerChrysler Material Standard MS-6395.
Oil – 4.0L	Use API Certified SAE 10W-30 engine oil. Refer to your oil filler cap for correct SAE grade, meeting DaimlerChrysler Material Standard MS-6395.
Oil Filter – 3.3L, 3.8L	Mopar® 4105409 or equivalent
Oil Filter – 4.0L	Mopar 5281090 or equivalent. Refer to your oil filler cap for correct SAE grade.
Spark Plugs – 3.3L, 3.8L, 4.0L	ZFR5LP-13G (Gap.050 in / 1.27 mm)
Fuel – 3.3L, 3.8L	87 Octane
Fuel – 4.0L	87 Octane Acceptable — 89 Recommended

Chassis

FLUIDS, LUBRICANTS AND GENUINE PARTS — CHASSIS	
Component	Fluids, Lubricants and Genuine Parts
Automatic Transmission	Mopar® ATF+4 Automatic Transmission Fluid
Brake Master Cylinder	Mopar® DOT 3 and SAE J1703 should be used or equivalent. If DOT 3 brake fluid is not available, then DOT 4 is acceptable. Use only recommended brake fluids.
Power Steering Reservoir	Mopar® Power Steering Fluid +4 or Mopar® ATF+4 Automatic Transmission Fluid

MAINTENANCE SCHEDULES

CONTENTS

■ Emissions Control System Maintenance	490	□ Required Maintenance Intervals	493
■ Maintenance Schedule	490		

EMISSIONS CONTROL SYSTEM MAINTENANCE

The Scheduled Maintenance services listed in **bold type**, must be done at the times or mileages specified to ensure the continued proper functioning of the Emissions Control System. These, and all other maintenance services included in this manual, should be done to provide best vehicle performance and reliability. More frequent maintenance may be needed for vehicles in severe operating conditions, such as dusty areas and very short trip driving.

Inspection and service should also be done anytime a malfunction is suspected.

NOTE: Maintenance, replacement, or repair of the emissions control devices and systems on your vehicle may be performed by any automotive repair establishment or individual using any automotive part that has been certified pursuant to U.S. EPA or in the State of California, California Air Resources Board regulations.

MAINTENANCE SCHEDULE

The oil change indicator system will remind you that it is time to take your vehicle in for scheduled maintenance.

On Non-EVIC equipped vehicles **CHAngE OIL** will flash in the instrument cluster odometer and a single chime will sound, indicating that an oil change is necessary.

On Electronic Vehicle Information Center (EVIC) equipped vehicles **Oil Change Required** will be displayed in the EVIC and a single chime will sound, indicating that an oil change is necessary.

Based on engine operation conditions the oil change indicator message will illuminate, this means that service is required for your vehicle. Have your vehicle serviced as soon as possible, within the next 500 mi (805 km).

NOTE:

- The oil change indicator message will not monitor the time since the last oil change. Change your vehicle's oil if it has been six months since your last oil change even if the oil change indicator message is NOT illuminated.
- Change your engine oil more often if you drive your vehicle off-road for an extended period of time.
- Under no circumstances should oil change intervals exceed 6,000 mi (10 000 km) or six months, whichever comes first.

Your authorized dealer will reset the oil change indicator message after completing the scheduled oil change. If this scheduled oil change is performed by someone other than your dealer, the message can be reset by referring to the steps described under “Oil Change Required” in “Use Factory Settings” of the EVIC section in this manual or

under “Odometer/Trip Odometer” in the “Instrument Cluster Descriptions” section of this manual.

At Each Stop For Fuel

- Check the engine oil level about five minutes after a fully warmed engine is shut off. Checking the oil level while the vehicle is on level ground will improve the accuracy of the oil level reading. Add oil only when the level is at or below the ADD, SAFE or MIN mark.
- Check the windshield washer solvent and add if required.

Once A Month

- Check tire pressure and look for unusual wear or damage.
- Inspect the battery and clean and tighten the terminals as required.

492 MAINTENANCE SCHEDULES

- Check the fluid levels of coolant reservoir, brake master cylinder, power steering and transmission and add as needed.
- Check all lights and other electrical items for correct operation.

At Each Oil Change

- Change the engine oil filter.
- Inspect the brake hoses and lines.

CAUTION!

Failure to perform the required maintenance items may result in damage to the vehicle.

Required Maintenance Intervals

	Perform Maintenance Every (Where time and mileage are listed, follow the interval that occurs first.)		
Maintenance Items	Miles	Kilometers	or Months
Change the engine oil and engine oil filter.	6,000	10 000	6
Rotate Tires.	6,000	10 000	6
If using your vehicle for any of the following: Dusty or off-road conditions. Inspect the engine air cleaner filter, replace if necessary.	12,000	20 000	12
Inspect the brake linings, replace if necessary.	12,000	20 000	12
Replace the air conditioning filter.	12,000	20 000	12
Inspect the CV Joints. Perform the first inspection at 12,000 mi (20 000 km) or 12 months.	24,000	40 000	24
Inspect Exhaust System. Perform the first inspection at 12,000 mi (20 000 km) or 12 months.	24,000	40 000	24
Inspect the front suspension, tie rod ends and boot seals, replace if necessary.	24,000	40 000	24
Replace the engine air cleaner filter.	30,000	50 000	30

	Perform Maintenance Every (Where time and mileage are listed, follow the interval that occurs first.)		
Maintenance Items	Miles	Kilometers	or Months
Change the automatic transmission fluid & filter if using your vehicle for any of the following: police, taxi, fleet or frequent trailer towing.	60,000	100 000	60
Inspect and replace PCV valve if necessary. †	90,000	150 000	90
Flush and replace the engine coolant.	102,000	170 000	60
Replace the ignition cables on 3.3L, 3.8L engines.	102,000	170 000	102
Replace the spark plugs on 3.3L, 3.8L, 4.0L engines.	102,000	170 000	102
Replace the timing belt on 4.0L engines.	102,000	170 000	102
Change the automatic transmission fluid & filter.	120,000	200 000	120
Replace Accessory Drive Belt(s).	120,000	200 000	120
† This maintenance is recommended by the manufacturer to the owner, but is not required to maintain emissions warranty.			

WARNING!

You can be badly injured working on or around a motor vehicle. Do only that service work for which you have the knowledge and the right equipment. If you have any doubt about your ability to perform a service job, take your vehicle to a competent mechanic.

IF YOU NEED CONSUMER ASSISTANCE

CONTENTS

■ Suggestions For Obtaining Service For Your Vehicle	499	□ Customer Assistance For The Hearing Or Speech Impaired (TDD/TTY)	501
□ Prepare For The Appointment	499	□ Service Contract	501
□ Prepare A List	499	■ Warranty Information (U.S. Vehicles Only)	502
□ Be Reasonable With Requests	499	■ MOPAR®Parts	503
■ If You Need Assistance	499	■ Reporting Safety Defects	503
□ Chrysler LLC Customer Center	500	□ In The 50 United States And Washington, D.C.	503
□ Chrysler Canada Inc. Customer Center	501	□ In Canada	503
□ In Mexico Contact	501	■ Publication Order Forms	504

- Department Of Transportation Uniform Tire Quality Grades505
 - Treadwear505

- Traction Grades505
- Temperature Grades506

SUGGESTIONS FOR OBTAINING SERVICE FOR YOUR VEHICLE

Prepare For The Appointment

If you're having warranty work done, be sure to have the right papers with you. Take your warranty folder. All work to be performed may not be covered by the warranty. Discuss additional charges with the service manager. Keep a maintenance log of your vehicle's service history. This can often provide a clue to the current problem.

Prepare A List

Make a written list of your vehicle's problems or the specific work you want done. If you've had an accident or work done that is not on your maintenance log, let the service advisor know.

Be Reasonable With Requests

If you list a number of items and you must have your vehicle by the end of the day, discuss the situation with the service advisor and list the items in order of priority. At many authorized dealers, you may obtain a rental vehicle at a minimal daily charge. If you need a rental, it is advisable to make these arrangements when you call for an appointment.

IF YOU NEED ASSISTANCE

The manufacturer and its authorized dealers are vitally interested in your satisfaction. We want you to be happy with our products and services.

Warranty service must be done by an authorized dealer. We strongly recommend that you take the vehicle to an authorized selling dealer. They know you and the vehicle best, and are most concerned that you get prompt and

high quality service. The manufacturer's authorized dealers have the facilities, factory-trained technicians, special tools, and the latest information to ensure the vehicle is fixed correctly and in a timely manner.

This is why you should always talk to an authorized dealer's service manager first. Most matters can be resolved with this process.

- If for some reason you are still not satisfied, talk to the general manager or owner of the authorized dealership. They want to know if you need assistance.
- If an authorized dealership is unable to resolve the concern, you may contact the Manufacturer's Customer Center.

Any communication to the Manufacturer's Customer Center should include the following information:

- Owner's name and address
- Owner's telephone number (home and office)
- Authorized dealership name
- Vehicle Identification Number (VIN)
- Vehicle delivery date and mileage

Chrysler LLC Customer Center

P.O. Box 21-8004

Auburn Hills, MI 48321-8004

Phone: (800) 992-1997

Chrysler Canada Inc. Customer Center

P.O. Box 1621

Windsor, Ontario N9A 4H6

Phone: (800) 465-2001

In Mexico contact:

Av. Prolongacion Paseo de la Reforma, 1240

Sante Fe C.P. 05109

Mexico, D. F.

In Mexico City: 5081-4568

Outside Mexico City: 1-800-505-1300

Customer Assistance For The Hearing Or Speech Impaired (TDD/TTY)

To assist customers who have hearing difficulties, the manufacturer has installed special TDD (Telecommunication Devices for the Deaf) equipment at its Customer Center. Any hearing or speech impaired customer, who has access to a TDD or a conventional teletypewriter

(TTY) in the United States, can communicate with the manufacturer by dialing 1-800-380-CHRY.

Service Contract

You may have purchased a service contract for an vehicle to help protect you from the high cost of unexpected repairs after the manufacturer's New Vehicle Limited Warranty expires. The manufacturer stands behind only the manufacturer's Service Contracts. If you purchased a manufacturer's Service Contract, you will receive Plan Provisions and an Owner Identification Card in the mail within three weeks of the vehicle delivery date. If you have any questions about the service contract, call the manufacturer's Service Contract National Customer Hotline at 1-800-521-9922.

The manufacturer will not stand behind any service contract that is not the manufacturer's Service Contract. It is not responsible for any service contract other than the manufacturer's Service Contract. If you purchased a

service contract that is not a manufacturer's Service Contract, and you require service after the manufacturer's New Vehicle Limited Warranty expires, please refer to the contract documents, and contact the person listed in those documents.

We appreciate that you have made a major investment when you purchased the vehicle. An authorized dealer has also made a major investment in facilities, tools, and training to assure that you are absolutely delighted with the ownership experience. You'll be pleased with their sincere efforts to resolve any warranty issues or related concerns.

WARNING!

Engine exhaust, some of its constituents, and certain vehicle components contain, or emit, chemicals known to the State of California to cause cancer and birth defects or other reproductive harm. In addition, certain fluids contained in vehicles and certain products of component wear contain, or emit, chemicals known to the State of California to cause cancer and birth defects or other reproductive harm.

WARRANTY INFORMATION (U.S. Vehicles Only)

See the Warranty Information Booklet for the terms and provisions of Chrysler LLC warranties applicable to this vehicle.

MOPAR® PARTS

Mopar® fluids, lubricants, parts, and accessories are available from an authorized dealer. They will help keep the vehicle operating at its best.

REPORTING SAFETY DEFECTS

In The 50 United States And Washington, D.C.

If you believe that your vehicle has a defect that could cause a crash or cause injury or death, you should immediately inform the National Highway Traffic Safety Administration (NHTSA) in addition to notifying the manufacturer.

If NHTSA receives similar complaints, it may open an investigation, and if it finds that a safety defect exists in a group of vehicles, it may order a recall and remedy campaign. However, NHTSA cannot become involved in individual problems between you, your authorized dealer, and the manufacturer.

To contact NHTSA, you may either call the Auto Safety Hotline toll free at 1-888-327-4236 (TTY: 1-800-424-9153), or go to <http://www.safercar.gov>; or write to: Administrator, NHTSA, 400 Seventh Street, SW., Washington, D.C. 20590. You can also obtain other information about motor vehicle safety from <http://www.safercar.gov>.

In Canada

If you believe that your vehicle has a safety defect, you should contact the Customer Service Department immediately. Canadian customers who wish to report a safety defect to the Canadian government should write to: Transport Canada, Motor Vehicle Defect Investigations and Recalls, 2780 Sheffield Road, Ottawa, Ontario K1B 3V9.

PUBLICATION ORDER FORMS

To order the following manuals, you may use either the website or the phone numbers listed below. Visa, Mastercard, American Express, and Discover orders are accepted. If you prefer mailing your payment, please call for an order form.

NOTE: A street address is required when ordering manuals (no P.O. Boxes).

- *Service Manuals*

These comprehensive Service Manuals provide the information that students and professional technicians need in diagnosing/troubleshooting, problem solving, maintaining, servicing, and repairing Chrysler LLC vehicles. A complete working knowledge of the vehicle, system, and/or components is written in straightforward language with illustrations, diagrams, and charts.

- *Diagnostic Procedure Manuals*

Diagnostic Procedure Manuals are filled with diagrams, charts and detailed illustrations. These practical manuals make it easy for students and technicians to find and fix problems on computer-controlled vehicle systems and features. They show exactly how to find and correct problems the first time, using step-by-step troubleshooting and drivability procedures, proven diagnostic tests and a complete list of all tools and equipment.

- *Owner's Manuals*

These Owner's Manuals have been prepared with the assistance of service and engineering specialists to acquaint you with specific Chrysler LLC vehicles. Included are starting, operating, emergency and maintenance procedures as well as specifications, capabilities and safety tips.

Call toll free at:

- 1-800-890-4038 (U.S.)
- 1-800-387-1143 (Canada)

Or

Visit us on the Worldwide Web at:

- www.techauthority.com

**DEPARTMENT OF TRANSPORTATION UNIFORM
TIRE QUALITY GRADES**

The following tire grading categories were established by the National Highway Traffic Safety Administration. The specific grade rating assigned by the tire's manufacturer in each category is shown on the sidewall of the tires on your vehicle.

All passenger car tires must conform to Federal safety requirements in addition to these grades.

Treadwear

The Treadwear grade is a comparative rating, based on the wear rate of the tire when tested under controlled conditions on a specified government test course. For example, a tire graded 150 would wear one and one-half times as well on the government course as a tire graded 100. The relative performance of tires depends upon the actual conditions of their use, however, and may depart significantly from the norm due to variations in driving habits, service practices, and differences in road characteristics and climate.

Traction Grades

The Traction grades, from highest to lowest, are AA, A, B, and C. These grades represent the tire's ability to stop on wet pavement, as measured under controlled conditions on specified government test surfaces of asphalt and concrete. A tire marked C may have poor traction performance.

WARNING!

The traction grade assigned to this tire is based on straight-ahead braking traction tests, and does not include acceleration, cornering, hydroplaning, or peak traction characteristics.

Temperature Grades

The temperature grades are A (the highest), B, and C, representing the tire's resistance to the generation of heat and its ability to dissipate heat, when tested under controlled conditions on a specified indoor laboratory test wheel. Sustained high temperature can cause the material of the tire to degenerate and reduce tire life, and excessive temperature can lead to sudden tire failure. The grade C corresponds to a level of performance, which all passenger car tires must meet under the Federal Motor

Vehicle Safety Standard No. 109. Grades B and A represent higher levels of performance on the laboratory test wheel, than the minimum required by law.

WARNING!

The temperature grade for this tire is established for a tire that is properly inflated and not overloaded. Excessive speed, under-inflation, or excessive loading, either separately or in combination, can cause heat buildup and possible tire failure.

INDEX

- Adding Engine Coolant (Antifreeze) 458
Adding Fuel 382
Adding Washer Fluid 455
Additives, Fuel 380
Adjustable Pedals 177
Air Cleaner, Engine (Engine Air Cleaner Filter) . . . 445
Air Conditioner Maintenance 450
Air Conditioning 301
Air Conditioning Controls 301
Air Conditioning Filter 320,451
Air Conditioning, Operating Tips 319
Air Conditioning, Rear Zone 307,314
Air Conditioning Refrigerant 450
Air Conditioning System 301,309,450
Air Conditioning System, Zone Control 305
Air Pressure, Tires 358
Airbag 66,74
Airbag Deployment 75
Airbag Light 67,73,77,94,233
Airbag Maintenance 76
Airbag, Side 68,72,74
Airbag, Window (Side Curtain) 70,72,74
Alarm Light 233
Alarm (Security Alarm) 18
Alignment and Balance 366
Alterations/Modifications, Vehicle 7
Antenna, Satellite Radio 288
Antifreeze (Engine Coolant) 457,458,486
 Disposal 459
Anti-Lock Brake System (ABS) 338
Anti-Lock Warning Light 227,339
Anti-Theft System 18
Appearance Care 467
Ashtray 201
Assistance Towing 117
Audio Systems (Radio) 280,283
Auto Down Power Windows 39
Auto Up Power Windows 40,194

Automatic Dimming Mirror	100	Ball Joints	453
Automatic Door Locks	34,35	Battery	448
Automatic Headlights	163	Gas Caution	449
Automatic Temperature Control (ATC)	309	Jump Starting	425
Automatic Transaxle	328	Keyless Transmitter Replacement (RKE)	26
Adding Fluid	465	Saving Feature (Protection)	166
Fluid Level Check	465	Bearings	467
Interlock System	329	Belts, Drive	445
Reset Mode	334	Body Mechanism Lubrication	454
Selection Of Lubricant	465,488	B-Pillar Location	353
Shifting	330	Brake Assist System	341
Special Additives	467	Brake Control System, Electronic	340
Automatic Transmission	464,467	Brake Fluid	488
Adding Fluid	466,467	Brake, Parking	335
Fluid and Filter Changes	467	Brake System	337,462
Fluid Change	467	Anti-Lock (ABS)	338
Fluid Level Check	466	Fluid Check	463
Fluid Type	465,488	Hoses	462
		Warning Light	228

- Brakes 337,462
Brake/Transmission Interlock 328
Break-In Recommendations, New Vehicle 93
Bulb Replacement 482
Bulbs, Light 481
- Calibration, Compass 240,246
Capacities, Fluid 486
Caps, Filler
 Fuel 382
 Oil (Engine) 434,443
 Radiator (Coolant Pressure) 458
Car Washes 468
Carbon Monoxide Warning 381
Cargo Compartment
 Luggage Carrier 215
Cargo (Vehicle Loading) 214
Catalytic Converter 446
Caution, Exhaust Gas 51,95,381
- CD (Compact Disc) Player 280,283
CD (Compact Disc) Player Maintenance 300
Cellular Phone 104,283,284,299
Center High Mounted Stop Light 485
Chains, Tire 367
Changing A Flat Tire 412
Chart, Tire Sizing 350
Check Engine Light
(Malfunction Indicator Light) 232,438
Child Restraint 81,83
Child Restraint Tether Anchors 86
Child Safety Locks 46
Child Seat 88
Clean Air Gasoline 378
Cleaning
 Wheels 470
Climate Control 301
Clock 254,269,281,285
Coat Hook 214

Coin Holder	201	Coolant Capacity	486
Cold Weather Operation	325	Coolant Level	456,459
Compact Disc (CD) Maintenance	300	Disposal of Used Coolant	459
Compact Spare Tire	361	Drain, Flush, and Refill	457
Compass	238,240,246	Inspection	459
Compass Calibration	240,246	Points to Remember	460
Compass Variance	240,247	Pressure Cap	458
Computer, Trip/Travel	244	Radiator Cap	458
Connector		Selection of Coolant (Antifreeze)	457,486,487
UCI	292	Cruise Control (Speed Control)	179
Universal Consumer Interface (UCI)	292	Cup Holder	200,473
Console	201	Customer Assistance	499
Console, Floor	201		
Console, Overhead	182	Data Recorder, Event	78
Console, Removable	207,211	Daytime Running Lights	163
Contract, Service	501	Dealer Service	440
Coolant Pressure Cap (Radiator Cap)	458	Defroster, Rear Window	320
Cooling System	456	Defroster, Windshield	94,303,313
Adding Coolant (Antifreeze)	458	Diagnostic System, Onboard	437

- Digital Video Disc (DVD) Player 280,283
- Dimmer Control 162
- Dimmer Switch, Headlight 170
- Dipsticks
- Automatic Transaxle 465
 - Automatic Transmission 466
 - Oil (Engine) 441
- Disabled Vehicle Towing 428
- Disposal
- Antifreeze (Engine Coolant) 459
 - Engine Oil 444
- Domelight 161
- Door Locks 31
- Door Locks, Automatic 34
- Door Opener, Garage 185
- Drive Belts 445
- Drive Shaft Universal Joints 454
- Driving
- On Slippery Surfaces 345
 - Through Flowing, Rising, or Shallow Standing Water 346
- DVD Player (Video Entertainment System) 297
- E-85 Fuel 384
- Electric Remote Mirrors 102,103
- Electrical Power Outlets 195
- Electronic Brake Control System 340
- Brake Assist System 341
 - Electronic Stability Program 342
- Electronic Range Select (ERS) 333
- Electronic Speed Control (Cruise Control) 179
- Electronic Stability Program (ESP) 342
- Electronic Vehicle Information Center (EVIC) 241
- Emergency, In Case of
- Hazard Warning Flasher 410
 - Jacking 412,415
 - Jump Starting 425
 - Overheating 410

- Emission Control System Maintenance 438,490
- Engine 93,434,435,436
 - Air Cleaner 445
 - Block Heater 327
 - Break-In Recommendations 93
 - Checking Oil Level 441
 - Compartment 435,436
 - Coolant (Antifreeze) 487
 - Cooling 456
 - Exhaust Gas Caution 51,381
 - Flooded, Starting 326
 - Fuel Requirements 377,486
 - Oil 441,486,487
 - Oil Change Interval 442
 - Oil Disposal 444
 - Oil Filler Cap 434,443
 - Oil Filter Disposal 444
 - Oil Selection 442,486
 - Oil Synthetic 444
 - Operation 93
 - Overheating 410
 - Starting 324
 - Temperature Gauge 226
- Enhanced Accident Response Feature 74
- Event Data Recorder 78
- Exhaust Gas Caution 51,95,381,448
- Exhaust System 447
- Extender, Seat Belt 66
- Exterior Folding Mirrors 102
- Fabric Care 470,471
- Filler Location Fuel 226
- Filters
 - Air Cleaner 445
 - Air Conditioning 320,451
 - Engine Oil 444,487
 - Engine Oil Disposal 444

- Flashers
 - Hazard Warning 410
 - Turn Signal 227,483,484
- Flash-To-Pass 170
- Flat Tire Stowage 422
- Flexible Fuel Vehicles
 - Cruising Range 387
 - Engine Oil 387
 - Fuel Requirements 384,386
 - Maintenance 388
 - Replacement Parts 387
 - Starting 387
- Flooded Engine Starting 326
- Floor Console 201
- Fluid Capacities 486
- Fluid Leaks 94
- Fluid Level Checks
 - Automatic Transaxle 465
 - Automatic Transmission 466
 - Brake 463
 - Power Steering 452
- Fluids 487
- Fluids, Lubricants and Genuine Parts 487
- Fog Light Service 483
- Fog Lights 165,233,483
- Fold in Floor (Stow 'n Go) Seating 138
- Freeing A Stuck Vehicle 427
- Fuel 377
 - Adding 382
 - Additives 380
 - Clean Air 378
 - Filler Cap (Gas Cap) 226,382
 - Filler Door (Gas Cap) 226
 - Gasoline 377
 - Gauge 226
 - Hoses 461
 - Light 234
 - Octane Rating 487

- Requirements 377,486
- System Hoses 461
- Tank Capacity 486
- Fuel, Flexible *See Flexible Fuel Vehicles*
- Fuel System Caution 380
- Fueling 382
- Fuses 474

- Garage Door Opener (HomeLink®) 185
- Gas Cap (Fuel Filler Cap) 382,384
- Gasoline, Clean Air 378
- Gasoline (Fuel) 377
- Gasoline, Reformulated 379
- Gauges
 - Coolant Temperature 226
 - Fuel 226
 - Speedometer 227
 - Tachometer 229
- Gearshift 330

- General Information 18,27,131,377
- Glass Cleaning 472
- Grocery Bag Retainer 155
- Gross Axle Weight Rating 389,394
- Gross Vehicle Weight Rating 389,393

- Hands-Free Phone (UConnect™) 104,283,284
- Hard Drive (HDD) 280,283
- Hazard
 - Driving Through Flowing, Rising, or Shallow Standing Water 346
- Hazard Warning Flasher 410
- Head Restraints 134
- Headlights 163
 - Bulb Replacement 482
 - Cleaning 472
 - High Beam/Low Beam Select Switch 170
 - Lights On Reminder 165
 - On With Wipers 164

Passing	170	Infant Restraint	81,83
Replacing	482	Information Center, Vehicle	241
Time Delay	164	Inside Rearview Mirror	100
Heated Seats	135	Instrument Cluster	224,225,226
Heater	301	Instrument Panel and Controls	223
Heater, Engine Block	327	Instrument Panel Cover	470
High Beam/Low Beam Select (Dimmer) Switch . .	170	Instrument Panel Lens Cleaning	472
Hitches		Integrated Power Module (Fuses)	474
Trailer Towing	397	Interior Appearance Care	470
HomeLink® (Garage Door Opener) Transmitter . .	185	Interior Lights	160,162
Hood Release	158	Intermittent Wipers (Delay Wipers)	169
Hook, Coat	214	Introduction	4
Hoses	461		
Ignition	14	Jack Location	413
Key	12,14	Jack Operation	412
Ignition Key Removal	14	Jump Starting	425
Illuminated Entry	20		
Immobilizer (Sentry Key)	15	Key, Programming	17
		Key, Replacement	16

Key, Sentry (Immobilizer)	15	Battery Saver	166
Key-In Reminder	15	Brake Assist Warning	343
Keyless Entry System	21	Brake Warning	228
Keys	12	Bulb Replacement	481,482
Knee Bolster	67	Center Mounted Stop	485
		Daytime Running	163
Lap/Shoulder Belts	57	Dimmer Switch, Headlight	162,170
LATCH (Lower Anchors and Tether for Children)	86	Engine Temperature Warning	232
Latches		Fog	165,233,483
Hood	158	Hazard Warning Flasher	410
Lead Free Gasoline	377	Headlight Switch	163
Life of Tires	364	Headlights	482
Liftgate	48	Headlights On Reminder	165
Lights	94,160	Headlights On With Wipers	164
Airbag	67,73,77,94,233	High Beam	170
Alarm	233	High Beam Indicator	227
Anti-Lock	227,339	High Beam/Low Beam Select	170
Automatic Headlights	163	Illuminated Entry	20
Back-Up	484	Interior	160,162

License	485	Load Leveling System	218
Lights On Reminder	165	Loading Vehicle	214,388,391
Low Fuel	234	Capacities	391
Malfunction Indicator (Check Engine)	232	Tires	353
Oil Pressure	233	Locks	
Park	162,483	Door	31
Passing	170	Lower Anchors and Tether for CHildren (LATCH)	86
Reading	183	Lubrication, Body	454
Rear Servicing	484	Luggage Rack (Roof Rack)	215
Rear Tail	484	Lumbar Support	137
Seat Belt Reminder	233	Maintenance Free Battery	448
Security Alarm (Theft Alarm)	233	Maintenance Procedures	441
Service	481,482	Maintenance Schedule	490
Service Engine Soon (Malfunction Indicator)	232	Maintenance, Sunroof	195
Side Marker	484	Malfunction Indicator Light (Check Engine)	232,438
Theft Alarm (Security Alarm)	233	Manual, Service	504
Turn Signal	166,483,484	Map/Reading Lights	183
Voltage	234	Memory Feature (Memory Seat)	155
Warning (Instrument Cluster Description)	226		

- Memory Seat 104,155
- Mini-Trip Computer 238,244
- Mirrors 100
 - Automatic Dimming 100
 - Electric Remote 102,103
 - Exterior Folding 102
 - Memory 155
 - Outside 102
 - Rearview 100
 - Vanity 101
- Modifications/Alterations, Vehicle 7
- Monitor, Tire Pressure System 369
- Mopar Parts 440,503
- MP3 Player 280,283
- Multi-Function Control Lever 166

- Navigation Radio 283
- Navigation System 283
- New Vehicle Break-In Period 93

- Occupant Restraints 55,72,75
- Occupant Restraints (Sedan) 68,70,72,74
- Odometer 229
- Oil Change Indicator 230,237,243
- Oil Change Indicator, Reset 230,237,243
- Oil, Engine 441,487
 - Capacity 486
 - Change Interval 442
 - Checking 441
 - Disposal 444
 - Filter 444,487
 - Filter Disposal 444
 - Identification Logo 443
 - Materials Added to 444
 - Recommendation 442,486
 - Synthetic 444
 - Viscosity 443,486
- Onboard Diagnostic System 437,438
- Opener, Garage Door (HomeLink®) 185

Outside Rearview Mirrors	100,102	Port	
Overdrive	332	Universal Serial Bus (USB)	280,283
Overhead Console	182	USB	280,283
Overhead Travel Information Center	182	Power	
Overheating, Engine	226,410	Brakes	337
Owner's Manual (Operator Manual)	504	Distribution Center (Fuses)	474
		Door Locks	32
Panic Alarm	24	Lift Gate	49
Park Sense System, Rear	171	Mirrors	102,103
Parking Brake	335	Outlet (Auxiliary Electrical Outlet)	195
Parking On Hill	335	Seats	133
Passing Light	170	Sliding Door	42
Pedals, Adjustable	177	Steering	344
Personal Settings	248	Steering, Checking	452
Pets, Transporting	89	Sunroof	192
Phone, Cellular	104,283,284	Windows	37
Phone, Hands-Free (UConnect™)	104,283,284	Power Steering Fluid	488
Placard, Tire and Loading Information	353	Pregnant Women and Seat Belts	65
		Preparation for Jacking	415

Pretensioners		Recreational Towing	407,429
Seat Belts	64	Reminder, Seat Belt	64
Programmable Electronic Features	248	Remote Keyless Entry (RKE)	21
Radial Ply Tires	361	Remote Sound System (Radio) Controls	299
Radiator Cap (Coolant Pressure Cap)	457,458	Remote Starting System	28
Radio Broadcast Signals	251	Removable Floor Console	207,211
Radio, Navigation	283	Replacement Keys	16
Radio Operation	281,284,299	Replacement Parts	440
Radio Remote Controls	299	Replacement Tires	365
Radio, Satellite	280,281,283,284,287,297	Reporting Safety Defects	503
Radio (Sound Systems)	280,283	Resetting Oil Change Indicator	230,237,243
Rear Air Conditioning	307,314	Restraint, Head	134
Rear Heater	307	Restraints, Child	81,88
Rear Park Sense System	171	Restraints, Infant	81
Rear Window Defroster	320	Rocking Vehicle When Stuck	427
Rearview Mirrors	100	Roof Rack (Luggage Rack)	215
Reclining Front Seats	136	Rotation, Tires	368
Recorder, Event Data	78	Safety Checks Inside Vehicle	93

Safety Checks Outside Vehicle	94	Seats	131
Safety Defects, Reporting	503	Adjustment	132
Safety, Exhaust Gas	51	Cleaning	471
Safety Information, Tire	348	Easy Entry	147
Safety Tips	93	Fold in Floor (Stow 'n Go)	138
Satellite Radio 280,281,283,284,287,297		Heated	135
Satellite Radio Antenna	288	Lumbar Support	137
Schedule, Maintenance	490	Memory	155
Seat Belt Maintenance	473	Power	133
Seat Belt Reminder	64	Reclining	136
Seat Belts	55	Stow 'n Go (Fold in Floor)	138
Adjustable Shoulder Belt	62	Tilting	147
Adjustable Upper Shoulder Anchorage	62	Security Alarm (Theft Alarm)	18
And Pregnant Women	65	Selection of Coolant (Antifreeze)	457,487
Child Restraint	81,83	Sentry Key (Immobilizer)	15
Extender	66	Sentry Key Programming	17
Front Seat	57	Sentry Key Replacement	16
Pretensioners	64	Service Assistance	499
Rear Seat	57	Service Contract	501

Service Engine Soon Light (Malfunction Indicator) . . .	232	Remote	28
Service Manuals	504	Starting and Operating	324
Setting the Clock	254,269,281,285	Starting Procedures	324
Settings, Personal	248	Steering	
Shoulder Belts	57	Column Controls	166
Signals, Turn	166,227,483,484	Linkage	453
Sliding Door	41	Power	344,452
Slippery Surfaces, Driving On	345	Shaft Seal	453
Snow Chains (Tire Chains)	367	Tilt Column	171
Snow Tires	368	Steering Wheel Mounted Sound System Controls . . .	299
Sound Systems (Radio)	280,283	Storage	208,481
Spare Tire	361,362,414	Storage Bin	208
Spark Plugs	445	Storage, Vehicle	318,481
Speed Control (Cruise Control)	179	Storing Your Vehicle	481
Speedometer	227	Stow 'n Go (Fold in Floor) Seats	138
Starting	324	Sun Roof	192
Automatic Transmission	325	Sunglasses Storage	183
Cold Weather	325	Sunroof Maintenance	195
Engine Fails to Start	326	Supplemental Restraint System - Airbag	66

Synthetic Engine Oil	444	Changing	412
System, Navigation	283	Compact Spare	361
System, Remote Starting	28	Flat Changing	422
Tachometer	229	General Information	357
Temperature Control, Automatic (ATC)	309	High Speed	360
Temperature Gauge, Engine Coolant	226,411	Inflation Pressures	358
Tether Anchor, Child Restraint	86	Jacking	412,415
Tilt Steering Column	171	Life of Tires	364
Tip Start	13	Load Capacity	353,354
Tire and Loading Information Placard	353	Pressure Monitor System (TPMS)	369
Tire Identification Number (TIN)	352	Quality Grading	505
Tire Markings	348	Radial	361
Tire Safety Information	348	Replacement	365
Tires	94,357,505	Rotation	368
Aging (Life of Tires)	364	Safety	348,357
Air Pressure	357	Sizes	350
Alignment	366	Snow Tires	368
Chains	367	Spare Tire	414
		Spinning	363

Tread Wear Indicators	364	Trailer Weight	398
Wheel Nut Torque	422	Transaxle	328
Tongue Weight/Trailer Weight	399	Automatic	328
Towing	393	Operation	328
24-Hour Towing Assistance	117	Overdrive	332
Disabled Vehicle	428	Selection of Lubricant	465,488
Guide	398	Transmission	464
Recreational	407,429	Automatic	464
Weight	398	Fluid	465,488
Towing Assistance	117	Transmitter Battery Service (Remote Keyless Entry)	26
Traction Control	340	Transmitter, Garage Door Opener (HomeLink®)	185
Traction Control Switch	340	Transmitter, Remote Keyless Entry (RKE)	21
Trailer Towing	393	Transporting Pets	89
Cooling System Tips	406	Tread Wear Indicators	364
Hitches	397	Trip Computer	238
Minimum Requirements	400	Trip Odometer	229
Trailer and Tongue Weight	399	Turn Signals	166,227,483,484
Wiring	404	UCI Connector	292
Trailer Towing Guide	398		

- UConnect™ (Hands-Free Phone) 104,283
- Uniform Tire Quality Grades 505
- Universal Consumer Interface (UCI) Connector . . . 292
- Universal Joints 454
- Universal Serial Bus (USB) Port 280,283
- Universal Transmitter 185
- Unleaded Gasoline 377
- Upholstery Care 470
- USB Port 280,283
- Vanity Mirrors 101
- Variance, Compass 240,247
- Vehicle Certification Label 389
- Vehicle Identification Number (VIN) 6
- Vehicle Loading 354,388,391
- Vehicle Modifications/Alterations 7
- Vehicle Storage 318,481
- Video Entertainment System
(Rear Seat Video System) 297
- Warning Flasher, Hazard 410
- Warning Lights (Instrument Cluster Description) . . . 226
- Warnings and Cautions 6
- Warranty Information 502
- Washer, Adding Fluid 455
- Washing Vehicle 468
- Water
- Driving Through 346
- Wheel Alignment and Balance 366
- Wheel and Wheel Trim 470
- Wheel and Wheel Trim Care 470
- Wheel Bearings 467
- Wheel Nut Torque 422
- Wind Buffeting 41,194
- Window Fogging 318
- Windows 36
- Power 37
- Rear Vent 36
- Windshield Washers 168,455

Windshield Wiper Blades	454	YES Essentials® Fabric Cleaning Procedure	471
Windshield Wipers	168		
Wiper Blade Replacement	454	Zone Control (Temperature Control)	305
Wipers, Intermittent	169		

INSTALLATION OF RADIO TRANSMITTING EQUIPMENT

Special design considerations are incorporated into this vehicle's electronic system to provide immunity to radio frequency signals. Mobile two-way radios and telephone equipment must be installed properly by trained personnel. The following must be observed during installation.

The positive power connection should be made directly to the battery and fused as close to the battery as possible. The negative power connection should be made to body sheet metal adjacent to the negative battery connection. This connection should not be fused.

Antennas for two-way radios should be mounted on the roof or the rear area of the vehicle. Care should be used in mounting antennas with magnet bases. Magnets may affect the accuracy or operation of the compass on vehicles so equipped.

The antenna cable should be as short as practical and routed away from the vehicle wiring when possible. Use only fully shielded coaxial cable.

Carefully match the antenna and cable to the radio to ensure a low Standing Wave Ratio (SWR).

Mobile radio equipment with output power greater than normal may require special precautions.

All installations should be checked for possible interference between the communications equipment and the vehicle's electronic systems.



Stick with the Specialists™

DaimlerChrysler Corporation

81-226-0819



Fourth Edition

Printed in U.S.A.